

# HOMECREST®

C A B I N E T R Y



**SPECIFICATIONS GUIDE**



Dear Homecrest® Partner:

Our January 2019 Product Launch will deliver continuous improvement changes that affect touch points throughout Homecrest's already great offering, starting with our cabinet box construction.

- **1/2" sides for standard construction, delivering consistency across all platforms from standard to plywood ends to all plywood construction**
- **3/8" flush back panel, glued and pinned to deep rabbets in the side panels for added box strength**
- **5" high frame opening for base top drawers, providing extra clearance**
- **15" deep adjustable shelves for base cabinets, adding 50% more support for cabinet contents**

Homecrest's modified full overlay styles are getting a facelift. Base cabinets will have a true full overlay design with 1/4" frame reveal at the sides, bottom, and top, while wall and tall cabinets maintain the 1" top frame reveal for easy application of decorative moulding treatments. A no charge "FULL" modification is available for wall and tall cabinets to create a true full overlay design, and the MI modification has been expanded to base and tall cabinets. Shaker profiles for Arbor, Bayport, Dover, and Sedona have been updated to a more squared frame edge, and Dover and Sedona 5-piece drawer fronts are enhanced with a wider rail.

**We're delivering two on-trend finishes in 2019:**

- Galaxy - dark gray opaque
- Fallow - light stain available on all wood species (coming Q2)

Your 2019 Launch Brochure is included as part of your Homecrest Specifications and Pricing Guide, and you'll find many "NEW" icons on products throughout the pages of the book.

**MBC11Touch is your central location to find:**

- Launch materials and selection center order forms
- 20-20 and ProKitchen catalogs
- PDF versions of literature

Join our celebration of a revitalized Homecrest. Update your merchandising, familiarize yourself with our new product specifications, download your design software, and begin your 2019 business year with confidence in Homecrest.

If you have questions, please contact your Sales or Customer Service Representative. Thank you for your continued support of Homecrest Cabinetry!

Sincerely,

A handwritten signature in black ink that reads "Jace Morrison". The signature is written in a cursive, flowing style.

Jace Morrison  
Sr. Product Manager



**DISCOVER HOMECREST**

RIGHT-SIZED.  
ORGANIZED.  
PERSONALIZED.  
THE GOOD LIFE, REALIZED.

**2019 PRODUCT INTRODUCTIONS**



# Galaxy Opaque\*

SEE SPEC BOOK PAGE 21

As consumer preferences continue to shift in favor of grays, we respond with a beautiful solution on the darker end of the spectrum. Galaxy is a show-stopper as a standalone color yet also complements both stains and lighter opaques as well. If designer demand is any indication, we can safely say that gray is here to stay!

\*Opaque center panels may be constructed of Medium Density Fiberboard (MDF). Facings consist of hardwood components.

### OPAQUE GLAZES



Brownstone



Cocoa



Ebony



Husk



Rye



Smoke



# Fallow Stain

(Coming Q2)

SEE SPEC BOOK PAGES 21-23

Fallow, a current and versatile light toned finish, will be added to the Homecrest lineup in Q2. Inspired by subtle, earthy tones, Fallow mixes mellow golds and modern grays to create a look that feels truly grounded.

Fallow can receive Brownstone, Cocoa, Ebony, Husk, Rye and Smoke glazes on all wood types, with the exception of Oak.

### SPECIES



Maple



Cherry



Hickory



Rustic Hickory

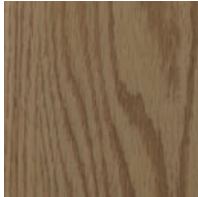

Oak





# Construction Changes

A refreshed construction platform and several impactful construction changes illustrate that Homecrest is focused on continuous improvement. Take a closer look at these enhancements and embrace the design possibilities they present.

## A. Modified Full Overlay

SEE SPEC BOOK PAGE 4

Base cabinets are moving from a modified full overlay to a true full overlay. This creates a 1/4" face frame reveal, changing the base cabinet to true full overlay on the left, right, top and bottom.

## B. Cabinet Box Improvements

SEE SPEC BOOK PAGE 24

Cabinet boxes now have 1/2" sides across all platforms with a rabbet joint to accept a 3/8" flush back that is glued and pinned to provide extra storage depth and installation points throughout the height of the cabinet.

## C. Drawer Opening Change

SEE SPEC BOOK PAGES 49-53

The new 5" high top drawer frame opening perfectly accommodates deep boxes of sandwich bags as well as larger utensils such as ladles and spatulas with an increased clearance of 1/2".

## D. Shelf Size Change

SEE SPEC BOOK

Every inch matters when it comes to storage. Base shelves have increased from 10" to 15" deep to maximize valuable cabinet storage space.

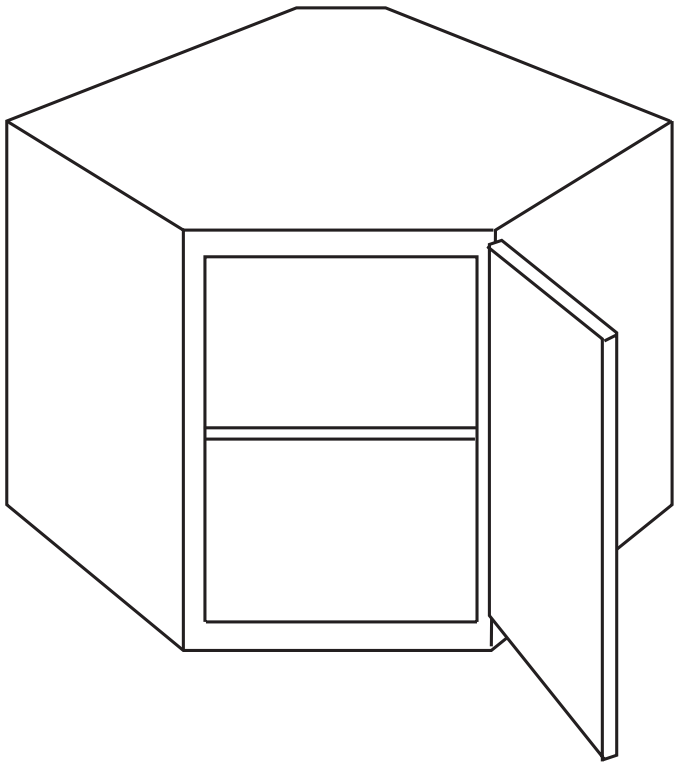

**A.**

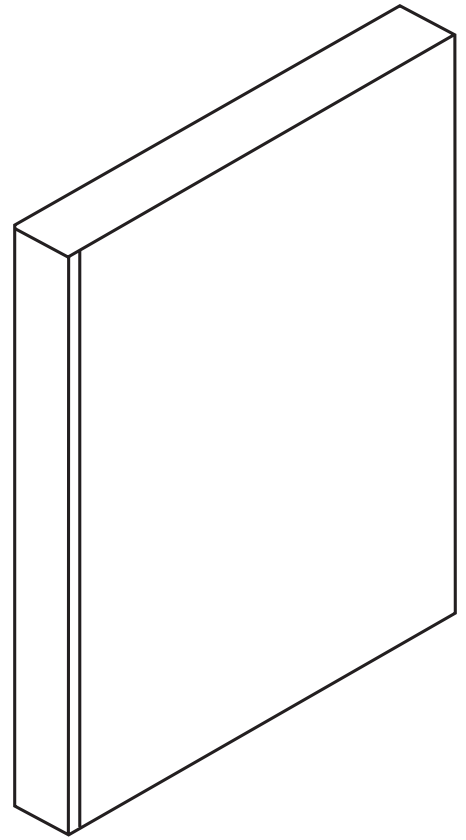

**B.**

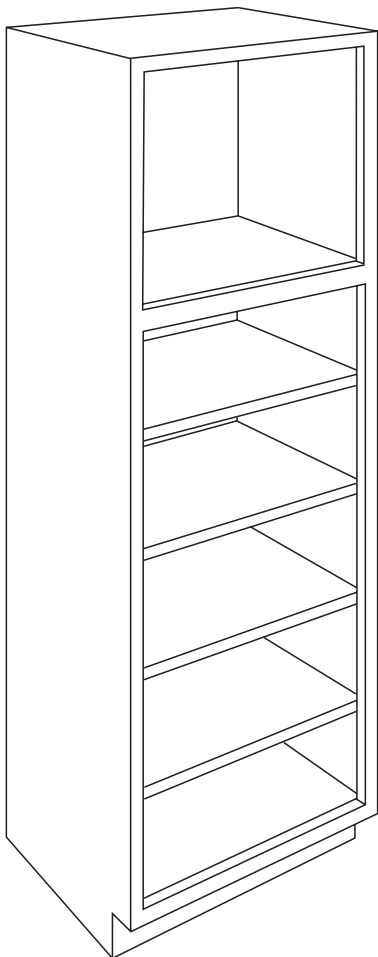

**C.**

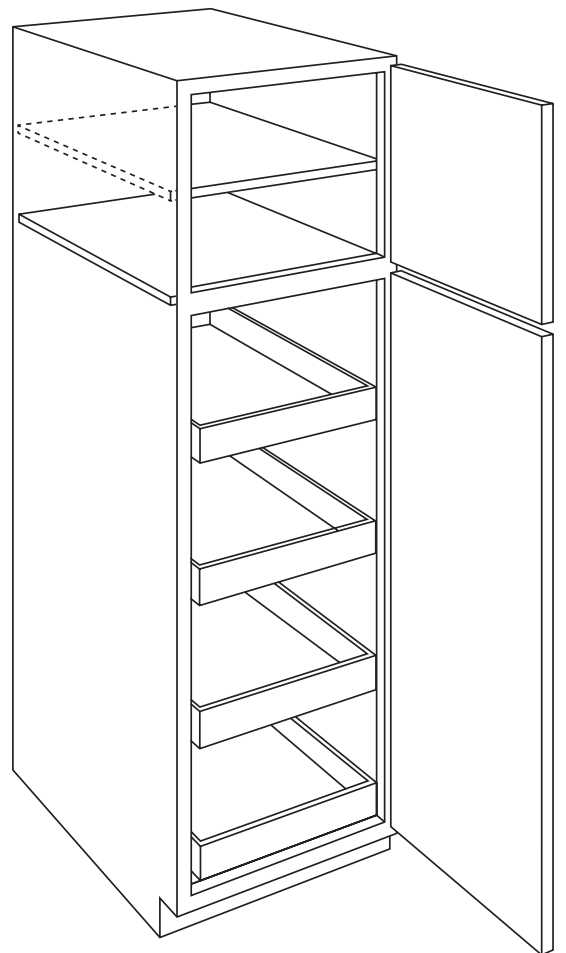

**D.**

## **A. Corner Cabinets**

BLS36L, BLS36R, and BC36SPN, SEE SPEC BOOK PAGES 110 & 158

Corner cabinets will now feature a clipped back corner. Although invisible from the exterior once installed, this change makes for an easier installation.

## **B. Column Box Fillers**

Includes all Column Box Fillers, SEE SPEC BOOK PAGES 284 - 285

Achieve personalization through design flexibility! Column Box Fillers are increasing by 3" depths with reduced depth modifications.

## **C. Utility Shelves Included**

Includes all standard Utility SKUs, SEE SPEC BOOK PAGE 198

Improving the ease of ordering, shelves are now included with Utility cabinets. The full capacity of the SKU will now be delivered to the customer in one easy step.

## **D. Installed Roll Tray SKUs**

SEE SPEC BOOK PAGES 142 & 210

For ease of ordering, Base and Utility cabinets are now offered with roll trays as a standard SKU, making it one simple step.

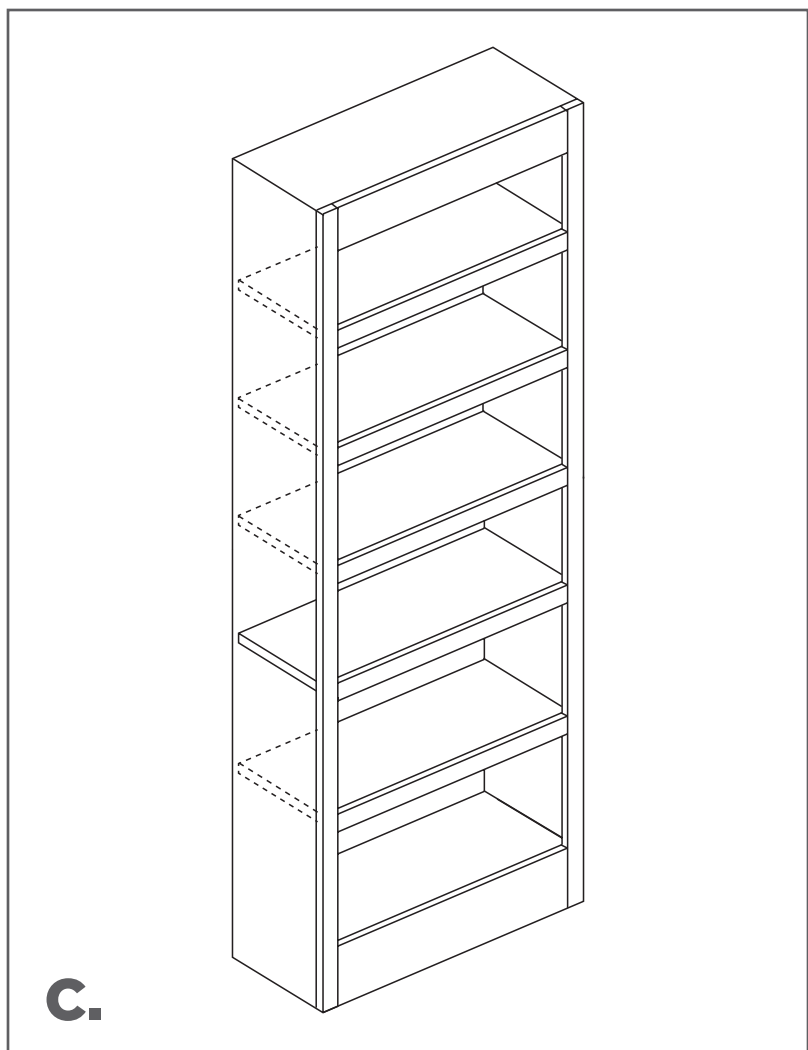

## **A. CabMat™ SKUs**

Includes: CNTYS30BCM, CNTYS33BCM, CNTYS36BCM, SB36STSCM, SB30BCM, SB33BCM & SB36BCM, SEE SPEC BOOK PAGE 148

One of our most popular accessories, the CabMat can now be ordered pre-installed in select base cabinets.

## **B. Tray Divider SKUs**

SEE SPEC BOOK PAGE 144

No kitchen is complete without a Tray Divider. Now, we have even more Tray Divider SKUs for the flexibility to select the option that works best for your design.

## **C. Tall Bookcase SKUs**

SEE SPEC BOOK PAGE 246

Open shelving offers consumers a great way to personalize space. Our new Tall Bookcase SKUs open up new design options that offer both fashion and function.

# Mouldings & Embellishments

SEE SPEC BOOK PAGE 291

Offering several fresh new designs, our selection of Mouldings & Embellishments allows you to add the perfect finishing touches to your project. Support your design aspirations and provide the ultimate in personalization for your customer.

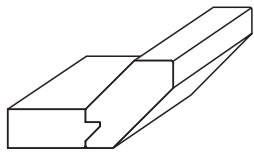

Straight  
Angle Crown  
**SACROWN8**

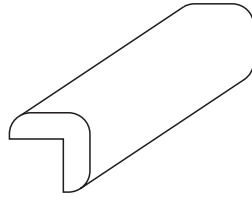

Outside Corner  
Small  
**SOCM8**

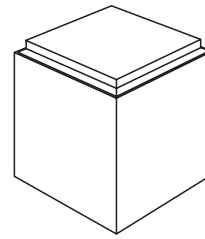

Large Square  
Foot  
**LGSQFOOT**

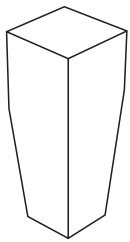

Tapered  
Leg  
**TAPLG**

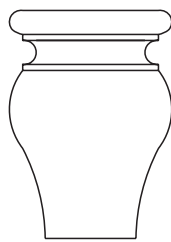

Tulip Foot  
**TLFOOT**

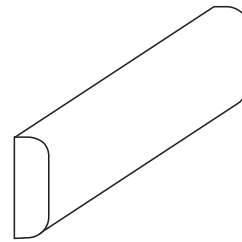

Batten Small  
**SM8**

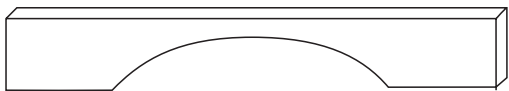

Arched Valance  
**AV36, AV48, AV60, AV72**

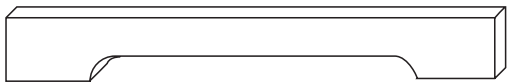

Furniture Valance  
**FV36, FV48, FV60, FV72**

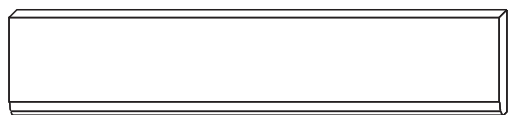

Straight Valance  
**SV48, SV96**



Estate Leg  
**JESTATELEGS**



Decorative Split Turnings  
**SPRINGEND (Sold in Pairs)**

# Not Shown

## Height Changes

- Desk Cabinets from 28½" to 29"
- Vanity Cabinets from 31½" to 32"
- Tall Fillers move to Frame Height

SEE SPEC BOOK PAGE 242  
SEE SPEC BOOK PAGE 248  
SEE SPEC BOOK PAGE 282

## Bookcase: Now with one fixed shelf

SEE SPEC BOOK PAGE 246

## Stacked Wall Configuration Change

SEE SPEC BOOK PAGE 94

## Wall Three Drawer Configuration Change

SEE SPEC BOOK PAGE 90

## Four Drawer Base Configuration Change

SEE SPEC BOOK PAGE 176

## Modification Expansion and Additions

SEE SPEC BOOK PAGES 30 - 33



**HOMECREST**<sup>®</sup>  
C A B I N E T R Y 

homecrestcabinetry.com  
#homecrestcabinetry

LIMITED  
LIFETIME  
WARRANTY



HOME CREST CABINETRY IS AN EQUAL OPPORTUNITY AFFIRMATIVE ACTION EMPLOYER. WE ARE AN EQUAL OPPORTUNITY EMPLOYER. ALL RIGHTS RESERVED. © 2019 HOME CREST CABINETRY. PHOTO: JEFFREY M. HARRIS



## TABLE OF CONTENTS

Index	A-E
Nomenclature Chart	F-G
Characteristics	1
Humidification	2
Door Styles	3-19
Finish Process and Characteristics	20
Finish Availability	21-23
Construction Specifications	24
Compatible Modifications	25
Construction Options	26
Drawer, Roll Tray, and Hinge Options	27
Drawer Front Options	28
Modifications	29-35
Specialty Doors	36-37
Glass Inserts	38
Custom Choice™ Cabinetry	39-44
Textured Laminates	45-46
Cabinet Dimensions	47-52
Installer Notes and Designer Tips	53
Design Checklist	54
NKBA Guidelines	55-56
Wall Cabinets	57-97
Base Cabinets	98-124
Universal Access Cabinets	125-128
Tall Cabinets	129-145
Other Rooms Cabinets	146-154
Vanity Cabinets	155-171
Fillers	172-175
Appliance Panels	175
Panels & Skins	176-180
Moulding	181-185
Valances	185-186
Embellishments	186-190
Decorative Corbels & Shelf Supports	190-191
Hardware	192
Accessories & Parts	193-198
Sales Support Tools	198
Miscellaneous Parts	199-200
Opaque Finish Awareness Agreement	201
Rustic Hickory Description Agreement	202

Description	Code	Page Number
11 1/2" Arts & Crafts Bracket	JBRACKETART	190
13" Large Scroll Corbel	LGCORBEL	191
14" Arts & Crafts Corbel	CORBELART	190
14" Arts & Crafts Open Corbel	JCORBELARTO	190
3" Filler w/2 1/2" Overlay	UF.OVLY	172
3" Wide Corner Filler	CWF	172
3" Wide Fillers	F, F.FH, UF	172
5" Old World Corbel	CORBELOWD	191
6" Filler w/5 1/2" Overlay	UF.OVLY	172
6" Mission Corbel	CORBELMIS	191
6" Wide Fillers	F, F.FH, UF	172
9" Art Corbel	CORBELART	190
9" Classic Revival Corbel	CORBELCR	191
9" Mission Corbel	CORBELMIS	191
Angle Base	AB	116
Angle Base Cabinet	AB..B	116
Angle End Base	AEB	116
Angled Corner Sink Front Bottom	ACSF	110
Angled Fluted/Plain 3" Wide Reversible Fillers	BLVDFF	174
Arched Valance	AV	185
Asymmetrical Base Easy Reach	BER	114
Asymmetrical Super Susan	BC..SS	115
Asymmetrical Wall Corner Easy Reach Cabinet	WCER	87
Bar Leg, 2-Sided or 4-Sided, 42 1/4" High	2SBARLEG, 4SBARLEG	187
Base Cabinet w/Mixer Lift	B..BFHMIX, B..FHMIX	123
Base Corner	BC	111
Base Corner Peninsula	BCP..B	122
Base Corner Peninsula w/Full Height Door	BCP..BFH	122
Base Corner Super Susan w/Wood Shelves	BC..SS	115
Base Double Door	B, B..B	99
Base Double Door w/Roll Trays	B..BRT	101
Base Easy Reach	BER	114
Base Lazy Susan Corner w/Full Height Door & Lazy Susan (w/Center Hinge Door)	BLS	112
Base Lazy Susan Corner (w/Revolving Door)	BC..SPN	112
Base Microwave Cabinet w/Drawer	BMWD	107
Base Microwave Cabinet w/Standard Drawer	BMWSD	108
Base Mixer Kit	MIXKIT..FH	193
Base Outside Cabinet	BOC	124
Base Oven Cabinet	BO	108
Base Pantry Pull-out	B..PO	120
Base Pull-out Filler	BPOF.OV, BPOF.PL	124
Base Single Door	B	98
Base Single Door w/Roll Trays	B..RT, B..RTL	101
Base Utensil Pantry Pull-out	BUPP	120
Base Utensil Pantry Pull-out w/Knife Block	BUPPKB	121
Base Wastebasket	BWB	119
Base Wastebasket, Full Height	BWB..FH	119
Base w/Roll-out Tray Divider	B..TDRO	102
Base w/Tray Divider	TD	102
Baseboard Shaker	BBMSH	182
Batten	BATTEN	182
Batten Small	SM	182
Batten Small, Premium	SM..P	182
Blowers	BLOWER	97
Bookcase Unit w/Straight Valance	BU..SV	153
30" SuperCabinet™	BSC..RTR	123
36" SuperCabinet™	BSC..PRP	123
CabMat™	CABMAT	193

Description	Code	Page Number
Cap Moulding	SOFFITA, SOFFITB, SOFFITE	184
Chair Rail	CHAIR	183
Column Box Fillers	CB..FL, CB..PL	174, 175
Cooking Utensil Divider	CUDD	193
Cookware Organizer	CO	193
Corner Diagonal Base	CDB	113
Corner Diagonal Base w/Full Height Door & Wood Shelves	CDB..SS	113
Corner Diagonal Sink Base	CDSB	109
Corner Sink Front	CSF	109
Countertop Edge	CTMR	183
Country Sink Base	CNTYSB, CNTYSB..B	105
Country Sink Base w/CabMat™	CNTYSB..BCM	105
Craftsman Foot	JCRAFTFOOT	189
Cross Grain Veneer Back Skin	L..X, W..BP, W..X	176
Cross Grain Veneer Back Skin, Premium	L..XP	177
Cutlery Divider Wood Tiered Drawer	WTC	194
Cutlery Insert Organizer	CDT	194
Cutlery Insert Wood Organizer	CIW	194
Decorative Arch Valance	DAV	185
Decorative Door Panel Kits — Base End	BDOP, VDOPBH	179
Decorative Door Panel Kits — Tall End	TDOP	180
Decorative Door Panel Kits — Wall End	WDOP	179
Decorative Split Turnings, 2"	SPTURNING, SPTURNINGSP	190
Designer Range Hood Ductless Conversion Kit & Filter Kits	DWK, FILTER	97
Designer Range Hood Square	DRH..S	96
Desk Height Door Drawer Base	DHB, DHB..B	151
Desk Height Drawer Base	DHBD	151
Desk Height File Drawer Base	DHFD	151
Dishwasher End Panels	DWEP, DWEP..FPE, DWEP..WD	175
Double Oven Cabinet	OD	140, 141
Double Oven Cabinet, Deep Drawer	OD..DD	142, 143
End Panel Skins	LBEP, LTEP, LWEP, WBEP, WTEP, WVEPBH, WWEPP	176
End Panel Skins, Premium	LBEP, LTEP..P, LWEP..P	176
End Panels	LSP, SE, SP	178
End Panels, Premium	LSP..P	178
English Bar Column, 42 1/4" High	ENGBARCOLUMN	187
English Country Leg	JENGCNTYLEG	187
English Island Column, 5" Wide, 35 1/4" High	ENGLISHCOLUMN	187
Estate Leg	JESTATELEGS	187
Finished Back Skins	L, W	177
Finished Back Skins, Premium	L..P	177
Floating Shelves	FS	95
Fluted 3" Wide Fillers	FL	173
Fluted 6" Wide Fillers	FL	174
Fluted Classic Column	JFLUTELEG	188
Four Drawer Base	4BD	118
Full Height Base Double Door	B..BFH, B..FH	100
Full Height Base Single Door	B..FH	99, 100
Full Height Base w/Tray Divider	TD..FH	103
Furniture Apron	FA	190
Furniture Base	FB	183, 184
Furniture Drawer Window Bench	FDWB	147
Furniture Valance	FV	186
Glass Shelf Kit, 12" Deep	GSK, GSKWD	195

Description	Code	Page Number
Hardware	.KNOB, PULL	192
Insert Crown	.INSCROWN	181
Inside Corner	.ISC	184
Inside Corner, Premium	.ISC..P	185
Island Leg, 2-Sided or 4-Sided, 35 1/4" High	.2SISLLEG, 4SISLLEG	188
Kensington Bun Foot	.JCRBUNFOOT	189
Kensington Column	.JCRLEG	188
Large Cove Crown	.LCOVE	181
Large Crown	.LCROWN	181
Large Square Foot	.LGSQFOOT	189
Laundry Base	.LB	147
Laundry Pull-out	.L.PO	148
Laundry Utility	.LU	149, 150
Library Moulding	.LIBRARY	183
Light Rail Moulding	.LRM	184
Lille Foot	.LIFOOT	189
Linen Storage Cabinet	.LT, LT..BH	168
Linen Utility w/Hamper	.L, L..BH	167, 168
Medicine Cabinet	.TV	171
Metro Column	.METISLCOLUMN	188
Mirror Frame	.MRM	183
Mission Leg, 34 1/2" High	.DLEMISSION	188
Mission Rosette	.ROSETTEMIS	186
Mudroom Hook	.MRHOOK	195
Mudroom Stacked Wall	.MRSTW, MRSTW..B	146
Ogee Edge	.OJM	183
Outside Corner	.OCM	185
Outside Corner 135°	.OSC	185
Outside Corner Small	.SOCM	185
Outside Corner Small, Premium	.SOCM..P	185
Oven Microwave Cabinet	.OMC	144, 145
Overlay Filler, 2 1/2" Wide	.OL	173
Overlay Filler, 5 1/2" Wide	.OL	173
Pegged Dish Organizer	.PDO, PDOPOSTS	195
Plinth Block	.PLINTHBLOCK	186
Range Hood Chimney	.RHC	96
Recessed Decorative Arch Valance	.DAVF	186
Recycle Center	.DS	195
Refrigerator Panels w/Filler Attached	.LREP, WREP	179
Roll Trays	.RTF, RTF..FW, RTPG, RTPG..FW	196
Sales Sample	.SSB, SSW	198
Sales Sample Base	.SSBASE	198
Shaker Crown	.LSHAKER, NSHAKER, SSHAKER	181
Shaker Crown, Premium	.LSHAKERP	181
Shelf Kits	.USK	196
Shoe - Convex Inside Corner	.SHM	185
Single Bead	.SB	183
Single Door Medicine Cabinet	.MC	169, 170
Single Oven Cabinet	.OS..S	138, 139
Sink Base	.SB, SB..B	104
Sink Base Caddy	.SBCADDY	196
Sink Base, Single Door	.SB	103
Sink Base SuperCabinet™ w/Tilt-out Trays	.SB..STS	106
Sink Base SuperCabinet™ w/Tilt-out Trays & CabMat™	.SB..STSCM	106
Sink Base SuperCabinet™ w/Tilt-out Trays & Caddy	.SB..STSCDY	106
Sink Base w/CabMat™	.SB..BCM	104
Sink Front Bottom	.SFB	107

Description	Code	Page Number
Small Crown	.SCROWN	181
Small Light Rail Moulding	.SMLR	184
Small Scribe	.SCRIBE	183
Small Scribe, Premium	.SCRIBE..P	183
Snack Bar Support	.SBS	191
Soffit Filler Moulding	.SFM	182
Solid-wood Large Crown	.SWLCRM	182
Solid-wood Victorian Crown	.SWVCRM	182
Spice Rack — Chrome	.SRCH	197
Spice Rack — Pull-down	.SPD	197
Square Island Leg, 35 1/4" High	.SQISLLEG	188
Stacked Diagonal Wall	.STWD	85
Stacked Wall Cabinets Double Door	.STW, STW..B	75-79
Stacked Wall Cabinets Single Door	.STW	75-79
Stacked Wall End Cabinet Single Door	.STWEC	88
Stain, Paint, & Touch-up Tools	.SPRAYPAINT, STAINGALLON, STAINQUART, TK	198
Starter Moulding	.STR	182
Stemware Holder	.SW..CH	197
Straight Angle Crown	.SACROWN	181
Straight Heat Shields	.OHS, OHSS	195
Straight Valance	.SV	186
Tablet Holder	.TABLEHLDR	197
Tall Bookcase w/Straight Valance	.T..BCV	153, 154
Tall Crown	.SWTCRM	182
Tapered Leg	.TAPLG	189
Tapered Wood Hood	.TWH	96
Three Drawer Base	.3BD, BD..D	118
Tilt-out Trays, Plastic	.TOT	197
Toekick Cap	.TKC	184
Toekick Overlay	.LTO, WTO	180
Toekick Overlay, Premium	.LTO..P	180
Traditional Batten	.MTBAT	184
Transition Base Fillers	.TF	174
Tray Divider Kit	.WTD	197
Tray Roll-out Divider	.TDRO	197
Triple Bead Edge	.TB	184
Tulip Foot	.TLFOOT	190
Turned Post	.TURNEDPOST	189
Turned Post Split	.SPLTRNEDPOST	189
Two Drawer Base	.2BD	117
Two Drawer Base Drop-in Range	.2BD..DR	117
Under Counter Drawers	.UCD	152, 170
Universal Access Base Corner Super Susan w/Wood Shelves	.BC..SS	127
Universal Access Base, Double Door	.B..B	125
Universal Access Base, Full Height Doors	.B..BFH, B..FH	127
Universal Access Base, Full Height Single Door	.B..FH	126
Universal Access Base Microwave Cabinet w/Standard Drawer	.BMWSD	128
Universal Access Base, Single Door	.B	125
Universal Access Sink Unit	.SU	128
Universal Access Three Drawer Base	.3BD	126
Utility	.U, U..B	129-134
Utility w/Roll Trays	.U..BRT, U..RT	135-137
Vanity Base, Double Door w/Drawer	.VB..B, VB..BBH	158, 159
Vanity Base, Single Door w/Drawer	.VB, VB..BH	158, 159

Description	Code	Page Number
Vanity Bowl Base	.VBB, VBB..B, VBB..BBH, VBB..BH	.161, 162
Vanity Bowl Base w/False Panel	.VBB..D, VBB..DBH, VBB..DLBH, VB..D, VB..DLBH	.162-165
Vanity Bowl Base w/Six Drawers & False Panel	.VBB..D, VBB..DBH	.165, 166
Vanity Desk Legs	.DL, VDL	.180
Vanity Drawer Base	.VDB, VDB..BH, VDB..D, VDB..DBH	.166, 167,
Vanity Four Drawer Base	.4VBD..BH	.161
Vanity Sink Base w/False Panel	.VSB..B, VSB..BBH	.155, 157
Vanity Sink Base w/False Panels	.VSB, VSB..BH	.156, 157
Vanity Sink Base w/Full Height Doors	.VSB..FH, VSB..FHBH	.156, 158
Vanity Three Drawer Base	.VBD, VBD..BH	.160
Vanity Wall	.W..B	.169
Vanity Wall Mirror Cabinet	.VWM	.171
Wall Appliance Garage Doors	.WAGD, WAGD..B	.93
Wall Boutique	.WB..B, WB..TB	.169
Wall Built-in Microwave Double Door Cabinet	.WBMW	.91
Wall Corner Double Door	.WC	.80
Wall Corner Easy Reach	.WCER	.86
Wall Corner Single Door	.WC	.80-82
Wall Diagonal	.WD	.83, 84
Wall Diagonal Appliance Garage Doors	.WDAGD	.93
Wall Diagonal w/Lazy Susan	.WD..S	.84
Wall Double Door	.W, W..B	.57-72
Wall End Cabinet Double Door	.WEC..D	.89
Wall End Cabinet Single Door	.WEC	.88
Wall Message Center Cabinet	.WMC	.89
Wall Microwave Double Door Cabinet	.MW..B	.90
Wall Organizer	.WO	.95
Wall Outside End Shelf, Square Top, Square Bottom	.WOC..STSB	.93
Wall Plate Rack	.W..PRC	.94
Wall Pull-out Filler	.WPOF..OV, WPOF..PL	.94
Wall Single Door	.W	.57-72
Wall Spice Pull-out	.WSP	.92
Wall Three Drawer Double Door	.W3DB	.74
Wall Three Drawer Single Door	.W3D	.73
Wall Top Hinge Single Door	.WTH	.58, 60, 62, 64
Wall Wine Cubby	.SQWC	.95
Wall Wine Rack	.WR	.95
Wine Glass Holders	.SWR	.198
Wine Rack	.WR..CH	.95
Wine Storage Cabinets	.WSC	.94
Wire Half Moon Swing-out	.DS	.198
Wood Hood Canopy Square	.WHCS	.96
Wood Spice Drawer Insert	.WSDI	.198
Wood V-Grooved Beaded Skin	.W..BB	.177

Code	Page Number
2BD	117
2BD..DR	117
2SBARLEG	187
2SISLLEG	188
3018WR	95
3618WR	95
3BD	118, 126
4BD	118
4SBARLEG	187
4SISLLEG	188
4VBD..BH	161
AB	116
AB..B	116
ACSF	110
AEB	116
AV	185
B	98, 99, 125
B..B	99, 125
B..BFH	100
B..BFHMIX	123
B..BRT	101
B..FH	99, 100, 126, 127
B..FHMIX	123
B..PO	120
B..RT	101
B..TDRO	102
BATTEN	182
BBMSH	182
BC	111
BC..SPN	112
BC..SS	115, 127
BCP..B	122
BCP..BFH	122
BD..D	118
BDOP	179
BER	114
BLOWER	97
BLS	112
BLVDF	174
BMWD	107
BMWSD	108, 128
BO	108
BOC	124
BPOF..OV	124
BPOF..PL	124
BSC..PRP	123
BSC..RTR	123
BU..SV	153
BUPP	120
BUPPKB	121
BWB	119
BWB..FH	119
CABMAT	193
CB..FL	174, 175
CB..PL	174, 175
CDB	113
CDB..SS	113
CDSB	109
CDT	194
CHAIR	183
CIW	194
CNTYSB	105
CNTYSB..B	105
CNTYSB..BCM	105
CO	193
CORBELART	190
CORBELCR	191

Code	Page Number
CORBELMIS	191
CORBELOWD	191
CSF	109
CTMR	183
CUDD	193
CWF	172
DAV	185
DAVF	186
DHB	151
DHB..B	151
DHBD	151
DHFD	151
DL	180
DLEMISSION	188
DRH..S	96
DS	195, 198
DWEP	175
DWEP..FPE	175
DWEP..WD	175
DWK	97
ENGBARCOLUMN	187
ENGISLCOLUMN	187
F	172
F..FH	172
FA	190
FB	183, 184
FDWB	147
FILTER	97
FL	173, 174
FS	95
FV	186
GSK	195
GSKWD	195
HCSLCHDWREBOARD	192
INSCROWN	181
ISC	184
ISC..P	185
JBRACKETART	190
JCORBELARTO	190
JCRAFTFOOT	189
JCRBUNFOOT	189
JCRLEG	188
JENGCNTYLEG	187
JESTATELEGS	187
JFLUTELEG	188
KNOB	192
L	167, 177
L..BH	168
L..P	177
L..PO	148
L..X	176
L..XP	177
LB	147
LBEP	176
LBEP	176
LCOVE	181
LCROWN	181
LGCORBEL	191
LGSQFOOT	189
LIBRARY	183
LIFOOT	189
LREP	179
LRM	184
LSHAKER	181
LSHAKERP	181
LSP	178
LSP..P	178

Code	Page Number
LT	168
LT..BH	168
LTEP	176
LTEP..P	176
LTO	180
LTO..P	180
LU	149, 150
LWEP	176
LWEP..P	176
MC	169, 170
METISLCOLUMN	188
MIXKIT..FH	193
MRHOOK	195
MRM	183
MRSTW	146
MRSTW..B	146
MTBAT	184
MW..B	90
NSHAKER	181
OCM	185
OD	140, 141
OD..DD	142, 143
OHS	195
OHSS	195
OJM	183
OL	173
OMC	144, 145
OS..S	138, 139
OSC	185
PDO	195
PDOPOSTS	195
PLINTHBLOCK	186
PULL	192
RHC	96
ROSETTEMIS	186
RTF	196
RTF..FW	196
RTPG	196
RTPG..FW	196
SACROWN	181
SB	103, 104, 183
SB..B	104
SB..BCM	104
SBCADDY	196
SBS	191
SB..STS	106
SB..STSCDY	106
SB..STSCM	106
SCRIBE	183
SCRIBE..P	183
SCROWN	181
SE	178
SFB	107
SFM	182
SHM	185
SM	182
SMLR	184
SM..P	182
SOCM	185
SOCM..P	185
SOFFITA	184
SOFFITB	184
SOFFITE	184
SP	178
SPD	197
SPLITRNEEDPOST	189
SPRAYPAINT	198

Code	Page Number
SPRINGEND	190
SPRINGSPOOL	190
SOISLLEG	188
SOWC	95
SRCH	197
SSB	198
SSBASE	198
SSHAKER	181
SSW	198
STAINGALLON	198
STAINQUART	198
STR	182
STW	75-79
STW..B	75-79
STWD	85
STWEC	88
SU	128
SV	186
SW..CH	197
SWLCRM	182
SWR	198
SWTCRM	182
SWVCRM	182
T..BCVV	153, 154
TABLETHLDR	197
TAPLG	189
TB	184
TD	102
TD..FH	103
TDOP	180
TDRO	197
TF	174
TK	198
TKC	184
TLFOOT	190
TOT	197
TURNEDPOST	189
TV	171
TWH	96
U	129-134
U..B	129-134
U..BRT	135-137
U..RT	135-137
UCD	152, 170
UF	172
UF..OVLY	172
USK	196
VB	158
VB..B	158
VB..BBH	159
VB..BH	159
VB..D	162
VB..DLBH	164
VBB	161
VBB..B	161
VBB..BBH	162
VBB..BH	162
VBB..D	163, 165
VBB..DBH	165, 166
VBB..DLBH	164
VBD	160
VBD..BH	160
VDB	166
VDB..BH	167
VDB..D	166
VDB..DBH	167
VDL	180

<b>Code</b>	<b>Page Number</b>
VDL . . . . .	180
VDOPBH . . . . .	179
VSB . . . . .	156
VSB..B . . . . .	155
VSB..BBH . . . . .	157
VSB..BH . . . . .	157
VSB..FH . . . . .	156
VSB..FHBH . . . . .	158
VWM . . . . .	171
W . . . . .	57-72, 177
W..B . . . . .	57-72, 169
W..BB . . . . .	177
W..BP . . . . .	176
W..PRC . . . . .	94
W..X . . . . .	176
W3D . . . . .	73
W3DB . . . . .	74
WAGD . . . . .	93
WAGD..B . . . . .	93
WB..B . . . . .	169
WB..TB . . . . .	169
WBEP . . . . .	176
WBMW . . . . .	91
WC . . . . .	80-82
WCER . . . . .	86, 87
WD . . . . .	83, 84
WDAGD . . . . .	93
WDOP . . . . .	179
WD..S . . . . .	84
WEC . . . . .	88
WEC..D . . . . .	89
WHCS . . . . .	96
WMC . . . . .	89
WO . . . . .	95
WOC..STSB . . . . .	93
WPOE.OV . . . . .	94
WPOE.PL . . . . .	94
WR . . . . .	95
WR..CH . . . . .	95
WREP . . . . .	179
WSC . . . . .	94
WSDI . . . . .	198
WSP . . . . .	92
WTCB . . . . .	194
WTD . . . . .	197
WTEP . . . . .	176
WTH . . . . .	58, 60, 62, 64
WTO . . . . .	180
WVEPBH . . . . .	176
WWEP . . . . .	176

**BRAND**

HC ..... Homecrest

**STYLE**

ARBR ..... Arbor  
 BYPT ..... Bayport  
 BRNR ..... Brenner  
 BXLY ..... Bexley  
 CARA ..... Cara  
 DOVR ..... Dover  
 ESPT ..... Eastport  
 HBCT ..... Harbour Court  
 HRTG ..... Heritage  
 HRTL ..... Heartland  
 HRSH ..... Hershing  
 JRDN ..... Jordan  
 JUNO ..... Juno  
 LARL ..... Laurel  
 LTNR ..... Lautner  
 LWRY ..... Lawry  
 MDSN ..... Madison  
 MTLA ..... Montella  
 OGLB ..... Ogilby  
 RNER ..... Rainier  
 SDNA ..... Sedona  
 TNSN ..... Tennyson  
 WRNR ..... Warner  
 WSLK ..... Westlake

**WOOD SPECIES**

C ..... Cherry  
 H ..... Hickory  
 L ..... Laminated  
 M ..... Maple  
 O ..... Oak  
 RH ..... Rustic Hickory  
 T ..... Thermofoil

**DOOR STYLE**

AR ..... Arch  
 SQ ..... Square

**FINISH**

ANC ..... Anchor  
 BIS ..... Bison  
 BUC ..... Buckboard  
 CHS ..... Chestnut  
 CIN ..... Cinnamon  
 DRB ..... Derby  
 FLO ..... Fallow  
 HON ..... Honey  
 JAV ..... Java  
 KAR ..... Karoo  
 NAT ..... Natural  
 NEC ..... Nectar  
 POR ..... Porter  
 SOR ..... Sorrel  
 TER ..... Terrain  
 TOF ..... Toffee  
 WHI ..... White

**OPAQUE FINISH**

ALO ..... Aloe  
 ALP ..... Alpine  
 CAD ..... Cadet  
 GLX ..... Galaxy  
 ONX ..... Onyx  
 SND ..... Sand Dollar  
 VAN ..... French Vanilla  
 WIL ..... Willow

**FINISH WITH GLAZE**

ANCBR ..... Anchor w/Brownstone  
 ANCCO ..... Anchor w/Cocoa  
 ANCEB ..... Anchor w/Ebony  
 ANCHU ..... Anchor w/Husk  
 ANCRY ..... Anchor w/Rye  
 ANCSK ..... Anchor w/Smoke  
 BISBR ..... Bison w/Brownstone  
 BISCO ..... Bison w/Cocoa  
 BISEB ..... Bison w/Ebony  
 BISHU ..... Bison w/Husk  
 BISRY ..... Bison w/Rye  
 BISSK ..... Bison w/Smoke  
 BUCBR ..... Buckboard w/Brownstone  
 BUCCO ..... Buckboard w/Cocoa  
 BUCEB ..... Buckboard w/Ebony  
 BUCHU ..... Buckboard w/Husk  
 BUCRY ..... Buckboard w/Rye  
 BUCSK ..... Buckboard w/Smoke  
 CHSBR ..... Chestnut w/Brownstone  
 CHSCO ..... Chestnut w/Cocoa  
 CHSEB ..... Chestnut w/Ebony  
 CHSHU ..... Chestnut w/Husk  
 CHSRY ..... Chestnut w/Rye  
 CHSSK ..... Chestnut w/Smoke  
 CINBR ..... Cinnamon w/Brownstone  
 CINCO ..... Cinnamon w/Cocoa  
 CINEB ..... Cinnamon w/Ebony  
 CINHU ..... Cinnamon w/Husk  
 CINRY ..... Cinnamon w/Rye  
 CINSK ..... Cinnamon w/Smoke  
 DRBBR ..... Derby w/Brownstone  
 DRBCO ..... Derby w/Cocoa  
 DRBEB ..... Derby w/Ebony  
 DRBHU ..... Derby w/Husk  
 DRBRY ..... Derby w/Rye  
 DRBSK ..... Derby w/Smoke  
 FLOBR ..... Fallow w/Brownstone  
 FLOCO ..... Fallow w/Cocoa  
 FLOEB ..... Fallow w/Ebony  
 FLOHU ..... Fallow w/Husk  
 FLORY ..... Fallow w/Rye  
 FLOSK ..... Fallow w/Smoke  
 HONBR ..... Honey w/Brownstone  
 HONCO ..... Honey w/Cocoa  
 HONEB ..... Honey w/Ebony  
 HONHU ..... Honey w/Husk  
 HONRY ..... Honey w/Rye  
 HONSK ..... Honey w/Smoke  
 JAVBR ..... Java w/Brownstone  
 JAVCO ..... Java w/Cocoa  
 JAVEB ..... Java w/Ebony  
 JAVHU ..... Java w/Husk  
 JAVRY ..... Java w/Rye  
 JAVSK ..... Java w/Smoke  
 KARBR ..... Karoo w/Brownstone  
 KARCO ..... Karoo w/Cocoa  
 KAREB ..... Karoo w/Ebony  
 KARHU ..... Karoo w/Husk  
 KARRY ..... Karoo w/Rye  
 KARSK ..... Karoo w/Smoke  
 NATBR ..... Natural w/Brownstone  
 NATCO ..... Natural w/Cocoa  
 NATEB ..... Natural w/Ebony  
 NATHU ..... Natural w/Husk  
 NATRY ..... Natural w/Rye  
 NATSK ..... Natural w/Smoke  
 NECBR ..... Nectar w/Brownstone  
 NECCO ..... Nectar w/Cocoa  
 NECEB ..... Nectar w/Ebony  
 NECHU ..... Nectar w/Husk

**FINISH WITH GLAZE continued**

NECRY ..... Nectar w/Rye  
 NECSK ..... Nectar w/Smoke  
 PORBR ..... Porter w/Brownstone  
 PORCO ..... Porter w/Cocoa  
 POREB ..... Porter w/Ebony  
 PORHU ..... Porter w/Husk  
 PORRY ..... Porter w/Rye  
 PORSK ..... Porter w/Smoke  
 SORBR ..... Sorrel w/Brownstone  
 SORCO ..... Sorrel w/Cocoa  
 SOREB ..... Sorrel w/Ebony  
 SORHU ..... Sorrel w/Husk  
 SORRY ..... Sorrel w/Rye  
 SORSK ..... Sorrel w/Smoke  
 TERBR ..... Terrain w/Brownstone  
 TERCO ..... Terrain w/Cocoa  
 TEREB ..... Terrain w/Ebony  
 TERHU ..... Terrain w/Husk  
 TERRY ..... Terrain w/Rye  
 TERSK ..... Terrain w/Smoke  
 TOFBR ..... Toffee w/Brownstone  
 TOFCO ..... Toffee w/Cocoa  
 TOFEB ..... Toffee w/Ebony  
 TOFHU ..... Toffee w/Husk  
 TOFRY ..... Toffee w/Rye  
 TOFSK ..... Toffee w/Smoke

**OPAQUE FINISH WITH GLAZE**

ALOBR ..... Aloe w/Brownstone  
 ALOCO ..... Aloe w/Cocoa  
 ALOEB ..... Aloe w/Ebony  
 ALOHU ..... Aloe w/Husk  
 ALORY ..... Aloe w/Rye  
 ALOSK ..... Aloe w/Smoke  
 ALPBR ..... Alpine w/Brownstone  
 ALPCO ..... Alpine w/Cocoa  
 ALPEB ..... Alpine w/Ebony  
 ALPHU ..... Alpine w/Husk  
 ALPRY ..... Alpine w/Rye  
 ALPSK ..... Alpine w/Smoke  
 CADBR ..... Cadet w/Brownstone  
 CADCO ..... Cadet w/Cocoa  
 CADEB ..... Cadet w/Ebony  
 CADHU ..... Cadet w/Husk  
 CADRY ..... Cadet w/Rye  
 CADSK ..... Cadet w/Smoke  
 GLXBR ..... Galaxy w/Brownstone  
 GLXCO ..... Galaxy w/Cocoa  
 GLXEB ..... Galaxy w/Ebony  
 GLXHU ..... Galaxy w/Husk  
 GLXRY ..... Galaxy w/Rye  
 GLXSK ..... Galaxy w/Smoke  
 ONXBR ..... Onyx w/Brownstone  
 ONXCO ..... Onyx w/Cocoa  
 ONXEB ..... Onyx w/Ebony  
 ONXHU ..... Onyx w/Husk  
 ONXRY ..... Onyx w/Rye  
 ONXSK ..... Onyx w/Smoke  
 SNDBR ..... Sand Dollar w/Brownstone  
 SNDCO ..... Sand Dollar w/Cocoa  
 SNDEB ..... Sand Dollar w/Ebony  
 SNDHU ..... Sand Dollar w/Husk  
 SNDRY ..... Sand Dollar w/Rye  
 SNDSK ..... Sand Dollar w/Smoke  
 VANBR ..... French Vanilla w/Brownstone  
 VANCO ..... French Vanilla w/Cocoa  
 VANEb ..... French Vanilla w/Ebony  
 VANHU ..... French Vanilla w/Husk  
 VANRY ..... French Vanilla w/Rye  
 VANSK ..... French Vanilla w/Smoke

**OPAQUE FINISH WITH GLAZE continued**

WILBR ..... Willow w/Brownstone  
 WILCO ..... Willow w/Cocoa  
 WILEB ..... Willow w/Ebony  
 WILHU ..... Willow w/Husk  
 WILRY ..... Willow w/Rye  
 WILSK ..... Willow w/Smoke

**STANDARD CONSTRUCTION**

LE ..... Laminate Ends

**CONSTRUCTION UPGRADES**

APF ..... 1/2" All-plywood Finished Ends  
 APU ..... 1/2" All-plywood Unfinished Ends  
 PEF ..... 1/2" Plywood Ends Finished  
 PEU ..... 1/2" Plywood Ends Unfinished

**DRAWER OPTIONS**

FDRW3/4XSM Furniture Board Drawer  
 WDRWPG.... Wood Dovetail Drawer w/SofTouch™ Guide

**ROLL TRAY OPTIONS**

RTF ..... Furniture Board Roll Tray  
 RTPG ..... Wood Dovetail Roll Trays w/SofTouch™ Guide

**STANDARD HINGE**

CH ..... Concealed Hinge

**HINGE OPTIONS**

INTGH ..... Integrated SofTouch™ Hinge

**DRAWER FRONT OPTIONS**

DFF5PC ..... Drawer Front Flat 5-piece  
 DFR5PC ..... Drawer Front Raised 5-piece

**END PANEL MODIFICATIONS**

AUTHB ..... Authentic Ends Both  
 AUTHL ..... Authentic End Left  
 AUTHR ..... Authentic End Right  
 FPFB ..... Furniture Finished Plywood Ends

**BOX MODIFICATIONS**

CBO ..... Cabinet Box Only  
 CCO ..... Cabinet Case Only  
 CFNTO ..... Cabinet Front Only  
 CFP ..... Cabinet False Panel  
 CND ..... Cabinet with No Door, with Drawer  
 EXB ..... Extended Stiles Both  
 EXL ..... Extended Stile Left  
 EXR ..... Extended Stile Right  
 ID15 ..... Increased Depth to 15"  
 ID18 ..... Increased Depth to 18"  
 ID21 ..... Increased Depth to 21"  
 ID24 ..... Increased Depth to 24"  
 ID27 ..... Increased Depth to 27"  
 ID30 ..... Increased Depth to 30"  
 INVFRM ..... Inverted Frame  
 P ..... Peninsula  
 RD6 ..... Reduced Depth to 6"  
 RD9 ..... Reduced Depth to 9"  
 RD12 ..... Reduced Depth to 12"  
 RD15 ..... Reduced Depth to 15"  
 RD18 ..... Reduced Depth to 18"  
 RD21 ..... Reduced Depth to 21"  
 RD24 ..... Reduced Depth to 24"  
 RD27 ..... Reduced Depth to 27"

**OVERLAY MODIFICATION**

FULL ..... Full Overlay

**INTERIOR MODIFICATIONS**

MI ..... Matching Interior  
 FD ..... Full Depth Shelf

**TOEKICK MODIFICATIONS**

ADTK ..... Add Toekick  
 FTK ..... Flush Toekick  
 RECTKALL ..... Island Toekick  
 RECTKBK ..... Recessed Toekick Back  
 RECTKL ..... Recessed Toekick Left  
 RECTKR ..... Recessed Toekick Right  
 VTK ..... Void Toekick

**SPECIALTY DOORS**

ALF ..... Aluminum Frame Door  
 CG ..... Cut-for-glass Door  
 MD ..... Mullion Door  
 PRMD ..... Prairie Mullion Door



# CHARACTERISTICS

## Wood

No matter which species you choose for your new kitchen or bath cabinetry, please keep in mind that no two pieces of wood are exactly the same. Stains are likely to exaggerate the difference between open and closed grains and other markings in wood. Grain variation and color change should be expected. As hardwood ages, it will darken when exposed to different types of light. Color differences or changes in wood can also be caused by exposure to harsh chemicals, extreme heat or moisture. Additionally, wood species exhibit other defining characteristics, such as mineral deposits/streaks, knots, sap runs, pin holes and wormholes. These markings make the wood unique and contribute to its enduring beauty.



**Cherry** is characterized by its red undertones, but may vary in color from white to a deep, rich brown. Cherry is a close-grained wood with fairly uniform texture, revealing pin knots and curly graining. All wood will age with time and the finish will darken. This is especially true for cherry. This is a sought-after quality in cherry cabinetry, and those who select it expect this evolution.



**Hickory** is a strong, heavy hardwood known for distinctive graining patterns. Contributing to its dramatic appearance is a wide variation in color and streaking, ranging from white to dark brown. This contrast in color can appear in a single door panel. Hickory also contains random knots and wormholes that further contribute to a varied appearance. These exaggerated characteristics are to be expected and are considered desirable in hickory cabinetry.



**Maple** is a close-grained hardwood that is predominately white to creamy-white in color, with occasional reddish-brown tones. While maple typically features uniform graining as compared to other wood species, characteristic markings may include fine brown lines, wavy or curly graining, bird pecks and mineral streaks. These traits are natural and serve to enhance maple's natural beauty.



**Oak** is a strong, open-grained hardwood that ranges in color from white to pink and reddish tones. Streaks of green, yellow and even black may appear due to mineral deposits. Oak may also contain wormholes and wild, varying grain patterns. This distinct graining is considered a desirable quality.



**Rustic Hickory** is a strong, heavy hardwood known for distinctive graining patterns. Color will vary from nearly white to dark brown, with wild flowing grain patterns and dramatic color variations. Rustic Hickory can have a fine uniform grain to large knots appearing black and brown in color of various shapes and sizes, sapwood, mineral and some checking. Cabinet face frames, plywood ends, Frieze Valances, mouldings, fillers, bookcases and any cabinets without doors and drawers will not be rustic.

**Sound Closed Knot** (not moveable) — Expected up to approximately 3" in diameter

**Sound Knot with Cracks** — Expect sound knots with open cracks up to approximately 1" in length

**Open Knot** (through door) — Expected with open area up to approximately 3/4" in diameter

**Unsound Knot** (moveable core) — Not to be expected

**Worm Holes/Pin Holes** (can go through the door) — Can be expected up to 1/4" diameter

**Worm Tracks** — Can be expected in sizes up to approximately 1/8" wide by 8" long

## Textured Laminate

Textured laminates feature design leading, high definition wood grain laminates on doors, drawer fronts, and Premium trim items. The surfaces are laminate based materials with an integrated top coat that provides superior beauty, durability, and performance while meeting or exceeding all of the KCMA performance standards. The core panel is made of MDF to ensure a consistent and stable product. Additional coordinating trim items in the cabinet box color are also available.

A heat shield is required to separate all laminate products from heat producing units to be in compliance with cabinet warranty.

## Thermofoil

Thermofoil doors and drawer fronts feature a shaped MDF core covered with a seamless vinyl laminate on the face and edges, and a melamine laminate on the back. The vinyl laminate is applied to the MDF with an adhesive using heat and pressure to create a product with excellent wear and heat resistance properties.

A heat shield is required to separate all laminate products from heat producing units to be in compliance with cabinet warranty.

## HUMIDIFICATION

The natural response to wood to changes in humidity is much more dramatic than most people realize.

Here is a table showing:

- (a) how much a cabinet door panel is likely to shrink in a low humidity environment,
- (b) how much a cabinet door is likely to expand in excess humidity, and
- (c) the total potential range of dimension changes from excess humidity to low humidity.

### Total Potential Movement (inches) of solid-wood panels

Species	Panel Dimension (inches)	(a) Low Humidity	(b) Excess Humidity	(c) Annual Range
Cherry	19.75	-0.26	0.25	0.51
Hickory	19.75	-0.34	0.31	0.65
Maple	19.75	-0.49	0.10	0.59
Oak	19.75	-0.32	0.31	0.63
Rustic Hickory	19.75	-0.34	0.31	0.65

Notice the annual dimension change for a solid-wood panel can approach three-quarters of an inch. For this reason, cabinet doors are typically manufactured at a targeted range of 40%–50% relative humidity.

In extremely cold, dry winters, some doors can be exposed to conditions that are below 20% relative humidity for weeks at a time. Exposure to sustained conditions such as these would cause panels to shrink and will not be considered defective. New construction makes the problem worse since the heat is on but no one is living in the home to raise the humidity levels. Conversely, where in-home humidity exceeds 70% relative humidity for extended periods of time, panels will swell and this will not be considered defective.

### Steps Consumers Can Take To Protect Real Wood Furnishings

- **Keep an eye on the humidity inside the home.** Reasonably accurate digital thermometers-hygrometer units are available to measure humidity.
- **Maintain the humidity at or above 20% when the temperature is below 20 degrees and over 35% when the temperature is above 20 degrees.** Some ways this may be accomplished are installing a whole-house humidifier on the furnace, running a portable humidifier in key rooms, or placing pans of water near the heat registers.
- **Don't over-do it.** Significant condensation on windows is a sign the humidity levels are too high for outside temperature conditions.
- **Recognize that finished wood responds to humidity over several days to several weeks.** It takes time before the wood returns to normal after any correction to the environment.

**Door Style Reference Chart**

	Cherry	Hickory	Maple	Oak	Rustic Hickory	Textured Laminate	Thermofoil
Arbor	✓	✓	✓	✓	✓		
Bayport	✓	✓	✓				
Bexley	✓	✓	✓				
Brenner	✓		✓	✓			
Cara							✓
Dover	✓	✓	✓	✓	✓		
Eastport	✓		✓	✓			
Harbour Court							✓
Heartland	✓	✓	✓	✓			
Heritage	✓	✓	✓	✓	✓		
Hershing	✓	✓	✓	✓			
Jordan	✓		✓	✓			
Juno						✓	
Laurel	✓	✓	✓	✓			
Lautner	✓	✓	✓				
Lawry	✓	✓	✓				
Madison	✓		✓				
Montella	✓		✓	✓			
Ogilby	✓	✓	✓	✓			
Rainier	✓		✓				
Sedona	✓	✓	✓	✓	✓		✓
Tennyson	✓		✓	✓			
Warner	✓		✓				
Westlake	✓		✓				

# OVERLAY SPECIFICATIONS

4

DOOR STYLES

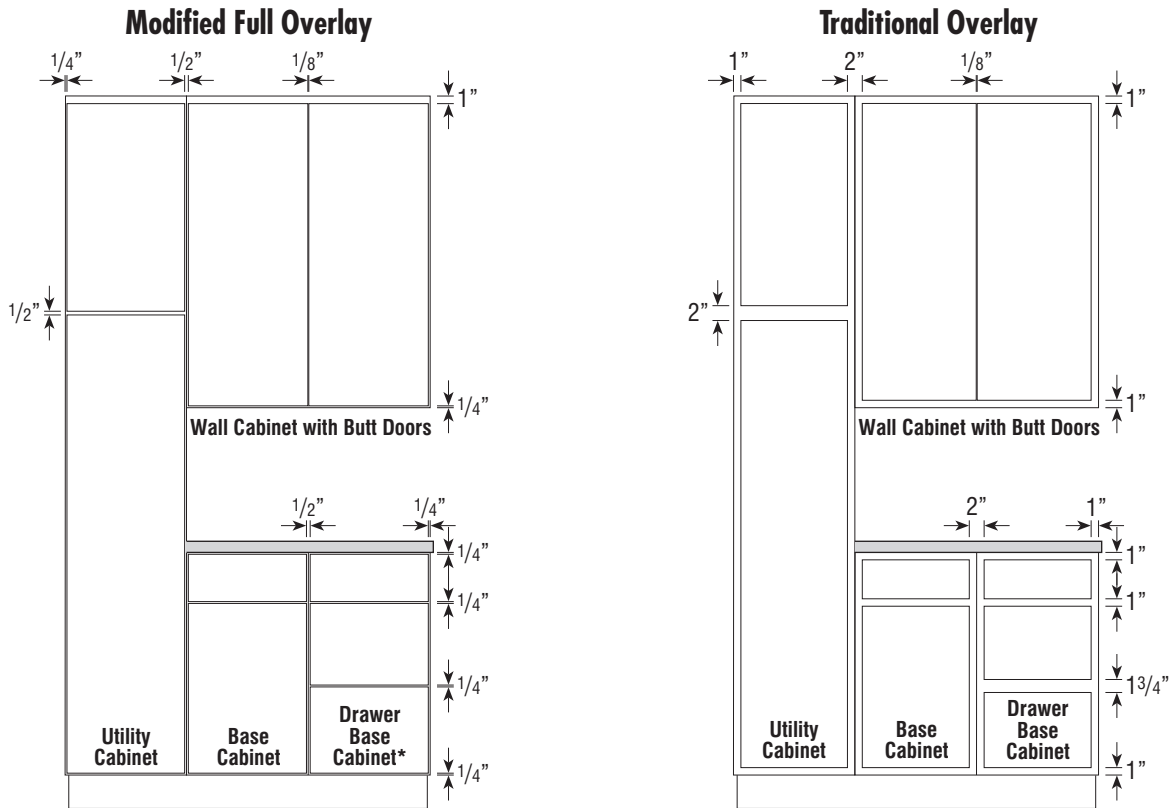

**Modified Full Overlay**

Wall and Tall Cabinets: The face frame remains the same and doors overlay the frame exposing 1/4" on the bottom rail and right and left stile. One full inch is exposed on the top rail of wall and tall cabinets. Typical units with a center stile expose 1/2" of that stile. Full Overlay (FULL) modification available.

Base Cabinets: The face frame remains the same and doors overlay the frame, exposing 1/4" on the top and bottom rails and right and left stiles of base cabinets. Typical base units with a center stile expose 1/2" of that stile.

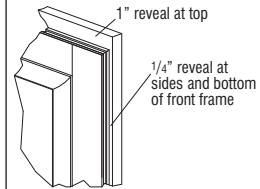

Modified Full Overlay

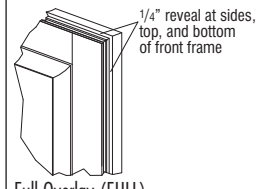

Full Overlay (FULL)

**Traditional Overlay**

The door and drawer fronts overlay the face frame 1/2", exposing 1" of the frame both on the stile and rail members. Typical wall and base cabinets with a center stile expose 2" of that stile.

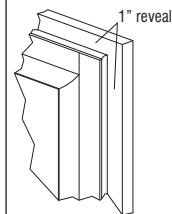

**Exceptions on Face Frame Reveals**

- Oven units have 3" stiles and 9" intermediate rails (designed for universal flexibility of cut-out options) that create various reveals.
- Blind corner wall and base cabinets expose different center stile reveals. Diagonal corners also vary.
- Please see the dimensional charts for oven units and blind bases located in the product section.

\*34 1/2" high application shown. On 32" high Full Overlay three drawer applications (drawer bases and sink bases with drawers), the reveal above the bottom drawer front is 1/2". On 29" high Full Overlay DDR\_\_ (Desk Drawer Base), the reveal above bottom drawer is 3/4".

- One double door center stile cabinet has the same reveal as two single door cabinets.
- Homecrest Full Overlay styles are designed with Modified Full Overlay on Wall and Tall cabinets, leaving 1" on the top rail for easy application of decorative mouldings.

# MODIFIED FULL OVERLAY DOOR STYLES

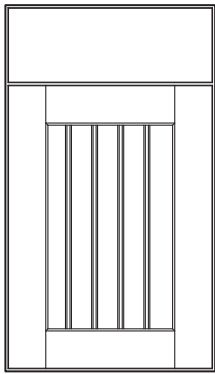

Bayport  
(page 7)

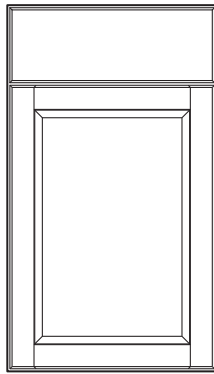

Bexley  
(page 8)

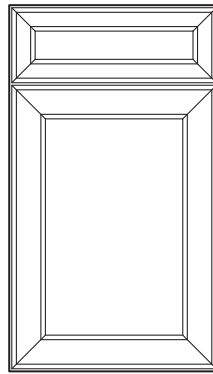

Brenner  
(page 8)

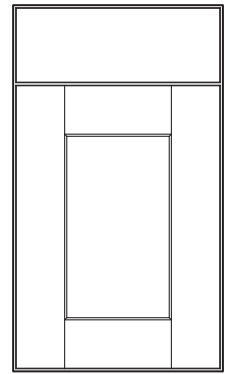

Dover  
(page 9)

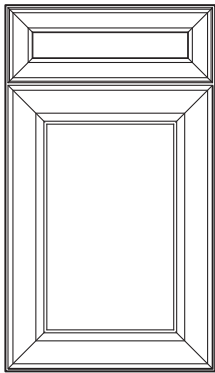

Eastport  
(page 10)

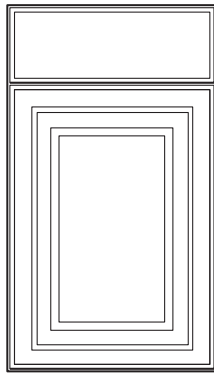

Harbour Court  
(page 10)

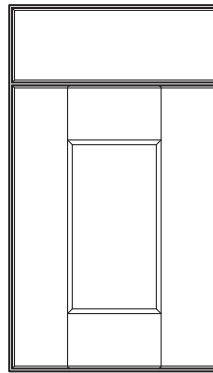

Hershing  
(page 12)

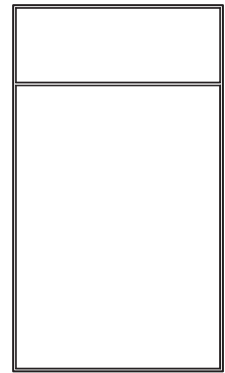

Juno  
(page 13)

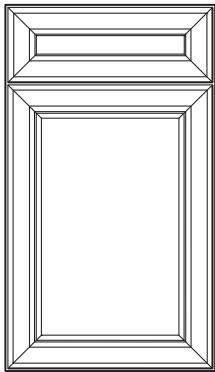

Madison  
(page 15)

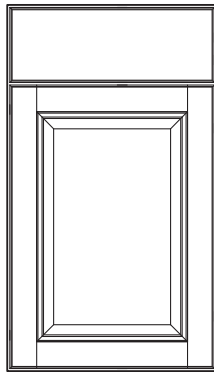

Montella  
(page 15)

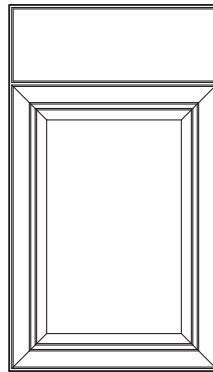

Ogilby  
(page 16)

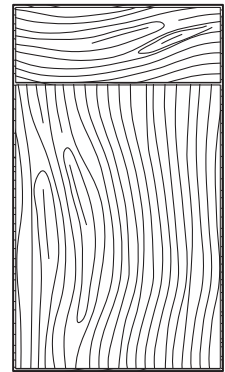

Rainier  
(page 16)

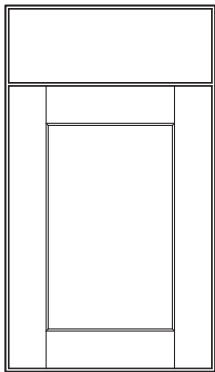

Sedona  
(page 17)

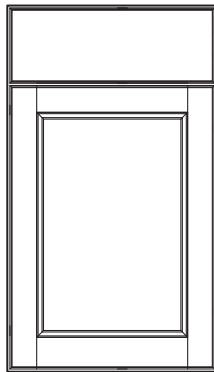

Tennyson  
(page 18)

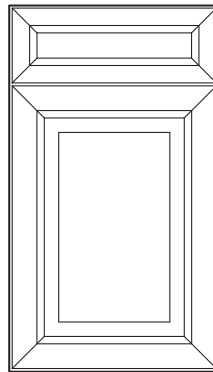

Warner  
(page 18)

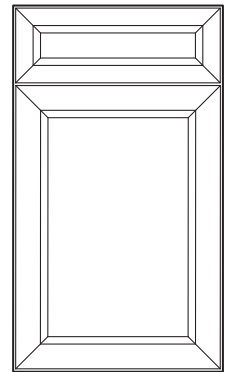

Westlake  
(page 19)

## TRADITIONAL OVERLAY DOOR STYLES

6

DOOR STYLES

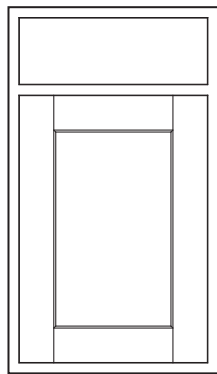

Arbor  
(page 7)

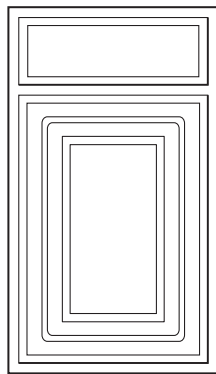

Cara  
(page 9)

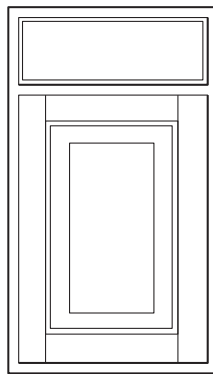

Heartland  
(page 11)

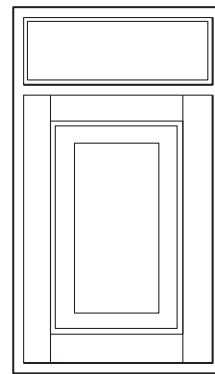

Heritage  
(page 11)

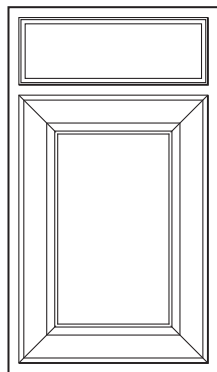

Jordan  
(page 12)

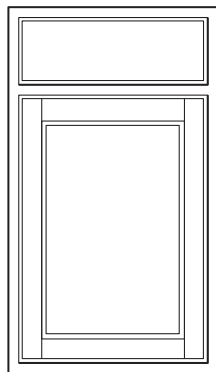

Laurel  
(page 13)

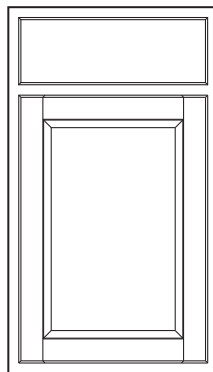

Lautner  
(page 14)

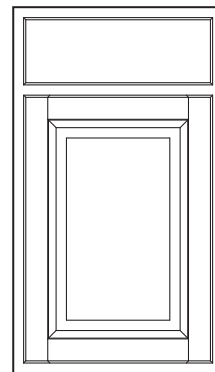

Lawry  
(page 14)

## DOOR STYLE SPECIFICATIONS

### Cherry

- When Cherry door styles are ordered, it is recommended to apply a finished end option or a veneer end panel for exposed ends due to the natural aging of Cherry.

### Opaque

- When Opaque or Opaque Glaze finish is specified, select doors and/or drawer front center panels may be constructed of Medium Density Fiberboard (MDF). MDF provides a smooth finish when painted, and is resistant to warping, expansion, and contraction. Facings may consist of other hardwood components.

### All Door Styles

- All doors and drawer fronts are 3/4" thick unless otherwise noted.

### Door and Drawer Front Side Profiles

- Veneer and MDF components are shown with gray shading on side profiles. Solid-wood components do not have shading.

### Wood Grain

- See reference images for wood grain direction on all door styles.

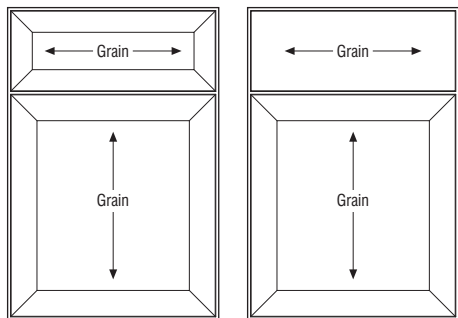

# DOOR STYLES

## Arbor Collection – Cherry, Hickory, Maple, Oak, Rustic Hickory

## Traditional Overlay Door Styles

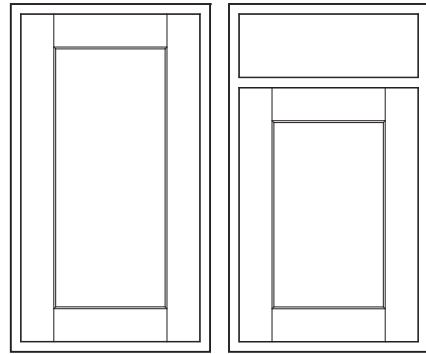

Square Wall Square Base

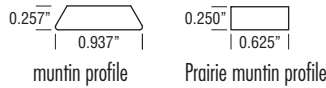

muntin profile Prairie muntin profile

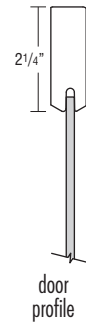

door profile



drawer front profile

### Door Style

- Cherry
- Hickory
- Maple
- Oak
- Rustic Hickory

- Square Wall and Square Base Doors
- 3/16" Veneer Center Panel in 3/4" Hardwood Frame
- Mortise and Tenon Joints
- 3/4" Solid Hardwood Slab Drawer Front

- When Rustic Hickory is specified, the center panel will have rustic characteristics with the exception of open knots or openings that would expose the panel core.
- When opaques are specified, the door and/or drawer front center panel may be constructed of Medium Density Fiberboard (MDF). MDF provides a smoother finish when painted, and is more resistant to warping, expansion, and contraction. Facings may consist of other hardwood components.

## Bayport Collection – Cherry, Hickory, Maple

## Modified Full Overlay Door Styles

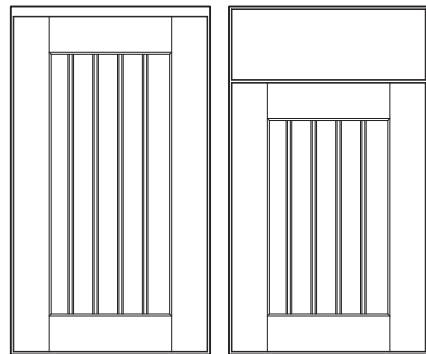

Square Wall Square Base

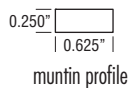

muntin profile

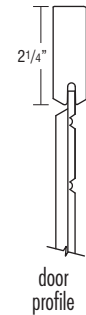

door profile

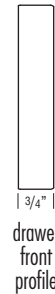

drawer front profile

### Door Style

- Cherry
- Hickory
- Maple

- Square Wall and Square Base Doors
- 1/2" Solid Hardwood Reverse Center Panel with 1 1/2" Beading in 3/4" Hardwood Frame
- Mortise and Tenon Joints
- 3/4" Solid Hardwood Slab Drawer Front

- When opaques are specified, the door and/or drawer front center panel may be constructed of Medium Density Fiberboard (MDF). MDF provides a smoother finish when painted, and is more resistant to warping, expansion, and contraction. Facings may consist of other hardwood components.

# DOOR STYLES

## Bexley Collection – Cherry, Hickory, Maple

## Modified Full Overlay Door Styles

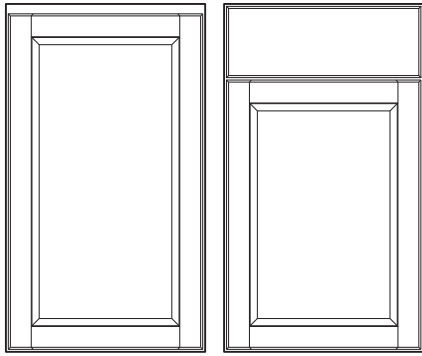

Square Wall

Square Base

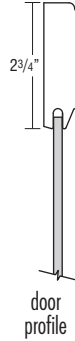
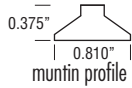

door profile



drawer front profile

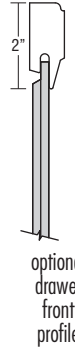

optional drawer front profile

### Door Style

Cherry  
Hickory  
Maple

- Square Wall and Square Base Doors
- 3/16" Veneer Recessed Center Panel in 3/4" Hardwood Frame
- 2 3/4" Wide Stiles and Rails
- Mortise and Tenon Joints
- 3/4" Solid Hardwood Slab Drawer Front

- When opaques are specified, the door and/or drawer front center panel may be constructed of Medium Density Fiberboard (MDF). MDF provides a smoother finish when painted, and is more resistant to warping, expansion, and contraction. Facings may consist of other hardwood components.
- See page 28 for 5-piece drawer front dimensions when specifying decorative hardware.

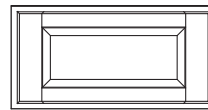

Optional 5-piece Drawer Front (DFF5PC)

## Brenner Collection – Cherry, Maple, Oak

## Modified Full Overlay Door Styles

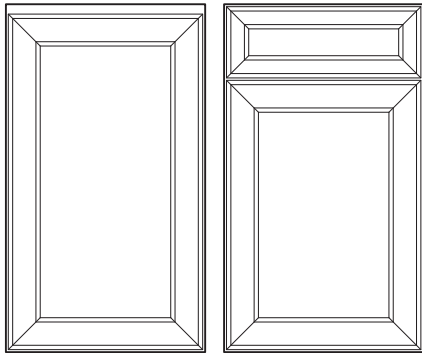

Square Wall

Square Base

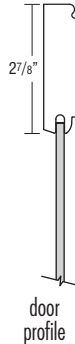
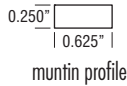

door profile



drawer front profile

### Door Style

Cherry  
Maple  
Oak

- Square Wall and Square Base Doors
- 3/16" Veneer Recessed Center Panel in 3/4" Hardwood Frame
- 2 7/8" Wide Stiles and Rails
- 45° Mitered Joints
- 5-piece Drawer Front

- When opaques are specified, the door and/or drawer front center panel may be constructed of Medium Density Fiberboard (MDF). MDF provides a smoother finish when painted, and is more resistant to warping, expansion, and contraction. Facings may consist of other hardwood components.
- See page 28 for 5-piece drawer front dimensions when specifying decorative hardware.



# DOOR STYLES

## Cara – Thermofoil

## Traditional Overlay Door Styles

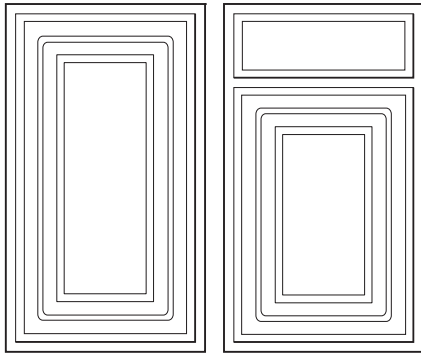

Square Wall

Square Base

- Square Wall and Square Base Doors
- 5/8" Medium Density Fiberboard
- Color Matched, Laminated Melamine Back
- Machine Contoured Finger Wells, No Decorative Hardware Required

Note: Thermofoil will not withstand sustained temperatures in excess of 170 degrees F. A 3" filler or heat shield is required between any thermofoil surface and any heat source to be in compliance with cabinet warranty. Failure to use a 3" filler or heat shield will void the cabinet warranty.



2 1/4"

door profile

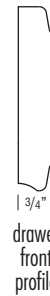

3/4"

drawer front profile

**Door Style**  
Thermofoil

## Doover Collection – Cherry, Hickory, Maple, Oak, Rustic Hickory

## Modified Full Overlay Door Styles

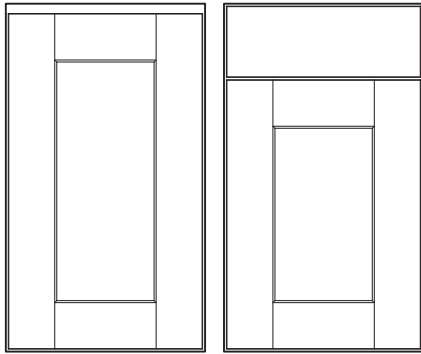

Square Wall

Square Base

- Square Wall and Square Base Doors
- 1/2" Solid Hardwood Reverse Raised Center Panel in 3/4" Hardwood Frame
- Mortise and Tenon Joints
- 2 7/8" Wide Slightly Beveled Inside Profile on Stiles and Rails
- 3/4" Solid Hardwood Slab Drawer Front

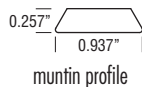

muntin profile

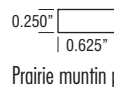

Prairie muntin profile

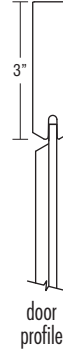

3"

door profile



3/4"

drawer front profile

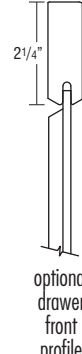

2 1/4"

optional drawer front profile

**Door Style**  
Cherry  
Hickory  
Maple  
Oak  
Rustic Hickory

- When opaques are specified, the door and/or drawer front center panel may be constructed of Medium Density Fiberboard (MDF). MDF provides a smoother finish when painted, and is more resistant to warping, expansion, and contraction. Facings may consist of other hardwood components.
- See page 28 for 5-piece drawer front dimensions when specifying decorative hardware.

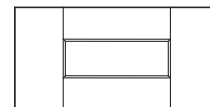

Optional 5-piece Drawer Front (DFF5PC)

# DOOR STYLES

## Eastport Collection – Cherry, Maple, Oak

## Modified Full Overlay Door Styles

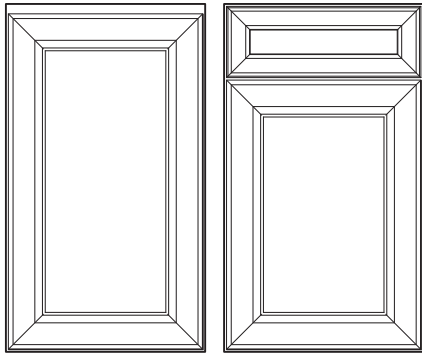

Square Wall

Square Base

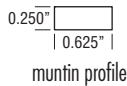

muntin profile

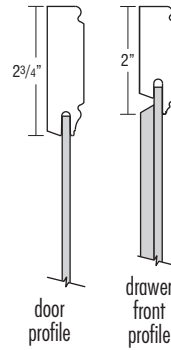

door profile

drawer front profile

### Door Style

Cherry  
Maple  
Oak

- Square Wall and Square Base Doors
- 3/16" Veneer Recessed Center Panel in 3/4" Hardwood Frame
- 45° Mitered Joints
- 5-piece Solid Reverse Raised Drawer Front

- When opaques are specified, the door and/or drawer front center panel may be constructed of Medium Density Fiberboard (MDF). MDF provides a smoother finish when painted, and is more resistant to warping, expansion, and contraction. Facings may consist of other hardwood components.
- See page 28 for 5-piece drawer front dimensions when specifying decorative hardware.

## Harbour Court – Thermofoil

## Modified Full Overlay Door Styles

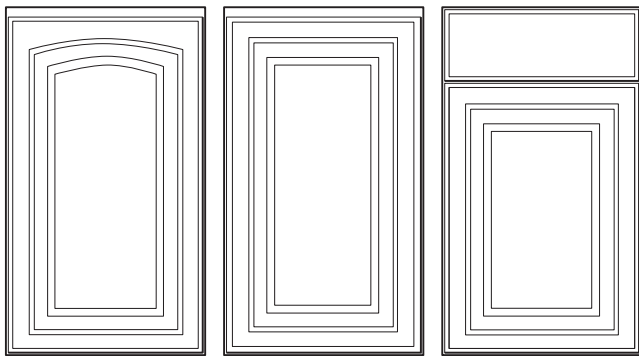

Arch Wall

Square Wall

Square Base

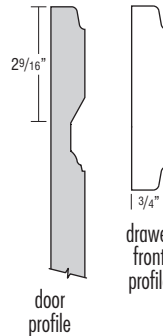

door profile

drawer front profile



optional drawer front profile

### Door Style

Thermofoil

- Arch or Square Wall and Square Base Doors
- 3/4" Medium Density Fiberboard
- Color Matched, Laminated Melamine Back
- See page 28 for 5-piece drawer front dimensions when specifying decorative hardware.

Note: Thermofoil will not withstand sustained temperatures in excess of 170 degrees F. A 3" filler or heat shield is required between any thermofoil surface and any heat source to be in compliance with cabinet warranty. Failure to use a 3" filler or heat shield will void the cabinet warranty.

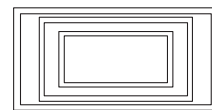

Optional 5-piece Drawer Front (DFR5PC)

Note: Arch door profiles available on wall and tall cabinets (top section only), not available on base and vanity cabinets.

# DOOR STYLES

## Heartland Collection – Cherry, Hickory, Maple, Oak

## Traditional Overlay Door Styles

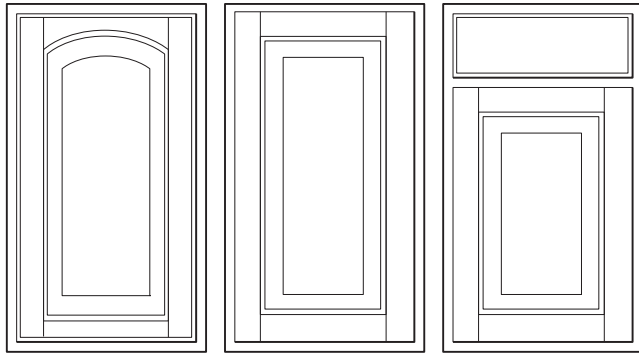

Arch Wall

Square Wall

Square Base

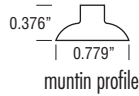

muntin profile



door profile



drawer front profile

### Door Style

- Cherry Arch
- Cherry Square
- Hickory Arch
- Hickory Square
- Maple Arch
- Maple Square
- Oak Arch
- Oak Square

- Arch or Square Wall and Square Base Doors
- 7/16" Veneer Raised Center Panel in 3/4" Hardwood Frame
- Mortise and Tenon Joints
- 3/4" Solid Hardwood Slab Profiled Drawer Front

- When opaques are specified, the door and/or drawer front center panel may be constructed of Medium Density Fiberboard (MDF). MDF provides a smoother finish when painted, and is more resistant to warping, expansion, and contraction. Facings may consist of other hardwood components.

## Heritage Collection – Cherry, Hickory, Maple, Oak, Rustic Hickory

## Traditional Overlay Door Styles

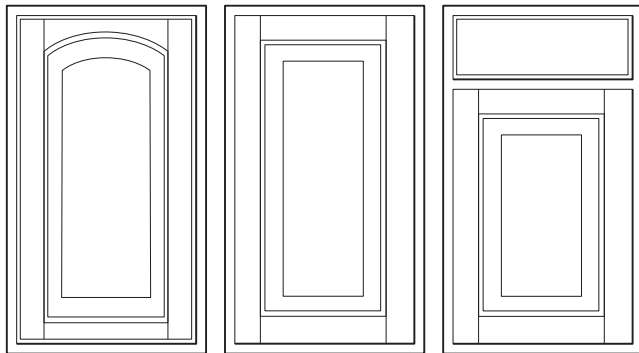

Arch Wall

Square Wall

Square Base

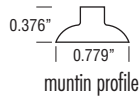

muntin profile



door profile



drawer front profile

### Door Style

- Cherry Arch
- Cherry Square
- Hickory Arch
- Hickory Square
- Maple Arch
- Maple Square
- Oak Arch
- Oak Square
- Rustic Hickory Square

- Arch or Square Wall and Square Base Doors
- Rustic Hickory Available with Square Wall and Square Base Doors
- 9/16" Solid Raised Center Panel in 3/4" Hardwood Frame
- 3/4" Solid Hardwood Profiled Slab Drawer Front

- When opaques are specified, the door and/or drawer front center panel may be constructed of Medium Density Fiberboard (MDF). MDF provides a smoother finish when painted, and is more resistant to warping, expansion, and contraction. Facings may consist of other hardwood components.

Note: Arch door profiles available on wall and tall cabinets (top section only), not available on base and vanity cabinets.

# DOOR STYLES

## Hershing Collection – Cherry, Hickory, Maple, Oak

## Modified Full Overlay Door Styles

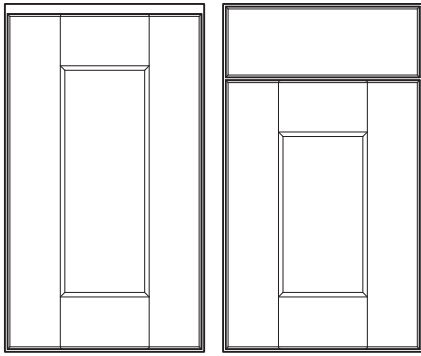

Square Wall

Square Base

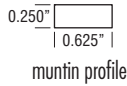

muntin profile

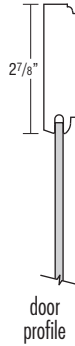

door profile

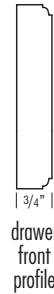

drawer front profile

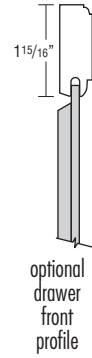

optional drawer front profile

### Door Style

Cherry  
Hickory  
Maple  
Oak

- Square Wall and Square Base Doors
- 3/4" Solid Hardwood Stiles and Rails
- 2 7/8" Wide Stile and Rail with a 3/16" Veneer Recessed Center Panel
- Mortise and Tenon Joints
- 3/4" Solid Hardwood Slab Drawer Front

- When opaques are specified, the door and/or drawer front center panel may be constructed of Medium Density Fiberboard (MDF). MDF provides a smoother finish when painted, and is more resistant to warping, expansion, and contraction. Facings may consist of other hardwood components.
- See page 28 for 5-piece drawer front dimensions when specifying decorative hardware.

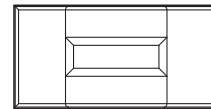

Optional 5-piece Drawer Front (DFF5PC)

## Jordan Collection – Cherry, Maple, Oak

## Traditional Overlay Door Styles

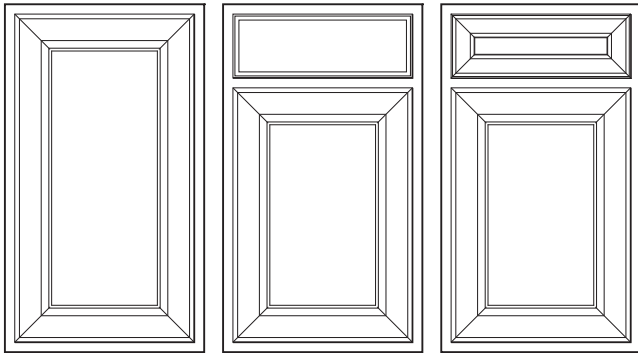

Square Wall

Square Base (Maple and Oak)

Square Base (Cherry)

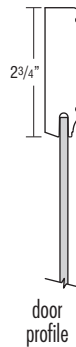

door profile



drawer front profile (Maple & Oak)

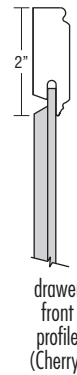

drawer front profile (Cherry)

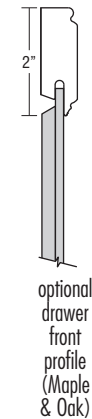

optional drawer front profile (Maple & Oak)

### Door Style

Cherry  
Maple  
Oak

- Square Wall and Square Base Doors
- 3/16" Veneer Center Panel in 3/4" Hardwood Frame
- 45° Mitered Joints
- Maple and Oak - 3/4" Solid Hardwood Profiled Drawer Front with Machined Groove and Eased Edge
- Cherry - 5-piece Drawer Front

- When opaques are specified, the door and/or drawer front center panel may be constructed of Medium Density Fiberboard (MDF). MDF provides a smoother finish when painted, and is more resistant to warping, expansion, and contraction. Facings may consist of other hardwood components.
- See page 28 for 5-piece drawer front dimensions when specifying decorative hardware.

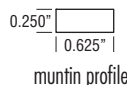

muntin profile

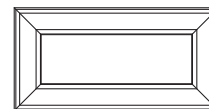

Optional 5-piece Drawer Front (DFF5PC)

- Available on Maple and Oak

# DOOR STYLES

## Juno – Textured Laminate

## Modified Full Overlay Door Styles

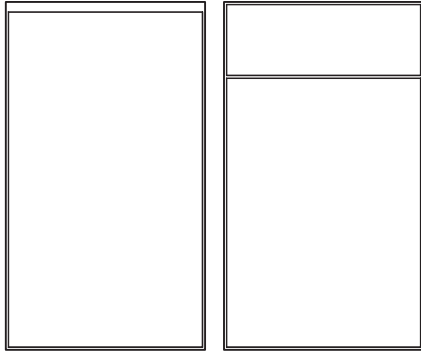

Slab Wall

Slab Base

Textured Laminate Finishes	Cabinet Box Color	
	Anchor	Buckboard
Cavern		•
Tusk	•	



**Door Style**  
Textured Laminate

- Slab Wall and Slab Base Doors with Matching Edgebanding
- Vertical Grain Pattern
- Doors, drawer fronts, filler overlays, and selected premium trim items will be in the selected laminate. **All other cabinet components and trim items will be in the cabinet box color.**
- A heat shield is required to separate Juno doors, drawer fronts, overlay fillers, and all textured laminate products from heat producing units to be in compliance with cabinet warranty.
- Standard construction matches cabinet box color. To achieve a cabinet end panel that matches the door, an Authentic End or a field applied skin or door kit is required.

## Laurel Collection – Cherry, Hickory, Maple, Oak

## Traditional Overlay Door Styles

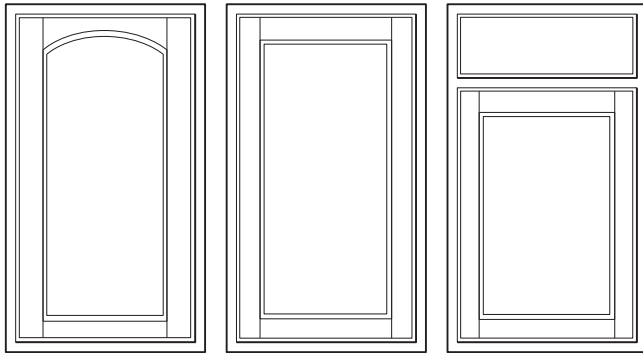

Arch Wall

Square Wall

Square Base

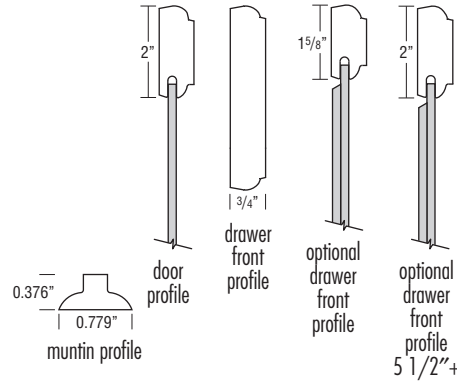

**Door Style**  
Cherry Arch  
Cherry Square  
Hickory Arch  
Hickory Square  
Maple Arch  
Maple Square  
Oak Arch  
Oak Square

- Arch or Square Wall and Square Base Doors
- 3/16" Veneer Recessed Center Panel in 3/4" Hardwood Frame
- Mortise and Tenon Joints
- 3/4" Solid Hardwood Slab Drawer Front
- When opaques are specified, the door and/or drawer front center panel may be constructed of Medium Density Fiberboard (MDF). MDF provides a smoother finish when painted, and is more resistant to warping, expansion, and contraction. Facings may consist of other hardwood components.
- See page 28 for 5-piece drawer front dimensions when specifying decorative hardware.

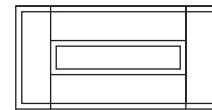

Optional 5-piece Drawer Front (DFF5PC)

Note: Arch door profiles available on wall and tall cabinets (top section only), not available on base and vanity cabinets.

# DOOR STYLES

## Lautner Collection – Cherry, Hickory, Maple

## Traditional Overlay Door Styles

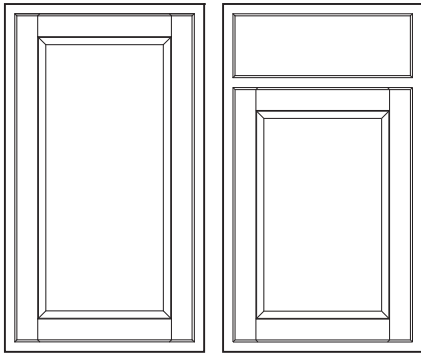

Square Wall

Square Base

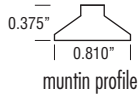

muntin profile

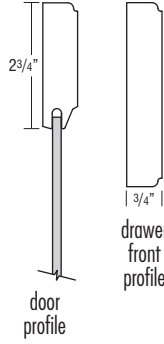

door profile

drawer front profile

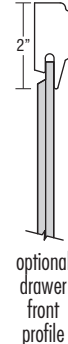

optional drawer front profile

### Door Style

Cherry  
Hickory  
Maple

- Square Wall and Square Base Doors
- 3/16" Veneer Recessed Center Panel in 3/4" Hardwood Frame
- 2 3/4" Wide Stiles and Rails
- Mortise and Tenon Joints
- 3/4" Solid Hardwood Slab Drawer Front

- When opaques are specified, the door and/or drawer front center panel may be constructed of Medium Density Fiberboard (MDF). MDF provides a smoother finish when painted, and is more resistant to warping, expansion, and contraction. Facings may consist of other hardwood components.
- See page 28 for 5-piece drawer front dimensions when specifying decorative hardware.

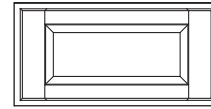

Optional 5-piece Drawer Front (DFF5PC)

## Lawry Collection – Cherry, Hickory, Maple

## Traditional Overlay Door Styles

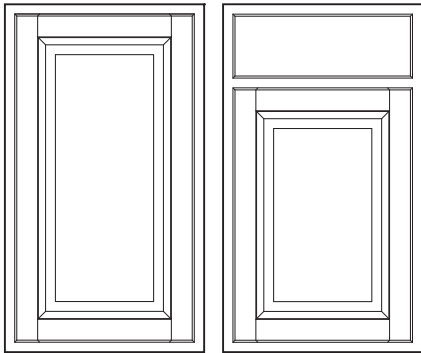

Square Wall

Square Base

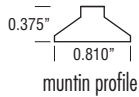

muntin profile

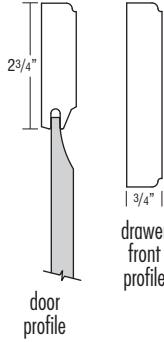

door profile

drawer front profile

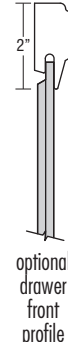

optional drawer front profile

### Door Style

Cherry  
Hickory  
Maple

- Square Wall and Square Base Doors
- 7/16" Veneer Raised Center Panel in 3/4" Hardwood Frame
- 2 3/4" Wide Stiles and Rails
- Mortise and Tenon Joints
- 3/4" Solid Hardwood Slab Drawer Front

- When opaques are specified, the door and/or drawer front center panel may be constructed of Medium Density Fiberboard (MDF). MDF provides a smoother finish when painted, and is more resistant to warping, expansion, and contraction. Facings may consist of other hardwood components.
- See page 28 for 5-piece drawer front dimensions when specifying decorative hardware.

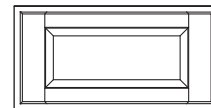

Optional 5-piece Drawer Front (DFF5PC)

# DOOR STYLES

## Madison Collection – Cherry, Maple

## Modified Full Overlay Door Styles

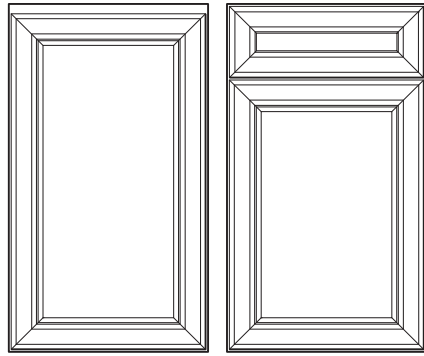

Square Wall Square Base

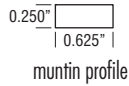

muntin profile

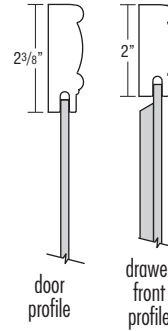

door profile

drawer front profile

**Door Style**  
Cherry  
Maple

- Square Wall and Square Base Doors
- 3/16" Veneer Recessed Center Panel in 3/4" Hardwood Frame
- 45° Mitered Joints
- 3/4" Solid Hardwood 5-piece Drawer Front with 1/2" Solid Hardwood Center Panel

- When opaques are specified, the door and/or drawer front center panel may be constructed of Medium Density Fiberboard (MDF). MDF provides a smoother finish when painted, and is more resistant to warping, expansion, and contraction. Facings may consist of other hardwood components.
- See page 28 for 5-piece drawer front dimensions when specifying decorative hardware.

## Montella Collection – Cherry, Maple, Oak

## Modified Full Overlay Door Styles

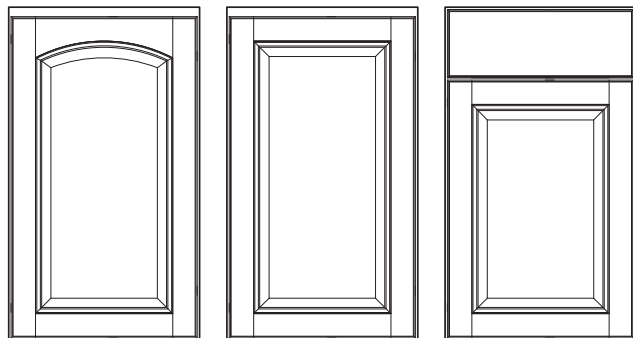

Arch Wall Square Wall Square Base

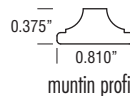

muntin profile

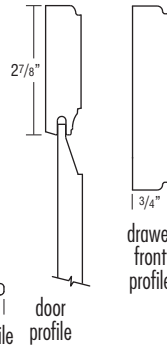

door profile

drawer front profile

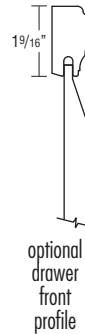

optional drawer front profile

**Door Style**  
Cherry Arch  
Cherry Square  
Maple Arch  
Maple Square  
Oak Arch  
Oak Square

- Arch or Square Wall and Square Base Doors
- 9/16" Solid Hardwood Center Panel in 3/4" Hardwood Frame
- 2 7/8" Wide Stiles and Rails
- Mortise and Tenon Joints
- 3/4" Solid Hardwood Slab Drawer Front

- When opaques are specified, the door and/or drawer front center panel may be constructed of Medium Density Fiberboard (MDF). MDF provides a smoother finish when painted, and is more resistant to warping, expansion, and contraction. Facings may consist of other hardwood components.
- See page 28 for 5-piece drawer front dimensions when specifying decorative hardware.

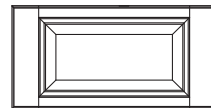

Optional 5-piece Drawer Front (DFR5PC)

Note: Arch door profiles available on wall and tall cabinets (top section only), not available on base and vanity cabinets.

# DOOR STYLES

## Ogilby Collection – Cherry, Hickory, Maple, Oak

## Modified Full Overlay Door Styles

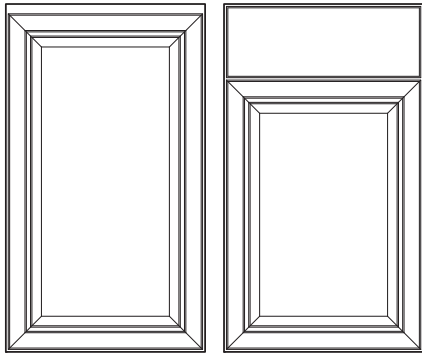

Square Wall

Square Base

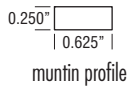

muntin profile

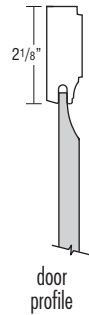

door profile

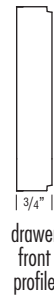

drawer front profile

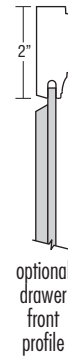

optional drawer front profile

### Door Style

Cherry  
Hickory  
Maple  
Oak

- Square Wall and Square Base Doors
- 7/16" Veneer Raised Center Panel in 3/4" Hardwood Frame
- 45° Mitered Joints
- 3/4" Solid Slab Hardwood Drawer Front

- When opaques are specified, the door and/or drawer front center panel may be constructed of Medium Density Fiberboard (MDF). MDF provides a smoother finish when painted, and is more resistant to warping, expansion, and contraction. Facings may consist of other hardwood components.
- See page 28 for 5-piece drawer front dimensions when specifying decorative hardware.

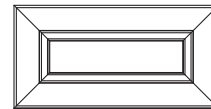

Optional 5-piece Drawer Front (DFF5PC)

## Rainier Collection – Cherry, Maple

## Modified Full Overlay Door Styles

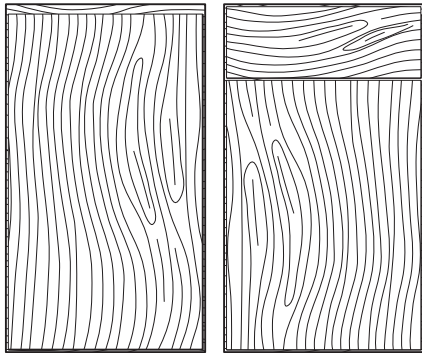

Slab Wall

Slab Base



door and drawer front profile

### Door Style

Cherry  
Maple

- Slab Wall and Slab Base Doors
- 23/32" Furniture Board Core with Architectural Grade Veneers on the Face and Back

- 1/8" Solid-wood Banding with Eased Edge



# DOOR STYLES

## Sedona Collection – Cherry, Hickory, Maple, Oak, Rustic Hickory

## Modified Full Overlay Door Styles

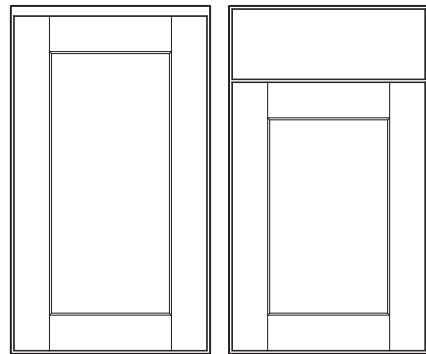

Square Wall

Square Base

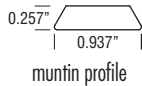

muntin profile

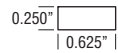

Prairie muntin profile

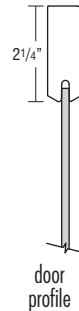

door profile



drawer front profile

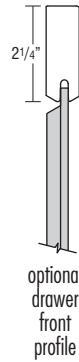

optional drawer front profile

### Door Style

Cherry  
Hickory  
Maple  
Oak  
Rustic Hickory

- Square Wall and Square Base Doors
- 3/16" Veneer Recessed Center Panel in 3/4" Hardwood Frame
- Mortise and Tenon Joints
- 3/4" Solid Hardwood Slab Drawer Front
- 1/2" Solid Hardwood Reverse Raised 5-piece Drawer Front

- When Rustic Hickory is specified, the center panel will have rustic characteristics with the exception of open knots or openings that would expose the panel core.
- When opaques are specified, the door and/or drawer front center panel may be constructed of Medium Density Fiberboard (MDF). MDF provides a smoother finish when painted, and is more resistant to warping, expansion, and contraction. Facings may consist of other hardwood components.
- See page 28 for 5-piece drawer front dimensions when specifying decorative hardware.

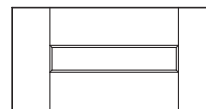

Optional 5-piece Drawer Front (DFF5PC)

## Sedona – Thermofoil

## Modified Full Overlay Door Styles

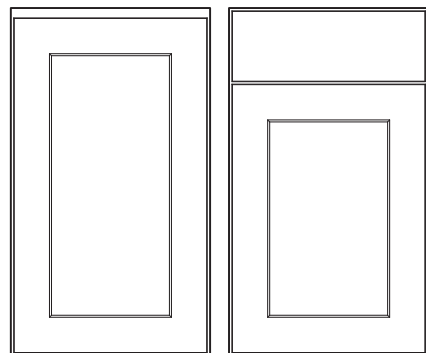

Square Wall

Square Base

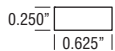

muntin profile

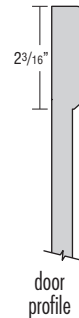

door profile



drawer front profile

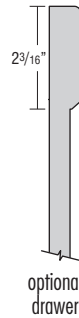

optional drawer front profile

### Door Style

Thermofoil

- Square Wall and Square Base Doors
- 3/4" Medium Density Fiberboard
- Color Matched, Laminated Melamine Back
- See page 28 for 5-piece drawer front dimensions when specifying decorative hardware.

Note: Thermofoil will not withstand sustained temperatures in excess of 170 degrees F. A 3" filler or heat shield is required between any thermofoil surface and any heat source to be in compliance with cabinet warranty. Failure to use a 3" filler or heat shield will void the cabinet warranty.

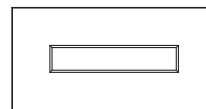

Optional 5-piece Drawer Front (DFF5PC)

# DOOR STYLES

## Tennyson Collection – Cherry, Maple, Oak

## Modified Full Overlay Door Styles

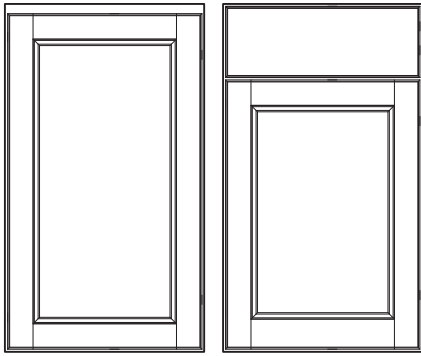

Square Wall

Square Base

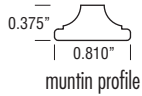

muntin profile

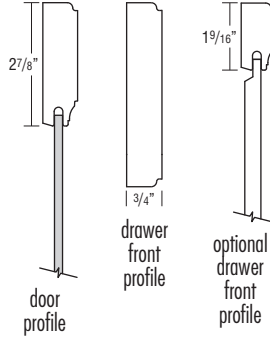

door profile

drawer front profile



optional drawer front profile

### Door Style

Cherry  
Maple  
Oak

- Square Wall and Square Base Doors
- 3/16" Veneer Recessed Center Panel in 3/4" Hardwood Frame
- 2 7/8" Wide Stiles and Rails
- Mortise and Tenon Joints
- 3/4" Solid Hardwood Slab Drawer Front

- When opaques are specified, the door and/or drawer front center panel may be constructed of Medium Density Fiberboard (MDF). MDF provides a smoother finish when painted, and is more resistant to warping, expansion, and contraction. Facings may consist of other hardwood components.
- See page 28 for 5-piece drawer front dimensions when specifying decorative hardware.



Optional 5-piece Drawer Front (DFF5PC)

## Warner Collection – Cherry, Maple

## Modified Full Overlay Door Styles

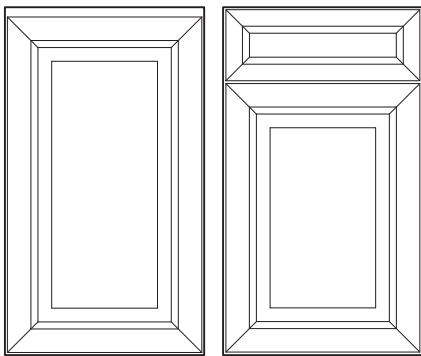

Square Wall

Square Base

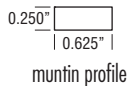

muntin profile

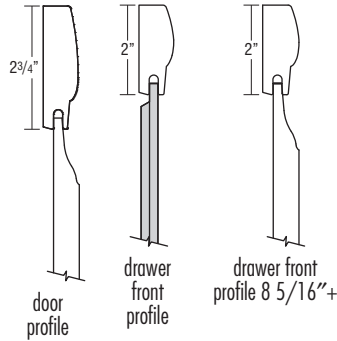

door profile

drawer front profile

drawer front profile 8 5/16"+

### Door Style

Cherry  
Maple

- Square Wall and Square Base Doors
- 9/16" Solid Hardwood Raised Center Panel in 3/4" Hardwood Frame
- 2 3/4" Wide Stiles and Rails
- 45° Mitered Joints
- 3/4" Solid Hardwood 5-piece Drawer Front

- When opaques are specified, the door and/or drawer front center panel may be constructed of Medium Density Fiberboard (MDF). MDF provides a smoother finish when painted, and is more resistant to warping, expansion, and contraction. Facings may consist of other hardwood components.
- See page 28 for 5-piece drawer front dimensions when specifying decorative hardware.

# DOOR STYLES

## Westlake Collection – Cherry, Maple

## Modified Full Overlay Door Styles

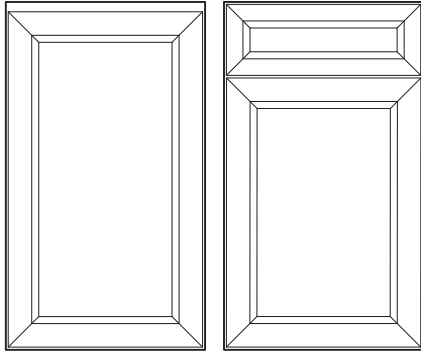

Square Wall

Square Base

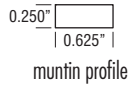

muntin profile

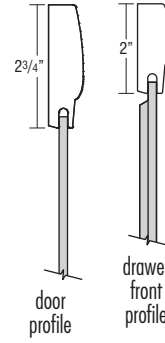

door profile

drawer front profile

### Door Style

Cherry  
Maple

- Square Wall and Square Base Doors
- 3/16" Veneer Recessed Center Panel in 3/4" Hardwood Frame
- 2 3/4" Wide Stiles and Rails
- 45° Mitered Joints
- 3/4" Solid Hardwood 5-piece Drawer Front

- When opaques are specified, the door and/or drawer front center panel may be constructed of Medium Density Fiberboard (MDF). MDF provides a smoother finish when painted, and is more resistant to warping, expansion, and contraction. Facings may consist of other hardwood components.
- See page 28 for 5-piece drawer front dimensions when specifying decorative hardware.

## FINISH PROCESS AND CHARACTERISTICS

We put our finishes to the test. Homecrest's multi-step finish is both beautiful and durable. To test the UV/oven-cured catalyzed varnish finish, twenty-six different household chemicals and agents were used. Three cc of each chemical/agent were applied to a test door and covered for a 24-hour period. Then the agent was washed off to determine the effect it had on the finish.

The results are impressive. Homecrest passed each and every test, exceeding all specifications by the Kitchen Cabinet Manufacturers Association, (ANSI/KCMA A161.1-2012).

### HOMECREST CABINETY FINISHING PROCESS

- 1. Wood Selection** – The selection of the finest woods including oak, maple, cherry, and hickory is the essential first step of Homecrest's finishing process.
- 2. Sanded to Perfection** – Our sanding utilizes an ultra fine grit paper, both with and against the wood grain. This process is completed on a vacuum table, allowing for a wood surface that is free of all dust particles.
- 3. Stain Application** – An environmentally safe stain is evenly applied to all surfaces. This deep penetrating stain is applied for even coverage on all profiles.
- 4. Removal of Excess Stain** – The wood is brushed to remove excess stain, emphasizing the cabinet's natural wood grain (where applicable).
- 5. Sanding Sealer** – A coat of tough, non-yellowing, sealer is applied to protect the grain from moisture.
- 6. Drying Process** – For added durability, the sealed wood is cured to lock in the beauty of wood.
- 7. Hand-Sanded** – To achieve an ultra-smooth finish, the wood is hand-sanded one last time.
- 8. Dust Removal** – The resulting dust is removed with both manual and automatic processes, which remove loose particles from the surface of the wood.
- 9. Top Coat** – A second application of a premium quality top coat is applied to protect the wood from yellowing and other environmental elements.
- 10. UV/Oven Cure** – The top coat is UV/oven cured to guarantee the strongest, most beautiful finish.
- 11. Final Inspection** – This last, thorough, inspection ensures lasting quality and beauty. Our gift to you is that every cabinet is crafted with care.

### CHARACTERISTICS OF GLAZING/PAINT

#### Characteristics of Glazing

A professional layer of glaze can add another layer of beauty to your cabinets. Homecrest's hand-detailed glaze application adds depth and dimension to cabinet appearance by highlighting the profile of your door style choice.



What to expect from glazed cabinetry...

- Hand-detailed glazing will leave a consistent, "penned" appearance around the profile.
- You should expect the result to yield a subtle to dramatic look based on the complexity of the cabinet design.
- Printed materials and online, electronic presentations can only do so much. It is important to both see and touch actual finished samples to ensure your satisfaction.

#### Characteristics of Opaque Finishes

Paint may develop hairline cracks in the finish, most notable around the joints. This is a result of natural expansion and contraction of the genuine hardwoods used in the manufacturing of this product. Hairline cracks are not considered a defect in the cabinetry or finish and will not be considered a reason for product replacement. A signed Opaque Finish Awareness Agreement is required for all Opaque orders — found on page 201.

# FINISH AVAILABILITY

Maple		Arbor	Bayport	Bexley	Brenner	Dover	Eastport	Heartland	Heritage	Hershing	Jordan	Laurel	Lautner	Lawry	Madison	Montella	Ogilby	Rainier	Sedona	Tennyson	Warner	Westlake
<b>Standard Finishes</b>	<b>Anchor</b>	✓	✓	✓	✓	✓	✓	✓	✓	✓	✓	✓	✓	✓	✓	✓	✓	✓	✓	✓	✓	✓
	<b>Bison</b>	✓	✓	✓	✓	✓	✓	✓	✓	✓	✓	✓	✓	✓	✓	✓	✓	✓	✓	✓	✓	✓
	<b>Buckboard</b>	✓	✓	✓	✓	✓	✓	✓	✓	✓	✓	✓	✓	✓	✓	✓	✓	✓	✓	✓	✓	✓
	<b>Derby</b>	✓	✓	✓	✓	✓	✓	✓	✓	✓	✓	✓	✓	✓	✓	✓	✓	✓	✓	✓	✓	✓
	<b>Fallow</b> 	✓	✓	✓	✓	✓	✓	✓	✓	✓	✓	✓	✓	✓	✓	✓	✓	✓	✓	✓	✓	✓
	<b>Java</b>	✓	✓	✓	✓	✓	✓	✓	✓	✓	✓	✓	✓	✓	✓	✓	✓	✓	✓	✓	✓	✓
	<b>Karoo</b>	✓	✓	✓	✓	✓	✓	✓	✓	✓	✓	✓	✓	✓	✓	✓	✓	✓	✓	✓	✓	✓
	<b>Natural</b>	✓	✓	✓	✓	✓	✓	✓	✓	✓	✓	✓	✓	✓	✓	✓	✓	✓	✓	✓	✓	✓
	<b>Nectar</b>	✓	✓	✓	✓	✓	✓	✓	✓	✓	✓	✓	✓	✓	✓	✓	✓	✓	✓	✓	✓	✓
	<b>Porter</b>	✓	✓	✓	✓	✓	✓	✓	✓	✓	✓	✓	✓	✓	✓	✓	✓	✓	✓	✓	✓	✓
	<b>Sorrel</b>	✓	✓	✓	✓	✓	✓	✓	✓	✓	✓	✓	✓	✓	✓	✓	✓	✓	✓	✓	✓	✓
	<b>Terrain</b>	✓	✓	✓	✓	✓	✓	✓	✓	✓	✓	✓	✓	✓	✓	✓	✓	✓	✓	✓	✓	✓
	<b>Toffee</b>	✓	✓	✓	✓	✓	✓	✓	✓	✓	✓	✓	✓	✓	✓	✓	✓	✓	✓	✓	✓	✓
<b>Wood Tone Glazes*</b>	<b>Brownstone</b>	✓	✓	✓	✓	✓	✓	✓	✓	✓	✓	✓	✓	✓	✓	✓	✓		✓	✓	✓	✓
	<b>Cocoa</b>	✓	✓	✓	✓	✓	✓	✓	✓	✓	✓	✓	✓	✓	✓	✓	✓		✓	✓	✓	✓
	<b>Ebony</b>	✓	✓	✓	✓	✓	✓	✓	✓	✓	✓	✓	✓	✓	✓	✓	✓		✓	✓	✓	✓
	<b>Husk</b>	✓	✓	✓	✓	✓	✓	✓	✓	✓	✓	✓	✓	✓	✓	✓	✓		✓	✓	✓	✓
	<b>Rye</b>	✓	✓	✓	✓	✓	✓	✓	✓	✓	✓	✓	✓	✓	✓	✓	✓		✓	✓	✓	✓
	<b>Smoke</b>	✓	✓	✓	✓	✓	✓	✓	✓	✓	✓	✓	✓	✓	✓	✓	✓		✓	✓	✓	✓
<b>Opaque</b>	<b>Aloe</b>	✓	✓	✓	✓	✓	✓	✓	✓	✓	✓	✓	✓	✓	✓	✓	✓		✓	✓	✓	✓
	<b>Alpine</b>	✓	✓	✓	✓	✓	✓	✓	✓	✓	✓	✓	✓	✓	✓	✓	✓	✓	✓	✓	✓	✓
	<b>Cadet</b>	✓	✓	✓	✓	✓	✓	✓	✓	✓	✓	✓	✓	✓	✓	✓	✓	✓	✓	✓	✓	✓
	<b>French Vanilla</b>	✓	✓	✓	✓	✓	✓	✓	✓	✓	✓	✓	✓	✓	✓	✓	✓	✓	✓	✓	✓	✓
	<b>Galaxy</b> 	✓	✓	✓	✓	✓	✓	✓	✓	✓	✓	✓	✓	✓	✓	✓	✓		✓	✓	✓	✓
	<b>Onyx</b>	✓	✓	✓	✓	✓	✓	✓	✓	✓	✓	✓	✓	✓	✓	✓	✓		✓	✓	✓	✓
	<b>Sand Dollar</b>	✓	✓	✓	✓	✓	✓	✓	✓	✓	✓	✓	✓	✓	✓	✓	✓	✓	✓	✓	✓	✓
	<b>Willow</b>	✓	✓	✓	✓	✓	✓	✓	✓	✓	✓	✓	✓	✓	✓	✓	✓	✓	✓	✓	✓	✓
<b>Opaque Glazes*</b>	<b>Brownstone</b>	✓	✓	✓	✓	✓	✓	✓	✓	✓	✓	✓	✓	✓	✓	✓	✓		✓	✓	✓	✓
	<b>Cocoa</b>	✓	✓	✓	✓	✓	✓	✓	✓	✓	✓	✓	✓	✓	✓	✓	✓		✓	✓	✓	✓
	<b>Ebony</b>	✓	✓	✓	✓	✓	✓	✓	✓	✓	✓	✓	✓	✓	✓	✓	✓		✓	✓	✓	✓
	<b>Husk</b>	✓	✓	✓	✓	✓	✓	✓	✓	✓	✓	✓	✓	✓	✓	✓	✓		✓	✓	✓	✓
	<b>Rye</b>	✓	✓	✓	✓	✓	✓	✓	✓	✓	✓	✓	✓	✓	✓	✓	✓		✓	✓	✓	✓
	<b>Smoke</b>	✓	✓	✓	✓	✓	✓	✓	✓	✓	✓	✓	✓	✓	✓	✓	✓		✓	✓	✓	✓

\*Glazes available on all Standard Finishes and Opaques

When opaques are specified, the door and/or drawer front center panel may be constructed of Medium Density Fiberboard (MDF). MDF provides a smoother finish when painted, and is more resistant to warping, expansion, and contraction. Facings may consist of other hardwood components.

Exteriors are laminate that match the color of the face frame with the exception of Aloe, Cadet, and Onyx. These finishes have natural Maple exteriors.

▲Coming Q2 2019

## FINISH AVAILABILITY

Cherry		Arbor	Bayport	Bexley	Brenner	Dover	Eastport	Heartland	Heritage	Hershing	Jordan	Laurel	Lautner	Lawry	Madison	Montella	Ogilby	Rainier	Sedona	Tennyson	Warner	Westlake
		<b>Standard Finishes</b>	<b>Anchor</b>	✓	✓	✓	✓	✓	✓	✓	✓	✓	✓	✓	✓	✓	✓	✓	✓	✓	✓	✓
	<b>Bison</b>	✓	✓	✓	✓	✓	✓	✓	✓	✓	✓	✓	✓	✓	✓	✓	✓	✓	✓	✓	✓	✓
	<b>Buckboard</b>	✓	✓	✓	✓	✓	✓	✓	✓	✓	✓	✓	✓	✓	✓	✓	✓	✓	✓	✓	✓	✓
	<b>Chestnut</b>	✓	✓	✓	✓	✓	✓	✓	✓	✓	✓	✓	✓	✓	✓	✓	✓	✓	✓	✓	✓	✓
	<b>Cinnamon</b>	✓	✓	✓	✓	✓	✓	✓	✓	✓	✓	✓	✓	✓	✓	✓	✓	✓	✓	✓	✓	✓
	<b>Derby</b>	✓	✓	✓	✓	✓	✓	✓	✓	✓	✓	✓	✓	✓	✓	✓	✓	✓	✓	✓	✓	✓
	<b>Fallow</b> <sup>▲</sup> 	✓	✓	✓	✓	✓	✓	✓	✓	✓	✓	✓	✓	✓	✓	✓	✓	✓	✓	✓	✓	✓
	<b>Java</b>	✓	✓	✓	✓	✓	✓	✓	✓	✓	✓	✓	✓	✓	✓	✓	✓	✓	✓	✓	✓	✓
	<b>Karoo</b>	✓	✓	✓	✓	✓	✓	✓	✓	✓	✓	✓	✓	✓	✓	✓	✓	✓	✓	✓	✓	✓
	<b>Natural</b>	✓	✓	✓	✓	✓	✓	✓	✓	✓	✓	✓	✓	✓	✓	✓	✓	✓	✓	✓	✓	✓
	<b>Porter</b>	✓	✓	✓	✓	✓	✓	✓	✓	✓	✓	✓	✓	✓	✓	✓	✓	✓	✓	✓	✓	✓
	<b>Sorrel</b>	✓	✓	✓	✓	✓	✓	✓	✓	✓	✓	✓	✓	✓	✓	✓	✓	✓	✓	✓	✓	✓
	<b>Terrain</b>	✓	✓	✓	✓	✓	✓	✓	✓	✓	✓	✓	✓	✓	✓	✓	✓	✓	✓	✓	✓	✓
<b>Wood Tone Glazes*</b>	<b>Brownstone</b>	✓	✓	✓	✓	✓	✓	✓	✓	✓	✓	✓	✓	✓	✓	✓	✓		✓	✓	✓	✓
	<b>Cocoa</b>	✓	✓	✓	✓	✓	✓	✓	✓	✓	✓	✓	✓	✓	✓	✓	✓		✓	✓	✓	✓
	<b>Ebony</b>	✓	✓	✓	✓	✓	✓	✓	✓	✓	✓	✓	✓	✓	✓	✓	✓		✓	✓	✓	✓
	<b>Husk</b>	✓	✓	✓	✓	✓	✓	✓	✓	✓	✓	✓	✓	✓	✓	✓	✓		✓	✓	✓	✓
	<b>Rye</b>	✓	✓	✓	✓	✓	✓	✓	✓	✓	✓	✓	✓	✓	✓	✓	✓		✓	✓	✓	✓
	<b>Smoke</b>	✓	✓	✓	✓	✓	✓	✓	✓	✓	✓	✓	✓	✓	✓	✓	✓		✓	✓	✓	✓

\* Wood Tone Glazes available on all Standard Finishes

▲Coming Q2 2019

Hickory		Arbor	Bayport	Bexley	Dover	Heartland	Heritage	Hershing	Laurel	Lautner	Lawry	Ogilby	Sedona
		<b>Standard Finishes</b>	<b>Anchor</b>	✓	✓	✓	✓	✓	✓	✓	✓	✓	✓
	<b>Buckboard</b>	✓	✓	✓	✓	✓	✓	✓	✓	✓	✓	✓	✓
	<b>Chestnut</b>	✓	✓	✓	✓	✓	✓	✓	✓	✓	✓	✓	✓
	<b>Fallow</b> <sup>▲</sup> 	✓	✓	✓	✓	✓	✓	✓	✓	✓	✓	✓	✓
	<b>Honey</b>	✓	✓	✓	✓	✓	✓	✓	✓	✓	✓	✓	✓
	<b>Karoo</b>	✓	✓	✓	✓	✓	✓	✓	✓	✓	✓	✓	✓
	<b>Natural</b>	✓	✓	✓	✓	✓	✓	✓	✓	✓	✓	✓	✓
	<b>Nectar</b>	✓	✓	✓	✓	✓	✓	✓	✓	✓	✓	✓	✓
	<b>Porter</b>	✓	✓	✓	✓	✓	✓	✓	✓	✓	✓	✓	✓
	<b>Terrain</b>	✓	✓	✓	✓	✓	✓	✓	✓	✓	✓	✓	✓
	<b>Toffee</b>	✓	✓	✓	✓	✓	✓	✓	✓	✓	✓	✓	✓
<b>Wood Tone Glazes*</b>	<b>Brownstone</b>	✓	✓	✓	✓	✓	✓	✓	✓	✓	✓	✓	✓
	<b>Cocoa</b>	✓	✓	✓	✓	✓	✓	✓	✓	✓	✓	✓	✓
	<b>Ebony</b>	✓	✓	✓	✓	✓	✓	✓	✓	✓	✓	✓	✓
	<b>Husk</b>	✓	✓	✓	✓	✓	✓	✓	✓	✓	✓	✓	✓
	<b>Rye</b>	✓	✓	✓	✓	✓	✓	✓	✓	✓	✓	✓	✓
	<b>Smoke</b>	✓	✓	✓	✓	✓	✓	✓	✓	✓	✓	✓	✓

\* Wood Tone Glazes available on all Standard Finishes

▲Coming Q2 2019

## FINISH AVAILABILITY

<b>Rustic Hickory</b>		Arbor	Dover	Heritage	Sedona
<b>Standard Finishes</b>	<b>Anchor</b>	✓	✓	✓	✓
	<b>Buckboard</b>	✓	✓	✓	✓
	<b>Chestnut</b>	✓	✓	✓	✓
	<b>Fallow</b> 	✓	✓	✓	✓
	<b>Honey</b>	✓	✓	✓	✓
	<b>Karoo</b>	✓	✓	✓	✓
	<b>Natural</b>	✓	✓	✓	✓
	<b>Nectar</b>	✓	✓	✓	✓
	<b>Porter</b>	✓	✓	✓	✓
	<b>Terrain</b>	✓	✓	✓	✓
	<b>Toffee</b>	✓	✓	✓	✓
<b>Wood Tone Glazes*</b>	<b>Brownstone</b>	✓	✓	✓	✓
	<b>Cocoa</b>	✓	✓	✓	✓
	<b>Ebony</b>	✓	✓	✓	✓
	<b>Husk</b>	✓	✓	✓	✓
	<b>Rye</b>	✓	✓	✓	✓
	<b>Smoke</b>	✓	✓	✓	✓

\*Wood Tone Glazes available on all Standard Finishes.

▲Coming Q2 2019

<b>Oak</b>		Arbor	Brenner	Dover	Eastport	Heartland	Heritage	Hershing	Jordan	Laurel	Montella	Ogilby	Sedona	Tennyson
<b>Standard Finishes</b>	<b>Anchor</b>	✓	✓	✓	✓	✓	✓	✓	✓	✓	✓	✓	✓	✓
	<b>Buckboard</b>	✓	✓	✓	✓	✓	✓	✓	✓	✓	✓	✓	✓	✓
	<b>Chestnut</b>	✓	✓	✓	✓	✓	✓	✓	✓	✓	✓	✓	✓	✓
	<b>Derby</b>	✓	✓	✓	✓	✓	✓	✓	✓	✓	✓	✓	✓	✓
	<b>Fallow</b> 	✓	✓	✓	✓	✓	✓	✓	✓	✓	✓	✓	✓	✓
	<b>Honey</b>	✓	✓	✓	✓	✓	✓	✓	✓	✓	✓	✓	✓	✓
	<b>Karoo</b>	✓	✓	✓	✓	✓	✓	✓	✓	✓	✓	✓	✓	✓
	<b>Natural</b>	✓	✓	✓	✓	✓	✓	✓	✓	✓	✓	✓	✓	✓
	<b>Nectar</b>	✓	✓	✓	✓	✓	✓	✓	✓	✓	✓	✓	✓	✓
	<b>Porter</b>	✓	✓	✓	✓	✓	✓	✓	✓	✓	✓	✓	✓	✓
	<b>Terrain</b>	✓	✓	✓	✓	✓	✓	✓	✓	✓	✓	✓	✓	✓

▲Coming Q2 2019

<b>Thermofoil</b>		Cara	Harbour Court	Sedona
<b>Standard Finishes</b>	<b>Alpine</b>			✓
	<b>White</b>	✓	✓	
	<b>Willow</b>			✓

<b>Textured Laminate</b>		Juno
<b>Standard Finishes</b>	<b>Cavern w/Buckboard Cabinet Box</b>	✓
	<b>Tusk w/Anchor Cabinet Box</b>	✓

# CONSTRUCTION SPECIFICATIONS

	HOMECREST STANDARD	ALL-PLYWOOD CONSTRUCTION†
<b>Doors &amp; Drawer Fronts</b>	See "Door Styles" pages 7-19 for door and drawer front configuration and construction details.	
<b>Front Frames</b>	3/4" thick solid-wood stiles and rails.	
<b>Sta-Beam™</b>	The Sta-Beam method utilizes 3/8" furniture board dadoed into face frame, end panels and back panels.	The Sta-Beam method utilizes 3/8" plywood dadoed into face frame, end panels and back panels.
<b>Cabinet Sides</b>	1/2" furniture board with natural Maple laminate interiors and matching laminate exterior.	1/2" plywood with natural Maple laminate interior and matching laminate exterior.
<b>Cabinet Tops &amp; Bottoms (Wall &amp; Tall)</b>	3/8" furniture board with natural Maple laminate interior and exterior surfaces.	3/8" plywood with natural Maple laminate interior and exterior surfaces.
<b>Cabinet Bottoms (Base &amp; Vanity)</b>	3/8" furniture board with natural Maple laminate interior surface.	3/8" plywood with natural Maple laminate interior surface.
<b>Cabinet Backs</b>	3/8" furniture board with natural Maple laminate interior. Base cabinets have 3mm system holes for easy drawer and roll tray installation.	3/8" plywood with natural Maple laminate interior. Base cabinets have 3mm system holes for easy drawer and roll tray installation.
<b>Shelves</b>	3/4" thick laminated furniture board shelves feature PVC edgebanding to protect exposed edges. Adjustable in both wall and base cabinets.	3/4" thick laminated plywood shelves feature PVC edgebanding to protect exposed edges. Adjustable in both wall and base cabinet.
<b>Hinges</b>	Hinges: Fully concealed cup hinge; 6-way adjustable and self-closing. Optional: Fully concealed, integrated soft-close cup hinge (INTGH); 6-way adjustable and self-closing. Hinge features deactivation option.	
<b>Drawer Box Construction and Drawer Guide</b>	Furniture Board Drawer Box Option (FDRW3/4XSM): 1/2" thick, four-sided construction with 3/8" thick bottom. Epoxy-coated steel drawer guides wrap around drawer bottom 1/2" for added strength.  Wood Dovetail Drawer Box with SoftTouch Guide Option (WDRWPG): Four-sided clear coated solid hardwood drawer box with dovetailed construction and 5.2mm laminated plywood captured in drawer sides, front, and back. SoftTouch features a self-closing, full extension mechanism, with a cushion close feature which prevents the drawer from slamming. Adjustable steel undermount full extension drawer guide system is completely hidden.	
<b>Toekick</b>	Toekick area is unfinished furniture board, inset between the cabinet end panels. Matching laminated or veneered toekick overlay is available in 8' lengths.	Toekick area is unlaminated plywood, inset between the cabinet end panels. Matching laminated or veneered toekick overlay is available in 8' lengths.

## STANDARD CONSTRUCTION SPECIFICATIONS

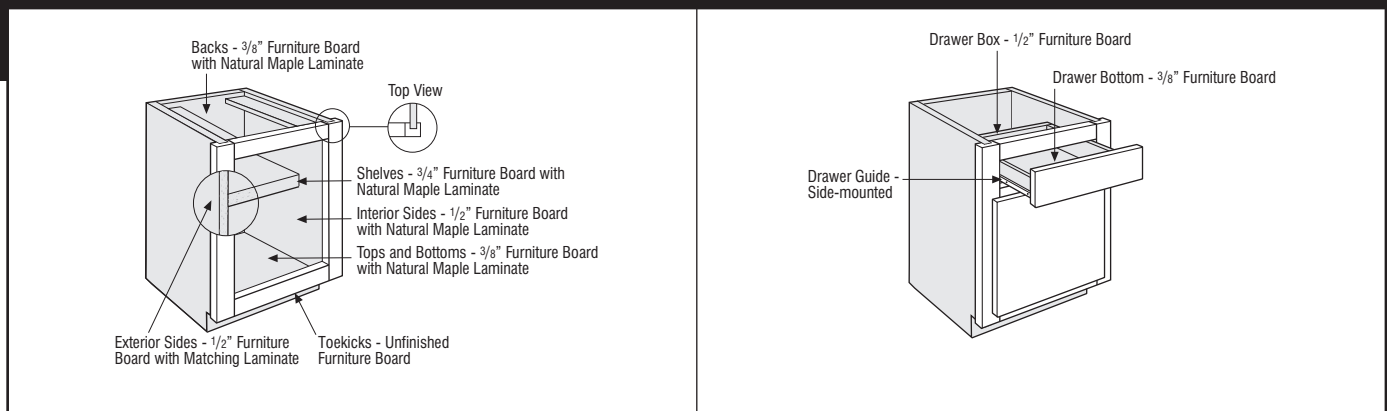

†All-plywood components meet ANSI/HPVA HP-1 standards and may contain MDF or particleboard.





# CONSTRUCTION OPTIONS

OPTION NAME	APPLICABLE CABINET GROUP	DESCRIPTION/LIMITATIONS
<b>Standard</b>		
<b>Laminate Ends (LE)</b>	Most wall, base, tall, other room, and vanity cabinets	1/2" thick furniture board with natural Maple laminate interiors. <b>Exteriors are laminate that match the color of the face frame with the exception of Aloe, Cadet, and Onyx. These finishes have natural Maple exteriors.</b>
<b>Upgrades</b>		
<b>All-plywood Finished (APF)<sup>†</sup></b>	Most wall, base, tall, other room, and vanity cabinets	1/2" thick plywood end panels have a matching veneer finished exterior and a natural Maple wood grain laminate interior. End panels are routed to receive tops, bottoms and backs which are secured with adhesives and/or fasteners.
<b>All-plywood Unfinished (APU)<sup>†</sup></b>	Most wall, base, tall, other room, and vanity cabinets	1/2" thick plywood end panels have a laminated natural Maple wood grain interior and unfinished exterior. End panels are routed to receive tops, bottoms and backs which are secured with adhesives and/or fasteners.
<b>Plywood Ends Finished (PEF)<sup>†</sup></b>	Most wall, base, tall, other room, and vanity cabinets	1/2" thick plywood end panels have a matching veneer exterior and a natural Maple wood grain laminate interior. End panels are routed to receive tops, bottoms and backs which are secured with adhesives and/or fasteners.
<b>Plywood Ends Unfinished (PEU)<sup>†</sup></b>	Most wall, base, tall, other room, and vanity cabinets	1/2" thick plywood end panels have a laminated natural Maple wood grain interior and unfinished exterior. End panels are routed to receive tops, bottoms and backs which are secured with adhesives and/or fasteners.

## ALL-PLYWOOD CONSTRUCTION (APF, APU)<sup>†</sup>

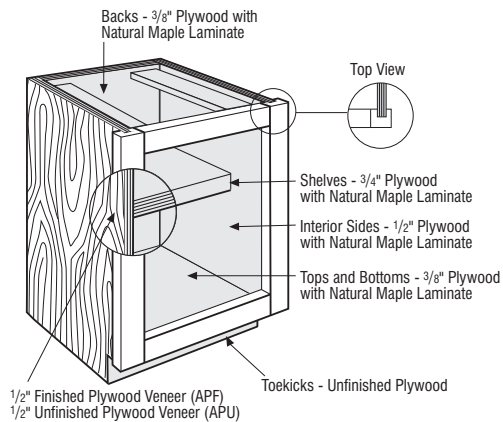

## PLYWOOD ENDS CONSTRUCTION UPGRADE (PEF, PEU)<sup>†</sup>

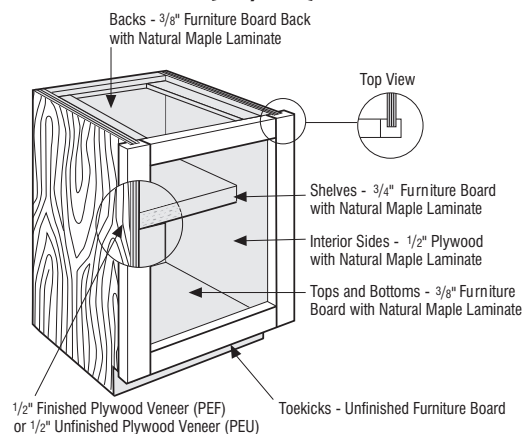

<sup>†</sup>All-plywood components meet ANSI/HPVA HP-1 standards and may contain MDF or particleboard.

## DRAWER, ROLL TRAY, AND HINGE OPTIONS

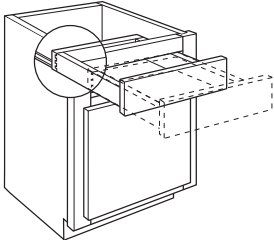
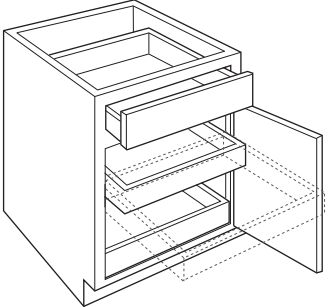
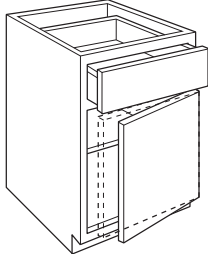
OPTION NAME	APPLICABLE CABINET GROUP	DESCRIPTION/LIMITATIONS
<b>Drawer</b>		
<b>Furniture Board Drawer (FDRW3/4XSM)</b>	Cabinets with drawers	1/2" thick, four-sided construction with 3/8" thick bottom. Epoxy-coated steel drawer guides wrap around drawer bottom 1/2" for added strength.
<b>Wood Dovetail Drawer w/SofTouch Guide (WDRWPG)</b>	Most cabinets with drawers	Replaces standard drawer and guide a four-sided clear coated solid hardwood drawer box with dovetailed construction and 5.2mm laminated plywood captured in drawer sides, front, and back. SofTouch features a self-closing, full extension mechanism, with a cushion close feature which prevents the drawer from slamming. Adjustable steel undermount full extension drawer guide system is completely hidden.
<b>Roll Tray</b>		
<b>Furniture Board Roll Tray (RTF)</b>	Select base, tall, other room, and vanity cabinets	Installs specified number of roll trays (1-5 per side). Example, for two roll trays, specify RTF2. Shelves will be replaced when Furniture Board Roll Tray is specified. Maximum of 4 roll trays per opening for base cabinets. Maximum of 5 roll trays per opening for utility cabinets. Availability for RTF is shown in the modification charts with RT.
<b>Wood Dovetail Roll Trays w/SofTouch Guide (RTPG)</b>	Select base, tall, other room, and vanity cabinets	Installs specified number of roll trays (1-5 per side). Example, for two roll trays, specify RTPG2. Shelves will be replaced when Wood Dovetail Roll Tray is specified. Maximum of 4 roll trays per opening for base cabinets. Maximum of 5 roll trays per opening for utility cabinets. Availability for RTPG is shown in the modification charts with RT.
<b>Hinge</b>		
<b>Integrated SofTouch Hinge (INTGH)</b>	Most cabinets with doors	Factory installed, 6-way adjustable hinge with integrated SofTouch feature.
<b>WOOD DOVETAIL DRAWER w/SOFTOUCH GUIDE (WDRWPG)</b>	<b>WOOD DOVETAIL ROLL TRAYS w/SOFTOUCH GUIDE (RTPG)</b>	
		
<b>INTEGRATED SOFTOUCH HINGE (INTGH)</b>		
		

Place Standard Modification nomenclature AFTER cabinet nomenclature and include any size dimension needed.

## DRAWER FRONT OPTIONS

OPTION NAME	APPLICABLE CABINET GROUP	DESCRIPTION/LIMITATIONS
<b>Drawer Front</b>		
<b>Drawer Front Flat 5-piece (DFF5PC)</b>	Base, tall, other room, and vanity cabinets on Bexley, Dover, Hershing, Jordan, Laurel, Lautner, Lawry, Ogilby, Sedona, and Tennyson	Replaces the standard drawer front with a 5-piece drawer front (see images with applicable door styles). Must upgrade all drawer fronts on a cabinet where applicable.
<b>Drawer Front Raised 5-piece (DFR5PC)</b>	Base, tall, other room, and vanity cabinets on Harbour Court and Montella	Replaces the standard drawer front with a slab drawer front (see images with applicable door styles). Must upgrade all drawer fronts on a cabinet where applicable.

Place Standard Modification nomenclature AFTER cabinet nomenclature and include any size dimension needed.

### 5-PIECE DRAWER FRONT DIMENSIONS CHART

5-PIECE DRAWER FRONTS	DRAWER FRONT WIDTH	DRAWER FRONT HEIGHT	PANEL FLAT WIDTH	PANEL FLAT HEIGHT
<b>Bexley</b>	8 1/2"	6 1/4"	3"	2 1/4"
<b>Brenner</b>	8 1/2"	6 1/4"	4 1/2"	2 1/4"
<b>Dover</b>	8 1/2"	6 1/4"	2 1/2"	1 3/4"
<b>Eastport</b>	8 1/2"	6 1/4"	3 3/4"	1 1/2"
<b>Harbour Court</b>	8 1/2"	6 1/4"	1 1/4"	1 3/8"
<b>Hershing</b>	8 1/2"	6 1/4"	2 3/4"	2 3/8"
<b>Jordan</b>	7"	5 1/2"	3"	1 1/2"
<b>Laurel</b>	7"	5 1/2"	3"	2 1/4"
<b>Lautner</b>	7"	5 1/2"	1 1/2"	1 1/2"
<b>Lawry</b>	7"	5 1/2"	1 1/2"	1 1/2"
<b>Madison</b>	8 1/2"	6 1/4"	4 1/2"	2 1/4"
<b>Montella</b>	8 1/2"	6 1/4"	7/8"	1 1/4"
<b>Ogilby</b>	8 1/2"	6 1/4"	4 1/2"	2 1/4"
<b>Sedona</b>	8 1/2"	6 1/4"	4"	1 3/4"
<b>Tennyson</b>	8 1/2"	6 1/4"	2 3/4"	3 1/8"
<b>Warner</b>	8 1/2"	6 1/4"	4 1/2"	2 1/4"
<b>Westlake</b>	8 1/2"	6 1/4"	4 1/2"	2 1/4"

Drawer front sizes are representative of a 9" wide base cabinet.

## END PANEL MODIFICATIONS

MODIFICATION NAME	APPLICABLE CABINET GROUP	DESCRIPTION/LIMITATIONS
<b>Authentic Ends (AUTHL) (AUTHR) (AUTHB)</b>	Wall, base, tall, other room, and vanity cabinets	<p>Modifies cabinet end panel(s) with applied decorative door(s) onto FPEB upgraded end panel(s).</p> <p>Includes FPEB modification; if AUTHL or AUTHR upgrades are specified, the opposite end panel is also FPEB.</p> <p>Available on most cabinets with depths of 12", 15", 18", 21", and 24".</p> <p>12" and 15" high wall cabinets will have double door configuration on 21" and 24" deep applications.</p> <p>Decorative door for wall and tall cabinets will match style chosen on order, i.e., arch or square.</p> <p>Other room base cabinets (29" high) will have double door configuration when specified on 24" deep cabinets.</p>
<b>Furniture Finished Plywood Ends (FPEB)<sup>†</sup></b>	Wall, base, tall, other room, and vanity cabinets	<p>Replaces standard cabinet ends with 3/4" finished veneer end panels to achieve a furniture end appearance. APF upgrade included. Not available with extended stiles or cabinets with frameless construction.</p>

### AUTHENTIC ENDS (AUTHB/AUTHL/AUTHR)

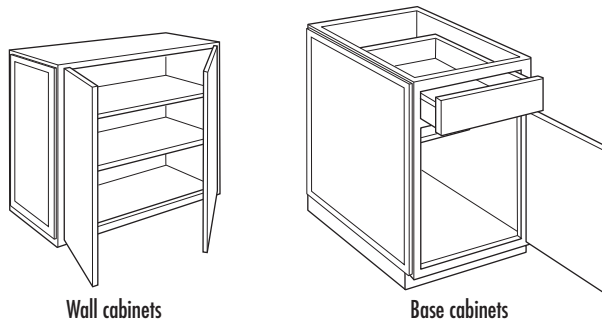



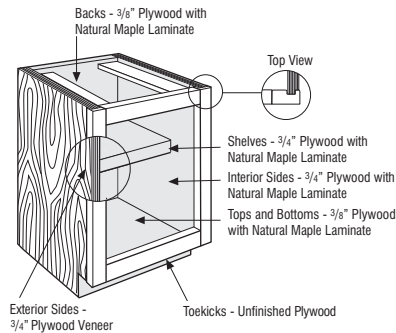

### FURNITURE FINISHED PLYWOOD END PANELS CONSTRUCTION UPGRADE (FPEB)<sup>†</sup>



Place Standard Modification nomenclature AFTER cabinet nomenclature and include any size dimension needed.

<sup>†</sup>All-plywood components meet ANSI/HPVA HP-1 standards and may contain MDF or particleboard.

# BOX MODIFICATIONS

MODIFICATION NAME	APPLICABLE CABINET GROUP	DESCRIPTION/LIMITATIONS
<b>Cabinet Box Only (CBO)</b> 	Most wall, base, tall, other room, and vanity cabinets	Removes doors, drawer fronts, and any accessory items attached to a door or drawer front. Drawer box and any interior components attached to the cabinet box will be included. Frames will not be drilled for hinges.
<b>Cabinet Case Only (CCO)</b> 	Most wall, base, tall, other room, and vanity cabinets	Removes doors, drawer fronts, drawers, and interior components. Frames will not be drilled for hinges.
<b>Cabinet Front Only (CFNTO)</b>	Most wall, base, tall, other room, and vanity cabinets	Creates a door and/or drawer front assembled with a frame.
<b>Cabinet False Panel (CFP)</b> 	Most base, tall, other room, and vanity cabinets with a top drawer	Replaces top drawer with false panel. Not available with deep drawers.
<b>Cabinet with No Door, with Drawer (CND)</b> 	Most wall, base, tall, other room, and vanity cabinets with door(s) and drawer(s)	Removes door(s). Complete drawer(s) with drawer front(s) and interior components remain in cabinet. Frames will not be drilled for hinges.

## CABINET BOX ONLY (CBO)

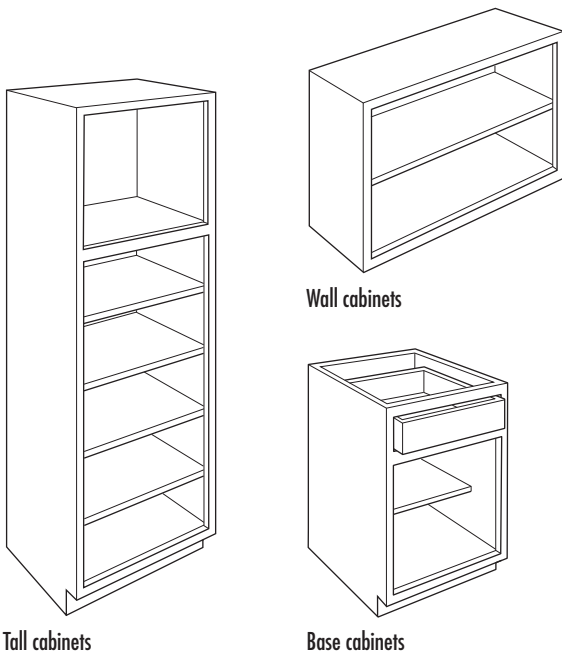

## CABINET CASE ONLY (CCO)

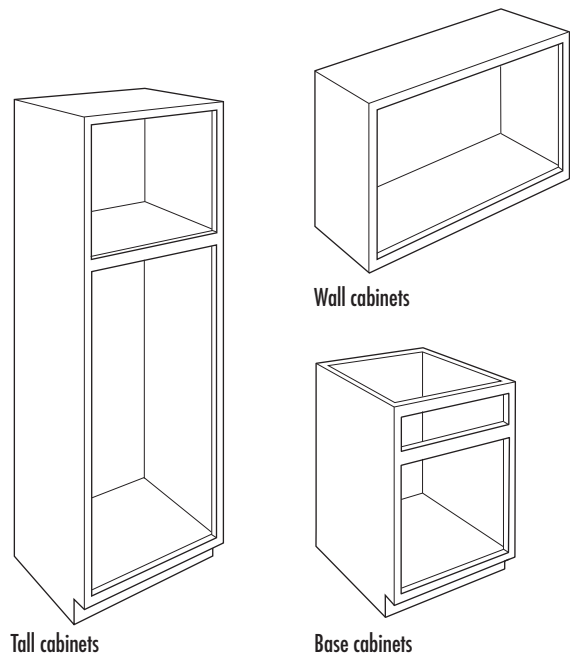

## CABINET FRONT ONLY (CFNTO)

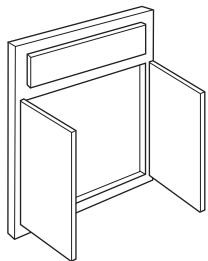

## CABINET FALSE PANEL (CFP)

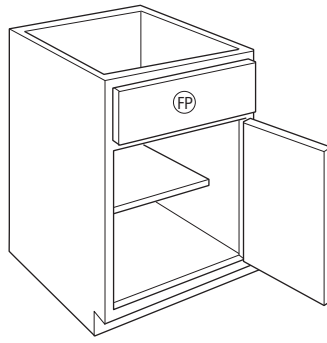

## CABINET WITH NO DOOR, WITH DRAWER (CND)

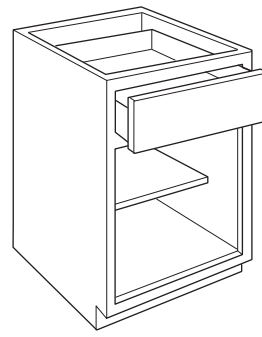

Place Standard Modification nomenclature AFTER cabinet nomenclature and include any size dimension needed.

## BOX MODIFICATIONS (cont'd)

MODIFICATION NAME	APPLICABLE CABINET GROUP	DESCRIPTION/LIMITATIONS
<b>Extended Stile (EXB) (EXL) (EXR)</b>	Most cabinets with a face frame	Creates up to 3" extended stile beyond its normal face frame width to achieve an overall frame width of 4 1/2". Stiles can be extended in 1/2" increments up to 3" per side. To extend a single stile, specify EXL or EXR. To extend both sides, specify EXB.
<b>Increased Depth (ID)*</b>	Most wall, other room, and vanity cabinets; select base cabinets	Increases the depth of wall cabinets to 15", 18", 21", or 24"; bookcases to 15", vanities to 24", and select base cabinets to 27".
	Most panels	Increases the depth in 3" increments to 30".
	Column box fillers	Increases the depth in 3" increments to 27".
<b>Inverted Frame (INVERM)</b>	Stacked wall cabinets and base cabinets with door and drawer combination	Inverts cabinet and places drawers at the bottom.

31

### EXTENDED STILE BOTH (EXB)

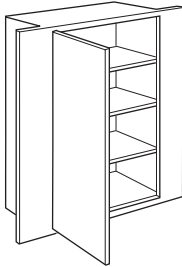

### EXTENDED STILE LEFT (EXL)

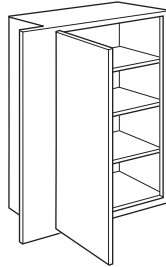

### EXTENDED STILE RIGHT (EXR)

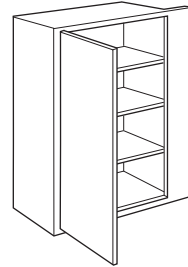

### INCREASED DEPTH (ID)

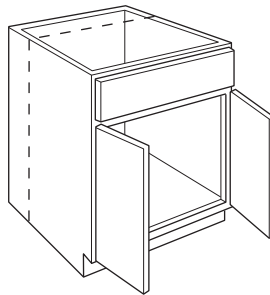

Vanity cabinets

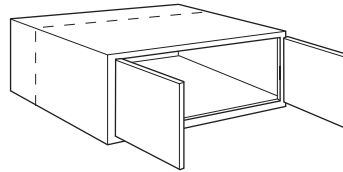

Wall cabinets

### INVERTED FRAME (INVERM)

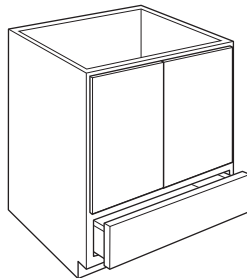

Base cabinets

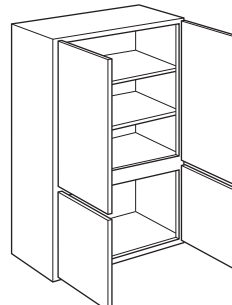

Wall cabinets

BOX MODIFICATIONS

Place Standard Modification nomenclature AFTER cabinet nomenclature and include any size dimension needed.

\*We recommend that all Increased Depth wall cabinets be installed with a minimum of three points of support, including at least on (or both) cabinet sides and either the cabinet top or the cabinet back.

## BOX MODIFICATIONS (cont'd)

MODIFICATION NAME	APPLICABLE CABINET GROUP	DESCRIPTION/LIMITATIONS
<b>Peninsula (P)</b>	Most wall and select base cabinets	Creates a 12 1/4" deep wall or a 24 1/4" deep base peninsula cabinet. Available on increased depth wall cabinets up to 18" deep. Single door cabinets are hinged on the same cabinet end, for example a W1230L will feature a Left hinge on the front side and a Right hinge on the peninsula side.
<b>Reduced Depth (RD)</b>	Most base, tall, other room, and vanity cabinets with drawers	Reduces the depth of base cabinets to 21", 18", 15", or 12". Talls can be reduced to 21", 18", or 15".
	Most wall, base, tall, other room, and vanity cabinets without drawers	Reduces the depth of wall cabinets to 9" or 6" and base cabinets without drawers to 21", 18", 15", or 12".
	Most end panels	Reduces the depth on most 12" deep panels, 9" or 6". Reduces the depth on most 24" deep panels, 21", 18", 15", or 12".
	Column box fillers	Reduces the depth in 3" increments to 6".
	Roll trays	Base cabinets - Reduced depth available on RTPG to 21", 18", 15", or 12". RTF can be reduced to 18". Utility cabinets - Reduced depth available on RTPG to 21", 18", or 15". RTF can be reduced to 18".

### PENINSULA (P)

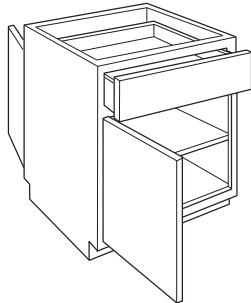

Base cabinets

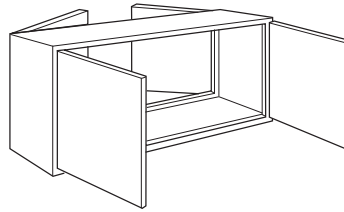

Wall cabinets

### REDUCED DEPTH (RD)

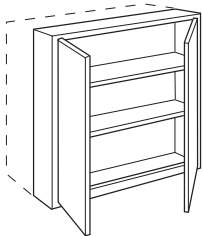

Wall cabinets

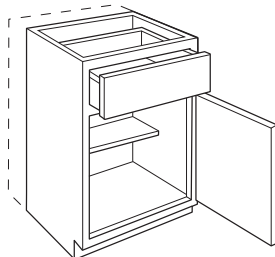

Base cabinets

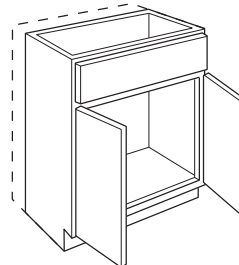

Vanity cabinets

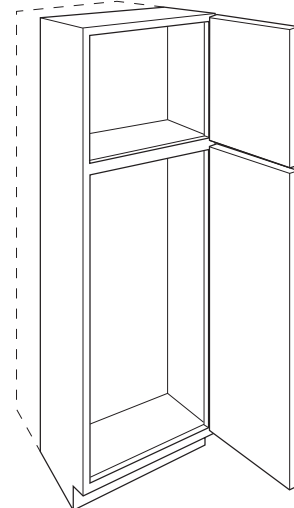

Tall cabinets

Place Standard Modification nomenclature AFTER cabinet nomenclature and include any size dimension needed.





# OVERLAY MODIFICATION

MODIFICATION NAME	APPLICABLE CABINET GROUP	DESCRIPTION/LIMITATIONS
<b>Full Overlay (FULL)</b> 	Modified full overlay styles of wall and tall cabinets; select other room and vanity cabinets	Changes wall and tall cabinet top frame reveal to 1/4" to align with base cabinet.

# INTERIOR MODIFICATIONS

MODIFICATION NAME	APPLICABLE CABINET GROUP	DESCRIPTION/LIMITATIONS
<b>Matching Interior (MI)</b>	Most cabinets	Finishes the interior and exterior of the cabinet. Side and back panel edges will be unfinished. Must order All Plywood Finished (APF) option. Base cabinets will include a full depth shelf.
<b>Installed Accessory (IN)</b>	Select base and vanity cabinets	Factory installed accessory. Available with CO24, TDRO12, TDRO15, TOT15, TOT18, WSDI18, WTC15, WTC18, WTC21, and WTC24 on select cabinets.
<b>Full Depth Shelf (FD)</b>	Most base cabinets; select other room cabinets	Replaces standard shelf with a full depth shelf.

## MATCHING INTERIOR (MI)

-  matching finished veneer
-  standard matching finished component
-  standard non-matching finished component

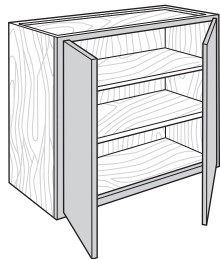

Wall cabinets

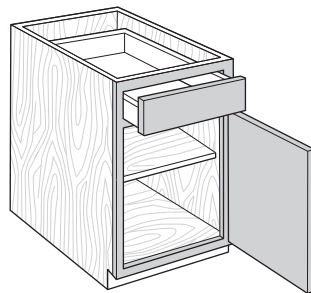

Base cabinets

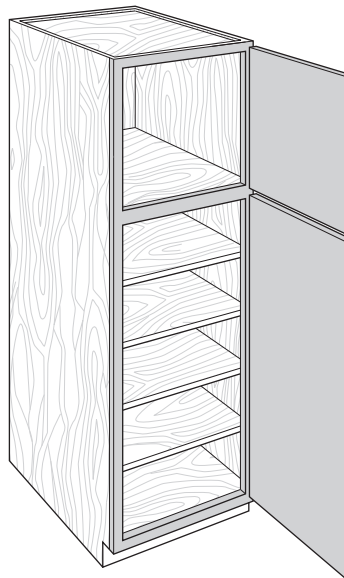

Tall cabinets

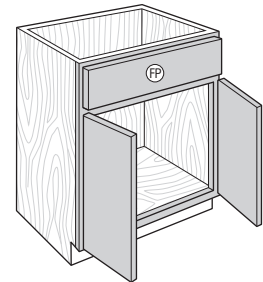

Vanity cabinets

## FULL DEPTH SHELF (FD)

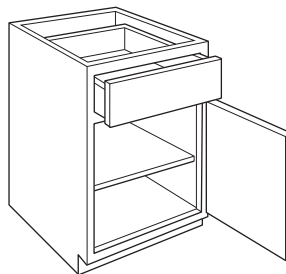

Place Standard Modification nomenclature AFTER cabinet nomenclature and include any size dimension needed.

# TOEKICK MODIFICATIONS

MODIFICATION NAME	APPLICABLE CABINET GROUP	DESCRIPTION/LIMITATIONS
<b>Add Toekick (ADDTK)</b>	Most wall cabinets	Creates a 4 1/2" high toekick on the front of the cabinet. Available with ID on depths 12" or greater.
<b>Flush Toekick (FTK)</b>	Most wall, base, tall, other room, and vanity cabinets	Extends the face frame to the floor eliminating the toe space.

34

## ADD TOEKICK (ADDTK)

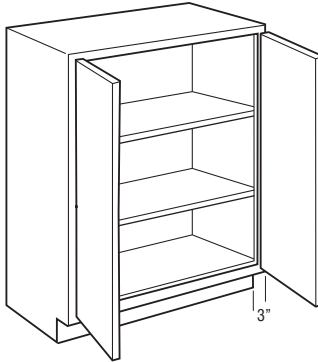

Wall cabinets

## FLUSH TOEKICK (FTK)

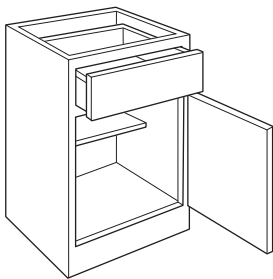

Base cabinets

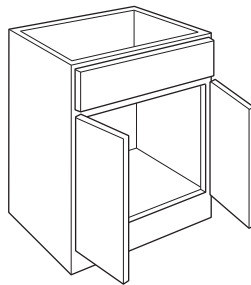

Vanity cabinets

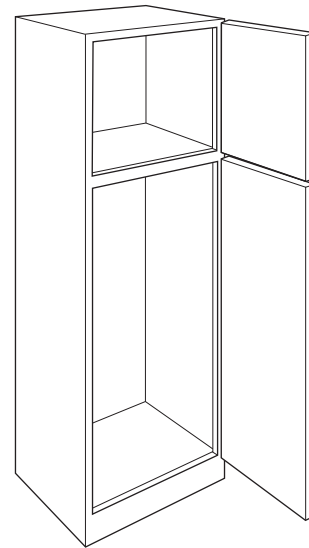

Tall cabinets

TOEKICK MODIFICATIONS

Place Standard Modification nomenclature AFTER cabinet nomenclature and include any size dimension needed.

## TOEKICK MODIFICATIONS (cont'd)

MODIFICATION NAME	APPLICABLE CABINET GROUP	DESCRIPTION/LIMITATIONS
<b>Recessed Toekick (RECTKBK) (RECTKL) (RECTKR)</b>	Most wall, base, tall, other room, and vanity cabinets	Creates a 3" recessed toekick on the back (RECTKBK), left (RECTKL), or right (RECTKR). Available on wall cabinets when ADDTK is specified.
<b>Island Toekick (RECTKALL)</b>	Base cabinets 27"-48" wide, 24" deep	Creates island toekick (toekick all 4 sides).
<b>Void Toekick (VTK)</b>	Most base, tall, other room, and vanity cabinets	Removes the toekick. When ordered on 93" or 96" high tall cabinets, pedestal will not be included.

35

### RECESSED TOEKICK LEFT (RECTKL)

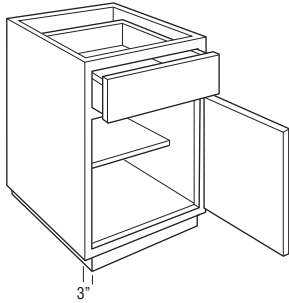

Base cabinets

### RECESSED TOEKICK RIGHT (RECTKR)

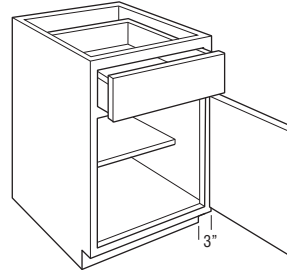

Base cabinets

### RECESSED TOEKICK BACK (RECTKBK)

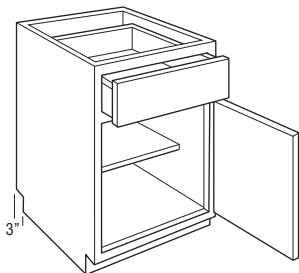

Base cabinets

### ISLAND TOEKICK (RECTKALL)

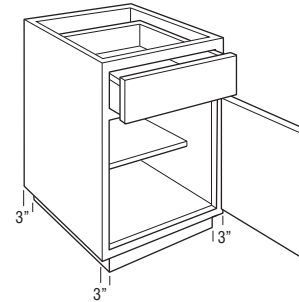

Base cabinets

### VOID TOEKICK (VTK)

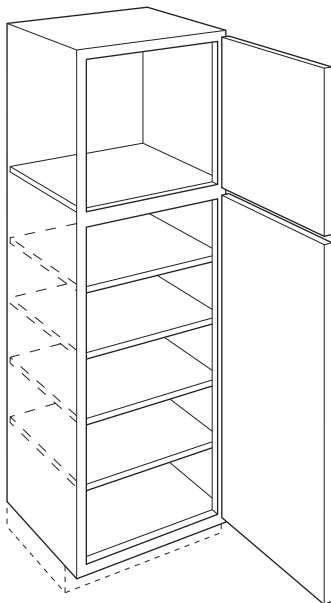

Tall cabinets

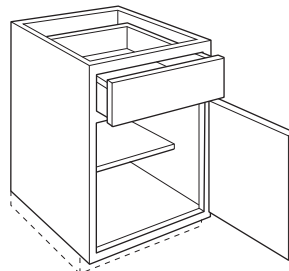

Base cabinets

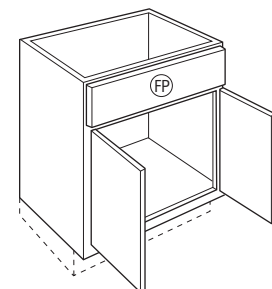

Vanity cabinets

TOEKICK MODIFICATIONS

Place Standard Modification nomenclature AFTER cabinet nomenclature and include any size dimension needed.

## ALUMINUM FRAME DOORS

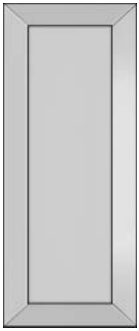

ALF  
Aluminum Frame Door  
in Aluminum finish  
with Frost glass

- Aluminum doors will be mitered construction.
- Cabinet face frame and end panels will be matched to the finish specified.
- When ordered as standard construction, cabinet will have standard interior unless ordered with MI option.
- When ordering upgraded construction, cabinet automatically will be ordered with MI and APF.
- Aluminum doors have an anodized finish.

### ALF AVAILABILITY

Cabinet Width	Cabinet Height					
	12"	15"	18"	21"	30"	36"
W12	N/A	N/A	N/A	N/A	✓	✓
W15	N/A	N/A	N/A	N/A	✓	✓
W18	N/A	N/A	N/A	N/A	✓	✓
W21	N/A	N/A	N/A	N/A	✓	✓
WTH30	✓	✓	✓	✓	N/A	N/A
WTH36	✓	✓	✓	✓	N/A	N/A

## MULLION DOORS

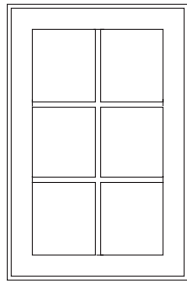

W\_MD  
Traditional Square

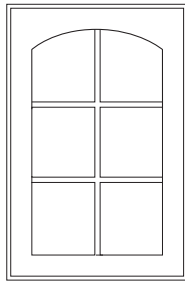

W\_MD  
Traditional Arch

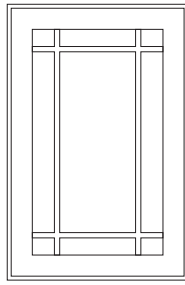

W\_PRMD  
Prairie Square

- Available with optional factory installed clear tempered or textured glass, see page 38.
- Mullion cabinets are shipped with retainer clips, although a preferred method of installation is the use of a silicone adhesive (not supplied).
- When ordered as standard construction, cabinet will have standard interior **unless** ordered with MI option.
- When ordering upgraded construction, cabinet automatically will be ordered with MI and APF.
- Juno and Rainier not available with Mullion Doors.
- See Modifications grids in the Wall section for availability.

## CUT-FOR-GLASS DOORS

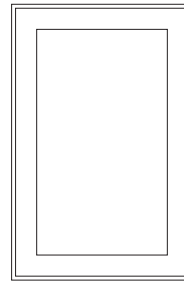

Cut-for-glass  
Doors Square

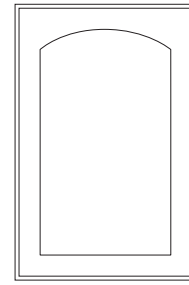

Cut-for-glass  
Doors Arch

- Cut-for-glass cabinets are shipped with retainer clips, although a preferred method of installation is the use of a silicone adhesive (not supplied).
- When ordered as standard construction, cabinet will have standard interior **unless** ordered with MI option.
- When ordering upgraded construction, cabinet automatically will be ordered with MI and APF.
- Glass not included, see page 38 for glass options.
- Juno is not available with Cut-for-glass Doors.
- See Modifications grids in the Wall section for availability.

### MULLION DOOR AVAILABILITY BY STYLE

Style	MD Traditional Mullion Door	PRMD Prairie Mullion Square Door
Arbor	✓*	✓
Bayport	✓*	✓
Bexley	✓*	
Brenner	✓	✓
Cara	✓*	
Dover	✓*	✓
Eastport	✓	✓
Harbour Court	✓*	
Heartland	✓*	✓
Heritage	✓*	✓
Hershing	✓	✓
Jordan	✓	✓
Laurel	✓*	✓
Lautner	✓*	
Lawry	✓*	
Madison	✓	✓
Montella	✓*	
Ogilby	✓	✓
Sedona (wood)	✓*	✓
Sedona Thermofoil		✓*
Tennyson	✓*	
Warner	✓	✓
Westlake	✓	✓

\*Fixed Mullion Grids (all other grids are removable).

### STACKED WALL SPECIALTY DOOR OPTIONS

Model	CGCG SDCG	CGSD SDSD	MDMD PDPD SDMD	MDS PDS SDP
STW12		✓		
STW15-42		✓		✓
STWD24-27		✓		✓
STWEC12		✓		✓

When ordering Specialty Doors for Stacked Wall Cabinets, please refer to the above chart for availability. Nomenclature represents top then bottom door options. See example below for details.

Ex. **SDMD**  
 Top Door Bottom Door  
 SD = Standard Door  
 MD = Mullion Door  
 PD = Prairie Mullion Door  
 CG = Cut-for-glass

# INSTALLED TEXTURED GLASS PANELS



Clear (CLEAR)



Antique (ANTIQ)



Bevel (BEVEL)\*



Frost (FROST)



Reeded (REEDE)



Rice Paper (RICEP)



Seeded (SEEDE)

TEXTURED GLASS PANELS	PANEL THICKNESS
Clear	1/8"
Antique	1/8"
Bevel*	1/4"
Frost	5/32"
Reeded	5/32"
Rice Paper	9/32"
Seeded	9/32"

\*Suggested to use with Square door styles.

- Mullion doors or Cut-for-glass doors must be ordered separately. See page 37.
- Mullion doors available with Clear, Reeded, Frost or Antique glass.
- Glass will be factory installed.
- On order acknowledgment, W3030B (cabinet description), CG-MD-PRMD (door style description), Clear (glass nomenclature).
- All glass is fully tempered or has a safety lamination.
- Door frame may reduce the amount of glass shown.
- When textured glass is ordered for use in wall top hinge (WTH) cabinets, the glass design will be turned horizontally and may not match the desired pattern.

## CUSTOM CHOICE CABINERY

With Homecrest's flexible manufacturing capabilities, Homecrest is able to produce cabinets and appliance cabinets & panels not listed in the specification guide. To utilize this process, please use the following procedures.

### Cabinets

- Complete the Custom Choice Request Form and provide a detailed drawing, including dimensions of the Custom Choice cabinet. Submitting a floor plan may reduce questions that arise during the engineering process.
- Fax (800.737.7800) or email (hccr@masterbrand.com) the Custom Choice Request Form to the Homecrest Customer Service Department.
- Approved custom configurations will be quoted and assigned a Custom Choice number. This information will be faxed or emailed to you. Engineering requires 48 hours to process the request and develop a quote.
- When placing the order, please include the Custom Choice number on the Homecrest Order Form.

### Notes

- Custom Choice items cannot be changed or cancelled once the order is placed.
- If specifications are altered, the Custom Choice item will need to be quoted again.
- Examples of custom cabinet configurations can be found on pages 41-44.

### Appliance Cabinets & Panels

- Appliance specifications are required from the designer.
- Fax (800.737.1500) or email (hccr@masterbrand.com) the Custom Choice Request Form to the Homecrest Customer Service Department.
- Engineering requires 48 hours to process the request and develop a quote. To expedite this process, please use the Custom Request Forms on page 40.

## CUSTOM CHOICE PRODUCT GUIDELINES

### Cabinet Dimensions

- Frames cannot be larger than 42" x 60" or 60" x 42".
- Adjustable shelves not available in cabinets wider than 36" without a center vertical.
- Maximum depth on tall cabinets and cabinets with drawers is 24".
- Maximum width:
  - bases - 60"
  - walls - 48"
  - talls - 36"
- Maximum height is 96".
- Frame angles cannot be altered or changed.

### Doors

- Custom Doors not available in Heartland, Juno, Lawry, Ogilby, or Sedona Thermofoil. Limitations exist on all styles.
- Mullion doors not available in custom sizes.
- Custom doors and drawer fronts are not available for cabinets not manufactured by Homecrest.
- Mixed door styles on a cabinet are not available.

### Drawers

- Drawers & Roll Trays available in existing sizes only.
- Minimum depth for drawers is 12".
- Maximum depth for drawers is 24".

### Other

- Applied mouldings not available.
- Countertops not available.
- Unfinished cabinets or finishes not in our standard offering not available.

## Custom Appliance Cabinets and Panels Worksheet.

**Note:** All preferences will be considered and standard cabinet components will be used. The microwave/oven opening size will determine top cabinet size.

### Microwave Cabinet

Overall cabinet size:

- A. \_\_\_\_\_ width
- B. \_\_\_\_\_ height
- C. \_\_\_\_\_ depth
- 1. Top cabinet (preferred height)
- D. \_\_\_\_\_ height
- 2. Microwave (opening required)
- E. \_\_\_\_\_ width
- F. \_\_\_\_\_ height
- 3. Actual microwave specs
- G. \_\_\_\_\_ width
- H. \_\_\_\_\_ height
- 4. Overall trim kit size
- I. \_\_\_\_\_ width
- J. \_\_\_\_\_ height
- 5. Drawer height
- K. \_\_\_\_\_ height

Will microwave be  
(built in) or (set in)?  
Please circle.

Extended (past cabinet bottom)  
Microwave Shelf -  
for 12" deep wall cabinet only.  
\_\_\_\_\_ yes \_\_\_\_\_ no

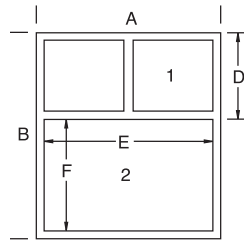
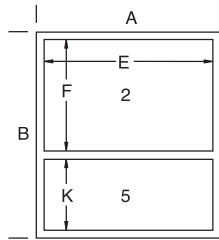
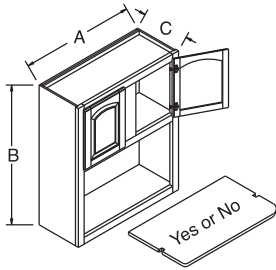

### Oven Cabinet

*Note: Oven cutouts are used to determine cabinet configuration. Whenever possible BD30D drawers will be used unless otherwise specified. Finished oven width may need to be cut on job site.*

Cabinet Size:

- A. \_\_\_\_\_ width
- B. \_\_\_\_\_ height

Wish List:

- 1. Top cabinet (preferred)
- C. \_\_\_\_\_ height
- 2. Microwave opening (option 2 only: will microwave be built-in or set-in?)

- D. \_\_\_\_\_ width
- E. \_\_\_\_\_ height

Wish List determined by this:

- 3. Oven opening (no standard)
- F. \_\_\_\_\_ width
- G. \_\_\_\_\_ height
- 4. Overall trim kit size
- H. \_\_\_\_\_ width
- I. \_\_\_\_\_ height
- 5. Bottom cabinet

Prefer doors:  
Doors: \_\_\_\_\_ yes or no \_\_\_\_\_  
Number of drawers \_\_\_\_\_

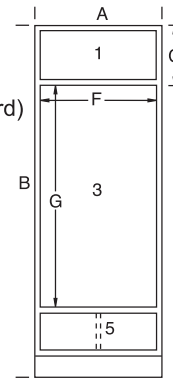

Single Oven  
Option 1

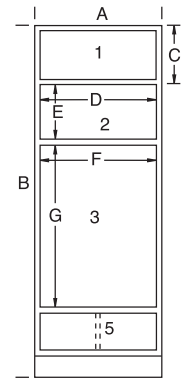

Oven/Microwave  
Combination  
Option 2

### Refrigerator Backer Panels

Manufacturer Backer Panel Sizes Required: Manufacturer Door Sizes Required:

- 1. A. \_\_\_\_\_ width
- B. \_\_\_\_\_ height
- 2. A. \_\_\_\_\_ width
- B. \_\_\_\_\_ height
- 3. A. \_\_\_\_\_ width
- B. \_\_\_\_\_ height

Grille (Top or Bottom) -  
Optional for all configurations

- 4. A. \_\_\_\_\_ width
- B. \_\_\_\_\_ height

- 1. A. \_\_\_\_\_ width
- B. \_\_\_\_\_ height
- 2. A. \_\_\_\_\_ width
- B. \_\_\_\_\_ height
- 3. A. \_\_\_\_\_ width
- B. \_\_\_\_\_ height

Grille (Top or Bottom) -  
Optional for all configurations

- 4. A. \_\_\_\_\_ width
- B. \_\_\_\_\_ height

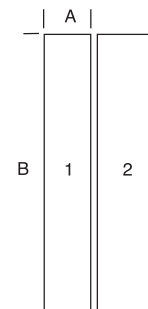
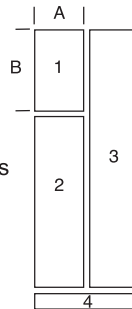

Sub Zero

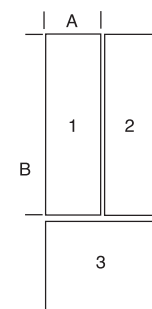

French Door

Must Have:

**NOTE: Customer must supply to receive quote.**

Manufacturer required handle clearance  
\_\_\_\_\_ inches

Required hinge clearance \_\_\_\_\_ inches

Doors & Drawer Fronts selected based on handle and hinge clearances and for creating the most appealing appearance.

Part No. 146760 12/07



# INTEGRATED WALL UNITS

Whenever possible, it is aesthetically pleasing and will reduce installation time to combine two stacked cabinets into one integrated face frame.

## Wall Cabinet + Organizer

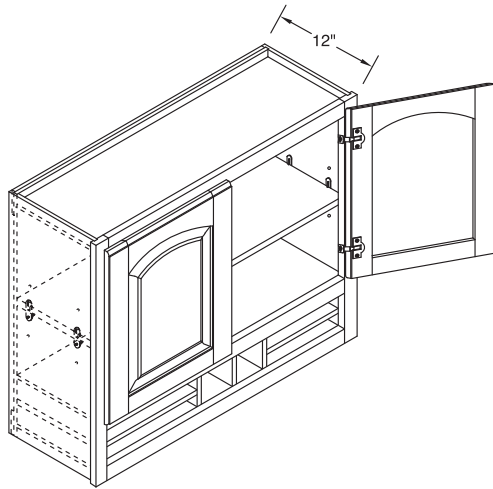

Wall cabinet with integrated organizer behind the face frame.

## Wall Cabinet + Valance

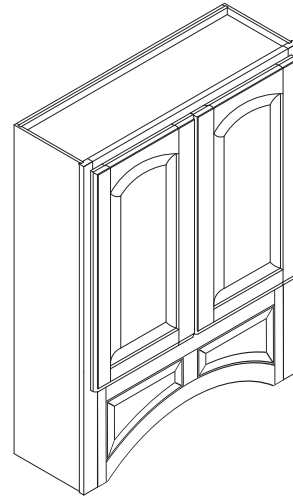

# WALL CABINET STORAGE IDEAS

## W3012B + W1512

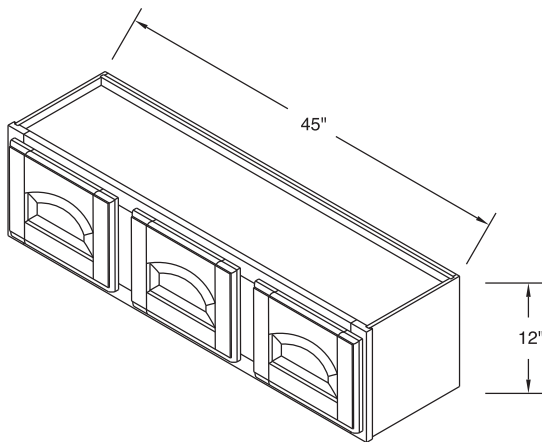

## W3012B + W1812

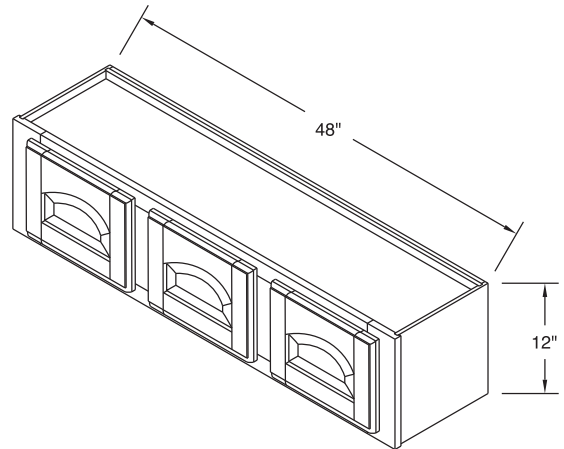

When extending the width of a cabinet, consider adding a third door.  
Need to specify hinging (i.e. LLR or LRR).

# CUSTOM BASE CABINETS

## Sink Base 36B + 2 Transitional Fluted Fillers

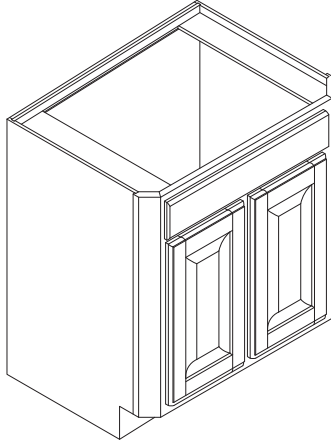

Save installation time by incorporating transitional fillers or fluted fillers into the construction of any sink base cabinet.

**B24R**

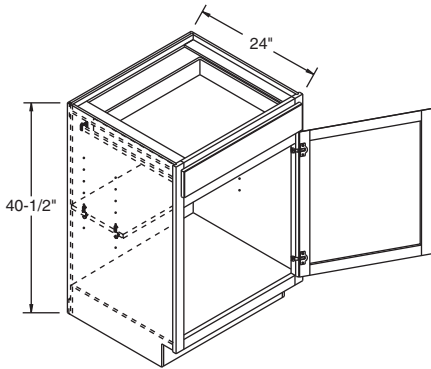

**BD36D + Drawer Assembly**

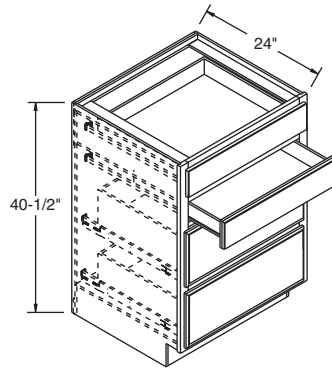

## TALL CABINETS

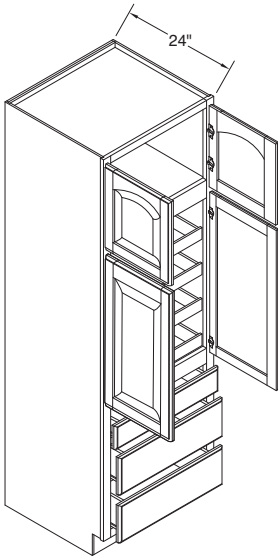

Oven Cabinet

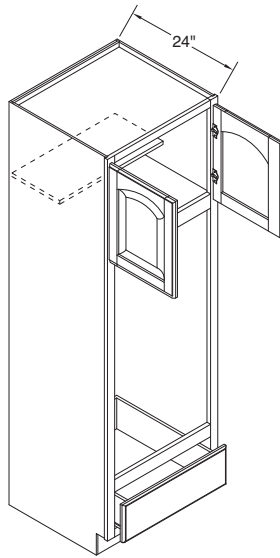

**Custom Appliance Cabinet:**  
Using your appliance specifications, create a custom microwave/oven unit from a universal oven cabinet.

Oven Cabinet

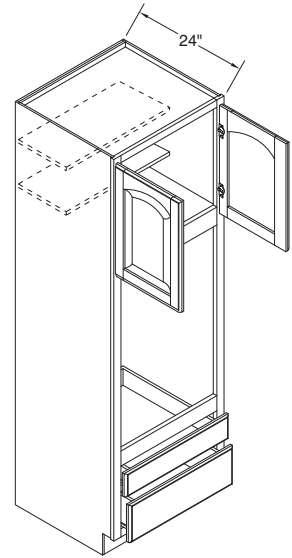

**Custom Appliance Cabinet:**  
Using your appliance specifications, create a custom microwave/oven unit from a universal oven cabinet.

## STORAGE IDEAS

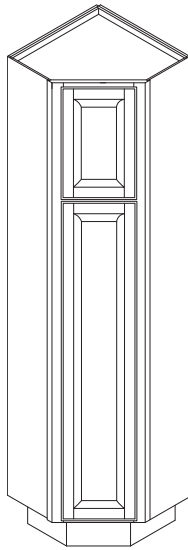

**Custom Utility Cabinet:**  
Turn often wasted corners of any master bath into closet or utility cabinet storage.

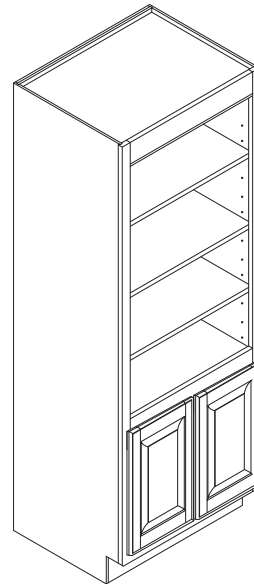

**Shelf Units:**  
Enhance the open shelf unit with cabinet doors. Field applied Soffit A moulding to any of the shelves creates a plate rail.

# VANITY CABINETS

VBB48 + VTK + EXB

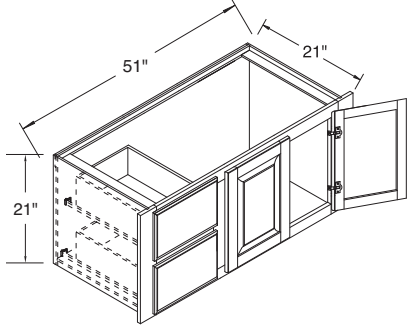

VBD27 + VTK

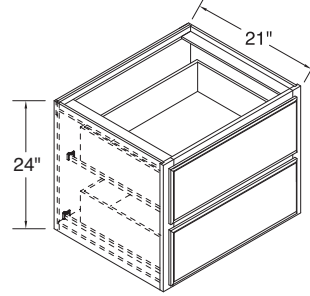

# DECORATIVE TUB FRONT

W3918 + CFNT0 x 2

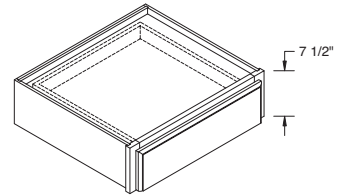
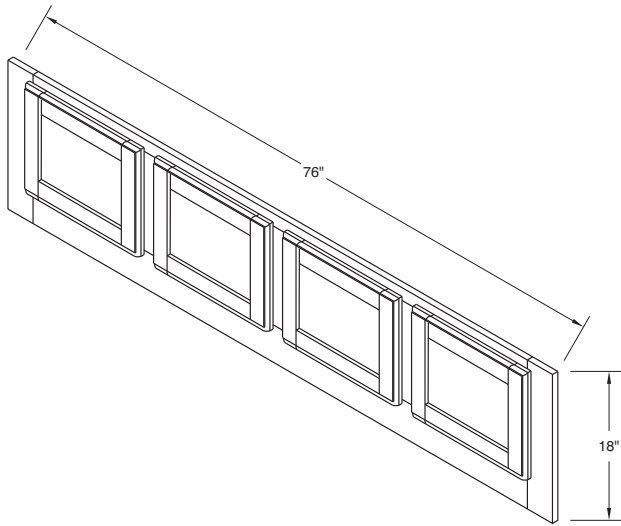

## Juno Textured Wood Grain Laminate

### Other Cabinet End Solutions

Panels to match cabinet case finish with applied Juno doors

- Decorative Door Panels: WDOP., BDOP., VDOPBH., and TDOP.

### Premium Juno 1/4" Skin and 3/4" Panel Options

- Panels and Skins: L4896P, LBEPP, LTEP.P, LWEPP
- Matching laminate only on the face of the panel; back of the panel will be raw
- Panels: LSP.P
- Matching laminate on both the face and back of panel
- Edgebanding on front edge only

### Premium Juno Trim Options

- Select Crown, Scribe, and Toeboard (ending with the letter "P")

## Design Options

### Maintain Clean Lines

- For design aesthetics and ease of installation, avoid installation tight to the ceiling
- For lower cabinets, use wider drawer bases or full height door cabinets
- For upper cabinets, use wall top hinge (WTH)

### Segment Tall Panels

- Use top of base cabinet line or bottom of wall cabinets to divide the tall space
- Limit to 96" tall per segment

### No Moulding Required

- Keep cabinet top lines uncomplicated
- Consider no top trim or use a filler for top trim and use at end of runs for doors to open beyond 90° next to a wall
- Only doors, drawer fronts, and premium trim items ending in "P" will have matching Textured Laminate

### Finishing the Look

- Cabinet face frame and all trim pieces that are not premium will match the cabinet box color
- Cabinet end panels will follow construction type and will not be Textured Laminate
- If you're looking for less of a contrast, try using premium trim items to coordinate design elements to match the doors and drawer fronts
- Use other design elements, such as mixed materials, to get a streamlined look

## Installation Notes

Laminate panels can be sawn, drilled or router cut. Be sure to use very sharp carbide tools and moderate feed rates. Ensure the peel coat is cut cleanly, and adjust the process so that there are no masking strands at the edge. Strands can be removed by lightly rubbing the edge with a medium abrasive cleaning pad.

### Saw Cutting

- Saw cutting is the preferred method for cutting laminate panels and fillers
- Use very sharp carbide tipped blades with 3-5 teeth per cm
- Best results are achieved using a 300mm blade at a speed of 3,200 rpm
- A score scribe blade will avoid chipping of the backing layer

### Routing

- Router cut using a feed rate of 10-15 meter/minute with a spindle speed of 18,000 rpm
- Solid carbide router cutters will deliver the best finish
- Position the laminate panel face down to avoid feathering of the masking film when using a standard straight single or twin flute cutter
- Twin flute compression cutters are ideal for through cuts; don't use "up" spiral bits; "down" spiral cutters are ideal for routing and dados

### Drilling

- Leave the peel coat on while drilling, and use a sharp bit
- Be sure to drill with high speed steel or carbide tipped drills
- Use slow to medium speeds to avoid overheating
- For best results, use drills with a tip angle of 110° to 130°
- When installing decorative hardware:
  - Do not remove the peel coat until after the hardware is installed and the project is complete
  - Avoid over-tightening the hardware as some "ripple" effect may occur on the laminate surface

## Care and Cleaning

### Textured Laminate Surfaces

- Do not store panels outside or in direct sunlight
- Avoid sliding the panels on the outer surface
- Do not clean in direct sunlight
- For best results, use a damp, not wet, microfiber cloth with 5% mild soap, 95% water solution
- Dry thoroughly with a clean microfiber cloth
- Wipe up cooking splashes immediately
- Never use wax furniture polish or harsh household cleaners and abrasives, such as bleach or chlorine based cleaners, multi-purpose cleaners, dilutes, acetone, solvent, paper towels, or similar products

Many multi-purpose cleaning agents are unsuitable for use on these products. The use of aggressive chemicals can result in irreversible damage. Always check the active ingredients of your cleaners to be sure there are no potentially harmful chemicals. Do not use acetone, chloroform, benzene, ammonia, thinners, caustic soda, toluene, xylene, dichloromethane, amylacetate, glacial acetate acid, butyl alcohol, butyl acetate, cellusolve, cresols/phenols, ethylacetate, chlorinated solvents, halogenated solvents, methyl alcohol, methyl ethyl ketone.

(Manufacturer is not responsible for any damage done by abrasive cleaning products or procedures.)

## CABINET DIMENSIONS

- Shown are the dimensions for the stiles and rails of Homecrest cabinets. The opening sizes change based on the width and height of each individual cabinet, while the stile and rail sizes remain fairly consistent.
- To determine the horizontal opening measurement, subtract the stiles (and center stile on 39" wide and larger) from the cabinet width. To determine the vertical opening, subtract the rail measurements from the cabinet height.
- The face frame dimension is given for base, vanity, desk and tall units. To determine the overall cabinet height, add Homecrest's standard 4 1/2" high toekick to the vertical dimension of face frame.

## DOOR SIZING AND REVEALS

- **Traditional Overlay Doors:** The doors and drawer fronts overlay the face frame 1/2", exposing 1" of the frame both on the stile and rail members. Typical wall and base cabinets with a center stile expose 2" of that stile.
- **Modified Full Overlay Doors (Wall and Tall Cabinets):** The face frame remains the same and larger doors overlay the frame exposing 1/4" on the bottom rail and right and left stile. One full inch is exposed on the top rail of wall and tall units. Typical wall and base units with a center stile expose 1/2" of that stile.
- **Full Overlay Doors (Base Cabinets):** The face frame remains the same and doors overlay the frame, exposing 1/4" on the top and bottom rails and right and left stiles of base cabinets. Typical base units with a center stile expose 1/2" of that stile.
- **Exceptions on Face Frame Reveals:** Oven units have 3" stiles and 9" intermediate rails (designed for universal flexibility of cut-out options) that create various reveals.
- Blind corner wall and base cabinets expose different center stiles reveals. Diagonal corners also vary.

# CABINET DIMENSIONS

## 84" HIGH APPLICATION

Number after "W" Represents Height of Cabinet

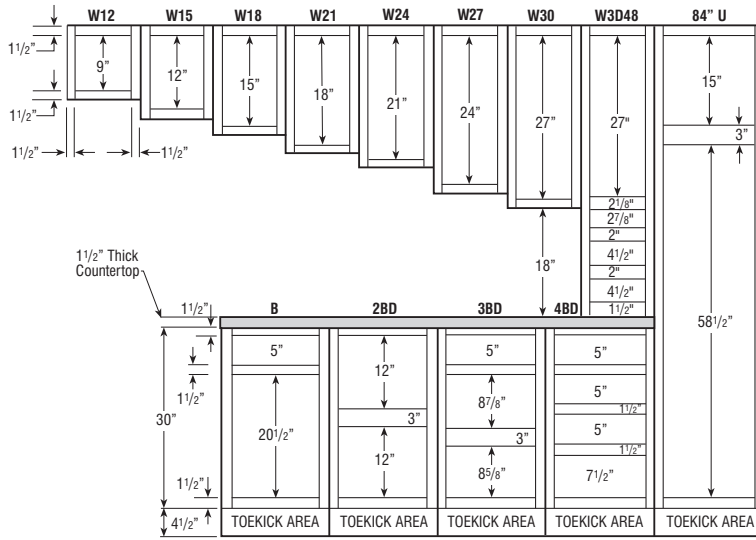

## 87" HIGH APPLICATION

Number after "W" Represents Height of Cabinet

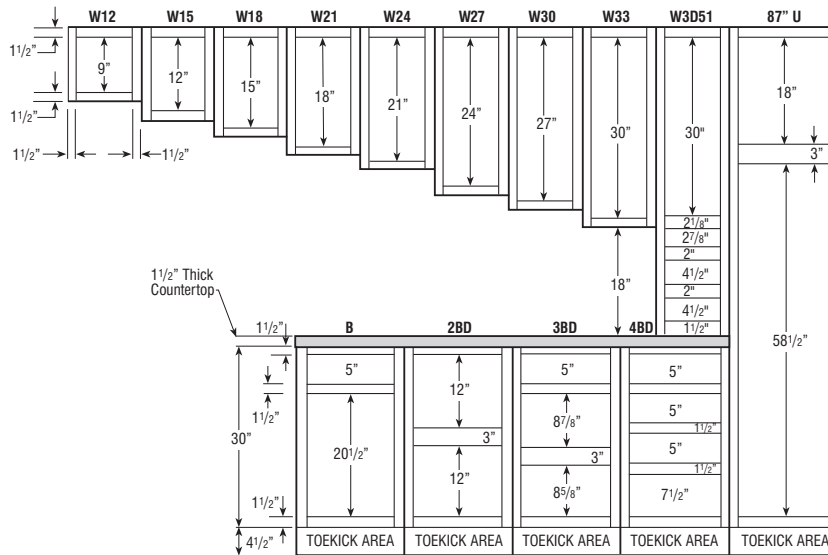



# CABINET DIMENSIONS

## 90" HIGH APPLICATION

Number after "W" Represents Height of Cabinet

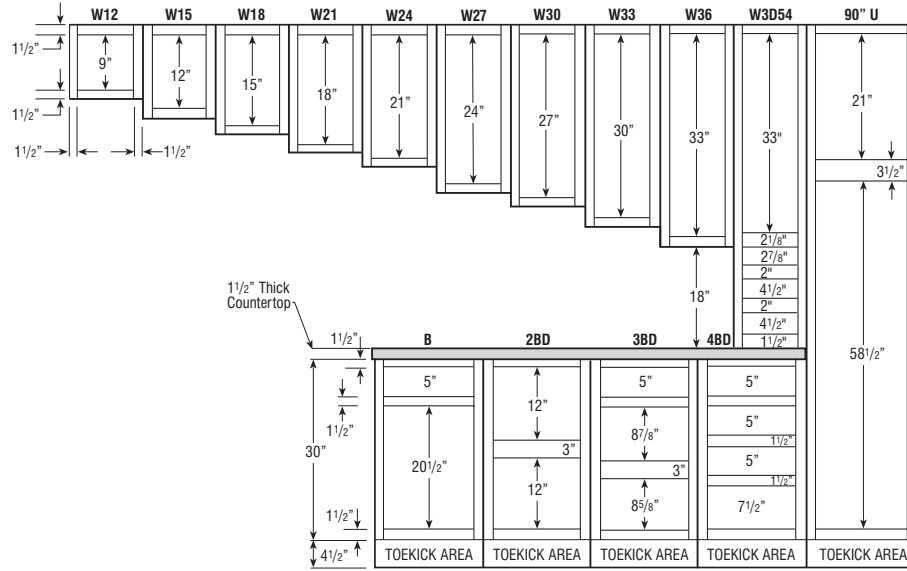

## 93" HIGH APPLICATION

Number after "W" Represents Height of Cabinet

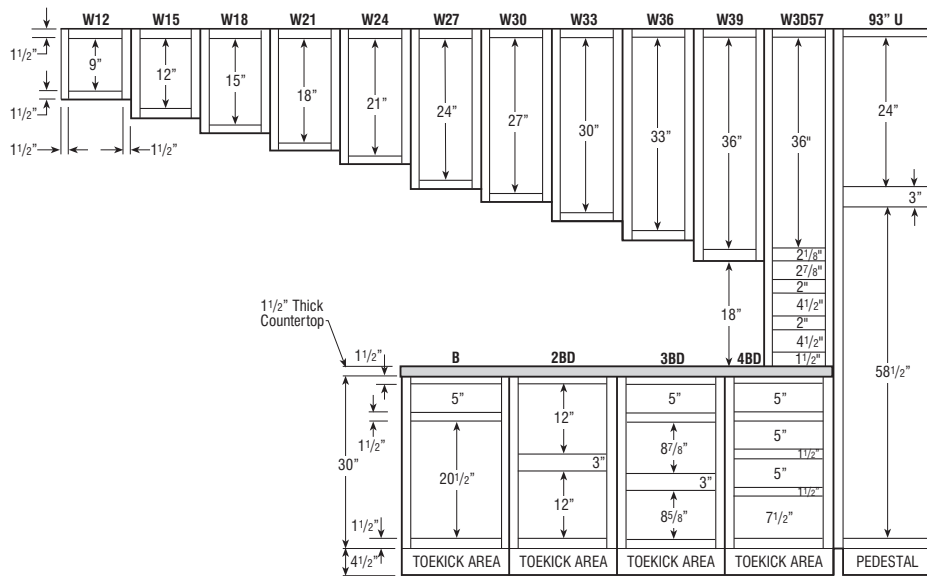

# CABINET DIMENSIONS

## 96" HIGH APPLICATION

Number after "W" Represents Height of Cabinet

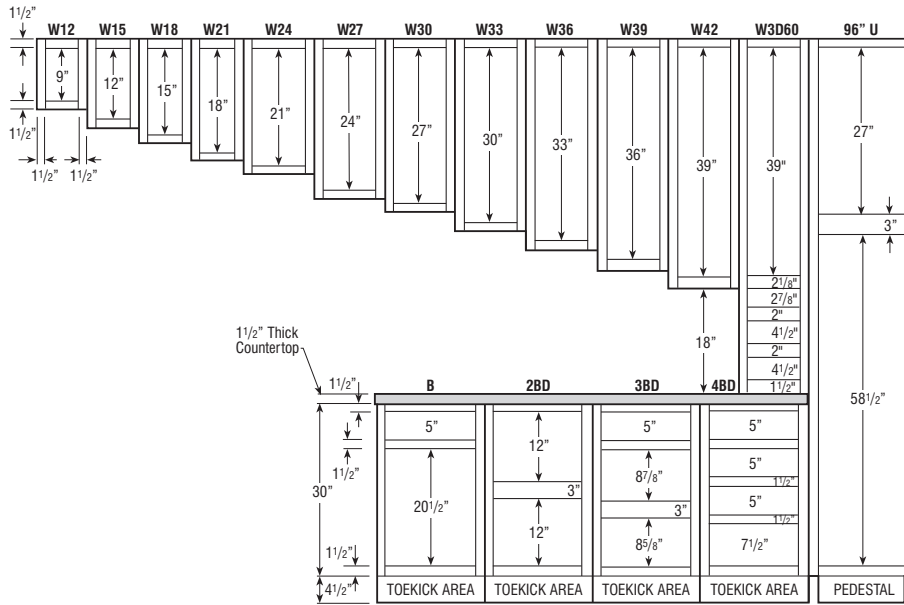

# CABINET DIMENSIONS

## 29" HIGH DESK CABINETS

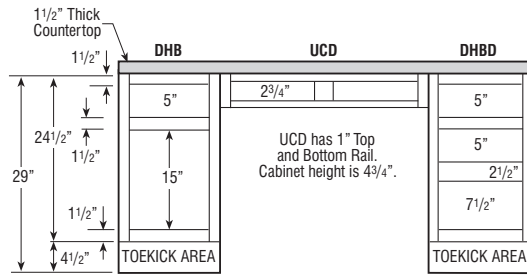

## 32 1/2" HIGH UNIVERSAL ACCESS CABINETS

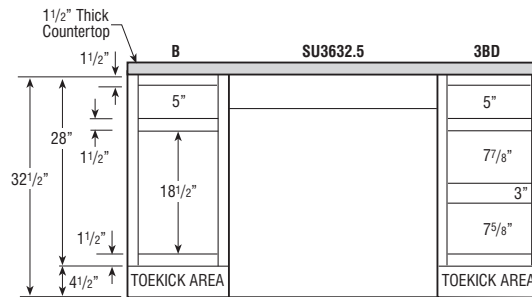

## MUDROOM STACKED WALL CABINETS APPLICATION

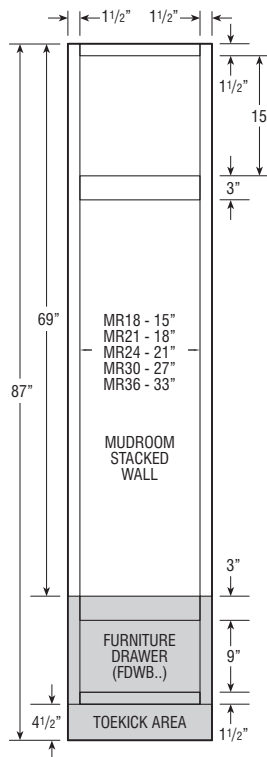

# CABINET DIMENSIONS

## 32" HIGH VANITY CABINETS

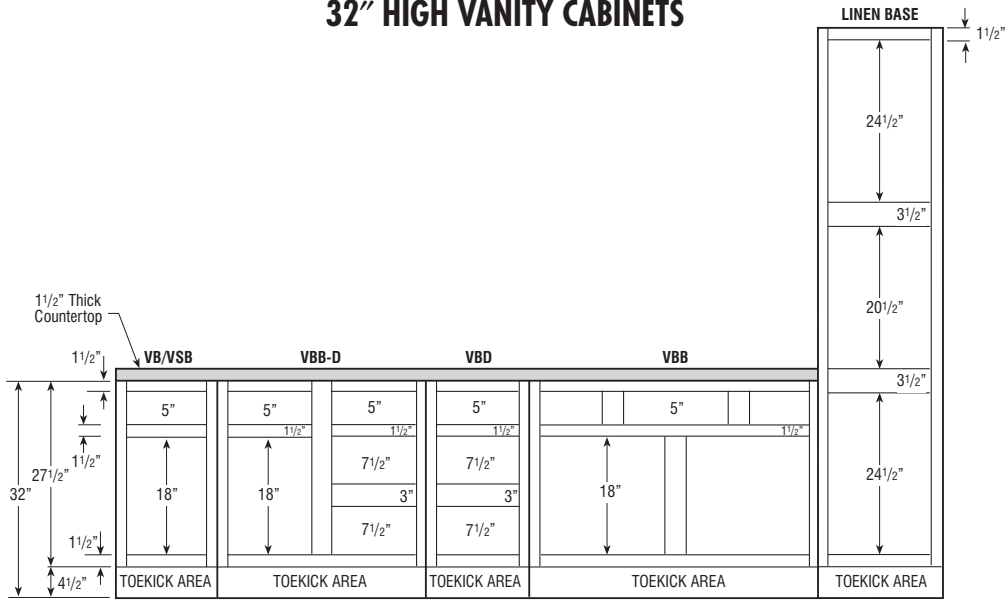

## 34 1/2" HIGH VANITY CABINETS

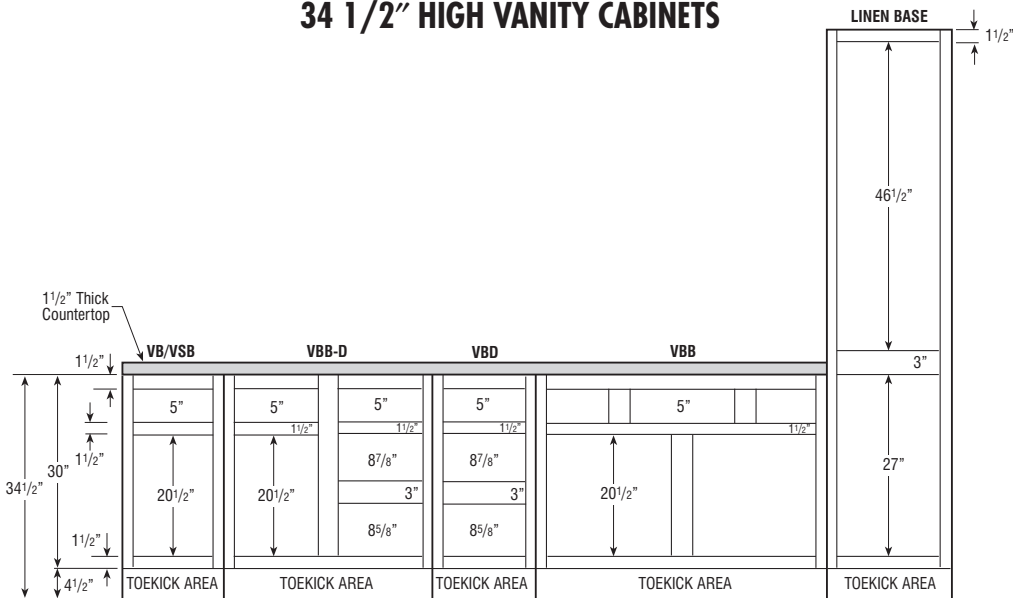

# INSTALLER NOTES AND DESIGNER TIPS

## NOTES TO THE INSTALLER

#10 x 2 1/2" installation screws are furnished and packaged inside all cabinets. Proper wall stud or ceiling joist installation is essential for Wall and Peninsula cabinets to support weight. Whenever possible, cabinets should be attached to each other for additional strength. Excessive weight should not be put on cabinets hung by themselves. Shimming may be required to ensure proper alignment. Wallboard alone is not strong enough to support the cabinets. To ensure proper installation, wall mounting screws should be within 2 1/2" from top and bottom of cabinet.

Our Warranty does not cover damage caused by improper installation. Please be sure to install cabinets properly. If you have questions, please contact your sales or customer service representative.

### WOOD DUST WARNING:

When cutting, sanding, sawing, or shaping cabinets or wood products, you are likely to generate wood dust. For your own safety, we recommend that you wear a protective mask to prevent breathing wood dust. We also recommend eye protection to avoid injury by flying wood chips or sawdust during cabinet installation.

## DIMENSIONS FOR CORNER INSTALLATIONS (45° DIAGONAL)

### 12" DEEP CABINETS

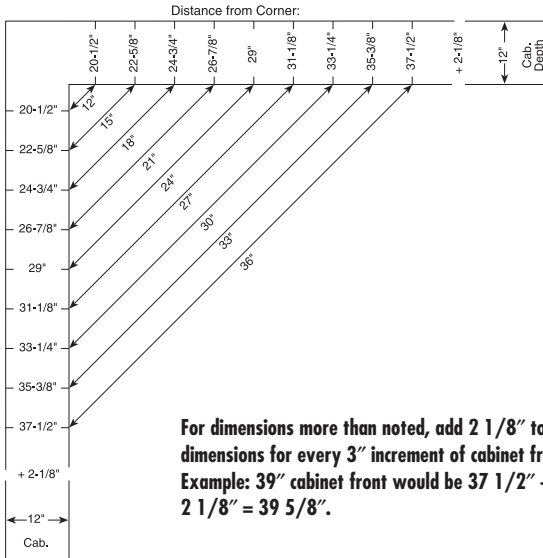

### 24" DEEP CABINETS

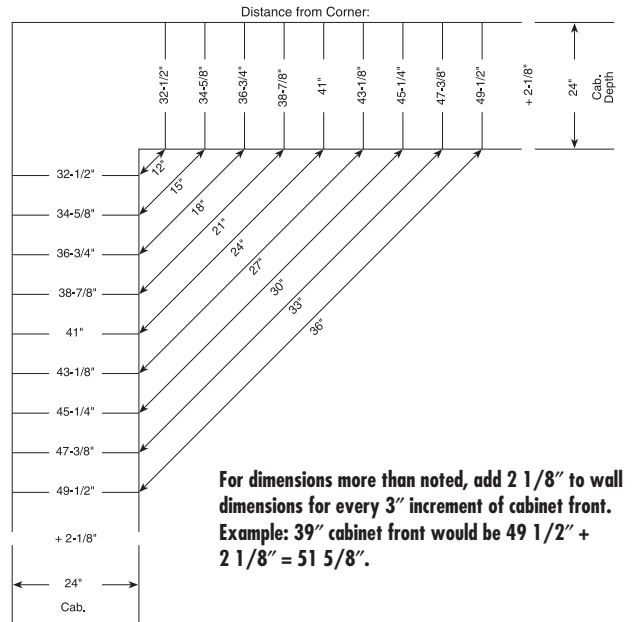

## INSTALLATION HEIGHT REQUIREMENTS

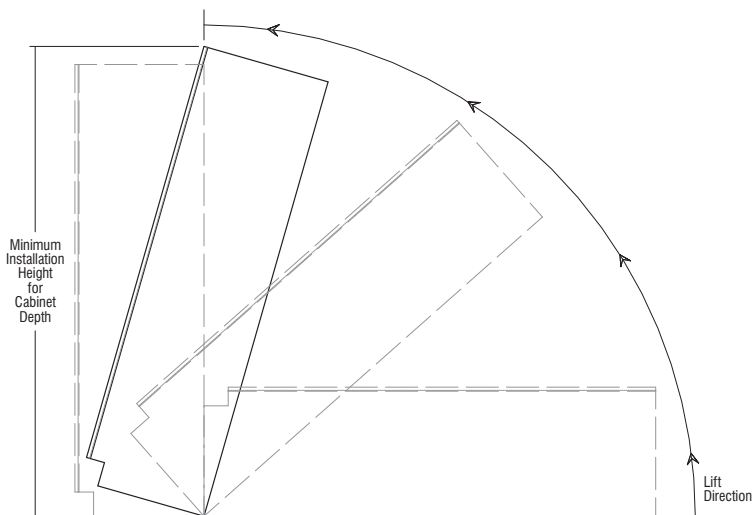

Height of ceiling needs to be considered for installation of tall cabinets. Cabinet height below includes toekick area:

Cabinet Height	Minimum Installation Height for Cabinet Depth	
	21"	24"
84"	86 19/32"	87 3/8"
87"	89 1/2"	90 1/4"
90"	92 7/16"	93 5/32"
93" *	90 31/32"	91 23/32"
96" *	93 29/32"	94 5/8"

\*Separate pedestal base included with cabinet to be installed after cabinet is in an upright position.

# HOMECREST CABINETRY'S DESIGN CHECKLIST

## CONSTRUCTION OPTIONS

Cabinets with plywood ends (APU or PEU) are unfinished on the exterior; consider the following solutions for exposed exterior ends:

- Order finished ends (APF or PEF).
- Order Authentic Ends (AUTHB, AUTHL, AUTHR).
- Modify exposed cabinet ends to FPEB.
- Apply 1/4" veneer skin to hide 1/4" reveal. This will allow the ends to age uniformly with the rest of the kitchen and will make it flush.
- Apply decorative door kit (WDOP, BDOP, TDOP). This kit includes 1/4" veneer skin, decorative doors, and screws for field installation.

## WOOD AND FINISH CHARACTERISTICS

Review specific details with the customer:

- Mineral Streaks, Birdseye Dots, Grain Variations, especially Hickory.
- Color Variations/Darkening.
- Finish Variations, hairline cracks may develop at frame joints on painted frame.
- Underside of cabinets are natural maple laminate. Use light rail or cabinet panel edge and skin to hide, especially when designing with peninsula wall cabinets.

## ORGANIZATION

Review storage and usage needs with Customer.

- Cooking Solutions:
  - Wall Spice Rack Cabinet
- Storage Solutions:
  - SuperCabinet™
  - Pegged Dish Organizer
  - Wall Message Center
- Clean-up Center:
  - Base Wastebasket

## CLEARANCES

- Add fillers between end cabinets and walls on full overlay door styles.
- Allow space between door/window trim and end cabinets for countertop and top moulding overhang.
- Include refrigerator door hinges in overall refrigerator height when placing cabinets above it.

Maintain a minimum clearance of 3" by pulling blind corners as follows:

- Full Overlay: 1 1/4", Standard Overlay 1/2". (More is needed in certain situations such as when adjacent to an appliance or when using oversized pulls or knobs.)
- Allow sufficient clearance (3") on each side of accessory cabinets (such as roll-out trays, etc). Doors on these cabinets must open fully for accessories to be functional.
- Ensure the height between the cooktop and range hood is 24" to meet NKBA guidelines.

Qualify customer carefully on upper cabinet/microwave advantages/disadvantages as follows:

- Minimum of 18" from cooktop to upper cabinet/above the range microwave which allows for easy access to either, but less room over back burner.
- Minimum of 21" from cooktop to upper cabinet/microwave which allows for access to large pots on back burner of cooktop, but longer reach to microwave.

## FILLERS

- Place fillers toward end of run where least conspicuous if needed.
- Attach overlay fillers on top of the base, wall, or tall fillers when using full overlay door styles to maintain a consistent reveal. Don't forget to include blind corner fillers.
- Add a filler at least 6" wide to accommodate a decorative onlay when the filler is used as valance.

## VARYING HEIGHTS AND DEPTHS

- Increase the depth of a wall cabinet run when you increase the height (so moulding on adjacent cabinet will kill into the side of the taller cabinet).
- Skin the sides of tall cabinets to 1) hide the seam between the toekick pedestal and the cabinet, 2) keep adjacent base and wall cabinets out from reveal of tall cabinet.
- Add increased depth on tall end panels for a built-in look for deep refrigerators.
- Account for the additional support needed for wall cabinets with a depth of 18" or greater. This can be achieved by installing end panels.

## MATCHING INTERIOR CABINETS/GLASS OPTIONS

- Verify cut-for-glass or mullion door option is available on desired cabinet size. (See page 37 for available cut-for-glass/mullion door sizes.)
- Verify glass insert option is available for desired cut-for-glass door size chosen.
- Verify matching interior option has been selected for all open or glass cabinets.
- Verify mullion door lite grid matches customer expectations.

## MOULDINGS

- Verify correct amount of crown moulding has been ordered.
- Order toekick caps.
- Order extra scribe.

## ISLANDS AND PENINSULAS

- Consider standard height bars are 34 1/2" tall and require 19" knee space. Raised bars are 42" tall.
- Consider base peninsula cabinets (P) are 24 1/4" deep and require 12" of knee space. Use back panels/doors to flush non-P cabinets with P cabinets.
- Use outside corner moulding if a skin is exposed on the back of the island.

## APPLIANCES

- Note for all consumers, appliances are not included with any cabinetry product.
- Do not place dishwashers next to diagonal front cabinet (interference) or next to a range (no countertop support).
- Verify refrigerator door has enough clearance to open beyond 90 degrees so refrigerator drawers can be utilized. Refer to appliance manufacturer's specs.
- Add TF696FH, as it may be required to frame around built-in microwave ovens and other built-in items. Refer to appliance manufacturer's specs.
- Order appliance panels.

## MISCELLANEOUS

- Order full size touch-up kit.

## kitchen planning guidelines

### DOOR/ENTRY

- Door opening should be at least 32" wide, requiring a minimum 2' 10" wide door.

### DOOR INTERFERENCE

- Entry door should not interfere with safe appliance operation or appliance doors.

### DISTANCE BETWEEN WORK CENTERS

- With three work centers, the total distance traveled should not be more than 26' with no single leg of the triangle less than 4' or more than 9'.
- With more than three work centers, each additional travel distance to another work center should be no less than 4' or more than 9'. Each leg is measured from the center-front of the appliance/sink. No work triangle leg should intersect an island/peninsula by more than 12".

### SEPARATING WORK CENTERS

- A tall obstacle should not separate two primary work centers. A properly recessed tall corner unit is acceptable.

### WORK TRIANGLE TRAFFIC

- Major traffic patterns should not cross through the basic work triangle.

### WORK AISLE

- The work aisle should be at least 42" for one cook and at least 48" for multiple cooks.

### WALKWAY

- The walkway width should be at least 36".

### TRAFFIC CLEARANCE AT SEATING

- Allow 32" of clearance from the table to wall/obstacle if no traffic passes behind a seated diner. If traffic passes behind the diner, allow at least 36" to edge past or 44" to walk past.

### SEATING CLEARANCE

- 30" high tables/counters should allow a 24" wide by 18" deep space for each seated diner and at least 18" knee space.
- 36" high counters should allow a 24" wide by 15" deep space for each seated diner and at least 15" kneespace.
- 42" high counters should allow a 24" wide by 12" deep space for each seated diner and at least 12" kneespace.

### CLEAN-UP/PREP SINK PLACEMENT

- With only one sink, locate it adjacent to or across from the cooking surface and refrigerator.

### CLEAN-UP/PREP SINK LANDING AREA

- Include at least a 24" wide landing space on one side of the sink and 18" on the other.
- If all the countertop at the sink is not the same height, plan a 24" landing space on one side of the sink and 3" of countertop frontage on the other, both at the same height of the sink.

### PREPARATION/WORK AREA

- Include a section of countertop at least 36" wide x 24" deep next to the sink for a work area.

### DISHWASHER PLACEMENT

- Nearest edge of dishwasher should be within 36" of nearest edge of sink. Provide at least 21" of standing space between the edge of the dishwasher and countertop frontage/appliances/cabinets which are placed at a right angle to the dishwasher.

### WASTE RECEPTACLES

- Include at least 2 waste receptacles, one near the sink and the other nearby for recycling.

### AUXILIARY SINK

- Provide at least 3" of countertop frontage on one side of the auxiliary sink and 18" on the other side, both at the same height as the sink.

### REFRIGERATOR LANDING AREA

- Include at least 15" of landing area on the handle side of the refrigerator, 15" on either side of a side-by-side refrigerator, 15" of landing space which is no more than 48" across from the front of the refrigerator, and 15" above or adjacent to any under-counter style refrigerator.

### COOKING SURFACE LANDING AREA

- Include a minimum of 12" of landing area on one side of the cooking surface and 15" on the other.
- If cooking surface is at a different countertop height than the rest of the kitchen, then the 12" and 15" landing areas must be the same height as the cooking surface.
- For safety reasons, in an island or peninsula situation, the countertop should extend a minimum of 9" behind the cooking surface if the counter height is the same height as the cooking surface.

### COOKING SURFACE CLEARANCE

- Allow 24" between the cooking surface and a protected noncombustible surface above it.
- At least 30" of clearance is required between the cooking surface and an unprotected/combustible surface above it.
- If a microwave/hood combination is used, then the manufacturer's specifications should be followed.

### COOKING SURFACE VENTILATION

- A correctly sized, ducted ventilation system is recommended for all cooking surface appliances. The recommended minimum is 150 CFM.
- Code requires that the manufacturer's specifications be followed. Minimum exhaust rate for a ducted hood is 100 CFM and must be ducted to the outside.
- Make-up air may need to be provided. Refer to local codes.

### COOKING SURFACE SAFETY

- Do not locate cooking surface under an operable window.
- Window treatments above cooking surface should not use flammable materials.
- Place a fire extinguisher near the kitchen exit away from cooking equipment.

### MICROWAVE OVEN PLACEMENT

- The ideal location for the bottom of the microwave is 3" below the principle user's shoulder, but no more than 54" above the floor.

### MICROWAVE LANDING AREA

- Provide at least 15" above, below, or adjacent to the handle side of a microwave oven.

### OVEN LANDING AREA

- Include at least 15" next to or above the oven.
- A 15" landing area that is not more than 48" away is also acceptable as long as the oven does not open into a walkway.

### COMBINING LANDING AREAS

- If two landing areas are adjacent to one another, determine a new minimum for the two by taking the longer of the two and adding 12".

*continued*

## kitchen planning guidelines (continued)

### COUNTERTOP SPACE

- A total of 158" of countertop frontage, 24" deep, with at least 15" clearance above is needed to accommodate all landing, preparation, work, and storage areas.

### COUNTERTOP EDGES

- Clipped or round corners, rather than sharp edges, are recommended on all counters.

### STORAGE

- The recommended total shelf/drawer frontage for a small kitchen (less than 150 square feet) is 1400", for a medium kitchen (151 to 350 square feet) is 1700", and for a large kitchen (greater than 350 square feet) is 2000".

Sizes:	S	M	L
Wall	300"	360"	360"
Base	520"	615"	660"
Drawer	360"	400"	525"
Pantry	180"	230"	310"
Misc.	40"	95"	145"

- The totals for wall, base, drawer, and pantry shelf/drawer frontage can be adjusted upward or downward as long as the recommended total stays the same.

### STORAGE AT CLEAN-UP/PREP SINK

- The recommended total for a small kitchen is 400", a medium kitchen is 480", a large kitchen is 560", and should be located within 72" of the centerline of the main clean-up/prep sink.

### CORNER CABINET STORAGE

- At least one corner cabinet should include a functional storage device.

### ELECTRICAL RECEPTACLES

- GFCI (Ground-Fault-Circuit-Interrupter) protection is required on all receptacles servicing countertop surfaces within the kitchen.

### LIGHTING

- Every work surface should be well illuminated. At least one wall switch-controlled light must be placed at the entrance.
- Window/skylight area, equal to at least 8% of the total square footage of the kitchen, or a total living space which includes a kitchen, is required.

## bathroom planning guidelines

### DOOR/ENTRY

- Doorway opening should be at least 32", requiring a minimum 2' 10" wide door.

### DOOR INTERFERENCE

- The door area should include clear floor space for maneuvering which varies according to the type of door and the direction of the approach.

### CEILING HEIGHT

- Bathroom floor to ceiling minimum height is 80". A shower or tub with a shower head shall have a minimum floor to ceiling height of 80" above a minimum area 30" x 30" at the shower head.

### CLEAR SPACE

- Plan a clear space of 30" from the front edge of all fixtures to any opposite bath fixture, wall, or obstacle.
- A minimum space of at least 21" is required in front of a lavatory, toilet, bidet, and tub, with a 24" minimum space in front of a shower entry.

### SINGLE LAVATORY PLACEMENT

- The distance from the centerline of the lavatory to the sidewall/tall obstacle should be at least 20".
- The minimum distance required is 15". The minimum distance required between a wall and the edge of a lavatory is 4".

### DOUBLE LAVATORY PLACEMENT

- The distance between the centerlines of two lavatories should be at least 36".
- The minimum distance required is 30".
- The minimum distance required between the edges of two lavatories is 4".

### LAVATORY/VANITY HEIGHT

- The height for a lavatory varies from 32" to 43" to fit the user.

### COUNTERTOP EDGES

- Clipped or round corners, rather than sharp edges, are recommended on all counters.

### SHOWER SIZE

- The interior shower size should be at least 36" x 36". The minimum interior shower size required is 30" x 30".

### STORAGE

- Provide adequate, accessible storage for toiletries, bath linens, grooming and general bathroom supplies.
- Storage of frequently used items should be 15" to 48" above floor.

### ELECTRICAL RECEPTACLES

- All GFCI receptacles should be located at electrical appliance points of use.

**Load bearing floors and shelves meet KCMA standards of 15 lbs. per square foot. Warranty does not cover overloading beyond this point.**

To view a complete and updated list of the NKBA Guidelines, visit <http://www.nkba.org/guidelines/default.aspx>

© Copyright 2007 National Kitchen & Bath Association



## WALL CABINET NOMENCLATURE

All Wall Cabinets are 12" deep unless otherwise noted.

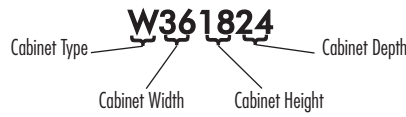

## MODIFICATIONS GRID KEY

- Available
- STD Standard on these cabinets

MODIFICATIONS			
Mod.	Description	Mod.	Description
ADDTK	Add Toekick	FPEB	Furniture Finished Plywood End Panels
AUTHB	Authentic Ends Both	FTK	Flush Toekick
AUTHL	Authentic End Left	FULL	Full Overlay
AUTHR	Authentic End Right	ID	Increased Depth
CBO	Cabinet Box Only	INTGH	Integrated SoftTouch Hinge
CCO	Cabinet Case Only	INVFRM	Inverted Frame
CFNTO	Cabinet Front Only	MI	Matching Interior
CND	Cabinet with No Door, with Drawer	P	Peninsula
EXB	Extended Siles Both	RD	Reduced Depth
EXL	Extended Sisle Left	RECTKL	Recessed Toekick Left
EXR	Extended Sisle Right	RECTKR	Recessed Toekick Right

CONSTRUCTION UPGRADES	
Mod.	Description
APF	All-plywood Finished
APU	All-plywood Unfinished
PEF	Plywood Ends Finished
PEU	Plywood Ends Unfinished

DECORATIVE DOOR OPTIONS	
Mod.	Description
ALF	Aluminum Frame Doors
CG	Cut-for-glass Doors
MD	Mullion Doors
PRMD	Prairie Mullion Doors

### Wall Single Door, 12" High

Model	Cubic Feet
W1212 L or R	1.6
W1512 L or R	1.9
W1812 L or R	2.3

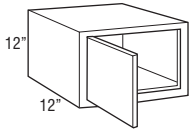

#### Modifications

ADDTK	AUTHB	AUTHL	AUTHR	CBO	CCO	CFNTO	CND	EXB	EXL	EXR	FPEB	FTK	FULL	ID	INTGH	INVFRM	MI	P	RD	RECTKL	RECTKR	
•	•	•	•																			

#### Construction Upgrades

APF	APU	PEF	PEU
•	•	•	•

#### Decorative Door Options

ALF	CG	MD	PRMD
	•		

### Wall Double Door, 12" High

Model	Cubic Feet
W2112B	2.6
W2412B	2.9
W2712B	3.3
W3012B	3.6
W3312B	4.1
W3612B	4.4
W3712B	4.4
W3912	4.7

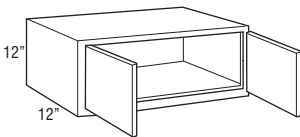

W2112B-W3712B

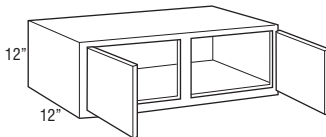

W3912

#### Modifications

ADDTK	AUTHB	AUTHL	AUTHR	CBO	CCO	CFNTO	CND	EXB	EXL	EXR	FPEB	FTK	FULL	ID	INTGH	INVFRM	MI	P	RD	RECTKL	RECTKR	
•	•	•	•																			

#### Construction Upgrades

APF	APU	PEF	PEU
•	•	•	•

#### Decorative Door Options

ALF	CG	MD	PRMD
	•		

### Wall Top Hinge Single Door, 12" High

Model	Cubic Feet
WTH3012	3.7
WTH3612	4.4

- Utilizes doors from 30" and 36" high wall cabinets. Grain on center panels will run horizontally and door rail configuration on non-miter doors will be unique from adjacent cabinet doors.
- Juno will have standard vertical grain pattern.
- When ordered in Arch door styles, door will be Square.
- Cabinet may utilize one or two lift mechanisms depending on door size and weight. Door lift mechanism tension can be field adjusted.
- Depth can be reduced to a minimum of 9".
- Door will open a maximum of 105° due to hinges. For applications close to a ceiling, door angle can be restricted to 86° with an INTGH Angle Restriction Clip-DTC (INTGH.RCLP.DTC, see page 199).
- Lift mechanisms and mounting brackets will be visible if used with transparent textured glass panels.

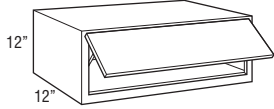

#### Modifications

ADDTK	AUTHB	AUTHL	AUTHR	CBO	CCO	CFNTO	CND	EXB	EXL	EXR	FPEB	FTK	FULL	ID	INTGH	INVFRM	MI	P	RD	RECTKL	RECTKR	
	•	•						•	•	•			•		•				•			

#### Construction Upgrades

APF	APU	PEF	PEU
•	•	•	•

#### Decorative Door Options

ALF	CG	MD	PRMD
•	•		

### Wall Double Door, 12" High, 24" Deep

Model	Cubic Feet
W331224B	7.4
W361224B	8.0
W371224B	8.2
W391224	8.6

- 24" deep cabinets must be fully supported by screws installed in a structural member in the ceiling or soffit, and into adjacent cabinets.
- Load limit is 15 lbs. per square foot of load bearing surface.

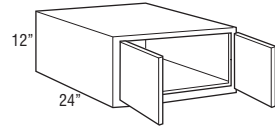

W331224B-W371224B

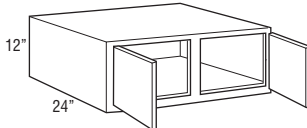

W391224

#### Modifications

ADDTK	AUTHB	AUTHL	AUTHR	CBO	CCO	CFNTO	CND	EXB	EXL	EXR	FPEB	FTK	FULL	ID	INTGH	INVFRM	MI	P	RD	RECTKL	RECTKR	
•	•	•	•		•	•		•	•	•	•	•	•	•	•				•	•	•	•

#### Construction Upgrades

APF	APU	PEF	PEU
•	•	•	•

#### Decorative Door Options

ALF	CG	MD	PRMD
	•		

### Wall Single Door, 15" High

Model	Cubic Feet
W1215 L or R	1.9
W1515 L or R	2.3
W1815 L or R	2.8

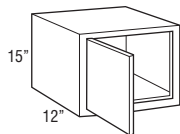

#### Modifications

ADDTK	AUTHB	AUTHL	AUTHR	CBO	CCO	CFNTO	CND	EXB	EXL	EXR	FPEB	FTK	FULL	ID	INTGH	INVERM	MI	P	RD	RECTKL	RECTKR
•	•	•	•		•	•		•	•	•	•	•	•	•	•		•	•	•	•	•

#### Construction Upgrades

APF	APU	PEF	PEU
•	•	•	•

#### Decorative Door Options

ALF	CG	MD	PRMD
	•		

### Wall Double Door, 15" High

Model	Cubic Feet
W2115B	3.2
W2415B	3.6
W2715B	4.0
W3015B	4.4
W3315B	4.9
W3615B	5.2
W3715B	5.4
W3915	5.6

#### Modifications

ADDTK	AUTHB	AUTHL	AUTHR	CBO	CCO	CFNTO	CND	EXB	EXL	EXR	FPEB	FTK	FULL	ID	INTGH	INVERM	MI	P	RD	RECTKL	RECTKR
•	•	•	•		•	•		•	•	•	•	•	•	•	•		•	•	•	•	•

#### Construction Upgrades

APF	APU	PEF	PEU
•	•	•	•

#### Decorative Door Options

ALF	CG	MD	PRMD
	•		

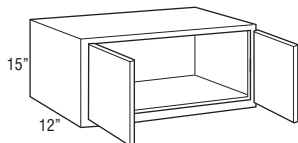

W2115B-W3715B

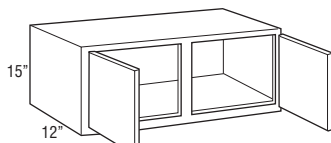

W3915

## Wall Top Hinge Single Door, 15" High

Model	Cubic Feet
WTH3015	4.5
WTH3615	5.4

- Utilizes doors from 30" and 36" high wall cabinets. Grain on center panels will run horizontally and door rail configuration on non-miter doors will be unique from adjacent cabinet doors.
- Juno will have standard vertical grain pattern.
- When ordered in Arch door styles, door will be Square.
- Cabinet may utilize one or two lift mechanisms depending on door size and weight. Door lift mechanism tension can be field adjusted.
- Depth can be reduced to a minimum of 9".
- Door will open a maximum of 105° due to hinges. For applications close to a ceiling, door angle can be restricted to 86° with an INTGH Angle Restriction Clip-DTC (INTGH.RCLP.DTC, see page 199).
- Lift mechanisms and mounting brackets will be visible if used with transparent textured glass panels.

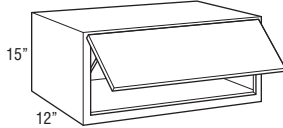

### Modifications

ADDTK	AUTHB	AUTHL	AUTHR	CBO	CCO	CFNTO	CND	EXB	EXL	EXR	FPEB	FTK	FULL	ID	INTGH	INVFRM	MI	P	RD	RECTKL	RECTKR	
	•	•	•		•			•	•	•			•		•				•			

### Construction Upgrades

APF	APU	PEF	PEU
•	•	•	•

### Decorative Door Options

ALF	CG	MD	PRMD
•	•		

60

## Wall Double Door, 15" High, 24" Deep

Model	Cubic Feet
W331524B	9.0
W361524B	9.7
W371524B	10.0
W391524	10.5

- 24" deep cabinets must be fully supported by screws installed in a structural member in the ceiling or soffit, and into adjacent cabinets.
- Load limit is 15 lbs. per square foot of load bearing surface.

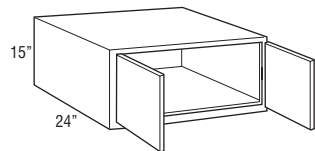

W331524B-W371524B

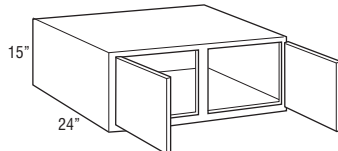

W391524

### Modifications

ADDTK	AUTHB	AUTHL	AUTHR	CBO	CCO	CFNTO	CND	EXB	EXL	EXR	FPEB	FTK	FULL	ID	INTGH	INVFRM	MI	P	RD	RECTKL	RECTKR	
•	•	•	•		•	•		•	•	•	•	•	•		•				•	•	•	•

### Construction Upgrades

APF	APU	PEF	PEU
•	•	•	•

### Decorative Door Options

ALF	CG	MD	PRMD
	•		

## Wall Single Door, 18" High

Model	Cubic Feet
W1218 L or R	2.3
W1518 L or R	2.8
W1818 L or R	3.2
W2118 L or R	3.7
W2418 L or R	4.3

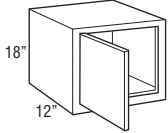

### Modifications

ADDTK	AUTHB	AUTHL	AUTHR	CBO	CCO	CFNTO	CND	EXB	EXL	EXR	FPEB	FTK	FULL	ID	INTGH	INVERM	MI	P	RD	RECTKL	RECTKR
•	•	•	•		•	•		•	•	•	•	•	•	•	•		•	•	•	•	•

### Construction Upgrades

APF	APU	PEF	PEU
•	•	•	•

### Decorative Door Options

ALF	CG	MD	PRMD
	•	•†	•†

†MD and PRMD not available on W1218.

## Wall Double Door, 18" High

Model	Cubic Feet
W2418B	4.3
W2718B	4.7
W3018B	5.2
W3318B	5.7
W3618B	6.3
W3718B	6.3
W3918	6.6
W4218	7.1

### Modifications

ADDTK	AUTHB	AUTHL	AUTHR	CBO	CCO	CFNTO	CND	EXB	EXL	EXR	FPEB	FTK	FULL	ID	INTGH	INVERM	MI	P	RD	RECTKL	RECTKR
•	•	•	•		•	•		•	•	•	•	•	•	•	•		•	•	•	•	•

### Construction Upgrades

APF	APU	PEF	PEU
•	•	•	•

### Decorative Door Options

ALF	CG	MD	PRMD
	•	•	•

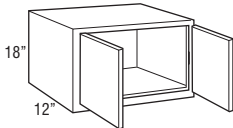

W2418B-W3718B

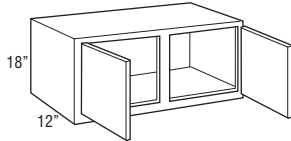

W3918-W4218

## Wall Top Hinge Single Door, 18" High

Model	Cubic Feet
WTH3018	5.3
WTH3618	6.3

- Utilizes doors from 30" and 36" high wall cabinets. Grain on center panels will run horizontally and door rail configuration on non-miter doors will be unique from adjacent cabinet doors.
- Juno will have standard vertical grain pattern.
- When ordered in Arch door styles, door will be Square.
- Cabinet may utilize one or two lift mechanisms depending on door size and weight. Door lift mechanism tension can be field adjusted.
- Depth can be reduced to a minimum of 9".
- Door will open a maximum of 105° due to hinges. For applications close to a ceiling, door angle can be restricted to 86° with an INTGH Angle Restriction Clip-DTC (INTGH.RCLP.DTC, see page 199).
- Lift mechanisms and mounting brackets will be visible if used with transparent textured glass panels.

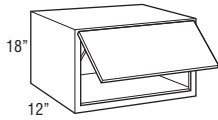

### Modifications

ADDTK	AUTHB	AUTHL	AUTHR	CBO	CCO	CFNTO	CND	EXB	EXL	EXR	FPEB	FTK	FULL	ID	INTGH	INVFRM	MI	P	RD	RECTKL	RECTKR	
	•	•	•					•	•	•			•		•				•			

### Construction Upgrades

APF	APU	PEF	PEU
•	•	•	•

### Decorative Door Options

ALF	CG	MD	PRMD
•	•		

62

## Wall Double Door, 18" High, 24" Deep

Model	Cubic Feet
W331824B	10.5
W361824B	11.4
W371824B	11.7
W391824	12.3

- 24" deep cabinets must be fully supported by screws installed in a structural member in the ceiling or soffit, and into adjacent cabinets.
- Load limit is 15 lbs. per square foot of load bearing surface.

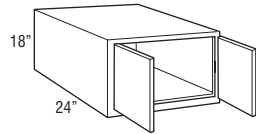

W331824B-W371824B

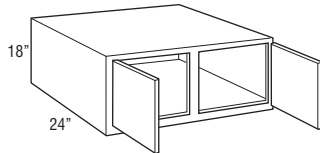

W391824

### Modifications

ADDTK	AUTHB	AUTHL	AUTHR	CBO	CCO	CFNTO	CND	EXB	EXL	EXR	FPEB	FTK	FULL	ID	INTGH	INVFRM	MI	P	RD	RECTKL	RECTKR	
•	•	•	•					•	•	•	•	•	•		•				•	•	•	•

### Construction Upgrades

APF	APU	PEF	PEU
•	•	•	•

### Decorative Door Options

ALF	CG	MD	PRMD
	•		

## Wall Single Door, 21" High

Model	Cubic Feet
W1221 L or R	2.6
W1521 L or R	3.2
W1821 L or R	3.7
W2121 L or R	4.3

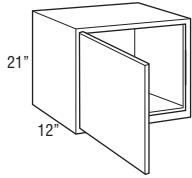

### Modifications

ADDTK	AUTHB	AUTHL	AUTHR	CBO	CCO	CFNTO	CND	EXB	EXL	EXR	FPEB	FTK	FULL	ID	INTGH	INVFRM	MI	P	RD	RECTKL	RECTKR
•	•	•	•		•	•		•	•	•	•	•	•	•	•		•	•	•	•	•

### Construction Upgrades

APF	APU	PEF	PEU
•	•	•	•

### Decorative Door Options

ALF	CG	MD	PRMD
	•	•†	•†

†MD and PRMD not available on W1221.

## Wall Double Door, 21" High

Model	Cubic Feet
W2421B	4.9
W2721B	5.4
W3021B	6.0
W3321B	6.5
W3621B	7.1
W3721B	7.3
W3921	7.6

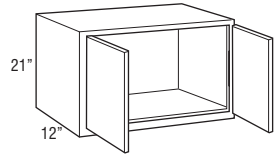

W2421B-W3721B

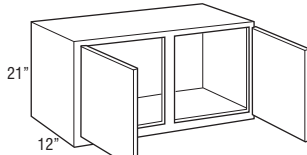

W3921

### Modifications

ADDTK	AUTHB	AUTHL	AUTHR	CBO	CCO	CFNTO	CND	EXB	EXL	EXR	FPEB	FTK	FULL	ID	INTGH	INVFRM	MI	P	RD	RECTKL	RECTKR
•	•	•	•		•	•		•	•	•	•	•	•	•	•		•	•	•	•	•

### Construction Upgrades

APF	APU	PEF	PEU
•	•	•	•

### Decorative Door Options

ALF	CG	MD	PRMD
	•	•	•

### Wall Top Hinge Single Door, 21" High

Model	Cubic Feet
WTH3021	5.6
WTH3621	7.2

- Utilizes doors from 30" and 36" high wall cabinets. Grain on center panels will run horizontally and door rail configuration on non-miter doors will be unique from adjacent cabinet doors.
- Juno will have standard vertical grain pattern.
- When ordered in Arch door styles, door will be Square.
- Cabinet may utilize one or two lift mechanisms depending on door size and weight. Door lift mechanism tension can be field adjusted.
- Depth can be reduced to a minimum of 9".
- Door will open a maximum of 105° due to hinges. For applications close to a ceiling, door angle can be restricted to 86° with an INTGH Angle Restriction Clip-DTC (INTGH.RCLP.DTC, see page 199).
- Lift mechanisms and mounting brackets will be visible if used with transparent textured glass panels.

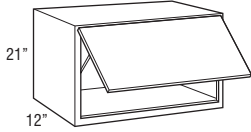

#### Modifications

ADDTK	AUTHB	AUTHL	AUTHR	CBO	CCO	CFNT0	CND	EXB	EXL	EXR	FPEB	FTK	FULL	ID	INTGH	INVFRM	MI	P	RD	RECTKL	RECTKR	
	•	•	•					•	•	•			•	•					•			

#### Construction Upgrades

APF	APU	PEF	PEU
•	•	•	•

#### Decorative Door Options

ALF	CG	MD	PRMD
•	•		

### Wall Double Door, 21" High, 24" Deep

Model	Cubic Feet
W302124B	11.1
W332124B	12.1
W362124B	13.1
W372124B	13.5
W392124	14.2

- 24" deep cabinets must be fully supported by screws installed in a structural member in the ceiling or soffit, and into adjacent cabinets.
- Load limit is 15 lbs. per square foot of load bearing surface.

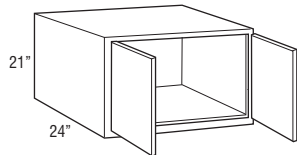

W302124B-W372124B

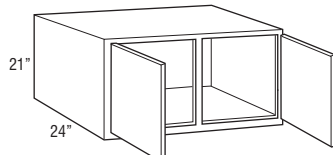

W392124

#### Modifications

ADDTK	AUTHB	AUTHL	AUTHR	CBO	CCO	CFNT0	CND	EXB	EXL	EXR	FPEB	FTK	FULL	ID	INTGH	INVFRM	MI	P	RD	RECTKL	RECTKR	
•	•	•	•					•	•	•	•	•	•	•	•				•	•	•	•

#### Construction Upgrades

APF	APU	PEF	PEU
•	•	•	•

#### Decorative Door Options

ALF	CG	MD	PRMD
	•		



## Wall Single Door, 24" High

Model	Cubic Feet
W1224 L or R	2.9
W1524 L or R	3.6
W1824 L or R	4.2
W2124 L or R	4.8
W2424 L or R	5.6

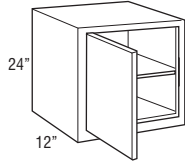

### Modifications

ADDTK	AUTHB	AUTHL	AUTHR	CBO	CCO	CFNTO	CND	EXB	EXL	EXR	FPEB	FTK	FULL	ID	INTGH	INVERM	MI	P	RD	RECTKL	RECTKR
•	•	•	•	•	•	•	•	•	•	•	•	•	•	•	•	•	•	•	•	•	•

### Construction Upgrades

APF	APU	PEF	PEU
•	•	•	•

### Decorative Door Options

ALF	CG	MD	PRMD
•	•	†	†

†MD and PRMD not available on W1224.

## Wall Double Door, 24" High

Model	Cubic Feet
W2424B	5.6
W2724B	6.2
W3024B	6.7
W3324B	7.5
W3624B	8.0
W3724B	8.2
W3924	8.6
W4224	9.5
W4524	9.9
W4824	10.5

### Modifications

ADDTK	AUTHB	AUTHL	AUTHR	CBO	CCO	CFNTO	CND	EXB	EXL	EXR	FPEB	FTK	FULL	ID	INTGH	INVERM	MI	P	RD	RECTKL	RECTKR
•	•	•	•	•	•	•	•	•	•	•	•	•	•	•	•	•	•	•	•	•	•

### Construction Upgrades

APF	APU	PEF	PEU
•	•	•	•

### Decorative Door Options

ALF	CG	MD	PRMD
•	•	•	•

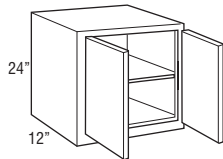



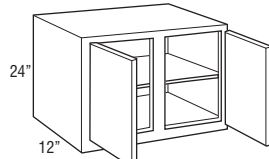

W2424B-W3724B



W3924-W4824

### Wall Double Door, 24" High, 24" Deep

Model	Cubic Feet
W302424B 	12.4
W332424B	13.8
W362424B	14.9
W372424B	15.3
W392424	16.0
W422424 	17.1
W452424 	18.2
W482424 	19.6

#### Modifications

ADDTK	AUTHB	AUTHL	AUTHR	CBO	CCO	CFNTD	CND	EXB	EXL	EXR	FPEB	FTK	FULL	ID	INTGH	INVFRM	MI	P	RD	RECTKL	RECTKR	
•	•	•	•	•	•	•	•	•	•	•	•	•	•	•	•	•	•	•	•	•	•	•

#### Construction Upgrades

APF	APU	PEF	PEU
•	•	•	•

#### Decorative Door Options

ALF	CG	MD	PRMD
	•		

- 24" deep cabinets must be fully supported by screws installed in a structural member in the ceiling or soffit, and into adjacent cabinets.
- Load limit is 15 lbs. per square foot of load bearing surface.

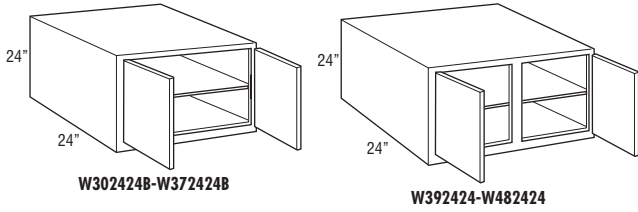

### Wall Single Door, 27" High

Model	Cubic Feet
W1227 L or R	3.3
W1527 L or R	4.0
W1827 L or R	4.7
W2127 L or R	5.4
W2427 L or R	6.1

#### Modifications

ADDTK	AUTHB	AUTHL	AUTHR	CBO	CCO	CFNTD	CND	EXB	EXL	EXR	FPEB	FTK	FULL	ID	INTGH	INVFRM	MI	P	RD	RECTKL	RECTKR	
•	•	•	•	•	•	•	•	•	•	•	•	•	•	•	•	•	•	•	•	•	•	•

#### Construction Upgrades

APF	APU	PEF	PEU
•	•	•	•

#### Decorative Door Options

ALF	CG	MD	PRMD
	•	•†	•†

†MD and PRMD not available on W1227.

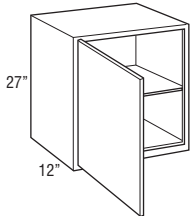

## Wall Double Door, 27" High

Model	Cubic Feet
W2427B	6.1
W2727B	6.8
W3027B	7.5
W3327B	8.2
W3627B	8.9
W3727B	9.2
W3927	9.6

### Modifications

ADTK	AUTHB	AUTHL	AUTHR	CBO	CCO	CFNTO	CND	EXB	EXL	EXR	FPEB	FTK	FULL	ID	INTGH	INVFRM	MI	P	RD	RECTKL	RECTKR
•	•	•	•	•	•	•	•	•	•	•	•	•	•	•	•	•	•	•	•	•	•

### Construction Upgrades

APF	APU	PEF	PEU
•	•	•	•

### Decorative Door Options

ALF	CG	MD	PRMD
•	•	•	•

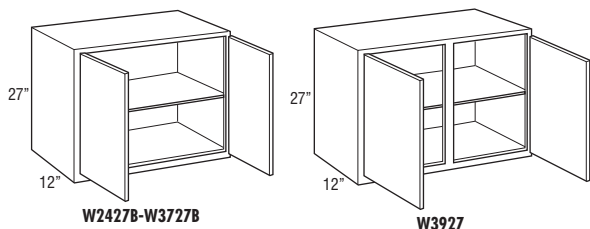

## Wall Double Door, 27" High, 24" Deep

Model	Cubic Feet
W332724B	15.3
W362724B	16.6
W372724B	17.0
W392724	17.9

### Modifications

ADTK	AUTHB	AUTHL	AUTHR	CBO	CCO	CFNTO	CND	EXB	EXL	EXR	FPEB	FTK	FULL	ID	INTGH	INVFRM	MI	P	RD	RECTKL	RECTKR
•	•	•	•	•	•	•	•	•	•	•	•	•	•	•	•	•	•	•	•	•	•

### Construction Upgrades

APF	APU	PEF	PEU
•	•	•	•

### Decorative Door Options

ALF	CG	MD	PRMD
•	•	•	•

- 24" deep cabinets must be fully supported by screws installed in a structural member in the ceiling or soffit, and into adjacent cabinets.
- Load limit is 15 lbs. per square foot of load bearing surface.

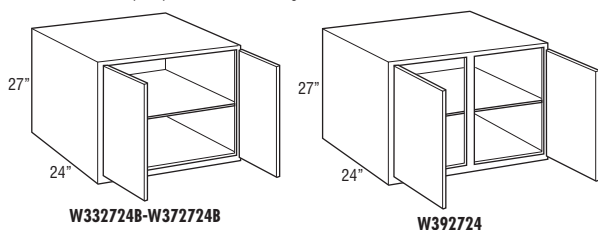

### Wall Single Door, 30" High

Model	Cubic Feet
W930 L or R†	2.8
W1230 L or R	3.6
W1530 L or R	4.4
W1830 L or R	5.2
W2130 L or R	6.0
W2430 L or R	6.7

†When Lawry is specified, the door panel will be recessed.

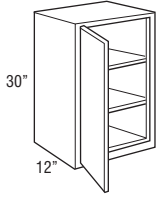

#### Modifications

ADTK	AUTHB	AUTHL	AUTHR	CBO	CCO	CFNTD	CND	EXB	EXL	EXR	FPEB	FTK	FULL	ID	INTGH	INVRM	MI	P	RD	RECTKL	RECTKR	
•	•	•	•	•	•	•	•	•	•	•	•	•	•	•	•	•	•	•	•	•	•	•

#### Construction Upgrades

APF	APU	PEF	PEU
•	•	•	•

#### Decorative Door Options

ALF	CG	MD	PRMD
•†	•	•‡	•‡

†ALF not available on W930 and W2430.

‡MD and PRMD not available on W930 and W1230.

### Wall Double Door, 30" High

Model	Cubic Feet
W2430B	6.7
W2730B	7.7
W3030B	8.3
W3330B	9.1
W3630B	9.9
W3930	10.6
W4230	11.6
W4530	12.2
W4830	13.0

#### Modifications

ADTK	AUTHB	AUTHL	AUTHR	CBO	CCO	CFNTD	CND	EXB	EXL	EXR	FPEB	FTK	FULL	ID	INTGH	INVRM	MI	P	RD	RECTKL	RECTKR	
•	•	•	•	•	•	•	•	•	•	•	•	•	•	•	•	•	•	•	•	•	•	•

#### Construction Upgrades

APF	APU	PEF	PEU
•	•	•	•

#### Decorative Door Options

ALF	CG	MD	PRMD
	•	•	•

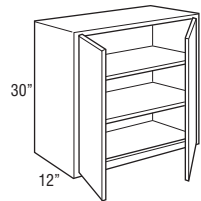

W2430B-W3630B

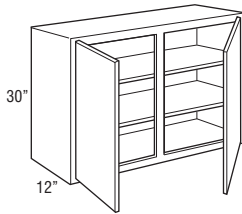

W3930-W4830

## Wall Single Door, 33" High

Model	Cubic Feet
W933 L or R†	3.1
W1233 L or R	4.0
W1533 L or R	4.8
W1833 L or R	5.7
W2133 L or R	6.5
W2433 L or R	7.4

†When Lawry is specified, the door panel will be recessed.

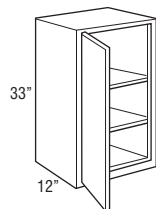

### Modifications

ADDTK	AUTHB	AUTHL	AUTHR	CBO	CCO	CFNTO	CND	EXB	EXL	EXR	FPEB	FTK	FULL	ID	INTGH	INVERM	MI	P	RD	RECTKL	RECTKR
•	•	•	•	•	•	•	•	•	•	•	•	•	•	•	•	•	•	•	•	•	•

### Construction Upgrades

APF	APU	PEF	PEU
•	•	•	•

### Decorative Door Options

ALF	CG	MD	PRMD
•	•	•†	•†

†MD and PRMD not available on W933 and W1233.

## Wall Double Door, 33" High

Model	Cubic Feet
W2433B	7.4
W2733B	8.2
W3033B	9.1
W3333B	10.0
W3633B	10.8
W3933	11.6
W4233	12.5
W4533	13.5
W4833	14.2

### Modifications

ADDTK	AUTHB	AUTHL	AUTHR	CBO	CCO	CFNTO	CND	EXB	EXL	EXR	FPEB	FTK	FULL	ID	INTGH	INVERM	MI	P	RD	RECTKL	RECTKR
•	•	•	•	•	•	•	•	•	•	•	•	•	•	•	•	•	•	•	•	•	•

### Construction Upgrades

APF	APU	PEF	PEU
•	•	•	•

### Decorative Door Options

ALF	CG	MD	PRMD
•	•	•	•

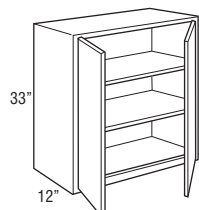

W2433B-W3633B

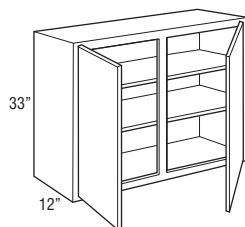

W3933-W4833

## Wall Single Door, 36" High

Model	Cubic Feet
W936 L or R†	3.4
W1236 L or R	4.3
W1536 L or R	5.2
W1836 L or R	6.2
W2136 L or R	7.1
W2436 L or R	8.0

†When Lawry is specified, the door panel will be recessed.

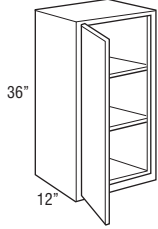

### Modifications

ADDTK	AUTHB	AUTHL	AUTHR	CBO	CCO	CFNTO	CND	EXB	EXL	EXR	FPEB	FTK	FULL	ID	INTGH	INVFRM	MI	P	RD	RECTKL	RECTKR
•	•	•	•	•	•	•	•	•	•	•	•	•	•	•	•	•	•	•	•	•	•

### Construction Upgrades

APF	APU	PEF	PEU
•	•	•	•

### Decorative Door Options

ALF	CG	MD	PRMD
•†	•	•‡	•‡

†ALF not available on W936 and W2436.

‡MD and PRMD not available on W936 and W1236.

70

## Wall Double Door, 36" High

Model	Cubic Feet
W2436B	8.0
W2736B	8.9
W3036B	9.9
W3336B	10.8
W3636B	11.7
W3936	12.6
W4236	13.5
W4536	14.4
W4836	15.4

### Modifications

ADDTK	AUTHB	AUTHL	AUTHR	CBO	CCO	CFNTO	CND	EXB	EXL	EXR	FPEB	FTK	FULL	ID	INTGH	INVFRM	MI	P	RD	RECTKL	RECTKR
•	•	•	•	•	•	•	•	•	•	•	•	•	•	•	•	•	•	•	•	•	•

### Construction Upgrades

APF	APU	PEF	PEU
•	•	•	•

### Decorative Door Options

ALF	CG	MD	PRMD
	•	•	•

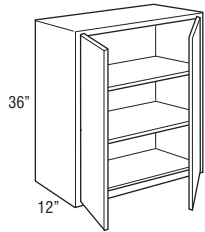

W2436B-W3636B

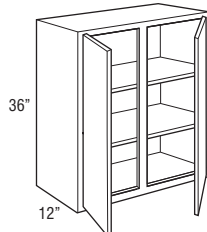

W3936-W4836

WALL CABINETS

## Wall Single Door, 39" High

Model	Cubic Feet
W939 L or R†	3.7
W1239 L or R	4.7
W1539 L or R	5.6
W1839 L or R	6.6
W2139 L or R	7.6
W2439 L or R	8.6

†When Lawry is specified, the door panel will be recessed.

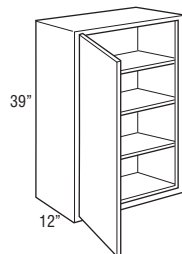

### Modifications

ADDTK	AUTHB	AUTHL	AUTHR	CBO	CCO	CFNTO	CND	EXB	EXL	EXR	FPEB	FTK	FULL	ID	INTGH	INVFRM	MI	P	RD	RECTKL	RECTKR
•	•	•	•	•	•	•	•	•	•	•	•	•	•	•	•	•	•	•	•	•	•

### Construction Upgrades

APF	APU	PEF	PEU
•	•	•	•

### Decorative Door Options

ALF	CG	MD	PRMD
•	•	•†	•†

†MD and PRMD not available on W939 and W1239.

## Wall Double Door, 39" High

Model	Cubic Feet
W2439B	8.6
W2739B	9.6
W3039B	10.6
W3339B	11.6
W3639B	12.6
W3939	13.6
W4239	14.6
W4539	15.6
W4839	16.6

### Modifications

ADDTK	AUTHB	AUTHL	AUTHR	CBO	CCO	CFNTO	CND	EXB	EXL	EXR	FPEB	FTK	FULL	ID	INTGH	INVFRM	MI	P	RD	RECTKL	RECTKR
•	•	•	•	•	•	•	•	•	•	•	•	•	•	•	•	•	•	•	•	•	•

### Construction Upgrades

APF	APU	PEF	PEU
•	•	•	•

### Decorative Door Options

ALF	CG	MD	PRMD
•	•	•	•

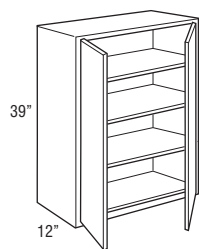

W2439B-W3639B

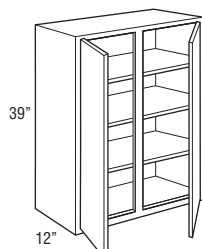

W3939-W4839

## Wall Single Door, 42" High

Model	Cubic Feet
W942 L or R†	3.9
W1242 L or R	5.0
W1542 L or R	6.1
W1842 L or R	7.2
W2142 L or R	8.3
W2442 L or R	9.4

†When Lawry is specified, the door panel will be recessed.

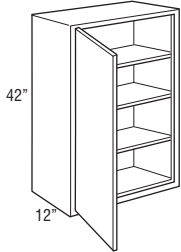

### Modifications

ADDTK	AUTHB	AUTHL	AUTHR	CBO	CCO	CFNTO	CND	EXB	EXL	EXR	FPEB	FTK	FULL	ID	INTGH	INVFRM	MI	P	RD	RECTKL	RECTKR	
•	•	•	•	•	•	•	•	•	•	•	•	•	•	•	•	•	•	•	•	•	•	•

### Construction Upgrades

APF	APU	PEF	PEU
•	•	•	•

### Decorative Door Options

ALF	CG	MD	PRMD
•	•	•†	•†

†MD and PRMD not available on W942 and W1242.

72

## Wall Double Door, 42" High

Model	Cubic Feet
W2442B	9.4
W2742B	10.3
W3042B	11.4
W3342B	12.5
W3642B	13.5
W3942	14.6
W4242	15.7
W4542	16.8
W4842	17.8

### Modifications

ADDTK	AUTHB	AUTHL	AUTHR	CBO	CCO	CFNTO	CND	EXB	EXL	EXR	FPEB	FTK	FULL	ID	INTGH	INVFRM	MI	P	RD	RECTKL	RECTKR	
•	•	•	•	•	•	•	•	•	•	•	•	•	•	•	•	•	•	•	•	•	•	•

### Construction Upgrades

APF	APU	PEF	PEU
•	•	•	•

### Decorative Door Options

ALF	CG	MD	PRMD
•	•	•	•

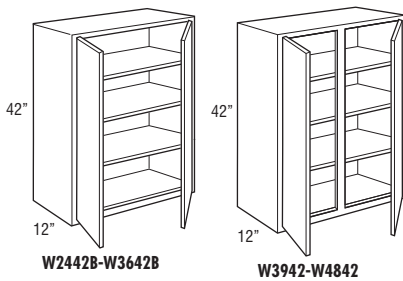

WALL CABINETS



## Wall Three Drawer Single Door, 48", 51", 54", 57", or 60" High

Model	Cubic Feet
W3D1548 L or R	6.9
W3D1848 L or R	8.1
W3D2448 L or R	10.5
W3D1551 L or R	7.3
W3D1851 L or R	8.6
W3D2451 L or R	11.2
W3D1554 L or R	7.7
W3D1854 L or R	9.1
W3D2454 L or R	11.8
W3D1557 L or R	8.1
W3D1857 L or R	9.6
W3D2457 L or R	12.4
W3D1560 L or R	8.5
W3D1860 L or R	10.0
W3D2460 L or R	13.1

### Modifications

ADDTK	AUTHB	AUTHL	AUTHR	CBO	CCO	CFNTO	CND	EXB	EXL	EXR	FPEB	FTK	FULL	ID	INTGH	INVERM	MI	P	RD	RECTKL	RECTKR	WDRWPG
	•	•	•	•	•	•	•	•	•	•	•	•	•	•	•		•					STD

### Construction Upgrades

APF	APU	PEF	PEU
•	•	•	•

### Decorative Door Options

ALF	CG	MD	PRMD
	•	•	•

- Includes one shallow depth drawer and two standard drawers with undermount SoftTouch guides.
- Top drawer will be slab drawer front for all 5-piece drawer applications.
- Drawer front to face frame reveal is justified to the top to be consistent with overlay. Bottom reveal is 7/8" for full/modified full overlay and 1" for traditional overlay.
- When ordering Aloe, Cadet, or Onyx, APF or PEF must be specified.

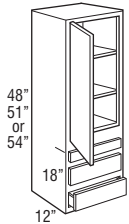

W3D1548-W3D2454 L or R

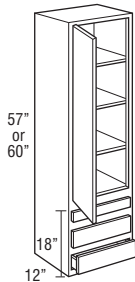

W3D1557-W3D2460 L or R

## Wall Three Drawer Double Door, 48", 51", 54", 57", or 60" High

Model	Cubic Feet
W3D2448B	10.4
W3D2451B	11.2
W3D2454B	11.8
W3D2457B	12.4
W3D2460B	13.1

- Includes one shallow depth drawer and two standard drawers with undermount SoftTouch guides.
- Top drawer will be slab drawer front for all 5-piece drawer applications.
- Drawer front to face frame reveal is justified to the top to be consistent with overlay. Bottom reveal is 7/8" for full/modified full overlay and 1" for traditional overlay.
- When ordering Aloe, Cadet, or Onyx, APF or PEF must be specified.

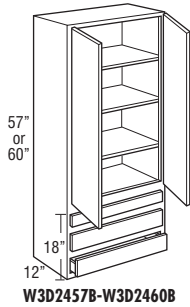
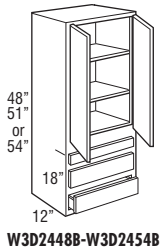

### Modifications

ADDTK	AUTHB	AUTHL	AUTHR	CBO	CCO	CFNTO	CND	EXB	EXL	EXR	FPEB	FTK	FULL	ID	INTGH	INVRM	MI	P	RD	RECTKL	RECTKR	WDRWPG
	•	•	•	•	•	•	•	•	•	•	•	•	•	•	•		•					STD

### Construction Upgrades

APF	APU	PEF	PEU
•	•	•	•

### Decorative Door Options

ALF	CG	MD	PRMD
	•	•	•

## Stacked Wall Cabinets Single Door, 48" High

Model	Cubic Feet
STW1248 L or R	5.7
STW1548 L or R	6.9
STW1848 L or R	8.1
STW2148 L or R	9.3
STW2448 L or R	10.5

- Bottom doors will always be square.

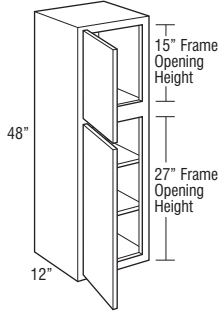

### Modifications

ADDTK	AUTHB	AUTHL	AUTHR	CBO	CCO	CFNTO	CND	EXB	EXL	EXR	FPEB	FTK	FULL	ID	INTGH	INVERM	MI	P	RD	RECTKL	RECTKR	
	•	•	•	•	•			•	•	•	•		•	•	•	•	•	•	•			

### Construction Upgrades

APF	APU	PEF	PEU
•	•	•	•

### Decorative Door Options

ALF	CGCG	CGSD	MDMD	MDSO	PDPD	PDSO	SDCG	SDMD	SDPD	SOSO
•	•	•	†	†	†	†	•	†	†	STD

†MDMD, MDSO, PDPD, PDSO, SDMD, and SOSO not available on STW1248.

## Stacked Wall Cabinets Double Door, 48" High

Model	Cubic Feet
STW2448B	10.5
STW2748B	11.7
STW3048B	13.0
STW3348B	14.2
STW3648B	15.4
STW3948	16.6
STW4248	17.8

- Bottom doors will always be square.

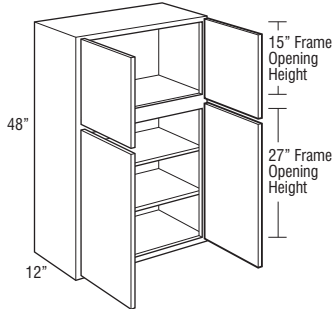

STW2448B-STW3648B

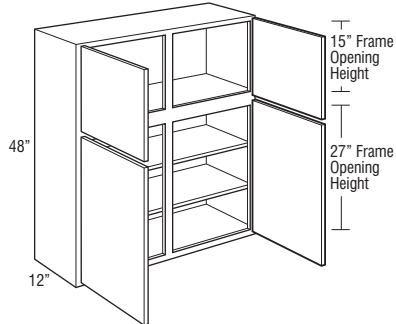

STW3948-STW4248

### Modifications

ADDTK	AUTHB	AUTHL	AUTHR	CBO	CCO	CFNTO	CND	EXB	EXL	EXR	FPEB	FTK	FULL	ID	INTGH	INVERM	MI	P	RD	RECTKL	RECTKR	
	•	•	•	•	•			•	•	•	•		•	•	•	•	•	•*	•			

\*P not available on STW3948 and STW4248.

### Construction Upgrades

APF	APU	PEF	PEU
•	•	•	•

### Decorative Door Options

ALF	CGCG	CGSD	MDMD	MDSO	PDPD	PDSO	SDCG	SDMD	SDPD	SOSO
•	•	•	•	•	•	•	•	•	•	STD

## Stacked Wall Cabinets Single Door, 51" High

Model	Cubic Feet
STW1251 L or R	6.0
STW1551 L or R	7.3
STW1851 L or R	8.6
STW2151 L or R	9.9
STW2451 L or R	11.2

- Bottom doors will always be square.

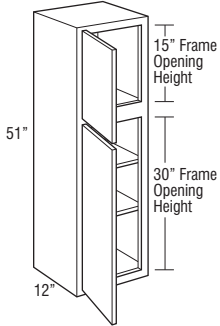

### Modifications

ADDTK	AUTHB	AUTHL	AUTHR	CBO	CCO	CFNTO	CND	EXB	EXL	EXR	FPEB	FTK	FULL	ID	INTGH	INVFRM	MI	P	RD	RECTKL	RECTKR	
	•	•	•	•	•			•	•	•	•	•	•	•	•	•	•	•	•			

### Construction Upgrades

APF	APU	PEF	PEU
•	•	•	•

### Decorative Door Options

ALF	CGCG	CGSD	MDMD	MDSO	PDPD	PDSO	SDCG	SDMD	SDPD	SOSO
	•	•	•†	•†	•†	•†	•	•†	•†	STD

†MDMD, MDSO, PDPD, PDSO, SDMD, and SOSO not available on STW1251.

76

## Stacked Wall Cabinets Double Door, 51" High

Model	Cubic Feet
STW2451B	11.2
STW2751B	12.5
STW3051B	13.7
STW3351B	15.0
STW3651B	16.3
STW3951	17.6
STW4251	18.9

- Bottom doors will always be square.

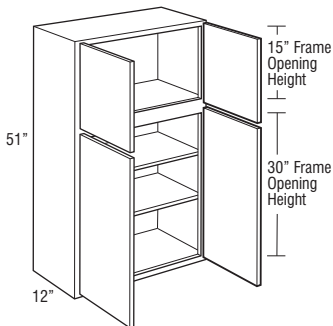

STW2451B-STW3651B

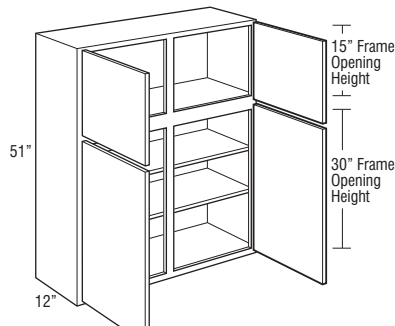

STW3951-STW4251

### Modifications

ADDTK	AUTHB	AUTHL	AUTHR	CBO	CCO	CFNTO	CND	EXB	EXL	EXR	FPEB	FTK	FULL	ID	INTGH	INVFRM	MI	P	RD	RECTKL	RECTKR	
	•	•	•	•	•			•	•	•	•	•	•	•	•	•	•	•*	•			

\*P not available on STW3951 and STW4251.

### Construction Upgrades

APF	APU	PEF	PEU
•	•	•	•

### Decorative Door Options

ALF	CGCG	CGSD	MDMD	MDSO	PDPD	PDSO	SDCG	SDMD	SDPD	SOSO
	•	•	•	•	•	•	•	•	•	STD

WALL CABINETS

## Stacked Wall Cabinets Single Door, 54" High

Model	Cubic Feet
STW1254 L or R	6.4
STW1554 L or R	7.7
STW1854 L or R	9.1
STW2154 L or R	10.4
STW2454 L or R	11.8

- Bottom doors will always be square.

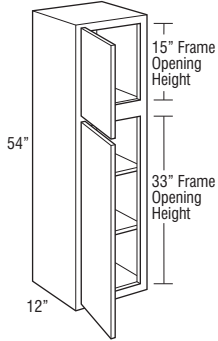

### Modifications

ADDTK	AUTHB	AUTHL	AUTHR	CBO	CCO	CFNTO	CND	EXB	EXL	EXR	FPEB	FTK	FULL	ID	INTGH	INVFRM	MI	P	RD	RECTKL	RECTKR	
	•	•	•	•	•			•	•	•	•		•	•	•	•	•	•	•			

### Construction Upgrades

APF	APU	PEF	PEU
•	•	•	•

### Decorative Door Options

ALF	CGCG	CGSD	MDMD	MDSL	PDPD	PDSL	SDCG	SDMD	SDPD	SDSL
•	•	•	•†	•†	•†	•†	•	•†	•†	STD

†MDMD, MDSL, PDPD, PDSL, SDMD, and SDSL not available on STW1254.

## Stacked Wall Cabinets Double Door, 54" High

Model	Cubic Feet
STW2454B	11.8
STW2754B	13.2
STW3054B	14.5
STW3354B	15.9
STW3654B	17.2
STW3954	18.6
STW4254	20.0

- Bottom doors will always be square.

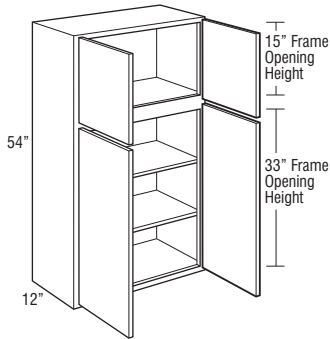

STW2454B-STW3654B

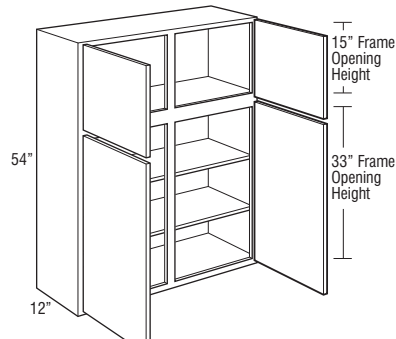

STW3954-STW4254

### Modifications

ADDTK	AUTHB	AUTHL	AUTHR	CBO	CCO	CFNTO	CND	EXB	EXL	EXR	FPEB	FTK	FULL	ID	INTGH	INVFRM	MI	P	RD	RECTKL	RECTKR	
	•	•	•	•	•			•	•	•	•		•	•	•	•	•	•*	•			

\*P not available on STW3954 and STW4254.

### Construction Upgrades

APF	APU	PEF	PEU
•	•	•	•

### Decorative Door Options

ALF	CGCG	CGSD	MDMD	MDSL	PDPD	PDSL	SDCG	SDMD	SDPD	SDSL
•	•	•	•	•	•	•	•	•	•	STD

## Stacked Wall Cabinets Single Door, 57" High

Model	Cubic Feet
STW1257 L or R	6.7
STW1557 L or R	8.1
STW1857 L or R	9.6
STW2157 L or R	11.0
STW2457 L or R	12.4

- Bottom doors will always be square.

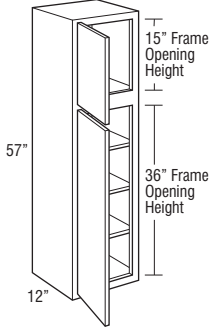

### Modifications

ADDTK	AUTHB	AUTHL	AUTHR	CBO	CCO	CFNTO	CND	EXB	EXL	EXR	FPEB	FTK	FULL	ID	INTGH	INVRM	MI	P	RD	RECTKL	RECTKR
	•	•	•	•	•			•	•	•			•	•	•	•	•	•	•		

### Construction Upgrades

APF	APU	PEF	PEU
•	•	•	•

### Decorative Door Options

ALF	CGCG	CGSD	MDMD	MDSD	PDPD	PDS	SDCG	SDMD	SDPD	S	SDSD
	•	•	•†	•†	•†	•†	•	•†	•†	•	STD

†MDMD, MSD, PDPD, PDS, SDMD, and SPSD not available on STW1257.

78

## Stacked Wall Cabinets Double Door, 57" High

Model	Cubic Feet
STW2457B	12.4
STW2757B	13.9
STW3057B	15.3
STW3357B	16.7
STW3657B	18.2
STW3957	19.6
STW4257	21.0

- Bottom doors will always be square.

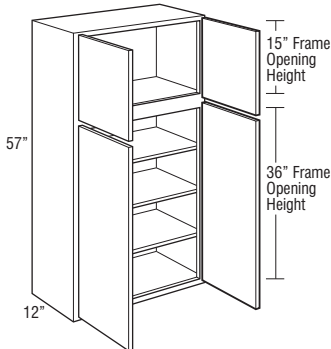

STW2457B-STW3657B

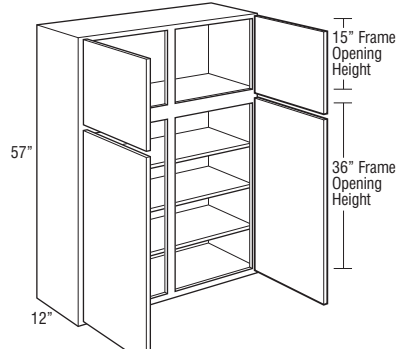

STW3957-STW4257

### Modifications

ADDTK	AUTHB	AUTHL	AUTHR	CBO	CCO	CFNTO	CND	EXB	EXL	EXR	FPEB	FTK	FULL	ID	INTGH	INVRM	MI	P	RD	RECTKL	RECTKR
	•	•	•	•	•			•	•	•			•	•	•	•	•	•	•*		

\*P not available on STW3957 and STW4257.

### Construction Upgrades

APF	APU	PEF	PEU
•	•	•	•

### Decorative Door Options

ALF	CGCG	CGSD	MDMD	MDSD	PDPD	PDS	SDCG	SDMD	SDPD	S	SDSD
	•	•	•	•	•	•	•	•	•	•	STD

WALL CABINETS

## Stacked Wall Cabinets Single Door, 60" High

Model	Cubic Feet
STW1260 L or R	7.0
STW1560 L or R	8.5
STW1860 L or R	10.0
STW2160 L or R	11.6
STW2460 L or R	13.1

- Bottom doors will always be square.

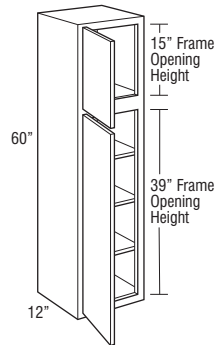

### Modifications

ADDTK	AUTHB	AUTHL	AUTHR	CBO	CCO	CFNTO	CND	EXB	EXL	EXR	FPEB	FTK	FULL	ID	INTGH	INVERM	MI	P	RD	RECTKL	RECTKR	
	•	•	•	•	•			•	•	•	•		•	•	•	•	•	•	•			

### Construction Upgrades

APF	APU	PEF	PEU
•	•	•	•

### Decorative Door Options

ALF	CGCG	CGSD	MDMD	MDSL	PDPD	PDSL	SDCG	SDMD	SDPD	SDSL
•	•	•	•†	•†	•†	•†	•	•†	•†	STD

†MDMD, MDSL, PDPD, PDSL, SDMD, and SDSL not available on STW1260.

## Stacked Wall Cabinets Double Door, 60" High

Model	Cubic Feet
STW2460B	13.1
STW2760B	14.6
STW3060B	16.1
STW3360B	17.6
STW3660B	19.1
STW3960	20.6
STW4260	22.1

- Bottom doors will always be square.

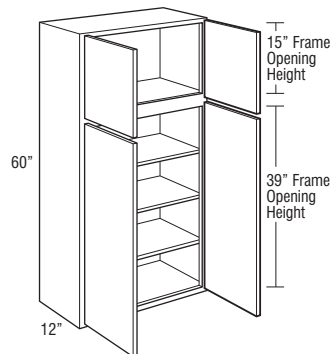

STW2460B-STW3660B

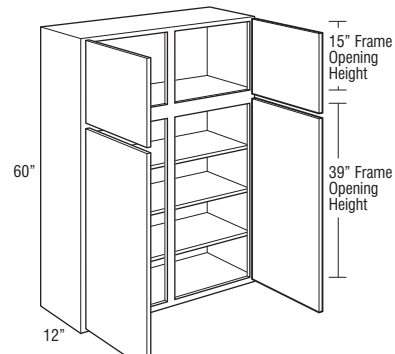

STW3960-STW4260

### Modifications

ADDTK	AUTHB	AUTHL	AUTHR	CBO	CCO	CFNTO	CND	EXB	EXL	EXR	FPEB	FTK	FULL	ID	INTGH	INVERM	MI	P	RD	RECTKL	RECTKR	
	•	•	•	•	•			•	•	•	•		•	•	•	•	•	•*	•			

\*P not available on STW3960 and STW4260.

### Construction Upgrades

APF	APU	PEF	PEU
•	•	•	•

### Decorative Door Options

ALF	CGCG	CGSD	MDMD	MDSL	PDPD	PDSL	SDCG	SDMD	SDPD	SDSL
•	•	•	•	•	•	•	•	•	•	STD

**Wall Corner Cabinets**

- Wall corner cabinets may be installed flush to the wall (left) or pulled 3" away from wall (right) to accommodate odd dimensions in a kitchen design. In either case, the adjoining run of 12" wall cabinets plus a 3" filler will butt against the solid-wood panel.
- When a cabinet is "pulled" it will use proportionally more wall space, for example, a 30" wide WC pulled 2" will use 32" of space.
- The BL or BR in the cabinet's nomenclature indicates the location of cabinet void.
- Blind side of wall corner cabinets cannot be installed next to a range hood or microwave shelf unit due to door interference.

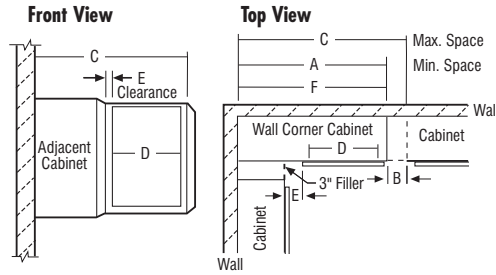

NOTE: All outside stiles are 1 1/2" wide

Model	A Min. Space	B Max. Pull*	C Max. Space	D Cabinet Opening	E* Modified Full Overlay At Min.	E* Modified Full Overlay At Max.	E Traditional Overlay At Min.	E Traditional Overlay At Max.	F Actual Cabinet
WC24..	24"	5"	29"	7 1/2"	1 3/4"	6 3/4"	2 1/2"	7 1/2"	24"
WC27..	27"	4 1/2"	31 1/2"	9"	3 1/4"	7 3/4"	4"	8 1/2"	27"
WC30..	30"	5"	35"	13 1/2"	1 3/4"	6 3/4"	2 1/2"	7 1/2"	30"
WC33..	33"	4 1/2"	37 1/2"	15"	3 1/4"	7 3/4"	4"	8 1/2"	33"
WC36..	36"	5"	41"	19 1/2"	1 3/4"	6 3/4"	2 1/2"	7 1/2"	36"
WC42..	42"	4 1/2"	46 1/2"	24"	3 1/4"	7 3/4"	4"	8 1/2"	42"
WC48..	48"	4 1/2"	52 1/2"	30"	3 1/4"	7 3/4"	4"	8 1/2"	48"

\*Minimum/maximum space between inside edge of door and face of filler/adjoining cabinet. If cabinet is pulled to maximum stated dimension, filler will need to be created for proper attachment.

**Wall Corner Single Door, 30" High**

Model	Cubic Feet
WC2430 BL or BR	6.7
WC2730 BL or BR	7.5
WC3030 BL or BR	8.3
WC3330 BL or BR	9.1
WC3630 BL or BR	9.9

- BL or BR indicates void. BR (right) void shown.
- Includes one 3" filler, shipped unattached.

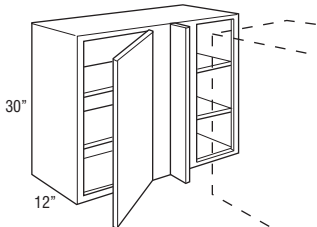

**Modifications**

ADDTK	AUTHB	AUTHL	AUTHR	CBO	CCO	CFNT0	CND	EXB	EXL	EXR	FPEB	FTK	FULL	ID	INTGH	INVFRM	MI	P	RD	RECTKL	RECTKR	
•	•	•	•	•	•	•	•	•	•	•	•	•	•	•	•	•	•	•	•	•	•	•

**Construction Upgrades**

APF	APU	PEF	PEU
•	•	•	•

**Decorative Door Options**

ALF	CG	MD	PRMD

**Wall Corner Double Door, 30" High**

Model	Cubic Feet
WC4230 BL or BR	11.4
WC4830 BL or BR	13.0

- BL or BR indicates void. BR (right) void shown.
- Includes one 3" filler, shipped unattached.

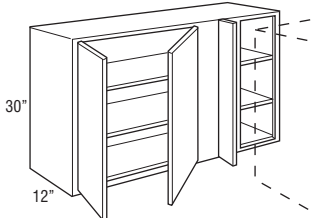

**Modifications**

ADDTK	AUTHB	AUTHL	AUTHR	CBO	CCO	CFNT0	CND	EXB	EXL	EXR	FPEB	FTK	FULL	ID	INTGH	INVFRM	MI	P	RD	RECTKL	RECTKR	
•	•	•	•	•	•	•	•	•	•	•	•	•	•	•	•	•	•	•	•	•	•	•

**Construction Upgrades**

APF	APU	PEF	PEU
•	•	•	•

**Decorative Door Options**

ALF	CG	MD	PRMD



## Wall Corner Single Door, 33" High

Model	Cubic Feet
WC2433 BL or BR	7.4
WC2733 BL or BR	8.2
WC3033 BL or BR	9.1
WC3333 BL or BR	9.9
WC3633 BL or BR	10.8

- BL or BR indicates void. BR (right) void shown.
- Includes one 3" filler, shipped unattached.

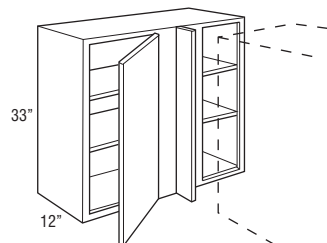

### Modifications

ADDTK	AUTHB	AUTHL	AUTHR	CBO	CCO	CFNTO	CND	EXB	EXL	EXR	FPEB	FTK	FULL	ID	INTGH	INVERM	MI	P	RD	RECTKL	RECTKR
•	•	•	•	•	•	•		•	•	•	•	•	•	•	•			•		•	•

### Construction Upgrades

APF	APU	PEF	PEU
•	•	•	•

### Decorative Door Options

ALF	CG	MD	PRMD

## Wall Corner Single Door, 36" High

Model	Cubic Feet
WC2436 BL or BR	8.0
WC2736 BL or BR	8.9
WC3036 BL or BR	9.9
WC3336 BL or BR	10.8
WC3636 BL or BR	11.7

- BL or BR indicates void. BR (right) void shown.
- Includes one 3" filler, shipped unattached.

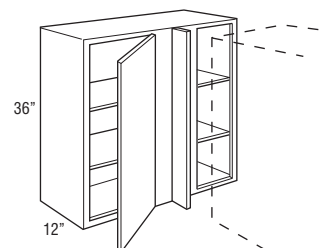

### Modifications

ADDTK	AUTHB	AUTHL	AUTHR	CBO	CCO	CFNTO	CND	EXB	EXL	EXR	FPEB	FTK	FULL	ID	INTGH	INVERM	MI	P	RD	RECTKL	RECTKR
•	•	•	•	•	•	•		•	•	•	•	•	•	•	•			•		•	•

### Construction Upgrades

APF	APU	PEF	PEU
•	•	•	•

### Decorative Door Options

ALF	CG	MD	PRMD

### Wall Corner Single Door, 39" High

Model	Cubic Feet
WC2439 BL or BR	8.6
WC2739 BL or BR	9.6
WC3039 BL or BR	10.6
WC3339 BL or BR	11.6
WC3639 BL or BR	12.6

- BL or BR indicates void. BR (right) void shown.
- Includes one 3" filler, shipped unattached.

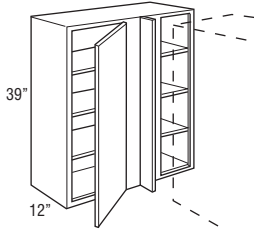

#### Modifications

ADDTK	AUTHB	AUTHL	AUTHR	CBO	CCO	CFNTO	CND	EXB	EXL	EXR	FPEB	FTK	FULL	ID	INTGH	INVFRM	MI	P	RD	RECTKL	RECTKR	
•	•	•	•	•	•	•	•	•	•	•	•	•	•	•	•	•	•	•	•	•	•	•

#### Construction Upgrades

APF	APU	PEF	PEU
•	•	•	•

#### Decorative Door Options

ALF	CG	MD	PRMD
•	•	•	•

### Wall Corner Single Door, 42" High

Model	Cubic Feet
WC2442 BL or BR	9.4
WC2742 BL or BR	10.3
WC3042 BL or BR	11.4
WC3342 BL or BR	12.5
WC3642 BL or BR	13.5

- BL or BR indicates void. BR (right) void shown.
- Includes one 3" filler, shipped unattached.

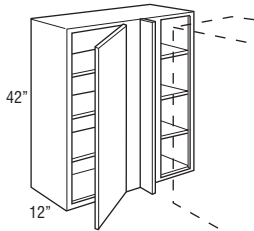

#### Modifications

ADDTK	AUTHB	AUTHL	AUTHR	CBO	CCO	CFNTO	CND	EXB	EXL	EXR	FPEB	FTK	FULL	ID	INTGH	INVFRM	MI	P	RD	RECTKL	RECTKR	
•	•	•	•	•	•	•	•	•	•	•	•	•	•	•	•	•	•	•	•	•	•	•

#### Construction Upgrades

APF	APU	PEF	PEU
•	•	•	•

#### Decorative Door Options

ALF	CG	MD	PRMD
•	•	•	•

## Wall Diagonal, 12", 15", 18", 21", 24", or 27" High, 24" x 24"

Model	Cubic Feet
WD2412 L or R	5.5
WD2415 L or R	6.7
WD2418 L or R	7.8
WD2421 L or R	9.0
WD2424 L or R	10.2
WD2427 L or R	11.3

- Cabinets require 24" x 24" of corner wall space.
- To allow for proper door clearance of adjacent cabinets, all door styles regardless of overlay utilize 14 1/2" wide doors with a traditional overlay hinge.
- Adjustable shelf cannot be removed or retrofitted.

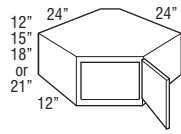

WD2412-WD2421 L or R

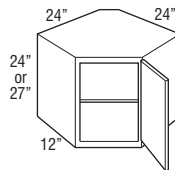

WD2424-WD2427 L or R

### Modifications

ADDTK	AUTHB	AUTHL	AUTHR	CBO	CCO	CFNTO	CND	EXB	EXL	EXR	FPEB	FTK	FULL	ID	INTGH	INVFRM	MI	P	RD	RECTKL	RECTKR	
	•	•	•	•*	•	•					•		•		•		•					

\*CBO available only on WD2424 and WD2427.

### Construction Upgrades

APF	APU	PEF	PEU
•	•	•	•

### Decorative Door Options

ALF	CG	MD	PRMD
	•	•†	•†

†MD and PRMD not available on WD2412 and WD2415.

## Wall Diagonal, 30", 33", 36", 39", or 42" High, 24" x 24"

Model	Cubic Feet
WD2430 L or R	12.5
WD2433 L or R	13.7
WD2436 L or R	14.9
WD2439 L or R	16.0
WD2442 L or R	17.2

- Cabinets require 24" x 24" of corner wall space.
- To allow for proper door clearance of adjacent cabinets, all door styles regardless of overlay utilize 14 1/2" wide doors with a traditional overlay hinge.

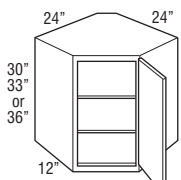

WD2430-WD2436 L or R

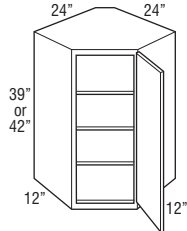

WD2439-WD2442 L or R

### Modifications

ADDTK	AUTHB	AUTHL	AUTHR	CBO	CCO	CFNTO	CND	EXB	EXL	EXR	FPEB	FTK	FULL	ID	INTGH	INVFRM	MI	P	RD	RECTKL	RECTKR	
	•	•	•	•	•	•					•		•		•		•					

### Construction Upgrades

APF	APU	PEF	PEU
•	•	•	•

### Decorative Door Options

ALF	CG	MD	PRMD
	•	•	•

## Wall Diagonal with Lazy Susan, 30", 33", 36", 39", or 42" High, 24" x 24"

Model	Cubic Feet
WD2430S L or R	12.5
WD2433S L or R	13.7
WD2436S L or R	14.9
WD2439S L or R	16.0
WD2442S L or R	17.2

- Cabinets require 24" x 24" of corner wall space.
- To allow for proper door clearance of adjacent cabinets, all door styles regardless of overlay utilize 14 1/2" wide doors with a traditional overlay hinge.
- Plywood shelves are 18" in overall diameter with a 17" interior diameter and 1" high lip.



### Modifications

ADDTK	AUTHB	AUTHL	AUTHR	CBO	CCO	CFNTO	CND	EXB	EXL	EXR	FPEB	FTK	FULL	ID	INTGH	INVFRM	MI	P	RD	RECTKL	RECTKR	
	•	•	•	•	•	•					•		•				•					

### Construction Upgrades

APF	APU	PEF	PEU
•	•	•	•

### Decorative Door Options

ALF	CG	MD	PRMD
	•	•	•

## Wall Diagonal, 30", 33", 36", 39", or 42" High, 27" x 27"

Model	Cubic Feet
WD2730 L or R	15.6
WD2733 L or R	17.0
WD2736 L or R	18.5
WD2739 L or R	20.0
WD2742 L or R	21.4

- Cabinets require 27" x 27" of corner wall space.
- To allow for proper door clearance of adjacent cabinets, all door styles regardless of overlay utilize 14 1/2" wide doors with a traditional overlay hinge.
- When ordering Aloe, Cadet, or Onyx, APF or PEF must be specified.

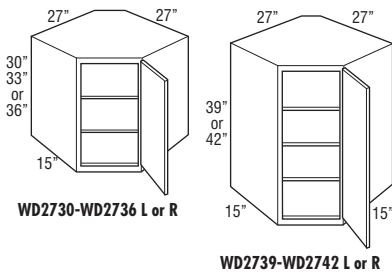

### Modifications

ADDTK	AUTHB	AUTHL	AUTHR	CBO	CCO	CFNTO	CND	EXB	EXL	EXR	FPEB	FTK	FULL	ID	INTGH	INVFRM	MI	P	RD	RECTKL	RECTKR	
	•	•	•	•	•	•					•		•				•					

### Construction Upgrades

APF	APU	PEF	PEU
•	•	•	•

### Decorative Door Options

ALF	CG	MD	PRMD
	•	•	•

## Stacked Diagonal Wall, 48", 51", 54", 57", or 60" High, 24" x 24"

Model	Cubic Feet
STWD2448 L or R	19.6
STWD2451 L or R	20.7
STWD2454 L or R	21.9
STWD2457 L or R	23.1
STWD2460 L or R	24.3

- Cabinets require 24" x 24" of corner wall space.
- To allow for proper door clearance of adjacent cabinets, all door styles regardless of overlay utilize 14 1/2" wide doors with a traditional overlay hinge.
- Bottom doors will always be square.

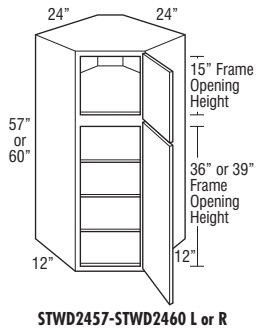
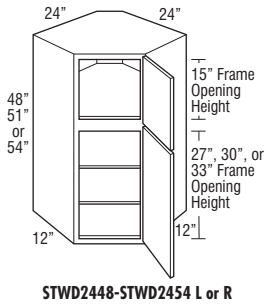

### Modifications

ADDTK	AUTHB	AUTHL	AUTHR	CBO	CCO	CFNTO	CND	EXB	EXL	EXR	FPEB	FTK	FULL	ID	INTGH	INVFRM	MI	P	RD	RECTKL	RECTKR	
	•	•	•	•	•						•		•		•		•					

### Construction Upgrades

APF	APU	PEF	PEU
•	•	•	•

### Decorative Door Options

ALF	CGCG	CGSD	MDMD	MDSL	PDPD	PDSL	SDCG	SDMD	SDPD	SDSL
•	•	•	•	•	•	•	•	•	•	STD

## Stacked Diagonal Wall, 48", 51", 54", 57", or 60" High, 27" x 27"

Model	Cubic Feet
STWD2748 L or R	24.3
STWD2751 L or R	25.8
STWD2754 L or R	27.3
STWD2757 L or R	28.7
STWD2760 L or R	30.2

- Cabinets require 27" x 27" of corner wall space.
- To allow for proper door clearance of adjacent cabinets, all door styles regardless of overlay utilize 14 1/2" wide doors with a traditional overlay hinge.
- Bottom doors will always be square.
- When ordering Aloe, Cadet, or Onyx, APF or PEF must be specified.

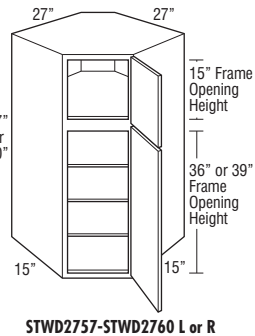
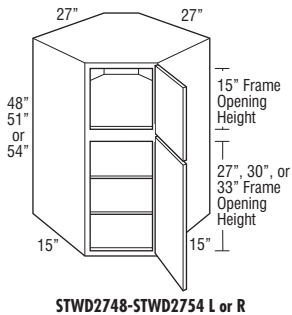

### Modifications

ADDTK	AUTHB	AUTHL	AUTHR	CBO	CCO	CFNTO	CND	EXB	EXL	EXR	FPEB	FTK	FULL	ID	INTGH	INVFRM	MI	P	RD	RECTKL	RECTKR	
				•	•						•		•		•		•					

### Construction Upgrades

APF	APU	PEF	PEU
•	•	•	•

### Decorative Door Options

ALF	CGCG	CGSD	MDMD	MDSL	PDPD	PDSL	SDCG	SDMD	SDPD	SDSL
•	•	•	•	•	•	•	•	•	•	STD

# Wall Corner Easy Reach, 30", 33", 36", 39", or 42" High, 24" x 24"

Model	Cubic Feet
WCER2430 L or R	12.5
WCER2433 L or R	13.7
WCER2436 L or R	14.9
WCER2439 L or R	16.1
WCER2442 L or R	17.2

- Cabinets require 24" x 24" of corner wall space.
- Hinged door opens to 170°.
- Decorative hardware screws must be countersunk to prevent scratching of adjacent cabinets and face frame of WCER.

### Modifications

ADDTK	AUTHB	AUTHL	AUTHR	CBO	CCO	CFNTO	CND	EXB	EXL	EXR	FPEB	FTK	FULL	ID	INTGH	INVRM	MI	P	RD	RECTKL	RECTKR
•	•	•	•	•	•			•	•	•	•	•	•				•			•	•

### Construction Upgrades

APF	APU	PEF	PEU
•	•	•	•

### Decorative Door Options

ALF	CG	MD	PRMD

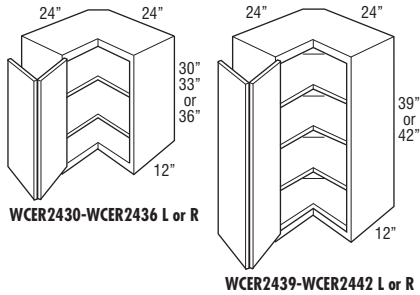

# Asymmetrical Wall Corner Easy Reach Cabinet, 30", 33", 36", 39", or 42" High

Model	Cubic Feet
WCER212430 L or R	12.5
WCER242130 L or R	12.5
WCER212433 L or R	13.7
WCER242133 L or R	13.7
WCER212436 L or R	14.9
WCER242136 L or R	14.9
WCER212439 L or R	16.1
WCER242139 L or R	16.1
WCER212442 L or R	17.2
WCER242142 L or R	17.2

### Modifications

ADTK	AUTHB	AUTHL	AUTHR	CBO	CCO	CFNTO	CND	EXB	EXL	EXR	FPEB	FTK	FULL	ID	INTGH	INVRM	MI	P	RD	RECTKL	RECTKR
•	•	•	•	•	•			•	•	•	•	•	•				•			•	•

### Construction Upgrades

APF	APU	PEF	PEU
•	•	•	•

### Decorative Door Options

ALF	CG	MD	PRMD

- Hinged door opens to 170°.
- Legs at the front frames are 9" on 21" leg and 12" on 24" leg.
- Nomenclature for asymmetrical cabinets reads as follows:  
 First set of numbers = left side  
 Second set of numbers = right side  
 Third set of numbers = height
- Decorative hardware screws must be countersunk to prevent scratching of adjacent cabinets and face frame of WCER.
- When Lawry is specified, the door panel will be recessed.
- WCER\_\_2124L shown.

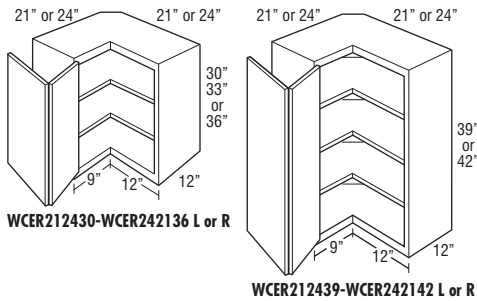

## Wall End Cabinet Single Door, 30", 33", 36", 39", or 42" High, 12" x 12"

Model	Cubic Feet
WEC30 L or R	3.6
WEC33 L or R	4.0
WEC36 L or R	4.3
WEC39 L or R	4.7
WEC42 L or R	5.0

- Width at wall: 12" x 12".
- Cabinet features two unfinished back panels. Must be installed with one back panel adjacent to a cabinet of equal height with the other back panel attached to the wall.
- When ordered with MD, shelves will not align with mullions.

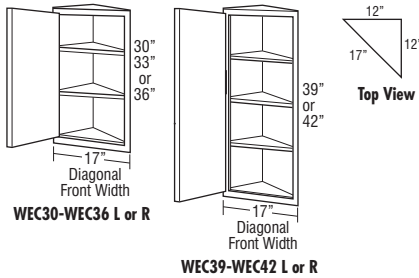

### Modifications

ADDTK	AUTHB	AUTHL	AUTHR	CBO	CCO	CFNTD	CND	EXB	EXL	EXR	FPEB	FTK	FULL	ID	INTGH	INVFRM	ML	P	RD	RECTKL	RECTKR	
•				•	•	•						•	•		•		•					

### Construction Upgrades

APF	APU	PEF	PEU
	•†		•

†APU constructed with 3/8" plywood ends.

### Decorative Door Options

ALF	CG	MD	PRMD
	•	•	•

88

## Stacked Wall End Cabinet Single Door, 48", 51", 54", 57", or 60" High, 12" x 12"

Model	Cubic Feet
STWEC1248 L or R	5.7
STWEC1251 L or R	6.0
STWEC1254 L or R	6.4
STWEC1257 L or R	6.7
STWEC1260 L or R	7.0

- Width at wall: 12" x 12".
- Cabinet features two unfinished back panels. Must be installed with one back panel adjacent to a cabinet of equal height with the other back panel attached to the wall.
- When ordered with MD, shelves will not align with mullions.

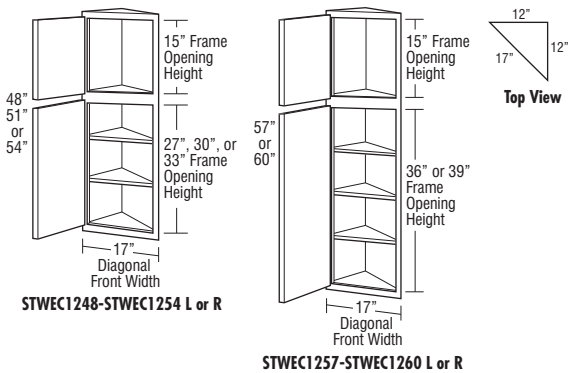

### Modifications

ADDTK	AUTHB	AUTHL	AUTHR	CBO	CCO	CFNTD	CND	EXB	EXL	EXR	FPEB	FTK	FULL	ID	INTGH	INVFRM	ML	P	RD	RECTKL	RECTKR	
				•	•								•		•	•	•					

### Construction Upgrades

APF	APU	PEF	PEU
•	•	•	•

### Decorative Door Options

ALF	CGCG	CGSD	MDMD	MDSO	PDPD	PDSO	SDCG	SDMD	SDPD	SDSO	STD
	•	•	•	•	•	•	•	•	•	•	STD

WALL CABINETS



## Wall End Cabinet Double Door, 30", 33", 36", 39", or 42" High, 12" x 12"

Model	Cubic Feet
WEC30D	3.6
WEC33D	4.0
WEC36D	4.3
WEC39D	4.7
WEC42D	5.0

- Width at wall: 12" x 12".
- Cabinet features two unfinished back panels. Must be installed with one back panel adjacent to a cabinet of equal height with the other back panel attached to the wall.
- When Lawry is specified, the door panel will be recessed.

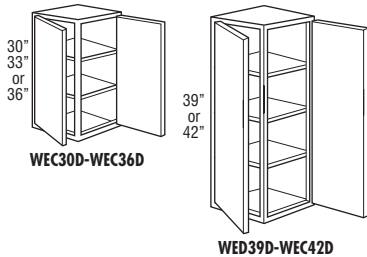

### Modifications

ADDTK	AUTHB	AUTHL	AUTHR	CBO	CCO	CFNTO	CND	EXB	EXL	EXR	FPEB	FTK	FULL	ID	INTGH	INVFRM	MI	P	RD	RECTKL	RECTKR	
•				•	•							•	•		•		•					

### Construction Upgrades

APF	APU	PEF	PEU
	•†		•

†APU constructed with 3/8" plywood ends.

### Decorative Door Options

ALF	CG	MD	PRMD

## Wall Message Center Cabinet, 30", 33", 36", 39", or 42" High, 3" Deep, 12" Wide

Model	Cubic Feet
WMC1230 L or R	1.3
WMC1233 L or R	1.4
WMC1236 L or R	1.5
WMC1239 L or R	1.7
WMC1242 L or R	1.8

- Includes magnetic whiteboard on back of door, key hooks, pencil holder, and fixed plexi-glass fronted shelves.
- Door will open 90° without decorative hardware.
- Cabinet should be hinged on wall side.
- Not available next to a Peninsula Cabinet.
- For proper installation, adjacent cabinet must have FPEB or 1/4" skin applied.
- Embellishments or overlay fillers can be used on side of cabinet to add a decorative touch.

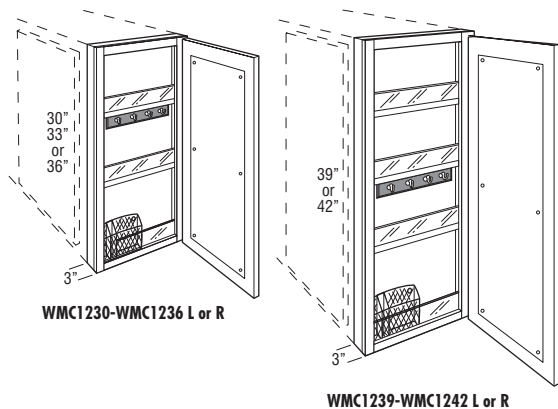

### Modifications

ADDTK	AUTHB	AUTHL	AUTHR	CBO	CCO	CFNTO	CND	EXB	EXL	EXR	FPEB	FTK	FULL	ID	INTGH	INVFRM	MI	P	RD	RECTKL	RECTKR	
											STD		•		•		•					

### Construction Upgrades

APF	APU	PEF	PEU
STD			

### Decorative Door Options

ALF	CG	MD	PRMD

# Wall Microwave Double Door Cabinet, 30", 33", 36", 39", or 42" High

Model	Cubic Feet
MW2730B	7.3
MW3030B	8.5
MW2733B	8.1
MW3033B	9.2
MW2736B	8.9
MW3036B	9.9
MW2739B	9.6
MW3039B	10.7
MW2742B	10.3
MW3042B	11.4

### Modifications

ADDTK	AUTHB	AUTHL	AUTHR	CBO	CCO	CFNTO	CND	EXB	EXL	EXR	FPEB	FTK	FULL	ID	INTGH	INVRM	MI	P	RD	RECTKL	RECTKR	
	•	•	•		•	•		•	•	•			•		•		STD					

### Construction Upgrades

APF	APU	PEF	PEU

### Decorative Door Options

ALF	CG	MD	PRMD
	•	• <sup>†</sup>	• <sup>‡</sup>

<sup>†</sup>MD not available on MW2730B, MW3030B, MW2733B, MW3033B, MW2736B, and MW3036B.

<sup>‡</sup>PRMD not available on MW2730B, MW3030B, MW2733B, and MW3033B.

- Includes one 3/4" shelf with six mounting screws. Shelf is hardwood veneer plywood. Microwave shelf extends beyond the front of the cabinet by 6 1/2", for a total shelf depth of 18 1/2".
- Microwave cabinet must be attached to wall stud and adjacent cabinets on both sides for support.
- Cabinet interior finished to match cabinet face frame.
- MW2730B Opening is 24" wide x 15 3/4" high.
- MW3030B Opening is 27" wide x 15 3/4" high.
- MW2733B-MW2742B Opening is 24" wide x 18 3/4" high.
- MW3033B-MW3042B Opening is 27" wide x 18 3/4" high.
- When ID is ordered shelf will not be included.

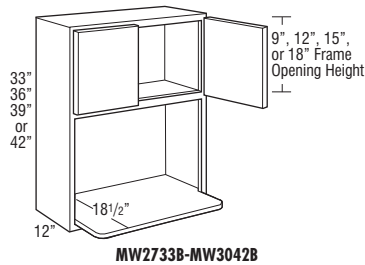
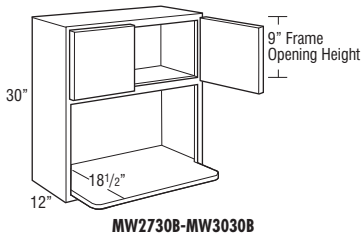

# Wall Built-in Microwave Double Door Cabinet, 36", 39", or 42" High

Model	Cubic Feet
WBMW273621	14.7
WBMW303621	16.2
WBMW273921	15.8
WBMW303921	17.5
WBMW274221	17.0
WBMW304221	18.7

### Modifications

ADDTK	AUTHB	AUTHL	AUTHR	CBO	CCO	CFNTO	CND	EXB	EXL	EXR	FPEB	FTK	FULL	ID	INTGH	INVERM	MI	P	RD	RECTKL	RECTKR
	•	•	•		•	•		•	•	•	•	•	•	•			•		•*		

\*RD to 18" available.

### Construction Upgrades

APF	APU	PEF	PEU
•		STD	

### Decorative Door Options

ALF	CG	MD	PRMD
	•		

- Microwave cabinet must be attached to wall stud and adjacent cabinets on both sides for support.

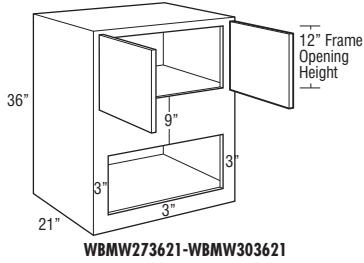

WBMW273621-WBMW303621

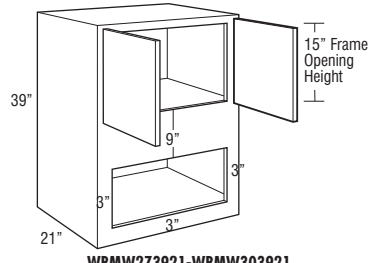

WBMW273921-WBMW303921

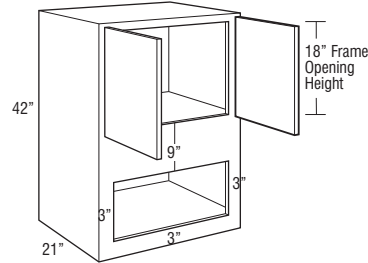

WBMW274221-WBMW304221

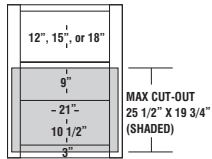

WBMW273621  
WBMW273921  
WBMW274221

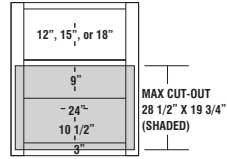

WBMW303621  
WBMW303921  
WBMW304221

Model	Factory Opening	Maximum Cut-out
2736	21W x 10 1/2H	25 1/2W x 19 3/4H
2739	21W x 10 1/2H	25 1/2W x 19 3/4H
2742	21W x 10 1/2H	25 1/2W x 19 3/4H
3036	24W x 10 1/2H	28 1/2W x 19 3/4H
3039	24W x 10 1/2H	28 1/2W x 19 3/4H
3042	24W x 10 1/2H	28 1/2W x 19 3/4H

# Wall Spice Pull-out, 30", 33", 36", 39", or 42" High

Model	Cubic Feet
WSP930†	2.9
WSP1230	3.7
WSP933†	3.1
WSP1233	4.0
WSP936†	3.5
WSP1236	4.4
WSP939†	3.7
WSP1239	4.7
WSP942†	4.0
WSP1242	5.1

- 30" to 33" high units include a natural finish, full extension wood pull-out with three adjustable shelves, one fixed shelf, and chrome finish rail sides.
- Wood plugs for top of 30" to 33" high pull-out included for field installation.
- 36" to 42" high units include a natural finish, full extension wood pull-out with three adjustable shelves, two fixed shelves, and chrome finish rail sides.
- Wire for top rail on 36" to 42" high pull-out included separately for field installation.

†When Lawry is specified, the door panel will be recessed.

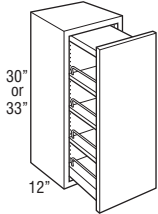

WSP930-WSP1233

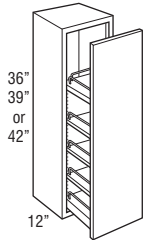

WSP936-WSP1242

### Modifications

ADDTK	AUTHB	AUTHL	AUTHR	CBO	CCO	CFNTO	CND	EXB	EXL	EXR	FPEB	FTK	FULL	ID	INTGH	INVFRM	MI	P	RD	RECTKL	RECTKR	
•	•	•	•	•	•			•	•	•	•	•	•									

### Construction Upgrades

APF	APU	PEF	PEU
•	•	•	•

### Decorative Door Options

ALF	CG	MD	PRMD

**MODEL CUBIC FEET**  
**Wall Outside End Shelf, Square Top, Square Bottom**

<b>WOC630STSB</b>	2.1
<b>WOC633STSB</b>	2.3
<b>WOC636STSB</b>	2.5
<b>WOC639STSB</b>	2.7
<b>WOC642STSB</b>	2.9

- Units are reversible.
- Hardwood veneer on 3/4" furniture board core.
- Matching interior.
- Veneer construction, finished to match cabinet face frame.
- Side is 1/4" plywood designed to fit behind front frame.
- When ordering Rustic Hickory, Hickory will be substituted.
- Shelves are fixed.

**MODIFICATIONS**  
 No modifications available for these products.

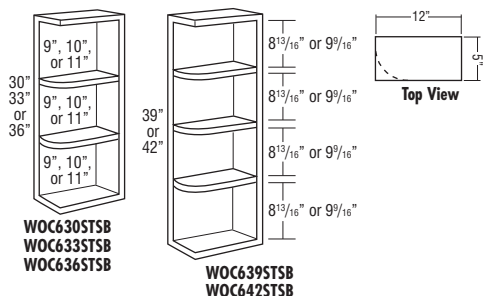

**Wall Outside End Shelf, Square Top, Square Bottom, 12" Radius**

<b>WOC1230STSB</b>	3.6
<b>WOC1233STSB</b>	4.0
<b>WOC1236STSB</b>	4.3
<b>WOC1239STSB</b>	4.7
<b>WOC1242STSB</b>	5.0

- Hardwood veneer on 3/4" furniture board core.
- Matching interior.
- Veneer construction, finished to match cabinet face frame. Thermofoil styles are laminate.
- When ordering Rustic Hickory, Hickory will be substituted.
- Shelves are fixed.

**MODIFICATIONS**  
 No modifications available for these products.

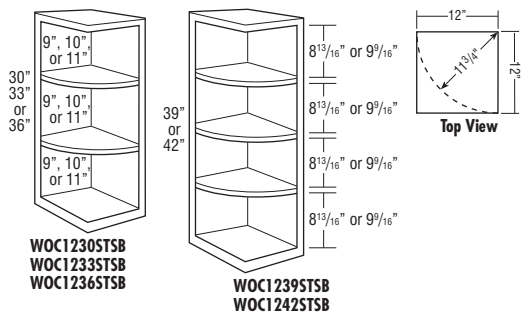

**MODEL CUBIC FEET**  
**Wall Appliance Garage Doors**

<b>WAGD18 L or R</b>	3.3
<b>WAGD24 L or R</b>	4.3
<b>WAGD24B</b>	4.3
<b>WAGD27B</b>	4.7
<b>WAGD30B</b>	5.2
<b>WAGD33B</b>	5.7
<b>WAGD36B</b>	6.3

- Cabinet does not have a bottom (floor).
- Bottom edge is not trimmable.
- Standard cabinet interior, order MI for matching interior.
- Cabinet is designed to fit beneath standard wall cabinets.
- Door will always be square.
- When ordering Aloe, Cadet, or Onyx, APF or PEF must be specified.

**Modifications**

AUTHB	AUTHL	AUTHR	CCO	CFNTO	FPEB	FULL	ID	INTGH	MI	RD
•	•	•	•	•	•	•	•	•	•	•

**Construction Upgrades**

APF	PEF
•	•

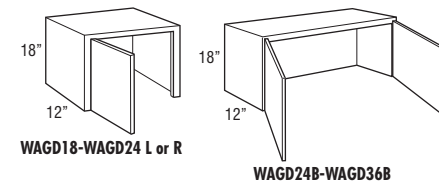

**Wall Diagonal Appliance Garage Doors**

<b>WDAGD1812 L or R</b>	7.8
<b>WDAGD1815 L or R</b>	9.7

- WDAGD1812 requires 24" x 24" wall space.
- WDAGD1815 requires 27" x 27" wall space.
- Cabinet is designed to fit beneath diagonal wall cabinets.
- Inside is maple laminate, and finished exterior.
- Does not have floor or top.
- To allow for proper door clearance of adjacent cabinets, all door styles regardless of overlay utilize 14 1/2" wide doors with a traditional overlay hinge.
- Door will always be square.
- When ordering Aloe, Cadet, or Onyx, APF or PEF must be specified.

**Modifications**

AUTHB	AUTHL	AUTHR	CCO	CFNTO	FPEB	FULL	INTGH	MI
•	•	•	•	•	•	•	•	•

**Construction Upgrades**

APF	PEF
•	•

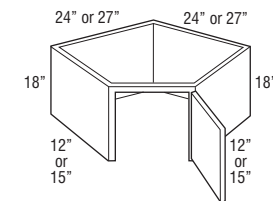

**MODEL CUBIC FEET**

**Wall Pull-out Filler**

<b>WPOF3PL (Plain)</b>	<b>0.6</b>
<b>WPOF6PL (Plain)</b>	<b>1.3</b>

- Recommend installation between two cabinets. Can be installed on the end of a run with the use of a 3/4" thick end panel.
- All styles feature a natural finish wood pull-out with adjustable shelves and chrome rail sides.
- Actual space required is 3 1/8" and 6 1/8" wide.
- Full extension guide standard.
- Includes filler.
- Not compatible with face mount moulding.

**MODIFICATIONS**

No modifications available for these products.

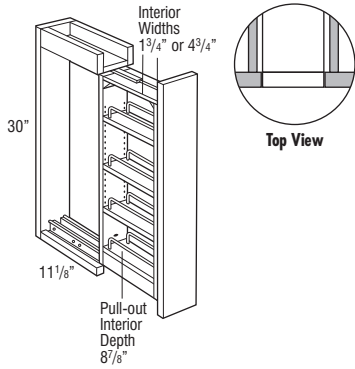

<b>WPOF3OV (Overlay)</b>	<b>0.6</b>
<b>WPOF6OV (Overlay)</b>	<b>1.3</b>

- Recommend installation between two cabinets. Can be installed on the end of a run with the use of a 3/4" thick end panel.
- Overlay application includes profiled modified full overlay and filler.
- All styles feature a natural finish wood pull-out with adjustable shelves and chrome rail sides.
- Actual space required is 3 1/8" and 6 1/8" wide.
- Full extension guide standard.
- Not compatible with face mount moulding.

**Modifications**

FULL
•

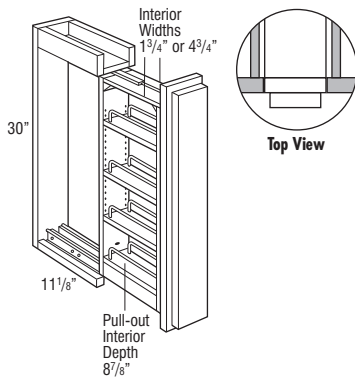

**MODEL CUBIC FEET**

**Wall Plate Rack**

<b>W3015PRC</b>	<b>4.4</b>
<b>W3615PRC</b>	<b>5.2</b>

- Hardwood veneer plywood ends.
- Individual dowels are not removable. Complete rack assembly is removable.

**Modifications**

EXB	EXL	EXR	ID	MI	RD
•	•	•	•	STD	•

**Construction Upgrades**

APF
STD

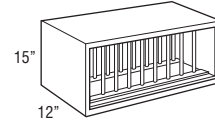

SKU	# of Plates
W3015PRC	11
W3615PRC	15

**Wine Storage Cabinets**

<b>WSC121212</b>	<b>1.6</b>
<b>WSC151512</b>	<b>2.3</b>
<b>WSC181812</b>	<b>3.2</b>
<b>WSC181818</b>	<b>4.6</b>
<b>WSC212112</b>	<b>4.3</b>
<b>WSC242412</b>	<b>5.6</b>

- Must be installed between two cabinets, between cabinet and wall, or mounted to a horizontal surface.
- "X" configuration cannot be removed.

**Modifications**

FPEB	MI	RD
•	STD	•*

\*RD not recommended for safe wine bottle storage.

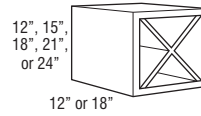

SKU	# of Bottles
WSC121212	4
WSC151512	10
WSC181812	18
WSC181818	18
WSC212112	24
WSC242412	32

**Construction Upgrades**

APF
STD

**MODEL CUBIC FEET**

**Wall Wine Rack**

<b>3018WR</b>	5.2
<b>3618WR</b>	6.2
<b>1830WR</b>	5.2
<b>1836WR</b>	6.2

- Hardwood veneer plywood with solid-wood lattice work.
- Wine bottle opening 4" x 4".

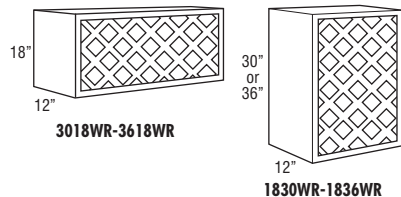

**Modifications**

EXB	EXL	EXR	FPEB	MI
•	•	•	•	STD

**Construction Upgrades**

APF
STD

SKU	# of Bottles
3018WR, 1830WR	11
3618WR, 1836WR	13

**Wall Wine Cubby**

<b>SQWC30</b> (5 openings)	2.1
<b>SQWC36</b> (6 openings)	2.5
<b>SQWC42</b> (7 openings)	2.9

- Hardwood veneer on 3/4" furniture board core.
- Matching interior.
- Frameless construction. Can be used in horizontal or vertical application.

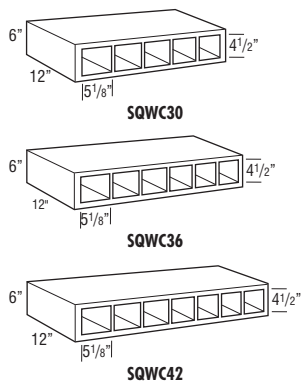

**Modifications**

ADDTK	MI
•	STD

**Wine Rack**

<b>WR630CH</b>	2.1
----------------	-----

- Vertical or horizontal application.
- Chrome bottle racks.
- 3/4" wood veneer construction.

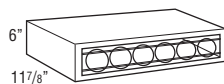

**Modifications**

ADDTK	MI
•	STD

**MODEL CUBIC FEET**

**Floating Shelves**

<b>FS24</b>	0.8
<b>FS30</b>	1.0
<b>FS36</b>	1.2
<b>FS42</b>	1.4

- When ordering Rustic Hickory, Hickory will be substituted.
- Includes wood mounting plate with metal brackets. Once installed, mounting system is fully concealed.
- 3/4" thick solid-wood front and sides. 3/8" veneered furniture board top and bottom. Front and ends are mitered together.

**MODIFICATIONS**

No modifications available for these products.

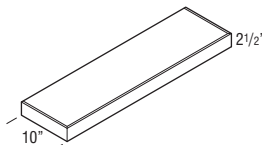

**Weight Capacity per Shelf**

FS24	30 lbs.
FS30	37.5 lbs.
FS36	45 lbs.
FS42	52.2 lbs.

**Wall Organizer**

<b>W024</b>	1.7
<b>W030</b>	2.1
<b>W036</b>	2.5

- Hardwood veneer on a 3/4" furniture board core.
- Frameless construction.
- Matching interior.

**Modifications**

MI
STD

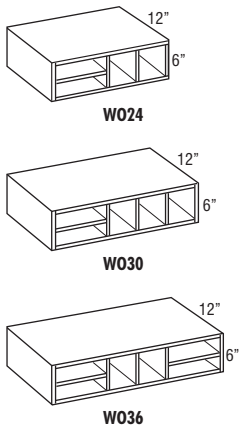

**MODEL CUBIC FEET**

**Designer Range Hood Square**

DRH30S <b>NEW</b>	10.8
DRH36S	11.6
DRH42S	13.4

- Freestanding unit (must be properly secured to wall and cannot be attached to adjacent cabinets).
- Chimney available (RHC.). See below.
- Check your local building code for installation heights above the range.
- Powder coated silver metallic metal liner included.
- Liner opening size: 10 1/4" deep by 19 1/2" wide.
- Installation instructions and hardware included.
- When ordering Rustic Hickory, Hickory will be substituted.
- Exhaust system not included. Compatible with all Homecrest blowers.

**MODIFICATIONS**

No modifications available for these products.

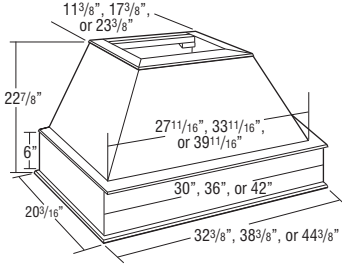

**Range Hood Chimney**

RHC30 <b>NEW</b>	2.5
RHC36	3.5
RHC42	4.4

- 3/4" thick plywood.
- Trimmable.
- Optional accessory for Designer Range Hoods.
- When ordering Rustic Hickory, Hickory will be substituted.

**MODIFICATIONS**

No modifications available for these products.

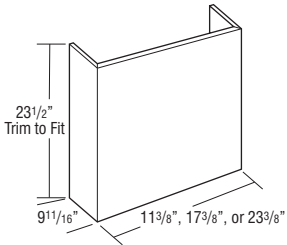

**MODEL CUBIC FEET**

**Wood Hood Canopy Square, 24" High**

WHCS30	4.3
WHCS36	5.1

- Operable doors.
- Doors available arch or square.
- Install wood hood canopy between adjacent cabinets.
- Powder coated silver metallic metal liner included.
- Liner opening size: 10 1/4" deep by 19 1/2" wide.
- Check your local building code for installation heights above the range.
- Exhaust system not included. Compatible with all Homecrest blowers.

**Modifications**

FULL	INTGH
•	•

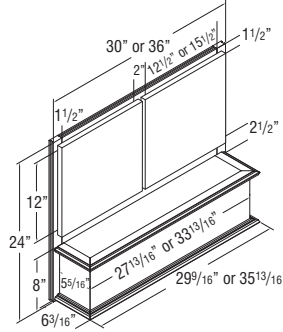

**Tapered Wood Hood**

TWH30	4.7
TWH36	5.6

- Install Wood Hood between adjacent cabinets.
- Check your local building code for installation heights above the range.
- Tapered design.
- Liner opening size: 10 1/4" deep x 19 1/2" wide.
- Silver metallic liner included, not available for order separately.
- Wood hoods ordered in Rustic Hickory will not feature Rustic characteristics.
- Exhaust system not included. Compatible with all Homecrest blowers.

**MODIFICATIONS**

No modifications available for these products.

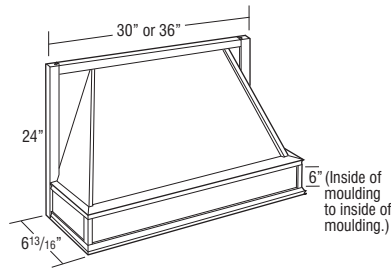



**MODEL CUBIC FEET**

**Blowers**

**BLOWER500 1.8**

- 500 CFM.
- Two 20 watt halogen lamps included (12 volt, G4 base).
- Installation instructions and warranty information included.
- Powder coated silver metallic finish.
- Three speed push button control.
- Includes two removable dishwasher safe grease filters.
- Designed for use in applications up to 60,000 BTUs.
- Compatible with all Wood Hoods.

**MODIFICATIONS**

No modifications available for these products.

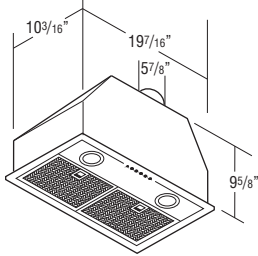

**BLOWER390 2.1**

- Range Hood Component Package has 3-speed centrifugal fan and lighted filter control.
- 6" diameter vent.
- 1 year warranty.
- Sound rating is 6 sones.
- Uses 3.2 amps.
- Two 40 watt candelabra lights required, but not included.
- Silver metallic exterior finish.
- Includes removable dishwasher safe grease filter.
- Compatible with all Wood Hoods.

**MODIFICATIONS**

No modifications available for these products.

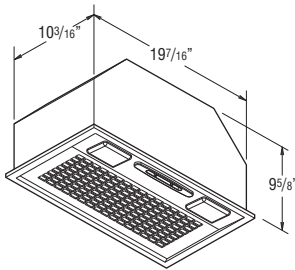

**BLOWER250 2.1**

- Range Hood Component Package has 2-speed single axial fan with lighted filter control.
- 7" diameter vent.
- 1 year warranty.
- Sound rating is 8 sones.
- Uses 2.1 amps.
- Two 40 watt candelabra lights required, but not included.
- Silver metallic exterior finish.
- Includes removable dishwasher safe grease filter.
- Compatible with all Wood Hoods.

**MODIFICATIONS**

No modifications available for these products.

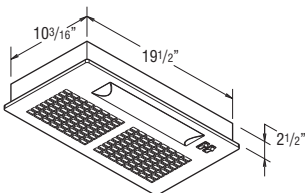

**MODEL CUBIC FEET**

**Designer Range Hood Ductless Conversion Kit and Filter Kits**

**DWK500 1.1**

**FILTER250/390 0.5**

**FILTER500 0.7**

**MODIFICATIONS**

No modifications available for these products.

- Duct Work Kit: Optional kit to allow recirculation of the hood exhaust back into the kitchen. Use this unit with DRH \_\_S and WHCS.
- FILTER250/390 required when DWK500 is used with BLOWER250/BLOWER390.
- FILTER500 required when DWK500 is used with BLOWER500 (not shown).
- DWK500 includes: (1) 21" x 7" round pipe, (1) adjustable collar, (1) white metal soffit grille, (1) adjustable boot, (1) 7" x 6" reducer, and installation instructions.

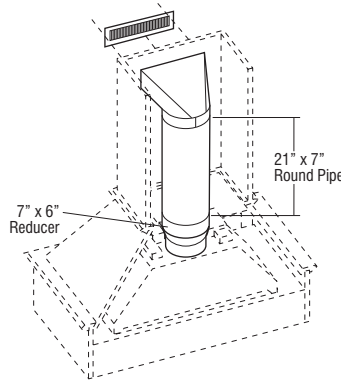

## BASE CABINET NOMENCLATURE

All Base Cabinets are 34 1/2" high and 24" deep unless otherwise noted.

**B24**

Cabinet Type      Cabinet Width

All Base Cabinets are available in Square Cabinet Styles only.  
 • Heat Shields available for field installation. See page 195.

## TOEKICKS

Base Cabinets are shipped with an unfinished toekick. Finished toekicks in matching wood veneer or laminate must be ordered separately and field installed.

MODIFICATIONS	
Mod.	Description
AUTHB	Authentic Ends Both
AUTHL	Authentic End Left
AUTHR	Authentic End Right
CBO	Cabinet Box Only
CCO	Cabinet Case Only
CFNTO	Cabinet Front Only
CFP	Cabinet False Panel
CND	Cabinet with No Door, with Drawer
EXB	Extended Stiles Both
EXL	Extended Stile Left
EXR	Extended Stile Right
FD	Full Depth Shelf
FPEB	Furniture Finished Plywood End Panels
FTK	Flush Toekick
ID	Increased Depth
INTGH	Integrated SoftTouch Hinge
INVFRM	Inverted Frame
MI	Matching Interior
P	Peninsula
RD	Reduced Depth
RECTKALL	Island Toekick
RECTKBK	Recessed Toekick Back
RECTKL	Recessed Toekick Left
RECTKR	Recessed Toekick Right
RT	Roll Tray
VTK	Void Toekick
WDRWPG	Wood Dovetail Drawer w./SoftTouch Guide

CONSTRUCTION UPGRADES	
Mod.	Description
APF	All-plywood Finished
APU	All-plywood Unfinished
PEF	Plywood Ends Finished
PEU	Plywood Ends Unfinished

MODIFICATIONS GRID KEY	
•	Available
STD	Standard on these cabinets

## Base Single Door

Model	Cubic Feet
B9 L or R†	5.9
B12 L or R	7.6
B15 L or R	9.2
B18 L or R	10.9
B21 L or R	12.6
B24 L or R	14.3

• Adjustable 15" deep shelf.

†All drawer fronts will be recessed. When Lawry is specified, the door panel will be recessed.

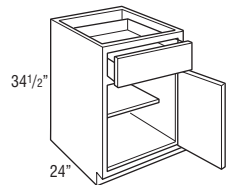

### Modifications

AUTHB	AUTHL	AUTHR	CBO	CCO	CFNTO	CFP	CND	EXB	EXL	EXR	FD	FPEB	FTK	ID
•	•	•	•	•	•	•	•	•	•	•	•	•	•	•
INTGH	INVFRM	MI	P	RD	RECTKALL	RECTKBK	RECTKL	RECTKR	RT	VTK	WDRWPG			
•	•*	•	•*	•	•	•	•	•	•*	•	•			

\*INVFRM, P, and RT not available on B9.

### Construction Upgrades

APF	APU	PEF	PEU
•	•	•	•

## Base Double Door

Model	Cubic Feet
B24B	14.3
B27B	15.9
B30B	17.6
B33B	19.3
B36B	21.0
B39	22.5
B42	24.2
B45	25.8
B48	27.5

### Modifications

AUTHB	AUTHL	AUTHR	CBO	CCO	CFNTO	CFP	CND	EXB	EXL	EXR	FD	FPEB	FTK	ID
•	•	•	•	•	•	•	•	•	•	•	•	•	•	•

INTGH	INVFRM	MI	P	RD	RECTKALL	RECTKBK	RECTKL	RECTKR	RT	VTK	WDRWPG
•	•	•	•	•	•*	•	•	•	•	•	•

\*RECTKALL available for B27B-B48.

### Construction Upgrades

APF	APU	PEF	PEU
•	•	•	•

- Adjustable 15" deep shelf.

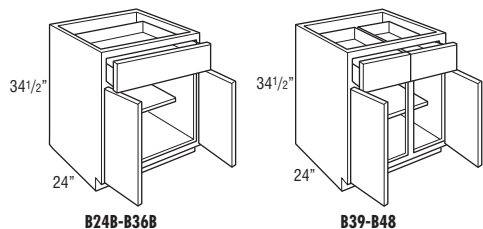

## Full Height Base Single Door

Model	Cubic Feet
B6FH L or R	4.4

- Frame opening is 3" wide.
- Cabinet has a full top panel.
- Utilizes a 5 1/2" wide filler as a hinged door for all overlay styles.

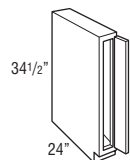

### Modifications

AUTHB	AUTHL	AUTHR	CBO	CCO	CFNTO	CFP	CND	EXB	EXL	EXR	FD	FPEB	FTK	ID
•	•	•	•	•	•	•	•	•	•	•	•	•	•	•

INTGH	INVFRM	MI	P	RD	RECTKALL	RECTKBK	RECTKL	RECTKR	RT	VTK	WDRWPG
•	•	•	•	•	•	•	•	•	•	•	•

### Construction Upgrades

APF	APU	PEF	PEU
•	•	•	•

## Full Height Base Single Door

Model	Cubic Feet
B9FH L or R†	5.9
B12FH L or R	7.6
B15FH L or R	9.2
B18FH L or R	10.9
B21FH L or R	12.6
B24FH L or R	14.3

- Adjustable 15" deep shelf.

†When Lawry is specified, the door panel will be recessed.

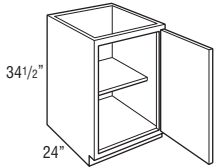

### Modifications

AUTHB	AUTHL	AUTHR	CBO	CCO	CFNTO	CFP	CND	EXB	EXL	EXR	FD	FPEB	FTK	ID
•	•	•	•	•	•	•	•	•	•	•	•	•	•	•

INTGH	INVFRM	MI	P	RD	RECTKALL	RECTKBK	RECTKL	RECTKR	RT	VTK	WDRWPG
•	•	•	•*	•	•	•	•	•	•*	•	•

\*P and RT not available on B9FH.

### Construction Upgrades

APF	APU	PEF	PEU
•	•	•	•

## Full Height Base Double Door

Model	Cubic Feet
B24BFH	14.3
B27BFH	15.9
B30BFH	17.6
B33BFH	19.3
B36BFH	21.0
B39FH	22.5
B42FH	24.2
B45FH	25.8
B48FH	27.5

- Adjustable 15" deep shelf.

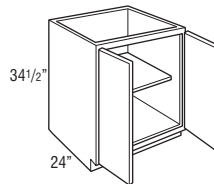

B24BFH-B36BFH

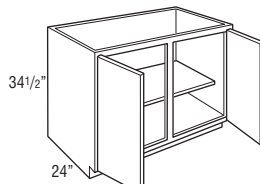

B39FH-B48FH

### Modifications

AUTHB	AUTHL	AUTHR	CBO	CCO	CFNTO	CFP	CND	EXB	EXL	EXR	FD	FPEB	FTK	ID
•	•	•	•	•	•	•	•	•	•	•	•	•	•	•

INTGH	INVFRM	MI	P	RD	RECTKALL	RECTKBK	RECTKL	RECTKR	RT	VTK	WDRWPG
•	•	•	•	•	•*	•	•	•	•	•	•

\*RECTKALL available for B27BFH-B48FH.

### Construction Upgrades

APF	APU	PEF	PEU
•	•	•	•



### Base Single Door with Roll Trays

Model	Cubic Feet
B15RT L or R	9.4
B18RT L or R	11.1
B21RT L or R	12.8
B24RT L or R	14.4

- 2 laminate roll trays standard. RTPG upgrade available.
- Cabinets may accommodate up to 4 roll trays, additional may be purchased separately for field installation. See page 196.

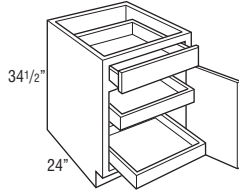

#### Modifications

AUTHB	AUTHL	AUTHR	CBO	CCO	CFNTO	CFP	CND	EXB	EXL	EXR	FD	FPEB	FTK	ID
•	•	•	•	•	•	•	•	•	•	•	•	•	•	•

INTGH	INVFRM	MI	P	RD	RECTKALL	RECTKBK	RECTKL	RECTKR	RT	VTK	WDRWPG
•	•	•	•	•	•	•	•	•	•	•	•

#### Construction Upgrades

APF	APU	PEF	PEU
•	•	•	•



### Base Double Door with Roll Trays

Model	Cubic Feet
B24BRT	14.4
B27BRT	16.1
B30BRT	17.7
B33BRT	19.6
B36BRT	21.1

- 2 laminate roll trays standard. RTPG upgrade available.
- Cabinet may accommodate up to 4 roll trays, additional may be purchased separately for field installation. See page 196.

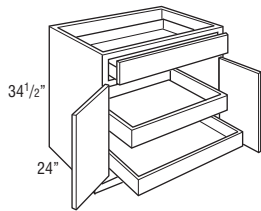

#### Modifications

AUTHB	AUTHL	AUTHR	CBO	CCO	CFNTO	CFP	CND	EXB	EXL	EXR	FD	FPEB	FTK	ID
•	•	•	•	•	•	•	•	•	•	•	•	•	•	•

INTGH	INVFRM	MI	P	RD	RECTKALL	RECTKBK	RECTKL	RECTKR	RT	VTK	WDRWPG
•	•	•	•	•	•	•	•	•	•	•	•

#### Construction Upgrades

APF	APU	PEF	PEU
•	•	•	•



### Base with Roll-out Tray Divider

Model	Cubic Feet
B12DRO L or R	7.8
B15DRO L or R	9.4

- Tray divider utilizes SoftTouch undermount guides and bumpers for door protection.
- Dividers are removable.
- 12" - 3 compartments.
- 15" - 4 compartments.

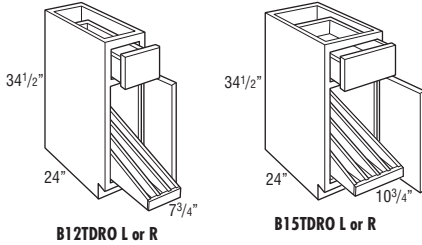

#### Modifications

AUTHB	AUTHL	AUTHR	CBO	CCO	CFNTO	CFP	CND	EXB	EXL	EXR	FD	FPEB	FTK	ID
•	•	•	•	•	•	•	•	•	•	•	•	•	•	•

INTGH	INVFRM	MI	P	RD	RECTKALL	RECTKBK	RECTKL	RECTKR	RT	VTK	WDRWPG
•	•	•	•	•	•	•	•	•	•	•	•

#### Construction Upgrades

APF	APU	PEF	PEU
•	•	•	•



### Base with Tray Divider

Model	Cubic Feet
TD9 L or R†	6.1
TD12 L or R	7.8
TD15 L or R	9.4

- Tray Divider is chrome.
- Tray Divider is also available as an accessory for field installation. See page 197.

†When Lawry is specified, the door panel will be recessed.

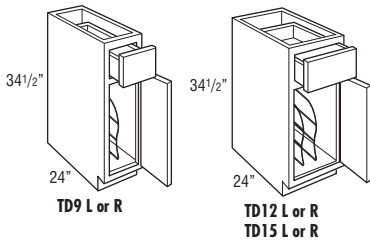

#### Modifications

AUTHB	AUTHL	AUTHR	CBO	CCO	CFNTO	CFP	CND	EXB	EXL	EXR	FD	FPEB	FTK	ID
•	•	•	•	•	•	•	•	•	•	•	•	•	•	•

INTGH	INVFRM	MI	P	RD	RECTKALL	RECTKBK	RECTKL	RECTKR	RT	VTK	WDRWPG
•	•	•	•	•	•	•	•	•	•	•	•

#### Construction Upgrades

APF	APU	PEF	PEU
•	•	•	•



## Full Height Base with Tray Divider

Model	Cubic Feet
TD9FH L or R†	6.1
TD12FH L or R	7.8
TD15FH L or R	9.4

- Tray Divider is chrome.
- Tray Divider is also available as an accessory for field installation. See page 197.

†When Lowry is specified, the door panel will be recessed.

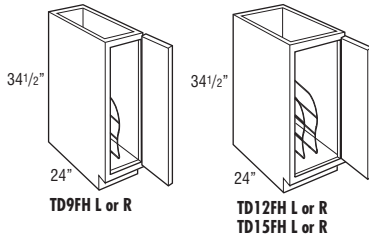

### Modifications

AUTHB	AUTHL	AUTHR	CBO	CCO	CFNTO	CFP	CND	EXB	EXL	EXR	FD	FPEB	FTK	ID
•	•	•	•	•	•			•	•	•			•	•

INTGH	INVFRM	MI	P	RD	RECTKALL	RECTKBK	RECTKL	RECTKR	RT	VTK	WDRWPG
•		•				•	•	•		•	

### Construction Upgrades

APF	APU	PEF	PEU
•	•	•	•

## Sink Base, Single Door

Model	Cubic Feet
SB21 L or R	12.6
SB24 L or R	14.3

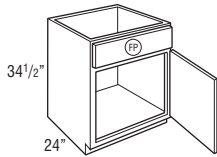

### Modifications

AUTHB	AUTHL	AUTHR	CBO	CCO	CFNTO	CFP	CND	EXB	EXL	EXR	FD	FPEB	FTK	ID
•	•	•				STD	•	•	•	•			•	•

INTGH	INVFRM	MI	P	RD	RECTKALL	RECTKBK	RECTKL	RECTKR	RT	VTK	WDRWPG
•		•				•	•	•		•	

### Construction Upgrades

APF	APU	PEF	PEU
•	•	•	•

**Sink Base**

Model	Cubic Feet
SB24B	14.3
SB27B	15.9
SB30B	17.6
SB33B	19.3
SB36B	21.0
SB39	22.7
SB42	24.4
SB45	25.5
SB48	27.7

**Modifications**

AUTHB	AUTHL	AUTHR	CBO	CCO	CFNTO	CFP	CND	EXB	EXL	EXR	FD	FPEB	FTK	ID
•	•	•		•	•		STD	•	•	•		•	•	•

INTGH	INVERM	MI	P	RD	RECTKALL	RECTKBK	RECTKL	RECTKR	RT	VTK	WDRWPG
•		•		•	•*	•	•	•		•	

\*RECTKALL available for SB27B-SB48.

**Construction Upgrades**

APF	APU	PEF	PEU
•	•	•	•

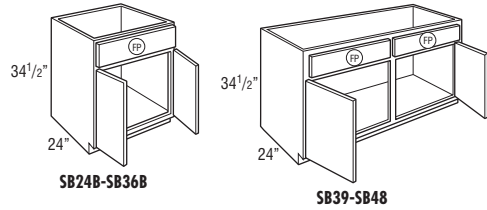

**NEW Sink Base with CabMat™**

Model	Cubic Feet
SB30BCM	17.7
SB33BCM	19.6
SB36BCM	21.1

- CabMat™ features a gray sloped mat to capture spills.
- CabMat™ is removable for cleaning.
- 30" wide CabMat™ has a liquid capacity of 4.2 quarts or 3.9 liters.
- 33" wide CabMat™ has a liquid capacity of 4.6 quarts or 4.3 liters.
- 36" wide CabMat™ has a liquid capacity of 5 quarts or 4.7 liters.

**Modifications**

AUTHB	AUTHL	AUTHR	CBO	CCO	CFNTO	CFP	CND	EXB	EXL	EXR	FD	FPEB	FTK	ID
•	•	•	•	•	•		STD	•	•	•		•	•	

INTGH	INVERM	MI	P	RD	RECTKALL	RECTKBK	RECTKL	RECTKR	RT	VTK	WDRWPG
•		•			•	•	•	•		•	

**Construction Upgrades**

APF	APU	PEF	PEU
•	•	•	•

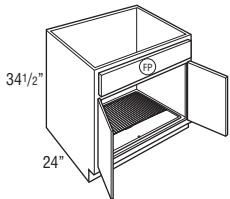



**Country Sink Base**

Model	Cubic Feet
CNTYSB30B	17.6
CNTYSB33B	19.2
CNTYSB36B	20.9
CNTYSB39	22.5
CNTYSB42	24.2
CNTYSB48	27.5

**Modifications**

AUTHB	AUTHL	AUTHR	CBO	CCO	CFNTO	CFP	CND	EXB	EXL	EXR	FD	FPEB	FTK	ID
•	•	•		•	•			•	•	•		•	•	•

  

INTGH	INVFRM	MI	P	RD	RECTKALL	RECTKBK	RECTKL	RECTKR	RT	VTK	WDRWPG
•		•	•	•	•	•	•	•		•	

**Construction Upgrades**

APF	APU	PEF	PEU
•	•	•	•

- 13 1/2" panel can be trimmed up to 12".
- For apron front sinks requiring a cut-out height of 6 1/2" or less, see Base Drop-in Range Cabinets on page 117.

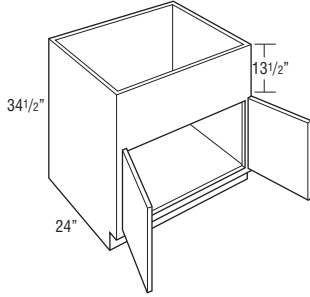

CNTYSB30B-CNTYSB36B

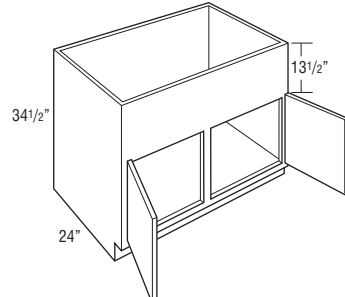

CNTYSB39-CNTYSB48

**NEW Country Sink Base with CabMat™**

Model	Cubic Feet
CNTYSB30BCM	24.4
CNTYSB33BCM	24.7
CNTYSB36BCM	27.7

**Modifications**

AUTHB	AUTHL	AUTHR	CBO	CCO	CFNTO	CFP	CND	EXB	EXL	EXR	FD	FPEB	FTK	ID
•	•	•		•	•			•	•	•		•	•	•

  

INTGH	INVFRM	MI	P	RD	RECTKALL	RECTKBK	RECTKL	RECTKR	RT	VTK	WDRWPG
•		•	•	•	•	•	•	•		•	

**Construction Upgrades**

APF	APU	PEF	PEU
•	•	•	•

- CabMat™ features a gray sloped mat to capture spills.
- CabMat™ is removable for cleaning.
- 30" wide CabMat™ has a liquid capacity of 4.2 quarts or 3.9 liters.
- 33" wide CabMat™ has a liquid capacity of 4.6 quarts or 4.3 liters.
- 36" wide CabMat™ has a liquid capacity of 5 quarts or 4.7 liters.
- 13 1/2" panel can be trimmed to 12".
- For apron front sinks requiring a cut-out height of 6 1/2" or less, see Base Drop-in Range Cabinets on page 117.

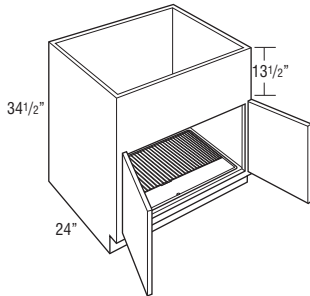



## Sink Base SuperCabinet™ with Tilt-out Trays and CabMat™

Model	Cubic Feet
SB36STSCM	21.1

- CabMat™ features a gray sloped mat to capture spills.
- CabMat™ is removable for cleaning.
- 36" wide CabMat™ has a liquid capacity of 5 quarts or 4.7 liters.
- Both doors will have a chrome and wood two-tiered rack.
- Racks on doors are 3 1/4" deep.
- Includes two tilt-out trays.
- Tilt-out trays are stain resistant, moisture resistant plastic to allow storage of sponges and other cleaning materials.

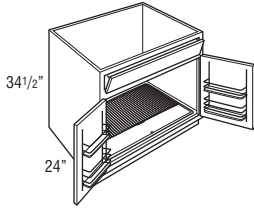

### Modifications

AUTHB	AUTHL	AUTHR	CBO	CCO	CFNTO	CFP	CND	EXB	EXL	EXR	FD	FPEB	FTK	ID
•	•	•						•	•	•			•	•

INTGH	INVFRM	MI	P	RD	RECTKALL	RECTKBK	RECTKL	RECTKR	RT	VTK	WDRWPG
•		•			•	•	•	•		•	

### Construction Upgrades

APF	APU	PEF	PEU
•	•	•	•

106

## Sink Base SuperCabinet™ with Tilt-out Trays

Model	Cubic Feet
SB36STS	21.1

- Quarter Round Reversible Shelf for left or right applications. (Shelf shipped secure, can be positioned in left or right corner.)
- Both doors will have a chrome and wood two-tiered rack.
- Racks on doors are 3 1/4" deep.
- Includes two tilt-out trays.
- Tilt-out trays are stain resistant, moisture resistant plastic to allow storage of sponges and other cleaning materials.

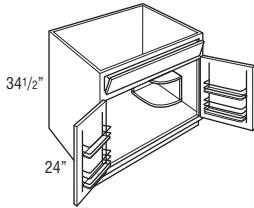

### Modifications

AUTHB	AUTHL	AUTHR	CBO	CCO	CFNTO	CFP	CND	EXB	EXL	EXR	FD	FPEB	FTK	ID
•	•	•						•	•	•			•	•

INTGH	INVFRM	MI	P	RD	RECTKALL	RECTKBK	RECTKL	RECTKR	RT	VTK	WDRWPG
•		•			•	•	•	•		•	

### Construction Upgrades

APF	APU	PEF	PEU
•	•	•	•

## Sink Base SuperCabinet™ with Tilt-out Trays and Caddy

Model	Cubic Feet
SB36STSCDY L or R	20.9

- L or R designates caddy location.
- Caddy is removable and portable.
- Includes two tilt-out trays.
- Tilt-out trays are stain resistant, moisture resistant plastic to allow storage of sponges and other cleaning materials.
- Caddy dimensions are: 9 15/16" wide x 18 5/16" tall x 18 5/8" deep.
- Door opposite caddy features a chrome and wood two-tiered rack.
- Door rack width is 13 7/8".
- Door rack depth is 3 1/2".

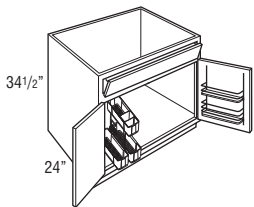

### Modifications

AUTHB	AUTHL	AUTHR	CBO	CCO	CFNTO	CFP	CND	EXB	EXL	EXR	FD	FPEB	FTK	ID
•	•	•						•	•	•			•	•

INTGH	INVFRM	MI	P	RD	RECTKALL	RECTKBK	RECTKL	RECTKR	RT	VTK	WDRWPG
•		•			•	•	•	•		•	

### Construction Upgrades

APF	APU	PEF	PEU
•	•	•	•

BASE CABINETS

**Sink Front Bottom**

Model	Cubic Feet
SFB36	1.0
SFB48	1.0

- Designed for use with Sink Fronts.
- 3/8" thick.
- Trimmable.

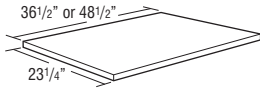

**MODIFICATIONS**

No modifications available for these products.

**Construction Upgrades**

APF	APU	PEF	PEU
	•†		

†APU sink front bottoms will be natural maple.

**Base Microwave Cabinet with Drawer**

Model	Cubic Feet
BMWD24	14.4
BMWD27	15.9
BMWD30	17.7
BMWD33	19.2
BMWD36	21.0

- Cabinet interior finished to match cabinet face frame.

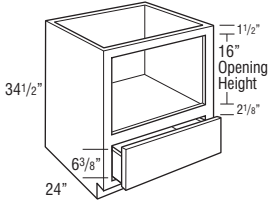

**Modifications**

AUTHB	AUTHL	AUTHR	CBO	CCO	CFNTO	CFP	CND	EXB	EXL	EXR	FD	FPEB	FTK	ID
•	•	•	•	•	•			•	•	•		•	•	

INTGH	INVFRM	MI	P	RD	RECTKALL	RECTKBK	RECTKL	RECTKR	RT	VTK	WDRWPG
				•*	•+	•	•	•		•	•

\*RD to 18" available.

+RECTKALL not available on BMWD24.

**Construction Upgrades**

APF	APU	PEF	PEU
STD			

Model	Opening Width	Maximum Width	Opening Height	Maximum Height
BMWD24	21"	22 1/2"	16"	16"
BMWD27	24"	25 1/2"	16"	16"
BMWD30	27"	28 1/2"	16"	16"
BMWD33	30"	31 1/2"	16"	16"
BMWD36	33"	34 1/2"	16"	16"

## Base Microwave Cabinet with Standard Drawer

Model	Cubic Feet
BMWSD24	14.3
BMWSD27	15.9
BMWSD30	17.6
BMWSD33	19.2
BMWSD36	21.0

- Cabinet interior finished to match cabinet face frame.

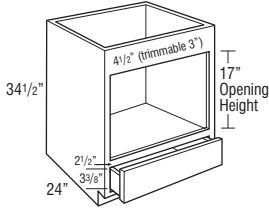

Model	Opening Width	Opening Maximum Width	Opening Height	Opening Maximum Height
BMWSD24	21"	22 1/2"	17"	20"
BMWSD27	24"	25 1/2"	17"	20"
BMWSD30	27"	28 1/2"	17"	20"
BMWSD33	30"	31 1/2"	17"	20"
BMWSD36	33"	34 1/2"	17"	20"

### Modifications

AUTHB	AUTHL	AUTHR	CBO	CCO	CFNTO	CFP	CND	EXB	EXL	EXR	FD	FPEB	FTK	ID
•	•	•	•	•	•	•	•	•	•	•	•	•	•	•

INTGH	INVFRM	MI	P	RD	RECTKALL	RECTKBK	RECTKL	RECTKR	RT	VTK	WDRWPG
				•*	•*	•	•	•	•	•	•

\*RD to 18" available.

\*RECTKALL not available on BMWSD24.

### Construction Upgrades

APF	APU	PEF	PEU
STD			

108

## Base Oven Cabinet

Model	Cubic Feet
B030	17.7
B033	19.2

- Oven cabinet has laminated interior.
- May not hold cooktop and slide-in oven combination. Refer to cooktop and slide-in oven manufacturer specifications.
- Wood oven supports included.
- Heat shield sold separately.

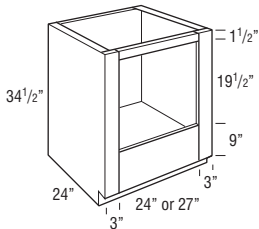

Model	Opening Width	Opening Maximum Width	Opening Height	Opening Maximum Height*
B030	24"	28 1/2"	19 1/2"	27 1/2"
B033	27"	31 1/2"	19 1/2"	27 1/2"

\*Top frame cross rail can be removed during field installation if cabinet is properly installed between two adjacent cabinets, increasing the maximum height to 28 1/4".

### Modifications

AUTHB	AUTHL	AUTHR	CBO	CCO	CFNTO	CFP	CND	EXB	EXL	EXR	FD	FPEB	FTK	ID
•	•	•						•	•	•	•	•	•	•

INTGH	INVFRM	MI	P	RD	RECTKALL	RECTKBK	RECTKL	RECTKR	RT	VTK	WDRWPG
				•*	•	•	•	•	•	•	•

\*RD to 18" and 21" available.

### Construction Upgrades

APF	APU	PEF	PEU
•	•	•	•

### Corner Diagonal Sink Base

Model	Cubic Feet
CDSB36 L or R	30.5
CDSB42†	40.9

- Edges beveled at 45°.
- For sufficient dishwasher door clearance and loading/unloading space, a 15" wide base cabinet is recommended for use between a corner sink base and dishwasher.
- To allow for proper door clearance of adjacent cabinets, all door styles regardless of overlay utilize 14 1/2" wide doors with a traditional overlay hinge.

†CDSB42 has butt doors with no center stile.

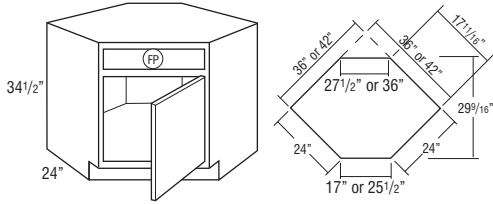

Max. Sink Widths if cut-out is 4" back from face of front frame

Wall Width	Frame	Maximum Sink Width	Maximum Sink Depth
36" x 36"	17"	25 3/4"	27 11/32"
42" x 42"	25 1/2"	34 1/4"	27 11/32"

#### Modifications

AUTHB	AUTHL	AUTHR	CBO	CCO	CFNTO	CFP	CND	EXB	EXL	EXR	FD	FPEB	FTK	ID
•	•	•		•	•	STD						•		

INTGH	INVFRM	MI	P	RD	RECTKALL	RECTKBK	RECTKL	RECTKR	RT	VTK	WDRWPG
•										•	

#### Construction Upgrades

APF	APU	PEF	PEU
•	•	•	•

### Corner Sink Front

Model	Cubic Feet
CSF36 L or R	1.4
CSF42†	2.0

- Edges beveled at 45°.
- Corner sink front bottom required for field installation. Order separately. See next item.
- To allow for proper door clearance of adjacent cabinets, all door styles regardless of overlay utilize 14 1/2" wide doors with a traditional overlay hinge.

†CSF42 has butt doors with no center stile.

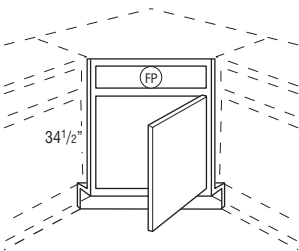

Max. Sink Widths if cut-out is 4" back from face of front frame

Wall Width	Frame	Maximum Sink Width	Maximum Sink Depth
36" x 36"	17"	25 3/4"	27 11/32"
42" x 42"	25 1/2"	34 1/4"	27 11/32"

#### Modifications

AUTHB	AUTHL	AUTHR	CBO	CCO	CFNTO	CFP	CND	EXB	EXL	EXR	FD	FPEB	FTK	ID
					STD	STD								

INTGH	INVFRM	MI	P	RD	RECTKALL	RECTKBK	RECTKL	RECTKR	RT	VTK	WDRWPG
•											

#### Construction Upgrades

APF	APU	PEF	PEU



## Angled Corner Sink Front Bottom

Model	Cubic Feet
ACSF36	1.0
ACSF42	1.0

- Designed for use with Corner Sink Front.
- 3/8" thick.

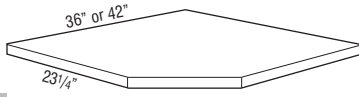

### MODIFICATIONS

No modifications available for these products.

### Construction Upgrades

APF	APU	PEF	PEU
	•†		

†APU sink front bottoms will be natural maple.

## Base Corner Cabinets

- BCs use the wall space the nomenclature implies and may be pulled up to 3" to accommodate odd dimensions in a kitchen.
- Remember to use 3" filler on adjoining cabinets.
- The adjoining run of cabinets will cover the void.
- The L or R in the cabinet nomenclature indicates the location of the void to ensure clearance; it is not recommended to place BC cabinets next to 27" deep appliances.

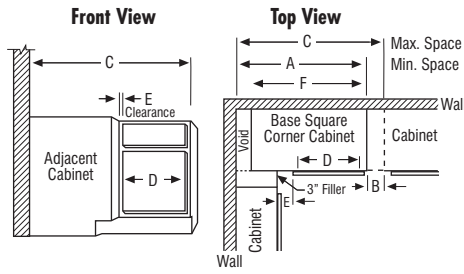

### NOTE:

Full overlay styles must be pulled an additional 1 1/2" to ensure proper drawer/pull clearance. 1 1/2" pull is not included in minimum and maximum list.

Model	A Min. Space	B Max. Pull*	C Max. Space	D Cabinet Opening	E* Full Overlay		E Traditional Overlay		F Actual Cabinet
					At Min.	At Max.	At Min.	At Max.	
BC3639	36"	6"	42"	7 1/2"	1 3/4"	7 3/4"	2 1/2"	8 1/2"	27"
BC3942	39"	4 1/2"	43 1/2"	9"	3 1/4"	7 3/4"	4"	8 1/2"	30"
BC4245	42"	6"	48"	13 1/2"	1 3/4"	7 3/4"	2 1/2"	8 1/2"	39"
BC4548	45"	4 1/2"	49 1/2"	15"	3 1/4"	7 3/4"	4"	8 1/2"	42"
BC4851	48"	3"	51"	16 1/2"	4 1/4"	7 3/4"	5 1/2"	8 1/2"	45"

\*Minimum/maximum space between inside edge of door and face of filler/adjoining cabinet.  
If cabinet is pulled to maximum stated dimension, filler will need to be created for proper attachment.

## Base Corner

Model	Cubic Feet
BC3639 L or R	15.9
BC3942 L or R	17.6
BC4245 L or R	21.0
BC4548 L or R	24.4
BC4851 L or R	27.7

- L or R indicates void. R (right) void shown.
- Adjustable 15" deep shelf.
- Includes one 3" filler, shipped unattached.
- Nomenclature refers to wall space occupied when installed at minimum and maximum.

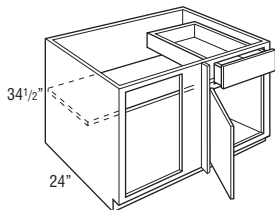

### Modifications

AUTHB	AUHL	AUHR	CBO	CCO	CFNTO	CFP	CND	EXB	EXL	EXR	FD	FPFB	FTK	ID
•	•	•	•	•	•	•	•	•	•	•	•	•	•	•

INTGH	INVERM	MI	P	RD	RECTKALL	RECTKBK	RECTKL	RECTKR	RT	VTK	WORDWPG
•	•	•	•	•	•	•	•	•	•	•	•

### Construction Upgrades

APF	APU	PEF	PEU
•	•	•	•

## Base Lazy Susan Corner (with Revolving Door)

Model	Cubic Feet
BC36SPN	30.5

- BC36SPN wall width is 36" x 36".
- Cabinet is drum-shaped; adjoining cabinets create sides.
- BC36SPN polymer shelves are 28" diameter with a chrome pole, shelves attach to doors.
- See Panels & Skins section for SE24 or SE24/PEF if used at end of cabinet run.
- Drum is composed of 1/8" thick non-print hardboard.
- Cabinet not available on Juno door style.

### Modifications

AUTHB	AUTHL	AUTHR	CBO	CCO	CFNTO	CFP	CND	EXB	EXL	EXR	FD	FPEB	FTK	ID
			•											

INTGH	INVERM	MI	P	RD	RECTKALL	RECTKBK	RECTKL	RECTKR	RT	VTK	WDRWPG

### Construction Upgrades

APF	APU	PEF	PEU

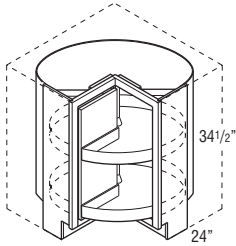

112

## NEW Base Lazy Susan Corner with Full Height Door and Lazy Susan (with Center Hinge Door)

Model	Cubic Feet
BLS36 L or R	20.0

- Cabinet is drum-shaped; adjoining cabinets create sides.
- BLS white plastic shelves are 28" diameter with a chrome pole.
- Drum diameter is 31 1/8" and composed of 1/8" thick hardboard.
- Decorative hardware screws must be countersunk to prevent scratching of adjacent cabinets and face frame of BLS.
- Not recommended for use next to an appliance deeper than standard cabinet depth.

### Modifications

AUTHB	AUTHL	AUTHR	CBO	CCO	CFNTO	CFP	CND	EXB	EXL	EXR	FD	FPEB	FTK	ID
			•	•										

INTGH	INVERM	MI	P	RD	RECTKALL	RECTKBK	RECTKL	RECTKR	RT	VTK	WDRWPG

### Construction Upgrades

APF	APU	PEF	PEU

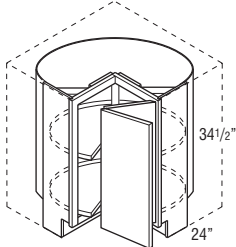



**Corner Diagonal Base**

Model	Cubic Feet
CDB36 L or R	30.5

- To allow for proper door clearance of adjacent cabinets, all door styles regardless of overlay utilize 14 1/2" wide doors with a traditional overlay hinge.
- One fixed 1/2" thick shelf.

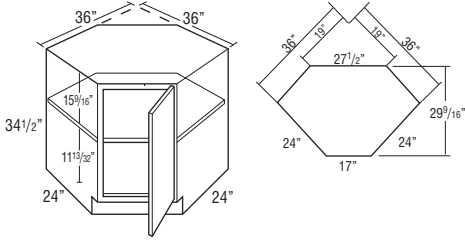

Due to fixed shelf mounting, shelves cannot be retrofitted.

**Modifications**

AUTHB	AUTHL	AUTHR	CBO	CCO	CFNTD	CFP	CND	EXB	EXL	EXR	FD	FPEB	FTK	ID
•	•	•	•	•	•						•			

INTGH	INVFRM	MI	P	RD	RECTKALL	RECTKBK	RECTKL	RECTKR	RT	VTK	WDRWPG
•		•								•	

**Construction Upgrades**

APF	APU	PEF	PEU
•	•	•	•

**Corner Diagonal Base with Full Height Door & Wood Shelves**

Model	Cubic Feet
CDB36SS L or R	30.5

- To allow for proper door clearance of adjacent cabinets, all door styles regardless of overlay utilize 14 1/2" wide doors with a traditional overlay hinge.
- Features two 28" diameter D-shaped plywood revolving shelves. Lower shelf is mounted to floor. Upper shelf is mounted to fixed shelf. Fixed shelf is 1/2" thick laminated furniture board.

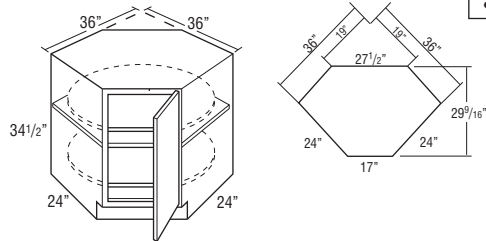

Due to fixed shelf mounting, shelves cannot be retrofitted.

**Modifications**

AUTHB	AUTHL	AUTHR	CBO	CCO	CFNTD	CFP	CND	EXB	EXL	EXR	FD	FPEB	FTK	ID
•	•	•	•	•	•						•			

INTGH	INVFRM	MI	P	RD	RECTKALL	RECTKBK	RECTKL	RECTKR	RT	VTK	WDRWPG
•		•								•	

**Construction Upgrades**

APF	APU	PEF	PEU
•	•	•	•

### Base Easy Reach

Model	Cubic Feet
BER33 L or R†	25.9
BER36 L or R	30.5

- Decorative hardware screws must be countersunk to prevent scratching of adjacent cabinets and face frame of BER.
- Fixed shelf is 1/2" thick laminated furniture board.
- Cabinet top features I-beam braces with a center support brace.
- Not recommended for use next to an appliance deeper than standard cabinet depth.

†When Lawry is specified, the door panel will be recessed.

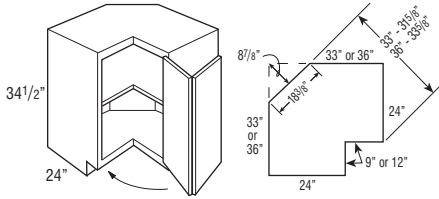

Due to fixed shelf mounting, shelves cannot be retrofitted.

#### Modifications

AUTHB	AUTHL	AUTHR	CBO	CCO	CFNTO	CFP	CND	EXB	EXL	EXR	FD	FPEB	FTK	ID
•	•	•	•	•	•							•		

INTGH	INVFRM	MI	P	RD	RECTKALL	RECTKBK	RECTKL	RECTKR	RT	VTK	WDRWPG
		•								•	

#### Construction Upgrades

APF	APU	PEF	PEU
•	•	•	•

### Asymmetrical Base Easy Reach

Model	Cubic Feet
BER3336 L or R	30.5
BER3633 L or R	30.5

- BER3336 L or R wall width is 33" x 36".
- BER3633 L or R wall width is 36" x 33".
- Legs at the front frames are 9" on 33" and 12" on 36".
- Nomenclature for asymmetrical cabinets reads as follows:  
First set of numbers = left side of cabinet dimensions.  
Second set of numbers = right side of cabinet dimensions.
- Decorative hardware screws must be countersunk to prevent scratching of adjacent cabinets and face frame of BER.
- Fixed shelf is 1/2" thick laminated furniture board.
- Cabinet top features I-beam braces with a center support brace.
- Not recommended for use next to an appliance deeper than standard cabinet depth.
- When Lawry is specified, the door panel will be recessed.

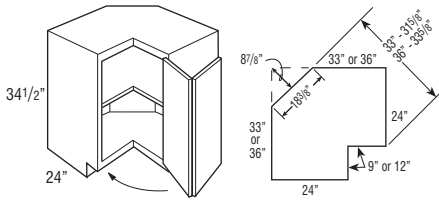

Due to fixed shelf mounting, shelves cannot be retrofitted.

#### Modifications

AUTHB	AUTHL	AUTHR	CBO	CCO	CFNTO	CFP	CND	EXB	EXL	EXR	FD	FPEB	FTK	ID
•	•	•	•	•	•							•		

INTGH	INVFRM	MI	P	RD	RECTKALL	RECTKBK	RECTKL	RECTKR	RT	VTK	WDRWPG
		•								•	

#### Construction Upgrades

APF	APU	PEF	PEU
•	•	•	•

**Base Corner Super Susan with Wood Shelves**

Model	Cubic Feet
BC3355 L or R <sup>†</sup>	25.9
BC3655 L or R	30.5

- SLS33 L or R wall width is 33" x 33".
- SLS36 L or R wall width is 36" x 36".
- SLS33 - Susans are 28" diameter.
- SLS36 - Susans are 32" diameter.
- Features two plywood revolving shelves. Lower shelf is mounted to floor. Upper shelf is mounted to fixed shelf. Fixed shelf is 1/2" thick laminated furniture board.
- Decorative hardware screws must be countersunk to prevent scratching adjacent cabinets and face frame of SLS.
- Cabinet top features I-beam braces with a center support brace.
- Not recommended for use next to an appliance deeper than standard cabinet depth.

<sup>†</sup>When Lawry is specified, the door panel will be recessed.

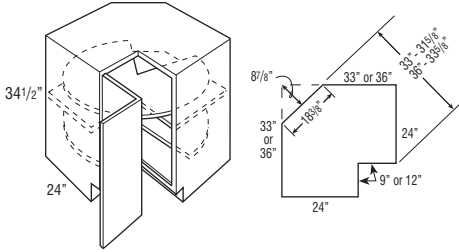

Due to fixed shelf mounting, shelves cannot be retrofitted.

**Modifications**

AUTHB	AUTHL	AUTHR	CBO	CCO	CFNTO	CFP	CND	EXB	EXL	EXR	FD	FPEB	FTK	ID
			•	•								•		
INTGH	INVFRM	MI	P	RD	RECTKALL	RECTKBK	RECTKL	RECTKR	RT	VTK	WDRWPG			
			•								•			

**Construction Upgrades**

APF	APU	PEF	PEU
•	•	•	•

**Asymmetrical Super Susan**

Model	Cubic Feet
BC3336SS L or R	30.5
BC3633SS L or R	30.5

- SLS3336 L or R wall width is 33" x 36".
- SLS3633 L or R wall width is 36" x 33".
- All Asymmetrical Super Susan shelves are 28" diameter.
- Features two plywood revolving shelves. Lower shelf is mounted to floor. Upper shelf is mounted to fixed shelf. Fixed shelf is 1/2" thick laminated furniture board.
- Nomenclature for asymmetrical cabinets reads as follows:  
First set of numbers = left side of cabinet dimensions.  
Second set of numbers = right side of cabinet dimensions.
- Decorative hardware screws must be countersunk to prevent scratching adjacent cabinets and face frame of SLS.
- Cabinet top features I-beam braces with a center support brace.
- Not recommended for use next to an appliance deeper than standard cabinet depth.
- When Lawry is specified, the door panel will be recessed.

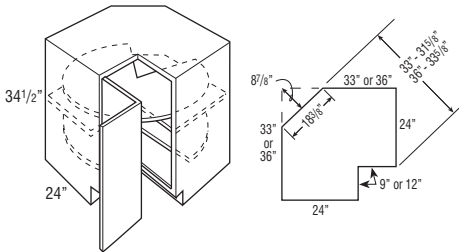

Due to fixed shelf mounting, shelves cannot be retrofitted.

**Modifications**

AUTHB	AUTHL	AUTHR	CBO	CCO	CFNTO	CFP	CND	EXB	EXL	EXR	FD	FPEB	FTK	ID
			•	•								•		
INTGH	INVFRM	MI	P	RD	RECTKALL	RECTKBK	RECTKL	RECTKR	RT	VTK	WDRWPG			
			•								•			

**Construction Upgrades**

APF	APU	PEF	PEU
•	•	•	•

## Angle Base

Model	Cubic Feet
AB12 L or R	7.8

- One adjustable shelf.
- Cabinets constructed with top.
- Door hinged on shallow depth side.
- To allow for proper door clearance of adjacent cabinets, all door styles regardless of overlay utilize 14 1/2" wide doors with a traditional overlay hinge.

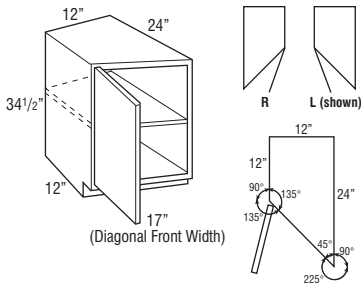

### Modifications

AUTHB	AUTHL	AUTHR	CBO	CCO	CFNTO	CFP	CND	EXB	EXL	EXR	FD	FPEB	FTK	ID
•	•	•	•	•	•							•*	•	

INTGH	INVFRM	MI	P	RD	RECTKALL	RECTKBK	RECTKL	RECTKR	RT	VTK	WDRWPG
•		•		•^			•^	•^		•	

\*FPEB available only on 12" deep side of cabinet.

^RD to 18" available.

^RECTKL and RECTKR cannot be ordered when RD is specified. RECTKL and RECTKR cannot be specified on the same cabinet.

### Construction Upgrades

APF	APU	PEF	PEU
•	•	•	•

## Angle End Base

Model	Cubic Feet
AEB24	14.3

- Wall width is 24" x 24".
- 24" W x 24" D x 34 1/2" H.
- 24" from outside corner point to frame face.
- Cabinets constructed with top.
- One adjustable shelf.
- Cabinet may be installed against either end of a run.

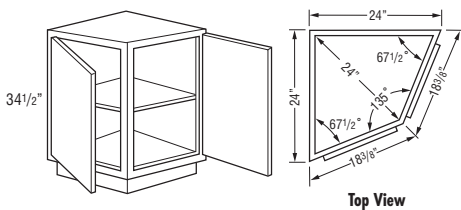

### Modifications

AUTHB	AUTHL	AUTHR	CBO	CCO	CFNTO	CFP	CND	EXB	EXL	EXR	FD	FPEB	FTK	ID
			•	•										

INTGH	INVFRM	MI	P	RD	RECTKALL	RECTKBK	RECTKL	RECTKR	RT	VTK	WDRWPG
•		•								•	

### Construction Upgrades

APF	APU	PEF	PEU
	•		•

## Angle Base Cabinet

Model	Cubic Feet
AB24B	14.3

- Wall width is 24" x 24".
- 24" from outside corner point to frame face.
- Cabinets constructed with top.
- One adjustable shelf.
- Cabinets may be installed against either end of a run.

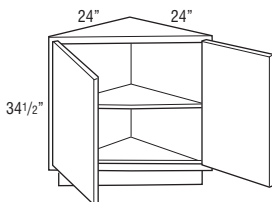

### Modifications

AUTHB	AUTHL	AUTHR	CBO	CCO	CFNTO	CFP	CND	EXB	EXL	EXR	FD	FPEB	FTK	ID
			•	•	•									

INTGH	INVFRM	MI	P	RD	RECTKALL	RECTKBK	RECTKL	RECTKR	RT	VTK	WDRWPG
•		•								•	

### Construction Upgrades

APF	APU	PEF	PEU
•	•	•	•

**Two Drawer Base**

Model	Cubic Feet
2BD18	11.0
2BD21	12.6
2BD24	14.3
2BD27	15.9
2BD30 <sup>†</sup>	17.6
2BD33 <sup>†</sup>	19.2
2BD36 <sup>†</sup>	20.9

<sup>†</sup>Standard drawers are solid-wood dovetail drawers with undermount full extension guides.

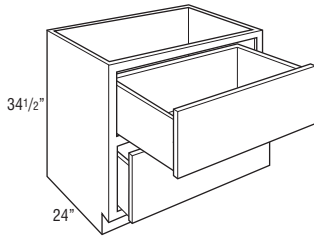

**Modifications**

AUTHB	AUTHL	AUTHR	CBO	CCO	CFNTO	CFP	CND	EXB	EXL	EXR	FD	FPEB	FTK	ID
•	•	•	•	•	•			•	•	•		•	•	
INTGH	INVFRM	MI	P	RD	RECTKALL	RECTKBK	RECTKL	RECTKR	RT	VTK	WDRWPG			
		•	•	•*	•	•	•			•	•			

\*RECTKALL available for 2BD27-2BD36.

**Construction Upgrades**

APF	APU	PEF	PEU
•	•	•	•

**Two Drawer Base Drop-in Range**

Model	Cubic Feet
2BD30DR	17.6
2BD36DR	20.9

• Standard drawers are solid-wood dovetail drawers with undermount full extension guides.

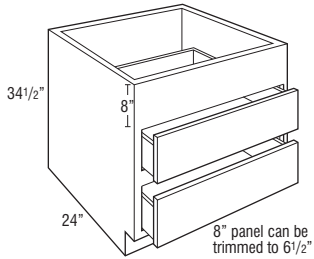

**Modifications**

AUTHB	AUTHL	AUTHR	CBO	CCO	CFNTO	CFP	CND	EXB	EXL	EXR	FD	FPEB	FTK	ID
•	•	•	•	•	•			•	•	•		•	•	
INTGH	INVFRM	MI	P	RD	RECTKALL	RECTKBK	RECTKL	RECTKR	RT	VTK	WDRWPG			
		•	•	•	•	•	•	•		•	•			

**Construction Upgrades**

APF	APU	PEF	PEU
•	•	•	•

**Three Drawer Base**

Model	Cubic Feet
3BD12	7.6
3BD15	9.2
3BD18	10.9
3BD21	12.6
3BD24	14.3
3BD27	15.9
BD30D†*	17.6
BD33D†*	19.3
BD36D†*	21.0

†Deep drawers are solid-wood dovetail drawers with undermount full extension guides. Top drawer is standard construction with 3/4 extension guides. When WDRWPG is selected, all three drawers and guides are upgraded.

\*Exterior height of bottom two drawers is 6 3/8".

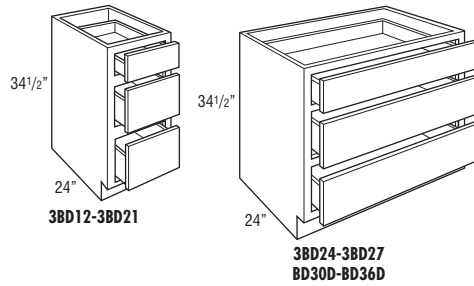

**Modifications**

AUTHB	AUTHL	AUTHR	CBO	CCO	CFNTO	CFP	CND	EXB	EXL	EXR	FD	FPEB	FTK	ID
•	•	•	•	•	•	•	•	•	•	•	•	•	•	•

INTGH	INVFRM	MI	P	RD	RECTKALL	RECTKBK	RECTKL	RECTKR	RT	VTK	WDRWPG
		•	•	•	•*	•	•	•	•	•	•

\*RECTKALL available for 3BD27 and BD30D-BD36D.

**Construction Upgrades**

APF	APU	PEF	PEU
•	•	•	•

**Four Drawer Base**

Model	Cubic Feet
4BD12	7.6
4BD15	9.2
4BD18	10.9
4BD21	12.6
4BD24	14.3
4BD27	15.9
4BD30	17.6
4BD33	19.3
4BD36	21.0

**Modifications**

AUTHB	AUTHL	AUTHR	CBO	CCO	CFNTO	CFP	CND	EXB	EXL	EXR	FD	FPEB	FTK	ID
•	•	•	•	•	•	•	•	•	•	•	•	•	•	•

INTGH	INVFRM	MI	P	RD	RECTKALL	RECTKBK	RECTKL	RECTKR	RT	VTK	WDRWPG
		•	•	•	•*	•	•	•	•	•	•

\*RECTKALL available for 4BD27-4BD36.

**Construction Upgrades**

APF	APU	PEF	PEU
•	•	•	•

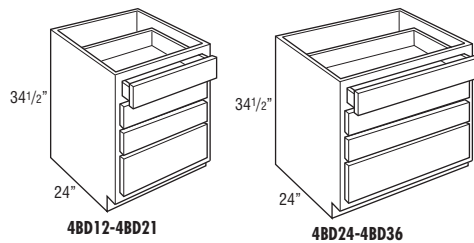

**Base Wastebasket**

Model	Cubic Feet
BWB15	9.2
BWB18	10.9
BWB21	12.6

**Modifications**

AUTHB	AUTHL	AUTHR	CBO	CCO	CFNTO	CFP	CND	EXB	EXL	EXR	FD	FPEB	FTK	ID
•	•	•	•	•	•	•	•	•	•	•	•	•	•	•

  

INTGH	INVFRM	MI	P	RD	RECTKALL	RECTKBK	RECTKL	RECTKR	RT	VTK	WDRWPG
•	•	•	•	•	•	•	•	•	•	•	•

**Construction Upgrades**

APF	APU	PEF	PEU
•	•	•	•

- BWB15 includes one 35 qt. basket.
- BWB18 and BWB21 include two 35 qt. baskets.
- Construction has wastebasket pull-out using SoftTouch guides.
- Bottom drawer is dovetailed.

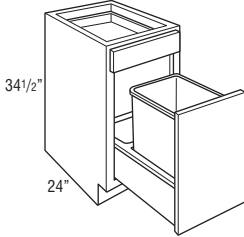

**BWB15**

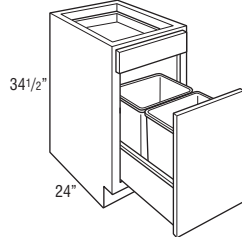

**BWB18-BWB21**

**Base Wastebasket, Full Height**

Model	Cubic Feet
BWB15FH	9.2
BWB18FH2 <b>NEW</b>	11.1
BWB21FH	12.6

**Modifications**

AUTHB	AUTHL	AUTHR	CBO	CCO	CFNTO	CFP	CND	EXB	EXL	EXR	FD	FPEB	FTK	ID
•	•	•	•	•	•	•	•	•	•	•	•	•	•	•

  

INTGH	INVFRM	MI	P	RD	RECTKALL	RECTKBK	RECTKL	RECTKR	RT	VTK	WDRWPG
•	•	•	•	•	•	•	•	•	•	•	•

**Construction Upgrades**

APF	APU	PEF	PEU
•	•	•	•

- BWB15FH includes one 50 qt. basket.
- BWB18FH2 includes two 35 qt. baskets.
- BWB21FH includes two 50 qt. baskets.
- Construction has wastebasket pull-out using SoftTouch guides.
- Bottom drawer is dovetailed.

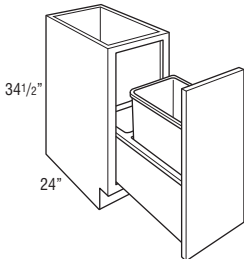

**BWB15FH**

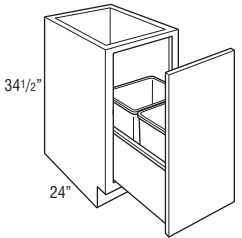

**BWB18FH2  
BWB21FH**

## Base Pantry Pull-out

Model	Cubic Feet
B9PO†	5.9
B12PO	7.7

- Full extension, SoftTouch wood pull-out with 1 fixed shelf and 3 adjustable shelves with chrome finished side rails.

†When Lawry is specified, the door panel will be recessed.

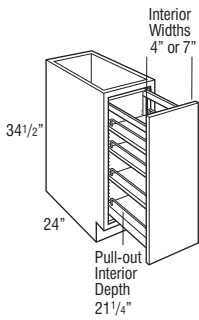

### Modifications

AUTHB	AUTHL	AUTHR	CBO	CCO	CFNTO	CFP	CND	EXB	EXL	EXR	FD	FPEB	FTK	ID
•	•	•	•	•					•	•		•	•	

INTGH	INVFRM	MI	P	RD	RECTKALL	RECTKBK	RECTKL	RECTKR	RT	VTK	WDRWPG
		•				•	•	•		•	

### Construction Upgrades

APF	APU	PEF	PEU
•	•	•	•

## Base Utensil Pantry Pull-out

Model	Cubic Feet
BUPP9†	6.0
BUPP12	7.7

- All styles include a natural finish SoftTouch wood pull-out with two adjustable shelves (including canister shelf) and one fixed shelf with chrome rail sides.
- Top shelf features three stainless steel canisters for utensils.
- The adjustable rear wall of the pull-out prevents items from falling behind the unit.
- BUPP9 canisters are 5.85" tall and have an inside diameter of 4.3".
- BUPP12 canisters are 6.7" tall and have an inside diameter of 5".

†When Lawry is specified, the door panel will be recessed.

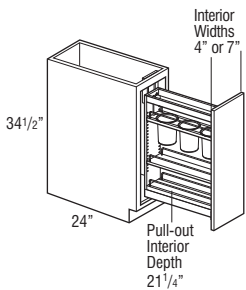

### Modifications

AUTHB	AUTHL	AUTHR	CBO	CCO	CFNTO	CFP	CND	EXB	EXL	EXR	FD	FPEB	FTK	ID
•	•	•	•	•				•	•	•		•	•	

INTGH	INVFRM	MI	P	RD	RECTKALL	RECTKBK	RECTKL	RECTKR	RT	VTK	WDRWPG
		•				•	•	•		•	

### Construction Upgrades

APF	APU	PEF	PEU
•	•	•	•



# Base Utensil Pantry Pull-out with Knife Block

Model	Cubic Feet
BUPPKB12	7.7
BUPPKB15	9.3

- Full extension, SoftTouch wood pull-out with natural finish and one fixed shelf.
- Features an adjustable shelf with knife blocks and stainless steel canister(s) and one fixed shelf with chrome rails.
- BUPPKB12: Canister is 6.7" tall and has an inside diameter of 5".
- BUPPKB15: Two canisters are 5.85" tall and have an inside diameter of 4.3", and the other two are 6.7" tall with an inside diameter of 5".
- Knife blocks feature movable flex rods that adjust to hold a multitude of knives.
- Includes adjustable rear wall for extra strength and stability.

### Modifications

AUTHB	AUTHL	AUTHR	CBO	CCO	CFNTO	CFP	CND	EXB	EXL	EXR	FD	FPEB	FTK	ID
•	•	•	•	•				•	•	•		•	•	

INTGH	INVFRM	MI	P	RD	RECTKALL	RECTKBK	RECTKL	RECTKR	RT	VTK	WDRWPG
		•				•	•	•		•	

### Construction Upgrades

APF	APU	PEF	PEU
•	•	•	•

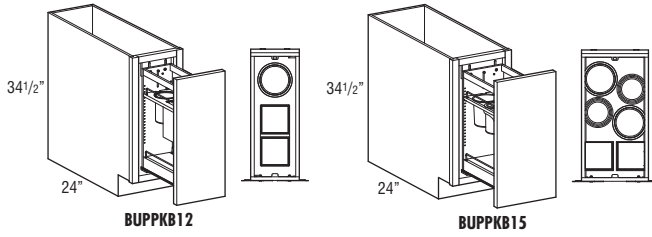

**NEW** Base Corner Peninsula

Model	Cubic Feet
BPC24B	14.4

- Cabinet width is 24".
- Adjustable full depth shelf.
- Includes two 3" fillers, shipped unattached. Fillers are required for drawer and door opening clearance of adjacent cabinets.
- Unfinished toe-kick on front (B24) and back (BCP) of cabinet.
- Will not accept roll trays.
- Peninsula base cabinets are 1/4" deeper to allow back paneling application on adjacent cabinets in a run with standard 24" deep cabinets.

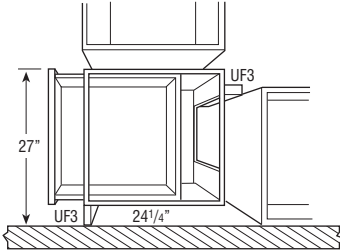

**Modifications**

AUTHB	AUTHL	AUTHR	CBO	CCO	CFNTO	CFP	CND	EXB	EXL	EXR	FD	FPEB	FTK	ID
•	•	•	•	•			•					•	•*	

INTGH	INVFRM	MI	P	RD	RECTKALL	RECTKBK	RECTKL	RECTKR	RT	VTK	WDRWPG
•		•	STD	•		STD	•	•		•	•

\*FTK available on front only.

**Construction Upgrades**

APF	APU	PEF	PEU
•	•	•	•

**NEW** Base Corner Peninsula with Full Height Door

Model	Cubic Feet
BPC24BFH	14.4

- Cabinet width is 24".
- Adjustable full depth shelf.
- Includes two 3" fillers, shipped unattached. Fillers are required for drawer and door opening clearance of adjacent cabinets.
- Unfinished toe-kick on front (B24) and back (BCP) of cabinet.
- Will not accept roll trays.
- Peninsula base cabinets are 1/4" deeper to allow back paneling application on adjacent cabinets in a run with standard 24" deep cabinets.

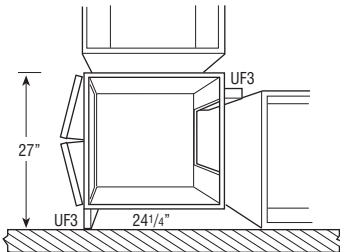

**Modifications**

AUTHB	AUTHL	AUTHR	CBO	CCO	CFNTO	CFP	CND	EXB	EXL	EXR	FD	FPEB	FTK	ID
•	•	•	•	•									•	•*

INTGH	INVFRM	MI	P	RD	RECTKALL	RECTKBK	RECTKL	RECTKR	RT	VTK	WDRWPG
•		•	STD	•		STD	•	•		•	

\*FTK available on front only.

**Construction Upgrades**

APF	APU	PEF	PEU
•	•	•	•

**30" SuperCabinet™**

Model	Cubic Feet
BSC30RTR	17.6

- Roll trays are Full Extension side-mounted.
- Cabinets utilize 170° hinge. For sufficient pull-out clearance, 12" of adjacent space is required for door to open 170° when installed near a wall or corner.
- Both doors have chrome and wood three-tiered 3 1/4" deep racks.

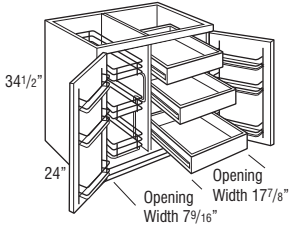

**Modifications**

AUTHB	AUTHL	AUTHR	CBO	CCO	CFNTO	CFP	CND	EXB	EXL	EXR	FD	FPEB	FTK	ID
•	•	•	•	•	•			•	•	•		•	•	•

INTGH	INVFRM	MI	P	RD	RECTKALL	RECTKBK	RECTKL	RECTKR	RT	VTK	WDRWPG
		•			•	•	•	•		•	

**Construction Upgrades**

APF	APU	PEF	PEU
•	•	•	•

**36" SuperCabinet™**

Model	Cubic Feet
BSC36PRP	20.9

- Roll trays are Full Extension side-mounted.
- Cabinets utilize 170° hinge. For sufficient pull-out clearance, 12" of adjacent space is required for door to open 170° when installed near a wall or corner.
- Both doors have chrome and wood three-tiered 3 1/4" deep racks.

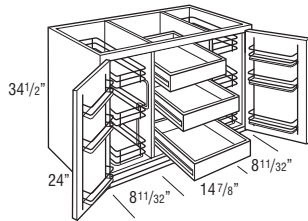

**Modifications**

AUTHB	AUTHL	AUTHR	CBO	CCO	CFNTO	CFP	CND	EXB	EXL	EXR	FD	FPEB	FTK	ID
•	•	•	•	•	•			•	•	•		•	•	•

INTGH	INVFRM	MI	P	RD	RECTKALL	RECTKBK	RECTKL	RECTKR	RT	VTK	WDRWPG
		•			•	•	•	•		•	

**Construction Upgrades**

APF	APU	PEF	PEU
•	•	•	•

**Base Cabinet with Mixer Lift**

Model	Cubic Feet
B18FHMIX L or R	11.0
B21FHMIX L or R	12.6
B24FHMIX L or R	14.3
B24BFHMIX	14.3

- SoftTouch mixer lift.
- Mixer shelf will be 3/4" thick natural finished veneer plywood, mixer shelf dimensions:  
18" wide: 11 3/4" wide x 20" deep.  
21" wide: 14 3/4" wide x 20" deep.  
24" wide: 17 3/4" wide x 20" deep.
- Maximum Weight Capacity for Mixer Shelf: 60 lbs.
- Mixer shelf locks in the fully open position. Release brackets lower the mixer shelf back into the cabinet.
- When installed in 34 1/2" full height cabinet and in closed position, clearance above shelf is 17 5/8"; clearance below shelf is 7 3/4".
- Mixer shelf is not intended to support mixer while mixer is in use.

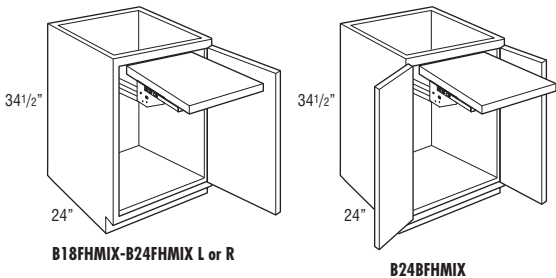

**Modifications**

AUTHB	AUTHL	AUTHR	CBO	CCO	CFNTO	CFP	CND	EXB	EXL	EXR	FD	FPEB	FTK	ID
•	•	•	•	•	•			•	•	•		•	•	•

INTGH	INVFRM	MI	P	RD	RECTKALL	RECTKBK	RECTKL	RECTKR	RT	VTK	WDRWPG
•						•		•		•	

**Construction Upgrades**

APF	APU	PEF	PEU
•	STD		

**MODEL CUBIC FEET**

**Base Pull-out Filler**

<b>BPOF3PL (Plain)</b>	<b>1.3</b>
<b>BPOF6PL (Plain)</b>	<b>2.5</b>

- Actual space required is 3 1/8" and 6 1/8" wide. May require trimming for top moulding applications or countertops that lip over the base top rail.
- Recommended installation between 2 cabinets.
- Can also be installed between a cabinet and a wall or between a cabinet and an end panel; requires 1/4" space filler for clearance.
- Filler is included but unattached.
- Install unit before removing shipping brace and attaching filler.
- Decorative hardware required on base units.
- Toekick not included; must be built up in the field.
- All styles feature a natural finish wood pull-out with adjustable shelves and chrome rail sides.
- Pull-out is full extension.

**MODIFICATIONS**

No modifications available for these products.

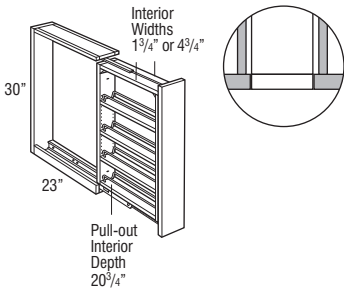

<b>BPOF3OV (Overlay)</b>	<b>1.3</b>
<b>BPOF6OV (Overlay)</b>	<b>2.5</b>

- Actual space required is 3 1/8" and 6 1/8" wide. May require trimming for top moulding applications or countertops that lip over the base top rail.
- Recommended installation between 2 cabinets.
- Can also be installed between a cabinet and a wall or between a cabinet and an end panel; requires 1/4" space filler for clearance.
- Filler is included but unattached.
- Install unit before removing shipping brace and attaching filler.
- Overlay application includes profiled full overlay filler.
- Decorative hardware required on base units.
- Toekick not included; must be built up in the field.
- All styles feature a natural finish wood pull-out with adjustable shelves and chrome rail sides.
- Pull-out is full extension.

**MODIFICATIONS**

No modifications available for these products.

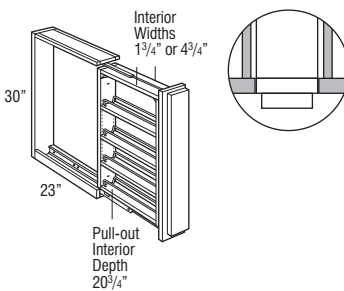

**MODEL CUBIC FEET**

**Base Outside Cabinet**

<b>BOC L or R</b>	<b>7.7</b>
-------------------	------------

- Angled pedestal design allows easier application of matching toekick.
- Veneer construction finished to match cabinet face frame.
- Matching interior.
- Cabinet is to be installed flush with face frame of the adjacent 24" deep base cabinet.
- When ordering Rustic Hickory, Hickory will be substituted.

**MODIFICATIONS**

No modifications available for these products.

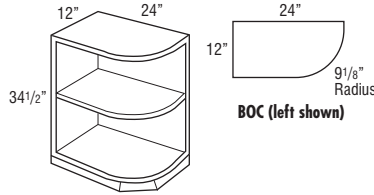

All UA Cabinets are 32 1/2" high unless otherwise noted.



MODIFICATIONS			
Mod.	Description	Mod.	Description
CBO	Cabinet Box Only	INTGH	Integrated SoftTouch Hinge
CCO	Cabinet Case Only	MI	Matching Interior
CFNTO	Cabinet Front Only	RD	Reduced Depth
CFP	Cabinet False Panel	RECTKALL	Island Toe Kick
CND	Cabinet with No Door, with Drawer	RECTKBK	Recessed Toe Kick Back
EXB	Extended Shelves Both	RECTKL	Recessed Toe Kick Left
EXL	Extended Shelves Left	RECTKR	Recessed Toe Kick Right
EXR	Extended Shelves Right	RT	Roll Tray
FD	Full Depth Shelf	VTK	Void Toe Kick
FPEB	Furniture Finished Plywood End Panels	WDRWPG	Wood Dovetail Drawer w/SoftTouch Guide
FTK	Flush Toe Kick		

CONSTRUCTION UPGRADES	
Mod.	Description
APF	All-plywood Finished
APU	All-plywood Unfinished
PEF	Plywood Ends Finished
PEU	Plywood Ends Unfinished

MODIFICATIONS GRID KEY	
•	Available
STD	Standard on these cabinets

**Universal Access Base, Single Door**

Model	Cubic Feet
B1232.5 L or R	7.3
B1532.5 L or R	8.8
B1832.5 L or R	10.4
B2132.5 L or R	11.9
B2432.5 L or R	13.5

**Modifications**

CBO	CCO	CFNTO	CFP	CND	EXB	EXL	EXR	FD	FPEB	FTK	INTGH	MI	RD	RECTKALL	RECTKBK	RECTKL	RECTKR	RT	VTK	WDRWPG
•	•	•	•	•	•	•	•	•	•	•	•	•	•	•	•	•	•	•	•	•

**Construction Upgrades**

APF	APU	PEF	PEU
•	•	•	•

- Adjustable 15" deep shelf.

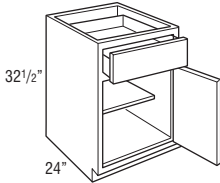

**Universal Access Base, Double Door**

Model	Cubic Feet
B2432.5B	13.5

**Modifications**

CBO	CCO	CFNTO	CFP	CND	EXB	EXL	EXR	FD	FPEB	FTK	INTGH	MI	RD	RECTKALL	RECTKBK	RECTKL	RECTKR	RT	VTK	WDRWPG
•	•	•	•	•	•	•	•	•	•	•	•	•	•	•	•	•	•	•	•	•

**Construction Upgrades**

APF	APU	PEF	PEU
•	•	•	•

- Adjustable 15" deep shelf.

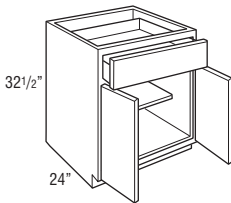

## Universal Access Three Drawer Base

Model	Cubic Feet
3BD1232.5	7.3
3BD1532.5	8.8
3BD1832.5	10.4
3BD2132.5	11.9
3BD2432.5	13.5

### Modifications

CBO	CCO	CFNTO	CFP	CND	EXB	EXL	EXR	FD	FPEB	FTK	INTGH	MI	RD	RECTKALL	RECTKBK	RECTKL	RECTKR	RT	VTK	WDRWPG
•	•	•	•		•	•	•		•	•			•		•	•	•		•	•

### Construction Upgrades

APF	APU	PEF	PEU
•	•	•	•

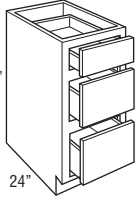

32 1/2"

24"

## Universal Access Base, Full Height Single Door

Model	Cubic Feet
B9FH32.5 L or R	5.7
B12FH32.5 L or R	7.3
B15FH32.5 L or R	8.8
B18FH32.5 L or R	10.4
B21FH32.5 L or R	11.9

### Modifications

CBO	CCO	CFNTO	CFP	CND	EXB	EXL	EXR	FD	FPEB	FTK	INTGH	MI	RD	RECTKALL	RECTKBK	RECTKL	RECTKR	RT	VTK	WDRWPG
•	•	•			•	•	•	•	•	•	•		•		•	•	•	•*	•	

\*RT not available on B9FH32.5.

### Construction Upgrades

APF	APU	PEF	PEU
•	•	•	•

- Adjustable 15" deep shelf.

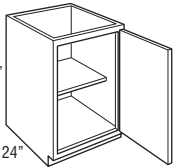

32 1/2"

24"

**Universal Access Base, Full Height Doors**

Model	Cubic Feet
B24BFH32.5	13.5
B27BFH32.5	15.1
B30BFH32.5	16.6
B33BFH32.5	18.2
B36BFH32.5	19.7
B39FH32.5	21.3
B42FH32.5	22.8
B48FH32.5	26.1

**Modifications**

CBO	CCO	CFNTO	CFP	CND	EXB	EXL	EXR	FD	FPEB	FTK	INTGH	MI	RD	RECTKALL	RECTKBK	RECTKL	RECTKR	RT	VTK	WDRWPG
•	•	•			•	•	•	•	•	•	•		•	•*	•	•	•	•		

\*RECTKALL not available on B24BFH32.5.

**Construction Upgrades**

APF	APU	PEF	PEU
•	•	•	•

- Adjustable 15" deep shelf.
- B24BFH32.5-B36BFH32.5 drilled to accept roll trays (sold separately).
- B39FH32.5-B48FH32.5 have a 3" center stile and are drilled to accept roll trays (sold separately).

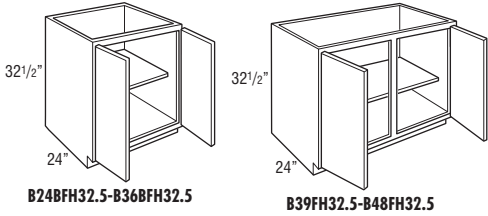

**Universal Access Base Corner Super Susan with Wood Shelves**

Model	Cubic Feet
BC3632.5SS L or R	28.8

**Modifications**

CBO	CCO	CFNTO	CFP	CND	EXB	EXL	EXR	FD	FPEB	FTK	INTGH	MI	RD	RECTKALL	RECTKBK	RECTKL	RECTKR	RT	VTK	WDRWPG
•	•	•							•										•	

**Construction Upgrades**

APF	APU	PEF	PEU
•	•	•	•

- Includes two 32" diameter wood shelves that spin independently.
- Decorative hardware screws must be countersunk to prevent scratching of adjacent cabinets and face frame.
- When Lawry is specified, the door panel will be recessed.

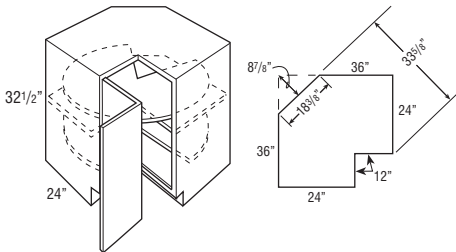

Due to fixed shelf mounting, shelves cannot be retrofitted.

## Universal Access Sink Unit

Model	Cubic Feet
SU3032.5	3.8
SU3332.5	4.0
SU3632.5	4.6

MODIFICATIONS
No modifications available for these products.

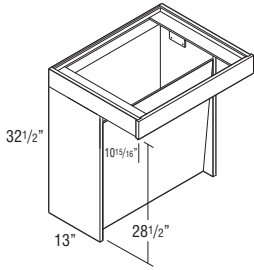

128

## Universal Access Base Microwave Cabinet with Standard Drawer

Model	Cubic Feet
BMWSD3032.5	16.6

- Cabinet interior finished to match cabinet face frame.
- Opening is 27" wide x 15" high.
- Maximum Opening: 28 1/2" wide x 18" high.

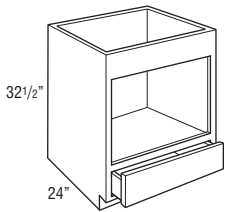

Modifications																				
CBO	CCO	CFNT0	CFP	CND	EXB	EXL	EXR	FD	FPEB	FTK	INTGH	MI	RD	RECTKALL	RECTKBK	RECTKL	RECTKR	RT	VTK	WDRWPG
•	•	•			•	•	•		•	•		STD	•	•	•	•	•	•	•	•

Construction Upgrades			
APF	APU	PEF	PEU
STD			



## TALL CABINET NOMENCLATURE

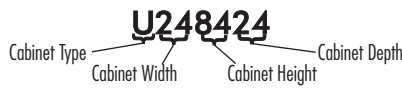

MODIFICATIONS			
Mod.	Description	Mod.	Description
AUTHB	Authentic Ends Both	FPEB	Furniture Finished Plywood End Panels
AUTHL	Authentic End Left	FTK	Flush Toekick
AUTHR	Authentic End Right	FULL	Full Overlay
CBO	Cabinet Box Only	INTGH	Integrated SoftTouch Hinge
CCO	Cabinet Case Only	MI	Matching Interior
CFNTO	Cabinet Front Only	RD	Reduced Depth
CND	Cabinet with No Door, with Drawer	RECTKL	Recessed Toekick Left
		RECTKR	Recessed Toekick Right
EXB	Extended Shelves Both	RT	Roll Tray
EXL	Extended Shile Left	VTK	Void Toekick
EXR	Extended Shile Right	WDRWPG	Wood Dovetail Drawer w/SoftTouch Guide

CONSTRUCTION UPGRADES	
Mod.	Description
APF	All-plywood Finished
APU	All-plywood Unfinished
PEF	Plywood Ends Finished
PEU	Plywood Ends Unfinished

MODIFICATIONS GRID KEY	
•	Available
STD	Standard on these cabinets

### Utility, 84", 87", 90", 93", or 96" Tall, 12" Deep

Model	Cubic Feet
U128412 L or R	9.8
U158412 L or R	11.8
U188412 L or R	13.9
U218412 L or R	16.0
U248412 L or R	18.1
U248412B	18.1
U278412	20.2
U308412	22.3
U338412	24.4
U368412	26.5

#### Modifications

AUTHB	AUTHL	AUTHR	CBO	CCO	CFNTO	CND	EXB	EXL	EXR	FPEB	FTK	FULL	INTGH	MI	RD	RECTKL	RECTKR	RT	VTK	WDRWPG
•	•	•	•	•	•		•	•	•	•	•	•	•	•		•	•	•	•	

#### Construction Upgrades

APF	APU	PEF	PEU
•	•	•	•

- Four full depth adjustable shelves are included.
- Mitered styles in lower section use 2 doors that are pinned together and operate as a single door.
- Upper doors available square or arch. Lower door available square only. Single door cabinets specify left or right.

U128712 L or R	10.1
U158712 L or R	12.3
U188712 L or R	14.4
U218712 L or R	16.6
U248712 L or R	18.8
U248712B	18.8
U278712	20.9
U308712	23.1
U338712	25.2
U368712	27.4

- Four full depth adjustable shelves are included.
- Mitered styles in lower section use 2 doors that are pinned together and operate as a single door.
- Upper doors available square or arch. Lower door available square only. Single door cabinets specify left or right.

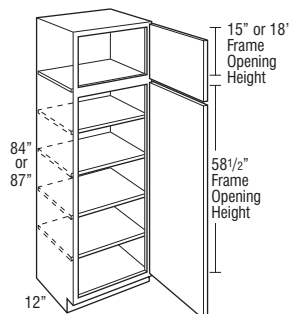

U128412-U248412 L or R  
U128712-U248712 L or R

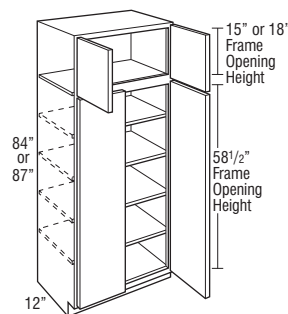

U248412B-U368412  
U248712B-U368712

Utility, 84", 87", 90", 93", or 96" Tall, 12" Deep, continued

Model	Cubic Feet
U129012 L or R	10.4
U159012 L or R	12.7
U189012 L or R	14.9
U219012 L or R	17.1
U249012 L or R	19.4
U249012B	19.4
U279012	21.6
U309012	23.9
U339012	26.1
U369012	28.3

Modifications

AUTHB	AUTHL	AUTHR	CBO	CCO	CFNTO	CND	EXB	EXL	EXR	FPEB	FTK	FULL	INTGH	MI	RD	RECTKL	RECTKR	RT	VTK	WDRWPG
•	•	•	•	•	•	•	•	•	•	•	•	•	•	•	•	•	•	•	•	•

Construction Upgrades

APF	APU	PEF	PEU
•	•	•	•

- Five full depth adjustable shelves are included.
- Mitered styles in lower section use 2 doors that are pinned together and operate as a single door.
- Upper doors available square or arch. Lower door available square only. Single door cabinets specify left or right.

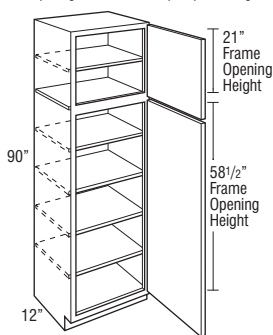

U129012-U249012 L or R

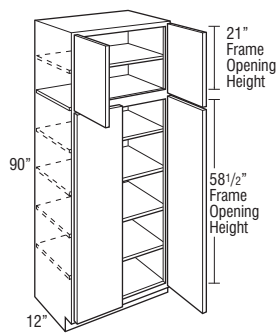

U249012B-U369012

Utility, 84", 87", 90", 93", or 96" Tall, 12" Deep, continued

Model	Cubic Feet
U129312 L or R	10.8
U159312 L or R	13.1
U189312 L or R	15.4
U219312 L or R	17.7
U249312 L or R	20.0
U249312B	20.0
U279312	22.3
U309312	24.6
U339312	26.9
U369312	29.2

Modifications

AUTHB	AUTHL	AUTHR	CBO	CCO	CFNTO	CND	EXB	EXL	EXR	FPEB	FTK	FULL	INTGH	MI	RD	RECTKL	RECTKR	RT	VTK	WDRWPG
•	•	•	•	•	•	•	•	•	•	•	•	•	•	•	•	•	•	•	•	•

Construction Upgrades

APF	APU	PEF	PEU
•	•	•	•

- Five full depth adjustable shelves are included.
- Mitered styles in lower section use 2 doors that are pinned together and operate as a single door.
- Upper doors available square or arch. Lower door available square only. Single door cabinets specify left or right.
- Toekick assembly shipped unattached.

U129612 L or R	11.1
U159612 L or R	13.5
U189612 L or R	15.9
U219612 L or R	18.3
U249612 L or R	20.6
U249612B	20.6
U279612	23.0
U309612	25.4
U339612	27.8
U369612	30.2

- Six full depth adjustable shelves are included.
- Mitered styles in lower section use 2 doors that are pinned together and operate as a single door.
- Upper doors available square or arch. Lower door available square only. Single door cabinets specify left or right.
- Toekick assembly shipped unattached.

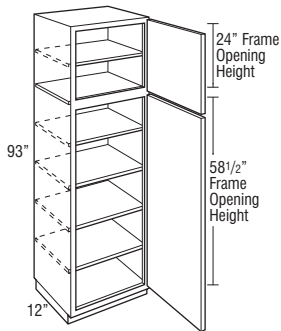

U129312-U249312 L or R

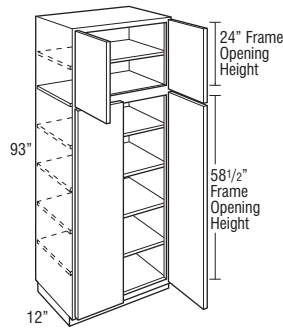

U249312B-U369312

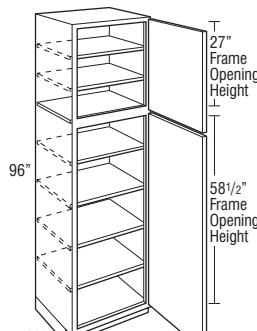

U129612-U249612 L or R

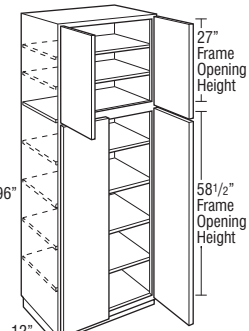

U249612B-U369612

Utility, 84", 87", 90", 93", or 96" Tall, 24" Deep

Model	Cubic Feet
U128424 L or R	18.1
U158424 L or R	22.0
U188424 L or R	25.9
U218424 L or R	29.8
U248424 L or R	33.5
U248424B	33.5
U278424	37.5
U308424	41.4
U338424	45.3
U368424	49.2

Modifications

AUTHB	AUTHL	AUTHR	CBO	CCO	CFNTO	CND	EXB	EXL	EXR	FPEB	FTK	FULL	INTGH	MI	RD	RECTKL	RECTKR	RT	VTK	WDRWPG
•	•	•	•	•	•	•	•	•	•	•	•	•	•	•	•	•	•	•	•	•

Construction Upgrades

APF	APU	PEF	PEU
•	•	•	•

- Four full depth adjustable shelves are included.
- Mitered styles in lower section use 2 doors that are pinned together and operate as a single door.
- Upper doors available square or arch. Lower door available square only. Single door cabinets specify left or right.

U128724 L or R	18.8
U158724 L or R	22.8
U188724 L or R	26.8
U218724 L or R	30.8
U248724 L or R	34.8
U248724B	34.8
U278724	38.8
U308724	42.9
U338724	46.9
U368724	50.9

- Four full depth adjustable shelves are included.
- Mitered styles in lower section use 2 doors that are pinned together and operate as a single door.
- Upper doors available square or arch. Lower door available square only. Single door cabinets specify left or right.

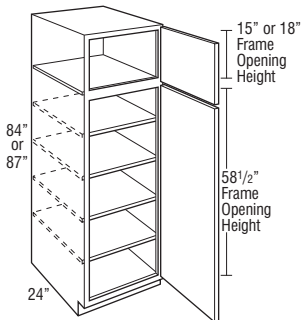

U128424-U248424 L or R  
U128724-U248724 L or R

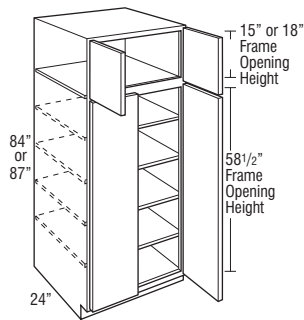

U248424B-U368424  
U248724B-U368724

Utility, 84", 87", 90", 93", or 96" Tall, 24" Deep, continued

Model	Cubic Feet
U129024 L or R	19.4
U159024 L or R	23.5
U189024 L or R	27.7
U219024 L or R	31.8
U249024 L or R	36.0
U249024B	36.0
U279024	40.1
U309024	44.3
U339024	48.4
U369024	52.6

Modifications

AUTHB	AUTHL	AUTHR	CBO	CCO	CFNTO	CND	EXB	EXL	EXR	FPEB	FTK	FULL	INTGH	MI	RD	RECTKL	RECTKR	RT	VTK	WDRWPG
•	•	•	•	•	•		•	•	•	•	•	•	•	•	•	•	•	•	•	

Construction Upgrades

APF	APU	PEF	PEU
•	•	•	•

- Five full depth adjustable shelves are included.
- Mitered styles in lower section use 2 doors that are pinned together and operate as a single door.
- Upper doors available square or arch. Lower door available square only. Single door cabinets specify left or right.

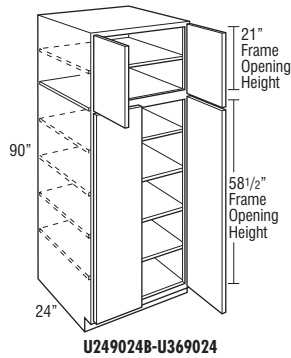
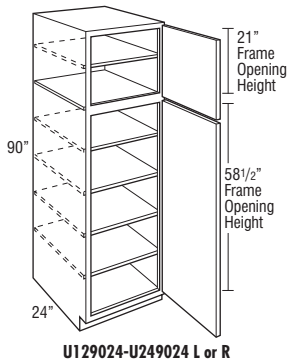

Utility, 84", 87", 90", 93", or 96" Tall, 24" Deep, continued

Model	Cubic Feet
U129324 L or R	20.0
U159324 L or R	24.3
U189324 L or R	28.6
U219324 L or R	32.9
U249324 L or R	37.2
U249324B	37.2
U279324	41.5
U309324	45.7
U339324	50.0
U369324	54.3

Modifications

AUTHB	AUTHL	AUTHR	CBO	CCO	CFNTO	CND	EXB	EXL	EXR	FPEB	FTK	FULL	INTGH	MI	RD	RECTKL	RECTKR	RT	VTK	WDRWPG
•	•	•	•	•	•	•	•	•	•	•	•	•	•	•	•	•	•	•	•	•

Construction Upgrades

APF	APU	PEF	PEU
•	•	•	•

- Five full depth adjustable shelves are included.
- Mitered styles in lower section use 2 doors that are pinned together and operate as a single door.
- Upper doors available square or arch. Lower door available square only. Single door cabinets specify left or right.
- Toekick assembly shipped unattached.

U129624 L or R	20.6
U159624 L or R	25.0
U189624 L or R	29.5
U219624 L or R	33.9
U249624 L or R	38.3
U249624B	38.3
U279624	42.8
U309624	47.2
U339624	51.6
U369624	56.0

- Six full depth adjustable shelves are included.
- Mitered styles in lower section use 2 doors that are pinned together and operate as a single door.
- Upper doors available square or arch. Lower door available square only. Single door cabinets specify left or right.
- Toekick assembly shipped unattached.

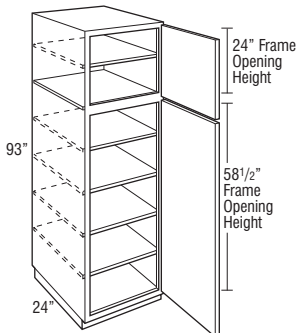

U129324-U249324 L or R

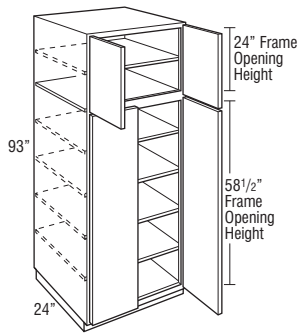

U249324B-U369324

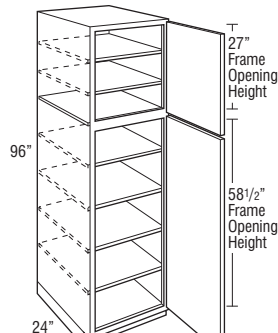

U129624-U249624 L or R

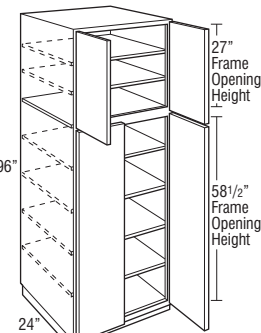

U249624B-U369624

**NEW** Utility with Roll Trays, 84", 87", 90", 93", or 96" Tall, 24" Deep

Model	Cubic Feet
U128424RT L or R	16.2
U158424RT L or R	22.3
U188424RT L or R	26.0
U218424RT L or R	29.3
U248424RT L or R	33.1
U248424BRT	33.1
U278424BRT	37.4
U308424BRT	40.8
U338424BRT	45.2
U368424BRT	51.2

**Modifications**

AUTHB	AUTHL	AUTHR	CBO	CCO	CFNTO	CND	EXB	EXL	EXR	FPEB	FTK	FULL	INTGH	MI	RD	RECTKL	RECTKR	RT	VTK	WDRWPG	
•	•	•	•	•	•		•	•	•	•	•	•	•	•	•	•	•	•	•	•	•

**Construction Upgrades**

APF	APU	PEF	PEU
•	•	•	•

- 4 laminate roll trays standard; installed in cabinet. RTPG upgrade available.
- Mitered styles in lower section use 2 doors that are pinned together and operate as a single door.
- Depth can be reduced to a minimum of 18".

U128724RT L or R	18.9
U158724RT L or R	22.4
U188724RT L or R	26.5
U218724RT L or R	30.5
U248724RT L or R	34.6
U248724BRT	34.6
U278724BRT	38.7
U308724BRT	42.8
U338724BRT	46.8
U368724BRT	50.9

- 4 laminate roll trays standard; installed in cabinet. RTPG upgrade available.
- Mitered styles in lower section use 2 doors that are pinned together and operate as a single door.
- Depth can be reduced to a minimum of 18".

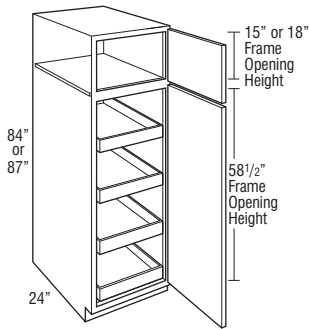

U128424RT-U248424RT L or R  
U128724RT-U248724RT L or R

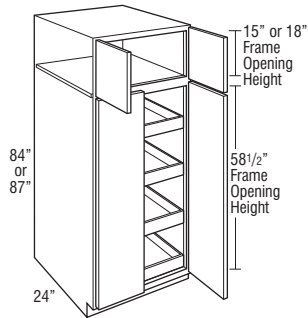

U248424BRT-U368424RT  
U248724BRT-U368724RT

**NEW** Utility with Roll Trays, 84", 87", 90", 93", or 96" Tall, 24" Deep, continued

Model	Cubic Feet
U129024RT L or R	17.3
U159024RT L or R	22.6
U189024RT L or R	28.6
U219024RT L or R	31.3
U249024RT L or R	35.5
U249024BRT	35.5
U279024BRT	40.0
U309024BRT	43.7
U339024BRT	48.4
U369024BRT	50.5

**Modifications**

AUTHB	AUTHL	AUTHR	CBO	CCO	CFNTO	CND	EXB	EXL	EXR	FPEB	FTK	FULL	INTGH	MI	RD	RECTKL	RECTKR	RT	VTK	WDRWPG
•	•	•	•	•	•		•	•	•	•	•	•	•	•	•	•	•	•	•	

**Construction Upgrades**

APF	APU	PEF	PEU
•	•	•	•

- 4 laminate roll trays standard; installed in cabinet. RTPG upgrade available.
- One adjustable shelf included.
- Mitered styles in lower section use 2 doors that are pinned together and operate as a single door.
- Depth can be reduced to a minimum of 18".

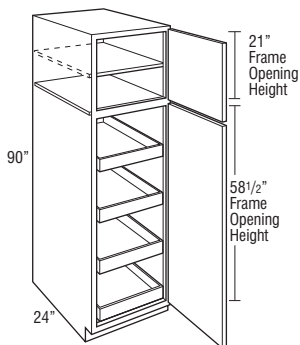

U129024RT-U249024RT L or R

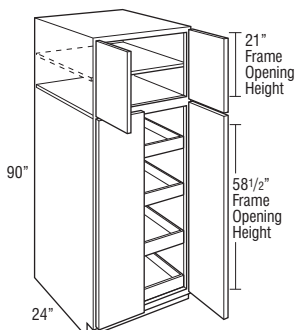

U249024BRT-U369024RT





Utility with Roll Trays, 84", 87", 90", 93", or 96" Tall, 24" Deep, continued

Model	Cubic Feet
U129324RT L or R	19.2
U159324RT L or R	21.5
U189324RT L or R	25.8
U219324RT L or R	29.9
U249324RT L or R	34.0
U249324BRT	34.0
U279324BRT	41.3
U309324BRT	44.9
U339324BRT	50.0
U369324BRT	50.3

Modifications

AUTHB	AUTHL	AUTHR	CBO	CCO	CFNTO	CND	EXB	EXL	EXR	FPEB	FTK	FULL	INTGH	MI	RD	RECTKL	RECTKR	RT	VTK	WDRWPG
•	•	•	•	•	•	•	•	•	•	•	•	•	•	•	•	•	•	•	•	•

Construction Upgrades

APF	APU	PEF	PEU
•	•	•	•

- Separate pedestal base included but shipped separately on 93" tall.
- 4 laminate roll trays standard; installed in cabinet. RTPG upgrade available.
- One adjustable shelf included.
- Mitered styles in lower section use 2 doors that are pinned together and operate as a single door.
- Depth can be reduced to a minimum of 18".

U129624RT L or R	18.5
U159624RT L or R	24.2
U189624RT L or R	28.4
U219624RT L or R	33.4
U249624RT L or R	37.8
U249624BRT	37.8
U279624BRT	42.6
U309624BRT	46.6
U339624BRT	51.6
U369624BRT	54.0

- Separate pedestal base included but shipped separately on 96" tall.
- 4 laminate roll trays standard; installed in cabinet. RTPG upgrade available.
- Two adjustable shelves included.
- Mitered styles in lower section use 2 doors that are pinned together and operate as a single door.
- Depth can be reduced to a minimum of 18".

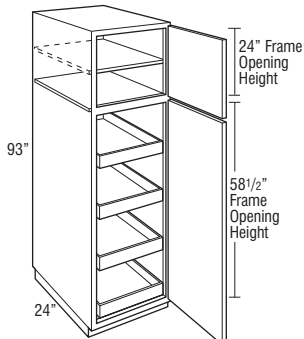

U129324RT-U249324RT L or R

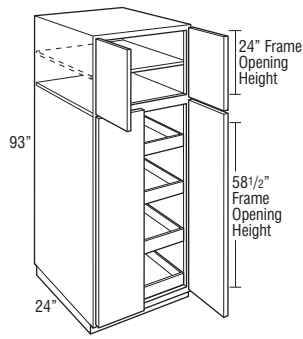

U249324BRT-U369324RT

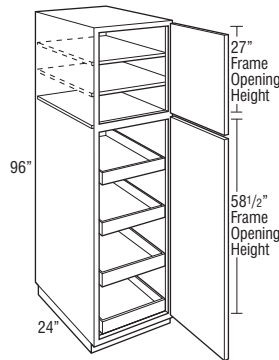

U129624RT-U249624RT L or R

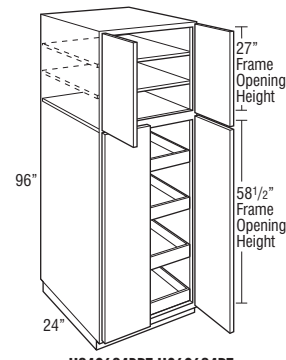

U249624BRT-U369624RT

Single Oven Cabinet, 84", 87", or 90" Tall, 24" Deep

Model	Cubic Feet
OS3084S	41.4
OS3384S	45.3
OS3087S	42.9
OS3387S	46.9
OS3090S	44.3
OS3390S	48.4

Modifications

AUTHB	AUTHL	AUTHR	CBO	CCO	CFNTO	CND	EXB	EXL	EXR	FPEB	FTK	FULL	INTGH	MI	RD	RECTKL	RECTKR	RT	VTK	WDRWPG
•	•	•	•*	•	•	•	•	•	•	•	•	•	•	•	•	•	•	•	•	•

\*CBO not available on 84" and 87" high cabinets.

Construction Upgrades

APF	APU	PEF	PEU
•	•	•	•

- Oven cabinets feature an open back in cut-out area designed to improve field appliance installation.
- Metal appliance support brackets included for 24" deep cabinets.
- Upper section on 90" tall has one full depth adjustable shelf.
- Oven cavity is standard interior.
- Modified Full overlay styles feature face mount hinges.
- All top and bottom cross rails are 1 1/2" wide.
- All cabinets have 3" stiles on frame.
- Be sure to confirm a heat shield is built into your appliance by the manufacturer or install the heat shield included with your appliance.
- Heat shields are also sold separately as an accessory.

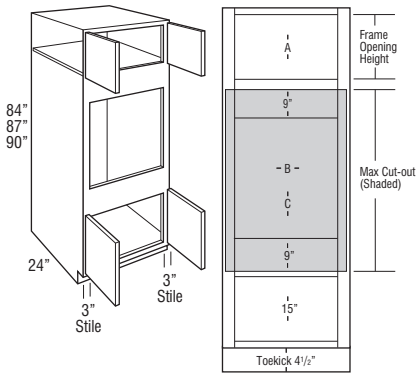

	A Frame Opening Height	B Cut-out Width		C Cut-out Height		Door Height (Upper Section)	
		Min.	Max.	Min.	Max.	Traditional Overlay	Modified Full Overlay
OS3084S	15"	24"	28 1/2"	28 1/2"	43 1/2"	16"	16 3/4"
OS3384S	15"	27"	31 1/2"	28 1/2"	43 1/2"	16"	16 3/4"
OS3087S	18"	24"	28 1/2"	28 1/2"	43 1/2"	19"	19 3/4"
OS3387S	18"	27"	31 1/2"	28 1/2"	43 1/2"	19"	19 3/4"
OS3090S	21"	24"	28 1/2"	28 1/2"	43 1/2"	22"	22 3/4"
OS3390S	21"	27"	31 1/2"	28 1/2"	43 1/2"	22"	22 3/4"

Maximum cut-out dimension will allow 1/4" reveal for doors and drawer fronts on modified full overlay and 1" for traditional overlay for trim kit face clearance.

**Single Oven Cabinet, 93" or 96" Tall, 24" Deep**

Model	Cubic Feet
OS3093S	45.7
OS3393S	50.0
OS3096S	47.2
OS3396S	51.6

**Modifications**

AUTHB	AUHL	AUHLR	CBO	CCO	CFNTO	CND	EXB	EXL	EXR	FPEB	FTK	FULL	INTGH	MI	RD	RECTKL	RECTKR	RT	VTK	WDRWPG
•	•	•	•	•	•		•	•	•	•	•	•	•	•	•			•		

**Construction Upgrades**

APF	APU	PEF	PEU
•	•	•	•

- Oven cabinets feature an open back in cut-out area designed to improve field appliance installation.
- Metal appliance support brackets included for 24" deep cabinets.
- Includes adjustable shelves in upper section:  
93" tall - one shelf  
96" tall - two shelves
- Toekick assembly shipped unattached.
- Oven cavity is standard interior.
- Modified Full overlay styles feature face mount hinges.
- All top and bottom cross rails are 1 1/2" wide.
- All cabinets have 3" stiles on frame.
- Be sure to confirm a heat shield is built into your appliance by the manufacturer or install the heat shield included with your appliance.
- Heat shields are also sold separately as an accessory.

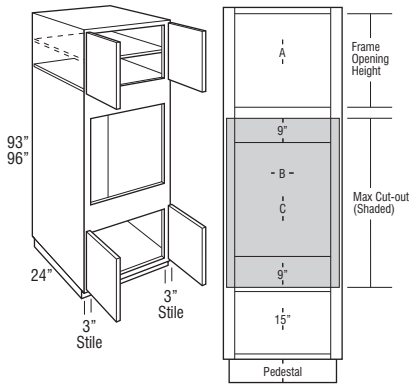

	A Frame Opening Height	B Cut-out Width		C Cut-out Height		Door Height (Upper Section)	
		Min.	Max.	Min.	Max.	Traditional Overlay	Modified Full Overlay
OS3093S	24"	24"	28 1/2"	28 1/2"	43 1/2"	25"	25 3/4"
OS3393S	24"	27"	31 1/2"	28 1/2"	43 1/2"	25"	25 3/4"
OS3096S	27"	24"	28 1/2"	28 1/2"	43 1/2"	28"	28 3/4"
OS3396S	27"	27"	31 1/2"	28 1/2"	43 1/2"	28"	28 3/4"

Maximum cut-out dimension will allow 1/4" reveal for doors and drawer fronts on modified full overlay and 1" for traditional overlay for trim kit face clearance.

Double Oven Cabinet, 84", 87", or 90" Tall, 24" Deep

Model	Cubic Feet
OD3084	41.4
OD3384	45.3
OD3087	42.9
OD3387	46.9
OD3090	44.3
OD3390	48.4

Modifications

AUTHB	AUTHL	AUTHR	CBO	CCO	CFNTO	CND	EXB	EXL	EXR	FPEB	FTK	FULL	INTGH	MI	RD	RECTKL	RECTKR	RT	VTK	WDRWPG
•	•	•	•	•	•	•	•	•	•	•	•	•	•	•	•	•	•	•	•	•

Construction Upgrades

APF	APU	PEF	PEU
•	•	•	•

- Oven cabinets feature an open back in cut-out area designed to improve field appliance installation.
- Metal appliance support brackets included for 24" deep cabinets.
- Upper section on 90" tall has one full depth adjustable shelf.
- Oven cavity is standard interior.
- Modified Full overlay styles feature face mount hinges.
- All top and bottom cross rails are 1 1/2" wide.
- All cabinets have 3" stiles on frame.
- Be sure to confirm a heat shield is built into your appliance by the manufacturer or install the heat shield included with your appliance.
- Heat shields are also sold separately as an accessory.

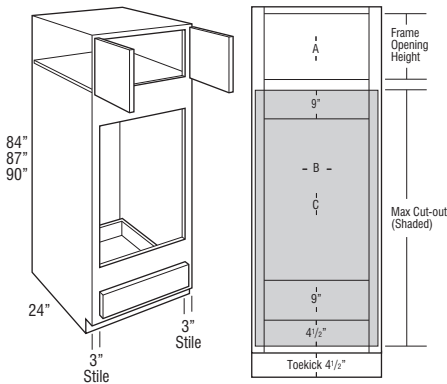

	A Frame Opening Height	B Cut-out Width		C Cut-out Height		Door Height (Upper Section)	
		Min.	Max.	Min.	Max.	Traditional Overlay	Modified Full Overlay
OD3084	15"	24"	28 1/2"	39"	60"	16"	16 3/4"
OD3384	15"	27"	31 1/2"	39"	60"	16"	16 3/4"
OD3087	18"	24"	28 1/2"	39"	60"	19"	19 3/4"
OD3387	18"	27"	31 1/2"	39"	60"	19"	19 3/4"
OD3090	21"	24"	28 1/2"	39"	60"	22"	22 3/4"
OD3390	21"	27"	31 1/2"	39"	60"	22"	22 3/4"

Maximum cut-out dimension will allow 1/4" reveal for doors and drawer fronts on modified full overlay and 1" for traditional overlay for trim kit face clearance.

**Double Oven Cabinet, 93" or 96" Tall, 24" Deep**

Model	Cubic Feet
OD3093	45.7
OD3393	50.0
OD3096	47.2
OD3396	51.6

**Modifications**

AUTHB	AUTHL	AUTHR	CBO	CCO	CFNTO	CND	EXB	EXL	EXR	FPEB	FTK	FULL	INTGH	MI	RD	RECTKL	RECTKR	RT	VTK	WDRWPG
•	•	•	•	•	•	•	•	•	•	•	•	•	•	•	•	•	•	•	•	•

**Construction Upgrades**

APF	APU	PEF	PEU
•	•	•	•

- Oven cabinets feature an open back in cut-out area designed to improve field appliance installation.
- Metal appliance support brackets included for 24" deep cabinets.
- Includes adjustable shelves in upper section:
  - 93" tall - one shelf
  - 96" tall - two shelves
- Toekick assembly shipped unattached.
- Oven cavity is standard interior.
- Modified Full overlay styles feature face mount hinges.
- All top and bottom cross rails are 1 1/2" wide.
- All cabinets have 3" stiles on frame.
- Be sure to confirm a heat shield is built into your appliance by the manufacturer or install the heat shield included with your appliance.
- Heat shields are also sold separately as an accessory.

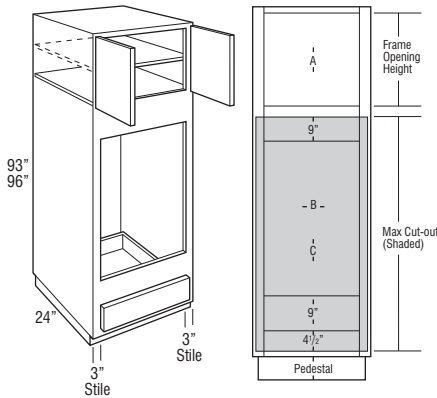

	A Frame Opening Height	B Cut-out Width		C Cut-out Height		Door Height (Upper Section)	
		Min.	Max.	Min.	Max.	Traditional Overlay	Modified Full Overlay
OD3093	24"	24"	28 1/2"	39"	60"	25"	25 3/4"
OD3393	24"	27"	31 1/2"	39"	60"	25"	25 3/4"
OD3096	27"	24"	28 1/2"	39"	60"	28"	28 3/4"
OD3396	27"	27"	31 1/2"	39"	60"	28"	28 3/4"

Maximum cut-out dimension will allow 1/4" reveal for doors and drawer fronts on modified full overlay and 1" for traditional overlay for trim kit face clearance.

**Double Oven Cabinet, Deep Drawer, 84", 87", or 90" Tall, 24" Deep**

Model	Cubic Feet
OD3084DD	41.4
OD3384DD	45.3
OD3087DD	42.9
OD3387DD	46.9
OD3090DD	44.3
OD3390DD	48.4

**Modifications**

AUTHB	AUTHL	AUTHR	CBO	CCO	CFNTO	CND	EXB	EXL	EXR	FPEB	FTK	FULL	INTGH	MI	RD	RECTKL	RECTKR	RT	VTK	WDRWPG	
•	•	•	•	•	•	•	•	•	•	•	•	•	•	•	•	•	•	•	•	•	STD

**Construction Upgrades**

APF	APU	PEF	PEU
•	•	•	•

- Oven cabinets feature an open back in cut-out area designed to improve field appliance installation.
- Metal appliance support brackets included for 24" deep cabinets.
- Oven cavity is standard interior.
- Modified Full overlay styles feature face mount hinges.
- All top and bottom cross rails are 1 1/2" wide.
- All cabinets have 3" stiles on frame.
- Be sure to confirm a heat shield is built into your appliance by the manufacturer or install the heat shield included with your appliance.
- Heat shields are also sold separately as an accessory.

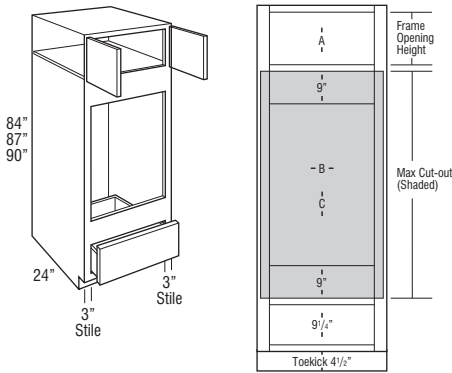

	A Frame Opening Height	B Cut-out Width		C Cut-out Height		Door Height (Upper Section)	
		Min.	Max.	Min.	Max.	Traditional Overlay	Modified Full Overlay
OD3084DD	12"	24"	28 1/2"	37 1/4"	52 1/4"	13"	13 3/4"
OD3384DD	12"	27"	31 1/2"	37 1/4"	52 1/4"	13"	13 3/4"
OD3087DD	15"	24"	28 1/2"	37 1/4"	52 1/4"	16"	16 3/4"
OD3387DD	15"	27"	31 1/2"	37 1/4"	52 1/4"	16"	16 3/4"
OD3090DD	18"	24"	28 1/2"	37 1/4"	52 1/4"	19"	19 3/4"
OD3390DD	18"	27"	31 1/2"	37 1/4"	52 1/4"	19"	19 3/4"

Maximum cut-out dimension will allow 1/4" reveal for doors and drawer fronts on modified full overlay and 1" for traditional overlay for trim kit face clearance.

**Double Oven Cabinet, Deep Drawer, 93" or 96" Tall, 24" Deep**

Model	Cubic Feet
OD3093DD	45.7
OD3393DD	50.0
OD3096DD	47.2
OD3396DD	51.6

**Modifications**

AUTHB	AUTHL	AUTHR	CBO	CCO	CFNTO	CND	EXB	EXL	EXR	FPEB	FTK	FULL	INTGH	MI	RD	RECTKL	RECTKR	RT	VTK	WDRWPG
•	•	•	•	•	•	•	•	•	•	•	•	•	•	•	•					STD

**Construction Upgrades**

APF	APU	PEF	PEU
•	•	•	•

- Oven cabinets feature an open back in cut-out area designed to improve field appliance installation.
- Metal appliance support brackets included for 24" deep cabinets.
- Toekick assembly shipped unattached.
- Oven cavity is standard interior.
- Modified Full overlay styles feature face mount hinges.
- All top and bottom cross rails are 1 1/2" wide.
- All cabinets have 3" stiles on frame.
- Be sure to confirm a heat shield is built into your appliance by the manufacturer or install the heat shield included with your appliance.
- Heat shields are also sold separately as an accessory.

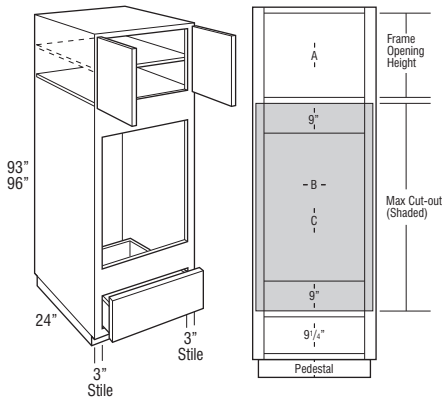

	A Frame Opening Height	B Cut-out Width		C Cut-out Height		Door Height (Upper Section)	
		Min.	Max.	Min.	Max.	Traditional Overlay	Modified Full Overlay
OD3093DD	21"	24"	28 1/2"	37 1/4"	52 1/4"	22"	22 3/4"
OD3393DD	21"	27"	31 1/2"	37 1/4"	52 1/4"	22"	22 3/4"
OD3096DD	24"	24"	28 1/2"	37 1/4"	52 1/4"	25"	25 3/4"
OD3396DD	24"	27"	31 1/2"	37 1/4"	52 1/4"	25"	25 3/4"

Maximum cut-out dimension will allow 1/4" reveal for doors and drawer fronts on modified full overlay and 1" for traditional overlay for trim kit face clearance.

Oven Microwave Cabinet , 84", 87", or 90" Tall, 24" Deep

Model	Cubic Feet
OMC3084	41.4
OMC3384	45.3
OMC3087	42.9
OMC3387	46.9
OMC3090	44.3
OMC3390	48.4

Modifications

AUTHB	AUTHL	AUTHR	CBO	CCO	CFNTO	CND	EXB	EXL	EXR	FPEB	FTK	FULL	INTGH	MI	RD	RECTKL	RECTKR	RT	VTK	WDRWPG
•	•	•	•	•	•	•	•	•	•	•	•	•	•	•	•	•	•	•	•	•

Construction Upgrades

APF	APU	PEF	PEU
•	•	•	•

- Oven cabinets feature an open back in cut-out area designed to improve field appliance installation.
- Metal appliance support brackets included for 24" deep cabinets.
- Upper section on 90" tall has one full depth adjustable shelf.
- Oven and microwave cavities are standard interior.
- Modified Full overlay styles feature face mount hinges.
- All top and bottom cross rails are 1 1/2" wide.
- All cabinets have 3" stiles on frame.
- Be sure to confirm a heat shield is built into your appliance by the manufacturer or install the heat shield included with your appliance.
- Heat shields are also sold separately as an accessory.

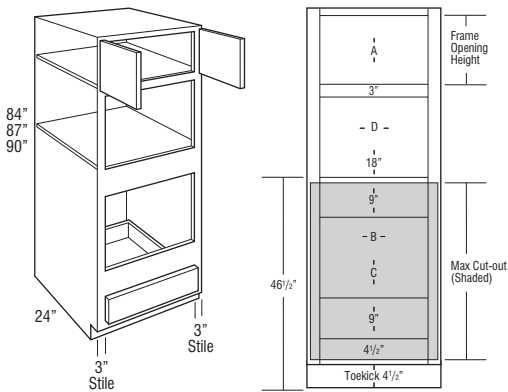

	A Frame Opening Height	B Cut-out Width		C Cut-out Height		D Frame Opening Width	Door Height (Upper Section)	
		Min.	Max.	Min.	Max.		Traditional Overlay	Modified Full Overlay
		24"	28 1/2"	18"	39"			
OMC3084	15"	24"	28 1/2"	18"	39"	24"	16"	16 3/4"
OMC3384	15"	27"	31 1/2"	18"	39"	27"	16"	16 3/4"
OMC3087	18"	24"	28 1/2"	18"	39"	24"	19"	19 3/4"
OMC3387	18"	27"	31 1/2"	18"	39"	27"	19"	19 3/4"
OMC3090	21"	24"	28 1/2"	18"	39"	24"	22"	22 3/4"
OMC3390	21"	27"	31 1/2"	18"	39"	27"	22"	22 3/4"

Maximum cut-out dimension will allow 1/4" reveal for doors and drawer fronts on modified full overlay and 1" for traditional overlay for trim kit face clearance.



**Oven Microwave Cabinet, 93" or 96" Tall, 24" Deep**

Model	Cubic Feet
OMC3093	45.7
OMC3393	50.0
OMC3096	47.2
OMC3396	51.6

**Modifications**

AUTHB	AUTHL	AUTHR	CBO	CCO	CFNTO	CND	EXB	EXL	EXR	FPEB	FTK	FULL	INTGH	MI	RD	RECTKL	RECTKR	RT	VTK	WDRWPG
•	•	•	•	•	•	•	•	•	•	•	•	•	•	•	•	•	•	•	•	•

**Construction Upgrades**

APF	APU	PEF	PEU
•	•	•	•

- Oven cabinets feature an open back in cut-out area designed to improve field appliance installation.
- Metal appliance support brackets included for 24" deep cabinets.
- Includes adjustable shelves in upper section:  
93" tall - one shelf  
96" tall - two shelves
- Toekick assembly shipped unattached.
- Oven and microwave cavities are standard interior.
- Modified Full overlay styles feature face mount hinges.
- All top and bottom cross rails are 1 1/2" wide.
- All cabinets have 3" stiles on frame.
- Be sure to confirm a heat shield is built into your appliance by the manufacturer or install the heat shield included with your appliance.
- Heat shields are also sold separately as an accessory.

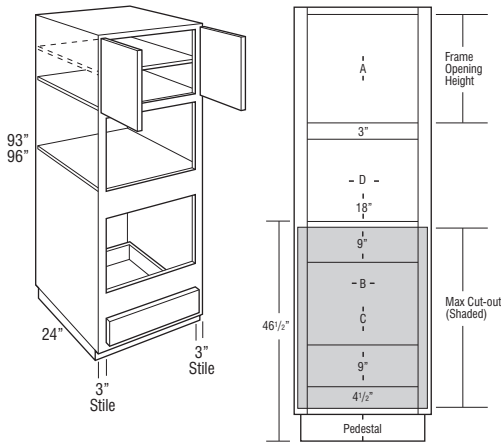

	A Frame Opening Height	B Cut-out Width		C Cut-out Height		D Frame Opening Width	Door Height (Upper Section)	
		Min.	Max.	Min.	Max.		Traditional Overlay	Modified Full Overlay
	OMC3093	24"	24"	28 1/2"	18"	39"	24"	25"
OMC3393	24"	27"	31 1/2"	18"	39"	27"	25"	25 3/4"
OMC3096	27"	24"	28 1/2"	18"	39"	24"	28"	28 3/4"
OMC3396	27"	27"	31 1/2"	18"	39"	27"	28"	28 3/4"

Maximum cut-out dimension will allow 1/4" reveal for doors and drawer fronts on modified full overlay and 1" for traditional overlay for trim kit face clearance.



- Available
- STD Standard on these cabinets

**NOTE:**  
If order is placed in Arch door style, Other Rooms bases will have Square doors.

MODIFICATIONS	
Mod.	Description
AUTHB	Authentic Ends Both
AUTHL	Authentic End Left
AUTHR	Authentic End Right
CBO	Cabinet Box Only
CCO	Cabinet Case Only
CFNTO	Cabinet Front Only
CFP	Cabinet False Panel
CND	Cabinet with No Door, with Drawer
EXB	Extended Stiles Both
EXL	Extended Stile Left
EXR	Extended Stile Right
FD	Full Depth Shelf
FPEB	Furniture Finished Plywood End Panels

CONSTRUCTION UPGRADES	
Mod.	Description
APF	All-plywood Finished
APU	All-plywood Unfinished
PEF	Plywood Ends Finished
PEU	Plywood Ends Unfinished

DECORATIVE DOOR OPTIONS	
Mod.	Description
CG	Cut-for-glass Doors
MD	Mullion Doors
PRMD	Prairie Mullion Doors

## Mudroom Stacked Wall, 69" High, 12" Deep

Model	Cubic Feet
MRSTW18 L or R	11.5
MRSTW21 L or R	13.2
MRSTW24 L or R	15.0
MRSTW30B	18.4
MRSTW36B	21.9

- Includes one adjustable shelf.
- Can be paired with Furniture Drawer Window Bench to create an Entry Ensemble.
- Mudroom hooks (MRHOOK) are available and must be ordered separately.

**Modifications**

AUTHB	AUTHL	AUTHR	CBO	CCO	CFNTO	CFP	CND	EXB	EXL	EXR	FD	FPEB	FTK
			•	•	•			•	•	•	STD	•	
FULL	ID	INTGH	MI	RD	RECTKALL	RECTKBK	RECTKL	RECTKR	RT	VTK	WDRWPG		
•	•	•	STD	•									

**Construction Upgrades**

APF	APU	PEF	PEU
STD			

**Decorative Door Options**

CG	MD	PRMD
•	•	•

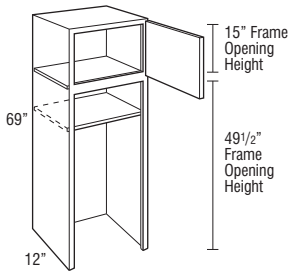

MRSTW18-MRSTW24 L or R

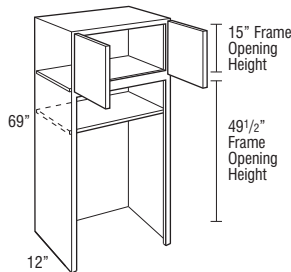

MRSTW30B-MRSTW36B

## Furniture Drawer Window Bench, 18" High, 24" Deep

Model	Cubic Feet
FDWB151824	5.1
FDWB181824	6.0
FDWB211824	6.9
FDWB241824	7.8
FDWB271824	8.7
FDWB301824	9.6
FDWB331824	10.5
FDWB361824	11.4

### Modifications

AUTHB	AUTHL	AUTHR	CBO	CCO	CFNTO	CFP	CND	EXB	EXL	EXR	FD	FPEB	FTK
			•	•	•			•	•	•		•	•

FULL	ID	INTGH	MI	RD	RECTKALL	RECTKBK	RECTKL	RECTKR	RT	VTK	WDRWPG
				•		•	•	•		•	•

### Construction Upgrades

APF	APU	PEF	PEU
•	•	•	•

- Drawer front to face frame reveal is justified to the bottom to be consistent with both full overlay and traditional overlay. Traditional overlay top reveal is 2 5/8" and bottom reveal is 1". Full overlay top reveal is 1 7/8" and bottom reveal is 1/4".

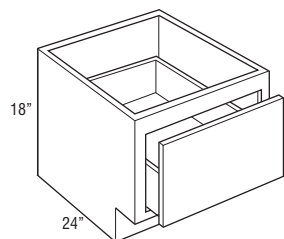

## Laundry Base

Model	Cubic Feet
LB18	11.0
LB21	12.6
LB24	14.3
LB27	15.9
LB30	17.6
LB33	19.2
LB36	20.9

### Modifications

AUTHB	AUTHL	AUTHR	CBO	CCO	CFNTO	CFP	CND	EXB	EXL	EXR	FD	FPEB	FTK
					•			•	•	•	STD	•	•

FULL	ID	INTGH	MI	RD	RECTKALL	RECTKBK	RECTKL	RECTKR	RT	VTK	WDRWPG
				STD	•	•*	•	•		•	

\*RECTKALL available for LB27-LB36.

### Construction Upgrades

APF	APU	PEF	PEU
STD			

- Includes one adjustable full depth shelf.

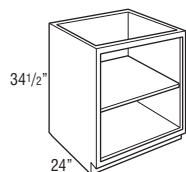

# Laundry Pull-out

Model	Cubic Feet
L15PO	9.3
L21PO	12.6

- L15PO includes one 35 qt. laundry basket.
- L21PO includes two 35 qt. laundry baskets.
- Pull-out uses SoftTouch guides.
- Bottom drawer is dovetailed.

### Modifications

AUTHB	AUTHL	AUTHR	CBO	CCO	CFNTO	CFP	CND	EXB	EXL	EXR	FD	FPEB	FTK
•	•	•	•	•	•			•	•	•		•	•

FULL	ID	INTGH	MI	RD	RECTKALL	RECTKBK	RECTKLL	RECTKR	RT	VTK	WDRWPG
			•			•	•	•		•	STD

### Construction Upgrades

APF	APU	PEF	PEU
•	•	•	•

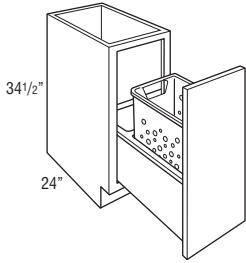

L15PO

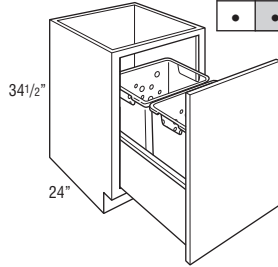

L21PO

## Laundry Utility, 84", 87", or 90" Tall, 24" Deep

Model	Cubic Feet
LU188424	25.9
LU218424	29.8
LU248424	33.6
LU278424	37.5
LU308424	41.4
LU338424	45.3
LU368424	49.2
LU188724	26.8
LU218724	30.8
LU248724	34.8
LU278724	38.8
LU308724	42.9
LU338724	46.9
LU368724	50.9
LU189024	27.7
LU219024	31.8
LU249024	36.0
LU279024	40.1
LU309024	44.3
LU339024	48.4
LU369024	52.6

### Modifications

AUTHB	AUTHL	AUTHR	CBO	CCO	CFNTO	CFP	CND	EXB	EXL	EXR	FD	FPEB	FTK
					•			•	•	•	STD	•	•

FULL	ID	INTGH	MI	RD	RECTKALL	RECTKBR	RECTKRL	RECTKR	RT	VTK	WDRWPG
			STD	•			•	•		•	

### Construction Upgrades

APF	APU	PEF	PEU
STD			

- Include 1 fixed shelf and 4 adjustable shelves.

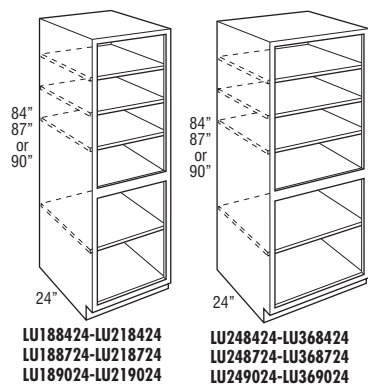

# Laundry Utility, 93" or 96" Tall, 24" Deep

Model	Cubic Feet
LU189324	28.6
LU219324	32.9
LU249324	37.2
LU279324	41.5
LU309324	45.7
LU339324	50.0
LU369324	54.3
LU189624	29.5
LU219624	33.9
LU249624	38.3
LU279624	42.8
LU309624	47.2
LU339624	51.6
LU369624	56.0

### Modifications

AUTHB	AUTHL	AUTHR	CBO	CCO	CFNTO	CFP	CND	EXB	EXL	EXR	FD	FPEB	FTK
					•			•	•	•	STD	•	•

FULL	ID	INTGH	MI	RD	RECTKALL	RECTKBK	RECTKL	RECTKR	RT	VTK	WDRWPG
			STD	•							

### Construction Upgrades

APF	APU	PEF	PEU
STD			

- Include 1 fixed shelf and 4 adjustable shelves.

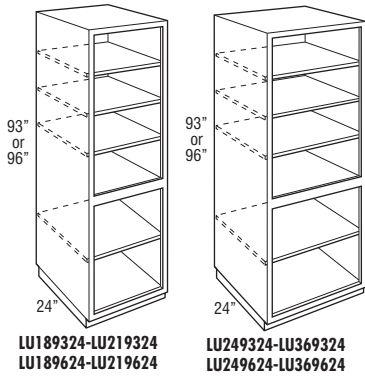

LU189324-LU219324  
LU189624-LU219624

LU249324-LU369324  
LU249624-LU369624

**Desk Height Door Drawer Base, 29" High, 21" Deep**

Model	Cubic Feet
DHB12 L or R	5.7
DHB15 L or R	6.9
DHB18 L or R	8.1
DHB21 L or R	9.3
DHB24B	10.6

**Modifications**

AUTHB	AUTHL	AUTHR	CBO	CCO	CFNTO	CFP	CND	EXB	EXL	EXR	FD	FPEB	FTK
•	•	•	•	•	•	•	•	•	•	•	•	•	•

FULL	ID	INTGH	MI	RD	RECTKALL	RECTKBK	RECTKL	RECTKR	RT	VTK	WDRWPG
•	•	•	•	•	•	•	•	•	•	•	•

**Construction Upgrades**

APF	APU	PEF	PEU
•	•	•	•

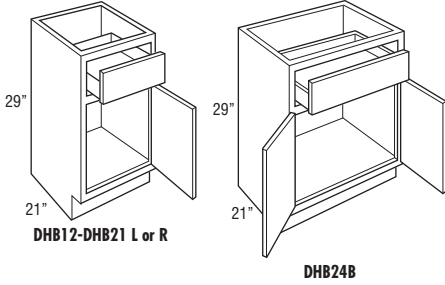

**Desk Height Drawer Base, 29" High, 21" Deep**

Model	Cubic Feet
DHBD12	5.7
DHBD15	6.9
DHBD18	8.1
DHBD21	8.5
DHBD24	9.7

**Modifications**

AUTHB	AUTHL	AUTHR	CBO	CCO	CFNTO	CFP	CND	EXB	EXL	EXR	FD	FPEB	FTK
•	•	•	•	•	•	•	•	•	•	•	•	•	•

FULL	ID	INTGH	MI	RD	RECTKALL	RECTKBK	RECTKL	RECTKR	RT	VTK	WDRWPG
•	•	•	•	•	•	•	•	•	•	•	•

**Construction Upgrades**

APF	APU	PEF	PEU
•	•	•	•

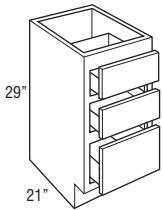

**Desk Height File Drawer Base, 29" High, 21" Deep**

Model	Cubic Feet
DHFD18	8.1

- Door is attached to file drawer.
- File drawer is a solid-wood dovetail drawer that utilizes undermount Softouch guide.

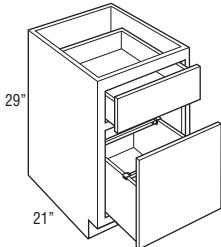

**Modifications**

AUTHB	AUTHL	AUTHR	CBO	CCO	CFNTO	CFP	CND	EXB	EXL	EXR	FD	FPEB	FTK
•	•	•	•	•	•	•	•	•	•	•	•	•	•

FULL	ID	INTGH	MI	RD	RECTKALL	RECTKBK	RECTKL	RECTKR	RT	VTK	WDRWPG
•	•	•	•	•	•	•	•	•	•	•	•*

\*WDRWPG available for top drawer only.

**Construction Upgrades**

APF	APU	PEF	PEU
•	•	•	•

## Under Counter Drawers, 21" Deep

Model	Cubic Feet
UCD2421	2.4
UCD2721	2.6
UCD3021	3.0
UCD3321	3.2
UCD3621	3.4

### Modifications

AUTHB	AUTHL	AUTHR	CBO	CCO	CFNTO	CFP	CND	EXB	EXL	EXR	FD	FPEB	FTK
			•	•	•			•	•	•			

FULL	ID	INTGH	MI	RD	RECTKALL	RECTKBK	RECTKLL	RECTKR	RT	VTK	WDRWPG
	•			•							•

### Construction Upgrades

APF	APU	PEF	PEU
	•		STD

- Cabinet is 4 3/4" high. Drawer box within cabinet is 2" high (outside dimension).
- Not trimmable.
- Drawer front is 3/4" slab front.
- The frame to end panel offset is 3/4", which is designed to accommodate the vanity desk leg.
- Non-matching end panels. Recommended installation between cabinets, panels, and/or walls.
- Plywood sides are unfinished.

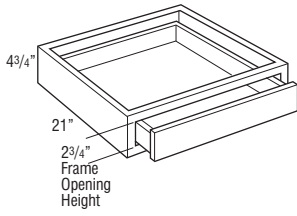

UCD2421-UCD2721

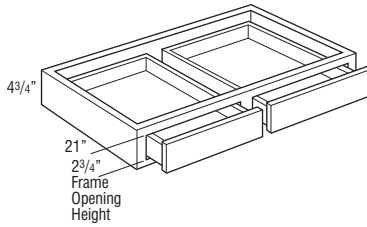

UCD3021-UCD3621



MODEL	CUBIC FEET
<b>Bookcase Unit with Straight Valance</b>	
BU1848SV	8.1
BU2448SV	10.5
BU3048SV	13.0
BU3648SV	15.4
BU1851SV	8.6
BU2451SV	11.2
BU3051SV	13.7
BU3651SV	16.3
BU1854SV	9.1
BU2454SV	11.8
BU3054SV	14.5
BU3654SV	17.2
BU1857SV	9.6
BU2457SV	12.4
BU3057SV	15.3
BU3657SV	18.2
BU1860SV	10.0
BU2460SV	13.1
BU3060SV	16.1
BU3660SV	19.1
BU1866SV	11.0
BU2466SV	14.3
BU3066SV	17.6
BU3666SV	20.9

- 48", 51", and 54" have two adjustable shelves and one fixed shelf.
- Ends, tops, bottoms, and backs are hardwood veneer plywood.
- Face frame has a profiled inside edge.
- Matching interiors.
- 3/4" plywood shelving.
- When ordering Rustic Hickory, Hickory will be substituted.

**Modifications**

AUTHB	AUTHL	AUTHR	CBO	EXB	EXL	EXR	FPEB	ID	MI	RD
•*	•*	•*	STD	•	•	•	•	•	•	•

\*AUTHB, AUTHL, and AUTHR not available on 66" high cabinets.

**Construction Upgrades**

APF
STD

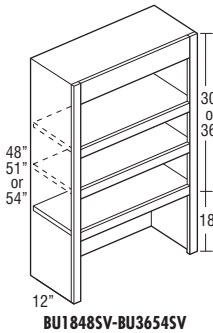

BU1848SV-BU3654SV

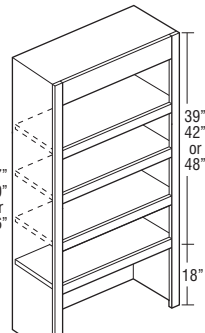

BU1857SV-BU3666SV

MODEL	CUBIC FEET
<b>NEW Tall Bookcase with Straight Valance</b>	
T248412BCVV	18.4
T308412BCVV	22.7
T368412BCVV	26.7
T248712BCVV	18.8
T308712BCVV	23.1
T368712BCVV	27.4
T249012BCVV	19.1
T309012BCVV	23.5
T369012BCVV	28.0

- Four adjustable shelves and one fixed shelf.
- Ends, tops, bottoms, and backs are hardwood veneer plywood.
- Matching interior.
- Face frame has a profiled inside edge.

- Five adjustable shelves and one fixed shelf.
- Ends, tops, bottoms, and backs are hardwood veneer plywood.
- Matching interior.
- Face frame has a profiled inside edge.

**Modifications**

CBO	FPEB	FTK	ID	MI	RD
STD	•	STD	•	STD	•

**Construction Upgrades**

APF
STD

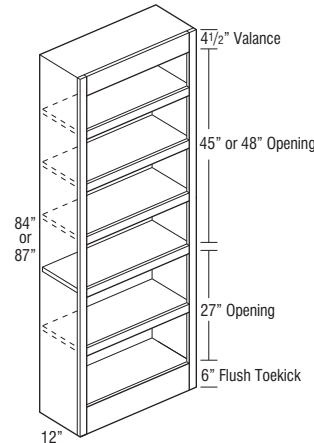

T248412BCVV-T368712BCVV

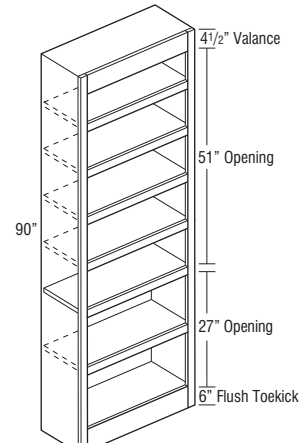

T249012BCVV-T369012BCVV

**MODEL CUBIC FEET**

**NEW Tall Bookcase with Straight Valance, continued**

<b>T249312BCVV</b>	<b>20.4</b>
<b>T309312BCVV</b>	<b>25.0</b>
<b>T369312BCVV</b>	<b>29.2</b>

- Five adjustable shelves and one fixed shelf.
- Ends, tops, bottoms, and backs are hardwood veneer plywood.
- Separate pedestal base included but shipped separately on 93" Tall.
- Matching interior.
- Face frame has a profiled inside edge.

<b>T249612BCVV</b>	<b>19.7</b>
<b>T309612BCVV</b>	<b>24.3</b>
<b>T369612BCVV</b>	<b>28.9</b>

- Six adjustable shelves and one fixed shelf.
- Ends, tops, bottoms, and backs are hardwood veneer plywood.
- Separate pedestal base included but shipped separately on 96" Tall.
- Matching interior.
- Face frame has a profiled inside edge.

**Modifications**

CBO	FPEB	ID	MI	RD
STD	•	•	STD	•

**Construction Upgrades**

APF
STD

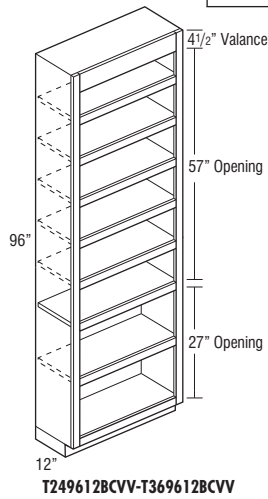
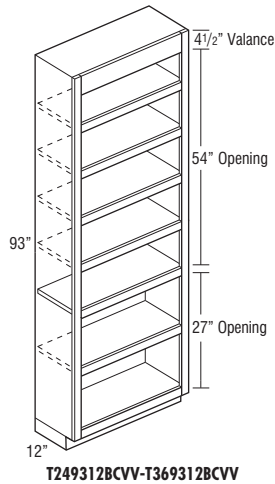

VANITY CABINET NOMENCLATURE

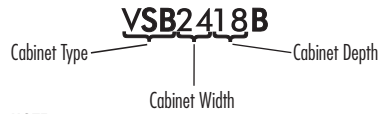

**NOTE:**

If order is placed in Arch door style, vanity bases will have Square doors and vanity utilities and linen closets will have an Arch top door and Square lower doors.

All vanity cabinets are predrilled for full depth shelves or roll trays. Shelves and roll trays must be ordered separately unless noted.

MODIFICATIONS			
Mod.	Description	Mod.	Description
AUTHB	Authentic Ends Both	FPEB	Furniture Finished Plywood End Panels
AUTHL	Authentic End Left	FTK	Flush Toekick
AUTHR	Authentic End Right	FULL	Full Overlay
CBO	Cabinet Box Only	ID	Increased Depth
CCO	Cabinet Case Only	INTGH	Integrated SoftTouch Hinge
CFNTO	Cabinet Front Only	MI	Matching Interior
CFP	Cabinet False Panel	RD	Reduced Depth
CND	Cabinet with No Door, with Drawer	RECTKBK	Recessed Toekick Back
		RECTKL	Recessed Toekick Left
EXB	Extended Shile Both	RECTKR	Recessed Toekick Right
EXL	Extended Shile Left	RT	Roll Tray
EXR	Extended Shile Right	VTK	Void Toekick
		WDRWPG	Wood Dovetail Drawer w/SoftTouch Guide

CONSTRUCTION UPGRADES	
Mod.	Description
APF	All-plywood Finished
APU	All-plywood Unfinished
PEF	Plywood Ends Finished
PEU	Plywood Ends Unfinished

MODIFICATIONS GRID KEY	
•	Available
STD	Standard on these cabinets

**Vanity Sink Base with False Panel, 32" High, 18" or 21" Deep**

Model	Cubic Feet
VSB2418B	10.1
VSB2718B	11.2
VSB3018B	12.4
VSB3318B	13.7
VSB3618B	14.7
VSB24B	11.6
VSB27B	12.9
VSB30B	14.3
VSB33B	15.6
VSB36B	16.9

**Modifications**

AUTHB	AUTHL	AUTHR	CBO	CCO	CFNTO	CFP	CND	EXB	EXL	EXR	FPEB	FTK	FULL	ID	INTGH	MI	RD	RECTKBK	RECTKL	RECTKR	RT	VTK	WDRWPG
•	•	•	•	•	•	STD	•	•	•	•	•	•	•	•*	•	•	•	•	•	•	•	•	•

\*ID available only on 21" deep vanities.

**Construction Upgrades**

APF	APU	PEF	PEU
•	•	•	•

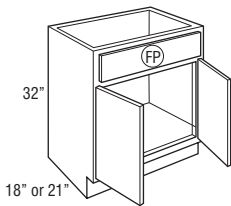

**Vanity Sink Base with False Panels, 32" High, 18" or 21" Deep**

Model	Cubic Feet
VSB3918	15.9
VSB4218	17.1
VSB4518	18.2
VSB4818	19.4
VSB39	18.3
VSB42	19.6
VSB45	21.0
VSB48	22.3
VSB5418	21.7
VSB5718	22.9
VSB6018	24.0
VSB54	25.0
VSB57	26.3
VSB60	27.6

**Modifications**

AUTHB	AUTHL	AUTHR	CBO	CCO	CFNTO	CFP	CND	EXB	EXL	EXR	FPEB	FTK	FULL	ID	INTGH	MI	RD	RECTKBK	RECTKL	RECTKR	RT	VTK	WDRWPG
•	•	•		•	•		STD	•	•	•	•	•		•*	•	•		•	•	•	•	•	

\*ID available only on 21" deep vanities.

**Construction Upgrades**

APF	APU	PEF	PEU
•	•	•	•

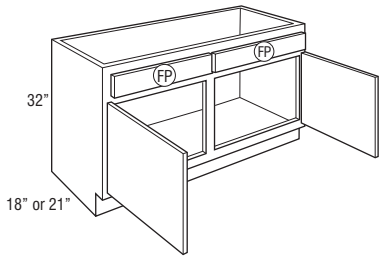

VSB3918-VSB4818  
VSB39-VSB48

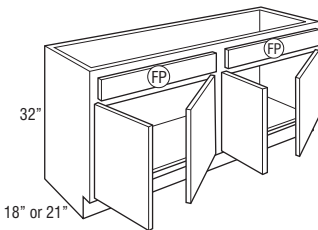

VSB5418-VSB6018  
VSB54-VSB60

**Vanity Sink Base with Full Height Doors, 32" High, 18" or 21" Deep**

Model	Cubic Feet
VSB6018FH	23.7
VSB60FH	27.6

**Modifications**

AUTHB	AUTHL	AUTHR	CBO	CCO	CFNTO	CFP	CND	EXB	EXL	EXR	FPEB	FTK	FULL	ID	INTGH	MI	RD	RECTKBK	RECTKL	RECTKR	RT	VTK	WDRWPG
•	•	•		•	•			•	•	•	•	•		•*	•	•		•	•	•	•	•	

\*ID available only on 21" deep vanities.

**Construction Upgrades**

APF	APU	PEF	PEU
•	•	•	•

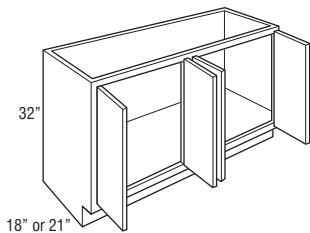

**Vanity Sink Base with False Panel, 34 1/2" High, 21" Deep**

Model	Cubic Feet
VSB24BBH	12.6
VSB27BBH	14.1
VSB30BBH	15.5
VSB33BBH	17.0
VSB36BBH	18.5

**Modifications**

AUTHB	AUTHL	AUTHR	CBO	CCO	CFNTO	CFP	CND	EXB	EXL	EXR	FPEB	FTK	FULL	ID	INTGH	MI	RD	RECTKBK	RECTKL	RECTKR	RT	VTK	WDRWPG
•	•	•			•	•	STD	•	•	•	•	•		•	•	•	•	•	•	•	•	•	

**Construction Upgrades**

APF	APU	PEF	PEU
•	•	•	•

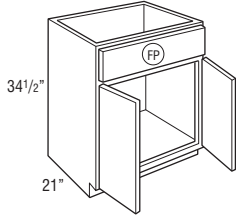

**Vanity Sink Base with False Panels, 34 1/2" High, 21" Deep**

Model	Cubic Feet
VSB39BH	19.9
VSB42BH	21.4
VSB45BH	22.8
VSB48BH	24.3
VSB54BH	27.2
VSB57BH	28.7
VSB60BH	30.1

**Modifications**

AUTHB	AUTHL	AUTHR	CBO	CCO	CFNTO	CFP	CND	EXB	EXL	EXR	FPEB	FTK	FULL	ID	INTGH	MI	RD	RECTKBK	RECTKL	RECTKR	RT	VTK	WDRWPG
•	•	•			•	•	STD	•	•	•	•	•		•	•	•	•	•	•	•	•	•	

**Construction Upgrades**

APF	APU	PEF	PEU
•	•	•	•

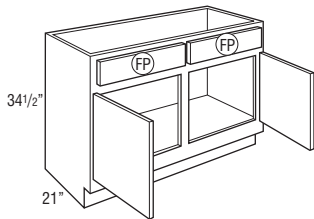

VSB39BH-VSB48BH

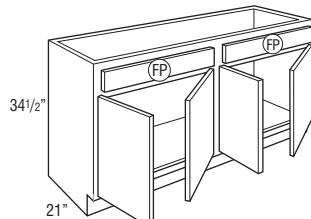

VSB54BH-VSB60BH

**Vanity Sink Base with Full Height Doors, 34 1/2" High, 21" Deep**

Model	Cubic Feet
VSB60FHBH	30.1

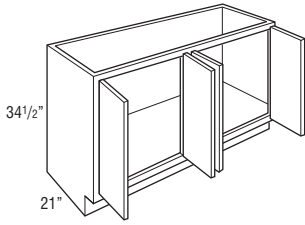

**Modifications**

AUTHB	AUTHL	AUTHR	CBO	CCO	CFNTO	CFP	CND	EXB	EXL	EXR	FPEB	FTK	FULL	ID	INTGH	MI	RD	RECTKBK	RECTKL	RECTKR	RT	VTK	WDRWPG
•	•	•			•	•				•	•	•	•		•	•	•	•	•	•	•	•	

**Construction Upgrades**

APF	APU	PEF	PEU
•	•	•	•

**Vanity Base, Single Door with Drawer, 32" High, 21" Deep**

Model	Cubic Feet
VB12 L or R	6.2
VB15 L or R	7.6
VB18 L or R	8.9
VB21 L or R	10.4
VB24 L or R	11.6

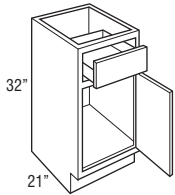

**Modifications**

AUTHB	AUTHL	AUTHR	CBO	CCO	CFNTO	CFP	CND	EXB	EXL	EXR	FPEB	FTK	FULL	ID	INTGH	MI	RD	RECTKBK	RECTKL	RECTKR	RT	VTK	WDRWPG
•	•	•	•	•	•	•	•	•	•	•	•	•		•	•	•	•	•	•	•	•*	•	•

**Construction Upgrades**

APF	APU	PEF	PEU
•	•	•	•

**Vanity Base, Double Door with Drawer, 32" High, 21" Deep**

Model	Cubic Feet
VB24B	11.6

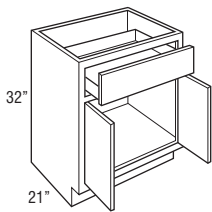

**Modifications**

AUTHB	AUTHL	AUTHR	CBO	CCO	CFNTO	CFP	CND	EXB	EXL	EXR	FPEB	FTK	FULL	ID	INTGH	MI	RD	RECTKBK	RECTKL	RECTKR	RT	VTK	WDRWPG
•	•	•	•	•	•	•	•	•	•	•	•	•		•	•	•	•	•	•	•	•	•	•

**Construction Upgrades**

APF	APU	PEF	PEU
•	•	•	•

### Vanity Base, Single Door with Drawer, 34 1/2" High, 21" Deep

Model	Cubic Feet
VB12BH L or R	6.8
VB15BH L or R	8.3
VB18BH L or R	9.7
VB21BH L or R	11.2
VB24BH L or R	12.6

#### Modifications

AUTHB	AUTHL	AUTHR	CBO	CCO	CFNTO	CFP	CND	EXB	EXL	EXR	FPEB	FTK	FULL	ID	INTGH	MI	RD	RECTKBK	RECTKL	RECTKR	RT	VTK	WDRWPG
•	•	•	•	•	•	•	•	•	•	•	•	•	•	•	•	•	•	•	•	•	•	•	•

#### Construction Upgrades

APF	APU	PEF	PEU
•	•	•	•

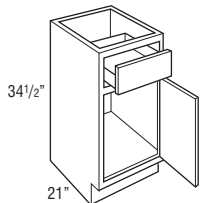

### Vanity Base, Double Door with Drawer, 34 1/2" High, 21" Deep

Model	Cubic Feet
VB24BBH	12.6

#### Modifications

AUTHB	AUTHL	AUTHR	CBO	CCO	CFNTO	CFP	CND	EXB	EXL	EXR	FPEB	FTK	FULL	ID	INTGH	MI	RD	RECTKBK	RECTKL	RECTKR	RT	VTK	WDRWPG
•	•	•	•	•	•	•	•	•	•	•	•	•	•	•	•	•	•	•	•	•	•	•	•

#### Construction Upgrades

APF	APU	PEF	PEU
•	•	•	•

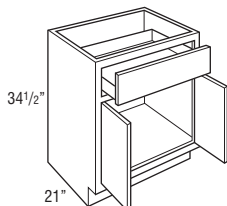

**Vanity Three Drawer Base, 32" High, 21" Deep**

Model	Cubic Feet
VBD12	6.2
VBD15	7.6
VBD18	8.9
VBD21	10.4
VBD24	11.6
VBD27	12.9
VBD30	14.3
VBD33	15.6
VBD36	16.9

**Modifications**

AUTHB	AUTHL	AUTHR	CBO	CCO	CFNTO	CFP	CND	EXB	EXL	EXR	FPEB	FTK	FULL	ID	INTGH	MI	RD	RECTKBK	RECTKL	RECTKR	RT	VTK	WDRWPG
•	•	•	•	•	•	•	•	•	•	•	•	•	•	•	•	•	•	•	•	•	•	•	•

**Construction Upgrades**

APF	APU	PEF	PEU
•	•	•	•

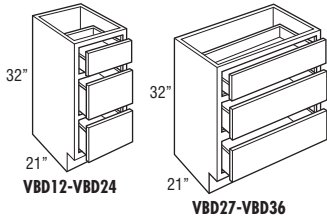

**Vanity Three Drawer Base, 34 1/2" High, 21" Deep**

Model	Cubic Feet
VBD12BH	6.8
VBD15BH	8.3
VBD18BH	9.7
VBD21BH	11.2
VBD24BH	12.6
VBD27BH	14.1
VBD30BH	15.5
VBD33BH	17.0
VBD36BH	18.5

**Modifications**

AUTHB	AUTHL	AUTHR	CBO	CCO	CFNTO	CFP	CND	EXB	EXL	EXR	FPEB	FTK	FULL	ID	INTGH	MI	RD	RECTKBK	RECTKL	RECTKR	RT	VTK	WDRWPG
•	•	•	•	•	•	•	•	•	•	•	•	•	•	•	•	•	•	•	•	•	•	•	•

**Construction Upgrades**

APF	APU	PEF	PEU
•	•	•	•

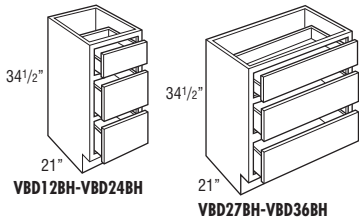



### Vanity Four Drawer Base, 34 1/2" High, 21" Deep

Model	Cubic Feet
4VBD12BH	6.8
4VBD15BH	8.3
4VBD18BH	9.7
4VBD21BH	11.2
4VBD24BH	12.6

#### Modifications

AUTHB	AUTHL	AUTHR	CBO	CCO	CFNTO	CFP	CND	EXB	EXL	EXR	FPEB	FTK	FULL	ID	INTGH	MI	RD	RECTKBK	RECTKL	RECTKR	RT	VTK	WDRWPG
•	•	•	•	•	•	•	•	•	•	•	•	•	•	•	•	•	•	•	•	•	•	•	•

#### Construction Upgrades

APF	APU	PEF	PEU
•	•	•	•

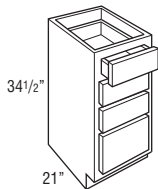

### Vanity Bowl Base, 32" High, 21" Deep

Model	Cubic Feet
VBB36B	16.9
VBB39	18.3
VBB42	19.6
VBB45	21.0
VBB48	22.3
VBB54	25.0
VBB57/60 	27.6

#### Modifications

AUTHB	AUTHL	AUTHR	CBO	CCO	CFNTO	CFP	CND	EXB	EXL	EXR	FPEB	FTK	FULL	ID	INTGH	MI	RD	RECTKBK	RECTKL	RECTKR	RT	VTK	WDRWPG
•*	•*	•*	•	•	•	•	•	•	•	•	•	•	•	•	•	•	•	•	•	•	•	•	•

\*AUTHB, AUTHL, and AUTHR not available on VBB57/60.

#### Construction Upgrades

APF	APU	PEF	PEU
•	•	•	•

Cabinet	Sink Opening (Width)	Space Available for Plumbing
VBB36B	21"	18 7/8"
VBB39	21"	18 7/8"
VBB42	21"	18 7/8"
VBB45	21"	18 7/8"
VBB48	21"	18 7/8"
VBB54	27"	24 7/8"
VBB57/60	30"	27 7/8"

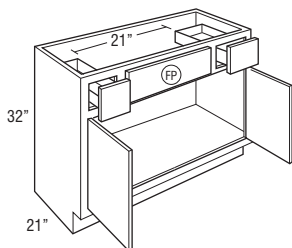

VBB36B

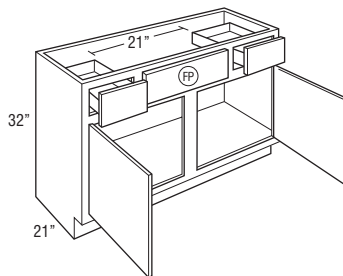

VBB39-VBB48

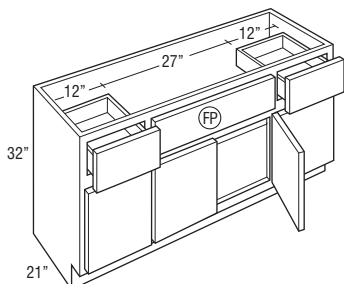

VBB54

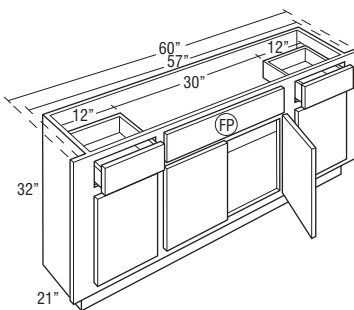

VBB57/60

**Vanity Bowl Base, 34 1/2" High, 21" Deep**

Model	Cubic Feet
VBB36BBH	18.5
VBB39BH	19.9
VBB42BH	21.4
VBB45BH	22.8
VBB48BH	24.3
VBB54BH	27.2
VBB57/60BH 	27.2

**Modifications**

AUTHB	AUTHL	AUTHR	CBO	CCO	CFNTO	CFP	CND	EXB	EXL	EXR	FPEB	FTK	FULL	ID	INTGH	MI	RD	RECTKBK	RECTKL	RECTKR	RT	VTK	WDRWPG
•*	•*	•*	•	•	•	•	•	•	•	•	•	•	•	•	•	•	•	•	•	•	•	•	•

\*AUTHB, AUTHL, and AUTHR not available on VBB57/60BH.

**Construction Upgrades**

APF	APU	PEF	PEU
•	•	•	•

Cabinet	Sink Opening (Width)	Space Available for Plumbing
VBB36BBH	21"	18 7/8"
VBB39BH	21"	18 7/8"
VBB42BH	21"	18 7/8"
VBB45BH	21"	18 7/8"
VBB48BH	21"	18 7/8"
VBB54BH	27"	24 7/8"
VBB57/60BH	30"	27 7/8"

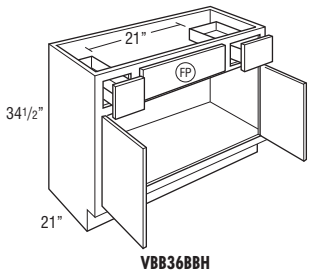

VBB36BBH

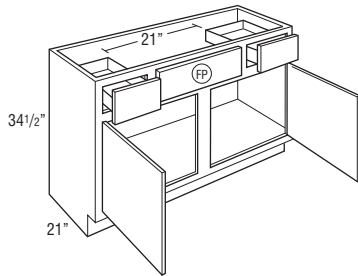

VBB39BH-VBB48BH

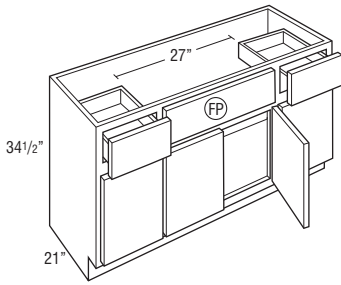

VBB54BH

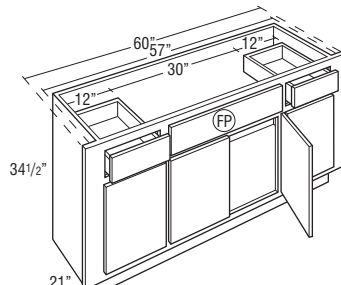

VBB57/60BH

**Vanity Bowl Base with False Panel, 32" High, 21" Deep**

Model	Cubic Feet
VB30D L or R	14.3
VB36D L or R	16.9

• L or R indicates drawer location.

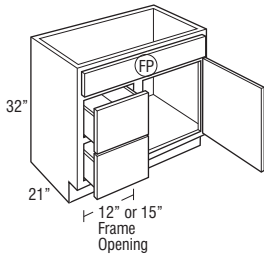

**Modifications**

AUTHB	AUTHL	AUTHR	CBO	CCO	CFNTO	CFP	CND	EXB	EXL	EXR	FPEB	FTK	FULL	ID	INTGH	MI	RD	RECTKBK	RECTKL	RECTKR	RT	VTK	WDRWPG
•	•	•	•	•	•	STD	•	•	•	•	•	•	•	•	•	•	•	•	•	•	•	•	•

**Construction Upgrades**

APF	APU	PEF	PEU
•	•	•	•

Cabinet	Sink Opening (Width)	Space Available for Plumbing
VB30D	28 1/2"	15 7/8"
VB36D	34 1/2"	18 7/8"

### Vanity Bowl Base with False Panel, 32" High, 21" Deep

Model	Cubic Feet
VBB24D L or R	11.6
VBB27D L or R	12.9
VBB30D L or R	14.3
VBB33D L or R	15.6

VBB36D L or R	16.9
---------------	------

VBB39D L or R	18.3
---------------	------

• L or R indicates drawer location.

#### Modifications

AUTHB	AUTHL	AUTHR	CBO	CCO	CFNTO	CFP	CND	EXB	EXL	EXR	FPEB	FTK	FULL	ID	INTGH	MI	RD	RECTKBK	RECTKL	RECTKR	RT	VTK	WDRWPG
•	•	•	•	•	•	•	•	•	•	•	•	•	•	•	•	•	•	•	•	•	•	•	•

#### Construction Upgrades

APF	APU	PEF	PEU
•	•	•	•

Cabinet	Sink Opening (Width)	Space Available for Plumbing
VBB24D	22 1/2"	12 7/8"
VBB27D	25 1/2"	15 7/8"
VBB30D	28 1/2"	18 7/8"
VBB33D	31 1/2"	21 7/8"
VBB36D	34 1/2"	24 7/8"
VBB39D	27 3/4"	27 7/8"

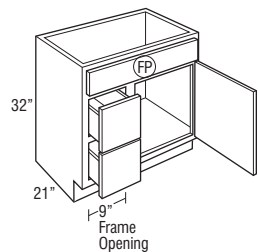

VBB24D-VBB33D L or R

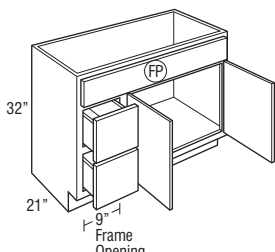

VBB36D L or R

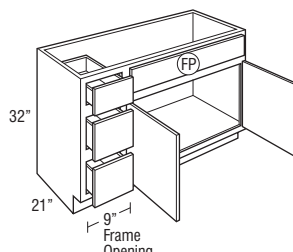

VBB39D L or R

### Vanity Bowl Base with False Panel, 32" High, 21" Deep

Model	Cubic Feet
VBB42D L or R	19.6
VBB45D L or R	21.0

• Specify L or R door swing.

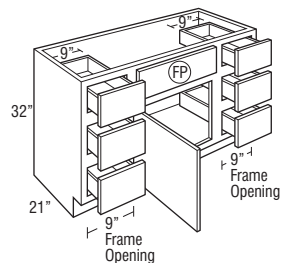

#### Modifications

AUTHB	AUTHL	AUTHR	CBO	CCO	CFNTO	CFP	CND	EXB	EXL	EXR	FPEB	FTK	FULL	ID	INTGH	MI	RD	RECTKBK	RECTKL	RECTKR	RT	VTK	WDRWPG
•	•	•	•	•	•	•	•	•	•	•	•	•	•	•	•	•	•	•	•	•	•	•	•

#### Construction Upgrades

APF	APU	PEF	PEU
•	•	•	•

Cabinet	Sink Opening (Width)	Space Available for Plumbing
VBB42D	21"	18 7/8"
VBB45D	24"	21 7/8"

### Vanity Bowl Base with False Panel, 34 1/2" High, 21" Deep

Model	Cubic Feet
VB30DLBH/DRBH	15.5
VB36DLBH/DRBH	18.5

• L or R indicates drawer location.

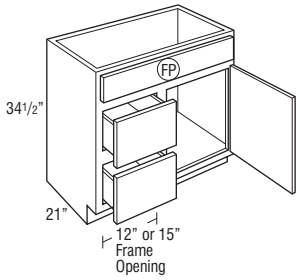

#### Modifications

AUTHB	AUTHL	AUTHR	CBO	CCO	CFNTD	CFP	CND	EXB	EXL	EXR	FPEB	FTK	FULL	ID	INTGH	MI	RD	RECTKBK	RECTKL	RECTKR	RT	VTK	WDRWPG
•	•	•	•	•	•	STD	•	•	•	•	•	•	•	•	•	•	•	•	•	•	•	•	•

#### Construction Upgrades

APF	APU	PEF	PEU
•	•	•	•

Cabinet	Sink Opening (Width)	Space Available for Plumbing
VB30D_BH	28 1/2"	15 7/8"
VB36D_BH	34 1/2"	18 7/8"

164

VANITY CABINETS

### Vanity Bowl Base with False Panel, 34 1/2" High, 21" Deep

Model	Cubic Feet
VBB24DLBH/DRBH	12.6
VBB27DLBH/DRBH	14.1
VBB30DLBH/DRBH	15.5
VBB33DLBH/DRBH	17.0
VBB36DLBH/DRBH	18.5
VBB39DLBH/DRBH	19.9

• L or R indicates drawer location.

#### Modifications

AUTHB	AUTHL	AUTHR	CBO	CCO	CFNTD	CFP	CND	EXB	EXL	EXR	FPEB	FTK	FULL	ID	INTGH	MI	RD	RECTKBK	RECTKL	RECTKR	RT	VTK	WDRWPG
•	•	•	•	•	•	STD	•	•	•	•	•	•	•	•	•	•	•	•	•	•	•	•	•

#### Construction Upgrades

APF	APU	PEF	PEU
•	•	•	•

Cabinet	Sink Opening (Width)	Space Available for Plumbing
VBB24D_BH	22 1/2"	12 7/8"
VBB27D_BH	25 1/2"	15 7/8"
VBB30D_BH	28 1/2"	18 7/8"
VBB33D_BH	31 1/2"	21 7/8"
VBB36D_BH	34 1/2"	24 7/8"
VBB39D_BH	27 3/4"	27 7/8"

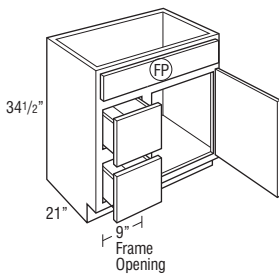

VBB24D\_BH-VBB33D\_BH

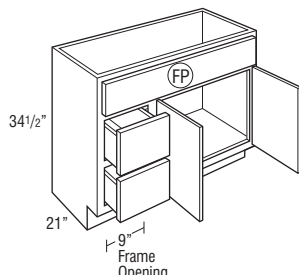

VBB36D\_BH

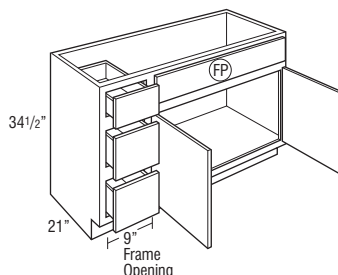

VBB39D\_BH

### Vanity Bowl Base with False Panel, 34 1/2" High, 21" Deep

Model	Cubic Feet
VBB42DBH L or R	21.4
VBB45DBH L or R	22.8

- Specify L or R door swing.

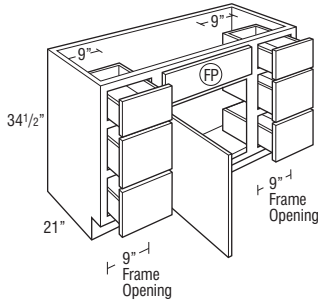

#### Modifications

AUTHB	AUTHL	AUTHR	CBO	CCO	CFNTO	CFP	CND	EXB	EXL	EXR	FPEB	FTK	FULL	ID	INTGH	MI	RD	RECTKBK	RECTKL	RECTKR	RT	VTK	WDRWPG
•	•	•	•	•	•	•	•	•	•	•	•	•	•	•	•	•	•	•	•	•	•	•	•

#### Construction Upgrades

APF	APU	PEF	PEU
•	•	•	•

Cabinet	Sink Opening (Width)	Space Available for Plumbing
VBB42DBH	21"	18 7/8"
VBB45DBH	24"	21 7/8"

### Vanity Bowl Base with Six Drawers & False Panel, 32" High, 21" Deep

Model	Cubic Feet
VBB48D	22.5
VBB54D	25.0
VBB57D	26.3
VBB60D	27.6

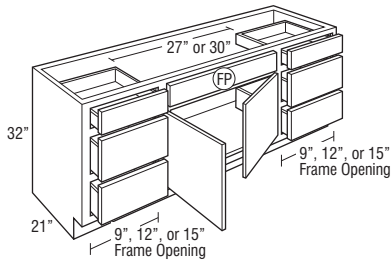

#### Modifications

AUTHB	AUTHL	AUTHR	CBO	CCO	CFNTO	CFP	CND	EXB	EXL	EXR	FPEB	FTK	FULL	ID	INTGH	MI	RD	RECTKBK	RECTKL	RECTKR	RT	VTK	WDRWPG
•	•	•	•	•	•	•	•	•	•	•	•	•	•	•	•	•	•	•	•	•	•	•	•

#### Construction Upgrades

APF	APU	PEF	PEU
•	•	•	•

Cabinet	Drawer Frame Opening (Width)	Sink Opening (Width)	Space Available for Plumbing
VBB48D	9"	27"	24 7/8"
VBB54D	12"	27"	24 7/8"
VBB57D	12"	30"	27 7/8"
VBB60D	15"	27"	30 7/8"

**Vanity Bowl Base with Six Drawers & False Panel, 34 1/2" High, 21" Deep**

Model	Cubic Feet
VBB48DBH	24.3
VBB54DBH	27.2
VBB57DBH	28.7
VBB60DBH	30.1

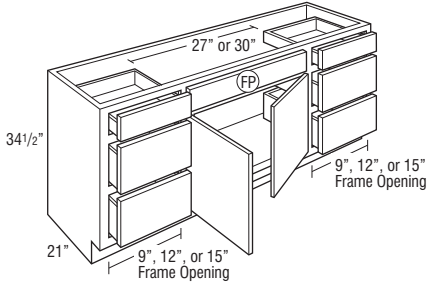

**Modifications**

AUTHB	AUTHL	AUTHR	CBO	CCO	CFNTO	CFP	CND	EXB	EXL	EXR	FPEB	FTK	FULL	ID	INTGH	MI	RD	RECTKBK	RECTKL	RECTKR	RT	VTK	WDRWPG
•	•	•	•	•	•	•	•	•	•	•	•	•	•	•	•	•	•	•	•	•	•	•	•

**Construction Upgrades**

APF	APU	PEF	PEU
•	•	•	•

Cabinet	Drawer Frame Opening (Width)	Sink Opening (Width)	Space Available for Plumbing
VBB48DBH	9"	27"	24 7/8"
VBB54DBH	12"	27"	24 7/8"
VBB57DBH	12"	30"	27 7/8"
VBB60DBH	15"	27"	30 7/8"

**Vanity Drawer Base, 32" High, 21" Deep**

Model	Cubic Feet
VDB54	25.0
VDB57	26.3
VDB603D	27.6

- Specify L or R door swing.

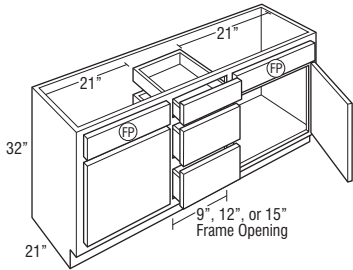

**Modifications**

AUTHB	AUTHL	AUTHR	CBO	CCO	CFNTO	CFP	CND	EXB	EXL	EXR	FPEB	FTK	FULL	ID	INTGH	MI	RD	RECTKBK	RECTKL	RECTKR	RT	VTK	WDRWPG
•	•	•	•	•	•	•	•	•	•	•	•	•	•	•	•	•	•	•	•	•	•	•	•

**Construction Upgrades**

APF	APU	PEF	PEU
•	•	•	•

Cabinet	Sink Opening (Width)	Space Available for Plumbing
VDB54	21"	18 7/8"
VDB57	21"	18 7/8"
VDB603D	21"	18 7/8"

## Vanity Drawer Base, 34 1/2" High, 21" Deep

Model	Cubic Feet
VDB54BH	27.2
VDB57BH	28.7
VDB603DBH 	30.1

- Specify L or R door swing.

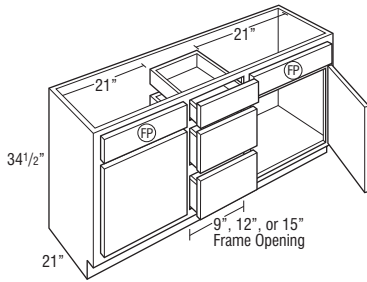

### Modifications

AUTHB	AUTHL	AUTHR	CBO	CCO	CFNTO	CFP	CND	EXB	EXL	EXR	FPEB	FTK	FULL	ID	INTGH	MI	RD	RECTKBK	RECTKL	RECTKR	RT	VTK	WDRWPG
•	•	•	•	•	•	•	•	•	•	•	•	•	•	•	•	•	•	•	•	•	•	•	•

### Construction Upgrades

APF	APU	PEF	PEU
•	•	•	•

Cabinet	Sink Opening (Width)	Space Available for Plumbing
VDB54BH	21"	18 7/8"
VDB57BH	21"	18 7/8"
VDB603DBH	21"	18 7/8"

## Linen Utility with Hamper, 84" Tall, 21" Deep

Model	Cubic Feet
L188421 L or R	22.9

- Designed to be used with 32" high vanities.
- If ordered in Arch door style, top door will be arch and bottom door will be square.
- Mitered styles in upper section use 2 doors that are pinned together and operate as a single door.
- Hamper size is 14 3/4" wide x 14 1/4" high x 19" deep.
- Hamper basket only available in 21" depth.
- Basket is white epoxy coated wire.

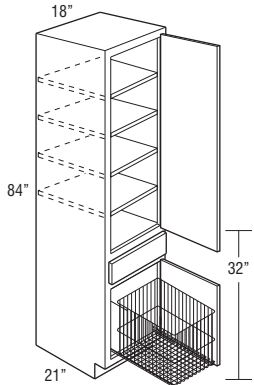

### Modifications

AUTHB	AUTHL	AUTHR	CBO	CCO	CFNTO	CFP	CND	EXB	EXL	EXR	FPEB	FTK	FULL	ID	INTGH	MI	RD	RECTKBK	RECTKL	RECTKR	RT	VTK	WDRWPG
			•	•	•			•	•	•	•	•	•	•	•	•	•	•	•	•	•	•	•

### Construction Upgrades

APF	APU	PEF	PEU
•	•	•	•

**Linen Utility with Hamper, 84" Tall, 21" Deep**

Model	Cubic Feet
L188421BH L or R	22.9

- Designed to be used with 34 1/2" high vanities.
- If ordered in Arch door style, top door will be arch and bottom door will be square.
- Mitered styles in upper section use 2 doors that are pinned together and operate as a single door.
- Hamper size is 14 3/4" wide x 14 1/4" high x 19" deep.
- Hamper basket only available in 21" depth.
- Basket is white epoxy coated wire.

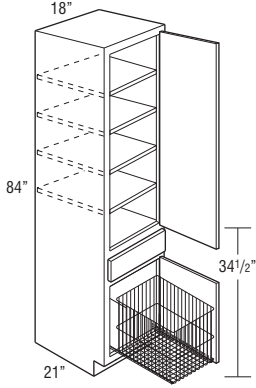

**Modifications**

AUTHB	AUTHL	AUTHR	CBO	CCO	CFNTO	CFP	CND	EXB	EXL	EXR	FPEB	FTK	FULL	ID	INTGH	MI	RD	RECTKBK	RECTKL	RECTKR	RT	VTK	WDRWPG
			•	•	•			•	•	•	•	•	•	•	•	•	•	•	•	•	•	•	•

**Construction Upgrades**

APF	APU	PEF	PEU
•	•	•	•

**Linen Storage Cabinet**

Model	Cubic Feet
LT188421 L or R	22.9
LT188421BH L or R	22.9

- LT188421 designed to be used with 32" high vanities.
- LT188421BH designed to be used with 34 1/2" high vanities.
- Mitered styles in upper section use 2 doors that are pinned together and operate as a single door.
- If ordered in Arch door style, top door will be arch and bottom door will be square.

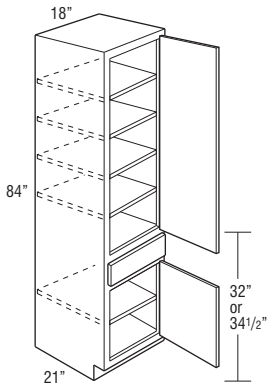

**Modifications**

AUTHB	AUTHL	AUTHR	CBO	CCO	CFNTO	CFP	CND	EXB	EXL	EXR	FPEB	FTK	FULL	ID	INTGH	MI	RD	RECTKBK	RECTKL	RECTKR	RT	VTK	WDRWPG
			•	•	•			•	•	•	•	•	•	•	•	•	•	•	•	•	•	•	•

**Construction Upgrades**

APF	APU	PEF	PEU
•	•	•	•



**NEW** Vanity Wall, 30" High, 6" Deep

Model	Cubic Feet
W24306B	4.0

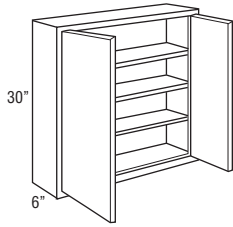

**Modifications**

AUTHB	AUTHL	AUTHR	CBO	CCO	CFNTO	CFP	CND	EXB	EXL	EXR	FPEB	FTK	FULL	ID	INTGH	MI	RD	RECTKBK	RECTKL	RECTKR	RT	VTK	WDRWPG
			•	•				•	•	•			•		•								

**Construction Upgrades**

APF	APU	PEF	PEU
•		•	

**Wall Boutique**

Model	Cubic Feet
WB2730B	5.9
WB2730TB	0.2

- Includes 1 adjustable shelf.
- Cabinet has butt doors, no center stile.
- Cabinet opening matches cabinet exterior.
- WB2730TB: Finished panels that mount to top and bottom of WB2730B to give a finished appearance.

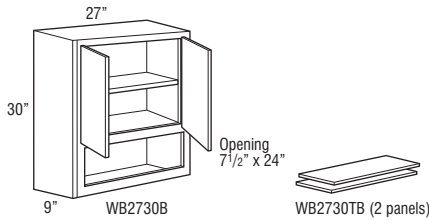

**Modifications**

AUTHB	AUTHL	AUTHR	CBO	CCO	CFNTO	CFP	CND	EXB	EXL	EXR	FPEB	FTK	FULL	ID	INTGH	MI	RD	RECTKBK	RECTKL	RECTKR	RT	VTK	WDRWPG
			•*	•	•			•	•	•			•*		•	•*							

\*CBO, FULL, and MI not available on WB2730TB.

**Construction Upgrades**

APF	APU	PEF	PEU
STD†			

†APF is available on WB2730TB, but standard on WB2730B.

**NEW** Single Door Medicine Cabinet

Model	Cubic Feet
MC16	2.5

- Cut-out dimensions are 14 7/16" wide x 25 5/8" high x 4" deep.
- Unit can be surface mounted or recessed.
- Door of cabinet is glass mirror.
- Matching cabinet doors not available.
- Cabinet has wood frame.
- 1/2" plywood ends, tops, and bottoms.
- Finished exterior.
- Natural Maple laminate interior.
- 3/4" laminated plywood shelves.
- Face frame has a profiled inside and outside edge.

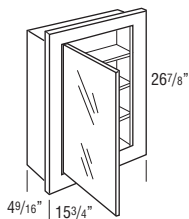

**Modifications**

AUTHB	AUTHL	AUTHR	CBO	CCO	CFNTO	CFP	CND	EXB	EXL	EXR	FPEB	FTK	FULL	ID	INTGH	MI	RD	RECTKBK	RECTKL	RECTKR	RT	VTK	WDRWPG
			•	•																			

**Construction Upgrades**

APF	APU	PEF	PEU
STD			

## Single Door Medicine Cabinet

Model	Cubic Feet
MC1624 L or R	1.6

- MC1624 can be surface or recessed mounted. Cut-out dimensions are 14 3/4" wide x 22 3/4" high x 3 7/8" deep. If ordered in Arch door style, door will be arch. Features a flush top and bottom.

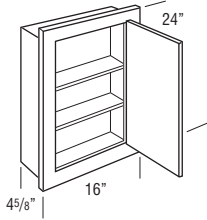

### Modifications

AUTHB	AUTHL	AUTHR	CBO	CCO	CFNTO	CFP	CND	EXB	EXL	EXR	FPEB	FTK	FULL	ID	INTGH	MI	RD	RECTKBK	RECTKL	RECTKR	RT	VTK	WDRWPG	
			•	•	•			•	•	•			•		•									

### Construction Upgrades

APF	APU	PEF	PEU
STD			

170

VANITY CABINETS

## Under Counter Drawers, 21" Deep

Model	Cubic Feet
UCD2421	2.4
UCD2721	2.6
UCD3021	3.0
UCD3321	3.2
UCD3621	3.4

- Cabinet is 4 3/4" high. Drawer box within cabinet is 2" high (outside dimension).
- Not trimmable.
- Drawer front is 3/4" slab front.
- The frame to end panel offset is 3/4", which is designed to accommodate the vanity desk leg.
- Non-matching end panels. Recommended installation between cabinets, panels, and/or walls.
- Plywood sides are unfinished.

### Modifications

AUTHB	AUTHL	AUTHR	CBO	CCO	CFNTO	CFP	CND	EXB	EXL	EXR	FPEB	FTK	FULL	ID	INTGH	MI	RD	RECTKBK	RECTKL	RECTKR	RT	VTK	WDRWPG	
			•	•	•			•	•	•				•										•

### Construction Upgrades

APF	APU	PEF	PEU
	•		
			STD

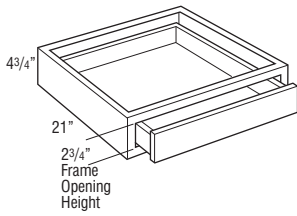

UCD2421-UCD2721

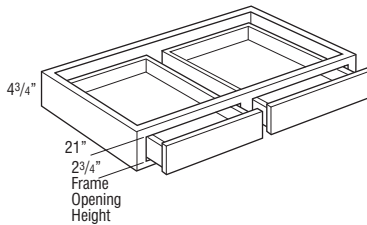

UCD3021-UCD3621



## Vanity Wall Mirror Cabinet, 30" High, 4 9/16" Deep

Model	Cubic Feet
VWM2430 L or R	3.5

- Standard with CG doors and installed mirror glass.
- Unit intended to be surface mounted. Features standard 1/4" face frame reveal on ends.
- Adjustable shelves.

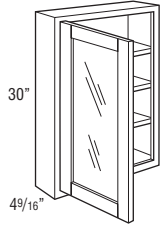

### Modifications

AUTHB	AUTHL	AUTHR	CBO	CCO	CFNTO	CFP	CND	EXB	EXL	EXR	FPEB	FTK	FULL	ID	INTGH	MI	RD	RECTKBK	RECTKL	RECTKR	RT	VTK	WDRWPG	
			•	•				•	•	•			•		•									

### Construction Upgrades

APF	APU	PEF	PEU
•		•	

## Medicine Cabinet

Model	Cubic Feet
TV30	3.5
TV36	4.2
TV48	5.5

- Surface or recessed mount.
- Knobs included with mirror.
- When ordering Rustic Hickory, Hickory will be substituted.

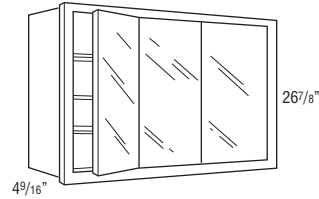

### Modifications

AUTHB	AUTHL	AUTHR	CBO	CCO	CFNTO	CFP	CND	EXB	EXL	EXR	FPEB	FTK	FULL	ID	INTGH	MI	RD	RECTKBK	RECTKL	RECTKR	RT	VTK	WDRWPG	
			•	•												•								

### Construction Upgrades

APF	APU	PEF	PEU
STD			

Model	Cabinet Dimensions			Cut-out Dimensions		
	Width	Height	Depth	Width	Height	Depth
TV30	30"	26 7/8"	4 9/16"	28 11/16"	25 5/8"	4"
TV36	36"	26 7/8"	4 9/16"	34 11/16"	25 5/8"	4"
TV48	48"	26 7/8"	4 9/16"	46 11/16"	25 5/8"	4"

**3" Wide Fillers**

UF3

F333

F336

F339

F342

F384

F387

F390

F393

F396

F396FH **NEW**

F3108FH†

- 3/4" thick.
- Finished on front and all edges (backs are unfinished).
- When ordering Rustic Hickory, Hickory will be substituted.

†F3108FH only available in Maple.

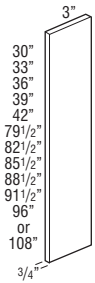

**6" Wide Fillers**

UF6

F633

F636

F639

F642

F684

F687

F690

F693

F696

F696FH **NEW**

F6108FH†

- 3/4" thick.
- Finished on front and all edges (backs are unfinished).
- When ordering Rustic Hickory, Hickory will be substituted.

†F6108FH only available in Maple.

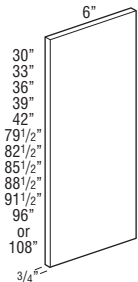

Premium trim items (...P) will be textured laminate. All others, excluding Overlay Fillers and Fillers with Overlays, will match the cabinet box color.

**3" Wide Corner Filler**

CWF330

- 3/4" thick.
- Finished on front and all edges (backs are unfinished).
- When ordering Rustic Hickory, Hickory will be substituted.

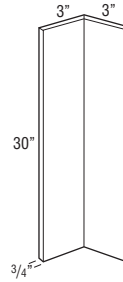

**3" Filler with 2 1/2" Overlay**

UF30VLY (28 3/4"H)

- Finished on front and all edges (backs are not finished).
- 3/4" thick filler, 3/4" thick overlay.
- When Juno is ordered, the overlay will be textured laminate.

**Modifications**

FULL
•



**6" Filler with 5 1/2" Overlay**

UF60VLY (28 3/4"H)

- Finished on front and all edges (backs are not finished).
- 3/4" thick filler, 3/4" thick overlay.
- When Juno is ordered, the overlay will be textured laminate.

**Modifications**

FULL
•

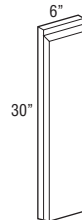

**Overlay Filler, 2 1/2" Wide**

- OL312 (10 3/4"H)
- OL315 (13 3/4"H)
- OL318 (16 3/4"H)
- OL321 (19 3/4"H)
- OL324 (22 3/4"H)
- OL327 (25 3/4"H)
- OL330 (28 3/4"H)
- OL333 (31 3/4"H)
- OL336 (34 3/4"H)
- OL339 (37 3/4"H)
- OL342 (40 3/4"H)
- OL384 (78 1/4"H)
- OL387 (81 1/4"H)
- OL390 (84 1/4"H)
- OL393 (87 1/4"H)
- OL396 (90 1/4"H)

- 3/4" thick.
- Finished on front and all edges (backs are unfinished).
- When Juno is ordered, the overlay will be textured laminate.

**Modifications**

FULL
•



Model	Traditional Overlay Height	Full Overlay Height	Modified Full Overlay Height
OL312	10"	11 1/2"	10 3/4"
OL315	13"	14 1/2"	13 3/4"
OL318	16"	17 1/2"	16 3/4"
OL321	19"	20 1/2"	19 3/4"
OL324	22"	23 1/2"	22 3/4"
OL327	25"	26 1/2"	25 3/4"
OL330	28"	29 1/2"	28 3/4"
OL333	31"	32 1/2"	31 3/4"
OL336	34"	35 1/2"	34 3/4"
OL339	37"	38 1/2"	37 3/4"
OL342	40"	41 1/2"	40 3/4"
OL384	77 1/2"	79"	78 1/4"
OL387	80 1/2"	82"	81 1/4"
OL390	83 1/2"	85"	84 1/4"
OL393	86 1/2"	88"	87 1/4"
OL396	89 1/2"	91"	90 1/4"

Premium trim items (.P) will be textured laminate. All others, excluding Overlay Fillers and Fillers with Overlays, will match the cabinet box color.



**Overlay Filler, 5 1/2" Wide**

- OL630 (28 3/4"H)
- OL633 (31 3/4"H)
- OL636 (34 3/4"H)
- OL639 (37 3/4"H)
- OL642 (40 3/4"H)
- OL684 (78 1/4"H)
- OL687 (81 1/4"H)
- OL690 (84 1/4"H)
- OL693 (87 1/4"H)
- OL696 (90 1/4"H)

- 3/4" thick.
- Finished on front and all edges (backs are unfinished).
- When Juno is ordered, the overlay will be textured laminate.

**Modifications**

FULL
•

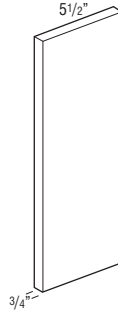

Model	Traditional Overlay Height	Full Overlay Height	Modified Full Overlay Height
OL630	28"	29 1/2"	28 3/4"
OL633	31"	32 1/2"	31 3/4"
OL636	34"	35 1/2"	34 3/4"
OL639	37"	38 1/2"	37 3/4"
OL642	40"	41 1/2"	40 3/4"
OL684	77 1/2"	79"	78 1/4"
OL687	80 1/2"	82"	81 1/4"
OL690	83 1/2"	85"	84 1/4"
OL693	86 1/2"	88"	87 1/4"
OL696	89 1/2"	91"	90 1/4"

**Fluted 3" Wide Fillers**

**FL330**

**FL334.5**

**FL336**

**FL396**

- Finished on front only.
- When ordering Rustic Hickory, Hickory will be substituted.

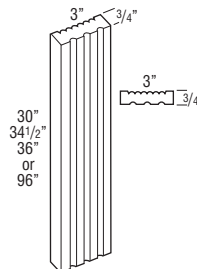

**Fluted 6" Wide Fillers**

FL630

FL636

FL696

- Finished on front only.
- When ordering Rustic Hickory, Hickory will be substituted.

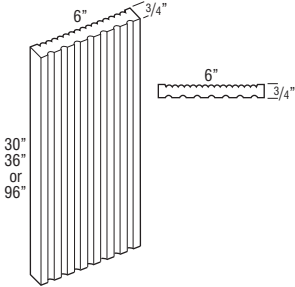

**Transition Base Fillers**

TF34.5

- TF34.5 is grooved.
- When ordering Rustic Hickory, Hickory will be substituted.

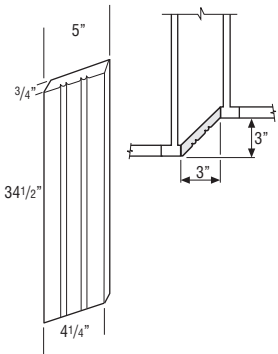

**Modifications**

FULL
•

**NEW Angled Fluted/Plain 3" Wide Reversible Fillers**

BLVDFF34.5 (Reversible)  
3" x 34 1/2"

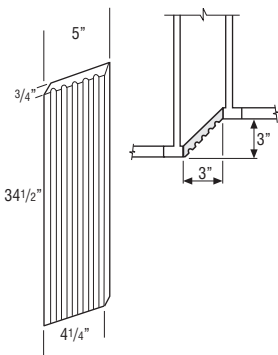

**Column Box Fillers, 3" Wide — Wall - 15" Deep**

CB33015PL

CB33315PL

CB33615PL

CB33915PL

CB34215PL

CB34815PL

CB35115PL

CB35415PL

CB35715PL

CB36015PL

CB36615PL

CB33015FL

CB33315FL

CB33615FL

CB33915FL

CB34215FL

CB34815FL

CB35115FL

CB35415FL

CB35715FL

CB36015FL

CB36615FL

- When ordering Rustic Hickory, Hickory will be substituted.
- FPEB construction.

**Modifications**

ID	RD
•	•

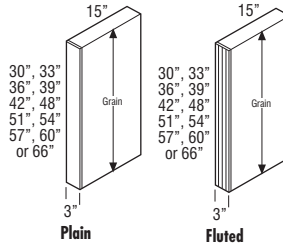

**Column Box Fillers, 3" Wide — Base - 21" or 27" Deep**

CB334.527PL

CB334.527FL

- When ordering Rustic Hickory, Hickory will be substituted.
- FPEB construction.

**Modifications**

RD
•

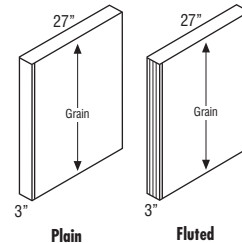

Premium trim items (...P) will be textured laminate. All others, excluding Overlay Fillers and Fillers with Overlays, will match the cabinet box color.

## Column Box Fillers, 3" Wide — Tall - 15" or 27" Deep

CB38415PL  
 CB38715PL  
 CB39015PL  
 CB39315PL  
 CB39615PL  
 CB38427PL  
 CB38727PL  
 CB39027PL  
 CB39327PL  
 CB39627PL  
 CB38415FL  
 CB38715FL  
 CB39015FL  
 CB39315FL  
 CB39615FL  
 CB38427FL  
 CB38727FL  
 CB39027FL  
 CB39327FL  
 CB39627FL

- When ordering Rustic Hickory, Hickory will be substituted.
- FPFB construction.

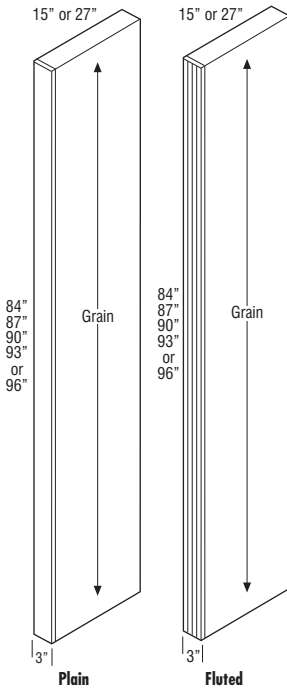

### Modifications

ID	RD
•*	•

\*ID available only on 15" deep.

## Dishwasher End Panels

DWEP1.5  
 DWEP3  
 DWEP1.5WD  
 DWEP3WD  
 DWEP1.5FPE  
 DWEP3FPE

- DWEP\_ constructed of 1/2" thick laminated furniture board.
- DWEP\_WD: 1/2" thick veneered or solid furniture board.
- DWEP\_FPE is 3/4" thick veneered plywood.
- ID27 and ID30 available. RD12, RD15, RD18 and RD21 available.
- When specifying Aloe, Cadet, or Onyx, PEF must be specified in order for panel to match.

### Modifications

FPFB	ID	RD
•*	•	•

\*FPFB available only on DWEP1.5 and DWEP3.

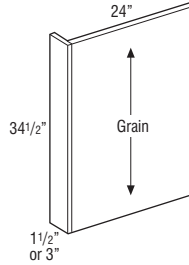

175

FILLERS/APPLIANCE PANELS

Premium trim items (.P) will be textured laminate. All others, excluding Overlay Fillers and Fillers with Overlays, will match the cabinet box color.

**End Panel Skins**

**WBEP**

**WVEPBH**

**WTEP84**

**WTEP96**

**WTEP108†**

**WWEP30**

**WWEP33**

**WWEP36**

**WWEP39**

**WWEP42**

- Opaques will be constructed of MDF.
- 1/4" thick wood veneered, MDF core.
- 12" deep panels - ID15, ID18, ID21, ID24, ID27, and ID30 available. RD9, RD6 available.
- 21" deep panels - ID24, ID27, and ID30 available. RD12, RD15, and RD18 available.
- 24" deep panels - ID27 and ID30 available. RD12, RD15, RD18, and RD21 available.
- When ordering Rustic Hickory, Hickory will be substituted.

†WTEP108 only available in Maple. ID not available on 108" panels.

**Modifications**

ID	RD
•	•

**LBEP**

**LTEP84**

**LTEP96**

**LWEP30**

**LWEP33**

**LWEP36**

**LWEP39**

**LWEP42**

- 1/4" thick laminated plywood. Not available in Aloe, Cadet, or Onyx.
- 12" deep panels - ID15, ID18, ID21, ID24, ID27, and ID30 available. RD9, RD6 available.
- 21" deep panels - ID24, ID27, and ID30 available. RD12, RD15, and RD18 available.
- 24" deep panels - ID27 and ID30 available. RD12, RD15, RD18, and RD21 available.
- When ordering Rustic Hickory, Hickory will be substituted.

**Modifications**

ID	RD
•	•

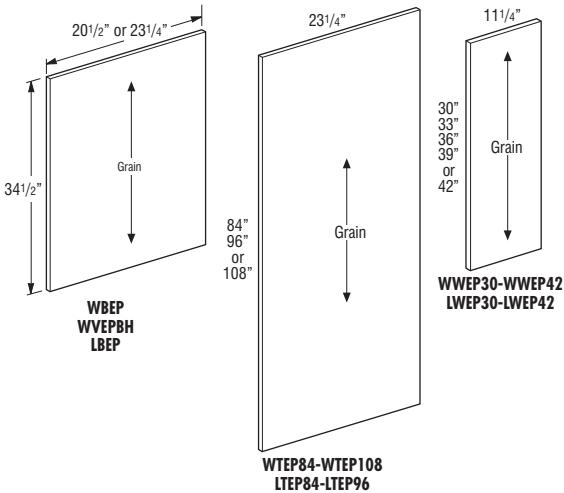

**End Panel Skins, Premium**

**LBEP**

**LTEP84P**

**LTEP96P**

**LWEP30P**

**LWEP33P**

**LWEP36P**

**LWEP39P**

**LWEP42P**

- 1/4" thick laminated MDF.
- 12" deep panels - ID15, ID18, ID21, ID24, ID27, and ID30 available. RD9, RD6 available.
- 24" deep panels - ID27 and ID30 available. RD12, RD15, RD18, and RD21 available.
- Available in Textured Laminate only.

**Modifications**

ID	RD
•	•

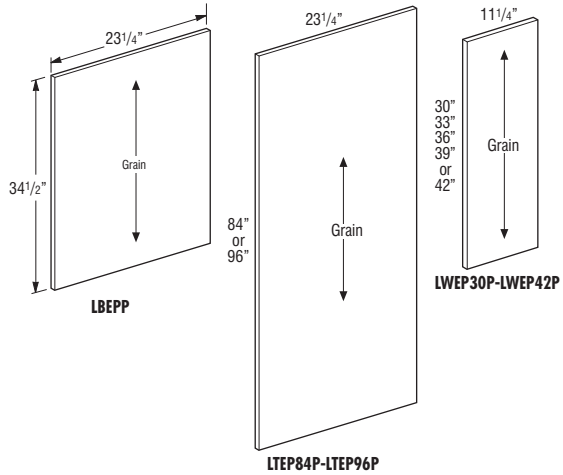

**Cross Grain Veneer Back Skin**

**W9648BP**

- Opaques will be constructed of MDF.
- 1/4" thick wood veneered, MDF core.
- 93" wide x 45" high usable material.
- When ordering Rustic Hickory, Hickory will be substituted.
- Not available in thermofoil and opaques.

**W48X34.5**

- Opaques will be constructed of MDF.
- 1/4" thick wood veneered, MDF core.
- When ordering Rustic Hickory, Hickory will be substituted.

**L48X34.5**

- 1/4" thick laminated plywood. Not available in Aloe, Cadet, or Onyx.
- When ordering Rustic Hickory, Hickory will be substituted.

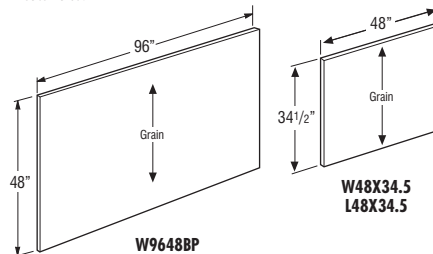

Premium trim items (...P) will be textured laminate. All others, excluding Overlay Fillers and Fillers with Overlays, will match the cabinet box color.



## Cross Grain Veneer Back Skin, Premium

### L48X34.5P

- 1/4" thick laminated MDF.
- Available in Textured Laminate only.

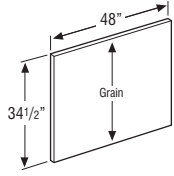

## Finished Back Skins

### W4896

- Opaques will be constructed entirely of MDF.
- 1/4" thick wood veneered, MDF core.
- When ordering Rustic Hickory, Hickory will be substituted.

### L4896

- 1/4" thick laminated plywood. Not available in Aloe, Cadet, or Onyx.
- When ordering Rustic Hickory, Hickory will be substituted.

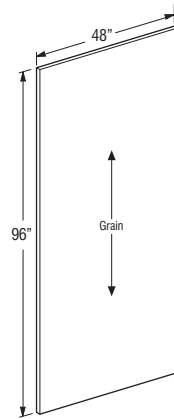

## Finished Back Skins, Premium

### L4896P

- 1/4" thick laminated MDF.
- Available in Textured Laminate only.

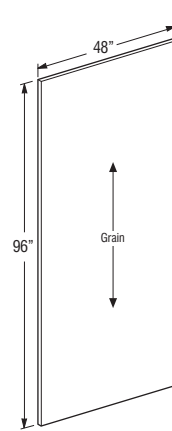

## Wood V-Grooved Beaded Skin

### W4848BB

- 1/4" veneer on MDF core.
- Includes a bead within a V-groove.
- V-groove on 3" centers.
- When ordering Rustic Hickory, Hickory will be substituted.

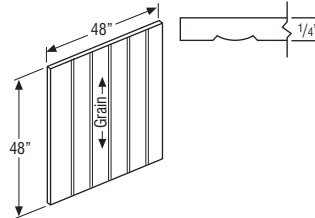

Premium trim items (.P) will be textured laminate. All others, excluding Overlay Fillers and Fillers with Overlays, will match the cabinet box color.

**End Panels**

**SE24**

- SE24 1/2" thick laminated furniture board.
- Edges are not finished.
- When ordering Aloe, Cadet, or Onyx, PEF must be specified.
- ID27 and ID30 available. RD12, RD15, RD18, and RD21 available.

**Modifications**

ID	RD
•	•

**Construction Upgrades**

PEF
•

**SP1248**

**SP1284**

**SP1296**

**SP12108†**

**SP2484**

**SP2496**

**SP24108†**

**SP3084**

**SP3096**

- 3/4" thick veneered furniture board finished both sides and long edges.
- When ordering Rustic Hickory, Hickory will be substituted.
- 12" deep panels - ID15, ID18, ID21, ID24, ID27, and ID30 available. RD9, RD6 available.
- 24" deep panels - ID27 and ID30 available. RD12, RD15, RD18, and RD21 available.
- 30" deep panels - RD27 available.

†SP12108 and SP24108 only available in Maple. ID not available on 108" panels.

**Modifications**

ID	RD
•	•

**LSP1248**

**LSP1284**

**LSP1296**

**LSP2484**

**LSP2496**

**LSP3084**

**LSP3096**

- 3/4" thick laminated furniture board.
- LSP panels are only available in Alpine and White.
- 12" deep panels - ID15, ID18, ID21, ID24, ID27, and ID30 available. RD9, RD6 available.
- 24" deep panels - ID27 and ID30 available. RD12, RD15, RD18, and RD21 available.
- 30" deep panels - RD27 available.

**Modifications**

ID	RD
•	•

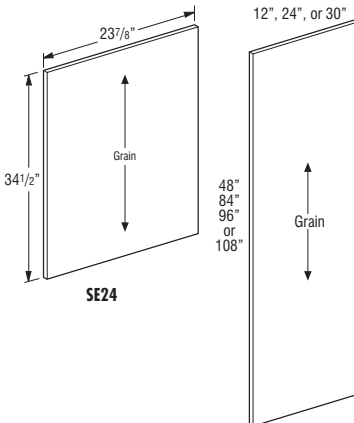

LSP/SP1248-LSP/SP1296  
 LSP/SP2484-LSP/SP2496  
 LSP/SP3084-LSP/SP3096  
 SP12108, SP24108

Premium trim items (...P) will be textured laminate. All others, excluding Overlay Fillers and Fillers with Overlays, will match the cabinet box color.

**End Panels, Premium**

**LSP1248P**

**LSP1296P**

**LSP2484P**

**LSP2496P**

- 3/4" thick laminated furniture board.
- 12" deep panels - ID15, ID18, ID21, ID24, ID27, and ID30 available. RD9, RD6 available.
- 24" deep panels - ID27 and ID30 available. RD12, RD15, RD18 and RD21 available.
- Available in Textured Laminate only.

**Modifications**

ID	RD
•	•

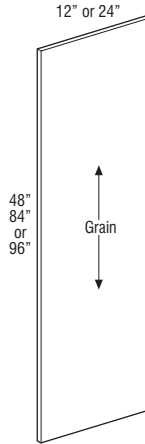

**Refrigerator Panels with Filler Attached**

- WREP1.52484
- WREP1.52487
- WREP1.52490
- WREP1.52493
- WREP1.52496
- WREP1.524108†
- WREP32484
- WREP32487
- WREP32490
- WREP32493
- WREP32496
- WREP324108†

- 1/2" thick plywood.
  - 1/4" reveal on filler at panel attachment.
  - Total panel depth includes 3/4" thick filler. Example: WREP1.52484 = panel depth of 24".
  - When ordering Rustic Hickory, Hickory will be substituted.
  - 24" deep panels - ID27 and ID30 available. RD12, RD15, RD18 and RD21 available.
- †WREP1.524108 and WREP324108 only available in Maple. ID not available on 108" panels.

**Modifications**

FPEB	ID	RD
•	•	•

- LREP1.52484
- LREP1.52487
- LREP1.52490
- LREP1.52493
- LREP1.52496
- LREP32484
- LREP32487
- LREP32490
- LREP32493
- LREP32496

- 1/2" thick laminated furniture board. Not available in Aloe, Cadet, or Onyx.
- 1/4" reveal on filler at panel attachment.
- Total panel depth includes 3/4" thick filler. Example: LREP1.52484 = panel depth of 24".
- When ordering Rustic Hickory, Hickory will be substituted.
- 24" deep panels - ID27 and ID30 available. RD12, RD15, RD18 and RD21 available.

**Modifications**

ID	RD
•	•

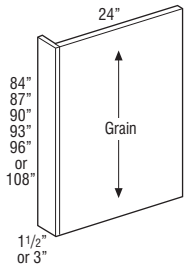

**Decorative Door Panel Kits — Wall End**

- WDOP30
- WDOP33
- WDOP36
- WDOP39
- WDOP42
- WDOP48
- WDOP51
- WDOP54
- WDOP57
- WDOP60

- Door panel kits include 1/4" thick veneer wood panels and doors with attachment screws for field installation.
- Door and panel shipped unattached for modified full overlay styles.

**Modifications**

FULL
•

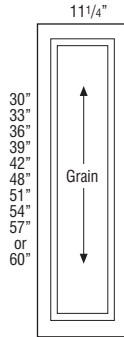

**Decorative Door Panel Kits — Base End**

- BDOP
- VDOPBH

- Door panel kits include 1/4" thick veneer wood panels and doors with attachment screws for field installation.
- Door and panel shipped unattached for modified full overlay styles.

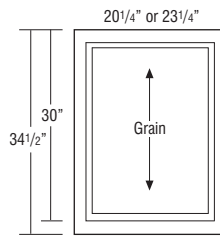

Premium trim items (.P) will be textured laminate. All others, excluding Overlay Fillers and Fillers with Overlays, will match the cabinet box color.

**Decorative Door Panel Kits — Tall End**

- TDOP1284
- TDOP1287
- TDOP1290
- TDOP1293
- TDOP1296
- TDOP2484
- TDOP2487
- TDOP2490
- TDOP2493
- TDOP2496

- Door panel kits include 1/4" thick veneer wood panels and doors with attachment screws for field installation.
- Door and panel shipped unattached for modified full overlay styles.
- TDOP configuration will match the front of the cabinet.

**Modifications**

FULL
•

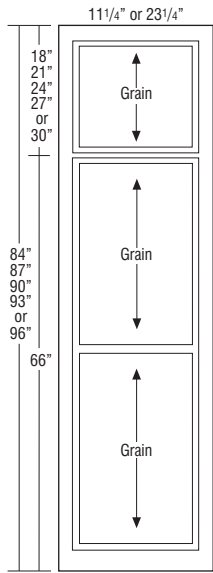

**Vanity Desk Legs**

- DL
- VDL

- All panels are finished 2 sides and front edge.
- 3/4" thick veneered furniture board.
- When ordering Rustic Hickory, Hickory will be substituted.

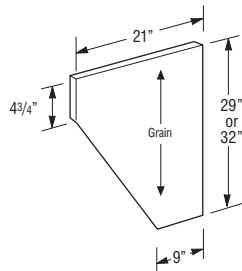

Premium trim items (...P) will be textured laminate. All others, excluding Overlay Fillers and Fillers with Overlays, will match the cabinet box color.

**Toekick Overlay**

**WT04.5 (4 1/2" x 96" x 1/4")**

- Opaques will be constructed entirely of MDF.
- 1/4" thick plywood finished veneer.
- When ordering Rustic Hickory, Hickory will be substituted.
- One 8' section.

**LTO4.5 (4 1/2" x 96" x 1/8" Laminate)**

- 1/8" thick laminated furniture board. Not available in Aloe, Cadet, or Onyx.
- When ordering Rustic Hickory, Hickory will be substituted.
- One 8' section.

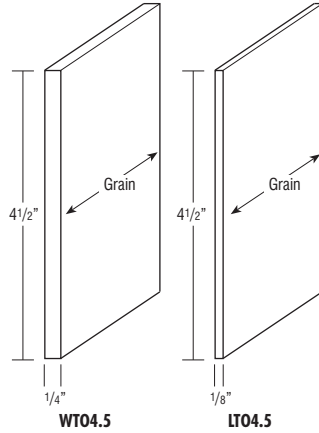

**Toekick Overlay, Premium**

**LTO4.5P (4 1/2" x 96" x 1/8" Laminate)**

- One 8' section.
- Available in Textured Laminate only.

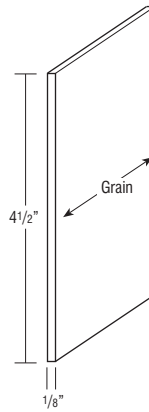

## Crown Moulding — Insert Crown

### INSCROWN

- One 8' section.
- Not available in Hickory or Rustic Hickory.

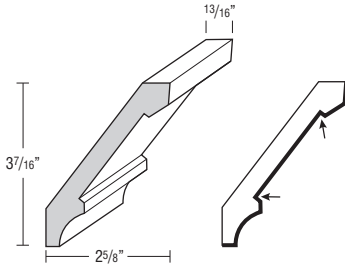

## Crown Moulding — Large Cove Crown

### LCOVE

- One 8' section.
- When ordering Rustic Hickory, Hickory will be substituted.

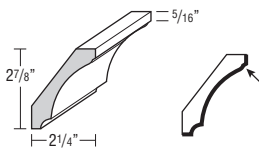

## Crown Moulding — Large Crown

### LCROWN8

- One 8' section.
- When ordering Rustic Hickory, Hickory will be substituted.

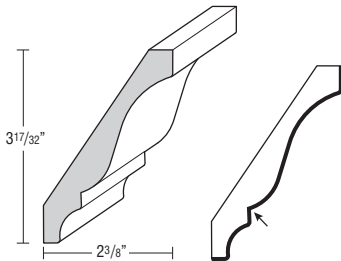

## NEW Crown Moulding — Straight Angle Crown

### SACROWN8

- One 8' section.
- Includes an unattached cleat.
- When ordering Rustic Hickory, Hickory will be substituted.

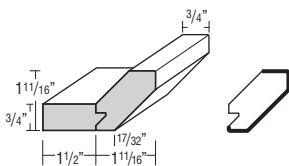

Premium trim items (..P) will be textured laminate. All others, excluding Overlay Fillers and Fillers with Overlays, will match the cabinet box color.

Finished edges indicated by bold lines on side view drawings.  
Glazed edges indicated by arrows on side view drawings.

## Crown Moulding — Shaker Crown

### LSHAKER

### SSHAKER

### NSHAKER

- One 8' section.
- NSHAKER is a top mount moulding.
- When ordering Rustic Hickory, Hickory will be substituted.

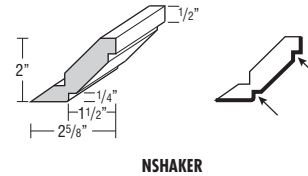
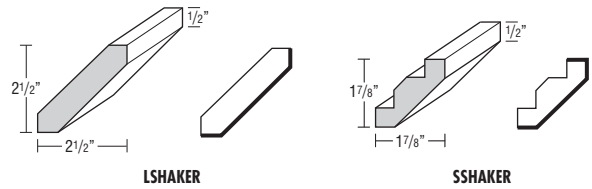

## Crown Moulding — Shaker Crown, Premium

### LSHAKERP

- One 8' section.
- Available in Textured Laminate only.

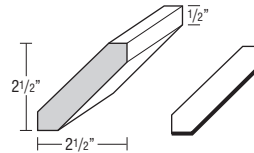

## Crown Moulding — Small Crown

### SCROWN8

- One 8' section.
- When ordering Rustic Hickory, Hickory will be substituted.

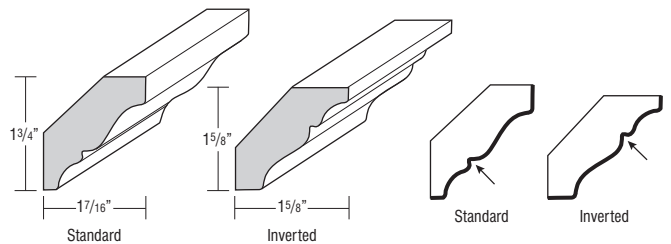

**Crown Moulding — Solid-wood Large Crown**

**SWLCRM8**

- One 8' section.
- When ordering Rustic Hickory, Hickory will be substituted.

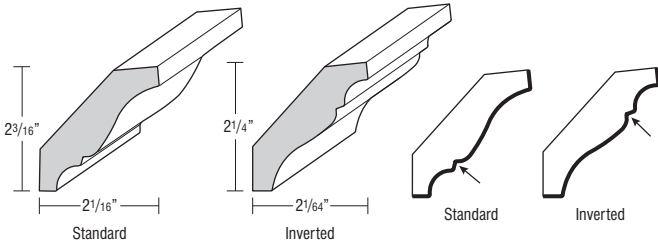

**Crown Moulding — Solid-wood Victorian Crown**

**SWVCRM8**

- One 8' section.
- When ordering Rustic Hickory, Hickory will be substituted.

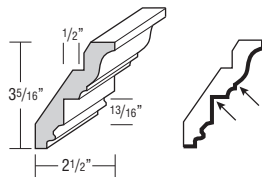

**Crown Moulding — Tall Crown**

**SWTCRM8**

- One 8' section.
- When ordering Rustic Hickory, Hickory will be substituted.

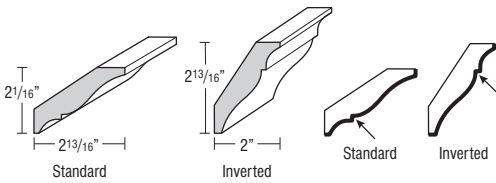

**Starter Moulding — Soffit Filler Moulding**

**SFM8**

- One 8' section.
- Includes an unattached cleat.
- When ordering Rustic Hickory, Hickory will be substituted.

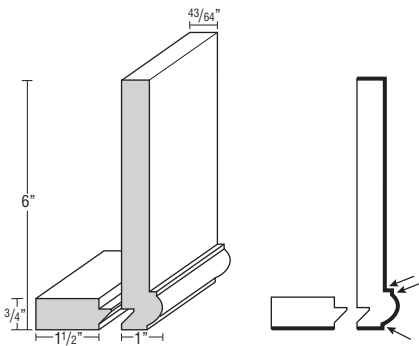

Premium trim items (...P) will be textured laminate. All others, excluding Overlay Fillers and Fillers with Overlays, will match the cabinet box color.

Finished edges indicated by bold lines on side view drawings.  
Glazed edges indicated by arrows on side view drawings.

**Starter Moulding — Starter Moulding**

**STR8**

- One 8' section.
- When ordering Rustic Hickory, Hickory will be substituted.

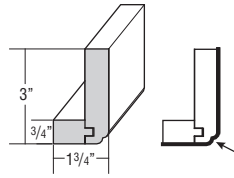

**Accent Moulding — Baseboard Shaker**

**BBMSH8**

- One 8' section.
- When ordering Rustic Hickory, Hickory will be substituted.

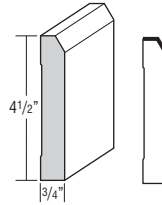

**Accent Moulding — Batten**

**BATTEN8**

- One 8' section.
- When ordering Rustic Hickory, Hickory will be substituted.

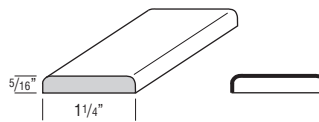

**NEW Accent Moulding — Batten Small**

**SM8**

- One 8' section.

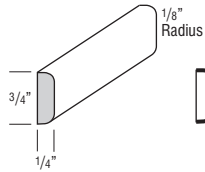

**Accent Moulding — Batten Small, Premium**

**SM8P**

- One 8' section.
- Available in Textured Laminate only.

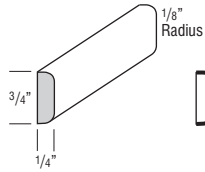

All mouldings and embellishments available unfinished.  
Specify unfinished (UNF) for finish code.

**Accent Moulding — Chair Rail**

**CHAIR**

- One 8' section.
- When ordering Rustic Hickory, Hickory will be substituted.

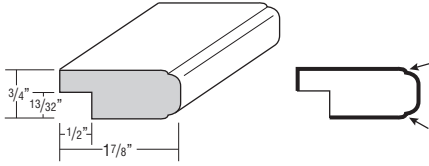

**Accent Moulding — Countertop Edge**

**CTMR**

- One 8' section.
- When ordering Rustic Hickory, Hickory will be substituted.

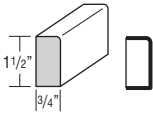

**Accent Moulding — Furniture Base**

**FB**

- One 8' section.
- When ordering Rustic Hickory, Hickory will be substituted.

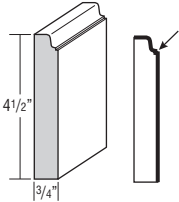

**Accent Moulding — Library Moulding**

**LIBRARY**

- One 8' section.
- When ordering Rustic Hickory, Hickory will be substituted.

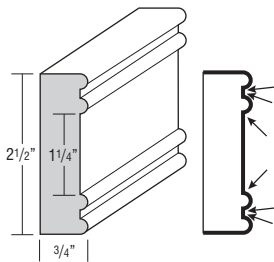

**Accent Moulding — Mirror Frame**

**MRM**

- Pre-grooved.
- One 8' section.
- When ordering Rustic Hickory, Hickory will be substituted.

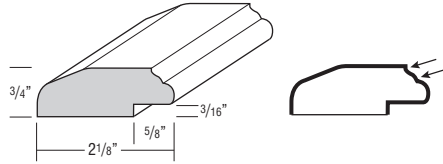

**Accent Moulding — Ogee Edge**

**OJM**

- One 8' section.
- When ordering Rustic Hickory, Hickory will be substituted.

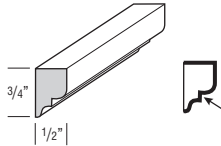

**Accent Moulding — Single Bead**

**SB8**

- One 8' section.
- When ordering Rustic Hickory, Hickory will be substituted.

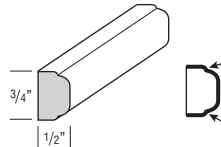

**Accent Moulding — Small Scribe**

**SCRIBE8**

- One 8' section.
- When ordering Rustic Hickory, Hickory will be substituted.

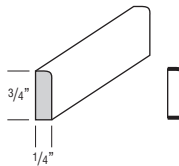

**Accent Moulding — Small Scribe, Premium**

**SCRIBE8P**

- One 8' section.
- Available in Textured Laminate only.

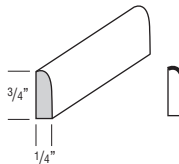

Premium trim items (...P) will be textured laminate. All others, excluding Overlay Fillers and Fillers with Overlays, will match the cabinet box color.

Finished edges indicated by bold lines on side view drawings.  
Glazed edges indicated by arrows on side view drawings.

**Accent Moulding — Toekick Cap**

**TKC**

- Sold in pairs.
- When ordering Rustic Hickory, Hickory will be substituted.

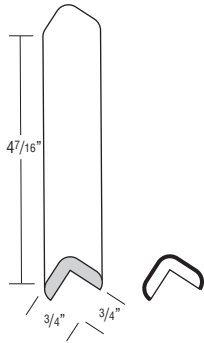

**Accent Moulding — Traditional Batten**

**MTBAT**

- One 8' section.
- When ordering Rustic Hickory, Hickory will be substituted.

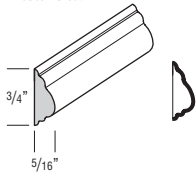

**Accent Moulding — Triple Bead Edge**

**TB**

- One 8' section.
- When ordering Rustic Hickory, Hickory will be substituted.

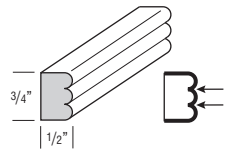

**Light Rails — Furniture Base**

**FB2**

- One 8' section.
- When ordering Rustic Hickory, Hickory will be substituted.

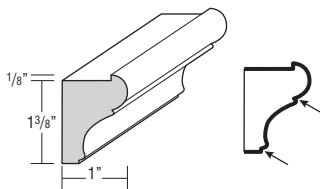

**Light Rails — Light Rail Moulding**

**LRM**

- One 8' section.
- When ordering Rustic Hickory, Hickory will be substituted.

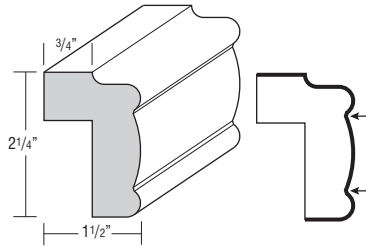

**Light Rails — Cap Moulding**

**SOFFITA**

**SOFFITB**

**SOFFITE**

- One 8' section.
- When ordering Rustic Hickory, Hickory will be substituted.

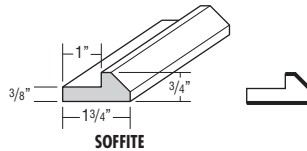
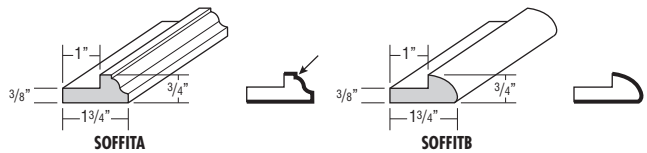

**Light Rails — Small Light Rail Moulding**

**SMLR**

- One 8' section.
- When ordering Rustic Hickory, Hickory will be substituted.

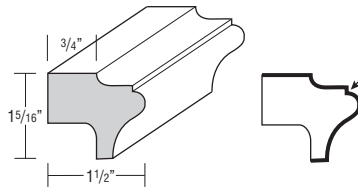

**Corner Mouldings — Inside Corner**

**ISC8**

- One 8' section.
- When ordering Rustic Hickory, Hickory will be substituted.

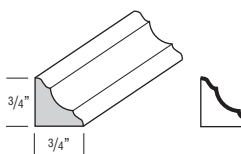

Premium trim items (...P) will be textured laminate. All others, excluding Overlay Fillers and Fillers with Overlays, will match the cabinet box color.

Finished edges indicated by bold lines on side view drawings.  
Glazed edges indicated by arrows on side view drawings.

All mouldings and embellishments available unfinished.  
Specify unfinished (UNF) for finish code.



## Corner Mouldings — Inside Corner, Premium

### ISC8P

- One 8' section.
- Available in Textured Laminate only.

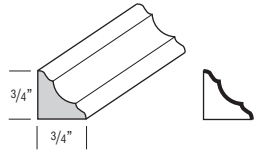

## Corner Mouldings — Outside Corner

### OCM8

- One 8' section.
- When ordering Rustic Hickory, Hickory will be substituted.

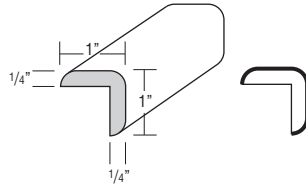

## **NEW** Corner Mouldings — Outside Corner Small

### SOCM8

- One 8' section.
- When ordering Rustic Hickory, Hickory will be substituted.

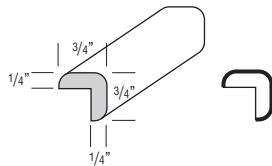

## Corner Mouldings — Outside Corner Small, Premium

### SOCM8P

- One 8' section.
- Available in Textured Laminate only.

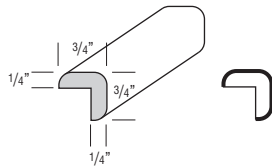

Premium trim items (..P) will be textured laminate. All others, excluding Overlay Fillers and Fillers with Overlays, will match the cabinet box color.

Finished edges indicated by bold lines on side view drawings.  
Glazed edges indicated by arrows on side view drawings.

## Corner Mouldings — Outside Corner 135°

### OSC135

- One 8' section.
- When ordering Rustic Hickory, Hickory will be substituted.

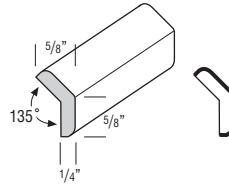

## Corner Mouldings — Shoe - Convex Inside Corner

### SHM8

- One 8' section.
- When ordering Rustic Hickory, Hickory will be substituted.

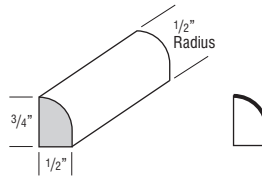

## **NEW** Arched Valance

### AV36

### AV48

### AV60

### AV72

- Side shoulders are 8" wide (6" trimmable each end).
- Bottom edge has 3/16" radius.
- 3/4" thick.
- When ordering Rustic Hickory, Hickory will be substituted.

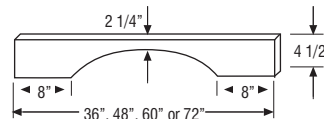

## Decorative Arch Valance

### DAV36

### DAV42

- Trimmable up to 1 3/4" per side and top and bottom.
- Center height 8".
- When ordering Rustic Hickory, Hickory will be substituted.

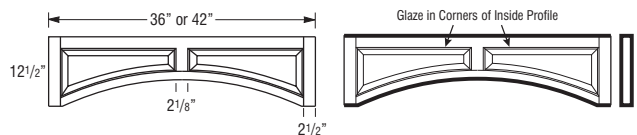

All mouldings and embellishments available unfinished.  
Specify unfinished (UNF) for finish code.

**Recessed Decorative Arch Valance**

**DAVF36**

**DAVF42**

- Trimable up to 1 3/4" per side and top and bottom.
- Center height 8".
- When ordering Rustic Hickory, Hickory will be substituted.

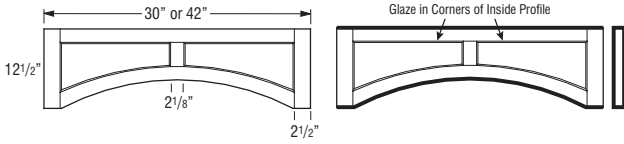

**NEW Furniture Valance**

**FV36**

**FV48**

**FV60**

**FV72**

- Side shoulders are 8" wide (6" trimmable each end).
- Bottom edge has 3/16" radius profile on face.
- 3/4" thick.
- When ordering Rustic Hickory, Hickory will be substituted.

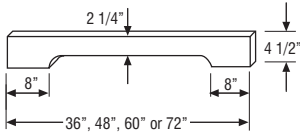

**NEW Straight Valance**

**SV48**

**SV96**

- Trimable.
- Profiled bottom edge.
- 3/4" thick.
- When ordering Rustic Hickory, Hickory will be substituted.

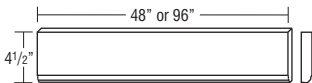

**Decorative Ornaments — Mission Rosette**

**ROSETTEMIS**

- Apply with small brad.
- Not available in Hickory or Rustic Hickory.

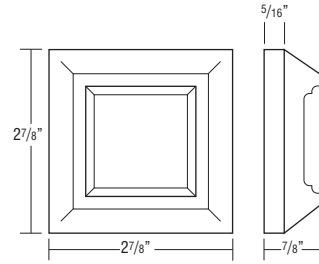

**Decorative Ornaments — Plinth Block**

**PLINTHBLOCK**

- When ordering Rustic Hickory, Hickory will be substituted.

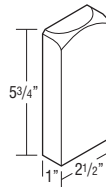

Premium trim items (...P) will be textured laminate. All others, excluding Overlay Fillers and Fillers with Overlays, will match the cabinet box color.

Finished edges indicated by bold lines on side view drawings.  
Glazed edges indicated by arrows on side view drawings.

All mouldings and embellishments available unfinished.  
Specify unfinished (UNF) for finish code.

## Decorative Supports — Bar Leg, 2-Sided or 4-Sided, 42 1/4" High

### 2SBARLEG

### 4SBARLEG

- Trimmable.
- When ordering Rustic Hickory, Hickory will be substituted.

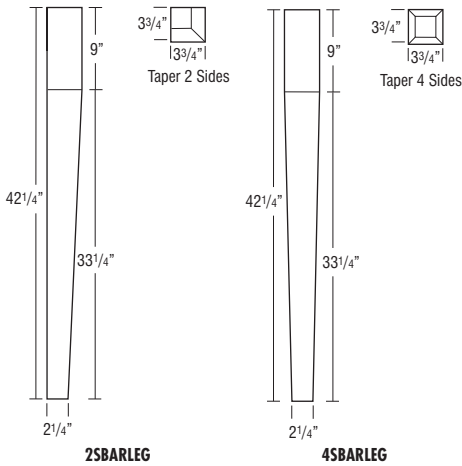

## Decorative Supports — English Bar Column, 42 1/4" High

### ENGBARCOLUMN

- Trimmable.
- When ordering Rustic Hickory, Hickory will be substituted.

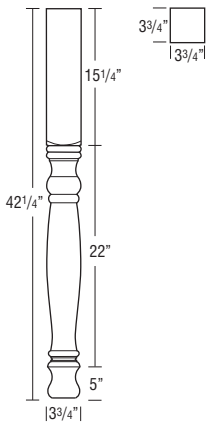

## Decorative Supports — English Country Leg

### JENGNTYLEG

- Trimmable.
- Not available in Hickory or Rustic Hickory.

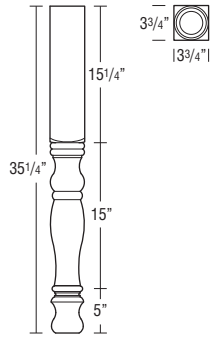

## Decorative Supports — English Island Column, 5" Wide, 35 1/4" High

### ENGISLCOLUMN

- Trimmable.
- When ordering Rustic Hickory, Hickory will be substituted.

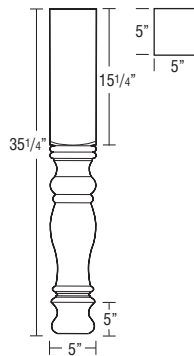

## NEW Decorative Supports — Estate Leg

### JESTATELEGS

- Trimmable.
- Not available in Hickory or Rustic Hickory.

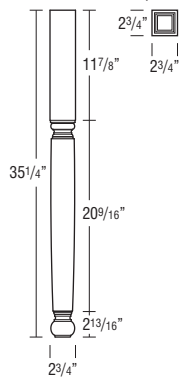

Premium trim items (.P) will be textured laminate. All others, excluding Overlay Fillers and Fillers with Overlays, will match the cabinet box color.

**Decorative Supports — Fluted Classic Column**

**JFLUTELEG**

- Trimable.
- Not available in Hickory or Rustic Hickory.

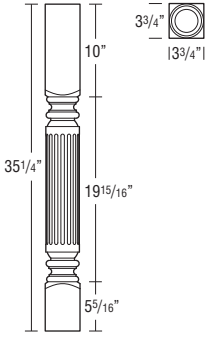

**Decorative Supports — Island Leg, 2-Sided or 4-Sided, 35 1/4" High**

**2SISLLEG**

**4SISLLEG**

- Trimable.
- When ordering Rustic Hickory, Hickory will be substituted.

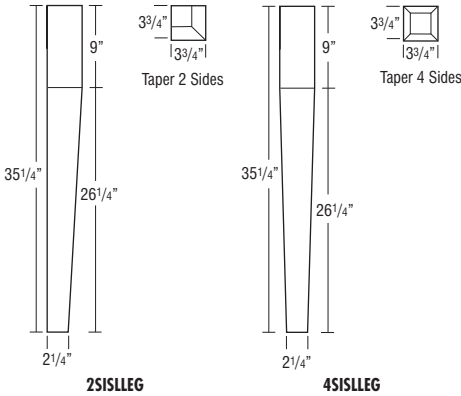

**Decorative Supports — Kensington Column**

**JCRLEG**

- Trimable.
- Not available in Hickory or Rustic Hickory.

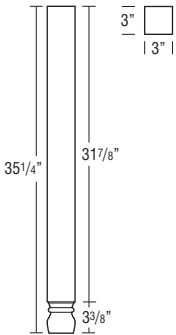

**Decorative Supports — Metro Column**

**METISLCOLUMN**

- Trimable.
- Not available in Hickory or Rustic Hickory.
- Leg is designed with three pieces joined together.

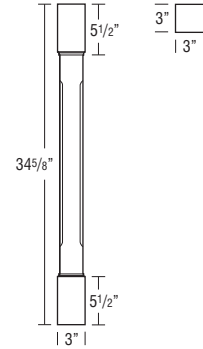

**Decorative Supports — Mission Leg, 34 1/2" High**

**DLEMISSION**

- Trimable.
- When ordering Rustic Hickory, Hickory will be substituted.

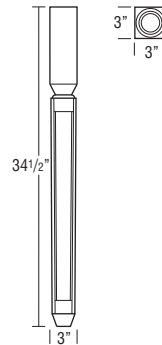

**Decorative Supports — Square Island Leg, 35 1/4" High**

**SQISLLEG3**

**SQISLLEG4**

**SQISLLEG5**

- Trimable.
- When ordering Rustic Hickory, Hickory will be substituted.

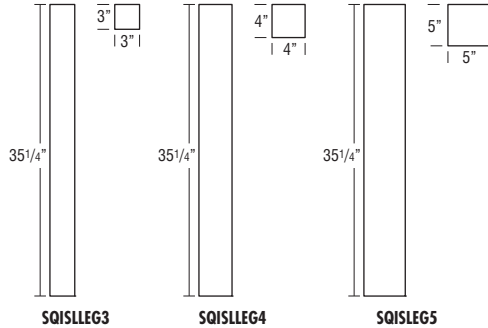

Premium trim items (...P) will be textured laminate. All others, excluding Overlay Fillers and Fillers with Overlays, will match the cabinet box color.

## Decorative Supports — Turned Post

### TURNEDPOST

- When ordering Rustic Hickory, Hickory will be substituted.

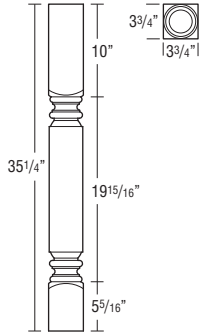

## Decorative Supports — Turned Post Split

### SPLTRNEDPOST

- When ordering Rustic Hickory, Hickory will be substituted.

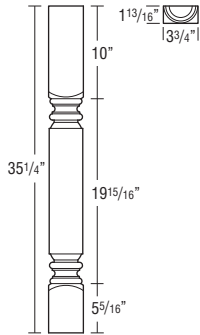

## Decorative Supports — Craftsman Foot

### JCRAFTFOOT

- Not available in Hickory or Rustic Hickory.

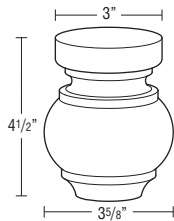

## Decorative Supports — Kensington Bun Foot

### JCRBUNFOOT

- Not available in Hickory or Rustic Hickory.

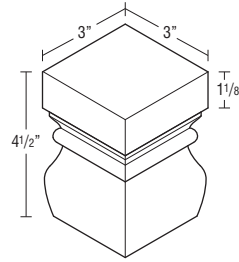

## Decorative Supports — Large Square Foot

### LGSQFOOT

- Trimable.

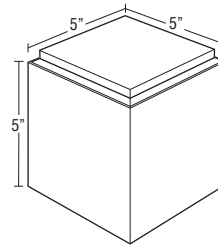

## Decorative Supports — Lille Foot

### LIFOOT

- Not available in Hickory or Rustic Hickory.

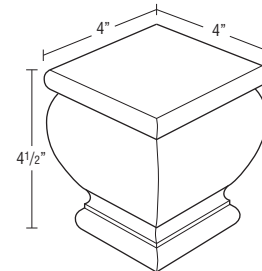

## Decorative Supports — Tapered Leg

### TAPLGL

- Trimable.

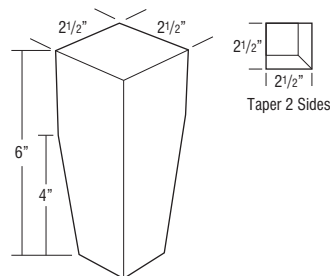

Premium trim items (.P) will be textured laminate. All others, excluding Overlay Fillers and Fillers with Overlays, will match the cabinet box color.

**NEW** Decorative Supports — Tulip Foot

**TLFOOT**

- Trimmable.
- When ordering Rustic Hickory, Hickory will be substituted.

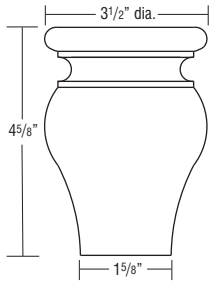

**Decorative Supports — Furniture Apron**

**FA24**

**FA27**

**FA30**

**FA33**

**FA36**

**FA42**

**FA48**

- When ordering Rustic Hickory, Hickory will be substituted.

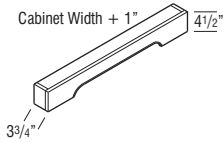

**NEW** Decorative Supports — 2" Decorative Split Turnings

**SPRINGEND** (Sold in Pairs)

- Ends sold separately from split turnings.

**SPRINGSPPOOL30** (Half Round)

**SPRINGSPPOOL96** (Half Round)

- Ends sold separately from split turnings.

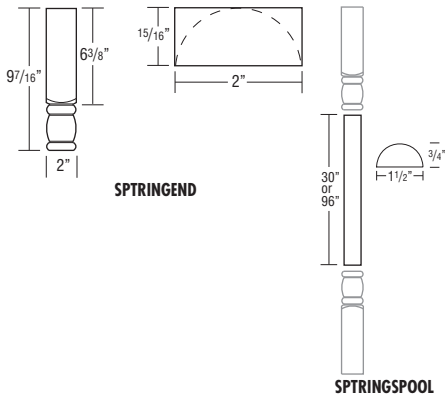

**9\"/>**

**CORBELART9**

- Not available in Hickory or Rustic Hickory.
- In order to support substantial weight, corbel must be properly installed with the attachment screws driven in a wall stud.

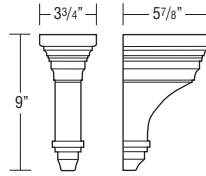

**11 1/2\"/>**

**JBRACKETART**

- Not available in Hickory or Rustic Hickory.
- In order to support substantial weight, corbel must be properly installed with the attachment screws driven in a wall stud.

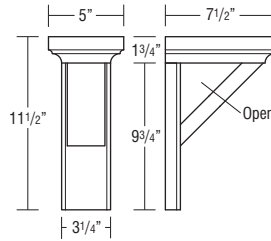

**14\"/>**

**CORBELART14**

- Not available in Hickory or Rustic Hickory.
- In order to support substantial weight, corbel must be properly installed with the attachment screws driven in a wall stud.

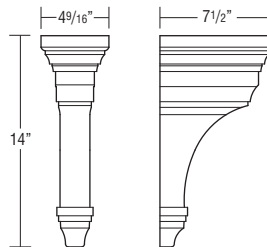

**14\"/>**

**JCORBELARTO**

- Not available in Hickory or Rustic Hickory.
- In order to support substantial weight, corbel must be properly installed with the attachment screws driven in a wall stud.

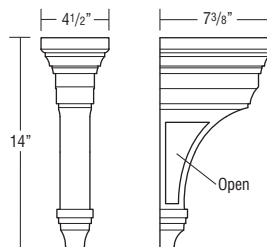

Premium trim items (...P) will be textured laminate. All others, excluding Overlay Fillers and Fillers with Overlays, will match the cabinet box color.

## 9" Classic Revival Corbel

### CORBELCR9

- Not available in Hickory or Rustic Hickory.
- In order to support substantial weight, corbel must be properly installed with the attachment screws driven in a wall stud.

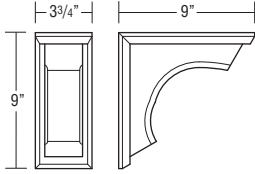

## 6" Mission Corbel

### CORBELMIS6

- Not available in Hickory or Rustic Hickory.
- In order to support substantial weight, corbel must be properly installed with the attachment screws driven in a wall stud.

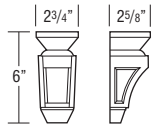

## 9" Mission Corbel

### CORBELMIS9

- Not available in Hickory or Rustic Hickory.
- In order to support substantial weight, corbel must be properly installed with the attachment screws driven in a wall stud.

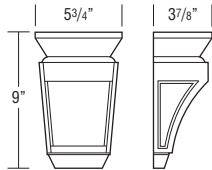

## 5" Old World Corbel

### CORBELOWD5

- Not available in Hickory or Rustic Hickory.
- In order to support substantial weight, corbel must be properly installed with the attachment screws driven in a wall stud.

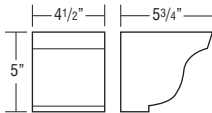

## 13" Large Scroll Corbel

### LGCORBEL

- Not available in Hickory or Rustic Hickory.
- In order to support substantial weight, corbel must be properly installed with the attachment screws driven in a wall stud.

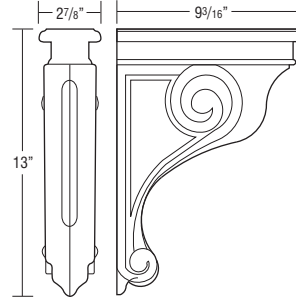

## Snack Bar Support

### SBS

- When ordering Rustic Hickory, Hickory will be substituted.

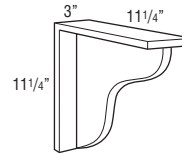

Premium trim items (.P) will be textured laminate. All others, excluding Overlay Fillers and Fillers with Overlays, will match the cabinet box color.

**Hardware**



**KNOB01 Acrylic Knob**  
1 3/4"H x 1 1/4"D



**KNOB31 Steel Transitional Knob**  
1 1/4"H x 1 1/4"SQ



**KNOB12 Black Mist Transitional Knob**  
1 3/16"H x 1 1/4"D



**KNOB24 Steel Williamsburg Knob**  
1"H x 1 1/4"D



**KNOB02 Square Nickel Studio Knob**  
1 1/8"H x 1 5/16"SQ



**PULL15 Nickel 4 3/4" Classic Studio Pull**  
96mm CC



**PULL16 Nickel 6 1/8" Classic Studio Pull**  
128mm CC



**PULL07 Nickel Rotterdam 4 9/16" Pull**  
3" CC



**PULL09 Chrome Cup Pull**  
3" / 96mm CC



**KNOB03 Chrome Knob**  
1"H x 1 3/16"SQ



**PULL04 Chrome Pull**  
96mm CC



**KNOB10 Bronze Bungalow 2 5/16" Knob**  
1"H x 2 5/16"L x 1 1/16"W



**PULL08 Bronze Bungalow 5 5/8" Bar Pull**  
3" / 96mm CC



**KNOB29 Nickel Transitional Euro Knob**  
1 1/16"H x 1 1/4"D



**PULL30 Nickel 4" Cavalier Pull**  
3" CC



**KNOB19 Steel Greenwich Knob**  
1 3/4"



**PULL18 Steel 3" Greenwich Pull**  
3" / 96mm CC



**PULL17 Steel 6 3/8" Greenwich Pull**  
128mm CC



**KNOB23 Antique Windover Knob #23**  
1"H x 1 1/4"D



**KNOB25 Antique Windover Knob #25**  
1 1/16"H x 1 1/4"D



**PULL22 Antique 5 1/2" Windover Pull**  
3" CC



**KNOB27 Nickel Contemporary Knob**  
1"H x 1 1/4"D



**PULL28 Nickel 4" Contemporary Pull**  
96mm CC



**KNOB11 Bronze Williamsburg Knob**  
1"H x 1 1/4"D



**KNOB26 Bronze Metropolis Knob**  
1"H x 1 1/8"D



**KNOB21 Bronze Swoop Knob**  
1 1/4"H x 1 1/4"D



**PULL20 Bronze 4 1/4" Swoop Pull**  
3" / 96mm CC



**PULL05 Bronze Rotterdam 5" Curved Pull**  
5" CC



**PULL06 Bronze Rotterdam 4 1/4" Pull**  
96mm CC



**PULL13 Steel Metro 7 13/32" Bar Pull**  
128mm CC



**PULL14 Nickel Metro 4 3/4" Arched Pull**  
96mm CC



**PULL31 Satin Nickel Pull**  
1 3/4"W x 7"L x 3/4"H



**PULL32 Satin Nickel Pull**  
1 3/4"W x 1 3/4"L x 3/4"H

**HCSLCHDWREBOARD**

**Hardware Board**  
(displays 31 pieces)





## Base Mixer Kit

MIXKIT18FH

MIXKIT21FH

MIXKIT24FH

- SoftTouch closing feature.
- Mixer shelf will be 3/4" thick natural finished veneer plywood, mixer shelf dimensions:  
18" wide: 11 3/4" wide x 20" deep.  
21" wide: 14 3/4" wide x 20" deep.  
24" wide: 17 3/4" wide x 20" deep.
- Maximum Weight Capacity for Mixer Shelf: 60 lbs.
- Mixer shelf locks in the fully open position. Release brackets lower the mixer shelf back into the cabinet.
- When installed in 34 1/2" full height cabinet and in closed position, clearance above shelf is 17 5/8"; clearance below shelf is 7 3/4".
- For use with **APF** or **APU** only.

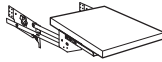

## CabMat™

CABMAT30

CABMAT33

CABMAT36

- Designed with a slope to capture spills and is removable for cleaning.

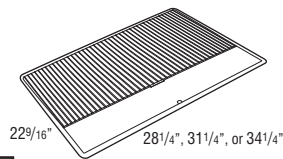

Model	Liquid Capacity		Cabinet Size	
	Quarts	Liters	Width	Depth
CABMAT30	4.2	3.9	30"	24"
CABMAT33	4.6	4.3	33"	24"
CABMAT36	5.0	4.7	36"	24"

## Cooking Utensil Divider

CUDD24

CUDD30

CUDD36

- Pre-assembled natural wood drawer insert.

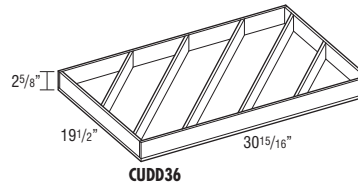
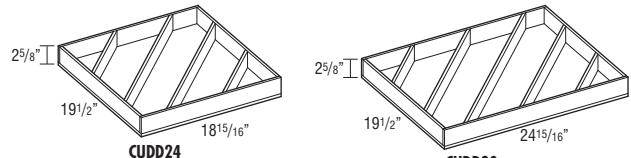

## Cookware Organizer

C024

- C024 for use in 24" wide cabinets.

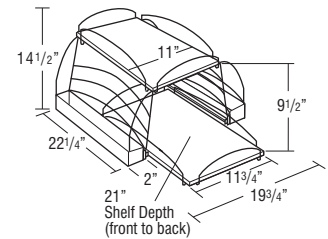

### Cutlery Divider Wood Tiered Drawer

WTCD15

WTCD18

WTCD21

WTCD24

- Replaces standard drawer. Uses existing cabinet member drawer hardware.
- Only compatible with PG SoftTouch guide.
- Requires field installation of drawer front.
- For use with 24" deep cabinets only.
- Exterior WTCD drawer box height is 3 3/4", interior height of top tier is 1 5/8", and interior height of bottom tier is 1 3/8".
- Top divider slides front-to-back.

Model	Application
WTCD15	15" Base
WTCD18	18" Base
WTCD21	21" Base
WTCD24	24" Base

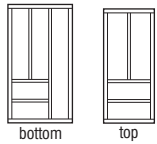
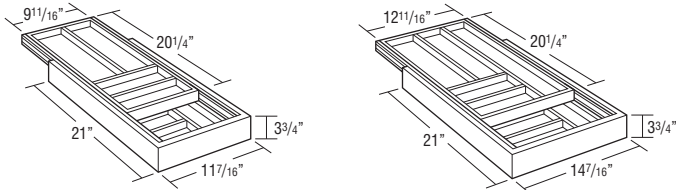

WTCD15

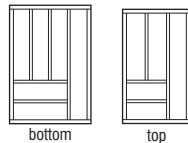

WTCD18

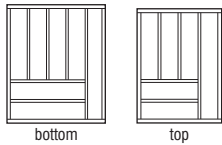
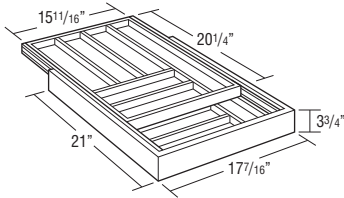

WTCD21

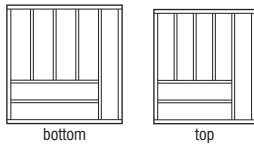
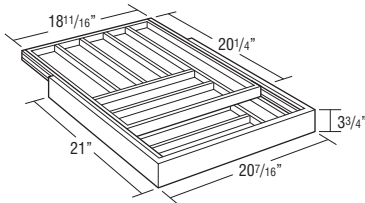

WTCD24

### Cutlery Insert Organizer

CDT

- Universal Application: Cut to fit your cabinet in the field.
- Laminate.

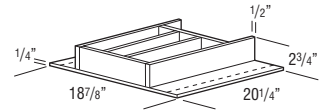

### NEW Cutlery Insert Wood Organizer

CIW15

CIW18

CIW21

CIW24

- Pre-assembled natural wood drawer insert.

Model	Application
CIW15	15" Base
CIW18	18" Base
CIW21	21" Base
CIW24	24" Base

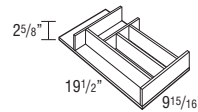

CIW15

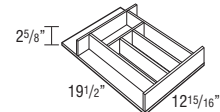

CIW18

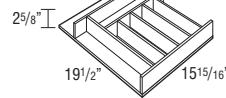

CIW21

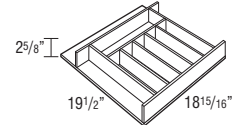

CIW24

## Glass Shelf Kit, 12" Deep

GSK1212

GSK1512

GSK1812

GSK2112

GSK2412

GSK2712

GSK3012

GSK3312

GSK3612

## Glass Shelf Kit, Diagonal:

GSKWD24 (Fits WD2430-WD2442)

GSKWD27 (Fits WD2730-WD2742)

- GSK cannot be trimmed.
- Kit includes two 1/4" tempered shelves.
- Direct ship from manufacturer.

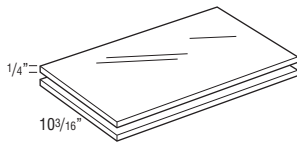

GSK912-GSK3612

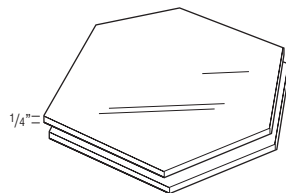

GSKWD24  
GSKWD27

## Straight Heat Shields

OHS

OHSS

- OHS is a pair of 1/16" thick, white metal shields.
- OHSS is a pair of 1/16" thick, stainless steel metal shields.
- Heat Shield is used to deflect heat from self-cleaning ovens away from cabinet doors and drawer fronts.
- For use when additional 1/8" can be added to the oven manufacturer's recommended space requirements.
- Installs on the side of the face frame of each cabinet adjacent to the oven.

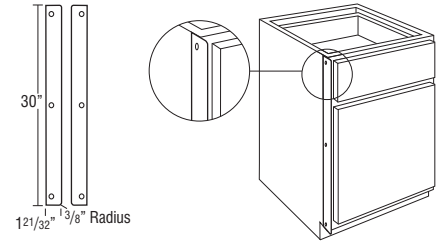

## Mudroom Hook

MRHOOK

- 4" Satin Nickel Mudroom Hook.



## Pegged Dish Organizer

PDO (8 Posts & Board)

PDOPOSTS (4 Posts)

- For use in 36" wide base cabinets.
- Pegged Board is 3/8" thick.
- 29 15/16" x 19 1/2"

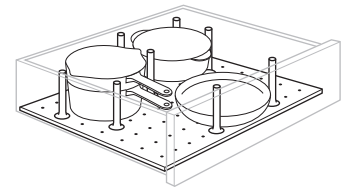

## Recycle Center

DS4

- Fits B27 cabinet. Full extension guides.
- Direct ship from manufacturer.

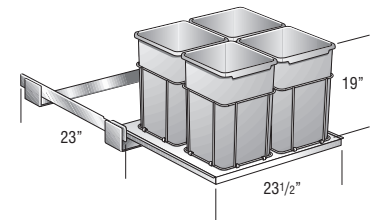

**Roll Trays**

- RTF1224 (B12)
- RTF1524 (B15)
- RTF1824 (B18)
- RTF2124 (B21)/(B42)
- RTF2424 (B24)/(B48)
- RTF2724 (B27)
- RTF3024FW (B30B)
- RTF3324FW (B33B)
- RTF3624FW (B36B)
- Laminate
- RTPG1224 (B12)
- RTPG1524 (B15)
- RTPG1824 (B18)
- RTPG1924 (B39)
- RTPG2124 (B21)/(B42)
- RTPG2224 (B45)
- RTPG2424 (B24)/(B48)
- RTPG2724 (B27)
- RTPG3024FW (B30B)
- RTPG3324FW (B33B)
- RTPG3624FW (B36B)

- Wood
- Includes cabinet and drawer members.
- RTPG trays have SoftTouch guides.
- Available in RD18 and RD21.

**Modifications**

RD
•

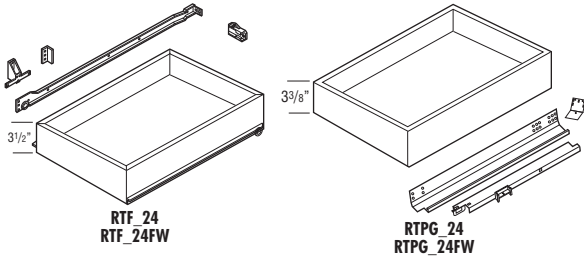

**Shelf Kits**

- USK1212
- USK1512
- USK1812
- USK2112
- USK2412
- USK2712
- USK3012
- USK3312
- USK3612
- USK1224
- USK1524
- USK1824
- USK2124
- USK2424
- USK2724
- USK3024
- USK3324
- USK3624

- 4 adjustable shelves.
- Clips included.

**Modifications**

RD
•*

\*RD not available on 12" deep shelf kits.

**Construction Upgrades**

APU
•

**Shelf Kits**

- USK1821

- 5 adjustable shelves.
- Clips included.

**Construction Upgrades**

APU
•†

†APU shelves will be natural maple.

**Sink Base Caddy**

- SBCADDY

- Caddy is removable and portable.
- Recommended for use in cabinets 18" and wider.
- Caddy dimensions are: 9 15/16" wide x 18 5/16" tall x 18 5/8" deep.
- Caddy fits in cabinets with a minimum: 12" wide x 20 1/2" high frame opening x 21" deep cabinet.

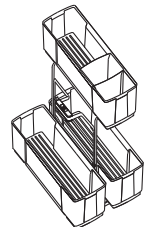

## Spice Rack — Chrome

SRCH12

SRCH15

SRCH18

- Designed for base cabinets only. Mounts to door top and bottom rails.
- Spice rack is chrome.

Model	Fits
SRCH12	B15, B30B, B33B
SRCH15	B18, B36B
SRCH18	B21, B24 L or R

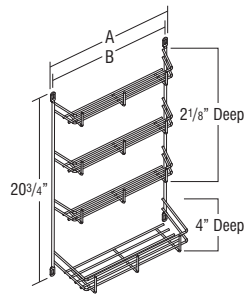

## Spice Rack — Pull-down

SPD18

- Spice Rack Pull-down dimensions: 8 15/16" high x 14 13/16" wide x 10 5/16" deep.
- For use in a minimum 15" wide opening (recommended for use in 18" wide cabinets).
- Maximum Weight Capacity: 15 lbs.
- Must be installed on the floor of the cabinet. Cannot be installed on an adjustable shelf.

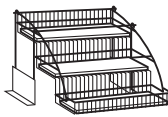

## Stemware Holder

SW24CH

SW30CH

SW36CH

- Holders are chrome. Available in Oak, Cherry, Hickory, and Maple.

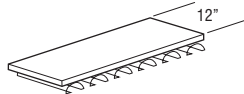

## Tablet Holder

TABLEHLDR

- Mounts under 15" wide cabinet or wider.
- Designed for cabinets a minimum of 12" deep.
- Features an acrylic mounting base and pull-down tablet holder tray.
- Tray is movable forward and backward with a slight side to side rotation, and can be utilized at any position.
- Tray has side cut-outs for a charging cord and can be used to store most tablets when closed, depending on overall thickness, width, height, and weight of the tablet.
- Maximum dimensions for tablet: 11 1/4" x 8 1/2" x 1 1/8" thick. Maximum tablet weight is 3 1/2 lbs.
- Tablet holder has an overall height of 1 17/32" when installed and in closed position (measured from the bottom panel of the cabinet), 0.78" visible from front of cabinet when closed.
- Installation instructions included.

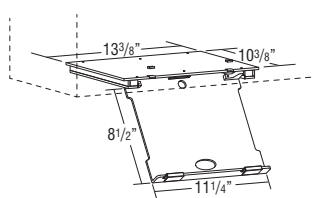

## NEW Tilt-out Trays, Plastic

TOT15

TOT18

- Kit includes 2 white trays and tilt-out hinges.
- SB39-SB48 have 2 fixed panels.
- SB30B-SB36B have 1 long fixed panel.
- SB21-SB27B may only accept one tray.

Model	Size	Application
TOT15	11" w x 2" d x 3 3/4" h	SB30B, SB33B
TOT18	14 1/4" w x 2" d x 3 3/4" h	SB21, SB24, SB24B, SB27B, SB36B, SB39, SB42, SB45, SB48

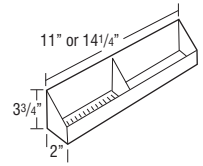

## Tray Divider Kit

WTD

- WTD: Includes 1 divider, 3 clips, and 3 screws.
- Tray divider is chrome.

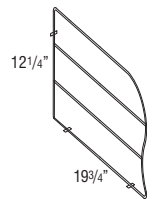

## Tray Roll-out Divider

TDRO12

TDRO15

- TDRO12: 2 removable dividers (3 compartments).
- TDRO15: 3 removable dividers (4 compartments).
- Includes guides.
- 3/8" plywood construction.
- TDRO12 fits B12.
- TDRO15 fits B15.
- Not compatible with roll tray option.
- Not available with RTPG guides.

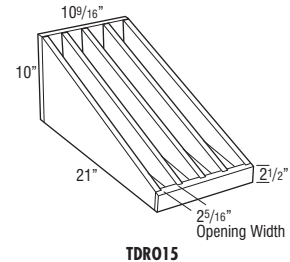
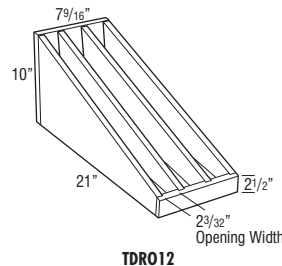

**Wine Glass Holders**

**SWR30 (7 slots)**

- Maximum wine glass base is 3 1/4" diameter.
- May be trimmed to fit smaller cabinets.

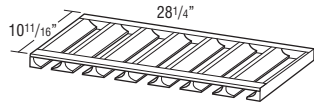

**Wire Half Moon Swing-out**

**DS2**

**DS3**

- DS2 - basket 28"L x 14"W x 1 1/2"H.
- DS3 - basket 34"L x 17"W x 1 1/2"H.
- Load capacity is 35 lbs. per shelf.
- Direct ship from manufacturer.

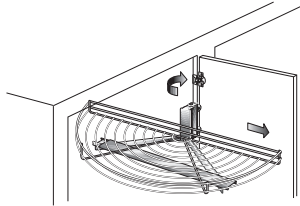

Wire Swing-out	Fits Cabinet
DS2	BC4548
DS3	BC4851

**Wood Spice Drawer Insert**

**WSDI18**

- Wood constructed spice drawer insert for use in 18" wide base cabinet.

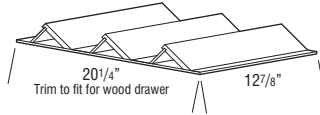

**NEW Stain, Paint, and Touch-up Tools**

**STAINGALLON**

**STAINQUART**

**SPRAYPAINT**

**TK**

**Sales Sample Base**

**SSBASE122915**

**Sales Sample Base**  
12" wide x 29" high x 15" deep

- Available in any style, species, and finish combination.

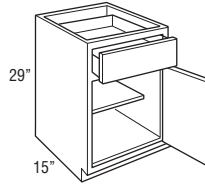

**Modifications**

FPEB	INTGH	WDRWPG
•	•	STD

**Construction Upgrades**

APF	APU	PEF	PEU
•	•	•	•

**Sales Sample**

**SSW Sales Sample Wall**  
15" wide x 21" high

**SSB Sales Sample Base**  
15" wide x 21" high

**SSW1221 Sales Sample Wall**  
12" wide x 21" high

**SSB1221 Sales Sample Base**  
12" wide x 21" high

- Sales sample wall (SSW and SSW1221) includes face frame and door.
- Sales sample base (SSB and SSB1221) includes face frame, door and drawer front.

**Modifications**

FULL
•*

\*FULL available only on SSW.

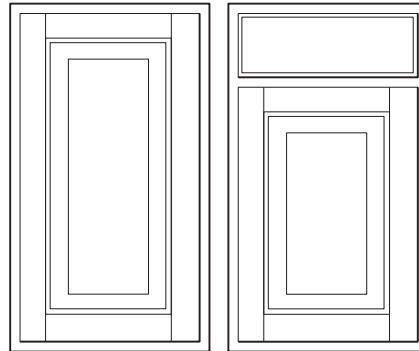

Square  
SSW  
SSW1221

Square  
SSB  
SSB1221

**Brackets, Bumpers, Clips, Screws and Spacers**

“L” Bracket (Fixed Overlay Locator)	L.BRKT
Fixed Front Button (For Sink & Vanity Sink Bases)	FIXDFRT.BTN
Fixed Drawer Front Clip (Pair)	FXD.FRT.CLIP.PR
RTF Roll Tray Bracket Set	RTF.RT.BRKT
RTPG Roll Tray Bracket Set	RTPG.RT.BRKT
Door And Drawer Front Bumpers (Pkg Of 25)	DR.DRWFR.T.BTNS
Glass Clip For Doors With Fixed Grids	GLASS.CLIP.TRAD
Glass Clip For Doors With Removable Grids	GLASS.CLIP.SHKR
Insert Clips W/Screws For Mullion Or Glass Door Frames (Pkg Of 6 Clips W/6 Sets Of Varied Ht Tips) (42 Pcs)	CLIP.RET.PK
Installation Screws For Cabinets (Qty 4)	INSTLSCWS
Microwave Installation Pack	MW.INSTLPK
3MM Peg Shelf Clip - 12Pk	SHE.CLIP.12PK
3MM Peg Shelf Clip - 24Pk	SHE.CLIP.24PK
Wire Tray Divider Clip	WTD.CLIP

**Guide Items**

BSC30 18" Slide Set	BSC30.SLIDSET
FDRW 24" Guide Set	FDRW.24.GDSET
FDRW 21" Guide Set	FDRW.21.GDSET
FDRW 18" Guide Set	FDRW.18.GDSET
PG 24" 5/8 Guide Set	PG.5/8.24.GDSET
PG 21" 5/8 Guide Set	PG.5/8.21.GDSET
PG 18" 5/8 Guide Set	PG.5/8.18.GDSET
PG 15" 5/8 Guide Set	PG.5/8.15.GDSET
PG 12" 5/8 Guide Set	PG.5/8.12.GDSET
DTC 5/8 24" Non-Soft Close Set	DTC.5/8.24.GDST
DTC 5/8 21" Non-Soft Close Set	DTC.5/8.21.GDST

**Hinge Items**

Concealed BER Hinge, Plate, and Screws	BLUM.BER.HGPIT
Concealed Hinge With Screw	.5.HG.SCREW
1 1/4" MFO Hinge w/ Screw	1.25.HG.SCR
1 3/8" Surface Mount Oven Hinge w/ Screw	1.375OVENHG.SCR
Hinge Cabinet Screw	HG.CABT.BERSCRW, HG.CABT.OVENS CR
Bi-Fold Door to Door Hinge For WCER, BC33SS, BC36SS, BER33, BER36 & BER36SF	BER.DR.DR.HGE
Hinge Spacer 25 Pk	HG.SPACER.25PK
Integrated SoftTouch Cup Hinge For Oven Cabinet	INTGH.SURF.MNT
Integrated SoftTouch Cup Hinge	INTGH.MFO, INTGH.PO
INTGH Angle Restriction Clip-DTC	INTGH.RCLP.DTC

**Medicine Cabinet Items**

Mirror Hinge Pair	MIRROR.HG.PR
Magnetic Catch, Plate, and Screw Set	MAG.CATCH.SET
Mirror for MC16	MIRROR
Mirror for TV30	MIRROR
Mirror for TV36	MIRROR
Mirror for TV48	MIRROR

**Miscellaneous Items**

Adjustable Strut (For Sink Base Overlays)	ADJ.STRUT.PR
Door Pin Pack (Pkg Of 2 - For Miter Utility And Pantry Doors)	DR.PIN
Stemware Rack - Chrome (for SW24CH, SW30CH, SW36CH)	SW.RACK
Toekick Box (for BOC or 96" tall cabinets)	TBRD.BOX
Oven Support Kit	OVEN.SUPP.SET
Waste Basket (35 qt. or 50 qt.)	WASTE.BSKT
Broom Clip	BRM.CLIP
Vanity Hamper	VAN.HAMPER

**Plate Rack Spindles**

W3015PRC Spindles - Maple, Cherry, Hickory, Oak, Thermofoil, Laminate	PLT.RCK
W3615PRC Spindles - Maple, Cherry, Hickory, Oak, Thermofoil, Laminate	PLT.RCK

**Shelves**

12" Angle Wall & Base	SHF
24" Wall Diagonal	SHF
27" Wall Diagonal	SHF
9" - 27" Wide Cabinets (Bases & 6"-12" Deep Walls)	SHF
9" - 27" Wide Cabinets (15"-24" Deep Walls)	SHF
30" - 48" Wide Cabinets (Bases & 6"-12" Deep Walls)	SHF
30" - 48" Wide Cabinets (15"-24" Deep Walls)	SHF
WEC30 - WEC42D & WCER	SHF
WCER24	SHF
MW2736B & MW2742B Microwave Shelf - Maple, Cherry, Hickory, Oak, Thermofoil, Laminate	MW.SHF
MW3036B & MW3042B Microwave Shelf - Maple, Cherry, Hickory, Oak, Thermofoil, Laminate	MW.SHF

- When MI is specified, must also specify plywood option (APF).

**Spin Shelves and Posts**

30"/33" High Wall Diagonal Spin Post	WD.POST
36" High Wall Diagonal Spin Post	WD.POST
39" High Wall Diagonal Spin Post	WD.POST
42" High Wall Diagonal Spin Post	WD.POST
BC36SPN shelf	SHF
Bearing W/Index & Template-After Oct 2013	SS.BRNG&TMPLT
Spin Hardware	SPN.HDWR
Spin Post	SPN.POST
Wall Diagonal Wood Spin Shelf	WD.SPN.SHF



# OPAQUE FINISH AWARENESS AGREEMENT



Thank you for choosing an opaque finish from Homecrest Cabinetry. Because your satisfaction is important to us, we want you to be aware of the unique characteristics of painted finishes that may be quite different from other cabinetry finishes.

## Characteristics of Opaque Finishes

Opaque finishes are different from standard wood finishes. On all wood products, expansion and contraction are typical due to changes in climate conditions. Due to this normal movement, opaque finishes may develop slight separation lines, finish breaks and seam lines. These will be most notable at stile, rail and panel joints. Joint separations may become more noticeable over time and through season changes.

All MDF and wood opaque finishes first receive a primer coat designed to provide optimum fill and leveling of the surface. This provides an even base for the color and finish coats.

Seam lines and finish breaks are normal characteristics of opaque finishes and should not be considered a reason for product replacement. Over time, there may be a slight color shift in the finish, due to exposure to natural and artificial light.



Example of door front joint separation



Example of door front joint separation



Example of door end joint separation

*I have read and understand the statements above and agree that the characteristics of opaque finishes from Homecrest Cabinetry are acceptable. I understand that neither Homecrest Cabinetry or the Homecrest Cabinetry Dealer listed below is responsible in the event that these characteristics are later found to be less desirable than expected.*

\_\_\_\_\_  
*Customer Signature*

\_\_\_\_\_  
*Dealer Signature*

\_\_\_\_\_  
*Customer Name (please print)*

\_\_\_\_\_  
*Dealer Name (please print)*

\_\_\_\_\_  
*Dealer Purchase Order Number*

**This completed form must accompany your product order.  
Orders for Opaque finishes will not be confirmed without a signed agreement.**

# RUSTIC HICKORY DESCRIPTION AGREEMENT



Congratulations on your selection of Homecrest cabinetry in Rustic Hickory. Because of its unique characteristics Rustic Hickory is quite different from other wood types you may be familiar with. Your satisfaction is important to us, and we want you to fully understand the characteristics that make Rustic Hickory so distinctive.

It is important to realize that the beauty of wood cabinetry comes from the natural qualities of wood itself. Rustic Hickory is characterized by its nearly white to dark brown dramatic color variations with wild flowing green patterns and may contain a variety of pin holes, open and closed knots of various sizes and colors, small cracks, bird pecks, mineral streaks, and grain variation. Some knots may have small holes through the panel. Larger holes will not be filled. In addition, the wood will contain color difference caused by variations in minerals found in the soil, creating visible mineral tracks. However, those characteristics that might compromise the structural integrity of the door will not be included.

Sound Closed Knot (not moveable) – Expected in Rustic Hickory up to approximately 3” diameter.

Sound Knot with Cracks – Expect sound knots with open cracks up to approximately 1” in length.

Open Knot (through door) – Expected in Rustic Hickory with open area up to approximately 3/4” diameter.

Note: 3/4” diameter is about the size of a penny. Holes created by open knots pass completely through the door and are desirable for this rustic look.

Unsound Knot (moveable core) – Not to be expected.

Knot Cluster (cluster of tight sound knots) – To be expected in Rustic Hickory.

Worm Holes/Pin Holes (can go through door) – Can be expected on Rustic Hickory up to approximately 1/4” diameter.

Worm Tracks – Can be expected on Rustic Hickory in sizes up to approximately 1/8” wide by 8” long.

Rustic Hickory as described is featured for doors and drawer fronts. Other areas of the product will utilize standard Hickory. Customers should expect a much lower occurrence of rustic characteristics in these other areas. Also, the natural characteristics mentioned occur randomly in Rustic Hickory. All doors and drawer fronts will contain some combination of the common Rustic Hickory markings; however, it will be uncommon to find all markings on any single piece.

The natural characteristics of wood described above and variations in grain patterns and color are not considered reasons for product replacement. We mention these characteristics because neither Homecrest nor your Homecrest dealer can be responsible for these conditions and variations.

Accordingly, we ask that the following agreement be signed for Rustic Hickory orders.

I have read the foregoing and find the characteristic variations of wood with Rustic Hickory are desirable.

As such, I agree not to hold Homecrest and/or the Homecrest dealer listed below responsible in the event that these characteristics are later found by me to be less desirable than I had expected.

\_\_\_\_\_  
Customer Signature

\_\_\_\_\_  
Dealer Signature

\_\_\_\_\_  
Customer Name (please print)

\_\_\_\_\_  
Dealer Name (please print)

\_\_\_\_\_  
Dealer Purchase Order Number



## **Announcing the Homecrest® Express Response™ Program**

### **Our commitment to Channel Partners, Designers and Customers**

**Purpose:** The Homecrest® Express Response program is used to expedite orders when customers need product faster than normal lead time to correct issues with an existing order. Below is an overview of the Express Response program and what you can expect from the Homecrest commitment to superior service.

#### **Express Response Guidelines**

- Eligible orders must be associated with a previous order number.
- All eligible orders received by 12 NOON E.T. Monday-Friday will be automatically scheduled for Express Response that same day. Orders received after the cut-off will be processed on the next business day.
- Lead time calculation is based on receipt of a clean order. Clean orders are orders in which all information is provided and accurate.
- There are no cancellations or returns once an Express Response order is received.
- Due to the nature of special orders and appliance panels, they are excluded from Express Response and will be processed as a standard lead time order.
- Express Response is available within the continental United States. Should Alaska, Hawaii or international shipments be required, customer service representatives are ready to assist by providing shipping information and determining lead times.

#### **Lead Times**

##### **12 working days or less from order to delivery (channel partner):**

- Items shipped via LTL, Parcel ground or truckload

**Questions?** If you have questions that aren't answered here, contact your Customer Service team.

### **Discontinued Product Policy**

60 days minimum notice to customers announcing the discontinuation of a product line.

Product will no longer be available for order after the discontinuation date. Only warranty orders will be considered. Even with warranty orders we will have the option to replace customer's defective product with the same discontinued product they originally purchased, or replace all doors originally ordered with a current product that is similar in appearance.



KITCHEN CABINET MANUFACTURERS ASSOCIATION  
ENVIRONMENTAL STEWARDSHIP PROGRAM (ESP)  
ALL PRODUCTS IMPACT THE ENVIRONMENT  
FOR ESP PROGRAM CRITERIA, VISIT KCMA.ORG

# LIMITED LIFETIME WARRANTY

Homecrest Cabinetry® is a certified brand in the Kitchen Cabinet Manufacturers Association (KCMA) Environmental Stewardship Program. The program recognizes companies that demonstrate an ongoing commitment to environmental practices and sustainability.

## VISIT US AT: [HOMECRESTCABINETRY.COM](http://homecrestcabinetry.com)

All orders taken are subject to approval by Homecrest and, after acceptance, are not subject to change without our consent. Homecrest carefully inspects and packages all merchandise and will ship via the best transportation facility available as it determines.

Any claim for transportation damage must be handled with the carrier.

No merchandise returns to Homecrest Cabinetry without prior written approval.

Styles, product availability and construction may vary slightly from those shown in this book due to material availability and/or design evolution. Specifications are subject to change without notice. Customer service is available if your design requires verification of product availability and specifications.

Prices effective 1.2.2019

MBCI Customer Service Operating Hours:  
Mon-Fri, 8:00AM – 6:00PM EST  
MBCI Customer Service Phone: 1.855.722.2148  
MBCI Customer Service Fax: 1.800.737.1500

Designer ID#: \_\_\_\_\_

Customer Account #: \_\_\_\_\_

Sales Rep: \_\_\_\_\_

# HOMECREST®

CABINETRY



[homecrestcabinetry.com](http://homecrestcabinetry.com)  
#homecrestcabinetry  
© 2019 MasterBrand Cabinets, Inc.

HCPRSPEC0119 2018-10/WDS/6.9M