

# Chapter 26. Hypercalcemia: Pathogenesis, Clinical Manifestations, Differential Diagnosis, and Management

Elizabeth Shane<sup>1</sup> and Dinaz Irani<sup>2</sup>

<sup>1</sup>Department of Medicine, Columbia University, College of Physicians and Surgeons, New York, New York; and <sup>2</sup>Metabolic Bone Disease Research Program, Columbia University Medical Center, New York, New York

## INTRODUCTION

The clinical presentation of hypercalcemia varies from a mild, asymptomatic, biochemical abnormality detected during routine screening to a life-threatening medical emergency. In this chapter, pathogenesis, clinical manifestations, differential diagnosis, and management of hypercalcemia will be discussed.

## PATHOGENESIS

The concentration of calcium in the extracellular fluid is critical for many physiologic processes. Under normal circumstances, the range is remarkably constant, between 8.5 and 10.5 mg/dl (2.1–2.5 mM). The exact normal range varies slightly, depending on the laboratory. Approximately one-half the total serum calcium is bound to plasma proteins, primarily albumin. A small component of the total calcium is complexed to anions such as citrate or sulfate. The remaining one-half circulates as the free calcium ion. It is only this ionized portion of the total serum calcium that is physiologically important, regulating neuromuscular contractility, the process of coagulation, and a variety of other cellular activities.

In a variety of chronic illnesses, there may be a substantial reduction in the serum albumin concentration. Under such circumstances, the total serum calcium concentration may be low, whereas ionized calcium concentrations remain normal. A simple correction for hypoalbuminemia may be made by adding 0.8 mg/dl to the total serum calcium concentration for every 1.0 g/dl by which the serum albumin concentration is lower than 4.0 g/dl. Thus, a patient with a total serum calcium of 10.5 mg/dl and a serum albumin level of 2.0 g/dl has a corrected total serum calcium of 12.1 mg/dl. Conversely, falsely elevated serum calcium levels may be observed, usually as the result of an elevation of the serum albumin because of dehydration or hemoconcentration during venipuncture. A similar maneuver can be performed to correct the serum calcium in this situation, except that the correction factor must be subtracted from the serum calcium level.

In contrast to changes in the serum albumin concentration, which affect the total but not the ionized calcium level, alterations in pH affect the ionized but not the total calcium concentration. Acidosis increases the ionized calcium by decreasing the binding of calcium ions to albumin, whereas alkalosis decreases the ionized calcium by enhancing binding of calcium ions to albumin. Measurement of total serum calcium, particularly if corrected for the serum albumin, is usually adequate for most situations. However in complex cases (changes in both albumin and pH), a direct measurement of the ionized calcium should be performed.

Under normal circumstances, the plasma calcium concentration reflects a balance between the flux of calcium into the extracellular fluid from the gastrointestinal (GI) tract, the skeleton, and the kidney, and the flux of calcium out of the extracellular fluid into the skeleton and the urine. Hypercalcemia develops when the rate of calcium entry into the blood compartment is greater than its rate of removal. This occurs most commonly when accelerated osteoclastic bone resorption or excessive GI calcium absorption delivers quantities of calcium into the blood that exceed the capac-

ities of the kidney to eliminate it and of the skeleton to reclaim it. Less commonly, normal rates of calcium entry into the extracellular fluid may result in hypercalcemia if the process of renal excretion or that of bone mineralization is impaired.

Accelerated bone resorption by multinucleated bone-resorbing osteoclasts is the primary pathogenetic mechanism in most instances of hypercalcemia.<sup>(1)</sup> Osteoclasts may be stimulated to resorb bone by PTH, PTH-related protein (PTHrP), and 1,25-dihydroxyvitamin D, all of which have been shown to cause hypercalcemia.<sup>(2,3)</sup> A number of cytokines (IL-1 $\alpha$ , IL-1 $\beta$ , IL-6, TNF, lymphotoxin, and TGF- $\alpha$ ) also stimulate osteoclastic bone resorption either alone or in concert with PTHrP.<sup>(4)</sup> Although low levels of PTHrP are expressed by many normal tissues, high levels may be secreted from some malignant tumors. Some cytokines have been linked to the development of hypercalcemia in human malignancy.<sup>(4)</sup> Excessive GI absorption of calcium is a much less common cause of hypercalcemia, although it may play a role in hypercalcemic states characterized by excess vitamin D, such as lymphoma or vitamin D intoxication. Whether the primary cause of the hypercalcemia is accelerated bone resorption or excessive GI tract absorption of calcium, the kidney is the primary defender against a rise in the serum calcium. Thus, hypercalcemia is usually preceded by hypercalciuria, and it is only when the capacity of the kidney to excrete calcium has been exceeded that the patient becomes hypercalcemic.<sup>(5)</sup>

Several other factors may contribute to the pathogenesis of hypercalcemia. In addition to stimulating osteoclast-mediated bone resorption, both PTH and PTHrP increase reabsorption of calcium from the distal tubule, thus interfering with the ability of the kidneys to clear the filtered calcium load. PTH and PTHrP also increase 1,25-dihydroxyvitamin D synthesis, further contributing to a hypercalcemic state.<sup>(6)</sup> Hypercalcemia interferes with the action of antidiuretic hormone on the distal tubule, causing a form of nephrogenic diabetes insipidus that results in polyuria. The thirst mechanism may not be fully operative because of the nausea and vomiting that frequently accompany hypercalcemia; thus, urinary fluid losses may not be replaced, and dehydration may ensue. The resulting reduction in the extracellular fluid volume and associated reduction in the glomerular filtration rate exacerbate the hypercalcemia. Finally, immobilization may also contribute to hypercalcemia by virtue of associated increases in bone resorption.

## CLINICAL MANIFESTATIONS

The clinical presentation of the hypercalcemic patient<sup>(7)</sup> may involve any of several organ systems (see Table 1). The signs and symptoms tend to be similar regardless of the etiology of the hypercalcemia. Because an optimal extracellular calcium concentration is necessary for normal neurologic function, symptoms of neurologic dysfunction often predominate in hypercalcemic states. The patient (or family members) may notice subtle changes in the ability to concentrate or an increased sleep requirement. With increasing severity of the hypercalcemia, symptoms may gradually progress to depression, confusion, and even coma. Muscle weakness is common.

Gastrointestinal symptoms are often prominent, with constipation, anorexia, nausea, and vomiting present in varying degrees.

Dr. Shane has received research funding from Novartis, but not in the field of hypercalcemia. Dr. Irani has reported no conflicts of interest.

TABLE 1. CLINICAL MANIFESTATIONS OF HYPERCALCEMIA

Cardiovascular
Shortened QT interval on ECG
Arrhythmias (rare unless on digitalis)
Bradycardia
Hypertension
Bundle branch/AV blocks
Cardiac arrest (if severe)
Neuromuscular
Emotional lability
Confusion
Delirium
Psychosis
Stupor
Muscle weakness
Headache
Seizures (rare)
Renal
Polyuria
Polydipsia
Nocturia
Hypercalciuria
Nephrolithiasis
Nephrocalcinosis
Renal failure
Gastrointestinal
Nausea/vomiting
Anorexia
Constipation
Abdominal pain
Peptic ulcers
Pancreatitis
Skeletal
Bone pain/arthralgia
Osteopenia/osteoporosis in cortical bone (often seen in wrist)
Other
Shock
Death

Pancreatitis and peptic ulcer disease are unusual but have been reported. They may be somewhat more common if the hypercalcemia is caused by primary hyperparathyroidism than other causes of hypercalcemia.

Polyuria, resulting from the impaired concentrating ability of the distal tubule, is common, particularly during the early phases. Polydipsia is also usually present. The combination of polyuria and diminished fluid intake caused by GI symptoms may lead to severe dehydration. Nephrolithiasis occurs in patients with primary hyperparathyroidism (15–20% in recent series), but along with nephrocalcinosis, it may also develop in patients with hypercalcemia because of other causes, particularly when the hypercalcemia is chronic.

Hypercalcemia increases the rate of cardiac repolarization. Thus, shortening of the Q-T interval is observed commonly on the electrocardiogram. Bradycardia and first-degree atrioventricular block, as well as other arrhythmias, may occur. Caution should be exercised when treating the hypercalcemic patient with digitalis, because increased sensitivity to this drug has been observed.

In general, the presence or absence of symptoms correlates both with the degree of elevation of the serum calcium and with the rapidity of its rise. Most patients do not begin to show clinical features of hypercalcemia until the total calcium concentration exceeds 12 mg/dl, and patients are almost invariably symptomatic at levels >14 mg/dl. However, there is much individual variation in this regard. Certain patients will be quite symptomatic with

moderate hypercalcemia of 12.0–14.0 mg/dl, whereas others may show no overt symptomatology at a similar level. The latter situation occurs most often in the setting of chronic hypercalcemia. In other circumstances, the absence of symptoms in the severely hypercalcemic patient should prompt one to measure the ionized calcium level to be certain that hypercalcemia is not secondary to excessive binding of calcium to plasma proteins.

## DIFFERENTIAL DIAGNOSIS

Detection of an elevated serum calcium requires that the etiology be established. The many causes of hypercalcemia are listed in Table 2, and most will be covered separately in subsequent chapters. However, certain general principles that apply to the differential diagnosis of hypercalcemia are covered here.

Malignancy and primary hyperparathyroidism are by far the most common causes of hypercalcemia, accounting for >90% of hypercalcemic patients.<sup>(7)</sup> Differentiating between these two diagnoses is generally not difficult on clinical grounds alone. The vast

TABLE 2. DIFFERENTIAL DIAGNOSIS OF HYPERCALCEMIA

Most common
Primary hyperparathyroidism
Malignant disease
PTH-related protein (carcinoma of lung, esophagus, head and neck, renal cell, breast, ovary, and bladder)
Ectopic production of 1,25-dihydroxyvitamin D (lymphoma)
Lytic bone metastases (multiple myeloma, hematologic malignancies and breast carcinoma)
Other factor(s) produced locally or ectopically
Uncommon
Endocrine disorders
Thyrotoxicosis
Granulomatous diseases
Sarcoidosis
HIV
Drug-induced
Vitamin D
Thiazide diuretics
Lithium
Estrogens and antiestrogens
Androgens (breast cancer therapy)
Aminophylline
Vitamin A
Aluminum intoxication (in chronic renal failure)
Miscellaneous
Immobilization
Renal failure (acute and chronic)
Total parenteral nutrition
Rare
Endocrine disorders
Pheochromocytoma
Vasoactive intestinal polypeptide-producing tumor
Familial hypocalciuric hypercalcemia
Granulomatous diseases
Tuberculosis
Histoplasmosis
Coccidioidomycosis
Leprosy
Miscellaneous
Milk-alkali syndrome
Hypophosphatasia
William's syndrome
Rhabdomyolysis (presentation is usually preceded by a hypocalcemic state)

majority of patients with primary hyperparathyroidism have relatively mild hypercalcemia, within 1.0 mg/dl above the upper limits of normal and usually <12.0 mg/dl. They are often asymptomatic. Review of past medical records may reveal that the hypercalcemia has been present for months to years. When symptoms of hypercalcemia are present, they tend to be chronic, such as nephrolithiasis. In contrast, patients with hypercalcemia of malignancy are usually overtly ill and are more likely to manifest the classic signs and symptoms of an elevated serum calcium. In general, the malignancy itself is readily apparent and presents little diagnostic challenge to the physician. Less commonly, occult malignancy may present with hypercalcemia, or the patient with primary hyperparathyroidism may present with moderate to severe elevation of the serum calcium that is associated with symptoms or with the acute onset of severe hypercalcemia (parathyroid crisis). Such cases pose a greater diagnostic problem.

The availability of reliable assays for intact PTH based on double antibody techniques (two-site, immunoradiometric, or chemiluminescent assays) has been of great diagnostic value in the evaluation of the hypercalcemic patient. The majority of patients with primary hyperparathyroidism have intact PTH levels that are frankly elevated. Patients with hypercalcemia of malignancy virtually always show suppressed or undetectable levels of intact PTH. It is distinctly unusual for a patient with malignancy (excepting parathyroid cancer) to show elevated levels of PTH. When this occurs, two possibilities exist: the patient may have concomitant primary hyperparathyroidism or the malignancy itself may be secreting PTH, an uncommon event.

In most patients with malignancy-associated hypercalcemia, the hypercalcemia is a result of secretion of PTHrP by the tumor.<sup>(2)</sup> Although elevated levels of PTHrP can prove helpful in the diagnosis of hypercalcemia of malignancy, a negative result does not exclude malignancy. Certain tumors cause hypercalcemia by mechanisms independent of PTHrP, such as secretion of other bone-resorbing cytokines or extrarenal conversion of 25-hydroxyvitamin D to 1,25-dihydroxyvitamin D. Local bone-resorbing effects of tumors such as breast cancer also may be involved.

Hypercalcemia from causes other than malignancy or primary hyperparathyroidism may also occur. A thorough history and physical examination are invaluable in arriving at the correct diagnosis. Each of the etiologies listed in Table 2 is covered in one of the other chapters in this section.

### MANAGEMENT

The management of hypercalcemia rests on several principles. The underlying cause of the hypercalcemia should be elucidated, followed by maneuvers that reduce the serum calcium by expanding intravascular volume, increasing urinary calcium excretion and inhibiting bone resorption. The decision to institute therapy for the hypercalcemic patient depends on the level of the serum calcium and the presence or absence of clinical manifestations of an elevated serum calcium. In general, patients with mild hypercalcemia (<12.0 mg/dl) do not have symptoms of hypercalcemia and do not derive significant clinical benefit from normalization of their serum calcium. However, although immediate intervention is not usually necessary, such patients should be encouraged to increase oral fluid intake, avoid becoming dehydrated, eat a diet that is moderate in calcium content, and discontinue any drugs that might be contributing to the hypercalcemia (e.g., thiazide diuretics). In contrast, when the serum calcium is >14.0 mg/dl, more aggressive therapy should be initiated regardless of whether the patient has signs or symptoms of hypercalcemia. Moderate elevation of the serum calcium (12.0–14.0 mg/dl) should be treated aggressively if the patient shows clinical signs or symptoms consistent with hypercalcemia. However, if such a patient is asym-

ptomatic, a more conservative approach may be appropriate. It is also important to consider the underlying cause of the hypercalcemia when deciding whether therapy is necessary and the type of therapy to institute. For example, a patient with acute primary hyperparathyroidism, a completely curable condition, would warrant more aggressive treatment than a patient with diffuse metastatic cancer and a poor prognosis. Another difficult situation arises in the patient whose serum calcium is ~12.0 mg/dl, not within the range one would usually treat aggressively, yet who has an altered mental status or other symptoms that could conceivably be ascribed to a hypercalcemic state. In such situations, it is important to consider other potential causes for the symptoms.

The management of acute hypercalcemia is outlined in Table 3. When the serum calcium exceeds 12.0 mg/dl and signs and symptoms are present, a series of general measures should be instituted. Initial management should include the discontinuation of thiazides, parent vitamin D or vitamin D analog (e.g., calcitriol, paricalcitol), lithium, and sedatives because they may contribute to the hypercalcemic state. The patient should also be mobilized as soon as possible to prevent increased bone resorption.<sup>(8)</sup> Other therapeutic maneuvers tend to lower serum calcium by increasing urinary calcium excretion.<sup>(9,10)</sup> Dehydration, resulting from the pathophysiologic events induced by the hypercalcemia (anorexia, nausea, vomiting, defective urinary concentrating mechanism, and polyuria) is very common. Hydration with normal saline, to correct the extracellular fluid deficit, is central to the early management of hypercalcemia from any cause. Restoration of the volume deficit can usually be achieved by the continuous infusion of 3–6 liters of 0.9% sodium chloride over a 24- to 48-h period. This maneuver generally lowers the serum calcium by 1.0–3.0 mg/dl. Hydration with saline enhances urinary calcium excretion by increasing glomerular filtration of calcium and decreasing both proximal and distal tubular reabsorption of sodium and calcium. However, saline hydration alone does not usually establish normocalcemia unless the calcium concentration is only modestly elevated. Moreover, this form of therapy must be used with caution in elderly patients or in others with compromised cardiovascular, hepatic or renal function.

In severe cases of hypercalcemia, a loop diuretic, such as furosemide or ethacrynic acid, may be added to saline hydration in the therapy of hypercalcemia. Loop diuretics act on the thick ascending loop of Henle to inhibit both sodium and calcium reabsorption. Thus, the use of such agents enhances urinary calcium losses, increases the likelihood of normalization of the serum calcium level, and mitigates the dangers of hypernatremia and volume overload that may accompany the use of intravenous saline. However, loop diuretics are not necessary in most cases, should be initiated only after extracellular fluid volume has been replenished, and only in small doses (furosemide, 10–20 mg) as necessary to control clinical manifestations of volume excess. It is essential to monitor volume status and serum electrolytes closely if diuretics are necessary to control hypercalcemia. Overzealous use of loop diuretics before intravascular volume has been restored can worsen hypercalcemia by exacerbating volume depletion. Hypokalemia and other electrolyte abnormalities can ensue. Intensive therapy with large doses of furosemide (80–100 mg every 1–2 h) and replacement of fluid and electrolytes based on measured urinary losses is rarely indicated. It must be emphasized that thiazide diuretics are contraindicated in this setting because they decrease renal calcium excretion and may worsen hypercalcemia.

Dialysis, another general measure, is usually reserved for the severely hypercalcemic patient. Peritoneal dialysis or hemodialysis with a low or zero calcium dialysate will lower serum calcium rapidly in those patients who are refractory to other measures or who have renal insufficiency.

Specific approaches to the hypercalcemic patient are based on

TABLE 3. MANAGEMENT OF HYPERCALCEMIA

<i>Intervention</i>	<i>Onset of action</i>	<i>Duration of action</i>	<i>Benefits</i>	<i>Risks</i>
Normal saline 3–6 liters IV daily for 1–3 days	Hours	During infusion	Rehydration; enhanced filtration and excretion of calcium	Volume overload/congestive heart failure
Furosemide 10–20 mg IV (for use in severe cases, and ONLY after ECF volume is restored)	Hours	During treatment	Prevents volume overload; further increases urinary calcium excretion	Hypokalemia; dehydration (patient should be monitored closely)
Calcitonin 4–8 IU/kg IM injection every 6–8 h	Hours	2–3 days	Rapid onset	Limited effect; short duration of action, flushing, nausea, rebound increase in serum calcium
Zoledronic acid 4 mg IV over 15 minutes	1–3 days	Weeks	Most potent/effective bisphosphonate; long acting	Renal failure; transient fever, mild hypophosphatemia, asymptomatic hypocalcemia
Pamidronate 60–90 mg IV over 2–4 h	1–3 days	Weeks	Potent; less costly than zoledronic acid	Renal failure; transient fever, mild hypophosphatemia, asymptomatic hypocalcemia
Glucocorticoids 200–300 mg IV hydrocortisone (or equivalent) daily for 3–5 days	Days	Days to weeks	Useful in the setting of some hematological malignancies, vitamin D intoxication and sarcoidosis	Not useful in solid tumor malignancies or for hyperparathyroidism, immunosuppression, Cushing's syndrome
Dialysis	Hours	During use (~2 days)	Rapid onset, useful in renal failure patients	Invasive, complex procedure

General measures should include treatment of underlying causes, oral hydration, early mobilization, and discontinuation of medications that may cause or exacerbate hypercalcemia.

the underlying pathophysiology. Excessive mobilization of calcium from the skeleton resulting from an accelerated rate of bone resorption is the most important factor in the pathogenesis of hypercalcemia in the majority of patients. Numerous pharmacologic agents are available that specifically block osteoclast-mediated bone resorption and effectively lower serum calcium in most hypercalcemic patients (Table 3). In severely hypercalcemic patients, agents that specifically inhibit bone resorption are necessary to effect normalization of the serum calcium.

Bisphosphonates are bone-seeking compounds that bind to hydroxyapatite and prevent its dissolution. Osteoclast function is impaired after exposure to bisphosphonates, and these drugs have enjoyed increasing use in disorders characterized by excessive bone resorption. Intravenous administration is usually necessary when they are used to treat hypercalcemia. Bisphosphonates should be administered in large volumes of saline over 15 minutes to 4 h, depending on the bisphosphonate, to prevent nephrotoxicity caused by precipitation of calcium bisphosphonate. Three bisphosphonates, zoledronic acid, pamidronate, and etidronate, are currently approved for the treatment of hypercalcemia in the United States. Clodronate and ibandronate are also effective bisphosphonates that have enjoyed widespread use in Europe and the United Kingdom for the treatment of hypercalcemia.<sup>(11,12)</sup>

Zoledronic acid is currently the most potent bisphosphonate available for the treatment of hypercalcemia. The recommended dose is 4 mg administered intravenously over 15 minutes. The most common adverse event is transient fever (44.2%). Mild hypophosphatemia and asymptomatic hypocalcemia may also occur. The majority of patients will normalize serum calcium levels

in <10 days.<sup>(13)</sup> Treatment with zoledronic acid may be repeated after at least 7 days if a complete response has not been achieved.

Pamidronate is also widely used for the treatment of hypercalcemia. Although a variety of regimens have been reported, the recommended dose is 60–90 mg administered intravenously as a single infusion over 2–4 h. Pamidronate may cause transient fever (33% of patients)<sup>(13)</sup> and myalgias during the day after the infusion. Preemptive treatment with acetaminophen ameliorates these side effects in the majority of patients. Occasionally, transient leukopenia may develop. Mild, usually asymptomatic, hypocalcemia and hypophosphatemia may occur in some patients, particularly with higher doses (90 mg). The 90-mg dose has also been associated with infusion reactions. The duration of the hypocalcemic effect of pamidronate is variable, ranging from several days to several weeks. The benefits of bisphosphonates reach beyond normalizing serum calcium levels in the setting of certain malignancies. Zoledronic acid, pamidronate, and clodronate are also beneficial in reducing the progression of skeletal metastases and preventing the onset of hypercalcemia in patients with breast and prostate cancer.<sup>(14–16)</sup> Additionally, monthly zoledronic acid and pamidronate infusions reduce the skeletal complications of multiple myeloma.<sup>(17,18)</sup> It is important to note that reversible decreases in renal function have been observed with the use of both zoledronic acid and pamidronate. Therefore, these agents should be used with caution in patients with impaired renal function. This risk is decreased when they are administered with adequate amounts of saline and over the appropriate amount of time (15 minutes for zoledronic acid and 2–4 h for pamidronate).<sup>(8)</sup>

A pooled analysis of two randomized, controlled clinical trials

found zoledronic acid to be more effective and longer acting than pamidronate in the treatment of hypercalcemia. Zoledronic acid has the added benefit of a shorter infusion time (15 minutes versus 2–4 h). Adverse event profiles were similar in both groups. However, it should be noted that pamidronate is less costly and some argue the clinical significance of the difference in calcemic control between the two groups.<sup>(8)</sup>

Etidronate, a first-generation bisphosphonate, can also be administered through intravenous infusion for therapy of hypercalcemia.<sup>(14)</sup> However, the more potent bisphosphonates are associated with a more rapid onset of action, a larger decline in serum calcium, a longer duration of action, and less renal toxicity than a 3-day course of etidronate.<sup>(13,19)</sup> Therefore, zoledronic acid and pamidronate have largely replaced etidronate in the therapy of hypercalcemia.

Calcitonin is a polypeptide hormone that is secreted by the parafollicular C cells of the thyroid gland. Salmon calcitonin is the most potent and frequently used form of the drug. Calcitonin inhibits osteoclastic bone resorption, increases urinary calcium excretion, and is a very safe drug. Moreover, calcitonin has the most rapid onset of action of the available calcium-lowering drugs, causing the serum calcium to fall within 2–6 h of administration. The usual dose ranges from 4 to 8 IU/kg administered by intramuscular or subcutaneous injection every 6–8 h. Unfortunately, the hypocalcemic effect of calcitonin is transient, not as pronounced as the bisphosphonates, and rarely normalizes the serum calcium. The serum calcium concentration usually declines by a mean of 2 mg/dl and may begin to rise again within 24 h, despite continued therapy. Calcitonin given in combination with bisphosphonates seems to achieve a more rapid and greater decrease in the serum calcium than when either drug is administered by itself. Used in this way, calcitonin has a role at the outset of therapy in instances of severe hypercalcemia, when it is desirable to lower the serum calcium more rapidly than can be accomplished with a bisphosphonate alone.<sup>(9)</sup>

Plicamycin, previously called mithramycin, is a cytotoxic antibiotic that blocks RNA synthesis in osteoclasts and therefore inhibits bone resorption. Plicamycin has considerable toxicity (bone marrow, renal, hepatic), which limits its usefulness in the treatment of hypercalcemia. Bisphosphonates have replaced plicamycin as a less toxic first-line therapy in the severely hypercalcemic patient. Gallium nitrate, originally studied as a therapeutic agent for cancer, is also approved by the Food and Drug Administration for the therapy of hypercalcemia. The rate of fall of the serum calcium was rather slow, especially compared with calcitonin and the bisphosphonates. Gallium nitrate also has nephrotoxic effects and is contraindicated in renal failure. For these reasons, it is not the ideal agent for therapy of hypercalcemia and is not in common use.

Glucocorticoid therapy has been used for many years to treat hypercalcemia, particularly when caused by hematologic malignancies such as lymphoma and multiple myeloma. Glucocorticoids are also effective in situations such as vitamin D toxicity or granulomatous diseases in which the hypercalcemia is mediated by the actions of 1,25-dihydroxyvitamin D. Glucocorticoids are seldom effective in patients with solid tumors or primary hyperparathyroidism. The usual dose is 200–300 mg of intravenous hydrocortisone, or its equivalent, daily for 3–5 days.

Intravenous phosphate was used in the past to lower serum calcium in hypercalcemic patients. However, intravenous phosphate is accompanied by a substantial risk of precipitation of calcium-phosphate complexes, leading to severe organ damage and even death. This form of therapy is not recommended.

Therapy for the underlying cause of the hypercalcemia should not be neglected, because specific therapy may be the most effective

approach to the problem. However, patients with widespread metastatic disease, in whom no further specific antitumor chemotherapy is to be given, may be approached with the realization that reduction of the serum calcium per se will achieve little in the long run. In these circumstances, sometimes the best approach is to resist specific measures to reduce the serum calcium and to make the patient as comfortable as possible.

## REFERENCES

1. Attie MF 1989 Treatment of hypercalcemia. *Endocrinol Metab Clin North Am* **18**:807–828.
2. Halloran BP, Nissenson BA (eds.) 1992 *Parathyroid Hormone-Related Protein: Normal Physiology and Its Role in Cancer*. CRC Press, Boca Raton, FL, USA.
3. Adams JS, Fernandez M, Gacad MA, Gill PS, Endres DB, Rasheed S, Singer FR 1989 Vitamin-D metabolite-mediated hypercalcemia and hypercalciuria in patients with AIDS and non-AIDS associated lymphoma. *Blood* **73**:235–239.
4. Mundy GR 1996 Role of cytokines, parathyroid hormone and growth factors in malignancy. In: Bilezikian JP, Raisz LG, Rodan GA (eds.) *Principles of Bone Biology*. Academic Press, New York, NY, USA, pp. 827–836.
5. Harinck HJJ, Bijvoet OLM, Plantingh AS, Body JJ, Elte JW, Sleeboom HP, Wildiers J, Neijt JP 1987 Role of bone and kidney in tumor-induced hypercalcemia and its treatment with bisphosphonate and sodium chloride. *Am J Med* **82**:1133–1142.
6. Kremer R, Sebag M, Chapigny C, Meerovitch K, Hendy GN, White J, Goltzman D 1996 Identification and characterization of 1,25-dihydroxyvitamin D3-responsive repressor sequences in the rat parathyroid hormone-related peptide gene. *J Biol Chem* **271**:16310–16316.
7. Bilezikian JP, Singer FR 1994 Acute management of hypercalcemia due to parathyroid hormone and parathyroid hormone-related protein. In: Bilezikian JP, Marcus R, Levine MA (eds.) *The Parathyroids*. Raven Press, New York, NY, USA, pp. 359–372.
8. Stewart AF 2005 Hypercalcemia associated with cancer. *N Engl J Med* **352**:373–379.
9. Bilezikian JP 1992 Management of acute hypercalcemia. *N Engl J Med* **326**:1196–1203.
10. Grill V, Murray RM, Ho PW, Santamaria JD, Pitt P, Potts C, Jerums G, Martin TJ 1990 Circulating PTH and PTHrP levels before and after treatment of tumor induced hypercalcemia with pamidronate disodium. *J Clin Endocrinol Metab* **74**:1468–1470.
11. Pecherstorfer M, Steinhauer EU, Rizzoli R, Wetterwald M, Berstrom B 2003 Efficacy and safety of ibandronate in the treatment of hypercalcemia of malignancy: A randomized multicentric comparison to pamidronate. *Support Care Cancer* **11**:539–547.
12. Shah S, Hardy J, Rees E, Ling J, Gwilliam B, Davis C, Broadley K, A'Hern R 2002 Is there a dose response relationship for clodronate in the treatment of tumour induced hypercalcaemia?. *Br J Cancer* **86**:1235–1237.
13. Major P, Lortholary A, Hon J, Abodi E, Mills G, Menssen HD, Yunus F, Bell R, Body J, Quebe-Fehling E, Seaman J 2001 Zoledronic acid is superior to pamidronate in the treatment of hypercalcemia of malignancy: A pooled analysis of two randomized, controlled clinical trials. *J Clin Oncol* **19**:558–567.
14. Nussbaum SR 1993 Pathophysiology and management of severe hypercalcemia. *Endocrinol Metab Clin North Am* **22**:343–362.
15. Gordon DH 2005 Efficacy and safety of intravenous bisphosphonates for patients with breast cancer metastatic to bone: A review of randomized, double-blind, phase III trials. *Clin Breast Cancer* **6**:125–131.
16. Green JR 2005 Skeletal complications of prostate cancer: Pathophysiology and therapeutic potential of bisphosphonates. *Acta Oncol* **44**:282–292.
17. Jacobs TP, Gordon AC, Silverberg SJ, Shane E, Reich L, Clemens TL, Gundberg CM 1987 Neoplastic hypercalcemia: Physiologic response to intravenous etidronate disodium. *Am J Med* **82**(Suppl 2a):42–50.
18. Berenson JR 2005 Myeloma bone disease. *Best Prac Res Clin Haematol* **18**:653–672.
19. Gucalp R, Ritch P, Wiernik PH, Sarma PR, Keller A, Richman SP, Tauer K, Neidhart J, Mallette LE, Siegel R 1992 Comparative study of pamidronate disodium and etidronate disodium in the treatment of cancer-related hypercalcemia. *J Clin Oncol* **10**:134–142.

# Chapter 27. Primary Hyperparathyroidism

John P. Bilezikian<sup>1</sup> and Shonni J. Silverberg<sup>2</sup>

<sup>1</sup>Department of Medicine and Pharmacology and <sup>2</sup>Department of Medicine, College of Physicians and Surgeons, Columbia University, New York, New York

## INTRODUCTION

Primary hyperparathyroidism is one of the two most common causes of hypercalcemia and thus ranks high as a key diagnostic possibility in anyone with an elevated serum calcium concentration. These two causes of hypercalcemia, primary hyperparathyroidism and malignancy, together account for >90% of all hypercalcemic patients. Other potential causes of hypercalcemia are considered after the first two are ruled out or if there is reason to believe that a different cause is likely. The differential diagnosis of hypercalcemia as well as features of hypercalcemia of malignancy are considered elsewhere in this primer. In this chapter, the clinical presentation, evaluation, and therapy of primary hyperparathyroidism are covered.

Primary hyperparathyroidism is a relatively common endocrine disease with an incidence as high as 1 in 500 to 1 in 1000. Among the endocrine diseases, perhaps only diabetes mellitus and hyperthyroidism are seen more frequently. The high visibility of primary hyperparathyroidism in the population today marks a dramatic change from several generations ago, when it was considered to be a rare disorder. A 4- to 5-fold increase in incidence was noted in the early 1970s, because of the widespread use of the autoanalyzer, which provided serum calcium determinations in patients being evaluated for a set of completely unrelated complaints. More recent data suggesting a decline in the incidence of primary hyperparathyroidism may be a local phenomenon or it may reflect a diminution of the “catch-up effect,” because most cases of previously unrecognized asymptomatic disease have now been diagnosed. Primary hyperparathyroidism occurs at all ages but is most frequent in the sixth decade of life. Women are affected more often than men by a ratio of 3:1. The majority of individuals are postmenopausal women. When found in children, an unusual event, it might be a component of one of several endocrinopathies with a genetic basis, such as multiple endocrine neoplasia type I or II.

Primary hyperparathyroidism is a hypercalcemic state resulting from excessive secretion of PTH from one or more parathyroid glands. The disease is caused by a benign, solitary adenoma 80% of the time. A parathyroid adenoma is a collection of chief cells surrounded by a rim of normal tissue at the outer perimeter of the gland. In the patient with a parathyroid adenoma, the remaining three parathyroid glands are usually normal. Less commonly, primary hyperparathyroidism is caused by a pathological process characterized by hyperplasia of all four parathyroid glands. Four-gland parathyroid hyperplasia is seen in ~15–20% of patients with primary hyperparathyroidism. It may occur sporadically or in association with multiple endocrine neoplasia type I or II. A very rare presentation of primary hyperparathyroidism is parathyroid carcinoma, occurring in <0.5% of patients with hyperparathyroidism. Pathological examination of the malignant tissue might show mitoses, vascular or capsular invasion, and fibrous trabeculae, but it is often not definitive. Unless gross local or distant metastases are present, the diagnosis of parathyroid cancer can be exceedingly difficult to make.

---

Dr. Silverberg received a research grant from Amgen. Dr. Bilezikian received a research grant from Amgen and is a consultant for Amgen and Merck.

The pathophysiology of primary hyperparathyroidism relates to the loss of normal feedback control of PTH by extracellular calcium. Under virtually all other hypercalcemic conditions, the parathyroid gland is suppressed, and PTH levels are low. Why the parathyroid cell loses its normal sensitivity to calcium is unknown, but in adenomas, this seems to be the major mechanism. In primary hyperparathyroidism due to hyperplasia of the parathyroid glands, the “setpoint” for calcium is not changed for a given parathyroid cell: it is the increase in the number of cells that gives rise to the hypercalcemia.

The underlying cause of primary hyperparathyroidism is not known. External neck irradiation in childhood, recognized in some patients, is unlikely to be causative in the majority of patients. The molecular basis for primary hyperparathyroidism continues to be elusive. The clonal origin of most parathyroid adenomas suggests a defect at the level of the gene controlling growth of the parathyroid cell or the expression of PTH. Patients with primary hyperparathyroidism have been discovered in whom the *PTH* gene is rearranged to a site adjacent to the *PRAD-1* oncogene. This kind of gene rearrangement could be responsible for the altered growth properties of the abnormal parathyroid cell. Overexpression of cyclin D1, an important cell cycle regulator, is felt to have a role in the pathogenesis of some sporadic parathyroid adenomas. Loss of one copy of the *MEN1* tumor suppressor gene located on chromosome 11 has also been seen in sporadic parathyroid adenomas. Abnormalities in the *p53* tumor suppressor gene have not been described in primary hyperparathyroidism. Among other genes studied for a possible role in the development of sporadic parathyroid adenomas are the *calcium-sensing receptor* gene, the *vitamin D receptor* gene, and *RET*. To date, such studies have not been revealing.

## SIGNS AND SYMPTOMS

Classical primary hyperparathyroidism is associated with skeletal and renal complications. The skeletal disease, described historically as *osteitis fibrosa cystica*, is characterized by subperiosteal resorption of the distal phalanges, tapering of the distal clavicles, a “salt and pepper” appearance of the skull, bone cysts, and brown tumors of the long bones. Overt hyperparathyroid bone disease is now seen in <5% of patients in the United States with primary hyperparathyroidism.

Like the skeleton, the kidney is also less commonly involved in primary hyperparathyroidism than before. The incidence of kidney stones has declined from ~33% in the 1960s to 20% now. Nephrolithiasis, nevertheless, is still the most common complication of the hyperparathyroid process. Other renal features of primary hyperparathyroidism include diffuse deposition of calcium-phosphate complexes in the parenchyma (nephrocalcinosis). Hypercalciuria (daily calcium excretion of >250 mg for women or >300 mg for men) is seen in 35–40% of patients. In the absence of any other cause, primary hyperparathyroidism may be associated with a reduction in creatinine clearance.

The classic neuromuscular syndrome of primary hyperparathyroidism included a definable myopathy that has virtually disappeared. In its place, however, is a less well-defined syndrome characterized by easy fatigue, a sense of weakness, and a feeling that the aging process is advancing faster than it

should. This is sometimes accompanied by an intellectual weariness and a sense that cognitive faculties are less sharp. In some studies, psychodynamic evaluation has appeared to reveal a distinct psychiatric profile. Whether these nonspecific features of primary hyperparathyroidism are truly part and parcel of the disease process, reversible on successful parathyroid surgery, are issues that are under active investigation.

Gastrointestinal manifestations of primary hyperparathyroidism have classically included peptic ulcer disease and pancreatitis. Peptic ulcer disease is not likely to be linked in a pathophysiologic way to primary hyperparathyroidism unless type I multiple endocrine neoplasia is present. Pancreatitis is virtually never seen anymore as a complication of primary hyperparathyroidism because the hypercalcemia tends to be so mild. Like peptic ulcer disease, the association between primary hyperparathyroidism and hypertension is tenuous. Although there may be an increased incidence of hypertension in primary hyperparathyroidism, it is rarely corrected or improved after successful surgery. In classical primary hyperparathyroidism, cardiovascular features included myocardial, valvular, and vascular calcification, with subsequent increased cardiovascular mortality. Although such overt involvement is not seen in mild primary hyperparathyroidism today, studies into the presence of subtle cardiovascular manifestations of the disease are ongoing. Other potential organ systems that in the past were affected by the hyperparathyroid state are now relegated to being archival curiosities. These include gout and pseudogout, anemia, band keratopathy, and loose teeth.

#### CLINICAL FORMS OF PRIMARY HYPERPARATHYROIDISM

In the United States today, classical primary hyperparathyroidism is rarely seen. Instead, the most common clinical presentation of primary hyperparathyroidism is characterized by asymptomatic hypercalcemia with serum calcium levels within 1 mg/dl above the upper limits of normal. Most patients do not have specific complaints and do not show evidence for any target organ complications. They usually have been discovered accidentally in the course of a routine multichannel screening test. Rarely, a patient will show serum calcium levels in the life-threatening range, so-called acute primary hyperparathyroidism or parathyroid crisis. These patients are invariably symptomatic of hypercalcemia. Although this is an unusual presentation of primary hyperparathyroidism, it does occur and should always be considered in any patient who presents with acute hypercalcemia of unclear etiology.

The very earliest manifestation of primary hyperparathyroidism may present with isolated elevations in PTH levels, while serum calcium is still normal. This abnormality is generally recognized in patients undergoing evaluation for low BMD or in other individuals who are receiving comprehensive screening tests for their skeletal health. In such patients, causes of secondary hyperparathyroidism must be ruled out. It is particularly important to be sure that these individuals do not have vitamin D insufficiency, as defined by a 25-hydroxyvitamin D level of <30 ng/ml. Re-evaluation of these individuals after vitamin D repletion and/or after correction of other secondary causes of hyperparathyroidism is needed. Unusual clinical presentations of primary hyperparathyroidism include the multiple endocrine neoplasias types I and II, familial primary hyperparathyroidism not associated with any other endocrine disorder, familial cystic parathyroid adenomatosis, and neonatal primary hyperparathyroidism.

#### EVALUATION AND DIAGNOSIS OF PRIMARY HYPERPARATHYROIDISM

The history and the physical examination rarely give any clear indications of primary hyperparathyroidism but are helpful because of the paucity of specific manifestations of the disease. The diagnosis of primary hyperparathyroidism is established by laboratory tests. The two biochemical hallmarks of primary hyperparathyroidism are hypercalcemia and elevated levels of PTH. The serum phosphorus tends to be in the lower range of normal. In only approximately one third of patients is the serum phosphorus concentration frankly low. The serum alkaline phosphatase activity may be elevated when bone disease is present. More specific markers of bone formation (bone-specific alkaline phosphatase and osteocalcin) and bone resorption (urinary deoxypyridinoline and N-telopeptide of collagen) will be above normal when there is active bone involvement but otherwise tend to be in the upper range of normal. The actions of PTH to alter acid-base handling in the kidney will lead, in some patients, to a small increase in the serum chloride concentration and a concomitant decrease in the serum bicarbonate concentration. Urinary calcium excretion is elevated in 35–40% of patients. The circulating 1,25-dihydroxyvitamin D concentration is elevated in ~25% of patients with primary hyperparathyroidism, although it is of little diagnostic value because 1,25-dihydroxyvitamin D levels are increased in other hypercalcemic states, such as sarcoidosis, other granulomatous diseases, and some lymphomas. 25-Hydroxyvitamin D levels tend to be in the lower end of the normal range. Considering newer definitions of vitamin D insufficiency, most patients with primary hyperparathyroidism have levels that are below the defined cut-point (i.e., <30 ng/ml).

X-rays are not cost effective in the evaluation of the patient with primary hyperparathyroidism because the vast majority of patients lack specific radiologic manifestations. On the other hand, bone mineral densitometry has proved to be an essential component of the evaluation because of its great sensitivity to detect early changes in bone mass. Patients with primary hyperparathyroidism tend to show a pattern of bone involvement that preferentially affects the cortical as opposed to the cancellous skeleton. The typical pattern is a reduction in BMD of the distal third of the forearm, a site enriched in cortical bone, and relative preservation of the lumbar spine, a site enriched in cancellous bone. The hip region, best typified by the femoral neck, tends to show values intermediate between the distal radius and the lumbar spine because its composition is a more equal mixture of cortical and cancellous elements. A small subset of patients (~15%) present with an atypical BMD profile, characterized by vertebral osteopenia or osteoporosis. Other patients with primary hyperparathyroidism can show uniform reductions in BMD at all sites. Bone densitometry has become an invaluable aspect of the evaluation of primary hyperparathyroidism because it gives a more accurate assessment of the degree of involvement of the skeleton than any other approach at this time. This information is used to make recommendations for parathyroid surgery or for conservative medical observation (see following sections).

Measurement of the circulating PTH concentration is the most definitive way to make the diagnosis of primary hyperparathyroidism. In the presence of hypercalcemia, an elevated level of PTH virtually establishes the diagnosis. A PTH level in the mid- or upper end of the normal range in the face of hypercalcemia is also consistent with the diagnosis of primary hyperparathyroidism. The standard assay for measurement of PTH is the immunoradiometric (IRMA) or immunochemiluminometric (ICMA) assay that measures the “intact” molecule. This assay detects large carboxyterminal fragments [PTH(7-

84) is one such fragment] of PTH in addition to full-length PTH(1-84) and can therefore overestimate the amount of bioactive hormone in the serum. A newer assay, specific for PTH(1-84) only, is elevated somewhat more frequently in patients with primary hyperparathyroidism. Although this assay may offer increased diagnostic sensitivity in cases where the intact IRMA is within the normal range (albeit inappropriately), the intact IRMA currently remains the standard assay in the diagnosis of the disease. The clinical use of PTH measurements in the differential diagnosis of hypercalcemia is a result both of refinements in assay techniques and of the fact that the most common other cause of hypercalcemia, namely hypercalcemia of malignancy, is associated with suppressed levels of hormone. There is no cross-reactivity between PTH and PTH-related peptide (PTHrP; the major causative factor in humoral hypercalcemia of malignancy) in the immunoradiometric assays for PTH. The only hypercalcemic disorders in which the PTH concentration might be elevated are those related to lithium or thiazide diuretic use. It is relatively easy to exclude either of these two possibilities by the history. If it is conceivable that the patient has drug-related hypercalcemia, the only secure way to make the diagnosis of primary hyperparathyroidism is to withdraw the medication and to confirm persistent hypercalcemia and elevated PTH levels 2–3 months later.

## TREATMENT OF PRIMARY HYPERPARATHYROIDISM

### Surgery

Primary hyperparathyroidism is cured when the abnormal parathyroid tissue is removed. While it is clear that surgery is appropriate in patients with classical symptoms of primary hyperparathyroidism, there is considerable controversy concerning the need for intervention in patients who have no clear signs or symptoms of their disease. In 2002, a Workshop was conducted at the National Institutes of Health to review the available data on this group of patients. The results of that meeting have led to a revision of the guidelines for management of asymptomatic primary hyperparathyroidism that were first recommended by the 1990 Consensus Development Conference on this subject. Patients are always advised to have surgery if they have symptomatic disease, such as overt bone disease or kidney stones, or if they have survived an episode of acute primary hyperparathyroidism with life-threatening hypercalcemia. Asymptomatic patients are now advised to have surgery if the serum calcium is  $>1$  mg/dl above the upper limit of normal. Marked hypercalciuria ( $>400$  mg daily excretion) or significantly reduced creatinine clearance ( $>30\%$  more than age- and sex-matched controls) is another general indication for surgery. If bone mass, as determined by bone densitometry, is more than 2.5 SD below young normal control subjects (T score  $< -2.5$ ) at any site, surgery should be recommended. Finally, the patient with primary hyperparathyroidism who is  $<50$  years old is at greater risk for progression of the hyperparathyroid disease process than older patients and should be advised to undergo parathyroidectomy.

Adherence to these guidelines for surgery, however, is dependent on both the physician and the patient. Some physicians will recommend surgery for all patients with primary hyperparathyroidism; other physicians will not recommend surgery unless clear-cut complications of primary hyperparathyroidism are present. Similarly, some patients cannot tolerate the idea of living with a curable disease and will seek surgery in the absence of the aforementioned guidelines. Other patients, with coexisting medical problems, may not wish to face the risks of surgery, although surgical indications are present.

Parathyroid surgery requires exceptional expertise and experience. The glands are notoriously variable in location, requiring the surgeon's knowledge of typical ectopic sites such as intrathyroidal, retroesophageal, the lateral neck, and the mediastinum. The surgeon must also be aware of the proper operation to perform. In the case of the adenoma, the other glands are ascertained to be normal and are not removed. More and more, expert parathyroid surgeons are performing this operation under local, as opposed to general, anesthesia. Recent advances in surgery have led to another approach to the patient with single gland disease. Minimally invasive parathyroidectomy (MIP) is an approach that takes advantage of successful preoperative localization by the most widely used localization modalities: technetium-99m-sestamibi and ultrasound. The surgeon limits the operative field only to the small region overlying the visualized adenoma. Within a few minutes after resection, a PTH level is obtained. If the PTH level falls by  $>50\%$ , the adenoma that has been removed is considered to be the only source of abnormal glandular activity, and the operation is terminated. If the PTH level does not fall by  $>50\%$ , the possibility of other overreactive parathyroid glands is considered, and the operation is converted to a more standardized approach. In the case of multiglandular disease, the approach is to remove all tissue except for a remnant that is left in situ or autotransplanted in the nondominant forearm. Postoperatively, the patient may experience a brief period of transient hypocalcemia, during which time the normal but suppressed parathyroid glands regain their sensitivity to calcium. This happens within the first few days after surgery, and it is usually not necessary to treat the postoperative patient aggressively with calcium when postoperative hypocalcemia is mild. Prolonged postoperative symptomatic hypocalcemia as a result of rapid deposition of calcium and phosphate into bone ("hungry bone" syndrome) is rarely seen today. Such patients may require parenteral calcium for symptomatic hypocalcemia. Permanent hypoparathyroidism is a potential complication of surgery in those who have had previous neck surgery or who undergo subtotal parathyroidectomy (for multiglandular disease). Another rare complication of parathyroid surgery is damage to the recurrent laryngeal nerve, which can lead to hoarseness and reduced voice volume.

A number of localization tests are available to define the site of abnormal parathyroid tissue preoperatively. Among the non-invasive tests, ultrasonography, CT, MRI, and scintigraphy are available. Radioisotopic imaging is now performed most commonly with technetium-99m-sestamibi. Sestamibi is taken up both by thyroid and parathyroid tissue but persists in the parathyroid glands. Parathyroid localization using scintigraphy offers important localization data that are mandatory before any planned minimally invasive surgery or for repeat parathyroid exploration. Parathyroid scintigraphy using Tc-99 alone may yield important information about the location of single parathyroid adenomata. Planar imaging may miss small or ectopic lesions. More precise localization is achieved by using single photon emission computed tomography (SPECT) as an adjunct to Sestamibi scanning. Use of iodine-123 along with Tc-99 may be helpful in distinguishing between thyroid and parathyroid tissue. It is important to note that these techniques are not particularly helpful in patients with primary hyperparathyroidism caused by hyperplasia. Invasive localization tests with arteriography and selective venous sampling for PTH in the draining thyroid veins are available when noninvasive studies have not been successful and it is deemed important to locate the abnormal parathyroid gland preoperatively.

The value of preoperative localization tests in patients about to undergo parathyroid surgery is controversial. In patients who have not had previous neck surgery, there is little evidence that



such tests prevent failed operations or shorten operating time. An experienced parathyroid surgeon will find the abnormal parathyroid gland(s) >95% of the time in the patient who has not had previous neck surgery. Thus, it is hard to justify these tests in this group. On the other hand, these preoperative localization tests have become very popular and are now used routinely in the United States. In patients who are to undergo the MIP procedure, preoperative localization is mandatory.

In patients who have had prior neck surgery, preoperative localization tests should be done. The general approach is to use the noninvasive studies first. Ultrasound and radioisotope imaging are best for parathyroid tissue that is located in proximity to the thyroid, whereas CT and MRI testing are better for ectopically located parathyroid tissue. Arteriography and selective venous studies are reserved for those individuals in whom the noninvasive studies have not been successful.

In patients who undergo successful parathyroid surgery, the hyperparathyroid state is completely cured. Serum biochemistries normalize, and the PTH level returns to normal. In addition, bone mass improves substantially in the first 1–3 years after surgery. The increase is documented by bone densitometry. The cumulative increase in bone mass at the lumbar spine and femoral neck is ~12%, a rather impressive improvement, and is sustained for at least a decade after parathyroidectomy. It is particularly noteworthy that the lumbar spine, a site where PTH seems to protect from age-related and estrogen-deficiency bone loss, is a site of rapid and substantial improvement. Those patients who present with evidence of vertebral osteopenia or osteoporosis sustain an even more impressive improvement in spine BMD after cure and should therefore be routinely referred for surgery regardless of the severity of their hypercalcemia.

### Medical Management

Patients who are not surgical candidates for parathyroidectomy seem to do very well when they are managed conservatively. Data on patients with primary hyperparathyroidism followed for up to a decade show that the biochemical indices of disease and BMD measures of bone mass remain remarkably stable. These include the serum calcium, phosphorus, PTH, 25-hydroxyvitamin D, 1,25-dihydroxyvitamin D, and urinary calcium excretion. More specific markers of bone formation and bone resorption also do not seem to change. There are several caveats to this statement, however. First, ~25% of patients with asymptomatic primary hyperparathyroidism will have biochemical or bone densitometric evidence of disease progression over a 10-year period. Second, those under the age of 50 years have a far higher incidence of progressive disease than do older patients (~65% versus 23%). This supports the notion that younger patients should be referred for parathyroidectomy. Finally, today, as in the day of classical primary hyperparathyroidism, patients with symptomatic disease do poorly when observed without surgery. Thus, the data support the safety of observation without surgery only in selected patients with asymptomatic primary hyperparathyroidism.

The longitudinal data on patients who do not have parathyroid surgery also support the need for medical monitoring. In those patients who do not undergo surgery, a set of general medical guidelines is recommended. Routine medical follow-up usually includes visits twice yearly with serum calcium determinations. Yearly assessment of serum creatinine and bone densitometry at the spine, hip, and distal one-third site of the forearm is also recommended. Adequate hydration and ambulation are always encouraged. Thiazide diuretics and lithium are to be avoided if possible, because they may lead to worsening hypercalcemia. Dietary intake

of calcium should be moderate. There is no good evidence that patients with primary hyperparathyroidism show significant fluctuations of their serum calcium as a function of dietary calcium intake. High calcium intakes should be avoided, however, especially in patients whose 1,25-dihydroxyvitamin D level is elevated. Low calcium diets should also be avoided because they could theoretically lead to further stimulation of PTH secretion.

We still lack an effective and safe therapeutic agent approved for the medical management of primary hyperparathyroidism. Oral phosphate will lower the serum calcium in patients with primary hyperparathyroidism by ~0.5–1 mg/dl. Phosphate seems to act by three mechanisms: interference with absorption of dietary calcium, inhibition of bone resorption, and inhibition of renal production of 1,25-dihydroxyvitamin D. Phosphate, however, is not recommended as an approach to management, because of concerns related to ectopic calcification in soft tissues as a result of increasing the calcium-phosphate product. Moreover, oral phosphate may lead to an undesirable further elevation of PTH levels. Gastrointestinal tolerance is another limiting feature of this approach.

In postmenopausal women, estrogen therapy remains an option in those women desiring hormone replacement for treatment of symptoms of menopause. The rationale for estrogen use in primary hyperparathyroidism is based on the known antagonism by estrogen of PTH-mediated bone resorption. Although the serum calcium concentration does tend to decline after estrogen administration (by ~0.5 mg/dl), PTH levels and the serum phosphorus concentration do not change. Estrogen replacement may have a salutary effect on BMD in these patients as well. Preliminary data suggest that the selective estrogen receptor modulator, raloxifene, may have a similar effect on serum calcium levels in postmenopausal women with primary hyperparathyroidism.

Bisphosphonates have also been considered as a possible medical approach to primary hyperparathyroidism. Two of the original bisphosphonates, etidronate and dichloromethylene bisphosphonate (clodronate; which is not available in the United States), have been studied. Although etidronate is not effective, dichloromethylene bisphosphonate temporarily reduces the serum calcium in primary hyperparathyroidism. The use of pamidronate, available exclusively as an intravenous preparation, is restricted to acute hypercalcemic states associated with primary hyperparathyroidism. Alendronate improves vertebral BMD in patients with primary hyperparathyroidism who choose not to have surgery but does not affect the underlying disorder.

Finally, a more targeted approach to the medical therapy of primary hyperparathyroidism is to interfere specifically with the production of PTH. Calcimimetic agents that alter the function of the extracellular calcium-sensing receptor offer an exciting new approach to primary hyperparathyroidism. These agents increase the affinity of the parathyroid cell calcium receptor for extracellular calcium, leading to increased intracellular calcium, a subsequent reduction in PTH secretion, and ultimately a reduction in hypercalcemia. Clinical trials have shown normalization of serum calcium for up to 3 years. In this study, no change in BMD by DXA was documented. The effect of this agent on fracture incidence in patients with primary hyperparathyroidism is unknown.

### ACKNOWLEDGMENTS

This work was supported in part by National Institutes of Health Grants DK32333 and DK66329.

## SUGGESTED READING

1. Arnold A, Shattuck TM, Mallya SM, Krebs LJ, Costa J, Gallagher J, Wild Y, Saucier K 2002 Molecular pathogenesis of primary hyperparathyroidism. *J Bone Miner Res* **17**:N30–N36.
2. Bilezikian JP, Potts JT, El-Hajj Fuleihan G, Kleerekoper M, Neer R, Peacock M, Rastad J, Silverberg SJ, Udelsman R, Wells SA 2002 Summary statement from a workshop on asymptomatic primary hyperparathyroidism: A perspective for the 21st century. *J Bone Miner Res* **17**:S2; N2–N11.
3. Cetani F, Pinchera A, Pardi E, Cianferotti L, Vignali E, Picone A, Miccoli P, Viacava P, Marcocci C 1999 No evidence for mutations in the calcium-sensing receptor gene in sporadic parathyroid adenomas. *J Bone Miner Res* **14**:878–882.
4. Deftos LJ 2001 Immunoassays for PTH and PTHrP. In: Bilezikian JP, Marcus R, Levine MA (eds.) *The Parathyroids*, 2nd ed. Raven Press, New York, NY, USA, pp. 143–166.
5. Doppman JL 2001 Preoperative localization of parathyroid tissue in primary hyperparathyroidism. In: Bilezikian JP, Marcus R, Levine MA (eds.) *The Parathyroids*, 2nd ed. Raven Press, New York, NY, USA, pp. 475–486.
6. Fitzpatrick LA 2001 Acute primary hyperparathyroidism. In: Bilezikian JP, Marcus R, Levine MA (eds.) *The Parathyroids*, 2nd ed. Raven Press, New York, NY, USA, pp. 527–360.
7. Heath H III, Hodgson SF, Kennedy MA 1980 Primary hyperparathyroidism: Incidence, morbidity, and potential economic impact in a community. *N Engl J Med* **302**:189.
8. Kahn AA, Bilezikian JP, Kung A, Ahmed MM, Dubois SJ, Ho AYY, Schussheim DH, Rubin MR, Shaikh AM, Silverberg SJ, Standish TI, Syed Z, Syed ZA 2004 Alendronate in primary hyperparathyroidism: A double-blind, randomized, placebo-controlled trial. *J Clin Endocrinol Metab* **89**:3319–3325.
9. Parisien MV, Silverberg SJ, Shane E, de la Cruz L, Lindsay R, Bilezikian JP, Dempster DW 1990 The histomorphometry of bone in primary hyperparathyroidism: Preservation of cancellous bone structure. *J Clin Endocrinol Metab* **70**:930–938.
10. Peacock M, Bilezikian JP, Klassen P, Guo, MD Turner SA, Shoback DS 2005 Cinacalcet HCl maintains long normocalcemia in patients with primary hyperparathyroidism with. *J Clin Endocrinol Metab* **90**:135–141.
11. Rubin MR, Lee K, Silverberg SJ 2003 Raloxifene lowers serum calcium and markers of bone turnover in primary hyperparathyroidism. *J Clin Endocrinol Metab* **88**:1174–1178.
12. Shane E 2001 Parathyroid carcinoma. In: Bilezikian JP, Marcus R, Levine MA (eds.) *The Parathyroids*, 2nd ed. Raven Press, New York, NY, USA, pp. 515–526.
13. Silverberg SJ, Shane E, de la Cruz L, Dempster DW, Feldman F, Seldin D, Jacobs TP, Siris ES, Cafferty M, Parisien MV, Lindsay R, Clemens TL, Bilezikian JP 1989 Skeletal disease in primary hyperparathyroidism. *J Bone Miner Res* **4**:283–291.
14. Silverberg SJ, Locker FG, Bilezikian JP 1996 Vertebral osteopenia: A new indication for surgery in primary hyperparathyroidism. *J Clin Endocrinol Metab* **81**:4007–4012.
15. Silverberg SJ, Shane E, Dempster DW, Bilezikian JP 1999 Vitamin D Deficiency in primary hyperparathyroidism. *Am J Med* **107**:561–567.
16. Silverberg SJ, Shane E, Jacobs TP, Siris E, Bilezikian JP 1999 The natural history of treated and untreated asymptomatic primary hyperparathyroidism: A ten year prospective study. *N Engl J Med* **41**:1249–1255.
17. Silverberg SJ, Brown I, Bilezikian JP 2002 Youthfulness as a criterion for surgery in primary hyperparathyroidism. *Am J Med* **113**:681–684.
18. Silverberg SJ 2002 Non-classical target organs in primary hyperparathyroidism. *J Bone Miner Res* **17**:S2;N117–N125.
19. Silverberg SJ, Bilezikian JP 2003 “Incipient” primary hyperparathyroidism: A “forme fruste” of an old disease. *J Clin Endocrinol Metab* **88**:5348–5352.
20. Silverberg SJ, Brown I, LoGerfo P, Gao P, Cantor T, Bilezikian JP 2003 Clinical utility of an immunoradiometric assay for whole PTH (1–84) in primary hyperparathyroidism. *J Clin Endocrinol Metab* **88**:4725–4730.
21. Silverberg SJ, Bilezikian JP 2006 Hyperparathyroidism. In: DeGroot LJ, Jameson JL (eds.) *Endocrinology*, 5th ed. JB Elsevier Saunders, Philadelphia, PA, USA, pp. 1533–1565.
22. Turken SA, Cafferty M, Silverberg SJ, de la Cruz L, Cimino C, Lange DJ, Lovelace RE, Bilezikian JP 1989 Neuromuscular involvement in mild, asymptomatic primary hyperparathyroidism. *Am J Med* **87**:553–557.
23. Udelsman R 2002 Surgery in primary hyperparathyroidism: The patient without previous neck surgery. *J Bone Miner Res* **17**:S2;N126–N132.
24. Wells SA, Doherty GM 2001 The surgical management of primary hyperparathyroidism. In: Bilezikian JP, Marcus R, Levine MA (eds.) *The Parathyroids*, 2nd ed. Raven Press, New York, NY, USA, pp. 487–498.
25. Wermers RA, Khosla S, Atkinson EJ, Grant CS, Hodgson SF, O’Fallon WM, Melton LJ III 1998 Survival after diagnosis of PHPT: A population based study. *Am J Med* **104**:115–122.

## Chapter 28. Familial Hyperparathyroid Syndromes

Andrew Arnold

*Center for Molecular Medicine and Division of Endocrinology & Metabolism, University of Connecticut School of Medicine, Farmington, Connecticut*

### INTRODUCTION

Individuals with recognizable familial predispositions to the development of parathyroid tumors constitute a small and important minority of all patients with primary hyperparathyroidism (HPT). These familial syndromes have been recognized as exhibiting Mendelian inheritance patterns and have been genetically elucidated to a large extent. They include multiple endocrine neoplasia types 1 and 2A, hyperparathyroidism-jaw tumor syndrome, and familial isolated hyperparathyroidism. Familial (benign) hypocalcemic hypercalcemia (FHH, FBH, FBHH) and neonatal severe hyperparathyroidism (NSHPT) also fall into this category but are the subjects of a separate chapter. Extraparathyroid manifestations of some familial HPT syndromes will be mentioned but lie outside the

focus of this chapter. It is worth noting that as more knowledge accumulates on genetic contributions to complex phenotypes, additional genetic loci may be identified as contributing to a less penetrant and more subtle predisposition to primary HPT in the general population.

### MULTIPLE ENDOCRINE NEOPLASIA TYPE 1

Multiple endocrine neoplasia type 1 (MEN1) is a rare heritable disorder with an estimated prevalence of 2–3/100,000. It is classically defined as a predisposition to tumors of the parathyroids, anterior pituitary, and pancreatic islet cells, although affected patients are now known to be predisposed to many additional endocrine and nonendocrine tumors.<sup>(1,2)</sup> Primary HPT is the most penetrant component of MEN1, occurring in almost all affected individuals by age 50, and is the initial clinical manifestation of the disorder in most patients. Approximately 2% of all cases of primary HPT may be caused

The author has reported no conflicts of interest.

by MEN1. Some of the other types of tumors associated with MEN1 include duodenal gastrinomas, bronchial or thymic carcinoids, gastric enterochromaffin-like tumors, adrenocortical adenomas, lipomas, facial angiofibromas, and truncal collagenomas.<sup>(1)</sup>

The inheritance of MEN1 follows an autosomal dominant pattern, and the molecular genetic basis is an inactivating germline mutation of the *MEN1* tumor suppressor gene, located on chromosome band 11q13.<sup>(3)</sup> *MEN1* encodes a protein called menin, whose specific cellular functions have not been fully established but may involve transcriptional regulation of gene expression. Typically, patients with MEN1 have inherited one inactivated copy of the *MEN1* gene from an affected parent or may have a spontaneous new germline mutation. The outgrowth of a tumor requires the subsequent somatic (acquired) inactivation of the normal, remaining copy of the gene in one cell. Such a parathyroid cell, for example, would then be devoid of *MEN1*'s tumor suppressor function, contributing to a selective advantage over its neighbors and clonal proliferation.

Primary HPT in MEN1 has a number of different features from the common sporadic (nonfamilial) form of the disease. The male to female ratio is even in MEN1, in contrast to the female predominance of sporadic HPT. HPT in MEN1 typically presents in the second to fourth decade of life, and has been found as early as age 8. Multiple gland involvement is typical in MEN1, and in most patients, three to four tumors are evident on initial neck exploration. However, these multiple tumors may vary widely in size, with an average 10:1 ratio between the largest and smallest glands.<sup>(4)</sup> An inexorable drive to parathyroid tumorigenesis exists in MEN1, reflected by an impressively high rate of recurrent HPT after apparently successful subtotal parathyroidectomy (>50% after 12 years).<sup>(4)</sup> This high recurrence rate contrasts with the behavior of HPT in MEN2A or in sporadic primary parathyroid hyperplasia. As mentioned below, familial isolated hyperparathyroidism can manifest as an occult or variant presentation of *MEN1* mutation.

The biochemical diagnosis of primary HPT in known or suspected MEN1 is based on the finding of hypercalcemia with elevated (or inappropriately nonsuppressed) serum PTH levels. Once the biochemical diagnosis is established, the indications for surgical intervention are similar to those in patients with sporadic primary HPT and include symptomatic hypercalcemia, nephrolithiasis, fractures, and/or decreased bone mass, which has been observed in women with MEN1 at the age of 35.<sup>(2)</sup> Because hypercalcemia can worsen hypergastrinemia, another indication for parathyroidectomy in MEN1 is the presence of medically refractory symptoms of gastrinoma, an unusual situation given the success of pharmacotherapy for Zollinger-Ellison syndrome.

Because direct evidence is lacking, opinions differ as to the optimal timing of surgical treatment of HPT in MEN1. Early presymptomatic intervention might, on one hand, lead to better long-term bone health. On the other hand, because of the high rate of recurrent HPT, a policy of deferring surgery might decrease a patient's total number of operations and thereby decrease the risk of complications.

Preoperative localization studies are not generally indicated in unoperated patients because of the multiplicity of parathyroid tumors in MEN1, the need to identify all parathyroid glands at surgery, and the inability of imaging tools to reliably detect all hypercellular glands. For the same reasons, a suspected or firm preoperative diagnosis of MEN1 argues against performing minimally invasive parathyroidectomy. In the context of bilateral operations, however, intraoperative PTH measurement may be helpful.<sup>(4)</sup> In contrast, preoperative imaging/localization is useful before reoperation in patients with

recurrent or persistent disease. The initial operation most frequently performed in MEN1 patients is 3.5 gland subtotal parathyroidectomy with transcervical near-total thymectomy. A parathyroid remnant of ~50 mg is usually left in situ and may be marked with a metal clip, but alternatively the remnant can be autotransplanted<sup>(2)</sup> to the forearm after intentionally complete parathyroidectomy. The efficacy of thymectomy is unproven but seems reasonable because it may cure incipient thymic carcinoids or prevent their development; in addition, the thymus is a common site for parathyroid tumors in MEN1 patients with recurrent HPT. Involvement of a highly experienced parathyroid surgical team is crucial to optimal outcome.

Management of the pituitary, enteropancreatic, and other neoplastic manifestations of MEN1 are discussed in detail elsewhere.<sup>(2)</sup> It should be emphasized that MEN1-associated malignancies cause fully one third of the deaths in MEN1 patients, and for most of these cancers, no effective prevention or cure currently exists.

Direct genetic testing for germline *MEN1* mutations is commercially available, but the indications for such testing remain under discussion.<sup>(2,3)</sup> Genetic analyses, typically limited to the coding region, fail to detect *MEN1* mutation in ~30% of typical MEN1 kindreds.<sup>(3)</sup> In contrast to the clear clinical efficacy of testing for *RET* gene mutations in MEN2, presymptomatic genetic diagnosis has not been established to improve morbidity or mortality in MEN1, and biochemical screening with serum calcium and PTH provides a nongenetic alternative. Thus, DNA testing is not currently determinative of important clinical interventions in MEN1, and the rationale for its use is not as well established as in MEN2.<sup>(1-3)</sup> Similarly, periodic biochemical or anatomic screening for endocrine tumor manifestations in MEN1 patients, or in family members at risk, has not been proven to enhance clinical outcomes, and whether such testing is of incremental benefit compared with careful histories and physical examinations remains to be determined. Suggested protocols for use of pre-symptomatic testing are available.<sup>(2)</sup>

## MULTIPLE ENDOCRINE NEOPLASIA TYPE 2A

MEN2 is subclassified into three major clinical syndromes: MEN2A, MEN2B, and familial medullary thyroid cancer (FMTC). Of these, MEN2A is the most common and the only one that manifests HPT.<sup>(1,2)</sup> MEN2A is a heritable predisposition to medullary thyroid cancer (MTC), pheochromocytoma, and primary HPT. The respective frequency of these tumors in MEN2A is >90% for MTC, 40–50% for pheochromocytoma, and 20% for HPT.<sup>(2)</sup> This low penetrance of HPT in MEN2A contrasts with the high penetrance found in all other familial hyperparathyroid syndromes.

MEN2A is inherited in an autosomal dominant pattern, with men and women affected in equal proportions, and the responsible genetic defect is germline mutation of the *RET* proto-oncogene on chromosome 10.<sup>(1,5)</sup> The *RET* protein is a receptor tyrosine kinase that normally transduces growth and differentiation signals in developing tissues including those derived from the neural crest. There are both differences and much overlap in the specific *RET* gene mutations underlying MEN2A and FMTC; in contrast, MEN2B is caused by entirely distinct *RET* mutations.<sup>(2,5)</sup> Why parathyroid disease fails to develop in FMTC patients who can bear identical *RET* mutations as found in MEN2A remains unclear. Unlike the numerous different inactivating mutations of *MEN1*, which are typical of a tumor suppressor mechanism, *RET* mutations in MEN2A are limited in number, reflecting the need for highly specific gain-of-function changes to activate this oncogene.<sup>(1,5)</sup> Germline *RET* mutation is detectable in >95% of MEN2A families. *RET*

mutation at codon 634 seems to be highly associated with the expression of HPT in MEN2A.

HPT in MEN2A is often asymptomatic, and its biochemical diagnosis, as well as indications for surgical treatment, parallel those in sporadic primary HPT.<sup>(2)</sup> Evidence of pheochromocytoma should be sought before parathyroidectomy and, if present, the pheochromocytoma(s) should be removed before parathyroid surgery. Primary HPT in MEN2A is almost always multiglandular, but less than four overtly hypercellular glands may be present. Thus, bilateral neck exploration to identify all glands is advisable in known or suspected MEN2A, with resection of hypercellular parathyroid tissue (up to 3.5 glands) being the most common surgical approach. Issues of preoperative localization in unoperated patients are similar to MEN1. In contrast to MEN1, however, recurrent HPT is infrequent after apparently successful resection of enlarged glands, similar to the excellent long-term outcome of surgically treated patients with nonfamilial primary hyperplasia. The low penetrance of HPT in MEN2A and the success of its treatment argue against prophylactic total parathyroidectomy with forearm autotransplantation at the time of thyroidectomy for MTC, an approach carrying substantial risk of hypoparathyroidism.

The other major manifestations of MEN2A are MTC and pheochromocytoma. MTC, the major life-threatening manifestation of MEN2A, evolves from preexisting parafollicular C-cell hyperplasia, and its calcitonin production provides a useful marker for monitoring tumor burden. Despite the pharmacologic properties of calcitonin, mineral metabolism is generally normal in the setting of metastatic MTC and its often dramatic hypercalcitoninemia. DNA testing for germline *RET* mutations is central to clinical management and worthy of emphasis for its role in prevention of MTC. *RET* testing is superior to immunoassay for basal or stimulated calcitonin for diagnosis of MEN2A. Molecular diagnosis allows for prophylactic or curative thyroidectomy to be performed (i.e., sufficiently early in childhood as to minimize the likelihood that metastases will have occurred).<sup>(1,2,5)</sup>

Pheochromocytomas in MEN2A can be unilateral or bilateral. Extraadrenal or malignant pheochromocytomas are underrepresented in MEN2A patients compared with patients with sporadic pheochromocytoma. Because undiagnosed pheochromocytoma could cause substantial morbidity or even death during thyroid or parathyroid surgery in MEN2A patients, it is important to first screen for pheochromocytoma. Different approaches to screening exist; a consensus report suggested measurement of plasma metanephrines and 24-h urinary excretion of catecholamines and metanephrines on an annual basis and supplemented by periodic imaging studies.<sup>(1,2)</sup> Laparoscopic adrenalectomy has greatly improved the management of pheochromocytoma in MEN2A, and adrenal cortical-sparing surgery may be helpful in obviating the problem of adrenal insufficiency after treatment of bilateral pheochromocytoma.<sup>(5)</sup>

### HYPERPARATHYROIDISM-JAW TUMOR SYNDROME

The hyperparathyroidism-jaw tumor syndrome (HPT-JT) is a rare, autosomal dominant predisposition to primary HPT, ossifying fibromas of the mandible and maxilla, renal manifestations including cysts, hamartomas, or Wilms tumors,<sup>(6,7)</sup> and uterine tumors.<sup>(8)</sup> In clinically ascertained "classical" HPT-JT kindreds, HPT is the most penetrant manifestation at 80% of adults, followed by 30% for ossifying fibromas, and lower for renal lesions. As mentioned below, familial isolated hyperparathyroidism and apparently sporadic parathyroid carcinoma can represent occult or allelic variant presentations of the molecular defect in HPT-JT.

Hyperparathyroidism in HPT-JT may develop as early as the first decade or two of life. Although all parathyroids are at risk, surgical exploration can reveal a solitary parathyroid tumor rather than multigland disease, in contrast to typical findings in MEN1 and MEN2A. Parathyroid neoplasms can be cystic, and whereas most tumors are classified as adenomas, the incidence of parathyroid carcinoma (15–20% of HPT) is markedly overrepresented in HPT-JT kindreds.<sup>(7)</sup> After a period of normocalcemia, treated patients may manifest recurrent HPT, and a solitary tumor asynchronously originating in a different parathyroid gland may prove responsible. The approach to monitoring and surgery in HPT-JT must take into account the predilection to parathyroid malignancy, and the finding of biochemical HPT should lead promptly to surgery. All parathyroids should be identified at operation, signs of malignancy sought, and appropriate resection of abnormal glands performed.<sup>(4)</sup> Because of malignant potential, consideration of prophylactic total parathyroidectomy has been raised as an alternative approach but is not favored by others in view of difficulties with lifelong management of surgical hypoparathyroidism, the incomplete penetrance of parathyroid cancer in the syndrome, and the plausible (albeit unproven) idea that close biochemical monitoring for recurrent HPT combined with early surgery will prevent metastatic disease.

Ossifying fibromas in HPT-JT may be large and destructive, but are often small, asymptomatic, and identified as incidental findings on dental radiographs. They are clearly distinct from the classic, osteoclast-rich "brown tumors" of severe hyperparathyroidism.

Germline mutation of the *HRPT2* gene, located on chromosome arm 1q, is responsible for HPT-JT.<sup>(9)</sup> The yield of *HRPT2* mutation detection in HPT-JT kindreds is ~60–70%<sup>(8,9)</sup>; the remaining kindreds most likely also have *HRPT2* mutations but evade detection because of their location outside the sequenced coding region. Mutations of *HRPT2* are predicted to inactivate or eliminate its protein product parafibromin, consistent with a classical "two-hit" tumor suppressor mechanism also shown in sporadic parathyroid carcinoma.<sup>(9,10)</sup> Parafibromin's normal cellular function may involve regulation of gene expression and chromatin modification.

Importantly, some patients with sporadic presentations of parathyroid carcinoma also harbor germline mutations in *HRPT2*, thus representing newly ascertained HPT-JT or a variant syndrome.<sup>(10)</sup> Recognition of *HRPT2*'s involvement in classic or variant HPT-JT has opened the door to DNA-based carrier identification in at-risk family members, aimed at preventing parathyroid malignancy.

### FHH AND NSHPT

FHH and NSHPT are mentioned as a reminder of their inclusion in the category of familial hyperparathyroid syndromes, but are the subject of another chapter. Germline mutations in the *CASR* gene that cause partial or severe loss of function of its product, the extracellular G-protein-coupled calcium receptor, are a major cause of these syndromes. Genetic linkage analyses indicate that the FHH phenotype can also be caused by mutation of different genes, which have not yet been identified. As mentioned below, familial isolated hyperparathyroidism can manifest as an occult or variant presentation of *CASR* mutation.

### FAMILIAL ISOLATED HYPERPARATHYROIDISM

Familial isolated primary hyperparathyroidism (FIHP) is a clinically defined entity, based on the absence of expression of the extraparathyroid manifestations that characterize other fa-

miliar HPT syndromes. As such, a designation of FIHP can change with new findings in the family. Furthermore, FIHP is genetically heterogeneous and can be caused by variant expressions of germline mutations in *MEN1*, *HRPT2*, *CASR*, and probably other genes.<sup>(4,11,12)</sup> Clinical monitoring and management must take into consideration the possibility that additional features of a genetically defined HPT syndrome could emerge or become detectable. For example, the heightened risk of parathyroid carcinoma must be borne in mind in FIHP when the genetic basis is not established and occult *HRPT2* mutation is possible. DNA testing should be considered (e.g., when results might impact on the advisability of, or approach to, parathyroid surgery).

## REFERENCES

- Gagel RF, Marx SJ 2003 Multiple endocrine neoplasia. In: Larsen PR, Kronenberg HM, Melmed S, Polonsky K (eds.) *Williams Textbook of Endocrinology*, 10th ed. WB Saunders, Philadelphia, PA, USA, pp. 1717–1762.
- Brandi ML, Gagel RF, Angeli A, Bilezikian JP, Beck-Peccoz P, Bordi C, Conte-Devolx B, Falchetti A, Gheri RG, Libroia A, Lips CJ, Lombardi G, Mannelli M, Pacini F, Ponder BA, Raue F, Skogseid B, Tamburrano G, Thakker RV, Thompson NW, Tomassetti P, Tonelli F, Wells SA Jr, Marx SJ 2001 Guidelines for diagnosis and therapy of MEN type 1 and type 2. *J Clin Endocrinol Metab* **86**:5658–5671.
- Marx SJ 2005 Molecular genetics of multiple endocrine neoplasia types 1 and 2. *Nat Rev Cancer* **5**:367–375.
- Marx SJ, Simonds WF, Agarwal SK, Burns AL, Weinstein LS, Cochran C, Skarulis MC, Spiegel AM, Libutti SK, Alexander HR Jr., Chen CC, Chang R, Chandrasekharappa SC, Collins FS 2002 Hyperparathyroidism in hereditary syndromes: Special expressions and special managements. *J Bone Miner Res* **17**:S1:N37–N43.
- Kouvaraki MA, Shapiro SE, Perrier ND, Cote GJ, Gagel RF, Hoff AO, Sherman SI, Lee JE, Evans DB 2005 RET proto-oncogene: A review and update of genotype-phenotype correlations in hereditary medullary thyroid cancer and associated endocrine tumors. *Thyroid* **15**:531–544.
- Jackson CE, Norum RA, Boyd SB, Talpos GB, Wilson SD, Taggart RT, Mallette LE 1990 Hereditary hyperparathyroidism and multiple ossifying jaw fibromas: A clinically and genetically distinct syndrome. *Surgery* **108**:1006–1013.
- Szabo J, Heath B, Hill VM, Jackson CE, Zarbo RJ, Mallette LE, Chew SL, Besser GM, Thakker RV, Huff V, Leppert MF, Heath H 1995 Hereditary hyperparathyroidism-jaw tumor syndrome: The endocrine tumor gene *HRPT2* maps to chromosome 1q21–q31. *Am J Hum Genet* **56**:944–950.
- Bradley KJ, Hobbs MR, Buley ID, Carpten JD, Cavaco BM, Fares JE, Laidler P, Manek S, Robbins CM, Salti IS, Thompson NW, Jackson CE, Thakker RV 2005 Uterine tumours are a phenotypic manifestation of the hyperparathyroidism-jaw tumour syndrome. *J Intern Med* **257**:18–26.
- Carpten JD, Robbins CM, Villablanca A, Forsberg L, Presciutti S, Bailey-Wilson J, Simonds WF, Gillanders EM, Kennedy AM, Chen JD, Agarwal SK, Sood R, Jones MP, Moses TY, Haven C, Petillo D, Leotlela PD, Harding B, Cameron D, Pannett AA, Hoog A, Heath H 3rd, James-Newton LA, Robinson B, Zarbo RJ, Cavaco BM, Wassif W, Perrier ND, Rosen IB, Kristoffersson U, Turmpenny PD, Farnebo LO, Besser GM, Jackson CE, Morreau H, Trent JM, Thakker RV, Marx SJ, Teh BT, Larsson C, Hobbs MR 2002 *HRPT2*, encoding parafibromin, is mutated in hyperparathyroidism-jaw tumor syndrome. *Nat Genet* **32**:676–680.
- Shattuck TM, Valimaki S, Obara T, Gaz RD, Clark OH, Shoback D, Wierman ME, Tojo K, Robbins CM, Carpten JD, Farnebo LO, Larsson C, Arnold A 2003 Somatic and germ-line mutations of the *HRPT2* gene in sporadic parathyroid carcinoma. *N Engl J Med* **349**:1722–1729.
- Simonds WF, James-Newton LA, Agarwal SK, Yang B, Skarulis MC, Hendy GN, Marx SJ 2002 Familial isolated hyperparathyroidism: Clinical and genetic characteristics of 36 kindreds. *Medicine (Baltimore)* **81**:1–26.
- Simonds WF, Robbins CM, Agarwal SK, Hendy GN, Carpten JD, Marx SJ 2004 Familial isolated hyperparathyroidism is rarely caused by germline mutation in *HRPT2*, the gene for the hyperparathyroidism-jaw tumor syndrome. *J Clin Endocrinol Metab* **89**:96–102.

# Chapter 29. Familial Hypocalciuric Hypercalcemia

Stephen J. Marx

*Genetics and Endocrinology Section, Metabolic Diseases Branch, National Institute of Diabetes and Digestive and Kidney Diseases, National Institutes of Health, Bethesda, Maryland*

## INTRODUCTION

Familial hypocalciuric hypercalcemia (FHH; also termed familial benign hypercalcemia or familial benign hypocalciuric hypercalcemia) is an autosomal dominant trait with lifelong high penetrance for both hypercalcemia and relative hypocalciuria.<sup>(1,2)</sup> The prevalence of FHH is similar to that for multiple endocrine neoplasia type 1; either accounts for ~2% of cases with asymptomatic hypercalcemia.

## CLINICAL FEATURES

### Symptoms and Signs

Patients with FHH are usually asymptomatic. Occasionally they note easy fatigue, weakness, thought disturbance, or polydipsia. These symptoms are less common and less severe than in typical primary hyperparathyroidism. There is a low but increased incidence of relapsing pancreatitis. The rate of peptic ulcer disease, nephrolithiasis, or even idiopathic hypercalciuria is the same as in a normal population.

### Radiographs and Indices of Bone Function

Radiographs are usually normal. Nephrocalcinosis has the same incidence as in a normal population. There is an increased incidence of chondrocalcinosis (usually clinically silent) and premature vascular calcification. Bone turnover is mildly increased. Bone mass and susceptibility to fracture are normal.

### Serum Electrolytes

Hypercalcemia has virtually 100% penetrance at all ages; its level is similar to that in typical primary hyperparathyroidism. Both free and bound calcium are increased, with a normal ratio of free to bound calcium. The degree of hypercalcemia clusters within kindreds, with several kindreds showing very modest hypercalcemia and several showing rather severe hypercalcemia (12.5–14 mg/dl).<sup>(1)</sup> Serum magnesium is typically in the high range of normal or modestly elevated, and serum phosphate is modestly depressed.

### Urinary Calcium Excretion Indices

Creatinine clearance is generally normal. Urinary excretion of calcium is normal, with affected and unaffected family

The author has reported no conflicts of interest.

members showing a similar distribution of values. The normal urinary calcium in the face of hypercalcemia reflects increased renal tubular reabsorption of calcium (i.e., relative hypocalciuria). Because total urinary calcium excretion depends heavily on glomerular filtration rate, total calcium excretion is not a practical index to distinguish a case of FHH from typical primary hyperparathyroidism. The ratio of calcium clearance to creatinine clearance is calculated easily:

$$\text{Ca}_{\text{Cl}}/\text{Cr}_{\text{Cl}} = (\text{Ca}_{\text{u}} \times \text{V}/\text{Ca}_{\text{s}}) / (\text{Cr}_{\text{u}} \times \text{V}/\text{Cr}_{\text{s}}) = (\text{Ca}_{\text{u}} \times \text{Cr}_{\text{s}}) / (\text{Cr}_{\text{u}} \times \text{Ca}_{\text{s}})$$

It is an empirically chosen index that corrects for most of the variation from glomerular filtration rate. This clearance ratio in FHH is one third of that in typical primary hyperparathyroidism, and a cut-off value at 0.01 (note that all units cancel out) is imperfect but helpful for diagnosis, although only in a hypercalcemic patient.

### Parathyroid Function and Surgery

Parathyroid function, including serum PTH and 1,25-dihydroxyvitamin D [ $1,25(\text{OH})_2\text{D}$ ], is usually normal, with modest elevations in 5–10% of cases.<sup>(3)</sup> Even the “normal” parathyroid function indices in the presence of lifelong hypercalcemia are inappropriate and reflect a specific role for the parathyroids in causing hypercalcemia. FHH cases often have mild enlargement of the parathyroid glands, evident only by careful measurement of gland size.<sup>(4,5)</sup> Most FHH cases are caused by heterozygous loss-of-function mutations in *CASR*, the gene that encodes the calcium sensing-receptor (Ca-S-R).<sup>(6,7)</sup> This explains the resistance of the parathyroid cell to suppression by hypercalcemia.

Standard subtotal parathyroidectomy in FHH results in only a very transient lowering of serum calcium, with restoration of hypercalcemia within a week. Total parathyroidectomy in FHH leads to low PTH, low  $1,25(\text{OH})_2\text{D}$ , and low calcium in blood, i.e., chronic hypoparathyroidism. However, attempted total parathyroidectomy can fail because a small remnant of parathyroid tissue is sufficient to sustain hypercalcemia in FHH.

## BROAD SPECTRUM OF DISORDERS RELATED TO FHH

### Making the Diagnosis of FHH

In the presence of hypercalcemia, a normal PTH, just like a low urine calcium, should raise the suspicion of FHH. Family screening for FHH can be valuable: first, to establish familial involvement (in the index case and in the family); second, to characterize a syndrome; and third, as a start toward avoiding failed parathyroidectomy. Because of high penetrance for hypercalcemia in FHH carriers, an accurate genetic assignment within a family can usually be made from one determination of total serum calcium (or preferably ionized or albumin-adjusted calcium). However, obtaining all the desired family data can take many months.

*CASR* mutation analysis (see below) also has an occasional role in diagnosis, particularly with an inconclusive clinical evaluation of the family or with an atypical presentation.<sup>(8)</sup> Failure to find mutation does not exclude this, because there may be a mutation outside the tested open reading frame (explaining 30% of false “normal” testing) or rarely in another FHH gene. Two unusual FHH kindreds not linked to the *CASR* locus at chromosome 3q, but linked to 19p or 19q, represent mutation in other unidentified genes.<sup>(9,10)</sup>

### Disorders Resembling FHH

**Typical Primary Hyperparathyroidism.** The resemblance of typical primary hyperparathyroidism to FHH is evident and important; their distinction is the main topic of this chapter.

**Autoimmune FHH.** FHH has rarely been caused by autoantibodies against the Ca-S-R and associated with other autoimmune features (thyroiditis or sprue); there is no *CASR* mutation.<sup>(11)</sup>

***CASR* Loss-of-Function Mutation Without FHH.** One large kindred with a germline missense mutation in the *CASR* had a hyperparathyroid syndrome unlike FHH. There was hypercalciuria, monoclonal parathyroid adenomas, and benefit from subtotal parathyroidectomy.<sup>(12)</sup> Several other small families with *CASR* loss-of-function mutations have contained some members with features partly resembling typical primary hyperparathyroidism.<sup>(8)</sup> Most are likely FHH kindreds with one affected member as outlier.

### Neonatal Severe Primary Hyperparathyroidism

Neonatal severe primary hyperparathyroidism is an unusual state of life-threatening, severe hypercalcemia with massive hyperplasia of all parathyroid glands. Most cases reflect a double dose of FHH genes.<sup>(2,13)</sup> Urgent total parathyroidectomy can be life saving.

## PATHOPHYSIOLOGY

### FHH as an Atypical Form of Primary Hyperparathyroidism

The parathyroid gland functions abnormally in FHH. Even the surgically decreased gland mass can maintain the same high calcium level, necessarily by greatly increasing hormone secretion rate per unit mass of tissue. There is a selective and mild increase in glandular “set-point” for calcium suppression of PTH secretion. This is even more striking for the causally related neonatal severe primary hyperparathyroidism. FHH can therefore be labeled as a form of primary hyperparathyroidism, albeit atypical. However, some authorities prefer not to classify FHH as a form of primary hyperparathyroidism to emphasize its contrasting management needs.<sup>(14)</sup>

### Independent Defect in the Kidneys

There also is a disturbance intrinsic to the kidneys. The tubular reabsorption of calcium, normally increased by PTH, is high and remains strikingly increased even after total parathyroidectomy in FHH.<sup>(15)</sup>

## MANAGEMENT

### Indications for Parathyroidectomy Are Rare

FHH is compatible with survival into the ninth decade. Because of the generally benign course and lack of response to subtotal parathyroidectomy, virtually all patients with FHH should be advised against parathyroidectomy. In rare situations, such as (1) life-threatening neonatal severe primary hyperparathyroidism, (2) an adult with relapsing pancreatitis, or (3) a child or an adult with serum calcium persistently above 14 mg/dl, parathyroidectomy may be necessary. Total parathyroidectomy should be attempted in these situations.

### Pharmacologic Intervention in the Typical Case

Chronic hypercalcemia in FHH has been resistant to medications (diuretics, bisphosphonates, phosphates, and estro-

gens). Calcimimetic drugs, acting on the Ca-S-R, might change these considerations<sup>(16)</sup>; they have not yet been approved by the U.S. Food and Drug Administration for this indication or even reported in FHH.

### Sporadic Hypocalciuric Hypercalcemia

Without a positive family history, the decision about management of sporadic hypocalciuric hypercalcemia is difficult. Because there is a wide range of urine calcium values in patients with FHH and with typical primary hyperparathyroidism, an occasional patient with parathyroid adenoma will show a very low calcium-to-creatinine clearance ratio. Moreover, occasionally a patient with FHH will show a high ratio. Sporadic hypocalciuric hypercalcemia should generally be managed as typical FHH. In time, the underlying diagnosis may become evident; low morbidity in such patients, even those with undiagnosed parathyroid adenoma, should be anticipated for the same reasons that the morbidity is low in FHH. Here, detection of a *CASR* mutation can be particularly helpful.

### Near the Time of Pregnancy

Several pairings may cause antagonism of blood calcium regulation between fetus and mother. The affected offspring of a mother with FHH should show asymptomatic hypercalcemia. The unaffected offspring of a mother with FHH may show symptomatic hypocalcemia. The affected offspring of an unaffected mother may show transiently worsened neonatal hyperparathyroidism because of superimposed intrauterine secondary hyperparathyroidism.<sup>(13,17)</sup>

### CONCLUSION

FHH is an important cause of asymptomatic hypercalcemia, with high representation in hypercalcemia at ages <20 years. The index case and sometimes relatives need appropriate assessments of serum calcium and PTH and a urinary calcium index. Subtotal parathyroidectomy virtually always results in persistent hypercalcemia. Although mild symptoms similar to those in typical primary hyperparathyroidism are common, almost no patients should have interventions.

### REFERENCES

1. Marx SJ, Attie MF, Levine MA, Spiegel AM, Downs RW Jr, Lasker RD 1981 The hypocalciuric or benign variant of familial hypercalcemia: Clinical and biochemical features in fifteen kindreds. *Medicine* **60**:397–412.
2. El-Hajj Fuleihan G, Brown EM, Heath H III 2002 Familial benign

- hypocalciuric hypercalcemia and neonatal primary hyperparathyroidism. In: Bilezikian JP, Raisz LG, Rodan GA (eds.) *Principles of Bone Biology*, 2nd ed. Academic Press, San Diego, CA, USA, pp. 1031–1045.
3. Firek AF, Kao PC, Heath H III 1991 Plasma intact parathyroid hormone (PTH) and PTH-related peptide in familial benign hypercalcemia: Greater responsiveness to endogenous PTH than in primary hyperparathyroidism. *J Clin Endocrinol Metab* **72**:541–546.
4. Thorgeirsson U, Costa J, Marx SJ 1981 The parathyroid glands in familial hypocalciuric hypercalcemia. *Hum Pathol* **12**:229–237.
5. Law WM Jr, Carney JA, Heath H III 1984 Parathyroid glands in familial benign hypercalcemia (familial hypocalciuric hypercalcemia). *Am J Med* **76**:1021–1026.
6. Tfelt-Hansen J, Brown EM 2005 The calcium-sensing receptor in normal physiology and pathophysiology: A review. *Critic Rev Clin Lab Sci* **42**:35–70.
7. Pidasheva S, D'Souza-Li L, Canaff L, Cole DEC, Hendy GN 2004 CASRdb: Calcium-sensing receptor locus-specific database for mutations causing familial (Benign) hypocalciuric hypercalcemia, neonatal severe hyperparathyroidism, and autosomal dominant hypocalcemia. *Hum Mutation* **24**:107–111.
8. Simonds WF, James-Newton LA, Agarwal SK, Yang B, Skarulis MC, Hendy GN, Marx SJ 2002 Familial isolated hyperparathyroidism: Clinical and genetic characteristics of thirty-six kindreds. *Medicine* **81**:1–26.
9. Heath H III, Jackson CE, Otterud B, Leppert MF 1993 Genetic linkage analysis in familial benign (hypocalciuric) hypercalcemia: Evidence for locus heterogeneity. *Am J Hum Genet* **53**:193–200.
10. Lloyd SE, Pannett AA, Dixon PH, Whyte MP, Thakker RV 1999 Localization of familial benign hypercalcemia, Oklahoma variant (FBHOk), to chromosome 19q13. *Am J Hum Genet* **64**:189–195.
11. Pallais JC, Kifor O, Chen YB, Slovik D, Brown EM 2004 Brief report—acquired hypocalciuric hypercalcemia due to autoantibodies against the calcium-sensing receptor. *N Engl J Med* **351**:362–369.
12. Szabo E, Carling T, Hessman O, Rastad J 2002 Loss of heterozygosity in parathyroid glands of familial hypercalcemia with hypercalciuria and point mutation in calcium receptor. *J Clin Endocrinol Metab* **87**:3961–3965.
13. Marx SJ, Attie MF, Spiegel AM, Levine MA, Lasker RD, Fox M 1982 An association between neonatal severe primary hyperparathyroidism and familial hypocalciuric hypercalcemia in three kindreds. *N Engl J Med* **306**:257–264.
14. Bilezikian JP, Potts JT Jr, El-Haj Fuleihan G, Kleerekoper M, Neer R, Peacock M, Rastad J, Silverberg SJ, Udelsman R, Wells SA Jr 2002 Summary statement from a workshop on asymptomatic primary hyperparathyroidism: A perspective for the 21st century. *J Bone Miner Res* **17**:S2;N2–N12.
15. Attie MF, Gill RJ Jr, Stock JL, Spiegel AM, Downs RW Jr, Levine MA, Marx SJ 1983 Urinary calcium excretion in familial hypocalciuric hypercalcemia: Persistence of relative hypocalciuria after induction of hypoparathyroidism. *J Clin Invest* **72**:667–676.
16. Peacock M, Bilezikian JP, Klassen PS, Guo MD, Turner SA, Shoback D 2005 Cinacalcet hydrochloride maintains long-term normocalcemia in patients with primary hyperparathyroidism. *J Clin Endocrinol Metab* **90**:135–141.
17. Page LA, Haddow JE 1987 Self-limited neonatal hyperparathyroidism in familial hypocalciuric hypercalcemia. *J Pediatr* **111**:261–264.

## Chapter 30. Secondary and Tertiary Hyperparathyroidism

Richard L. Prince

*School of Medicine and Pharmacology, University of Western Australia, Perth, Australia*

### INTRODUCTION

A detailed understanding of the physiological basis of the regulation of calcium homeostasis is central to the understand-

ing of the causes of secondary hyperparathyroidism (HPT). It is failures in these systems that are detected biochemically as secondary HPT. PTH is the most important short-term endocrine initiator of defense against a reduction in the extracellular calcium concentration. Although magnesium, phosphate, and calcitriol also exert regulatory influences on PTH independent of the calcium level, the principal regulator of PTH secretion is

---

The author has reported no conflicts of interest.

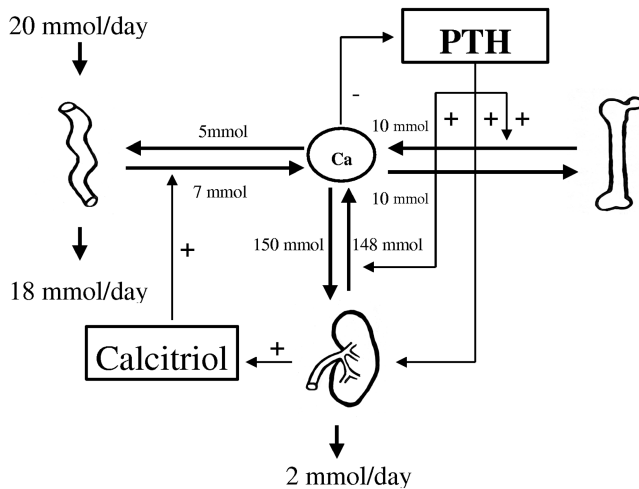

FIG. 1. Physiology of calcium transport.

the ionized calcium concentration. The sensing system uses the calcium sensing receptor located in the plasma membrane of the parathyroid gland.<sup>(1)</sup> When this system senses a calcium level below that considered physiological, increased PTH secretion occurs, termed secondary HPT. The raised level of PTH corrects the low calcium by actions on the bone and kidney, and indirectly the bowel, to correct the calcium level (Fig. 1). Thus, secondary HPT is a condition in which the parathyroid glands are responding appropriately to a low extracellular calcium concentration; this in general corrects the extracellular calcium. However, if the increased PTH secretion cannot correct the plasma calcium, either because of a disorder within those organs responsible for calcium transport or because of reduced availability of calcium, hypocalcemia can result. Thus, secondary HPT can be associated with calcium concentrations that are within or below the population reference range. It is the task of the clinician to determine the reason or reasons for the persistent error signal and correct them efficiently and effectively.

The three major regulated sources of calcium entry and exit into the extracellular compartment are the intestine, kidney, and bone. Perspiration is another small source of calcium loss to the extracellular compartment. Impairment in the balance between entry and exit of calcium from the intestine, bone, and kidney will induce secondary HPT when there is an overall inability of all the organs acting together to maintain a normal or reference range calcium concentration in the extracellular compartment. Thus, secondary HPT may be caused by a variety of disorders of the organs involved in maintenance of extracellular calcium concentrations (Table 1). In addition, calcium exchange occurs across all cell membranes under the influence of a variety of channels and transporters. In general, these fluxes of calcium have no net effect on extracellular calcium concentration because intracellular calcium concentrations are on the order of 100 nM, whereas extracellular calcium concentration is about 1.0 mM, a difference that is 10,000-fold greater in blood. As discussed below, there are a few pathological situations where this is not the case.

While it is true that high phosphate and low calcitriol levels may stimulate PTH secretion independently of the calcium level, they usually occur in the setting of chronic kidney disease, which is itself a low calcium state. One of the principal clinical effects of magnesium, in addition to impairing PTH action, is to reduce PTH secretion, thus counteracting secondary HPT.

## CONSEQUENCES OF SECONDARY HPT

Symptoms of hypocalcemia may occur if secondary HPT fails to maintain the extracellular calcium concentration, especially in children. The bone is a major "calcium sink" during skeletal growth and also during pregnancy and after cessation of lactation. If absorption of calcium from the intestine and reabsorption of filtered calcium from the renal tubule are ineffective in restoring the extracellular calcium concentration, the major alternate supply of calcium is resorption from the skeleton. Childhood and adolescence represent particularly important times when intestinal calcium absorption is important because there is a constant flux of calcium into the growing skeleton. At this time, dietary calcium deficiency can result in secondary HPT, and if persistent, rickets.<sup>(2)</sup> In adults, if intestinal calcium absorption consistently fails to replace calcium loss from the extracellular compartment, osteoporosis results.<sup>(3)</sup> Both osteoporosis and osteomalacia result in biomechanical insufficiency of bone; thus, persistent secondary HPT may result in bone pain, deformity, and minimal trauma fractures. It is of interest to note that under the influence of secondary HPT, bone is preferentially resorbed from the appendicular cortical skeleton<sup>(4)</sup> as opposed to estrogen deficiency, where axial trabecular bone is the first target.

## INTESTINAL CAUSES OF SECONDARY HPT

The intestine is the only external source of calcium supply to the various body compartments. The sites of calcium loss that

TABLE 1. DIFFERENTIAL DIAGNOSIS OF SECONDARY HYPERPARATHYROIDISM

Impaired intestinal calcium entry into the extracellular compartment	
Impaired dietary calcium intake	
Lactose intolerance	
Impaired dietary calcium absorption	
Pancreatic disease—fat malabsorption	
Damaged enterocytes—coeliac disease	
Calcium sequestration—phytates	
Deficiency of vitamin D	
Sunlight deprivation	
Intestinal vitamin D malabsorption (e.g., liver disease)	
Loss of calcium from the extracellular compartment	
To the bone	
Growth	
Recovery postlactation	
Bisphosphonate treatment	
Pagets disease	
Osteoporosis	
Bone cancer	
"Hungry bone syndrome"	
To the urine	
Idiopathic hypercalciuria	
Increased sodium excretion	
Loop diuretics	
To soft tissue	
Rhabdomyolysis	
Sepsis	
Episodic oral phosphate for treatment of hypophosphatemia	
Impaired PTH action	
Pseudo-hypoparathyroidism	
G protein deficiency	
Renal failure with impaired calcitriol formation and phosphate excretion	
Impaired gut calcium absorption	
Impaired parathyroid calcium sensing	



intestinal calcium absorption must replace are the kidney, through a net obligatory renal calcium loss, the skeleton, as discussed above, and occasionally soft tissue.

### Inadequate Dietary Calcium Intake

Reliable determination of dietary calcium deficiency based on dietary history is difficult. This is in part because the dietary calcium requirement depends on calcium handling in the kidney and bone. There are also great interindividual variations in the amount of dietary calcium required to achieve calcium balance. Thus, in practice, although it may be occasionally be possible to make a positive clinical diagnosis of a low calcium intake, it is usually a diagnosis of exclusion. It is appropriate to determine whether milk products cause abdominal symptoms because this may be an indicator of lactose intolerance, which reduces calcium intake associated with avoidance of milk products. In addition, in subjects with lactose intolerance lactose will itself induce calcium malabsorption. Interestingly, in normal subjects, lactose may increase calcium absorption. Lactose intolerance predicts development of osteoporosis and fracture.<sup>(5)</sup> The genetic polymorphism resulting in lactose intolerance has recently been described and presents a new diagnostic approach

Management of calcium deficiency in adults is discussed in elsewhere, but should include the use of calcium supplements in doses of at least 1200 mg of elemental calcium per day. Management of calcium deficiency in childhood is discussed elsewhere, but should include doses of calcium of at least 800 mg/day.

### Dietary Calcium Malabsorption

Calcium soaps form in the intestinal lumen when free fatty acids are generated in the gut lumen but are not absorbed, and are therefore available to bind calcium and prevent its absorption. Formation of insoluble calcium soaps may occur in primary intestinal disorders such as celiac sprue and short bowel syndrome, but not in primary pancreatic disease where no lipase is produced.

Thus, secondary HPT, osteoporosis, and occasionally osteomalacia are common presenting features of celiac disease.<sup>(6)</sup>

Exocrine pancreatic failure may occur as a result of alcohol, biliary calculi, or cystic fibrosis, and results in fat malabsorption. This may promote the development of nonabsorbable calcium soaps within the bowel. Associated malabsorption of fat-soluble vitamins, particularly vitamin D, can induce calcium malabsorption caused by vitamin D deficiency.

Another minor cause of impaired calcium absorption is dietary fiber in the form of phytic acid that may bind calcium within the bowel, thus contributing to calcium malabsorption. Studies that have examined the effects of these diets on calcium absorption have not found any significant deleterious effects, at least at moderate consumption of these foods. However, at high fiber intakes, calcium retention can be reduced from 25% to 19%.<sup>(7)</sup>

### Vitamin D Deficiency

The principal cause of vitamin D deficiency is lack of sunlight exposure preventing the formation of vitamin D in the skin. Patients at high risk of vitamin D are those with restricted sunlight exposure by reason of northern or southern latitude, lack of outdoor activity, clothing restrictions, or sunscreen use. The elderly are particularly at risk. Malabsorption and anti-epileptic therapy may exacerbate the problem.

Secondary HPT and increased bone turnover markers such as alkaline phosphatase are common but not universal for reasons that remain somewhat unclear. Diagnosis is best estab-

lished by measuring the serum concentration of 25-hydroxyvitamin D. Renal calcium conservation manifest by hypocalciuria is usually present.

Therapy should include increased calcium intake and sunlight exposure where possible and the use of oral cholecalciferol or ergocalciferol in a dose of at least 10,000 U/week until healing has occurred. If there is impaired renal synthesis of calcitriol, a 1-hydroxylated derivative of vitamin D should be prescribed in addition to dietary calcium supplementation.

## LOSS OF CALCIUM FROM THE EXTRACELLULAR COMPARTMENT AS A CAUSE OF SECONDARY HPT

A net loss of calcium from the extracellular compartment can occur into the skeleton, urine, breast milk during lactation, and the soft tissue of the body after ischemia. Under circumstances of extremely low calcium intake, there can be a net loss of calcium from the bowel because of calcium contained within pancreatic and intestinal secretions. This is called endogenous fecal calcium.

### Entry of Calcium Into the Bone Compartment

A net flux of calcium into the skeletal compartment may be large enough to cause a decrease in the extracellular calcium concentration and the development of secondary HPT if intestinal calcium absorption and renal calcium reabsorption cannot maintain the calcium concentration. In childhood and adolescence, skeletal growth is the major cause of entry of calcium into the skeletal compartment. In adult life, the reformation of the skeleton after lactation-induced bone loss is the major physiological cause of entry of calcium into the skeletal compartment. Another cause of rapid entry of calcium into the skeleton may occur is bisphosphonate therapy for Paget's disease,<sup>(8)</sup> osteoporosis, or cancer. In the past, this phenomenon was observed with the use of estrogen in prostate cancer.<sup>(9)</sup> It may also occur after parathyroidectomy for severe primary HPT or tertiary HPT. The critical diagnostic factor in this setting is the low serum calcium concentration. Therapy is replacement of calcium and or vitamin D as discussed above.

### Entry of Calcium Into Breast Milk

During lactation, skeletal calcium is released to provide calcium for the developing and growing infant. This process does not involve extra secretion of PTH and is thus not classified as a cause of secondary HPT, although there are many similarities. It has been suggested that PTH-related peptide secreted by the breast may be the etiological factor. At the end of lactation, the skeleton begins to regenerate, and secondary HPT may occur if dietary calcium intake is inadequate.<sup>(10)</sup>

### Entry of Calcium Into the Urine

Primary renal calcium loss (renal hypercalciuria) is a hereditary disorder associated with renal stones, perhaps caused by defects in renal ion transport channels. It may also be caused by excessive salt intake<sup>(11)</sup> or loop diuretic therapy,<sup>(12)</sup> both of which increase calcium loss in the urine. If these losses are not matched by increased intestinal calcium absorption, secondary HPT and osteoporosis may occur. The diagnosis is supported by increased renal calcium excretion as assessed by an elevated 24 h and fasting urine calcium (Fig. 2).

### Entry of Calcium Into Soft Tissue

Hypoxic tissue damage to muscle and other soft tissues may result in precipitation of calcium and phosphate as a result of

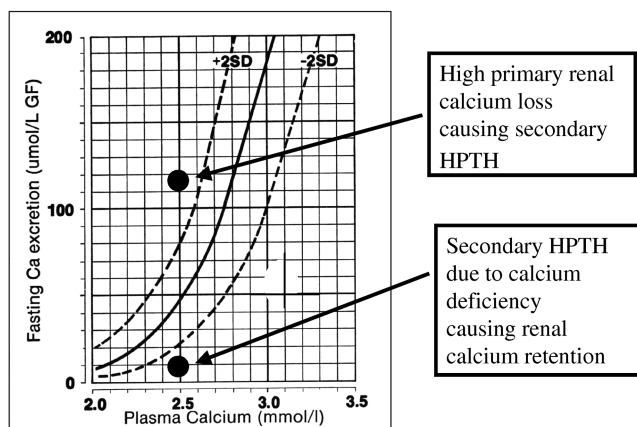

FIG. 2. Relationship between urine and plasma calcium.

the dramatic increases in the calcium  $\times$  phosphate ion product that results from the release of large amounts of phosphate from damaged tissues as during crush injury and rhabdomyolysis or after chemotherapy. If rapid enough, this results in hypocalcemia and secondary HPT.<sup>(13)</sup> Rhabdomyolysis is associated with drugs or compartment syndromes and is best diagnosed by measurement of a raised creatine phosphokinase (CPK), myoglobinuria, and technetium diphosphonate isotope scan to detect the soft tissue uptake.<sup>(14)</sup> Therapy is supportive while muscle healing occurs.

#### IMPAIRED PTH ACTION ON KIDNEY AND BONE AS CAUSES OF SECONDARY HYPERPARATHYROIDISM

The bone and kidney are the two organs on which PTH exerts a direct action. Some of the conditions discussed above may in part result in impaired PTH action on the bone. However, the classical end organ resistance disease is pseudohypoparathyroidism. End organ damage to the kidney from any cause can result also result in secondary HPT from a complex set of pathophysiologic effects including resistance to PTH action because of reduced functional renal mass.

#### Impaired PTH Signal Transduction

Failure of PTH signal transduction in the bone and kidney caused by mutations in the G protein coupling system is an uncommon cause of secondary HPT, which is addressed elsewhere. The failure of PTH action on the bone and kidney results in hypocalcemia and appropriate secondary increases in HPT. One manifestation of this disorder, a syndrome first described by Fuller Albright in 1934 without the benefit of a PTH assay,<sup>(15)</sup> is associated with short stature, calcific deposits in soft tissue, and one or more short metacarpals or metatarsals. The defect in G protein signal transduction may be restricted to bone or kidney or may occur in both tissues. If there is loss of the effect of PTH on renal phosphate handling, a high plasma phosphate and renal phosphate threshold is present as opposed to a low phosphate and renal phosphate threshold found in other causes of secondary HPT. Management is aimed at correcting extracellular calcium, usually with the use of calcitriol and calcium.

#### Renal Failure

The role of PTH in the pathophysiology of renal failure is complex, but in essence could be considered a state of increased PTH action on the kidney and bone to compensate for

inadequate production of calcitriol in the kidney. Secondary HPT appears early in the course of renal failure and may be evident before the appearance of phosphate retention<sup>(16)</sup> (when glomerular filtration rate [GFR] approaches 60 ml/minute). This is a treatable cause of progression of osteoporosis, especially frequent in elderly patients. Early in the course of development of renal failure, restoration of intestinal calcium absorption by increased dietary calcium and vitamin D intake either as calciferol or calcitriol should be undertaken. In addition, dietary calcium supplementation assists in the control of phosphate concentrations in the extracellular compartment by binding phosphate in the intestine. When serum phosphate concentrations rise, secondary HPT may develop by a direct stimulation of phosphate on PTH secretion<sup>(17)</sup> and by indirectly stimulating PTH secretion through lowering serum calcium by its complex with phosphate. Management includes a combination of dietary phosphorus restriction, phosphate binders, and dialysis to remove phosphate from the body.

#### TERTIARY HPT

The critical difference between secondary and tertiary HPT is that the plasma calcium is normal or low in secondary HPT but is elevated in tertiary HPT. Like primary HPT, the pathological problem in tertiary HPT is the development of adenoma or multigland hyperplasia. In addition, defective calcium-sensing receptor function may permit continued PTH secretion.

Tertiary HPT occurs after a prolonged period of secondary HPT. Indeed it has been argued that primary HPT may occur more commonly in populations with increased prevalence of calcium and vitamin D deficiency, perhaps causing subclinical stimulation of parathyroid cells eventually resulting in a clone of cells becoming hyperplastic.

A specific situation in which the term tertiary HPT is used is the hypercalcemic HPT that occurs after the prolonged secondary HPT of renal failure. This is caused by hyperplasia of one or more parathyroid glands. This term may also be used in the development of hypercalcemic HPT after the prolonged use of phosphate supplements in patients with hypophosphatemic rickets. In this situation, the episodic increase in plasma phosphate after ingestion of the supplement may induce transient hypocalcemia. Together with relative calcitriol deficiency, this results in parathyroid gland hyperplasia.<sup>(18)</sup> The diagnostic and therapeutic approach for tertiary HPT is similar to that used for primary HPT, which may be associated with four-gland hyperplasia or an enlarged single gland. The development of calcium mimetic drugs that activate the parathyroid calcium receptor, thus reducing tertiary HPT, is a promising new therapeutic approach. Currently, no calcimimetic agents have been approved by the Food and Drug Administration (FDA) for use in treatment of tertiary HPT.

#### BIOCHEMICAL DIAGNOSIS OF SECONDARY AND TERTIARY HPT

The diagnosis of secondary HPT is best made by the measurement of a PTH concentration above the reference range at the time that the measured plasma calcium is normal or low (Tables 1 and 2). As in primary HPT, the diagnosis of tertiary HPT is made by the measurement of a PTH concentration above the reference range at the time that the measured plasma calcium is high. These tests should be performed on a fasting resting venous blood sample taken without a tourniquet (because of its effects of increasing albumin concentrations and decreasing pH, both of which may inappropriately increase the measured calcium concentration).

The determination of the circulating calcium concentration

TABLE 2. CLINICAL HISTORY IN THE DIAGNOSIS OF THE CAUSE OF SECONDARY HYPERPARATHYROIDISM

<i>Mechanism</i>	<i>Clinical history</i>
Impaired intestinal calcium absorption	Low dairy product consumption
Impaired dietary calcium intake	Lactose intolerance
Impaired dietary calcium absorption	Pancreatic steatorrhea
	Enterocyte failure
	Weight loss
	Diarrhea
	Iron or B <sub>12</sub> deficiency
	High dietary fiber intake
Vitamin D deficiency	Extreme northern or southern latitudes
	Lack of outdoor exposure
	Lack of skin exposure (personal or religious preference)
	Use of sun screens (skin cancer protection, sun sensitivities)
Loss of calcium from the extracellular compartment	
To the bone	Growth
	Recent history of weaning
	Bisphosphonate treatment
To the urine	Kidney stones
	Family history
To soft tissue	Loop diuretic use
	Traumatic muscle damage
	Intensive care treatment
	Extensive burns
	Oral phosphate therapy
Impaired PTH action	
Renal failure	Pruritus
	Anemia
Pseudohypoparathyroidism	Albright phenotype
	Family history
	Tetany

should be undertaken by the use of an ionized calcium measurement corrected to a pH of 7.4, detected using a calcium-sensitive electrode. However, the albumin-corrected total calcium concentration is often used. It is especially important to definitively exclude hypercalcemia because, if present, the diagnosis is that of primary or tertiary HPT, diagnoses that require a radically different therapeutic approach. There are many excellent PTH assays now available that measure the full-length 1-84 molecule, although cross-reactivity with the 7-84 peptide may be a problem in chronic renal failure.

A good assay of circulating 25-hydroxyvitamin D, which measures both the cholecalciferol and ergocalciferol forms, is helpful for the diagnosis of vitamin D deficiency. Unfortunately, many current assays do not detect ergocalciferol with the same sensitivity as cholecalciferol. This may be a problem in patients who receive oral ergocalciferol as a vitamin D supplement because their vitamin D level may seem to be inappropriately low. Furthermore, there are substantial problems with cross-reactivity in many assays that do not use a vitamin D lipid extraction step, so that at high levels, they over-report but at low levels they under-report.

The diagnosis of increased end organ action on the kidney caused by secondary or tertiary HPT is facilitated by the use of the relation between plasma calcium and renal calcium excretion, first described by Nordin and Peacock.<sup>(19)</sup> In this test, the renal excretion of calcium per liter glomerular filtrate, easily calculated from the plasma and urine creatinine concentration and the urine calcium concentration, is plotted against the plasma calcium (Fig. 2). In secondary and tertiary HPT, the kidney conserves calcium by increasing renal calcium reab-

sorption. This reabsorption may be stimulated by a variety of transporters in the distal tubule, including the sodium calcium co-transporter that is under the regulation of PTH.<sup>(20)</sup> Stimulation of renal transporters results in renal calcium conservation and a low urine calcium concentration. This is a sensitive measurement of parathyroid overactivity in calcium deficiency. It is detected by a low urine calcium excretion relative to the plasma calcium; when plotted, the patient's renal calcium excretion will be to the right of the reference data. The only exception is when the kidney is the primary source of loss of calcium from the body: so-called renal hypercalciuria. Under these circumstances, the renal calcium excretion is to the left of the reference curve. Another test of increased PTH activity on the kidney is that of a low renal phosphate threshold (Tm<sub>p</sub>). This can be calculated from the measurement of plasma and urine creatinine concentration and the urine phosphate concentration and the use of a nomogram.<sup>(21)</sup> Finally, bone turnover markers are useful to identify increased bone resorption often associated with increased osteoblast activity associated with the skeletal response to secondary HPT.

The use of these measures on the same fasting blood and second urine sample after an overnight fast enables an efficient assessment of the function of the bone and kidney and indirectly the intestine under the action of PTH and usually allows a specific diagnosis that acts as the basis for treatment.

## REFERENCES

1. Brown EM, MacLeod RJ 2001 Extracellular calcium sensing and extracellular calcium signaling. *Physiol Rev* **81**:239–297.

2. Marie PJ, Pettifor JM, Ross FP, Glorieux FH 1982 Histological osteomalacia due to dietary calcium deficiency in children. *N Engl J Med* **307**: 584–588.
3. Prince RL, Dick IM, Lemmon J, Randell D 1997 The pathogenesis of age-related osteoporotic fracture: Effects of dietary calcium deprivation. *J Clin Endocrinol Metab* **82**:260–264.
4. Price RL, Gutteridge DH, Stuckey BGA, Kent N, Retallack RW, Prince RL, Bhagat CI, Johnston CA, Nicholson GC, Stewart GO, 1993 Rapid, divergent changes in spinal and forearm bone density following short-term intravenous treatment of Paget's disease with pamidronate disodium. *J Bone Miner Res* **8**:209–217.
5. Honkanen R, Koger H, Alhava E, Tuppurainen M, Saarikoski S 1997 Lactose intolerance associated with fractures of weight-bearing bones in Finnish women aged 38–57 years. *Bone* **21**:473–477.
6. Selby PL, Davies M, Adams JE, Mawer EB 1999 Bone loss in celiac disease is related to secondary hyperparathyroidism. *J Bone Miner Res* **14**:652–657.
7. Wisker E, Nagel R, Tanudjaja TK, Feldheim W 1991 Calcium, magnesium, zinc, and iron balances in young women: Effects of a low-phytate barley-fiber concentrate. *Am J Clin Nutr* **54**:553–559.
8. Devlin RD, Retallack RW, Fenton AJ, Grill V, Gutteridge DH, Kent GN, Prince RL, Worth GK 1994 Long-term elevation of 1,25-dihydroxyvitamin D after short-term intravenous administration of pamidronate (aminohydroxypropylidene bisphosphonate, APD) in Paget's disease of bone. *J Bone Miner Res* **9**:81–85.
9. Kukreja SC, Shanmugam A, Lad TE 1988 Hypocalcemia in patients with prostate cancer. *Calcif. Tissue Int* **43**:340–345.
10. DeSantiago S, Alonso L, Halhali A, Larrea F, Isoard F, Bourges H 2002 Negative calcium balance during lactation in rural Mexican women. *Am J Clin Nutr* **76**:845–851.
11. Devine A, Criddle RA, Dick IM, Kerr DA, Prince RL 1995 A longitudinal study of the effect of sodium and calcium intakes on regional bone density in postmenopausal women. *Am J Clin Nutr* **62**:740–745.
12. Stein MS, Scherer SC, Walton SL, Gilbert RE, Ebeling PR, Flicker L, Wark JD 1996 Risk factors for secondary hyperparathyroidism in a nursing home population. *Clin Endocrinol (Oxf)* **44**:375–383.
13. Llach F, Felsenfeld AJ, Haussler MR 1981 The pathophysiology of altered calcium metabolism in rhabdomyolysis-induced acute renal failure. Interactions of parathyroid hormone, 25-hydroxycholecalciferol, and 1,25-dihydroxycholecalciferol. *N Engl J Med* **305**:117–123.
14. Prince RL, Eisman JA, Simpson RW 1983 Hypercalcaemia in association with renal failure: The role of immobilisation. *Aust NZ J Med* **13**:8–10.
15. Albright F BC, Smith OH 1942 Pseudohypoparathyroidism: An example of "Seabright Bantam" syndrome. *Endocrinology* **30**:922–932.
16. St. John A, Thomas MB, Davies CP, Mullan B, Dick I, Hutchison B, van der Schaff A, Prince RL 1992 Determinants of intact parathyroid hormone and free 1,25-dihydroxyvitamin D levels in mild and moderate renal failure. *Nephron* **61**:422–427.
17. Estepa JC, Aguilera-Tejero E, Lopez I, Almaden Y, Rodriguez M, Felsenfeld AJ 1999 Effect of phosphate on parathyroid hormone secretion in vivo. *J Bone Miner Res* **14**:1848–1854.
18. Makitie O, Kooh SW, Sochett E 2003 Prolonged high-dose phosphate treatment: A risk factor for tertiary hyperparathyroidism in X-linked hypophosphatemic rickets. *Clin Endocrinol (Oxf)* **58**:163–168.
19. Nordin BE, Peacock M 1969 Role of kidney in regulation of plasma-calcium. *Lancet* **2**:1280–1283.
20. Khundmiri SJ, Dean WL, McLeish KR, Lederer ED 2005 Parathyroid hormone-mediated regulation of Na<sup>+</sup>-K<sup>+</sup>-ATPase requires ERK-dependent translocation of protein kinase C alpha. *J Biol Chem* **280**:8705–8713.
21. Walton RJ, Bijvoet OLM 1975 Nomogram for derivation of renal threshold phosphate concentration. *Lancet* **1**:309–310.

## Chapter 31. Hypercalcemia Associated With Malignancy

Mara J. Horwitz and Andrew F. Stewart

*Division of Endocrinology, University of Pittsburgh School of Medicine, Pittsburgh, Pennsylvania*

### INTRODUCTION

Malignancy-associated hypercalcemia (MAHC) was first reported to occur simultaneously with the deployment of clinical serum calcium measurements in the early 1920s. It is by far the most common cause of hypercalcemia among hospitalized patients and is a frequent cause of death among patients with cancer. It is also a serious, life-threatening complication of cancer and forecasts a grave prognosis: it has reported that the 50% survival among patients with MAHC, regardless of treatment, is 30 days.

The first clinical series included patients with extensive skeletal involvement caused by multiple myeloma and breast cancer, a syndrome called "local osteolytic hypercalcemia" (LOH). By the 1940s and 1950s, it was apparent that many patients with MAHC had limited or no skeletal involvement and had different tumor types than those with LOH. These patients are now referred to as having "humoral hypercalcemia of malignancy" (HHM). In the 1980s, occasional patients with lymphoma and MAHC were described in whom hypercalcemia resulted from production by tumors of the active form of vitamin D, 1,25(OH)<sub>2</sub>D, also called calcitriol. Most recently, beginning in the 1990s, rare but convincing cases of authentic

ectopic secretion of PTH have been described. The salient features of these four mechanistic subtypes of MAHC are summarized in Table 1. Each is discussed in more detail below. Therapy of HHM is discussed in more detail elsewhere and should include measures aimed at (1) reducing the tumor burden; (2) reducing osteoclastic bone resorption; and (3) augmenting renal calcium clearance.

Finally, it is important to emphasize that patients with cancer may develop hypercalcemia as a result of other coexisting conditions, such as primary hyperparathyroidism (HPT), tuberculosis, sarcoidosis, immobilization, and use of calcium-containing hyperalimentation solutions. These causes are summarized elsewhere and should be actively sought and corrected because they are easier to treat and have a more optimistic prognosis than MAHC.

### LOH

In large series of unselected patients with MAHC, LOH accounts for ~20% of cases. Skeletal involvement is extensive, as assessed by bone or bone marrow biopsy, bone scintigraphic scanning, and/or autopsy. Biochemically (Figs. 1–3; Table 2), LOH is characterized by hypercalcemia, normal or high serum phosphorus levels, suppression of PTH secretion with reductions in nephrogenous cyclic AMP excretion, an increase in fractional and 24-h calcium excretion, a reduction in serum 1,25(OH)<sub>2</sub>D, and increased markers of bone resorption (e.g.,

Dr. Stewart is a consultant for Wyeth, Eli Lilly, Proctor & Gamble, and Amgen and owns stock in Osteotrophin. Dr. Horwitz has reported no conflicts of interest.

TABLE 1. MECHANISTIC CATEGORIES OF MAHC

LOH
20% of patients with MAHC
Extensive skeletal tumor involvement
Types of tumors
Breast cancer
Multiple myeloma
Lymphoma
Leukemia
HHM
80% of patients with MAHC
Limited or no skeletal tumor involvement
Types of tumors
Squamous carcinoma, any organ
Renal carcinoma
Bladder carcinoma
Ovarian carcinoma
Endometrial carcinoma
HTLV-1 lymphoma
Breast cancer
1,25(OH) <sub>2</sub> Vitamin D–mediated hypercalcemia
Rare (~50 cases)
Variable skeletal tumor involvement
Types of tumors
Lymphoma
Ovarian dysgerminoma
Authentic ectopic hyperparathyroidism
Rare (~9 cases)
Variable skeletal involvement
Types of tumors: variable

serum N-telopeptide). Two general tumor types are typical: breast cancer and hematologic malignancies.

### Breast Cancer

Whereas many types of solid tumors metastasize to bone, among solid tumors, breast cancer is by far the most com-

mon cause of LOH. To be sure, prostate cancer and small cell cancer frequently metastasize to the skeleton, but they rarely cause hypercalcemia. Squamous carcinoma of the lung frequently causes hypercalcemia, but typically through HHM. Breast cancer cells seem to have a particular trophism for bone, and it is now well established that breast cancer cells within the skeleton are particularly likely to produce PTH-related protein (PTHrP) and that local PTHrP production by breast cancers is augmented by the resultant release of bone-derived cytokines such as TGF- $\beta$ . Thus, a vicious cycle develops in which PTHrP leads to increasing skeletal resorption by osteoclasts, which in turn release local cytokines that augment PTHrP secretion by the breast cancer metastases. These mechanisms are described in further detail elsewhere.

### Hematologic Malignancies

Multiple myeloma (MM) remains the hematologic malignancy most commonly associated with hypercalcemia: up to 30% of patients with multiple myeloma may develop hypercalcemia. Histologically, myeloma is characterized by purely lytic or osteoclastic bone resorption, with absent bone formation. Hypercalcemia is most likely to occur in patients with renal insufficiency, who combine increases in bone resorption with reduced calcium clearance. Hypercalcemia of this type is also associated with other hematologic malignancies, particularly lymphomas of all histologies. Chronic lymphocytic leukemia, acute lymphoblastic leukemia, chronic myelocytic leukemia, and acute myeloblastic leukemia have all been reported to cause hypercalcemia, but this is uncommon. The mechanisms responsible for increased osteoclastic activity and bone destruction in hematologic malignancies include local production by tumor cells within the marrow compartment of specific osteoclast-activating cytokines, including macrophage inflammatory protein-1 $\alpha$ , interleukins-1 and -6, PTHrP, RANKL, and others. These are discussed in detail elsewhere.

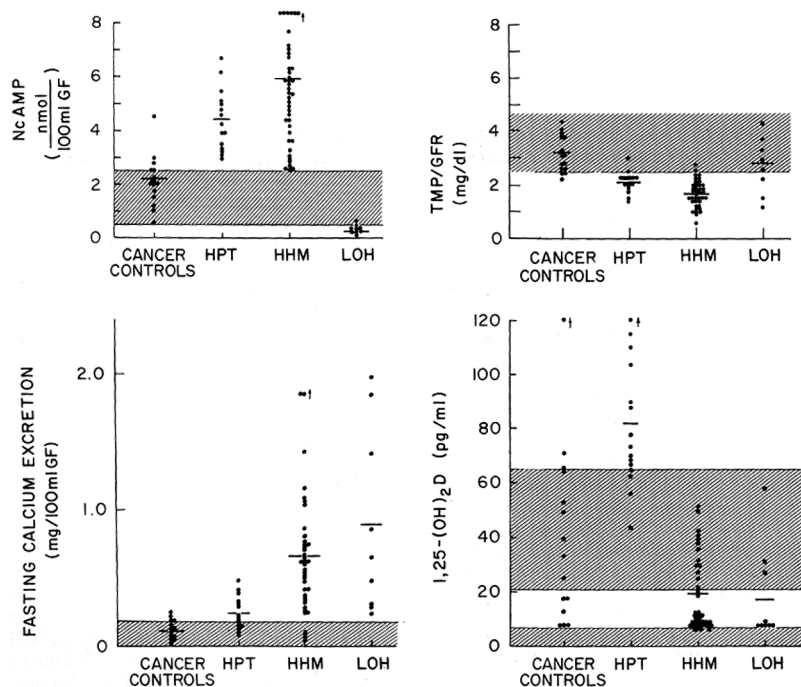
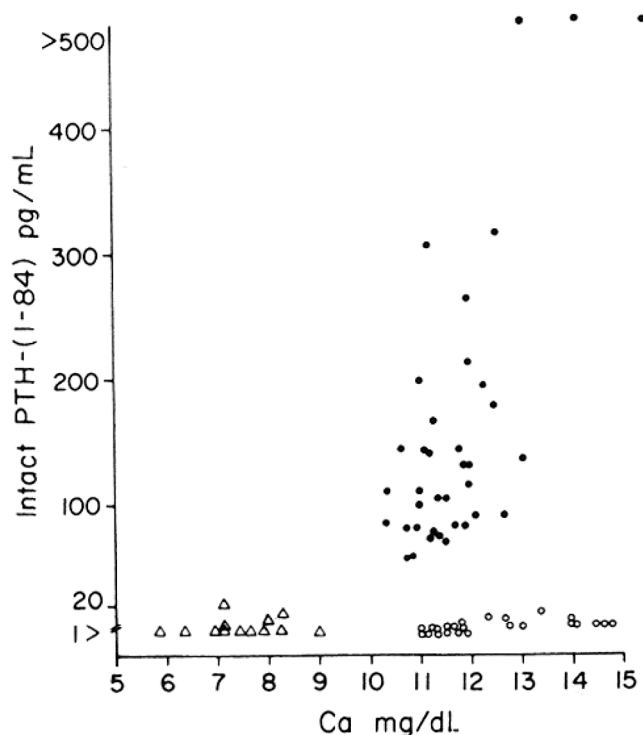

FIG. 1. Nephrogenous cyclic adenosine monophosphate excretion (NcAMP), renal tubular maximum for phosphorus (TmP/GFR), fasting calcium excretion, and plasma 1,25-dihydroxyvitamin D values in normocalcemic patients with cancer (cancer controls) and in patients with primary HPT, HHM, and hypercalcemia caused by bone metastases or local osteolytic hypercalcemia (LOH). (Adapted with permission from Stewart AF, Horst R, Defetos LJ, Cadman EC, Lang R, Broadus AE 1980 Biochemical evaluation of patients with cancer-associated hypercalcemia: Evidence for humoral and non-humoral groups. *N Engl J Med* 303:1377–1383.) Copyright © 1980 Massachusetts Medical Society. All rights reserved. Adapted with permission, 2006.



**FIG. 2.** Immunoreactive PTH concentration of PTH by using a two-site immunoradiometric assay for PTH(1-84) in patients with primary HPT (●), hypoparathyroidism (△), and hypercalcemia of malignancy (○). (Reprinted with permission from Nussbaum S, Zahradnik RJ, Lavigne JR, et al. 1987 Highly sensitive two-site immunoradiometric assay of parathyrin and its clinical utility in evaluating patients with hypercalcemia. *Clin Chem* 33:1364-1367.)

**HHM**

The term “humoral hypercalcemia of malignancy” describes a clinical syndrome that results from the production of PTHrP. The syndrome was first described in 1941 in a patient with renal carcinoma and a solitary skeletal metastasis. Reports in the 1950s and 1960s documented the humoral nature of the syndrome by showing that (1) typical patients had little or no skeletal tumor involvement and (2) the hypercalcemia and other biochemical abnormalities reversed when the tumor was resected or treated. Evidence from the 1960s and 1970s suggested that the responsible factor was either prostaglandin E<sub>2</sub>, a vitamin D-like sterol, or PTH. It is now clear that none of these is responsible.

Large clinical series show that HHM accounts for up to 80% of patients with MAHC. From a clinical standpoint, patients with HHM have advanced disease with tumors that are usually large, obvious clinically and with a poor prognosis. In contrast to the typical tumor types associated with LOH, patients with HHM most often have squamous carcinomas (involving lung, esophagus, head and neck, cervix, vulva, skin, etc.; Table 1). Other tumor types commonly associated with HHM are renal, bladder, and ovarian carcinomas. Breast carcinoma may cause typical HHM or may lead to hypercalcemia through skeletal metastatic involvement. Finally, the subset of hypercalcemic patients with lymphomas caused by human T-cell leukemia virus-I seems to have classic PTHrP-mediated HHM, although, others have suggested that macrophage inflammatory protein-1 $\alpha$  may also contribute to the syndrome.

Biochemically and histologically, patients with HHM share certain features with patients with primary HPT and differ in

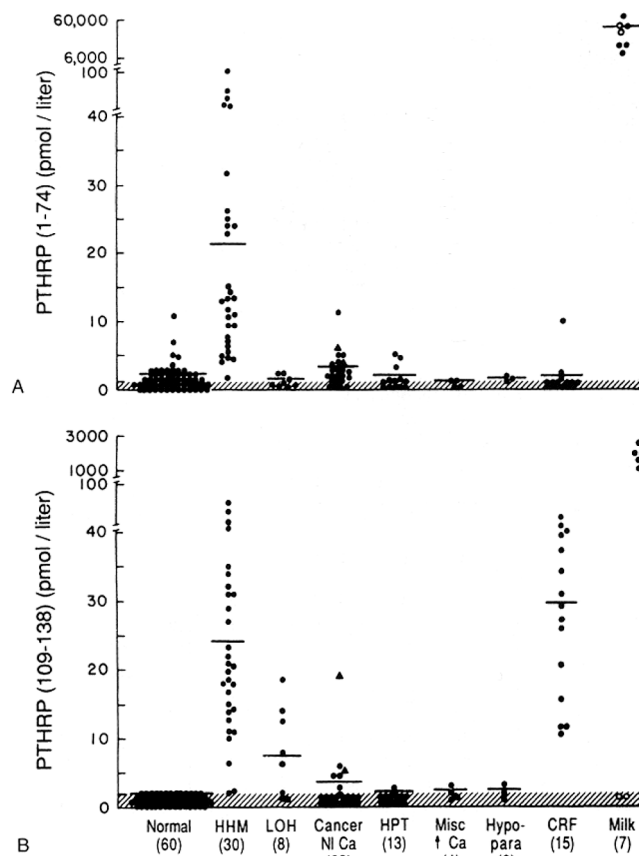

**FIG. 3.** Immunoreactive PTHrP values in patients with HHM and in various control groups. PTHrP values shown were obtained by using a two-site immunoradiometric assay (IRMA) directed against PTHrP(1-74). (Reprinted with permission from Burtis WJ, Brady TG, Orloff JJ, et al. 1980 Immunochemical characterization of circulating PTH-related protein in patients with humoral hypercalcemia of malignancy. *N Engl J Med* 322:1106-1112.) Copyright © 1980 Massachusetts Medical Society. All rights reserved.

other respects (Table 2; Figs. 1-4). Both groups of patients have a humoral syndrome, both are hypercalcemic, and both are hypophosphatemic and display reductions in the renal tubular phosphorus threshold. Both groups display increased

**TABLE 2. SIMILARITIES AND DIFFERENCES BETWEEN PATIENTS WITH PRIMARY HPT AND HHM**

	HPT	HHM	LOH
Humorally mediated hypercalcemia	+	+	-
Increased osteoclastic bone resorption	+	+	+
Increased renal calcium reabsorption	+	+	-
Hypophosphatemia	+	+	-
Phosphaturia	+	+	-
Nephrogenous cAMP elevation	+	+	-
Increased plasma 1,25(OH) <sub>2</sub> D	+	-	-
Increased osteoblastic bone formation	+	-	±
Increased circulating immunoreactive PTH	+	-	-
Increased circulating immunoreactive PTHrP	-	+	-
Hypercalcemia due primarily to effects on kidney and GI tract	+	-	-
Hypercalcemia due to combined effects on kidney and bone	-	+	-
Hypercalcemia due primarily to effects on bone	-	-	+



**FIG. 4.** Comparison of bone histology in a patient with HPT (top) and HHM (bottom). In both groups, osteoclastic activity is accelerated, although it is higher in HHM than in HPT. In HPT, osteoblastic activity and osteoid are increased, but both are markedly decreased in HHM. This uncoupling of formation from resorption in HHM plays the major role in causing hypercalcemia. (Reprinted with permission from Stewart AF, Vignery A, Silvergate A, et al. 1982 Quantitative bone histomorphometry in humoral hypercalcemia of malignancy: Uncoupling of bone cell activity. *J Clin Endocrinol Metab* **55**:219–227.) Copyright © 1982, The Endocrine Society.

nephrogenous or urinary cAMP excretion, indicating an interaction of the respective humoral mediator with proximal tubular PTH receptors. Both groups display increases in osteoclastic bone resorption histologically (Fig. 4) and using bone resorption markers. Hypercalcemia in both groups result, in part, from increased distal tubular calcium reabsorption mediated by PTH and PTHrP.

In contrast, patients with HHM differ from those with HPT in two important respects (Table 2). First, because PTH is a potent stimulus for the renal production of  $1,25(\text{OH})_2\text{D}$ , patients with HPT typically show increases in circulating  $1,25(\text{OH})_2\text{D}$  (Fig. 1) and a resultant increase in calcium absorption by the intestine. In contrast, patients with HHM display reductions in serum  $1,25(\text{OH})_2\text{D}$  values and in intestinal calcium absorption. The pathophysiology underlying this observation is uncertain, but PTHrP seems to be a poor agonist for  $1,25(\text{OH})_2\text{D}$  production in humans. Second, in patients with HPT, osteoblastic bone formation is increased and coupled to the increased bone resorption rate (Fig. 4). In patients with HHM, however, osteoblastic bone formation is reduced and is therefore dissociated or uncoupled from the increased osteoclastic bone resorption. This is apparent both histologically as

well as by measurement of biochemical markers of bone formation. The reasons for this uncoupling are also unclear. Of course, PTH concentrations in plasma are elevated in patients with HPT, but they are suppressed in patients with HHM (Fig. 2). Conversely, PTHrP values are elevated in HHM, but they are normal in patients with HPT (Fig. 3). Preliminary studies suggest that the PTHrP concentration may be useful in monitoring responses to surgery, chemotherapy, or radiotherapy in patients in whom levels are elevated before therapy.

Hypercalcemia in patients with HHM has both skeletal and renal components. The skeletal component, as noted earlier, reflects increased osteoclast activity and uncoupling of osteoblasts from osteoclasts. The renal component reflects PTHrP-mediated increases in distal tubular calcium reabsorption. In addition, patients with HHM are usually volume depleted, partly as a result of their hypercalcemia, with resultant inability to concentrate the urine, and partly as a result of poor oral fluid intake. The volume depletion leads to a reduction in the filtered load of calcium and a reduction in the fractional excretion of calcium.

### 1,25(OH)<sub>2</sub>D-MEDIATED HYPERCALCEMIA

In the 1980s, six patients were described with malignant lymphomas in whom circulating concentrations of  $1,25(\text{OH})_2\text{D}$  were found to be elevated, in some cases strikingly so. More cases were added in 1994, and additional cases have been reported subsequently. The elevation of plasma  $1,25(\text{OH})_2\text{D}$  contrasts with findings in other types of malignancy-associated hypercalcemia (Fig. 1). No evidence for a role for either PTH or PTHrP has been found. Resection or medical therapy of the lymphomas reverses the hypercalcemia and reverses the elevations of  $1,25(\text{OH})_2\text{D}$  in plasma. No unifying histological theme is present among the lymphomas. Rather, lymphomas of several different subcategories are included in this group. The  $1,25(\text{OH})_2\text{D}$  elevations and hypercalcemia are corrected with glucocorticoid therapy. This syndrome seems to be the malignant counterpart of sarcoidosis, with malignant lymphocytes, macrophages, or both converting diet- and sun-derived  $25(\text{OH})\text{D}$  to  $1,25(\text{OH})_2\text{D}$ . In addition to lymphomas, dysgerminomas of the ovary have also been associated with hypercalcemia caused by elevated serum  $1,25(\text{OH})_2\text{D}$ . It is thought that the local inflammatory response to the dysgerminoma stimulates the expression and activity of  $1\alpha$ -hydroxylase. This in turn leads to the increased levels of circulating  $1,25(\text{OH})_2\text{D}$ .

### AUTHENTIC ECTOPIC HYPERPARATHYROIDISM

From the 1940s through the 1970s, what is now called HHM was widely attributed to ectopic secretion of PTH by malignant tumors. Terms such as “ectopic hyperparathyroidism” and “pseudohyperparathyroidism” were in common use. By the 1980s, it was clear that the vast majority of cases of HHM were caused by PTHrP, and it was questioned whether “ectopic secretion of PTH” even existed. In the 1990s, this question was clearly answered by the unequivocal demonstration that tumors can express the *PTH* gene and thereby cause hypercalcemia. At the time of this writing, nine cases of what can be described as “authentic ectopic hyperparathyroidism” have been reported. These tumors included three small-cell carcinomas (two of the lung and one of the ovary), a squamous carcinoma of the lung, an adenocarcinoma of the ovary, a thymoma, an undifferentiated neuroendocrine tumor, and a papillary carcinoma of the thyroid. Immunoreactive PTH was found to be elevated in state-of-the-art PTH two-site assays and declined with the hypercalcemia after tumor resection. In most cases, PTH was

present immunohistochemically; the tumors secreted PTH, but not PTHrP, into their culture medium *in vitro*; the tumors contained PTH, but not PTHrP, mRNA. In one case, PTH overexpression by an ovarian tumor resulted from a rearrangement of the *PTH* gene, which placed it under the control of an ovarian promoter. These findings make it clear that authentic ectopic secretion of PTH, although exceedingly rare, can occur. This entity should be considered in the diagnosis of patients with hypercalcemia and increased concentrations of PTH.

#### UNUSUAL FORMS OF HUMORAL HYPERCALCEMIA

The four broad categories of malignancy-associated hypercalcemia described in Table 1 comprise the vast majority of patients with cancer and hypercalcemia. It should, however, be clear that other mechanisms, although uncommon, may be encountered. For example, patients who clearly display humorally mediated hypercalcemic syndromes (i.e., hypercalcemia that is reversed by tumor resection) have been reported who do not fit into the HHM biochemical categorization described. The humoral mediator in these patients is unknown. Rare patients with renal carcinomas have been described who seem to have bona fide tumor secretion of prostaglandin E<sub>2</sub> as a cause.

#### SUGGESTED READING

1. Stewart AF, Broadus AE 2006 Malignancy-associated hypercalcemia. In: DeGroot L, Jameson LJ (eds.) *Endocrinology*, 5th ed. W.B. Saunders, Philadelphia, PA, USA, pp. 1555–1565.
2. Stewart AF 2005 Hypercalcemia associated with cancer. *N Engl J Med* **352**:373–379.
3. Perry CM, Figgitt DP 2004 Zoledronic acid: A review of its use in patients with advanced cancer. *Drugs* **64**:1197–1211.
4. Major P, Lortholary A, Hon J, Abdi E, Mills G, Menssen HD, Yunus F, Bell R, Body J, Quebe-Fehling E, Seaman J 2001 Zoledronic acid is superior to pamidronate in the treatment of hypercalcemia of malignancy: A pooled analysis of two randomized, controlled clinical trials. *J Clin Oncol* **19**:558–567.
5. Ralson SH, Gallagher SJ, Patel U, Campbell J, Boyle IT 1990 Cancer-associated hypercalcemia: Morbidity and mortality. *Ann Intern Med* **112**: 499–504.
6. Nakayama K, Fukumoto S, Takeda S, Takeuchi Y, Ishikawa T, Miura M, Hata K, Hane M, Tamura Y, Tanaka Y, Kitaoka M, Obara T, Ogata E, Matsumoto T 1996 Differences in bone and vitamin D metabolism between primary hyperparathyroidism and malignancy-associated hypercalcemia. *J Clin Endocrinol Metab* **81**:607–611.
7. Guise TA, Yin JJ, Taylor SD 1996 Evidence for a causal role of parathyroid hormone-related protein in the pathogenesis of human breast cancer-mediated osteolysis. *J Clin Invest* **98**:1544.
8. Anderson KC, Shaughnessy JD, Barlogie B, Harousseau JL, Roodman GD 2002 Multiple Myeloma. American Society of Hematology, Washington, DC, USA.
9. Kakonen SM, Mundy GR 2003 Mechanisms of osteolytic bone metastases in breast carcinoma. *Cancer* **97**(3 Suppl):834–839.
10. Roodman GD 2004 Mechanisms of bone metastasis. *N Engl J Med* **350**:1655–1664.
11. Stewart AF, Horst R, Deftos LJ, Cadman EC, Lang R, Broadus AE 1980 Biochemical evaluation of patients with cancer-associated hypercalcemia: Evidence for humoral and non-humoral groups. *N Engl J Med* **303**:1377–1383.
12. Stewart AF, Vignery A, Silvergate A, Ravin ND, LiVolsi V, Broadus AE, Baron R 1982 Quantitative bone histomorphometry in humoral hypercalcemia of malignancy: Uncoupling of bone cell activity. *J Clin Endocrinol Metab* **55**:219–227.
13. Burtis WJ, Brady TG, Orloff JJ, Ersbak JB, Warrell RP, Olson BR, Wu TL, Mitnick MA, Broadus AE, Stewart AF 1990 Immunohistochemical characterization of circulating parathyroid hormone-related protein in patients with humoral hypercalcemia of malignancy. *N Engl J Med* **322**:1106–1112.
14. Motokura T, Fukumoto S, Matsumoto T, Takahashi S, Fujita A, Yamashita T, Igarashi T, Ogata E 1989 Parathyroid hormone-related protein in adult T-cell leukemia-lymphoma. *Ann Intern Med* **111**:484–488.
15. Grill V, Ho P, Body JJ, Johanson N, Lee SC, Kukreja SC, Moseley JM, Martin TJ 1991 Parathyroid hormone-related protein: Elevated levels in both humoral hypercalcemia of malignancy and hypercalcemia complicating metastatic breast cancer. *J Clin Endocrinol Metab* **73**:1309–1315.
16. Ikeda K, Ohno H, Hane M, Yokoi H, Okada M, Honma T, Yamada A, Tatsumi Y, Tanaka T, Saitoh T 1994 Development of a sensitive two-site immunoradiometric assay for parathyroid hormone-related peptide: Evidence for elevated levels in plasma from patients with adult T-cell leukemia/lymphoma and B-cell lymphoma. *J Clin Endocrinol Metab* **79**:1322–1327.
17. Horwitz MJ, Tedesco MB, Sereika S, Hollis B, Garcia-Ocaña A, Stewart AF 2003 Direct comparison of sustained infusion of hPTHrP(1–36) versus hPTH(1–34) on serum calcium, plasma 1,25(OH)<sub>2</sub> vitamin D concentrations and fractional calcium excretion in healthy human volunteers. *J Clin Endocrinol Metab* **88**:1603–1609.
18. Okada Y, Tsukuda J, Nakano K, Tonai S, Mine S, Tanaka Y 2004 Macrophage inflammatory protein-1 $\alpha$  induces hypercalcemia in adult T-cell leukemia. *J Bone Miner Res* **19**:1105–1113.
19. Horwitz MJ, Tedesco MB, Sereika SM, Syed MA, Garcia-Ocaña A, Bisello A, Hollis BW, Rosen CJ, Wysolmerski JJ, Dann P, Gundberg CM, Stewart AF 2005 Continuous infusion of parathyroid hormone versus parathyroid hormone-related protein in humans: Discordant effects on 1,25(OH)<sub>2</sub> vitamin D and prolonged suppression of bone formation. *J Bone Miner Res* **20**:1792–1803.
20. Breslau NA, McGuire JL, Zerwekh JR, Frenkel EP, Pak CYC 1984 Hypercalcemia associated with increased serum calcitonin levels in three patients with lymphoma. *Ann Intern Med* **100**:1–7.
21. Rosenthal NR, Insogna KL, Godsall JW, Smaldone L, Waldron JW, Stewart AF 1985 1,25 dihydroxyvitamin D-mediated humoral hypercalcemia in malignant lymphoma. *J Clin Endocrinol Metab* **60**:29–33.
22. Seymour JF, Gagel RF, Hagemester FB, Dimopoulos MA, Cabanillas F 1994 Calcitriol production in hypercalcemia and normocalcemic patients with non-Hodgkin lymphoma. *Ann Intern Med* **121**:633–640.
23. Evans KN, Taylor H, Zehnder D, Kilby MD, Bulmer JN, Shah F, Adams JS, Hewison M 2004 Increased expression of 25-hydroxyvitamin D-1 $\alpha$ -hydroxylase in dysgerminomas: A novel form of humoral hypercalcemia of malignancy. *Am J Pathol* **165**:807–813.
24. Nussbaum SR, Gaz RD, Arnold A 1990 Hypercalcemia and ectopic secretion of PTH by an ovarian carcinoma with rearrangement of the gene for PTH. *N Engl J Med* **323**:1324–1328.
25. Iguchi H, Miyagi C, Tomita K, Kawachi S, Nozuka Y, Tsuneyoshi M, Wakasugi H 1998 Hypercalcemia caused by ectopic production of parathyroid hormone in a patient with papillary adenocarcinoma of the thyroid gland. *J Clin Endocrinol Metab* **83**:2653–2657.
26. Eid W, Wheeler TM, Sharma MD 2004 Recurrent hypercalcemia due to ectopic production of parathyroid hormone-related protein and intact parathyroid hormone is a single patient with multiple malignancies. *Endoc Pract* **10**:125–128.



# Chapter 32. Hypercalcemia Caused by Granuloma-Forming Disorders

John S. Adams and Martin Hewison

*Division of Endocrinology, Diabetes and Metabolism, Burns and Allen Research Institute, Cedars-Sinai Medical Center, Los Angeles, California*

## **PATHOGENESIS**

The association of dysregulated calcium homeostasis and granuloma-forming disease was established in 1939 by the work of Harrell and Fisher.<sup>(1)</sup> With the advent of automated serum chemistry testing, more recent studies indicate that mild to severe hypercalcemia is detected in 10% of patients with sarcoidosis, and up to 50% of patients will become hypercalciuric at some time during the course of their disease.<sup>(2)</sup> Vitamin D was implicated in the pathogenesis of abnormal calcium metabolism after it was appreciated that patients with sarcoidosis who had hypercalcemia or hypercalciuria (or both) absorbed high amounts of dietary calcium and that normocalcemic patients were prone to hypercalcemia after receiving small amounts of vitamin D or UV light.<sup>(3)</sup> It has been proposed that bone resorption is also an important contributor to the pathogenesis of hypercalciuria and hypercalcemia,<sup>(4)</sup> based on the observations that a diet low in calcium seldom induces a normocalcemic state in sarcoidosis patients with moderate to severe hypercalcemia and that urinary calcium excretion often exceeds dietary calcium intake. More recent studies have shown that generalized, accelerated trabecular bone loss occurs in patients with sarcoidosis before institution of steroid therapy. Rizzato et al.<sup>(5)</sup> showed that (1) bone mass was significantly decreased in patients with active sarcoidosis, (2) bone loss was most marked in patients with hypercalcemia and/or hypercalciuria, and (3) bone loss was most prominent in postmenopausal women with long-standing disease.

For many years, these and similar clinical observations suggested that hypercalcemia and/or hypercalciuria in patients with sarcoidosis resulted from a heightened sensitivity to the biological effects of vitamin D. However, the discovery that a high proportion of these patients had elevated circulating concentrations of 1,25-dihydroxyvitamin D [1,25(OH)<sub>2</sub>D] indicated that the endogenous overproduction of an active vitamin D metabolite was the etiology of disordered calcium regulation in this disease. High serum 1,25(OH)<sub>2</sub>D concentrations have been reported in hypercalcemic patients with other granuloma-forming diseases and in patients harboring lymphoproliferative neoplasms (Table 1). In all of these disorders, there is a presumed extrarenal source for 1,25(OH)<sub>2</sub>D.<sup>(6–23)</sup>

## **CELLULAR SOURCE OF ACTIVE VITAMIN D METABOLITES**

The experiments of Barbour et al.<sup>(24)</sup> proved that in sarcoidosis the source of 1,25(OH)<sub>2</sub>D is extrarenal. These investigators described an anephric patient with sarcoidosis, hypercalcemia, and a high serum 1,25(OH)<sub>2</sub>D concentration. Subsequent studies showed that the elevated level of 1,25(OH)<sub>2</sub>D in patients with sarcoidosis was caused by increased production of the steroid hormone by macrophages,<sup>(6)</sup> which make up a significant proportion of the cell population in sarcoid granulomata. More recent work has revealed that macrophage synthesis of 1,25(OH)<sub>2</sub>D is also a feature of lymphomas and other malignancies. Immunohistochemical analysis of the enzyme 1 $\alpha$ -hydroxylase in a B-cell lymphoma associated with hypercalcemia and raised circu-

TABLE 1. HUMAN DISEASE ASSOCIATED WITH 1,25-DIHYDROXYVITAMIN D-MEDIATED HYPERCALCEMIA/HYPERCALCIURIA

Granuloma-forming diseases	
Noninfectious	
Sarcoidosis	Adams et al. (6)
Silicone-induced granulomatosis	Kozeny et al. (7)
Paraffin-induced granulomatosis	Albitar et al. (8)
Berylliosis	Stoeckle et al. (9)
Wegener's granulomatosis	Edelson et al. (10)
Eosinophilic granuloma	Jurney (11)
Infantile fat necrosis	Cook et al. (12)
Crohn's disease	Abreu et al. (13)
Infectious	
Tuberculosis	Gkonos et al. (14)
Candidiasis	Kantarijian et al. (15)
Leprosy	Hoffman and Korzeniowski (16)
Histoplasmosis	Walker et al. (17)
Coccidioidomycosis	Parker et al. (18)
Cat-scratch disease	Bosch (19)
Malignant lymphoproliferative disease	
B-cell lymphoma	Adams et al. (20)
Hodgkin's disease	Seymour and Gagel (21)
Lymphomatoid granulomatosis	Schienman et al. (22)
Dysgerminoma/seminoma	Evans et al. (23)

lating levels of 1,25(OH)<sub>2</sub>D suggests that the tumor itself is not a source of the steroid hormone. Rather, macrophages adjacent to the tumor are likely to be the major site of 1,25(OH)<sub>2</sub>D synthesis.<sup>(25)</sup> Similar observations have been made for other tumors, such as dysgerminomas, which are also known to be associated with hypercalcemia.<sup>(23)</sup> However, the situation with more common malignancies is less clear. Breast tumors show elevated levels of 1 $\alpha$ -hydroxylase expression, but this seems to involve expression of the enzyme by both malignant cells and leukocytes from the associated immune infiltrate.<sup>(26)</sup> Furthermore, it is not immediately apparent that the increased expression of extrarenal 1 $\alpha$ -hydroxylase seen in breast cancer is a cause of elevated serum 1,25(OH)<sub>2</sub>D. This seems to be caused by coincident expression of the vitamin D catabolic enzyme 24-hydroxylase, which attenuates accumulation of 1,25(OH)<sub>2</sub>D by catalyzing its conversion to less active metabolites such as 1,24,25-trihydroxyvitamin D.<sup>(26)</sup> In view of this, it is possible to speculate that there are two forms of humoral hypercalcemia of malignancy. In common neoplasms such as breast cancer, which have relatively normal circulating levels of 1,25(OH)<sub>2</sub>D, the underlying cause of hypercalcemia seems to be PTH-related peptide. In contrast, in tumors such as lymphomas or dysgerminomas, the apparent cause of hypercalcemia is extrarenal 1 $\alpha$ -hydroxylase activity associated with raised circulating levels of 1,25(OH)<sub>2</sub>D.

## **REGULATION OF EXTRARENAL 1 $\alpha$ -HYDROXYLASE ACTIVITY**

Recent RNA and protein analyses have confirmed that the enzyme 1 $\alpha$ -hydroxylase is overexpressed in affected tissues from patients with granulomatous diseases. However, this alone does not seem to account for the high levels of local 1,25(OH)<sub>2</sub>D

The authors have reported no conflicts of interest.

production required to raise circulating levels of the hormone. Indeed, four major lines of clinical evidence suggest that the endogenous extrarenal synthesis of  $1,25(\text{OH})_2\text{D}$  in hypercalcemic/hypercalciuric patients with granulomatous disease or lymphoma is not subject to normal, physiologic regulatory influences.<sup>(27-29)</sup> First, hypercalcemic patients possess high or inappropriately elevated serum  $1,25(\text{OH})_2\text{D}$  concentrations, although serum immunoreactive PTH levels are suppressed and serum phosphorus concentrations are relatively elevated. If  $1,25(\text{OH})_2\text{D}$  synthesis were under the trophic control of PTH and phosphorus,  $1,25(\text{OH})_2\text{D}$  concentrations would be low. Second, in normal individuals, serum  $1,25(\text{OH})_2\text{D}$  concentrations are not influenced by small to moderate increments of circulating 25-hydroxyvitamin D [ $25(\text{OH})\text{D}$ ] concentrations. In contrast, in patients with active sarcoidosis who have widespread disease and high serum angiotensin-converting enzyme activity, small to moderate changes in  $25(\text{OH})\text{D}$  are associated with increases in  $1,25(\text{OH})_2\text{D}$  that are, in turn, likely to cause hypercalciuria or hypercalcemia. Third, serum calcium and  $1,25(\text{OH})_2\text{D}$  concentrations are positively correlated to indices of disease activity; patients with sarcoidosis who have widespread disease and high serum angiotensin-converting enzyme activity are more likely to hypercalciuric or hypercalcemic. Finally, the rate of endogenous  $1,25(\text{OH})_2\text{D}$  production, which is significantly increased in patients with sarcoidosis, is unusually sensitive to inhibition by factors (e.g., glucocorticoids) that do not directly influence the renal  $1\alpha$ -hydroxylase enzyme that catalyzes synthesis of  $1,25(\text{OH})_2\text{D}$ .

Although substrate specificity and enzyme kinetics for the  $1\alpha$ -hydroxylase reaction seems to be the same for both kidney cells and macrophages,<sup>(30)</sup> the regulation of  $1,25(\text{OH})_2\text{D}$  synthesis at these sites seems to be very different. For example, the macrophage  $1\alpha$ -hydroxylation reaction is not induced by PTH, but it is very sensitive to stimulation by immunoactivators such as lipopolysaccharide<sup>(30)</sup> and cytokines such as interferon- $\gamma$  (IFN- $\gamma$ ).<sup>(31)</sup> Macrophage synthesis of  $1,25(\text{OH})_2\text{D}$  is very sensitive to inhibition by glucocorticoids,<sup>(31)</sup> chloroquine and related analogs,<sup>(32)</sup> and the cytochrome P-450 inhibitor ketoconazole,<sup>(33)</sup> but it is refractory to inhibition by  $1,25(\text{OH})_2\text{D}$ .<sup>(31)</sup> The renal enzyme, on the other hand, is relatively insensitive to inhibition by glucocorticoids and is downregulated by  $1,25(\text{OH})_2\text{D}$ . These differences in the regulation of  $1\alpha$ -hydroxylase activity in the kidney and macrophages do not seem to be caused by the expression of two different gene products. Analysis of mRNA for  $1\alpha$ -hydroxylase in extrarenal tissues including macrophages and keratinocytes has revealed identity with the renal gene sequence.<sup>(34,35)</sup> Rather, it is likely that there is differential regulation of the  $1\alpha$ -hydroxylase gene in different cell types.<sup>(36)</sup> Renal  $1\alpha$ -hydroxylase is upregulated at the level of transcription by calciotropic hormones such as PTH and calcitonin and is also subject to exquisite autoregulation by  $1,25(\text{OH})_2\text{D}$  itself.<sup>(37)</sup> In contrast, macrophage  $1\alpha$ -hydroxylase mRNA expression is potently stimulated by inflammatory agents such as IFN- $\gamma$  and shows no feedback control in response to  $1,25(\text{OH})_2\text{D}$ .<sup>(38)</sup> The precise molecular mechanism for this remains unclear and may involve differential induction of the catabolic enzyme 24-hydroxylase.

#### IMMUNOACTIVITY OF $1,25(\text{OH})_2\text{D}$

Studies over the last 25 years have shown very clearly that vitamin D can exert effects that extend far beyond its established role in calcium homeostasis and bone metabolism. For example, the antiproliferative properties of  $1,25(\text{OH})_2\text{D}$  have promoted its potential use in the treatment of cancer and psoriasis and has led in turn to the development of synthetic analogs of  $1,25(\text{OH})_2\text{D}$  to limit calcemic side effects.<sup>(39)</sup> Stud-

ies in vitro suggest that  $1,25(\text{OH})_2\text{D}$  is also a potent immunomodulatory steroid capable of suppressing lymphocyte proliferation, lymphokine production, and immunoglobulin synthesis.<sup>(39)</sup> While this represents another potential therapeutic target for vitamin D analogs, it has become apparent that  $1,25(\text{OH})_2\text{D}$  may play a role as an endogenous modulator of normal immune responses. In particular, it has been suggested that  $1,25(\text{OH})_2\text{D}$  produced by the macrophage in granulomatous diseases fulfills a paracrine immunoinhibitory function by modulating the proliferation and cytokine profile of neighboring, activated lymphocytes that express receptors for the hormone. In this way, locally synthesized  $1,25(\text{OH})_2\text{D}$  may act to slow an otherwise "overzealous" immune response that may be detrimental to the host.<sup>(40)</sup> The physiological significance of this has been highlighted by the recent development of  $1\alpha$ -hydroxylase knockout mouse models,<sup>(41,42)</sup> which presented with multiple enlarged lymph nodes.

#### TREATMENT OF HYPERCALCEMIA/ HYPERCALCIURIA ASSOCIATED WITH SARCOIDOSIS

The most important factor in the successful management of disordered vitamin D metabolism of sarcoidosis is recognition of patients at risk. Those at risk include patients with (1) indices of active, widespread disease (i.e., elevated serum angiotensin-converting enzyme levels, diffuse infiltrative pulmonary disease); (2) preexistent hypercalciuria; (3) a previous history of hypercalcemia or hypercalciuria; (4) a diet enriched in vitamin D and calcium; and (5) a recent history of sunlight exposure or treatment with vitamin D. All patients with active sarcoidosis should be screened for hypercalciuria. In a timed, fasting urine collection, a fractional urinary calcium excretion rate exceeding 0.16 mg calcium/100 ml glomerular filtrate is considered hypercalciuria. Alternatively, 24-h urinary calcium excretion values greater than the usual normal limits for men (300 mg) and women (250 mg) are also indicative of hypercalciuria, based on a complete sample collection containing between 1.0 and 2.0 g creatinine. If the urinary calcium excretion is elevated, serum  $25(\text{OH})\text{D}$  and  $1,25(\text{OH})_2\text{D}$  concentrations should be determined as a disease marker and to judge the efficacy of therapy. Because hypercalciuria frequently precedes the development of overt hypercalcemia, the occurrence of either is an indication for therapy.

Glucocorticoids (40–60 mg prednisone or equivalent daily) are the mainstay of therapy of disordered calcium homeostasis resulting from the endogenous overproduction of active vitamin D metabolites. Institution of glucocorticoid therapy results in a prompt decrease in the circulating  $1,25(\text{OH})_2\text{D}$  concentration (within 3 days), presumably by inhibition of macrophage  $1\alpha$ -hydroxylase activity. Normalization of the serum or urine calcium usually occurs within a matter of days.<sup>(28)</sup> Failure to normalize the serum calcium after 10 days of therapy suggests the coexistence of another hypercalcemic process (e.g., hyperparathyroidism or humoral hypercalcemia of malignancy). The dietary intake of calcium and vitamin D should be limited in such patients, as should sunlight (UV light) exposure. After a hypercalcemic episode, urinary calcium excretion rates should be monitored intermittently to detect recurrence.

#### TREATMENT OF HYPERCALCEMIA/ HYPERCALCIURIA IN OTHER DISORDERS ASSOCIATED WITH OVERPRODUCTION OF $1,25(\text{OH})_2\text{D}$

Glucocorticoids may also be effective in the management of vitamin D-mediated hypercalcemia or hypercalciuria associ-

ated with lymphoma or granuloma-forming diseases other than sarcoidosis. However, steroid therapy may not always be appropriate for these diseases, and consequently, alternative treatments may be necessary. Chloroquine<sup>(32,43)</sup> or hydroxychloroquine<sup>(44)</sup> and ketoconazole<sup>(33)</sup> are also capable of reducing the serum 1,25(OH)<sub>2</sub>D and calcium concentrations, although chloroquine and its analogs do not seem to be effective in lymphoma patients.<sup>(44)</sup> Because of the limited experience with these drugs as antihypercalcemic agents, they should be restricted to patients in whom steroid therapy is unsuccessful or contraindicated. The theoretic advantage of these agents over glucocorticoids is that correction of the serum 1,25(OH)<sub>2</sub>D concentration should result in rapid recovery of at least some of the BMD lost to the disease.<sup>(45)</sup> The use of the newer bisphosphonates in blocking bone resorption in hypercalcemic/hypercalciuric patients with sarcoidosis is still unknown.

## REFERENCES

- Harrell GT, Fisher S 1939 Blood chemical changes in Boeck's sarcoid with particular reference to protein, calcium and phosphates values. *J Clin Invest* **18**:687-693.
- Studdy PR, Bird R, Neville E, James DG 1980 Biochemical findings in sarcoidosis. *J Clin Pathol* **33**:528-533.
- Bell NH, Gill JR Jr, Bartter FC 1964 On the abnormal calcium absorption in sarcoidosis: Evidence for increased sensitivity to vitamin D. *Am J Med* **36**:500-513.
- Fallon MD, Perry HM 3rd, Teitelbaum SL 1981 Skeletal sarcoidosis with osteopenia. *Metab Bone Dis Relat Res* **3**:171-174.
- Rizzato GL, Montemurro L, Fraioli P 1992 Bone mineral content in sarcoidosis. *Semin Resp Med* **13**:411-423.
- Adams JS, Singer FR, Gacad MA, Sharma OP, Hayes MJ, Vouros P, Holick MF 1985 Isolation and structural identification of 1,25-dihydroxyvitamin D<sub>3</sub> produced by cultured alveolar macrophages in sarcoidosis. *J Clin Endocrinol Metab* **60**:960-966.
- Kozeny GA, Barbato AL, Bansal VK, Vertuno LL, Hano JE 1984 Hypercalcemia associated with silicone-induced granulomas. *N Engl J Med* **311**:1103-1105.
- Albitar S, Genin R, Fen-Chong M, Schohn D, Riviere JP, Serveaux MO, Chuet C, Bourgeon B 1997 Multisystem granulomatous injuries 28 years after paraffin injections. *Nephrol Dial Transplant* **12**:1974-1976.
- Stoeckle JD, Hardy HL, Weber AL 1969 Chronic beryllium disease. Long-term follow-up of sixty cases and selective review of the literature. *Am J Med* **46**:545-561.
- Edelson GW, Talpos GB, Bone HG III 1993 Hypercalcemia associated with Wegener's granulomatosis and hyperparathyroidism: Etiology and management. *Am J Nephrol* **13**:275-277.
- Jurney TH 1984 Hypercalcemia in a patient with eosinophilic granuloma. *Am J Med* **76**:527-528.
- Cook JS, Stone MS, Hansen JR 1992 Hypercalcemia in association with subcutaneous fat necrosis of the newborn: Studies of calcium-regulating hormones. *Pediatrics* **90**:93-96.
- Abreu MT, Kantorovich V, Vasiliauskas EA, Gruntmanis U, Matuk R, Daigle K, Thomas LS, Chen S, Zehnder D, Lin Y, Yang H, Hewison M, Adams JS 2004 Measurement of vitamin D levels in inflammatory bowel disease (IBD) patients reveals a subset of Crohn's disease patients with elevated 1,25-dihydroxyvitamin D and low bone mineral density. *Gut* **53**:1129-1136.
- Gkonos PJ, London R, Hendlar ED 1984 Hypercalcemia and elevated 1,25-dihydroxyvitamin D levels in a patient with end-stage renal disease and active tuberculosis. *N Engl J Med* **311**:1683-1685.
- Kantarjian HM, Saad MF, Estey EH, Sellin RV, Samaan NA 1983 Hypercalcemia in disseminated candidiasis. *Am J Med* **74**:721-724.
- Hoffman VN, Korzeniowski OM 1986 Leprosy, hypercalcemia, and elevated serum calcitriol levels. *Ann Intern Med* **105**:890-891.
- Walker JV, Baran D, Yakub N, Freeman RB 1977 Histoplasmosis with hypercalcemia, renal failure, and papillary necrosis. Confusion with sarcoidosis. *Jama* **237**:1350-1352.
- Parker MS, Dokoh S, Woolfenden JM, Buchsbaum HW 1984 Hypercalcemia in coccidioidomycosis. *Am J Med* **76**:341-344.
- Bosch X 1988 Hypercalcemia due to endogenous overproduction of active vitamin D in identical twins with cat-scratch disease. *Jama* **279**:532-534.
- Adams JS, Fernandez M, Gacad MA, Gill PS, Endres DB, Rasheed S, Singer FR 1989 Vitamin D metabolite-mediated hypercalcemia and hypercalciuria patients with AIDS- and non-AIDS-associated lymphoma. *Blood* **73**:235-239.
- Seymour JF, Gagel RF 1993 Calcitriol: The major humoral mediator of hypercalcemia in Hodgkin's disease and non-Hodgkin's lymphomas. *Blood* **82**:1383-1394.
- Scheinman SJ, Kelberman MW, Tatum AH, Zamkoff KW 1991 Hypercalcemia with excess serum 1,25 dihydroxyvitamin D in lymphomatoid granulomatosis/angiocentric lymphoma. *Am J Med Sci* **301**:178-181.
- Evans KN, Shah F, Innes BA, Bulmer JN, Adams JS, Taylor H, Kilby MD, Hewison M 2004 Increased expression of 25-hydroxyvitamin D-1 $\alpha$ -hydroxylase in dysgerminomas: A novel form of humoral hypercalcemia of malignancy. *Am J Pathol* **165**:807-813.
- Barbour GL, Coburn JW, Slatopolsky E, Norman AW, Horst RL 1981 Hypercalcemia in an anephric patient with sarcoidosis: Evidence for extrarenal generation of 1,25-dihydroxyvitamin D. *N Engl J Med* **305**:440-443.
- Hewison M, Kantorovich V, Van Herle AJ, Cohan P, Zehnder D, Adams JS 2003 Vitamin D-mediated hypercalcemia in lymphoma: Evidence for hormone production by tumor-adjacent macrophages. *J Bone Miner Res* **18**:579-582.
- Townsend K, Banwell CM, Guy M, Colston KW, Mansi JL, Stewart PM, Campbell MJ, Hewison M 2005 Autocrine metabolism of vitamin D in normal and malignant breast tissue. *Clin Cancer Res* **11**:3579-3586.
- Sandler LM, Winearls CJ, Fraher LJ, Clemens TL, Smith R, O'Riordan JLH 1984 Studies of the hypercalcaemia of sarcoidosis: Effect of steroids and exogenous vitamin D<sub>3</sub> on the circulating concentrations of 1,25-dihydroxyvitamin D<sub>3</sub>. *Q J Med* **53**:165-180.
- Meyrier A, Valeyre D, Bouillon R, Paillard F, Battesti JP, Georges R 1985 Resorptive versus absorptive hypercalcaemia in sarcoidosis: Correlations with 25-hydroxy vitamin D<sub>3</sub> and 1,25-dihydroxy vitamin D<sub>3</sub> and parameters of disease activity. *Q J Med* **54**:269-281.
- Inogna KL, Dreyer BE, Mitnick M, Ellison AF, Broadus AE 1988 Enhanced production rate of 1,25-dihydroxyvitamin D in sarcoidosis. *J Clin Endocrinol Metab* **66**:72-75.
- Reichel H, Koeffler HP, Bishop JE, Norman AW 1987 25-Hydroxyvitamin D<sub>3</sub> metabolism by lipopolysaccharide-stimulated normal human macrophages. *J Clin Endocrinol Metab* **64**:1-9.
- Adams JS, Gacad MA 1985 Characterization of 1 alpha-hydroxylation of vitamin D<sub>3</sub> sterols by cultured alveolar macrophages from patients with sarcoidosis. *J Exp Med* **161**:755-765.
- Adams JS, Diz MM, Sharma OP 1989 Effective reduction in the serum 1,25-dihydroxyvitamin D and calcium concentration in sarcoidosis-associated hypercalcemia with short-course chloroquine therapy. *Ann Intern Med* **111**:437-438.
- Adams JS, Sharma OP, Diz MM, Endres DB 1990 Ketoconazole decreases the serum 1,25-dihydroxyvitamin D and calcium concentration in sarcoidosis-associated hypercalcemia. *J Clin Endocrinol Metab* **70**:1090-1095.
- Fu GK, Lin D, Zhang MY, Bikle DD, Shackleton CH, Miller WL, Portale AA 1997 Cloning of human 25-hydroxyvitamin D-1 $\alpha$ -hydroxylase and mutations causing vitamin D-dependent rickets type 1. *Mol Endocrinol* **11**:1961-1970.
- Smith SJ, Rucka AK, Berry JL, Davies M, Mylchreest S, Paterson CR, Heath DA, Tassabehji M, Read AP, Mee AP, Mawer EB 1999 Novel mutations in the 1 $\alpha$ -hydroxylase (P450c1) gene in three families with pseudovitamin D-deficiency rickets resulting in loss of functional enzyme activity in blood-derived macrophages. *J Bone Miner Res* **14**:730-739.
- Hewison M, Bland R, Zehnder D, Stewart PM 2000 1 $\alpha$ -hydroxylase and the action of vitamin D. *J Mol Endo* **25**:141-148.
- Kong XF, Zhu XH, Pei YL, Jackson DM, Holick MF 1999 Molecular cloning, characterization, and promoter analysis of the human 25-hydroxyvitamin D<sub>3</sub>-1 $\alpha$ -hydroxylase gene. *Proc Natl Acad Sci USA* **96**:6988-6993.
- Monkawa T, Yoshida T, Hayashi M, Saruta T 2000 Identification of 25-hydroxyvitamin D<sub>3</sub> 1 $\alpha$ -hydroxylase gene expression in macrophages. *Kidney Int* **58**:559-568.
- Nagpal S, Na S, Rathnachalam R 2005 Noncalcemic actions of vitamin D receptor ligands. *Endocr Rev* **26**:662-687.
- Lemire JM 1995 Immunomodulatory actions of 1,25-dihydroxyvitamin D<sub>3</sub>. *J Steroid Biochem Mol Biol* **53**:599-602.
- Panda DK, Miao D, Tremblay ML, Sirois J, Farookhi R, Hendy GN, Goltzman D 2001 Targeted ablation of the 25-hydroxyvitamin D 1 $\alpha$ -hydroxylase enzyme: Evidence for skeletal, reproductive, and immune dysfunction. *Proc Natl Acad Sci USA* **98**:7498-7503.
- Dardenne O, Prud'homme J, Arabian A, Glorieux FH, St-Arnaud R 2001 Targeted inactivation of the 25-hydroxyvitamin D<sub>3</sub>-1 $\alpha$ -hydroxylase gene (CYP27B1) creates an animal model of pseudovitamin D-deficiency rickets. *Endocrinology* **142**:3135-3141.
- O'Leary TJ, Jones G, Yip A, Lohnes D, Cohan M, Yendt ER 1986 The effects of chloroquine on serum 1,25-dihydroxyvitamin D and calcium metabolism in sarcoidosis. *N Engl J Med* **315**:727-730.
- Adams JS, Kantorovich V 1999 Inability of short-term, low dose hydroxychloroquine to resolve vitamin D-mediated hypercalcemia in patients with B-cell lymphoma. *J Clin Endocrinol Metab* **84**:799-801.
- Adams JS, Lee G 1997 Recovery of bone mineral density with resolution of exogenous vitamin D intoxication. *Ann Intern Med* **127**:203-206.

# Chapter 33. Miscellaneous Causes of Hypercalcemia

John J. Wysolmerski

*Section of Endocrinology and Metabolism, Department of Internal Medicine, Yale University School of Medicine, New Haven, Connecticut*

## INTRODUCTION

The majority of cases of hypercalcemia are caused by disorders of PTH secretion, by malignancy or by granulomatous disorders. Each of these situations has been discussed separately in other chapters. This chapter will discuss less common causes of hypercalcemia.

## PSEUDOHYPERCALCEMIA

Pseudohypercalcemia refers to instances in which the measured total serum calcium is elevated, but the patient is not truly hypercalcemic. This has been described in three settings: hyperalbuminemia, increased circulating levels of an abnormal, calcium-binding immunoglobulin, and pronounced thrombocytosis.

Albumin is the primary binding protein for circulating calcium ions. Therefore, abnormalities in the concentration of albumin can lead to abnormalities in the total concentration of calcium measured in the bloodstream. Although it is widely recognized that hypoalbuminemia can lead to hypocalcemia on this basis, it is less appreciated that hyperalbuminemia can result in hypercalcemia. Hyperalbuminemia principally occurs in the setting of volume contraction, and although the total calcium is elevated, the ionized calcium level is normal. Therefore, symptoms and signs of hypercalcemia are absent. Formulae have been developed to correct the calcium concentration for elevations or reductions in serum albumin, but these are not fully reliable. This is especially true in critically ill patients, and recent studies have suggested that the usual correction formulas systematically overestimate the incidence of hypercalcemia in intensive care units.<sup>(1)</sup> If knowing the true calcium concentration is important clinically, an ionized calcium level should be determined.

Abnormalities in calcium binding in the circulation have also been reported in multiple myeloma and Waldenström's macroglobulinemia.<sup>(2,3)</sup> These patients have an abnormal circulating immunoglobulin that binds calcium ions. In this setting, the globulin fraction, the total protein, and the total calcium levels are all elevated, but the ionized calcium level is normal. A similar situation has been reported when elevated immunoglobulins interfere with the total calcium determination by autoanalyzer. In this instance, the total calcium performed by autoanalyzer is elevated. However, both the total calcium level performed by atomic absorption and the ionized calcium level are normal. Because true hypercalcemia can complicate multiple myeloma, and because hyperparathyroidism has been reported to be associated with monoclonal gammopathy, care must be taken not to confuse pseudohypercalcemia and true hypercalcemia in these settings. As before, the absence of all signs and symptoms of hypercalcemia coupled with a normal ionized calcium level should allow for the discrimination between these possibilities and prevent inappropriate therapy directed at pseudohypercalcemia.

The third and final situation in which pseudohypercalcemia has been described is in patients with essential thrombocythemia and platelet counts  $>700,000$ .<sup>(4)</sup> One study reported that

15% of these patients had frank hypercalcemia when total calcium levels were measured. Ionized calcium levels were also elevated, and PTH levels were normal (not suppressed). Signs and symptoms of hypercalcemia were absent. The hypercalcemia was accompanied by hyperkalemia and resolved when platelet counts were normalized. It is thought that the hypercalcemia and hyperkalemia result from the secretion of these ions from the large number of abnormally activated platelets within the specimen tube as a clot is formed. Consistent with this thought, calcium and potassium levels have been found to improve if plasma samples are analyzed instead of serum samples. As in the previous two disorders, the elevation in serum calcium is an artifact that does not warrant specific therapy.

## ENDOCRINE CAUSES OF HYPERCALCEMIA OTHER THAN HYPERPARATHYROIDISM

### Thyrotoxicosis

Patients with thyrotoxicosis frequently manifest mild degrees of hypercalcemia.<sup>(5-9)</sup> It has been reported that the average calcium level rises in patients with hyperthyroidism, and up to 50% of patients with thyrotoxicosis present with serum calciums in the range of 10.5–11.5 mg/dl. A number of cases of coexistent Graves disease and hyperparathyroidism have also been reported. In this instance, the hyperthyroidism can exacerbate the degree of hypercalcemia and actually suppress the PTH values toward the normal range. However, thyrotoxicosis alone can clearly result in elevations of serum calcium, which can be severe. Thyroid hormone has been shown to exert direct effects on bone turnover, increasing bone resorption rates. In addition, recent studies have suggested that thyroid-stimulating hormone (TSH) may directly suppress bone resorption. Perhaps because of a combination of these factors, thyrotoxicosis leads to excess bone resorption, which releases calcium into the circulation and suppresses PTH levels. Therefore, patients with hyperthyroidism as a sole cause of their hypercalcemia should have low PTH and 1,25-dihydroxyvitamin D [ $1,25(\text{OH})_2\text{D}$ ] levels with reduced renal reabsorption of calcium. Hypercalcemia may respond to  $\beta$ -adrenergic blockade and is fully reversible on correction of the thyrotoxicosis.

### Pheochromocytoma

Hypercalcemia can occur in patients with pheochromocytoma for two reasons.<sup>(10,11)</sup> Most commonly, the hypercalcemia is a reflection of coexistent primary hyperparathyroidism in patients with multiple endocrine neoplasia (MEN)IIa. The diagnosis of pheochromocytoma should be considered before parathyroidectomy in all hypertensive patients with hyperparathyroidism. However, hypercalcemia that resolves after adrenalectomy has also been reported in sporadic cases of pheochromocytoma, suggesting that elevations in calcium can result from factors secreted by the tumor itself. There is some evidence that catecholamines can directly affect bone turnover and thus might be the cause of hypercalcemia. However, recent experience has shown that, like many other tumors of neuroendocrine origin, pheochromocytomas can secrete PTH-related protein (PTHrP) and produce hypercalcemia in a fashion identical to many carcinomas.

Dr. Wysolmerski has been a consultant for and received funding from Procter and Gamble Pharmaceuticals.

### Adrenal Insufficiency

Hypercalcemia has been associated with adrenal insufficiency, especially in patients presenting with Addisonian crisis.<sup>(12–14)</sup> It has been seen both in patients with primary as well as secondary adrenal insufficiency. The pathophysiology is unclear. Hypercalcemia may result in part from hemoconcentration and hypovolemia, but some reports have noted increases in ionized as well as total calcium. More recent reports have described suppressed values for PTH and 1,25(OH)<sub>2</sub>D. It is interesting that the human homolog of stanniocalcin, a calcium-lowering agent in fish, has recently been shown to be expressed in the adrenal gland.<sup>(15)</sup> It is not yet clear if this hormone has any effects on systemic calcium metabolism in humans. Hypercalcemia responds to intravenous fluids and glucocorticoid replacement.

### Islet Cell Tumors of the Pancreas/Vasoactive Intestinal Polypeptideomas

Islet cell tumors can be associated with hypercalcemia caused by MEN1 syndrome and coexistent primary hyperparathyroidism. They have also been found to secrete PTHrP and mimic humoral hypercalcemia of malignancy (HHM) syndrome.<sup>(16)</sup> In addition, up to 90% of patients with islet cell tumors producing vasoactive intestinal polypeptide (VIP) develop hypercalcemia.<sup>(17–19)</sup> These patients typically present with the syndrome of watery diarrhea, hypokalemia, and achlorhydria. The pathophysiology of the hypercalcemia in this syndrome has not been fully defined. However, recent studies have shown that PTH levels are suppressed during hypercalcemia, suggesting a PTH-independent mechanism. Furthermore, VIP and VIP receptors have been shown to be present in bone cells and exert effects on bone turnover in cell culture systems. Therefore, it is likely that the hypercalcemia is caused by direct effects of VIP acting on the skeleton.

### MILK-ALKALI SYNDROME

The milk-alkali syndrome results from the ingestion of large amounts of calcium and absorbable alkali.<sup>(20–22)</sup> It was first described in the 1930s as a complication of ulcer therapy, which, at the time, required the ingestion of large quantities of milk together with sodium bicarbonate. It continued to be seen commonly in the era before the introduction of H<sub>2</sub>-blockers when peptic ulcer disease was often treated with up to 20–60 g of calcium carbonate per day. With the introduction of nonabsorbable antacids and then H<sub>2</sub>-blockers and proton pump inhibitors, this syndrome became rare. However, in recent years, it has become more common again because of the widespread use of calcium carbonate to treat or prevent osteoporosis. The syndrome has also been documented in betel-nut users, who sometimes mix the nuts with oyster shell calcium and alkali. One series from the University of Oklahoma reported that milk-alkali syndrome caused by calcium carbonate ingestion had become the third most common cause of hypercalcemia in hospitalized patients, representing 16% of hospital admissions for hypercalcemia over a 3-year survey.

Milk-alkali syndrome is classically defined as the triad of hypercalcemia, systemic alkalosis, and renal insufficiency. Hypercalcemia is often severe and symptomatic, with presenting values commonly between 15 and 20 mg/dl. Renal dysfunction can vary from mild to severe, and nephrocalcinosis often exists if the syndrome has been present for some time. Other sites of soft tissue calcification, as evidenced by band keratopathy, are common as well. In the older literature, patients were generally reported to be hyperphosphatemic, but in more recent series, phosphate levels have been reported to be normal or low. This

most likely reflects the shift from milk, which has a high phosphate content, as a source of calcium to calcium carbonate, which does not. Although some confusion existed in the original literature, recent measurements using modern assays have documented that PTH levels are suppressed. The diagnosis of the syndrome requires a careful history especially of over-the-counter medication use.

The pathophysiology of milk-alkali syndrome is not fully understood, but most likely represents a vicious cycle set up by the ingestion of large amounts of calcium in the setting of volume contraction, systemic alkalosis, and progressive renal insufficiency. It is unclear what the threshold for the induction of hypercalcemia from oral calcium is, but it may be as low as 2 g of calcium daily. This varies with renal function and also between different subjects. By suppressing PTH and leading to volume contraction, hypercalcemia can limit the kidney's ability to excrete bicarbonate. There may also be direct tubular effects of calcium in this regard. In turn, systemic alkalosis can impair the renal excretion of calcium, and it also favors the precipitation of calcium phosphate in the kidney and other soft tissues. The development of nephrocalcinosis leads to progressive renal dysfunction which, in turn, contributes to the inability to excrete calcium and bicarbonate. Vomiting can precipitate the syndrome by causing volume contraction and the induction of systemic alkalosis. Likewise, the use of thiazide diuretics is a risk factor caused by these drugs' ability to interfere with calcium excretion and to cause volume contraction. The biochemical abnormalities are usually reversible with the discontinuation of oral calcium and alkali and with rehydration followed by forced saline diuresis. If renal failure is severe, making vigorous hydration difficult, hemodialysis against a low calcium bath has also been shown to be effective in lowering calcium levels. If the syndrome is acute, hypercalcemia and renal dysfunction resolve promptly and completely. In this setting, there can be rebound hypocalcemia and secondary hyperparathyroidism. In more chronic cases, especially if severe nephrocalcinosis is present, recovery takes longer and renal function may not completely normalize.

### IMMOBILIZATION

The skeleton has the ability to sense mechanical stress and adjust bone mass to meet the physical load placed on it. Although the mechanisms underlying this skeletal "mechanosensing" are not fully understood, it seems that the coupling of loading and bone turnover is accomplished primarily through the actions of osteocytes and osteoblasts. One pathological consequence of the active adjustment of bone mass to mechanical demands is that unloading of the skeleton, as happens during the weightlessness of space flight or during prolonged and complete bed rest after orthopedic or neurologic injury, leads to reductions in bone mass.<sup>(23–27)</sup> In this setting, bone loss occurs because of an uncoupling of bone turnover; one sees a simultaneous reduction in the rate of bone formation and an increase in the rate of bone resorption. This, in turn, leads to the rapid efflux of calcium from skeletal stores, the suppression of PTH and 1,25(OH)<sub>2</sub>D levels, and the development of hypercalciuria. If the amount of calcium released from the skeleton exceeds the amount of calcium that can be excreted by the kidney, hypercalcemia ensues. The two main risk factors for the development of hypercalcemia during immobilization seem to be (1) an impairment in renal function and (2) an antecedent elevation in bone turnover. Possible reasons for an increased baseline rate of bone turnover include a growing skeleton as seen in children, adolescents, and young adults, hyperparathyroidism, Paget's disease of bone, and "subclinical" or mild malignancy-associated hypercalcemia. For example, 25% of

children or young adults with spinal cord injury develop hypercalcemia, whereas it is unusual in middle-aged patients with normal renal function, despite similar degrees of immobility. Although the classic presentation is in a child or young adult with spinal cord injury, recent reports have suggested that hypercalcemia is a more common complication of stroke and hip fracture than was previously appreciated. This may be a consequence of the age-related decline of renal function in these generally older populations. Another population reported to be at risk are those suffering serious complications after bariatric surgery.<sup>(28)</sup> Special care needs to be taken in the management of patients with hyperparathyroidism or Paget's disease who are put at bed rest, because severe elevations in serum calcium levels can occur. Hypercalcemia, if it is to occur, develops within days to weeks of complete bed rest and, if immobilization is prolonged, it can be associated with the development of upper and lower tract nephrolithiasis and osteopenia. The best treatment is the restoration of weight bearing, which normalizes calcium levels and bone turnover parameters. Passive range-of-motion exercises are not effective. If weight bearing is not possible, hydration, forced saline diuresis, and bisphosphonates have been shown to be effective at lowering calcium levels.

### TOTAL PARENTERAL NUTRITION

Hypercalcemia has been reported in patients receiving total parenteral nutrition (TPN) for two reasons.<sup>(29–31)</sup> The first involves the addition of excessive amounts of calcium and/or vitamin D to the hyperalimentation fluid. This usually occurs early in the course of therapy (days to weeks) and resolves with the reduction of the amount of calcium in the TPN formula. However, there has also been at least one case report of nephrocalcinosis and hypercalcemia developing after several years of continuous TPN that responded to a reduction of the calcium content of the TPN. The second involves inadvertent aluminum toxicity derived from amino acid hydrolysates added to the hyperalimentation fluid. These patients presented after having been on TPN for months to years and were found to have hypercalcemia and low turnover osteomalacia, characteristic of aluminum bone disease. Now that aluminum has been removed from the TPN formulations, this syndrome has disappeared.

### HYPERCALCEMIA SECONDARY TO MEDICATIONS

#### Vitamin D and Its Analogs

Hypercalcemia is a common complication of therapy with vitamin D preparations.<sup>(32–36)</sup> Vitamin D exerts effects on the intestine, skeleton, and kidney, and the hypercalcemia of vitamin D intoxication seems to be multifactorial, resulting primarily from a combination of increased gastrointestinal absorption of calcium and increased bone resorption. In the kidney, vitamin D primarily regulates the production and metabolism of calcitriol, although it has also been suggested to affect renal tubular calcium handling. Classically, patients with vitamin D intoxication present with hypercalcemia, hyperphosphatemia, and markedly elevated levels of 25-hydroxyvitamin D. Because PTH levels are appropriately suppressed, and because vitamin D and hypercalcemia both exert negative feedback on 1 $\alpha$ -hydroxylase in the proximal tubules, 1,25(OH)<sub>2</sub>D levels are usually either normal or only slightly elevated. The recommended daily allowance for vitamin D is 400–800 IU/day. The amount of vitamin D required to produce hypercalcemia has been estimated to be in excess of 25,000–50,000 IU/week. Therefore, it is unusual to see vitamin D intoxication from

over-the-counter nutritional supplements. However, there have been reports of hypercalcemia caused by poor quality control in the manufacture of these supplements. In these cases, the actual vitamin D content of the supplements was much higher than what was listed on the labels. There have also been outbreaks of vitamin D intoxication resulting from the accidental over-supplementation of vitamin D into cow's milk by commercial dairies. Nevertheless, the majority of cases of hypercalcemia occur in patients treated with pharmacologic doses of vitamin D or its analogs for the therapy of hypoparathyroidism, malabsorption, or renal osteodystrophy. Potent vitamin D analogs have also been used in topical preparations for the treatment of psoriasis and for the treatment of advanced prostate cancer. The most frequent setting in which vitamin D use leads to hypercalcemia remains the treatment of secondary hyperparathyroidism complicating renal osteodystrophy. However, newer analogs of vitamin D, such as 1 $\alpha$ -hydroxy vitamin D<sub>2</sub> (Hectorol; Bone Care International, Middleton, WI, USA) and paricalcitol (Zemlar; Abbot Laboratories, North Chicago, IL, USA) seem to have less of a tendency to produce hypercalcemia. Treatment of vitamin D intoxication involves discontinuation of the vitamin D compound, volume expansion, and calciuresis. If hypercalcemia is severe or refractory to the above, treatment with glucocorticoids and/or bisphosphonates may be necessary. The duration of hypercalcemia after the withdrawal of the vitamin D source depends on the biological half-life of the compound used.

#### PTH

It has been known for some time that while continuous exposure to excess PTH leads to high bone turnover and bone loss, exposure to intermittent elevations in PTH lead to high bone turnover and an increase in bone mass.<sup>(37,38)</sup> These observations have now led to the therapeutic use of once daily injections of PTH(1–34) (teriparatide) for the treatment of osteoporosis. PTH(1–84) is currently being evaluated by the Food and Drug Administration for use in osteoporosis as well. Hypercalcemia was reported to occur in ~10% of patients in trials with teriparatide. The degree of hypercalcemia was generally mild, and it was usually transient. Sustained hypercalcemia responded to withholding the drug and/or reductions in the dose of teriparatide. Mechanistically, this is a form of drug-induced, iatrogenic hyperparathyroidism.

#### Vitamin A and Related Compounds

Vitamin A activates osteoclast-mediated bone resorption through mechanisms not well understood. The use of supplements containing vitamin A has been associated with low bone mass and fractures, and the ingestion of large doses (>50,000 IU/day) has been associated with hypercalcemia.<sup>(39–42)</sup> Like other types of "resorptive" hypercalcemia, PTH and 1,25(OH)<sub>2</sub>D levels are suppressed in vitamin A intoxication. In the past, this disorder was only seen as the result of drug overdoses and in the exotic setting of arctic explorers consuming polar bear or sled-dog liver. However, more recently, hypercalcemia has been associated with the use of Vitamin A analogs, such as *cis*-retinoic acid and all *trans*-retinoic acid for the treatment of dermatologic conditions and for the therapy of neuroblastoma and hematologic malignancies.

#### Lithium

There have been many reports of hypercalcemia in patients receiving lithium carbonate.<sup>(43–45)</sup> The true prevalence of this disorder is uncertain, but retrospective series have suggested that hypercalcemia can occur in 5–40% of patients on the drug.

Prospective studies have documented that the average serum calcium level rises in patients started on lithium. The classic presentation resembles familial hypocalciuric hypercalcemia (FHH), with elevations in calcium and PTH levels and reductions in renal calcium excretion. In fact, studies *in vitro* and *in vivo* have shown that, just like FHH, the set point for calcium-regulated PTH release is shifted to the right in patients taking lithium. That is, there is an impairment of the ability of elevated calcium levels to suppress PTH release from the parathyroids. The mechanisms for this shift in Ca-PTH set-point are not completely understood, but these observations suggest that lithium may somehow modulate the function of the extracellular calcium-sensing receptor (CaR). There are also reports of an association between lithium use and the development of parathyroid adenomas. However, many of these cases are likely to be patients with previously mild or subclinical primary hyperparathyroidism whose hypercalcemia was worsened by the initiation of therapy with lithium. Hypercalcemia should resolve completely after the discontinuation of lithium.

### Estrogens and Antiestrogens

The initiation of antiestrogens (or estrogens) has been shown to produce hypercalcemia in ~30% of patients with breast cancer metastatic to the skeleton.<sup>(46,47)</sup> This estrogen, or antiestrogen, flare is often associated with an increase in bone pain and seems to be related to transient increases in rates of bone resorption surrounding tumor deposits in the skeleton. The mechanisms leading to this flare are not fully understood, although recent work has suggested that estrogens and antiestrogens may modulate the production of PTHrP by breast tumors. The hypercalcemia can be treated with hydration, glucocorticoids, and bisphosphonates and is self-limiting. The occurrence of this flare has been shown to be a good prognostic sign and may be associated with subsequent tumor regression.

### Thiazide Diuretics

Thiazide diuretics enhance calcium reabsorption in the distal tubule.<sup>(48)</sup> This effect on the kidney is used therapeutically to limit urinary calcium excretion in patients with hypoparathyroidism and nephrolithiasis caused by renal calcium wasting. However, in some patients, it can produce hypercalcemia. Other mechanisms may also contribute to the development of hypercalcemia; it has been reported in anephric patients on thiazides as well. The degree of hypercalcemia is usually mild and it resolves rapidly on discontinuation of the drug.

### Aminophylline

Mild hypercalcemia has been reported in association with the use of aminophylline and theophylline.<sup>(49)</sup> This has been observed in the setting of acute loading doses that result in drug levels that exceed the therapeutic range. It has uniformly resolved when patients are placed on maintenance therapy and levels are kept within the therapeutic range. The mechanisms causing the hypercalcemia are unknown.

### Growth Hormone

Growth hormone has been used in patients with AIDS, in burn patients, and in patients in surgical intensive care units to try to reverse the catabolic state of severe illness. The use of growth hormone in this way has been reported to cause moderate degrees of hypercalcemia with serum calcium values between 11.5 and 13.5 mg/dl. The mechanisms leading to the hypercalcemia are not well defined, but serum PTH and 1,25(OH)<sub>2</sub>D levels have been reported to be low.<sup>(50,51)</sup>

### 8-Chloro-cAMP

8-Chloro-cAMP is a protein kinase A modulator developed as an anti-neoplastic agent. In phase I trials, hypercalcemia was a dose-limiting toxicity. It seems that the hypercalcemia occurs, in part, because of a PTH-like induction of renal 1,25(OH)<sub>2</sub>D production.<sup>(52)</sup>

### Foscarnet

Foscarnet is an antiviral agent used in the treatment of patients with AIDS. It has been reported to cause both hypocalcemia and hypercalcemia through unknown mechanisms.<sup>(53)</sup>

### Fibrin Glue

Fibrin glue is a biological adhesive that contains fibrinogen, factor XIII, thrombin, and calcium and forms a fibrin clot on activation. Use of fibrin glue in the treatment of persistent pneumothorax in neonates was reported to cause hypercalcemia in 25% of patients in one report.<sup>(54)</sup> The mechanism of the hypercalcemia was not studied, but it was speculated to be related to the large amounts of calcium contained within the fibrin glue.

## INFLAMMATORY DISEASES

As reviewed in another chapter, granulomatous disorders such as sarcoidosis and tuberculosis can lead to hypercalcemia because of the unregulated production of 1,25(OH)<sub>2</sub>D by activated macrophages. In addition, several other inflammatory conditions such as systemic lupus erythematosus, juvenile rheumatoid arthritis, and recent hepatitis B vaccination have also been reported to cause hypercalcemia.<sup>(55-57)</sup> In patients with lupus, hypercalcemia has been reported together with lymphadenopathy and pleuritis. This so-called "hypercalcemia-lymphoedema" syndrome has sometimes been associated with elevated circulating levels of PTHrP. It has also been suggested that these patients might have circulating antibodies that activate the PTH receptor. In general, the mechanisms for hypercalcemia in patients with these inflammatory disorders are ill defined.

## AIDS

AIDS patients can develop hypercalcemia for a variety of reasons. As already discussed, hypoadrenalism caused by infections, granulomatous disorders such as typical and atypical mycobacterial infections, and malignancy-associated hypercalcemia caused by lymphomas can all occur. In addition, skeletal infection with HIV, HTLV-III, and/or cytomegalovirus has been reported to lead to bone resorption and hypercalcemia.<sup>(58)</sup>

## RENAL FAILURE

Hypercalcemia is a common occurrence in patients with chronic renal failure on hemodialysis and can result from hyperparathyroidism, vitamin D intoxication, calcium antacid overingestion, immobilization, aluminum toxicity, or combinations of these factors. In addition, hypercalcemia is particularly common in the first year after renal transplantation. Renal bone disease and related disorders of mineral homeostasis are discussed in greater detail elsewhere.

Hypercalcemia can also occur in acute renal failure.<sup>(59)</sup> This has classically been described during the recovery phase from acute tubular necrosis caused by rhabdomyolysis. It has been postulated that the severe hyperphosphatemia that accompanies this syndrome leads to the deposition of calcium phosphate in soft tissues and causes hypocalcemia and secondary hyperparathyroidism. When renal function recovers, soft tissue calcium

is mobilized and there is a lag in the return of parathyroid function to normal. The combination of these two phenomena leads to transient hypercalcemia. Hypercalcemia has also been associated with granulomatous forms of interstitial nephritis caused by drug allergy.<sup>(60)</sup>

Continuous renal replacement therapy (CRRT) is a common therapy for the treatment of acute renal failure in critically ill patients. Systemic anticoagulation of this patient population with heparin is often associated with bleeding complications. Therefore, an increasingly common alternative for CRRT is regional citrate anticoagulation. This involves the infusion of citrate and calcium and has been reported to lead to either hypocalcemia or hypercalcemia. Patients with liver dysfunction seem to be at increased risk for the development of hypercalcemia with these regimens.<sup>(61)</sup>

### MAMMARY HYPERPLASIA

PTHrP is produced by mammary epithelial cells during lactation and it participates in the regulation of maternal calcium metabolism during this time. There have been several reports of hypercalcemia caused by elevated circulating levels of PTHrP associated with the development of significant mammary hyperplasia in pregnant or lactating women.<sup>(62)</sup> This has also occurred in the setting of breast hyperplasia and inflammation caused by cyclosporin use after organ transplantation. The hypercalcemia has resolved with the resolution of the breast hyperplasia or on reduction mammoplasty.

### GAUCHER'S DISEASE

One case of hypercalcemia in a patient with Gaucher's disease and acute pneumonia has been reported.<sup>(63)</sup> This patient had a normal calcium before developing pneumonia, and the mechanisms of the elevation in calcium are unknown.

### MANGANESE INTOXICATION

Workers exposed to toxic concentrations of manganese in contaminated workplaces or wells can develop severe hypercalcemia.<sup>(64)</sup> The mechanisms by which manganese exposure causes hypercalcemia are unknown.

### END-STAGE LIVER DISEASE

Patients with end-stage chronic liver disease awaiting liver transplantation have been reported to develop hypercalcemia.<sup>(65)</sup> The mechanisms underlying the elevations in calcium are not known, but are likely to be multifactorial.

### PRIMARY OXALOSIS

Adults with primary oxalosis have been reported to develop severe hypercalcemia.<sup>(66)</sup> There seems to be increased bone resorption, perhaps caused by the formation of oxalate-induced granulomas in the bone marrow. This would be consistent with the observation that PTH and 1,25(OH)<sub>2</sub>D levels are low. However, the mechanisms underlying the development of hypercalcemia are not completely understood.

### ACKNOWLEDGMENTS

This work was supported by National Institutes of Health Grants DK55501, DK069542, and CA094175.

### REFERENCES

- Slomp J, van der Voort PHJ, Gerritsen RT, Berk JAM, Bakker AJ 2003 Albumin-adjusted calcium is not suitable for diagnosis of hyper- and hypocalcemia in the critically ill. *Crit Care Med* **31**:1389–1393.
- Merlini G, Fitzpatrick LA, Siris ES, Bilezikian JP, Birken S, Beychok S, Osserman EF 1984 A human myeloma immunoglobulin G binding four moles of calcium associated with asymptomatic hypercalcemia. *J Clin Immunol* **4**:185–196.
- John R, Oleesky D, Issa B, Scanlon MF, Williams CP, Harrison CB, Child DF 1997 Pseudohypercalcemia in two patients with IgM paraproteinemia. *Ann Clin Biochem* **34**:694–696.
- Howard MR, Ashwell S, Bond LR, Holbrook I 2000 Artefactual serum hyperkalaemia and hypercalcaemia in essential thrombocythaemia. *J Clin Path* **53**:105–109.
- Burman KD, Monchick JM, Earll JM, Wartofski L 1976 Ionized and total serum calcium and parathyroid hormone in hyperthyroidism. *Ann Intern Med* **84**:668–671.
- Britto JM, Fenton AJ, Holloway WR, Nicholson GC 1994 Osteoblasts mediate thyroid hormone stimulation of osteoclastic bone resorption. *Endocrinology* **123**:169–176.
- Rude RK, Oldham SB, Singer FR, Nicoloff JT 1976 Treatment of thyrotoxic hypercalcemia with propranolol. *N Engl J Med* **294**:431–433.
- Xiao H, Yu B, Wang S, Chen G 2002 Concomitant Graves disease and primary hyperparathyroidism: The first case report in mainland of China and literature review. *Chinese Med J* **115**:939–941.
- Abe E, Mariani RC, Yu W, Wu XB, Ando T, Li Y, Iqbal J, Eldeiry L, Rajendren G, Blair HC, Davies TF, Zaidi M 2003 TSH is a negative regulator of skeletal remodeling. *Cell* **115**:151–162.
- Mune T, Katakami H, Kato Y, Yasuda K, Matsukura S, Miura K 1993 Production and secretion of parathyroid hormone-related protein in pheochromocytoma: A participation of an  $\alpha$ -adrenergic mechanism. *J Clin Endocrinol Metab* **76**:757–762.
- Taleda S, Elefteriou F, Levasseur R, Liu X, Zhao L, Parker KL, Armstrong D, Ducy P, Karsenty G 2002 Leptin regulates bone formation via the sympathetic nervous system. *Cell* **111**:305–317.
- Muls E, Bouillon R, Boelaert J, Lamberigts G, Van Imschoot S, Daneels R, De Moor P 1982 Etiology of hypercalcemia in a patient with Addison's disease. *Calcif Tissue Int* **34**:523–526.
- Vasikaran SD, Tallis GA, Braund WJ 1994 Secondary hypoadrenalism presenting with hypercalcaemia. *Clin Endocrinol (Oxf)* **41**:261–265.
- Wong RK, Gregory R, Lo TC 2000 A case of isolated ACTH deficiency presenting with hypercalcaemia. *Int J Clin Practice* **54**:623–624.
- Miura W, Mizunashi K, Kimura N, Koide Y, Noshiro T, Miura Y, Furukawa Y, Nagura H 2000 Expression of stanniocalcin in zona glomerulosa and medulla of normal human adrenal glands, and some adrenal tumors and cell lines. *Acta Pathol Microbiol Immunol Scand* **108**:367–372.
- Asa SL, Henderson J, Goltzman D, Drucker DJ 1990 Parathyroid hormone-like peptide in normal and neoplastic human endocrine tissues. *J Clin Endocrinol Metab* **71**:1112–1118.
- Holdaway IM, Evans MC, Clarke ED 1977 Watery diarrhoea syndrome with episodic hypercalcaemia. *Aust N Z J Med* **7**:63–65.
- Lundgren P, Lundgren I, Mukohyama H, Lehenkari PP, Horton MA, Lerner UH 2001 Vasoactive intestinal peptide (VIP)/pituitary adenylate cyclase-activating peptide receptor subtypes in mouse calvarial osteoblasts: Presence of VIP-2 receptors and differentiation-induced expression of VIP-1 receptors. *Endocrinology* **142**:339–347.
- Lundberg P, Lie A, Bjurholm A, Lehenkari PP, Horton MA, Lerner UH, Ransjo M 2000 Vasoactive intestinal peptide regulates osteoclast activity via specific binding sites on both osteoclasts and osteoblasts. *Bone* **27**:803–810.
- Beall DP, Scofield RH 1995 Milk-alkali syndrome associated with calcium carbonate consumption. *Medicine* **74**:89–96.
- Fiorino AS 1996 Hypercalcemia and alkalosis due to the milk-alkali syndrome: A case report and review. *Yale J Biol Med* **69**:517–523.
- Wu KD, Chuang RB, Wu FL, Hsu WA, Jan IS, Tsai KS 1996 The milk-alkali syndrome caused by betelnuts in oyster shell paste. *J Toxicol* **34**:741–745.
- Stewart AF, Adler M, Byers CM, Segre GV, Broadus AE 1982 Calcium homeostasis in immobilization: An example of resorptive hypercalciuria. *N Engl J Med* **306**:1136–1140.
- Roberts D, Lee W, Cuneo RC, Wittmann J, Ward G, Flatman R, McWhinney B, Hickman PE 1998 Longitudinal study of bone turnover after acute spinal cord injury. *J Clin Endocrinol Metab* **83**:415–42.
- Sato Y, Kaji M, Higuchi F, Yanagida I, Oishi K, Oizumi K 2001 Changes in bone and calcium metabolism following hip fracture in elderly patients. *Osteopor Int* **12**:445–449.



26. Sato Y 2000 Abnormal bone and calcium metabolism in patients after stroke. *Arch Phys Med Rehab* **81**:117–121.
27. Massagli TL, Cardenas DD 1999 Immobilization hypercalcemia treatment with pamidronate disodium after spinal cord injury. *Arch Phys Med Rehab* **80**:998–1000.
28. Alborzi F, Leibowitz AB 2002 Immobilization hypercalcemia in critical illness following bariatric surgery. *Obes Surg* **12**:871–873.
29. Ott SM, Maloney NA, Klein GL, Alfrey AC, Ament ME, Coburn JW, Sherrard DJ 1983 Aluminum is associated with low bone formation in patients receiving chronic parenteral nutrition. *Ann Intern Med* **96**:910–914.
30. Shike M, Sturtridge WC, Tam CS, Harrison JE, Jones G, Murray TM, Husdan H, Whitwell J, Wilson DR, Jeejeebhoy KN 1981 A possible role of vitamin D in the genesis of parenteral-nutrition-induced metabolic bone disease. *Ann Intern Med* **95**:560–568.
31. Ikema S, Horikawa R, Nakano M, Yokouchi K, Yamazaki H, Tanaka T, Tanae A. 2000 Growth and metabolic disturbances in a patient with total parenteral nutrition: A case of hypercalciuric hypercalcemia. *Endocrine J* **47**(Suppl):S137–S140.
32. Holick MF, Shao Q, Liu WW, Chen TC 1992 The vitamin D content of fortified milk and infant formula. *N Engl J Med* **326**:1178–1181.
33. Jacobus CH, Holick MF, Shao Q, Chen TC, Holm IA, Kolodny JM, Fuleihan GE, Seely EW 1992 Hypervitaminosis D associated with drinking milk. *N Engl J Med* **326**:1173–1177.
34. Pettifor JM, Bikle DD, Cavalerso M, Zachen D, Kamdar MC, Ross FP 1995 Serum levels of free 1,25-dihydroxyvitamin D in vitamin D toxicity. *Ann Intern Med* **122**:511–513.
35. Martin KJ, Gonzalez E, Lindberg JS, Taccetta C, Amdahl M, Malhotra K, Llach F 2001 Paricalcitol dosing according to body weight or severity of hyperparathyroidism: A double-blind, multicenter, randomized study. *Am J Kid Dis* **38**(Suppl 5):S57–S63.
36. Koutkia P, Chen TC, Holick MF 2001 Vitamin D intoxication associated with an over-the-counter supplement. *N Engl J Med* **345**:66–67.
37. Cappuzzo KA, Delafuente JC 2004 Teriparatide for severe osteoporosis. *Ann Pharmacother* **38**:294–302.
38. Neer RM, Arnaud CD, Zanchetta JR, Prince R, Gaich GA, Reginster JY, Hodsman AB, Eriksen EF, Ish-Shalom S, Genant HK, Wang O, Mitlak BH 2001 Effect of parathyroid hormone (1–34) on fractures and bone mineral density in postmenopausal women with osteoporosis. *N Engl J Med* **344**:1434–1441.
39. Valente JD, Elias AN, Weinstein GD 1983 Hypercalcemia associated with oral isotretinoin in the treatment of severe acne. *JAMA* **250**:1899.
40. Suzumiya J, Asahara F, Katakami H, Kimuran N, Hisano S, Okumura M, Ohno R 1994 Hypercalcaemia caused by all-trans retinoic acid treatment of acute promyelocytic leukaemia: Case report. *Eur J Haematol* **53**:126–127.
41. Villablanca JG, Khan AA, Avramis VI, Seeger RC, Matthay KK, Ramsay NK, Reynolds CP 1995 Phase I trial of 13-cis-retinoic acid in children with neuroblastoma following bone marrow transplantation. *J Clin Oncol* **13**:894–901.
42. Michaëlsson K, Lithell H, Vessby B, Melhus H 2003 Serum retinal levels and the risk of fracture. *N Engl J Med* **348**:287–294.
43. Haden ST, Stoll AL, McCormick S, Scott J, Fuleihan GE 1979 Alterations in parathyroid dynamics in lithium-treated subjects. *J Clin Endocrinol Metab* **82**:2844–2848.
44. Rifal MA, Moles K, Harrington DP 2001 Lithium-induced hypercalcemia and parathyroid dysfunction. *Psychosomatics* **42**:359–361.
45. Dwight T, Kytola S, The BT, Theodosopoulos G, Richardson AL, Philips J, Twigg S, Delbridge L, Marsh DJ, Nelson AE, Larsson C, Robinson BG 2002 Genetic analysis of lithium-associated parathyroid tumors. *Euro J Endocrin* **146**:619–627.
46. Legha SS, Powell K, Buzdar AU, Blumen-Schein GR 1981 Tamoxifen-induced hypercalcemia in breast cancer. *Cancer* **47**:2803.
47. Funk JL, Wei H 1998 Regulation of parathyroid hormone-related protein expression of MCF-7 breast carcinoma cells by estrogen and antiestrogens. *Bio Biophys Res Comm* **251**:849–854.
48. Porter RH, Cox BG, Heaney D, Hostetter TH, Stinebaugh BJ, Suki WN 1978 Treatment of hypoparathyroid patients with chlorthalidone. *N Engl J Med* **298**:577.
49. McPherson ML, Prince SR, Atamer E, Maxwell DB, Ross-Clunis H, Estep H 1986 Theophylline-induced hypercalcemia. *Ann Intern Med* **105**:52–54.
50. Knox JB, Demling RH, Wilmore DW, Sarraf P, Santos AA 1995 Hypercalcemia associated with the use of human growth hormone in an adult surgical intensive care unit. *Arch Surg* **130**:442–445.
51. Sakoulas G, Tritos NA, Lally M, Wanke C, Hartzband P 1977 Hypercalcemia in an AIDS patient treated with growth hormone. *AIDS* **11**:1353–1356.
52. Saunders MP, Salisbury AJ, O'Byrne KJ, Long L, Whitehouse RM, Talbot DC, Mawer EB, Harris AL 1997 A novel cyclic adenosine monophosphate analog induces hypercalcemia via production of 1,25-dihydroxyvitamin D in patients with solid tumors. *J Clin Endocrinol Metab* **83**:4044–4048.
53. Gayet S, Ville E, Durand JM, Mars ME, Morange S, Kaplanski G, Gallais H, Soubeyrand J 1997 Foscarnet-induced hypercalcemia in AIDS. *AIDS* **11**:1068–1070.
54. Sarkar S, Hussain N, Herson V 2003 Fibrin glue for persistent pneumothorax in neonates. *J Perinatology* **23**:82–84.
55. Schurman SJ, Bergstrom WH, Root AW, Souid AK, Hannah WP 1998 Interleukin 1 beta-mediated calcitropic activity in serum of children with juvenile rheumatoid arthritis. *J Rheumatol* **25**:161–165.
56. Cathebras P, Cartry O, Lafage-Proust MH, Lauwers A, Acquart S, Thomas T, Rousset H 1996 Arthritis, hypercalcemia and lytic bone lesions after hepatitis B vaccination. *J Rheumatol* **23**:558–560.
57. Berar-Yanay N, Weiner P, Magadle R 2001 Hypercalcaemia in systemic lupus erythematosus. *Clin Rheumatol* **20**:147–149.
58. Zaloga GP, Chernow B, Eil C 1985 Hypercalcemia and disseminated cytomegalovirus infection in the acquired immunodeficiency syndrome. *Ann Intern Med* **102**:331–333.
59. Llach F, Felsenfeld AJ, Haussler MR 1981 The pathophysiology of altered calcium metabolism in rhabdomyolysis-induced acute renal failure. *N Engl J Med* **305**:117–123.
60. Wall CA, Gaffney EF, Mellotte GJ 2000 Hypercalcaemia and acute interstitial nephritis associated with omeprazole therapy. *Nephrol Dial Transplant* **15**:1450–1452.
61. Morgera S, Scholle C, Voss M, Haase M, Vargas-Hein O, Krausch D, Melzer C, Rosseau S, Zuckermann-Becker H, Neumayer HH 2004 Metabolic complications during regional citrate anticoagulation in continuous venous hemodialysis: Single-center experience. *Nephron Clin Pract* **97**:c131–c136.
62. Khosla S, van Heerden JA, Gharib H, Jackson IT, Danks J, Hayman JA, Martin TJ 1990 Parathyroid hormone-related protein and hypercalcemia secondary to massive mammary hyperplasia. *N Engl J Med* **322**:1157.
63. Bryne CD, Bermann L, Cox TM 1997 Pathologic bone fractures preceded by sustained hypercalcemia in Gaucher disease. *J Inherit Metab Dis* **20**:709–710.
64. Chandra SV, Seth PK, Mankeshwar JK 1974 Manganese poisoning: Clinical and biochemical observations. *Environ Res* **7**:374–380.
65. Gerhardt A, Greenberg A, Reilly JJ, Van Thiel DH 1987 Hypercalcemia, a complication of advanced chronic liver disease. *Arch Intern Med* **147**:274–277.
66. Yamaguchi K, Grant J, Noble-Jamieson G, Jamieson N, Barnes ND, Compston JE 1995 Hypercalcemia in primary oxalosis: Role of increased bone resorption and effects of treatment with pamidronate. *Bone* **16**:61–67.

# Chapter 34. Hypercalcemic Syndromes in Infants and Children

Craig B. Langman

*Department of Pediatrics, Feinberg School of Medicine, Northwestern University, and Kidney Diseases Department, Children's Memorial Hospital, Chicago, Illinois*

## INTRODUCTION

Blood ionized calcium levels in normal infants and young children are similar to those of adults, with a mean  $\pm$  2 SD =  $1.21 \pm -0.13$  mM. In neonates, the normal blood ionized calcium level is dependent on postnatal age.<sup>(1)</sup> In the first 72 h after birth, there is a significant decrease in the blood ionized calcium level in term newborns, from 1.4 to 1.2 mM; the decrease is exaggerated in preterm neonates. Levels of total calcium vary in parallel with the ionized calcium values, but additionally, are dependent on the level of serum albumin. Hypercalcemia is defined by a total blood calcium level  $>10.8$  mg/dl.

Chronic hypercalcemia in young infants and children may not be associated with the usual signs and symptoms described elsewhere. Rather, the predominant manifestation of hypercalcemia is "failure to thrive," in which linear growth is arrested, and there is lack of appropriate weight gain. Additional features of chronic hypercalcemia in children include nonspecific symptoms of irritability, gastrointestinal reflux, abdominal pain, and anorexia. Acute hypercalcemia is very uncommon in infants and children; when it occurs, its manifestations are similar to those of older children and adults, with potential alterations in the nervous system, the conduction system of the heart, and kidney glomerular and tubular functions.

## WILLIAMS SYNDROME

Williams et al.<sup>(2)</sup> described a syndrome in infants with supravalvular aortic stenosis and peculiar (elfin-like) facies; hypercalcemia during the first year of life also was noted.<sup>(3)</sup> However, the severe elevations in serum calcium initially described failed to appear with equal frequency in subsequent series of such infants. Other series of children with the cardiac lesion failed to show the associated facial dysmorphism. It is thought that there exists a spectrum of infants with some or all of these abnormalities, and a scoring system has been described to assign suspected infants as lying within or outside of the syndrome classification.<sup>(4)</sup>

Two thirds of infants with Williams syndrome are small for their gestational age, and many are born past their expected date of birth. The facial abnormalities consist of structural asymmetry, temporal depression, flat malae with full cheeks, microcephaly, epicanthal folds, lacy or stellate irises, a short nose, long philtrum, arched upper lip with full lower lip, and small, maloccluded teeth. The vocal tone is often hoarse. Neurologic manifestations include hypotonia, hyperreflexia, and mild-to-moderate motor retardation. The personality of affected children has been described as "cocktail party," in that they are unusually friendly to strangers. Other vascular abnormalities have been described in addition to supravalvular aortic stenosis, including other congenital heart defects and many peripheral organ arterial stenoses (renal, mesenteric, and celiac).

Hypercalcemia, if initially present, rarely persists to the end of the first year of life and generally disappears spontaneously.

Despite the rarity of chronic hypercalcemia, persistent hypercalciuria is not uncommon. Additionally, many of the signs and symptoms of hypercalcemia mentioned previously and in the introduction to this section have been noted in these infants. The long-term prognosis for patients with Williams syndrome seems to depend on features other than the level of blood calcium, such as the level of mental retardation and the clinical significance of the cardiovascular abnormalities. Approximately 25% of patients may have radioulnar synostosis, which may impede normal developmental milestones of fine motor activities of the upper extremities if not recognized.<sup>(5)</sup>

A search for the gene(s) responsible for Williams syndrome localized the cardiac component, supravalvular aortic stenosis, the long arm of chromosome 7.<sup>(6)</sup> It seems that translocations of the elastin gene may be responsible for isolated or familial supravalvular aortic stenosis,<sup>(7,8)</sup> whereas a heterozygous microdeletion of chromosome 7q11.23, which encompasses the elastin gene,<sup>(9)</sup> produces Williams syndrome. Rarely it may involve a defect of chromosome 11 [del(11)(q13.5q14.2)] or 22 [r(22)(p11→q13)].<sup>(10)</sup>

Despite the potential localization of the disorder of the deletion of the elastin locus on chromosome 7, the pathogenesis of the disorder remains unknown, although many studies focused on disordered control of vitamin D metabolism. Previous studies of affected children showed increased circulating levels of 25-hydroxyvitamin D after vitamin D administration,<sup>(11)</sup> increased levels of calcitriol {1,25-dihydroxyvitamin D [1,25(OH)<sub>2</sub>D]} during periods of hypercalcemia<sup>(12)</sup> but not during normocalcemia,<sup>(13,14)</sup> or diminished levels of calcitonin during calcium infusion.<sup>(15)</sup> Although excess administration of vitamin D to pregnant rabbits may produce an experimental picture not dissimilar to that in humans with Williams syndrome, the overwhelming majority of children with Williams syndrome are not the result of maternal vitamin D intoxication.

## IDIOPATHIC INFANTILE HYPERCALCEMIA

In the early 1950s in England, Lightwood<sup>(16)</sup> reported a series of infants with severe hypercalcemia. Epidemiologic studies revealed that the majority of affected infants were born to mothers ingesting foods heavily fortified with vitamin D. The incidence of the disease declined dramatically with reduction of vitamin D supplementation. Other cases have been described without previous exposure to excessive maternal vitamin D intake, and the incidence of idiopathic infantile hypercalcemia (IIH) has remained fixed over the past 20 years. Affected infants have polyuria, increased thirst, and the general manifestations of hypercalcemia previously noted. Severely affected neonates may have cardiac lesions similar to those seen in Williams syndrome and may even manifest the dysmorphic features of those infants and children. The distinction between the two syndromes remains problematic.<sup>(17)</sup> Other clinical manifestations include chronic arterial hypertension, strabismus, inguinal hernias, musculoskeletal abnormalities (disordered posture and mild kyphosis), and bony abnormalities (radioulnar synostosis and dislocated patella). Hyperacusis is present in the majority of affected children with IIH, but not Williams syndrome, and it is persistent.

As in Williams syndrome, disordered vitamin D metabolism

---

The author has reported no conflicts of interest.

with increased vitamin D sensitivity with respect to gastrointestinal transport of calcium has been posited as the cause of this disorder,<sup>(18)</sup> although the data are conflicting. We identified seven consecutive children with IIH in whom the presence of an elevated level of N-terminal PTH-related peptide (PTHrP) was shown at the time of hypercalcemia.<sup>(19)</sup> Its familial occurrence has been described.<sup>(20)</sup> Furthermore, in five of these children who achieved normocalcemia, the levels of PTHrP normalized or were unmeasurably low, and in one child with persistent hypercalcemia, the level of PTHrP remained elevated. No other nonmalignant disorder of childhood that we have examined, including two children with hypercalcemia from Williams syndrome, has had elevated levels of PTHrP, although a report of an infantile fibrosarcoma and hypercalcemia showed PTHrP production from the soft tissue tumor.<sup>(21)</sup> In contrast to the hypercalcemia of Williams syndrome, the level of blood calcium in IIH remains elevated for a prolonged period in the most severely affected children. After relief of the hypercalcemia, persistent hypercalciuria has been noted.<sup>(22)</sup> Therapy includes the use of glucocorticoids to reduce gastrointestinal absorption of calcium, as well as the avoidance of vitamin D and excess dietary calcium.

### FAMILIAL HYPOCALCIURIC HYPERCALCEMIA

This disorder also is called familial benign hypercalcemia and has been recognized since 1972<sup>(23)</sup> as a cause of elevated total and serum ionized calcium. The onset of the change in calcium is commonly before 10 years of age and was described in newborns.<sup>(24)</sup>

### NEONATAL PRIMARY HYPERPARATHYROIDISM

Primary hyperparathyroidism is uncommon in neonates and children,<sup>(25)</sup> with <100 cases reported. Additionally, only 20% of those reported cases occur in children younger than 10 years of age. Hypercalcemia in the first decade of life may more likely be caused by the other disorders discussed in this chapter. The presenting clinical manifestations are weakness, anorexia, and irritability, which are seen in a multitude of pediatric disorders. The association with other endocrine disorders occurs with decreased frequency in young children with primary hyperparathyroidism. Histological examination of the parathyroid glands show that 20–40% of affected children may have hyperplasia rather than the more typical adenoma in older individuals.

However, the neonate may show one unusual form of hyperparathyroidism. Neonatal severe primary hyperparathyroidism is now known to result from inheritance of two mutant alleles associated with the calcium-sensing receptor gene on chromosome 3.<sup>(26)</sup> Extreme elevations of serum calcium (total calcium  $\geq 20$  mg/dl; blood ionized calcium levels  $\geq 3$  mM) is a hallmark of the disorder, and emergency total surgical parathyroidectomy is required for life-saving reasons. An attempt to salvage one of the parathyroid glands and perform autotransplantation is suggested for such infants. Certain heterozygous inactivating mutations in the extracellular calcium receptor gene may still produce neonatal hypercalcemia,<sup>(27)</sup> leading to the conclusion that even the heterozygous state has important clinical implications for the neonate.

### JANSEN SYNDROME

Jansen syndrome<sup>(28–31)</sup> presents in neonates with hypercalcemia and skeletal radiographs that resemble a rachitic condition. It is a form of metaphyseal dysplasia, and after infancy, the radiographic condition evolves into a more typical picture,

with resultant mottled calcifications in the distal end of the long bones (Fig. 1). These areas represent patches of partially calcified cartilage protruding into the diaphyseal portion of bone. The skull and spine may be affected also. The hypercalcemia seems to be lifelong. The life span of patients with Jansen syndrome remains uncertain, but there are several adult survivors with the syndrome.

Biochemical findings in patients with Jansen syndrome are consistent with primary hyperparathyroidism, but there are no measurable levels of PTH or PTHrP. The disorder results from a defect in the gene for the PTH/PTHrP receptor. One of three different amino acid substitutions produces a mutant receptor that is capable of autoactivation in the absence of ligand. This produces unopposed PTH/PTHrP actions in such patients and thereby explains the absence of circulating levels of either hormone. Such patients seem to be at risk for the development of the complications of hyperparathyroidism in the adult years. However, other patients have been given the diagnosis of Jansen syndrome without either hypercalcemia or the finding of a mutation in the gene for the PTH/PTHrP receptor.

## MISCELLANEOUS DISORDERS

### Subcutaneous Fat Necrosis

Michael et al.<sup>(32)</sup> reported the association of significant birth trauma with fat necrosis in two small-for-gestational-age infants who subsequently developed severe hypercalcemia (serum calcium > 15 mg/dl) and violaceous discolorations at pressure sites. Histological examination of the affected pressure sites in such patients showed both an inflammatory, mononuclear cell infiltrate and crystals that contain calcium. We also noted hypercalcemia in several children with subcutaneous fat necrosis associated with major trauma or disseminated varicella. The mechanism of the hypercalcemia is unknown, but it may be related to mildly elevated levels of  $1,25(\text{OH})_2\text{D}$ <sup>(33)</sup> or excess prostaglandin E production.<sup>(34)</sup> The prognosis for infants and children with subcutaneous fat necrosis depends on the duration of the hypercalcemia. Reductions in serum calcium have been noted with the use of exogenous corticosteroids, saline, and furosemide diuresis and the avoidance of excess dietary calcium and vitamin D. Recurrence of hypercalcemia has not been seen.

### Hypophosphatasia

This disorder is discussed in detail elsewhere in this book and is mentioned here only for completeness. Severe infantile hypophosphatasia is associated with markedly elevated serum calcium levels and a reduction in circulating alkaline phosphatase, increase in urinary phosphoethanolamine, and elevated serum pyridoxal-5-phosphate concentrations. The use of calcitonin in a neonate with hypercalcemia was reported as beneficial to long-term outcome.<sup>(35)</sup>

### Sarcoidosis and Other Granulomatous Disorders of Childhood

Thirty percent to 50% of children with the autoimmune disorder sarcoidosis<sup>(36)</sup> manifest hypercalcemia, and an additional 20–30% show hypercalciuria with normocalcemia. Many of the presenting manifestations of children with sarcoidosis may be related to the presence of hypercalcemia. A recent report of hypercalcemia in twin children with cat-scratch disease,<sup>(37)</sup> a granulomatous disorder resulting from infection with *Bartonella henselae*, showed that the granuloma may represent a source of  $1,25(\text{OH})_2\text{D}$  production that leads to the

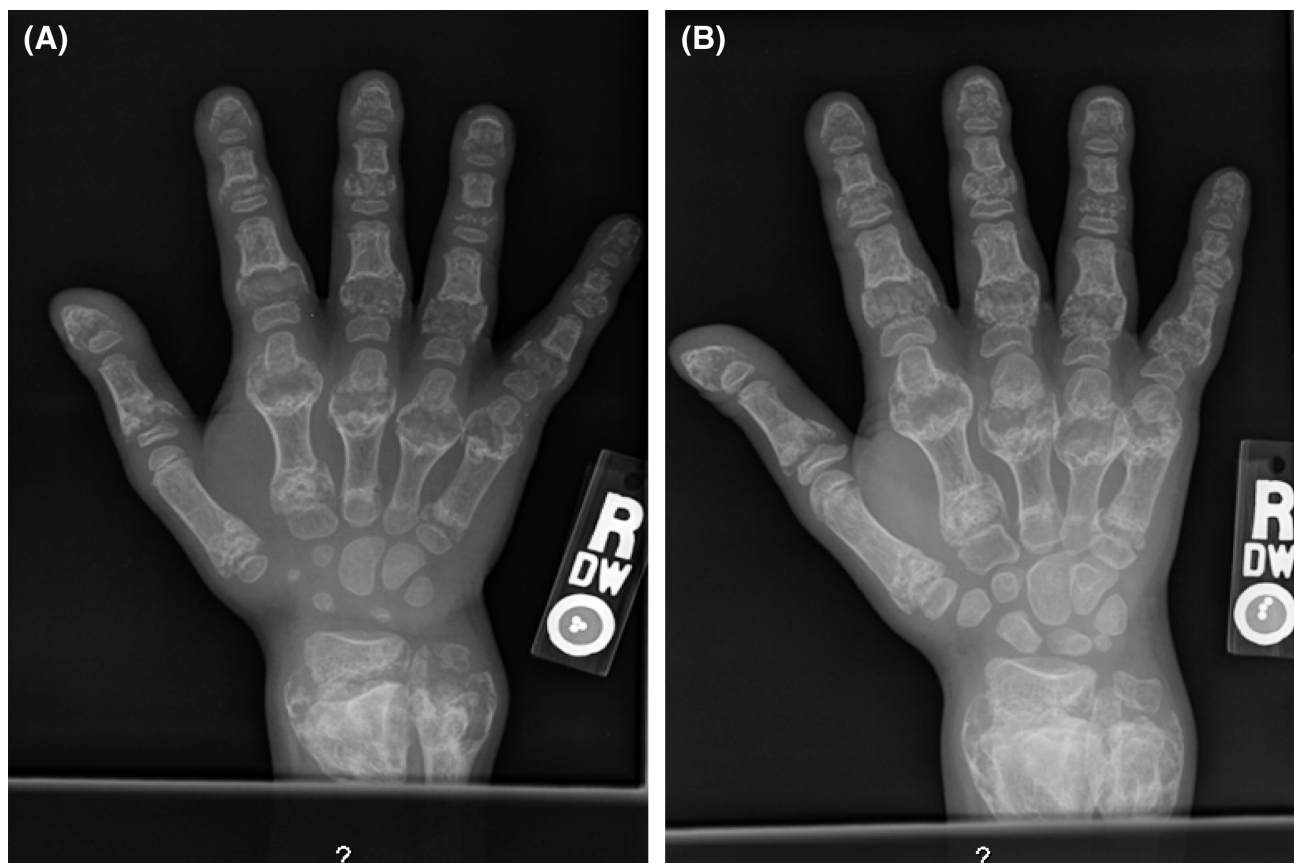

FIG. 1. (A) Hand radiograph in a patient with Jansen syndrome, 8 years of age. (B) The same patient at 12 years of age.

hypercalcemia. Successful therapy of these disorders reduces the circulating levels of that hormone to normal.

#### Limb Fracture

Isolated weight-bearing limb fracture<sup>(38)</sup> that requires immobilization for even several days may be associated with elevated blood ionized calcium levels and hypercalciuria in young children and adolescents. Although prolonged immobilization itself commonly produces hypercalcemia and hypercalciuria, the occurrence after short-term bed rest in children probably reflects their more rapid skeletal turnover.

#### Vitamin D (or Vitamin D Metabolite)

Hypervitaminosis D (vitamin D intoxication) produces symptomatic hypercalcemia. In childhood, vitamin D intoxication has been seen after excessively prolonged feeding of premature infants with a vitamin D-fortified formula,<sup>(39)</sup> after ingestion of improperly fortified dairy milk,<sup>(40,41)</sup> and in children receiving therapeutic vitamin D or vitamin D metabolites.<sup>(42)</sup>

An outbreak of hypercalcemia in eight patients was reported from the incorrect dosing of dairy milk with vitamin D,<sup>(40)</sup> and in addition, a defect was found in the concentrate used to fortify the milk (containing cholecalciferol rather than the expected ergocalciferol). These same investigators extended their measurements of the vitamin D content to both commercial dairy milks and fortified infant formulas, and they found that only 29% of the milks and formulas contained a vitamin D content within 20% of the stated amount.<sup>(41)</sup> These studies suggest that improved monitoring of the fortification process is

mandatory and may explain the rare finding of clinical vitamin D deficiency in children drinking fortified milk.

Children with renal osteodystrophy are commonly treated with 1,25-dihydroxyvitamin D<sub>3</sub> [1,25(OH)<sub>2</sub>D<sub>3</sub>] and develop hypercalcemia once every 12–15 treatment months, whereas the use of 25-hydroxyvitamin D<sub>3</sub> is associated with a lower incidence of hypercalcemia. Children with frank hypocalcemic disorders treated with 1,25(OH)<sub>2</sub>D<sub>3</sub> develop hypercalcemia at one third the frequency of children with renal osteodystrophy treated with any vitamin D metabolite.<sup>(42)</sup> Treatment with the parent vitamin D compound is associated with the production of hypercalcemia similar to the rate produced with calcitriol. However, the hypercalcemia associated with vitamin D is prolonged 4- to 6-fold in comparison with hypercalcemia with metabolite therapy because of retention in body fat stores.

#### Prostaglandin E

Barter syndrome may result from one of several mutations in the genes for various sodium-linked chloride transporters.<sup>(43)</sup> A neonatal form may produce a marked increase in prostaglandin E production and lead to hypercalcemia, in part, from excessive bone resorption.<sup>(44)</sup> Such a disturbance in bone also may contribute to the hypercalcemia seen in neonates who receive prostaglandin E infusions for congenital cardiovascular diseases that mandate patency of the fetal ductus arteriosus.

#### Congenital Lactase Deficiency

In one study it was noted that 7 of 10 infants with congenital lactase deficiency manifested hypercalcemia within the first 3 months of life, and this was associated with renal medullary

nephrocalcinosis.<sup>(45)</sup> A lactose-free diet was associated with return of elevated serum calcium levels to normal. The mechanism of the hypercalcemia remains unclear but may reflect the known effects of lactose to promote direct calcium absorption through the intestine.

### Extremely Rare Reported Causes

Hypercalcemia has been reported twice in Down syndrome, once in infantile hypothyroidism, and once in oxalosis.<sup>(46)</sup>

### REFERENCES

- Specker BL, Lichtenstein P, Mimouni F, Gormley C, Tsang RC 1986 Calcium-regulating hormones and minerals from birth to 18 months of age: A cross-sectional study. II. Effects of sex, race, age, season and diet on serum minerals, parathyroid hormone and calcitonin. *Pediatrics* **77**: 891–896.
- Williams JCP, Barratt-Boyes BG, Lower JB 1961 Supravalvular aortic stenosis. *Circulation* **24**:1311–1316.
- Black JA, Bonham Carter RE 1984 Association between aortic stenosis and facies of severe infantile hypercalcemia. *Lancet* **2**:745–748.
- Preus M 1984 The Williams syndrome: Objective definition and diagnosis. *Clin Genet* **25**:422–428.
- Charvat KA, Hornstein L, Oestreich AE 1991 Radio-ulnarsynostosis in Williams syndrome: A frequently associated anomaly. *Pediatr Radiol* **21**:508–510.
- Ewart AK, Morris CA, Ensing GJ, Loker J, Moore C, Leppert M, Keating M 1993 A human vascular disorder, supravalvular aortic stenosis, maps to chromosome 7. *Proc Natl Acad Sci USA* **90**:3226–3230.
- Curran ME, Atkinson DL, Ewart AK, Morris CA, Keppert MF, Keating MT 1993 The elastin gene is disrupted by a translocation associated with supravalvular aortic stenosis. *Cell* **73**:159–168.
- Ewart AK, Jin W, Atkinson D, Morris CA, Keating MT 1994 Supravalvular aortic stenosis associated with a deletion disrupting the elastin gene. *J Clin Invest* **93**:1071–1077.
- Perez Jurado LA, Peoples R, Kaplan P, Hamel BC, Francke U 1996 Molecular definition of the chromosome 7 deletion in Williams syndrome and parent-of-origin effects on growth. *Am J Hum Genet* **59**:781–792.
- Joyce CA, Zorich B, Pike SJ, Barber JC, Dennis NR 1996 Williams-Beuren syndrome: Phenotypic variability and deletions of chromosomes 7, 11 and 22 in a series of 52 patients. *J Med Genet* **33**:986–992.
- Taylor AB, Stern PH, Bell NH 1982 Abnormal regulation of circulating 25(OH)D in the Williams syndrome. *N Engl J Med* **306**:972–975.
- Garabedian M, Jacqz E, Guillozo H, Grimberg R, Guillot M, Gagnadoux MF, Broyer M, Lenoir G, Balsan S 1985 Elevated plasma 1,25(OH)<sub>2</sub>D<sub>3</sub> concentrations in infants with hypercalcemia and an elfin facies. *N Engl J Med* **312**:948–952.
- Martin NDT, Snodgrass GJAI, Makin HLJ, Cohen RD 1985 Letter. *N Engl J Med* **313**:889–890.
- Chesney RW, DeLuca HF, Gertner JM, Genel M 1985 Letter. *N Engl J Med* **313**:889–890.
- Culler FL, Jones KL, Deftos LJ 1985 Impaired calcitonin secretion in patients with Williams syndrome. *J Pediatr* **107**:720–723.
- Lightwood RL 1952 Idiopathic hypercalcemia with failure to thrive. *Arch Dis Child* **27**:302–303.
- Martin NDT, Snodgrass GJAI, Cohen RD 1984 Idiopathic infantile hypercalcemia: A continuing enigma. *Arch Dis Child* **59**:605–613.
- Aarskog D, Asknes L, Markstead T 1981 Vitamin D metabolism in idiopathic infantile hypercalcemia. *Am J Dis Child* **135**:1021–1025.
- Langman CB, Budayr AA, Sailer DE, Strewler GJ 1992 Nonmalignant expression of parathyroid hormone-related protein is responsible for idiopathic infantile hypercalcemia. *J Bone Miner Res* **7**:593S.
- McTaggart SJ, Craig J, MacMillan J, Burke JR 1999 Familial occurrence of idiopathic infantile hypercalcemia. *Pediatr Nephrol* **13**:668–671.
- Michigami T, Yamato H, Mushiaki S, Nakayama M, Yoneda A, Satomura K, Imura K, Ozono K 1996 Hypercalcemia associated with infantile fibrosarcoma producing parathyroid hormone-related protein. *J Clin Endocrinol Metab* **81**:1090–1095.
- Pronicka E, Rowinska E, Kulzycka H, Lukaszkiwicz J, Lorenc R, Janas R 1997 Persistent hypercalciuria and elevated 25-hydroxyvitamin D<sub>3</sub> in children with infantile hypercalcemia. *Pediatr Nephrol* **11**:2–6.
- Foley TP Jr, Jarrison HC, Arnaud CD, Harrison HE 1972 Familial benign hypercalcemia. *J Pediatr* **81**:1060–1067.
- Marx SJ, Attie MF, Spiegel AM, Levine MA, Lasker RD, Fox M 1982 An association between neonatal severe primary hyperparathyroidism and familial hypocalciuric hypercalcemia. *N Engl J Med* **306**:257–264.
- Bernulf J, Hall K, Sjogren I, Werner I 1970 Primary hyperparathyroidism in children. *Acta Paediatr Scand* **59**:249–258.
- Pollak MR, Chou YH, Marx SJ, Steinmann B, Cole DE, Brandt ML, Papapoulos SE, Menko FH, Hendy GN, Brown EM 1994 Familial hypocalciuric hypercalcemia and neonatal severe hyperparathyroidism: Effects of mutant gene dosage on phenotype. *J Clin Invest* **93**:1108–1112.
- Cole DE, Janicic N, Salisbury SR, Hendy GN 1997 Neonatal severe hyperparathyroidism, secondary hyperparathyroidism and familial hypocalciuric hypercalcemia: Multiple different phenotypes associated with an inactivating Alu insertion mutation of the calcium-sensing receptor gene. *Am J Hum Genet* **71**:202–210.
- Frame B, Poznanski AK 1980 Conditions that may be confused with rickets. In: Deluca HR, Anast CN (eds.) *Pediatric Diseases Related to Calcium*. Elsevier, New York, NY, USA, pp. 269–289.
- Schipani E, Kruse K, Juppner H 1995 A constitutively active mutant PTH-PTHrP receptor in Jansen-type metaphyseal chondrodysplasia. *Science* **268**:98–100.
- Schipani E, Langman CB, Parfitt AM, Jensen GS, Kikuchi S, Kooh SW, Cole WG, Juppner H 1996 Two different constitutively active PTH/PTHrP receptor mutations cause Jansen-type metaphyseal chondrodysplasia. *N Engl J Med* **335**:708–714.
- Schipani E, Langman C, Hunzelman J, Le Merrer M, Loke KY, Dillon MJ, Silve C, Juppner H 1999 A novel parathyroid hormone (PTH)/PTH-related peptide receptor mutation in Jansen's metaphyseal chondrodysplasia. *J Clin Endocrinol Metab* **84**:3052–3057.
- Michael AF, Hong R, West CD 1962 Hypercalcemia in infancy. *Am J Dis Child* **104**:235–244.
- Sharata H, Postellon DC, Hashimoto K 1995 Subcutaneous fat necrosis, hypercalcemia and prostaglandin E. *Pediatr Dermatol* **12**:43–47.
- Kruse K, Irlé U, Uhlig R 1993 Elevated 1,25-dihydroxyvitamin D serum concentrations in infants with subcutaneous fat necrosis. *J Pediatr* **122**: 460–463.
- Barcia JP, Strife CF, Langman CB 1997 Infantile hypophosphatasia: Treatment options to control acute hypercalcemia and chronic bone demineralization. *J Pediatr* **130**:825–828.
- Jasper PL, Denny FW 1968 Sarcoidosis in children. *J Pediatr* **73**:499–512.
- Bosch X 1998 Hypercalcemia due to endogenous overproduction of vitamin D in identical twins with cat-scratch disease. *JAMA* **279**:532–534.
- Rosen JF, Wolin DA, Finberg L 1978 Immobilization hypercalcemia after single limb fractures in children and adolescents. *Am J Dis Child* **132**: 560–564.
- Nako Y, Fukushima N, Tomomasa T, Nagashima K, Kuroume T 1993 Hypervitaminosis D after prolonged feeding with a premature formula. *Pediatrics* **92**:862–864.
- Jacobus CH, Holick MF, Shao Q, Chen TC, Holm IA, Kolodny JM, Fuleihan GE, Seely EW 1992 Hypervitaminosis D associated with drinking milk. *N Engl J Med* **326**:1173–1177.
- Holick MF, Shao Q, Liu WW, Chen TC 1992 The vitamin D content of fortified milk and infant formula. *N Engl J Med* **326**:1178–1181.
- Chan JCM, Young RB, Alon U, Manunes P 1983 Hypercalcemia in children with disorders of calcium and phosphate metabolism during long-term treatment with 1,25(OH)<sub>2</sub>D. *Pediatrics* **72**:225–233.
- Karolyi L, Koch MC, Grzeschik KH, Seyberth HW 1998 The molecular genetic approach to Bartter's syndrome. *J Mol Med* **76**:317–325.
- Welch TR 1997 The hyperprostaglandin E syndrome: A hypercalciuric variation of Bartter syndrome. *J Bone Miner Res* **12**:1753–1754.
- Saarela T, Simila S, Koivisto M 1995 Hypercalcemia and nephrocalcinosis in patients with congenital lactase deficiency. *J Pediatr* **127**:920–923.
- Jacobs TB, Bilezikian JP 2005 Rare causes of hypercalcemia. *J Clin Endocrinol Metab* **90**:6316–6322.

# Chapter 35. Hypocalcemia: Pathogenesis, Differential Diagnosis, and Management

Rajesh V. Thakker

*Nuffield Department of Clinical Medicine, Oxford Centre for Diabetes, Endocrinology and Metabolism, Churchill Hospital, University of Oxford, Headington, Oxford, United Kingdom.*

## INTRODUCTION

Hypocalcemia, which is frequently encountered in adult and pediatric medicine, has many causes (Table 1) that can be broadly subdivided into two groups according to whether the hypocalcemia is associated with low serum PTH concentrations (i.e., hypoparathyroidism) or with high PTH concentrations (i.e., secondary hyperparathyroidism). These hypocalcemic diseases are considered separately in subsequent chapters, and this chapter will review the general principles that determine calcium homeostasis and apply to the differential diagnosis and management of hypocalcemia.

## CALCIUM HOMEOSTASIS, PATHOGENESIS, AND DIFFERENTIAL DIAGNOSIS OF HYPOCALCEMIA

The total body content of calcium in a normal adult is 1000 g; >99% of this is within the crystal structure of bone mineral and <1% is in the soluble form in the extracellular and intracellular fluid compartments. In the extracellular fluid (ECF) compartment, ~50% of the total calcium is ionized, and the rest is principally bound to albumin or complexed with counter-ions. The ionized calcium concentrations range from 1.00 to 1.25 mM, and the total serum calcium concentration ranges from 2.20 to 2.60 mM (8.8–10.2 mg/dl), depending on the laboratory. Measurements of ionized calcium, which has the main regulatory role, are not often undertaken because the methods are difficult and variable; thus, a total serum calcium concentration is the usual estimation. However, the usual 2:1 ratio of total to ionized calcium may be disturbed by disorders such as metabolic acidosis, which reduces calcium binding by proteins; metabolic alkalosis, which increases calcium binding by proteins; or by changes in protein concentration (e.g., starvation, cirrhosis, dehydration, venous stasis, or multiple myeloma). In view of this, total serum calcium concentrations are adjusted, or “corrected,” to a reference albumin concentration; thus, the corrected serum calcium may be expressed to a reference albumin concentration of 41 g/liter (4.1 g/dl), and for every 1 g/liter (1.0 g/dl) of albumin above or below the reference value, the calcium is adjusted by  $\pm 0.016$  mM (0.064 mg/dl), respectively. For example, a total serum calcium of 2.10 mM (8.4 mg/dl) with an albumin concentration of 35 g/liter (3.5 g/dl) would be equivalent to a corrected serum calcium of 2.20 mM (8.8 mg/dl), thereby correcting the initial apparent hypocalcemic value to a normal value.

The extracellular concentration of calcium is closely regulated within the narrow physiological range that is optimal for the normal cellular functions affected by calcium in many tissues. This regulation of extracellular calcium takes place through complex interactions (Fig. 1) at the target organs of the major calcium regulating hormone (PTH) and vitamin D and its active metabolites [e.g., 1,25-dihydroxy (1,25(OH)<sub>2</sub>] vitamin D. The parathyroid glands secrete PTH at a rate that is appropriate to, and dependent on, the prevailing extracellular calcium ion concentration. Thus, hypocalcemic diseases may arise because of a destruction of the parathyroids or from a failure of

parathyroid gland development, PTH secretion, or PTH-mediated actions in target tissues. These diseases may therefore be classified as being caused by a deficiency of PTH, a defect in the PTH receptor (i.e., the PTH/PTH-related protein [PTHrP] receptor), or an insensitivity to PTH caused by defects downstream of the PTH-PTHrP receptor (Fig. 1). The diseases may be inherited, and molecular genetic studies have identified many of the underlying genetic abnormalities (Table 2).

## CLINICAL FEATURES AND INVESTIGATIONS

The clinical presentation of hypocalcemia (serum calcium < 2.20 mM or 8.8 mg/dl) ranges from an asymptomatic biochemical abnormality to a severe, life-threatening condition. In mild hypocalcemia (serum calcium = 2.00–2.20 mM or 8.0–8.8 mg/dl), patients may be asymptomatic. Those with more severe (serum calcium < 1.9 mM or 7.6 mg/dl) and long-term hypocalcemia may develop acute symptoms of neuromuscular irritability (Table 3); ectopic calcification (e.g., in the basal ganglia, which may be associated with extrapyramidal neurological symptoms); subcapsular cataracts; papilledema; or abnormal dentition. Studies should be directed at confirming the presence of hypocalcemia and establishing the cause.

The causes of hypocalcemia (Table 1) can be classified according to whether serum PTH concentrations are low (i.e., hypoparathyroid disorders) or high (i.e., disorders associated with secondary hyperparathyroidism). The most common causes of hypocalcemia are hypoparathyroidism, a deficiency or abnormal metabolism of vitamin D, acute or chronic renal failure, and hypomagnesemia. In hypoparathyroidism, serum calcium is low, phosphate is high, and PTH is undetectable; renal function and concentrations of the 25-hydroxy and 1,25-dihydroxy metabolites of vitamin D are usually normal. The features of pseudohypoparathyroidism are similar to those of hypoparathyroidism except for PTH, which is markedly increased. In chronic renal failure, which is the most common cause of hypocalcemia, phosphate is high, and alkaline phosphatase, creatinine, and PTH are elevated; 25-hydroxyvitamin D<sub>3</sub> is normal and 1,25-dihydroxyvitamin D<sub>3</sub> is low. In vitamin D deficiency osteomalacia, serum calcium and phosphate are low, alkaline phosphatase and PTH are elevated, renal function is normal, and 25-hydroxy vitamin D<sub>3</sub> is low. The most common artifactual cause of hypocalcemia is hypoalbuminemia, such as occurs in liver disease.

## MANAGEMENT OF ACUTE HYPOCALCEMIA

The management of acute hypocalcemia depends on the severity of the hypocalcemia, the rapidity with which it developed, and the degree of neuromuscular irritability (Table 3). Treatment should be given to symptomatic patients (e.g., with seizures or tetany) and asymptomatic patients with a serum calcium of <1.90 mM (7.6 mg/dl) who may be at high risk of developing complications. The preferred treatment for acute symptomatic hypocalcemia is calcium gluconate, 10 ml 10% wt/vol (2.20 mmol or 90 mg of calcium) intravenously, diluted in 50 ml of 5% dextrose or 0.9% sodium chloride and given by slow injection (>5 minutes); this can be repeated as required to control symptoms. Serum calcium should be assessed regu-

The author has reported no conflicts of interest.

TABLE 1. CAUSES OF HYPOCALCEMIA

Low PTH levels (hypoparathyroidism)	
• Parathyroid agenesis	• Isolated or part of complex developmental anomaly (e.g., Di George syndrome)
• Parathyroid destruction	• Surgery*
• Radiation	• Infiltration by metastases or systemic disease (e.g., hemochromatosis, amyloidosis, sarcoidosis, Wilson's disease, thalassemia)
• Autoimmune	• Isolated
• Polyglandular (type 1)*	• Reduced parathyroid function (i.e., PTH secretion)
• PTH gene defects	• Hypomagnesaemia*
• Neonatal hypocalcemia (may be associated with maternal hypercalcemia)	• Hungry bone disease (post-parathyroidectomy)
• Calcium-sensing receptor mutations	
High PTH levels (secondary hyperparathyroidism)	
• Vitamin D deficiency*	As a result of nutritional lack,* lack of sunlight,* malabsorption,* liver disease, or acute or chronic renal failure.*
• Vitamin D resistance (rickets)	As a result of renal tubular dysfunction (Fanconi's syndrome), or vitamin D receptor defects
• PTH resistance (e.g., pseudohypoparathyroidism, hypomagnesaemia)	
• Drugs	
• Calcium chelators (e.g., citrated blood transfusions, phosphate, cow's milk is rich in phosphate)	
• Inhibitors of bone resorption (e.g., bisphosphonate, calcitonin, plicamycin, gallium nitrate, cisplatin, doxorubicin)	
• Altered vitamin D metabolism (e.g., phenytoin, ketoconazole)	
• Fosarnet	
• Miscellaneous	
• Acute pancreatitis	
• Acute rhabdomyolysis	
• Massive tumour lysis	
• Osteoblastic metastases (e.g., from prostate or breast carcinoma)	
• Toxic shock syndrome	
• Hyperventilation	
• Acute severe illness	

\* Most common causes.

larly. Continuing hypocalcemia may be managed acutely by administration of a calcium gluconate infusion; for example, dilute 10 ampoules of calcium gluconate, 10 ml 10% wt/vol (22.0 mmol or 900 mg of calcium), in 1 liter of 5% dextrose or 0.9% sodium chloride, start infusion at 50 ml/h, and titrate to maintain serum calcium in the low normal range. Generally, 0.30–0.40 mmol/kg or 15 mg/kg of elemental calcium infused over 4–6 h increases serum calcium by 0.5–0.75 mM (2–3 mg/dl). If hypocalcemia is likely to persist, oral vitamin D therapy should also be started. It is important to note that, in hypocalcemic patients who are also hypomagnesemic, the hypomagnesemia must be corrected before the hypocalcemia will resolve. This may occur in the post-parathyroidectomy period or in those with alcoholism or severe malabsorption. While acute hypocalcemia is being treated, studies to establish the underlying cause (Table 1) should be undertaken, and appropriate treatment should be initiated.

## MANAGEMENT OF PERSISTENT HYPOCALCEMIA

The two major groups of drugs available for the treatment of hypocalcemia are supplemental calcium, ~10–20 mmol (400–800 mg) calcium every 6–12 h, and vitamin D preparations. Patients with hypoparathyroidism seldom require calcium supplements after the early stages of stabilization on vitamin D. A variety of vitamin D preparations have been used. These include vitamin D<sub>3</sub> (cholecalciferol) or vitamin D<sub>2</sub> (ergocalciferol), 40,000–100,000 U (1.0–2.5 mg/day); dihydroxycholesterol (now seldom used), 0.25–1.25 mg/day; alfacalcidol (1 $\alpha$ -hydroxycholecalciferol), 0.25–1.0  $\mu$ g/day; and calcitriol (1,25-dihydroxycholecalciferol), 0.25–2.0  $\mu$ g/day. In children, these preparations are prescribed in doses based on body weight. Cholecalciferol and ergocalciferol are the least expensive preparations but have the longest durations of action and may result in prolonged toxicity. The other preparations, which do not require renal 1 $\alpha$ -hydroxylation, have the advantage of shorter half-lives and thereby minimize the risk of prolonged toxicity.

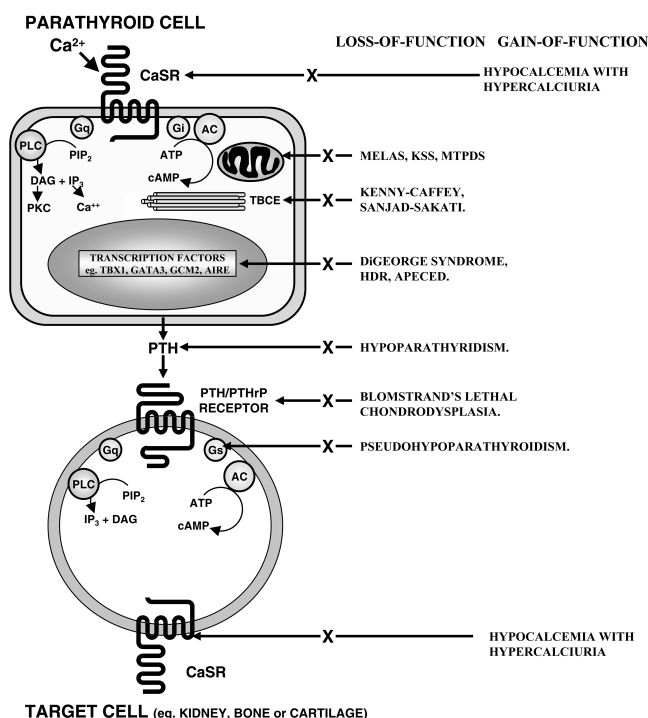

**FIG. 1.** Schematic representation of some of the components involved in calcium homeostasis. Alterations in extracellular calcium are detected by the calcium-sensing receptor (CaSR), which is a 1078 amino acid G protein-coupled receptor. The PTH/PTHrP receptor, which mediates the actions of PTH and PTHrP, is also a G protein-coupled receptor. Thus, Ca<sup>2+</sup>, PTH, and PTHrP involve G protein-coupled signaling pathways, and interaction with their specific receptors can lead to activation of Gs, Gi, and Gq, respectively. Gs stimulates adenylyl cyclase (AC), which catalyzes the formation of cAMP from ATP. Gi inhibits AC activity. cAMP stimulates protein kinase A (PKA), which phosphorylates cell-specific substrates. Activation of Gq stimulates phospholipase C (PLC), which catalyzes the hydrolysis of the phosphoinositide (PIP<sub>2</sub>) to inositol triphosphate (IP<sub>3</sub>), which increases intracellular calcium, and diacylglycerol (DAG), which activates protein kinase C (PKC). These proximal signals modulate downstream pathways, which result in specific physiological effects. Abnormalities in several genes, which lead to mutations in proteins in these pathways, have been identified in specific disorders of calcium homeostasis (Table 2). (Adapted from Thakker RV 2000 Parathyroid disorders, molecular genetics and histology. In: Morris PJ, Wood WC (eds.) Oxford Textbook of Surgery. Oxford University Press, Oxford, UK, pp. 1121–1129.)

TABLE 2. HYPOPARATHYROID DISEASES AND THEIR CHROMOSOMAL LOCATIONS

<i>Disease</i>	<i>Inheritance</i>	<i>Gene product</i>	<i>Chromosomal location</i>
Isolated hypoparathyroidism	Autosomal dominant	PTH	11p15*
	Autosomal recessive	PTH, GCMB	11p15*, 6p23–24*
	X-linked recessive	SOX3	Xq26–27
Hypocalcemic hypercalciuria	Autosomal dominant	CaSR	3q21.1
Hypoparathyroidism associated with polyglandular autoimmune syndrome (APECED)	Autosomal recessive	AIRE-1	21q22.3
Hypoparathyroidism associated with KSS, MELAS and MTPDS	Maternal	Mitochondrial genome	
Hypoparathyroidism associated with complex congenital syndromes			
DiGeorge	Autosomal dominant	TBX1	22q11.12/10p
HDR syndrome	Autosomal dominant	GATA3	10p13–14
Blomstrand lethal chondrodysplasia	Autosomal recessive	PTH/PTHrPR	3p21.1-p22
Kenney-Caffey, Sanjad-Sakati	Autosomal recessive	TBCE	1q43–44
Barakat	Autosomal recessive <sup>†</sup>	Unknown	?
Lymphoedema	Autosomal recessive	Unknown	?
Nephropathy, nerve deafness	Autosomal dominant <sup>†</sup>	Unknown	?
Nerve deafness without renal dysplasia	Autosomal dominant	Unknown	?
Pseudohypoparathyroidism (type Ia)	Autosomal dominant parentally imprinted	GNAS1 exons 1–13	20q13.3
Pseudohypoparathyroidism (type Ib)	Autosomal dominant parentally imprinted	GNAS1—deletions within or upstream of locus	20q13.3

\* Mutations identified only in some families.

<sup>†</sup> Most likely inheritance shown.

? Location not known.

KSS, Kearns Sayre syndrome; MELAS, mitochondrial encephalopathy, lactic acidosis, and stroke-like episodes; MTPDS, mitochondrial trifunctional protein deficiency syndrome; AIRE-1, autoimmune regulator 1; HDR, hypoparathyroidism, deafness, renal dysplasia; GCMB, glial cells missing B; GATA3, third member of family of transcriptional factors that bind to DNA sequence motif GATA; TBCE, tubulin-specific chaperone E.

Calcitriol is probably the drug of choice because it is the active metabolite and, unlike alfacalcidol, does not require hepatic 25-hydroxylation. However, in patients with low serum 25-hydroxy vitamin D concentrations because of vitamin D deficiency, the treatment of choice is a parent vitamin D compound

such as cholecalciferol or ergocalciferol. Close monitoring of the patient's serum and urine calcium are required initially at ~1- to 2-week intervals, and at 3- to 6-month intervals once stabilization is achieved. The aim is to avoid hypercalcemia, hypercalciuria, nephrolithiasis, and renal failure. It should be noted that hypercalciuria may occur in the absence of hypercalcemia.

TABLE 3. HYPOCALCEMIC CLINICAL FEATURES OF NEUROMUSCULAR IRRITABILITY

Paraesthesia, usually of fingers, toes, and circumoral regions
Tetany, carpedal spasm, muscle cramps
Chvostek's sign*
Trousseau's sign <sup>†</sup>
Seizures of all types (i.e., focal or petit mal, grand mal, or syncope)
Prolonged QT interval on ECG
Laryngospasm
Bronchospasm

\* Chvostek's sign is twitching of the circumoral muscles in response to gentle tapping of the facial nerve just anterior to the ear; it may be present in 10% of normal individuals.

<sup>†</sup> Trousseau's sign is carpal spasm elicited by inflation of a blood pressure cuff to 20 mmHg above the patient's systolic blood pressure for 3 minutes.

## SUGGESTED READING

1. Thakker RV 2004 Genetics of endocrine and metabolic disorders: parathyroid. *Rev Endocr Metab Dis* 5:37–57.
2. Deftos LJ 1998 *Clinical Essentials of Calcium and Skeletal Disorders*, 1st ed. Professional Communications, Caddo, OK, USA.
3. Thakker RV, Juppner H 2001 Genetic disorders of calcium homeostasis caused by abnormal regulation of parathyroid hormone secretion or responsiveness. In: DeGroot LJ, Jameson JL (eds.) *Endocrinology*, 4th ed. WB Saunders Company, Philadelphia, PA, USA, pp. 1062–1074.
4. Marx SJ 2000 Hyperparathyroid and hypoparathyroid disorders. *N Engl J Med* 343:1803–1875.
5. Thakker RV 2000 Parathyroid disorders. Molecular genetics and physiology. In: Morris PJ, Wood WC (eds.) *Oxford Textbook of Surgery*. Oxford University Press, Oxford, UK, pp. 1121–1129.



# Chapter 36. Hypoparathyroidism

David Goltzman<sup>1</sup> and David E. C. Cole<sup>2</sup>

<sup>1</sup>Department of Medicine, McGill University and McGill University Health Centre, Montreal, Quebec, Canada; and <sup>2</sup>Departments of Laboratory Medicine and Pathobiology, Medicine, and Paediatrics (Genetics), University of Toronto, Toronto, Ontario, Canada

## INTRODUCTION

Hypoparathyroidism is a clinical disorder that manifests when the PTH produced by the parathyroid gland is insufficient to maintain extracellular fluid (ECF) calcium in the normal range or when adequate circulating concentrations of PTH are unable to function optimally in target tissues to maintain normal ECF calcium levels. The causes of hypoparathyroidism (Table 1) can be classified broadly as (1) failure of parathyroid gland development, (2) destruction of the parathyroid glands, (3) reduced parathyroid gland function caused by altered PTH production or secretion, and (4) impaired PTH action. The common aspect of these conditions is the presence of reduced, biologically active PTH. This results in characteristic clinical and laboratory features, which may be influenced, however, by the specific pathogenetic mechanism.

## CLINICAL MANIFESTATIONS

The acute clinical signs and symptoms of hypoparathyroidism of any etiology include evidence of latent or overt increased neuromuscular irritability caused by hypocalcemia. The acute symptoms are more likely to occur during times of increased demand on the calcium homeostatic system (pregnancy and lactation, the menstrual cycle, and states of alkalosis). Chronically, patients may manifest muscle cramps, pseudopapilledema, extrapyramidal signs, mental retardation, and personality disturbances, as well as cataracts, dry rough skin, coarse brittle hair, alopecia, and abnormal dentition. The dental abnormalities may include defects caused by enamel hypoplasia, defects in dentin, shortened premolar roots, thickened lamina dura, delayed tooth eruption, and increased frequency of dental caries. Occasionally, patients may be edentulous. Finally, some patients may be diagnosed only after a low serum calcium is detected on routine blood screening.

## LABORATORY ABNORMALITIES

The biochemical hallmarks of hypoparathyroidism are hypocalcemia and hyperphosphatemia in the presence of normal renal function. Serum calcium concentrations are often 6–7 mg/dl (1.50–1.75 mM) and serum phosphorus levels 6–9 mg/dl (1.93–2.90 mM). In most instances, an ionized calcium concentration of <4 mg/liter (1.0 mM) is also observed. Serum concentrations of immunoreactive PTH are low or undetectable except in cases of PTH resistance, where they are elevated or high normal. Serum concentrations of 1,25(OH)<sub>2</sub>D are usually low or low normal, but alkaline phosphatase activity is unchanged. The 24-h urinary excretion of calcium is reduced, despite the fact that the fractional excretion of calcium is increased because the filtered load is low, caused by the hypocalcemia induced by decreased intestinal calcium absorption and diminished bone resorption. Nephrogenous cAMP excretion is low, and renal tubular reabsorption of phosphorus is elevated. Urinary cAMP and phosphorus excretion both increase markedly after administration of exogenous bioactive PTH except in PTH-resistant states. If hypoparathyroidism presenting at birth or in early childhood is not otherwise explained, serum magnesium should be measured. If serum magnesium is low, a more complete assessment of magnesium metabolism is warranted.

Calcification of the basal ganglia or other intracranial structures may be detected on routine radiographs or by enhanced imaging (CT scan or MRI), and electroencephalographic changes may be present. These are occasionally the only clinical evidence of disease. Detection of limited parathyroid gland reserve may rarely require an EDTA or citrate infusion study, which should only be conducted under close supervision.

## CAUSES OF HYPOPARATHYROIDISM

### Abnormal Parathyroid Gland Development

Congenital agenesis or hypoplasia of the parathyroid glands can produce hypoparathyroidism that manifests in the newborn period. Most often, this occurs as isolated or sporadic hypoparathyroidism and would have previously been considered idiopathic. There is now evidence that *de novo* activating mutations of the calcium-sensing receptor gene account for a number of these cases.

Familial isolated hypoparathyroidism may show autosomal recessive or X-linked inheritance patterns. Examples of the latter are rare. However, linkage analysis of the few affected families has narrowed the X chromosome locus to the Xq26–27 region. Recently, an autosomal recessive form of familial isolated hypoparathyroidism has been attributed to mutations of the *GCMB* (*glial cells missing B*) gene, which encodes a nuclear transcription factor that is predominantly expressed in the parathyroid gland and is critical for its development.

Maldevelopment of the parathyroid gland more often occurs as a feature of various multiple malformation syndromes. When other structures derived from the third and fourth branchial pouches are involved, thymic aplasia with immunodeficiency and congenital conotruncal cardiac anomalies are typically present. Originally called DiGeorge syndrome, this phenotype is now known to include a wide range of congenital anomalies, including distinctive facial features, cleft lip/palate, oropharyngeal anomalies, and other forms of congenital heart disease. In most cases, a microdeletion of chromosome 22 in the region of 22q11.21-q11.23 is the cause. Detection of the microdeletion by fluorescence in situ hybridization (FISH) is diagnostic, but a negative result does not exclude the possibility of a 22q abnormality. Individuals with the velocardiofacial (VCF or Schprintzen) syndrome also have microdeletions of 22q, and the two conditions overlap. Haploinsufficiency of a transcription factor gene, *Tbx1*, has been implicated as the common molecular defect, but there are no human examples to date of specific *Tbx1* mutations causing the DiGeorge phenotype. The possibility that other candidate genes or modifiers may be important is being pursued.

The clinical overlap has led to increasing use of the term, 22q11 syndrome, to include the varying phenotypes associated with the chromosomal microdeletion. In the VCF subgroup, anatomical anomalies of the pharynx are prominent, and hypernasal speech caused by abnormal pharyngeal musculature with or without cleft palate is typical. In most patients, some degree of intellectual deficit is present, and there is strong predisposition to psychotic illness (schizophrenia or bipolar disorder) in adolescents and adults. A number of web sites (<http://www.vcfsef.org/> or <http://www.geneclinics.org/profiles/22q11deletion/details.html>) provide regularly updated information on this common and complex group of disorders.

Hypoparathyroidism is a part of the Barakat or HDR (hypoparathyroidism, nerve deafness, and renal dysplasia) syndrome. De-

The authors have reported no conflicts of interest.

TABLE 1. PATHOGENETIC CLASSIFICATION OF HYPOPARATHYROIDISM

I. Abnormal parathyroid gland development
Isolated hypoparathyroidism
X-linked (307700)*
Autosomal recessive (241400)
GCMB mutation (603716)
DiGeorge syndrome (188400)
Velocardiofacial (VCF) syndrome (192430)
DiGeorge critical region 1—22q11.2 (602054)
Barakat (HDR) syndrome—10p (146255 and 256340)
DiGeorge critical region 2—10p13–14 (601362)
GATA3 haploinsufficiency (131320)
Hypoparathyroidism with short stature, mental retardation, and seizures
Sanjat-Sakati syndrome (241410)
Kenny-Caffey syndrome Type I (244460)
TBCE mutations (604934)
Mitochondrial neuromyopathies
Kearns-Sayre syndrome (530000)
Pearson syndrome (557000)
tRNA-Leu mutations (590050)
Long-chain hydroxyacyl-CoA dehydrogenase deficiency (600890)
II. Destruction of the parathyroid glands
Surgical
Autoimmune disease
Polyglandular autoimmune disease (APECED) (240300)
AIRE mutations (607358)
Radiation
Metal overload (iron, copper)
Granulomatous infiltration
Neoplastic invasion
III. Decreased parathyroid gland function caused by altered PTH production or secretion
Primary
Autosomal dominant (146200)
Calcium-sensing receptor mutations (145980) <sup>†</sup>
PTH mutation (168450.0001)
Autosomal recessive
PTH mutation (168450.0002)
Secondary
Activating antibodies to CASR
Maternal hyperparathyroidism
Hypomagnesemia
IV. Impaired PTH action
Hypomagnesemia
Pseudohypoparathyroidism

\* Numbers from Online Mendelian Inheritance in Man<sup>®</sup>. (<http://www.ncbi.nlm.nih.gov/entrez/query.fcgi?db=OMIM>), accessible by browsing the Internet using the search term "OMIM."

<sup>†</sup> De novo mutations are common in sporadic hypoparathyroidism.

letions of two nonoverlapping regions of chromosome 10p contribute to a DiGeorge-like phenotype (the DiGeorge critical region II on 10p13–14 and the HDR syndrome (10p14–10pter). Deletion mapping studies in HDR patients defined a region containing the *GATA3* gene that encodes a zinc finger transcription factor involved in vertebrate embryonic development. Microdeletions leading to *GATA3* haploinsufficiency and point mutations in the gene itself have been identified in various HDR kindreds. Thus, *GATA3* seems essential for normal embryonic development of the parathyroids, auditory system, and kidney.

All patients with otherwise unexplained persistent hypoparathyroidism in childhood should be karyotyped ( $\pm$ FISH for 22q11 or 10p microdeletions) and evaluated for other occult anomalies, including subclinical cardiac disease, renal dysplasia, hearing ab-

normalities, and gastrointestinal maldevelopment. Conversely, because the hypoparathyroidism may be very mild, transient, or greatly delayed in onset, demonstration of decreased parathyroid reserve in an otherwise healthy individual with a suspected syndrome may require provocative testing. Evidence of dominant inheritance may depend on detailed examination to identify other features (conotruncal cardiac anomalies, renal dysplasia, decreased cell-mediated immunity, etc.) in first degree relatives of the index case. Although many cases with the DiGeorge phenotype are the result of de novo deletions, autosomal dominant inheritance is not uncommon, and such families require detailed genetic counseling and follow-up. Other karyotypic abnormalities have been reported occasionally in patients with the DiGeorge phenotype, raising the possibility that other genetic loci are yet to be identified.

The Sanjat-Sakati syndrome is an autosomal recessive disorder of congenital hypoparathyroidism associated with short stature, mental retardation, and seizures. Distinctive dysmorphic features include deep-set eyes, depressed nasal bridge with beaked nose, long philtrum, thin upper lip, micrognathia, and large floppy ears. Described in Middle Eastern kindreds, it has been localized to chromosome 1q43–44 along with a recessive form of Kenny-Caffey syndrome, a condition dominated by radiologic findings that include calvarial hyperostosis and marked tubular stenosis of the long bones. The relationship between mutations of the *TBCE* (*tubulin-specific chaperone E*) gene, which encodes a protein required for folding of  $\alpha$ -tubulin and its heterodimerization with  $\beta$ -tubulin, and hypoparathyroidism is unexpected, and further studies will undoubtedly offer new insights into parathyroid gland biology.

Hypoparathyroidism is also a variable component of the neuromyopathies caused by mitochondrial gene defects. Among the clinical conditions are the Kearns-Sayre syndrome (ophthalmoplegia, retinal degeneration, and cardiac conduction defects), the Pearson marrow pancreas syndrome (lactic acidosis, neutropenia, sideroblastic anemia, and pancreatic exocrine dysfunction), and mitochondrial encephalomyopathy. The molecular defects range from large deletions of the mitochondrial genomes in an extensive range of tissues (Pearson syndrome) to single base pair mutations in one of the transfer RNA genes found only in a restricted range of cell types (mitochondrial encephalomyopathy). Because renal magnesium wasting is frequently seen in these conditions, a readily reversible form of hypocalcemic hypoparathyroidism caused by hypomagnesemia should also be considered.

Another unusual myopathy associated with an inborn error of fatty acid oxidation (long-chain hydroxyacyl CoA dehydrogenase deficiency or LCHAD) may also be accompanied by hypoparathyroidism. This condition manifests as nonketotic hypoglycemia, cardiomyopathy, hepatic dysfunction, and developmental delay and is associated with maternal fatty liver of pregnancy.

### Destruction of the Parathyroid Glands

The most common cause of hypoparathyroidism in adults is surgical excision of or damage to the parathyroid glands as a result of total thyroidectomy for thyroid cancer, radical neck dissection for other cancers, or repeated operations for primary hyperparathyroidism. Transient and reversible hypocalcemia after parathyroid surgery may be caused by (1) edema or hemorrhage into the parathyroids, (2) "hungry bone syndrome" caused by severe hyperparathyroidism, or (3) postoperative hypomagnesemia. Prolonged hypocalcemia, which may develop immediately or weeks to years after neck surgery, suggests permanent hypoparathyroidism. The incidence of this condition after neck exploration for primary hyperparathyroidism is usually <5%. In patients with a higher risk of developing permanent hypoparathyroidism, such as those with primary parathyroid hyperplasia or with repeated neck

explorations required to identify an adenoma, parathyroid tissue may be autotransplanted into the brachioradialis or sternocleidomastoid muscle at the time of parathyroidectomy or cryopreserved for subsequent transplantation as necessary.

Rarely, hypoparathyroidism has also been described in a small number of patients who receive extensive radiation to the neck and mediastinum. It is also reported in metal overload diseases such as hemochromatosis (iron), thalassemia (iron), and Wilson's disease (copper), and in neoplastic or granulomatous infiltration of the parathyroid glands. In view of the fact that permanent hypoparathyroidism will only occur if all four parathyroid glands are affected, these are unusual causes of hypoparathyroidism.

Hypoparathyroidism may also occur as a presumed autoimmune disorder either alone or in association with other endocrine deficiency states. Antibodies directed against parathyroid tissue can be detected in 33% of patients with isolated disease and 41% of patients with hypoparathyroidism and other endocrine deficiencies. The genetic etiology of the autosomal recessive polyglandular disorder, APECED (autoimmune polyglandular candidiasis ectodermal dystrophy syndrome)—also known as APS1 (autoimmune polyglandular syndrome, type 1)—has been traced to mutations of the *autoimmune regulator (AIRE)* gene on chromosome 21q22.3, which encodes a unique protein with characteristics of a transcription factor. Showing either sporadic or autosomal-recessive inheritance, APECED has been associated with >40 different mutations of the AIRE gene, and updates can be found in the online mutation database (<http://bioinf.uta.fi/AIREbase/>).

This protein is expressed predominantly in immunologically related tissues, especially the thymus, and functional loss leads to breakdown of immune tolerance to organ-specific self-antigens. Clinically, the most common associated manifestations are hypoparathyroidism with mucocutaneous candidiasis and Addison's disease. Additional associations include insulin-dependent diabetes mellitus, primary hypogonadism, and autoimmune thyroiditis, as well as ectodermal dysplasia, keratoconjunctivitis, pernicious anemia, chronic active hepatitis, steatorrhea (malabsorption resembling celiac disease), alopecia (totalis or areata), and vitiligo.

The phenotype is quite variable, and patients may not express all elements of the basic triad, leading to the suggestion that the criteria used for deciding whether to screen for mutations be relaxed. Typically, however, the disease usually presents in infancy with candidiasis, followed by hypoparathyroidism in the first decade, and adrenocortical failure in the third decade. The hypoparathyroidism may present between 6 months and 20 years of age (average age, 7–8 years). Candidiasis may affect the skin, nails and mucous membranes of the mouth and vagina and is often intractable. Addison's disease can mask the presence of hypoparathyroidism or may manifest only in improvement of the hypoparathyroidism with a reduced requirement for calcium and vitamin D. By diminishing gastrointestinal absorption of calcium and increasing renal calcium excretion, glucocorticoid therapy for the adrenal insufficiency may exacerbate the hypocalcemia and could cause complications if introduced before the hypoparathyroidism is recognized.

The antibody epitopes responsible for the hypoparathyroidism are not well understood, but these are presumably not directed to epitopes in the calcium-sensing receptor (CaSR) and presumably initiate destruction of parathyroid tissue. Nondestructive antibodies to CaSR have also been described.

### Reduced Parathyroid Gland Function Because of Altered Regulation

Altered regulation of parathyroid gland function may be primary or secondary. Primary alterations of parathyroid gland secretion are most commonly caused by activating mutations of the *CaSR* gene on chromosome 3q13.3-q21. These mutations, which

decrease the set-point for calcium or otherwise increase the sensitivity to ECF calcium concentrations, cause a functional hypoparathyroid state with hypocalcemia and hypercalciuria (online CaSR database: <http://www.casrdb.mcgill.ca/>). When the mutations are transmitted through several generations, the clinical picture is one of familial isolated autosomal dominant hypocalcemia. Not infrequently, however, sporadic disease has been shown to arise from de novo activating mutations. The consequence of the activated parathyroid gland CaSR is chronic suppression of PTH secretion, whereas the activated CaSR receptor in kidney induces hypercalciuria that exacerbates the hypocalcemia. In many instances, however, the degree of hypocalcemia and hypercalciuria may be mild and well-tolerated. For subjects without symptoms, the greatest threat can be excessive intervention with vitamin D. However, individuals who are aware of the condition are more likely to identify early, nonspecific signs and symptoms of hypocalcemia and can avert the sudden, unexpected onset of more serious manifestations, such as tetany and seizures. Because of the therapeutic implications, molecular studies to identify *CaSR* mutations are now recommended for all cases of sporadic isolated hypoparathyroidism.

Isolated hypoparathyroidism has also been found with a single base substitution in exon 2 of the *PTH* gene. This mutation in the signal sequence of PTH apparently impedes conversion of prepro-PTH to pro-PTH, thereby reducing normal production of the mature hormone. In another family with autosomal recessive isolated hypoparathyroidism, the entire exon 2 of the *PTH* gene was deleted. This exon contains the initiation codon and a portion of the signal sequence required for peptide translocation at the endoplasmic reticulum in the process of generating a mature secretory peptide.

Secondary alterations in parathyroid regulation may occur as a result of activating autoantibodies to CaSR. These may occur in association with other autoimmune disorders such as Graves disease and Addison's disease and are generally not destructive to the gland. They do, however, inhibit PTH release and may cause hypercalciuria. The spectrum of epitopes responsible for the hypoparathyroidism is not well understood, but antibodies directed against the extracellular domain of CaSR have been found in more than one-half of patients with APS-1 and hypoparathyroidism with autoimmune hypothyroid disease. Although some studies have found a similarly high rate in patients with isolated acquired hypoparathyroidism, the positive rate in controls may be >10%. Some have argued that CaSR antibody assays are clinically indicated in acquired isolated hypoparathyroidism, whereas others urge caution, at least until better assay standardization has been achieved.

Secondary causes of parathyroid gland suppression include maternal hyperparathyroidism and hypomagnesemia. The infant of a mother with primary hyperparathyroidism generally develops hypocalcemia within the first 3 weeks of life, but it may occur up to a year after birth. Although therapy may be required acutely, the disorder is usually self-limited. Hypomagnesemia caused by defective intestinal absorption or renal tubular reabsorption of magnesium may impair secretion of PTH and in this way contribute to hypoparathyroidism. Magnesium replacement will correct the hypoparathyroidism.

### Impaired PTH Action

Although, in theory, a bioinactive form of PTH could be synthesized and secreted by the parathyroid gland, this has not been documented. Rather, ineffective PTH action seems to be caused by peripheral resistance to the hormone's effects. Such resistance may occur secondary to hypomagnesemia or as a primary disorder (pseudohypoparathyroidism and its variants).

## PATHOPHYSIOLOGY

Recently the availability of murine models of hypoparathyroidism has shed new light on the pathophysiology of this disorder. Hypoparathyroidism has generally been reported to be characterized by increased bone mass associated with decreased bone turnover caused by diminished circulating PTH. Analysis of mouse fetuses and neonates with targeted deletion of the *PTH* gene has shown reduced trabecular bone volume, reflecting the deficient anabolic action of endogenous PTH. With increasing age, however, bone mass in these animals increases, reflecting the deficient catabolic actions of the PTH, but even this change in bone mass in hypoparathyroid animals may be modified by dietary calcium intake. Furthermore, adult mice expressing the PTH null allele who are also lacking one allele encoding PTHrP exhibited reduced rather than increased trabecular bone. The increased trabecular bone volume in PTH deficiency therefore seems to be caused by diminished PTH-induced osteoclastic bone resorption coupled with persistent PTHrP-stimulated osteoblastic bone formation. These observations in mice may provide new insight into the complexity of both the hypoparathyroid state and of PTH action during development in humans and rodents, but confirmation in humans will be required.

## THERAPY

The major goal of therapy in all hypoparathyroid states is to restore serum calcium and phosphorus as close to normal as possible. The main pharmacologic agents available are supplemental calcium and vitamin D preparations. Phosphate binders and thiazide diuretics may be useful ancillary agents. The major impediment to restoration of normocalcemia is the development of hypercalciuria with a resulting predilection for renal stone formation. With the loss of the renal calcium-retaining effect of PTH, the enhanced calcium absorption of the gut induced by vitamin D therapy results in an increased filtered load of calcium that is readily cleared through the kidney. Consequently, urinary calcium excretion frequently increases in response to vitamin D supplementation well before serum calcium is normalized. It is often necessary, or even desirable, to aim for a low normal serum calcium concentration to prevent chronic hypercalciuria. Avoidance of hypercalciuria is probably most important for patients with hypercalciuric hypocalcemia caused by activating mutations of the *CaSR* gene, and thiazides may be the preferred treatment. Hydrochlorothiazide therapy (25–100 mg/day in adults to 0.5–2.0 mg/kg/day in children) have been effective in reducing the vitamin D requirement, but potassium supplementation is necessary to offset the thiazide-induced hypokalemia. Recombinant human PTH (rhPTH or teriparatide) has recently become available, and it offers considerable promise as a long-term alternative in patients who do not respond to vitamin D and/or thiazide therapy. Furthermore, in the future, it is possible that calcilytics (small molecule inhibitors of CaSR function) may be of therapeutic use in some patients with autoimmune hypoparathyroidism caused by activating CaSR antibodies.

If serum calcium is normalized, and serum phosphorus remains >6 mg/dl (1.93 mM), a nonabsorbable antacid may be added to reduce the hyperphosphatemia and prevent metastatic calcification. Dairy products, which are high in phosphate, should be avoided, and calcium should be administered in the form of supplements. Generally, at least 1 g/day of elemental calcium is required.

A variety of vitamin D preparations may be used including (1) vitamin D<sub>3</sub> or D<sub>2</sub>, 25,000–100,000 IU (1.25–5 mg) per day; (2) dihydrotachysterol, 0.2–1.2 mg/day; (3) 1 $\alpha$ -hydroxyvitamin D<sub>3</sub>, 0.5–2.0  $\mu$ g/day; or intravenous calcitriol [1,25(OH)<sub>2</sub>D<sub>3</sub>], 0.25–1.0  $\mu$ g/day. Although vitamin D<sub>3</sub> and D<sub>2</sub> are the least expensive forms of therapy, they have the longest

duration of action and can result in prolonged toxicity. Vitamin D<sub>3</sub> is generally of more reliable potency and is to be preferred. The other preparations listed above all have the advantage of shorter half-lives and no requirement for renal 1 $\alpha$ -hydroxylation, which is impaired in hypoparathyroidism. Dihydrotachysterol is rarely used today, however, and calcitriol is probably the treatment of choice. In children, these preparations should be prescribed on a body weight basis. Close monitoring of urine calcium, serum calcium, and serum phosphate are required in the first month or so, but follow-up at 3- to 6-month intervals may be adequate once stable laboratory values are reached.

## SUGGESTED READING

- Daw SC, Taylor C, Kraman M, Call K, Mao J, Schuffenhauer S, Meitinger T, Lipson T, Goodship J, Scambler P 1996 A common region of 10p deleted in diGeorge and velocardiofacial syndromes. *Nature Genet* **13**:458–460.
- Ding C, Buckingham B, Levine MA 2001 Familial isolated hypoparathyroidism caused by a mutation in the gene for the transcription factor GCMB. *J Clin Invest* **108**:1215–1220.
- Eisenbarth GS, Gottlieb PA 2004 Autoimmune polyendocrine syndromes. *N Engl J Med* **350**:2068–2079.
- Gidding SS, Minciotti AL, Langman CB 1988 Unmasking of hypoparathyroidism in familial partial DiGeorge syndrome by challenge with disodium edetate. *N Engl J Med* **319**:1589–1591.
- Harvey JN, Barnett D 1992 Endocrine dysfunction in Kearns-Sayre syndrome. *Clin Endocrinol (Oxf)* **37**:97–103.
- HRD/Autosomal Recessive Kenny-Caffey Syndrome Consortium 2002 Mutation of *TBCE* causes hypoparathyroidism retardation dysmorphism and autosomal recessive Kenny-Caffey syndrome. *Nature Genet* **32**:448–452.
- Kifor O, McElduff A, LeBoff MS, Moore FD Jr, Butters R, Gao P, Cantor TL, Kifor I, Brown EM 2004 Activating antibodies to the calcium-sensing receptor in two patients with autoimmune hypoparathyroidism. *J Clin Endocrinol Metab* **89**:548–556.
- Lienhardt A, Bai M, Lagarde JP, Rigaud M, Zhang Z, Jiang Y, Kottler ML, Brown EM, Garabedian M 2001 Activating mutations of the calcium-sensing receptor: Management of hypocalcemia. *J Clin Endocrinol Metab* **86**:5313–5323.
- Miao D, He B, Karaplis AC, Goltzman D 2002 Parathyroid hormone is essential for normal fetal bone formation. *J Clin Invest* **109**:1173–1182.
- Miao D, Li J, Xue Y, Su H, Karaplis AC, Goltzman D 2004 Parathyroid hormone-related peptide is required for increased trabecular bone volume in parathyroid hormone-null mice. *Endocrinology* **145**:3554–3562.
- Xue Y, Karaplis AC, Hendy GN, Goltzman D, Miao D 2005 Genetic models show that parathyroid hormone and 1,25-dihydroxyvitamin D<sub>3</sub> play distinct and synergistic roles in postnatal mineral ion homeostasis and skeletal development. *Hum Mol Genet* **14**:1515–1528.
- Muroya K, Hasegawa T, Ito Y, Nagai T, Isotani H, Iwata Y, Yamamoto K, Fujimoto S, Seishu S, Fukushima Y, Hasegawa Y, Ogata T 2001 GATA3 abnormalities and the phenotypic spectrum of HDR syndrome. *J Med Genet* **38**:374–380.
- Okano O, Furukawa Y, Morii H, Fujita T 1982 Comparative efficacy of various vitamin D metabolites in the treatment of various types of hypoparathyroidism. *J Clin Endocrinol Metab* **55**:238–243.
- Pollak MR, Brown EM, Estep HL, McLaine PN, Kifor O, Park J, Hebert SC, Seidman CE, Seidman JG 1994 Autosomal dominant hypocalcemia caused by a Ca<sup>2+</sup>-sensing receptor gene mutation. *Nature Genet* **8**:303–307.
- Sato K, Hasegawa Y, Nakae J, Nanao K, Takahashi I, Tajima T, Shinohara N, Fujieda K 2002 Hydrochlorothiazide effectively reduces urinary calcium excretion in two Japanese patients with gain-of-function mutations of the calcium-sensing receptor gene. *J Clin Endocrinol Metab* **87**:3068–3073.
- Seneca S, DeMeirleir L, DeSchepper J, Balduck N, Jochmans K, Liebaers I, Lissens W 1997 Pearson marrow pancreas syndrome: A molecular study and clinical management. *Clin Genet* **51**:338–342.
- Sherwood LM, Santora AC 1994 Hypoparathyroid states in the differential diagnosis of hypocalcemia. In: Bilezikian JP, Marcus R, Levine MA (eds.) *The Parathyroids*. Raven Press, New York, NY, USA, pp. 747–752.
- Stewart AF 2004 Translational implications of the parathyroid calcium receptor. *N Engl J Med* **351**:324–332.
- Thakker RV 2001 Genetic developments in hypoparathyroidism. *Lancet* **357**:974–976.
- Winer KK, Ko CW, Reynolds JC, Dowdy K, Keil M, Peterson D, Gerber LH, McGarvey C, Cutler GB Jr 2003 Long-term treatment of hypoparathyroidism: A randomized controlled study comparing parathyroid hormone-(1–34) versus calcitriol and calcium. *J Clin Endocrinol Metab* **88**:4214–4220.

# Chapter 37. Parathyroid Hormone Resistance Syndromes

Michael A. Levine

*Children's Hospital, Cleveland Clinic and Department of Pediatrics, Cleveland Clinic Lerner College of Medicine, Case Western Reserve University, Cleveland, Ohio*

## INTRODUCTION

The term pseudohypoparathyroidism (PHP) describes a group of disorders characterized by biochemical hypoparathyroidism (i.e., hypocalcemia and hyperphosphatemia), increased secretion of PTH, and target tissue unresponsiveness to the biological actions of PTH.

In the initial description of PHP, Albright et al.<sup>(1)</sup> focused on the failure of patients with this syndrome to show either a calcemic or a phosphaturic response to administered parathyroid extract. These observations provided the basis for the hypothesis that PHP was not caused by a deficiency of PTH but rather to resistance of the target organs, bone and kidney, to the biological actions of PTH. Thus, the pathophysiology of PHP differs fundamentally from true hypoparathyroidism, in which PTH secretion rather than PTH responsiveness is defective.

The initial event in PTH action is binding of the hormone to specific G protein-coupled receptors that are embedded in the plasma membrane of target cells. The primary receptor for PTH also binds PTH-related protein (PTHrP) with equivalent affinity, and thus is termed the PTH/PTHrP or PTH1 receptor. The PTH1 receptor is a member of a superfamily of receptors that are coupled by heterotrimeric ( $\alpha$ ,  $\beta$ ,  $\gamma$ ) guanine nucleotide binding regulatory proteins (G proteins) to signal effector molecules that are localized to the inner surface of the plasma membrane. PTH binding leads to generation of a variety of second messengers, including cAMP, inositol 1,4,5-trisphosphate, and diacylglycerol, and cytosolic calcium, consistent with evidence that the PTH1 receptor can couple not only to  $G_s$  to stimulate adenylyl cyclase but also to  $G_q$  and  $G_{11}$ , albeit with lesser affinity, to stimulate phospholipase C. The best-characterized mediator of PTH action is cAMP, which rapidly activates protein kinase A. The relevant target proteins that are phosphorylated by protein kinase A and the precise actions of these proteins have not yet been fully characterized, but include enzymes, ion channels, and proteins that regulate gene expression. In contrast to the well-recognized effects of the second messenger cAMP in bone and kidney cells, the physiological importance of the phospholipase C signaling pathway in these PTH target tissues has not yet been established.

## PATHOGENESIS OF PSEUDOHYPOPARTHROIDISM

The PTH infusion test facilitates the diagnosis of PHP and enables distinction between the several variants of the syndrome (Fig. 1). Thus, patients with PHP type 1 fail to show an appropriate increase in urinary excretion of both cAMP and phosphate, whereas subjects with the less common type 2 form show a normal increase in urinary cAMP excretion but do not manifest a phosphaturic response.

### Pseudohypoparathyroidism Type 1

The blunted nephrogenous cAMP response to PTH in subjects with PHP type 1 is caused by a deficiency of the alpha subunit of Gs ( $G_{\alpha_s}$ ), the signaling protein that couples PTH1

receptors to stimulation of adenylyl cyclase. Studies of  $G_{\alpha_s}$  expression in membranes from a variety of accessible cell types, including erythrocytes and cultured fibroblasts, have provided a basis for distinguishing two groups of patients with PHP type 1: patients with generalized  $G_{\alpha_s}$  deficiency are classified as PHP type 1a, whereas patients with tissue-specific deficiency of  $G_{\alpha_s}$  are classified as PHP type 1b. Comprehensive studies of endocrine function in patients with PHP type 1a have shown that these patients have resistance not only to PTH, but also to additional hormones, including thyroid-stimulating hormone (TSH), gonadotropins, glucagon, calcitonin, and growth hormone releasing hormone, whose receptors interact with Gs to stimulate adenylyl cyclase. In contrast, subjects with PHP type 1b show hormone resistance that is principally to PTH.

### Albright Hereditary Osteodystrophy

In addition to hormone resistance, patients with PHP type 1a (OMIM 30080, 103580) also manifest a constellation of developmental and somatic defects that are collectively termed Albright's hereditary osteodystrophy (AHO). The AHO phenotype consists of short stature, round faces, obesity, brachydactyly, and subcutaneous ossifications (Fig. 1), but dental defects and sensory-neural abnormalities may also be present. Some individuals with AHO have normal hormone responsiveness, a condition that is termed pseudopseudohypoparathyroidism (pseudo-PHP). Subjects with pseudo-PHP have a normal urinary cAMP response to PTH, which distinguishes them from occasional patients with PHP type 1a who maintain normal serum calcium levels without treatment. Pseudo-PHP is genetically related to PHP type 1a, and within a given kindred, some affected members will have only AHO (i.e., pseudo-PHP), whereas others will have hormone resistance as well (i.e., PHP type 1a), despite equivalent functional deficiency of  $G_{\alpha_s}$  in tissues that have been analyzed.

$G_{\alpha_s}$  deficiency in patients with AHO results from heterozygous inactivating mutations in the *GNAS* gene that account for autosomal dominant inheritance of the disorder. AHO patients with *GNAS* mutations on maternally inherited alleles develop hormone resistance. In contrast, AHO patients with *GNAS* mutations on paternally inherited alleles have only the phenotypic features of AHO without hormonal resistance (i.e., pseudo-PHP). This unusual inheritance pattern was first observed clinically by inspection of published pedigrees and was subsequently ascribed to genomic imprinting of the *GNAS* gene.

The *GNAS* locus on chromosome 20q13.2 in humans and the syntenic mouse *Gnas* locus on chromosome 2 consist of 13 exons that encode  $G_{\alpha_s}$  (Fig. 2). Upstream of exon 1 are three alternative first exons that each splice onto exons 2–13 to create novel transcripts. These include XL, which is expressed only from the paternal allele and which generates a transcript with overlapping open reading frames that encode XL $\alpha$ s and ALEX, (the alternative gene product encoded by the XL-exon). The two proteins are interacting cofactors and are specifically expressed in neuroendocrine cells. XL $\alpha$ s is a much larger signaling protein than  $G_{\alpha_s}$  ( $\approx 78$  versus 45–52 kDa) and is able to interact with  $\beta\gamma$  chains through sequences in the carboxy-terminal region of the XL domain, which shows high homology to the exon 1–encoded portion of  $G_{\alpha_s}$  that promotes

---

The author has reported no conflicts of interest.

A.



B.

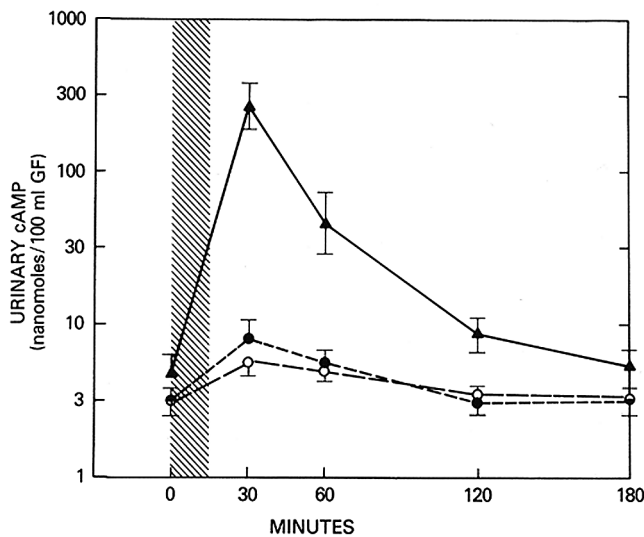
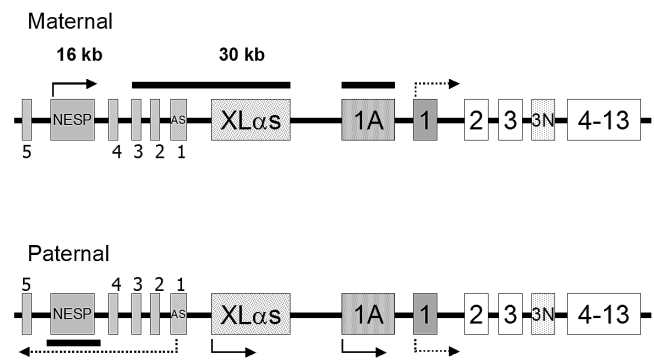

**FIG. 1.** (A) Typical features of AHO. The female in the picture show short stature, obesity, sexual immaturity, and brachydactyly. (B) cAMP excretion in urine in response to intravenous administration of bovine parathyroid extract (300 USP units) from 9:00 a.m. to 9:15 a.m. The peak response in normals (▲) is 50- to 100-fold times basal; patients with PHP type Ia (●) or PHP type Ib (○) show only a 2- to 5-fold response.

binding to  $\beta\gamma$  dimers.  $XL\alpha_s$  is targeted to the plasma membrane and can activate adenyl cyclase. Although recombinant  $XL\alpha_s$  can interact with receptors for PTH and a variety of other hormones in vitro, the native receptors that interact with  $XL\alpha_s$  in vivo are presently unknown. A second alternative promoter encodes the secretory protein Nesp55, which is expressed only from the maternal allele and shares no protein homology with  $G\alpha_s$ . An exon 1A (associated first exon) transcript is derived only from the paternal allele and does not encode a known protein. These alternative first exons are reciprocally imprinted and are associated with promoters that contain differentially methylated regions (DMRs) that are methylated on the nonexpressed allele (Fig. 2). In contrast, the promoter for exon 1 is within a CpG island but is unmethylated on both alleles in all tissues. Imprinting of *GNAS* is controlled by at least two primary maternal imprint marks that are established during oogenesis and that control independent imprinting domains (NESP/XL and exon 1A/ $G\alpha_s$ ).

### Pseudohypoparathyroidism Type 1a

PHP type 1a is characterized by resistance to multiple hormones whose receptors require  $G\alpha_s$  for activation of adenyl cyclase.  $G\alpha_s$  is biallelically transcribed in most tissues, so a heterozygous mutation would be expected to reduce  $G\alpha_s$  expression to 50% of normal, certainly an adequate level to permit normal hormone signaling. However, expression of the paternal  $G\alpha_s$  allele is naturally suppressed in some tissues, including the renal proximal tubule cells, human pituitary, human thyroid, and human ovary. Thus, inactivating germline mutations on the maternal *GNAS* allele will lead to expression of little or no  $G\alpha_s$  protein only in these imprinted tissues, which accounts for the characteristic pattern of hormone resistance found in patients with PHP type 1a and in murine models of AHO in which the maternal *Gnas* allele has been disrupted. The *cis*-acting elements that control tissue-specific paternal imprinting of  $G\alpha_s$  seem to be located within the primary imprint region in exon 1A, because paternal deletion of the



**FIG. 2.** General organization of the *GNAS* gene complex. The *GNAS* gene complex consists of 13 exons that encode the signaling protein  $G\alpha_s$ . Upstream of exon 1 are three alternative first exons that are labeled exon 1A,  $XL\alpha_s$ , and Nesp55; exons 1-5 for the NESP antisense transcript (AS) are also depicted. The three alternative exons are spliced to exons 2-13 to produce unique transcripts. The DMRs are denoted above the respective promoters, and arrows denote the direction of transcription. Nesp55 is transcribed exclusively from the maternal allele;  $XL\alpha_s$  and exon 1A are transcribed exclusively from the paternal allele. Nesp AS (antisense) and exon 1a transcripts produce noncoding RNA.  $G\alpha_s$  transcripts are biallelically expressed except in a small number of tissues, such as the renal proximal tubules, thyroid, gonads, and pituitary somatotrophs, where expression is preferentially from the maternal allele.

exon 1A DMR in mice is associated with increased  $G\alpha_s$  expression.

Although at least three unique proteins are produced from the *GNAS* gene, it seems as if loss of  $G\alpha_s$  is sufficient to explain the PHP type 1a phenotype. In contrast, generation of knockout mice that specifically lack *XLas* or *Nesp55* manifest unique characteristics that implicate these proteins in a variety of other postnatal adaptations. Similarly, patients with paternal deletion of the *GNAS* imprinted locus, and consequent deficiency of *XLas*, have severe pre- and postnatal growth retardation intractable feeding difficulties and abnormal adipose tissue and other neurocognitive defects. Thus, loss of these additional proteins can explain the unusual body habitus, poor suckling behavior, and high perinatal mortality of knockout mice that lack exon 2 of *Gnas*.

Private mutations have been found in nearly all of the AHO kindreds studied, although a four-base deletion in exon 7 has been detected in multiple families, and an unusual missense mutation in exon 13 (A366S) has been identified in two unrelated young boys suggesting that these two regions may be genetic “hot spots.” Small deletions or point mutations can be identified in ~80% of AHO patients using PCR-based techniques, and larger genomic rearrangements or uniparental disomy may account for AHO in other patients.

Postzygotic somatic mutations in the *GNAS* gene that enhance activity of the protein are found in many autonomous endocrine tumors and affected tissues of patients with the McCune-Albright syndrome. These mutations lead to constitutive activation of adenylyl cyclase, and result in proliferation and autonomous hyperfunction of hormonally responsive cells. Clinically significant effects are more likely to ensue when *GNAS* activating mutations occur on the maternally derived allele, which is preferentially expressed in imprinted tissues. The clinical significance of  $G\alpha_s$  activity as a determinant of hormone action is further emphasized by the description by Iiri et al. of two unrelated males with both precocious puberty and PHP type 1a. These two subjects had identical *GNAS* mutations in exon 13 (A366S) that resulted in a temperature-sensitive form of  $G\alpha_s$ . This  $G\alpha_s$  is constitutively active in the cooler environment of the testis, while being rapidly degraded in other tissues at normal body temperature. Thus, different tissues in these two individuals could show hormone resistance (to PTH and TSH), hormone responsiveness (to adrenocorticotropic hormone [ACTH]), or hormone independent activation (to luteinizing hormone [LH]).

### Pseudohypoparathyroidism Type 1b

The characteristics of PHP type 1a contrast sharply with those of PHP type 1b (OMIM 603233). Although most cases of PHP type 1b are sporadic, the disorder may be transmitted in an autosomal dominant manner with phenotypic expression dependent on genomic imprinting. Subjects with PHP type 1b lack features of AHO, show decreased responsiveness to PTH as the principal manifestation of hormone resistance, and have normal  $G\alpha_s$  activity in accessible tissues. Despite renal resistance to PTH, subjects with PHP type 1b who have elevated levels of PTH often manifest skeletal lesions similar to those that occur in patients with hyperparathyroidism.

Specific resistance of target tissues to PTH, and normal activity of  $G\alpha_s$ , first suggested decreased expression or function of the PTH/PTHrP receptor as the cause for hormone resistance in PHP type 1b. However, a variety of genetic studies failed to disclose mutations in the coding exons and promoter regions of the PTH/PTHrP receptor gene or its mRNA, and mice and humans that are heterozygous for inactivation of the gene encoding the PTH/PTHrP receptor do not

manifest PTH resistance or hypocalcemia. In contrast, genetic linkage analyses of PHP type 1b kindreds have mapped PHP type 1b to the *GNAS* locus. The nucleotide sequence of the coding exons and flanking intron-exon boundaries of the *GNAS* gene is normal in patients with PHP type 1b, but an epigenetic defect that results in switching of the maternal *GNAS* allele to a paternal pattern of methylation (i.e., paternal epigenotype) is a consistent finding in sporadic and familial PHP type 1b. Mutations have been described in familial but not sporadic forms of PHP type 1b, including two microdeletions in the *STX16* gene located ~220 kb centromeric of *GNAS* exon 1A and deletions that remove the DMR encompassing exon NESP55 and exons 3 and 4 of the antisense transcript (Fig. 2). In each case, inheritance of the mutation from a female abolishes the maternal *GNAS* epigenotype and results in PTH resistance.

It is conceivable that the conversion of the maternal *GNAS* allele to a “paternal” epigenotype in PHP type 1b leads to transcriptional silencing of the *Gas* promoter in imprinted tissues, with the result that little or no  $G\alpha_s$  is expressed from either *GNAS* allele in these tissues. A similar mechanism has been invoked to explain the development of  $G\alpha_s$  deficiency in one patient with an unusual form of PHP type 1b, in whom molecular genetic studies showed paternal uniparental disomy of *GNAS*. This mechanism would explain severe deficiency of functional  $G\alpha_s$  in some imprinted tissues (e.g., the renal proximal tubules) and normal expression of  $G\alpha_s$  in nonimprinted tissues (e.g., erythrocytes).

### Pseudohypoparathyroidism Type 1c

In rare instances, patients with PHP type 1 and features of AHO show resistance to multiple hormones in the absence of a demonstrable biochemical defect in  $G_s$  or  $G_i$ . Recent molecular studies now suggest that these patients have *GNAS* mutations that result in functional defects of  $G\alpha_s$  that are not apparent in current in vitro assays.

### Pseudohypoparathyroidism Type 2

Pseudohypoparathyroidism type 2 lacks a clear genetic or familial basis. PTH resistance is manifested by a reduced phosphaturic response to administration of PTH, despite a normal increase in urinary cAMP excretion. These observations have suggested that the PTH receptor-adenylyl cyclase complex functions normally to increase nephrogenous cAMP in response to PTH and are consistent with a model in which PTH resistance arises from an inability of intracellular cAMP to activate downstream targets. A similar clinical and biochemical picture occurs in patients with severe deficiency of vitamin D, which raises the possibility that most cases of PHP type 2 are actually examples of unsuspected vitamin D deficiency.

### Osteoma Cutis and Progressive Osseous Heteroplasia

Some patients with isolated ectopic ossification have heterozygous *GNAS* mutations that are identical to those that occur in patients with AHO. The ossification occurs in the absence of a preexisting or associated lesion, as opposed to secondary types of cutaneous ossification that occur by metaplastic reaction to inflammatory, traumatic, and neoplastic processes. Osteoma cutis refers to the development of membranous ossification that is limited to the superficial skin. Progressive osseous heteroplasia (POH) is a more disabling disorder, in which extensive dermal ossification occurs during childhood, followed by widespread ossification of skeletal muscle and deep connective tissue. Heterozygous inactivating *GNAS* mutations have been identified in many patients with

POH, and in each case, the defective allele was paternally inherited. Remarkably, although these patients lack other features of AHO, when POH females transmit the defective *GNAS* allele, their affected children manifest the complete PHP type 1a phenotype. The development of ectopic ossification in patients with haploinsufficiency of *GNAS* is consistent with the role of  $G\alpha_s$  and cAMP as negative regulators of osteogenic commitment.

### Circulating Inhibitors as a Cause of PTH Resistance

Several studies have reported an apparent dissociation between circulating levels of immunoreactive and bioactive PTH in patients with PHP type 1, and plasma from many of these patients had been shown to diminish the biological activity of exogenous PTH in *in vitro* cytochemical bioassays. Although the identity of this putative inhibitor or antagonist is unknown, one potential candidate is the N-terminally truncated PTH fragment, hPTH(7-84), which can inhibit the calcemic actions of hPTH(1-34) or hPTH(1-84) through a nonclassical PTH receptor. Circulating levels of PTH(7-84) immunoreactivity are elevated in patients with PHP type 1a and 1b, and the proportion of PTH(7-84)-like fragments to biologically active PTH(1-84) is increased. Although it is conceivable that circulating hPTH(7-84)-like fragments may contribute to PTH resistance in some patients with PHP, it is likely that these circulating antagonists arise as a consequence of sustained secondary hyperparathyroidism and do not have a significant role in the primary pathophysiology of the disorder.

### DIAGNOSIS OF PSEUDOHYPOPARATHYROIDISM

PHP should be considered in any patient with functional hypoparathyroidism (i.e., hypocalcemia and hyperphosphatemia) and an elevated plasma concentration of PTH. Hypomagnesemia and severe vitamin D deficiency can produce biochemical features of PTH resistance in some patients, and thus plasma concentrations of magnesium and 25(OH)D must be measured. Unusual initial manifestations of PHP include neonatal hypothyroidism, unexplained cardiac failure, seizures, intracerebral calcification of basal ganglia and frontal lobes, dyskinesia and other movement disorders, and spinal cord compression.

PHP or pseudo-PHP may be suspected in patients who present with somatic features of AHO. However, several aspects of AHO, such as obesity, round face, brachydactyly, and mental retardation, also occur in other congenital disorders (e.g., Prader-Willi syndrome, acrodysostosis, Ullrich-Turner syndrome). An interesting phenocopy of AHO occurs in subjects who have small terminal deletions of chromosome 2q37 [del(2)(q37.3)]. These patients have normal endocrine function and normal  $G\alpha_s$  activity.

The classical tests for PHP, the Ellsworth-Howard test and later modifications by Chase et al., involved the administration of 200–300 USP units of purified bovine PTH or parathyroid extract. Although these preparations are no longer available, the synthetic hPTH(1-34) peptide has been approved for human use, and several protocols for its use in the differential diagnosis of hypoparathyroidism have been developed. These protocols are based on intravenous infusion of the peptide, but similar results may be obtained after subcutaneous injection of hPTH(1-34) or hPTH(1-84), albeit requiring administration of higher doses of peptide. The patient should be fasting except for fluids (250 ml of water hourly from 6:00 a.m. to 12:00 a.m.). Two control urine specimens are collected before 9:00 a.m. Synthetic human PTH(1-34) peptide (0.625  $\mu\text{g}/\text{kg}$  body weight to a maximum of 25  $\mu\text{g}$  for intravenous use and 40  $\mu\text{g}$  for subcutaneous use) is administered at 9:00 a.m. either by subcutaneous injection or intravenous infusion over 15

minutes, and experimental urine specimens are collected from 9:00 a.m. to 9:30 a.m., 9:30 a.m. to 10:00 a.m., 10:00 a.m. to 11:00 a.m., and 11:00 a.m. to 12:00 a.m. Blood samples should be obtained at 9:00 a.m. and 11:00 a.m. for measurement of serum creatinine and phosphorous concentrations. Urine samples are analyzed for cAMP, phosphorous, and creatinine concentrations, and results are expressed as nanomoles of cAMP per 100 ml glomerular filtrate (GF) and Tmp/GFR. Normal subjects and patients with hormonopenic hypoparathyroidism usually display a 10- to 20-fold increase in urinary cAMP excretion, whereas patients with PHP type 1 (type 1a and type 1b), regardless of their serum calcium concentration, will show a markedly blunted response (Fig. 1). Thus, this test can distinguish patients with so-called “normocalcemic” PHP (i.e., patients with PTH resistance who are able to maintain normal serum calcium levels without treatment) from subjects with pseudo-PHP (who will have a normal urinary cAMP response to PTH). Recent studies indicate that measurement of plasma cAMP or plasma 1,25-dihydroxyvitamin D after infusion of hPTH(1-34) may also differentiate PHP type 1 from other causes of hypoparathyroidism.

Mutational analysis of the *GNAS* gene is now available as an approved test by several clinical laboratories. In contrast, genetic testing for PHP type 1b is still considered a research test.

The diagnosis of PHP type 2 requires exclusion of magnesium depletion or vitamin D deficiency. Documentation of elevated serum PTH and nephrogenous cAMP is a prerequisite for a definitive diagnosis of PHP type 2. These subjects have a normal urinary cAMP response to infusion of PTH but characteristically fail to show a phosphaturic response. Unfortunately, interpretation of the phosphaturic response to PTH is often complicated by random variations in phosphate clearance, and it is sometimes not possible to classify a phosphaturic response as normal or subnormal regardless of the criteria used.

### TREATMENT

Treatment of hypocalcemia in PHP is directed at maintaining a low- to mid-normal serum calcium concentration to relieve symptoms of tetany while avoiding hypercalciuria. Activated forms of vitamin D (e.g., calcitriol) provide the advantage of rapid onset (and offset) of action, but their corresponding short half-lives necessitate multiple daily doses. Patients with PHP require lower doses of vitamin D and have less risk of treatment-related hypercalciuria than patients with hormonopenic forms of hypoparathyroidism. All patients with hypocalcemia should receive treatment, and it is the author's practice to initiate vitamin D therapy even in normocalcemic patients when the serum concentration of PTH exceeds the upper limit of normal to prevent adverse effects of hyperparathyroidism on the skeleton. Treatment with calcium and vitamin D usually decreases the elevated serum phosphate to a high normal level because of a favorable balance between increased urinary phosphate excretion and decreased intestinal phosphate absorption. In some cases, short-term use of phosphate-binding gels such as aluminum hydroxide may be helpful, but these agents are typically not required for maintenance therapy.

Estrogen therapy and pregnancy have particularly interesting effects on the maintenance of normocalcemia in patients with PHP. Estrogen therapy may reduce serum levels of calcium in women with PHP or hypoparathyroidism. In addition, symptomatic hypocalcemia may also occur in some women at the time of the menses, when estrogen levels are low, with the cause remaining unknown. Paradoxically, during the high estrogen state of pregnancy, some patients with PHP have required less, or no, vitamin D to maintain normal serum concentrations of calcium owing to physiological increases in serum concentration of 1,25(OH)<sub>2</sub>D<sub>3</sub>. After delivery, serum



calcium and  $1,25(\text{OH})_2\text{D}_3$  levels typically decrease and PTH rises. Because placental synthesis of  $1,25(\text{OH})_2\text{D}_3$  is not compromised in patients with PHP, it seems that the placenta may contribute to the maintenance of normocalcemia during pregnancy. In contrast, patients with hypoparathyroidism may require treatment with larger amounts of vitamin D and calcium in the latter half of pregnancy.

Patients with PHP type 1a will frequently manifest resistance to other hormones in addition to PTH and may display clinical evidence of hypothyroidism, gonadal dysfunction, or growth hormone deficiency. The basic principles used in the diagnosis and treatment of these additional endocrine defects apply to patients with PHP type 1a.

### SUGGESTED READING

1. Albright F, Burnett CH, Smith PH 1942 Pseudohypoparathyroidism: An example of "Seabright-Bantam syndrome." *Endocrinology* **30**:922–932.
2. Bastepe M, Frohlich LF, Hendy GN, Indridason OS, Josse RG, Koshiyama H, Korkko J, Nakamoto JM, Rosenbloom AL, Slyper AH, Sugimoto T, Tsatsoulis A, Crawford JD, Juppner H 2003 Autosomal dominant pseudohypoparathyroidism type 1b is associated with a heterozygous microdeletion that likely disrupts a putative imprinting control element of GNAS. *J Clin Invest* **112**:1255–1263.
3. Bastepe M, Frohlich LF, Linglart A, Abu-Zahra HS, Tojo K, Ward LM, Juppner H 2005 Deletion of the NESP55 differentially methylated region causes loss of maternal GNAS imprints and pseudohypoparathyroidism type 1b. *Nat Genet* **37**:25–27.
4. Drezner MK, Neelon FA, Lebovitz HE 1973 Pseudohypoparathyroidism type II: A possible defect in the reception of the cyclic AMP signal. *N Engl J Med* **280**:1056–1060.
5. Germain-Lee EL, Schwindinger W, Crane JL, Zewdu R, Zweifel LS,

Wand G, Huso DL, Saji M, Ringel MD, Levine MA 2005 A mouse model of Albright hereditary osteodystrophy generated by targeted disruption of exon 1 of the *Gnas* gene. *Endocrinology* **146**:4697–4709.

6. Hayward BE, Moran V, Strain L, Bonthron DT 1998 Bidirectional imprinting of a single gene: GNAS1 encodes maternally, paternally, and biallelically derived proteins. *Proc Natl Acad Sci USA* **95**:15475–15480.
7. Levine MA, Zapalowski C, Kappy MS 2005 Disorders of calcium, phosphate, parathyroid hormone and vitamin D. In: Kappy MS, Allen DB, Geffner ME (eds.) *Principles and Practice of Pediatric Endocrinology*. Charles C. Thomas, Springfield, IL, USA, pp. 695–814.
8. Linglart A, Gensure RC, Olney RC, Juppner H, Bastepe M 2005 A novel STX16 deletion in autosomal dominant pseudohypoparathyroidism type 1b redefines the boundaries of a cis-acting imprinting control element of GNAS. *Am J Hum Genet* **76**:804–814.
9. Liu J, Chen M, Deng C, Bourc'his D, Nealon JG, Erlichman B, Bestor TH, Weinstein LS 2005 Identification of the control region for tissue-specific imprinting of the stimulatory G protein alpha-subunit. *Proc Natl Acad Sci USA* **102**:5513–5518.
10. Liu J, Litman D, Rosenberg MJ, Yu S, Biesecker LG, Weinstein LS 2000 A GNAS1 imprinting defect in pseudohypoparathyroidism type 1b. *J Clin Invest* **106**:1167–1174.
11. Rao DS, Parfitt AM, Kleerekoper M, Pumo BS, Frame B 1985 Dissociation between the effects of endogenous parathyroid hormone on adenosine 3',5'-monophosphate generation and phosphate reabsorption in hypocalcemia due to vitamin D depletion: An acquired disorder resembling pseudohypoparathyroidism type II. *J Clin Endocrinol Metab* **61**:285–290.
12. Shore EM, Ahn J, Jan de Beur SM, Li M, Xu M, Gardner RJ, Zasloff MA, Whyte MP, Levine MA, Kaplan FS 2002 Paternally inherited inactivating mutations of the GNAS1 gene in progressive osseous heteroplasia. *N Engl J Med* **346**:99–106.
13. Yu S, Yu D, Lee E, Eckhaus M, Lee R, Corria Z, Accili D, Westphal H, Weinstein LS 1998 Variable and tissue-specific hormone resistance in heterotrimeric Gs protein alpha-subunit (G $\alpha$ ) knockout mice is due to tissue-specific imprinting of the *gsalpha* gene. *Proc Natl Acad Sci USA* **95**:8715–8720.

## Chapter 38. Neonatal Hypocalcemia

Thomas O. Carpenter

*Department of Pediatrics, Yale University School of Medicine, New Haven, Connecticut*

### CALCIUM METABOLISM IN THE PERINATAL PERIOD

Mineralization of the fetal skeleton is provided for by active calcium (Ca) transport from mother to fetus across the placenta, such that the fetus is relatively hypercalcemic compared with the mother. The rate-limiting step in Ca transport is thought to be a Ca pump in the basal membrane (fetus-directed side) of the trophoblast. The net effect of this system is to maintain a 1:1.4 (mother:fetus) Ca gradient throughout gestation,<sup>(1)</sup> providing ample mineral for the demands of mineralization of the skeleton. Although there seems to be little Ca flux in early gestation, this becomes considerable in the third trimester. Both PTH-related protein (PTHrP) and PTH are thought to contribute to the regulation of transplacental Ca transport. At term, the fetus is hypercalcemic and has low levels of PTH compared with the maternal circulation. An abrupt transition to autonomous regulation of mineral homeostasis occurs at partum. With removal of the abundant placental supply of Ca, circulating Ca level decreases, reaching a nadir within the first 3–4 days of life, subsequently rising to normal adult levels in the second week of life. This decrease in

ionized Ca levels postpartum provides the initial stimulus for extrauterine PTH secretion.

### HYPOCALCEMIC SYNDROMES IN THE NEWBORN PERIOD

Manifestations of neonatal hypocalcemia are variable and may not correlate with the magnitude of depression in the circulating ionized Ca level. As in older people, increased neuromuscular excitability (tetany) is a cardinal feature of newborn hypocalcemia. Generalized or focal clonic seizures, jitteriness, irritability, and frequent twitches or jerking of limbs are seen. Hyperacusis and laryngospasm may occur. Nonspecific signs include apnea, tachycardia, tachypnea, cyanosis, and edema; vomiting has also been reported. Neonatal hypocalcemia is traditionally classified by its time of onset; differences in etiology are suggested by "early" occurring hypocalcemia versus that occurring "late."<sup>(2)</sup>

#### Early Neonatal Hypocalcemia

Early neonatal hypocalcemia occurs during the first 3 days of life, usually between 24 and 48 h, and characteristically is seen in premature infants, infants of diabetic mothers, and asphyxiated infants. The premature infant normally has an exaggerated postnatal depression in circulating Ca, dropping lower and

The author has reported no conflicts of interest.

TABLE 1. NEONATAL HYPOCALCEMIA

<i>Characteristics</i>		<i>Mechanism</i>
Early	Onset within first 3–4 days of life; seen in infants of diabetic mother, perinatal asphyxia, pre-eclampsia	Likely decrease in parathyroid response possible exaggerated postnatal calcitonin surge
Late	Onset days 5–10 of life, more common in winter, in infants of mother with marginal vitamin D intake; associated with dietary phosphate load	Possible transient parathyroid dysfunction; hypomagnesemia in some cases; calcium malabsorption
Congenital hypoparathyroidism “Late-late” hypocalcemia		Usually present after first 5 days of life with overt tetany Presents in premature at 2–4 months; associated with skeletal hypomineralization and inadequate dietary mineral or vitamin D intake
Infants of hyperparathyroid mothers		May present as late as 1 year of age; mother possibly undiagnosed
Ionized hypocalcemia (with normal total calcium) Phosphate load		In exchange transfusion with citrated blood produces, lipid infusions, or alkalosis Can be severe after administration of phosphate enemas
Osteopetrosis		Defective mobilization of skeletal calcium due to severe osteoclast defects
Magnesium-wasting		Familial disorders of renal Mg wasting may result in refractory hypocalcemia in infancy

earlier than in the term infant. Total Ca levels may drop below 7.0 mg/dl, but the proportional drop in ionized Ca is less and may explain the lack of symptoms in many premature infants with total Ca in this range.

PTH secretion in response to low serum Ca is often insufficient in premature infants, and the transition to a normal response to hypocalcemia is prolonged. A several-day delay in the phosphaturic effect of PTH in term and preterm infants has been described; resultant hyperphosphatemia may decrease serum Ca. The premature infant's exaggerated rise in calcitonin may provoke hypocalcemia. A role for vitamin D and its metabolites in early neonatal hypocalcemia has been suggested in the setting of severe maternal vitamin D deficiency.

The infant of the diabetic mother (IDM) shows an exaggerated postnatal decrease in circulating Ca compared with other infants of comparable maturity. The pregnant diabetic tends to have lower circulating PTH and magnesium levels; the IDM has lower circulating magnesium and PTH, but normal calcitonin. Abnormalities in vitamin D metabolism do not seem to play a role in the development of hypocalcemia in the IDM. IDMs who maintain optimal glycemic control during pregnancy have a decreased incidence of hypocalcemia compared with infants of diabetic mothers with less regulated blood sugar levels; however, the incidence of hypocalcemia, even with optimal maternal glycemic control, is greater than control infants of mothers without diabetes.<sup>(3)</sup> One preventative strategy, administration of intramuscular magnesium to IDMs, failed to show a reduction in the incidence of hypocalcemia.<sup>(4)</sup>

Early hypocalcemia occurs in asphyxiated infants; calcitonin response is augmented, and PTH levels are elevated. Infants of pre-eclamptic mothers and postmature infants with growth retardation develop early hypocalcemia and are prone to hypomagnesemia.

### Late Neonatal Hypocalcemia

The presentation of hypocalcemic tetany between 5 and 10 days of life is termed “late” neonatal hypocalcemia and occurs more frequently in term infants than in premature infants. It is not correlated with birth trauma or asphyxia. Affected children may have received cow's milk or cow's milk formula, which may have considerably more phosphate than human milk. Hyperphosphatemia is associated with late neonatal hypocalcemia and may reflect (1) inability of the immature kidney to efficiently excrete phosphate; (2) dietary phosphate load; or (3)

transiently low levels of circulating PTH. Others have noted an association between late neonatal hypocalcemia and modest maternal vitamin D insufficiency. An increased occurrence of late neonatal hypocalcemia in winter has also been noted.

Hypocalcemia associated with magnesium deficiency may present as late neonatal hypocalcemia. Severe hypomagnesemia (circulating levels < 0.8 mg/dl) may occur in congenital defects of intestinal magnesium absorption or renal tubular reabsorption. Transient hypomagnesemia of unknown etiology is associated with a less severe decrease in circulating magnesium (between 0.8 and 1.4 mg/dl). Hypocalcemia frequently complicates hypomagnesemic states because of impaired secretion of PTH. Impaired PTH responsiveness has also been shown as an inconsistent finding in magnesium deficiency. Hypomagnesemia with secondary hypocalcemia (and hypocalciuria) has been recently identified to be caused by homozygous mutations in TRPM6, a bifunctional protein found in renal and intestinal epithelia.<sup>(5)</sup> The protein acts as a divalent cation channel and has receptor-like protein kinase activity. Hypocalcemia in this setting is refractory to therapy unless correction of magnesium levels is attained and usually presents at several weeks of age. Mutations in a renal tubular paracellular transport protein, CLDN16, also can cause hypomagnesemia and hypocalcemia associated with hypercalciuria.<sup>(6)</sup>

### Other Causes of Neonatal Hypocalcemia

Symptomatic neonatal hypocalcemia may occur within the first 3 weeks of life in infants born to mothers with hyperparathyroidism. Presentation at 1 year of age has also been reported. Serum phosphate is often >8 mg/dl; symptoms may be exacerbated by feeding cow's milk or other high phosphate formulas. The proposed mechanism for the development of neonatal hypocalcemia in the infant of the hyperparathyroid mother is as follows: maternal hypercalcemia occurs secondary to hyperparathyroidism, resulting in increased Ca delivery to the fetus and fetal hypercalcemia, which inhibits fetal parathyroid secretion. The infant's oversuppressed parathyroid is not able to maintain normal Ca levels postpartum. Hypomagnesemia may be observed in the infant of the hyperparathyroid mother. Maternal hyperparathyroidism has been diagnosed after hypocalcemic infants have been identified.

“Late-late” neonatal hypocalcemia has been used in reference to premature infants who develop hypocalcemia with poor bone mineralization within the first 3–4 months of life. These

infants tend to have an inadequate dietary supply of mineral and/or vitamin D.

The previously discussed forms of neonatal hypocalcemia are generally found to be of a transient nature. More rarely, hypocalcemia that is permanent is detected in the newborn periods and caused by congenital hypoparathyroidism. Isolated absence of the parathyroids may be inherited in X-linked recessive or autosomal dominant or recessive fashion. Mutations in genes involved in parathyroid gland development, PTH processing, PTH secretion (CaSR),<sup>(7)</sup> PTH structure, and PTH action (PTH receptor, Gs $\alpha$ ) have been identified. The most frequently identified defect of parathyroid gland development is the DiGeorge anomaly: the triad of hypoparathyroidism, T-cell incompetence caused by a partial or absent thymus, and conotruncal heart defects (e.g., tetralogy of Fallot, truncus arteriosus) or aortic arch abnormalities. These structures are derived from the embryologic third and fourth pharyngeal pouches; the usual sporadic occurrence reflects developmental abnormalities of these structures, which can be seen in association with microdeletions of chromosome 22q11.2.<sup>(8)</sup> Other defects may variably occur in this broad spectrum field defect, including other midline anomalies such as cleft palate and facial dysmorphism or the velo-cardio-facial syndrome. Individuals with various phenotypic features of this syndrome have come to attention in late childhood or in adolescence with the onset of symptomatic hypocalcemia.<sup>(9)</sup> Presumably "partial" hypoparathyroidism in these individuals was not apparent early in life because of the mild nature of the defect. Deletion of the gene encoding the T-box transcription factor *TBX1* has recently been identified as sufficient to cause the cardiac, parathyroid, thymic, facial, and velopharyngeal features of DiGeorge syndrome.<sup>(10)</sup> Other known causes of heritable hypoparathyroidism<sup>(11)</sup> evident in the newborn period are discussed in greater detail elsewhere.

Severe hypocalcemia has been induced in the newborn period when phosphate enema preparations have been administered.<sup>(12)</sup> The phosphate load resulting from this inappropriate measure can result in extreme hyperphosphatemia, life-threatening hypocalcemia, and hypomagnesemia. Such preparations should never be administered to infants <2 years of age. Rotavirus infections in newborns frequently result in hypocalcemia,<sup>(13)</sup> because of the malabsorption that accompanies markedly increased intestinal transit time with severe diarrhea.

Hypocalcemia in the newborn period may be the presenting manifestation of malignant infantile osteopetrosis, in which resorption of bone is defective, thereby compromising the maintenance of normal serum Ca levels. Resistance to PTH in infancy has also been described in association with propionic acidemia.<sup>(14)</sup>

Decreases in the ionized fraction of the circulating Ca occur in infants undergoing exchange transfusions with citrated blood products or receiving lipid infusions. Citrate and fatty acids form complexes with ionized Ca, reducing the free Ca compartment. Alkalosis secondary to adjustments in ventilatory assistance may provoke a shift of ionized Ca to the protein-bound compartment. It should be pointed out that appropriate collection of sample for performance of ionized Ca levels may require collection of blood with no exposure to air (thus filling collection tubes completely) and without a tourniquet. Additionally, prompt sample handling is usually important for accurate results. Given all of these conditions, the measurement of ionized Ca may be difficult to obtain under routine circumstances in small children.

#### TREATMENT OF NEONATAL HYPOCALCEMIA

Early neonatal hypocalcemia may be asymptomatic, and the necessity of therapy may be questioned in such infants. Most authors recommend that early neonatal hypocalcemia be

treated when the circulating concentration of total serum Ca is <5–6 mg/dl (1.25–1.50 mM; or of ionized Ca <2.5–3 mg/dl, 0.62–0.72 mM) in the premature infant and when total serum Ca is <6–7 mg/dl (1.50–1.75 mM) in the term infant. Emergency therapy of acute tetany consists of intravenous (never intramuscular) Ca gluconate (10% solution) given slowly (<1 ml/minute). A dose of 1–3 ml will usually arrest convulsions. Doses should generally not exceed 20 mg of elemental Ca/kg body weight and may be repeated up to four times per 24 h. After successful management of acute emergencies, maintenance therapy may be achieved by intravenous administration of 20–50 mg elemental Ca/kg body weight/24 h. Ca glubionate is a commonly used oral supplement. Management of late neonatal tetany should include a low phosphate formula such as Similac PM 60/40 (Ross Products, Abbott Laboratories, Abbott Park, IL, USA) in addition to Ca supplements. A Ca:phosphate ratio of 4:1 has been recommended. Monitoring generally reveals that therapy can be discontinued after several weeks.

When hypomagnesemia is a causal feature of hypocalcemia, magnesium administration may be indicated. Magnesium sulfate is given intravenously using cardiac monitoring or intramuscularly as a 50% solution at a dose of 0.1–0.2 ml/kg. One or two doses may treat transient hypomagnesemia; a dose may be repeated after 12–24 h. Patients with primary defects in magnesium metabolism require long-term oral magnesium supplements.

The place of vitamin D in the management of transient hypocalcemia is less clear. A significant portion of intestinal calcium absorption in newborns occurs by facilitated diffusion and is not vitamin D dependent. Thus, pharmacologic use of active metabolites may not be as useful for the short-term management of transient hypocalcemia as the provision of added calcium. Nevertheless, the recent rise in reported cases of vitamin D deficiency has resulted in the suggestion that all premature infants receive daily supplementation of 400–800 U of vitamin D as a preventative measure. Those patients with no evidence of generalized intestinal malabsorption who develop "late-late" hypocalcemia with vitamin D deficiency rickets should respond within 4 weeks to 1000–2000 U of daily oral vitamin D. Such patients should receive a total of at least 40 mg of elemental Ca/kg body weight/day. In the various forms of persistent congenital hypoparathyroidism, long-term treatment with vitamin D (or its therapeutic metabolites) are used; the preferred agent is calcitriol for these purposes at our center.

#### REFERENCES

1. Kohlmeier L, Marcus R 1995 Calcium disorders of pregnancy. *Endocrinol Metab Clin North Am* **24**:15–39.
2. Hillman LS, Haddad JG 1982 Hypocalcemia and other abnormalities of mineral homeostasis during the neonatal period. In: Heath DA, Marx SJ (eds.) *Calcium Disorders*. Butterworths International Medical Reviews, Butterworths, London, UK, pp. 248–276.
3. Jimenez-Moleon JJ, Bueno-Cavanillas A, Luna-del-Castillo Jde D, Garcia-Martin M, Lardelli-Claret P, Galvez-Vargas R 2002 Impact of different levels of carbohydrate intolerance on neonatal outcomes classically associated with gestational diabetes mellitus. *Eur J Obstet Gyn Reprod Biol* **102**:36–41.
4. Mehta KC, Kalkwarf HJ, Mimouni F, Khoury J, Tsang RC 1998 Randomized trial of magnesium administration to prevent hypocalcemia in infants of diabetic mothers. *J Perinatol* **18**:352–356.
5. Schlingmann KP, Weber S, Peters M, Niemann Nejsum L, Vitzhum H, Klingel K, Kratz M, Haddad E, Ristoff E, Dinour D, Syrrou M, Nielsen S, Sassen M, Waldegger S, Seyberth HW, Konrad M 2002 Hypomagnesemia with secondary hypocalcemia is caused by mutations in *TRPM6*, a new member of the TRPM gene family. *Nat Genet* **31**:166–170.
6. Simon DB, Lu Y, Choate KA, Velazquez H, Al-Sabban E, Praga M, Casari G, Bettinelli A, Colussi G, Rodriguez-Soriano J, McCredie D, Milford D, Sanjad S, Lifton RP 1999 Paracellin-1, a renal tight junction protein required for paracellular Mg<sup>2+</sup> resorption. *Science* **285**:103–106.

7. Watanabe T, Bai M, Lane CR, Matsumoto S, Minamatani K, Minagawa M, Niimi H, Brown EM, Yasuda T 1998 Familial hypoparathyroidism: Identification of a novel gain of function mutation in transmembrane domain 5 of the calcium-sensing receptor. *J Clin Endocrinol Metab* **83**:2497–2502.
8. Webber SA, Hatchwell E, Barber JC, Daubeney PE, Crolla JA, Salmon AP, Keeton BR, Temple IK, Dennis NR 1996 Importance of microdeletions of chromosomal region 22q11 as a cause of selected malformations of the ventricular outflow tracts and aortic arch: A three-year prospective study. *J Pediatr* **129**:26–32.
9. Sykes KS, Bachrach LK, Siegel-Bartelt J, Ipp M, Kooh SW, Cytrynbaum C 1997 Velocardiofacial syndrome presenting as hypocalcemia in early adolescence. *Archiv Pediatr Adolescent Med* **151**:745–747.
10. Thakker RV 2004 Genetics of endocrine and metabolic disorders: Parathyroid. *Revs Endocr Metabol Disorders* **5**:37–51.
11. Hsu SC, Levine MA 2004 Perinatal calcium metabolism: Physiology and pathophysiology. *Sem Neonatol* **9**:23–36.
12. Walton DM, Thomas DC, Aly HZ, Short BL 2000 Morbid hypocalcemia associated with phosphate enema in a six-week-old infant. *Pediatrics* **106**:E37.
13. Foldenauer A, Vossbeck S, Pohlandt F 1998 Neonatal hypocalcaemia associated with rotavirus diarrhoea. *Eur J Pediatr* **157**:838–842.
14. Griffin TA, Hostoffer RW, Tserng KY, Lebovitz DJ, Hoppel CL, Mosser JL, Kaplan D, Kerr DS 1996 Parathyroid hormone resistance and B cell lymphopenia in propionic acidemia. *Acta Paediatr* **85**:875–878.

## Chapter 39. Miscellaneous Causes of Hypocalcemia

Robert W. Downs, Jr.

*Division of Endocrinology and Metabolism, Department of Internal Medicine, Virginia Commonwealth University School of Medicine, Richmond, Virginia*

### INTRODUCTION

The complete differential diagnosis of hypocalcemic disorders is extensive and is reviewed in a previous chapter. Other chapters in this text have covered in detail the important aspects of hypoparathyroidism, pseudohypoparathyroidism, disorders of vitamin D deficiency, and vitamin D metabolism, and special consideration has been given to neonatal hypocalcemia and magnesium depletion as causes of hypocalcemia.

This chapter will deal with other “miscellaneous,” but not necessarily less common, causes of hypocalcemia

### HYPOALBUMINEMIA

The ionized or free fraction of serum calcium is physiologically important for cellular function, and low ionized calcium is responsible for the symptoms of hypocalcemia. However, we most often measure total serum calcium, of which about one half is bound to proteins, mostly to albumin. Significant changes in serum protein concentrations can sometimes cause large changes in total serum calcium concentration without affecting the important ionized calcium fraction. Thus, in malnourished and ill individuals, hypoalbuminemia is the most common cause of a low total serum calcium measurement, and such patients do not have symptoms or clinical signs of ionized hypocalcemia (see other chapters for review of the effect of albumin on calcium concentration in hypercalcemia).

There are a number of “rule of thumb” correction formulas that can be used to estimate whether low total serum calcium can be attributed simply to low albumin or serum protein. The most widely used is based on the fact that, at normal pH, each gram of albumin is capable of binding ~0.8 mg of calcium:

$$\text{“Corrected Calcium”} = \text{Measured Total Calcium} \\ + [0.8 \times (4.0 - \text{Measured Albumin})]$$

None of these formulas are entirely satisfactory, however.<sup>(1)</sup> Low sensitivity for the accurate diagnosis of hypocalcemia has been well documented, particularly in severely ill patients.<sup>(2)</sup>

---

Dr. Downs has been a consultant for and received research support from Merck, Novartis, Roche and GlaxoSmithKline.

Therefore, in severely ill patients or when there are symptoms or signs that could be caused by hypocalcemia, it is preferable to obtain direct measurement of ionized calcium performed in a reliable laboratory.

### LABORATORY ERROR

It should be obvious that laboratory test results suggesting hypocalcemia can only be dependable if sample collection and handling is correct. Nevertheless, it is worth emphasizing that if the serum calcium is significantly abnormal in a patient who is asymptomatic, the laboratory findings should be confirmed. There have been reports of apparently “severe” hypocalcemia in cases in which blood is mistakenly collected in tubes containing EDTA.<sup>(3)</sup> Recently two gadolinium chelates, gadodiamide and gadoversetamide, have been reported to interfere with the commonly used colorimetric assay of calcium, but other gadolinium containing contrast agents do not show this interference.<sup>(4,5)</sup>

### ALTERATIONS IN BOUND CALCIUM

In addition to the binding of calcium to albumin and plasma proteins, ~5% of circulating calcium is complexed with inorganic anions. There are a number of situations in which increases in the concentration of anions or changes in pH will result in a shift between bound and ionized calcium.

Hyperphosphatemia is a common cause of hypocalcemia. Rapid increases in serum phosphorus concentrations can occur in the setting of exogenous phosphate administration by oral, rectal, or intravenous routes. Hypocalcemia has been reported after phosphate enemas, particularly in children.<sup>(6)</sup> Even short courses of oral sodium phosphate can cause symptomatic hypocalcemia in adults who may have underlying asymptomatic vitamin D deficiency, magnesium depletion, or significant renal insufficiency preventing normal elimination of phosphorus.<sup>(7)</sup> Patients who have impaired ability to mobilize calcium from skeletal stores because of bisphosphonate therapy may also be at increased risk for the development of hypocalcemia after phosphate administration.<sup>(8)</sup> Hyperphosphatemia can also cause hypocalcemia as a result of release of phosphate from endogenous tissue stores in patients who have rhabdomyolysis and the tumor lysis syndrome.<sup>(9)</sup> The causes of hyperphosphatemia

and its management are reviewed in detail elsewhere in this volume.

Infusion of citrate will complex calcium and lead to acute decreases in ionized calcium concentrations. This is well recognized for massive transfusion with citrated blood products, particularly in the setting of liver transplantation, in which the citrate may not be readily metabolized.<sup>(10)</sup> Citrate is also used during plasma exchange and during apheresis, and monitoring of citrate delivery and steps to prevent hypocalcemic toxicity during plasmapheresis are important.<sup>(11)</sup> Mild hypocalcemia without serious symptoms can even occur during simple automated plateletpheresis in normal blood donors.<sup>(12)</sup> Interestingly, small volume blood transfusion has been associated with the precipitation of hypocalcemic symptoms in patients with pre-existing untreated asymptomatic hypocalcemia.<sup>(13)</sup>

Other calcium chelators can also cause hypocalcemia. A review of the effects of EDTA chelation therapy for cardiovascular disease emphasizes that hypocalcemia may occur as an adverse event during such treatment.<sup>(14)</sup>

Because albumin binds calcium, it is possible that infusion of albumin could lower ionized calcium. This is generally not a problem for the small 100-ml volumes of 25% albumin administered to patients on medical wards, but can be a problem during infusion of larger volumes of colloid during therapeutic plasma exchange, a problem that can be ameliorated by use of an alternate non-calcium-binding colloid.<sup>(11)</sup>

#### INCREASED OSTEOBLASTIC ACTIVITY

Bone formation and resorption are usually tightly coupled, but in certain circumstances, osteoblastic activity may be so great that hypocalcemia occurs. Two situations in which this occurs are during healing of bone disease after parathyroidectomy (hungry-bones syndrome) and in the presence of widespread osteoblastic metastases.

In most patients with relatively mild hyperparathyroidism, surgical removal of an abnormal parathyroid gland results in mild transient hypocalcemia caused by suppression of the remaining normal parathyroid glands, but prompt recovery to normal serum calcium concentrations is expected. In other patients with more severe hyperparathyroidism who have evidence for significant bone disease, hypocalcemia and hypophosphatemia persist despite recovery of PTH secretion from the remaining normal glands. The distinction between hungry bones and postoperative hypoparathyroidism is based on the persistently low serum phosphorus concentration in patients with hungry bones and on normal or even high concentrations of PTH. Individuals with pre-existing vitamin D deficiency accompanying their primary hyperparathyroidism seem to be at greater risk for hungry bones. Patients may require treatment with calcium and vitamin D to enhance intestinal calcium absorption for weeks and even months, until the bone heals.<sup>(15,16)</sup>

Avid uptake of calcium by osteoblastic metastatic lesions can also cause hypocalcemia. Prostate cancer metastases are commonly osteoblastic and are frequently associated with this syndrome, but other cancers can also cause hypocalcemia by this mechanism.<sup>(17)</sup> A prospective study of patients with advanced prostate cancer found that 57% of patients with proven bone metastases had elevated circulating concentrations of PTH, suggesting that mild secondary hyperparathyroidism caused by osteoblastic metastases could be more common than generally recognized.<sup>(18)</sup>

#### ACUTE ILLNESS

Hypocalcemia is quite common in severely ill patients.<sup>(19)</sup> In some patients, changes in serum proteins are responsible for

the majority of the change in serum calcium, and ionized calcium remains normal. This seems to be the case for much of the mild hypocalcemia that often accompanies surgical procedures.<sup>(20)</sup> However, most patients develop some ionized hypocalcemia during severe acute illness, and in some patients, the degree of hypocalcemia is clinically significant. Because serum proteins are often abnormal in these patients, ionized calcium determination is required in severely ill individuals for appropriate diagnosis and treatment.

Hypocalcemia is common in acute pancreatitis and is one of the prognostic signs indicative of overall poor outcome. Free fatty acids are generated by the actions of pancreatic enzymes, and these complex with calcium to form insoluble soaps. In addition, the inflammatory process may be associated with other systemic mediators, although it is not clear whether elevations of these mediators are causally related to the hypocalcemia. Patients with acute pancreatitis may often have other factors contributing to the development of hypocalcemia, such as hypomagnesemia, malabsorption with vitamin D deficiency, and hypoalbuminemia.<sup>(21)</sup>

Hypocalcemia in the setting of other acute illnesses, particularly bacterial sepsis, is a very poor prognostic sign. The mechanism of hypocalcemia in sepsis remains unclear. PTH secretion seems to be appropriately increased, but the degree of hypocalcemia is inversely correlated with TNF- $\alpha$  and interleukin-6 (IL-6) activity, so it is likely that circulating cytokines play a role in the development of the hypocalcemia.<sup>(22)</sup> Patients with AIDS and hypocalcemia may have a distinct pathophysiology. After adjusting for hypoalbuminemia, hypocalcemia is present in AIDS patients more commonly than in control hospital outpatients (6.5% versus 1.1% in one study). AIDS patients may have concomitant vitamin D deficiency or hypomagnesemia and may not have an entirely normal parathyroid hormone secretory response for the degree of hypocalcemia.<sup>(23)</sup> CD4 is expressed in parathyroid glands, so there is the possibility that a lack of parathyroid hormone reserve could be related to HIV infection of parathyroid cells.<sup>(24)</sup>

#### MEDICATIONS

In patients who seem to have drug-related hypocalcemia, the presence of symptomatic hypocalcemia should prompt a complete evaluation for other underlying abnormalities of calcium regulatory hormones. A common theme that runs through many of the case reports of patients who have symptomatic hypocalcemia induced by medications and during acute illness is that the development of hypocalcemia often leads to the discovery of previously unrecognized vitamin D deficiency or hypoparathyroidism.

During aggressive treatment of patients who have hypercalcemia, potent antiresorptive medications that interfere with mobilization of calcium from skeletal stores can cause hypocalcemia. Even when care is used, there may be a brief phase of transient hypocalcemia after successful reduction of the serum calcium until PTH secretion recovers from suppression. If treatment is particularly zealous, osteoclastic activity may be more profoundly decreased, and hypocalcemia can be long-lasting. In addition, patients with malignancy may have other problems, such as hypomagnesemia or vitamin D deficiency, which can be unmasked during aggressive intravenous bisphosphonate treatment.<sup>(25)</sup>

Mild asymptomatic hypocalcemia occurs occasionally in patients with osteoporosis, Paget's disease, or metastatic bone disease who are treated with oral or intravenous bisphosphonates, and this is not usually a clinical problem. However, patients who have unrecognized hypoparathyroidism or vita-

min D deficiency can develop more severe and prolonged symptomatic hypocalcemia during bisphosphonate therapy.<sup>(26,27)</sup>

Long-term anticonvulsant therapy with phenytoin or phenobarbital is associated with an increased risk for osteomalacia and hypocalcemia. Institutionalized patients seem most likely to be affected,<sup>(28)</sup> and ambulatory outpatients who have adequate calcium and vitamin D intake have a fairly low risk for this complication.

Medications that cause hypomagnesemia, such as amphotericin B, furosemide, cyclosporine, and cisplatin, can provoke hypocalcemia.<sup>(29)</sup> Medications that contain calcium-binding properties can precipitate hypocalcemia. Fosphenytoin provides a large phosphate load.<sup>(30)</sup> Foscarnet, an antiviral antibiotic used primarily in patients with AIDS, is a pyrophosphate analog that complexes calcium and magnesium.<sup>(31)</sup> Intravenous contrast agents containing EDTA were previously reported to cause hypocalcemia and are not used commonly, but EDTA chelation therapy is associated with the development of hypocalcemia in some patients.<sup>(14)</sup>

Antineoplastic agents seem capable of causing hypocalcemia in some patients, even when a tumor lysis syndrome does not occur. It may be that effective treatment of patients who have bone lesions allows healing of bones with a hungry-bones effect, and this has been reported in several patients who have prostate cancer treated with estramustine.<sup>(32)</sup>

Finally, symptomatic hypocalcemia has been reported in patients receiving magnesium as tocolytic therapy for premature labor.<sup>(33)</sup> Increases in magnesium are known to suppress PTH secretion, probably through effects on the calcium-sensing receptor, but it is not clear why some patients are more susceptible to this complication.

## REFERENCES

- Ladenson JH, Lewis JW, Boyd JC 1978 Failure of total calcium corrected for protein, albumin, and pH to correctly assess free calcium status. *J Clin Endocrinol Metab* **46**:986–993.
- Dickerson RN, Alexander KH, Minard G, Croce MA, Brown RO 2004 Accuracy of methods to estimate ionized and “corrected” serum calcium concentrations in critically ill multiple trauma patients receiving specialized nutrition support. *J Parenter Enteral Nutr* **28**:133–141.
- Naguib MT, Evans N 2002 Combined false hyperkalemia and hypocalcemia due to specimen contamination during routine phlebotomy. *South Med J* **95**:18–20.
- Lowe A, Balzer T, Hirt U 2005 Interference of gadolinium-containing contrast-enhancing agents with colorimetric calcium laboratory testing. *Invest Radiol* **40**:521–525.
- Prince MR 2004 More on pseudohypocalcemia and gadolinium-enhanced MRI. *N Engl J Med* **350**:87–88.
- Helikson MA, Parham WA, Tobias JD 1997 Hypocalcemia and hyperphosphatemia after phosphate enema use in a child. *J Pediatr Surg* **32**:1244–1246.
- Boivin MA, Kahn SR 1998 Symptomatic hypocalcemia from oral sodium phosphate: A report of two cases. *Am J Gastroenterol* **93**:2577–2579.
- Campisi P, Badhwar V, Morin S, Trudel JL 1999 Postoperative hypocalcemic tetany caused by fleet phosphosoda preparation in patient taking alendronate sodium: Report of a case. *Dis Colon Rectum* **42**:1499–1501.
- Akmal M, Bishop JE, Telfer N, Norman AW, Massry SG 1986 Hypocalcemia and hypercalcemia in patients with rhabdomyolysis with and without acute renal failure. *J Clin Endocrinol Metab* **63**:137–142.
- Wu AH, Bracey A, Bryan-Brown CW, Harper JV, Burritt MF 1987 Ionized calcium monitoring during liver transplantation. *Arch Pathol Lab Med* **111**:935–938.
- Weinstein R 2001 Hypocalcemic toxicity and atypical reactions in therapeutic plasma exchange. *J Clin Apheresis* **16**:210–211.
- Das SS, Chaudhary R, Khetan D, Shukla JS, Agarwal P, Mishra RB 2005 Calcium and magnesium levels during automated plateletpheresis in normal donors. *Transfus Med* **15**:233–236.
- Niven MJ, Zohar M, Shimoni Z, Glick J 1998 Symptomatic hypocalcemia precipitated by small-volume blood transfusion. *Ann Emerg Med* **32**:498–501.
- Seely DM, Wu P, Mills EJ 2005 EDTA chelation therapy for cardiovascular disease: A systematic review. *BMC Cardiovasc Disord* **5**:32.
- Brasier AR, Nussbaum SR 1988 Hungry bone syndrome: Clinical and biochemical predictors of its occurrence after parathyroid surgery. *Am J Med* **84**:654–660.
- Savazzi GM, Allegri L 1993 The hungry bone syndrome: Clinical problems and therapeutic approaches following parathyroidectomy. *Eur J Med* **2**:363–368.
- Riancho JA, Arjona R, Valle R, Sanz J, Gonzalez-Macias J 1989 The clinical spectrum of hypocalcemia associated with bone metastases. *J Intern Med* **226**:449–452.
- Murray RML, Grill V, Crinis N, Ho PWM, Davison J, Pitt P 2001 Hypocalcemia and normocalcemic hyperparathyroidism in patients with advanced prostate cancer. *J Clin Endocrinol Metab* **86**:4133–4138.
- Vivien B, Langeron O, Morell E, Devilliers C, Carli PA, Coriat P, Riou B 2005 Early hypocalcemia in severe trauma. *Crit Care Med* **33**:1946–1952.
- Lepage R, Legare G, Racicot C, Brossard J-H, Lapointe R, Dagenais M, D’Amour P 1999 Hypocalcemia induced during major and minor abdominal surgery in humans. *J Clin Endocrinol Metab* **84**:2654–2658.
- Ammori BJ, Barclay GR, Larvin M, McMahon MJ 2003 Hypocalcemia in patients with acute pancreatitis: A putative role for systemic endotoxin exposure. *Pancreas* **26**:213–217.
- Lind L, Carlstedt F, Rastad J, Stiernstrom H, Stridsberg M, Ljunggren O, Wide L, Larsson A, Hellman P, Ljunghall S 2000 Hypocalcemia and parathyroid hormone secretion in critically ill patients. *Crit Care Med* **28**:93–99.
- Kuehn EW, Anders HJ, Bogner JR, Obermaier J, Goebel FD, Schlondorff D 1999 Hypocalcemia in HIV infection and AIDS. *J Intern Med* **245**:69–73.
- Hellman P, Karlsson PA, Klareskog L, Ridefelt P, Bjerneroth G, Rastad J 1996 Expression and function of a CD-4 like molecule in parathyroid tissue. *Surgery* **120**:985–992.
- Champallou C, Basuyau JP, Veyret C, Chinet P, Debled M, Chevrier A, Gronget MH, Brunelle P 2003 Hypocalcemia following pamidronate administration for bone metastases of solid tumor: Three clinical case reports. *J Pain Symptom Manage* **25**:185–190.
- Breen TL, Shane E 2004 Prolonged hypocalcemia after treatment with zoledronic acid in a patient with prostate cancer and vitamin D deficiency. *J Clin Oncol* **22**:1531–1532.
- Schussheim DH, Jacobs TP, Silverberg SJ 1999 Hypocalcemia associated with alendronate. *Ann Intern Med* **130**:329.
- Schmitt BP, Nordlund DJ, Rodgers LA 1984 Prevalence of hypocalcemia and elevated serum alkaline phosphatase in patients receiving chronic anticonvulsant therapy. *J Fam Pract* **18**:873–877.
- Atsmon J, Dolev E 2005 Drug-induced hypomagnesaemia: Scope and management. *Drug Saf* **28**:763–788.
- Keegan MT, Bondy LR, Blackshear JL, Lanier WL 2002 Hypocalcemia-like electrocardiographic changes after administration of fosphenytoin. *Mayo Clin Proc* **77**:584–586.
- Huycke MM, Naguib MT, Stroemmel MM, Blick K, Monti K, Martin-Munley S, Kaufman C 2000 A double-blind placebo-controlled crossover trial of intravenous magnesium sulfate for foscarnet-induced ionized hypocalcemia and hypomagnesemia in patients with AIDS and cytomegalovirus infection. *Antimicrob Agents Chemother* **44**:2143–2148.
- Park DS, Sellin RV, Tu SM 2001 Estramustine-related hypocalcemia in patients with prostate carcinoma and osteoblastic metastases. *Urology* **58**:105xii–105xv.
- Koontz SL, Friedman SA, Schwartz ML 2004 Symptomatic hypocalcemia after tocolytic therapy with magnesium sulfate and nifedipine. *Am J Obstet Gynecol* **190**:1773–1776.

# Chapter 40. Magnesium Depletion and Hypermagnesemia

Robert K. Rude

Division of Endocrinology, Keck School of Medicine, University of Southern California, Los Angeles, California

## HYPOMAGNESEMIA/MAGNESIUM DEPLETION

Magnesium (Mg) depletion, as determined by low serum Mg levels, is present in ~10% of patients admitted to city hospitals and as many as 65% of patients in intensive care units. Hypomagnesemia and/or Mg depletion is usually caused by losses of Mg from either the gastrointestinal tract or the kidney, as outlined in Table 1.

### Causes of Magnesium Depletion

The Mg content of upper intestinal tract fluids is ~1 mEq/liter; therefore, vomiting and nasogastric suction may contribute to Mg depletion. The Mg content of diarrheal fluids and fistulous drainage are much higher (up to 15 mEq/liter), and consequently, Mg depletion is common in acute and chronic diarrhea, regional enteritis, ulcerative colitis, and intestinal and biliary fistulas. Malabsorption syndromes may also result in Mg deficiency. Steatorrhea and resection or bypass of the small bowel, particularly the ileum, often results in intestinal Mg malabsorption. Last, acute severe pancreatitis is associated with hypomagnesemia, which may be caused by a clinical problem, such as alcoholism, or to saponification of Mg in necrotic parapancreatic fat. A primary defect in intestinal Mg absorption, which presents early in life with hypomagnesemia, hypocalcemia, and seizures, has been described as an autosomal recessive disorder linked to chromosome 9q22. This disorder seems to be caused by mutations in *TRPM6*, which expresses a protein involved with active intestinal Mg transport.

Excessive excretion of Mg into the urine may be the basis of Mg depletion. Renal Mg reabsorption is proportional to tubular fluid flow as well as to sodium and calcium excretion. Chronic parenteral fluid therapy, particularly with saline, and volume expansion states such as primary aldosteronism may result in Mg depletion. Hypercalciuric states may also cause renal Mg wasting. Hypercalcemia has been shown to decrease renal Mg reabsorption, probably mediated by calcium binding to the calcium-sensing receptor in the thick ascending limb of Henle and decreasing transepithelial voltage, and hence a decrease in paracellular absorption of both calcium and Mg. This is probably the cause of renal Mg wasting and hypomagnesemia observed in many hypercalcemic states. Osmotic diuresis caused by glucosuria will result in urinary Mg wasting. Diabetes mellitus is probably the most common clinical disorder associated with Mg depletion.

An increasing list of drugs is becoming recognized as causing renal Mg wasting and Mg depletion. The major site of renal Mg reabsorption is at the loop of Henle; therefore, diuretics such as furosemide have been shown to result in marked Mg wasting. Aminoglycosides have been shown to cause a reversible renal lesion that results in hypermagnesuria and hypomagnesemia. Similarly, amphotericin B therapy has been reported to result in renal Mg wasting. Other renal Mg-wasting agents include cisplatin, cyclosporin, tacrolimus, and pentamidine. A rising blood alcohol level is associated with hypermagnesuria and is one factor contributing to Mg depletion in chronic alcoholism. Metabolic acidosis caused by diabetic ketoacido-

sis, starvation, or alcoholism may also result in renal Mg wasting.

Several renal Mg wasting disorders have been described that may be genetic or sporadic. One form, which is autosomal recessive, results from mutations in the *paracellin-1* gene on chromosome 3. This disorder is characterized by low serum Mg, hypercalciuria, and nephrocalcinosis. Another autosomal dominant form of isolated renal Mg wasting and hypomagnesemia has been linked to chromosome 11q23 and identified as a mutation on the Na<sup>+</sup>,K<sup>+</sup>-ATPase  $\gamma$ -subunit of the *FXD2* gene. Gitelman syndrome (familial hypokalemia-hypomagnesemia syndrome) is an autosomal recessive disorder caused by a genetic defect of the thiazide-sensitive NaCl cotransporter gene on chromosome 16.

Hypomagnesemia may accompany a number of other disorders. Phosphate depletion has been shown experimentally to result in urinary Mg wasting and hypomagnesemia. Hypomagnesemia may also accompany the "hungry bone" syndrome, a phase of rapid bone mineral accretion in subjects with hyperparathyroidism or hyperthyroidism after surgical treatment. Finally, chronic renal tubular, glomerular, or interstitial diseases may be associated with renal Mg wasting. Rarely excessive lactation may result in hypomagnesemia.

TABLE 1. CAUSES OF MG DEFICIENCY

Gastrointestinal disorders
Prolonged nasogastric suction/vomiting
Acute and chronic diarrhea
Intestinal and biliary fistulas
Malabsorption syndromes
Extensive bowel resection or bypass
Acute hemorrhagic pancreatitis
Protein-calorie malnutrition
Primary intestinal hypomagnesemia
Renal loss
Chronic parenteral fluid therapy
Osmotic diuresis (glucose, urea, manitol)
Hypercalcemia
Alcohol
Diuretics (eg, furosemide)
Aminoglycosides
Cisplatin
Cyclosporin
Amphotericin B
Pentamidine
Tacrolimus
Metabolic acidosis
Chronic renal disorders with Mg wasting
Primary renal hypomagnesemia
Endocrine and metabolic disorders
Diabetes mellitus (glycosuria)
Phosphate depletion
Primary hyperparathyroidism (hypercalcemia)
Hypoparathyroidism (hypercalciuria, hypercalcemia due to over-treatment with vitamin D)
Primary aldosteronism
Hungry bone syndrome
Excessive lactation

Dr. Rude has been a consultant for Blaine Pharmaceuticals.

### Manifestations of Magnesium Depletion

Because Mg depletion is usually secondary to another disease process or to a therapeutic agent, the features of the primary disease process may complicate or mask Mg depletion. A high index of suspicion is therefore warranted.

Neuromuscular hyperexcitability may be the presenting complaint. Latent tetany, as elicited by positive Chvostek's and Trousseau's signs, or spontaneous carpal-pedal spasm may be present. Frank generalized seizures may also occur. Although hypocalcemia often contributes to the neurological signs, hypomagnesemia without hypocalcemia has been reported to result in neuromuscular hyperexcitability. Other signs may include vertigo, ataxia, nystagmus, and athetoid and choreiform movements as well as muscular tremor, fasciculation, wasting, and weakness.

Electrocardiographic abnormalities of Mg depletion in humans include prolonged P-R interval and Q-T interval. Mg depletion may also result in cardiac arrhythmias. Supraventricular arrhythmias including premature atrial complexes, atrial tachycardia, atrial fibrillation, and junctional arrhythmias have been described. Ventricular premature complexes, ventricular tachycardia, and ventricular fibrillation are more serious complications. Mg administration to patients with acute myocardial infarction may decrease the mortality rate.

A common laboratory feature of Mg depletion is hypokalemia. During Mg depletion, there is loss of potassium from the cell with intracellular potassium depletion as well as an inability of the kidney to conserve potassium. Attempts to replete the potassium deficit with potassium therapy alone are not successful without simultaneous Mg therapy. This biochemical feature may be a contributing cause of the electrocardiologic findings and cardiac arrhythmias discussed above.

Hypocalcemia is a common manifestation of moderate to severe Mg depletion. The hypocalcemia may be a major contributing factor to the increased neuromuscular excitability often present in Mg-depleted patients. The pathogenesis of hypocalcemia is multifactorial. In normal subjects, acute changes in the serum Mg concentration will influence PTH secretion in a manner similar to calcium through binding to the calcium-sensing receptor. An acute fall in serum Mg stimulates PTH secretion, whereas hypermagnesemia inhibits PTH secretion. During chronic and severe Mg depletion, however, PTH secretion is impaired. Most patients will have serum PTH concentrations that are undetectable or inappropriately normal for the degree of hypocalcemia. Some patients, however, may have serum PTH levels above the normal range that may reflect early magnesium depletion. Regardless of the basal circulating PTH concentration in a Mg-deficient patient, an acute injection of Mg stimulates PTH secretion as shown in Fig. 1. Impaired PTH secretion therefore seems to be a major factor in hypomagnesemia-induced hypocalcemia. Hypocalcemia in the presence of normal or elevated serum PTH concentrations also suggests end-organ resistance to PTH. Patients with hypocalcemia caused by Mg depletion have both renal and skeletal resistance to exogenously administered PTH as manifested by subnormal urinary cyclic adenosine monophosphate (cAMP) and phosphate excretion and diminished calcemic response. This renal and skeletal resistance to PTH is reversed after several days of Mg therapy. The basis for the defect in PTH secretion and PTH end-organ resistance is unclear but may be caused by a defect in the adenylate cyclase and/or phospholipase C second messenger systems, because they are important in PTH secretion and mediating PTH effects in kidney and bone. Magnesium is necessary for the activity of the G-proteins in both enzyme systems. Magnesium is also necessary for substrate formation (MgATP) as well as being an allosteric

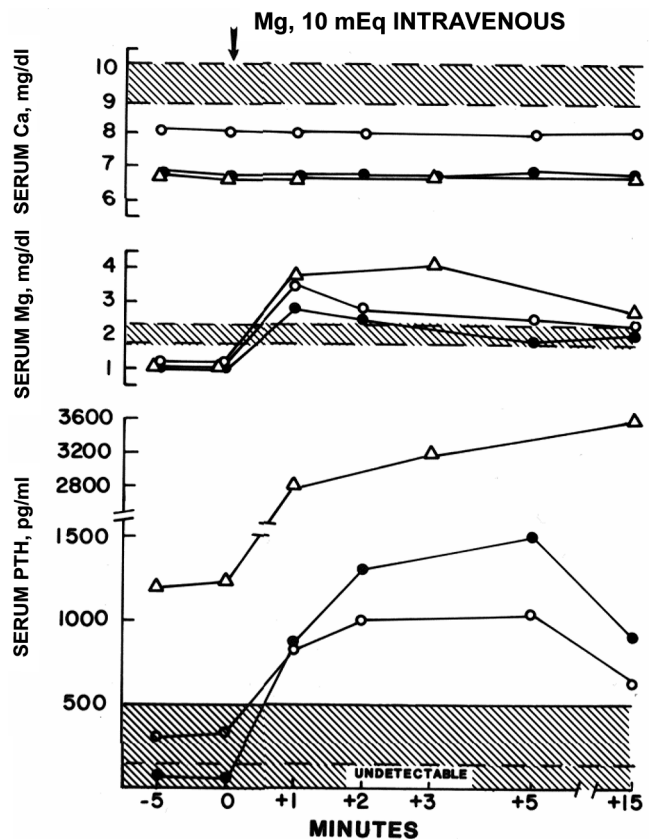

**FIG. 1.** Effect of an intravenous injection of 10 mEq magnesium on the serum concentration of calcium, magnesium, and PTH in hypocalcemic magnesium-deficient patients with undetectable (●), normal (○), or elevated (△) levels of PTH. Shaded area represents the range of normal for assay. Broken line for the PTH assay represents the level of detection. The magnesium injection resulted in a marked rise in PTH secretion within 1 minute in all three patients.

activator of adenylate cyclase. Recent data suggest that Mg deficiency disinhibits  $G\alpha$  subunits and mimics activation of the calcium-sensing receptor.

Clinically, patients with hypocalcemia caused by Mg depletion are resistant not only to PTH, but also to calcium and vitamin D therapy. The vitamin D resistance may be caused by impaired metabolism of vitamin D, because serum concentrations of 1,25-dihydroxyvitamin D are low.

### Diagnosis of Magnesium Depletion

Measurement of the serum Mg concentration is the most commonly used test to assess Mg status. The normal serum Mg concentration ranges from 1.5 to 1.9 mEq/liter (1.8–2.2 mg/dl) and a value <1.5 mEq/liter usually indicates Mg depletion. Mg is principally an intracellular cation and only ~1% of the body Mg content is in the extracellular fluid compartments. The serum Mg concentration therefore may not reflect the intracellular Mg content. Ion selective electrodes for Mg are now available; however, different instruments between manufacturers differ in accuracy from each other and may give misleading results in sera with low Mg levels. Because vitamin D and calcium therapy are relatively ineffective in correcting the hypocalcemia, there must be a high index of suspicion for the presence of Mg depletion. Patients with Mg depletion severe enough to result in hypocalcemia are usually significantly hypomagnesemic. However, occasionally, patients may have



TABLE 2. SUGGESTED PROTOCOL FOR USE OF MAGNESIUM TOLERANCE TEST

I.	Collect baseline 24-h urine for magnesium/creatinine ratio.*
II.	Infuse 0.2 mEq (2.4 mg) elemental magnesium per kilogram lean body weight in 50 ml 5% dextrose over 4 h.
III.	Collect urine (starting with infusion) for magnesium and creatinine for 24 h.
IV.	Percentage magnesium retained is calculated by the following formula: $\%Mg \text{ retained} = 1 - \frac{[\text{Postinfusion 24-h urine Mg} - \text{Preinfusion urine Mg} / \text{creatinine} \times \text{Postinfusion urine creatinine}]}{\text{Total elemental Mg infused}} \times 100$
V.	Criteria for Mg deficiency: >50% retention at 24 h = definite deficiency >25% retention at 24 h = probable deficiency

\* A fasting shorter timed-urine (2-h spot) may be used.

normal serum Mg concentrations. Magnesium deficiency in the presence of a normal serum Mg concentration has been shown by measuring intracellular Mg or by whole body retention of infused Mg. Therefore, hypocalcemic patients who are at risk for Mg depletion but who have normal serum Mg levels should receive a trial of Mg therapy. The Mg tolerance test (or retention test) seems to be an accurate means of assessing Mg status. Correlations with skeletal muscle Mg content and Mg balance studies have been shown. This test seems to be discriminatory in patients with normal renal function; however, its usefulness may be limited if the patient has a renal Mg wasting disorder or is on a medication that induces renal Mg wasting. A suggested protocol for the Mg tolerance test is shown in Table 2.

### Therapy

Patients who present with signs and symptoms of Mg depletion should be treated with Mg. These patients will usually be hypomagnesemic and/or have an abnormal Mg tolerance test. The extent of the total body Mg deficit is impossible to predict, but it may be as high as 200–400 mEq. Under these circumstances, parenteral Mg administration is usually indicated. An effective treatment regimen is the administration of 2 g  $MgSO_4 \cdot 7 H_2O$  (16.2 mEq Mg) as a 50% solution every 8 h intramuscularly. Because these injections are painful, a continuous intravenous infusion of 48 mEq over 24 h may be preferred. Either regimen will usually result in a normal to slightly elevated serum Mg concentration. Despite the fact that PTH secretion increases within minutes after beginning Mg administration, the serum calcium concentration may not return to normal for 3–7 days. This probably reflects slow restoration of intracellular Mg. During this period of therapy, serum Mg concentration may be normal, but the total body deficit may not yet be corrected. Magnesium should be continued until the clinical and biochemical manifestations (hypocalcemia and hypokalemia) of Mg depletion are resolved.

Patients who are hypomagnesemic and have seizures or an acute arrhythmia may be given 8–16 mEq of Mg as an intravenous injection over 5–10 minutes followed by 48 mEq IV/day. Ongoing Mg losses should be monitored during therapy. If the patient continues to lose Mg from the intestine or kidney, therapy may have to be continued for a longer duration. Once repletion has been accomplished, patients usually can maintain a normal Mg status on a regular diet. If repletion is accom-

plished and the patient cannot eat, a maintenance dose of 8 mEq should be given daily. Patients who have chronic Mg loss from the intestine or kidney may require continued oral Mg supplementation. A daily dose of 300–600 mg of elemental Mg may be given, but these should be in divided doses to avoid the cathartic effect of Mg.

Caution should be taken during Mg therapy in patients with any degree of renal failure. If a decrease in glomerular filtration rate exists, the dose of Mg should be halved, and the serum Mg concentration must be monitored daily. If hypermagnesemia ensues, therapy must be stopped.

### HYPERMAGNESEMIA

Magnesium intoxication is not a frequently encountered clinical problem, although mild to moderate elevations in the serum Mg concentration may be seen in as many as 12% of hospitalized patients.

Symptomatic hypermagnesemia is virtually always caused by excessive intake or administration of Mg salts. The majority of patients with hypermagnesemia have concomitant renal failure. Hypermagnesemia is usually seen in patients with renal failure who are receiving Mg as an antacid, enema, or infusion. Hypermagnesemia is also sometimes seen in acute renal failure in the setting of rhabdomyolysis.

Large amounts of oral Mg have rarely been reported to cause symptomatic hypermagnesemia in patients with normal renal function. The rectal administration of Mg for purgation may result in hypermagnesemia. Mg is a standard form of therapy for pregnancy-induced hypertension (preeclampsia and eclampsia) and may cause Mg intoxication in the mother as well as in the neonate. Ureteral irrigation with hemiacidrin (Renacidin) has been reported to cause symptomatic hypermagnesemia in patients with and without renal failure. Modest elevations in the serum Mg concentration may be seen in familial hypocalciuric hypercalcemia, lithium ingestion, and during volume depletion.

### Signs and Symptoms

Neuromuscular symptoms are the most common presenting problem of Mg intoxication. One of the earliest shown effects of hypermagnesemia is the disappearance of the deep tendon reflexes. This is reached at serum Mg concentrations of 4–7 mEq/liter. Depressed respiration and apnea caused by paralysis of the voluntary musculature may be seen at serum Mg concentrations in excess of 8–10 mEq/liter. Somnolence may be observed at levels as low as 3 mEq/liter and above.

Moderate elevations in the serum Mg concentration of 3–5 mEq/liter result in a mild reduction in blood pressure. High concentrations may result in severe symptomatic hypotension. Mg can also be cardiotoxic. At serum Mg concentrations >5 mEq/liter, electrocardiographic findings of prolonged P-R intervals as well as increased QRS duration and QT interval are seen. Complete heart block, as well as cardiac arrest, may occur at concentrations >15 mEq/liter.

Hypermagnesemia causes a fall in the serum calcium concentration. The hypocalcemia may be related to the suppressive effect of hypermagnesemia on PTH secretion or to hypermagnesemia-induced PTH end-organ resistance. A direct effect of Mg on decreasing the serum calcium is suggested by the observation that hypermagnesemia causes hypocalcemia in hypoparathyroid subjects as well.

Other nonspecific manifestations of Mg intoxication include nausea, vomiting, and cutaneous flushing at serum levels of 3–9 mEq/liter.

## Therapy

The possibility of Mg intoxication should be anticipated in any patient receiving Mg, especially if the patient has a reduction in renal function. Mg therapy should merely be discontinued in patients with mild to moderate elevations in the serum Mg level. Excess Mg will be excreted by the kidney, and any symptoms or signs of Mg intoxication will resolve. Patients with severe Mg intoxication may be treated with intravenous calcium. Calcium will antagonize the toxic effects of Mg. This antagonism is immediate but transient. The usual dose is an infusion of 100–200 mg of elemental calcium over 5–10 minutes. If the patient is in renal failure, peritoneal dialysis or hemodialysis against a low dialysis Mg bath will rapidly and effectively lower the serum Mg concentration.

## SUGGESTED READING

1. Cholest IN, Steinberg SF, Trooper PJ, Fox HE, Segre GV, Bilezikian JP 1984 The influence of hypermagnesemia on serum calcium and parathyroid hormone levels in human subjects. *N Engl J Med* **310**:1221–1225.
2. Fassler CA, Rodriguez RM, Badesch DB, Stone WJ, Marini JJ 1985 Magnesium toxicity as a cause of hypotension and hypoventilation: Occurrence in patients with normal renal function. *Arch Intern Med* **145**:1604–1606.
3. Quamme GA 1997 Renal magnesium handling: New insights in understanding old problems. *Kidney Int* **52**:1180–1195.

4. Rude RK 1998 Magnesium deficiency: A heterogeneous cause of disease in humans. *J Bone Miner Res* **13**:749–758.
5. Brown EM, MacLeod RJ 2001 Extracellular calcium sensing and extracellular calcium signaling. *Physiol Rev* **81**:239–297.
6. Quitterer U, Hoffmann M, Freichel M, Lohse MJ 2001 Paradoxical block of parathormone secretion is mediated by increased activity of G alpha subunits. *J Biol Chem* **276**:6763–6769.
7. Rude RK 2001 Magnesium deficiency in parathyroid function. In: Bilezikian JP (ed.) *The Parathyroids*. Raven Press, New York, NY, USA, pp. 763–777.
8. Magnesium in Coronaries (MAGIC) Trial Investigators 2002 Early administration of intravenous magnesium to high-risk patients with acute myocardial infarction in the magnesium coronaries (MAGIC) trial: A randomized controlled trial. *Lancet* **360**:1189–1196.
9. Vetter T, Lohse MJ 2002 Magnesium and the parathyroid. *Curr Opin Nephrol Hypertens* **11**:403–410.
10. Kondrad M, Weber S 2003 Recent advances in molecular genetics of hereditary magnesium-losing disorders. *J Am Soc Nephrol* **14**:249–260.
11. Rude RK, Gruber HE 2004 Magnesium deficiency and osteoporosis: Animal and human observations. *J Nutr Biochem* **15**:710–716.
12. Silver BB 2004 Development of cellular magnesium nano-analysis in treatment of clinical magnesium deficiency. *J Am Coll Nutr* **23**:732S–737S.
13. Rude RK 2005 Magnesium. In: Coates P, Blackman MR, Cragg G, Levine M, Moss J, White J (eds.) *Encyclopedia of Dietary Supplements*. Marcel Dekker, New York, NY, USA, pp. 445–455.
14. Tong GM, Rude RK 2005 Magnesium deficiency in critical illness. *J Intensive Care Med* **20**:3–17.

# Chapter 41. Hyperphosphatemia and Hypophosphatemia

Keith A. Hruska

*Departments of Pediatrics, Medicine, and Cell Biology, Washington University School of Medicine, St. Louis, Missouri*

## INTRODUCTION

New data show that serum phosphate, similar to serum calcium, is a signaling molecule and this chapter begins to consider the serum phosphorus in a greater arena than one limited to mineral homeostasis. The mechanisms for sensing serum phosphate and stimulating signal transduction are not understood. The bulk of total body phosphate (85%) is in the bone as part of the mineralized extracellular matrix. This phosphate pool is accessible, albeit in a limited fashion through bone resorption. Phosphate is a predominantly intracellular anion with an estimated concentration of ~100 mM, most of which is either complexed or bound to proteins or lipids. Serum phosphorus concentration varies with age, time of day, fasting state, and season. It is higher in children than adults. Phosphorus levels exhibit a diurnal variation, with the lowest phosphate level occurring near noon. Serum phosphorus concentration is regulated by diet, hormones, and physical factors such as pH and changes in intestinal, kidney, and skeletal function. Importantly, because phosphate moves in and out of cells under several influences, the serum concentration of phosphorus may not reflect phosphate stores.

## HYPERPHOSPHATEMIA

Serum inorganic phosphorus (Pi) concentrations are generally maintained at 2.5–4.5 mg/dl or 0.75–1.45 mM in adults. In children, normal serum Pi levels are 6–7 mg/dl at <2 years of

age. Hyperphosphatemia may be the consequence of an increased intake of Pi, a decreased excretion of Pi, or translocation of Pi from tissue breakdown into the extracellular fluid<sup>(1)</sup> (Table 1). Because the kidneys are able to excrete phosphate very efficiently over a wide range of dietary intakes, hyperphosphatemia most frequently results from renal insufficiency and the attendant inability to excrete Pi. However, in metabolic bone disorders such as osteoporosis and renal osteodystrophy, the skeleton is a poorly recognized contributor to the serum phosphorus.

## Etiology and Pathogenesis

**Increased Intake.** Hyperphosphatemia may be caused by an increased dietary intake or the administration of Pi. Intravenous administration of Pi during parenteral nutrition, the treatment of Pi depletion, or hypercalcemia can cause hyperphosphatemia, especially in patients with underlying renal insufficiency. Hyperphosphatemia may also result from overzealous use of oral phosphates or of phosphate-containing enemas, because phosphate can be absorbed passively from the colon through paracellular pathways. Administration of vitamin D and its metabolites in pharmacologic doses may be responsible for the development of hyperphosphatemia, although suppression of PTH and hypercalcemia-induced renal failure are important pathogenetic co-factors in this setting.

**Decreased Renal Excretion.** Clinically, hyperphosphatemia is most often caused by impaired excretion because of kidney failure. During stages II and III of chronic kidney diseases (CKDs), phosphate balance is maintained by a progressive

The author has reported no conflicts of interest.

TABLE 1. CAUSES OF HYPERPHOSPHATEMIA

Increased intake
Intravenous—sodium or potassium phosphate
Oral administration—NeutraPhos
Rectal—Fleets phosphosoda enemas
Decreased renal excretion
Renal insufficiency/failure—acute or chronic
Pseudohypoparathyroidism
Tumoral calcinosis
Hypoparathyroidism
Acromegaly
Bisphosphonates
Childhood
Excess bone resorption
Transcellular shift from intracellular to extracellular spaces
Catabolic states
Fulminant hepatitis
Hyperthermia
Rhabdomyolysis—crush injuries or nontraumatic
Cytotoxic therapy—tumor lysis
Acute leukemia
Diabetic ketoacidosis
Hemolytic anemia
Acidosis—metabolic or respiratory
Artifactual

reduction in the fraction of filtered phosphate resorbed by the tubules, leading to increased Pi excretion by the remaining nephrons and a maintenance of normal renal Pi clearance.<sup>(2)</sup> In advanced kidney failure, the fractional excretion of Pi may be as high as 60–90% of the filtered load of phosphate. However, when the number of functional nephrons becomes too diminished (glomerular filtration rate usually <20 ml/minute) and dietary intake is constant, Pi balance can no longer be maintained by reductions of tubular reabsorption, and hyperphosphatemia develops.<sup>(2)</sup> When hyperphosphatemia develops, the filtered load of Pi per nephron increases, and Pi excretion rises. As a result, Pi balance and renal excretory rate is re-established but at a higher serum Pi level (hyperphosphatemia).

Defects in renal excretion of Pi in the absence of renal failure may be primary, as in pseudohypoparathyroidism (PHP). PHP is a term for a group of disorders characterized by hypocalcemia and hyperphosphatemia caused by resistance to the renal tubular actions of PTH.<sup>(3)</sup> PHP1a is caused by mutations in the heterotrimeric G protein,  $G_s\alpha$ , whereas the molecular pathogenesis of PHP1b seems to be related to abnormalities in epigenetic imprinting of maternal  $G_s\alpha$  alleles<sup>(4)</sup> and that of PHP2 is unknown. As a result of the molecular abnormalities in PHP, PTH does not decrease proximal renal tubular phosphate transport causing hyperphosphatemia.

A second primary defect in renal Pi excretion is tumoral calcinosis.<sup>(5)</sup> This is usually seen in young black males with ectopic calcification around large joints and is characterized by increased tubular reabsorption of calcium and Pi and normal responses to PTH. Familial forms of tumoral calcinosis are caused by mutations in the *UDP-N-acetyl- $\alpha$ -D-galactosamine: polypeptide N-acetylgalactosaminyltransferase 3 (GALNT3)* gene<sup>(6)</sup> and missense mutations in fibroblast growth factor (FGF)-23.<sup>(7,8)</sup> These studies show that, besides PTH, FGF23 is a second hormonal regulator of renal phosphate transport in physiologic conditions.

Secondary tubular defects in phosphate transport include hypoparathyroidism<sup>(9)</sup> and high blood levels of growth hormone in acromegaly. Finally, bisphosphonates such as Didronel (disodium etidronate), pamidronate, or alendronate

may cause hyperphosphatemia. The mechanisms of action are unclear, but they may involve cellular phosphate redistribution and decreased renal excretion.<sup>(10)</sup>

**Excess Bone Resorption.** Clinical and translational studies show that excess bone resorption contributes to the level of serum phosphorus that is poorly appreciated. Even in clinical situations where bone formation is decreased (adynamic) such as osteoporosis, a variability in the serum phosphorus is produced when bone formation is stimulated (Fig. 1).<sup>(11,12)</sup> For instance, in low turnover osteodystrophy treated with a skeletal anabolic agent, if phosphorus intake is constant, the serum phosphorus falls despite no change or a decrease in phosphate excretion<sup>(12)</sup> (Fig. 1B).

**Transcellular Shift.** Transcellular shift of Pi from cells into the extracellular fluid compartment may lead to hyperphosphatemia, as seen in conditions associated with increased catabolism or tissue destruction (e.g., systemic infections, fulminant hepatitis, severe hyperthermia, crush injuries, non-traumatic rhabdomyolysis, and cytotoxic therapy for hematologic malignancies such as acute lymphoblastic leukemia and Burkitt's lymphoma).<sup>(13,1)</sup> In the "tumor lysis syndrome," serum Pi levels typically rise because of release from dying cells within 12 days after initiation of treatment. The rising serum Pi concentration often is accompanied by hypocalcemia, hyperuricemia, hyperkalemia, and renal failure. Patients with diabetic ketoacidosis commonly have hyperphosphatemia at the time of presentation despite total body Pi depletion. Insulin, fluid, and acid-base therapy are accompanied by a shift of Pi back into cells and the development of hypophosphatemia. In lactic acidosis, hyperphosphatemia likely results from tissue hypoxia with a breakdown of ATP to AMP and Pi.

**Artifactual.** Hyperphosphatemia may be artifactual when hemolysis occurs during the collection, storage, or processing of blood samples.

### Clinical Consequences of Hyperphosphatemia

The most important short-term consequences of hyperphosphatemia are hypocalcemia and tetany, which occur most commonly in patients with an increased Pi load from any source, exogenous or endogenous. In contrast, soft tissue calcification and secondary hyperparathyroidism are long-term consequences of hyperphosphatemia that occur mainly in patients with renal insufficiency and decreased renal Pi excretion.

**Hypocalcemia and Tetany.** With rapid elevations of serum Pi, hypocalcemia and tetany may occur with serum Pi concentrations as low as 6 mg/dl, a level that, if reached more slowly, has no detectable effect on serum calcium. Hyperphosphatemia, in addition to its effect on the calcium  $\times$  phosphate ion product with resultant calcium deposition in soft tissues, also inhibits the activity of 1 $\alpha$ -hydroxylase in the kidney, resulting in a lower circulating level of 1,25-dihydroxyvitamin D<sub>3</sub>. This further aggravates hypocalcemia by impairing intestinal absorption of calcium and inducing a state of skeletal resistance to the action of PTH.

Phosphate-induced hypocalcemia is common in patients with acute or chronic renal failure and usually develops slowly. Tetany is uncommon unless a superimposed acid-base disorder produces an abrupt rise in plasma pH that acutely lowers the serum ionized calcium concentration. Profound hypocalcemia and tetany are occasionally observed during the early phase of the "tumor lysis" syndrome and rhabdomyolysis.

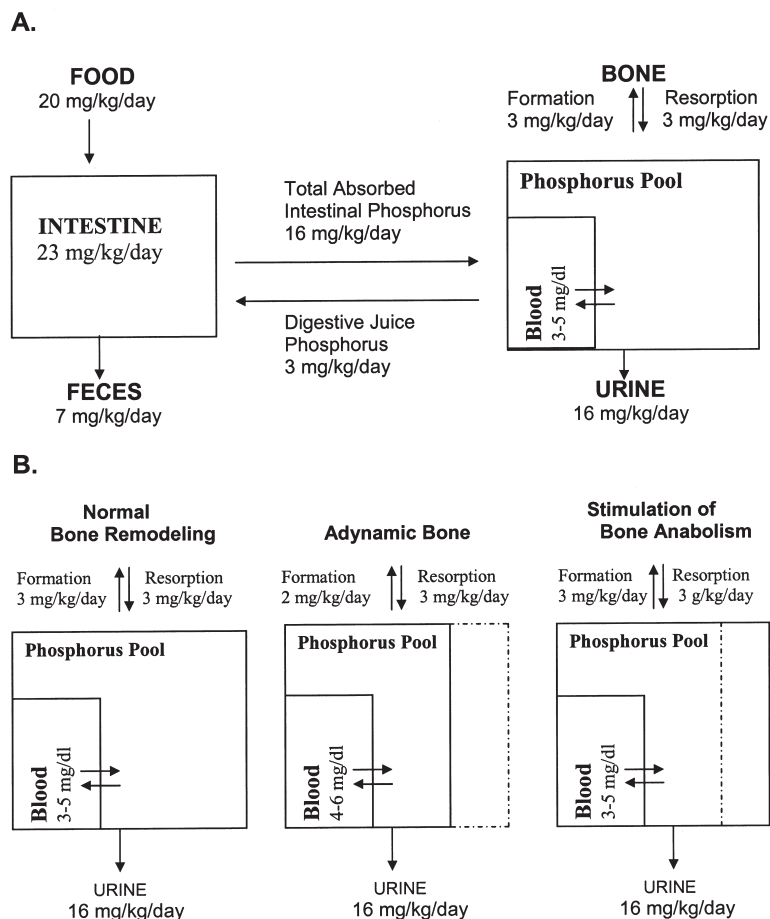

**FIG. 1.** Skeletal remodeling contributes to phosphate balance and serum phosphorus levels. (A) The phosphate balance diagram is amplified to show that serum phosphorus is a small component of a rapidly exchangeable phosphorus pool comprised of cellular phosphorus and the bone mineralization front. (B) When bone formation is decreased (adynamic bone disorders), the exchangeable pool size is diminished, and intestinal absorption from food intake will produce larger fluctuations in the serum phosphorus. These fluctuations are sufficient to activate the signaling actions of the serum Pi, although the fasting serum Pi is normal. Stimulation of bone anabolism increases the exchangeable phosphorus pool size and decreases serum phosphorus fluctuations. In end-stage kidney disease, treatment of secondary hyperparathyroidism with a calcimimetic that does not affect phosphate absorption decreases the serum phosphate, showing the role of the skeleton in hyperphosphatemia.

**Soft Tissue Calcification.** Extraskelatal calcification associated with hyperphosphatemia is usually seen in patients with CKD, diabetes, severe atherosclerosis, and aging. Recent basic, translational, and clinical research studies have led to new theories concerning the pathogenesis and the consequences of this phenomenon.<sup>(14-16)</sup> Several inhibitors of vascular calcification have been discovered, including osteoprotegerin,<sup>(17)</sup> osteopontin,<sup>(18,19)</sup> matrix Gla protein,<sup>(20)</sup> the klotho gene product,<sup>(21)</sup> and Smad 6<sup>(22)</sup> through phenotyping transgenic knockout mice. These substances constitute an inherent defense against heterotopic mineralization that is breached in the disease environment. In the setting of CKD, hyperphosphatemia has been identified as a major factor contributing to the forces favoring mineralization.<sup>(23)</sup> In contrast to the breach of defense theory of vascular calcification, there is significant evidence that vascular cells undergo osteogenic differentiation including expression of the osteoblast-specific transcription factors RUNX2/Cbfa1, osterix, MSX2, and DIX5. As a result, the osteoblastic transcriptosome, including the marker protein osteocalcin, and vascular mineralization is observed.<sup>(14-16)</sup> Experimental models have shown that elevated phosphate is a direct stimulus of this transformation.<sup>(11,24,25)</sup> The finding of vascular calcification and the role of hyperphosphatemia has more than academic significance. Calcification of the neointima or the tunica media including the large blood vessels, coronary arteries, and heart valves in renal failure patients and diabetic subjects is associated with a high morbidity and mortality from systolic hypertension, congestive heart failure, coronary artery disease, and myocardial infarction.<sup>(26-28)</sup> Another manifestation of vascular calcification in more peripheral ar-

teries, calciphylaxis, is also associated with hyperphosphatemia and carries a poor prognosis.<sup>(29,30)</sup> As a result, both vascular calcification and hyperphosphatemia are independent risk factors for cardiovascular disease and mortality.

Occasionally, an acute rise in serum Pi (e.g., during Pi treatment for hypercalcemia or vitamin D intoxication) may lead to soft tissue calcification in clinical settings besides those mentioned in the preceding paragraph. The blood vessels, skin, cornea (band keratopathy), and periarticular tissues are common sites of calcium phosphate deposition.

**Secondary Hyperparathyroidism and Renal Osteodystrophy.** Hyperphosphatemia caused by renal failure also plays a critical role in development of secondary hyperparathyroidism, renal osteodystrophy, and mortality.<sup>(11,23,31,32)</sup> Several mechanisms contribute to these complications including hyperphosphatemia-induced hypocalcemia through physical-chemical interactions, expression of TGF $\alpha$  and the epidermal growth factor receptor (EGFR) in parathyroid chief cells leading to hyperplasia and increased PTH secretion,<sup>(33,34)</sup> and inhibition of vitamin D synthesis and hyperphosphatemia-stimulated vascular calcification.<sup>(11)</sup> In patients with advanced renal failure, the enhanced phosphate load from PTH-mediated osteolysis may ultimately become the dominant influence on serum phosphorus levels (Fig. 1B). This phenomenon may account for the correlation between serum phosphorus levels and the severity of osteitis fibrosa cystica in patients maintained on chronic hemodialysis. Hyperphosphatemia also plays a critical role in the development of vascular calcification as discussed above.<sup>(11,25)</sup> There is a direct relationship between defective

orthotopic mineralization (bone formation) in CKD and increased heterotopic mineralization.<sup>(11,17,24,35)</sup> Our data<sup>(11)</sup> and that of Price et al.<sup>(36)</sup> and Morshita et al.<sup>(24)</sup> show that increasing bone formation will lower phosphate levels and diminish vascular calcification in CKD.

### Treatment

Correction of the pathogenetic defect should be the primary aim in the treatment of hyperphosphatemia. When hyperphosphatemia is due solely to increased intake, discontinuation of supplemental phosphate and maintenance of adequate volume for diuresis is generally sufficient because the kidneys will promptly excrete the excess. In the uncommon circumstance of significant hyperphosphatemia caused by transcellular shift, treatment should be dictated by the underlying cause. For example, hyperphosphatemia that accompanies diabetic ketoacidosis will resolve with insulin therapy, because insulin stimulates cellular uptake of phosphate. On the other hand, hyperphosphatemia seen with tumor lysis, rhabdomyolysis, or other conditions characterized by massive cell death or injury should be treated as an excess phosphate load, albeit endogenous instead of exogenous. Limitation of phosphate intake and enhanced diuresis will generally resolve this cause of hyperphosphatemia, provided renal function is adequate.

When renal insufficiency is present, however, the most effective way to treat hyperphosphatemia is to reduce dietary Pi intake and to add phosphate-binding agents. Because Pi is present in almost all foodstuffs, rigid dietary phosphate restriction requires a barely palatable diet that few patients can accept. However, dietary Pi can be reduced to 800-1000 mg/day with modest protein restriction. A predialysis level of 4.5-5.0 mg/dl is reasonable and allows some room for removal of phosphorus with dialysis while avoiding severe postdialysis hypophosphatemia. To achieve this, the addition of phosphate binders to reduce intestinal absorption of dietary Pi is required. Calcium salts and Sevelamer have replaced aluminum salts as first-line Pi binders.<sup>(37,38)</sup> However, calcium salts contribute to the calcium phosphate ion product, and massive calcium intake is often required to maintain serum phosphorus in the target range. Elevated calcium phosphorus products and the calcium load induced increase in the serum calcium contribute to the development of vascular calcification.<sup>(39,40)</sup> Therefore, newer Pi binders have been introduced such as sevelamer hydrochloride and lanthanum carbonate. Sevelamer has an improved safety profile over calcium salts, and as a binding resin, it also binds cholesterol and low-density lipoproteins (LDLs), leading to improved lipid profiles in patients with end-stage kidney disease (ESKD).<sup>(38)</sup> Calcium acetate and lanthanum carbonate bind more Pi than equivalent amounts of calcium carbonate or citrate. Sevelamer binds calcium equally to calcium carbonate, but the large doses required to maintain serum phosphorus, the pill sizes, and gastrointestinal side effects make compliance a difficult issue with the sole use of sevelamer. In addition, the cost of new agents have limited coverage in some instances. Therefore, the prescription of an effective Pi-binding regimen is a complex issue for patients with ESKD.

New treatments for secondary hyperparathyroidism of kidney failure besides phosphate binders discussed above and vitamin D analogs that suppress PTH gene transcription but increase intestinal Pi absorption are calcimimetics, which activate the Ca sensor of the PTH gland. A calcimimetic (cinacalcet), when used in dialysis patients, decreases serum phosphorus, showing the role of the skeleton in the hyperphosphatemia of ESKD.

The treatment of chronic hyperphosphatemia secondary to

TABLE 2. CAUSES OF MODERATE HYPOPHOSPHATEMIA AND/OR PHOSPHATE DEPLETION

Decreased intestinal absorption
Abnormalities of vitamin D metabolism
Antacid abuse
Malabsorption
Alcoholism
Starvation—famine, anorexia nervosa, alcoholism
Increased urinary losses
Alcoholism
Hyperparathyroidism
Renal tubular defects—Fanconi, Dent's, post transplant, hypomagnesemia, fructose intolerance
X-linked hypophosphatemia, autosomal dominant hypophosphatemia
Oncogenic osteomalacia
McCune-Albright syndrome (MAS) and fibrous dysplasia (FD)
Diabetic ketoacidosis
Metabolic or respiratory acidosis
Respiratory alkalosis
Drugs: calcitonin, diuretics, glucocorticoids, bicarbonate, agonists
Extracellular fluid volume expansion
Transcellular shift from the extracellular to the intracellular space
Respiratory alkalosis
Leukemia (Blast Crisis)
Recovery from metabolic acidosis, commonly diabetic ketoacidosis
Recovery from hypothermia
Nutritional repletion—refeeding syndrome
Sepsis, especially gram negative bacteremia
Salicylate intoxication
Sugars—glucose, fructose, glycerol
Insulin therapy
"Hungry-bone" syndrome after parathyroidectomy

hypoparathyroidism occasionally requires that phosphate binders be added to the other therapeutic agents.

### HYPOPHOSPHATEMIA

Hypophosphatemia is defined as an abnormally low concentration of inorganic phosphate in serum or plasma. Hypophosphatemia does not necessarily indicate total body Pi depletion, because only 1% of the total body Pi is found in extracellular fluids. Conversely, serious Pi depletion may exist in the presence of a normal or even elevated serum Pi concentration. Moderate hypophosphatemia, defined as a serum Pi concentration between 2.5 and 1 mg/dl, is not uncommon, and is usually not associated with signs or symptoms.<sup>(1)</sup> Severe hypophosphatemia, defined as serum phosphorus levels <1.0 mg/dl, is often associated with clinical signs and symptoms that require therapy. Approximately 2% of hospital patients have levels of serum Pi <2 mg/dl according to some estimates. Hypophosphatemia is encountered more frequently among alcoholic patients, and up to 10% of patients admitted to hospitals because of chronic alcoholism are hypophosphatemic.

### Etiology and Pathogenesis

Three types of pathophysiologic abnormalities can cause hypophosphatemia and total body Pi depletion: decreased intestinal absorption of Pi, increased urinary losses of this ion, and a shift of Pi from extracellular to intracellular compartments (Table 2). Combinations of these disturbances are common. The causes and mechanisms of moderate hypophosphatemia are shown in Table 2; the clinical conditions associated with severe hypophosphatemia are shown in Table 3.

TABLE 3. RISK FACTORS FOR SEVERE HYPOPHOSPHATEMIA AND/OR PHOSPHATE DEPLETION

Alcohol withdrawal
Nutritional repletion in at risk patients
Anorexia nervosa and other eating disorders
Starvation due to famine, neglect, alcoholism, malabsorption, prisoners of war
AIDS and other chronic infections
Massive weight loss for morbid obesity
Treatment of diabetic ketoacidosis
Critical illness
Sepsis
Posttrauma
Extensive burns

### Decreased Intestinal Absorption

**Vitamin D Deficiency.** Diets deficient in vitamin D lead to the metabolic disorder known as rickets in children or osteomalacia when it appears in adults.<sup>(41)</sup> Rickets result in severe deformities of bone because of rapid growth. These deformities are characterized by soft loose areas in the skull known as cranioabes and costochondral swelling or bending (known as rachitic rosary). The chest usually becomes flattened, and the sternum may be pushed forward to form the so-called pigeon chest. Thoracic expansion may be greatly reduced with impairment of respiratory function. Kyphosis is a common finding. There is remarkable swelling of the joints, particularly the wrists and ankles, with characteristic anterior bowing of the legs, and fractures of the “greenstick” variety may also be seen. In adults, the symptoms are not as striking and are usually characterized by bone pain, weakness, radiolucent areas, and pseudofractures. Pseudofractures represent stress fractures in which the normal process of healing is impaired because of a mineralization defect. Mild hypocalcemia may be present; however, hypophosphatemia is the most frequent biochemical alteration. This metabolic abnormality responds well to administration of small amounts of vitamin D.

**Vitamin D–Resistant Rickets.** These are recessively inherited forms of vitamin D refractory rickets. The conditions are characterized by hypophosphatemia, hypocalcemia, elevated levels of serum alkaline phosphatase, and sometimes, generalized aminoaciduria and severe bone lesions. Two main forms of vitamin D–dependent rickets have been characterized. The serum concentrations of 1,25-dihydroxycholecalciferol serves to differentiate the two types of vitamin D–dependent rickets. Type I is caused by a mutation in the gene converting 25(OH)D to 1,25-dihydroxycholecalciferol, the renal 1 $\alpha$ -hydroxylase enzyme.<sup>(42)</sup> This condition responds to very large doses of vitamin D<sub>2</sub> and D<sub>3</sub> (100–300 times the normal requirement of physiologic doses; 0.5–1.0  $\mu$ g/day of 1,25-dihydroxycholecalciferol). Type II is characterized by an end-organ resistance to 1,25-dihydroxycholecalciferol. Plasma levels of 1,25-dihydroxycholecalciferol are elevated. This finding, in association with radiographic and biochemical signs of rickets, implies resistance to the target tissue to 1,25-dihydroxycholecalciferol. Cellular defects found in patients with Vitamin D–resistant rickets type II are heterogeneous, providing in part an explanation for the different clinical manifestations of this disorder.

Numerous studies<sup>(43)</sup> have shown that hereditary type II vitamin D–resistant rickets is a genetic disease affecting the vitamin D receptor (VDR). The treatment of this condition requires large pharmacologic doses of calcium, which over-

come the receptor defects and maintain bone remodeling.<sup>(43)</sup> Studies in mice with targeted disruption of the VDR gene, an animal model of vitamin D–resistant rickets type II, confirm that many aspects of the clinical phenotype are caused by decreased intestinal ion transport and can be overcome by adjustments of dietary intake.<sup>(44)</sup>

**Antacid Abuse and Malabsorption.** Severe hypophosphatemia and phosphate depletion may result from vigorous use of oral antacids, which bind phosphate, usually for peptic ulcer disease.<sup>(45)</sup> Patients so treated may develop osteomalacia and severe skeletal symptoms caused by phosphorus deficiency. Intestinal malabsorption can cause hypophosphatemia and phosphate depletion through malabsorption of Pi and vitamin D and through increased urinary Pi losses resulting from secondary hyperparathyroidism induced by calcium malabsorption.

**Alcohol and Alcohol Withdrawal.** Alcohol abuse is a common cause of hypophosphatemia, which may be severe (Table 2),<sup>(46,47)</sup> due to both poor intake and excessive losses. Poor intake results from dietary deficiencies, the use of antacids, and vomiting. Patients with alcoholism have also been shown to have a variety of defects in renal tubular function, including a decrease in threshold for phosphate excretion, which are reversible with abstinence. Ethanol enhances urinary Pi excretion, and marked phosphaturia tends to occur during episodes of alcoholic ketoacidosis. Because such patients often eat poorly, ketonuria is common. Repeated episodes of ketoacidosis catabolize organic phosphates within cells and cause phosphaturia by mechanisms analogous to those seen in diabetic ketoacidosis. Chronic alcoholism may also cause magnesium deficiency and hypomagnesemia, which may, in turn, cause phosphaturia and Pi depletion, especially in skeletal muscle.

**Nutritional Repletion: Oral, Enteral, and Parenteral Nutrition.** Nutritional repletion of the malnourished patient implies the provision of sufficient calories, protein, and other nutrients to allow accelerated tissue accretion. In the course of this process, cellular uptake and use of Pi increase. When insufficient amounts of Pi are provided, an acute state of severe hypophosphatemia and intracellular Pi depletion with serious clinical and metabolic consequences can occur.<sup>(48,49)</sup> This type of hypophosphatemia has been observed in malnourished patients receiving parenteral nutrition and after refeeding of prisoners of war.

### Increased Urinary Losses

**Hyperparathyroidism.** Primary hyperparathyroidism (Table 2) is a common entity in clinical medicine. PTH is secreted in excess of the physiologic needs for mineral homeostasis owing either to adenoma or hyperplasia of the parathyroid glands. This results in decreased phosphorus reabsorption by the kidney, and the urinary losses of phosphorus result in hypophosphatemia. The degree of hypophosphatemia varies considerably because mobilization of phosphorus from stimulation of skeletal remodeling in part mitigates the hypophosphatemia. Secondary hyperparathyroidism associated with normal renal function has been observed in patients with gastrointestinal abnormalities resulting in calcium malabsorption. Such patients may have low levels of serum calcium and phosphorus. In these patients, the hypocalcemia is responsible for increased release of PTH. Decreased intestinal absorption of phosphorus as a result of the primary gastrointestinal disease may contribute to the decrement in the levels of the serum phosphorus. In general, these patients have urinary losses of phosphorus that

are out of proportion to the hypophosphatemia in contrast to patients with predominant phosphorus malabsorption and no secondary hyperparathyroidism in whom urinary excretion of phosphorus is low.

**Renal Tubular Defects.** Several conditions characterized by either single or multiple tubular ion transport defects have been characterized in which phosphorus reabsorption is decreased. In Fanconi syndrome, patients excrete not only an increased amount of phosphorus in the urine but also increased quantities of amino acids, uric acid, and glucose, resulting in hypouricemia and hypophosphatemia.<sup>(50)</sup> In Dent's disease, a proximal tubular trafficking vesicle chloride channel, *CLCN5*,<sup>(51,52)</sup> is mutated. This leads to hypercalciuria and hypophosphatemia.<sup>(53)</sup> There are other conditions in which an isolated defect in the renal tubular transport of phosphorus has been found (e.g., in fructose intolerance, an autosomal recessive disorder). After renal transplantation, an acquired renal tubular defect is responsible for the persistence of hypophosphatemia in some patients. Studies in patients after transplantation<sup>(54,55)</sup> show that a phosphatonin-like substance is responsible for posttransplant hypophosphatemia. The hypophosphatemia is important because recent studies implicate it in the osteoblast failure contributing to the development of osteoporosis.<sup>(56)</sup> The known phosphatonins, FGF23, secreted Frizzled related protein 4 (sFRP4), and matrix extracellular phosphoglycoprotein expression (MEPE) have been studied and found not to be the basis for posttransplant hypophosphatemia.<sup>(1,55)</sup>

**X-Linked Hypophosphatemic Rickets and Autosomal Dominant Hypophosphatemic Rickets.** These hereditary disorders are characterized by hypophosphatemia, decreased reabsorption of phosphorus by the renal tubule, decreased absorption of calcium and phosphorus from the gastrointestinal tract, and varying degrees of rickets or osteomalacia.<sup>(57)</sup> Patients with the disorders exhibit normal or reduced levels of 1,25-dihydroxycholecalciferol (which should be elevated because of the hypophosphatemia) and reduced Na-phosphate transport in the proximal tubule in the face of severe hypophosphatemia. The gene for X-linked hypophosphatemia (XLH) is not the Pi transport protein itself,<sup>(58)</sup> but a gene termed *PHEX*,<sup>(59)</sup> which encodes for a neutral endopeptidase presumed to be responsible for degradation of a group of new hormones identified as systemic phosphaturic factors, "phosphatonins."<sup>(60–62)</sup> The defective *PHEX* gene product in XLH rickets permits a phosphatonin, most likely FGF23, to inhibit renal phosphate absorption, despite persistent hypophosphatemia.<sup>(63)</sup> Studies have shown that FGF23 levels are elevated in many, but not all, patients with XLH.<sup>(64)</sup> A substance that stimulates FGF23 expression and is not appropriately processed by the mutated *PHEX* seems to be the pathogenesis of XLH.<sup>(65,66)</sup>

**Oncogenic Osteomalacia.** This entity is characterized by hypophosphatemia in association with mesenchymal tumors. The patients exhibit osteomalacia on histomorphologic examination of bone biopsy specimens, renal wasting of phosphorus, and markedly reduced levels of 1,25-dihydroxyvitamin D<sub>3</sub>. The existence of a possible circulating humoral factor has long been suspected and is supported by the identification of tumor products from patients with hemangiopericytomas that inhibit renal phosphate transport<sup>(67)</sup> and recent genetic screens of tumors associated with hypophosphatemia compared with those without.<sup>(68–70)</sup> Three novel new hormones have been discovered by these studies. The first, FGF23, is the etiologic agent in XLH and autosomal dominant hypophosphatemic rickets (ADHR) discussed above. Physiologic secretion of FGF23 by osteoblasts is low because of the function of *PHEX*. Overpro-

duction of FGF23 by the oncogenic osteomalacic tumors leads to the syndrome. Thus, FGF23 is the first hormone discovered that is produced in the bone and functions to regulate renal and intestinal phosphate transport.

The second new hormone regulating phosphate transport in the kidney is a member of the secreted frizzled related protein (sFRP) family, decoy receptors involved in Wnt signaling.<sup>(71)</sup> Recent studies have shown that sFRP4 is a phosphatonin in some cases of oncogenic osteomalacia.<sup>(69)</sup> The frizzled proteins are the receptors for the Wnt family of developmental morphogens along with the co-receptor, low-density lipoprotein receptor-related protein 5 (Lrp5).<sup>(72)</sup> Lrp5 is a member of the Lrp family, which are promiscuous endocytic receptors.<sup>(73)</sup> Lrp2 is megalin, which is involved in endocytosis of the vitamin D-binding protein in the proximal tubule and delivery of 25(OH)D<sub>3</sub> for production of calcitriol.<sup>(74)</sup> Lrp5 is a divergent family member and its main function seems to be as the co-receptor with the frizzled family for the Wnts.<sup>(75)</sup> Lrp5 has been identified as the nonsyndromic high bone mass gene,<sup>(76)</sup> showing the critical nature of Wnt signaling in bone anabolism and setting the pathophysiologic stage for interference with Wnt signaling by sFRP4 to decrease bone formation and as a phosphatonin to increase Pi excretion. sFRP4 is widely expressed, including in the kidney, and disease states increase its production,<sup>(77)</sup> potentially leading to a mechanism whereby CKD inhibits bone formation and contributes to renal osteodystrophy.

The third phosphatonin is MEPE, which is expressed in osteoblasts and is upregulated in murine XLH (Hyp).<sup>(78–80)</sup> Processing of MEPE yields an acidic serine-aspartate rich motif (ASARM) peptide that plays a role in mineralization (Minhibin). *PHEX* prevents proteolysis of MEPE and release of ASARM.<sup>(81)</sup> Disruption of the *MEPE* gene results in increased bone formation and mass,<sup>(82)</sup> but the mice have normal Pi levels.

**McCune-Albright Syndrome/Fibrous Dysplasia.** McCune-Albright Syndrome (MAS) is a triad of polyostotic fibrous dysplasia (FD), café au lait skin pigmentation, and endocrine disorders mediated by activating mutations in the receptor associated heterotrimeric G protein, G<sub>s</sub>α.<sup>(83)</sup> The effects of the G<sub>s</sub>α mutation, increased cAMP, may lead to rickets and osteomalacia because of hyperphosphaturic hypophosphatemia.<sup>(84,85)</sup>

**Diabetic Ketoacidosis.** Patients with well-controlled diabetes mellitus do not have excessive losses of phosphate. However, in the presence of hyperglycemia, polyuria, and acidosis, Pi is lost through the urine in excessive amounts. In ketoacidosis, intracellular organic components tend to be broken down, releasing a large amount of Pi into the plasma, which is subsequently lost in the urine. This process, combined with the enhanced osmotic Pi diuresis secondary to glycosuria, ketonuria, and polyuria, may cause large urinary losses of Pi and subsequent depletion. The plasma Pi is usually normal or slightly elevated in the ketotic patient despite the excessive urinary losses because of the continuous large shift of Pi from the cells into the plasma. With insulin, fluids, and correction of the ketoacidosis, however, serum and urine Pi may fall sharply. Despite the appearance of hypophosphatemia during treatment, previously well-controlled patients with diabetic ketoacidosis of only a few days duration almost never have serious phosphorus deficiency. Serum Pi rarely falls below 1.0 mg/dl in these patients. Administration of Pi-containing salts does not improve glucose use, nor does it reduce insulin requirements or the time for recovery from ketoacidosis. Thus, Pi therapy should be reserved for patients with serum Pi concentration <1.0 mg/dl.

TABLE 4. CONSEQUENCES OF SEVERE HYPOPHOSPHATEMIA

---

CNS dysfunction—encephalopathy, seizures, delirium, coma, paresthesias
Red blood cell dysfunction—hemolysis, tissue hypoxia
Leukocyte dysfunction—increased susceptibility to infection
Platelet dysfunction—thrombocytopenia, hemorrhage
Skeletal muscle dysfunction—weakness, respiratory failure, rhabdomyolysis
Cardiac muscle dysfunction—cardiomyopathy, congestive heart failure
Bone disease—osteomalacia/rickets
Metabolic acidosis

---

**Miscellaneous Urinary Losses.** Abnormalities in tubular handling of phosphate have also been implicated in the genesis of severe hypophosphatemia induced by systemic acidosis, hypokalemia, hypomagnesemia, hypothyroidism, and humoral hypercalcemia of malignancy. During the recovery phase from severe burns (Table 3), hypophosphatemia may occur secondary to massive diuresis with phosphaturia.

### Transcellular Shift

**Respiratory Alkalosis.** Intense hyperventilation for prolonged periods may depress serum Pi to values <1.0 mg/dL.<sup>(86)</sup> This is important in patients with alcoholic withdrawal who have attendant hyperventilation and Pi depletion. A similar degree of alkalemia induced by infusion of bicarbonate depresses Pi concentration only mildly. The combined hypophosphatemic effects of respiratory and metabolic alkalosis may be pronounced.

Severe hypophosphatemia is common in patients with extensive burns (Table 3). It usually appears within several days after the injury. Phosphorus is virtually undetectable in the urine. Hypophosphatemia may result from transductive losses, respiratory alkalosis, or other factors.

**Leukemia (Blast Crisis).** Advanced leukemia that is markedly proliferative (blast crisis) with total leukocyte counts >100,000 has been associated with severe hypophosphatemia. This would seem to result from excessive phosphorus uptake into rapidly multiplying cells.<sup>(87)</sup>

### Clinical Consequences of Severe Hypophosphatemia

Severe hypophosphatemia with phosphorus deficiency may cause widespread disturbances. There are at least eight well-established effects of severe hypophosphatemia (Table 4). The signs and symptoms of severe hypophosphatemia may be related to a decrease in 2,3-diphosphoglycerate in the red cell. This change is associated with increased affinity of hemoglobin for oxygen and therefore tissue hypoxia. There is also a decrease in tissue content of ATP and, consequently, a decrease in the availability of energy-rich phosphate compounds for cell function.

### Central Nervous System

Some patients with severe hypophosphatemia display symptoms compatible with metabolic encephalopathy.<sup>(88–90)</sup> They may display, in sequence, irritability, apprehension, weakness, numbness, paresthesias, dysarthria, confusion, obtundation, seizures, and coma. In contrast to delirium tremens, the syndrome does not include hallucinations. Patients with very severe hypophosphatemia may show diffuse slowing of their electroencephalogram.

### Hematopoietic System

A decrease in the red cell content of 2,3-diphosphoglycerate and ATP leads to increased rigidity and, in rare instances, hemolysis.<sup>(91)</sup> Hemolysis is usually provoked by unusual stress on the metabolic requirements of the red cell, such as severe metabolic acidosis or infection. When hemolysis has occurred, ATP content has invariably been reduced. Leukocyte/macrophage dysfunction can be shown in vitro using Pi-depleted cells.<sup>(92)</sup> The suggestion that a predisposition to infection commonly seen in patients on intravenous hyperalimentation may be partly related to hypophosphatemia remains to be proven. Hypophosphatemia impairs granulocyte function by interfering with ATP synthesis. In experimental hypophosphatemia there is an increase in platelet diameter, suggesting shortened platelet survival and also a marked acceleration of platelet disappearance from the blood. These lead to thrombocytopenia and a reactive megakaryocytosis. In addition, there is an impairment of clot retraction and a hemorrhagic tendency, especially involving gut and skin.

### Musculoskeletal System

**Myopathy and Rhabdomyolysis.** Muscle tissue requires large amounts of high-energy bonds (ATP, creatine phosphate) and oxygen for contraction for maintenance of membrane potential and for other functions. Pi deprivation induces muscle cell injury characterized by a decrease in intracellular Pi and an increase in water, sodium, and chloride. An apparent relationship between hypophosphatemia and alcoholic myopathy has been observed in chronic alcoholism.<sup>(93)</sup> The muscular clinical manifestations of Pi deficiency syndrome include myalgia, objective weakness, and myopathy with pathological findings of intracellular edema and a subnormal resting muscle membrane potential on electromyography. In patients with pre-existing Pi deficiency who develop acute hypophosphatemia, rhabdomyolysis might occur.<sup>(94)</sup> Hypophosphatemia and phosphate deficiency may be associated with creatine phosphokinase elevations in blood.

**Bone.** Skeletal defects have been reported in association with Pi depletion of different causes. These are discussed in detail elsewhere. Suffice it to say here that phosphate depletion is associated with rickets in children and osteomalacia in adults. However, the discovery of the phosphatonins, especially FGF23, shows that osteomalacia is more than just hypophosphatemia decreasing mineralization, but rather impaired osteoblast function caused by the actions of FGF23 or the inhibition of Wnt signaling by sFrp4 that contribute directly to impaired mineralization.

### Cardiovascular System

Severe hypophosphatemia has been associated with a cardiomyopathy characterized by a low cardiac output, a decreased ventricular ejection velocity, and an elevated left ventricular end diastolic pressure.<sup>(95)</sup> A decrease in myocardial content of inorganic phosphorus, ATP, and creatinine phosphate seems to underlie the impairment in myocardial contractility.<sup>(96)</sup> During phosphorus depletion, blood pressure may be low, and the pressor response to naturally occurring vasoconstrictor agonists such as norepinephrine or angiotensin II is reduced.

### Renal Effects of Hypophosphatemia and Phosphate Depletion

Severe hypophosphatemia and phosphate depletion affect the balance and serum concentrations of various electrolytes.<sup>(1)</sup>



TABLE 5. RENAL EFFECTS OF HYPOPHOSPHATEMIA

Decreased glomerular filtration rate
Metabolic abnormalities
Decreased gluconeogenesis
Insulin resistance
Hypoparathyroidism, reduced urinary cAMP
Increased production of 1,25 dihydroxyvitamin D <sub>3</sub>
Transport abnormalities
Hypercalciuria
Decreased proximal tubular sodium transport
Hypermagnesuria
Hypophosphaturia
Bicarbonaturia
Glycosuria

It may produce changes in cardiovascular function as described above; renal hemodynamics affect renal tubular transport processes and induce marked changes in renal cell metabolism. These disturbances are listed in Table 5.

### Tubular Transport

**Calcium.** A marked increase in urinary calcium excretion occurs during phosphate depletion proportional to the severity of phosphate depletion and the degree of hypophosphatemia.<sup>(97)</sup>

**Phosphate.** Dietary Pi restriction and Pi depletion is associated with enhanced renal tubular reabsorption of Pi.<sup>(89,98)</sup> Urinary excretion of Pi declines within hours after the reduction in its dietary intake, and Pi virtually disappears from the urine within 12 days. The changes in renal tubular reabsorption of Pi occur before detectable falls in the serum Pi. The adaptation to a reduction in Pi supply is a direct response of the proximal tubule, rendering this nephron segment resistant to most phosphaturic stimuli, including PTH.<sup>(98)</sup> Acutely, Pi depletion causes an increase in the apical membrane expression of sodium-phosphate co-transporters likely by insertion of pre-existing transporter proteins from an endosomal pool.<sup>(1)</sup> Chronically, the increase in transporter expression is also accomplished by the synthesis of new transporter proteins. The adaptation to reduced Pi supply is independent of cellular responses to PTH. The signaling mechanisms responsible for adaptation are unknown.

**Metabolic Acidosis.** Severe hypophosphatemia with Pi deficiency may result in metabolic acidosis through three mechanisms.<sup>(99,100)</sup> First, severe hypophosphatemia is generally associated with a proportionate reduction of Pi excretion in the urine, thereby limiting hydrogen excretion as a titratable acid. Second, if Pi buffer is inadequate, acid secretion depends on production of ammonia and its conversion to ammonium ion. Ammonia production is severely depressed in Pi deficiency. The third mechanism is that of decreased renal tubular reabsorption of bicarbonate.

### Treatment

The appropriate management of hypophosphatemia and Pi depletion requires identification of the underlying causes, treatment with supplemental Pi when necessary, and prevention of recurrence of the problem by correcting the underlying causes. The symptoms and signs of Pi depletion can vary, are nonspecific, and are usually seen in patients with multiple problems such as those encountered in intensive care unit settings. This makes it difficult to identify Pi depletion as the cause of clinical manifestations and Pi depletion is frequently overlooked.

Mild hypophosphatemia secondary to redistribution, with plasma Pi levels >2 mg/dl, is transient and requires no treatment. In cases of moderate hypophosphatemia, associated with Pi depletion (serum Pi >1.0 mg/dl in adults or 2.0 mg/dl in children), Pi supplementation should be administered in addition to treating the cause of hypophosphatemia. Milk is an excellent source of phosphorus, containing 1 g (33 mM) of inorganic phosphorus per liter. Skimmed milk may be better tolerated than whole milk, especially in children and malnourished patients because of concomitant lactose or fat intolerance. Alternatively, Neutraphos tablets (which contain 250 mg of Pi per tablet as a sodium or potassium salt) may be given. Oral Pi can be given in a dose up to 3 g/day (i.e., 3 tablets of Neutraphos every 6 h). The serum Pi level rises by as much as 1.5 mg/dl, 60–120 minutes after ingestion of 1000 mg of Pi. A phosphosoda enema solution, composed of buffered sodium phosphate, may also be used in a dose of 15–30 ml three or four times daily.

Severe hypophosphatemia with serum levels <0.5 mg/dl occurs only when there is cumulative net loss of >3.3 g of Pi. If asymptomatic, oral replacement with a total of 6–10 g of Pi (1–3 g Pi/day) over a few days is usually sufficient. Symptomatic hypophosphatemia indicates that net Pi deficit exceeds 10 g. In these cases, 20 g of Pi is given spread over 1 week (up to 3 g/day). Patients with Pi deficiency tolerate substantially larger doses of oral Pi without side effects, such as diarrhea, than do normal subjects. However, patients with severe symptomatic hypophosphatemia who are unable to eat may be safely treated intravenously with 1 g of Pi delivered in 1 liter of fluid over 8–12 h. This is usually sufficient to raise serum Pi level to 1.0 mg/dl. It is unusual for hypophosphatemia to cause metabolic disturbances at serum Pi >1.0 mg/dl, so that full parenteral replacement is neither necessary nor desirable.

Treatment with phosphate can result in diarrhea, hyperphosphatemia, hypocalcemia, and hyperkalemia. These side effects can be prevented by paying careful attention to phosphorus dosages.

### Prevention

The most effective approach to hypophosphatemia is prevention of predisposing conditions. Patients on total parenteral nutrition should receive a daily maintenance dose of Pi amounting to 1000 mg in 24 h, with increases as required by the clinical and metabolic states. Alcoholic patients and malnourished patients receiving intravenous fluids, particularly those containing glucose, should receive Pi supplementation, particularly if hypophosphatemia is observed.

### ACKNOWLEDGMENTS

This work was supported by National Institutes of Health Grants DK59602, AR41677, and DK09976 and a grant from Johnson and Johnson.

### REFERENCES

1. Hruska KA, Levi M, Slatopolsky E 2006 Disorders of phosphorus, calcium, and magnesium metabolism. In: Schrier RW (ed.) *Diseases of the Kidney and Urinary Tract*, 8th ed. Lippincott Williams & Wilkins, Philadelphia, USA (in press).
2. Slatopolsky E, Robson AM, Elkan I, Bricker NS 1968 Control of phosphate excretion in uremic man. *J Clin Invest* **47**:1865–1874.
3. Weinstein LS, Liu J, Sakamoto A, Xie T, Chen M 2004 Mini-review: GNAS: Normal and abnormal functions. *Endocrinology* **145**:5459–5464.
4. Bastepe M, Frohlich LF, Linglart A, Abu-Zahra HS, Tojo K, Ward LM, Juppner H 2005 Deletion of the NESP55 differentially methylated region

- causes loss of maternal *GNAS* imprints and pseudohypoparathyroidism type Ib. *Nat Genet* **37**:25–27.
5. Mitnick PD, Goldbarb S, Slatopolsky E, Lemann JJ, Gray RW, Agus ZS 1980 Calcium and phosphate metabolism in tumoral calcinosis. *Ann Intern Med* **92**:482–487.
  6. Ichikawa S, Lyles KW, Econs MJ 2005 A novel *GALNT3* mutation in a pseudoautosomal dominant form of tumoral calcinosis: Evidence that the disorder is autosomal recessive. *J Clin Endocrinol Metab* **90**:2420–2423.
  7. Benet-Pages A, Orlik P, Strom TM, Lorenz-Depiereux B 2005 An *FGF23* missense mutation causes familial tumoral calcinosis with hyperphosphatemia. *Hum Mol Genet* **14**:385–390.
  8. Larsson T, Yu X, Davis SI, Draman MS, Mooney SD, Cullen MJ, White KE 2005 A novel recessive mutation in fibroblast growth factor-23 causes familial tumoral calcinosis. *J Clin Endocrinol Metab* **90**:2424–2427.
  9. Parfitt AJ 1972 The spectrum of hypoparathyroidism. *J Clin Endocrinol Metab* **34**:152.
  10. Walton RJ, Russell RG, Smith R 1975 Changes in the renal and extra-renal handling of phosphate induced by disodium etidronate (EHDP) in man. *Clin Sci Mol Med* **49**:45–56.
  11. Davies MR, Lund RJ, Mathew S, Hruska KA 2005 Low turnover osteodystrophy and vascular calcification are amenable to skeletal anabolism in an animal model of chronic kidney disease and the metabolic syndrome. *J Am Soc Nephrol* **16**:917–928.
  12. Lund RJ, Davies MR, Brown AJ, Hruska KA 2004 Successful treatment of an adynamic bone disorder with bone morphogenetic protein-7 in a renal ablation model. *J Am Soc Nephrol* **15**:359–369.
  13. Cohen LF, Balow JE, Magrath IT, Poplack DG, Ziegler JL 1980 Acute tumor lysis syndrome. A review of 37 patients with Burkitt's lymphoma. *Am J Med* **68**:486–491.
  14. Hruska KA, Mathew S, Saab G 2005 Bone morphogenetic proteins in vascular calcification. *Circ Res* **97**:105–114.
  15. Doherty TM, Asotra K, Fitzpatrick LA, Qiao J, Wilkin DJ, Detrano RC, Dunstan CR, Shah PK, Rajavavishth TB 2004 Calcification in atherosclerosis: Bone biology and chronic inflammation at the arterial crossroads. *Proc Natl Acad Sci USA* **100**:11201–11206.
  16. Vattikuti R, Towler DA 2004 Osteogenic regulation of vascular calcification: An early perspective. *Am J Physiol Endocrinol Metab* **286**:E686–E696.
  17. Bucay N, Sarosi I, Dunstan CR, Morony S, Tarpley J, Capparelli C, Scully S, Tan HL, Xu W, Lacey DL, Boyle WJ, Simonet WS 1998 Osteoprotegerin-deficient mice develop early onset osteoporosis and arterial calcification. *Genes Dev* **12**:1260–1268.
  18. Jono S, Peinado C, Giachelli CM 2000 Phosphorylation of osteopontin is required for inhibition of vascular smooth muscle cell calcification. *J Biol Chem* **275**:20197–20203.
  19. Demer LL, Tintut Y 1999 Osteopontin: Between a rock and a hard plaque. *Circ Res* **84**:250–252.
  20. Luo G, Ducey P, McKee MD, Pinero GJ, Loyer E, Behringer RR, Karsenty G 1997 Spontaneous calcification of arteries and cartilage in mice lacking matrix GLA protein. *Nature* **386**:78–81.
  21. Kawaguchi H, Manabe N, Miyaura C, Chikuda H, Nakamura K, Kuro-o M 1999 Independent impairment of osteoblast and osteoclast differentiation in *kltho* mouse exhibiting low-turnover osteopenia. *J Clin Invest* **104**:229–237.
  22. Galvin KM, Donovan MJ, Lynch CA, Meyer RI, Paul RJ, Lorenz JN, Fairchild-Huntress V, Dixon KL, Dunmore JH, Gimbrone MA Jr, Falb D, Huszar D 2000 A role for *Smad6* in development and homeostasis of the cardiovascular system. *Nat Genet* **24**:171–174.
  23. Block GA, Port FK 2000 Re-evaluation of risks associated with hyperphosphatemia and hyperparathyroidism in dialysis patients: Recommendations for a change in management. *Am J Kidney Dis* **35**:1226–1237.
  24. Morishita K, Shirai A, Kubota M, Katakura Y, Nabeshima Y, Takeshige K, Kamiya T 2001 The progression of aging in *kltho* mutant mice can be modified by dietary phosphorus and zinc. *J Nutr* **131**:3182–3188.
  25. Jono S, McKee MD, Murray CE, Shioi A, Nishizawa Y, Mori K, Morii H, Giachelli CM 2000 Phosphate regulation of vascular smooth muscle cell calcification. *Circ Res* **87**:e10–e17, 2000.
  26. Blacher J, Guerin AP, Pannier B, Marchais SJ, London GM 2001 Arterial calcifications, arterial stiffness, and cardiovascular risk in end-stage renal disease. *Hypertension* **38**:938–942.
  27. Iribarren C, Sidney S, Sternfeld B, Browner WS 2000 Calcification of the aortic arch: Risk factors and association with coronary heart disease, stroke, and peripheral vascular disease. *JAMA* **283**:2810–2815.
  28. Newman AB, Naydeck BL, Sutton-Tyrrell K, Edmondowicz D, O'Leary D, Kronmal R, Burke GL, Kuller LH 2002 Relationship between coronary artery calcification and other measures of subclinical cardiovascular disease in older adults. *Arterioscler Thromb Vasc Biol* **22**:1674–1679.
  29. Ahmed S, O'Neill KD, Hood AF, Evan AP, Moe SM 2001 Calciphylaxis is associated with hyperphosphatemia and increased osteopontin expression by vascular smooth muscle cells. *Am J Kid Dis* **37**:1267–1276.
  30. Wilmer WA, Magro CM 2002 Calciphylaxis: Emerging concepts in prevention, diagnosis, and treatment. *Semin Dial* **15**:172–186.
  31. Slatopolsky E, Finch J, Denda M, Ritter C, Zhong M, Dusso A, MacDonald PNB 1996 Phosphorus restriction prevents parathyroid gland growth. High phosphorus directly stimulates PTH secretion in vitro. *J Clin Invest* **97**:2534–2540.
  32. Fatica RA, Dennis VW 2002 Cardiovascular mortality in chronic renal failure: Hyperphosphatemia, coronary calcification, and the role of phosphate binders. *Cleve Clin J Med* **69**:S21–S27.
  33. Cozzolino M, Lu Y, Sato T, Yang J, Suarez IG, Brancaccio D, Slatopolsky E, Dusso ASA 2005 Critical role for enhanced-TGF- $\alpha$  and EGFR expression in the initiation of parathyroid hyperplasia in experimental kidney disease. *Am J Physiol Renal Physiol* **20**:F1096–F1102.
  34. Martin DR, Ritter CS, Slatopolsky E, Brown AJ 2005 Acute regulation of parathyroid hormone by dietary phosphate. *Endocrinol Metab* **289**:E729–E734.
  35. Hak AE, Pols HAP, van Hemert AM, Hofman A, Witteman JCM 2000 Progression of aortic calcification is associated with metacarpal bone loss during menopause. A population-based longitudinal study. *Arterio Thromb Vasc Biol* **20**:1926–1931.
  36. Price PA, June HH, Buckley JR, Williamson MK 2001 Osteoprotegerin inhibits artery calcification induced by warfarin and by vitamin D. *Arterioscler Thromb Vasc Biol* **21**:1610–1616.
  37. Slatopolsky E, Weerts C, Lopez S 1986 Calcium carbonate is an effective phosphate binder in dialysis patients. *N Engl J Med* **315**:157.
  38. Slatopolsky E, Burke SK, Dillon MA 1999 RenaGel, a nonabsorbed calcium and aluminum-free phosphate-binder, lowers serum phosphorus and parathyroid hormone. *Kidney Int* **55**:299–307.
  39. Chertow GM, Burke SK, Raggi P 2002 Sevelamer attenuates the progression of coronary and aortic calcification in hemodialysis patients. *Kidney Int* **62**:245–252.
  40. Chertow GM, Burke SK, Dillon MA, Slatopolsky E 1999 Long-term effects of sevelamer hydrochloride on the calcium x phosphate product and lipid profile of haemodialysis patients. *Nephrol Dialysis Transplant* **14**:2907–2914.
  41. Frame B, Parfitt AM 1978 Osteomalacia current concepts. *Ann Intern Med* **89**:966–982.
  42. Fu GK, Lin D, Zhang MY, Bikle DD, Shackleton CH, Miller WL, Portale AA 1997 Cloning of human 25-hydroxyvitamin D-1  $\alpha$ -hydroxylase and mutations causing vitamin D-dependent rickets type 1. *Molec Endocrinol* **11**:1961–1970.
  43. Hochberg Z, Weisman Y 1995 Calcitriol-resistant rickets due to vitamin D receptor defects. *Trends Endocrinol Metab* **6**:216–220.
  44. Li YC, Amling M, Pirro AE, Priemel M, Meuse J, Baron R, Delling G, Demay MB 1998 Normalization of mineral ion homeostasis by dietary means prevents hyperparathyroidism, rickets, and osteomalacia, but not alopecia in vitamin D receptor-ablated mice. *Endocrinology* **139**:4391–4396.
  45. Shields HM 1978 Rapid fall of serum phosphorus secondary to antacid therapy. *Gastroenterology* **75**:1137–1141.
  46. Larsson L, Rebel K, Sorbo B 1983 Severe hypophosphatemia—a hospital survey. *Acta Med Scand* **214**:221–223.
  47. Ryback RS, Eckardt MJ, Pautler CP 1980 Clinical relationships between serum phosphorus and other blood chemistry values in alcoholics. *Arch Intern Med* **140**:673–677.
  48. Juan D, Elrazak MA 1979 Hypophosphatemia in hospitalized patients. *JAMA* **242**:163–164.
  49. Betro MG, Pain RW 1972 Hypophosphatemia and hyperphosphatemia in a hospital population. *BMJ* **1**:273–276.
  50. Roth KS, Foreman JW, Segal S 1981 The Faconi syndrome and mechanisms of tubular dysfunction. *Kidney Int* **20**:705–716.
  51. Lloyd SE, Pearce SHS, Fisher SE, Steinmeyer K, Schwappach B, Scheinman SJ, Harding B, Bolino A, Devoto M, Goodyer P, Rigden SPA, Wrong O, Jentsch TJ, Craig IW, Thakker RV 1996 A common molecular basis for three inherited kidney stone diseases. *Nature* **379**:445–449.
  52. Scheinman SJ 1998 X-linked hypercalciuric nephrolithiasis: Clinical syndromes and chloride channel mutations. *Kidney Int* **53**:3–17.
  53. Jentsch TJ, Poet M, Fuhrmann JC, Zdebek AA 2005 Physiological functions of CLC Cl<sup>-</sup> channels gleaned from human genetic disease and mouse models. *Annu Rev Physiol* **67**:779–807.
  54. Rosenbaum RW, Hruska KA, Korkor A, Anderson C, Slatopolsky E 1981 Decreased phosphate reabsorption after renal transplantation: Evi-

- dence for a mechanism independent of calcium and parathyroid hormone. *Kidney Int* **19**:568–578.
55. Green J, Debby H, Lederer E, Levi M, Zajicek HK, Bick T 2001 Evidence for a PTH-independent humoral mechanism in post-transplant hypophosphatemia and phosphaturia. *Kidney Int* **60**:1182–1196.
  56. Rojas E, Carlini RG, Clesca P, Arminio A, Zuniaga O, de Elguezabal K, Weisinger JR, Hruska KA, Bellorin-Font E 2003 The pathogenesis of post-transplant osteodystrophy as detected by early alterations in bone remodeling. *Kidney Int* **63**:1915–1923.
  57. Econs MJ, Francis F 1997 Positional cloning of the PEX gene: New insights into the pathophysiology of X-linked hypophosphatemic rickets. *Am J Physiol* **273**:F489–F498.
  58. Tenenhouse HS 2005 Regulation of phosphorus homeostasis by the type IIa Na/phosphate cotransporter. *Annu Rev Nutr* **25**:10.1–10.18.
  59. The Hyp Consortium 1995 A gene (PEX) with homologies to endopeptidases is mutated in patients with X-linked hypophosphatemic rickets. *Nat Genet* **11**:130–136.
  60. Econs MJ, Drezner MK 1994 Tumor-induced osteomalacia: Unveiling a new hormone. *N Engl J Med* **330**:1645–1649.
  61. Schiavi SC, Kumar R 2004 The phosphatonin pathway: New insights in phosphate homeostasis. *Kidney Int* **65**:1–14.
  62. Quarles LD 2003 FGF23, PHEX, and MEPE regulation of phosphate homeostasis and skeletal mineralization. *Am J Physiol Endocrinol Metab* **285**:1–9.
  63. The ADHR consortium, Group 1: White KE, Evans WE, O’Riordan JLH, Speer MC, Econs JJ, Groups 2: Lorenz-Depiereux B, Grabowski M, Meitinger T, Strom TM 2000 Autosomal dominant hypophosphatemic rickets is associated with mutations in FGF23. *Nat Genet* **26**:345–348.
  64. Yamazaki Y, Okazaki R, Shibata M, Hasegawa Y, Satoh K, Tajima T, Takeuchi Y, Fujita T, Nakahara K, Yamashita T, Fukumoto S 2002 Increased circulatory level of biologically active full-length FGF-23 in patients with hypophosphatemic rickets/osteomalacia. *J Clin Endocrinol Metab* **87**:4957–4960.
  65. Liu S, Guo R, Simpson LG, Xiao ZS, Burnham CE, Quarles LD 2003 Regulation of fibroblastic growth factor 23 expression but not degradation by PHEX131. *J Biol Chem* **278**:37419–37426.
  66. Shimada T, Urakawa I, Yamazaki Y, Hasegawa H, Hino R, Yoneya T, Takeuchi Y, Fujita T, Fukumoto S, Yamashita T 2004 FGF-23 transgenic mice demonstrate hypophosphatemic rickets with reduced expression of sodium phosphate cotransporter type IIa. *Biochem Biophys Res Com* **314**:409–414.
  67. Cai Q, Hodgson SF, Kao PC, Lennon VA, Klee GG, Zinsmeister AR, Kumar R 1994 Brief report: Inhibition of renal phosphate transport by a tumor product in a patient with oncogenic osteomalacia. *N Engl J Med* **330**:1645–1649.
  68. Shimada T, Mizutani S, Muto T, Yoneya T, Hino R, Takeda S, Takeuchi Y, Fujita T, Fukumoto S, Yamashita T 2001 Cloning and characterization of FGF23 as a causative factor of tumor-induced osteomalacia. *Proc Natl Acad Sci USA* **98**:6500–6505.
  69. Kumar R 2002 New insights into phosphate homeostasis: Fibroblast growth factor 23 and frizzled-related protein-4 are phosphaturic factors derived from tumors associated with osteomalacia. *Curr Opin Nephrol Hypertens* **11**:547–553.
  70. Rowe PS, de Zoysa PA, Dong R, Wang HR, White KE, Econs MJ, Oudet CL 2000 MEPE, a new gene expressed in bone marrow and tumors causing osteomalacia. *Genomics* **67**:54–68.
  71. Berndt T, Craig TA, Bowe AE, Vassiliadis J, Reczek D, Finnegan R, Jan de Beur SM, Schiavi SC, Kumar R 2003 Secreted frizzled-related protein 4 is a potent tumor-derived phosphaturic agent. *J Clin Invest* **112**:785–94.
  72. Hey PJ, Twells RCJ, Phillips MS, Nakagawa Y, Brown SD, Kawaguchi Y, Cox R, Xie G, Dugan V, Hammond H, Metzker ML, Todd JA, Hess JF 1998 Cloning of a novel member of the low-density lipoprotein receptor family. *Gene* **216**:103–111.
  73. Schneider WJ, Nimpf J 2003 LDL receptor relatives at the crossroad of endocytosis and signaling. *Cell Mol Life Sci* **60**:903.
  74. Leheste JR, Melsen F, Wellner M, Jansen P, Schlichting U, Renner-Müller I, Andreassen TT, Wolf E, Bachmann S, Nykjaer A, Willnow TE 2002 Hypocalcemia and osteopathy in mice with kidney-specific megalin gene defect. *FASEB J* **17**:247–249.
  75. He X, Semenov M, Tamai K, Zeng X 2004 LDL receptor-related proteins 5 and 6 in Wnt/ $\beta$ -catenin signaling: Arrows point the way. *Development* **131**:1663–1667.
  76. Little RD, Carulli JP, DeMastro RG, Dupuis J, Osborne M, Folz C, Manning SP, Swain PM, Zhao S-C, Eustace B, Lappe MM, Spitzer L, Zweier S, Braunschweiger K, Benchekroun Y, Hu X, Adair R, Chee L, Fitzgerald MG, Tulig C, Caruso A, Tzellans N, Bawa A, Franklin B, McGuire S, Noguez X, Gong G, Allen KM, Anisowicz A, Morales AJ, Lomedico PT, Recker SM, Van Eerdewegh P, Recker RR, Johnson ML 2002 A mutation in the LDL receptor-related protein 5 gene results in the autosomal dominant high-bone-mass trait. *Am J Hum Genet* **70**:11–19.
  77. Surendran K, Schiavi S, Hruska KA 2005 Wnt-dependent- $\beta$ -catenin signaling is activated after unilateral ureteral obstruction, and recombinant secreted frizzled-related protein 4 alters the progression of renal fibrosis. *J Am Soc Neph* **16**:2373–2384.
  78. Argiro L, Desbarats M, Glorieux FH, Ecarot B 2001 Mepe, the gene encoding a tumor-secreted protein in oncogenic hypophosphatemic osteomalacia, is expressed in bone. *Genomics* **74**:342–351.
  79. Bresler D, Bruder J, Mohnike K, Fraser WD, Rowe PS 2004 Serum MEPE-ASARM-peptides are elevated in X-linked rickets (HYP): Implications for phosphaturia and rickets. *J Endocrinol* **183**:1–9.
  80. Rowe PS, Kumagai Y, Gutierrez G, Garrett IR, Blacher R, Rosen D, Cundy J, Navvab S, Chen D, Drezner MK, Quarles LD, Mundy GR 2004 MEPE has the properties of an osteoblastic phosphatonin and minihibin. *Bone* **34**:303–19.
  81. Rowe PS, Garrett IR, Schwarz PM, Carnes DL, Lafer EM, Mundy GR, Gutierrez GE 2005 Surface plasmon resonance (SPR) confirms that MEPE binds to PHEX via the MEPE-ASARM motif: A model for impaired mineralization in X-linked rickets (HYP). *Bone* **36**:33–46.
  82. Gowen LC, Petersen DN, Mansolf AL, Qi H, Stock JL, Tkalecic GT, Simmons HA, Crawford DT, Chidsey-Frink KL, Ke HZ, McNeish JD, Brown TA 2003 Targeted disruption of the osteoblast/osteocyte factor 45 gene (OF45) results in increased bone formation and bone mass. *J Biol Chem* **278**:1998–2007.
  83. Weinstein LS, Shenker A, Gejman PV, Merino MJ, Friedman E, Spiegel AM 1991 Activating mutations of the stimulatory G protein in the McCune-Albright syndrome. *N Engl J Med* **325**:1688–1695.
  84. Collins MT, Chebli C, Jones J, Kushner H, Consugar M, Rinaldo P, Wientroub S, Bianco P, Robey PG 2001 Renal phosphate wasting in fibrous dysplasia of bone is part of a generalized renal tubular dysfunction similar to that seen in tumor-induced osteomalacia. *J Bone Miner Res* **16**:806–813.
  85. Corsi A, Collins MT, Riminucci M, Howell PG, Boyde A, Robey PG, Bianco P 2003 Osteomalacic and hyperparathyroid changes in fibrous dysplasia of bone: Core biopsy studies and clinical correlations. *J Bone Miner Res* **18**:1235–1246.
  86. Mostellar ME, Tuttle EPJ 1964 Effects of alkalosis on plasma concentration and urinary excretion of urinary phosphate in man. *J Clin Invest* **43**:138–149.
  87. Zamkoff KW, Kirshner JJ 1980 Marked hypophosphatemia associated with acute myelomonocytic leukemia: Indirect evidence of phosphorus uptake by leukemic cells. *Arch Intern Med* **140**:1523–1524.
  88. Lotz M, Ney R, Bartter FC 1964 Osteomalacia and debility resulting from phosphorus depletion. *Trans Assoc Am Physicians* **77**:281–295.
  89. Lotz M, Zisman E, Bartter FC 1968 Evidence for a phosphorus-depletion syndrome in man. *N Engl J Med* **278**:409–415.
  90. Prins JG, Schrijver H, Staghouwer JM 1973 Hyperalimantation, hypophosphatemia and coma. *Lancet* **1**:1253–1254.
  91. Jacob HS, Amsden T 1971 Acute hemolytic anemia and rigid red cells in hypophosphatemia. *N Engl J Med* **285**:1446–1450.
  92. Craddock PR, Yawata Y, Van Santen L, Gilbertstadt S, Silvis S, Jacob HS 1974 Acquired phagocyte dysfunction: A complication of the hypophosphatemia of parental hyperalimantation. *N Engl J Med* **290**:1403–1407.
  93. Knochel JP, Billbrely GL, Fuller TJ 1975 The muscle cell in chronic alcoholism: The possible role of phosphate depletion in alcoholic myopathy. *Ann NY Acad Sci* **252**:274–286.
  94. Knochel JP, Barcenas C, Cotton JR, Fuller TJ, Haller R, Carter NW 1978 Hypophosphatemia and rhabdomyolysis. *J Clin Invest* **62**:1240–1246.
  95. Zazzo J-F, Troche G, Ruel P, Maintenant J 1995 High incidence of hypophosphatemia in surgical intensive care patients: Efficacy of phosphorus therapy on myocardial function. *Intensive Care Med* **21**:826–831.
  96. Fuller TJ, Nichols WW, Brenner BJ, Peterson JC 1978 Reversible depression in myocardial performance in dogs with experimental phosphorus deficiency. *J Clin Invest* **62**:1194–1190.
  97. Coburn JW, Massry SG 1970 Changes in serum and urinary calcium during phosphate depletion: Studies on mechanisms. *J Clin Invest* **49**:1073–1087.
  98. Steele TH, Stromberg BA, Larmore CA 1976 Renal resistance to parathyroid hormone during phosphorus deprivation. *J Clin Invest* **58**:1461–1464.
  99. Dominguez JH, Gray RW, Lemann JJ 1976 Dietary phosphate deprivation in women and men: Effects on mineral and acid balances, parathyroid hormone and the metabolism of 25-OH-vitamin D. *J Clin Endocrinol Metab* **43**:1056–1068.
  100. O’Donovan DJ, Lotspeich WD 1966 Activation of kidney mitochondrial glutaminase by inorganic phosphate and organic acids. *Nature* **212**:930–932.