



1-22

11

Diagnostik
Diagnostic
Diagnostic
Diagnostico



103-133

18

Neuro chirurgie
Neuro Surgery
Neuro chirurgie
Neuro cirugia

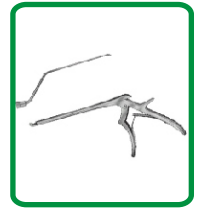

23-42

12

Pinzetten
Forceps
Pincas
Pinzas



134-138

19

Nagel instrumente
Nail Instruments
Instruments pour ongles
Instrumentos para unas

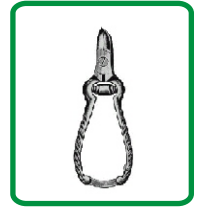

43-44

13

Splitterzangen
Splinter Forceps
Pincas a echardas
Pinzas para espinas



139-157

20

Scheren,
Scissors
Ciseaux
Tijeras



45-69

14

Verschiedene Klemmen
Miscellaneous Forceps
Pincas diverses
Pinzas diversas



158-163

21

Bandage and Plaster
Instruments
Instrumentos para
vendajes y yeso



70-74

15

Dermatologie
Dermatology
Dermatologie
Dermatologia



164-180

22

Instruments with
Tungsten Carbide Insert
Instrumentos con
placas carbuto tungsteno



75-86

16

Messer, Skalpelle
Knives, Scalpels
Couteaux, Bistouris
Cuchillos, Bisturios



181-208

23

Naht
Suture
Suture
Sutura



87-102

17

Rektum Instrumente
Rectal Instruments
Instruments Rectaux
Instrumentos Rectales



209-221

24

Impfen und Punktion
Vaccination, Puncture
Vaccination et ponction
Vacunacion y puncion



222-226

25

Sonden, Watteträger
Probes, Applicators
Sondes, Porte-contons
Sondas, Porta-algodone



387-400

32

Galle, Niere, Urologie
Bile, Kidney, Urology
Bile, Rein, Urologie
Vesicula biliar, Renon,



227-277

26

Wundhaken
Retractors
Ecarteurs
Separadores



401-443

33

Gynakologie, Geburtshilfe
Gynecology, Obstetrics
Gynecologie, Accouchement
Ginecologia, Obstetricia



278-345

27

Knochen chirurgie
Bone Surgery
Chirurgie Osseuse
Cirugia osea



444-493

34

HNO-Instrumente
ENT Instruments
Instruments ORL
Instrumental ORL



346-362

28

Cardiovascular and
Thoracic Surgery
Cirugia cardiocascular
y Toracoplastica



494-521

35

Augen instrumente
Ophthalmic Instruments
Instruments ophtalmolo
Instrumental oftalmolo

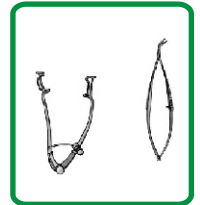

363-366

29

Tracheotomie
Tracheotomy
Tracheotomie
Traqueotomia



367-377

30

Narkose
Anaesthesia
Anesthesie
Anestesia



378-386

31

Magen und Darm
Stomach, Intestine
Estomac, Intestin
Estomago, Intestino



**Diagnostik
Diagnostic
Diagnostic
Diagnóstico**



11



11.8	Fig. 000	=	6 mmØ	11.28
11.9	Fig. 00	=	8 mmØ	11.29
11.10	Fig. 0	=	10 mmØ	11.30
11.11	Fig. 1	=	12 mmØ	11.31
11.12	Fig. 2	=	14 mmØ	11.32
11.13	Fig. 3	=	16 mmØ	11.33
11.14	Fig. 4	=	18 mmØ	11.34
11.15	Fig. 5	=	20 mmØ	11.35
11.16	Fig. 6	=	22 mmØ	11.36
11.17	Fig. 7	=	24 mmØ	11.37
11.18	Fig. 8	=	26 mmØ	11.38
11.19	Fig. 9	=	28 mmØ	11.39
11.20	Fig.10	=	30 mmØ	11.40

11.25
10,0 cm/4"
Metallgriff für Kehlkopfspiegel
Metal handle for laryngeal mirrors
Manche pour miroirs laryngiens
Mango metálico para espejos laríngeos

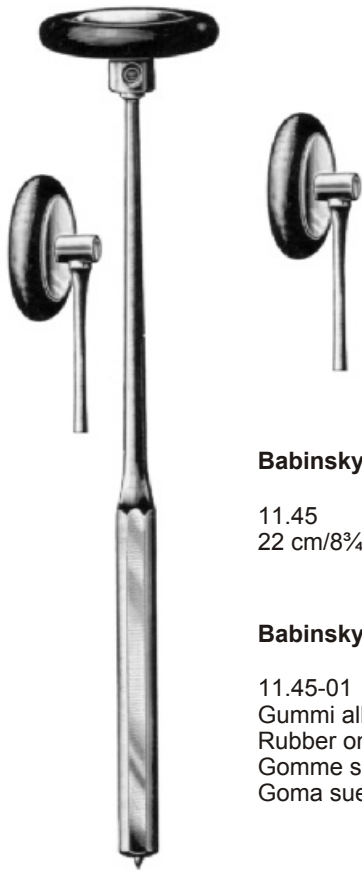

Babinsky

11.45
22 cm/8³/₄"

Babinsky

11.45-01
Gummi allein
Rubber only
Gomme seul
Goma suelta



Taylor

11.46
20 cm/8"



Berliner

11.47
20 cm/8"



Traube

11.48
17 cm/6³/₄"



Troemner

11.49
24 cm/9¹/₂"

11

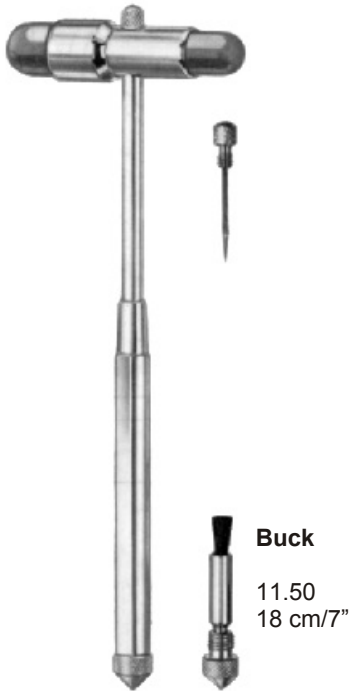

Buck
11.50
18 cm/7"

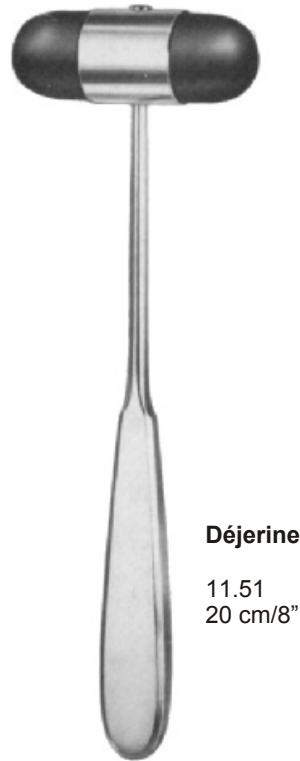

Déjerine
11.51
20 cm/8"

ohne Nadel
without needle
sans aiguille
sin aguja

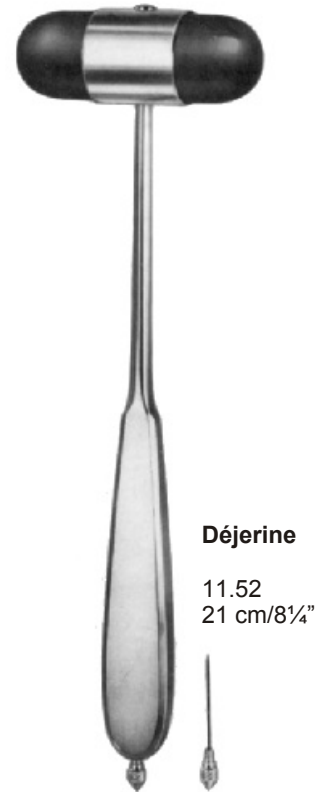

Déjerine
11.52
21 cm/8¼"

mit Nadel
with needle
avec aiguille
con aguja



Rabiner
11.53
23 cm/9"

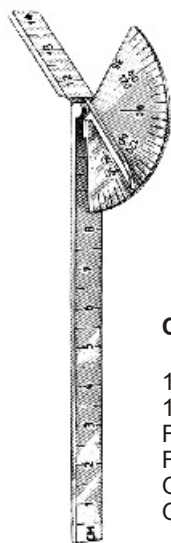

Caroll

11.56
14,0 cm/5½"
Finger-Goniometer
Finger-Goniometer
Goniomètre
Goniómetro

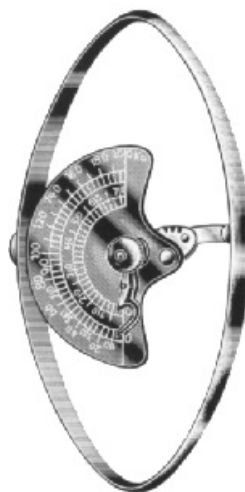

Collin

11.57
12,5 cm/5"
Dynamometer, für Kinder
Dynamometer, for children
Dynamomètre, pour enfants
Dinamómetro, para niños

11.58
12,5 cm/5"
Dynamometer, für Erwachsene
Dynamometer, for adults
Dynamomètre, pour adultes
Dinamómetro, para adultos



Moeltgen

11.59
24,0 cm/9½"
Winkelmesser für die Gliedmaßen
Goniometer (Flexometer) for extremities
Goniomètre pour les membres
Goniómetro para miembros



Wartenberg

11.60
19,0 cm/7½"
Nervrädchen
Neurological Pinwheel
Roue neurologique
Instrumento para examen neurológico

11

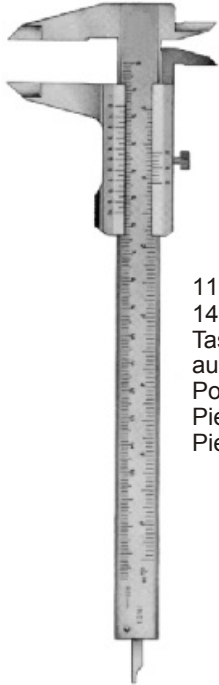

11.61
14,0 cm/5½"
Taschen-Meßschieber
aus nichtrostendem Stahl
Pocket Slide Caliper, of stainless steel
Pied à coulisse de poche, en acier inoxydable
Pie de rey de bolsillo, de acero inoxidable

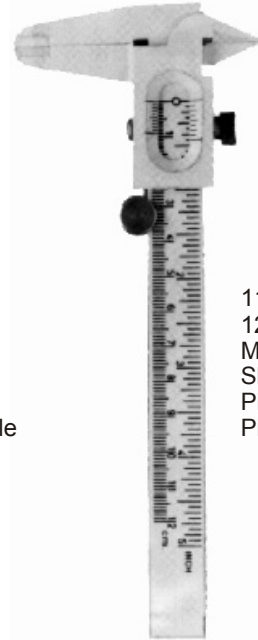

11.62
12,0 cm/5"
Meßschieber aus Kunststoff
Slide Caliper of synthetic material
Pied à coulisse, en matière synthétique
Pie de rey, en materia sintética



11.64
1,5 m
Bandmaß in Metallkapsel
aus Wachstuch/Leinen
Tape Measure in metal case
of oil cloth
Metre à ruban dans une boîte de métal
en toile cirée
Cinta métrica en cápsula metálica
de tela encerada

11.65
2,0 m
aus Stahl
of steel
en acier
de acero



Metall-aMeßstab mit Millimetereinteilung
Metal Rule graduated in millimeters and inches
Règle en métal divisé en centimètres et pouces
Regla métrica de metal graduada en milímetros y pulgadas

11.66 15,0 cm/6"
11.67 20,0 cm/8"
11.68 30,0 cm/12"
11.69 50,0 cm/20"



11.70 15,0 cm/6"

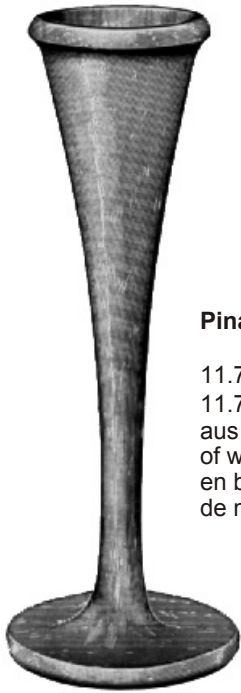

Pinard

11.71 30,0 cm/12"
 11.72 18,0 cm/7"
 aus Holz
 of wood
 en bois
 de madera



Pinard

11.73 15,0 cm/6"
 aus Aluminium
 of aluminium
 en aluminium
 de aluminio

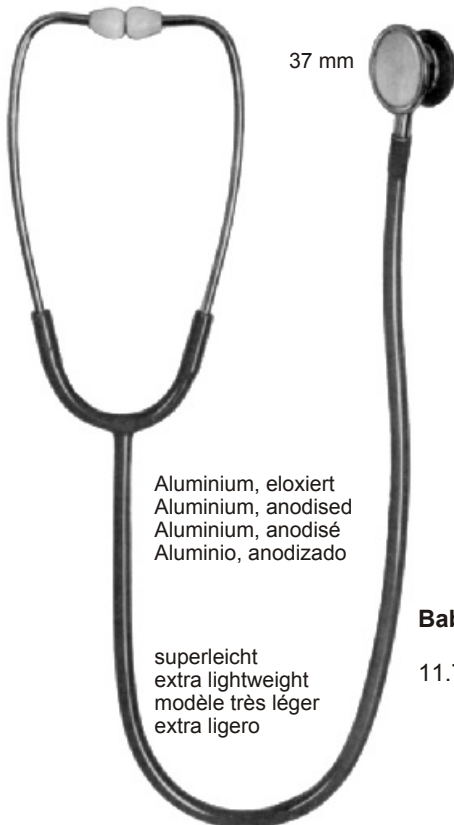

37 mm

Aluminium, eloxiert
 Aluminium, anodised
 Aluminium, anodisé
 Aluminio, anodizado

superleicht
 extra lightweight
 modèle très léger
 extra ligero

Baby-Duplex

11.75

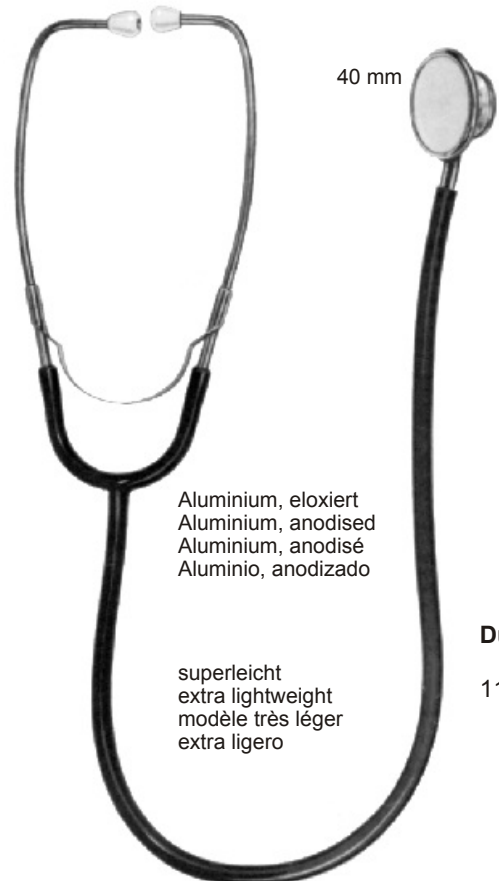

40 mm

Aluminium, eloxiert
 Aluminium, anodised
 Aluminium, anodisé
 Aluminio, anodizado

superleicht
 extra lightweight
 modèle très léger
 extra ligero

Duplex

11.76

11



47 mm

Anestophon

11.77



Rirap

11.78

Drei verschiedene austauschbare Trichteransätze
Three additional interchangeable bell-type pieces
Trois pièces supplémentaires interchangeables
Tres diferentes piezas adicionales intercambiables
en forma de embudo



aus rostfreiem Stahl
stainless steel
en acier inoxydable
de acero inoxidable

Cardiophon

11.79



Diplomat Presameter

11.80
Quecksilbergerät
Mercury apparatus
Appareil de mercure
Tensiómetro de mercurio

mit Hakenmanschette
with hook cuff
avec manchette à crochets
con brazaletes a ganchos

11.81
mit Velcromanschette
with velcro cuff
avec manchette velcro
con brazaletes velcro



Empire

11.82
Quecksilbergerät
Mercury apparatus
Appareil de mercure
Tensiómetro de mercurio

mit Hakenmanschette
with hook cuff
avec manchette à crochets
con brazaletes a ganchos

11.83
mit Velcromanschette
with velcro cuff
avec manchette velcro
con brazaletes velcro

11



Precisa

11.84
Einhandmodell
One hand model
Modèle à main
Modelo a mano

mit Velcromanschette
with velcro cuff
avec manchette velcro
con brazaletes velcro

Minimus III

11.85
Einhandmodell
One hand model
Modèle à main
Modelo a mano

mit Hakenmanschette
with hook cuff
avec manchette à crochets
con brazaletes a ganchos

11.86
mit Velcromanschette
with velcro cuff
avec manchette velcro
con brazaletes velcro





11.119
 Stirrband aus Plastik
 Head band of plastic
 Bandeau de plastique
 Cinta de plástico

11.122
 Ersatzspiegel, 100 mm Ø
 Mirror only, 100 mm Ø
 Miroir seul, 100 mm Ø
 Espejo suelto, 100 mm Ø

Clar
 Stirnlampe
 Head Lamp
 Eclaireur frontal
 Lámpara frontal

11.118
 mit Stirrband aus Plastik, 100 mm Ø
 with head band of plastic, 100 mm Ø
 avec bandeau de plastique, 100 mm de Ø
 con cinta de plástico, 100 mm de Ø

11.120
 mit Stirrband aus Celluloid, 100 mm Ø
 with head band of celluloid, 100 mm Ø
 avec bandeau de celluloid, 100 mm de Ø
 con cinta de celuloide, 100 mm de Ø

11.121
 Stirrband aus Celluloid
 Head band of celluloid
 Bandeau de celluloid
 Cinta de celuloide

11.123
 Ersatz-Birnchen, 6 V
 Spare bulb, 6 V
 Lampe de rechange, 6 V
 Bombillas de repuesto, 6 V



Clar
 Stirnlampe
 Head Lamp
 Eclaireur frontal
 Lámpara frontal

11.124
 mit Stirrband aus Celluloid
 with head band of celluloid
 avec bandeau de celluloid
 con cinta de celuloide

11.125
 Stirrband aus Celluloid
 Head band of celluloid
 Bandeau de celluloid
 Cinta de celuloide

11.126
 Ersatzspiegel, 100 mm Ø
 Mirror only, 100 mm Ø
 Miroir seul, 100 mm Ø
 Espejo suelto, 100 mm Ø

11.127
 Ersatz-Birnchen, 6 V
 Spare bulb, 6 V
 Lampe de rechange, 6 V
 Bombillas de repuesto, 6 V



Schioetz
Tonometer, Spez. 5
Tonometer, Spec. 5
Tonomètre, Spécif. 5
Tonómetro, Spec. 5



11.130
gerade Skala
straight scale
cadre droit
escala recta

11.131
schräge Skala
inclined scale
cadre courbe
escala inclinada

11.132
Eichgebühr
rate for gauging
droits pour étalonnage
precio para aforo



Schultze

11.135
20,0 cm/8"
Salpingograph, komplett
Salpingograph, complete
Salpingographe, complet
Salpingografo, completo

11



11.136
Komprimeter
Comprimeter
Appareil compressif complet
Aparato de compresión

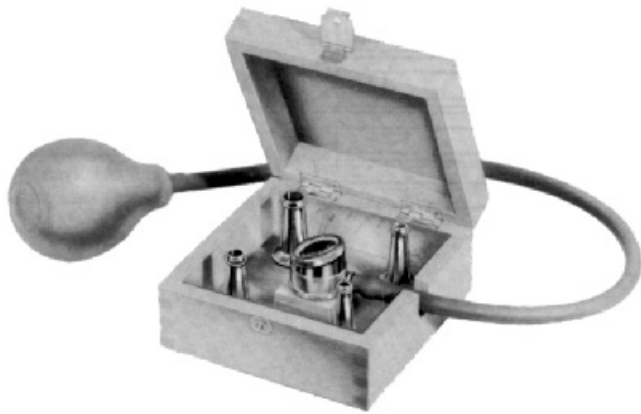

Fig. 1
 11.151
 6 mm Ø



Fig. 2
 11.152
 7,5 mm Ø



Fig. 3
 11.153
 8,2 mm Ø

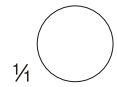

Fig. 4
 11.154
 10 mm Ø

Bruenings

11.150
 Ohrspekula, komplett
 Ear Specula, complete
 Spéculum auriculaire, complet
 Espéculo auricular, completo

11.156
 Gummiball mit Schlauch, allein
 Rubber Bulb and tube, only
 Poire soufflante et tube, seule
 Insuflador con tubo, solo

11.157
 Holzetui, allein
 Wooden Case, only
 Boîte en bois, seule
 Estuche de madera, solo

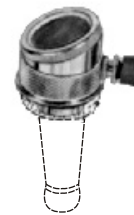

11.155
 Kopfstück, allein
 Head piece, only
 Pièce de tête, seule
 Pieza de cabeza, solo



Hartmann

Ohrspekula
 Ear Specula
 Spéculum auriculaire
 Espéculo auricular



Fig. 0
 11.160
 3,0 mm Ø



Fig. 1
 11.161
 4,0 mm Ø



Fig. 2
 11.162
 5,0 mm Ø



Fig. 3
 11.163
 6,0 mm Ø

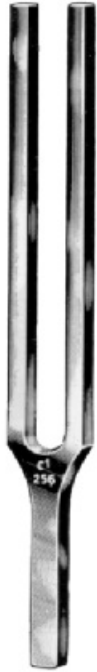

Fig. 4
 11.164
 7,5 mm Ø

11



Hartmann
c 128
11.180-00



Hartmann
c¹ 256
11.180-01



Hartmann
c² 512
11.180-02



Hartmann
c³ 1024
11.180-03



Hartmann
c⁴ 2048
11.180-04



Hartmann
c⁵ 4096
11.180-05



Hartmann
c 64
11.180-06



Hartmann
c 128
11.180-07



Hartmann
c¹ 256
11.180-08

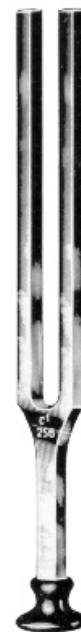

Hartmann
mit Fuß, with foot
avec pied, con pie
c¹ 256
11.180-09

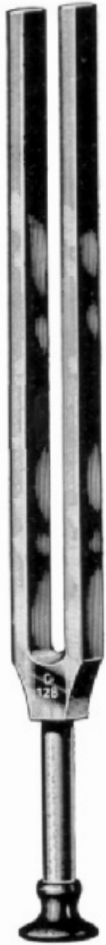

Lucae
c 128
11.181-00

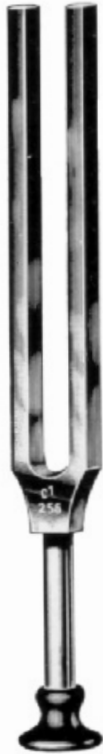

Lucae
c¹ 256
11.181-01



Lucae
c² 512
11.181-02



Lucae
c³ 1024
11.181-03



Lucae
c⁴ 2048
11.181-04



Lucae
c⁵ 4096
11.181-05



Lucae
c 128
11.181-06

11

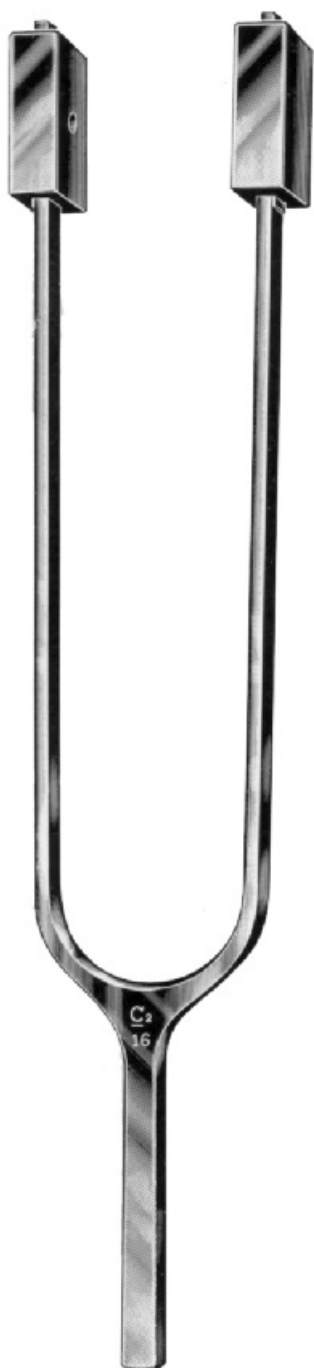

French
c₂ 16
Doppel-Contra
Double-contra
Double-contra
Doble-contra

11.182-01

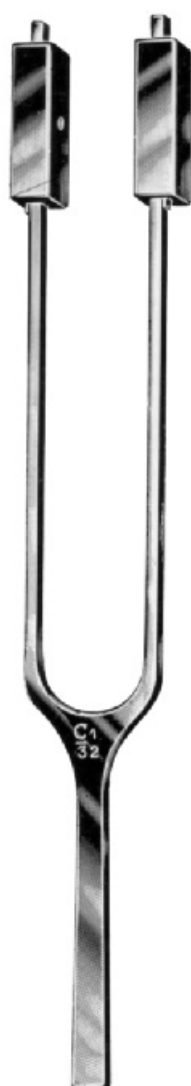

French
c₁ 32
Contra
Contra
Contra
Contra

11.182-02



Rydel-Seiffer
C 64 / c 128
mit Dämpfern = C 64 / ohne Dämpfer = c 128
with clamps = C 64 / without clamps = c 128
avec curseurs = C 64 / sans curseurs = c 128
con sordinas = C 64 / sin sordinas = c 128

11.183-01



Stimmgabel für neurologische Untersuchungen, mit Reflexhammer, Nadelrad, Pinsel und Nadel

Tuning fork for neurological examinations, with percussion hammer, pinwheel, brush, and needle

Diapason pour examens neurologiques, avec marteaux-percuteurs, roue aux épingles, brosse et aiguille

Diapasón para exámenes neurológicos, con martillo percusor, rueda con espinas, cepillo y aguja

11.184-01



Koenig
A 109
verschiebbar bis g
variable up to g
variable jusqu' à g
variable hasta g

11.185-01



a¹ 440
11.186-01

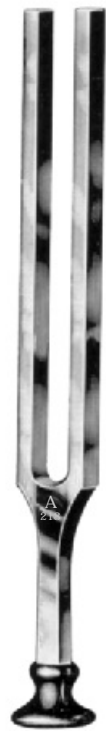

A 218
11.186-02

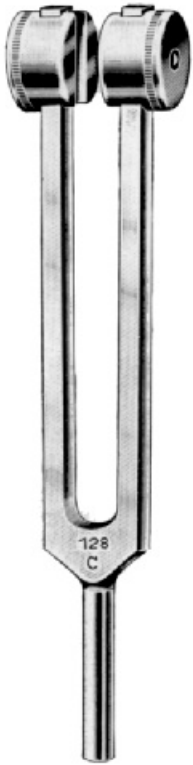

c 128
11.187-00



c¹ 256
11.187-01



c² 512
11.187-02



c³ 1024
11.187-03



c⁴ 2048
11.187-04

Stimmgabeln aus Spezial Aluminium-Magnesium-Legierung für medizinische Zwecke z. B. für Gehörprüfungen (Luft- und Knochenleitung), für Sensibilitätsprüfungen und andere diagnostische Zwecke.

Tuning forks made from special aluminium-magnesium-alloy, for medical purposes, such as examination of hearing (air and bone conduction), for sensibility examinations, and other diagnostic purposes.

Diapasons faits d' un alliage spécial d' aluminium et de magnésium, à des fins médicales, telles que l' examen de l' ouïe (conduite de l' air et os) et l' examen de la sensibilité et tout autre diagnostique.

Diapasón de una aleación especial al aluminio y magnesio, destinado a fines médicos por ejemplo, reconocimiento del oído (conducto del aire y huesos), reconocimiento de la sensibilidad y otros fines diagnósticos.



11.188-00
Satz zu 5 Spezial Aluminium-Magnesium-
Legierung Stimmgabeln im Etui
Set of 5 special aluminium-magnesium-
alloy tuning forks in a case
Jeu de 5 diapasons, alliage spécial
alluminium/magnésium dans un étui
Juego de 5 diapasones de una aleación
especial de aluminio y magnesio en estuche
(11.187-00, 11.187-01, 11.187-02,
11.187-03, 11.187-04)



11.189-05
Satz zu 5 Hartmann Stimmgabeln im Etui
Set of 5 Hartmann tuning forks in a case
Jeu de 5 Hartmann diapasons dans un étui
Juego de 5 Hartmann diapasones en estuche
(11.180-02, 11.180-03, 11.180-04,
11.180-07, 11.180-08)

11



11.189-06
Satz zu 6 Hartmann Stimmgabeln im Etui
Set of 6 Hartmann tuning forks in a case
Jeu de 6 Hartmann diapasons dans un étui
Juego de 6 Hartmann diapasones en estuche
(11.180-02, 11.180-03, 11.180-04,
11.180-05, 11.180-07, 11.180-08)



11.189-08
Satz zu 8 Hartmann Stimmgabeln im Etui
Set of 8 Hartmann tuning forks in a case
Jeu de 8 Hartmann diapasons dans un étui
Juego de 8 Hartmann diapasones en estuche
(11.180-02, 11.180-03, 11.180-04, 11.180-05,
11.180-06, 11.180-07, 11.180-08, 11.182-02)

Pinzetten
Forceps
Pinces
Pinzas



12



0,3 mm

12.101



0,3 mm

12.102



0,2 mm

12.103



0,2 mm

12.104



0,15 mm

12.105



0,2 mm

12.106



0,25 mm

12.107



Standard

12.199	10,5 cm/4¼"
12.200	11,5 cm/4½"
12.201	13,0 cm/5"
12.202	14,5 cm/5½"
12.203	16,0 cm/6¼"
12.204	18,0 cm/7"
12.205	20,0 cm/8"
12.206	25,0 cm/10"
12.207	30,0 cm/12"

12.205L 20,0 cm/8"
Isoliert für Laser- und Elektrochirurgie
insulated for Laser- and Electrosurgery
isolé pour les interventions au laser et
électrochirurgical
aislado para láser y electrocirugía



Standard

gebogen, curved
courbe, curvas

12.209	10,5 cm/4¼"
12.210	11,5 cm/4½"
12.211	13,0 cm/5"
12.212	14,5 cm/5½"
12.213	16,0 cm/6¼"
12.214	18,0 cm/7"
12.215	20,0 cm/8"
12.216	25,0 cm/10"
12.217	30,0 cm/12"



schmal, narrow
étroite, estrechas

12.220	11,5 cm/4½"
12.221	13,0 cm/5"
12.222	14,5 cm/5½"
12.223	16,0 cm/6¼"
12.224	18,0 cm/7"
12.225	20,0 cm/8"
12.226	25,0 cm/10"
12.227	30,0 cm/12"



schmal, narrow
étroite, estrechas

12.230	11,5 cm/4½"
12.231	13,0 cm/5"
12.232	14,5 cm/5½"
12.233	16,0 cm/6¼"
12.234	18,0 cm/7"
12.235	20,0 cm/8"
12.236	25,0 cm/10"
12.237	30,0 cm/12"



fein, delicate
fine, finas

12.241	13,0 cm/5"
12.242	14,5 cm/5½"



Schwedisches Modell
Swedish pattern
Modèle suédois
Modelo sueco

12.247	13,0 cm/5"
12.248	15,0 cm/6"
12.249	17,0 cm/6¾"

12



USA-Mod. Standard

12.250	12,0 cm/4 ³ / ₄ "
12.251	13,0 cm/5"
12.252	14,5 cm/5 ¹ / ₂ "
12.253	15,5 cm/6"
12.254	18,0 cm/7"
12.255	21,0 cm/8 ¹ / ₄ "
12.256	25,0 cm/10"
12.257	31,0 cm/12 ¹ / ₄ "



USA-Mod.

schmal, narrow
étroite, estrechas

12.260	12,0 cm/4 ³ / ₄ "
12.261	13,0 cm/5"
12.262	14,5 cm/5 ¹ / ₂ "
12.263	15,5 cm/6"



engl. Mod.

12.265	13,0 cm/5"
12.266	14,5 cm/5 ¹ / ₂ "
12.267	15,5 cm/6"



Semken

12.271	12,5 cm/5"
12.272	15,0 cm/6"



Adson

Micro 0,8 mm

12.274	12,0 cm/4 ³ / ₄ "
1,2 mm	
12.275	12,0 cm/4 ³ / ₄ "



Mc Indoe

12.277	15,0 cm/6"
--------	------------



Potts-Smith

- 12.280 18,0 cm/7"
- 12.281 21,0 cm/8¼"
- 12.282 25,0 cm/10"



Potts-Smith

- gebogen, curved
courbe, curvas
- 12.283 18,0 cm/7"
 - 12.284 21,0 cm/8¼"
 - 12.285 25,0 cm/10"



Gerald

- 12.288 18,0 cm/7"



Gerald

- gebogen, curved
courbe, curvas
- 12.289 18,0 cm/7"



Taylor

- 12.290 17,5 cm/7"



Taylor

- gebogen, curved
courbe, curvas
- 12.291 17,5 cm/7"



Taylor

- 12.292 17,5 cm/7"



Taylor

- gebogen, curved
courbe, curvas
- 12.293 17,5 cm/7"

12



Waugh

12.294 15,0 cm/6"
12.295 20,0 cm/8"



Brophy

12.296 20,0 cm/8"



Brophy

gebogen, curved
courbe, curvas
12.297 20,0 cm/8"



Cushing

12.298 17,5 cm/7"



Cushing

gebogen, curved,
courbe, curvas
12.299 17,5 cm/7"



1:2

12.308	10,5 cm/4 ¹ / ₄ "
12.300	11,5 cm/4 ¹ / ₂ "
12.301	13,0 cm/5"
12.302	14,5 cm/5 ¹ / ₂ "
12.303	16,0 cm/6 ¹ / ₄ "
12.304	18,0 cm/7"
12.305	20,0 cm/8"
12.306	25,0 cm/10"
12.307	30,0 cm/12"



2:3

12.310	11,5 cm/4 ¹ / ₂ "
12.311	13,0 cm/5"
12.312	14,5 cm/5 ¹ / ₂ "
12.313	16,0 cm/6 ¹ / ₄ "
12.314	18,0 cm/7"
12.315	20,0 cm/8"
12.316	25,0 cm/10"
12.317	30,0 cm/12"



3:4

12.321	13,0 cm/5"
12.322	14,5 cm/5 ¹ / ₂ "
12.323	16,0 cm/6 ¹ / ₄ "



4:5

12.327	13,0 cm/5"
12.328	14,5 cm/5 ¹ / ₂ "
12.329	16,0 cm/6 ¹ / ₄ "



1:2

schmal, narrow
étroite, estrechas

12.331	13,0 cm/5"
12.332	14,5 cm/5 ¹ / ₂ "
12.333	16,0 cm/6 ¹ / ₄ "
12.335	20,0 cm/8"



USA-Mod. 1:2

12.340	12,0 cm/4 ³ / ₄ "
12.341	13,0 cm/5"
12.342	14,5 cm/5 ¹ / ₂ "
12.343	15,5 cm/6"
12.344	18,0 cm/7"
12.345	21,0 cm/8 ¹ / ₄ "
12.346	25,0 cm/10"
12.347	31,0 cm/12 ¹ / ₄ "



USA-Mod. 2:3

12.350	12,0 cm/4 ³ / ₄ "
12.351	13,0 cm/5"
12.352	14,5 cm/5 ¹ / ₂ "
12.353	15,5 cm/6"
12.354	18,0 cm/7"
12.355	21,0 cm/8 ¹ / ₄ "
12.356	25,0 cm/10"
12.357	31,0 cm/12 ¹ / ₄ "

12



USA-Mod.
fein, delicate
fine, finas

12.371 13,0 cm/5"
12.372 14,5 cm/5½"
12.373 15,0 cm/6"



Adlerkreutz



2:3



4:5

15 cm/6"	12.374-15	12.375-15
20 cm/8"	12.374-20	12.375-20
25 cm/10"	12.374-25	12.375-25



Semken

12.381 12,5 cm/5"
12.382 15,0 cm/6"



Adson

Micro 0,8 mm
12.384 12,0 cm/4½"
12.384-15 15,0 cm/6"

1,2 mm
12.385 12,0 cm/4½"
12.385-15 15,0 cm/6"



Adson Brown
9 x 9
12.386 12,0 cm/4½"



Gillies
12.387 15,0 cm/6"



Gerald
12.388 17,5 cm/7"



Gerald
gebogen, curved
courbe, curvas
12.389 17,5 cm/7"

12



Taylor

12.390 17,5 cm/7"



Taylor

gebogen, curved,
courbe, curvas

12.391 17,5 cm/7"



Cushing

12.392 17,5 cm/7"



Cushing

gebogen, curved,
courbe, curvas

12.393 17,5 cm/7"



Brophy

12.394 20,0 cm/8"



Brophy

gebogen, curved,
courbe, curvas

12.395 20,0 cm/8"



Waugh

12.396 15,0 cm/6"

12.397 20,0 cm/8"



Taylor

12.398 17,5 cm/



Taylor

12.399 17,5 cm/7"



Potts-Smith

12.400 18,0 cm/7"
12.401 21,0 cm/8¼"
12.402 25,0 cm/10"



Potts-Smith

gebogen, curved,
courbe, curvas
12.403 18,0 cm/7"
12.404 21,0 cm/8¼"
12.405 25,0 cm/10"



Lane 1:2

12.407 14,5 cm/5½"
12.408 18,0 cm/7"



Lane 2:3

12.409 14,5 cm/5½"
12.410 18,0 cm/7"



Bonney 1:2

12.411 18,0 cm/7"



Bonney 2:3

12.412 18,0 cm/7"

12



Mod. Russ.

12.413 15,0 cm/6"
12.414 20,0 cm/8"
12.415 25,0 cm/10"



Singley-Tuttle

12.416 23,0 cm/9"



Nelson

12.417 23,0 cm/9"



Mod. Mayo-Russ.

12.419 23,0 cm/9"



De Bakey
gerade, straight,
droite, rectas

	1,5 mm	2,0 mm	2,7 mm	3,5 mm
16,0 cm/6¼"	12.420-16	12.421-16	12.422-16	12.423-16
20,0 cm/8"	12.420-20	12.421-20	12.422-20	12.423-20
24,0 cm/9½"	12.420-24	12.421-24	12.422-24	12.423-24
30,0 cm/12"	12.420-30	12.421-30	12.422-30	12.423-30



De Bakey
abgewinkelt, angular,
angulaire, angulares

	2,0 mm
16,0 cm/6¼"	12.424-16
20,0 cm/8"	12.424-20
24,0 cm/9½"	12.424-24
30,0 cm/12"	12.424-30

12



12.425 10,5 cm/4½"

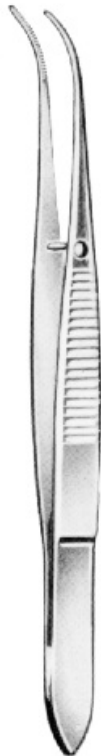

12.426 10,5 cm/4½"



12.427 10,5 cm/4½"



12.428 10,5 cm/4 1/2"

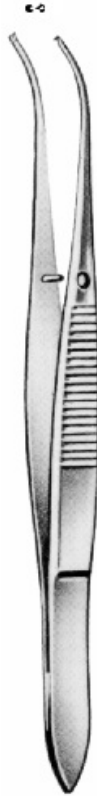

12.429 10,5 cm/4 1/2"



12.430 10,5 cm/4 1/2"

12



glatt, smooth
lisse, lisas
ohne Stift, without pin
sans cheville, sin perno

12.431	8,0 cm/3¼"
12.432	9,0 cm/3½"
12.433	10,5 cm/4¼"
12.434	11,5 cm/4½"
12.435	12,5 cm/5"
12.436	8,0 cm/3¼"
12.437	9,0 cm/3½"
12.438	10,5 cm/4¼"
12.439	11,5 cm/4½"
12.440	12,5 cm/5"



gerieft, serrated
striée, estriadas
ohne Stift, without pin
sans cheville, sin perno

12.441	8,0 cm/3¼"
12.442	9,0 cm/3½"
12.443	10,5 cm/4¼"
12.444	11,5 cm/4½"
12.445	12,5 cm/5"
12.446	8,0 cm/3¼"
12.447	9,0 cm/3½"
12.448	10,5 cm/4¼"
12.449	11,5 cm/4½"
12.450	12,5 cm/5"



glatt, smooth
lisse, lisas
mit Stift, with pin
avec cheville, con perno

12.451	8,0 cm/3¼"
12.452	9,0 cm/3½"
12.453	10,5 cm/4¼"
12.454	11,5 cm/4½"
12.455	12,5 cm/5"
12.456	8,0 cm/3¼"
12.457	9,0 cm/3½"
12.458	10,5 cm/4¼"
12.459	11,5 cm/4½"
12.460	12,5 cm/5"



gerieft, serrated
striée, estriadas
mit Stift, with pin
avec cheville, con perno

12.461	8,0 cm/3¼"
12.462	9,0 cm/3½"
12.463	10,5 cm/4¼"
12.464	11,5 cm/4½"
12.465	12,5 cm/5"
12.466	8,0 cm/3¼"
12.467	9,0 cm/3½"
12.468	10,5 cm/4¼"
12.469	11,5 cm/4½"
12.470	12,5 cm/5"





Feilchenfeld

- 12.471 7,5 cm/3"
- 12.472 9,0 cm/3½"
- 12.473 11,5 cm/4½"



Hunter

- 12.474 10,5 cm/4¼"



Hunter

- 12.475 10,5 cm/4¼"



Walter-Carmalt

- 12.476 10,5 cm/4¼"



Walter-Carmalt

- 12.477 10,5 cm/4¼"

Mikroskopierpinzetten
Microscope Forceps
Pinces pour microscopier
Pinzas para el microscopio



- 12.485 10,0 cm/4"
- stumpf
- blunt
- mousse
- romas



- 12.486 10,0 cm/4"
- spitz
- sharp
- pointue
- agudas

12



Yasargil
22,0 cm/8³/₄"
glatt, smooth,
lisse, lisas



Ø 3 mm Ø 5 mm
12.487-03 12.487-05



Yasargil
22,0 cm/8³/₄"
gerieft, serrated,
striée, estriadas



Ø 3 mm Ø 5 mm
12.488-03 12.488-05



Heifetz
22,0 cm/8³/₄"
gerieft, serrated,
striée, estriadas



Ø 3 mm Ø 5 mm
12.489-03 12.489-05



Beer

12.491 8,0 cm/3¼"
12.492 9,0 cm/3½"



Littauer

12.493 8,5 cm/3½"



Douglas

schmal, narrow,
étroite, estrechas
12.494-01 9,0 cm/3½"



Douglas

breit, broad,
large, anchas
12.494-02 9,0 cm/3½"

12



Kuehne

12.495-01
10,5 cm/4¼"
gerade
straight
droite
rectas

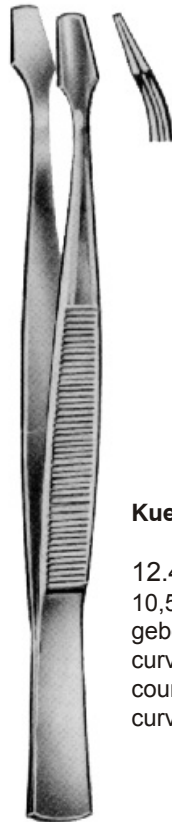

Kuehne

12.495-02
10,5 cm/4¼"
gebogen
curved
courbe
curvas



Kuehne

12.495-03
10,5 cm/4¼"
überkreuzt
curved crossed
courbe croisée
curvas cruzadas



12.496
10,5 cm/4¼"

Splitterzangen
Splinter Forceps
Pinces à échardes
Pinzas para espinas

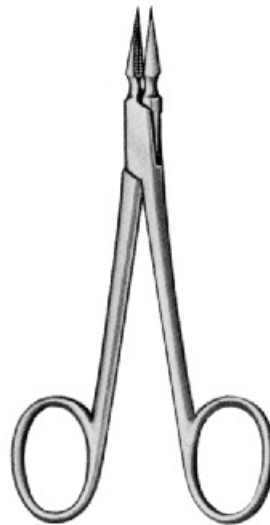

13

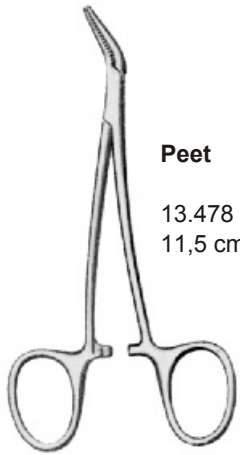

Peet

13.478
11,5 cm/4½"

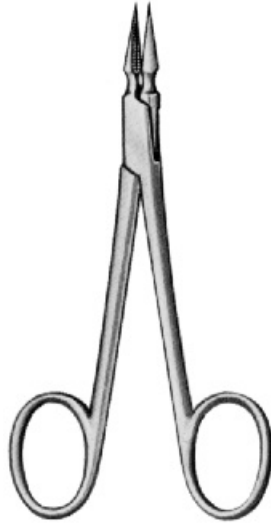

Arthur

13.479
13,5 cm/5½"
gerade, straight,
droite, recta

13.480
gebogen, curved,
courbe, curva



Stieglitz

13.481
13,5 cm/5½"
gerade, straight,
droite, recta

13.482
gebogen, curved,
courbe, curva



Ralk
15,0 cm/6"

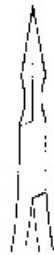

13.483
gerade
straight
droite
recta

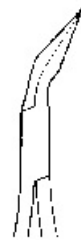

13.484
gebogen
curved
courbe
curva

Verschiedene Klemmen
Miscellaneous Forceps
Pinces diverses
Pinzas diversas

14



14



14.497



14.498

Dieffenbach
6,0 cm/2½"



3,5 cm/1½"
14.499 13.501



Dieffenbach

5,0 cm/2"
14.500 13.502



John Hopkins

14.505 5,0 cm/2"
14506 6,5 cm/2½"
14.507 7,5 cm/3"

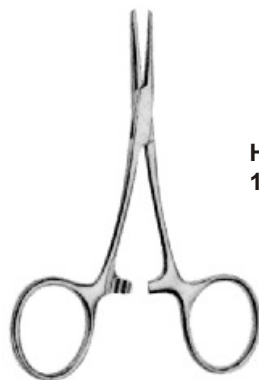

14.503 micro
14.508

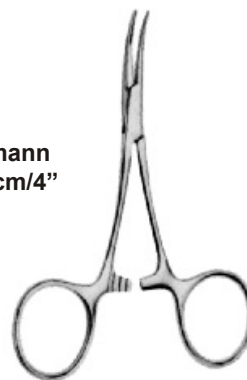

14.504 micro
14.509

Hartmann
10,0 cm/4"



Halsted-Mosquito

- | | | |
|--------------|-------------|--------------|
| 14.510 | 12,5 cm/5" | 14.515 |
| 14.511 | 14,0 cm/5½" | 14.516 |
| 14.514 micro | 12,5 cm/5" | 14.519 micro |
| gerade | | gebogen |
| straight | | curved |
| droite | | courbe |
| recta | | curva |



Halsted-Mosquito 1:2

- | | | |
|--------------|-------------|--------------|
| 14.520 | 12,5 cm/5" | 14.525 |
| 14.521 | 14,0 cm/5½" | 14.526 |
| 14.529 micro | 12,5 cm/5" | 14.530 micro |
| gerade | | gebogen |
| straight | | curved |
| droite | | courbe |
| recta | | curva |

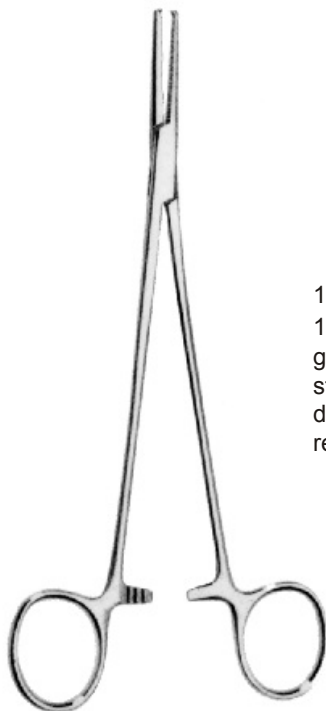

- | | |
|----------|-------------|
| 14.512 | 18,0 cm/7" |
| 14.513 | 21,0 cm/8¼" |
| gerade | |
| straight | |
| droite | |
| recta | |

Halsted-Mosquito

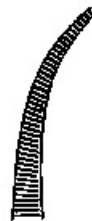

- | |
|---------|
| 14.517 |
| 14.518 |
| gebogen |
| curved |
| courbe |
| curva |



- | | |
|----------|-------------|
| 14.522 | 18,0 cm/7" |
| 14.523 | 21,0 cm/8¼" |
| gerade | |
| straight | |
| droite | |
| recta | |

Halsted-Mosquito 1:2

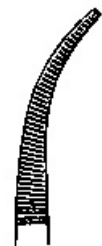

- | |
|---------|
| 14.527 |
| 14.528 |
| gebogen |
| curved |
| courbe |
| curva |

14



Pean

14.531 14,0 cm/5½"
14.532 16,0 cm/6¼"



Pean

14,0 cm/5½"
fein, delicate, fine, fina

14.538
gerade, straight,
droite, recta

14.540
gebogen, curved,
courbe, curva



Rochester-Pean

gerade, straight,
droite, recta

14.533 13,0 cm/5"
14.541 14,0 cm/5½"
14.542 16,0 cm/6¼"
14.543 18,0 cm/7"
14.544 20,0 cm/8"
14.545 22,0 cm/8¾"
14.546 24,0 cm/9½"
14.547 26,0 cm/10¼"
14.549 30,0 cm/12"

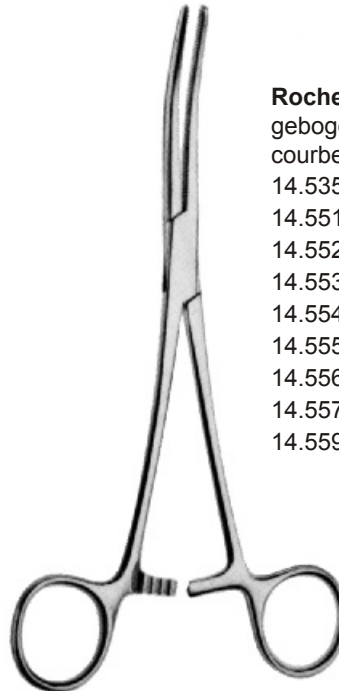

Rochester-Pean

gebogen, curved,
courbe, curva

14.535 13,0 cm/5"
14.551 14,0 cm/5½"
14.552 16,0 cm/6¼"
14.553 18,0 cm/7"
14.554 20,0 cm/8"
14.555 22,0 cm/8¾"
14.556 24,0 cm/9½"
14.557 26,0 cm/10¼"
14.559 30,0 cm/12"



Kocher
 14,0 cm/5½"
 fein, delicate, fine, fina

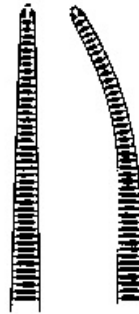

14.566
 gerade
 straight
 droite
 recta

14.568
 gebogen
 curved
 courbe
 curva



Ochsner-Kocher
 gerade, straight,
 droite, recta
 14.561 13,0 cm/5"
 14.571 14,0 cm/5½"
 14.572 16,0 cm/6¼"
 14.573 18,0 cm/7"
 14.574 20,0 cm/8"
 14.575 22,0 cm/8¾"
 14.576 24,0 cm/9½"
 14.577 26,0 cm/10¼"
 14.579 30,0 cm/12"

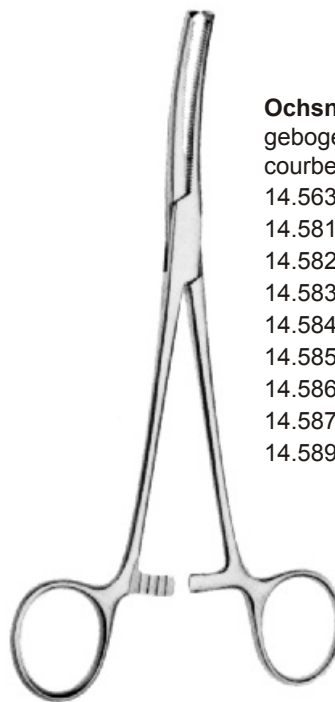

Ochsner-Kocher
 gebogen, curved,
 courbe, curva
 14.563 13,0 cm/5"
 14.581 14,0 cm/5½"
 14.582 16,0 cm/6¼"
 14.583 18,0 cm/7"
 14.584 20,0 cm/8"
 14.585 22,0 cm/8¾"
 14.586 24,0 cm/9½"
 14.587 26,0 cm/10¼"
 14.589 30,0 cm/12"

14



Rochester-Carmalt



14.591
14.593
gerade
straight
droite
recta

16,0 cm/6¼"
20,0 cm/8"



14.595
14.597
gebogen
curved
courbe
curva

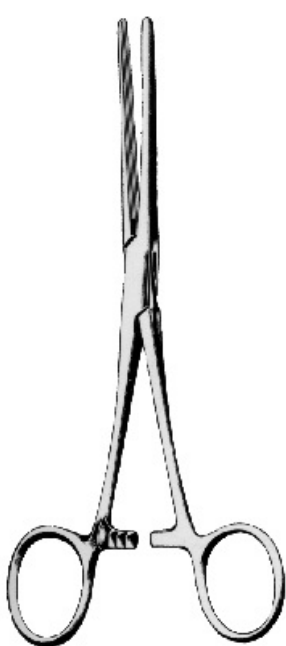

Bainbridge
15 cm/6"



14.596
gerade
straight
droite
recta



14.598
gebogen
curved
courbe
curva



Bainbridge
18,5 cm/7¼"



14.599
gerade
straight
droite
recta



14.600
gebogen
curved
courbe
curva



Kelly
 14,0 cm/5½"



14.601
 gerade
 straight
 droite
 recta



14.602
 gebogen
 curved
 courbe
 curva



Kelly-Rankin
 16,0 cm/6¼"



14.603
 gerade
 straight
 droite
 recta

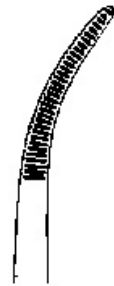

14.604
 gebogen
 curved
 courbe
 curva

14

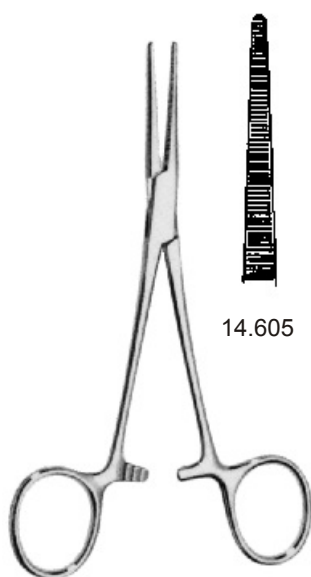

Crile
 14,0 cm/5½"



14.605



14.606



14.607



1:2
 14.608



Crile-Rankin
 16,0 cm/6¼"



14.609
 gerade
 straight
 droite
 recta

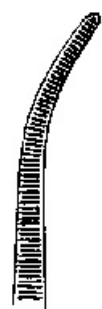

14.610
 gebogen
 curved
 courbe
 curva

14

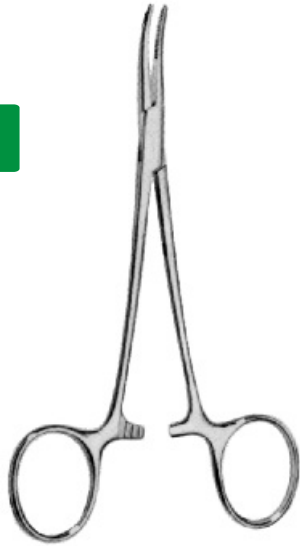

14.611
gerade
straight
droite
recta

Providence Hospital
14,0 cm/5½"



14.612
gebogen
curved
courbe
curva

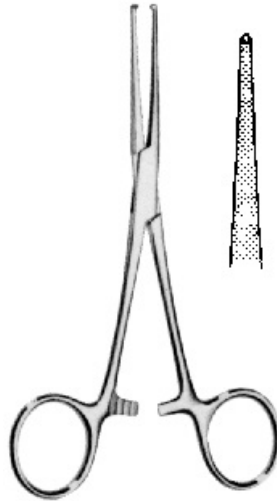

Lovelace
14.614 15,5 cm/6"



seitwärts gebogen
curved on side
courbe sur le côté
curva lateral

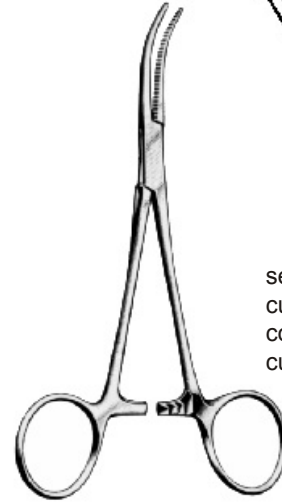

Dandy Crile
14.615 14,0 cm/5½"



14.617 14,0 cm/5½"
14.619 16,0 cm/6¼"
gerade
straight
droite
recta



Baby-Crile



14.618
14.620
gebogen
curved
courbe
curva



Spencer-Wells



14.621 13,0 cm/5"
14.622 14,0 cm/5½"
14.623 15,5 cm/6"
14.624 18,0 cm/7"
14.625 20,0 cm/8"
14.626 24,0 cm/9"
gerade
straight
droite
recta

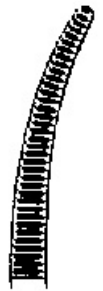

14.627
14.628
14.629
14.630
14.631
14.632
gebogen
curved
courbe
curva



14.634
 gerade
 straight
 droite
 recta

14.635
 gebogen
 curved
 courbe
 curva

Leriche
 15,0 cm/6"



Pennington

14.636 15,5 cm/6"
 14.637 20,0 cm/8"

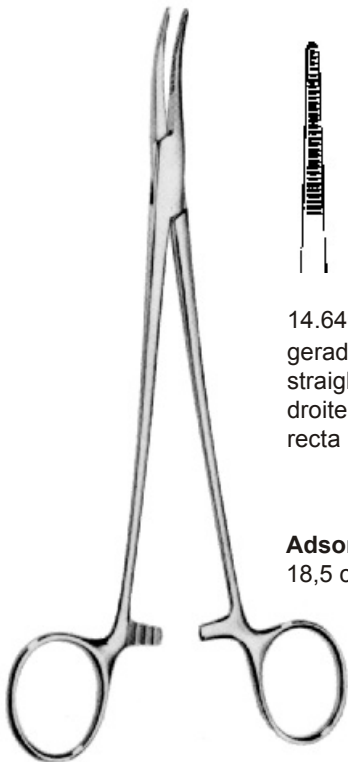

14.640
 gerade
 straight
 droite
 recta

14.641
 gebogen
 curved
 courbe
 curva

Adson
 18,5 cm/7¼"

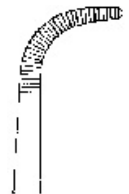
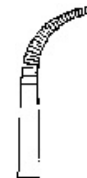

14.642
 14,0 cm/5½"

14.643
 18,0 cm/7"

Baby-Adson

14

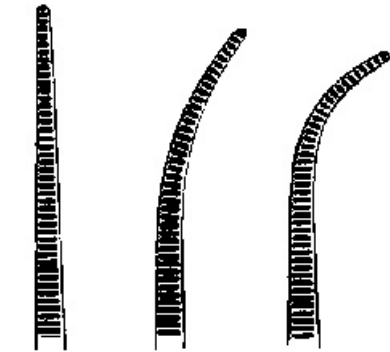
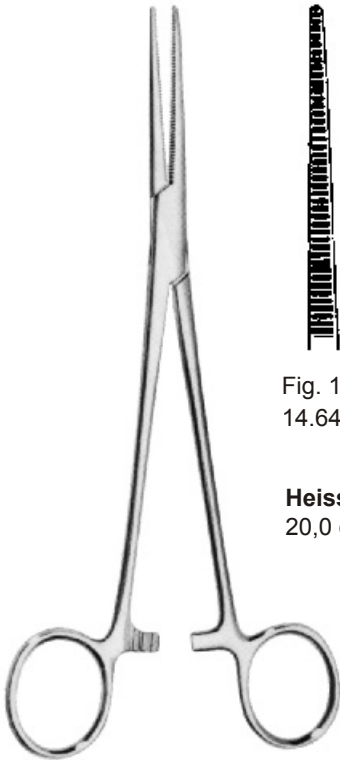

Fig. 1 14.644
Fig. 2 14.645
Fig. 3 14.646

Arterienklemmen
Hemostatic Forceps
Pincès hémostatiques
Pinzas hemostáticas

Heiss
20,0 cm/8"

Präparier- und Ligaturklemmen, Dissecting and Ligature Forceps
Pincès à disséquer et à ligatures, Pinzas para preparaciones y ligaduras

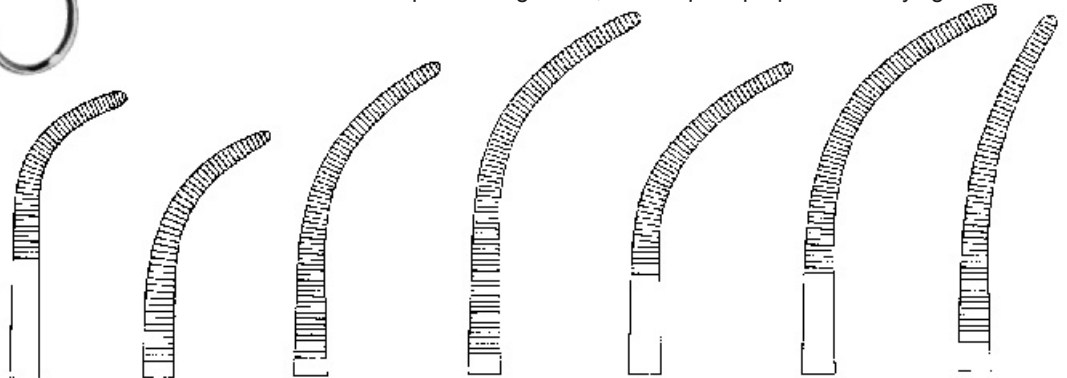

Fig. 1 19,5cm/7¼" 14.650-01
Fig. 2 21,0cm/8¼" 14.650-02
Fig. 3 22,0cm/8¾" 14.650-03
Fig. 4 22,5cm/9" 14.650-04
Fig. 5 21,5cm/8½" 14.650-05
Fig. 6 22,5cm/9" 14.650-06
Fig. 7 22,5cm/9" 14.650-07

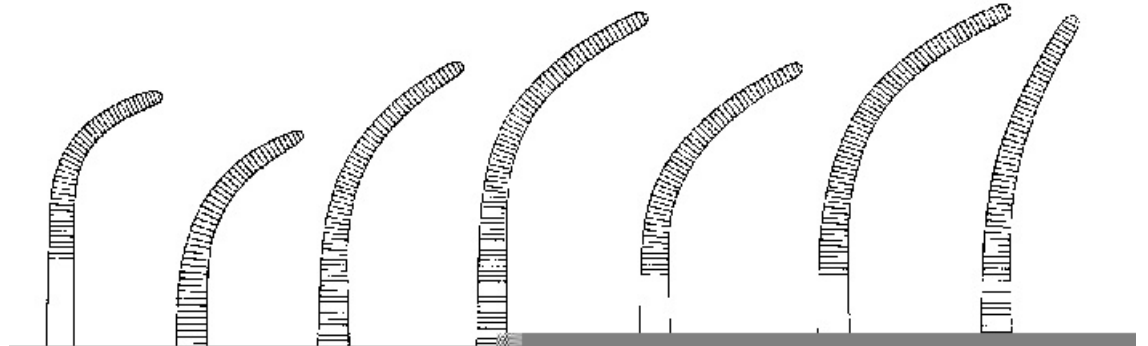
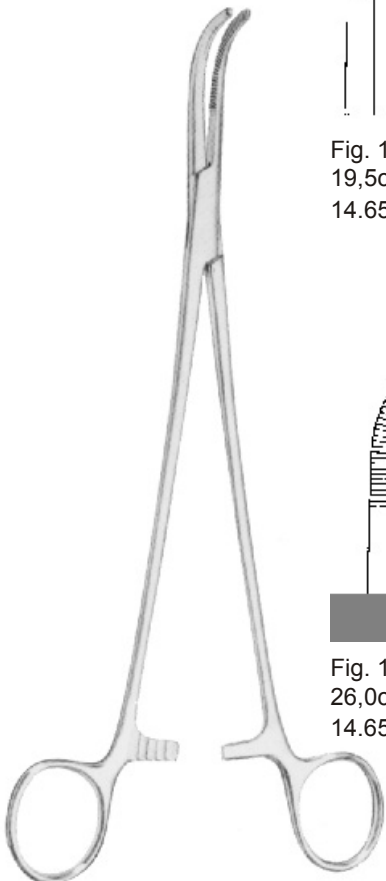
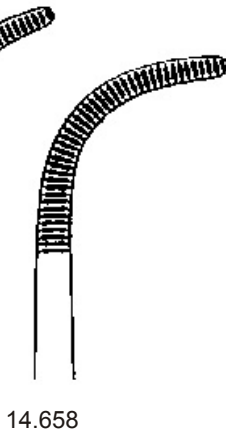
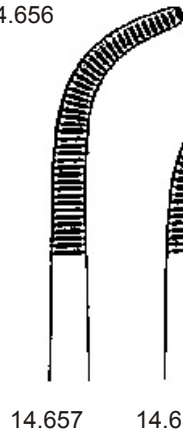
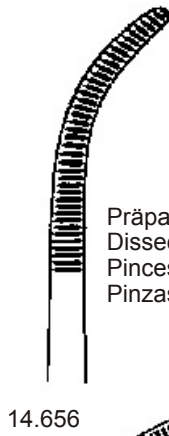
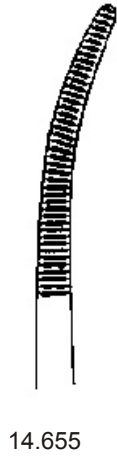
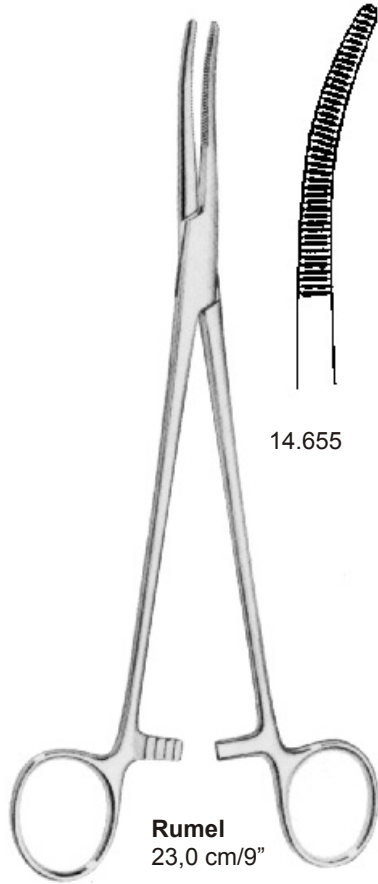
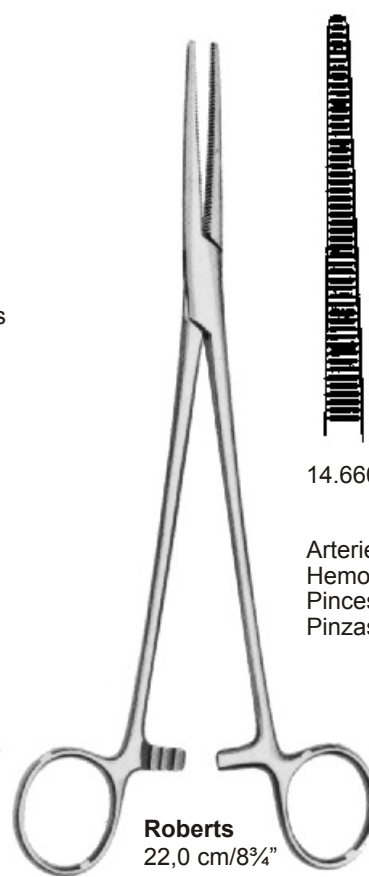

Fig. 1 26,0cm/10¼" 14.651-01
Fig. 2 27,0cm/10½" 14.651-02
Fig. 3 27,5cm/10¾" 14.651-03
Fig. 4 27,5cm/10¾" 14.651-04
Fig. 5 27,5cm/10¾" 14.651-05
Fig. 6 28,0cm/11" 14.651-06
Fig. 7 27,5cm/10¾" 14.651-07

Overholt-Geissendoerfer



Präparierklemmen
 Dissecting Forceps
 Pincas à disséquer
 Pinzas para preparaciones



Arterienklemmen
 Hemostatic Forceps
 Pincas hémostatiques
 Pinzas hemostáticas

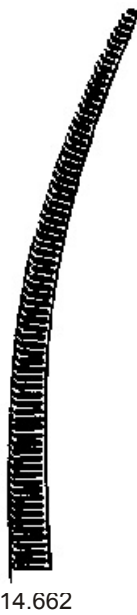

Arterienklemmen
 Hemostatic Forceps
 Pincas hémostatiques
 Pinzas hemostáticas

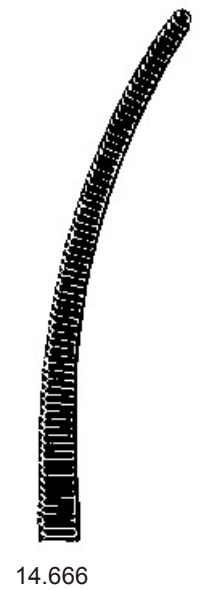
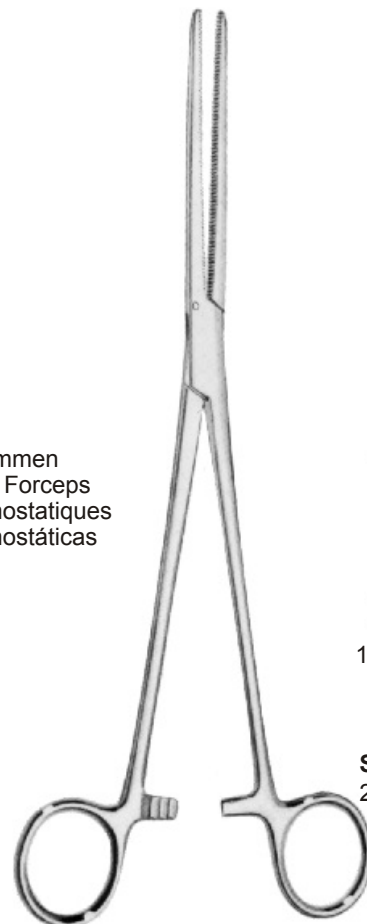

14



Bengolea

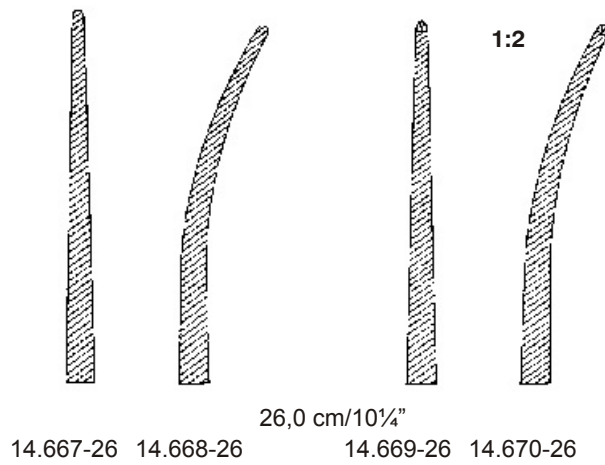
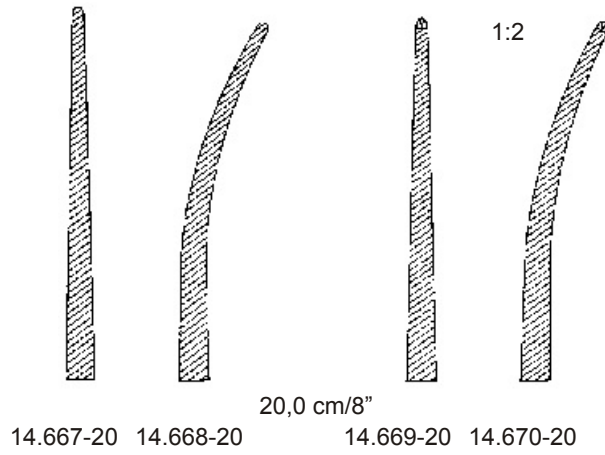



Mini-Gemini

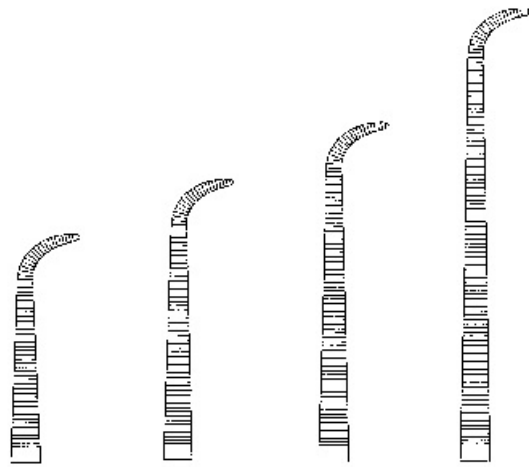

18,0 cm/7"	22,0 cm/8¾"	25,0 cm/10"	28,0 cm/11"
14.671-18	14.671-22	14.671-25	14.671-28



Gemini

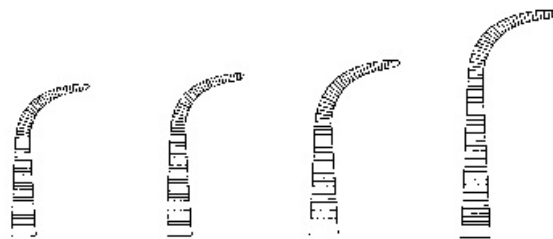

13,0 cm/5"	14,0 cm/5½"	16,0 cm/6¼"	18,0 cm/7"
14.672-13	14.672-14	14.672-16	14.672-18

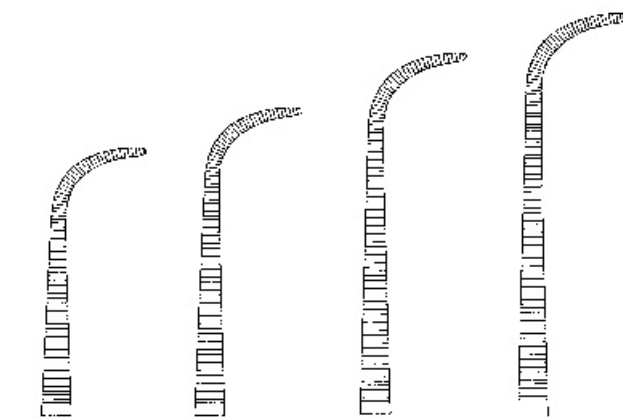

20,0 cm/8"	23,0 cm/9"	25,0 cm/10"	28,0 cm/11"
14.672-20	14.672-23	14.672-25	14.672-28

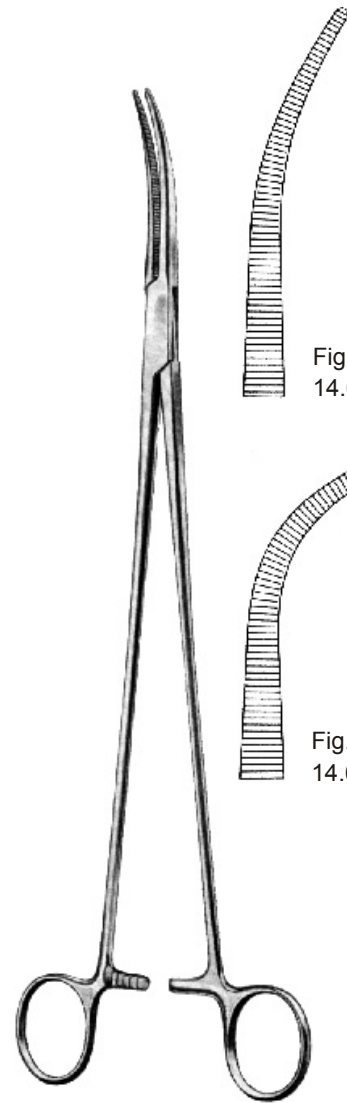

Zenker
 29,5 cm/11½"

Fig. 1
 14.673-01

Fig. 2
 14.673-02

14



Mixer-Baby
14.675 14,0 cm/5½"
14.675-18 18,0 cm/7"



Mixer
14.676 15,5 cm/6"
14.677 19,0 cm/7½"

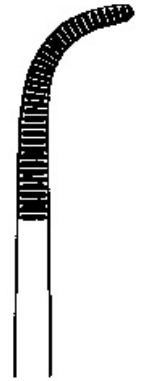
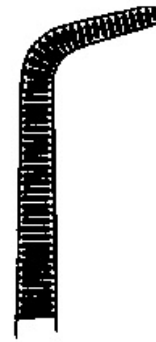

13.678
22,0 cm/8¾"



Mixer-O'Shaugnessy
14.679 15,5 cm/6"
14.680 19,0 cm/7½"

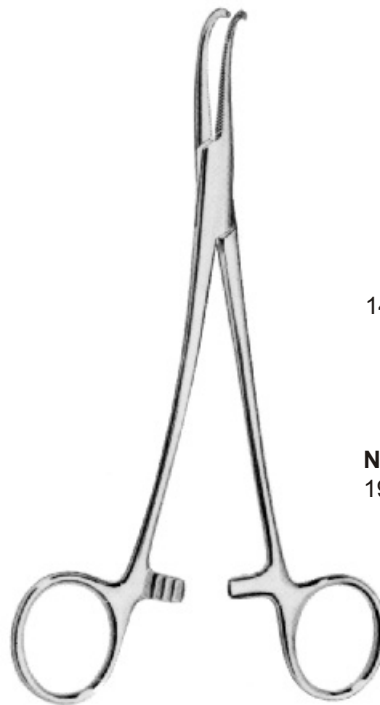
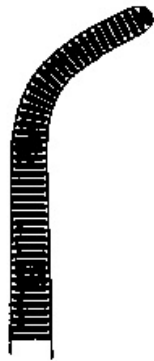

Negus
19,0 cm/7½"

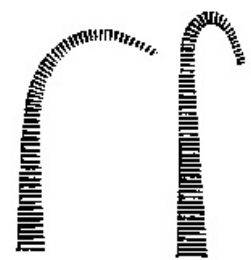

14.681

14.682

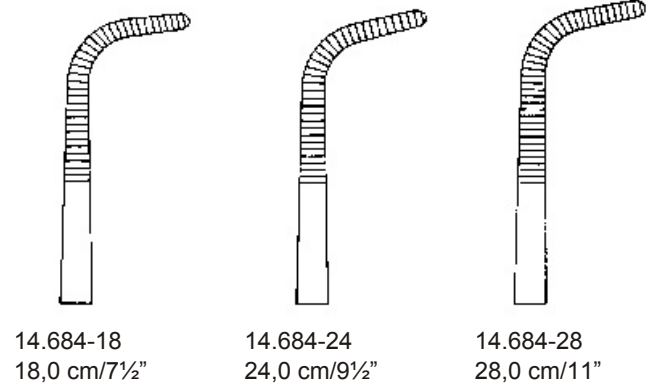

14.684-18
 18,0 cm/7½"

14.684-24
 24,0 cm/9½"

14.684-28
 28,0 cm/11"

Kantrowitz

Gallenkanalklemmen
 Gall Duct Clamps
 Pincas pour voies biliaires
 Pinzas para conductos biliares

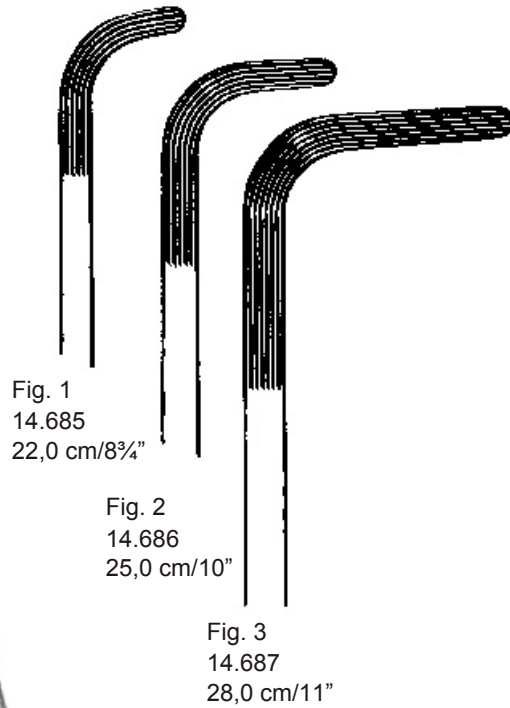
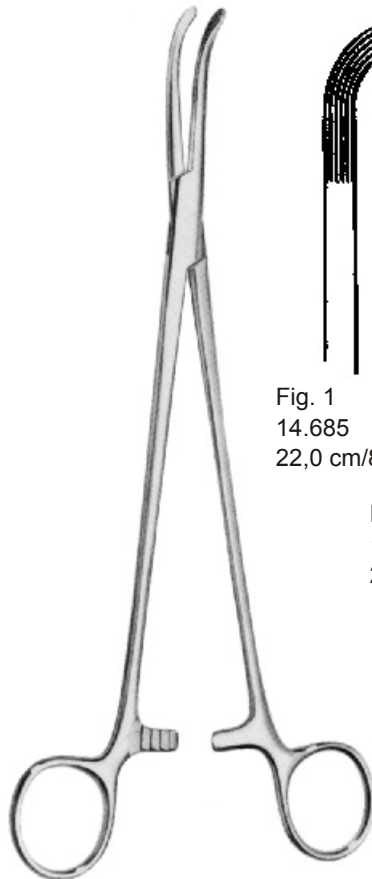
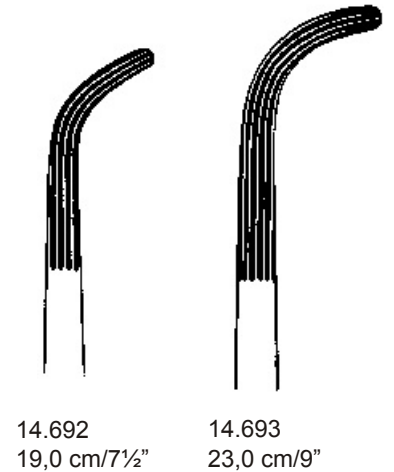
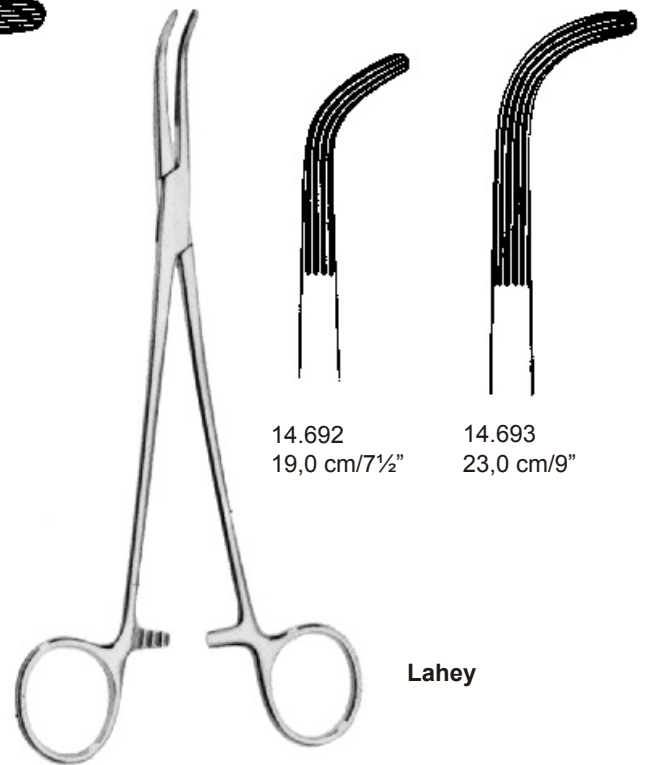

Fig. 1
 14.685
 22,0 cm/8¾"

Fig. 2
 14.686
 25,0 cm/10"

Fig. 3
 14.687
 28,0 cm/11"

Mixer



14.692
 19,0 cm/7½"

14.693
 23,0 cm/9"

Lahey

14



Heaney-Ballentine
21,0 cm/8¼"
14.712 14.713

Hysterektomieklemmen
Hysterectomy Forceps
Pincès à hystérectomie
Pinzas para histerectomia



Heaney
14.716 21,0 cm/8¼" 14.722
14.717 23,0 cm/9" 14.723

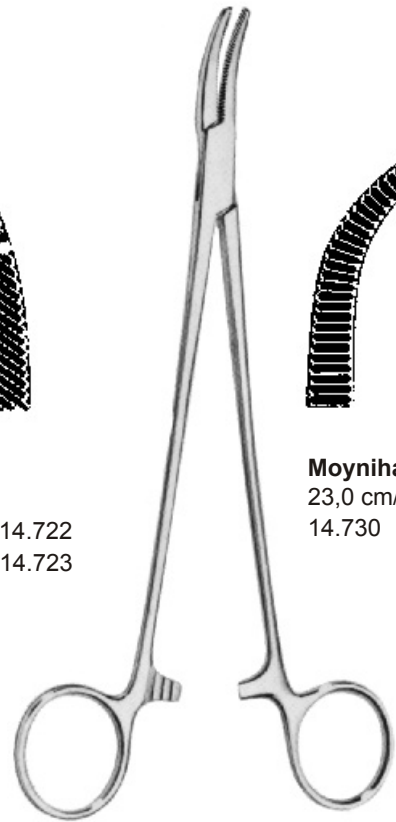

Moynihan
23,0 cm/9"
14.730

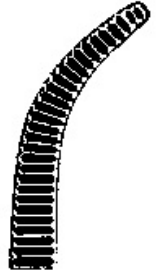

Wertheim-Cullen
21,5 cm/8½"
14.732



Wertheim
25,0 cm/10"
14.733

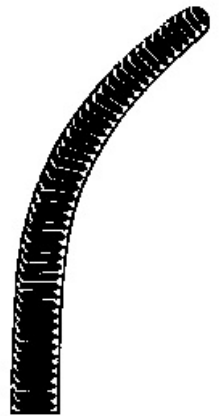

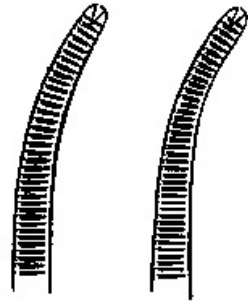

Klemmzangen
 Clamp Forceps
 Pinces clamps
 Pinzas-clamps

Wertheim
 22,0 cm/8³/₄" 23,0 cm/9"
 14.734 14.735

Peritoneumklemmen, Peritoneal Clamp Forceps, Pinces pour péritoine, Pinzas para peritoneo

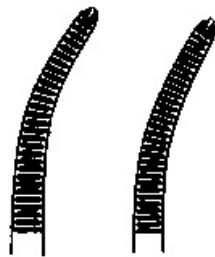

14.737 14.738

Mikulicz
 20,0 cm/8"

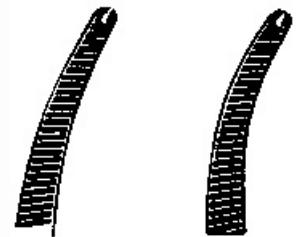
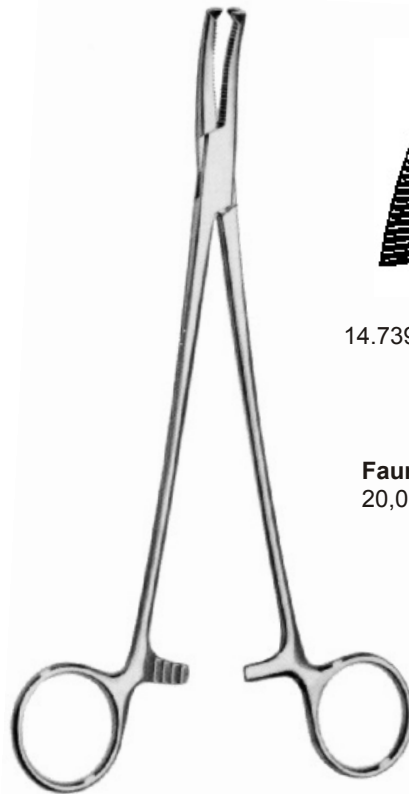

14.739 14.740

Faure
 20,0 cm/8"

14



Schädel
9,0 cm/3½"

14.761
gebogen
curved
courbe
curva



Jones
14.762 5,5 cm/2¼"
14.763 9,0 cm/3½"



Doyen
18,0 cm/7"
14.764



Peers
14,5 cm/5¾"
14.770

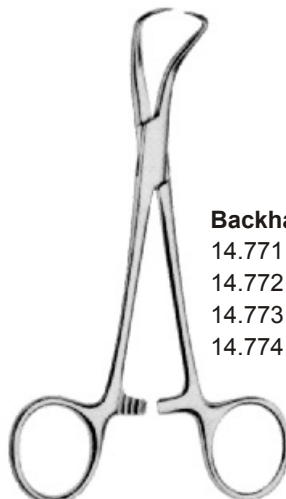

Backhaus
14.771 9,0 cm/3½"
14.772 11,0 cm/4½"
14.773 13,0 cm/5"
14.774 15,0 cm/6"

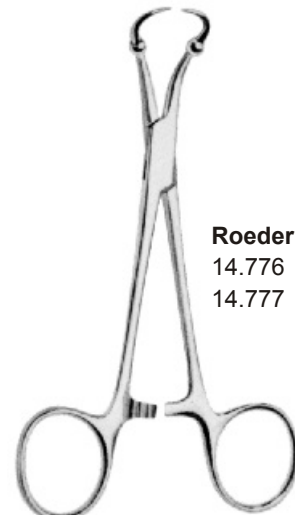

Roeder
14.776 13,0 cm/5"
14.777 15,0 cm/6"



Bernhard
16,0 cm/6¼"
14.778



Lane
20,0 cm/8"
14.780



Lorna
14.781 10,0 cm/4"
14.782 13,0 cm/5"



Ombredanne
13,5 cm/5½"
14.783

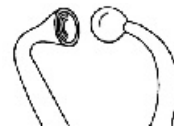

14.785 11,0 cm/4½"
14.786 13,0 cm/5"
Kugel/Pfanne
Ball/Socket
boule/poêle
bola/paila



14.787 11,0 cm/4½"
14.788 13,0 cm/5"
Kugel/Kugel
Ball/Ball
boule/boule
bola/bola

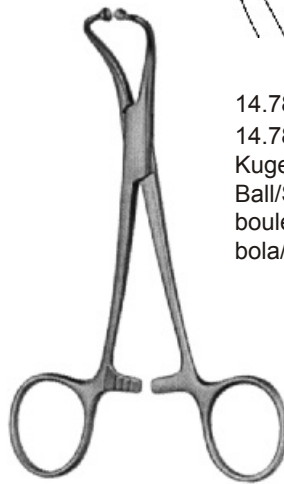

Tuchklemmen, Towel Forceps, Pincès à champs, Pinzas de campo

14

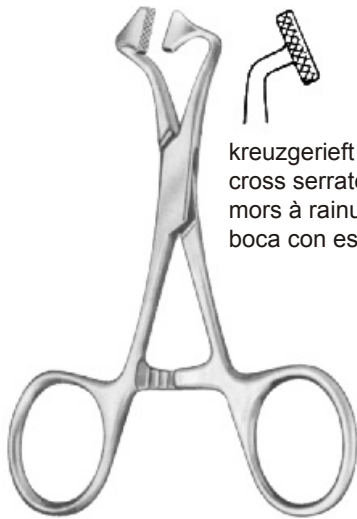

kreuzgerieft
cross serrated
mors à rainures croisées
boca con estrías cruzadas

Thomas

14.788-10 10,0 cm/4"
14.788-13 13,0 cm/5"

chlauchklemmen, Tubing Clamps, Pincès presse-tube, Pinzas para tubos

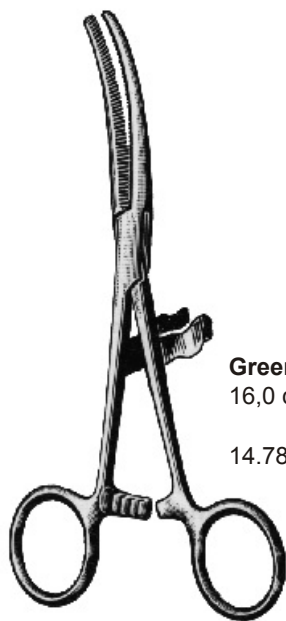

Green
16,0 cm/6¼"
14.789



Presbyterian
16,0 cm/6½"
14.790
glatt
smooth
mousse
lisse

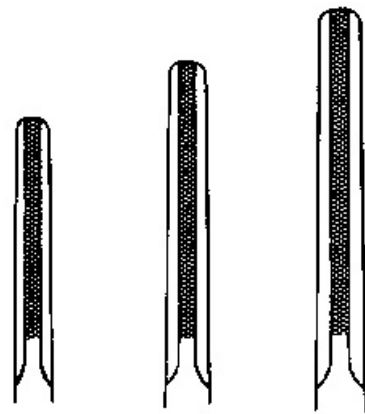

14,0 cm/5½" 14.791
 18,0 cm/7" 14.792
 20,0 cm/8" 14.793

ohne U
 without guard
 sans protection
 sin protección

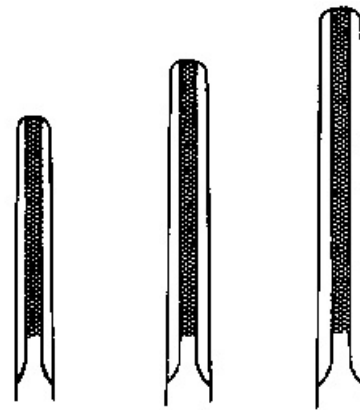

14,0 cm/5½" 14.796
 18,0 cm/7" 14.797
 20,0 cm/8" 14.798

mit U
 with guard
 avec protection
 con protección

14



Lister
Sinusklemmen
Sinus Forceps
Pincès à sinus
Pinzas para seno
14.825 13,0 cm/5"
14.826 16,0 cm/6¼"
14.827 18,0 cm/7"

Korn-(Polypen-) zangen, Polypus and Dressing Forceps
Pincès à pansements et à polypes, Pinzas para pólipos y vendajes



14.821
gerade, straight
droite, recta

Gross
20,0 cm/8"

14.822
gebogen, curved
courbe, curva

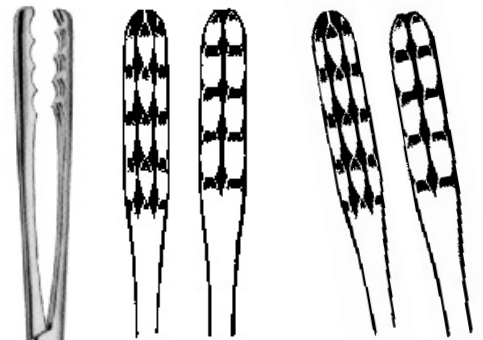

14.851	22,0 cm/8¾"	14.853
14.852	25,0 cm/10"	14.854
gerade		gebogen
straight		curved
droite		courbe
recta		curva

Tupferzangen
Cotton Swab Forceps
Pincès à tampons
Pinzas para tampones

Ulrich

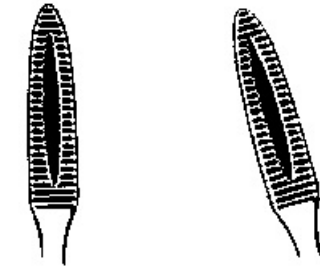

14.855 22,0 cm/8¾" 14.857
 14.856 25,0 cm/10" 14.858

Korn-(Polypen-) zangen
 Polypus and Dressing Forceps
 Pinces à pansements et à polypes
 Pinzas para pólipos y vendajes

Maier

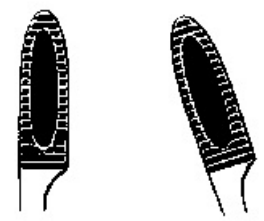
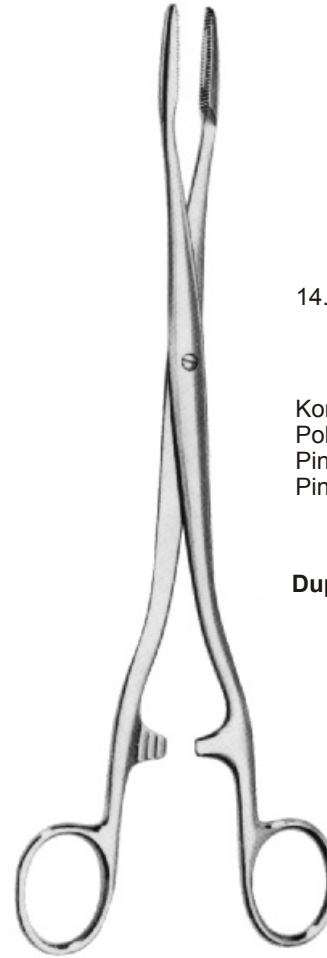

14.861 25,0 cm/10" 14.862

Korn-(Polypen-) zangen
 Polypus and Dressing Forceps
 Pinces à pansements et à polypes
 Pinzas para pólipos y vendajes

Duplay

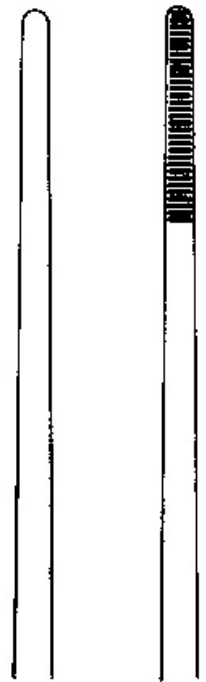

14.865 14.866



Tupferzangen
 Cotton Swab Forceps
 Pinces à tampons
 Pinzas para tampones



14.867 14.868

Bozemann
 26,0 cm/10¼"

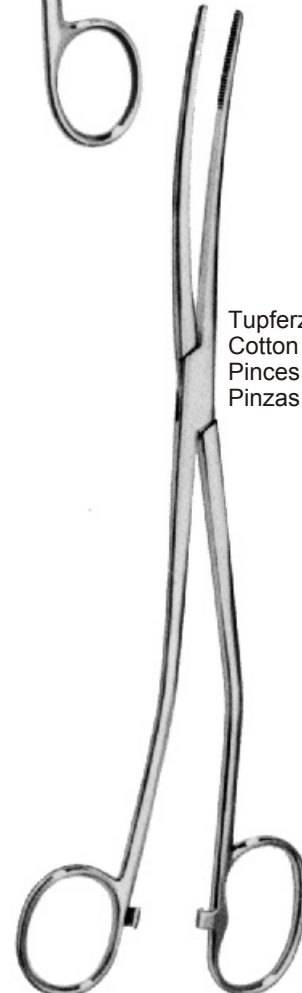

Tupferzangen
 Cotton Swab Forceps
 Pinces à tampons
 Pinzas para tampones

Bozemann-Douglas
 26,0 cm/10¼"
 14.869

14

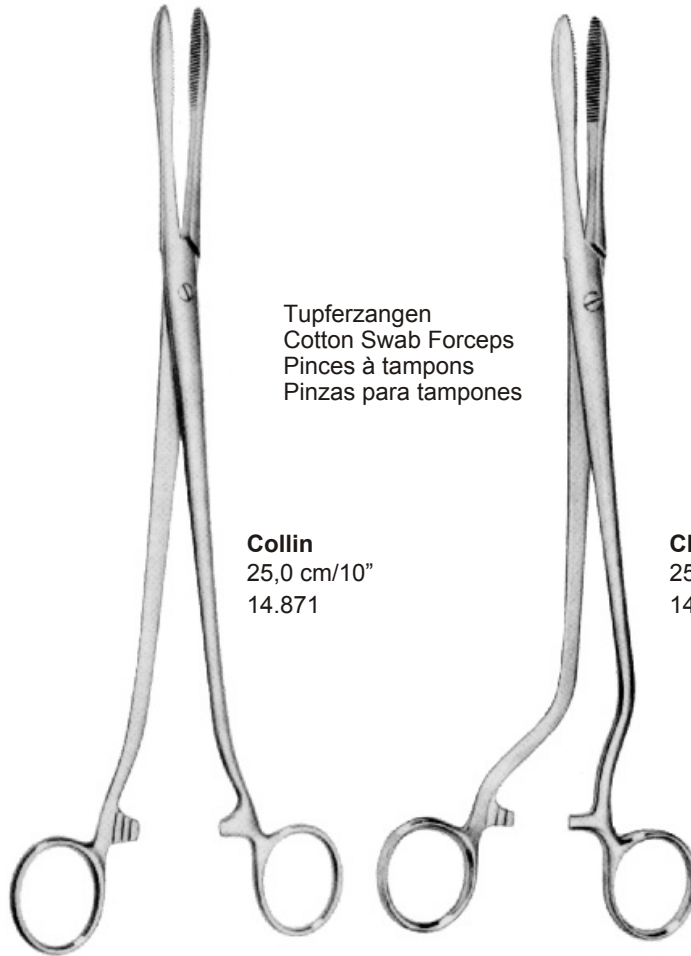

Tupezangen
Cotton Swab Forceps
Pinces à tampons
Pinzas para tampones

Collin
25,0 cm/10"
14.871

Cheron
25,0 cm/10"
14.873

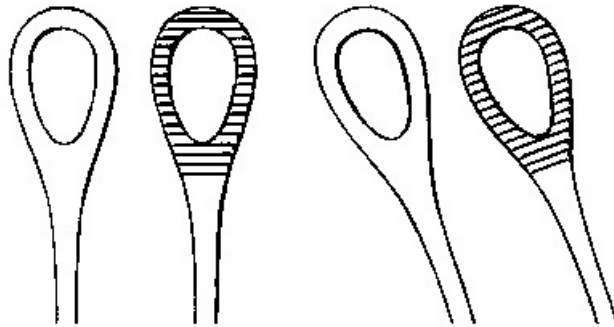

- | | | | | |
|--------|--------|-------------|--------|--------|
| 14.881 | 14.884 | 18,0 cm/7" | 14.887 | 14.890 |
| 14.882 | 14.885 | 20,0 cm/8" | 14.888 | 14.891 |
| 14.883 | 14.886 | 25,0 cm/10" | 14.889 | 14.892 |

14.883L 25,0 cm/10"
Isoliert für Laser- und Elektrochirurgie
Insulated for Laser- and Electrosurgery
Isolé pour les interventions au laser et électrochirurgical
Aislado para láser y electrocirugía

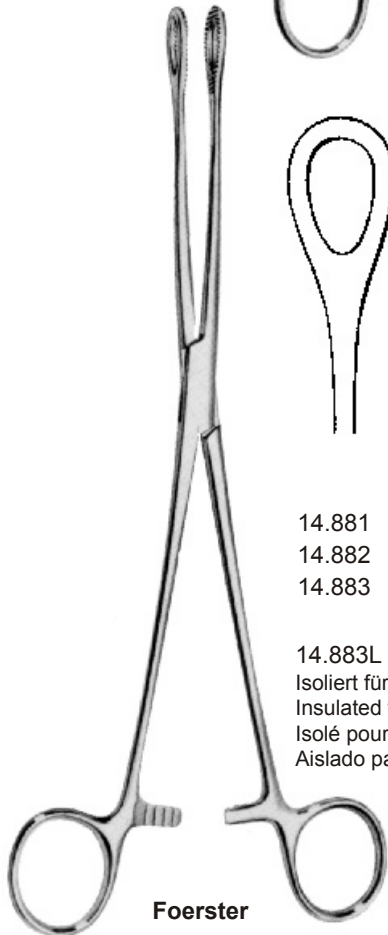

Foerster

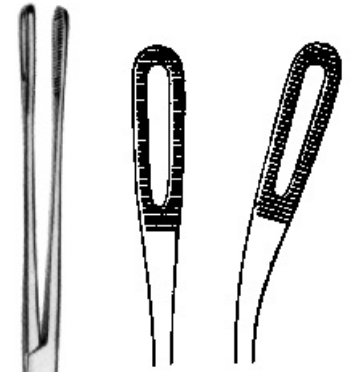

14.893 14.894

Foerster
25,0 cm/10"
schmal
narrow
étroite
estrecha

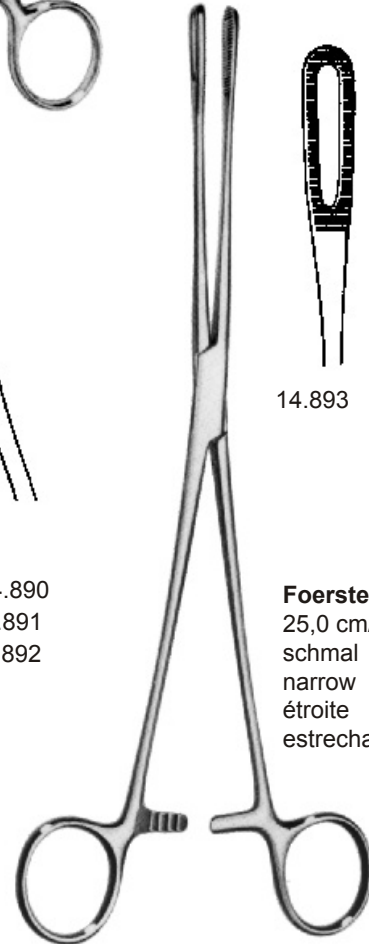

Schwammzangen
Sponge Holding Forceps
Pinces à éponges
Pinzas porta-esponjas

Sterilisierzangen
Sterilizing Forceps
Pinces à stérilisation
Pinzas para esterilización

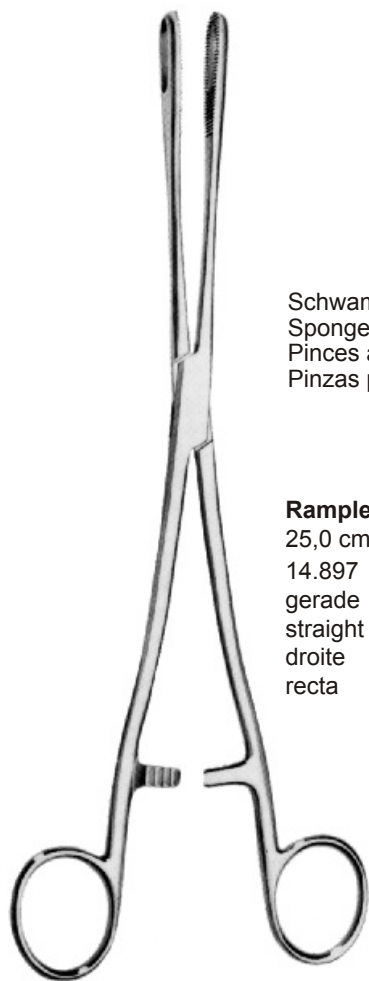

Schwammzange
 Sponge Holding Forceps
 Pinces à éponges
 Pinzas porta-esponjas

Rampley
 25,0 cm/10"
 14.897 gerade
 straight
 droite
 recta

14.898 gebogen
 curved
 courbe
 curva

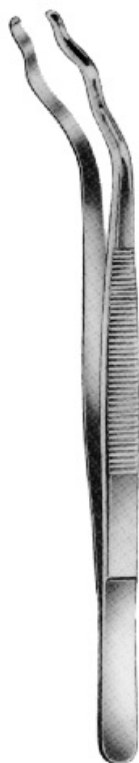

Davis
 Sterilisierpinzette
 Sterilizing Forceps
 Pinces à stérilisation
 Pinzas para esterilización
 14.901 16,0 cm/6¼"
 14.902 20,0 cm/8"
 14.903 24,0 cm/9½"

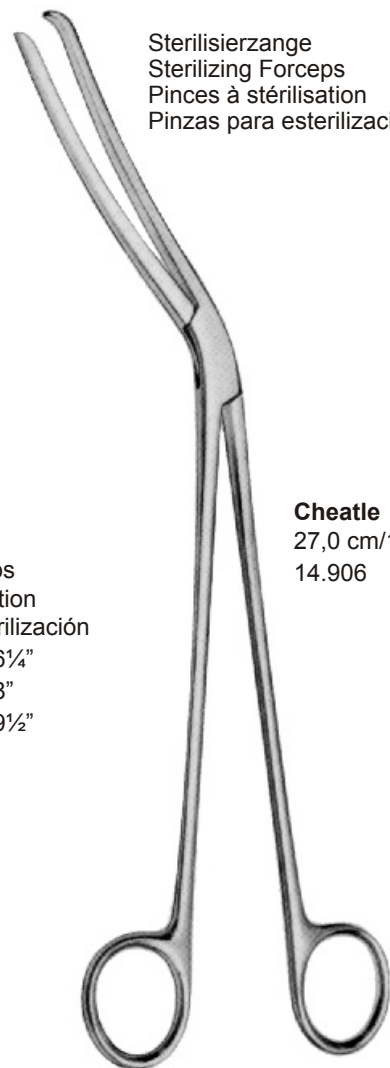

Sterilisierzange
 Sterilizing Forceps
 Pinces à stérilisation
 Pinzas para esterilización

Cheatle
 27,0 cm/10½"
 14.906

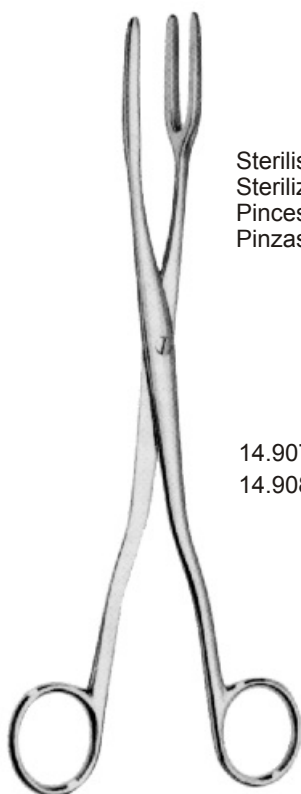

Sterilisierzange
 Sterilizing Forceps
 Pinces à stérilisation
 Pinzas para esterilización

14.907 20,0 cm/8"
 14.908 30,0 cm/12"

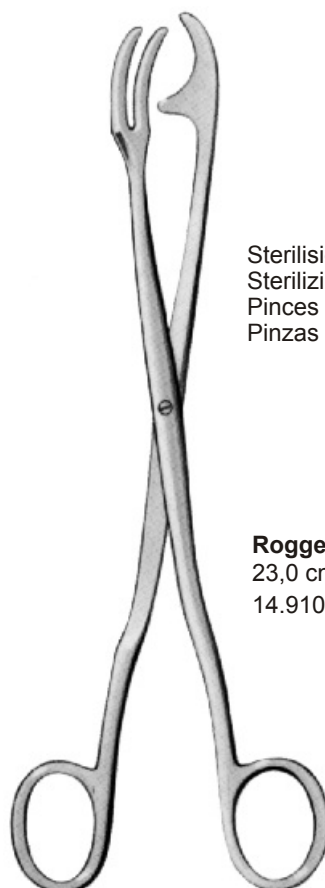

Sterilisierzange
 Sterilizing Forceps
 Pinces à stérilisation
 Pinzas para esterilización

Rogge
 23,0 cm/9"
 14.910

Dermatologie
Dermatology
Dermatologie
Dermatologia



Keys

- 15.922 (2 mm)
- 15.923 (3 mm)
- 15.924 (4 mm)
- 15.925 (5 mm)
- 15.926 (6 mm)
- 15.927 (7 mm)
- 15.928 (8 mm)

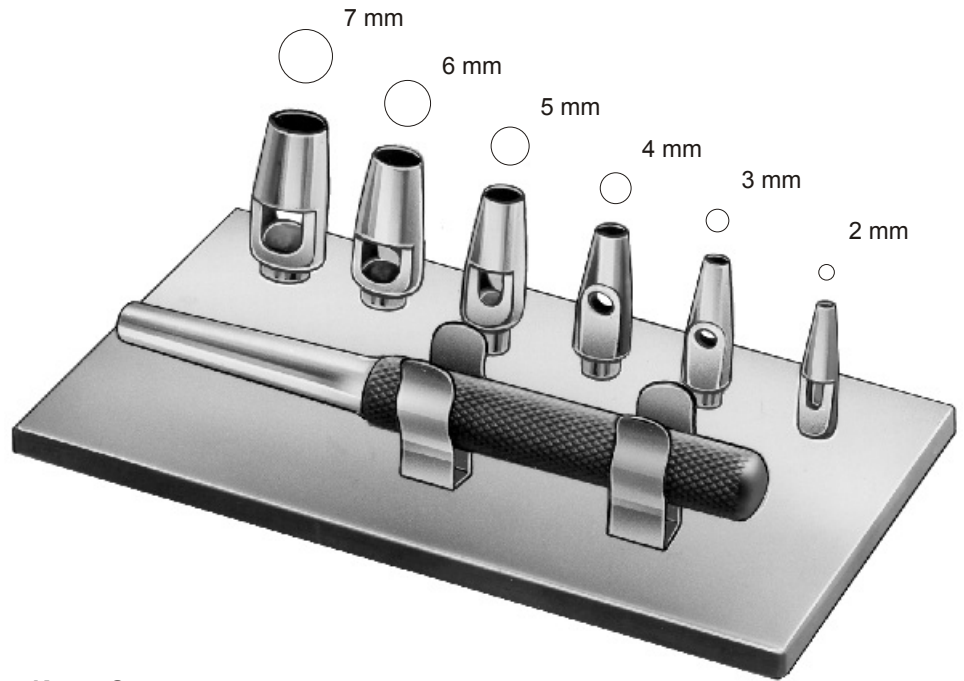

Keys Set

15.930

Hautstanze komplett, mit 6 auswechselbaren Stanzköpfen
Dermal Punch complete, with 6 interchangeable tips
Trépanos cutanés completos, avec 6 embouts interchangeables
Trépanos cutáneos completos, con 6 puntas intercambiables



Schink

1/2

15

15.950

30,0 cm/12"

Dermatom, einstellbar von 0,1 - 2,0 mm, komplett, mit 1 auswechselbarer Klinge und 2 Spannplatten

Dermatome, adjustable from 0,1 to 2,0 mm, complete, with 1 interchangeable blade and 2 skin straightening blades

Dermatome, réglable en épaisseur de 0,1 à 2,0 mm, complet, avec 1 lame interchangeable et 2 plaques pour tendre la peau

Dermátomo, graduable de 0,1 hasta 2,0 mms, completo, con 1 hoja intercambiable y 2 placas para extender la piel

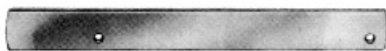

15.951

1/2

Ersatzklinge, allein
Spare blade only
Lame de rechange, seule
Hoja de repuesto, suelta

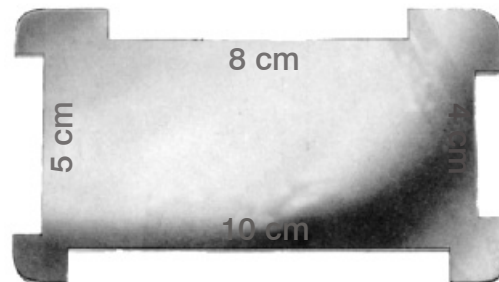

15.952

1/2

Spannplatte, allein
Skin straightening plate only
Plaque pour tendre la peau, seule
Placa para extender la piel, suelta



Silver

1/2

15.953

19,0 cm/7 1/2"

Dermatom
Dermatome
Dermatome
Dermátomo



15

Lupusküretten
Lupus curettes
Curettes pour le lupus
Curetas para lupus

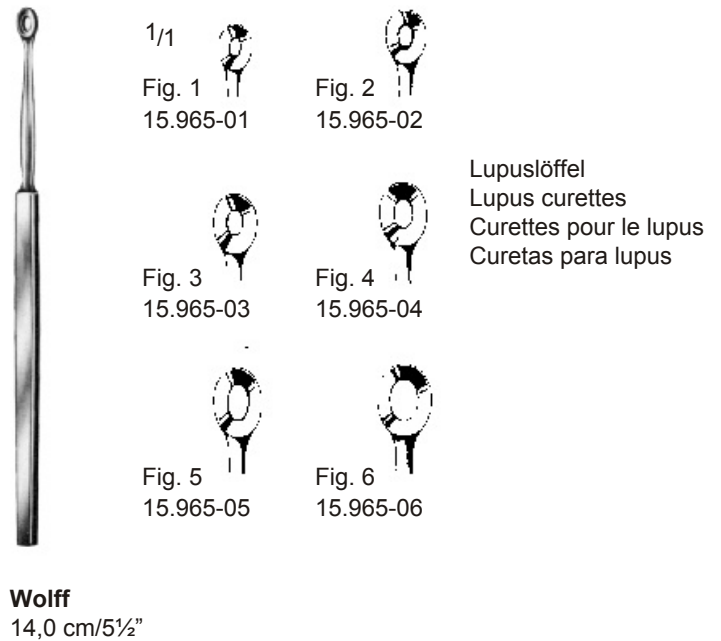
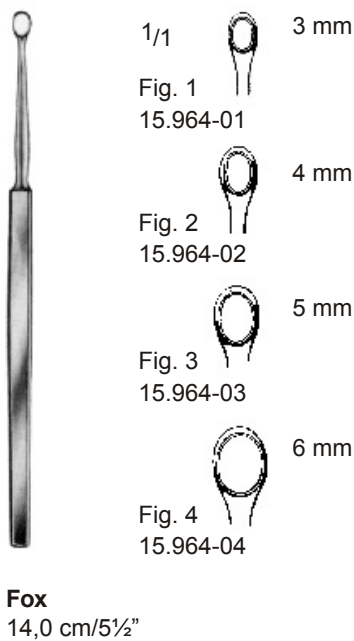

15



Unna
14,5 cm/5½"
oval, oval
ovale, oval
15.966

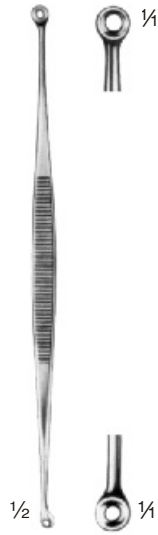

Unna
14,5 cm/5½"
rund, round
ronde, redondo
15.967



Saalfeld
11,0 cm/4"
15.968-11



Saalfeld
14,5 cm/6"
15.968-14



Schamberg
9,5 cm/4"
15.969

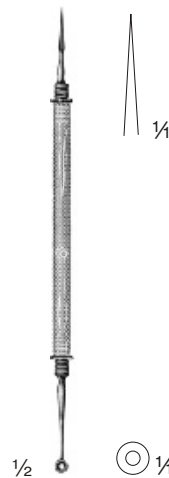

Unna-Vidal
11,5 cm/4½"
15.970

Messer, Skalpele
Knives, Scalpels
Couteaux, Bistouris
Cuchillos, Bisturías

16



16

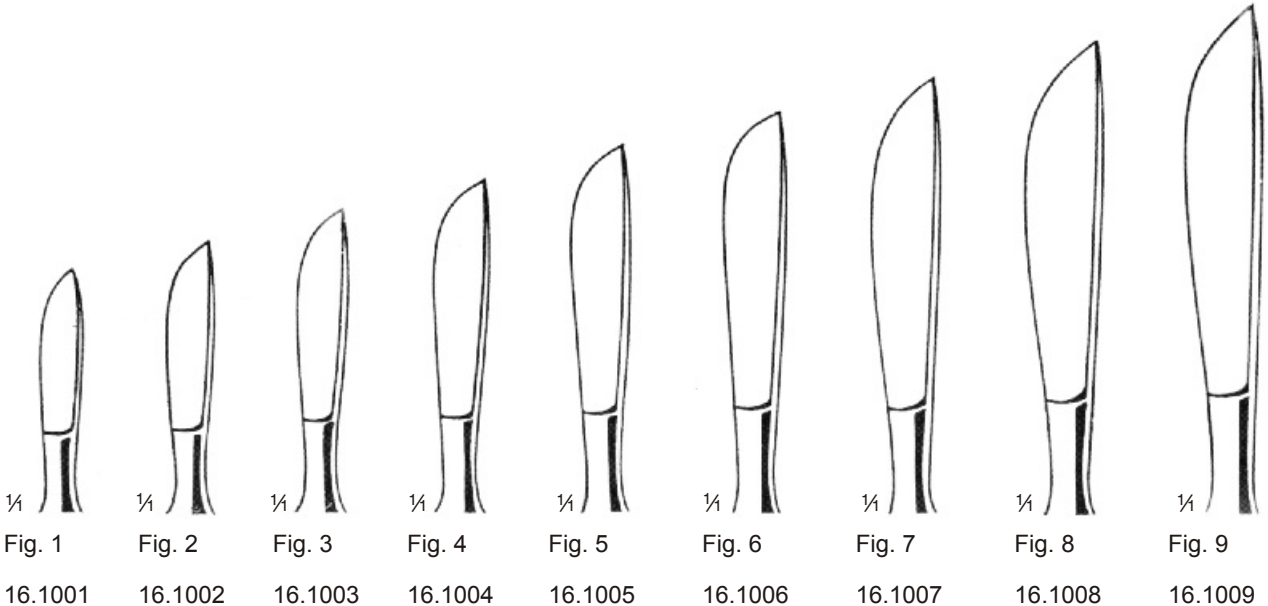

¼ Fig. 1 16.1001 ¼ Fig. 2 16.1002 ¼ Fig. 3 16.1003 ¼ Fig. 4 16.1004 ¼ Fig. 5 16.1005 ¼ Fig. 6 16.1006 ¼ Fig. 7 16.1007 ¼ Fig. 8 16.1008 ¼ Fig. 9 16.1009

17,0 cm/6¾"
massiv
solid
massif
macizo

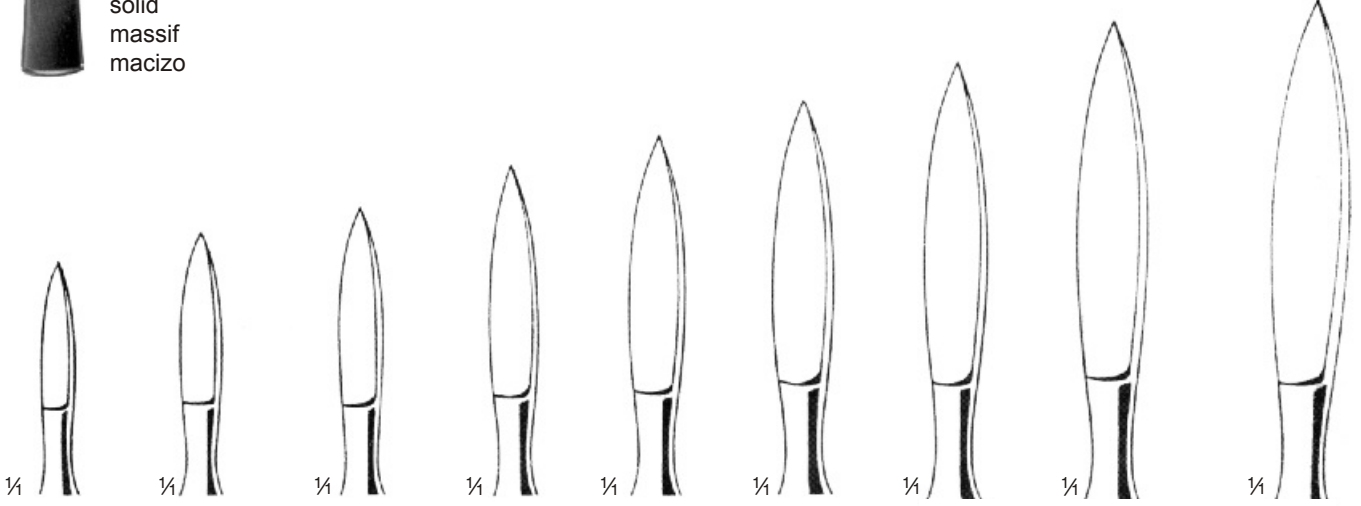

¼ Fig. 10 16.1010 ¼ Fig. 11 16.1011 ¼ Fig. 12 16.1012 ¼ Fig. 13 16.1013 ¼ Fig. 14 16.1014 ¼ Fig. 15 16.1015 ¼ Fig. 16 16.1016 ¼ Fig. 17 16.1017 ¼ Fig. 18 16.1018

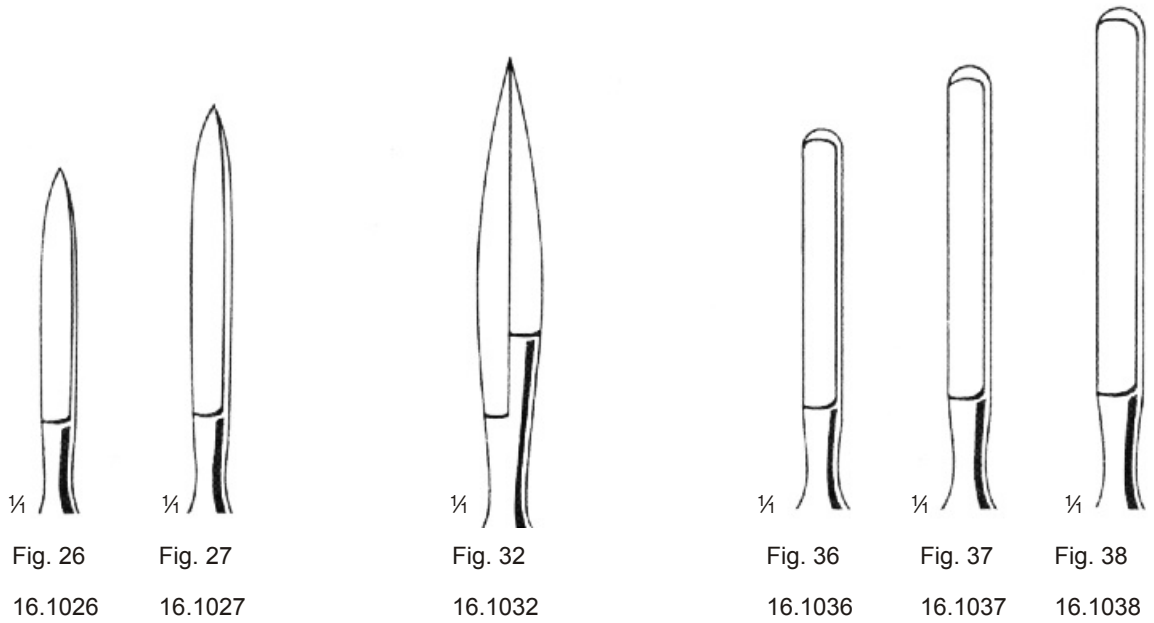

16

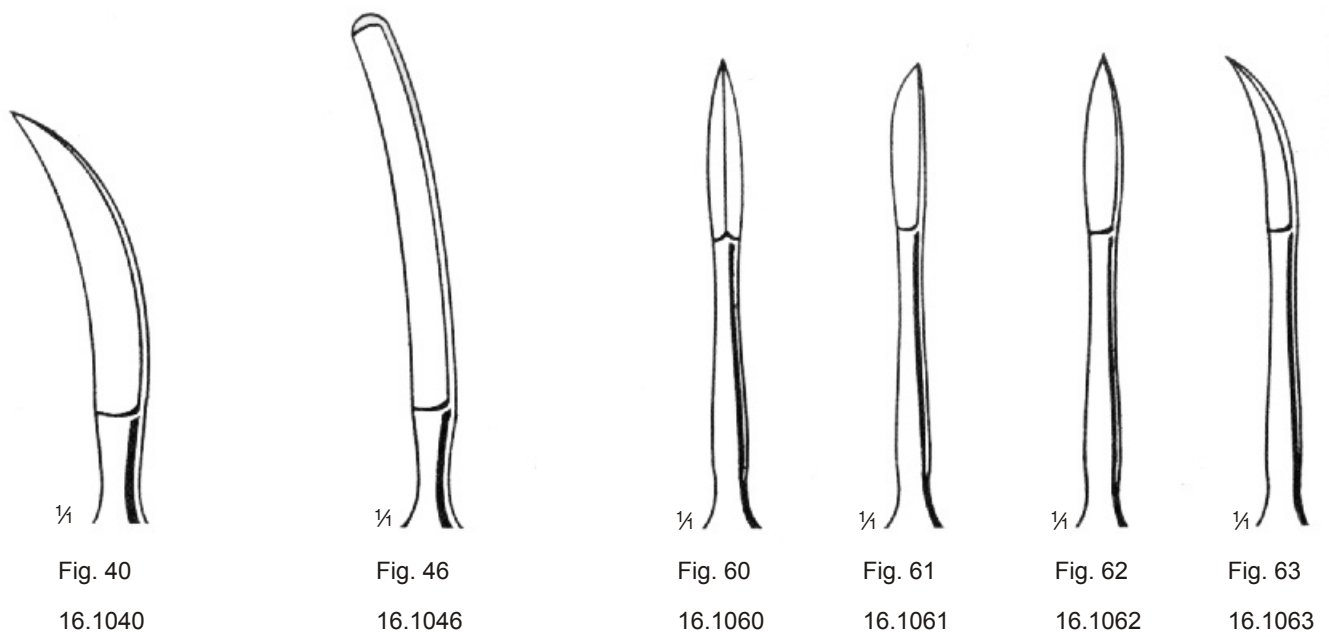

16



Collin
15,0 cm/6"
Fig. 1-6

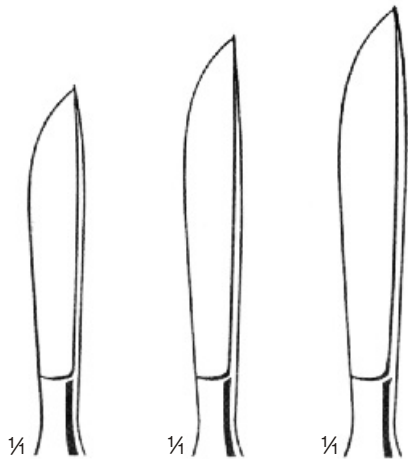

Fig. 1
16.1071

Fig. 2
16.1072

Fig. 3
16.1073

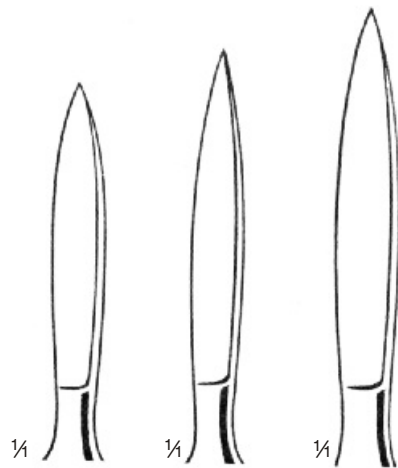

Fig. 4
16.1074

Fig. 5
16.1075

Fig. 6
16.1076



Dieffenbach
17,0 cm/6¾"
Fig. 1-9

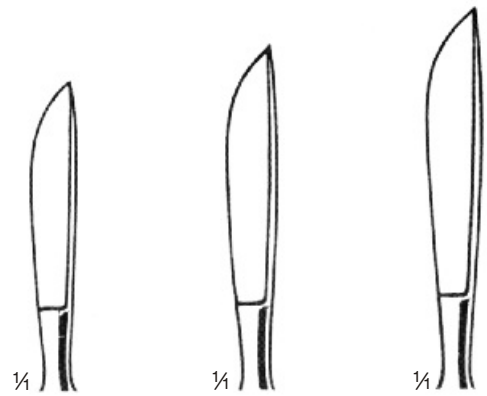

Fig. 1
16.1081

Fig. 2
16.1082

Fig. 3
16.1083

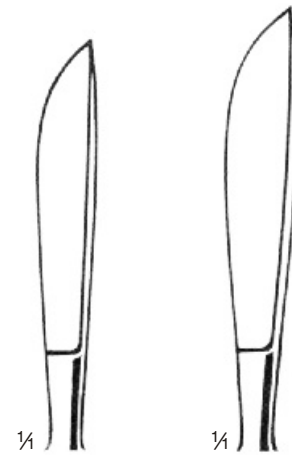

Fig. 4
16.1084

Fig. 5
16.1085

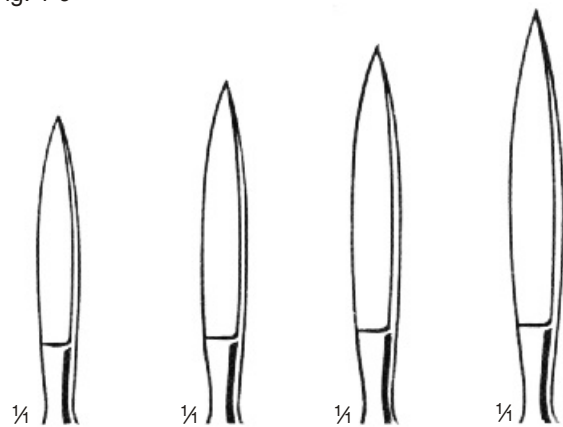
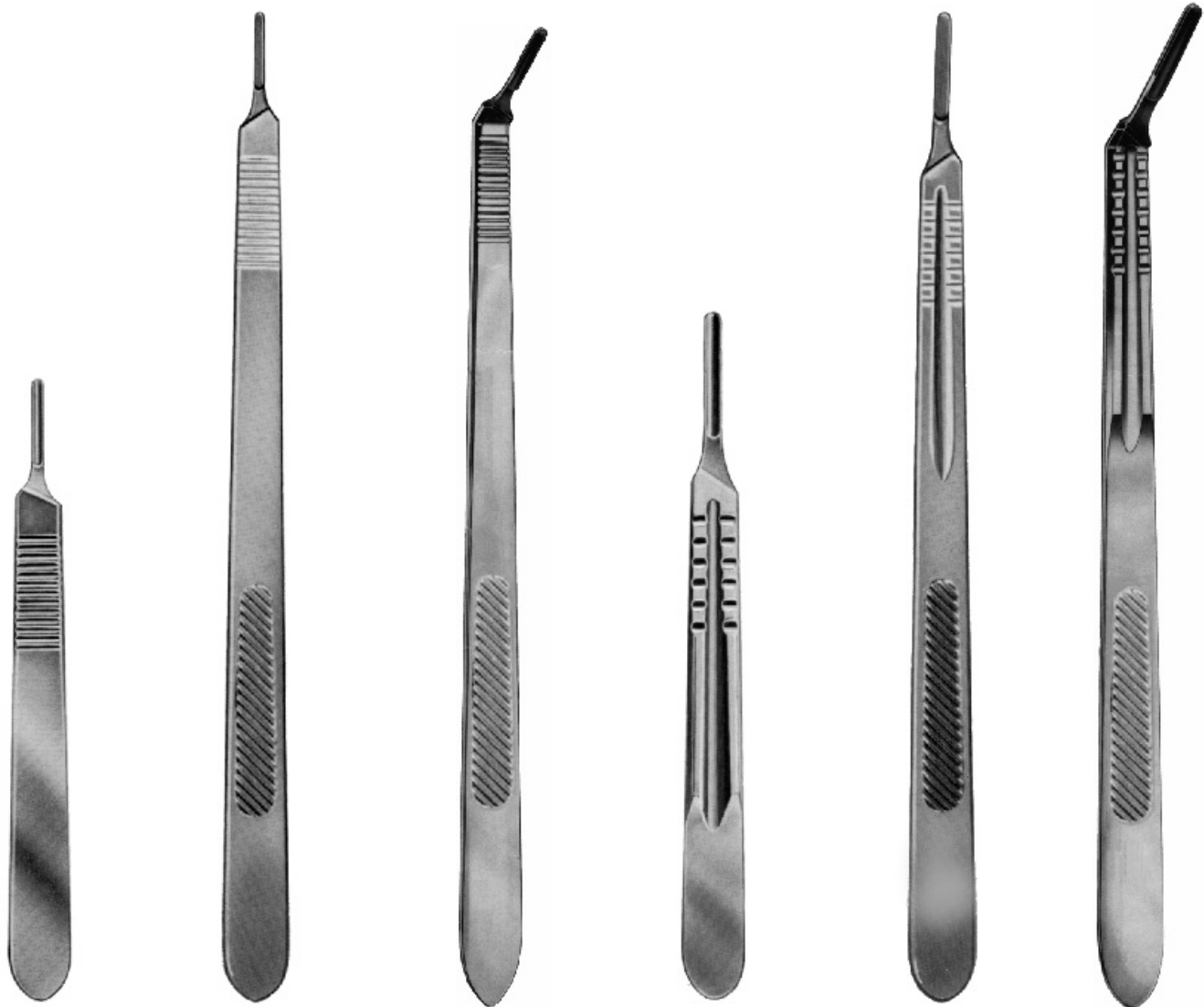

Fig. 6
16.1086

Fig. 7
16.1087

Fig. 8
16.1088

Fig. 9
16.1089



16

Standard

16.1091
No. 3
massiv
solid
massif
macizo

16.1092
No. 3L
massiv
solid
massif
macizo

16.1092G
No. 3L
massiv, abgewinkelt
solid, angular
massif, coudé
macizo, acodado

Standard

16.1095
No. 4
massiv
solid
massif
macizo

16.1096
No. 4L
massiv
solid
massif
macizo

16.1096G
No. 4L
massiv, abgewinkelt
solid, angular
massif, coudé
macizo, acodado

16



Standard
16.1097
No. 7
massiv
solid
massif
macizo



16.1097K
No. 7K
massiv
solid
massif
macizo



16.1098
No. 8
hohl
hollow
creux
hueco

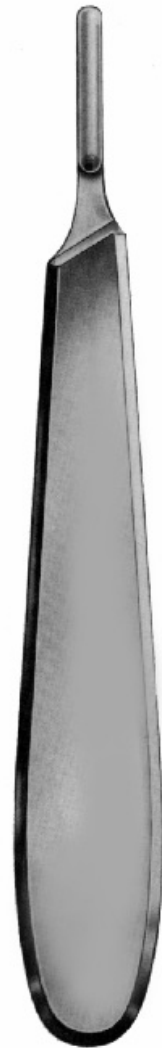

16.1099
No. 9
hohl
hollow
creux
hueco

steril
 sterile
 stériles
 estériles

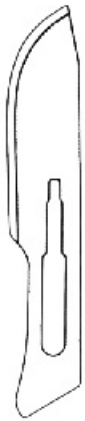

Fig. 10
Standard

16.1110

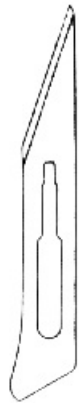

Fig. 11
Standard

16.1111



Fig. 12
Standard

16.1112



Fig. 13
Standard

16.1113

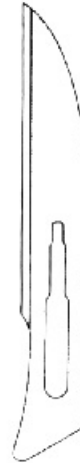

Fig. 14
Standard

16.1114

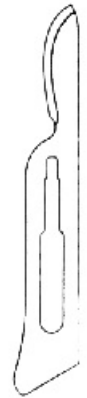

Fig. 15
Standard

16.1116

16

steril
 sterile
 stériles
 estériles



Fig. 16
Standard

16.1116



Fig. 17
Standard

16.1117

Verkaufseinheit: Pack à 100 Stück
 Sales unit: Package of 100 pieces
 Quantité de vente: Paquet de 100 pièces
 Unidad de venta: Paquet de 100 piezas

steril
sterile
stériles
estériles

16

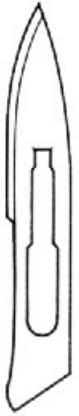

Fig. 18
Standard

16.1118



Fig. 19
Standard

16.1119



Fig. 20
Standard

16.1120

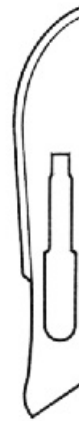

Fig. 21
Standard

16.1121



Fig. 22
Standard

16.1122



Fig. 23
Standard

16.1123

steril
sterile
stériles
estériles



Fig. 24
Standard

16.1124



Fig. 25
Standard

16.1125



Fig. 34
Standard

16.1134



Fig. 36
Standard

16.1136

Verkaufseinheit: Pack à 100 Stück
Sales unit: Package of 100 pieces
Quantité de vente: Paquet de 100 pièces
Unidad de venta: Paquet de 100 piezas



Lappenmesser
 Flap knife
 Couteau lobaire
 Cuchilla para lóbulos

Phalangenmaesser
 Phalangeal knife
 Couteau à phalanges
 Cuchilla para falanges

Zwischenknochen-
 messer
 Interosseous knife
 Couteaux interosseux
 Cuchillas interóseos

16

Schnittlänge
 Length of blades
 Longueur des lames
 Largo de hojas
 cm in.

Catlin

Liston

Langenbeck

9,5	3¾				16.1187
11,0	4½				16.1188
12,0	4¾			16.1185	
13,0	5	16.1171		16.1186	
16,0	6¼	16.1172	16.1175		
17,0	6¾			16.1178	
19,0	7½	16.1173	16.1176		
20,0	8			16.1179	
22,0	8¾	16.1174	16.1177		

16



Langenbeck
geballt, bellied
convexe, convexo



Langenbeck
spitz, pointed
pointu, agudo



Seziernmesser
Autopsy knife
Couteau à autopsie
Cuchillo para autopsia

mit Schaber
with dissector
avec rugine
con raspador

Schnittlänge
Length of blades
Longueur des lames
Largo de hojas

cm	in.			
5,5	2¼	16.1189		16.1190
6,5	2½			16.1191



Organmesser
 Post mortem knife
 Couteau à autopsie
 Cuchillo para órganos

Walb

Schnittlänge	16.1194-11	11,0 cm/4½"
Length of blades	16.1194-14	14,0 cm/5½"
Longueur des lames	16.1194-17	17,0 cm/6¾"
Largo de hojas		



Hirnmesser
 Brain knife
 Couteau à cerveau
 Cuchillo para cerebro

Virchow

16.1195-16	16,0 cm/6¼"
16.1195-20	20,0 cm/8"
16.1195-24	24,0 cm/9½"

Schnittlänge
Length of blades
Longueur des lames
Largo de hojas

9,0 cm/3½"

9,0 cm/3½"

12,0 cm/4¾"

20,0 cm/8"

16



Virchow

16.1196
Metallgriff
Metal handle
Manche en métal
Mango de metal



Virchow

16.1197
Holzgriff
Wooden handle
Manche en bois
Mango de madera



16.1198
Holzgriff
Wooden handle
Manche en bois
Mango de madera



16.1199
Metaalgriff
Metal handle
Manche en métal
Mango de metal

**Rektum Instrumente
Rectal Instruments
Instruments Rectaux
Instrumentos Rectales**

17





17.1201-08 Ø 8 mm
17.1201-10 Ø 10 mm
21,0 cm/8½"
mit Ladekegel und Saugunterbrechung
with charging cone and suction interrupter
avec cône de charge y interruption d'aspiration
con cono-cargador y interruptor de aspiración

17

17.1202-08 Ø 8 mm
17.1202-10 Ø 10 mm
Ladekegel, allein
Charging cone, only
Cône de charge, seul
Cono-cargador, suelto

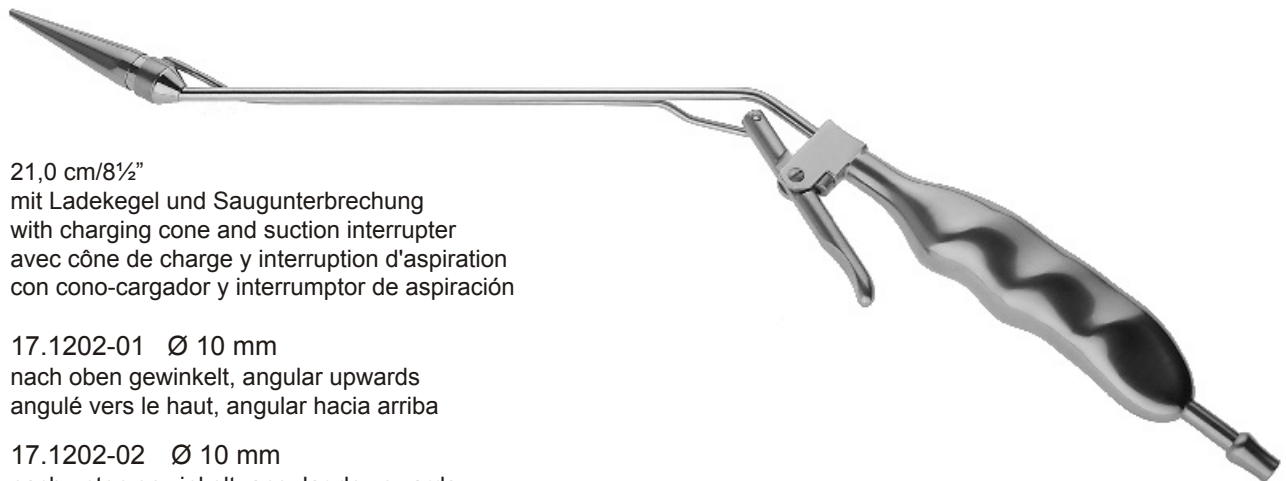

21,0 cm/8½"
mit Ladekegel und Saugunterbrechung
with charging cone and suction interrupter
avec cône de charge y interruption d'aspiration
con cono-cargador y interruptor de aspiración

17.1202-01 Ø 10 mm
nach oben gewinkelt, angular upwards
angulé vers le haut, angular hacia arriba

17.1202-02 Ø 10 mm
nach unten gewinkelt, angular downwards
angulé vers le bas, angular hacia abajo

17.1202-10
Ladekegel 10 mm
Charging cone 10 mm
Cône de charge 10 mm
Cono-cargador 10 mm

17.1203-05
Ligatur-Gummiringe, Packung à 100 Stück
Ligatur rubber rings in package of 100 pieces
Bagues de caoutchouc pour ligatures, paquet de 100 pièces
Arandelas de goma para ligadura en paquete de 100 unidades

Auf Anfrage auch mit Kaltlichtanschluß lieferbar. On request, also available with coldlight connection.
A demande aussi livrable avec connexion de lumière froide. A demanda se puede también suministrar con conexión de luz fría.



17.1203-01
 mit Ladekegel 12 mm, leicht zerlegbar
 with charging cone 12 mm, easily dismantable
 avec cône de charge 12 mm, facilement
 démontable
 con cono-cargador 12 mm, facilmente
 desmontable

17.1203-12
 Ladekegel 12 mm
 Charging cone 12 mm
 Cône de charge 12 mm
 Cono-cargador 12 mm

17.1203-05
 Ligatur-Gummiringe, Packung à 100 Stück
 Ligatur rubber rings in package of 100 pieces
 Bagues de caoutchouc pour ligatures,
 paquet de 100 pièces
 Arandelas de goma para ligadura en paquete
 de 100 unidades

17

Hämorrhoidal-Faßzangen, Hämorrhoidal Forceps, Pincés pour saisir les hémorroïdes, Pinzas hemorroidales



McGivney
 17.1204-01
 19,0 cm/7½"



McGivney
 17.1204-02
 19,0 cm/7½"

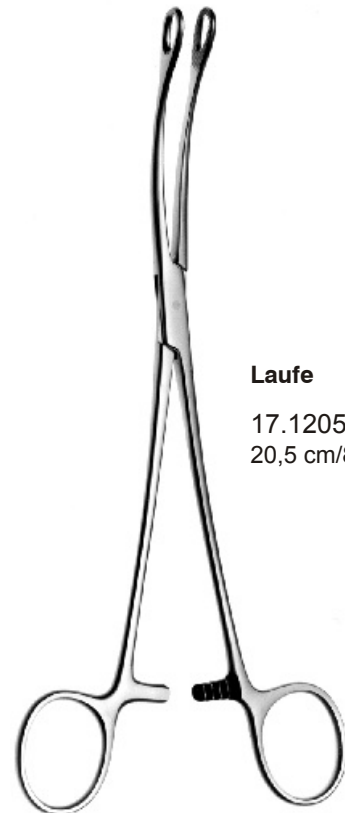

Laufe
 17.1205-20
 20,5 cm/8¼"

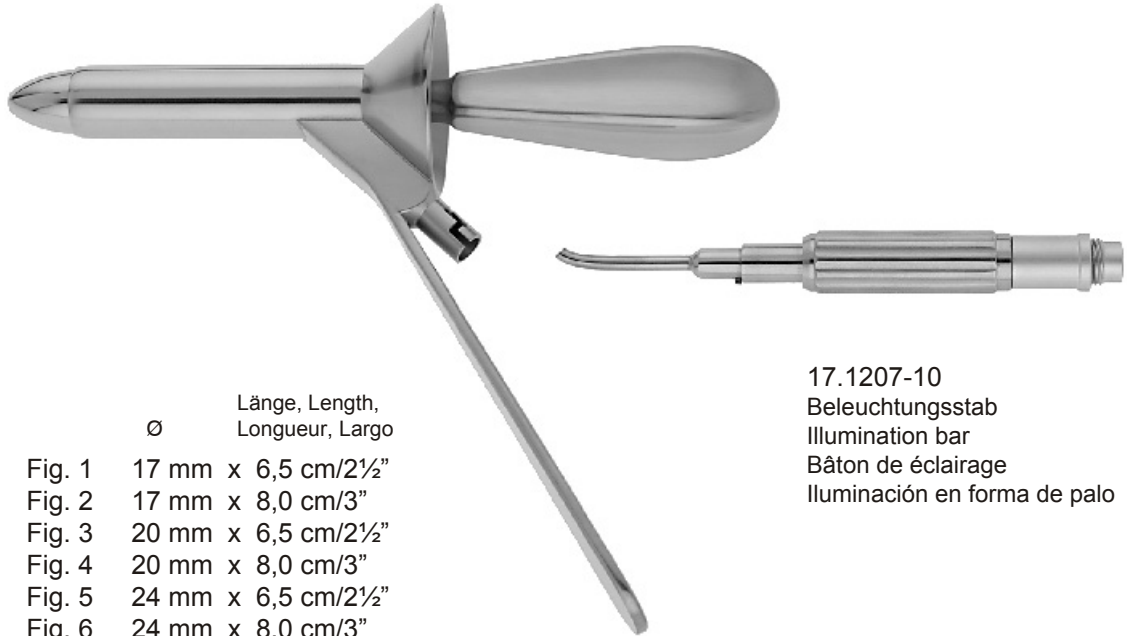

17

Morgan

		∅	Länge, Length, Longueur, Largo
17.1207-01	Fig. 1	17 mm	6,5 cm/2½"
17.1207-02	Fig. 2	17 mm	8,0 cm/3"
17.1207-03	Fig. 3	20 mm	6,5 cm/2½"
17.1207-04	Fig. 4	20 mm	8,0 cm/3"
17.1207-05	Fig. 5	24 mm	6,5 cm/2½"
17.1207-06	Fig. 6	24 mm	8,0 cm/3"

17.1207-10
Beleuchtungsstab
Illumination bar
Bâton de éclairage
Iluminación en forma de palo



Anuskope
Anusscopes
Anusscopes
Anuscopios



Hirschmann

		∅	Länge, Length, Longueur, Largo
17.1208-01	Fig. 1	16 mm	6,5 cm/2½"
17.1208-02	Fig. 2	19 mm	6,5 cm/2½"
17.1208-03	Fig. 3	22 mm	6,5 cm/2½"

Hirschmann

		∅	Länge, Length, Longueur, Largo
17.1208-04	Fig. 4	22 mm	13 cm/5"



Chelsea Eaton

		∅	Länge, Length, Longueur, Largo
17.1209-22	Fig. 1	22 mm	6,5 cm/2½"
17.1209-30	Fig. 2	30 mm	6,5 cm/2½"



Anoskop
 Anuscope
 Anuscope
 Anuscopio

Bensaude

		∅	Länge, Length, Longueur, Largo
17.1210-19	Fig. 1	19 mm	7,0 cm/2¾"
17.1210-22	Fig. 2	22 mm	7,0 cm/2¾"



Sphinkteroskope
Sphincteroscopes
Sphinctérosopes
Esfincteroscopios

17

Kelly

		Ø	Länge, Length, Longueur, Largo
17.1211-21	Fig. 1	21 mm	5,0 cm/2"
17.1211-25	Fig. 2	25 mm	5,0 cm/2"

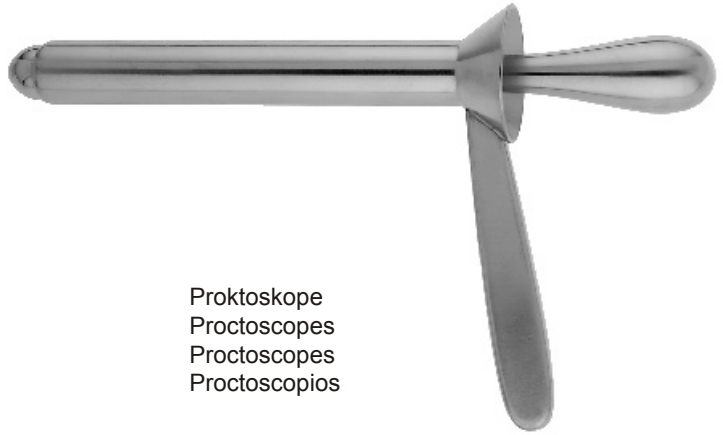

Proktoskope
Proctoscopes
Proctoscopes
Proctoscopios

Kelly

		Ø	Länge, Length, Longueur, Largo
17.1212-01	Fig. 1	22 mm	5,0 cm/2"
17.1212-02	Fig. 2	22 mm	10,0 cm/4"
17.1212-03	Fig. 3	22 mm	14,5 cm/6"
17.1212-04	Fig. 4	22 mm	20,0 cm/8"



Anuskope
Anusopes
Anusopes
Anuscopios

Ives-Fansler

		Ø	Länge, Length, Longueur, Largo
17.1213-22		22 mm	9,5 cm/4"

mit Kaltlichtanschluß
with cold light connection
avec connexion de lumière froide
con conexión de luz fría

Ives-Fansler

		Ø	Länge, Length, Longueur, Largo
17.1214-22		22 mm	9,5 cm/4"



Analspreizer
 17.1215-01
 18,0 cm/7"
 15/30 x 70 mm

17.1215-10
 Kaltlichtaufsatz
 Cold light attachment
 Élément de lumière froide
 Empalme de luz fría



Analspreizer
 18,0 cm/7"
 15/30 x 70 mm

 17.1215-02
 mit Kaltlichtaufsatz
 with cold light attachment
 avec élément de lumière
 froide
 con empalme de luz fría

17



70 x 22 mm

Mastdarm-Spekula
 Rectal Specula
 Spéculums rectaux
 Espéculos rectales

Barr

17.1216-17
 17,0 cm/6¾"

Analspreizer
 Anal Retractors
 Ecarteurs rectaux
 Separadores rectales

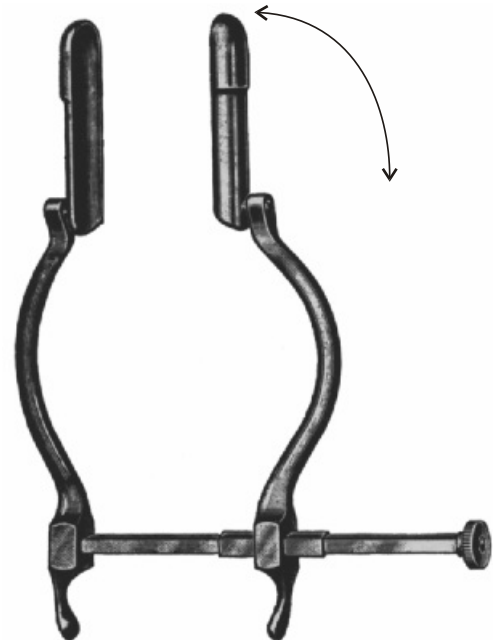

Smith-Buie

17.1218-15
 15,0 cm/6"

17



Alan Parks

17.1220-00
13,5 cm/13¼"

bestehend aus:
consisting of:
composé de:
compuesto de:

17.1220-01
17.1220-02
17.1220-03 2x
17.1220-04 2x



17.1220-01
Sperrer, allein
Spreader, only
Ecarteur, seul
Separador, suelto

17.1220-02
Mittelblatt, allein
Center blade, only
Valve centrale, seule
Valva central, suelta
95 x 24 mm

17.1220-03
Blatt, allein
Blade, only
Valve, seule
Valva, suelta
75 x 24 mm

17.1220-04
Blatt, allein
Blade, only
Valve, seule
Valva, suelta
95 x 24 mm



Czerny

17.1223-22
22,0 cm/8³/₄"

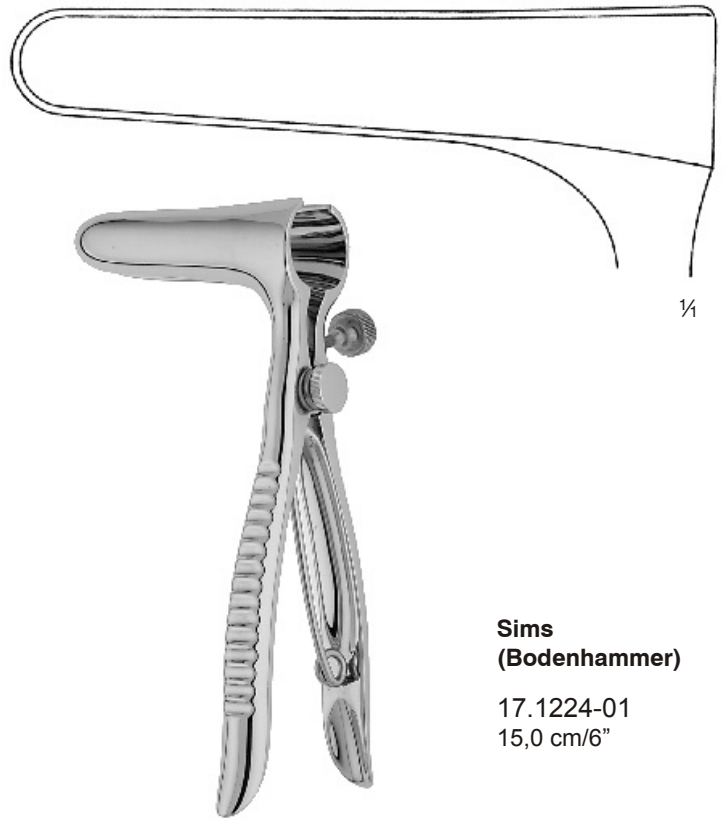

**Sims
(Bodenhammer)**

17.1224-01
15,0 cm/6"

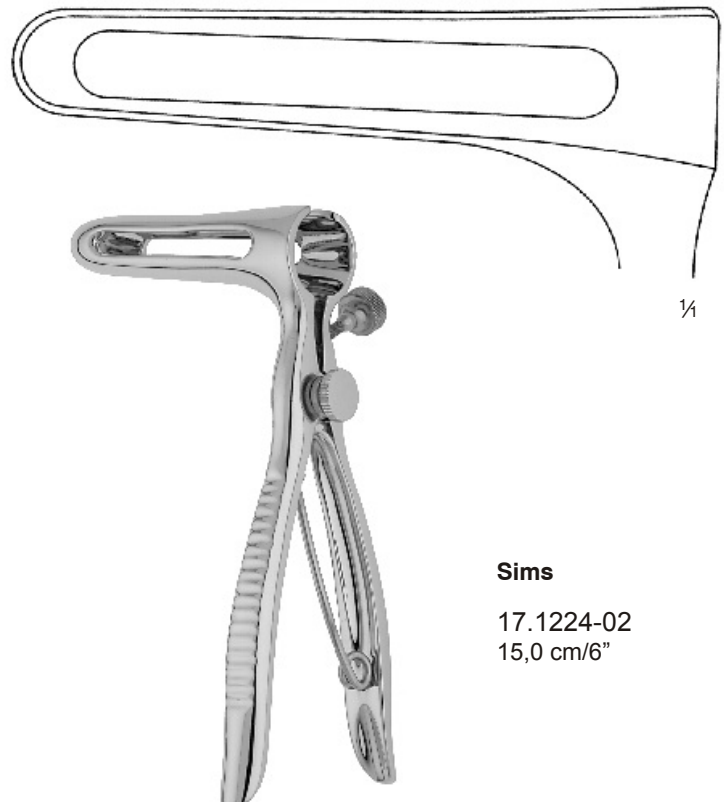

Sims

17.1224-02
15,0 cm/6"

17

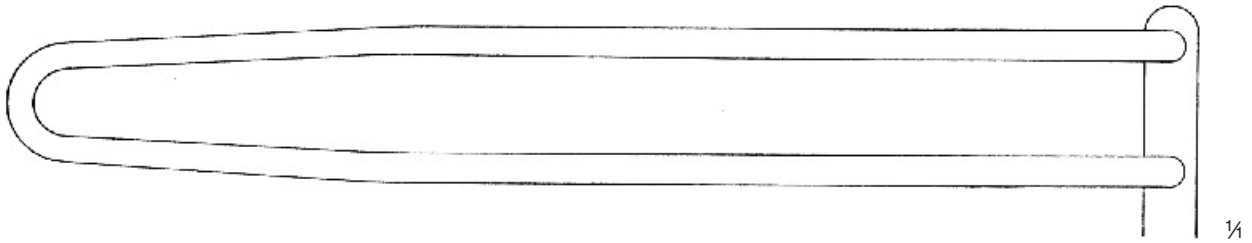

23 x 150 mm

17.1225-01

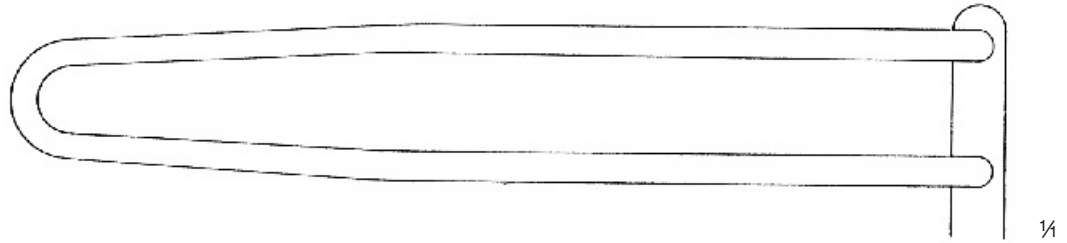

23 x 125 mm

17.1225-02



23 x 80 mm

17.1225-03

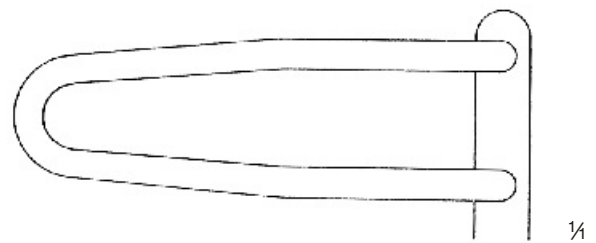

20 x 60 mm

17.1225-04



Sims

Gesamtlänge
Total length,
Longueur totale
Largo total

17.1225-01	24,0 cm/9½"
17.1225-02	24,0 cm/9½"
17.1225-03	24,0 cm/9½"
17.1225-04	17,0 cm/6¾"

Auf Anfrage auch mit Kaltlichtanschluß lieferbar. On request, also available with coldlight connection.
A demande aussi livrable avec connexion de lumière froide. A demanda se puede también suministrar con conexión de luz fría.

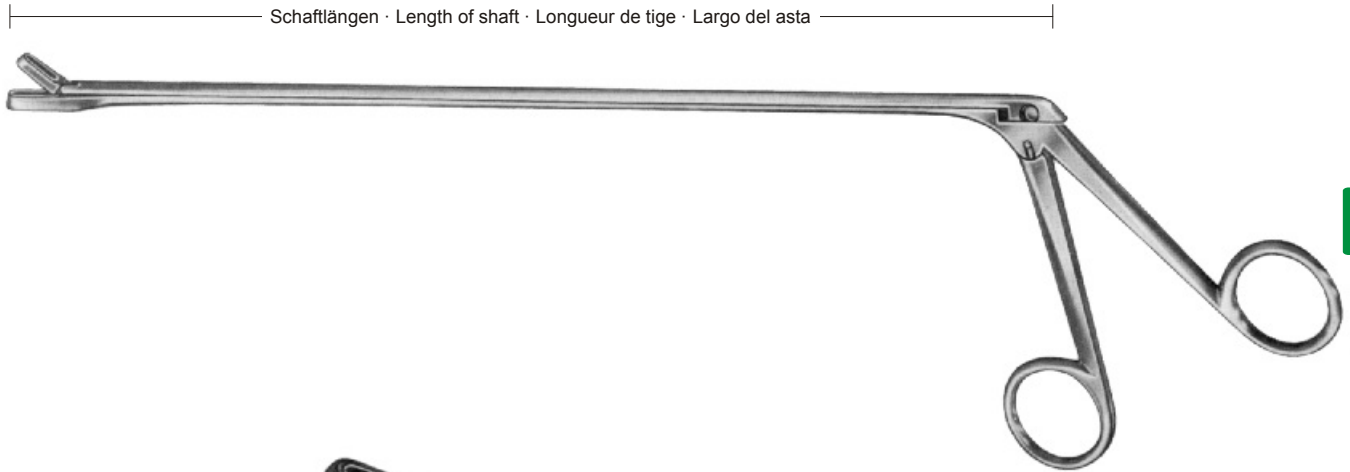

17

Fig. 1

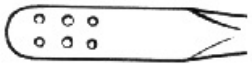
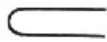

3,5 x 14 mm

Yeoman

17.1230-28	28 cm/11"
17.1230-35	35 cm/13 ³ / ₄ "
17.1230-42	42 cm/16 ¹ / ₂ "

Fig. 2

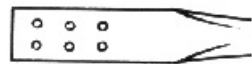
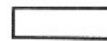

3,5 x 14 mm

Yeoman

17.1231-28	28 cm/11"
17.1231-35	35 cm/13 ³ / ₄ "
17.1231-42	42 cm/16 ¹ / ₂ "

17

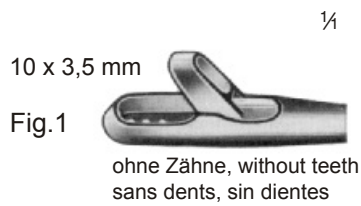
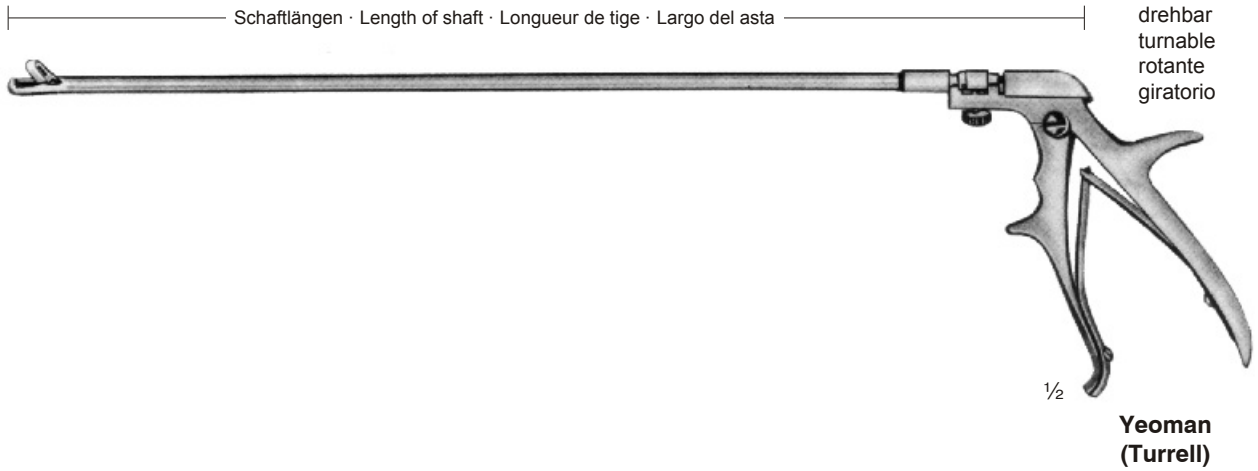

Zange komplett mit Griff Forceps complete with handle Pince complète avec manche Pinza completa con mango	Schaftlänge Length of shaft Longueur de tige Largo del asta	Aufsatz allein Attachment only Embout seul Punta suelta
17.1233-33	33 cm / 13"	17.1233-01
17.1233-40	40 cm / 16"	17.1233-02
17.1234-33	33 cm / 13"	17.1234-01
17.1234-40	40 cm / 16"	17.1234-02
17.1235-33	33 cm / 13"	17.1235-01
17.1235-40	40 cm / 16"	17.1235-02
17.1236-33	33 cm / 13"	17.1236-01
17.1236-40	40 cm / 16"	17.1236-02



Universal
17.1240-01



Yeoman
17.1240-02
Ringgriff
Ring Handle
Manche d'anneaux
Mango de anillo



Walton
17.1240-03

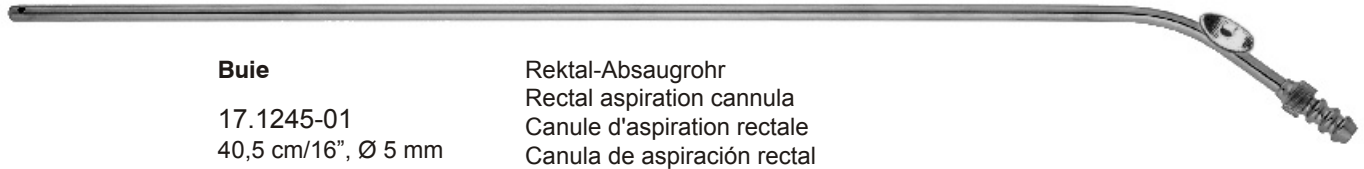

Buie
17.1245-01
40,5 cm/16", Ø 5 mm
Rektal-Absaugrohr
Rectal aspiration cannula
Canule d'aspiration rectale
Canula de aspiración rectal

17

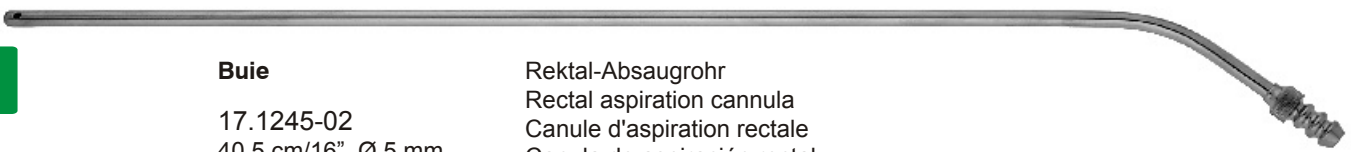

Buie
17.1245-02
40,5 cm/16", Ø 5 mm
Rektal-Absaugrohr
Rectal aspiration cannula
Canule d'aspiration rectale
Canula de aspiración rectal



Larry
17.1246-15
15,0 cm/6"
biegsam, malleable
malléable, maleable
Rektal-Sonde
Rectal director
Sonde rectale
Sonda rectal

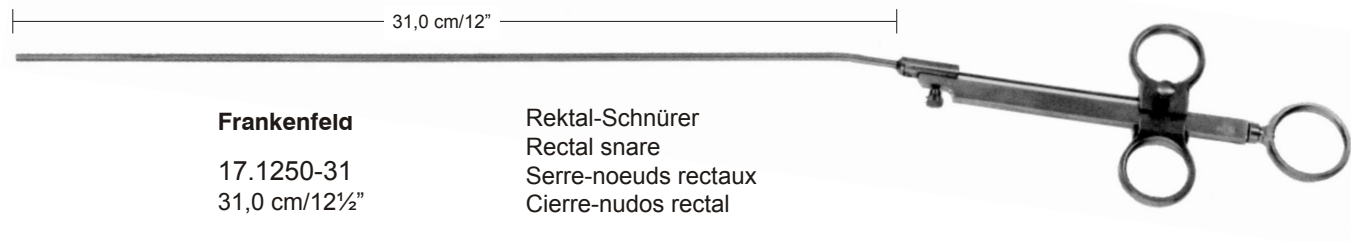

Frankenfeld
17.1250-31
31,0 cm/12½"
Rektal-Schnürer
Rectal snare
Serre-noeuds rectaux
Cierre-nudos rectal



17.1250-03 0,3 mmØ
Pack à 12 Stück
Pack of 12 pieces
Paquet à 12 pièces
Paquete con 12 piezas
Stahldraht für Rektalschnürer
Steel wire for rectal snares
Anses en fil d'acier pour serre- noeuds rectaux
Alambre de acero para cierre-nudos rectales



Frankfeldt

17.1251-36 36,0 cm/14½"

Dreiteiliges Maul
Jaw of three pieces
Mors à trois pièces
Boca de tres piezas

7



17.1252-28 28,0 cm/11¼"

17.1252-38 38,0 cm/15¼"

Zweiteiliges Maul
Jaw of two pieces
Mors à deux pièces
Boca de dos piezas



Eder

17.1253-28 28,0 cm/11¼"

17.1253-38 38,0 cm/15¼"

Dreiteiliges Maul
Jaw of three pieces
Mors à trois pièces
Boca de tres piezas



17.1260-00
Kaltlichtquelle
Coldlight source
Source de lumière froide
Fuente de luz fría
150 Watt/230 Volt



17

Kaltlichtkabel
Fibre optic cable
Câble de lumière froide
Cable de luz fría

Ø	Länge, Length Longueur, Largo	
	180 cm/72"	230 cm/92"
3,5 mm	17.1261-35	17.1262-35
4,5 mm	17.1261-45	17.1262-45
6,0 mm	17.1261-60	17.1262-60

Adapter für
Adapter for
Adapter pour
Adaptador para

Projektorseite, projector side, côte du projecteur, lado del proyector	
Volpi, Schöilly, Loptec, RFQ	17.1265-01
Storz	17.1265-02
Henke Sass Wolf, Wolf, Richards	17.1265-03
Heine, ACM	17.1265-04
Winter, Ibe	17.1265-05
Olympus	17.1265-06
Schott, Zeiss	17.1265-07
Dyonics	17.1265-08

Instrumentenseite, instrument side, côte de l'instrument, lado del instrumento	
Storz, Winter, Ibe	17.1266-01
Henke Sass Wolf, Wolf, Richards	17.1266-02
ACM, Heine	17.1266-03
Stryker	17.1266-04
Schott, Zeiss	17.1266-05

**Neurochirurgie und Laminektomie
Neurosurgery and Laminectomy
Neurochirurgie et Laminectomie
Neurocirugía y Laminectomía**

18

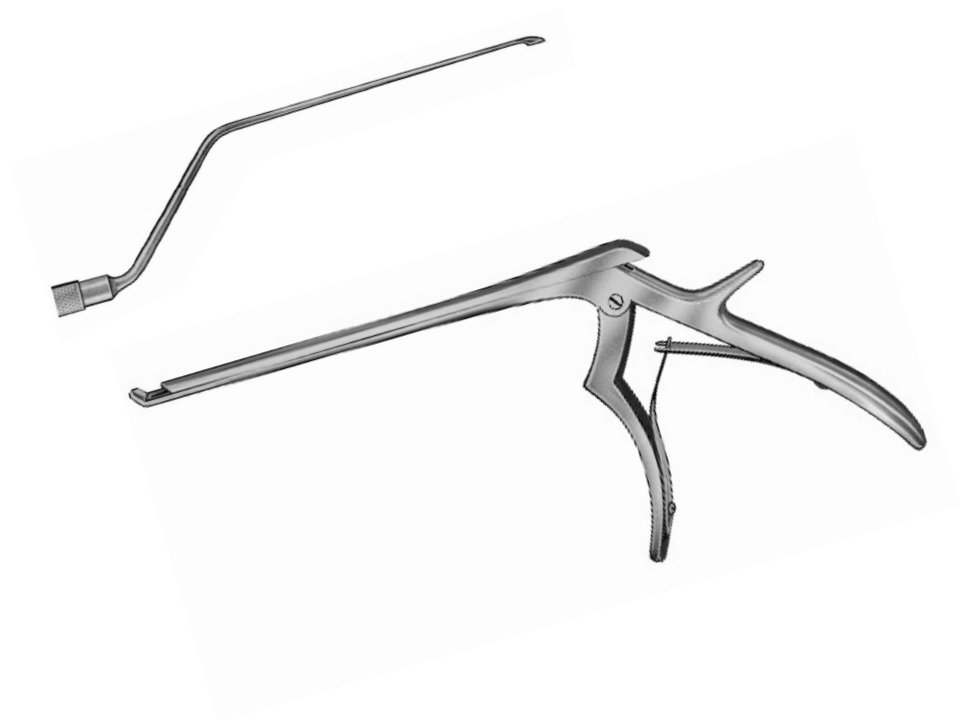

Drahtsäge
Wire Saw
Scie en fil
Sierra de hilo

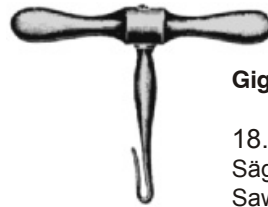
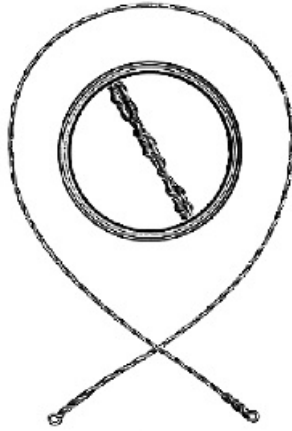

Gigli

18.1323-00
Sägegriff
Saw handle
Manche pour scies
Mango para sierras



18

Olivecrona

2-fach, two-fold, à deux pièces,
de dos piezas
1,2 mmØ

18.1320-30 Fig. 1 30 cm/12"
18.1320-40 Fig. 2 40 cm/16"
18.1320-50 Fig. 3 50 cm/20"
18.1320-60 Fig. 4 60 cm/24"
18.1320-70 Fig. 5 70 cm/28"

Gigli

3-fach, three-fold, à trois pièces,
de tres piezas
1,4 mmØ

18.1321-30 Fig. 1 30 cm/12"
18.1321-40 Fig. 2 40 cm/16"
18.1321-50 Fig. 3 50 cm/20"
1,8 mmØ
18.1322-50 Fig. 1 50 cm/20"

Martel

Einführungsinstrument für Drahtsägen
Conductor for wire saws
Conducteur pour scies en fil
Conductores para sierras de hilo

18.1324-30 30,0 cm/12"
18.1324-33 33,0 cm/13¼"



Dahlgren

18.1328-20
20,0 cm/8"

Schädelzangen
Skull-Cutting Forceps
Pinces pour le crâne
Pinzas para el cráneo



De Vibiss

18.1329-21
21,0 cm/8¼"



18.1340-00
 Schädelhalter für die Extension des Halswirbels, Dorne verstellbar,
 Vorbohren nicht erforderlich

Cervical Traction Tong, for extension of the neck vertebrae,
 pins adjustable hence no initial drilling

Pince de traction crânienne, pour l'extension des vertèbres
 cervicales,
 madrins réglables supprimant la perforation initiale

Pinza de tracción craneal para la extensión de las vertebras de
 cuello,
 puntas ajustables suprimiendo perforaciones iniciales

18.1340-01
 Ersatzdorn, Spare pin only, Pointe de rechange seule,
 Punta de repuesto suelta

Ø 3,5 mm



Ø 5,0 mm



18.1341-04
 3,5 mm

18.1341-05
 5,0 mm

Vorbohrer für Crutchfield Schädelhalter
 Drill Point for Crutchfield Cervical
 Traction Tongs
 Alésoir pour pince de traction
 crânienne de Crutchfield
 Perforador inicial para pinzas de
 tracción craneal de Crutchfield



18

Crutchfield
Fig. 1
18.1341-01
 Schädelhalter
 Cervical Traction Tong
 Pince de traction crânienne
 Pinza de tracción craneal



Crutchfield
Fig. 2
18.1341-02
 Schädelhalter
 Cervical Traction Tong
 Pince de traction crânienne
 Pinza de tracción craneal

18



Cloward
18.1345-16
16,0 cm/6½"



Inge
18.1345-17
16,5 cm/6½"

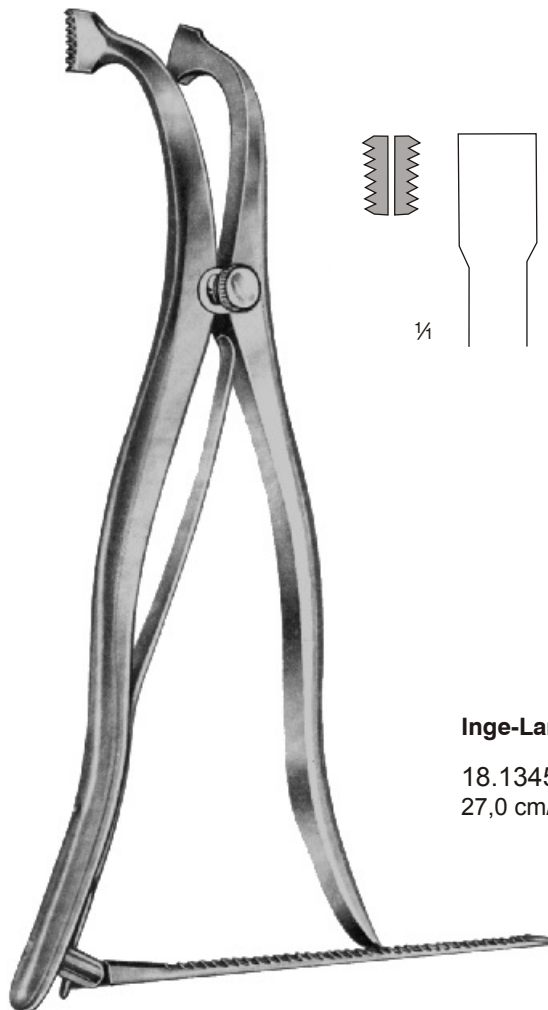

Inge-Lamina
18.1345-27
27,0 cm/10¾"

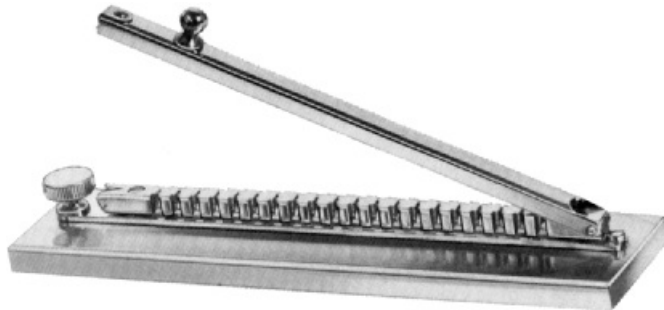

18.1350-01
 Klammernblock mit 1 Klammerbügel
 Brain Clip Carrier, with 1 clip holding rack
 Support porte-agrafe, avec 1 rangée d'agrafes
 Porta-grapas, con 1 riel para grapas
 148 x 40 x 6 mm / 5¾ x 1½ x ¼"

Mc Kenzie

18.1350-02
 Klammernblock mit 2 Klammerbügeln und
 Schiebedeckeln
 Brain Clip Carrier, with 2 clip holding rack and
 sliding covers
 Support porte-agrafe, avec 2 rangée d'agrafes
 et couvercle à glissière
 Porta-grapas, con 2 rieles para grapas y tapas
 corredizas
 190 x 48 x 13 mm / 7½ x 2 x ½"

18



18.1351-00
 100 Stück Silberklammern in Plastikbehälter
 100 pieces Silver Brain Clips in plastic case
 100 pièces agrafes en argent, dans une boîte
 de plastique
 100 piezas grapas de plata en tubo de
 plástico

¼

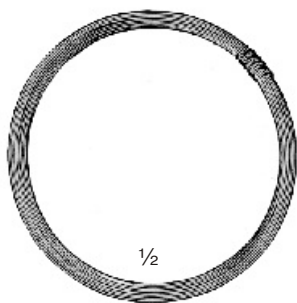

McKenzie

18.1352-00
 Silberdraht in Ringen zu 2,5 Gramm
 Silver Wire in coils of 2,5 g
 Fil d'argent, par rouleaux de 2,5 g
 Hilo de plata en rollos de 2,5 g

½



Raney

18.1354-00
 16,0 cm/6½"
 Anlege- und Abnehmezange für Kopfhaut-klammern
 Applying and Removing Forceps for Scalp Hemostasis
 Clips
 Pince pour appliquer et enlever les clips hémostatiques
 pour le cuir chevelu
 Pinza para aplicar y quitar clips hemostáticas para el
 cuero cabelludo



¼

Raney

18.1353-00
 Kopfhautklammer
 Scalp Hemostasis Clip
 Clip hémostatique pour
 le cuir chevelu
 Clip hemostática para
 el cuero cabelludo

½

18

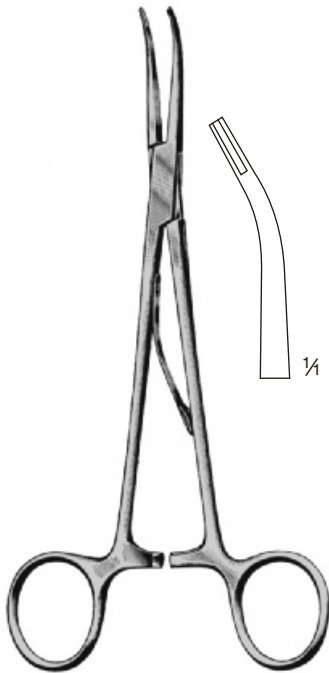

Klammer-Anlegezangen,
gebogen
Clip Applying Forceps,
curved
Pinces pour appliquer des
agrafes, courbes
Pinzas para poner grapas,
curvas

McKenzie

18.1360-15 15,0 cm/6"
18.1360-19 19,0 cm/7½"

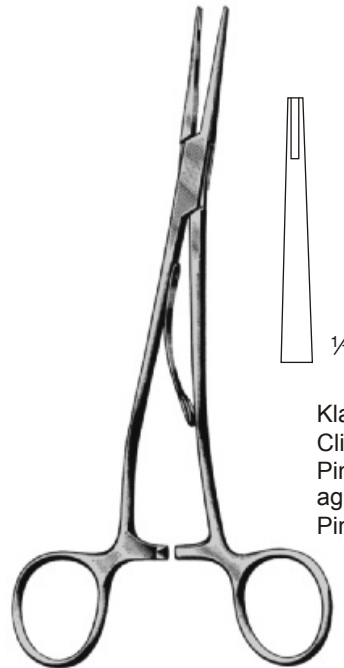

Klammer-Anlegezangen, gerade
Clip Applying Forceps, straight
Pinces pour appliquer des
agrafes, droits
Pinzas para poner grapas, rectas

McKenzie

18.1361-15 15,0 cm/6"
18.1361-19 19,0 cm/7½"

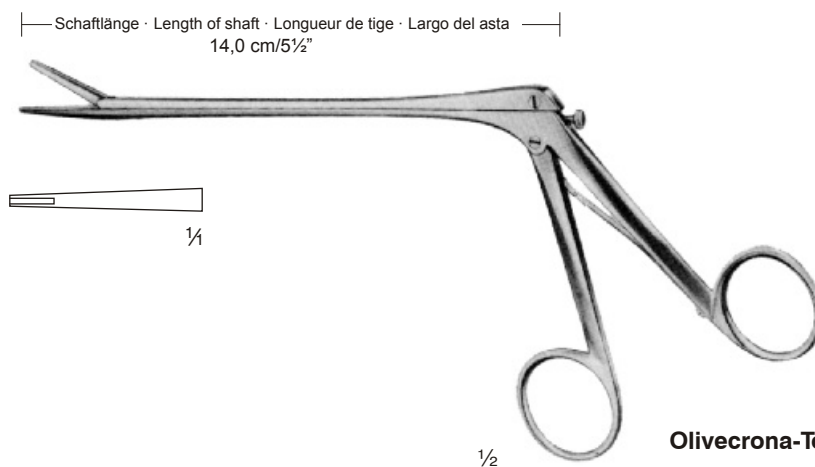

Olivecrona-Toennis

18.1362-14
14,0 cm/5½"

Klammer-Anlegezange
Clip Applying Forceps
Pince pour appliquer des agrafes
Pinza para poner grapa

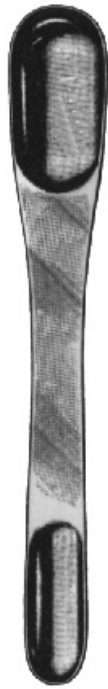

Cushing
18,0 cm/7"

	mm
18.1364-01	7/ 9
18.1364-02	11/13
18.1364-03	15/18
18.1364-04	18/22



Heifetz
biegsam, malleable
malléable, maleable
20,0 cm/8"

	mm
18.1365-08	8
18.1365-11	11
18.1365-14	14
18.1365-17	17
18.1365-20	20

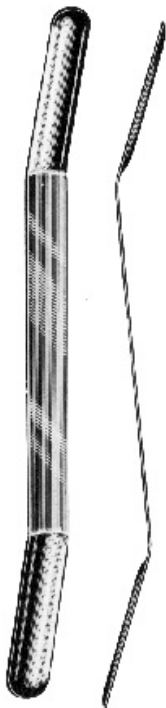

Olivecrona
18,0 cm/7"

Spatelbreite, mm
Width of spatulas, mm
Largeur de spatule, mm
Anchura de espátulas, mm

	oben upper end en haut arriba	unten lower end en bas abajo	
18.1366-01	7	9	18.1367-01
18.1366-02	11	13	18.1367-02
18.1366-03	15	18	18.1367-03
18.1366-04	18	22	18.1367-04

18



Fig. 1
18.1369-01



Fig. 2
18.1369-02



Fig. 3
18.1369-03



Fig. 4
18.1369-04

Caspar
24,5 cm/9³/₄"

geknöpft, isoliert
probe-end, insulated
boutonné, isolé
abotonado, aislado

1/4



Fig. 1
18.1370-01
18,5 cm/7¼"
Fadenführer, geknöpft
Ligature Guide, probe pointed
Passe-fil, boutonné
Guía-ligadura, abotonado

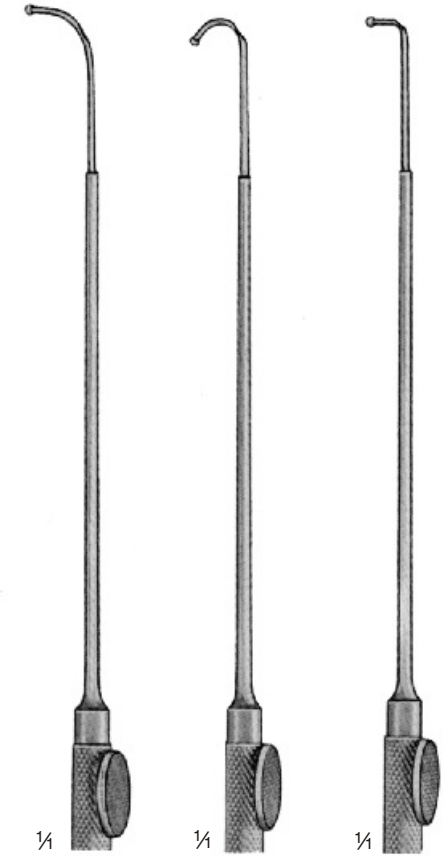

Fig. 2 18.1370-02
Fig. 3 18.1370-03
Fig. 4 18.1370-04

Yasargil

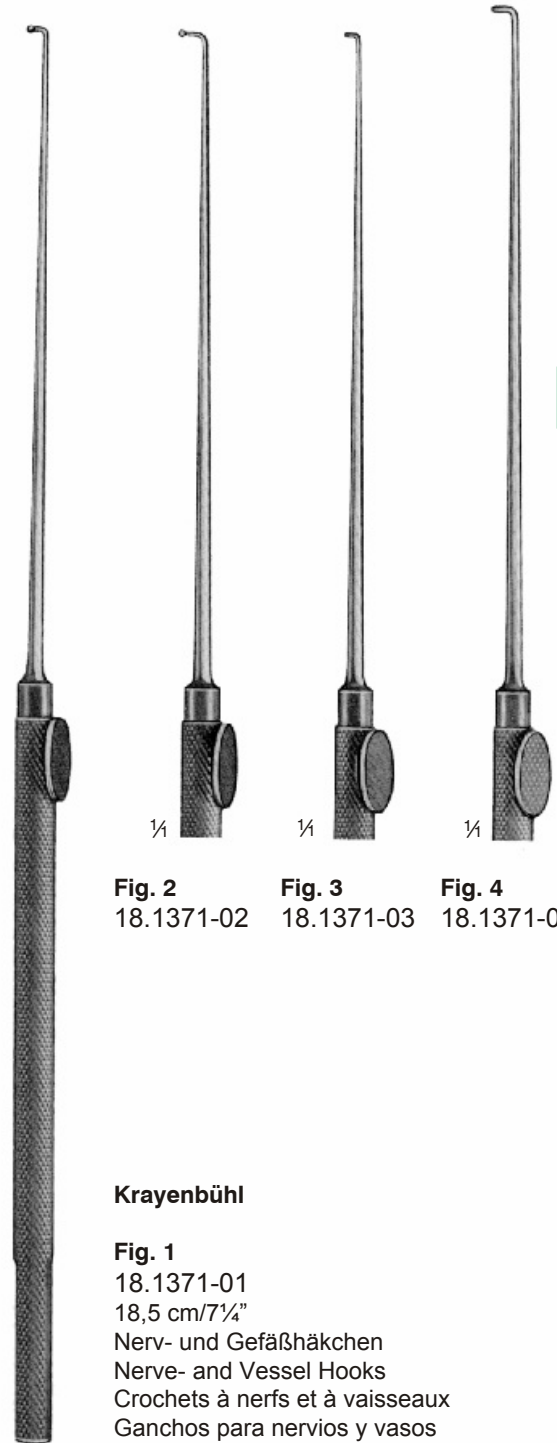

Fig. 1
18.1371-01
18,5 cm/7¼"
Nerv- und Gefäßhäkchen
Nerve- and Vessel Hooks
Crochets à nerfs et à vaisseaux
Ganchos para nervios y vasos

Fig. 2 18.1371-02
Fig. 3 18.1371-03
Fig. 4 18.1371-04

Krayenbühl

18



18.1372-19
18,5 cm/7¼"

Durahäkchen
Dura Hook
Crochet pour la dure-mère
Ganchito para dura-madre



Fisch

18.1373-19
18,5 cm/7¼"

Feines Häkchen
Delicate Hook
Crochet fin
Ganchito muy fino



Yasargil

18,5 cm/7¼"

Mikro-Raspator
Micro-raspatory
Micro-rugine
Micro-periostótomo



Fig. 1
18.1374-01

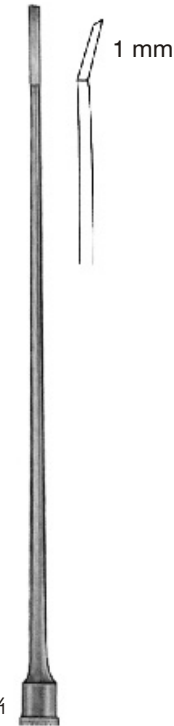

Fig. 2
18.1374-02



Fig. 3
18.1374-03

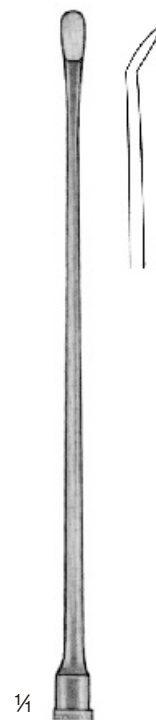

Fig. 4
18.1374-04

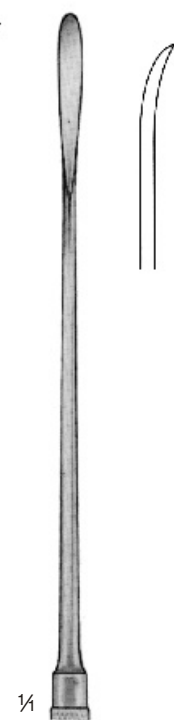

Fig. 5
18.1374-05

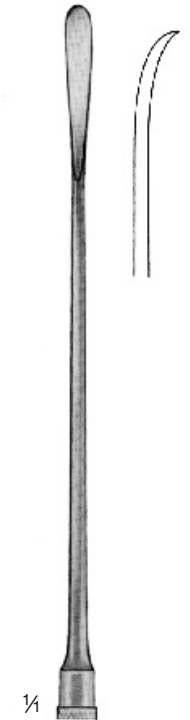
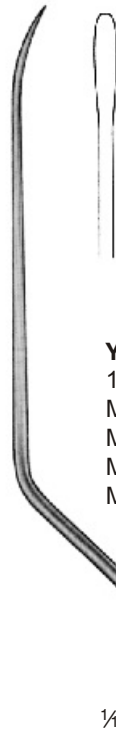

Fig. 6
18.1374-06



Yasargil
 18,5 cm/7¼"
 Fadengabel
 Suture pusher
 Fourche à fil
 Empujador de sutura

Fig. 1
 18.1375-01



Yasargil
 18,5 cm/7¼"
 Mikro-Raspatorien
 Micro-raspatories
 Micro-rugines
 Micro-periostótomos

Fig. 2
 18.1375-02

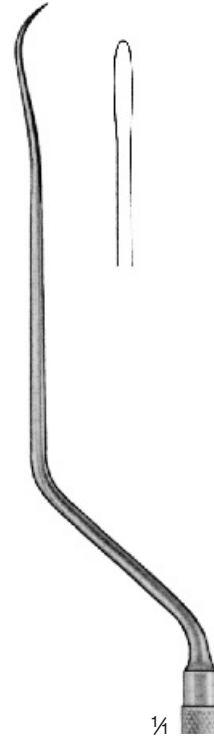

Fig. 3
 18.1375-03

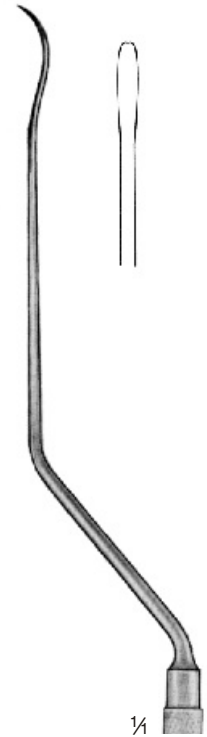

Fig. 4
 18.1375-04

18



Yasargil
 18,5 cm/7¼"
 Scharfer Löffel
 Scoop, bayonet-shaped
 Curette tranchante
 Cucharilla cortante

18.1376-19



Jakobson
 18,5 cm/7¼"
 Doppelsonde
 Twin Probe
 Sonde double
 Sonda doble

18.1377-19



Jacobson
 18,5 cm/7¼"
 Knopfsonde
 Buttoned Probe
 Sonde boutonée
 Sonda abotonada

18.1378-19

18



Jacobson
18.1379-19
18,5 cm/7¼"

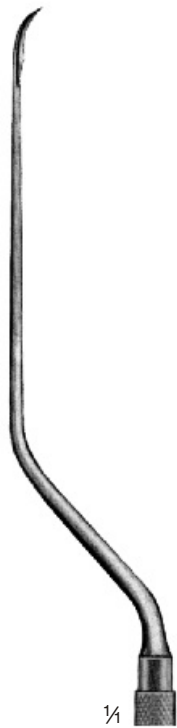

Koos
Fig. 1
18.1380-01
18,5 cm/7¼"



Koos
Fig. 2
18.1380-02
18,5 cm/7¼"



Koos
Fig. 3
18.1380-03
18,5 cm/7¼"

Schneide seitlich
Lateral cutting edge
Tranchant latéral
Filo de corte lateral

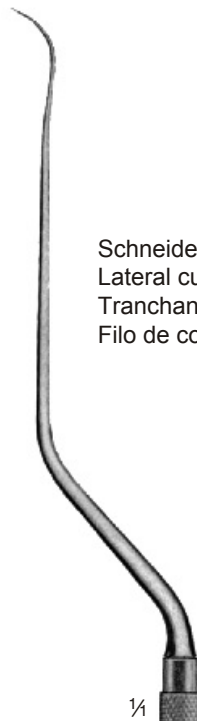

Kraus
18.1381-19
18,5 cm/7¼"

Arachnoidea-Messer
Arachnoid Knife
Couteau à arachnoïdes
Cuchillo para arachnoide

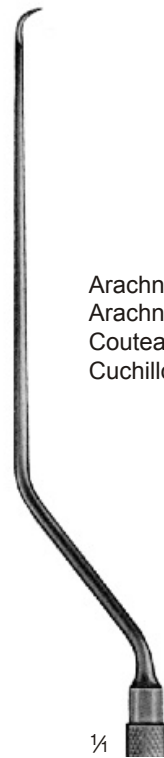

Yasargil
18.1382-19
18,5 cm/7¼"

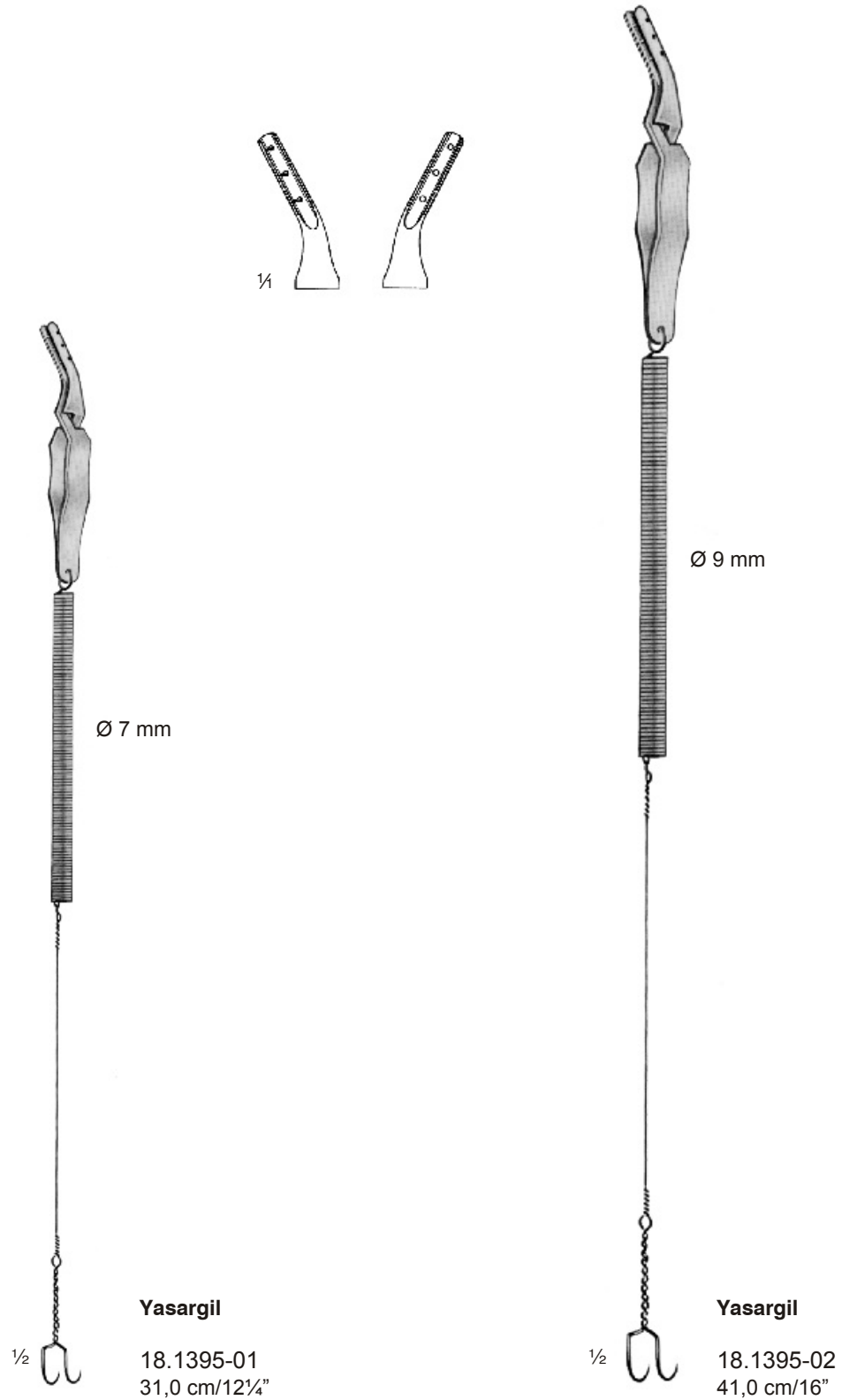

18



Penfield

Fig. 1
18.1401-01
18,0 cm/7"

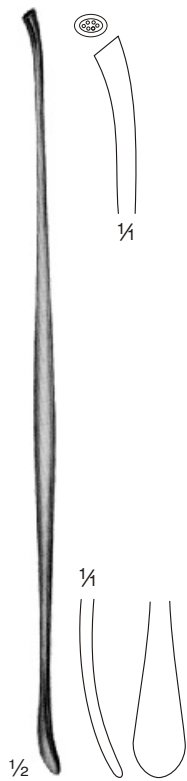

Penfield

Fig. 2
18.1401-02
20,0 cm/8"

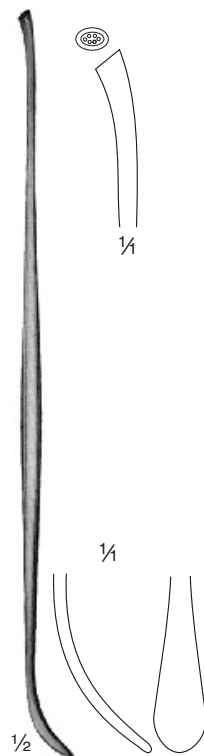

Penfield

Fig. 3
18.1401-03
20,0 cm/8"



Penfield

Fig. 4
18.1401-04
21,5 cm/8½"



Penfield

Fig. 5
18.1401-05
29,0 cm/11½"

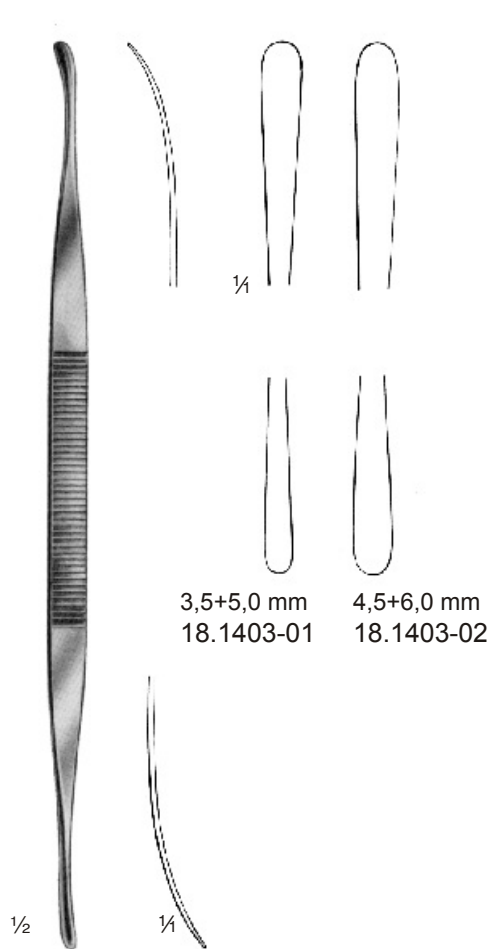

Toennis
 24,0 cm/9½"

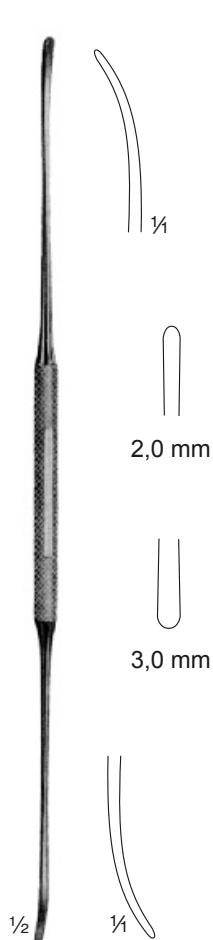

Olivecrona
 2 + 3 mm
 18.1404-01 18,0 cm/7"
 18.1404-02 24,0 cm/9½"

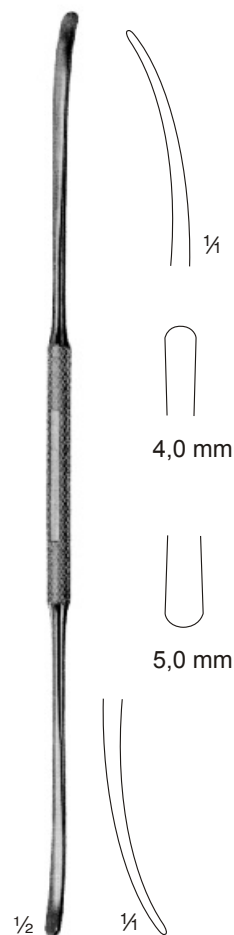

Olivecrona
 4 + 5 mm
 18.1404-03 18,0 cm/7"
 18.1404-04 24,0 cm/9½"

18

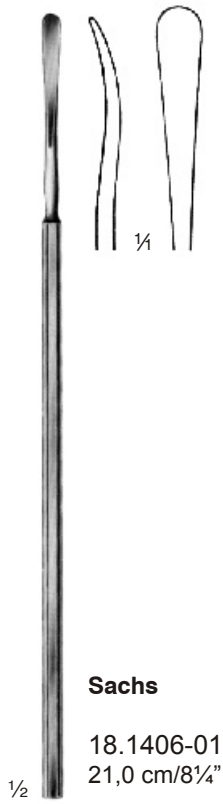

Sachs

18.1406-01
21,0 cm/8 1/4"



Sachs

18.1406-02
21,0 cm/8 1/4"

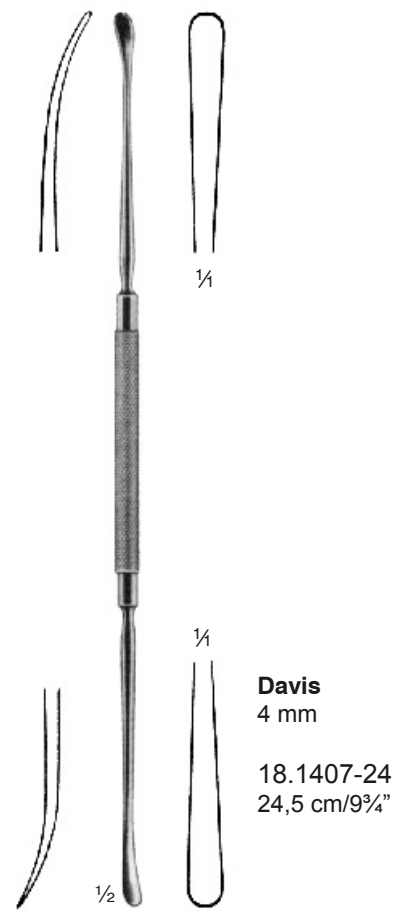

Davis
4 mm

18.1407-24
24,5 cm/9 3/4"

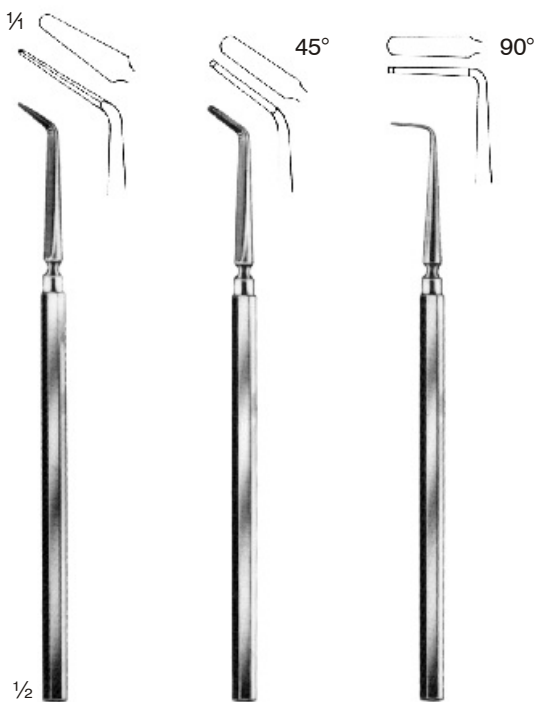

Frazier

18.1410-01
15,0 cm/6"

Hoehn

18.1410-02
15,0 cm/6"

Hoehn

18.1410-03
15,0 cm/6"

Dura-Separatoren
Dura Dissectors
Dissecteurs pour la dure-mère
Descoladores de dura-madre

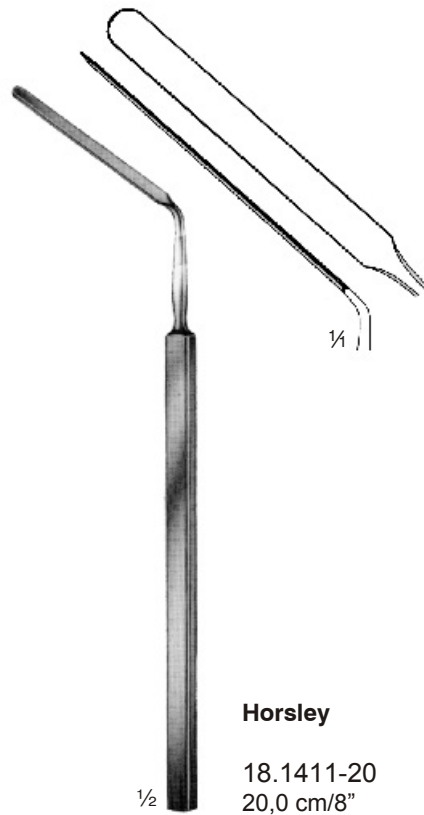

Dura Separator
 Dura Dissector
 Dissecteur pour la dure-mère
 Descolador de dura-madre

18

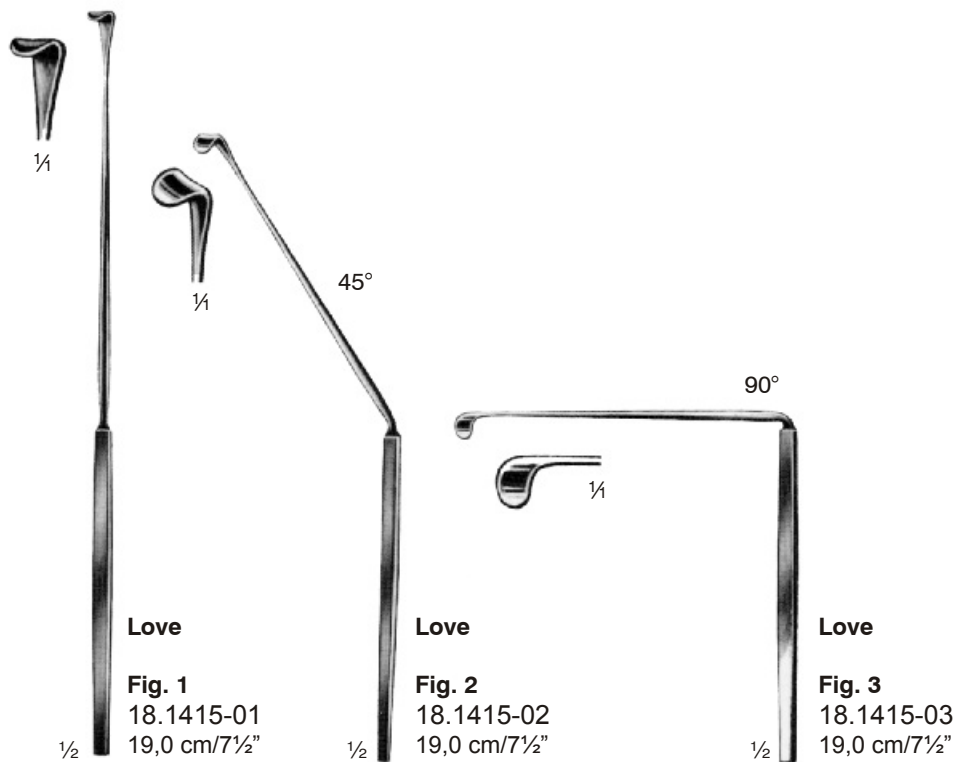

Love

Fig. 1
 18.1415-01
 19,0 cm/7½"

Love

Fig. 2
 18.1415-02
 19,0 cm/7½"

Love

Fig. 3
 18.1415-03
 19,0 cm/7½"

18



Scoville

18.1416-01
23,0 cm/9"
gerade, straight
droit, recto

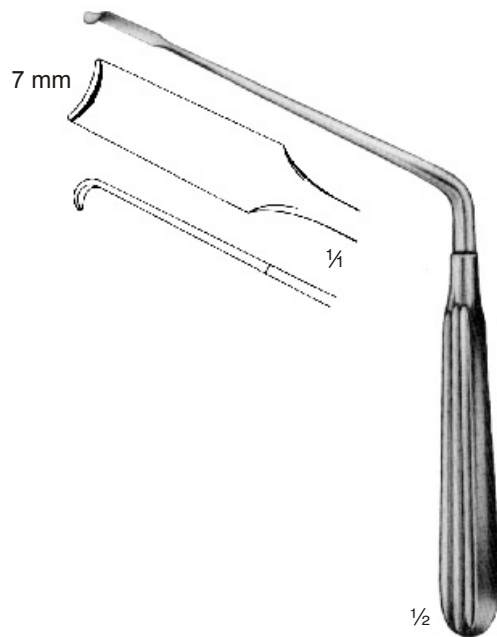

Scoville

18.1416-02
20,0 cm/8"
abgewinkelt, angular
coudé, angular

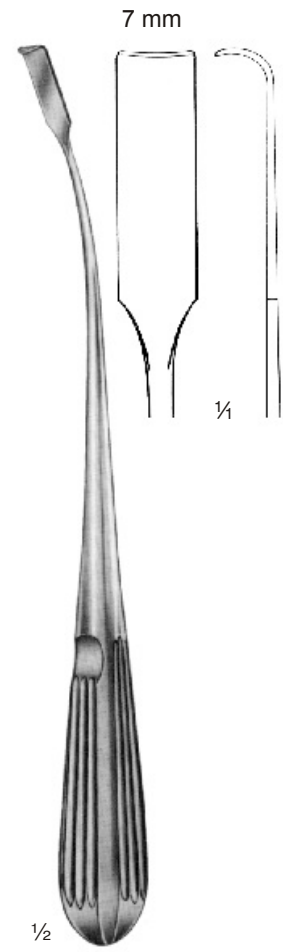

Holsher

18.1417-24
24,0 cm/9½"

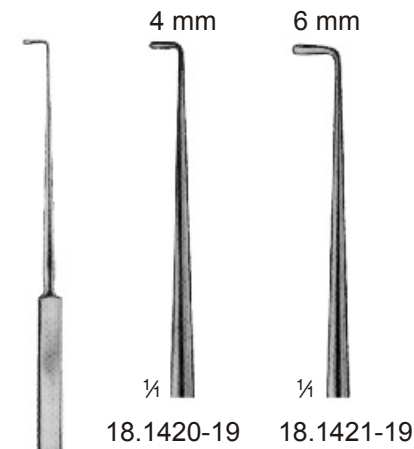

Cushing

18.1420-19 19,0 cm/7½"
 18.1421-19 19,0 cm/7½"

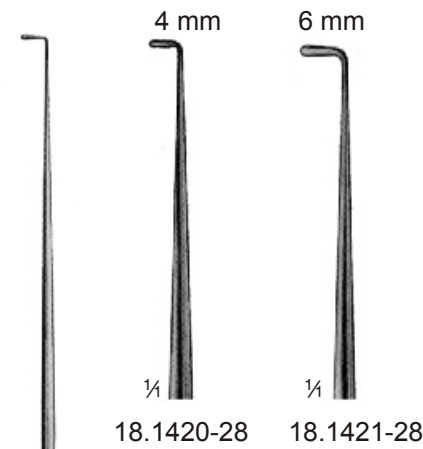

Cushing

18.1420-28 28,0 cm/11"
 18.1421-28 28,0 cm/11"

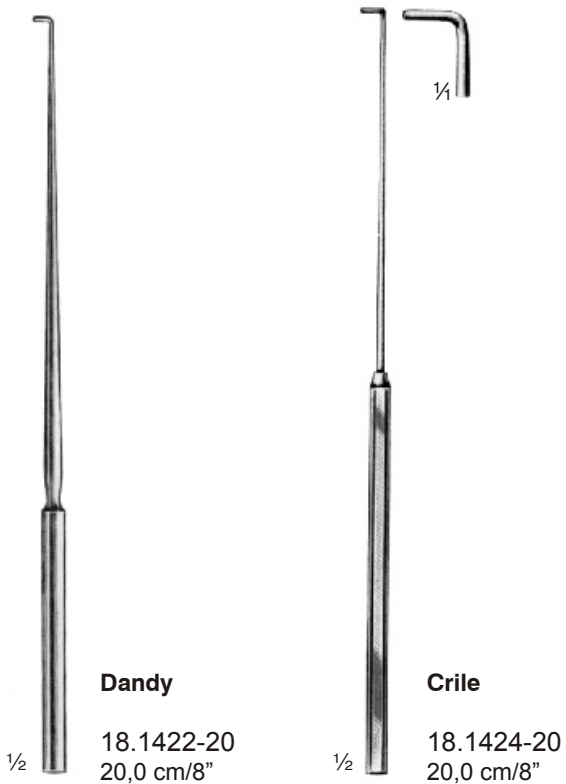

Dandy

18.1422-20
 20,0 cm/8"

Crile

18.1424-20
 20,0 cm/8"

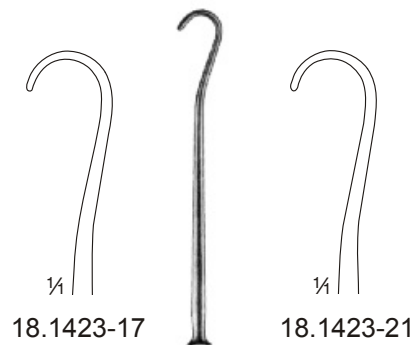

Smithwick

18.1423-17 17,0 cm/6½"
 18.1423-21 21,0 cm/8¼"

18



Adson
spitz, sharp
pointu, agudo

18.1425-01
20,0 cm/8"



Adson
stumpf, blunt
mousse, romo

18.1425-02
20,0 cm/8"



Frazier
spitz, sharp
pointu, agudo

18.1426-13 13,0 cm/5"
18.1426-18 18,0 cm/7"

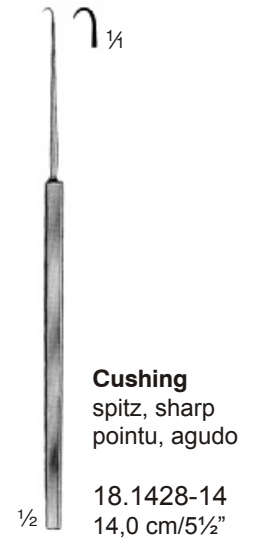

Cushing
spitz, sharp
pointu, agudo

18.1428-14
14,0 cm/5½"

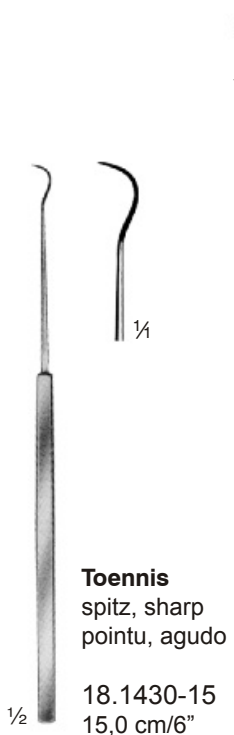

Toennis
spitz, sharp
pointu, agudo

18.1430-15
15,0 cm/6"

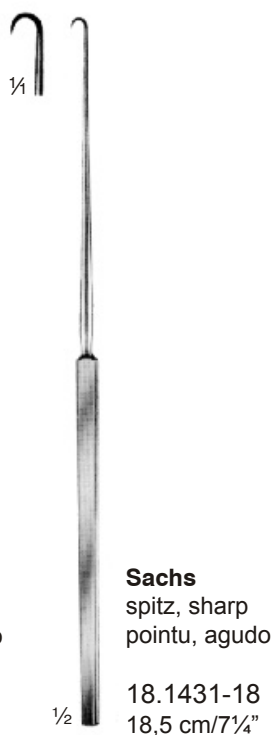

Sachs
spitz, sharp
pointu, agudo

18.1431-18
18,5 cm/7¼"



Graham
stumpf, blunt
mousse, romo

18.1432-16
16,5 cm/6½"

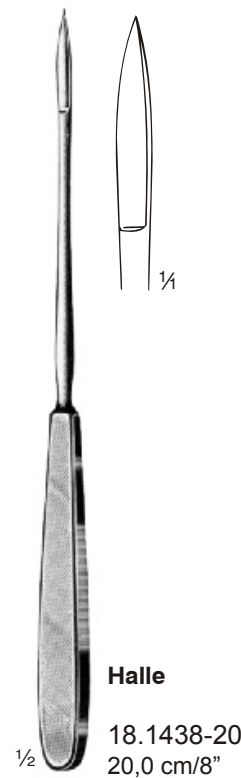

Halle

18.1438-20
20,0 cm/8"

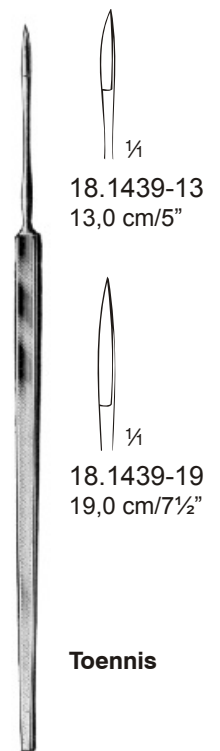

Toennis

18.1439-13
13,0 cm/5"

18.1439-19
19,0 cm/7½"

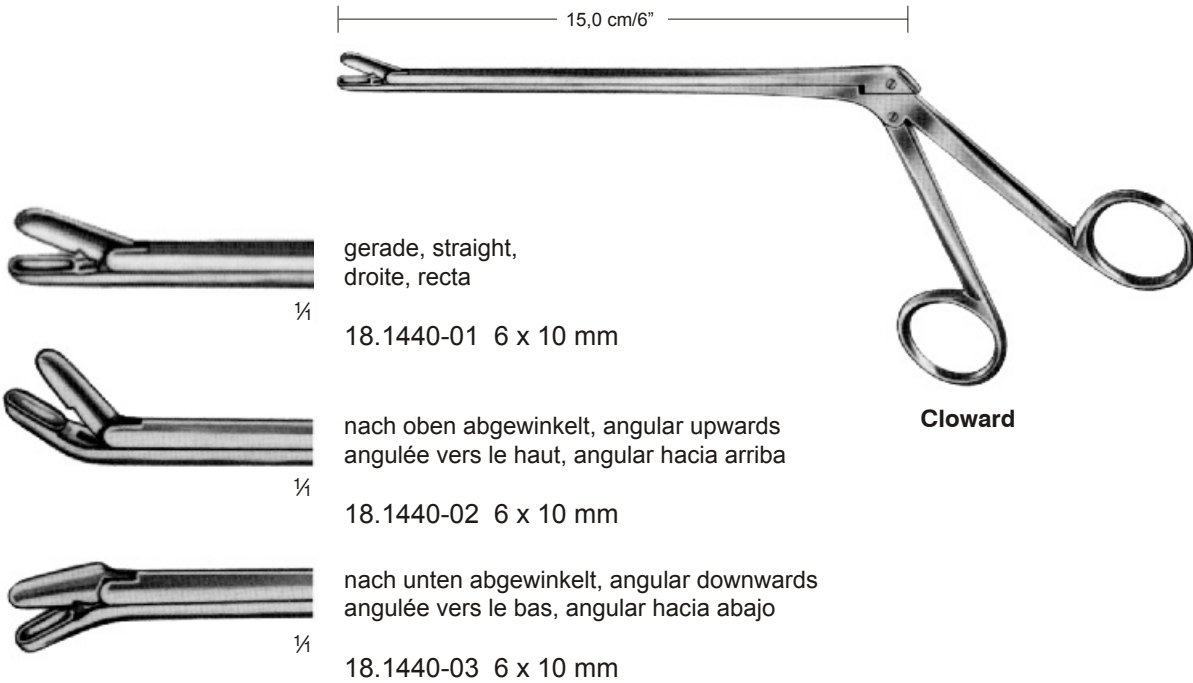

18

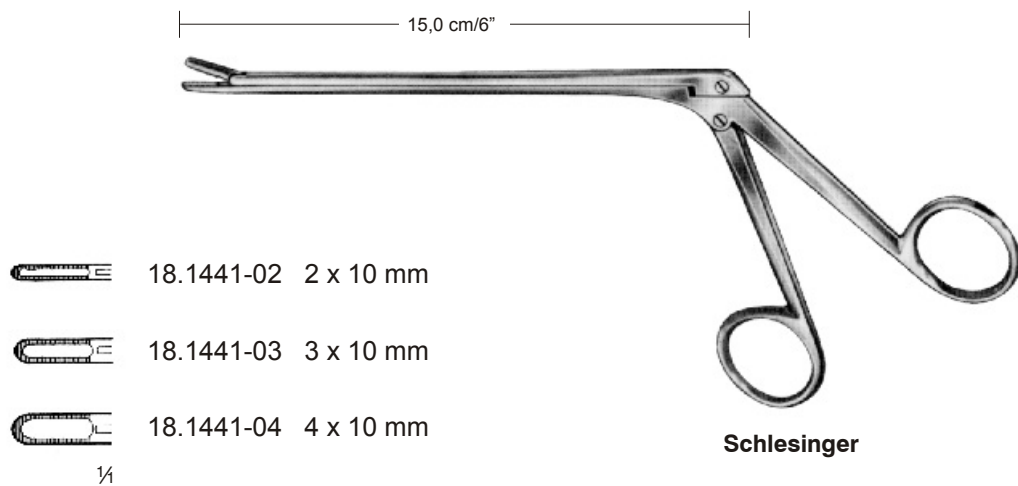

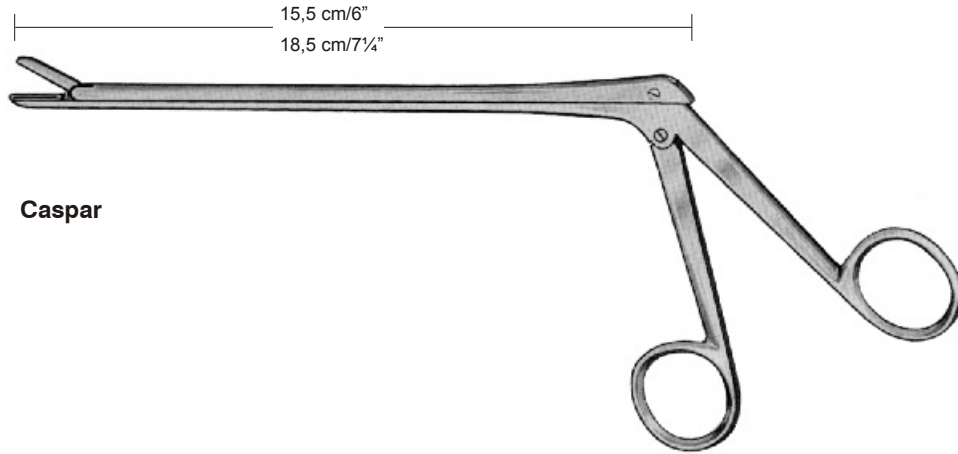





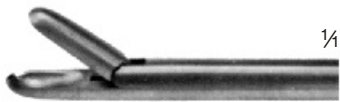

Caspar

18





	 2 x 12 mm	 3 x 12 mm	 4 x 14 mm
15,5 cm/6"	18.1442-02	18.1442-03	18.1442-04
18,5 cm/7 1/4"	18.1443-02	18.1443-03	18.1443-04



	 2 x 12 mm	 3 x 12 mm	 4 x 14 mm
15,5 cm/6"	18.1444-02	18.1444-03	18.1444-04
18,5 cm/7 1/4"	18.1445-02	18.1445-03	18.1445-04



	 2 x 12 mm	 3 x 12 mm	 4 x 14 mm
15,5 cm/6"	18.1446-02	18.1446-03	18.1446-04
18,5 cm/7 1/4"	18.1447-02	18.1447-03	18.1447-04

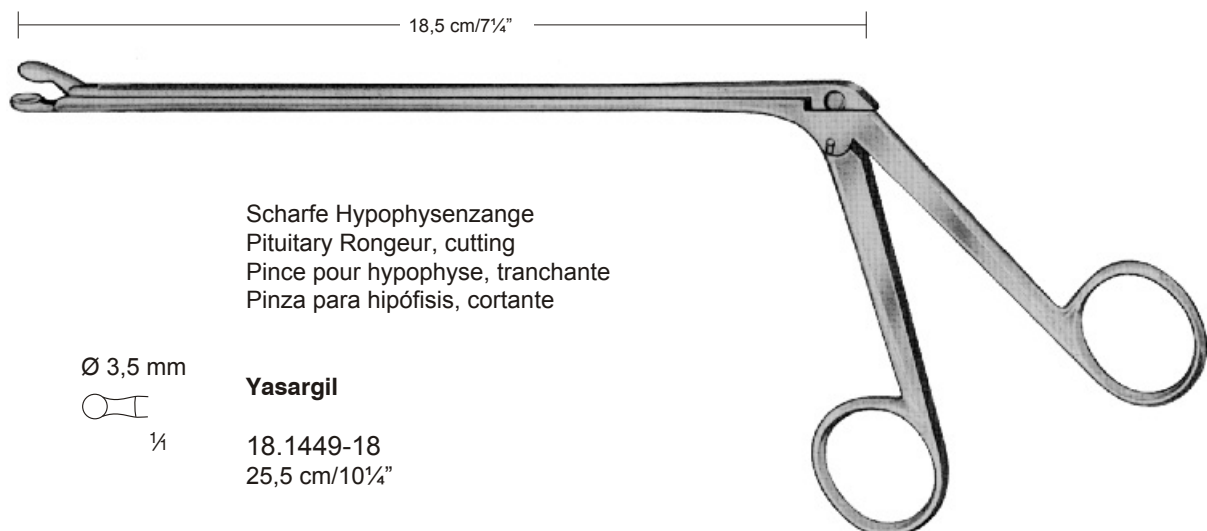
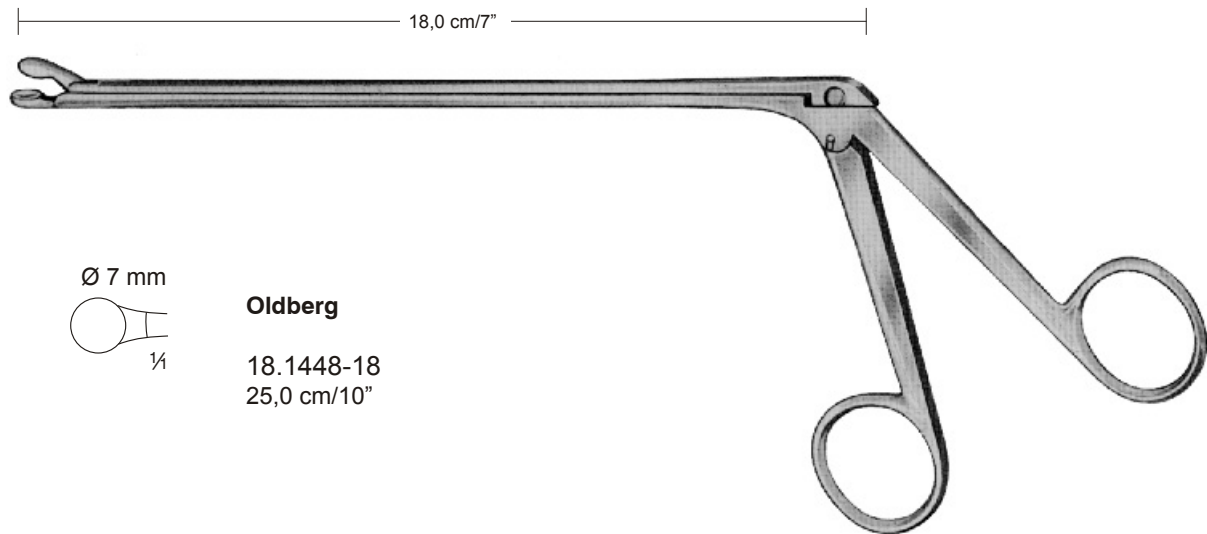
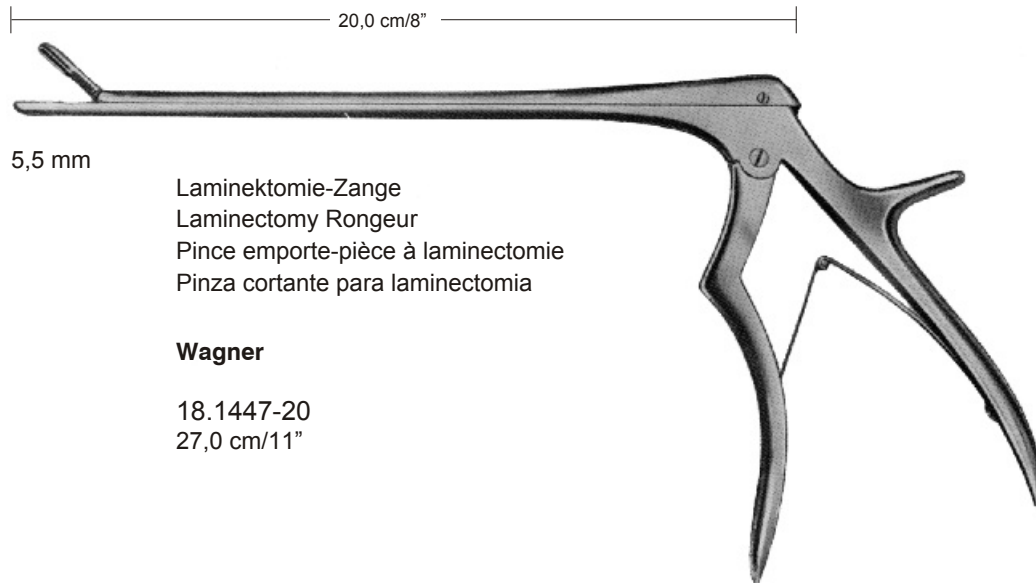

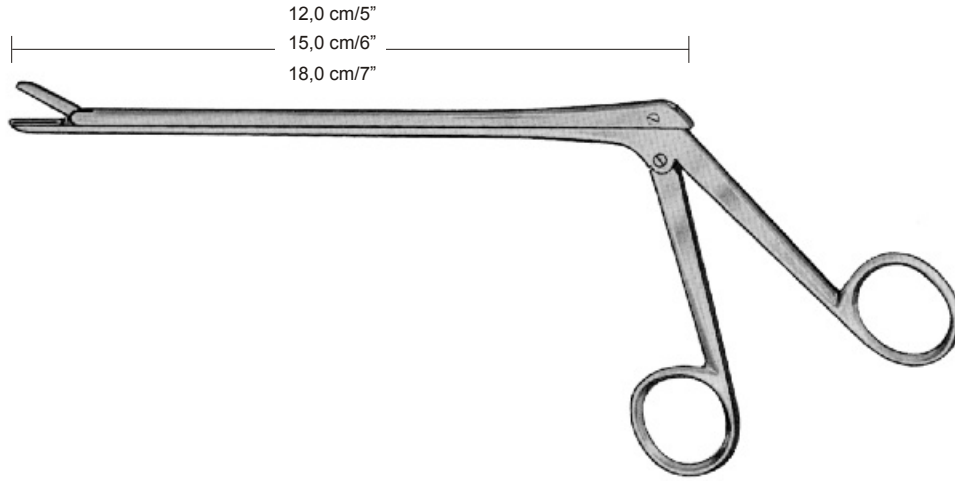

18

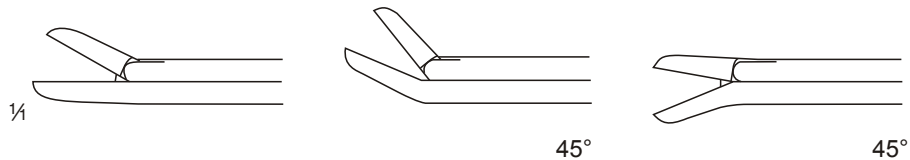

Cushing
2 x 10mm

12,0 cm/5"	18.1450-12	18.1451-12	18.1452-12
15,0 cm/6"	18.1450-15	18.1451-15	18.1452-15
18,0 cm/7"	18.1450-18	18.1451-18	18.1452-18

Love-Gruenwald
3 x 10mm

12,0 cm/5"	18.1460-12	18.1461-12	18.1462-12
15,0 cm/6"	18.1460-15	18.1461-15	18.1462-15
18,0 cm/7"	18.1460-18	18.1461-18	18.1462-18

Spurling
4 x 10mm

12,0 cm/5"	18.1470-12	18.1471-12	18.1472-12
15,0 cm/6"	18.1470-15	18.1471-15	18.1472-15
18,0 cm/7"	18.1470-18	18.1471-18	18.1472-18



Ferris-Smith-Kerrison

18

		reguläres Modell regular pattern modèle regulier modelo regular		zerlegbares Model dismantable pattern modèle démontable modelo desmontable		
90° nach oben schneidend 90° upwards cutting coupante vers le haut 90° cortante hacia arriba 90°		Bißbreite Width of bite Grandeur de coupe Ancho de la boca	Schaftlänge , Length of shaft Longueur de tige, Largo del asta		Schaftlänge , Length of shaft Longueur de tige, Largo del asta	
			18,0 cm/7"	20,0 cm/8"	18,0 cm/7"	20,0 cm/8"
¼		1 mm	18.1480-01	18.1481-01	18.1486-01	18.1487-01
		2 mm	18.1480-02	18.1481-02	18.1486-02	18.1487-02
		3 mm	18.1480-03	18.1481-03	18.1486-03	18.1487-03
		4 mm	18.1480-04	18.1481-04	18.1486-04	18.1487-04
		5 mm	18.1480-05	18.1481-05	18.1486-05	18.1487-05
		6 mm	18.1480-06	18.1481-06	18.1486-06	18.1487-06

40° nach oben schneidend 40° upwards cutting coupante vers le haut 40° cortante hacia arriba 40°					
¼		1 mm	18.1482-01	18.1483-01	18.1488-01
		2 mm	18.1482-02	18.1483-02	18.1488-02
		3 mm	18.1482-03	18.1483-03	18.1488-03
		4 mm	18.1482-04	18.1483-04	18.1488-04
		5 mm	18.1482-05	18.1483-05	18.1488-05
		6 mm	18.1482-06	18.1483-06	18.1488-06

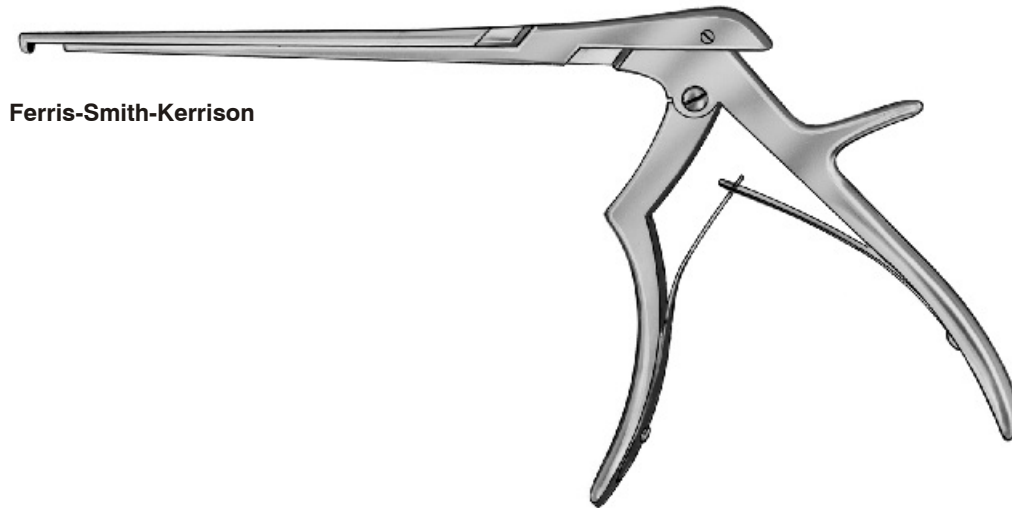

Ferris-Smith-Kerrison

18

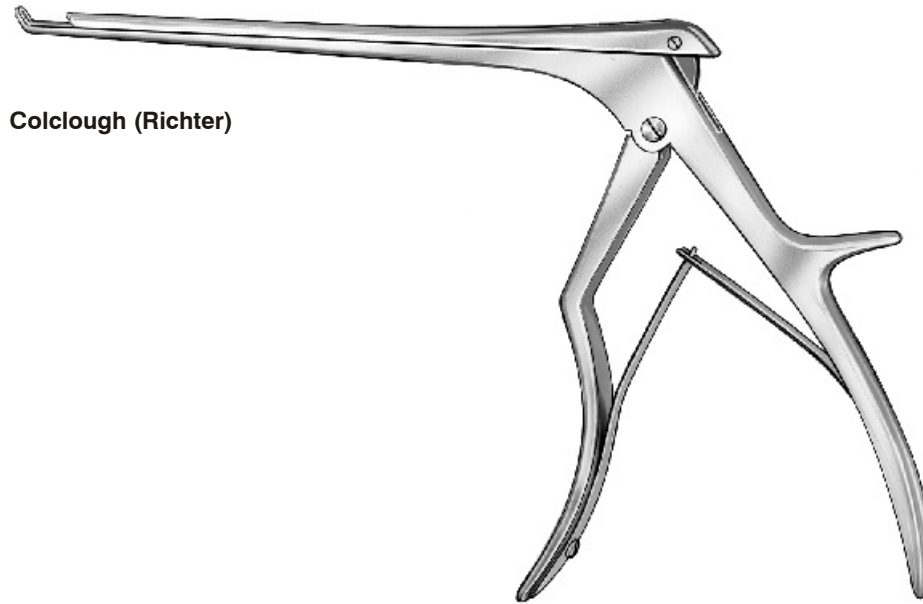

		Bißbreite Width of bite Grandeur de coupe Ancho de la boca	Schaftlänge , Length of shaft Longueur de tige, Largo del asta	
			18,0 cm/7"	20,0 cm/8"
90° nach unten schneidend 90° downwards cutting coupante vers le bas 90° cortante hacia abajo 90°				
¼		1 mm	18.1484-01	18.1485-01
		2 mm	18.1484-02	18.1485-02
		3 mm	18.1484-03	18.1485-03
		4 mm	18.1484-04	18.1485-04
		5 mm	18.1484-05	18.1485-05
		6 mm	18.1484-06	18.1485-06



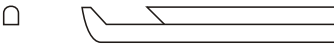
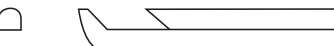
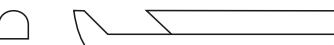

18

		Bißbreite Width of bite Grandeur de coupe Ancho de la boca	Schaftlänge , Length of shaft Longueur de tige, Largo del asta		
90° nach oben schneidend 90° upwards cutting coupante ver le haut 90° cortante hacia arriba 90°			15,0 cm/6"	18,0 cm/7"	20,0 cm/8"
$\frac{1}{4}$ □		2 mm	18.1502-15	18.1502-18	18.1502-20
□		3 mm	18.1503-15	18.1503-18	18.1503-20
□		4 mm	18.1504-15	18.1504-18	18.1504-20
□		5 mm	18.1505-15	18.1505-18	18.1505-20
□		6 mm	18.1506-15	18.1506-18	18.1506-20

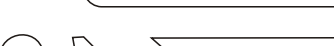
Colclough (Richter)

		Bißbreite Width of bite Grandeur de coupe Ancho de la boca	Schaftlänge , Length of shaft Longueur de tige, Largo del asta		
			15,0 cm/6"	18,0 cm/7"	20,0 cm/8"
¼		2 mm	18.1512-15	18.1512-18	18.1512-20
		3 mm	18.1513-15	18.1513-18	18.1513-20
		4 mm	18.1514-15	18.1514-18	18.1514-20
		5 mm	18.1515-15	18.1515-18	18.1515-20
		6 mm	18.1516-15	18.1516-18	18.1516-20

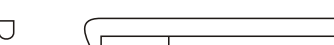
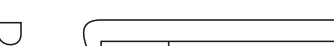
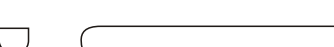
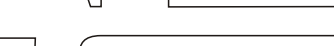
18

		Bißbreite Width of bite Grandeur de coupe Ancho de la boca	Schaftlänge , Length of shaft Longueur de tige, Largo del asta		
			15,0 cm/6"	18,0 cm/7"	20,0 cm 8"
¼		2 mm	18.1522-15	18.1522-18	18.1522-20
		3 mm	18.1523-15	18.1523-18	18.1523-20
		4 mm	18.1524-15	18.1524-18	18.1524-20
		5 mm	18.1525-15	18.1525-18	18.1525-20
		6 mm	18.1526-15	18.1526-18	18.1526-20

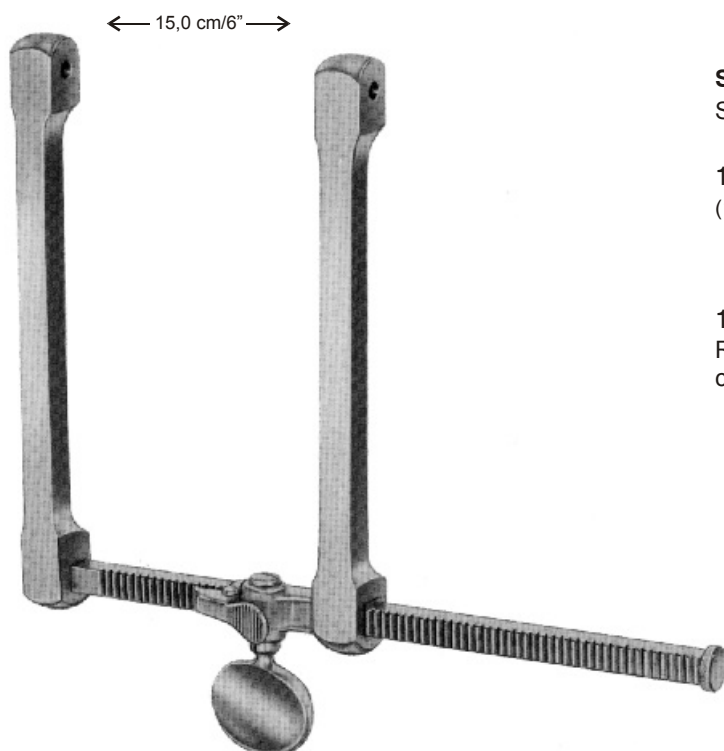

Scoville

Set, set, série, juego

18.1540-00

(1 x 18.1540-01, 1 x 18.1543-50, 1 x 18.1545-01)

18.1540-01

Rahmen allein, frame only,
cadre seul, cuadro solo

18

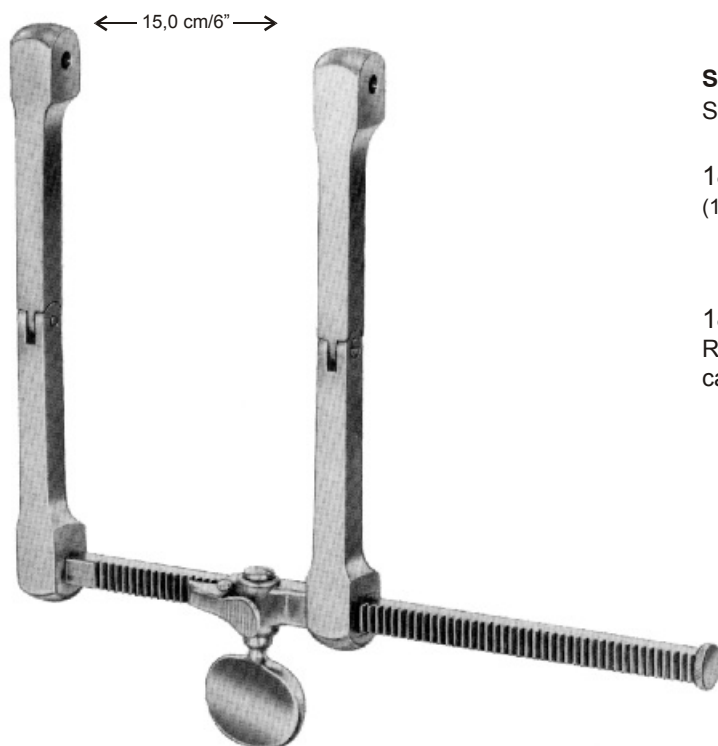

Scoville-Haverfield

Set, set, série, juego

18.1541-00

(1 x 18.1541-01, 1 x 18.1543-50, 1 x 18.1545-01)

18.1541-01

Rahmen allein, frame only,
cadre seul, cuadro solo

Haken, Hooks, Crochets, Separadores



Scoville
stumpf, blunt
mousse, romo

- 18.1543-50 50 mm/2"
- 18.1543-70 70 mm/2¾"
- 18.1543-75 75 mm/3"



Scoville
spitz, sharp
pointu, agudo

- 18.1544-50 50 mm/2"
- 18.1544-70 70 mm/2¾"
- 18.1544-75 75 mm/3"

18

Valven, Blades, Valves, Valvas



Scoville

- 18.1545-01 64 x 25 mm
- 18.1545-02 64 x 29 mm
- 18.1545-03 64 x 50 mm
- 18.1545-04 88 x 25 mm



Taylor

- 18.1546-01 38 x 44 mm



Taylor

- 18.1547-01 48 x 50 mm
- 18.1547-02 64 x 50 mm
- 18.1547-03 64 x 64 mm
- 18.1547-04 80 x 57 mm

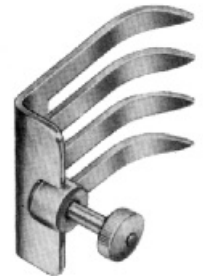

Scoville

- 18.1548-01 41 x 38 mm
- 18.1548-02 67 x 44 mm



Taylor

- 18.1549-01 32 x 75 mm
- 18.1549-02 42 x 100 mm



Meyerding-Scoville

- 18.1550-01 50 x 25 mm
- 18.1550-02 70 x 25 mm
- 18.1550-03 83 x 25 mm

gezahnt
saw edge
dentelée
dentada



Cloward

18.1560-01 25,0 cm/9½"
Sperrer allein, spreader only
ecarteur seule, separador solo

18.1560-00
Set mit 5 gezahnten Valven 18.1561-40 - 18.1561-60
Set with 5 toothed blades 18.1561-40 - 18.1561-60
Jeu avec 5 valves dentelées 18.1561-40 - 18.1561-60
Juego con 5 valvas dentadas 18.1561-40 - 18.1561-60



Valve, gezahnt
Blade, saw edge
Valve, dentelée
Valva, dentada

18.1561-40 40 mm
18.1561-45 45 mm
18.1561-50 50 mm
18.1561-55 55 mm
18.1561-60 60 mm

18



Cloward

18.1562-01 17,0 cm/6¾"
Sperrer allein, spreader only
ecarteur seule, separador solo

18.1562-00
Set mit 5 stumpfen Valven 18.1562-40 - 18.1562-60
Set with 5 blunt blades 18.1562-40 - 18.1562-60
Jeu avec 5 valves mouses 18.1562-40 - 18.1562-60
Juego con 5 valvas romas 18.1562-40 - 18.1562-60



Valve, stumpf
Blade, blunt
Valve, mousse
Valva, roma

18.1562-40 40 mm
18.1562-45 45 mm
18.1562-50 50 mm
18.1562-55 55 mm
18.1562-60 60 mm

Verschiedene Nagelinstrumente
Miscellaneous Nail Instruments
Instrumentes divers pour les ongles
Instrumentos diversos para las uñas

19





Nagelfeile
Nail File
Lime à ongles
Lima para uñas

19.1620 10,0 cm/4"
19.1621 12,0 cm/4¾"



Nagelfeile
Nail File
Lime à ongles
Lima para uñas

19.1622 11,0 cm/4½"

19



19.1625
Schwestern Set
Set for nurses
Jeu pour une infirmière
Juego para una enfermera

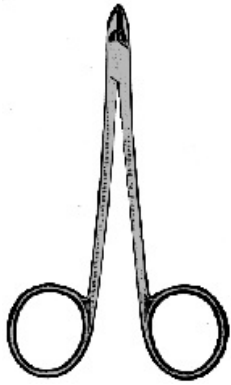

19.1628
10,0 cm/4"
Hautzange
Cuticle Nippers
Pince à envies
Pinza para cuticulares

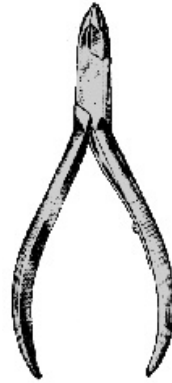

19.1629
10,5 cm/4¼"
Hautzange
Cuticle Nippers
Pince à envies
Pinza para cuticulares

19



19.1630
14,5 cm/5¾"
Pedicure-Zange
Nail Nippers
Pincés à ongles
Alicates corta-uñas



19.1631
14,5 cm/5¾"
Kopfschneider
Nail Nippers
Pincés à ongles
Alicates corta-uñas



19.1632
13,0 cm/5"
Nagelzange
Nail Nippers
Pincés à ongles
Alicates corta-uñas



19.1633
 12,0 cm/4¾"
 Nagelzange
 Nail Nippers
 Pincès à ongles
 Alicates corta-uñas



19.1634 12,0 cm/4¾"
 19.1635 13,5 cm/5¼"
 Nagelzange
 Nail Nippers
 Pincès à ongles
 Alicates corta-uñas



19.1636
 13,0 cm/5"
 Nagelzange
 Nail Nippers
 Pincès à ongles
 Alicates corta-uñas

19

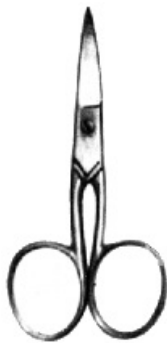

Nagelschere
 Nail Scissors
 Ciseaux à ongles
 Tijeras para uñas

19.1638 9,0 cm/3½"
 19.1639 10,5 cm/4½"
 gebogen
 curved
 courbes
 curvas



Nagelschere
 Nail Scissors
 Ciseaux à ongles
 Tijeras para uñas

19.1640 9,0 cm/3½"
 gebogen
 curved
 courbes
 curvas



19.1641
17,0 cm/6³/₄"
Fingerring-Säge
Finger Ring Saw
Scie pour bagues
Sierra para abrir anillos



19.1642
16,0 cm/6¹/₄"
Fingerring-Säge, verchromt
Finger Ring Saw, chrome plated
Scie pour bagues, chromée
Sierra para abrir anillos, cromada

19.1643
Sägeblatt
Saw blade
Lame de scie
Hoja de sierra

19.1644
Sägeblatt
Saw blade
Lame de scie
Hoja de sierra

19



19.1651
Bohrer, Satz
Drill, set
Perforateurs, jeu
Perforadores, juego



19.1650
Fingernagel-Bohrer, Satz
Finger nail drill, set
Perforateurs pour les ongles, jeu
Perforadores para uñas, juego



19.1652
14,0 cm/5¹/₂"
Nagelausreißzange
Forceps for tearing out toe and finger nails
Pincers pour l'extraction des ongles
Pinzas para arrancar uñas



Feldmann
19.1653
10,0 cm/4"
Finger- und Zehenkompressorium
Tourniquet for fingers and toes
Appareil à compression pour les doigts et les orteils
Compresor para los dedos de la mano y del pie

**Scheren, Supercut-Scheren
Scissors, Supercut Scissors
Ciseaux, Ciseaux Supercut
Tijeras, Tijeras Supercut**





Standard

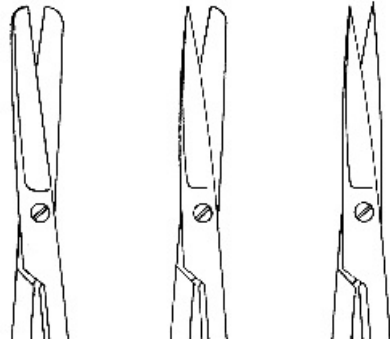

Standard

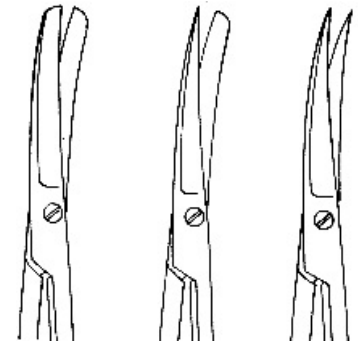

20

Fig. 1	Fig. 2	Fig. 3		Fig. 1	Fig. 2	Fig. 3
20.1701	20.1711	20.1721	10,5 cm/4¼"	20.1731	20.1741	20.1751
20.1702	20.1712	20.1722	11,5 cm/4½"	20.1732	20.1742	20.1752
20.1703	20.1713	20.1723	13,0 cm/5"	20.1733	20.1743	20.1753
20.1704	20.1714	20.1724	14,5 cm/5½"	20.1734	20.1744	20.1754
20.1705	20.1715	20.1725	15,5 cm/6"	20.1735	20.1745	20.1755
20.1706	20.1716	20.1726	16,5 cm/6½"	20.1736	20.1746	20.1756
20.1707	20.1717	20.1727	17,5 cm/7"	20.1737	20.1747	20.1757
20.1708	20.1718	20.1728	18,5 cm/7¼"	20.1738	20.1748	20.1758
20.1709	20.1719	20.1729	20,0 cm/8"	20.1739	20.1749	20.1759



Graziil

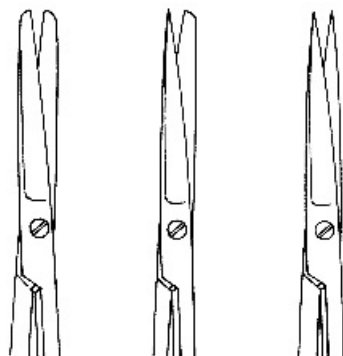

Graziil

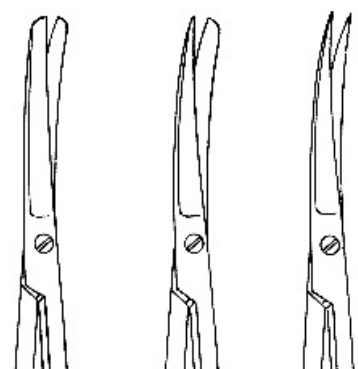

Fig.1	Fig. 2	Fig. 3		Fig. 1	Fig. 2	Fig. 3
20.1761	20.1763	20.1765	13,0 cm/5"	20.1767	20.1769	20.1771
20.1762	20.1764	20.1766	14,5 cm/5½"	20.1768	20.1770	20.1772



20.1773

20.1775
 gezahnt
 saw edge
 dentelés
 dentadas

Deaver
 14,5 cm/5½"

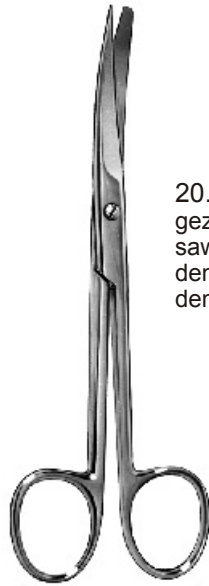

20.1774

20.1776
 gezahnt
 saw edge
 dentelés
 dentadas

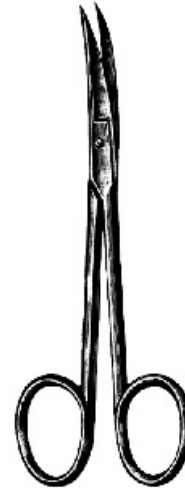

Goldmann-Fox
 13,0 cm/5"



20.1777-01 20.1777-02

Inzisionsschere
Incision Scissors
Ciseaux à incision
Tijeras para incisión



20.1780 13,0 cm/5"
 20.1781 14,5 cm/5½"



Richter
 20.1783 14,5 cm/5½"



20.1785

20.1787
 gezahnt
 saw edge
 dentelés
 dentadas

Mixer
 15,5 cm/6"



20.1786

20.1788
 gezahnt
 saw edge
 dentelés
 dentadas



20

20. 1791
20. 1792
20. 1793
20. 1794

Mayo
14,5 cm/5½"
15,0 cm/6"
17,0 cm/6¾"
23,0 cm/9"

20. 1796
20. 1797
20. 1798
20.1799

20.1801
20.1802
20.1802-21

Mayo-Stillle
15,0 cm/6"
17,0 cm/6¾"
21,0 cm/8¼"

20.1803
20.1804
20.1804-21

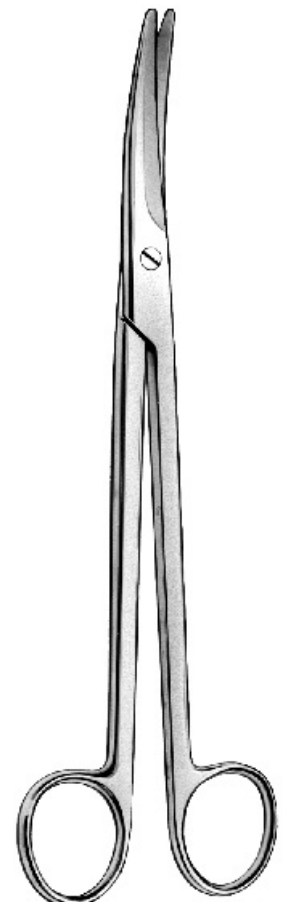

20.1806

Mayo-Noble
17,0 cm/6¾"

20.1808

20.1810

Mayo-Harrington
23,0 cm/9"

20.1811



20.1812
20.1814

Bauchdecken-Scheren
Abdominal Scissors
Ciseaux abdominaux
Tijeras abdominales



Doyen
16,0 cm/6¼"
17,5 cm/7"

20.1813
20.1815

20



20.1817

Mayo-Lexer
16,0 cm/6¼"



20.1818



20.1819

Baby-Lexer
10,0 cm/4"



20.1820



Metzenbaum
14,5 cm/5½"



Fig. 1
20.1821



Fig. 2
20.1831



Fig. 3
20.1841



Metzenbaum
14,5 cm/5½"



Fig. 1
20.1851

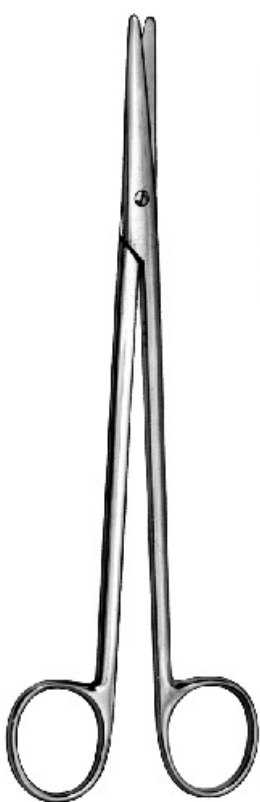

Fig. 2
20.1861



Fig. 3
20.1871

20



Metzenbaum



Fig. 1
20.1822
20.1823
20.1824
20.1825
20.1826
20.1827



Fig. 2
20.1832
20.1833
20.1834
20.1835
20.1836
20.1837



Fig. 3
20.1842
20.1843
20.1844
20.1845
20.1846
20.1847

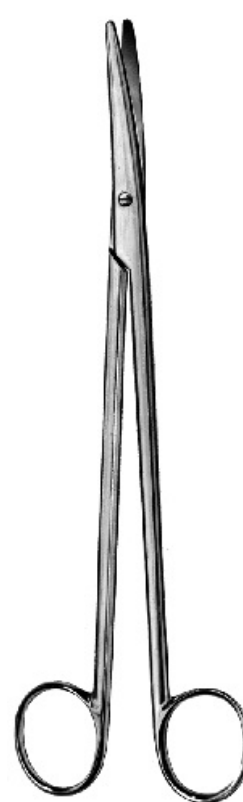

Metzenbaum



18,0 cm/7"
20,0 cm/8"
23,0 cm/9"
25,0 cm/10"
28,0 cm/11"
30,0 cm/12"

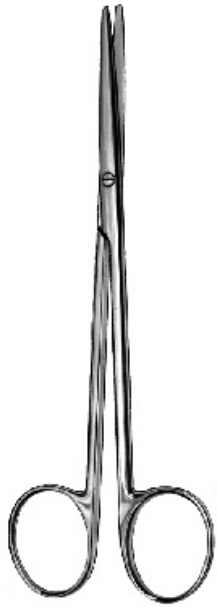

Fig. 1
20.1852
20.1853
20.1854
20.1855
20.1856
20.1857



Fig. 2
20.1862
20.1863
20.1864
20.1865
20.1866
20.1867

Fig. 3
20.1872
20.1873
20.1874
20.1875
20.1876
20.1877



20.1880
 20.1881
 20.1882

Metzenbaum, Fino
 14,5 cm/5½"
 15,0 cm/6"
 18,0 cm/7"



20.1884
 20.1885
 20.1886



20.1887-01

Metzenbaum-Lahey
 14,0 cm/4¾"



20.1887-02

20

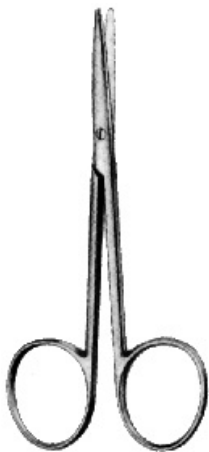

Metzenbaum
(Strabismus)
 11,5 cm/4½"



20.1888

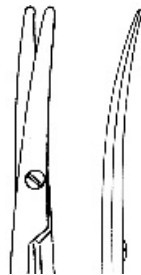

20.1889



Chirurgische und gynäkologische Schere
 Operating and gynecological Scissors
 Ciseaux à chirurgie et à gynécologie
 Tijeras para cirugía y ginecología

Wertheim

20.1890 14,5 cm/5½"
 20.1891 19,5 cm/7¾"
 20.1892 22,5 cm/9"

20



Sims

Fig. 1
20.1893 20,0 cm/8"
20.1895 23,0 cm/9"

Fig. 2
20.1896
20.1898

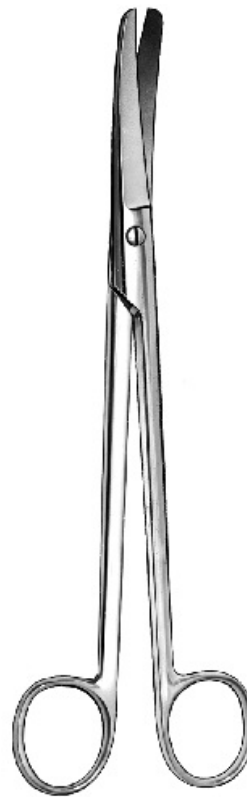

Sims

Fig. 1
20.1899 20,0 cm/8"
20.1901 23,0 cm/9"

Fig. 2
20.1902
20.1904



Feine Scheren
Delicate Scissors
Ciseaux fins
Tijeras finas

20.1905-16
20.1905-18



Kelly
16,0 cm/6¼"
18,0 cm/7"

20.1906-16
20.1906-18

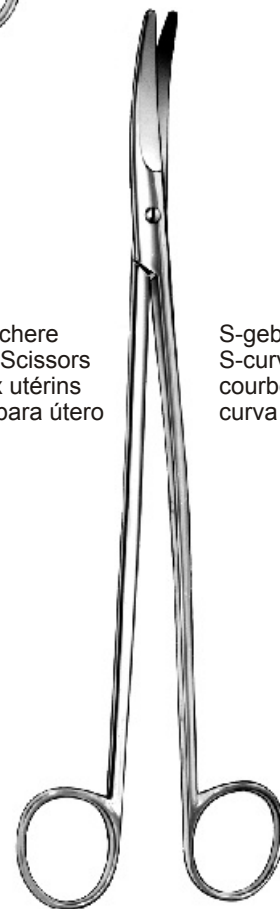

Uterusschere
Uterine Scissors
Ciseaux utérins
Tijeras para útero

S-gebogen
S-curved
courbes forme S
curva forma S

Siebold
20.1907 24,0 cm/9½"



20.1908

Kephalotomie-Scheren
 Cephalotomy Scissors
 Ciseaux à céphalotomie
 Tijeras para cefalotomia

Dubois
 27 cm/10½"



20.1909



Dammscheren
 Perineum Scissors
 Ciseaux à périnée
 Tijeras para perineo

20.1910
 14,5 cm/5½"

**Braun-
 Stadler**

20.1911
 22 cm/8¾"

20



Dammschere
 Perineum Scissors
 Ciseaux à périnée
 Tijeras para perineo

Waldmann
 18,0 cm/7¼"

20.1910-18



Nabelschnurscheren
Umbilical Scissors
Ciseaux pour le cordon ombilical
Tijeras umbilicales

20

Schumacher
15,5 cm/6¼"

20.1912



Nabelschnurscheren
Umbilical Scissors
Ciseaux pour le cordon ombilical
Tijeras umbilicales

Busch

20.1913 13,0 cm/5"
20.1914 16,0 cm/6¼"



Mod. USA
10,5 cm/4¼"

20.1915



Feine Chirurgische Scheren
Delicate Operating Scissors
Ciseaux chirurgicaux fins
Tijeras finas para cirugía

20.1916

Joseph
14,5 cm/5½"



20.1917



Präparierscheren
Dissecting Scissors
Ciseaux à dissection
Tijeras para preparaciones

Kilner

20.1918 13,0 cm/5"
20.1919 15,0 cm/6"

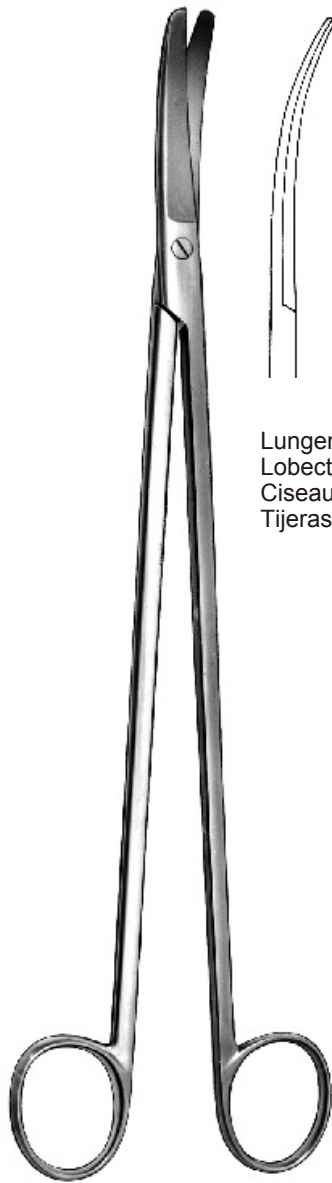

Lungenlappenschere
Lobectomy Scissors
Ciseaux à lobectomie
Tijeras para lobectomia

Crafoord
30,0 cm/12"

20.1920

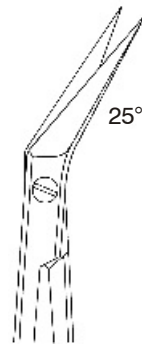

20.1922-01

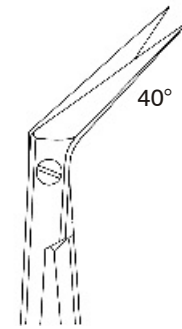

20.1922-02

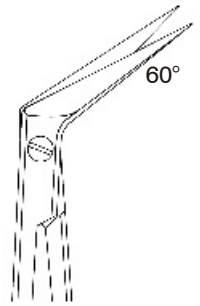

20.1922-03

20

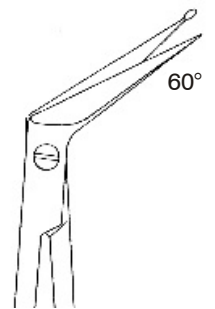

20.1922-04

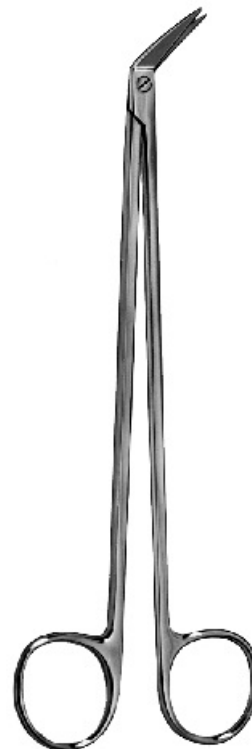

Potts-Smith
19,0 cm/7½"

20

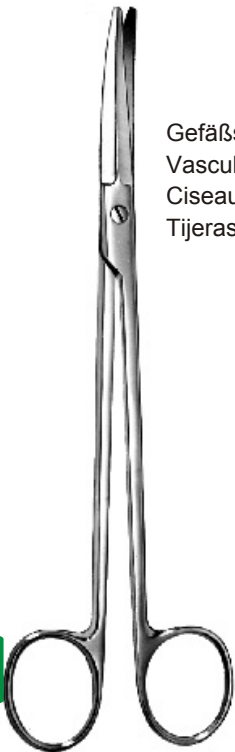

Gefäßschere
Vascular Scissors
Ciseaux vasculaires
Tijeras vasculares

Potts-Smith

20.1923 19,0 cm/7½"



Präparierschere
Dissecting Scissors
Ciseaux à dissection
Tijeras para preparaciones

Reynolds

20.1924 16,0 cm/6¼"



Gefäßschere
Vascular Scissors
Ciseaux vasculaires
Tijeras vasculares

Satinsky

20.1925 24,5 cm/10"



Knorpelschere
Cartilage Scissors
Ciseaux pour le cartilage
Tijeras para cartílago

Mc Indoe

20.1926 19,0 cm/7½"

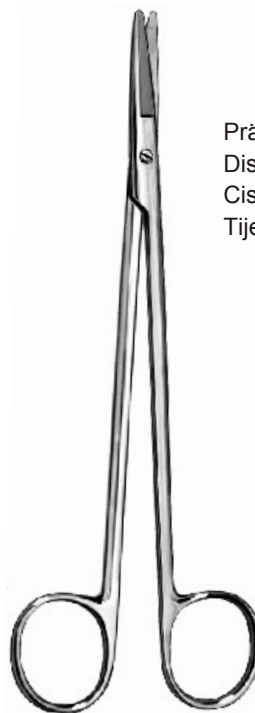

Präparierscheren
Dissecting Scissors
Ciseaux à dissection
Tijeras para preparaciones

20.1927



Tönis
18,0 cm/7"

20.1928



Präparierschere
 Dissecting Scissors
 Ciseaux à dissection
 Tijeras para preparaciones

Adson-Tönnis

20.1929 17,5 cm/7"



Dandy

20.1930 17,0 cm/6¾"



Gefäßschere
 Vascular Scissors
 Ciseaux vasculaires
 Tijeras vasculares

Strully

20.1931 22,0 cm/8½"

Gefäß- und Coronarschere
 Vascular and Coronary Scissors
 Ciseaux vasculaires et coronaires
 Tijeras para vasculares y coronarias



20.1932 11,5 cm/4½"

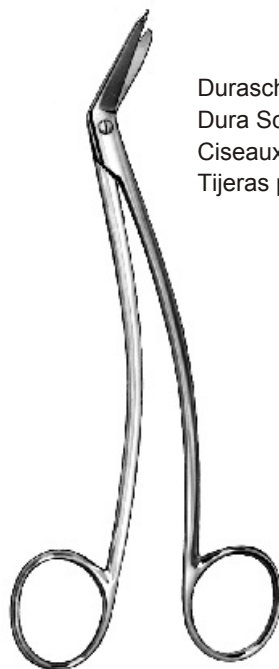

Duraschere
 Dura Scissors
 Ciseaux pour la dure-mère
 Tijeras para dura-madre

Schmieden

20.1933 17,0 cm/6¾"

Bronchialschere
 Bronchial Scissors
 Ciseaux pour les bronches
 Tijeras para bronquios

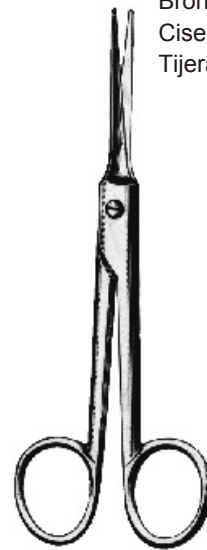

20.1934 14,5 cm/6"

20



Heymann

20.1935 18,0 cm/7"

Nasenscheren
Nasal Scissors
Ciseaux nasaux
Tijeras nasales



Seiler

20.1937 17,0 cm/6¾"

Tonsillenscheren, Tonsil Scissors, Ciseaux pour les amygdales, Tijeras para amígdalas



Böttcher

20.1940 18,0 cm/7"



Prince

20.1941 17,5 cm/7"

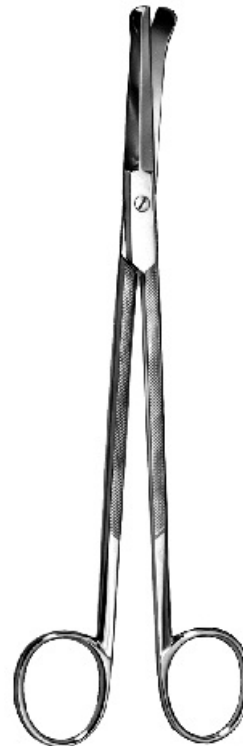

Good

20.1942 19,0 cm/7½"



Dean

20.1943 17,0 cm/6¾"



20.1945

Ligaturschere
11,5 cm/4½"



20.1946



Littauer

20.1947 14,0 cm/5½"

gebogen, curved
courbes, curvas

20.1948G 9,0 cm/3½"
20.1950G 12,0 cm/4¾"



Spencer

20.1948 9,0 cm/3½"
20.1949 10,5 cm/4"
20.1950 12,0 cm/4¾"

20

Drahtschere
Wire Cutting Scissors
Coupe-fils alambre
Cizallas para cortar alambre

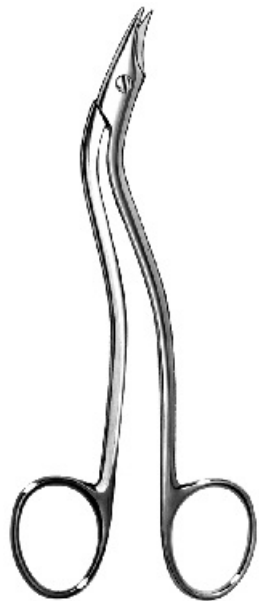

Heath

20.1951 15,0 cm/6"



Universal

20.1952 12,0 cm/4¾"

Nagelspalt-Scheren, Nail Splitting Scissors
Ciseaux à fendre les ongles, Tijeras para hender las uñas



20.1954

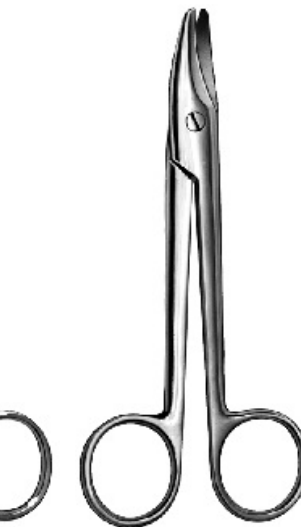

Sistrunk 20.1955

13,0 cm/5"

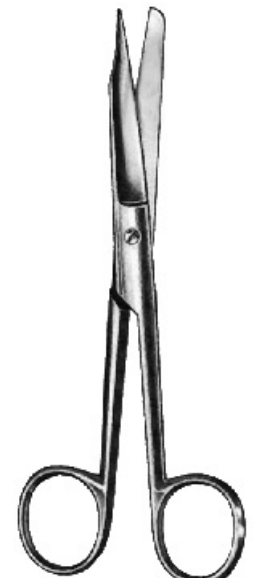

20.1956-15 15,0 cm/6"

20

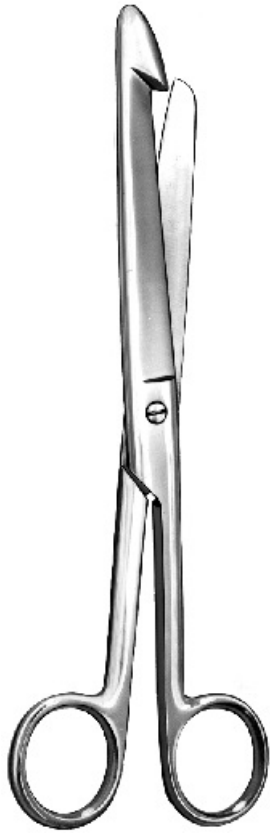

Darmschere

20.1961 21,0 cm/8¼"

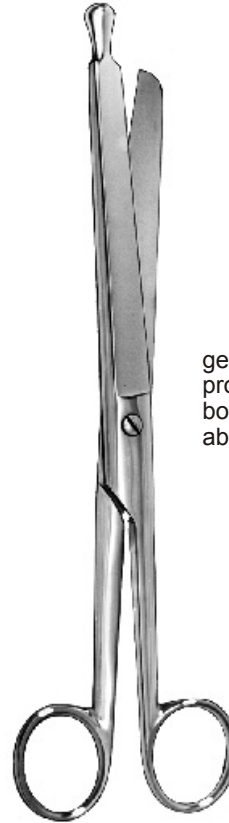

geknoepft
probe-pointed
boutonnés
abotonadas

Darmschere

20.1963 21,0 cm/8¼"



Anatomie-Scheren
Dissecting Scissors
Ciseaux à dissection
Tijeras para disección



20.1965	11,5 cm/4½"	20.1968
20.1966	13,0 cm/5"	20.1969
20.1967	14,5 cm/5½"	20.1970



20.1791-SC
20.1793-SC

Mayo
14,5 cm/5½"
17,0 cm/6¾"



20.1796-SC
20.1798-SC



20.1801-SC
20.1802-SC

Mayo-Stillé
15,0 cm/6"
17,0 cm/6¾"



20.1803-SC
20.1804-SC

20



20.1817-SC

Mayo-Lexer
16,0 cm/6¼"



20.1818-SC



20.1821-SC

Metzenbaum
14,5 cm/5½"



20.1851-SC

Metzenbaum
14,5 cm/5½"

20

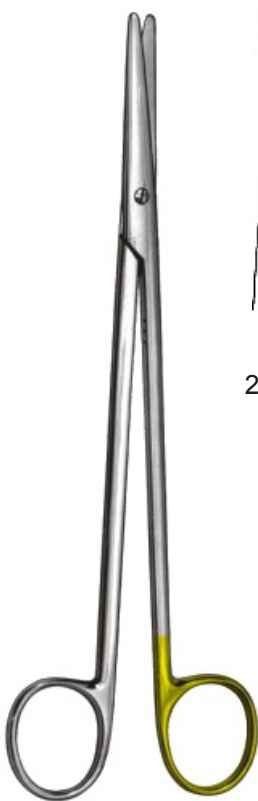

20.1822-SC

Metzenbaum
18,0 cm/7"

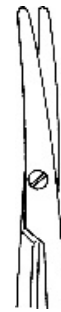

20.1852-SC

Metzenbaum
18,0 cm/7"



20.1880-SC

Metzenbaum, Fino
 14,5 cm/5½"



20.1884-SC



**Metzenbaum
 (Strabismus)**
 11,5 cm/4½"

20.1888-SC

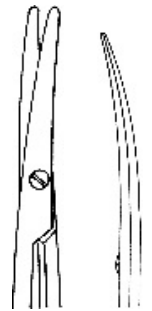

20.1889-SC



Lister

- 20.1979-SC 14,0 cm/5½"
- 20.1980-SC 18,0 cm/7"
- 20.1981-SC 20,0 cm/8"



Irisschere
 11,5 cm/4¾"

20.7458-SC



20.7459-SC

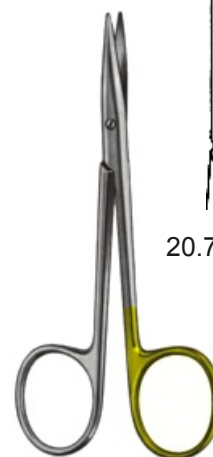

Stevens
 11,0 cm/4½"
 stumpf
 blunt
 mousses
 romas

20.7496-SC



20.7497-SC

**Instrumente für Verband und Gips
Bandage and Plaster Instruments
Instruments pour pansements et plâtre
Instrumentos para vendajes y yeso**

21





Smith

21.1971 16,0 cm/6¼"
 21.1972 18,0 cm/7"
 21.1973 20,0 cm/8"
 21.1974 23,0 cm/9"

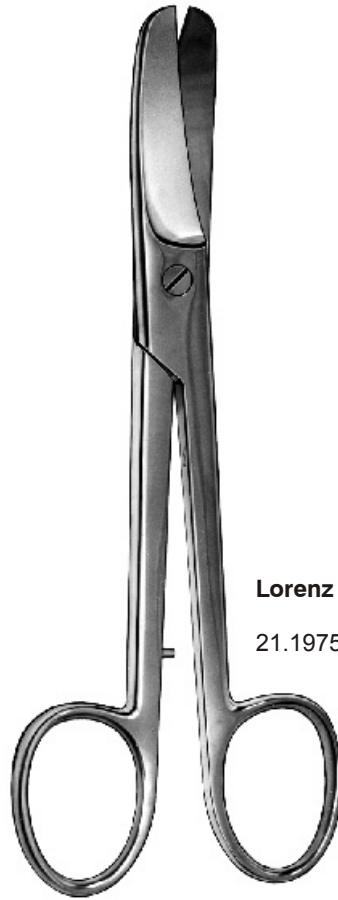

Lorenz

21.1975 23,0 cm/9"



Knowles
 14,5 cm/5½"

21.1976 21.1976G

gerade, straight gebogen, curved
 droits, rectas courbes, curvas

21



Lister

21.1977 9,0 cm/3½"
 21.1978 11,0 cm/4½"
 21.1979 14,0 cm/5½"
 21.1980 18,0 cm/7"
 21.1981 20,0 cm/8"



Esmarch

21.1982 20,0 cm/8"
 21.1983 23,0 cm/9"

21



Bruns
24,0 cm/9½"

21.1984

glatt, smooth
lisses, lisas

21.1985

gezahnt, saw edge
dentelés, dentadas



Lister

21.1986S
18,0 cm/7"

schwarz
black
noir
negro

21.1987S
15,0 cm/6"

schwarz
black
noir
negro

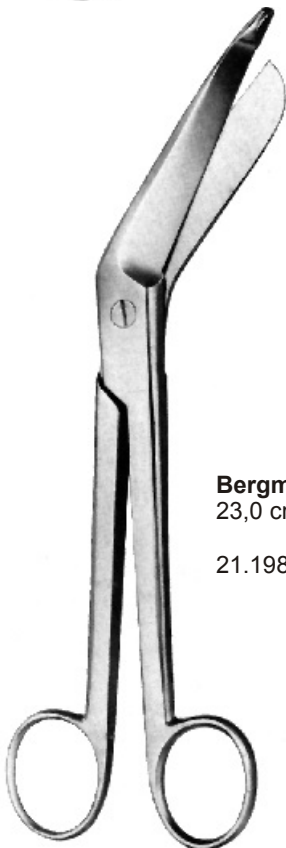

Bergmann
23,0 cm/9"

21.1988



Lister-Excentric
16,0 cm/6¼"

21.1989

Gipsscheren

Plaster-of-Paris Shears

Ciseaux pour pansements et plâtre

Tijeras para vendajes

Gipsmesser

Plaster-of-Paris knives

Couteaux a plâtre

Cuchillos para yeso



Seutin

21.1990 23,0 cm/9"

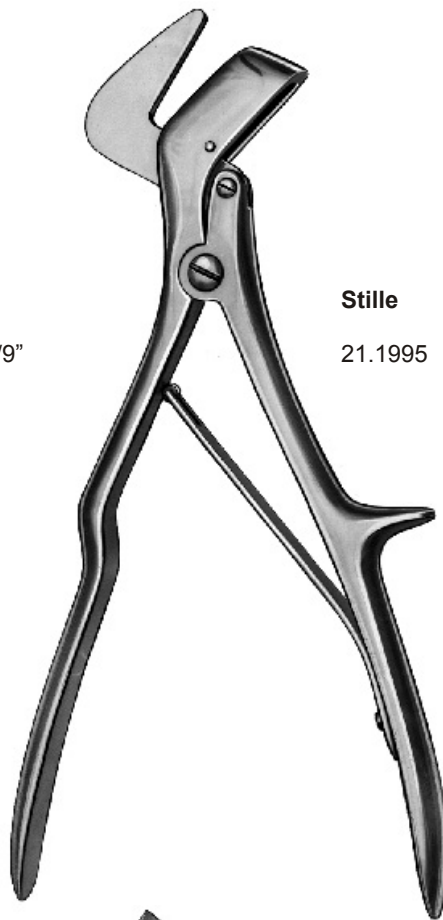

Stille

21.1995 24,0 cm/9½"



Esmarch
18,0 cm/7"

21.2021



Reiner
18,0 cm/7"

21.2022



Hopkins
20,0 cm/8"

21.2024



Stille

21.1996 23,0 cm/9"

21.1997 26,0 cm/10½"

21.1998 37,0 cm/14½"

verstärkter Rücken
reinforced back
à dos renforcé
lomo reforzado

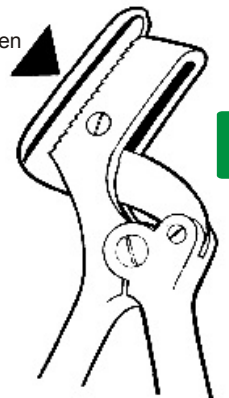

21

21.1999
26,0 cm/10½"

21.2000
37,0 cm/14½"



Engel

21.2028

21

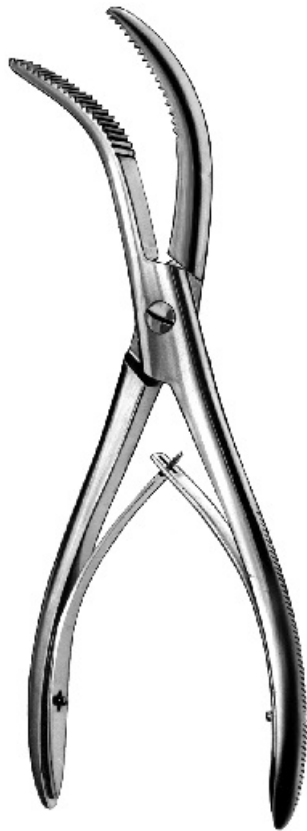

Wolff

21.2032 18,0 cm/7"
21.2033 24,0 cm/9½"



Henning

21.2034 28,0 cm/11"



Haglund-Stille

21.2036 28,0 cm/11"



USA-Modell

21.2037 23,0 cm/9"

Instrumente mit Hartmetalleinlagen
Instruments with Tungsten Carbide Inserts
Instrumentes avec mors en carbure de tungstène
Instrumentos con placas de carburo tungsteno

22



Anatomische Pinzetten mit Hartmetall-Einsätzen

Dressing Forceps with T/C jaws

Pinces à disséquer avec mors en carbure de tungstène

Pinzas de disección con boca de carburo de tungsteno

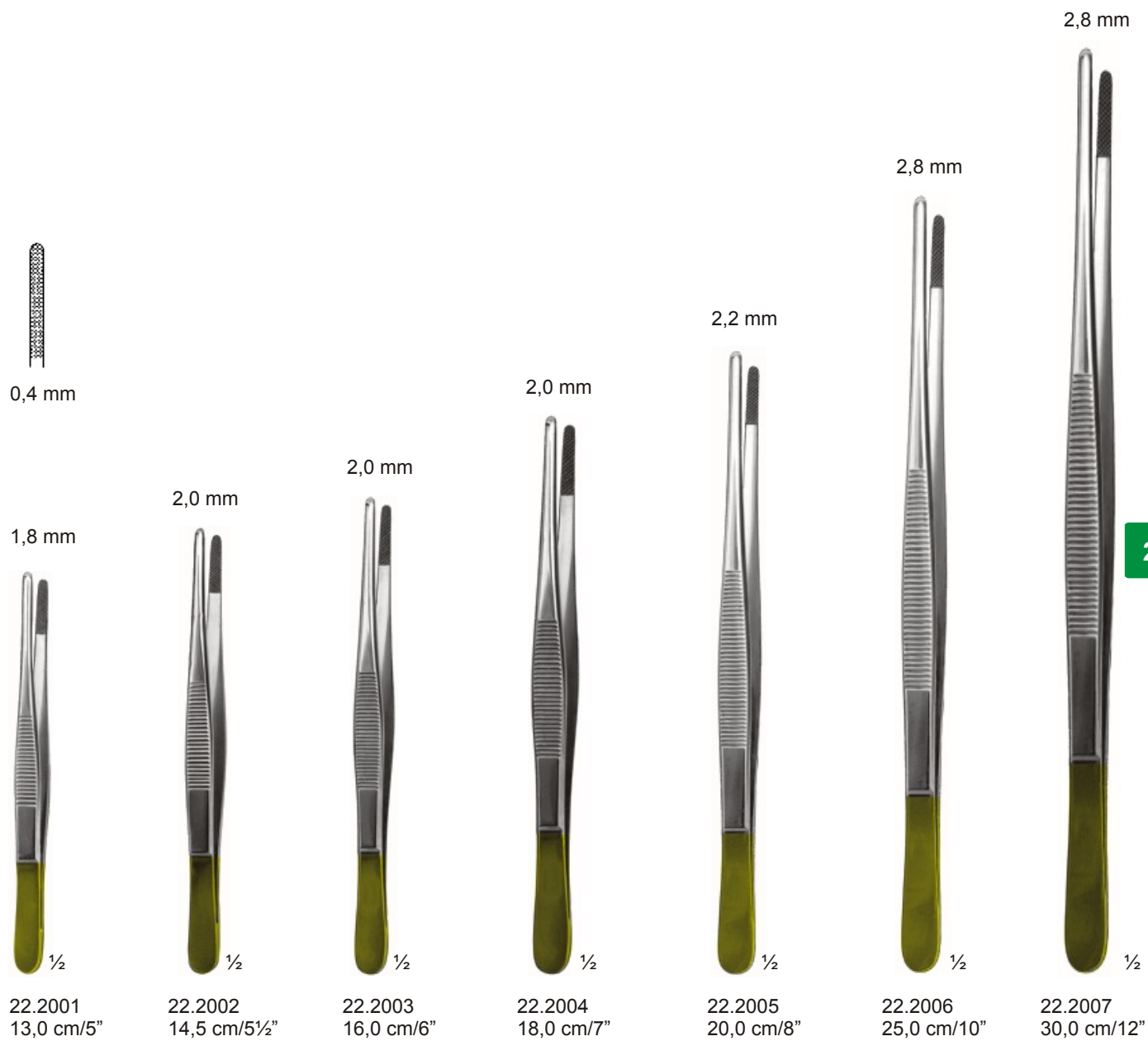

22

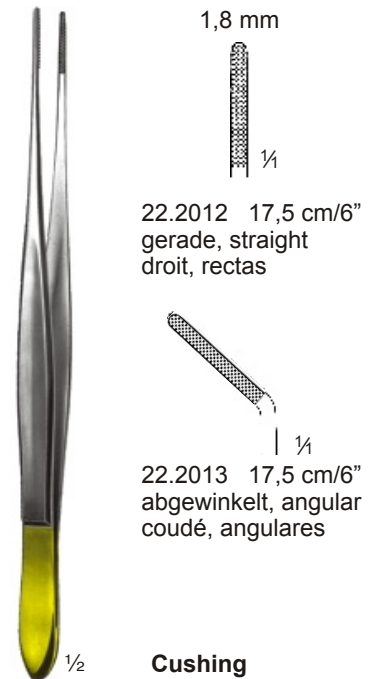
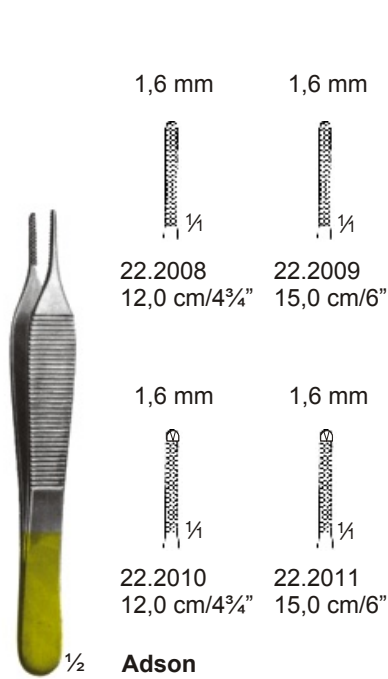

22

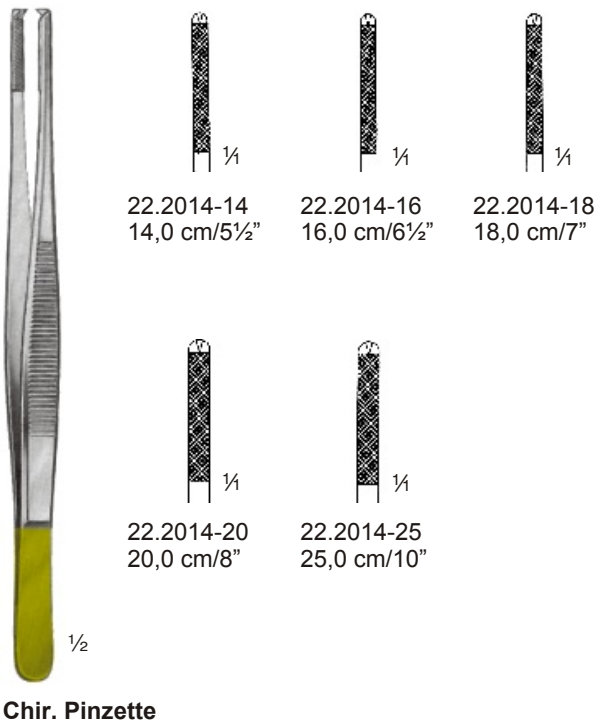

22.2015 18,0 cm/7"
22.2016 21,0 cm/8¼"
22.2017 25,0 cm/10"

22.2018 15,0 cm/6"
22.2019 23,0 cm/9"

**ohne Sperre, without ratchet
sans crémaillère, sin cremallera**



22.2095-14 14,0 cm/5½"
gerade
straight
droite
recta



22.2096-14
gebogen
curved
courbe
curva



22.2097-14 14,0 cm/5½"
gerade
straight
droite
recta



22.2098-14
gebogen
curved
courbe
curva



Castroviejo

**mit Sperre, with ratchet
avec crémaillère, con cremallera**



22.2099-14 14,0 cm/5½"
22.2099-18 18,0 cm/7"
22.2099-21 21,0 cm/8¼"
gerade
straight
droite
recta



22.2100-14
22.2100-18
22.2100-21
gebogen
curved
courbe
curva



22.2101-14 14,0 cm/5½"
22.2101-18 18,0 cm/7"
22.2101-21 21,0 cm/8¼"
gerade
straight
droite
recta



22.2102-14
22.2102-18
22.2102-21
gebogen
curved
courbe
curva



Kalt
22.2104 14,0 cm/5½"

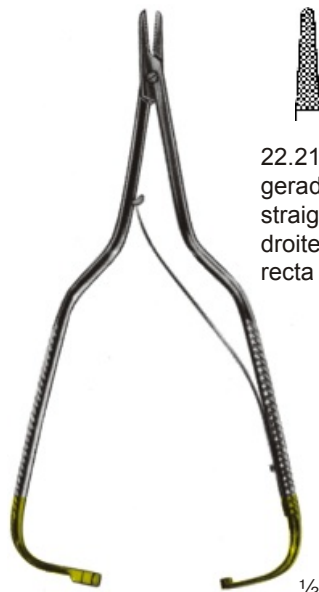

Arruga
16,0 cm/6¼"



22.2105
gerade
straight
droite
recta



22.2106
gebogen
curved
courbe
curva



Barraquer
13,5 cm/5¼"

22.2110 22.2111
gerade gebogen
straight curved
droite courbe
recta curva



13,0 cm = 1,2 mm
14,5 cm = 1,4 mm
16,0 cm = 1,5 mm
18,0 cm = 1,7 mm
20,0 cm = 2,0 mm
23,0 cm = 2,2 mm
26,0 cm = 2,4 mm

French

- 22.2113 13,0 cm/5"
- 22.2114 14,5 cm/5½"
- 22.2115 16,0 cm//6¼"
- 22.2116 18,0 cm/7"
- 22.2117 20,0 cm/8"
- 22.2118 23,0 cm/9"
- 22.2119 26,0 cm/10¼"



Derf

- 22.2192 12,5 cm/5"

22



Mayo-Hegar

- 22.2199 30,0 cm/12"

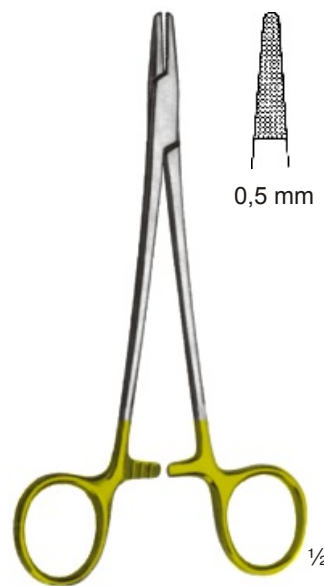

Mayo-Hegar

- 22.2200 14,0 cm/5½"
- 22.2201 16,0 cm/6¼"
- 22.2202 18,0 cm/7¼"
- 22.2203 20,0 cm/8"
- 22.2204 23,0 cm/9"
- 22.2205 26,0 cm/10¼"

Nadelhalter mit Hartmetall-Einsätzen

Needle holders with T/C jaws

Porte-aiguilles avec mors en carbure de tungstène

Porta-agujas con boca de carburo de tungsteno

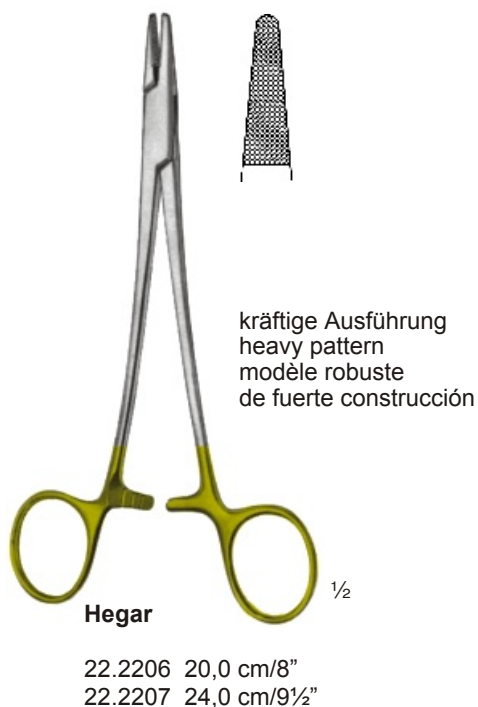

22



Wangenstein

22.2211 27,0 cm/10½"



Finochietto

22.2212 26,0 cm/10¼"
22.2213 20,0 cm/8"



Baumgartner

22.2214 13,0 cm/5"



Crile-Wood

22.2215 15,0 cm/6"
22.2216 18,0 cm/7"
22.2217 20,0 cm/8"
22.2218 23,0 cm/9"
22.2228 26,0 cm/10¼"



De Bakey

22.2216D 18,0 cm/7"
22.2217D 20,0 cm/8"
22.2218D 23,0 cm/9"
22.2228D 26,0 cm/10¼"

Nadelhalter mit Hartmetall-Einsätzen

Needle holders with T/C jaws

Porte-aiguilles avec mors en carbure de tungstène

Porta-agujas con boca de carburo de tungsteno



Heaney

22.2219 20,0 cm/8"
22.2220 26,0 cm/10¼"

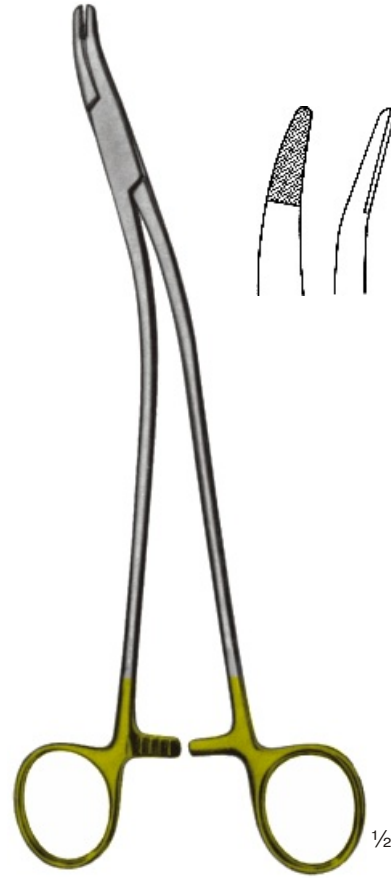

Stratte

22.2221 23,0 cm/9"



Mathieu

22.2222 14,0 cm/5½"
22.2223 17,0 cm/6½"
22.2224 20,0 cm/8"



Halsey

13,0 cm/5"

22.2225 22.2226
glatt
smooth
lisse
lisa



Webster

22.2227 13,0 cm/5"



Mathieu

22.2231 17,0 cm/6½"
22.2232 20,0 cm/8"



kräftige Ausführung
heavy pattern
modèle robuste
de fuerte construcción

für den Veterinär-Bereich
for the veterinary field
pour des vétérinaires
para los veterinarios

Mathieu

22.2233-17 17,0 cm/6½"
22.2233-20 20,0 cm/8"

22

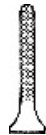

schmales Modell
delicate pattern
modèle étroit
modelo estrecho

French-Mathieu

22.2234 14,0 cm/5½"
22.2235 17,0 cm/6½"
22.2236 20,0 cm/8"



gebogenes Modell
curved pattern
modèle courbe
modelo curvo

Mathieu

22.2237 14,0 cm/5½"
22.2238 17,0 cm/6½"
22.2239 20,0 cm/8"

Nadelhalter mit Hartmetall-Einsätzen

Needle holders with T/C jaws

Porte-aiguilles avec mors en carbure de tungstène

Porta-agujas con boca de carburo de tungsteno



Sarot

22.2240 18,0 cm/7"

22.2241 20,0 cm/8"

22.2242 26,0 cm/10¼"



Masson

22.2244 27,0 cm/10½"



Olsen-Hegar

22.2245 14,0 cm/5½"

kräftige Ausführung
heavy pattern
modèle robuste
de fuerte construcción

für den Veterinär-Bereich
for the veterinary field
pour des vétérinaires
para los veterinarios



Olsen-Hegar

22.2246 17,0 cm/6¾"



für sehr feine Nadeln
for fine needles
pour des aiguilles très fines
para agujas finas

Baby-Olsen-Hegar
11,5 cm/4½"

22.2247	22.2248
gerieft	glatt
serrated	smooth
striée	lisse
estriada	lisa

22

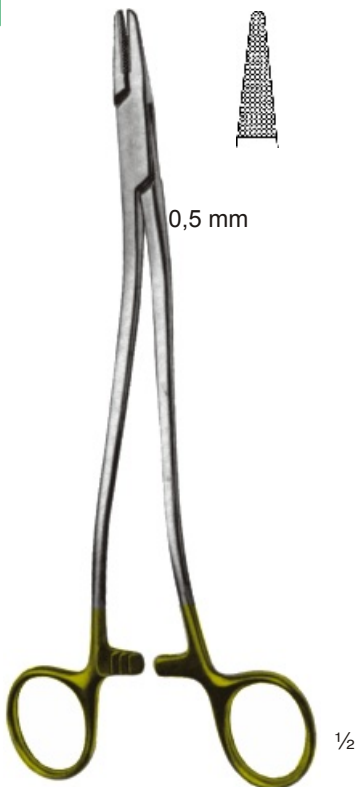

0,5 mm

Bozemann

22.2250 20,0 cm/8"
22.2251 24,0 cm/9½"
22.2252 26,0 cm/10¼"



Gillies-Baby

22.2253-11 11,0 cm/4"

Gillies

22.2253-16 16,0 cm/6¼"



Gewebefaßzange
 Tissue Seizing Forceps
 Pince à saisir les tissus
 Pinza para coger tejidos

Duval

22.2254 20,0 cm/8"

22



Babcock

22.2255 16,0 cm/6¼"
 22.2256 20,0 cm/8"



Allis

22.2257 16,0 cm/6¼"
 22.2258 19,0 cm/7½"



Standard
14,5 cm/5½"

½



Standard
14,5 cm/5½"



Fig. 1
22.2260



Fig. 2
22.2261



Fig. 3
22.2262

gerade
straight
droits
rectas

gebogen
curved
courbes
curvas

22.2263

22.2264

22.2265

22



Parametrium

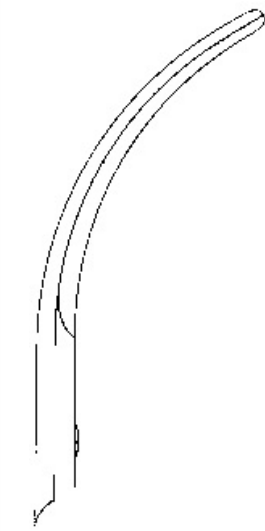

22.2268-22
22,5 cm/9"



22.2268-23
23,0 cm/9"

½



Lister

22.2269
18,0 cm/7"

½



Mayo

22.2270
22.2271

14,5 cm/5½"
17,0 cm/6¾"

Mayo

22.2272
22.2273

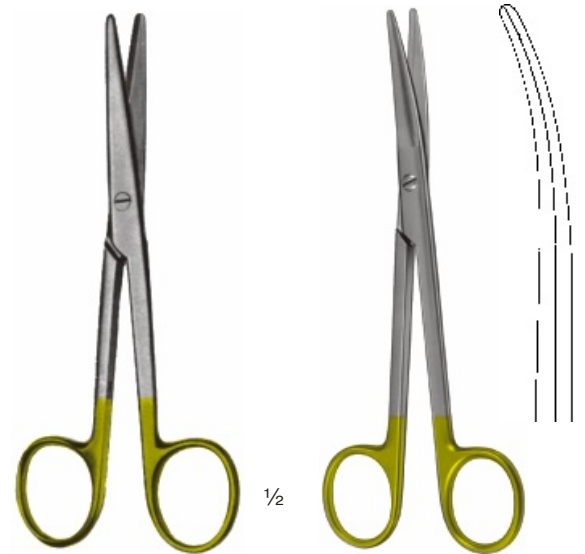

Mayo-Stille

22.2274
22.2275

15,0 cm/6"
17,0 cm/6¾"

Mayo-Stille

22.2276
22.2277

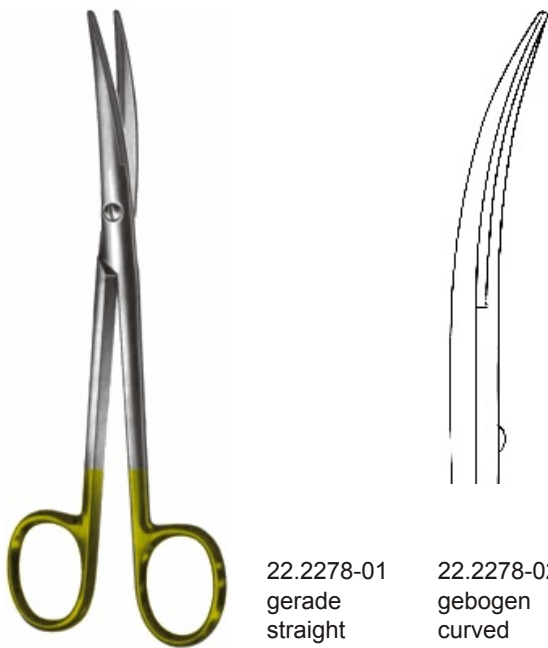

Mayo-Lexer
16,5 cm/6½"

22.2278-01
gerade
straight
droits
rectas

22.2278-02
gebogen
curved
courbes
curvas

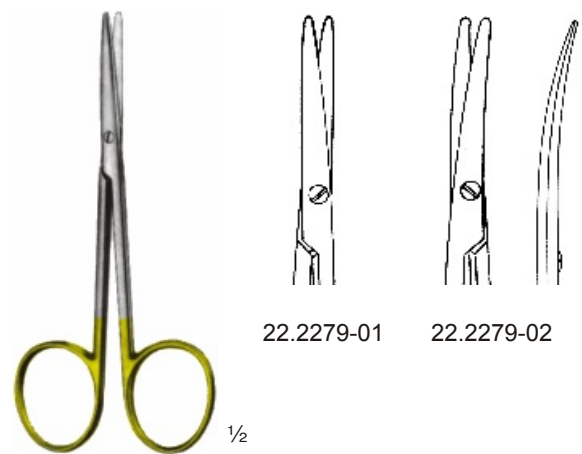

**Strabismus
(Metzenbaum)**
11,5 cm/4½"

22.2279-01

22.2279-02

22

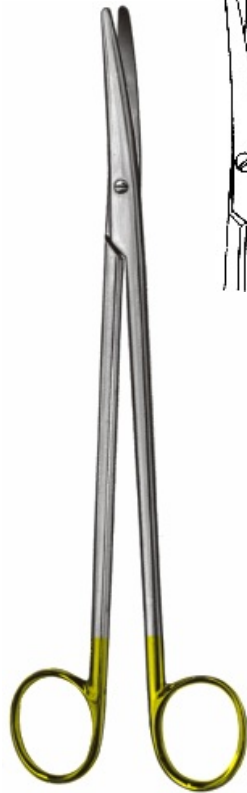

Metzenbaum

- 22.2280 14,5 cm/5½"
- 22.2281 18,0 cm/7"
- 22.2282 20,0 cm/8"
- 22.2283 23,0 cm/9"

- 22.2284
- 22.2285
- 22.2286
- 22.2287

Metzenbaum, Fino

- 22.2280F 14,5 cm/5½"
- 22.2281F 18,0 cm/7"
- 22.2282F 20,0 cm/8"
- 22.2283F 23,0 cm/9"
- 22.2284F
- 22.2285F
- 22.2286F
- 22.2287F



Tönnis-Adson

- 22.2288 17,0 cm/7"



Irischere
11,5 cm/4¾"



22.2289-01



22.2289-02





gezahnte Schneide
 saw edge
 lame de scie
 corte con dientes

Universal

22.2290 12,0 cm/5"



22.2291 12,5 cm/5"



22.2292 17,5 cm/7"

für Drähte bis 1,6 mm Ø
 for wires up to 1,6 mm Ø
 pour fils jusqu'a 1,6 mm Ø
 para hilos hasta 1,6 mm Ø



22.2293 22,0 cm/8¾"

für Drähte bis 2,5 mm Ø
 for wires up to 2,5 mm Ø
 pour fils jusqu'a 2,5 mm Ø
 para hilos hasta 2,5 mm Ø



22.2294-16 16,0 cm/6½"

für Drähte bis 1,6 mm Ø
 for wires up to 1,6 mm Ø
 pour fils jusqu'a 1,6 mm Ø
 para hilos hasta 1,6 mm Ø



18,0 cm/7"



Fig. 1
22.2296-01



Fig. 2
22.2296-02



Fig. 3
22.2296-03

22



22.2297-18 18,0 cm/7"

für weiche Drähte bis 2,0 mm Ø
for soft wires up to 2,0 mm Ø
pour fils mous jusqu'à 2,0 mm Ø
para hilos blandos hasta 2,0 mm Ø

für harte Drähte bis 1,7 mm Ø
for hard wires up to 1,7 mm Ø
pour fils durs jusqu'à 1,7 mm Ø
para hilos duros hasta 1,7 mm Ø



Drahtziehzange
Wire Seizing Forceps
Pinces à saisir le fil
Pinzas para coger alambre

22.2298-16 16,0 cm/6½"
22.2298-18 18,5 cm/7"

Naht
Suture
Suture
Sutura





Collier

23.2301 12,5 cm/5"

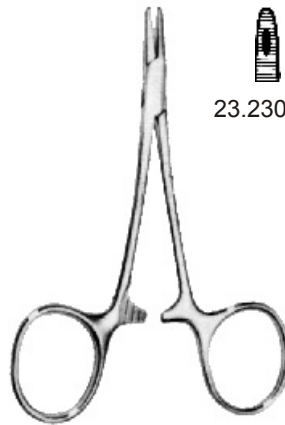

Derf

12,5 cm/5"

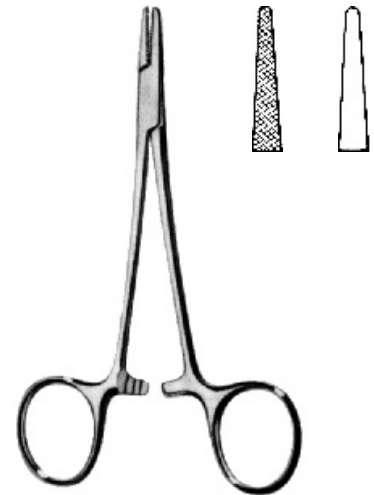
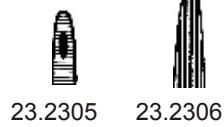

Halsey

23.2310 13,0 cm/5" 23.2311
gerieft glatt
serrated smooth
striée lisse
estriada lisa

23



Webster

23.2312 13,0 cm/5"
glatt
smooth
lisse
lisa

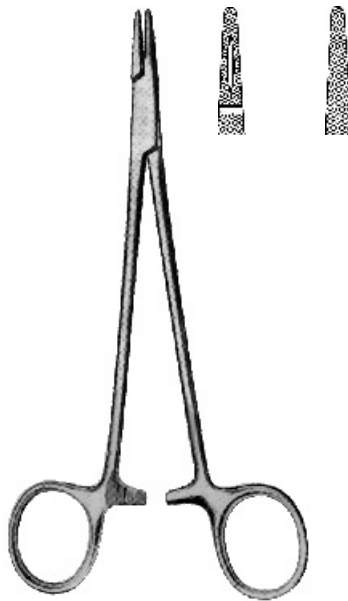

Crile-Wood

23.2314 15,0 cm/6"
mit Rille
with groove
avec cannelure
con ranura

Crile-Wood

23.2315
ohne Rille
without groove
sans cannelure
sin ranura



Brown

23.2318 13,0 cm/5"
23.2319 18,0 cm/7"



Sarot

23.2322 18,0 cm/7¼"
 23.2324 26,0 cm/10¼"



M.G.H.

23.2329 17,0 cm/6¾"



Mayo-Hegar

23.2330	14,0 cm/5½"	
23.2331	16,0 cm/6¼"	23.2341
23.2332	18,0 cm/7¼"	23.2342
23.2333	20,0 cm/8"	23.2343
23.2334	24,0 cm/9½"	23.2344
23.2335	26,0 cm/10¼"	23.2345

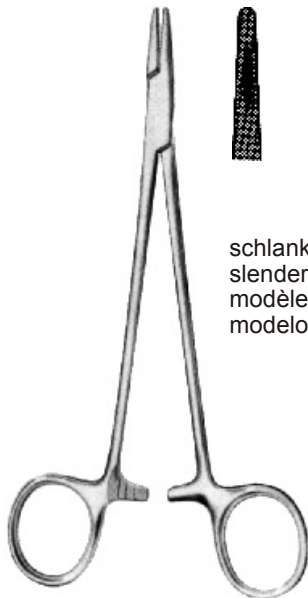

Mayo-Hegar

23.2351 16,0 cm/6¼"
 23.2352 18,0 cm/7"
 23.2353 20,0 cm/8"

schlankes Modell
 slender pattern
 modèle gracile
 modelo delgado

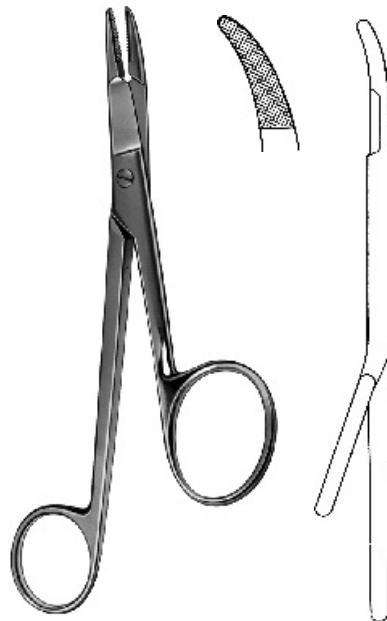

Gillies

23.2354 16,0 cm/6¼"



Hegar-Baumgartner

23.2355 14,0 cm/5½"



für sehr feine Nadeln
for fine needles
pour des aiguilles très fines
para agujas finas

Baby-Olsen-Hegar
11,5 cm/4½"

23.2356-01	23.2356-02
gerieft	glatt
serrated	smooth
striée	lisse
estriada	lisa



Olsen-Hegar

23.2357 14,0 cm/5½"

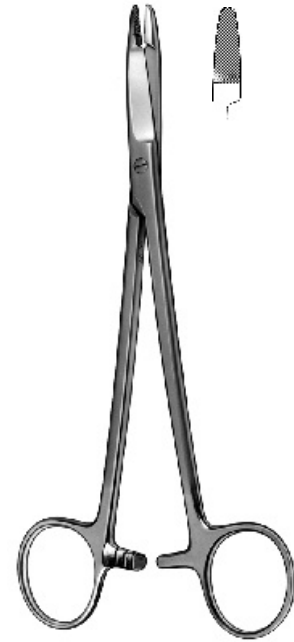

Olsen-Hegar

23.2358 16,0 cm/6¼"

23

kräftige Ausführung
heavy pattern
modèle robuste
de fuerte construcción



Olsen-Hegar

23.2257N 14,0 cm/5½"



Olsen-Hegar

23.2258N 17,0 cm/6¼"



Olsen-Hegar

23.2359 18,0 cm/7"

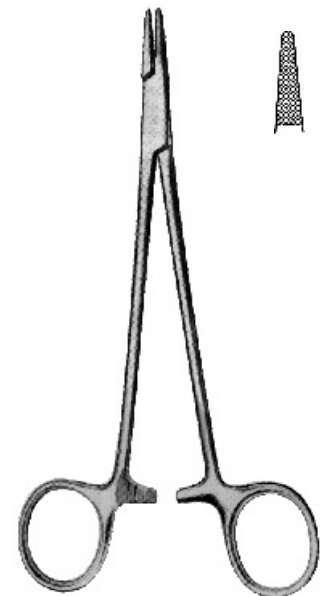

Crile-Wood

23.2360 15,0 cm/6"
23.2361 18,0 cm/7"
23.2362 20,0 cm/8"
23.2363 23,0 cm/9"

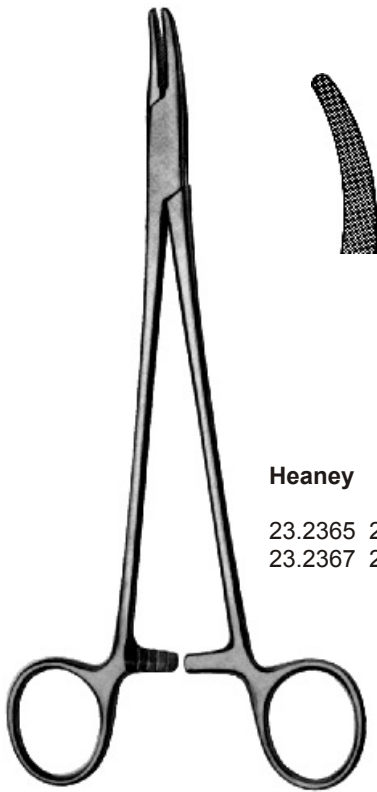

Heaney

23.2365 21,0 cm/8¼"
 23.2367 26,0 cm/10¼"

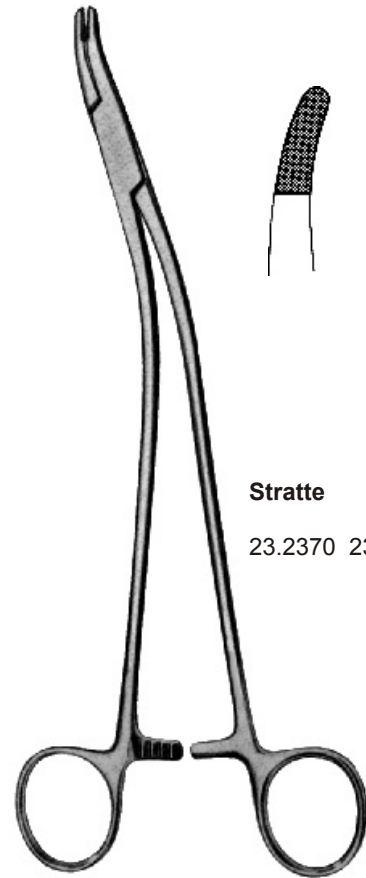

Stratte

23.2370 23,0 cm/9"

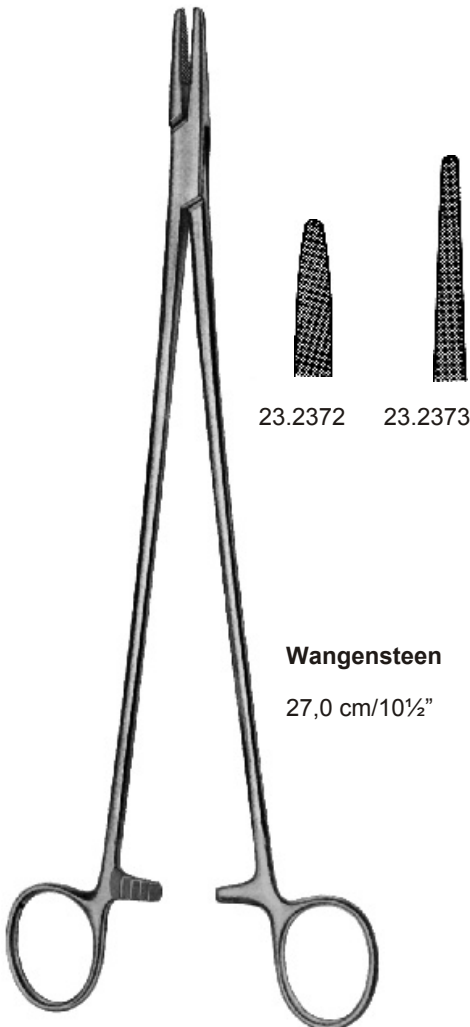

23.2372 23.2373

Wangenstein

27,0 cm/10½"



Masson

23.2375
 27,0 cm/10½"

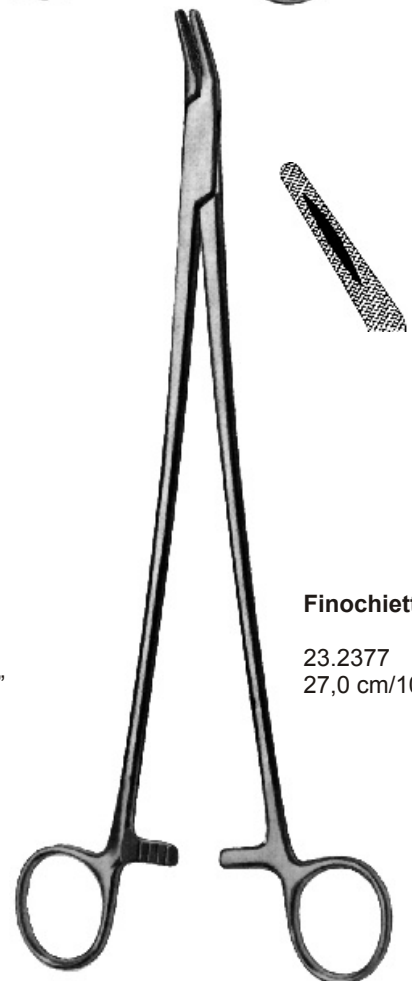

Finochietto

23.2377
 27,0 cm/10½"



Crile

23.2382 15,0 cm/6"



Adson

23.2384 18,0 cm/7"

23

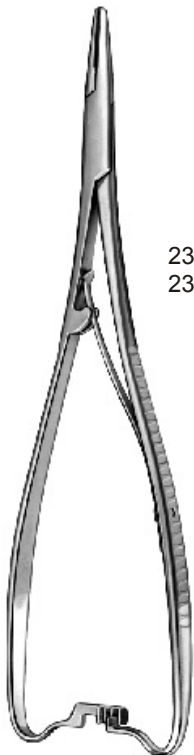

Mathieu

23.2385 17,0 cm/6½" 23.2390
23.2386 20,0 cm/8" 23.2391



Mathieu

23.2387 14,0 cm/2½" 23.2392
23.2388 17,0 cm/6½" 23.2393
23.2389 20,0 cm/8" 23.2394

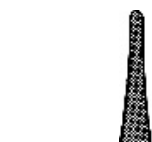

23.2397 14,0 cm/5½"
23.2398 17,0 cm/6¾"
schlankes Maul
slender jaw
mors étroit
boca fina

23.2388K 17,0 cm/6½"
23.2389K 20,0 cm/8"
kräftige Ausführung
heavy pattern
modèle robuste
de fuerte construcción

mit Sperre, with ratchet
avec crémaillère, con cremallera



23.2405-14 14,0 cm/5½"
 23.2405-18 18,0 cm/7"
 23.2405-21 21,0 cm/8¼"
 gerade
 straight
 droite
 recta



23.2406-14
 23.2406-18
 23.2406-21
 gebogen
 curved
 courbe
 curva



23.2419-14 14,0 cm/5½"
 gerade
 straight
 droite
 recta



23.2420-14
 gebogen
 curved
 courbe
 curva



Castroviejo

ohne Sperre, without ratchet
sans crémaillère, sin cremallera



23.2407-14 14,0 cm/5½"
 gerade
 straight
 droite
 recta



23.2408-14
 gebogen
 curved
 courbe
 curva

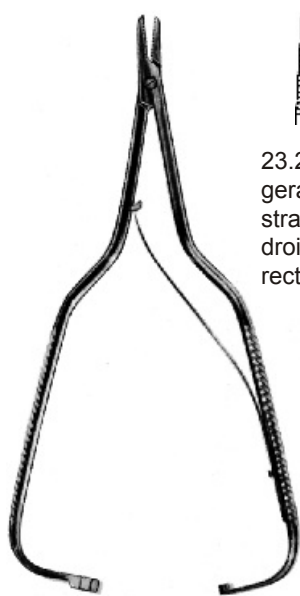

Arruga
 16,0 cm/6¼"



23.2401
 gerade
 straight
 droite
 recta



23.2402
 gebogen
 curved
 courbe
 curva



Kalt
 23.2410 14,0 cm/5½"



Barraquer

23.2412 13,5 cm/5"
 23.2417 18,0 cm/7"
 gerade
 straight
 droite
 recta



23.2413
 23.2418
 gebogen
 curved
 courbe
 curva



Gewöhnliches Ohr
Regular eye
Chas régulier
Ojo ordinario

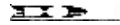

Federöhr
Spring eye
Chas à ressort
Ojo de resorte

	gerade	straight	droite	recta
	halbgebogen	half curved	½ courbée	½ curva
	3/8 Kreis	3/8 circle	3/8 cercle	3/8 círculo
	1/2 Kreis	1/2 circle	1/2 cercle	1/2 círculo

23



Nadeln mit dreikantiger Schneide
Triangular point
Pointe triangulaire
Punta triangular



Runde Nadeln
Round point
Pointe ronde
Punta redonda

Bestell-Nr. + Order-No. + Ref. No. + Ref. No. +	Größen sizes mesures tamaños
-30	000
-20	00
-00	0
-01	1
-02	2
-03	3
-04	4
-05	5
-06	6
-07	7
-08	8
-09	9
-10	10
-11	11
-12	12
-13	13
-14	14
-15	15
-16	16

Verpackungsformen: Päckchen à 12 Stück
Packaging: packets of 12 pieces
Formes d'emballage: paquets de 12 pièces
Formas de embalaje: paquetes de 12 unidades

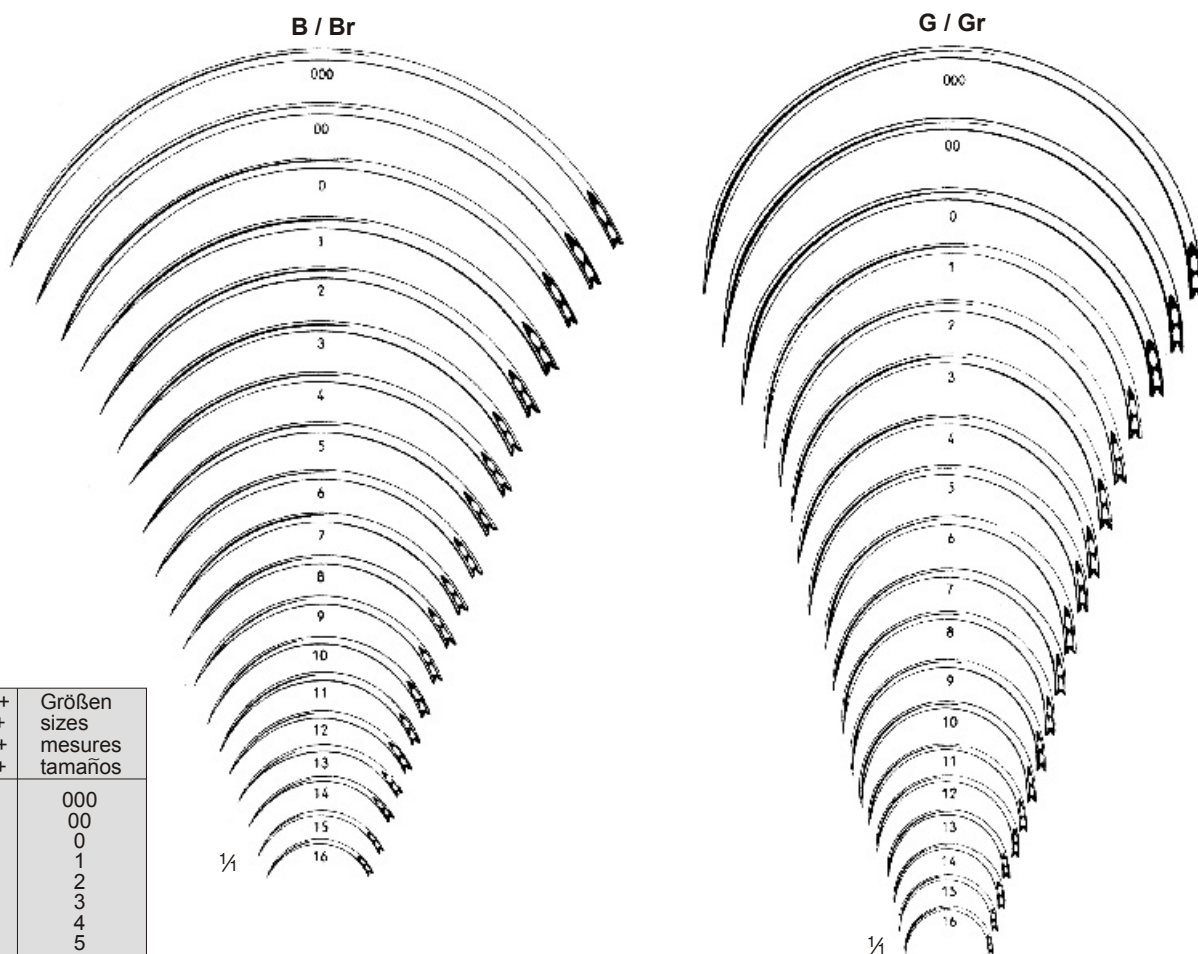

Bestell-Nr. + Order-No. + Ref. No. + Ref. No. +	Größen sizes mesures tamaños
-30	000
-20	00
-00	0
-01	1
-02	2
-03	3
-04	4
-05	5
-06	6
-07	7
-08	8
-09	9
-10	10
-11	11
-12	12
-13	13
-14	14
-15	15
-16	16

23

Bestell-Nr. Order-No. Ref. No. Ref. No.		Öhr Eye Chas Ojo	Größen Sizes Mesures Tamaños	Profil Profile Profil Perfil	Biegung Curvature Courbure Curvatura
23.2440-30 - 23.2440-16	B		000 - 16	▲	3/8 Kreis; 3/8 circle; 3/8 cercle; 3/8 círculo
23.2441-30 - 23.2441-16	B		000 - 16	▲	3/8 Kreis; 3/8 circle; 3/8 cercle; 3/8 círculo
23.2442-30 - 23.2442-16	Br		000 - 16	●	3/8 Kreis; 3/8 circle; 3/8 cercle; 3/8 círculo
23.2443-30 - 23.2443-16	Br		000 - 16	●	3/8 Kreis; 3/8 circle; 3/8 cercle; 3/8 círculo
23.2446-30 - 23.2446-16	G		000 - 16	▲	1/2 Kreis; 1/2 circle; 1/2 cercle; 1/2 círculo
23.2447-30 - 23.2447-16	G		000 - 16	▲	1/2 Kreis; 1/2 circle; 1/2 cercle; 1/2 círculo
23.2448-30 - 23.2448-16	Gr		000 - 16	●	1/2 Kreis; 1/2 circle; 1/2 cercle; 1/2 círculo
23.2449-30 - 23.2449-16	Gr		000 - 16	●	1/2 Kreis; 1/2 circle; 1/2 cercle; 1/2 círculo

Ga / Gar

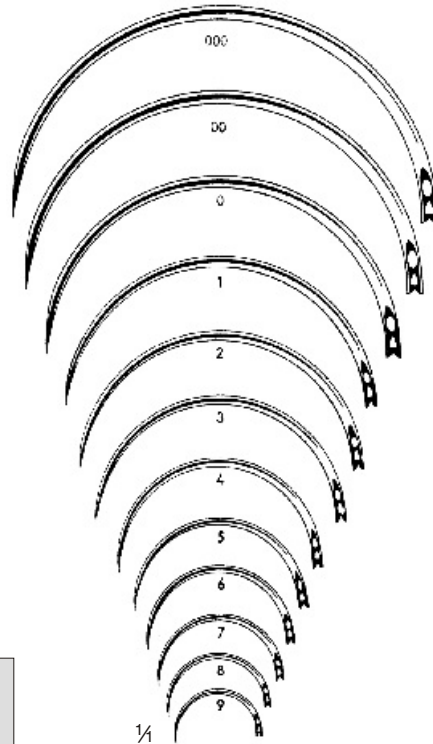

Keith

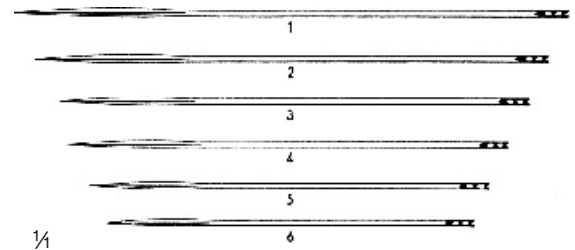

Bestell-Nr. Order-No. Ref. No. Ref. No.	+ + + +	Größen sizes mesures tamaños
-30		000
-20		00
-00		0
-01		1
-02		2
-03		3
-04		4
-05		5
-06		6
-07		7
-08		8
-09		9
-10		10
-11		11
-12		12
-13		13
-14		14
-15		15
-16		16

23

Bestell-Nr. Order-No. Ref. No. Ref. No.		Öhr Eye Chas Ojo	Größen Sizes Mesures Tamaños	Profil Profile Profil Perfil	Biegung Curvature Courbure Curvatura
23.2451-30 - 23.2451-09	Ga		000 - 9	▲	½ Kreis; ½ circle; ½ cercle; ½ círculo
23.2452-30 - 23.2452-09	Ga		000 - 9	▲	½ Kreis; ½ circle; ½ cercle; ½ círculo
23.2453-30 - 23.2453-09	Gar		000 - 9	●	½ Kreis; ½ circle; ½ cercle; ½ círculo
23.2454-30 - 23.2454-09	Gar		000 - 9	●	½ Kreis; ½ circle; ½ cercle; ½ círculo
23.2457-01 - 23.2457-06	Keith		1 - 6	▲	gerade, straight, droite, recta
23.2458-01 - 23.2458-06	Keith		1 - 6	▲	gerade, straight, droite, recta
23.2459-01 - 23.2459-06	Keith		1 - 6	●	gerade, straight, droite, recta
23.2460-01 - 23.2460-06	Keith		1 - 6	●	gerade, straight, droite, recta

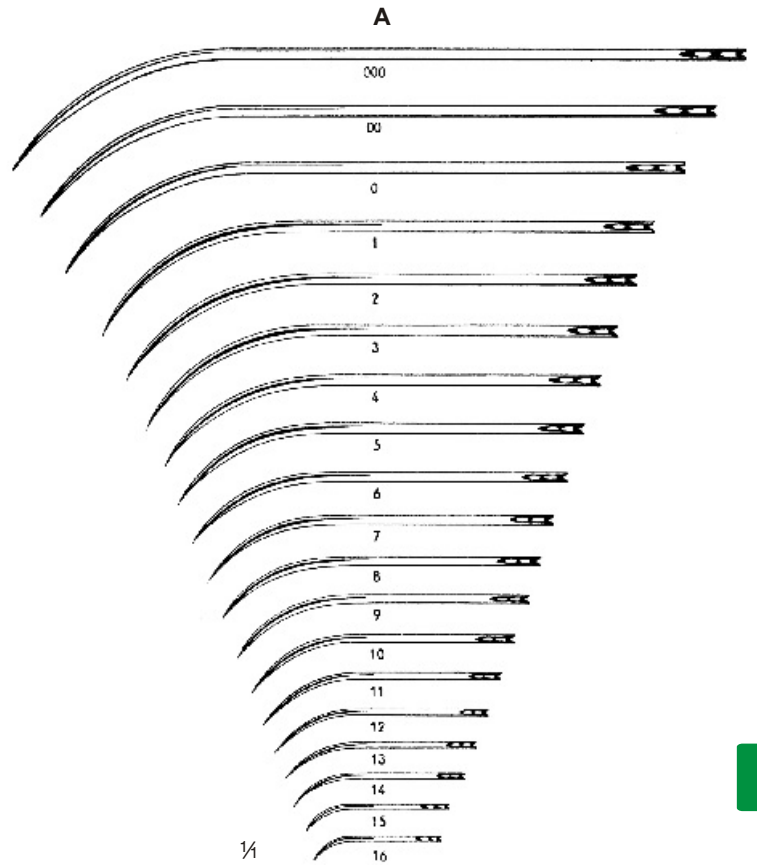
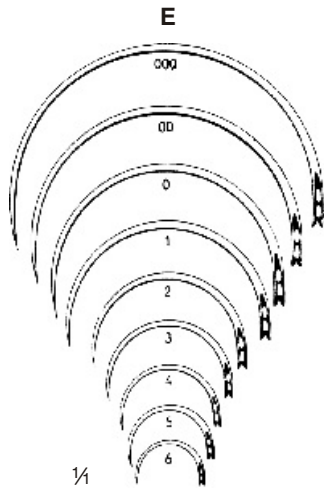

Bestell-Nr. + Order-No. + Ref. No. + Ref. No. +	Größen sizes mesures tamaños
-30	000
-20	00
-00	0
-01	1
-02	2
-03	3
-04	4
-05	5
-06	6
-07	7
-08	8
-09	9
-10	10
-11	11
-12	12
-13	13
-14	14
-15	15
-16	16

23

Bestell-Nr. Order-No. Ref. No. Ref. No.		Öhr Eye Chas Ojo	Größen Sizes Mesures Tamaños	Profil Profile Profil Perfil	Biegung Curvature Courbure Curvatura
23.2463-30 - 23.2463-06	E		000 - 6	●	½ Kreis; ½ circle; ½ cercle; ½ círculo
23.2464-30 - 23.2464-06	E		000 - 6	●	½ Kreis; ½ circle; ½ cercle; ½ círculo

23.2466-30 - 23.2466-16	A		000 - 16	▲	halb-gebogen, half-curved, ½ courbée, ½ curva
23.2467-30 - 23.2467-16	A		000 - 16	▲	halb-gebogen, half-curved, ½ courbée, ½ curva

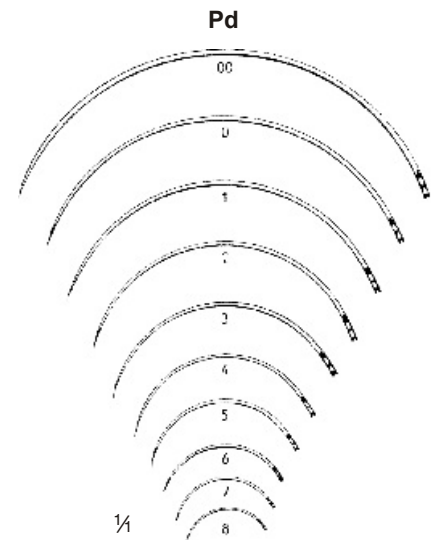
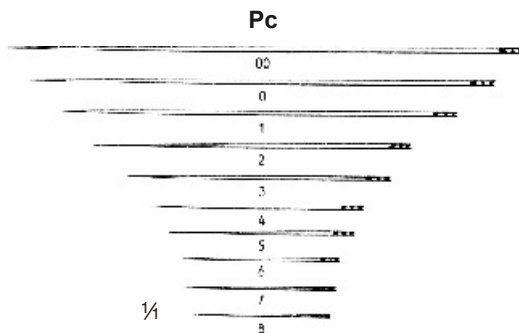
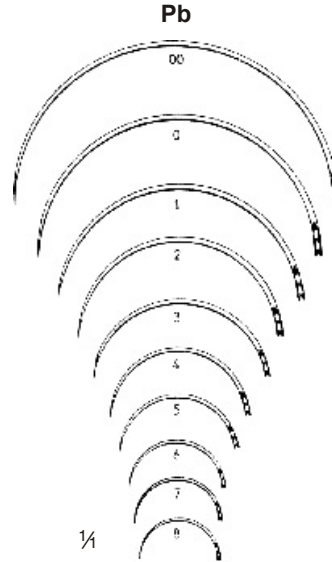
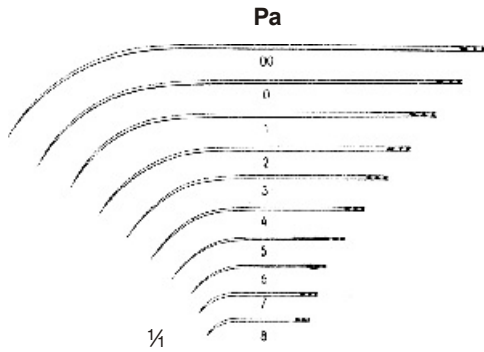

Bestell-Nr. + Order-No. + Ref. No. + Ref. No. +	Größen sizes mesures tamaños
-30	000
-20	00
-00	0
-01	1
-02	2
-03	3
-04	4
-05	5
-06	6
-07	7
-08	8
-09	9
-10	10
-11	11
-12	12
-13	13
-14	14
-15	15
-16	16

23

Bestell-Nr. Order-No. Ref. No. Ref. No.		Öhr Eye Chas Ojo	Größen Sizes Mesures Tamaños	Profil Profile Profil Perfil	Biegung Curvature Courbure Curvatura
23.2470-20 - 23.2470-08	Pa		00 - 8	●	halb-gebogen, half-curved, 1/2 courbée, 1/2 curva
23.2471-20 - 23.2471-08	Pa		00 - 8	●	halb-gebogen, half-curved, 1/2 courbée, 1/2 curva
23.2472-20 - 23.2472-08	Pb		00 - 8	●	1/2 Kreis; 1/2 circle; 1/2 cercle; 1/2 círculo
23.2473-20 - 23.2473-08	Pb		00 - 8	●	1/2 Kreis; 1/2 circle; 1/2 cercle; 1/2 círculo
23.2474-20 - 23.2474-08	Pc		00 - 8	●	gerade, straight, droite, recta
23.2475-20 - 23.2475-08	Pc		00 - 8	●	gerade, straight, droite, recta
23.2476-20 - 23.2476-08	Pd		00 - 8	●	3/8 Kreis; 3/8 circle; 3/8 cercle; 3/8 círculo
23.2477-20 - 23.2477-08	Pd		00 - 8	●	3/8 Kreis; 3/8 circle; 3/8 cercle; 3/8 círculo

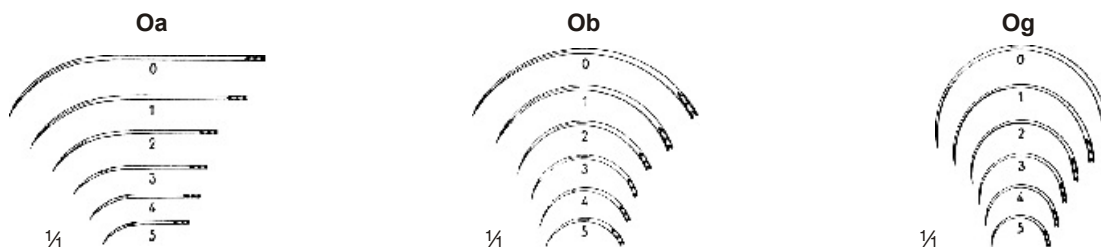

Bestell-Nr. + Order-No. + Ref. No. + Ref. No. +	Größen sizes mesures tamaños
-30	000
-20	00
-00	0
-01	1
-02	2
-03	3
-04	4
-05	5
-06	6
-07	7
-08	8
-09	9
-10	10
-11	11
-12	12
-13	13
-14	14
-15	15
-16	16

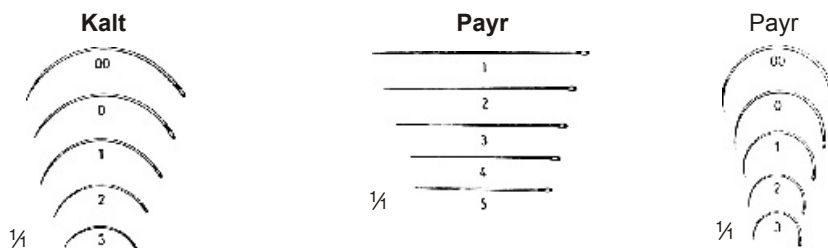

Bestell-Nr. Order-No. Ref. No. Ref. No.		Öhr Eye Chas Ojo	Größen Sizes Mesures Tamaños	Profil Profile Profil Perfil	Biegung Curvature Courbure Curvatura
23.2480-00 - 23.2480-05	Oa		0 - 5	▲	halb-gebogen, half-curved, ½ courbée, ½ curva
23.2481-00 - 23.2481-05	Oa		0 - 5	▲	halb-gebogen, half-curved, ½ courbée, ½ curva
23.2482-00 - 23.2482-05	Ob		0 - 5	▲	⅓ Kreis; ⅓ circle; ⅓ cercle; ⅓ círculo
23.2483-00 - 23.2483-05	Ob		0 - 5	▲	⅓ Kreis; ⅓ circle; ⅓ cercle; ⅓ círculo
23.2484-00 - 23.2484-05	Og		0 - 5	▲	½ Kreis; ½ circle; ½ cercle; ½ círculo
23.2485-00 - 23.2485-05	Og		0 - 5	▲	½ Kreis; ½ circle; ½ cercle; ½ círculo
23.2486-20 - 23.2486-03	Kalt		00-3	●	⅓ Kreis; ⅓ circle; ⅓ cercle; ⅓ círculo
23.2487-01 - 23.2487-05	Payr		1 - 5	●	gerade, straight, droite, recta
23.2488-20 - 23.2488-03	Payr		00 - 3	●	½ Kreis; ½ circle; ½ cercle; ½ círculo

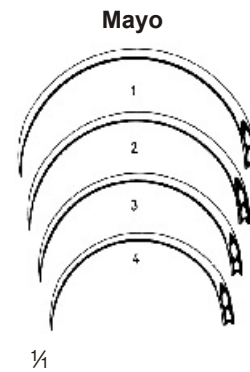
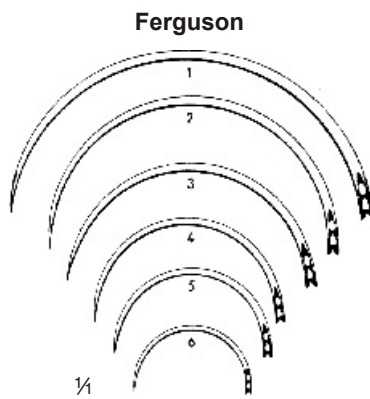

Bestell-Nr. + Order-No. + Ref. No. + Ref. No. +	Größen sizes mesures tamaños
-30	000
-20	00
-00	0
-01	1
-02	2
-03	3
-04	4
-05	5
-06	6
-07	7
-08	8
-09	9
-10	10
-11	11
-12	12
-13	13
-14	14
-15	15
-16	16

23

Bestell-Nr. Order-No. Ref. No. Ref. No.		Öhr Eye Chas Ojo	Größen Sizes Mesures Tamaños	Profil Profile Profil Perfil	Biegung Curvature Courbure Curvatura
23.2490-01 - 23.2490-06	Ferguson		1 - 6	●	½ Kreis; ½ circle; ½ cercle; ½ círculo
23.2491-01 - 23.2491-06	Ferguson		1 - 6	●	½ Kreis; ½ circle; ½ cercle; ½ círculo
23.2492-01 - 23.2492-04	Mayo		1 - 4	●	½ Kreis; ½ circle; ½ cercle; ½ círculo
23.2493-01 - 23.2493-04	Mayo		1 - 4	●	½ Kreis; ½ circle; ½ cercle; ½ círculo



Michel (1x2)
23.2500 12,0 cm/4¾"



Michel
23.2505 12,0 cm/4¾"



Hegenbarth
23.2508 12,5 cm/5"



Wachenfeldt
23.2509 12,5 cm/5"



Michel
23.2511 12,0 cm/4¾"

Wundklammer-Zangen
Clip Applying Forceps
Pincès pour agrafes
Pinzas para agrafes



Collin
23.2515 13,0 cm/5¼"



Standard
23.2518 165 x 90 x 28 mm

23

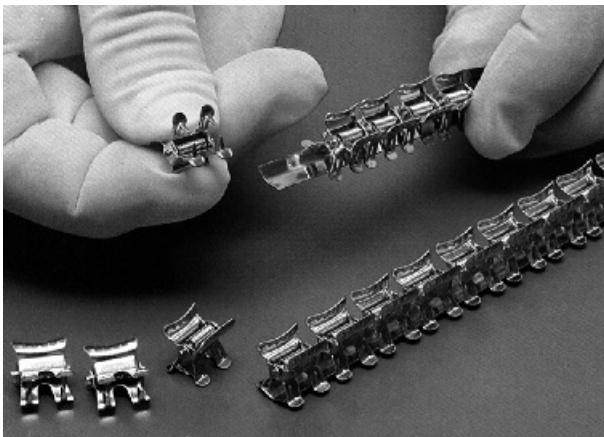

Wundsparklammern
23.2516

Mindestabnahme: 50 Stück
Minimum quantity: 50 each
Quantité minimum: 50 pièces
Cantidad mínimo: 50 piezas

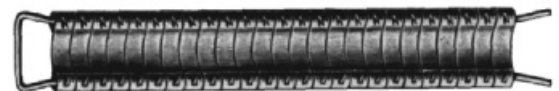

1 Pack = 100 Stück
1 Package = 100 each
1 Paquet = 100 pièces
1 Paquete = 100 piezas

Michel

23.2519-01	7,5 x 1,75 mm
23.2519-02	11 x 2 mm
23.2519-03	12 x 3 mm
23.2519-04	14 x 3 mm
23.2519-05	16 x 3 mm
23.2519-06	18 x 3 mm
23.2519-07	20 x 3 mm
23.2519-08	22 x 3 mm

Mindestabnahme: 10 Pack
Minimum quantity: 10 packages
Quantité minimum: 10 paquets
Cantidad mínimo: 10 paquetes

links gebogen
für die rechte
Hand

curved to the left,
for the right
hand

courbe à gauche
pour la main
droite

curva a la izquierda,
para la mano
derecha

rechts gebogen
für die linke
Hand

curved to the right,
for the left
hand

courbe à droite
pour la main
gauche

curva a la derecha,
para la mano
izquierda

links gebogen
für die rechte
Hand

curved to the left,
for the right
hand

courbe à gauche
pour la main
droite

curva a la izquierda,
para la mano
derecha

rechts gebogen
für die linke
Hand

curved to the right,
for the left
hand

courbe à droite
pour la main
gauche

curva a la derecha,
para la mano
izquierda

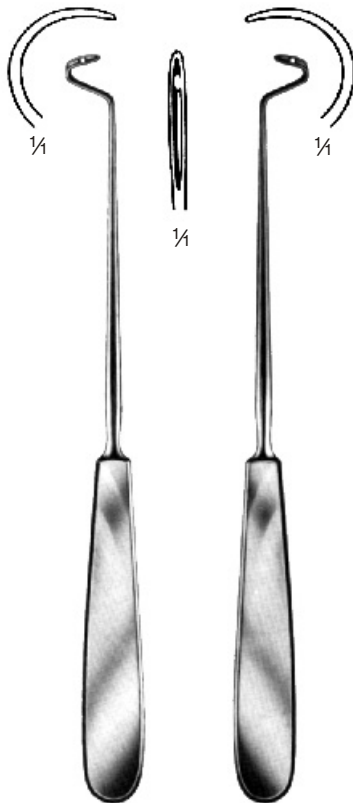

Deschamps

23.2530-20
20,0 cm/8"
stumpf
blunt
mousse
roma

Deschamps

23.2531-20
20,0 cm/8"
stumpf
blunt
mousse
roma

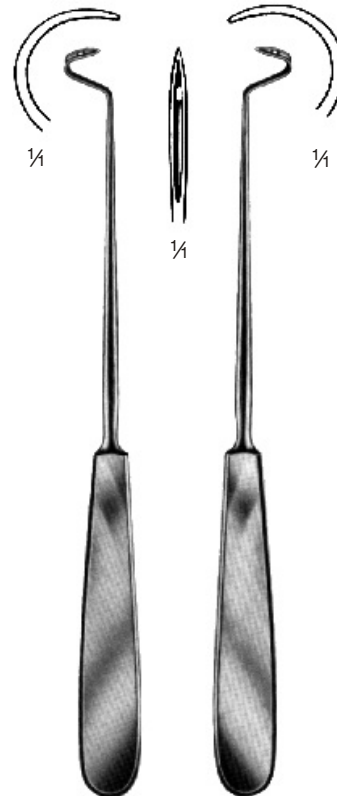

Deschamps

23.2532-20
20,0 cm/8"
scharf
sharp
pointue
aguda

Deschamps

23.2533-20
20,0 cm/8"
scharf
sharp
pointue
aguda

links gebogen
für die rechte
Hand

curved to the left,
for the right
hand

courbe à gauche
pour la main
droite

curva a la izquierda,
para la mano
derecha

rechts gebogen
für die linke
Hand

curved to the right,
for the left
hand

courbe à droite
pour la main
gauche

curva a la derecha,
para la mano
izquierda

links gebogen
für die rechte
Hand

curved to the left,
for the right
hand

courbe à gauche
pour la main
droite

curva a la izquierda,
para la mano
derecha

rechts gebogen
für die linke
Hand

curved to the right,
for the left
hand

courbe à droite
pour la main
gauche

curva a la derecha,
para la mano
izquierda

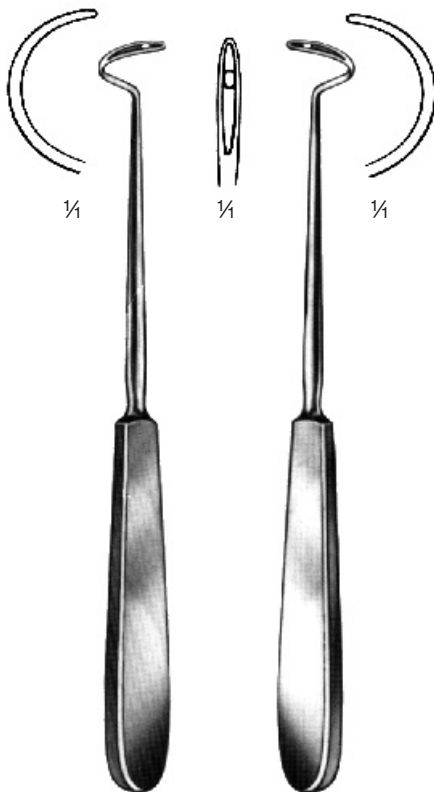

Deschamps

23.2534-20
20,0 cm/8"
stumpf
blunt
mousse
roma

Deschamps

23.2535-20
20,0 cm/8"
stumpf
blunt
mousse
roma

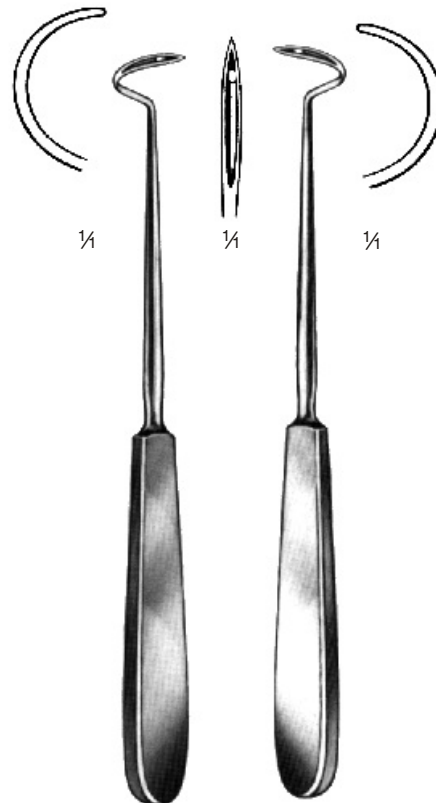

Deschamps

23.2536-20
20,0 cm/8"
scharf
sharp
pointue
aguda

Deschamps

23.2537-20
20,0 cm/8"
scharf
sharp
pointue
aguda

links gebogen
für die rechte
Hand

curved to the left,
for the right
hand

courbe à gauche
pour la main
droite

curva a la izquierda,
para la mano
derecha

rechts gebogen
für die linke
Hand

curved to the right,
for the left
hand

courbe à droite
pour la main
gauche

curva a la derecha,
para la mano
izquierda

links gebogen
für die rechte
Hand

curved to the left,
for the right
hand

courbe à gauche
pour la main
droite

curva a la izquierda,
para la mano
derecha

rechts gebogen
für die linke
Hand

curved to the right,
for the left
hand

courbe à droite
pour la main
gauche

curva a la derecha,
para la mano
izquierda

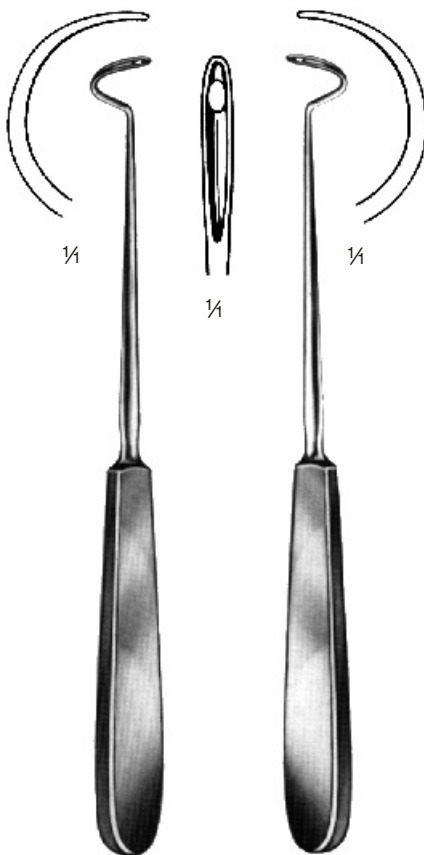

Deschamps

23.2538-21
21,0 cm/8¼"
stumpf
blunt
mousse
roma

Deschamps

23.2539-21
21,0 cm/8¼"
stumpf
blunt
mousse
roma

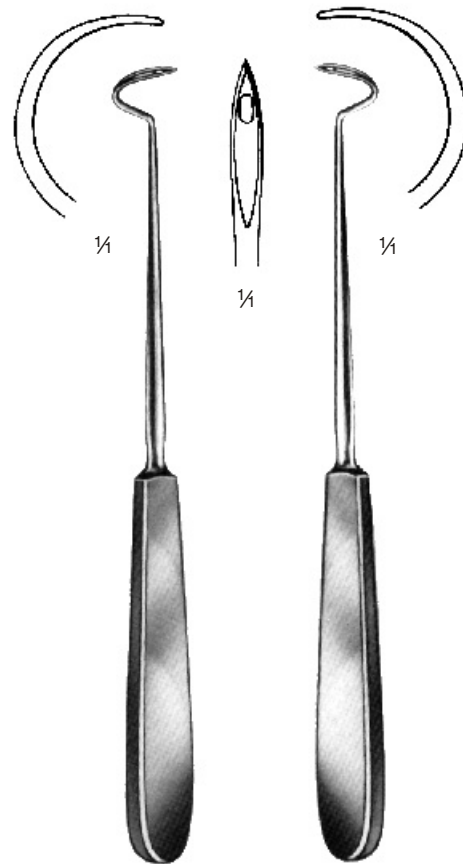

Deschamps

23.2540-21
21,0 cm/8¼"
scharf
sharp
pointue
aguda

Deschamps

23.2541-21
21,0 cm/8¼"
scharf
sharp
pointue
aguda

links gebogen
für die rechte
Hand

curved to the left,
for the right
hand

courbe à gauche
pour la main
droite

curva a la izquierda,
para la mano
derecha

rechts gebogen
für die linke
Hand

curved to the right,
for the left
hand

courbe à droite
pour la main
gauche

curva a la derecha,
para la mano
izquierda

links gebogen
für die rechte
Hand

curved to the left,
for the right
hand

courbe à gauche
pour la main
droite

curva a la izquierda,
para la mano
derecha

rechts gebogen
für die linke
Hand

curved to the right,
for the left
hand

courbe à droite
pour la main
gauche

curva a la derecha,
para la mano
izquierda

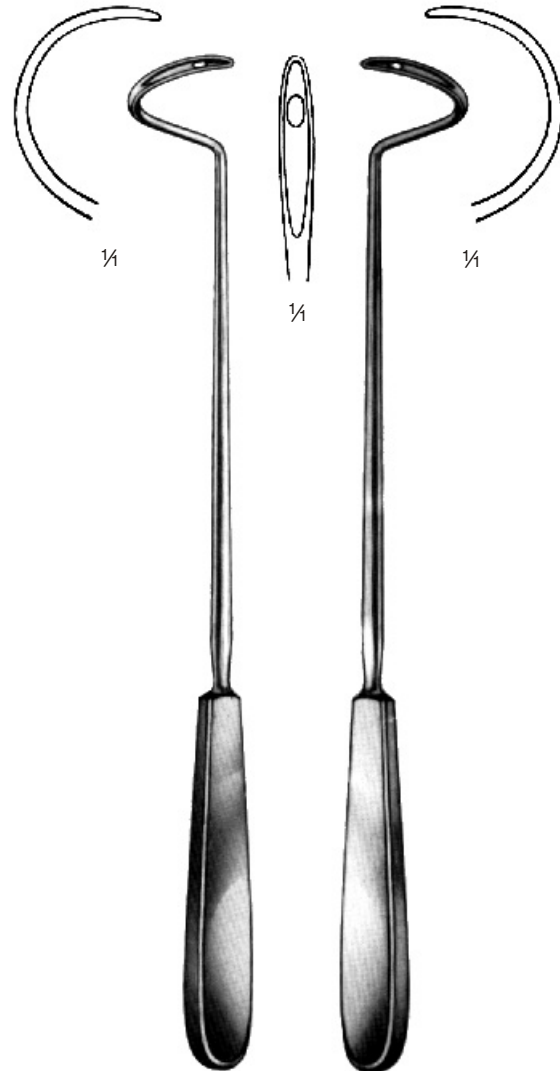
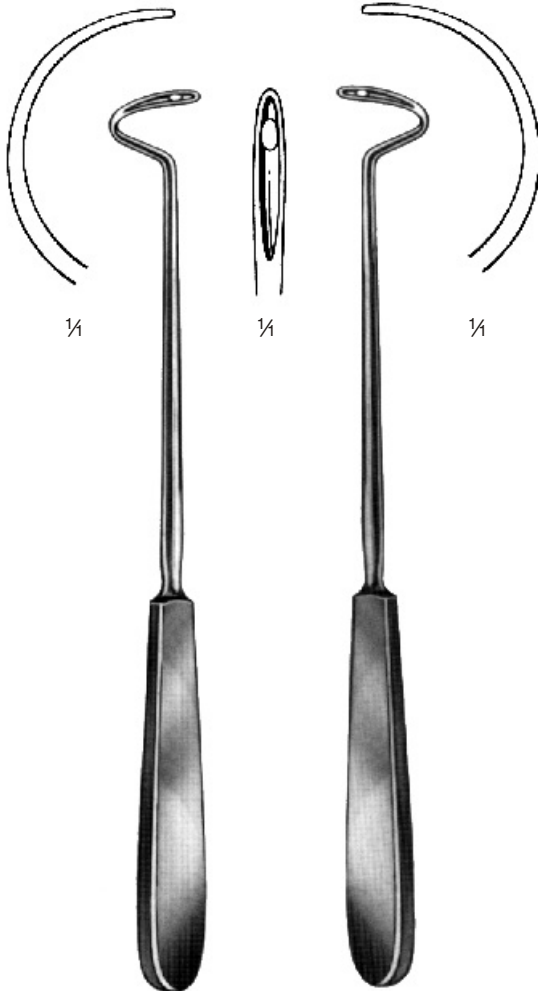

23

Deschamps

23.2542-24
24,0 cm/9½"
stumpf
blunt
mousse
roma

Deschamps

23.2543-24
24,0 cm/9½"
stumpf
blunt
mousse
roma

Deschamps

23.2544-27
27,0 cm/10½"
stumpf
blunt
mousse
roma

Deschamps

23.2545-27
27,0 cm/10½"
stumpf
blunt
mousse
roma

links gebogen
für die rechte
Hand

curved to the left,
for the right
hand

courbe à gauche
pour la main
droite

curva a la izquierda,
para la mano
derecha

rechts gebogen
für die linke
Hand

curved to the right,
for the left
hand

courbe à droite
pour la main
gauche

curva a la derecha,
para la mano
izquierda

links gebogen
für die rechte
Hand

curved to the left,
for the right
hand

courbe à gauche
pour la main
droite

curva a la izquierda,
para la mano
derecha

rechts gebogen
für die linke
Hand

curved to the right,
for the left
hand

courbe à droite
pour la main
gauche

curva a la derecha,
para la mano
izquierda

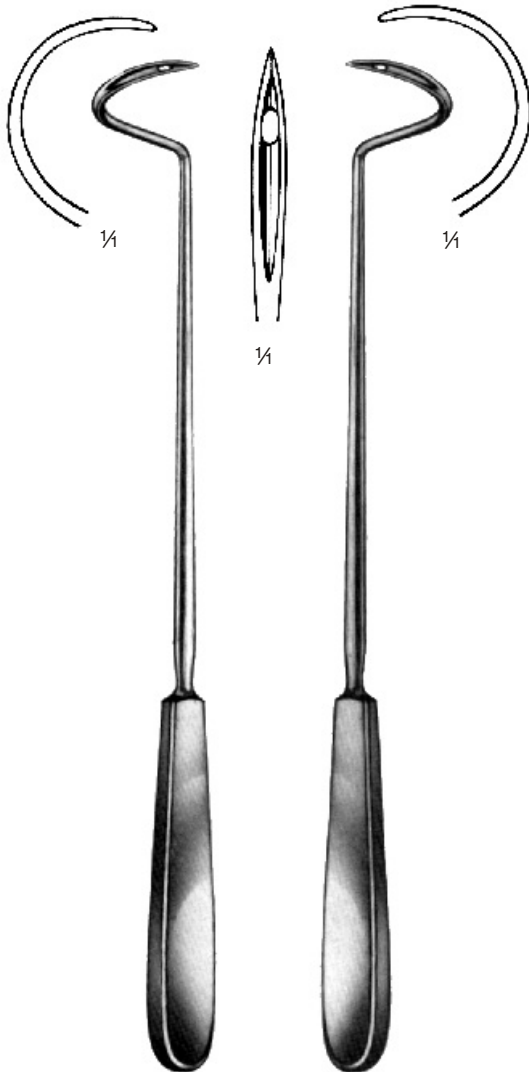

Deschamps

23.2546-27
27,0 cm/10½"
scharf
sharp
pointue
aguda

Deschamps

23.2547-27
27,0 cm/10½"
scharf
sharp
pointue
aguda

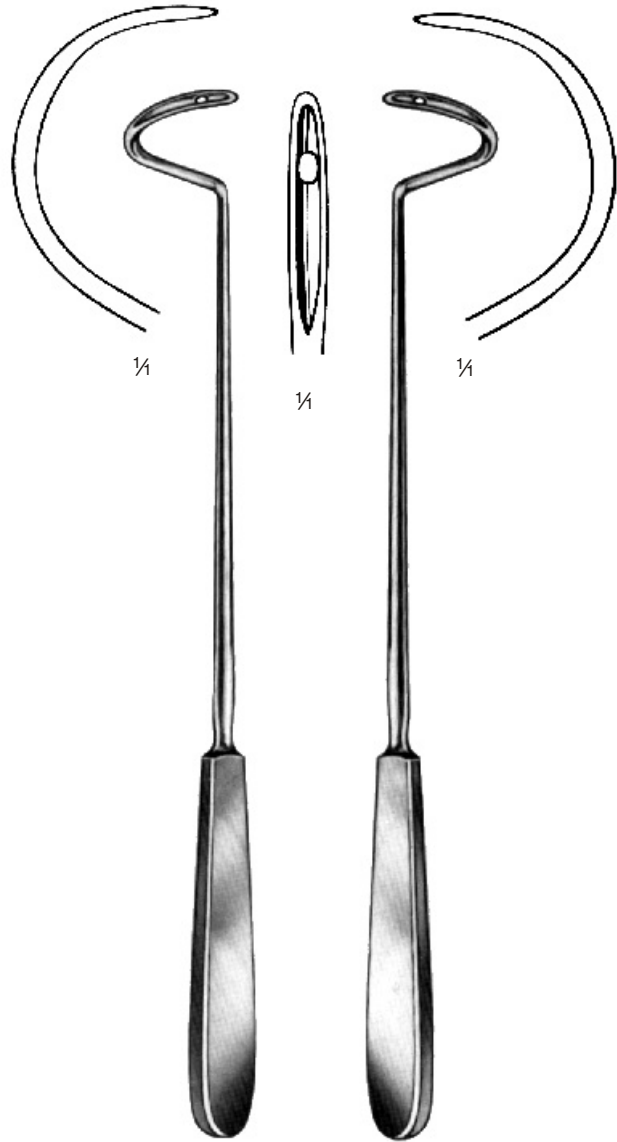

Deschamps

23.2548-28
28,0 cm/11"
stumpf
blunt
mousse
roma

Deschamps

23.2549-28
28,0 cm/11"
stumpf
blunt
mousse
roma

links gebogen
für die rechte
Hand

curved to the left,
for the right
hand

courbe à gauche
pour la main
droite

curva a la izquierda,
para la mano
derecha

rechts gebogen
für die linke
Hand

curved to the right,
for the left
hand

courbe à droite
pour la main
gauche

curva a la derecha,
para la mano
izquierda



Kronecker

23.2550-01
13,0 cm/5"

Kronecker

23.2550-02
13,0 cm/5"

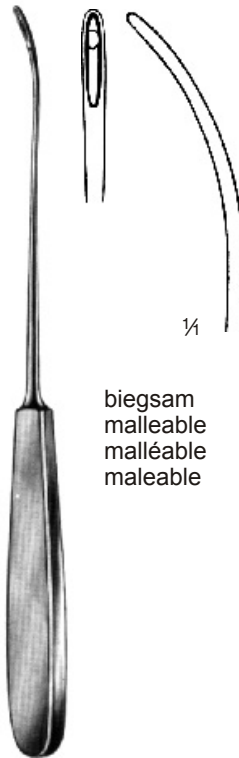

biegsam
malleable
malléable
maleable

23.2551-01
20,0 cm/8"



Cooper

23.2551-02
19,0 cm/7½"



biegsam
malleable
malléable
maleable

Schmieden-Dick

23.2552-32
32,0 cm/12½"



Schmieden

23.2553-21
21,0 cm/8¼"



Hessberg

23.2554-15
 15,0 cm/6"



Woodruff
 13,0 cm/5"

23.2555-01	23.2555-02
rechts	links
right	left
à droite	à gauche
derecha	izquierda

links gebogen
 für die rechte
 Hand

rechts gebogen
 für die linke
 Hand

curved to the left,
 for the right
 hand

curved to the right,
 for the left
 hand

courbe à gauche
 pour la main
 droite

courbe à droite
 pour la main
 gauche

curva a la izquierda,
 para la mano
 derecha

curva a la derecha,
 para la mano
 izquierda



23.2556-01
 23.2556-01



23.2556-02
 23.2556-02

De la Roza
 12,0 cm/4¾"



¼
 ¼

Narath

23.2557-22
 22,0 cm/9"



Fig. 1
23.2560-01



Fig. 2
23.2560-02



Fig. 3
23.2560-03

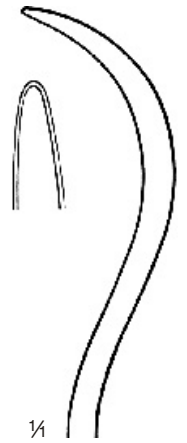
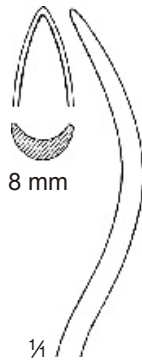

Fig. 4
23.2560-04

23

Brunner
30,0 cm/12"

Brunner
30,0 cm/12"



Schmieden

23.2561-01
 19,0 cm/7½"

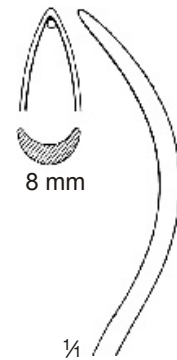

Schmieden-Payr

23.2561-02
 19,0 cm/7½"

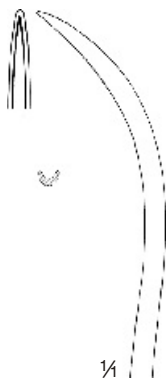

König

23.2562-01
 19,5 cm/7¾"

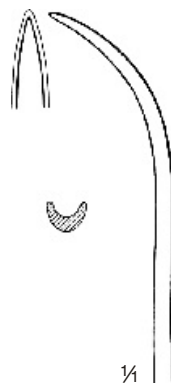

König

23.2562-02
 19,5 cm/7¾"



König

23.2562-03
 20,0 cm/8"



Payr

23

Fig. 1

23.2563-01
22,0 cm/8³/₄"

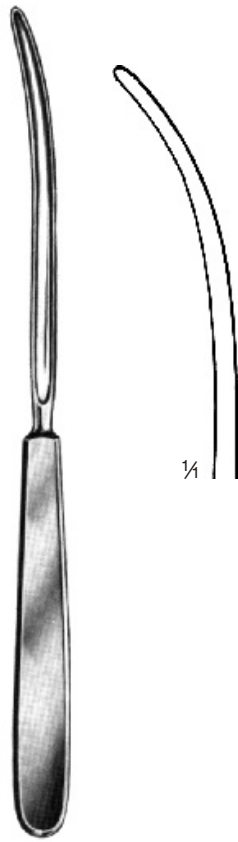

Payr

Fig. 2

23.2563-02
22,0 cm/8³/₄"



23.2564-25
19,5 cm/7³/₄"



Kocher

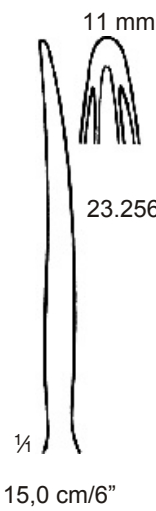

15,0 cm/6"

11 mm

23.2565-01



11 mm

23.2565-02

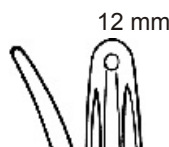

12 mm

23.2565-03

17,0 cm/7"



Brunner-Ferrozell

23.2566-18 18,0 cm/7"
23.2566-27 27,0 cm/10¹/₂"



Reverdin
14,0 cm/5½"



Fig. 1
23.2570-01



Fig. 2
23.2570-02



Fig. 3
23.2570-03



Fig. 4
23.2570-04



Reverdin
19,5 cm/7¾"



Fig. 1
23.2571-01



Fig. 2
23.2571-02



Fig. 3
23.2571-03



Fig. 4
23.2571-04

23



Reverdin
22,5 cm/8¾"



Fig. 1
23.2572-01



Fig. 2
23.2572-02



Fig. 3
23.2572-03



Fig. 4
232572-04

Impfen und Punktion
Vaccination and Puncture
Vaccination et ponction
Vacunación y punción



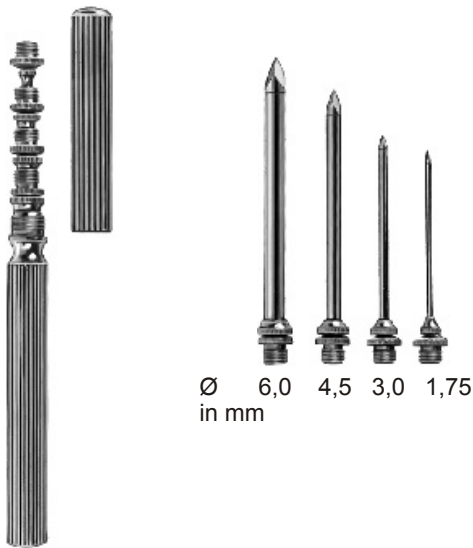

Ø 6,0
in mm

Universal

24.2603
mit Satz 3-teilig (4,5/3,0/1,75mm)
with set of 3 pieces(4,5/3,0/1,75mm)
avec jeu de 3 pièces(4,5/3,0/1,75mm)
con juego de 3 piezas(4,5/3,0/1,75mm)

24.2604
mit Satz 4-teilig
with set of 4 pieces
avec jeu de 4 pièces
con juego de 4 piezas

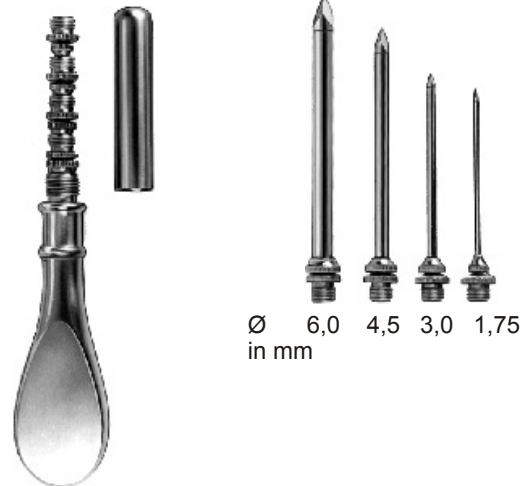

Ø 6,0
in mm

Universal

24.2606
mit Satz 3-teilig (4,5/3,0/1,75mm)
with set of 3 pieces(4,5/3,0/1,75mm)
avec jeu de 3 pièces(4,5/3,0/1,75mm)
con juego de 3 piezas(4,5/3,0/1,75mm)

24.2607
mit Satz 4-teilig
with set of 4 pieces
avec jeu de 4 pièces
con juego de 4 piezas

24

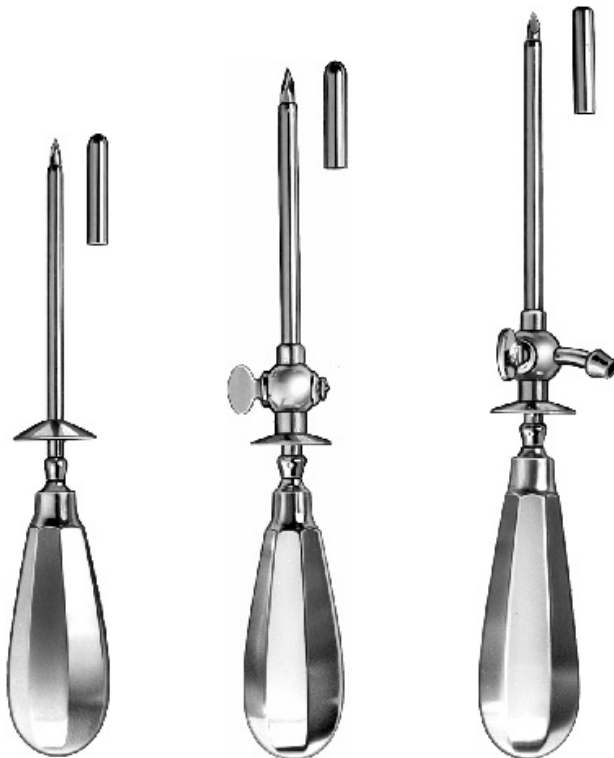

Ø mm	Standard 11,0 cm/4½"	Standard 12,0 cm/4¾"	Standard 12,0 cm/4¾"
3,0	24.2610	24.2620	24.2630
3,5	24.2611	24.2621	24.2631
4,0	24.2612	24.2622	24.2632
4,5	24.2613	24.2623	24.2633
5,0	24.2614	24.2624	24.2634
5,5	24.2615	24.2625	24.2635
6,0	24.2616	24.2626	24.2636



Nelson
21,0 cm/8½"



24.2637-07



24.2637-09



24.2637-11



24.2637-12

Ø außen, Ø outside 7,5 mm
Ø à l'extérieur, Ø al exterior

Ø innen, Ø inside 6,0 mm
Ø à l'intérieur, Ø al interior

9,5 mm

11,0 mm

12,5 mm

8,0 mm

9,5 mm

11,0 mm

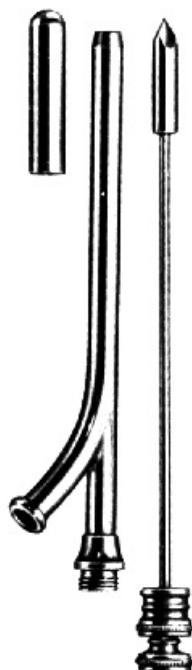

Ochsner
14,5 cm/5½"

Ø außen
Ø outside
Ø à l'extérieur
Ø al exterior

Charr. mm

24.2640-10	10	3,0
24.2640-12	12	4,0
24.2640-14	14	4,5
24.2640-16	16	5,5
24.2640-18	18	6,0
24.2640-20	20	6,5
24.2640-22	22	7,5
24.2640-24	24	8,0
24.2640-26	26	8,5
24.2640-28	28	9,0

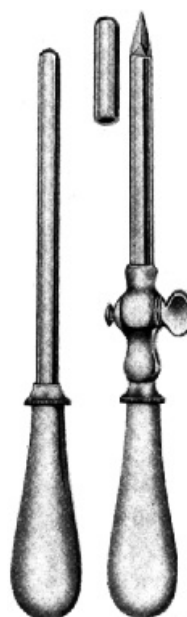

Buelau
24,0 cm/9½"

Ø außen Ø innen
Ø outside Ø inside
Ø à l'extérieur Ø à l'intérieur
Ø al exterior Ø al interior

24.2641-08

8,0 mm

6,5 mm

24.2641-10

10,0 mm

8,5 mm

2,0 mmØ



Landau

24.2642-01

2,0 mmØ



Landau

24.2642-02

13,5 mmØ



Péan

24.2644

24

1,75 mmØ



Lichtwitz

24.2651

2,0 mmØ



Lichtwitz

24.2652



Pierce

24.2655 3,0 mmØ
24.2656 4,0 mmØ
24.2657 5,0 mmØ



Krause
24.2660



Coakley
24.2661

24



Führungsnadel, gerade
Guide Needle, straight
Aiguille d'introduction, droite
Aguja de guía, recta

Führungsnadel, gebogen
Guide Needle, curved
Aiguille d'introduction, courbe
Aguja de guía, curva

Führungsnadel, mit Lanzettenspitze
Guide Needle, with lancet point
Aiguille d'introduction, à pointe lancéolaire
Aguja de guía, con punta lanceolar

Charr.	
8	24.2662-08
10	24.2662-10
12	24.2662-12
14	24.2662-14
16	24.2662-16
18	24.2662-18

Charr.	
8	24.2663-08
10	24.2663-10
12	24.2663-12
14	24.2663-14
16	24.2663-16
18	24.2663-18

Charr.	
8	24.2664-08
10	24.2664-10
12	24.2664-12
14	24.2664-14
16	24.2664-16
18	24.2664-18



Adson
21,0 cm/8½"

	Charr.	Ø mm
24.2668-12	12	4,0
24.2668-15	15	5,0



Wullstein
14,0 cm/5½"

0,4 mmØ

0,6 mmØ

0,8 mmØ



24.2669-04

24.2669-06

24.2669-08

24.2669-01

Mikro-Absaugrohr allein, mit Luer-Bohrung
Micro suction tube only, with Luer perforation
Micro tube d'aspiration seule, avec perforation Luer
Micro tubo de aspiración suelto, con perforación de Luer

24.2669-00

Satz komplett 24.2669-01 - 24.2669-08
Set complete 24.2669-01 - 24.2669-08
Jeu complet 24.2669-01 - 24.2669-08
Juego completo 24.2669-01 - 24.2669-08

24



Arbeitslänge
Working length
Longueur utile
Largo útil
12,5 cm/5"

Frazier
18,0 cm/7"

Charr.

6	24.2670-06
7	24.2670-07
8	24.2670-08
9	24.2670-09
10	24.2670-10
11	24.2670-11
12	24.2670-12
15	24.2670-15



Frazier
18,0 cm/7"

	Charr.	Ø mm
24.2671-09	9	3,0
24.2671-15	15	5,0



Fergusson
18,0 cm/7"

	Charr.	Ø mm
24.2672-00	12	4,0

24



Fergusson
18,0 cm/7"

	Charr.	Ø mm
24.2672-06	6	2,0
24.2672-07	7	2,3
24.2672-08	8	2,5
24.2672-09	9	3,0
24.2672-10	10	3,3
24.2672-11	11	3,5
24.2672-12	12	4,0
24.2672-15	15	5,0



Plester
19,5 cm/7¾"

	Charr.	Ø mm
24.2673-05	5	1,5
24.2673-06	6	2,0
24.2673-07	7	2,3
24.2673-08	8	2,5
24.2673-09	9	3,0
24.2673-10	10	3,5



Punktionskanüle
Puncture Cannula
Canule à ponction
Cánula de punción

Klima-Rosegger
1,80 x 35 mm

24.2674

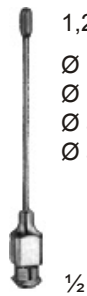

1,2 mm
Ø innen
Ø inside
Ø à l'intérieur
Ø al interior

Mock

24.2675-03 3,0 cm/1¼"

24.2675-06 6,0 cm/2½"



Biopsiekanüle
Biopsy Needle
Aiguille à biopsie
Aguja para biopsía

24.2676-01	1,00 x 35 mm
24.2676-02	1,00 x 70 mm
24.2676-03	1,20 x 70 mm
24.2676-04	1,20 x 100 mm
24.2676-05	1,40 x 70 mm
24.2676-06	1,40 x 100 mm
24.2676-07	1,60 x 70 mm
24.2676-08	1,80 x 100 mm

Menghini



Biopsiekanüle
Biopsy Needle
Aiguille à biopsie
Aguja para biopsía

24.2677-14	1,40 x 168 mm
24.2677-18	1,80 x 168 mm

Menghini



24.2678-01	2,00 x 80 mm
24.2678-02	2,00 x 100 mm
24.2678-03	2,00 x 120 mm

Verres

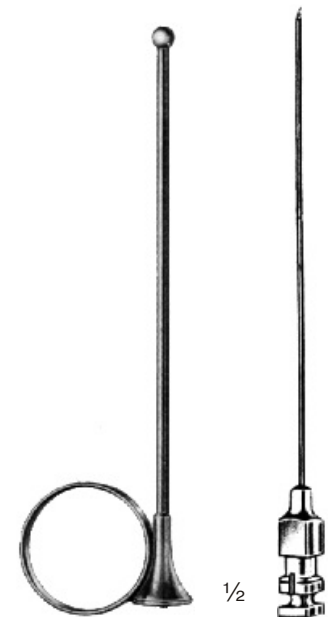

Iowa
14,0 cm/5½"

24.2679-00

Luer Lock
0,90 x 150 mm

24.2679-01

24.2680A

Saugkopf allein
Aspiration part only
Part d'aspiration seule
Parte de aspiración suelta

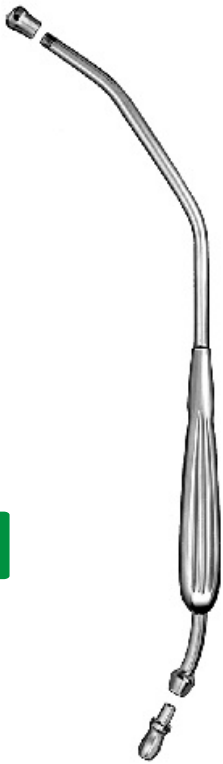

Yankauer

24.2680



10 mmØ
(Charr./Fr. 30)

Poole

22,0 cm/8¾"

24.2681



8 mmØ
(Charr./Fr. 24)

Poole

22,0 cm/8¾"

24.2682



De Bakey

27,5 cm/10¾"

24.2683

24



Magill

Magill-Baby



24.2689

15,0 cm/6"
für Kleinkinder
pediatric size
pour bébés
para párvulos



24.2690

20,0 cm/8"
für Kinder
for children
pour enfants
para niños



24.2691

25,0 cm/10"
für Erwachsene
for adults
pour adultes
para adultos

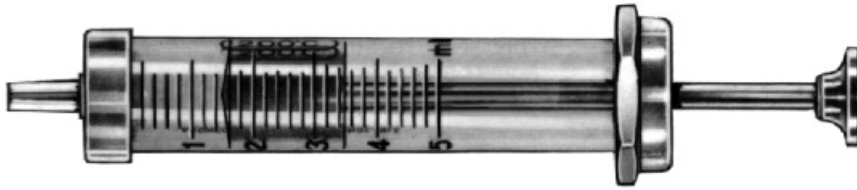

Luer

24.2692-01	1 ml
24.2692-02	2 ml
24.2692-05	5 ml
24.2692-10	10 ml
24.2692-20	20 ml
24.2692-50	50 ml

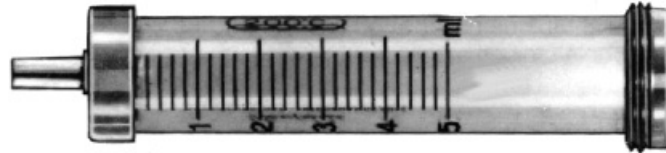

Luer

Zylinder	24.2693-01	1 ml
Barrels	24.2693-02	2 ml
Cylindre	24.2693-05	5 ml
Cilindro	24.2693-10	10 ml
	24.2693-20	20 ml
	24.2693-50	50 ml

24

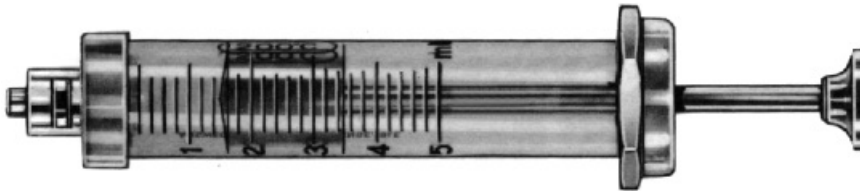

Luer Lock

24.2694-01	1 ml
24.2694-02	2 ml
24.2694-05	5 ml
24.2694-10	10 ml
24.2694-20	20 ml
24.2694-50	50 ml

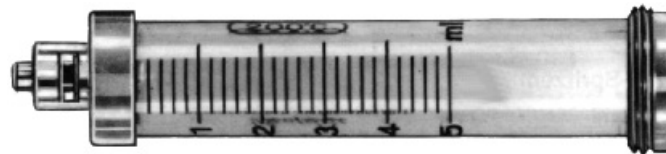

Luer Lock

Zylinder	24.2695-01	1 ml
Barrels	24.2695-02	2 ml
Cylindre	24.2695-05	5 ml
Cilindro	24.2695-10	10 ml
	24.2695-20	20 ml
	24.2695-50	50 ml



Spritze mit Luer-Lock Ansatz (mit 3 Ringen)
Syringe with Luer-Lock joint (with 3 rings)
Seringue avec arrêt Luer-Lock (avec 3 anneaux)
Jeringa con cierre Luer-Lock (con 3 anillos)

24.2696-02	2 ml
24.2696-05	5 ml
24.2696-10	10 ml



Zylinder	24.2697-02	2 ml
Barrels	24.2697-05	5 ml
Cylindre	24.2697-10	10 ml
Cilindro		

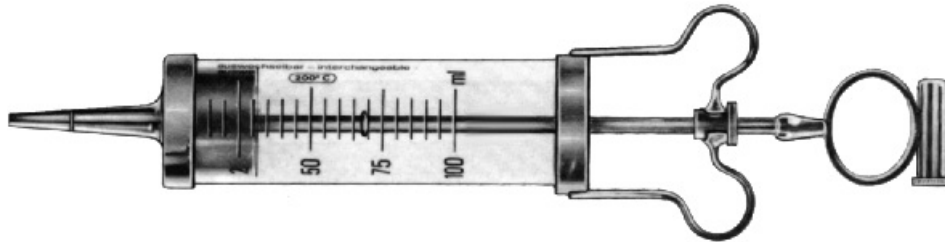

Janet

24.2698-05	50 ml
24.2698-07	75 ml
24.2698-10	100 ml
24.2698-15	150 ml
24.2698-20	200 ml
24.2698-25	250 ml

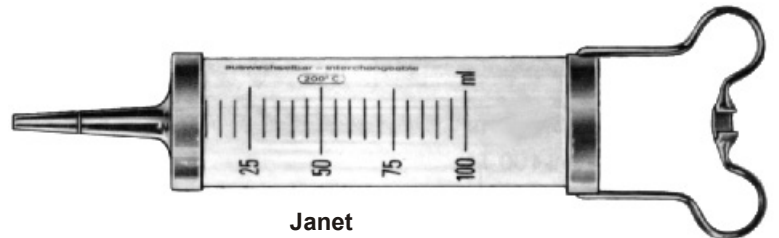

Janet

Zylinder	24.2699-05	50 ml
Barrels	24.2699-07	75 ml
Cylindre	24.2699-10	100 ml
Cilindro	24.2699-15	150 ml
	24.2699-20	200 ml
	24.2699-25	250 ml

Sonden, Watteträger, Spatel, Veneninstrumente
Probes, Applicators, Spatulas, Vein Instruments
Sondes, Porte-cotons, Spatules, Instruments à varices
Sondas, Porta-algodones, Espátulas, Instrumentos para várices

25



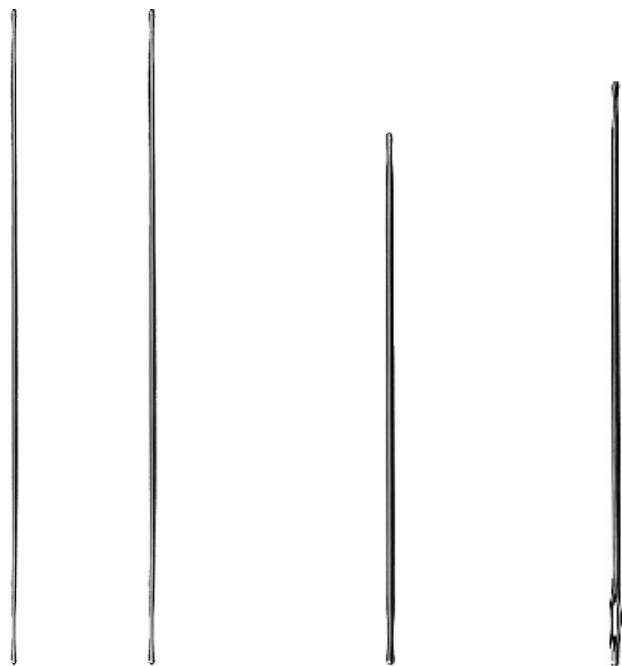

cm	in.	1,0 mmØ	1,5 mmØ	2,0 mmØ	2,0 mmØ
11,5	4½	25.2701		25.2711	25.2731
13,0	5	25.2703		25.2713	25.2733
14,5	5½	25.2704	25.2715-14	25.2714	25.2734
16,0	6¼	25.2706	25.2715-16	25.2716	25.2736
18,0	7	25.2708	25.2715-18	25.2718	25.2738
20,0	8	25.2710	25.2715-20	25.2720	25.2740
25,0	10			25.2725	25.2745

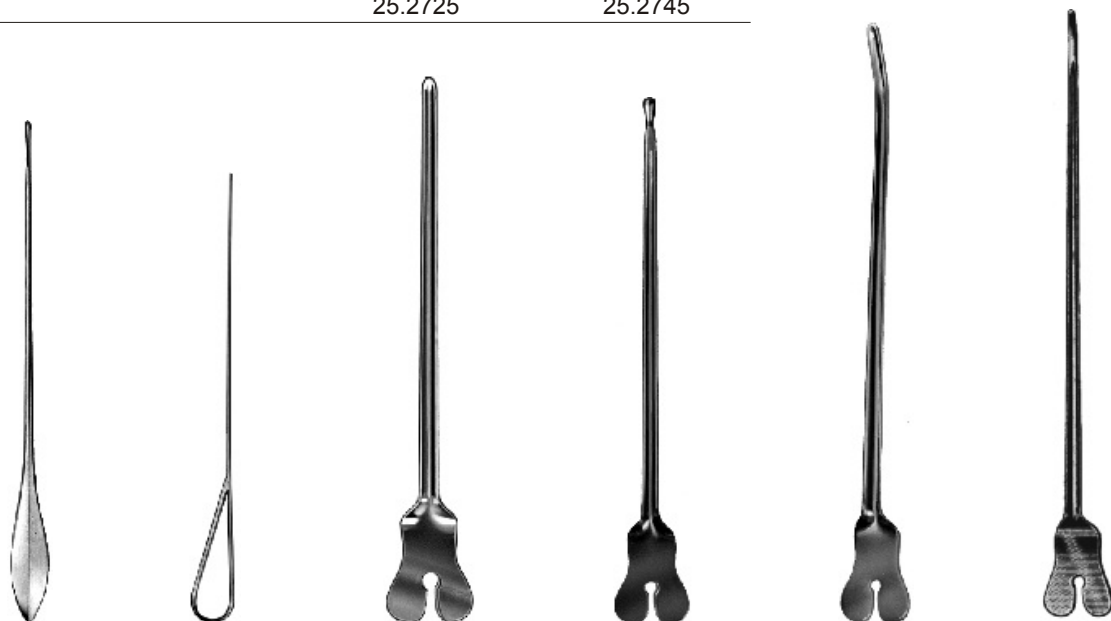

cm	in.		Stacke		Doyen	Nélaton
10,5	4¼		25.2760			
11,5	4½	25.2751		25.2761		
13,0	5	25.2753		25.2763	25.2773	
14,0	5½	25.2754		25.2764	25.2774	25.2780
16,0	6¼	25.2756		25.2766	25.2776	25.2781
18,0	7			25.2768		
20,0	8			25.2770		



Watson-Cheyne

25.2782-13 13,0 cm/5"
25.2782-18 18,0 cm/7¼"



Roser

25.2785 12,5 cm/5"

25



Lockhart-Mummery
16,5 cm/6½"



Fig. 1
25.2786-01



Fig. 2
25.2786-02

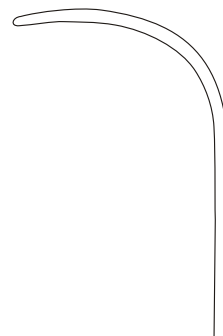

Fig. 3
25.2786-03

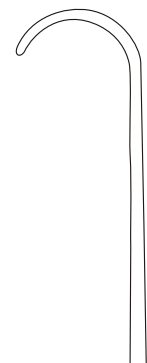

Fig. 4
25.2786-04

Fistelsonden
Fistula probes
Sondes pour fistules
Sondas para fístulas



Pflasterspatel
Plaster Spatula
Spatules
Espátulas

25.2800-13 13,0 cm/5"
25.2800-14 14,5 cm/5½"



Farrell
(Lathbury)

	cm	in.	mmØ
25.2812-09	12,0	4¾	0,9
25.2814-01	14,0	5½	1,0
25.2814-09	14,0	5½	0,9
25.2814-12	14,0	5½	1,2
25.2816-11	16,5	6½	1,1
25.2818-12	18,0	7	1,2
25.2818-15	18,0	7	1,5
25.2818-18	18,0	7	1,8



Jobson-Horne

25.2820-18
18,0 cm/7"

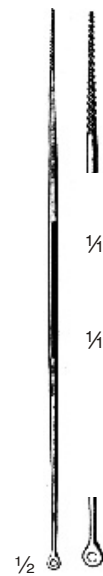

Uckermann

25.2822
16,0 cm/6¼"

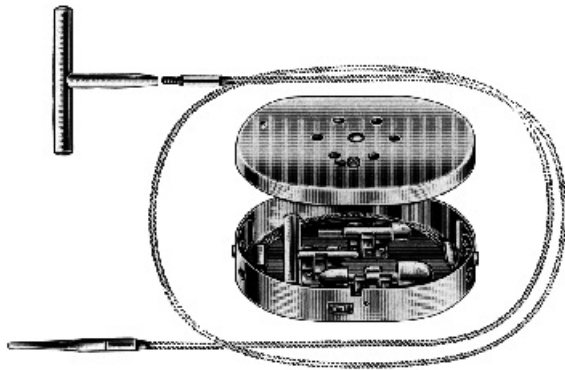

Nabattoff

25.2850-00
135 x 100 x 25 mm
Satz komplett
Set complete
Jeu complet
Juego completo

25.2850-70
Metalletui allein
Metal case only
Boîte métal seule
Estuche de metal suelto

25.2850-02

25.2850-50

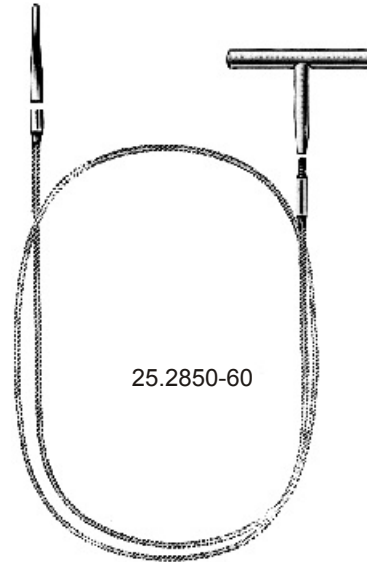

25.2850-60

1/4

25.2850-03
Ø 3,0 mm

25.2850-06
Ø 6,0 mm

25.2850-09
Ø 9,0 mm

25.2850-12
Ø 12,0 mm

25.2850-15
Ø 15,0 mm

25

Endarterektomiestripper, Endarterectomy strippers, Sondes pour endartérectomie, Sondas para endarterectomía

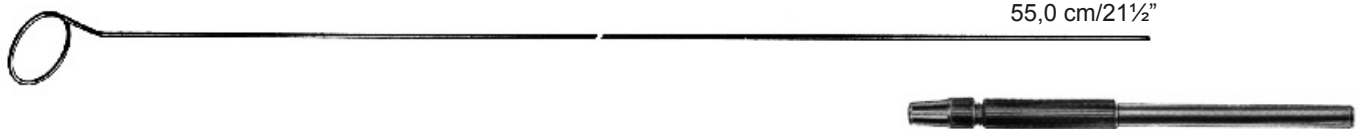

55,0 cm/21½"

25.2852-02
2,0 mmØ

25.2852-03
3,0 mmØ

25.2852-04
4,0 mmØ

25.2852-06
6,0 mmØ

25.2852-50
12,0 cm/4¼"
Griff allein
Handle only
Manche seule
Mango suelto

25.2852-07
7,0 mmØ

25.2852-08
8,0 mmØ

25.2852-10
10,0 mmØ

25.2852-12
12,0 mmØ

25.2852-14
14,0 mmØ

Wundhaken, Wundsperrer
Retractors
Ecarteurs
Separadores





16,0 cm/6½"

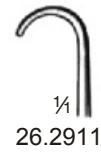
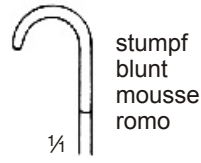
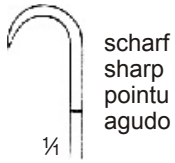

26



16,0 cm/6½"
flexibel
flexible
flexible
flexible

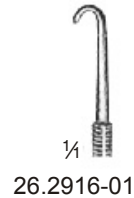
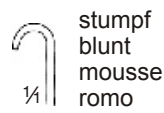
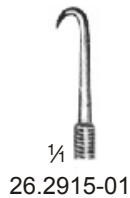
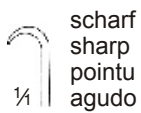



16,0 cm/6½"

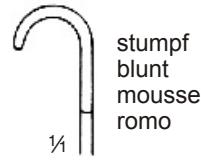
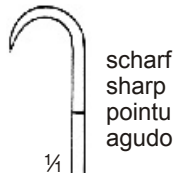

Meyerding
18,0 cm/7"

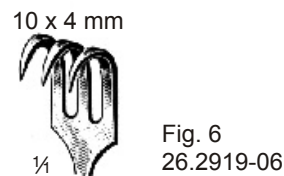

26



$\frac{1}{2}$
Cushing
20,0 cm/8"

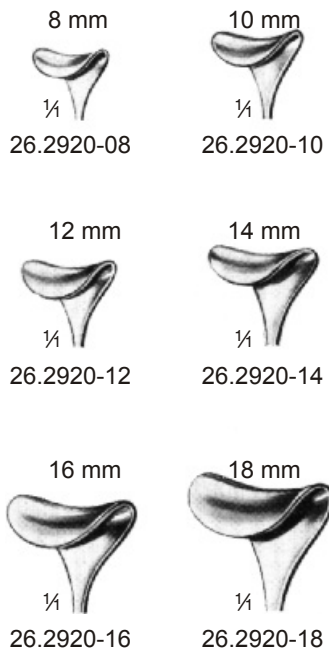

$\frac{1}{2}$
Cushing
24,0 cm/9 $\frac{1}{2}$ "

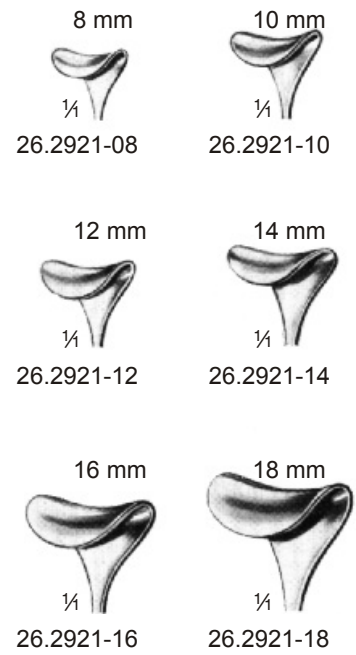

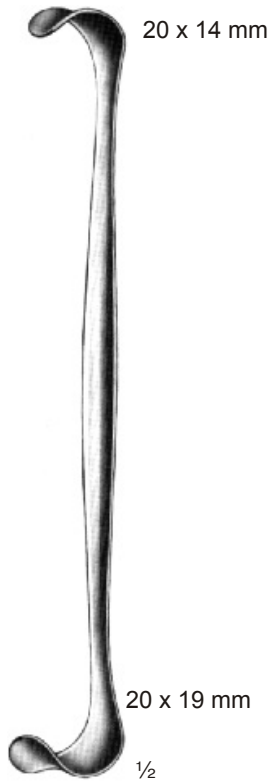

26.2922
20,0 cm/8"



Crile
26.2923
11,0 cm/4 1/4"



Klapp
17,5 cm/7"

Sehnenscheidenhaken
Tendon Sheath Retractors
Ecarteurs pour la gaine
Separadores para tendones

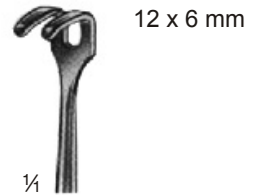

26.2924-01

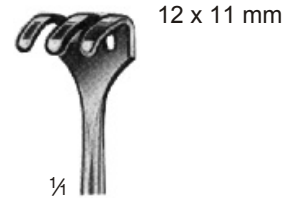

26.2924-02



Mini-Langenbeck
16,0 cm/6 1/2"



26.2925-10

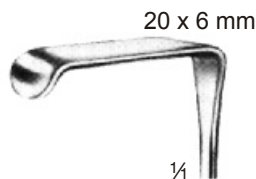

26.2925-20

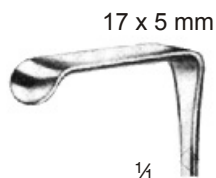

26.2925-17

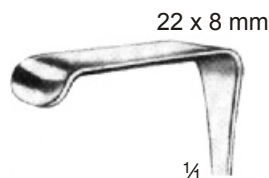

26.2925-22

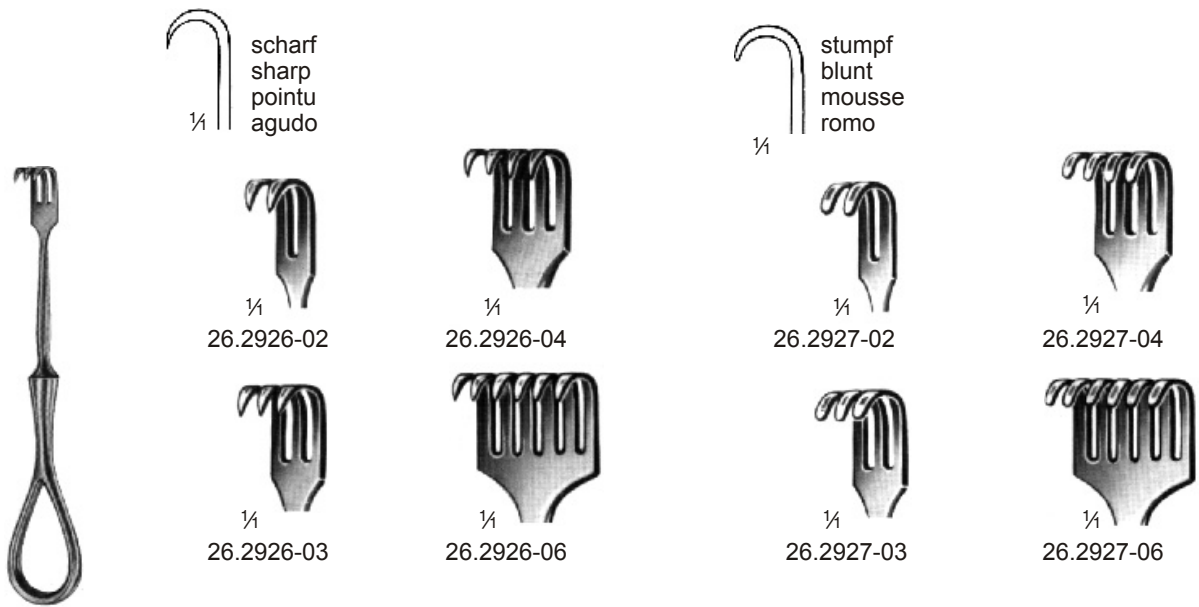

Volkmann
11,5 cm/4½"

26

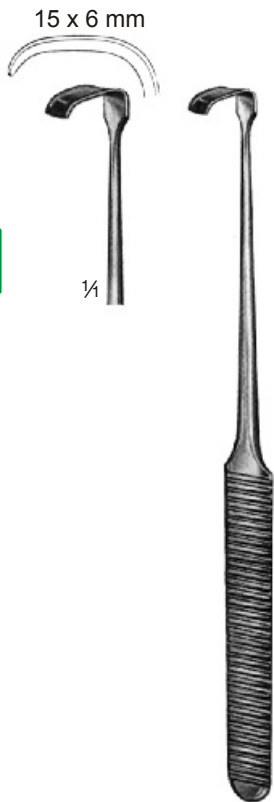

Strandell-Stille

26.2930-01
19,0 cm/7½"

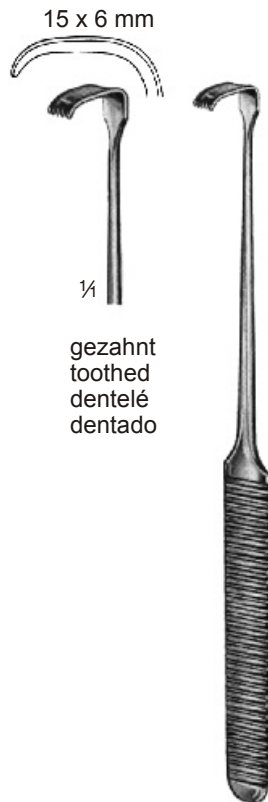

Strandell-Stille

26.2930-02
19,0 cm/7½"

gezahnt
toothed
dentelé
dentado



Cushing

26.2931
20,0 cm/8"

Dekompressionshaken
Decompression hook
Ecarteur de décompression
Separador para descompresión



Volkmann
 23,0 cm/9"



26.3001

scharf
 sharp
 pointu
 agudo



26.3011

stumpf
 blunt
 mousse
 romo



26.3002



26.3004



26.3012



26.3014



26.3003



26.3006



26.3013



26.3016



Volkmann

26.3021
 21,5 cm/8½"

scharf
 sharp
 pointu
 agudo



26.3022



26.3024

stumpf
 blunt
 mousse
 romo



26.3032



26.3034



26.3023



26.3026



26.3033



26.3036



Volkmann

26.3031
 21,5 cm/8½"



scharf
sharp
pointu
agudo

Volkmann

26.3040
21,5 cm/8½"



stumpf
blunt
mousse
romo

Volkmann

26.3041
21,5 cm/8½"

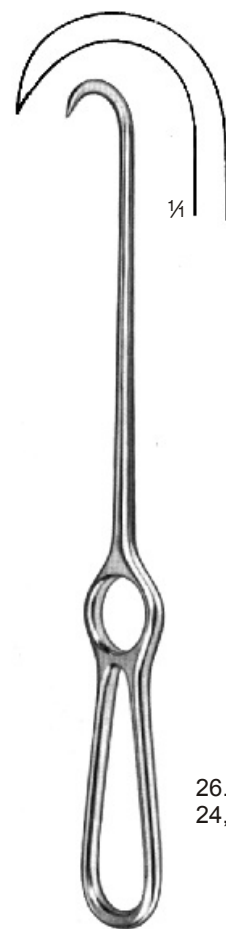

scharf
sharp
pointu
agudo

26.3043
24,5 cm/10"

26



Kocher
22,0 cm/8½"

scharf
sharp
pointu
agudo



26.3051



26.3052



26.3053



26.3054



26.3056

stumpf
blunt
mousse
romo



26.3061



26.3062



26.3063



26.3064



26.3066



Koerte
 23,5 cm/9¼"



¼
 26.3067

scharf
 sharp
 pointu
 agudo

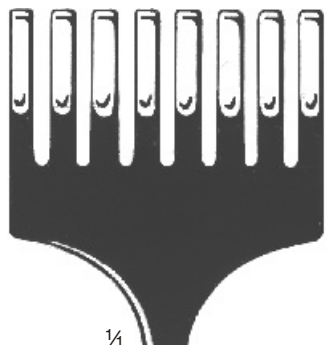

¼
 26.3068

stumpf
 blunt
 mousse
 romo



36 x 30 mm

36 x 60 mm

½

26.3069-03

26.3069-04

33 x 20 mm



Wassmund

26.3070-20
 20,5 cm/8"

Ollier
 22,5 cm/9"

½



1/2

Israel
25,0 cm/10"

26

40 x 40 mm

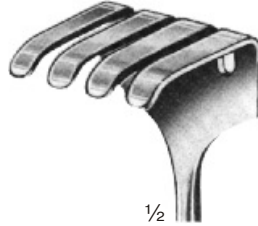

1/2

26.3074-04

45 x 50 mm



1/2

26.3074-05

50 x 60 mm

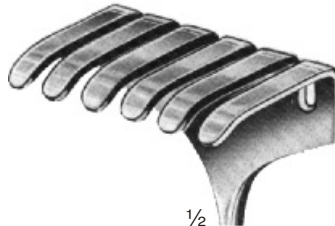

1/2

26.3074-06

70 x 70 mm

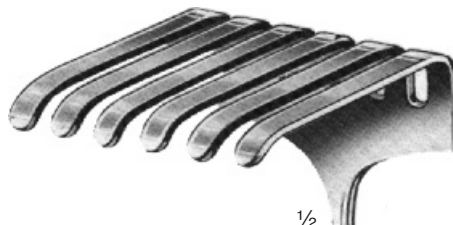

1/2

26.3074-07



Hüftgelenkhaken
Retractors
Ecarteurs
Separadores

1/2

Langenbeck
21,0 cm/8 1/4"

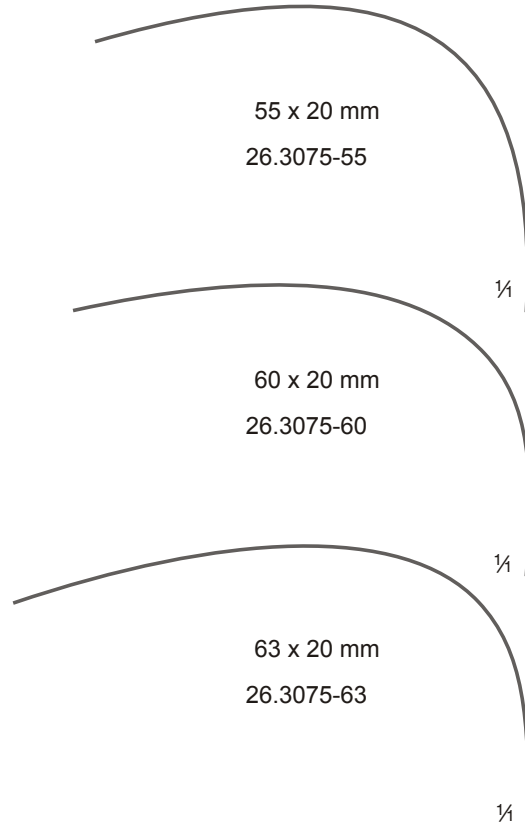

1/2

Langenbeck
21,0 cm/8 1/4"

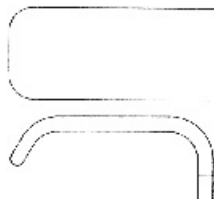

Kocher
21,5 cm/8 1/2"

26.3076	40 x 18 mm
26.3077	60 x 20 mm
26.3078	60 x 25 mm
26.3079	75 x 30 mm
26.3080	75 x 40 mm



Langenbeck
21,0 cm/8 1/4"

26.3085	30 x 11 mm
26.3086	30 x 14 mm
26.3087	30 x 16 mm
26.3088	40 x 11 mm
26.3089	50 x 11 mm



Kocher-Langenbeck
21,5 cm/8 1/2"

26.3090	25 x 6 mm
26.3091	35 x 8 mm
26.3092	35 x 11 mm
26.3093	35 x 15 mm
26.3094	40 x 11 mm
26.3095	55 x 11 mm
26.3096	70 x 14 mm
26.3097	80 x 12 mm
26.3098	80 x 16 mm



1/2

Langenbeck
22,0 cm/8 3/4"



26.3081 30 x 11 mm
26.3082 30 x 14 mm
26.3083 30 x 16 mm



26.3084 40 x 11 mm



1/2

Sauerbruch
22,5 cm/9"

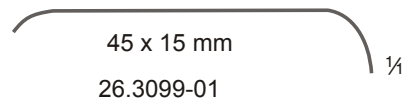

45 x 15 mm

26.3099-01

1/4

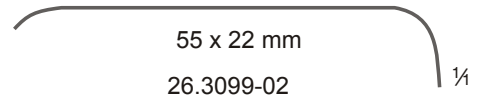

55 x 22 mm

26.3099-02

1/4

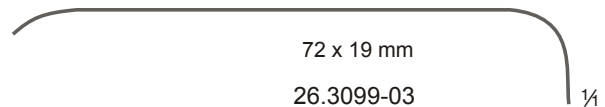

72 x 19 mm

26.3099-03

1/4



Lahey

26.3100
19,0 cm/7½"

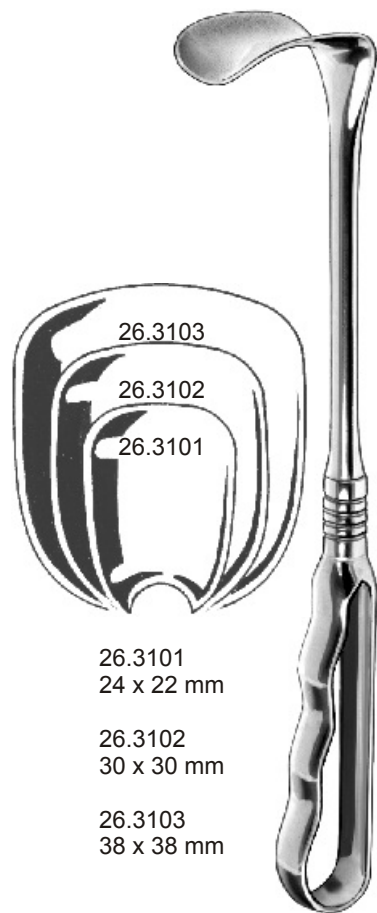

26.3101
24 x 22 mm
26.3102
30 x 30 mm
26.3103
38 x 38 mm

Richardson
24,0 cm/9½"



Richardson

26.3104
24,0 cm/9½"



Kelly

26.3105
26,0 cm/10¼"

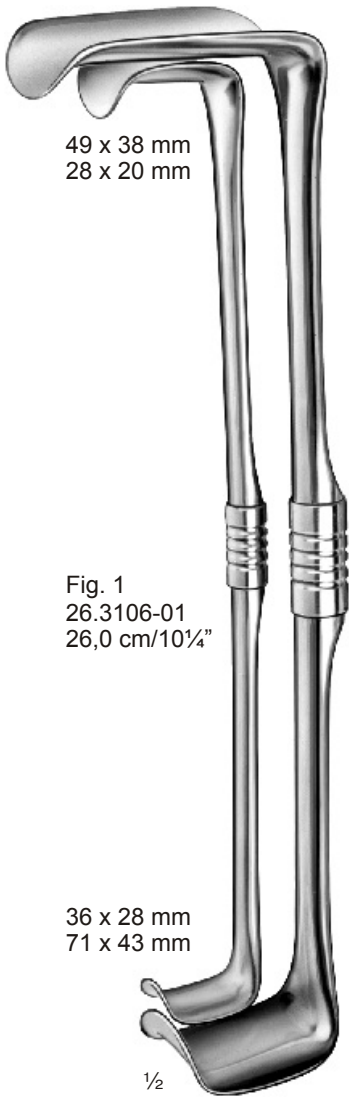

49 x 38 mm
28 x 20 mm

Fig. 1
26.3106-01
26,0 cm/10¹/₄"

Fig. 2
26.3106-02
28,0 cm/11"

36 x 28 mm
71 x 43 mm

1/2

Richardson-Eastman

26.3106
Satz 2-teilig
Set of 2 pieces
Jeu de 2 pièces
Juego de 2 piezas

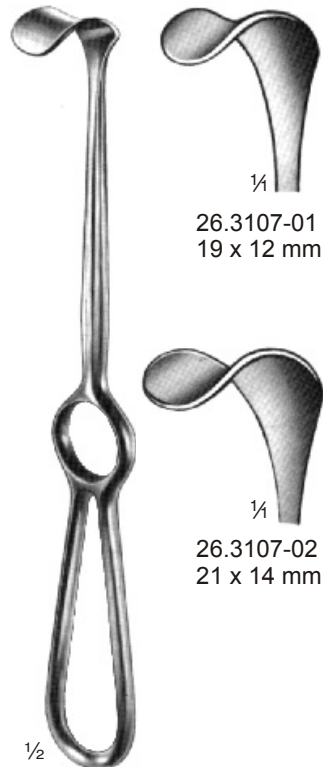

1/4
26.3107-01
19 x 12 mm

1/4
26.3107-02
21 x 14 mm

1/2

Kocher
20,5 cm/8"



1/2

Kocher
22,0 cm/8³/₄"

26.3108-01
40 x 10 mm

26.3108-02
40 x 15 mm

26.3108-03
40 x 20 mm

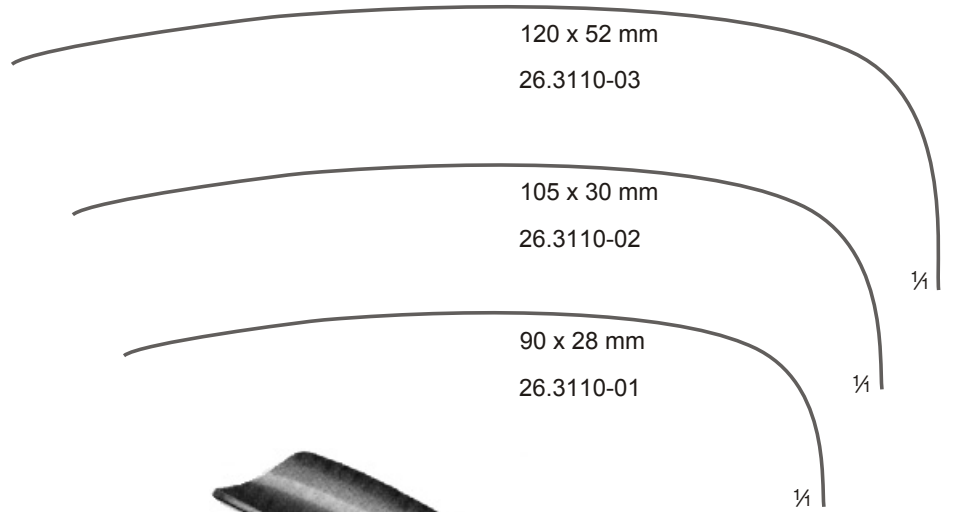

Middeldorpf



1/2
 26.3109-01
 14 x 17 mm
 21,5 cm/8 1/2"



1/2
 26.3109-02
 20 x 22 mm
 22,0 cm/8 3/4"



1/2
 26.3109-03
 26 x 30 mm
 23,5 cm/9 1/2"

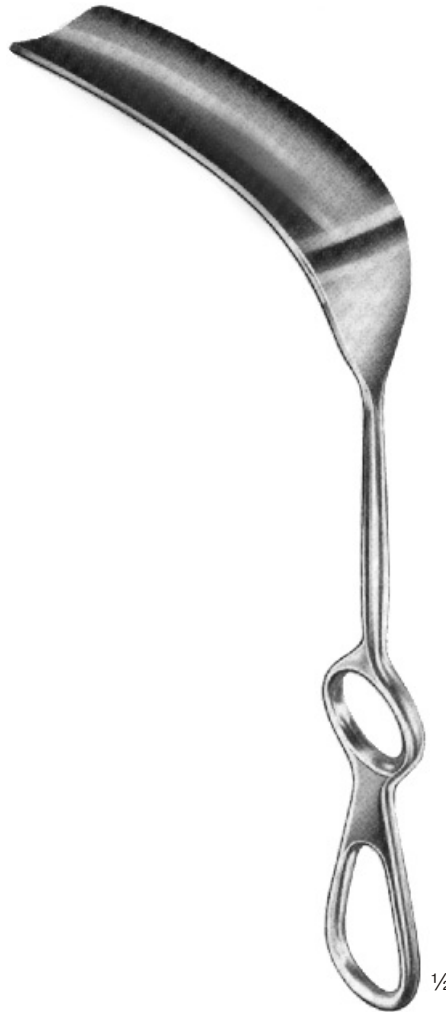

Doyen-Stille
 22,0 cm/8 1/4"



Fritsch
24,0 cm/9 1/2"

- 26.3111 Fig. 1 40 x 40 mm
- 26.3112 Fig. 2 45 x 50 mm
- 26.3113 Fig. 3 45 x 60 mm
- 26.3114 Fig. 4 45 x 75 mm

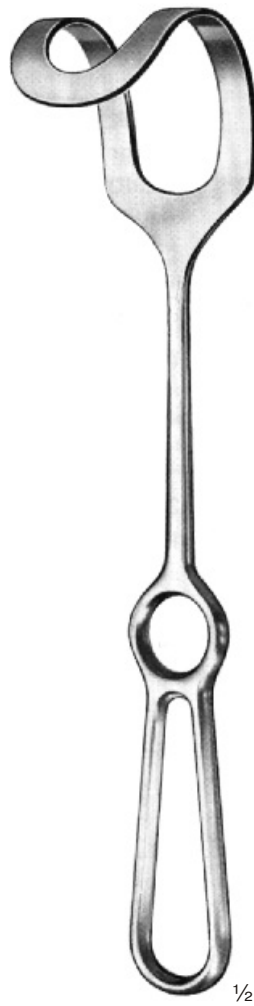

Middeldorpf
27,5 cm/11"

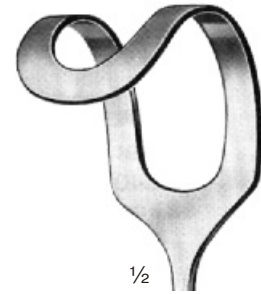

26.3115-01
45 x 45 mm

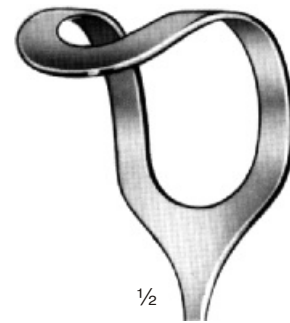

26.3115-02
45 x 50 mm



26.3115-03
55 x 70 mm

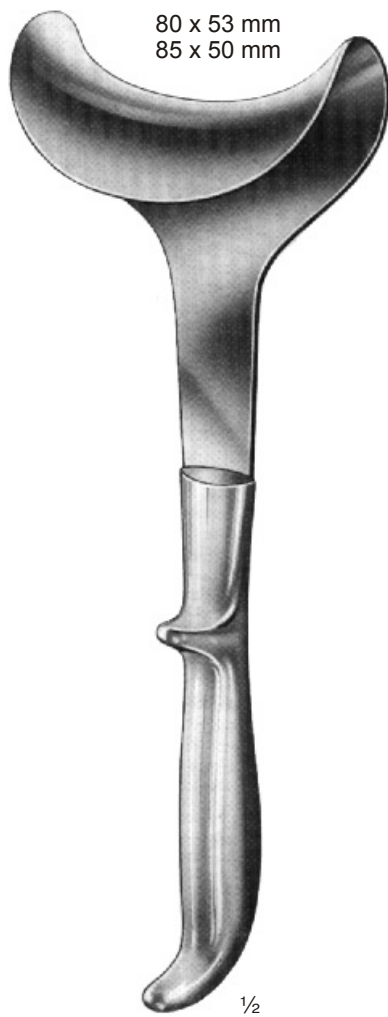

Doyen
25,0 cm/10"

26.3116-80 53 x 80 mm
26.3116-85 50 x 85 mm

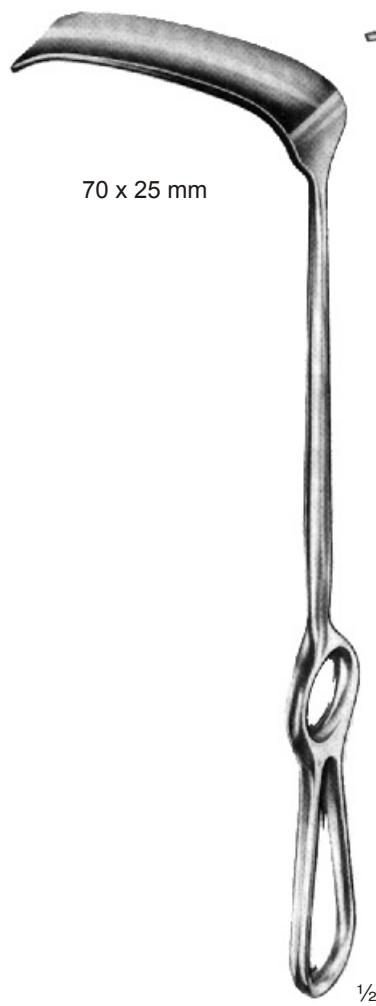

Kocher
23,5 cm/9 1/4"

26.3117-23

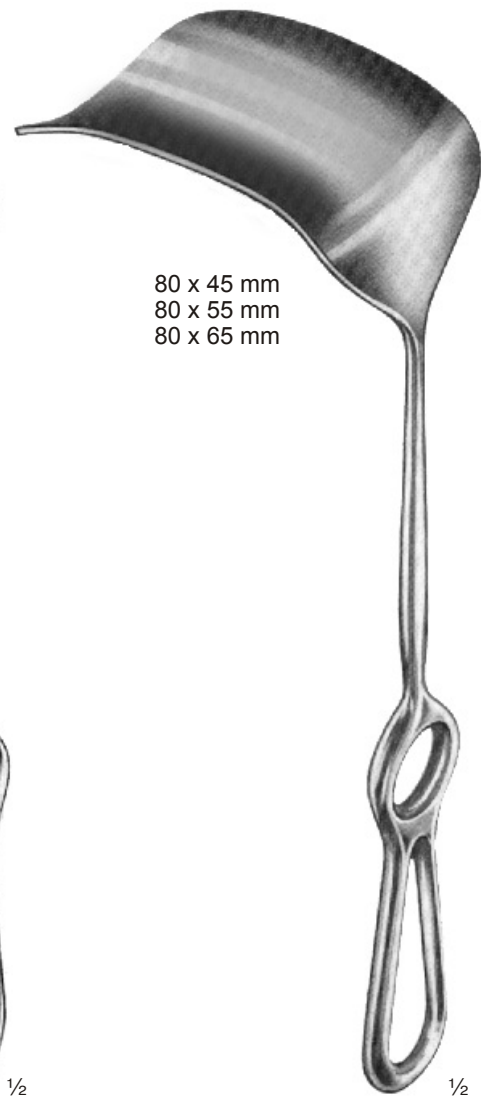

Kocher
25,0 cm/10"

26.3118-01 80 x 45 mm
26.3118-02 80 x 55 mm
26.3118-03 80 x 65 mm



Hösel
25,0 cm/10"

1/2

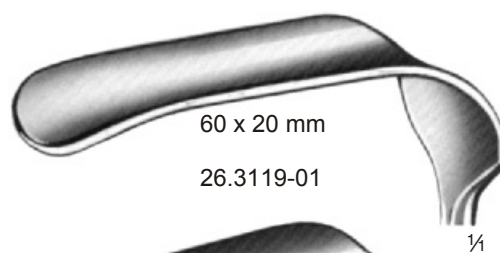

60 x 20 mm

26.3119-01

1/4

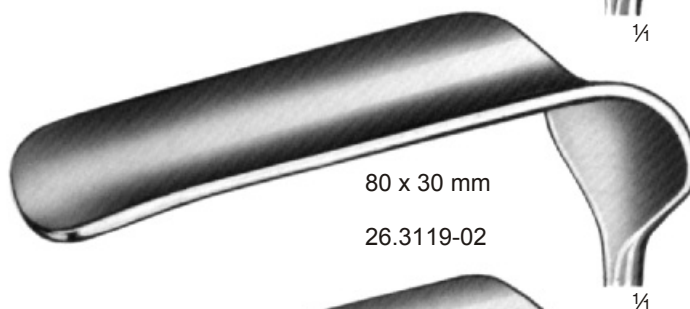

80 x 30 mm

26.3119-02

1/4

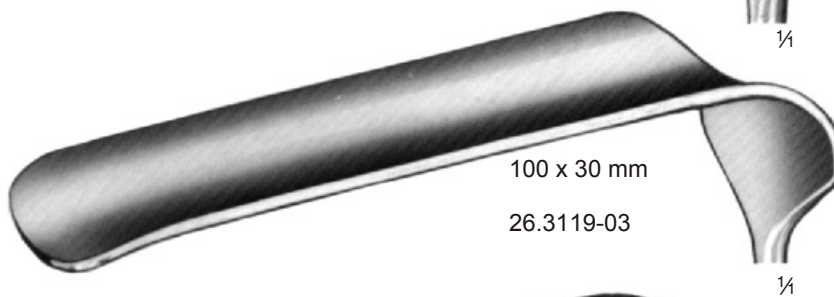

100 x 30 mm

26.3119-03

1/4



120 x 30 mm

26.3119-04

1/4



140 x 30 mm

26.3119-05

1/4



140 x 40 mm

26.3119-06

1/4



Zenker

35 x 8 mm
26.3120-01
23,5 cm/9¹/₄" $\frac{1}{4}$

60 x 12 mm
26.3120-02
26,0 cm/10¹/₄" $\frac{1}{4}$

75 x 12 mm
26.3120-03
27,5 cm/10³/₄" $\frac{1}{4}$

120 x 12 mm
26.3120-04
29,0 cm/11¹/₂" $\frac{1}{4}$

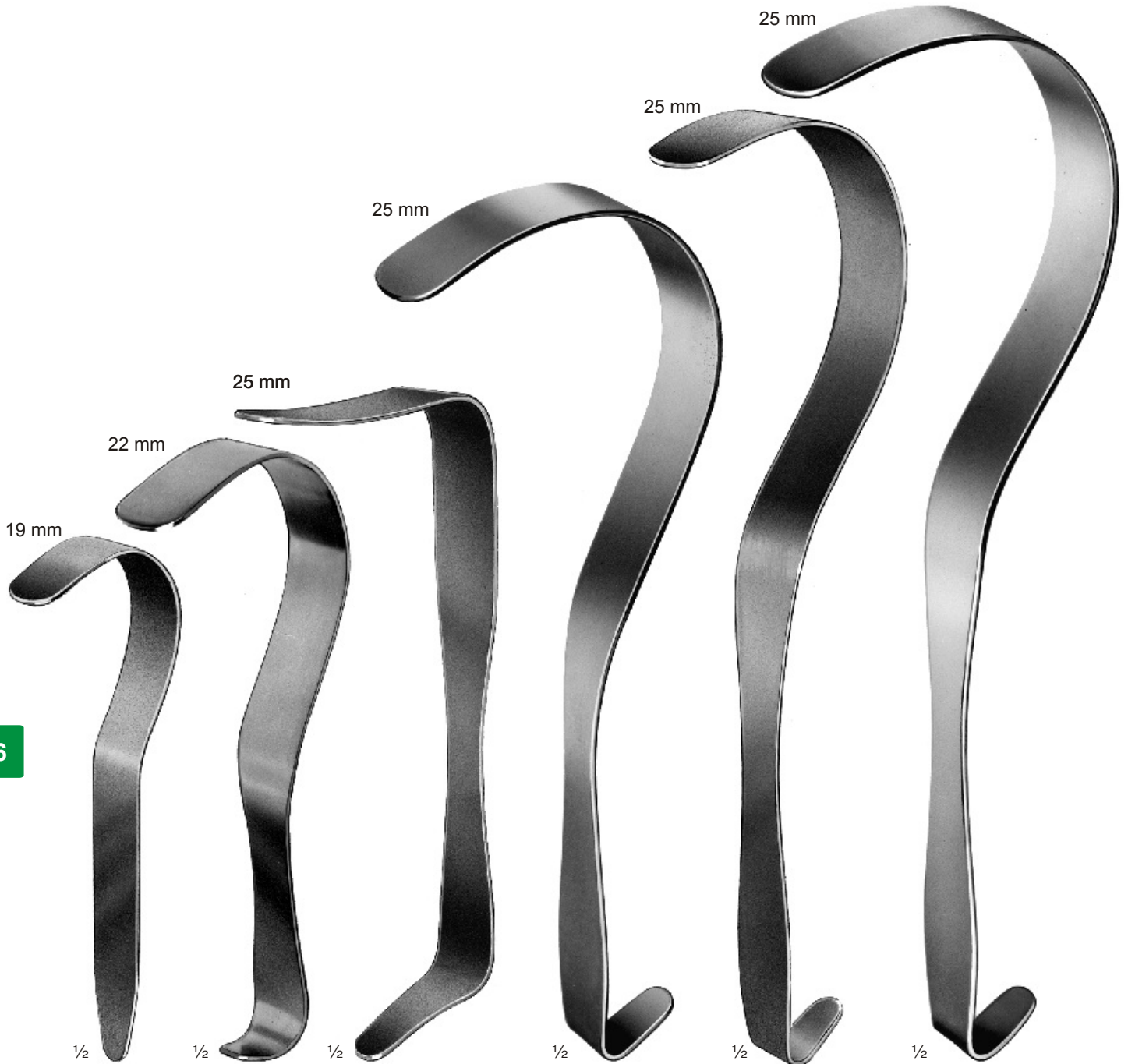

26

Deaver

26.3121
18,0 cm/7"

Deaver

26.3122
21,5 cm/8½"

Deaver

26.3123
23,0 cm/9"

Deaver

26.3124
30,0 cm/12"

Deaver

26.3125
33,0 cm/13"

Deaver

26.3126
36,0 cm/14"



Deaver

26.3127
30,0 cm/12"



Deaver

26.3128
30,0 cm/12"



Deaver

26.3129
30,0 cm/12"



Harrington

32,0 cm/12½"

26.3132 127 x 40 mm
26.3133 127 x 62 mm

115 x 22 mm
115 x 26 mm



Simon
27,5 cm/10³/₄"

26.3135-01 115 x 22 mm
26.3135-02 115 x 26 mm

95 x 20 mm



Modell Tübingen

26.3136-26
26,5 cm/10¹/₂"

105 x 27 mm



Martin

26.3137-25
25,0 cm/10"

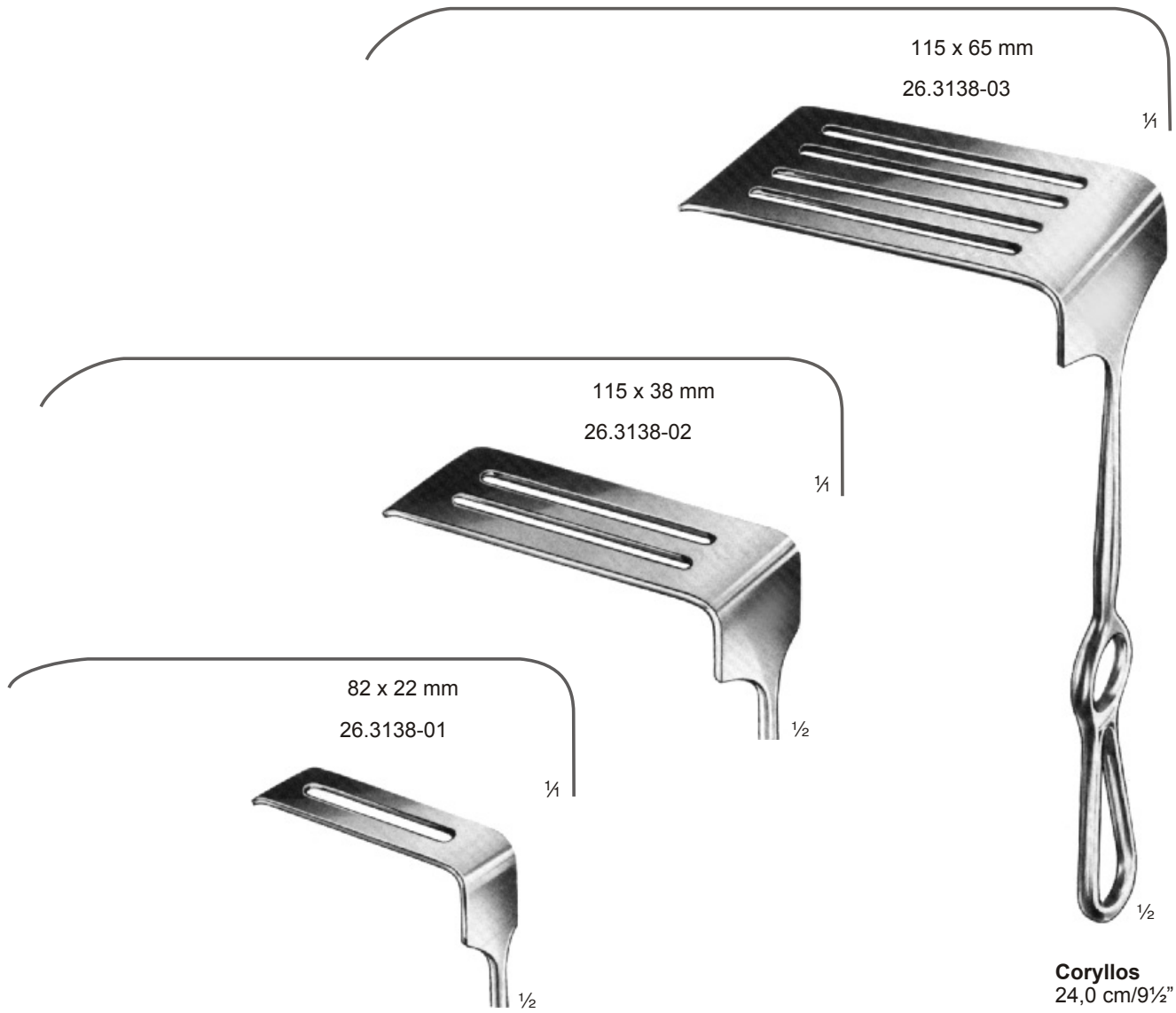

26.3139-01
75 x 50 mm



26.3139-02
75 x 90 mm



Davidson
16,0 cm/6¼"

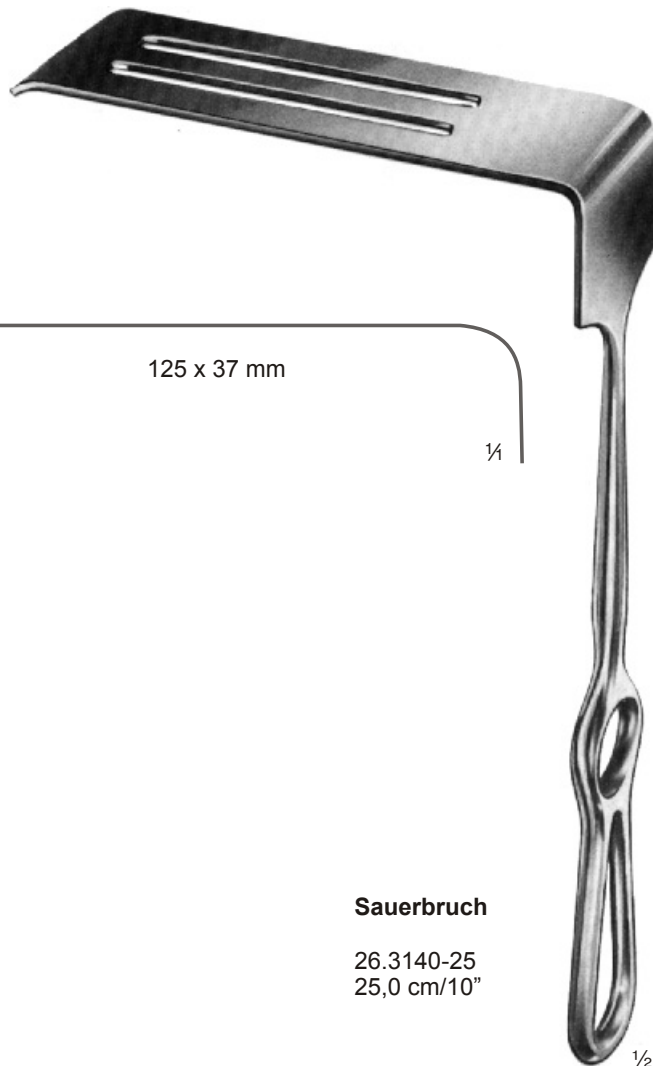

26

125 x 37 mm

¼

Sauerbruch

26.3140-25
25,0 cm/10"

½

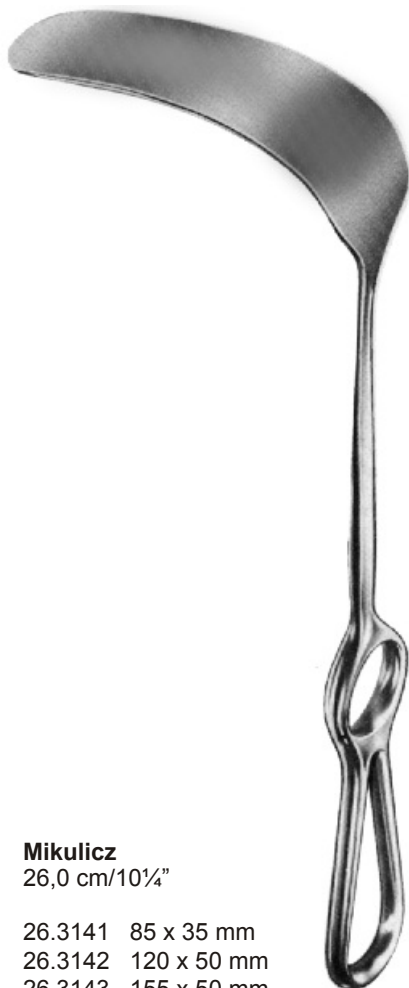
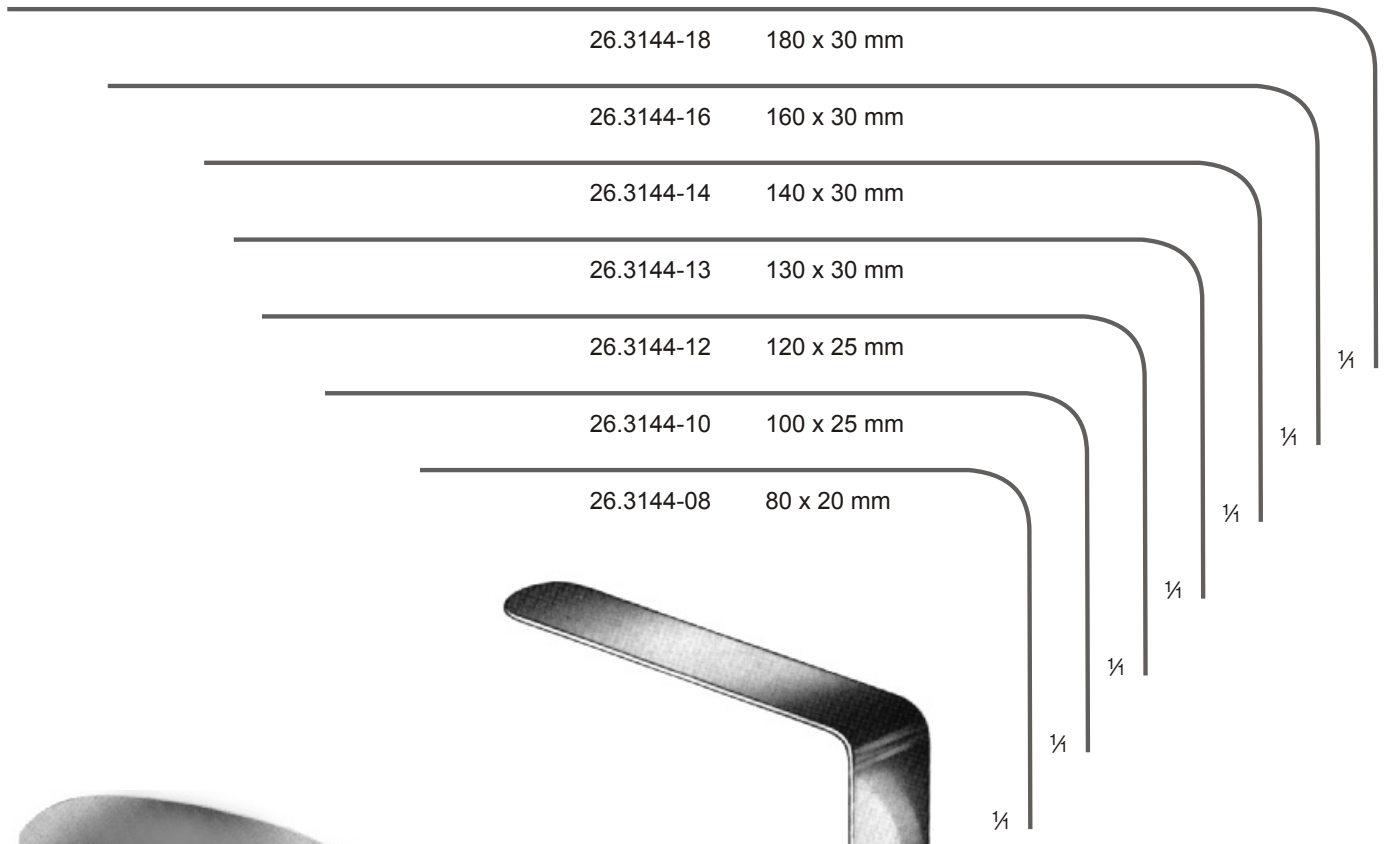

Mikulicz
 26,0 cm/10¼"

- 26.3141 85 x 35 mm
- 26.3142 120 x 50 mm
- 26.3143 155 x 50 mm

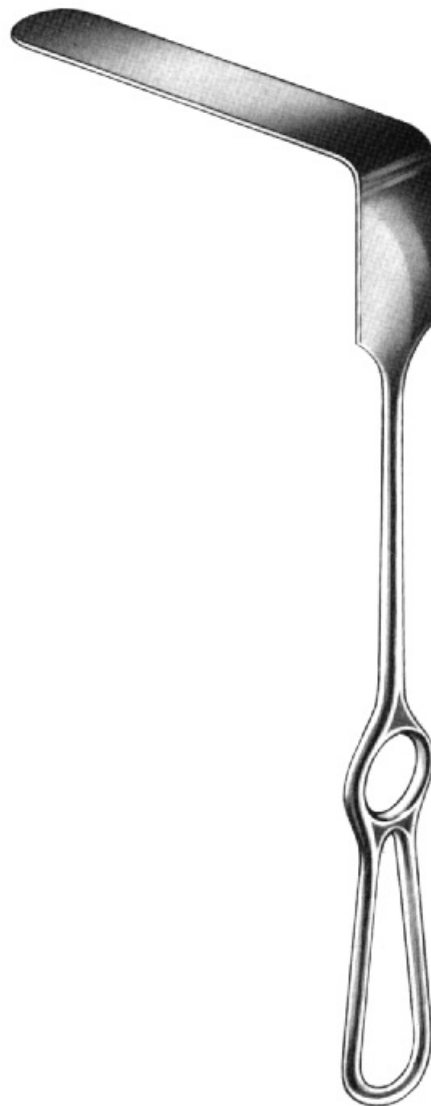

Brunner
 25,0 cm/10"

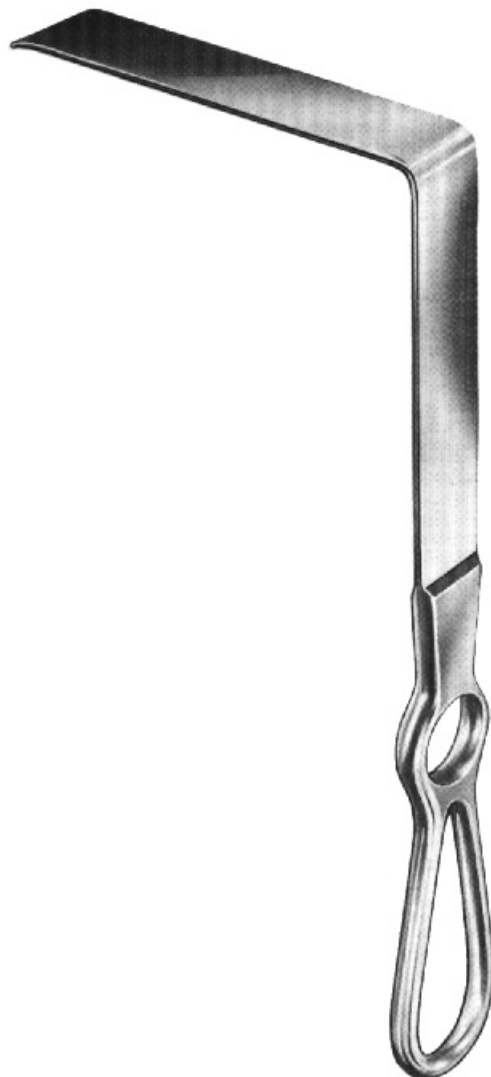
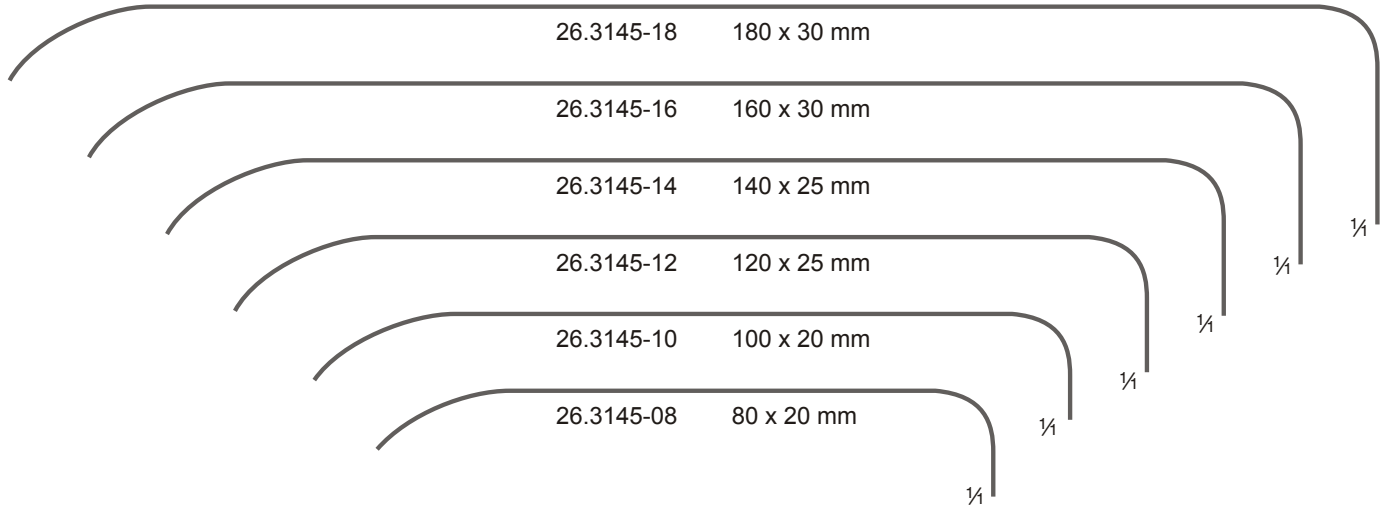

Brunner
25,0 cm/10"

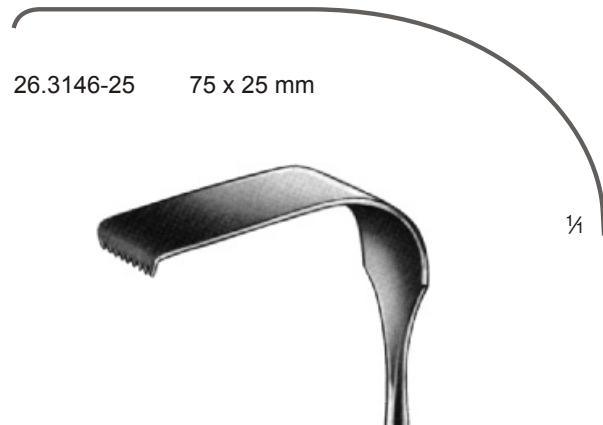
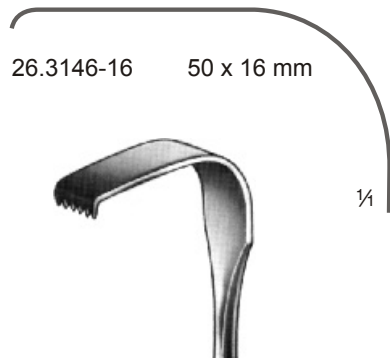

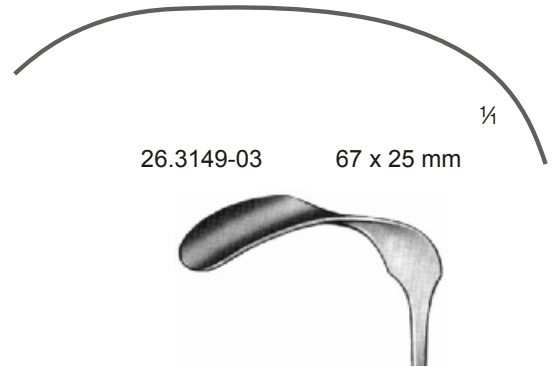
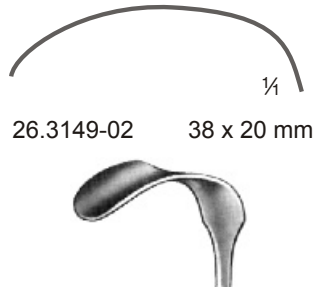
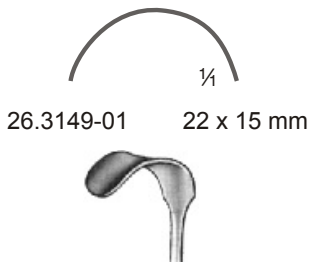

Kocher-Wagner
28,0 cm/11"

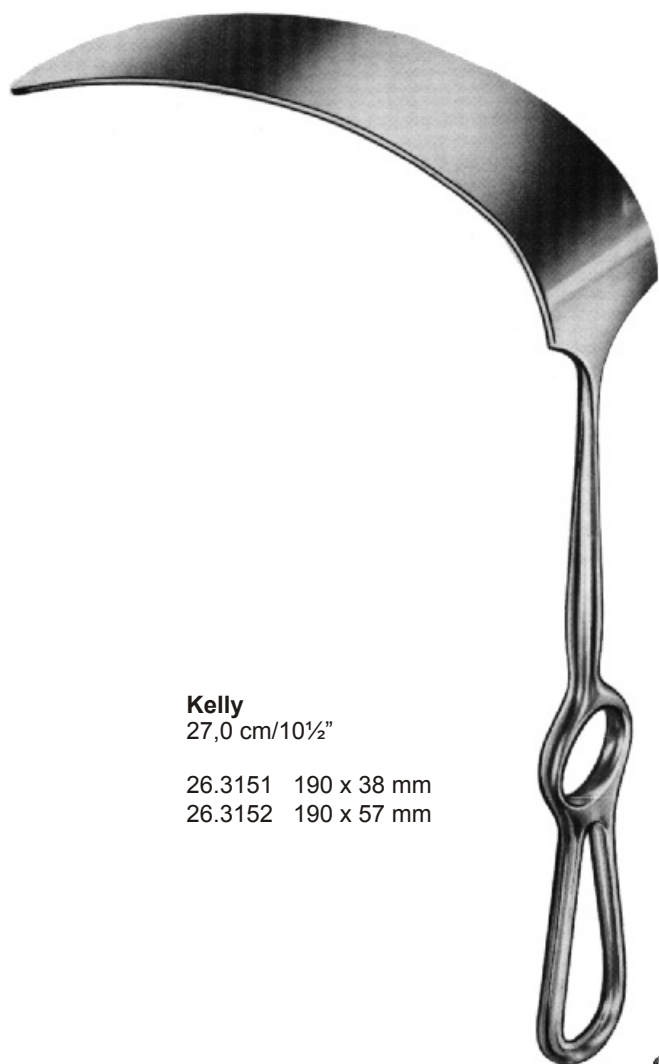

Kelly
27,0 cm/10½"

26.3151 190 x 38 mm
26.3152 190 x 57 mm



Baby-Senn-Miller
15,5 cm/6"



26.3153-01

scharf
sharp
pointu
agudo



26.3153-02

stumpf
blunt
mousse
romo



Ragnell-Davis

26.3154
14,0 cm/5½"



Senn-Miller
16,0 cm/6¼"



26.3155
scharf
sharp
pointu
agudo



26.3156
stumpf
blunt
mousse
romo



Senn-Green
15,0 cm/6"



26.3157
20 x 6 mm



26.3158
10 x 6 mm

26

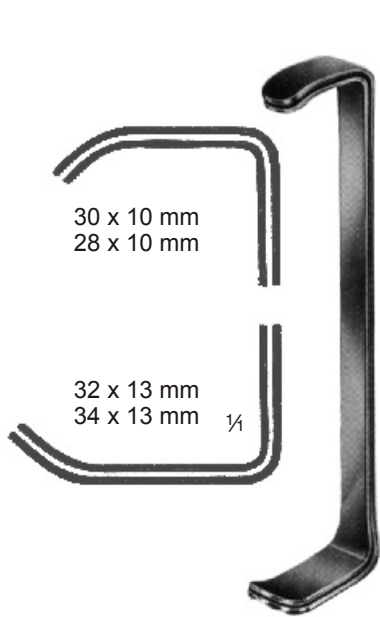

Farabeuf
12,0 cm/4¾"

26.3160
Satz, set
jeu, juego

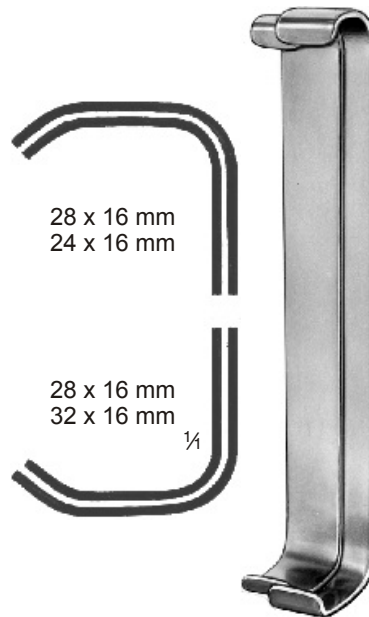

Farabeuf
15,0 cm/6"

26.3161
Satz, set
jeu, juego

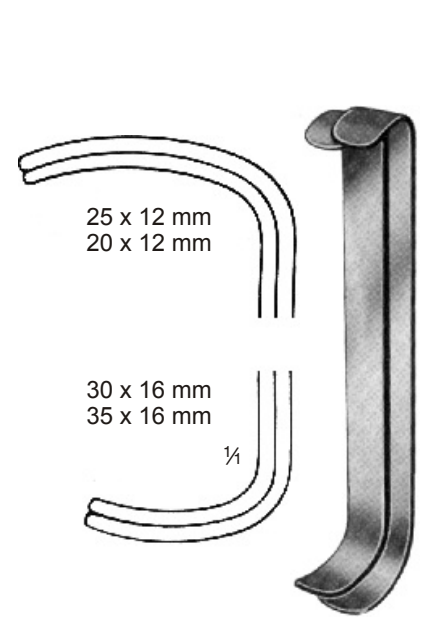

Collin
15,0 cm/6"

26.3162
Satz, set
jeu, juego

26

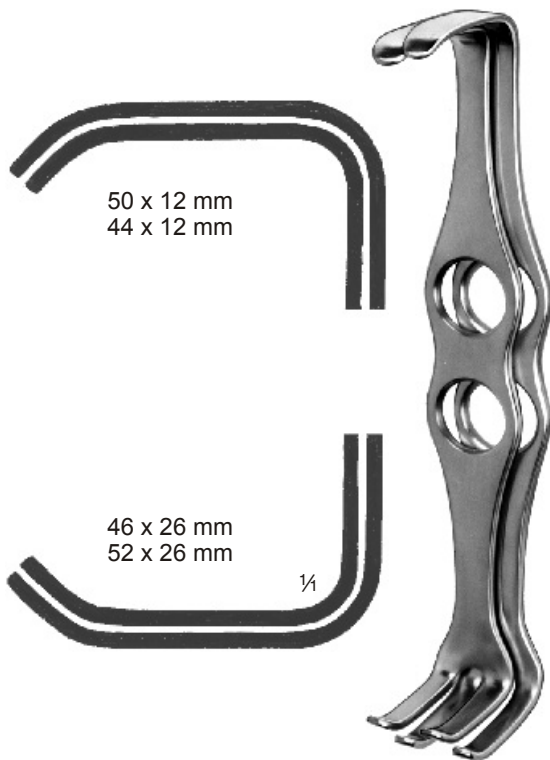

Mathieu
20,0 cm/8"

26.3164
Satz, set
jeu, juego

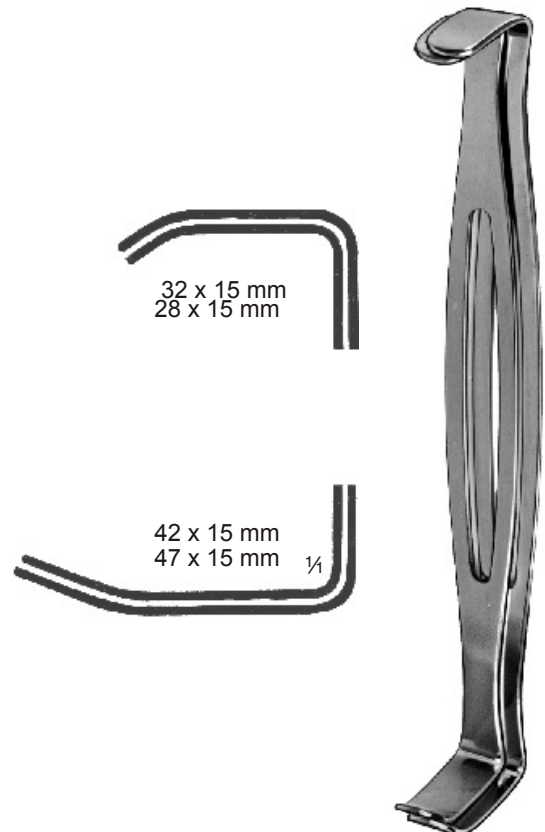

**Parker-Langenbeck
(US-Army)**
21,0 cm/8¼"

26.3165
Satz, set
jeu, juego

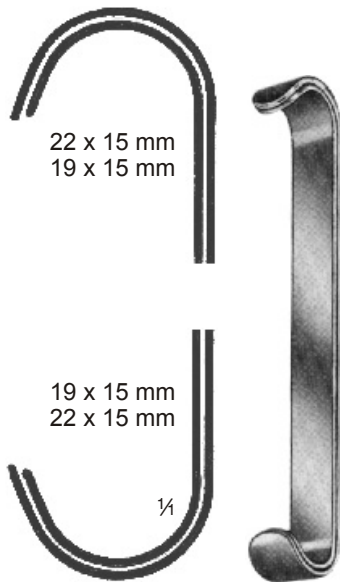

Parker
13,5 cm/5¼"

26.3166
Satz, set
jeu, juego

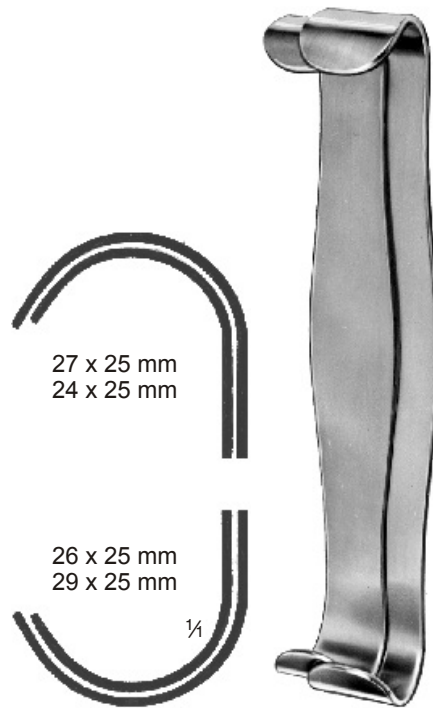

Parker
18,0 cm/7"

26.3167
Satz, set
jeu, juego

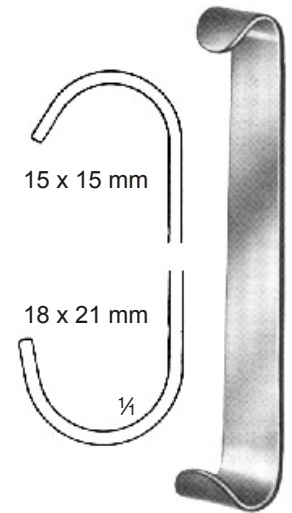

Baby-Roux
13,0 cm/5¼"

26.3168



Mini-Roux
15,0 cm/6"

26.3169

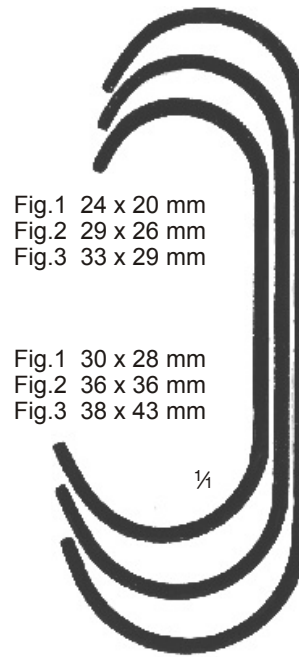

Roux

26.3170-00
Satz, set
jeu, juego

Roux

Fig.1 26.3171 14,0 cm/5½"
Fig.2 26.3172 15,0 cm/6"
Fig.3 26.3173 17,0 cm/6¾"



26.3176-01
scharf
sharp
pointu
agudo

Finsen
5,0 cm/2"

26.3176-02
stumpf
blunt
mousse
romo

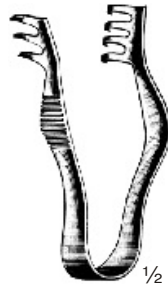

26.3177-01
scharf
sharp
pointu
agudo

Finsen
7,0 cm/2³/₄"

26.3177-02
stumpf
blunt
mousse
romo

26



26.3178-01
scharf
sharp
pointu
agudo

Jansen
10,0 cm/4"



26.3178-02
stumpf
blunt
mousse
romo

Jansen
10,0 cm/4"



26.3179-01
scharf
sharp
pointu
agudo

Holtzheimer
10,0 cm/4"

26.3179-02
stumpf
blunt
mousse
romo



26.3181
 scharf
 sharp
 pointu
 agudo

Weitlaner-Loktite
 10,5 cm/4 1/4"



26.3183
 26.3186
 26.3189
 scharf
 sharp
 pointu
 agudo

Weitlaner-Loktite

13,0 cm/5"
 16,5 cm/6 1/2"
 20,0 cm/8"

26.3193
 26.3196
 26.3199
 stumpf
 blunt
 mousse
 romo



Weitlaner-Wullstein
 13,0 cm/5"

26.3202-01
 scharf
 sharp
 pointu
 agudo

26.3202-02
 stumpf
 blunt
 mousse
 romo

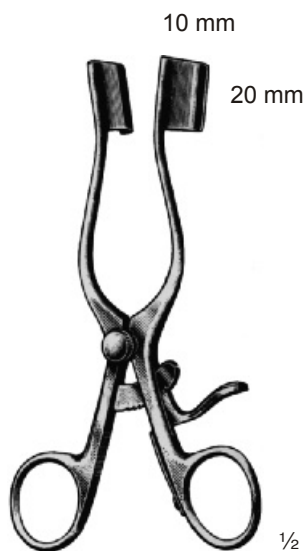

Weitlaner-Baby
 13,0 cm/5"

26.3203



Scalp Contour
 14,0 cm/5 1/2"

26.3204-01
 scharf
 sharp
 pointu
 agudo

26.3204-02
 stumpf
 blunt
 mousse
 romo

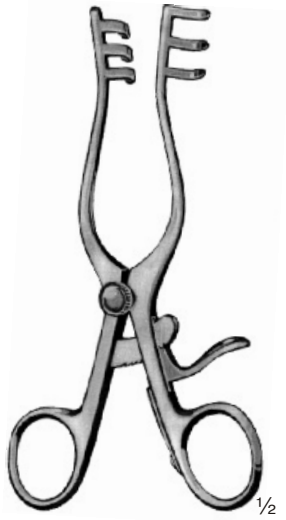

26.3205
stumpf
blunt
mousse
romo

Milligan
13,0 cm/5"



26.3206-01
scharf
sharp
pointu
agudo

Plester
13,0 cm/5"

26.3206-02
stumpf
blunt
mousse
romo

26



26.3207
stumpf
blunt
mousse
romo

Plester
11,0 cm/4¼"



26.3208
stumpf
blunt
mousse
romo

Plester
11,0 cm/4¼"

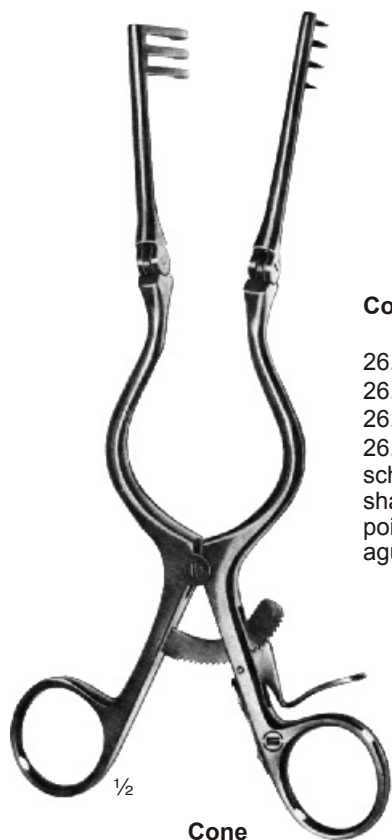

Cone

26.3210-01
26.3211-01
26.3212-01
26.3213-01
scharf
sharp
pointu
agudo

13,0 cm/5"
16,5 cm/6½"
20,0 cm/8"
25,0 cm/9½"

26.3210-02
26.3211-02
26.3212-02
26.3213-02
stumpf
blunt
mousse
romo



Tübinger Modell

26.3216
16,5 cm/6½"



Mollison
15,5 cm/6"

26.3217
scharf
sharp
pointu
agudo



Adson-Baby
16,0 cm/6¼"

26.3218
scharf
sharp
pointu
agudo

26.3219
stumpf
blunt
mousse
romo

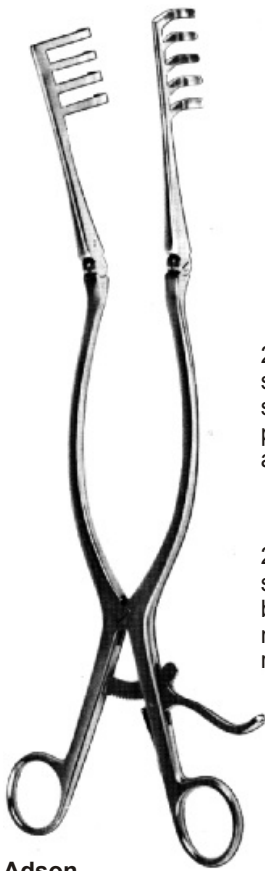

26.3220-01
scharf
sharp
pointu
agudo

26.3220-02
stumpf
blunt
mousse
romo

Adson
32,0 cm/12½"



26.3221-01
scharf
sharp
pointu
agudo

26.3221-02
stumpf
blunt
mousse
romo

Beckmann
31,0 cm/12¼"



26.3222-01
scharf
sharp
pointu
agudo

26.3222-02
stumpf
blunt
mousse
romo

½

Adson
20,0 cm/8"

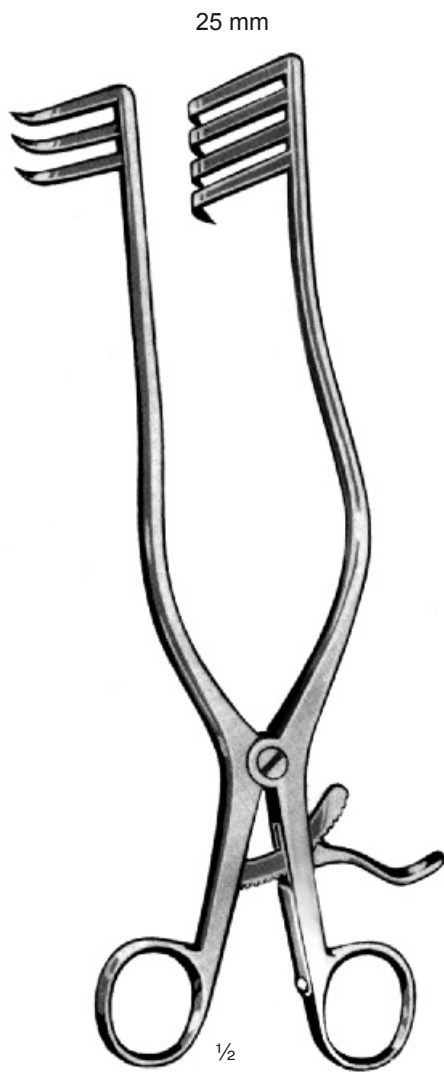

Adson
 26,5 cm/10½"

- | | |
|------------|------------|
| 26.3223-01 | 26.3223-02 |
| scharf | stumpf |
| sharp | blunt |
| pointu | mousse |
| agudo | romo |



Adson
 26,5 cm/10½"

- | | |
|------------|------------|
| 26.3224-01 | 26.3224-02 |
| scharf | stumpf |
| sharp | blunt |
| pointu | mousse |
| agudo | romo |

26



1/2
Beckmann-Eaton
32,0 cm/12 3/4"

26.3225
scharf
sharp
pointu
agudo

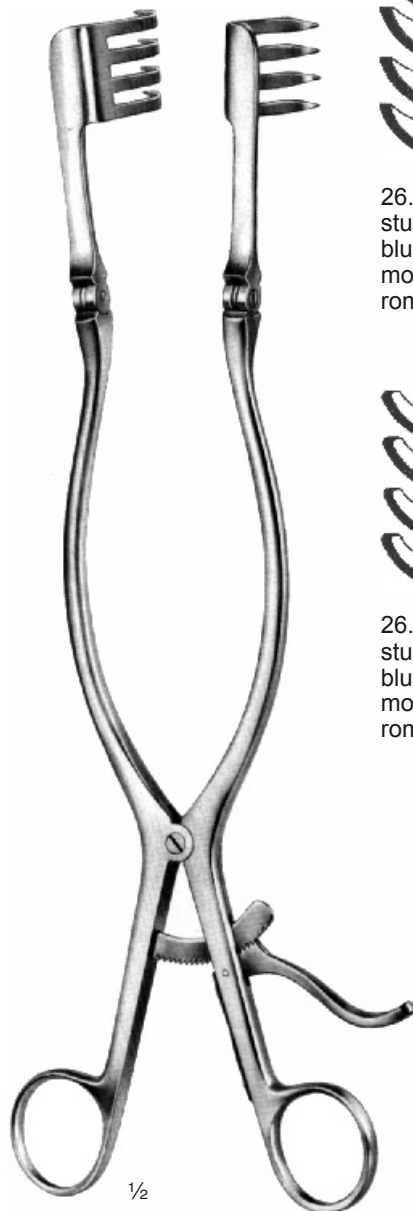

1/2
Beckmann-Adson
31,0 cm/12 1/4"

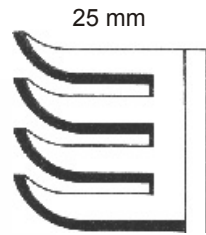

25 mm
26.3226-00 stumpf
blunt
mousse
romo
26.3226-01 scharf
sharp
pointu
agudo

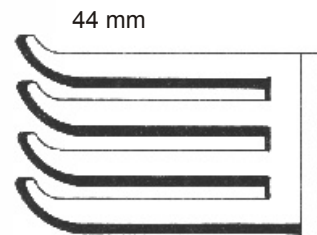

44 mm
26.3226-02 stumpf
blunt
mousse
romo
26.3226-03 scharf
sharp
pointu
agudo



1/2
Anderson-Adson
19,5 cm/8"

26.3228
scharf
sharp
pointu
agudo
gewinkelte Arme
angular
anglé
angulado

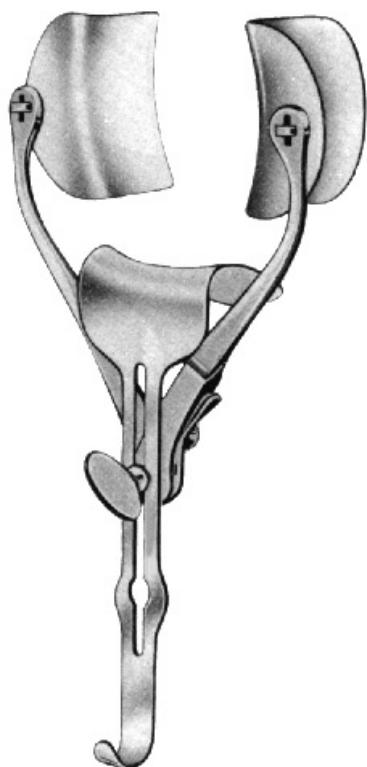

Ricard

26.3305-28	280 mm	72 x 85 mm	80 x 90 mm
26.3305-30	300 mm	60 x 80 mm	55 x 70 mm
	Spreizweite	Seitliche Valven	Mittelvalve
	Spread	Lateral blades	Center blade
	Ecartement	Valves latérales	Valve centrale
	Apertura de la hoja	Valvas laterales	Valva central



Holzbach

26.3307	62 x 80 mm	80 x 80 mm
	Seitliche Valven	Mittelvalve
	Lateral blades	Center blade
	Valves latérales	Valve centrale
	Valvas laterales	Valva central



Collin-Loktite

26,0 cm/10½"

26.3308	160 mm	60 x 80 mm	60 x 75 mm
	Spreizweite	Seitliche Valven	Mittelvalve
	Spread	Lateral blades	Center blade
	Ecartement	Valves latérales	Valve centrale
	Apertura de la hoja	Valvas laterales	Valva central



komplett mit 2 Paar Valven
complete, with 2 pairs of blades
complet, avec 2 paires de valves
completo, con 2 pares de valvas

Baby-Collin
26.3309

80 mm	27 x 40 mm
Spreizweite	18 x 40 mm
Spread	Seitliche Valven
Ecartement	Lateral blades
Apertura de la hoja	Valves latérales
	Valvas laterales



Collin
26.3310

100 mm	38 x 60 mm
Spreizweite	Seitliche Valven
Spread	Lateral blades
Ecartement	Valves latérales
Apertura de la hoja	Valvas laterales

26



Collin-Loktite

26.3311	100 mm	38 x 60 mm	38 x 55 mm
26.3312	100 mm	38 x 80 mm	50 x 75 mm
	Spreizweite	Seitliche Valven	Mittelvalve
	Spread	Lateral blades	Center blade
	Ecartement	Valves latérales	Valve centrale
	Apertura de la hoja	Valvas laterales	Valva central



**Wechselvalven
Exchangeable blades
Valves interchangeables
Valvas intercambiables**

26.3313-18	18 x 40 mm
26.3313-27	27 x 40 mm
26.3313-38	38 x 60 mm
26.3313-40	40 x 80 mm
26.3313-45	45 x 80 mm
26.3313-60	60 x 80 mm



Gosset
26.3315

100 mm
Spreizweite
Spread
Ecartement
Apertura de la hoja

30 x 40 mm
Seitliche Valven
Lateral blades
Valves latérales
Valvas laterales

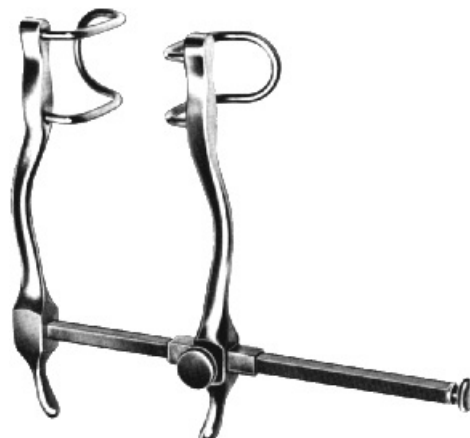

Gosset
26.3316

100 mm
Spreizweite
Spread
Ecartement
Apertura de la hoja

30 x 40 mm
Seitliche Valven
Lateral blades
Valves latérales
Valvas laterales



Gosset
26.3317

140 mm
Spreizweite
Spread
Ecartement
Apertura de la hoja

35 x 63 mm
Seitliche Valven
Lateral blades
Valves latérales
Valvas laterales



Gosset
26.3318

160 mm
Spreizweite
Spread
Ecartement
Apertura de la hoja

35 x 63 mm
Seitliche Valven
Lateral blades
Valves latérales
Valvas laterales

56 x 60 mm
Mittelvalve
Center blade
Valve centrale
Valva central

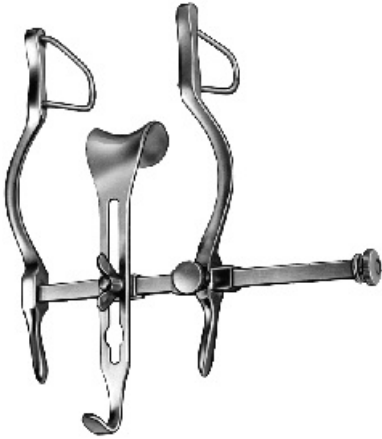

Balfour-Baby

26.3320

90 mm	26 x 38 mm	25 x 23 mm
Spreizweite	Seitliche Valven	Mittelvalve
Spread	Lateral blades	Center blade
Ecartement	Valves latérales	Valve centrale
Apertura de la hoja	Valvas laterales	Valva central



Balfour

26.3321

180 mm	35 x 70 mm	45 x 80 mm
Spreizweite	Seitliche Valven	Mittelvalve
Spread	Lateral blades	Center blade
Ecartement	Valves latérales	Valve centrale
Apertura de la hoja	Valvas laterales	Valva central

26

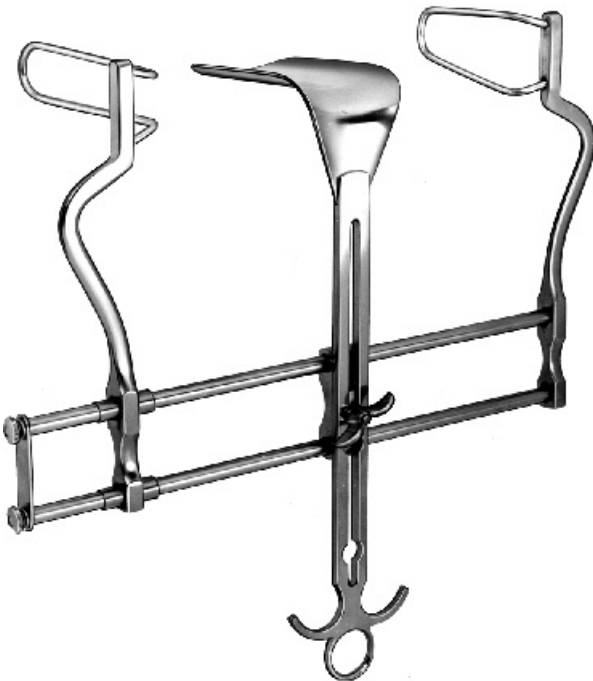

Balfour

26.3323

200 mm	35 x 100 mm	60 x 100 mm
Spreizweite	Seitliche Valven	Mittelvalve
Spread	Lateral blades	Center blade
Ecartement	Valves latérales	Valve centrale
Apertura de la hoja	Valvas laterales	Valva central

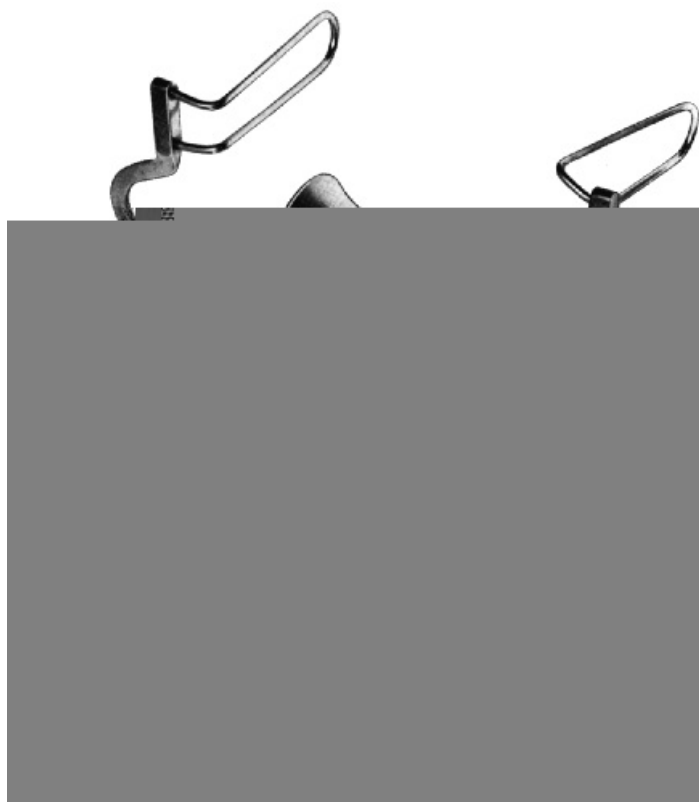

Balfour
26.3324

250 mm	35 x 100 mm	70 x 85 mm
Spreizweite	Seitliche Valven	Mittelvalve
Spread	Lateral blades	Center blade
Ecartement	Valves latérales	Valve centrale
Apertura de la hoja	Valvas laterales	Valva central



Balfour
26.3325

180 mm	35 x 70 mm	45 x 80 mm
Spreizweite	Seitliche Valven	Mittelvalve
Spread	Lateral blades	Center blade
Ecartement	Valves latérales	Valve centrale
Apertura de la hoja	Valvas laterales	Valva central

26

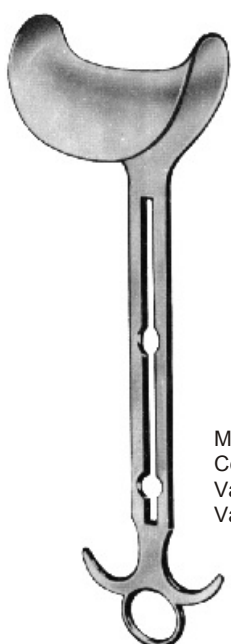

Mittelvalve allein
 Center blade only
 Valve centrale seule
 Valva central suelta

Balfour

26.3326-01	45 x 80 mm
26.3326-02	70 x 85 mm
26.3326-03	100 x 60 mm

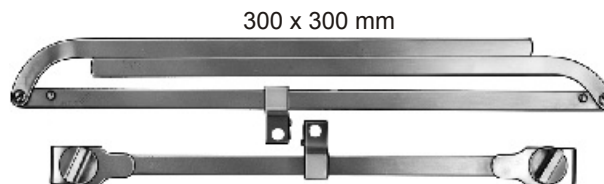
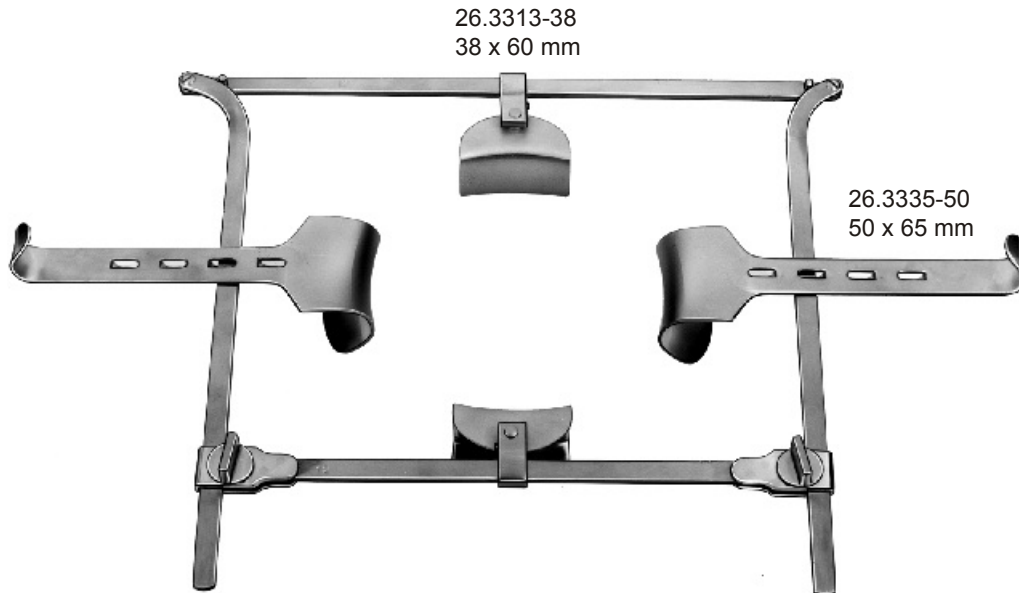

26.3330-10
Rahmen zusammenlegbar
Folding frame
Cadre pliant
Cuadro plegable

26

Franz			Tiefe Depth Profondeur Profundidad		Breite Width Largueur Anchura	
26.3330-00	mit 4 Valven with 4 valves avec 4 valves con 4 valvas	2x	50	x	65	mm
		2x	38	x	60	mm
26.3331-00	mit 8 Valven with 8 valves	2x	50	x	65	mm
	avec 8 valves	2x	38	x	60	mm
	con 8 valvas	2x	60		85	
		2x	45		80	

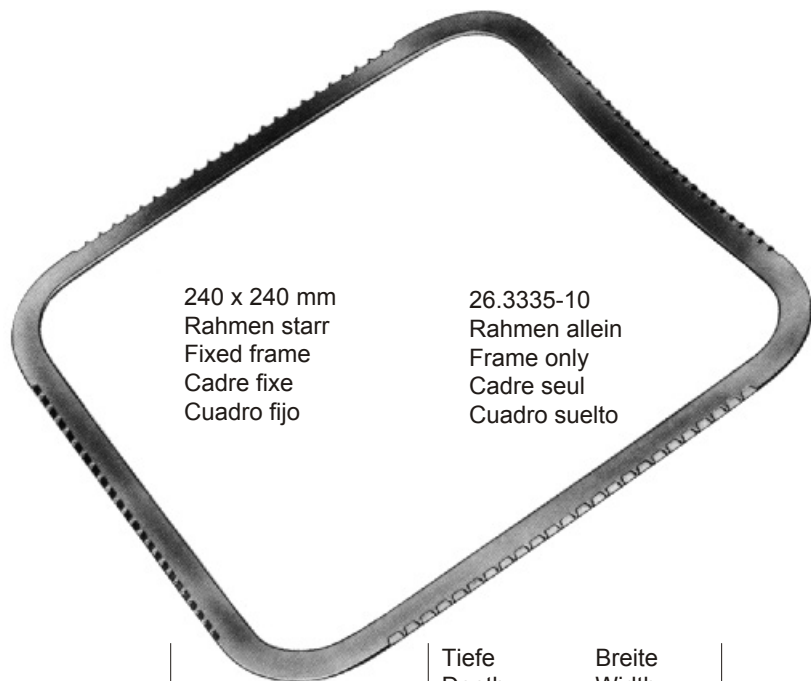

240 x 240 mm
 Rahmen starr
 Fixed frame
 Cadre fixe
 Cuadro fijo

26.3335-10
 Rahmen allein
 Frame only
 Cadre seul
 Cuadro suelto

Kirschner			Tiefe Depth Profondeur Profundidad		Breite Width Largueur Anchura	
26.3335-00	mit 4 Valven with 4 valves avec 4 valves con 4 valvas	2x 2x	40 50	x x	55 65	mm mm



Kirschner

- 26.3335-40 40 x 55 mm
- 26.3335-50 50 x 65 mm
- 26.3335-60 60 x 85 mm
- 26.3335-78 78 x 65 mm
- 26.3335-80 80 x 90 mm



Kirschner

- 26.3335-98 98 x 50 mm
- 26.3335-99 105 x 35 mm

175 x 150 mm

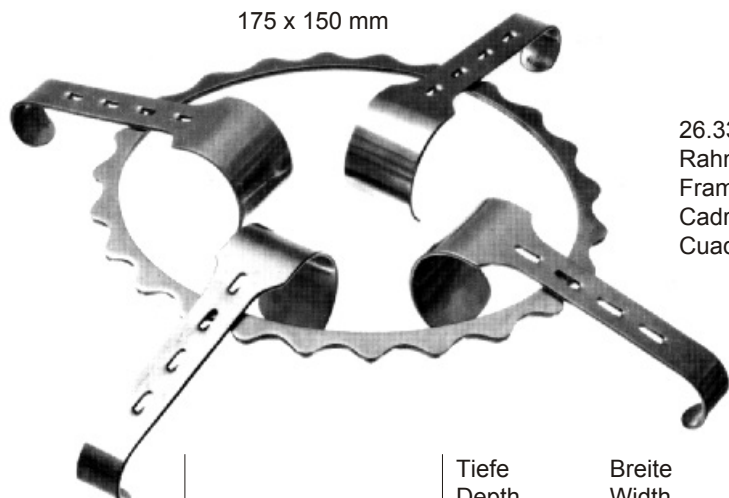

26.3336-10
 Rahmen allein
 Frame only
 Cadre seul
 Cuadro suelto

Denis-Browne			Tiefe Depth Profondeur Profundidad		Breite Width Largueur Anchura	
26.3336-00	mit 4 Valven with 4 valves avec 4 valves con 4 valvas	2x 2x	40 40	x x	30 40	mm mm

Valven allein
 Valves only
 Valves seules
 Valvas sueltas

Denis-Browne

- 26.3336-01 20 x 30 mm
- 26.3336-02 20 x 40 mm
- 26.3336-03 40 x 30 mm
- 26.3336-04 40 x 40 mm



26.3340-10
Rahmen allein
Frame only
Cadre seul
Cuadro suelto



O'Sullivan-O'Connor

		Tiefe Depth Profondeur Profundidad	Breite Width Largueur Anchura
26.3340-00	mit 3 Valven with 3 valves avec 3 valves con 3 valvas	2x 1x	80 x 45 mm 110 x 70 mm

26

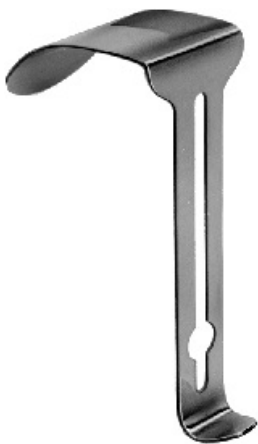

Valve allein
Valve only
Valve seule
Valva suelta

26.3340-45
80 x 45 mm



Valve allein
Valve only
Valave seule
Valva suelta

26.3340-70
110 x 70 mm



Rigby
26.3342

100 mm	70 x 16 mm
Spreizweite	Seitliche Valven
Spread	Lateral blades
Ecartement	Valves latérales
Apertura de la hoja	Valvas laterales

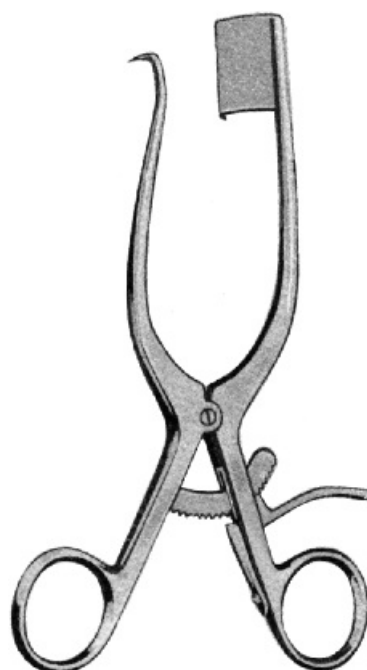

Markham-Meyerding
26.3343-01

18,0 cm/7"

83 mm	45 x 25 mm
Spreizweite	Valve rechts
Spread	Blade right side
Ecartement	Valve à droite
Apertura de la hoja	Valva a la derecha

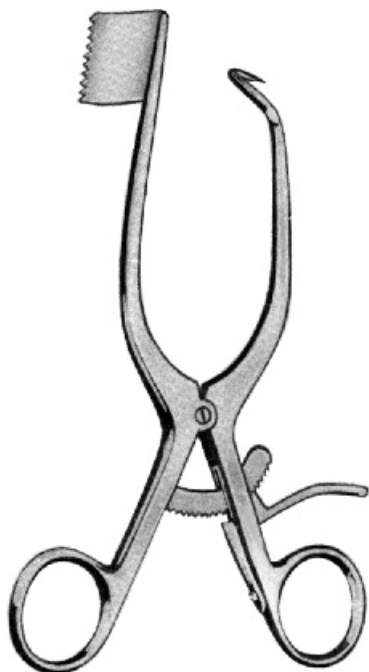

Markham-Meyerding
26.3343-02

18,0 cm/7"

83 mm	45 x 25 mm
Spreizweite	Valve links
Spread	Blade left side
Ecartement	Valve à gauche
Apertura de la hoja	Valva a la izquierda



19,0 cm/7½"

Meyerding

26.3344-01
26.3344-02
26.3344-03
26.3344-04

25 x 30 mm
25 x 55 mm
25 x 60 mm
20 x 60 mm
Seitliche Valven
Lateral blades
Valves latérales
Valvas laterales



Gelpi-Loktite

26.3345-09 9,0 cm/3½"
26.3345-11 11,5 cm/4½"



Gelpi-Loktite

26.3345-14 14,0 cm/5½"
26.3345-18 18,0 cm/7"

26

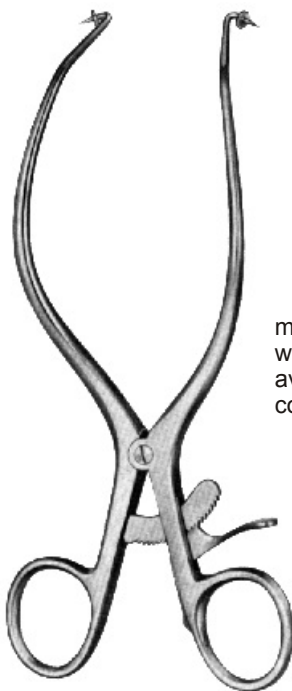

Gelpi-Loktite

26.3346-18 18,0 cm/7"

mit Kugel
with balls
avec boules
con bolas



DeBakey

26.3348 100 mm
26.3349 145 mm
Spreizweite
Spread
Ecartement
Apertura de la hoja

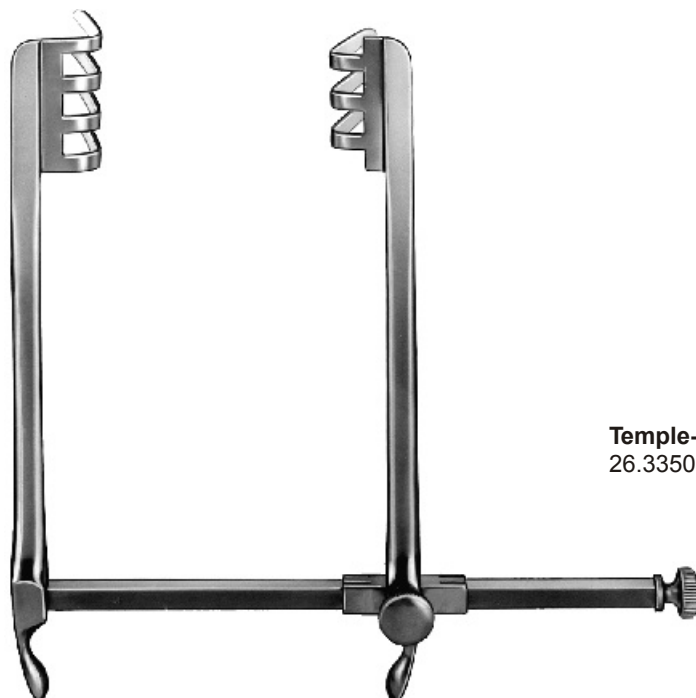

Temple-Fay
26.3350 120 mm
Spreizweite
Spread
Ecartement
Apertura de la hoja

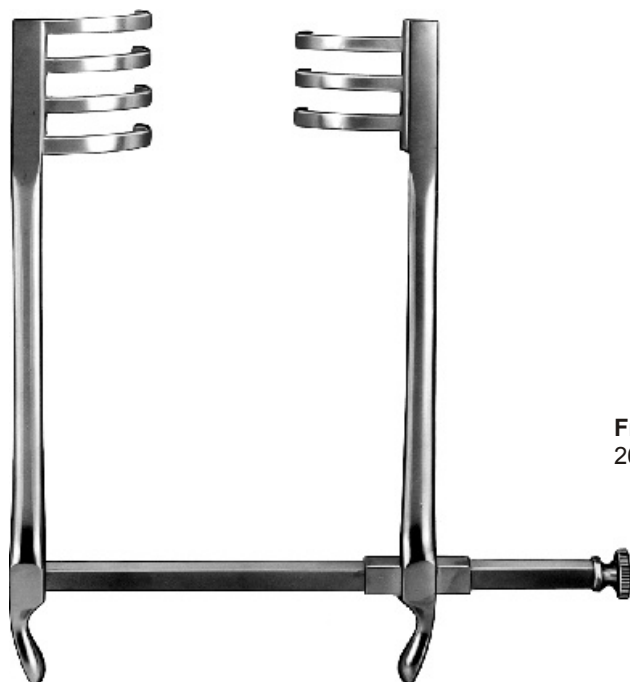

Frazier
26.3351 85 mm
Spreizweite
Spread
Ecartement
Apertura de la hoja

biegsam, flexible, malléable, flexible



26.3360	26.3361	26.3362
33,0 cm/13"	33,0 cm/13"	33,0 cm/13"
30 mm	40 mm	50 mm

biegsam, flexible, malléable, flexible

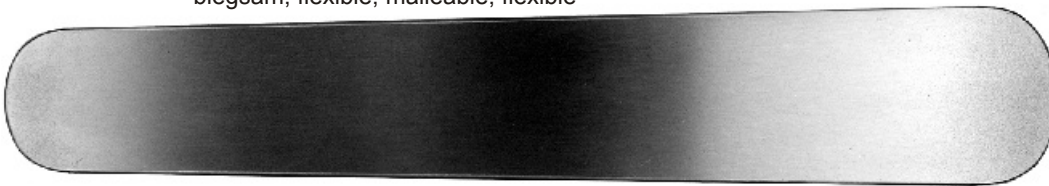

Haberer	26.3365	26.3366
	28,0 cm/11"	30,0 cm/12"
	25 x 30 mm	37 x 45 mm



Reverdin	26.3367
	28,5 cm/11¼"
	65 x 45 mm

26

biegsam, flexible, malléable, flexible



26.3368-06	20,0 cm/8"	6 mm	26.3368-17	20,0 cm/8"	17 mm
26.3368-09	20,0 cm/8"	9 mm	26.3368-20	20,0 cm/8"	20 mm
26.3368-12	20,0 cm/8"	12 mm	26.3368-25	20,0 cm/8"	25 mm

biegsam, flexible, malléable, flexible



Tuffier	26.3369
	20,0 cm/8"
	17 x 25 mm

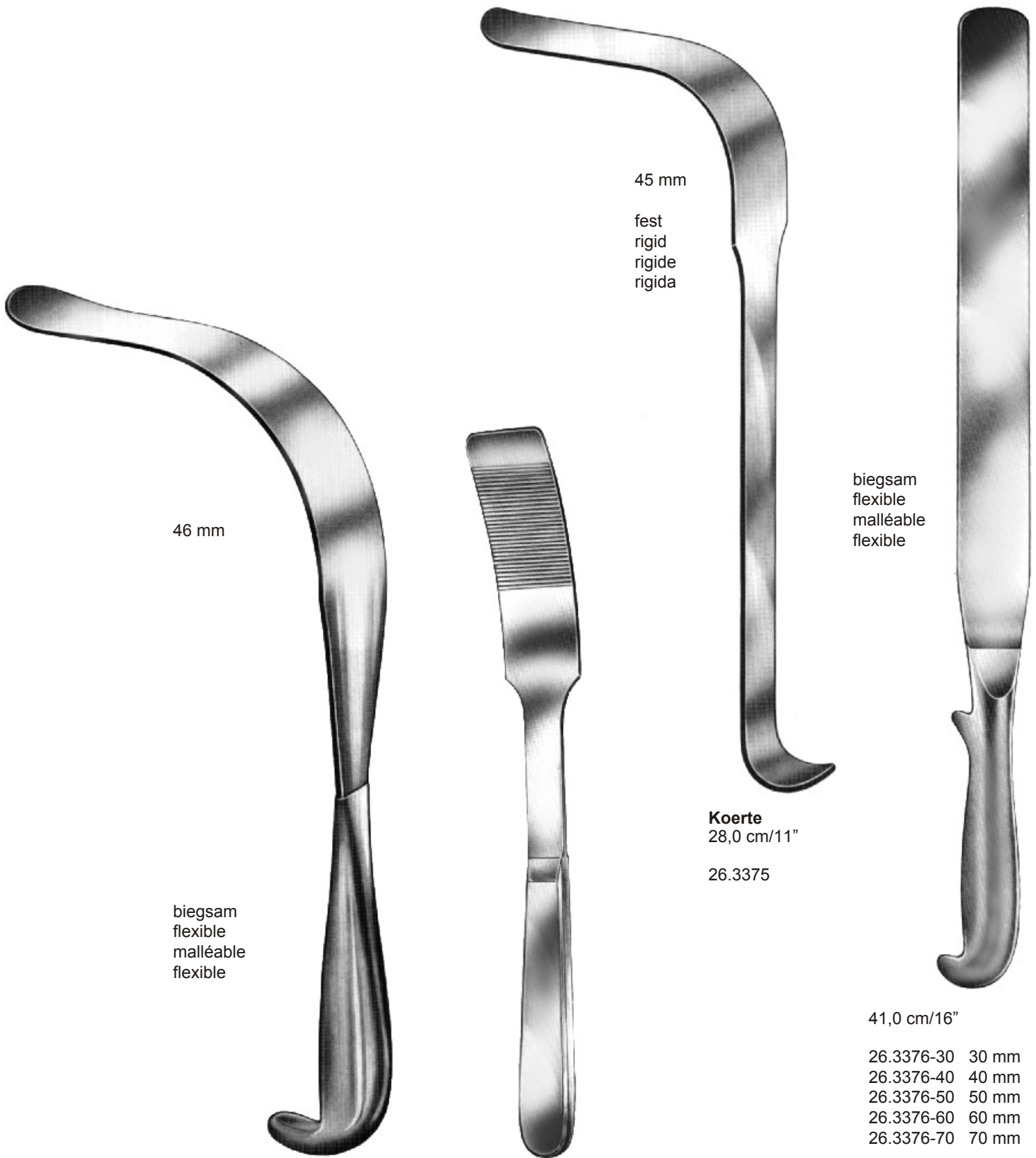

46 mm

biegsam
flexible
malléable
flexible

Kuemmel
26.3371 33,0 cm/13"

45 mm

fest
rigid
rigide
rigida

Koerte
28,0 cm/11"

26.3375

biegsam
flexible
malléable
flexible

41,0 cm/16"

26.3376-30 30 mm
 26.3376-40 40 mm
 26.3376-50 50 mm
 26.3376-60 60 mm
 26.3376-70 70 mm

Kader
27,0 cm/10¾"

26.3372-20 20 mm
 26.3372-30 30 mm
 26.3372-40 40 mm

26

Knochenchirurgie-Instrumente
Bone Surgery Instruments
Instrumentation pour la Chirurgie Osseuse
Instrumental para la cirugía ósea



27



Charrière

27.3400-00
 35,0 cm/14"

Ersatzsägeblatt
 Spare saw blade
 Lame scie de rechange
 Hoja de sierra de repuesto

27.3400-12 12 mm
 27.3400-15 15 mm
 27.3400-18 18 mm

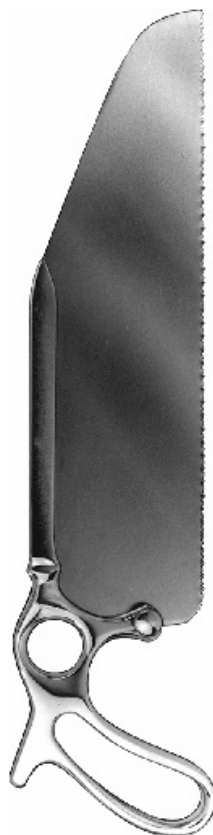

Satterlee

27.3401-00
 29,0 cm/11½"

Ersatzsägeblatt
 Spare saw blade
 Lame scie de rechange
 Hoja de sierra de repuesto

27.3401-20



Langenbeck

27.3402
 23,0 cm/9"



Charrière

27.3403-27 27,0 cm/10½"
 27.3403-30 30,0 cm/12"
 27.3403-34 34,0 cm/13½"

Ersatzsägeblatt
 Spare saw blade
 Lame scie de rechange
 Hoja de sierra de repuesto

27.3403-65 15 cm
 27.3403-70 20 cm
 27.3403-75 25 cm

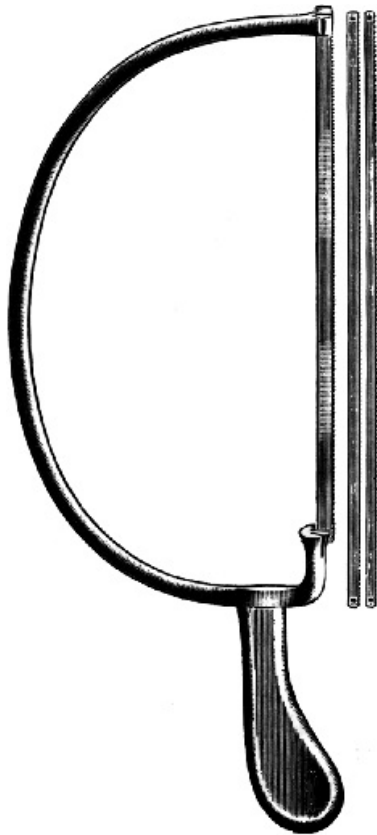

Helferich-Bier

27.3404-00
39,0 cm/15½"

Ersatzsägeblatt
Spare saw blade
Lame scie de rechange
Hoja de sierra de repuesto

27.3404-65 5 mm
27.3404-66 6 mm
27.3404-68 8 mm

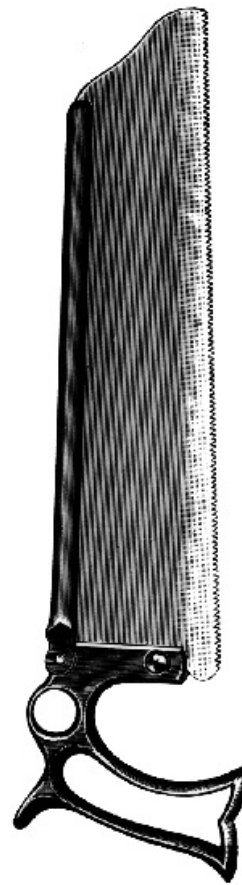

Weiss

27.3405-35
35,0 cm/14"

27



Rust

27.3406-00
24,0 cm/9½"

komplett mit je 1 Sägeblatt
12 und 18 mm
complete with saw blade
12 and 18 mm
complet avec lame de scie
12 et 18 mm
completo con hoja de sierra
12 y 18 mm

Ersatzsägeblatt
Spare saw blade
Lame scie de rechange
Hoja de sierra de repuesto

27.3406-06 6 mm
27.3406-08 8 mm
27.3406-12 12 mm
27.3406-15 15 mm
27.3406-18 18 mm

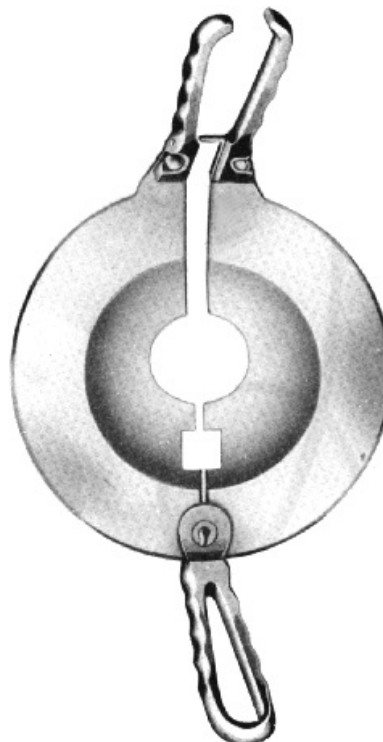

Percy

27.3408
Amputations-Retraktor
Amputating retractor
Rétracteur à amputation
Retractor para amputación



27.3410-14
14,0 cm/5½"

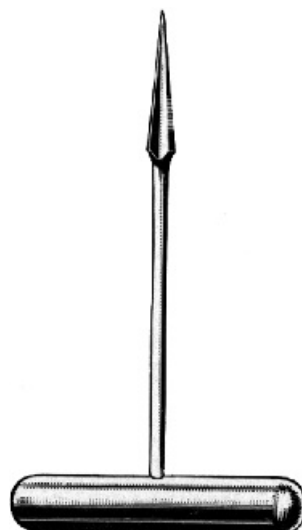

27.3411-14
14,0 cm/5½"

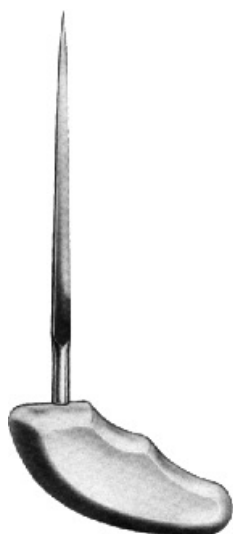

Perthes

27.3412-01 18,0 cm/7"
27.3412-02 21,0 cm/8¼"

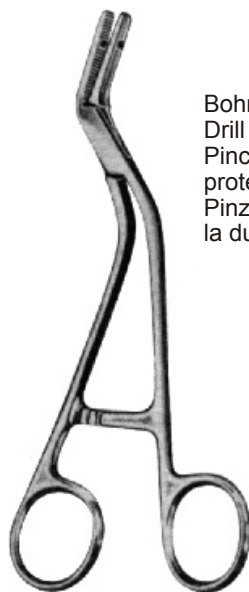

Adson

27.3413-15
15,0 cm/6"

Bohrer-, Führungs- und Dura-Schutzzange
Drill guide and dura protecting forceps
Pince-guide pour des perforateurs et pour
protéger la dure-mère
Pinza-guía para taladros y para proteger
la dura-madre



Gewindeschneider mit Quergriff
Tap with cross handle
Taraud avec manche transversal
Terraña con mango transversal



27

27.3420-25 2,5 mm
27.3420-35 3,5 mm

Lane

27.3421-25
25,0 cm/10"

27.3422-25
25,0 cm/10"

	Ø	
27.3428-25	2,5 mm	14,0 cm/5½"
27.3428-27	2,7 mm	14,0 cm/5½"
27.3428-30	3,0 mm	16,0 cm/6½"
27.3428-35	3,5 mm	16,0 cm/6½"
27.3428-36	3,6 mm	16,0 cm/6½"
27.3428-40	4,0 mm	18,0 cm/7¼"
27.3428-45	4,5 mm	18,0 cm/7¼"
27.3428-65	6,5 mm	22,0 cm/9"

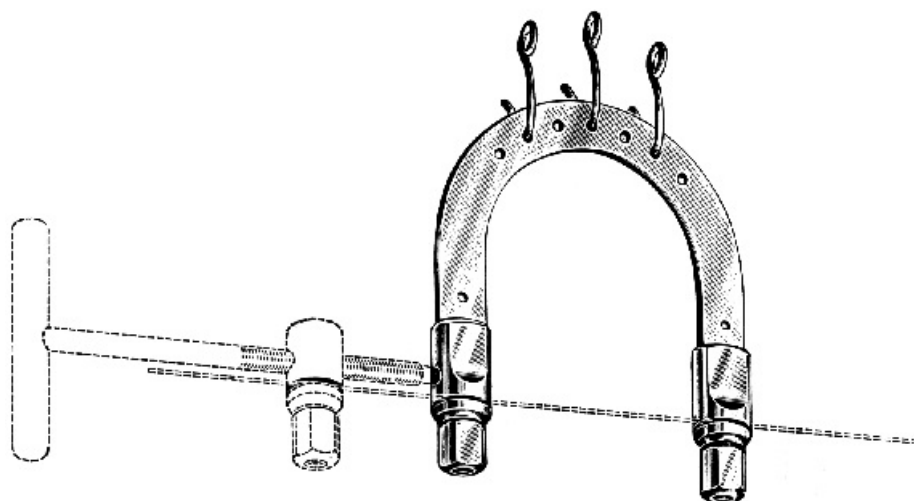

mit 3 Zughaken
 with 3 traction hooks
 avec 3 crochets de traction
 con 3 ganchos de tracción

Kirschner

27.3430-01	9,5 x 7,0 cm
27.3430-02	10,5 x 10,5 cm
27.3430-03	12,0 x 12,0 cm
27.3430-04	15,5 x 15,5 cm
27.3430-05	20,0 x 15,5 cm

lichte Weite
 clear width
 largeur ouverte
 anchura interior

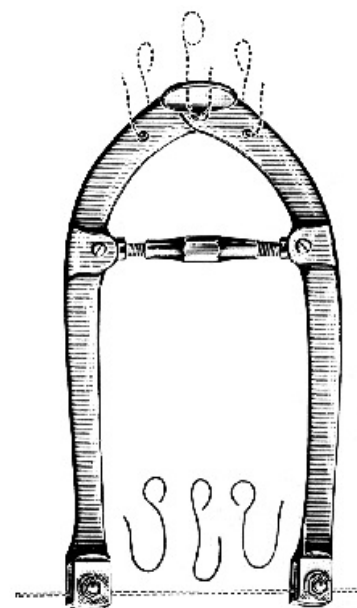

lichte Weite
 clear width
 largeur ouverte
 anchura interior

27.3431-01	18,0 x 10,0
27.3431-02	27,0 x 16,0

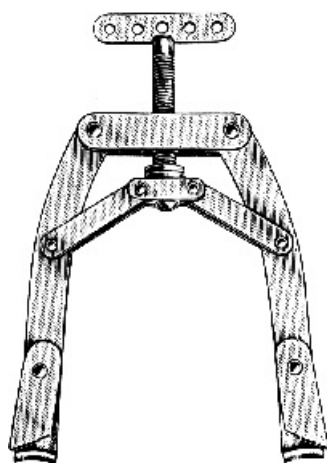

Kirschner
(amerikanisches Modell)

27.3432-01	27.3432-02
kleines Modell	großes Modell
small pattern	large pattern
petit modèle	modèle grand
modelo pequeño	modelo grande

mit 3 Zughaken
 with 3 traction hooks
 avec 3 crochets de traction
 con 3 ganchos de tracción

Spannschlüssel
 Wire strainer
 Tendeur de broches
 Tensor de taladros



27.3433-18

Mutterschlüssel
 Screw nut wrench
 Clé de serrage
 Llave de tuercas



27.3433-19

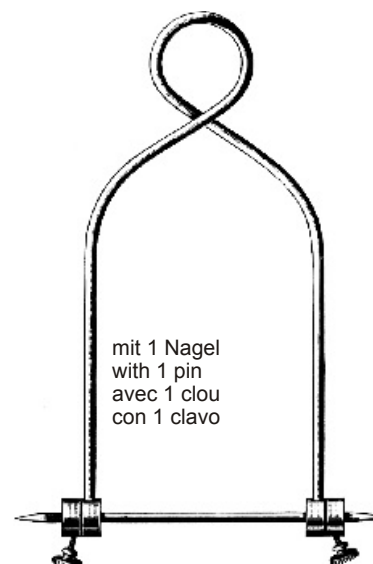

mit 1 Nagel
 with 1 pin
 avec 1 clou
 con 1 clavo

Böhler

27.3434-01	16,0 x 9,0
27.3434-02	21,0 x 11,0

lichte Weite
 clear width
 largeur ouverte
 anchura interior

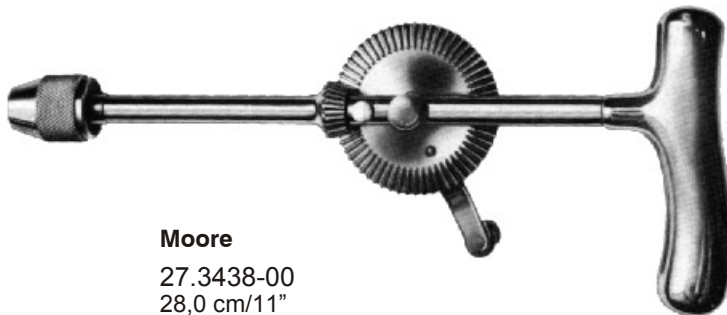

Moore
27.3438-00
28,0 cm/11"
komplett
complete
complet
completo



27.3438-03
Spiralbohrer-Satz
Set of twist drills
Jeu de fraises
Juego de taladros espirales

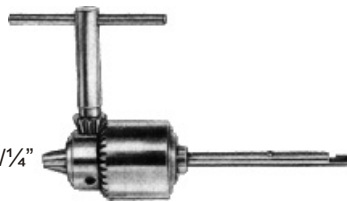

6,35 mm/¼"

Jacobs
27.3439-00
Dreibacken-Spannfutter
Three-jaw-chuck
Mandrin à trois mâchoires
Mandril de tres mordazas

27

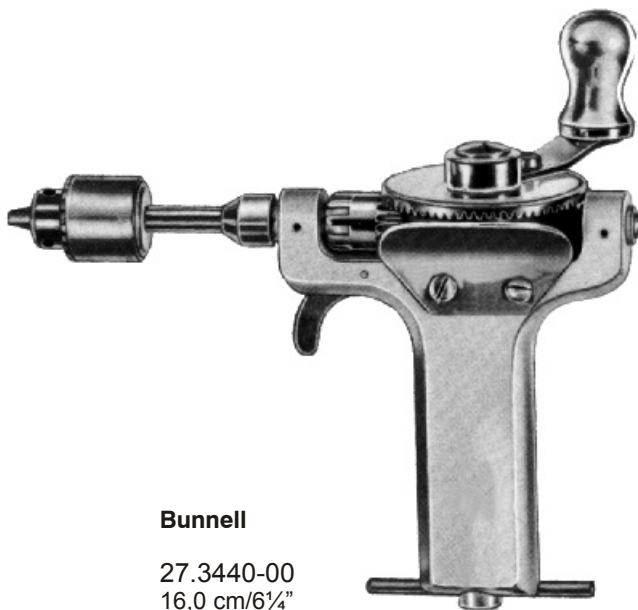

Bunnell
27.3440-00
16,0 cm/6¼"

27.3440-01
Schlüssel, allein
Wrench, only
Clé, seule
Llave, suelta



Ralk
27.3441-00



27.3441-01
Schlüssel, allein
Wrench, only
Clé, seule
Llave, suelta



Smedberg
27.3442-00



27.3442-01
Schlüssel, allein
Wrench, only
Clé, seule
Llave, suelta



27.3443-27
Griff, allein
Handle, only
Manche, seul
Mango, suelto

Hudson
27,0 cm/10½"

- 27.3443-00
- komplett mit Fräsern Fig. 1-4
und Verlängerungsstück Fig. 9
- complete with 4 burrs. fig. 1-4
and extension piece fig. 9
- complet avec 4 fraises, fig. 1-4
et pièce de rallonge fig. 9
- completo con 4 fresas fig. 1-4
y pieza de prolongación fig. 9



Hudson
Fig. 1
27.3443-01
Ø 9 mm



Hudson
Fig. 2
27.3443-02
Ø 14 mm



Hudson
Fig. 3
27.3443-03
Ø 16 mm



Hudson
Fig. 4
27.3443-04
Ø 22 mm



Hudson
Fig. 9
27.3443-09
Verlängerungsstück
Extension piece
Pièce de rallonge
Pieza de prolongación

27



Cuching
Fig. 5
27.3443-05
Ø 14 mm



Adson
Fig. 6
27.3443-06
Ø 2 mm



McKenzie
Fig. 7
27.3443-07
Ø 13 mm



Errico
Fig. 8
27.3443-08
Ø 16 mm

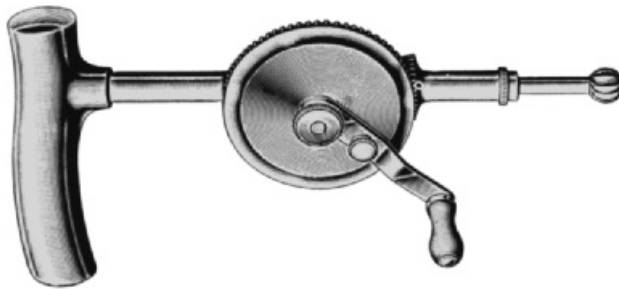

Stille
 20,0 cm/8"

27.3444-00
 komplett mit Fräsern Fig. 1-9
 complete with burrs fig. 1-9
 complet avec fraises fig. 1-9
 completo con fresas fig. 1-9



Fig. 1
 27.3444-01
 Ø 2,5 mm



Fig. 2
 27.3444-02
 Ø 3,0 mm



Fig. 3
 27.3444-03
 Ø 3,5 mm



Fig. 4
 27.3444-04
 Ø 4,0 mm



Fig. 5
 27.3444-05
 Ø 10 mm



Fig. 6
 27.3444-06
 Ø 5,0 mm



Fig. 7
 27.3444-07
 Ø 8,0 mm



Fig. 8
 27.3444-08
 Ø 12,0 mm



Fig. 9
 27.3444-09
 Ø 16,0 mm



Fig. 10
 27.3444-10
 Ø 1,0 mm



Fig. 11
 27.3444-11
 Ø 1,5 mm



Fig. 12
 27.3444-12
 Ø 2,0 mm



17,0 cm/6¾"



27.3450-01



27.3450-02

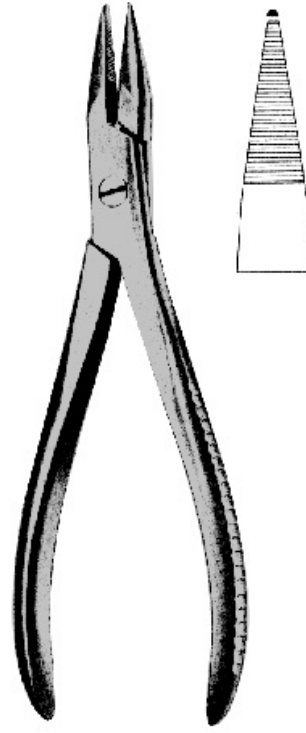

27.3451-19
19,0 cm/7½"



spitz
sharp
pointu
agudo

27.3452-14
14,0 cm/5½"

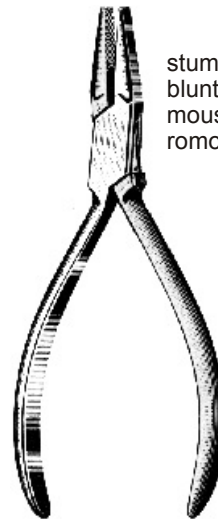

stumpf
blunt
mousse
romo

27.3453-14
14,0 cm/5½"



18,0 cm/7"



Fig. 1
27.3454-01



Fig. 2
27.3454-02



Fig. 3
27.3454-03

Flachzangen
 Flat nose pliers
 Pinces plates
 Alicates planos



18,0 cm/7"



Fig. 4
27.3454-04



27.3455-16
 16,0 cm/6¼"

Kopfschneider
 Wire cutting pliers
 Pinces à couper le fil
 Alicates para cortar alambre



27.3456-15
 15,0 cm/6"

Kopfschneider
 Wire cutting pliers
 Pinces à couper le fil
 Alicates para cortar alambre

für harten Draht bis 1,5 mm
 for hard wire up to 1,5 mm
 pour fils durs jusqu'à 1,5 mm
 para hilos duros hasta 1,5 mm

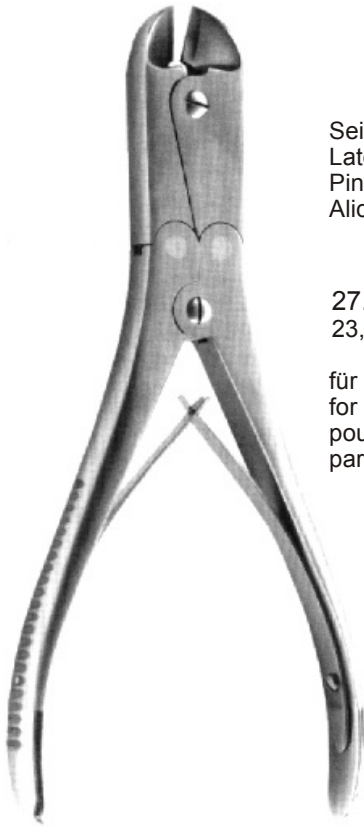

Seitenschneider
Lateral wire cutter
Pince à couper le fil à tranchant latéral
Alicates para cortar alambre con corte lateral

27.3457-23
23,0 cm/9"

für harten Draht bis 2,2 mm
for hard wire up to 2,2 mm
pour fils durs jusqu'à 2,2 mm
para hilos duros hasta 2,2 mm



Bolzenschneider
Wire cutting pliers
Pince à couper le fil
Alicates para cortar alambre

27.3459-45
45,0 cm/18"

27.3459-56
56,0 cm/22½"

für Draht bis
for wire up to
pour fils jusqu'à
para hilos hasta

6,0 mm
6,0 mm
6,0 mm
6,0 mm

7,5 mm
7,5 mm
7,5 mm
7,5 mm

27.3459-90
Ersatzbacken allein
Cutting parts only
Pièces coupantes seules
Juego de mandíbulas de repuesto



Kopfschneider
Frontal wire cutting pliers
Pince à couper le fil à tranchant frontal
Alicates para cortar alambre con corte frontal

27.3458-21
21,0 cm/8¼"

für harten Draht bis 2,5 mm
for hard wire up to 2,5 mm
pour fils durs jusqu'à 2,5 mm
para hilos duros hasta 2,5 mm

Osteotome
 Osteotomes
 Osteotomes
 Osteotomos

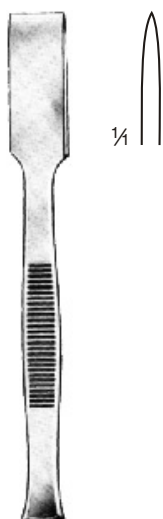

13,5 cm/5 1/4"

- 27.3460-03 3 mm
- 27.3460-04 4 mm
- 27.2460-05 5 mm
- 27.3460-06 6 mm
- 27.3460-08 8 mm
- 27.3460-10 10 mm
- 27.3460-12 12 mm
- 27.3460-14 14 mm
- 27.3460-16 16 mm

Flachmeissel
 Bone chisels
 Ciseaux-burins
 Cinceles



13,5 cm/5 1/4"

- 27.3461-04 4 mm
- 27.3461-06 6 mm
- 27.3461-08 8 mm
- 27.3461-10 10 mm
- 27.3461-12 12 mm
- 27.3461-14 14 mm
- 27.3461-16 16 mm

Hohlmeissel
 Gouges
 Gouges
 Gubias



13,5 cm/5 1/4"

- 27.3462-03 3 mm
- 27.3462-04 4 mm
- 27.3462-05 5 mm
- 27.3462-06 6 mm
- 27.3462-08 8 mm
- 27.3462-10 10 mm
- 27.3462-12 12 mm
- 27.3462-14 14 mm
- 27.3462-16 16 mm

Flachmeissel
 Bone chisels
 Ciseaux-burins
 Cinceles

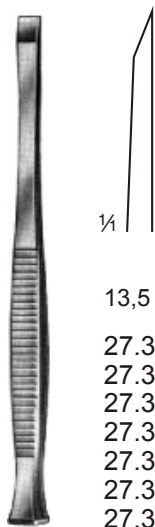

13,5 cm/5 1/4"

- 27.3463-02 2 mm
- 27.3463-03 3 mm
- 27.3463-04 4 mm
- 27.3463-05 5 mm
- 27.3463-06 6 mm
- 27.3463-07 7 mm
- 27.3463-08 8 mm

Partsch



17,0 cm/6 3/4"

- 27.3464-02 2 mm
- 27.3464-03 3 mm
- 27.3464-04 4 mm
- 27.3464-05 5 mm
- 27.3464-06 6 mm
- 27.3464-07 7 mm
- 27.3464-08 8 mm

Hohlmeissel
 Gouges
 Gouges
 Gubias



13,5 cm/5 1/4"

- 27.3465-02 2 mm
- 27.3465-03 3 mm
- 27.3465-04 4 mm
- 27.3465-05 5 mm
- 27.3465-06 6 mm
- 27.3465-07 7 mm
- 27.3465-08 8 mm

Partsch

17,0 cm/6 3/4"

- 27.3466-02 2 mm
- 27.3466-03 3 mm
- 27.3466-04 4 mm
- 27.3466-05 5 mm
- 27.3466-06 6 mm
- 27.3466-07 7 mm
- 27.3466-08 8 mm



Flachmeissel
Bone chisels
Ciseaux-burins
Cinceles

Alexander
18,0 cm/7"

- | | |
|------------|-------|
| 27.3467-04 | 4 mm |
| 27.3467-06 | 6 mm |
| 27.3467-08 | 8 mm |
| 27.3467-10 | 10 mm |
| 27.3467-12 | 12 mm |
| 27.3467-14 | 14 mm |



Hohlmeissel
Gouges
Gouges
Gubias

Alexander
18,0 cm/7"

- | | |
|------------|-------|
| 27.3468-04 | 4 mm |
| 27.3468-06 | 6 mm |
| 27.3468-08 | 8 mm |
| 27.3468-10 | 10 mm |
| 27.3468-12 | 12 mm |
| 27.3468-14 | 14 mm |

27



Osteotome
Osteotomes
Osteotomes
Osteotomos

12,5 cm/5"

- | | |
|------------|-------|
| 27.3469-03 | 3 mm |
| 27.3469-04 | 4 mm |
| 27.3469-06 | 6 mm |
| 27.3469-08 | 8 mm |
| 27.3469-10 | 10 mm |
| 27.3469-12 | 12 mm |
| 27.3469-15 | 15 mm |

Mini-Lambotte



Osteotome
Osteotomes
Osteotomes
Osteotomos

17,0 cm/6¾"

- | | |
|------------|-------|
| 27.3470-03 | 3 mm |
| 27.3470-04 | 4 mm |
| 27.3470-06 | 6 mm |
| 27.3470-08 | 8 mm |
| 27.3470-10 | 10 mm |
| 27.3470-12 | 12 mm |
| 27.3470-15 | 15 mm |



Osteotome, gerade
 Osteotomes, straight
 Osteotomes, droits
 Osteotomos, rectos

27.3471-08 8 mm
 27.3471-10 10 mm
 27.3471-13 13 mm
 27.3471-15 15 mm
 27.3471-20 20 mm
 27.3471-25 25 mm
 27.3471-30 30 mm
 27.3471-38 38 mm
 27.3471-44 44 mm
 27.3471-50 50 mm

1/2

Lambotte
 24,0 cm/9 1/2"



Osteotome, gebogen
 Osteotomes, curved
 Osteotomes, courbes
 Osteotomos, curvos

27.3472-08 8 mm
 27.3472-10 10 mm
 27.3472-13 13 mm
 27.3472-15 15 mm
 27.3472-20 20 mm
 27.3472-25 25 mm
 27.3472-30 30 mm
 27.3472-38 38 mm
 27.3472-44 44 mm
 27.3472-50 50 mm

1/2

Lambotte
 23,0 cm/9"



Flachmeissel
 Bone chisels
 Ciseaux-burins
 Cinceles

27.3473-04 4 mm
 27.3473-06 6 mm

1/2

Lucas
 16,0 cm/6 1/4"



Hohlmeissel
 Gouges
 Gouges
 Gubias

27.3474-03 3 mm
 27.3474-05 5 mm

1/2

Lucas
 16,0 cm/6 1/4"



Osteotome
Osteotomes
Osteotomes
Osteotomos

27.3476-04	4 mm
27.3476-06	6 mm
27.3476-08	8 mm
27.3476-10	10 mm
27.3476-12	12 mm
27.3476-15	15 mm

1/2

Stille
16,0 cm/6 1/4"



Hohlmeissel
Gouges
Gouges
Gubias

27.3477-06	6 mm
27.3477-08	8 mm
27.3477-10	10 mm
27.3477-12	12 mm
27.3477-15	15 mm

1/2

Stille
16,0 cm/6 1/4"

27



Osteotome, gebogen
Osteotomes, curved
Osteotomes, courbes
Osteotomos, curvos

27.3478-10	10 mm
27.3478-15	15 mm
27.3478-20	20 mm
27.3478-25	25 mm

1/2

Stille
20,0 cm/8"



Flachmeissel
Bone chisels
Ciseaux-burins
Cinceles

27.3479-06	6 mm
27.3479-08	8 mm
27.3479-10	10 mm
27.3479-12	12 mm
27.3479-15	15 mm
27.3479-20	20 mm
27.3479-25	25 mm
27.3479-30	30 mm

1/2

Stille
20,0 cm/8"



Osteotome
 Osteotomes
 Osteotomes
 Osteotomos

- 27.3480-06 6 mm
- 27.3480-08 8 mm
- 27.3480-10 10 mm
- 27.3480-12 12 mm
- 27.3480-15 15 mm
- 27.3480-20 20 mm
- 27.3480-25 25 mm
- 27.3480-30 30 mm

Stille
 20,0 cm/8"



Hohlmeissel
 Gouges
 Gouges
 Gubias

- 27.3481-06 6 mm
- 27.3481-08 8 mm
- 27.3481-10 10 mm
- 27.3481-12 12 mm
- 27.3481-15 15 mm
- 27.3481-20 20 mm
- 27.3481-25 25 mm
- 27.3481-30 30 mm

Stille
 20,0 cm/8"



Osteotome, gerade
 Osteotomes, straight
 Osteotomes, droits
 Osteotomos, rectos

- 27.3482-06 6 mm
- 27.3482-09 9 mm
- 27.3482-13 13 mm
- 27.3482-16 16 mm
- 27.3482-19 19 mm
- 27.3482-25 25 mm
- 27.3482-32 32 mm

Smith-Petersen
 20,0 cm/8"

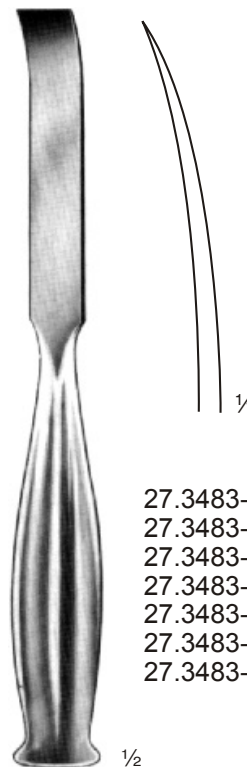

Osteotome, gebogen
 Osteotomes, curved
 Osteotomes, courbes
 Osteotomos, curvos

- 27.3483-06 6 mm
- 27.3483-09 9 mm
- 27.3483-13 13 mm
- 27.3483-16 16 mm
- 27.3483-19 19 mm
- 27.3483-25 25 mm
- 27.3483-32 32 mm

Smith-Petersen
 20,0 cm/8"



Hohlmeissel, gerade
Bone chisels, straight
Ciseaux-burins, droits
Cinceles, rectos

- 27.3484-06 6 mm
- 27.3484-09 9 mm
- 27.3484-13 13 mm
- 27.3484-16 16 mm
- 27.3484-19 19 mm
- 27.3484-25 25 mm
- 27.3484-32 32 mm

1/2

Smith-Petersen
20,0 cm/8"



Hohlmeissel, gebogen
Bone chisels, curved
Ciseaux-burins, courbes
Cinceles, curvos

- 27.3485-06 6 mm
- 27.3485-09 9 mm
- 27.3485-13 13 mm
- 27.3485-16 16 mm
- 27.3485-19 19 mm
- 27.3485-25 25 mm
- 27.3485-32 32 mm

1/2

Smith-Petersen
20,0 cm/8"

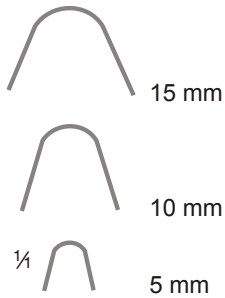

1/4

Hohlmeissel, gerade
Bone chisels, straight
Ciseaux-burins, droits
Cinceles, rectos

- 27.3486-05 5 mm
- 27.3486-10 10 mm
- 27.3486-15 15 mm

1/2

Lexer
25,0 cm/10"

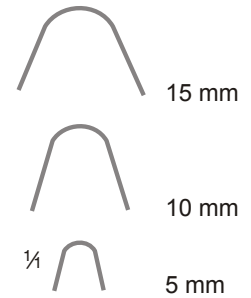

1/4

Hohlmeissel, gebogen
Bone chisels, curved
Ciseaux-burins, courbes
Cinceles, curvos

- 27.3487-05 5 mm
- 27.3487-10 10 mm
- 27.3487-15 15 mm

1/2

Lexer
25,0 cm/10"

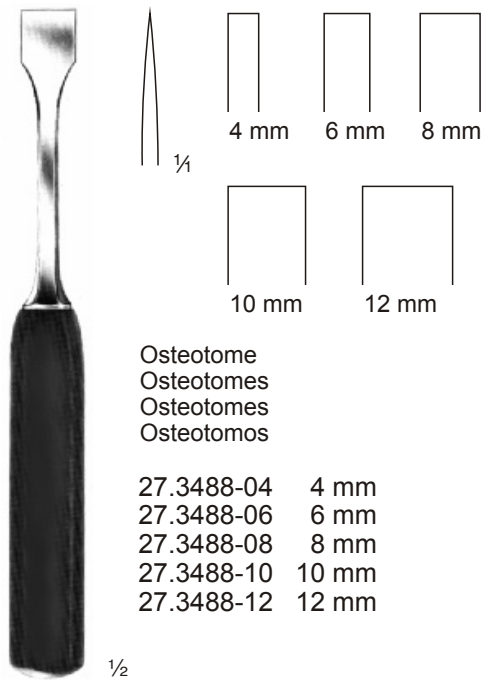

Osteotome
 Osteotomes
 Osteotomes
 Osteotomos

- 27.3488-04 4 mm
- 27.3488-06 6 mm
- 27.3488-08 8 mm
- 27.3488-10 10 mm
- 27.3488-12 12 mm

Mini-Lexer
 18,0 cm/7"

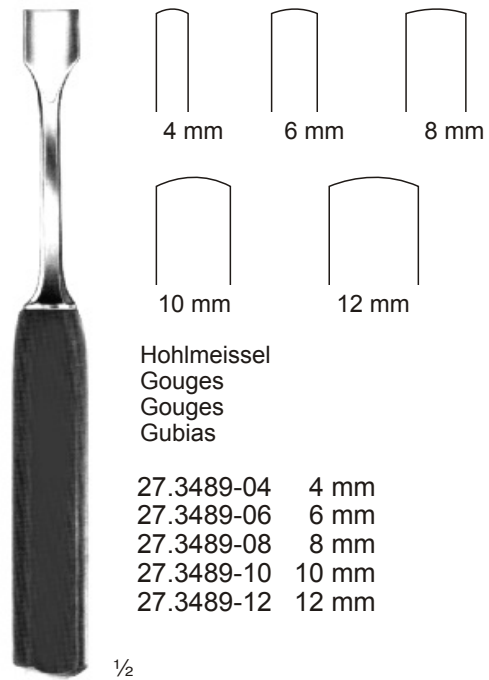

Hohlmeissel
 Gouges
 Gouges
 Gubias

- 27.3489-04 4 mm
- 27.3489-06 6 mm
- 27.3489-08 8 mm
- 27.3489-10 10 mm
- 27.3489-12 12 mm

Mini-Lexer
 18,0 cm/7"



Osteotome
 Osteotomes
 Osteotomes
 Osteotomos

- 27.3490-05 5 mm
- 27.3490-07 7 mm
- 27.3490-10 10 mm
- 27.3490-15 15 mm
- 27.3490-20 20 mm
- 27.3490-25 25 mm
- 27.3490-30 30 mm

Lexer
 22,0 cm/8¾"

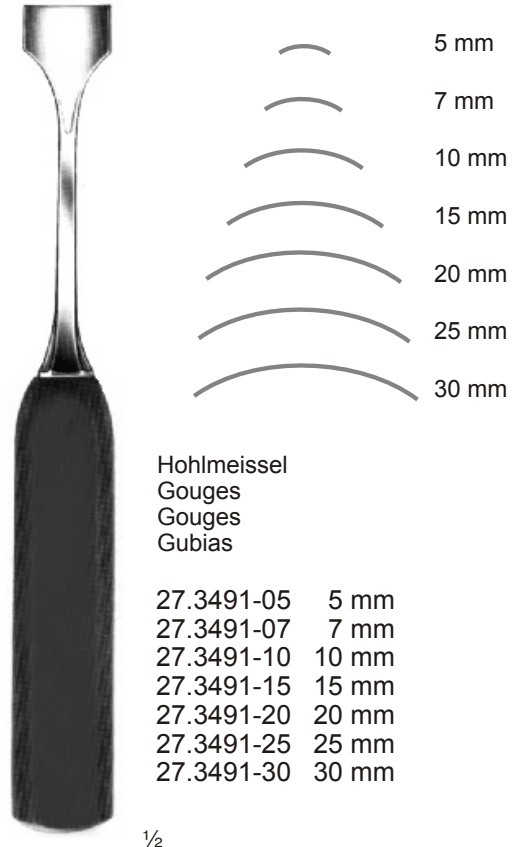

Hohlmeissel
 Gouges
 Gouges
 Gubias

- 27.3491-05 5 mm
- 27.3491-07 7 mm
- 27.3491-10 10 mm
- 27.3491-15 15 mm
- 27.3491-20 20 mm
- 27.3491-25 25 mm
- 27.3491-30 30 mm

Lexer
 22,0 cm/8¾"

Osteotome, gerade
Osteotomes, straight
Osteotomes, droits
Osteotomos, rectos



27.3492-03 3 mm
27.3492-05 5 mm
27.3492-06 6 mm
27.3492-08 8 mm
27.3492-09 9 mm

Hoke
17,0 cm/6³/₄"

Osteotome, gerade
Osteotomes, straight
Osteotomes, droits
Osteotomos, rectos



27.3493-06 6 mm
27.3493-13 13 mm
27.3493-19 19 mm
27.3493-25 25 mm
27.3493-32 32 mm

Hibbs
24,0 cm/9¹/₂"

Flachmeissel, gerade
Bone chisels, straight
Ciseaux-burins, droits
Cinceles, rectos



27.3494-06 6 mm
27.3494-13 13 mm
27.3494-19 19 mm
27.3494-25 25 mm
27.3494-32 32 mm

Hibbs
24,0 cm/9¹/₂"

Osteotome
 Osteotomes
 Osteotomos
 Osteotomos



27.3495-06 6 mm
 27.3495-13 13 mm
 27.3495-19 19 mm
 27.3495-25 25 mm
 27.3495-32 32 mm

Hibbs
 24,0 cm/9½"

Hohlmeissel
 Gouges
 Gouges
 Gubias



27.3496-06 6 mm
 27.3496-13 13 mm
 27.3496-19 19 mm
 27.3496-25 25 mm
 27.3496-32 32 mm

Hibbs
 24,0 cm/9½"

Hohlmeissel
 Gouges
 Gouges
 Gubias



27.3497-06 6 mm
 27.3497-13 13 mm
 27.3497-19 19 mm
 27.3497-25 25 mm
 27.3497-32 32 mm

Hibbs
 24,0 cm/9½"

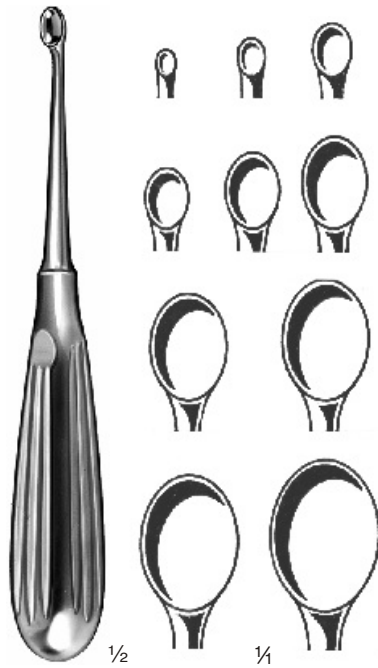

Volkmann
17,0 cm/6¾"

	Fig.	mm
27.3500	0000	3,0
27.3501	000	4,0
27.3502	00	5,0
27.3503	0	6,0
27.3504	1	7,0
27.3505	2	8,0
27.3506	3	10,0
27.3507	4	11,6
27.3508	5	12,6
27.3509	6	13,8

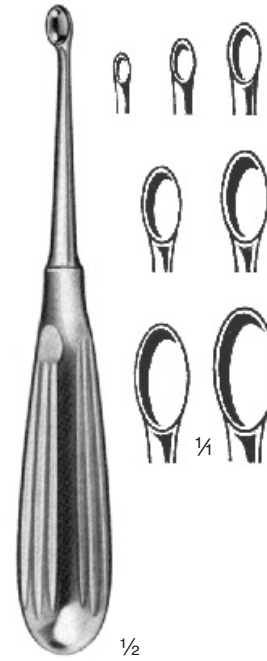

Schede
17,0 cm/6¾"

	Fig.	mm
27.3510	000	3,0
27.3511	00	4,0
27.3512	0	5,0
27.3513	1	6,0
27.3514	2	6,5
27.3515	3	7,5
27.3516	4	8,5

27

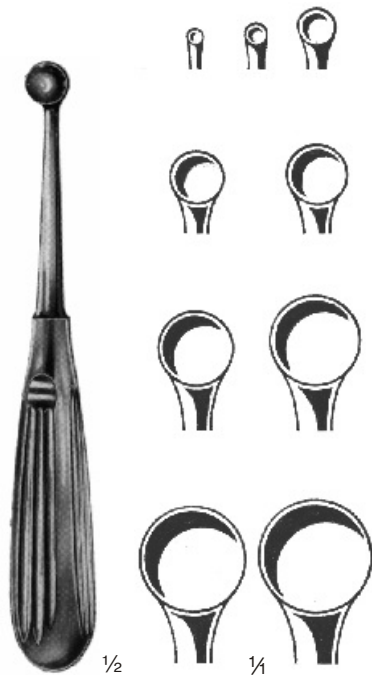

Bruns
17,0 cm/6¾"

	Fig.	mm
27.3520	000	3,0
27.3521	00	4,0
27.3522	0	5,0
27.3523	1	6,0
27.3524	2	8,0
27.3525	3	10,0
27.3526	4	12,0
27.3527	5	13,0
27.3528	6	14,0

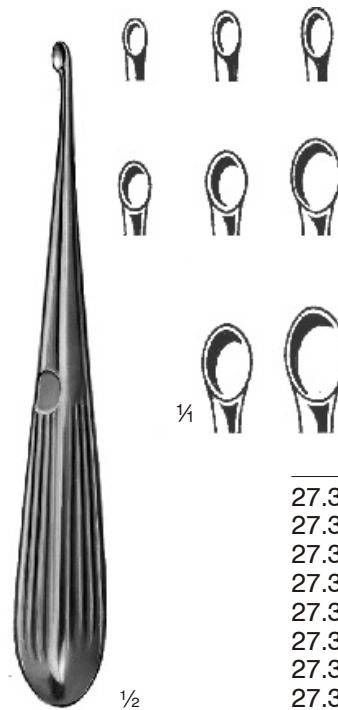

Spratt
17,0 cm/6¾"

	Fig.	mm
27.3530	000	3,0
27.3531	00	4,0
27.3532	0	4,5
27.3533	1	5,0
27.3534	2	6,0
27.3535	3	7,0
27.3536	4	8,5
27.3537	5	9,5



Williger
 17,0 cm/6 3/4"

	Fig.	mm
27.3538-20	00	2,0
27.3538-10	0	2,5
27.3538-01	1	3,5
27.3538-02	2	5,0



Bruns
 23,0 cm/9"

	Fig.	mm
27.3540	000	2,0
27.3541	00	2,5
27.3542	0	3,3
27.3543	1	3,8
27.3544	2	4,8
27.3545	3	5,3
27.3546	4	6,0
27.3547	5	6,7
27.3548	6	7,3

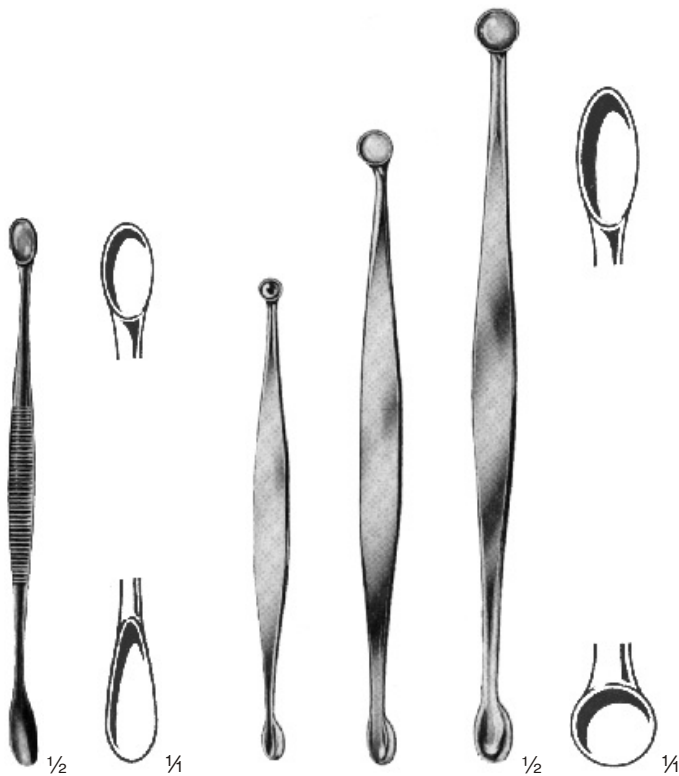

Volkmann
 27.3550 - 27.3552

Volkmann
 27.3555 - 27.3557

Länge Length Longueur Largo cm in.	oval/oval oval/oval ovale/ovale ovalada/ovalada	oval/rund oval/round ovale/ronde ovalada/redonda
13,0 5	27.3550 7,5/6,3 mm	27.3555 6,3/6,8 mm
14,5 5 3/4	27.3551 6,8/5,8 mm	
16,0 6 1/4		27.3556 7,0/9,0 mm
17,0 6 3/4	27.3552 6,8/7,3 mm	
20,0 8		27.3557 9,1/11,1 mm

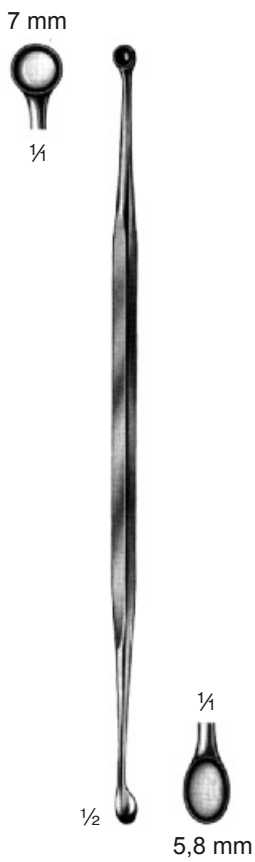

27.3558
21,0 cm/8 1/4"

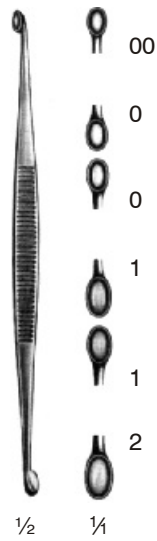

Williger
13,5 cm/5 1/4"

	Fig.
27.3561	0/00
27.3562	0/1
27.3563	1/2

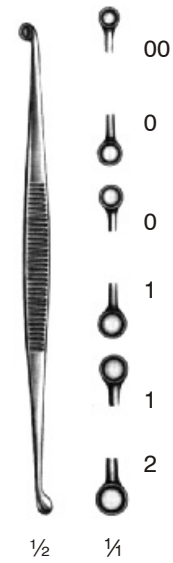

Martini
13,5 cm/5 1/4"

	Fig.
27.3571	0/00
27.3572	0/1
27.3573	1/2

27

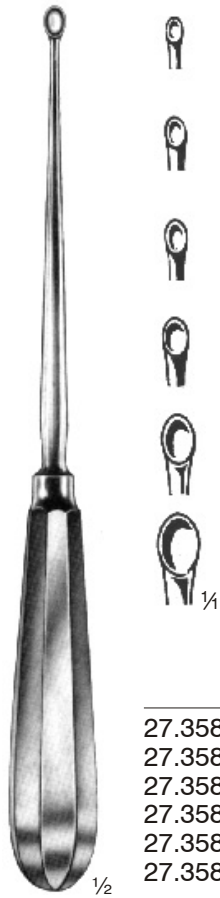

Simon
 24,0 cm/9½"

	Fig.	mm
27.3581-01	1	2,2
27.3581-02	2	2,8
27.3581-03	3	3,3
27.3581-04	4	3,7
27.3581-05	5	4,5
27.3581-06	6	4,8



Daubenspeck
 20,0 cm/8"

	Fig.	mm
27.3582-20	00	2,8
27.3582-10	0	3,8
27.3582-01	1	5,0
27.3582-02	2	6,0

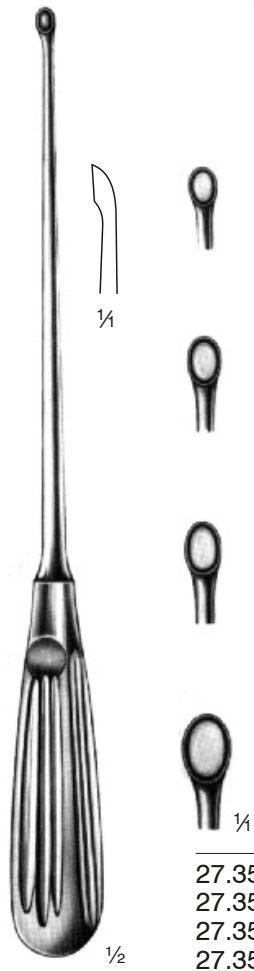

25,0 cm/10"

	Fig.	mm
27.3583-30	000	3,6
27.3583-20	00	4,4
27.3583-10	0	5,2
27.3583-01	1	6,0



25,0 cm/10"

	Fig.	mm
27.3584-30	000	3,6
27.3584-20	00	4,4
27.3584-10	0	5,2
27.3584-01	1	6,0



27

Volkmann
27,0 cm/10³/₄"

	Fig.	mm
27.3585-00	0	5
27.3585-01	1	6
27.3585-02	2	6,5
27.3585-03	3	7
27.3585-04	4	8,5

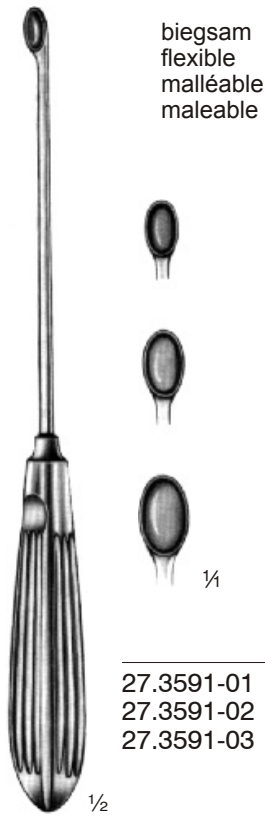

Halle
21,0 cm/8¹/₄"

biegsam
flexible
malléable
maleable

	Fig.	mm
27.3591-01	1	4,8
27.3591-02	2	5,8
27.3591-03	3	6,8

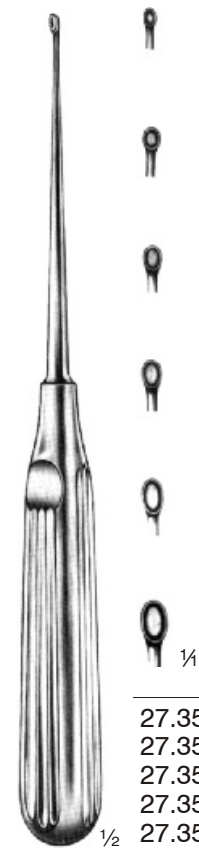

Lempert
21,5 cm/8¹/₂"

	Fig.	mm
27.3594-01	1	1,7
27.3594-02	2	2,0
27.3594-03	3	2,4
27.3594-04	4	2,7
27.3594-05	5	3,0



gerade
 straight
 droit
 recta

Spinal
 20,0 cm/8"

Spratt
 23,0 cm/9"



gebogen
 curved
 courbe
 curva

Spinal
 20,0 cm/8"

Spratt
 23,0 cm/9"

	¼								
Fig.	000	00	0	1	2	3	4	5	6
gerade straight droit recta									
20,0 cm/8"	27.3595 -30	27.3595 -20	27.3595 -10	27.3595 -01	27.3595 -02	27.3595 -03	27.3595 -04	27.3595 -05	27.3595 -06
23,0 cm/9"	27.3596 -30	27.3596 -20	27.3596 -10	27.3596 -01	27.3596 -02	27.3596 -03	27.3596 -04	27.3596 -05	27.3596 -06
gebogen curved courbe curva									
20,0 cm/8"	27.3597 -30	27.3597 -20	27.3597 -10	27.3597 -01	27.3597 -02	27.3597 -03	27.3597 -04	27.3597 -05	27.3597 -06
23,0 cm/9"	27.3598 -30	27.3598 -20	27.3598 -10	27.3598 -01	27.3598 -02	27.3598 -03	27.3598 -04	27.3598 -05	27.3598 -06



Langenbeck
27.3600
19,0 cm/7½"



Langenbeck
27.3601
18,0 cm/7"



Sedillot
27.3602
21,0 cm/8¼"



27.3603-01
14,0 cm/5½"



27.3603-02
14,0 cm/5½"



Farabeuf
27.3604
15,0 cm/6"

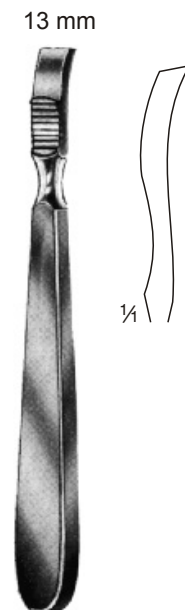

Farabeuf
27.3605
15,0 cm/6"



10 mm
 15 mm
 20 mm
 25 mm



27.3606-10 10 mm
 27.3606-15 15 mm
 27.3606-20 20 mm
 27.3606-25 25 mm

Lambotte
 21,0 cm/8 1/4"

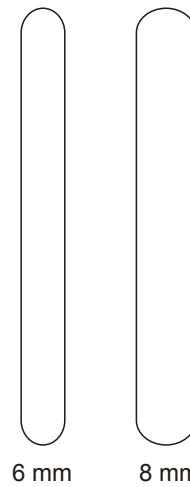

6 mm 8 mm

27.3607-06 6 mm
 27.3607-08 8 mm
 17,0 cm/6 3/4"



5 mm

Williger

27.3608
 13,0 cm/5"



6 mm

Williger

27.3609
 16,0 cm/6 1/4"



Howarth

27.3610
 21,5 cm/8 1/2"



8 mm

27.3611-08



17 mm

27.3611-17



Wagner
 33,0 cm/13"



Alexander

27.3612
20,0 cm/8"



Matson

27.3613
22,0 cm/8¾"



6 mm
12 mm
19 mm
25 mm

leicht gebogen
slightly curved
courbe légèrement
curva ligeramente

27.3614-06 6 mm
27.3614-12 12 mm
27.3614-19 19 mm
27.3614-25 25 mm

Key
19,0 cm/7½"

27



27.3615



27.3617

rechts gebogen
curved to the right
courbe à droite
curva a la derecha



Doyen
17,0 cm/6¾"

Doyen
17,0 cm/6¾"

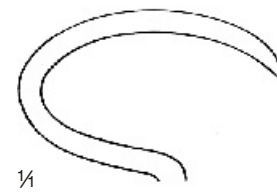

27.3616



27.3618

links gebogen
curved to the left
courbe à gauche
curva a la izquierda



Semb

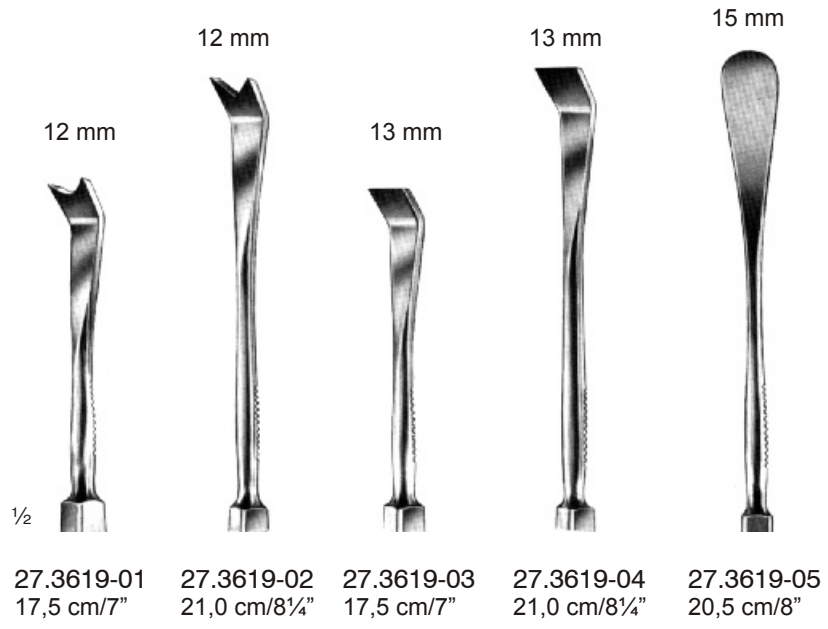

Hylin

27.3620
 14,5 cm/6"



Jansen

27.3621
 17,0 cm/6 3/4"

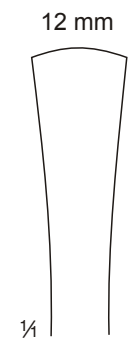

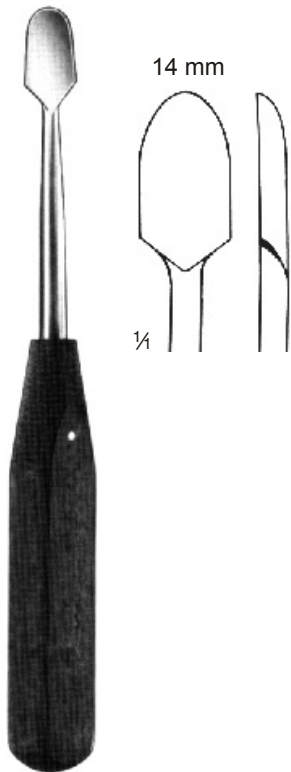

27.3622-01
20,0 cm/8"

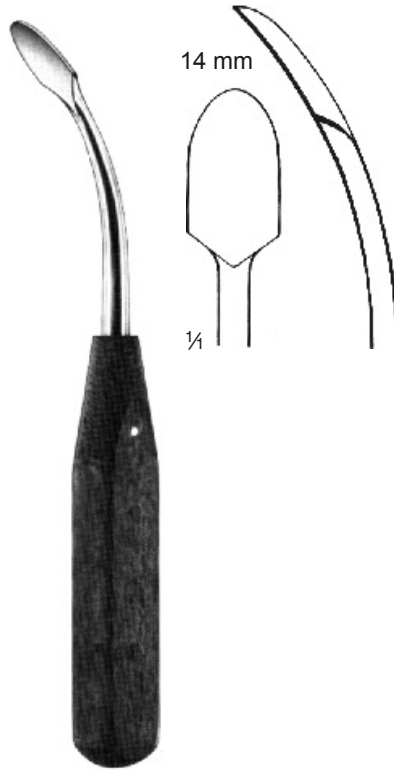

27.3622-02
20,0 cm/8"

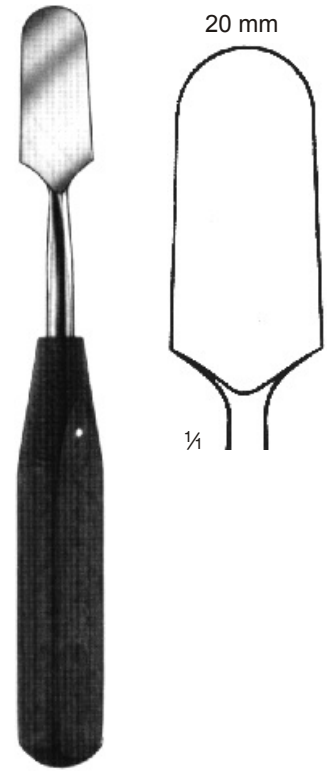

27.3622-03
20,0 cm/8"

27

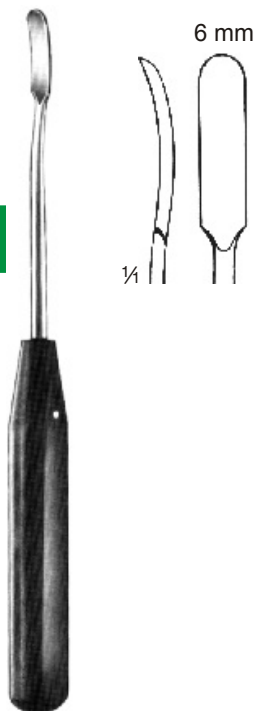

27.3623
18,0 cm/7"

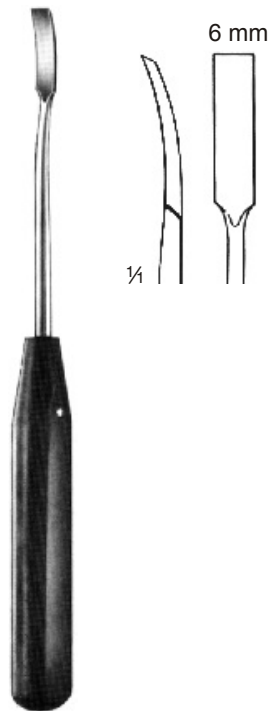

27.3624
18,0 cm/7"

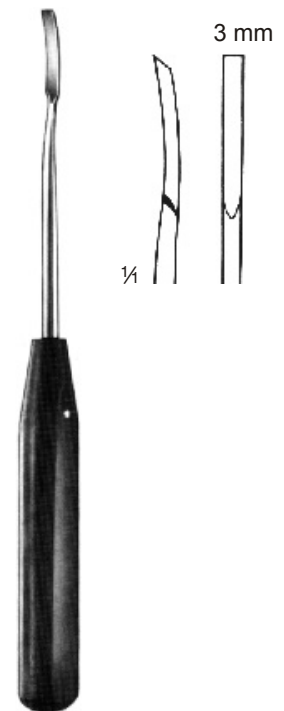

27.3625
18,0 cm/7"

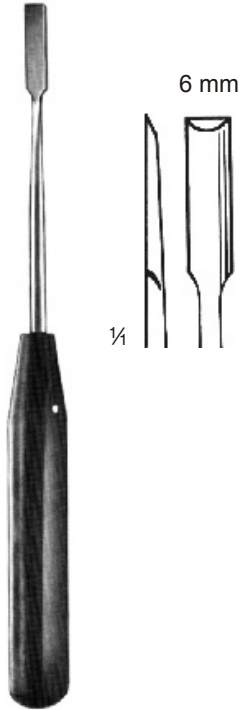

27.3626
 19,0 cm/7½"

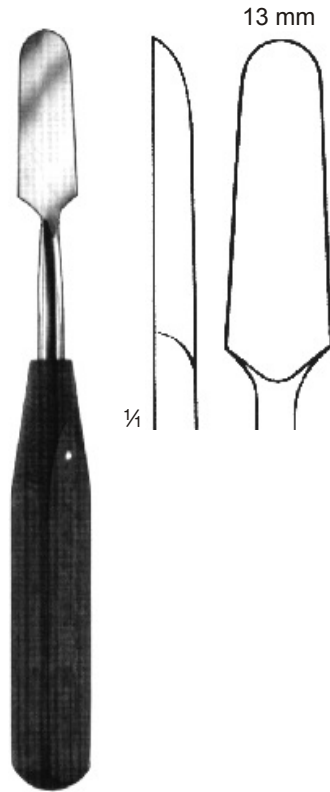

27.3627
 20,0 cm/8"

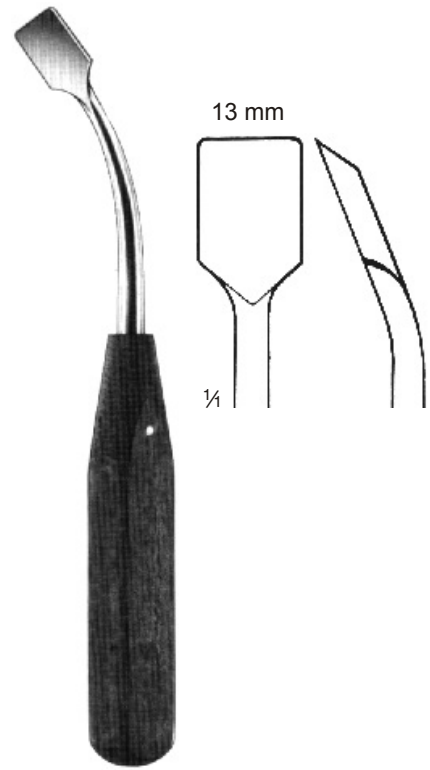

27.3628
 18,5 cm/7¼"



Adson
 17,0 cm/6¾"



27.3629-01



27.3629-02



27.3629-03



27.3629-04

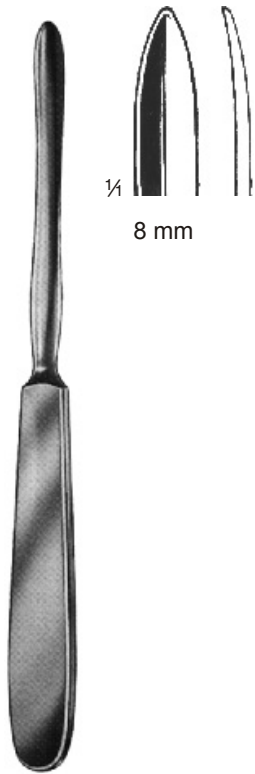

Langenbeck

27.3630
20,0 cm/8"

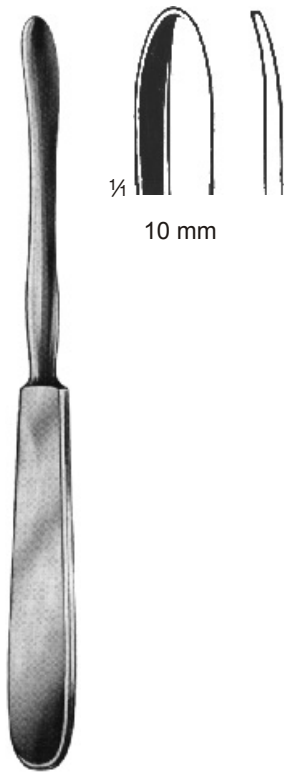

Langenbeck

27.3631
20,0 cm/8"

5 mm



Williger

27.3632
16,0 cm/6¼"

6,5 mm



Williger

27.3633
17,0 cm/6¾"

6 mm



Quervain

27.3634-20
19,5 cm/7¾"

6 mm



McDonald

27.3635
19,0 cm/7½"

4 mm







Joseph

27.3636
16,5 cm/6½"

Raspatorium
Periosteal Raspatory
Rugine-raspatoire
Legra-Periostótomo

Sehenschäler
 Tendon stripper
 Instrument à écorcher
 Enucleador de tendones



-  27.3640-01
-  27.3640-02
-  27.3640-03
-  27.3640-04
-  27.3640-05



Bunnell
 15,0 cm/6"

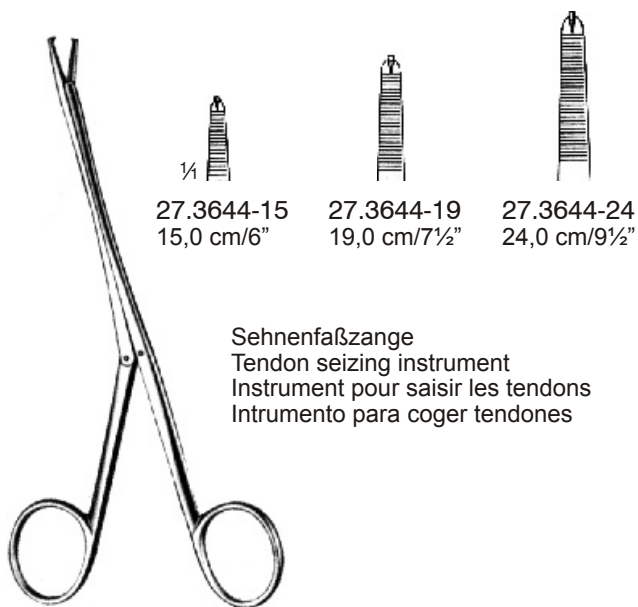

Sehnenführer
 Tendon passing instrument
 Instrument pour passer les tendons
 Intrumento para el tunel del tendón

Bunnell
 27.3642
 23,0 cm/9"



-  27.3644-15
15,0 cm/6"
-  27.3644-19
19,0 cm/7½"
-  27.3644-24
24,0 cm/9½"

Sehnenfaßzange
 Tendon seizing instrument
 Instrument pour saisir les tendons
 Intrumento para coger tendones

Brand



Caroll

27.3645
 11,0 cm/4½"



Gallaher
18,0 cm/7"



¼
Fig. 1
27.3647-01



Fig. 2
27.3647-02



Fig. 3
27.3647-03



Joseph
16,0 cm/6½"



¼
Fig. 1
27.3648-01



Fig. 2
27.3648-02



Fig. 3
27.3648-03



27.3650
24,5 cm/9¾"

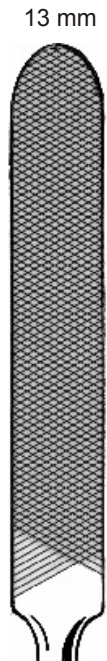

13 mm



27.3651
28,0 cm/11"

20 mm

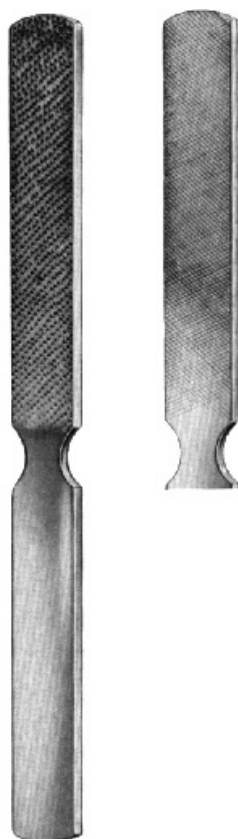

27.3652
22,0 cm/8¾"



Putti
27.3653
30,0 cm/12"



Putti
27.3654
27,0 cm/10½"

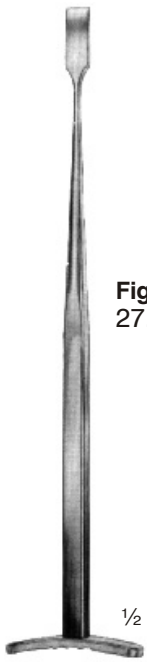

Smillie
17,0 cm/6¾"

Fig. 1
27.3655-01



Fig. 2
27.3655-02



Fig. 3
27.3655-03



Bircher

27.3656-01
19,0 cm/7½"



Bircher

27.3656-02
19,0 cm/7½"



doppelschneidig
double edged
double tranchant
doble cortante

27.3657-18
18,0 cm/7"



Neff
22,0 cm/8¾"



27.3658-01

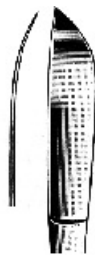

27.3658-02



Salenius

27.3659-01
22,0 cm/8¾"



Salenius

27.3659-02
22,0 cm/8¾"

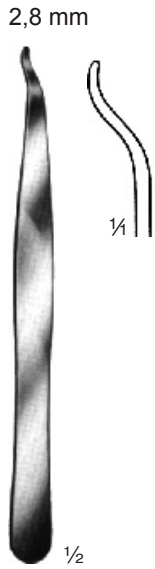

27.3660-03
 14,0 cm/5½"

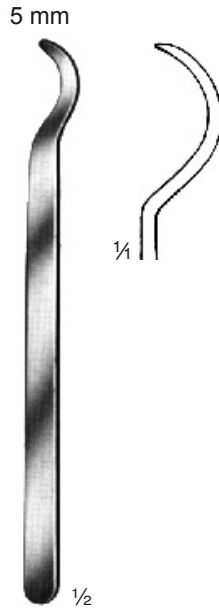

27.3661-05
 15,0 cm/6"

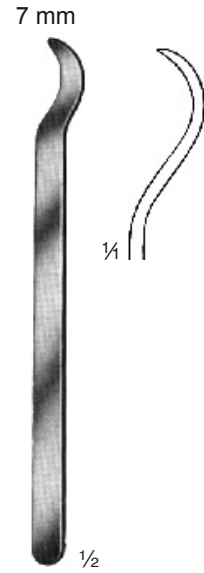

27.3662-07
 15,0 cm/6"

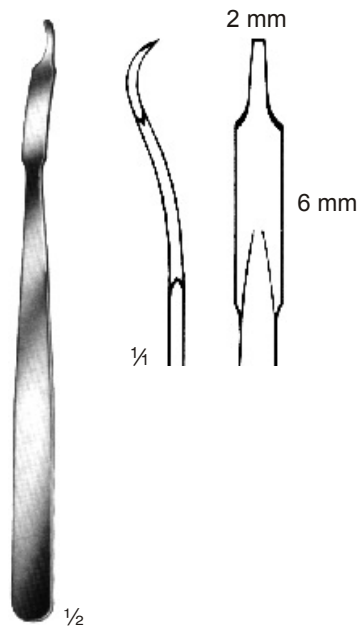

Mini-Hohmann
 27.3664-06
 16,0 cm/6¼"

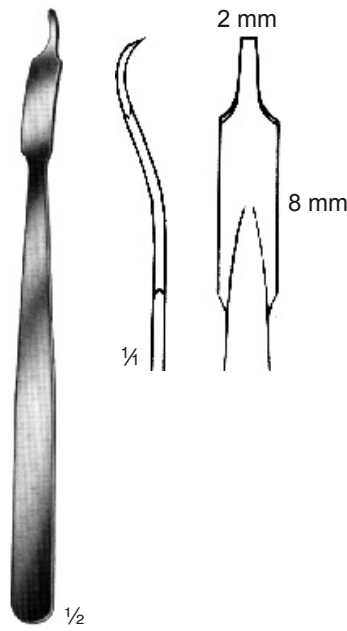

Mini-Hohmann
 27.3664-08
 16,0 cm/6¼"

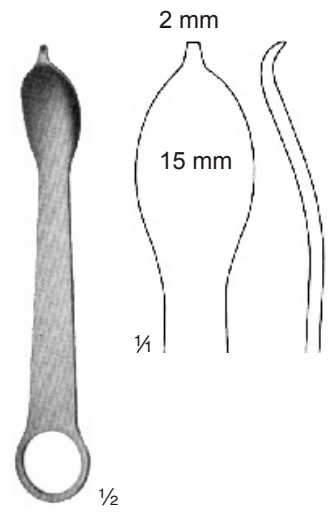

27.3665-15
 12,5 cm/5"

27

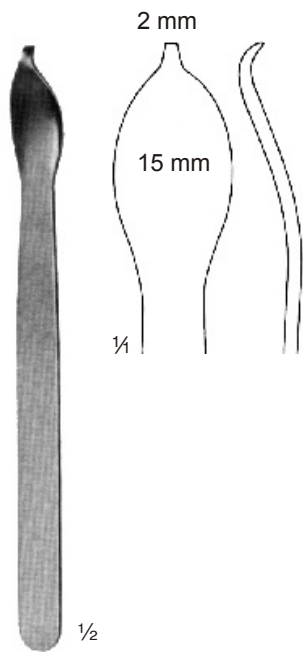

27.3666-15
16,0 cm/6¼"



Hohmann
22,0 cm/8¾"

27.3667-08 8 mm
27.3667-10 10 mm

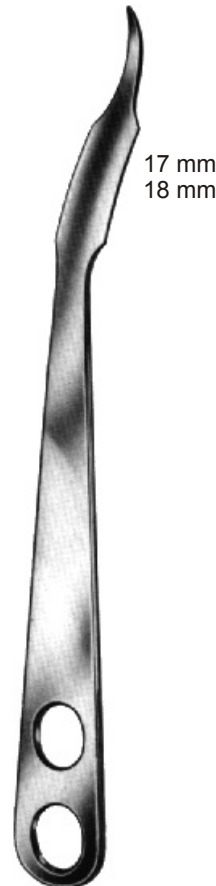

Hohmann
24,0 cm/9½"

27.3667-17 17 mm
spitz, sharp
pointu, agudo

27.3667-18 18 mm
stumpf, blunt
mousse, romo

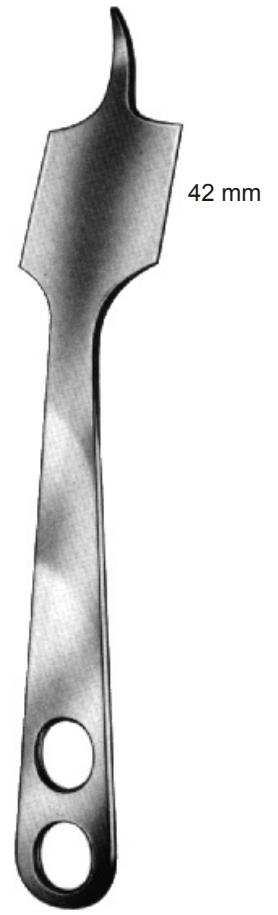

Hohmann

27.3667-42
24,0 cm/9½"

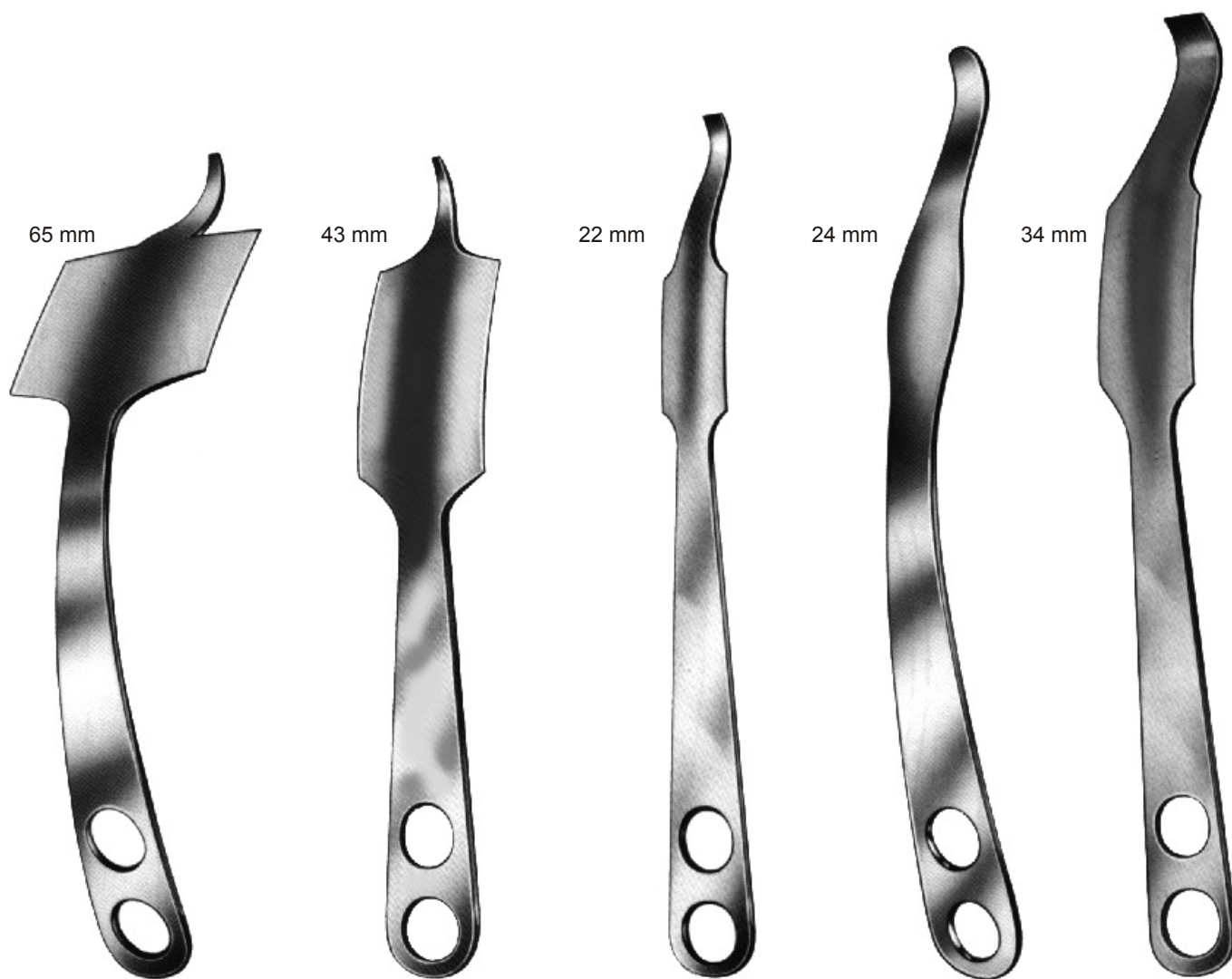

65 mm

43 mm

22 mm

24 mm

34 mm

Hohmann

27.3667-65
25,5 cm/10"

Hohmann

27.3668-43
24,0 cm/9½"

Hohmann

27.3669-22
26,0 cm/10¼"

Hohmann

27.3669-24
27,0 cm/10¾"

Hohmann

27.3669-34
28,5 cm/11¼"

27

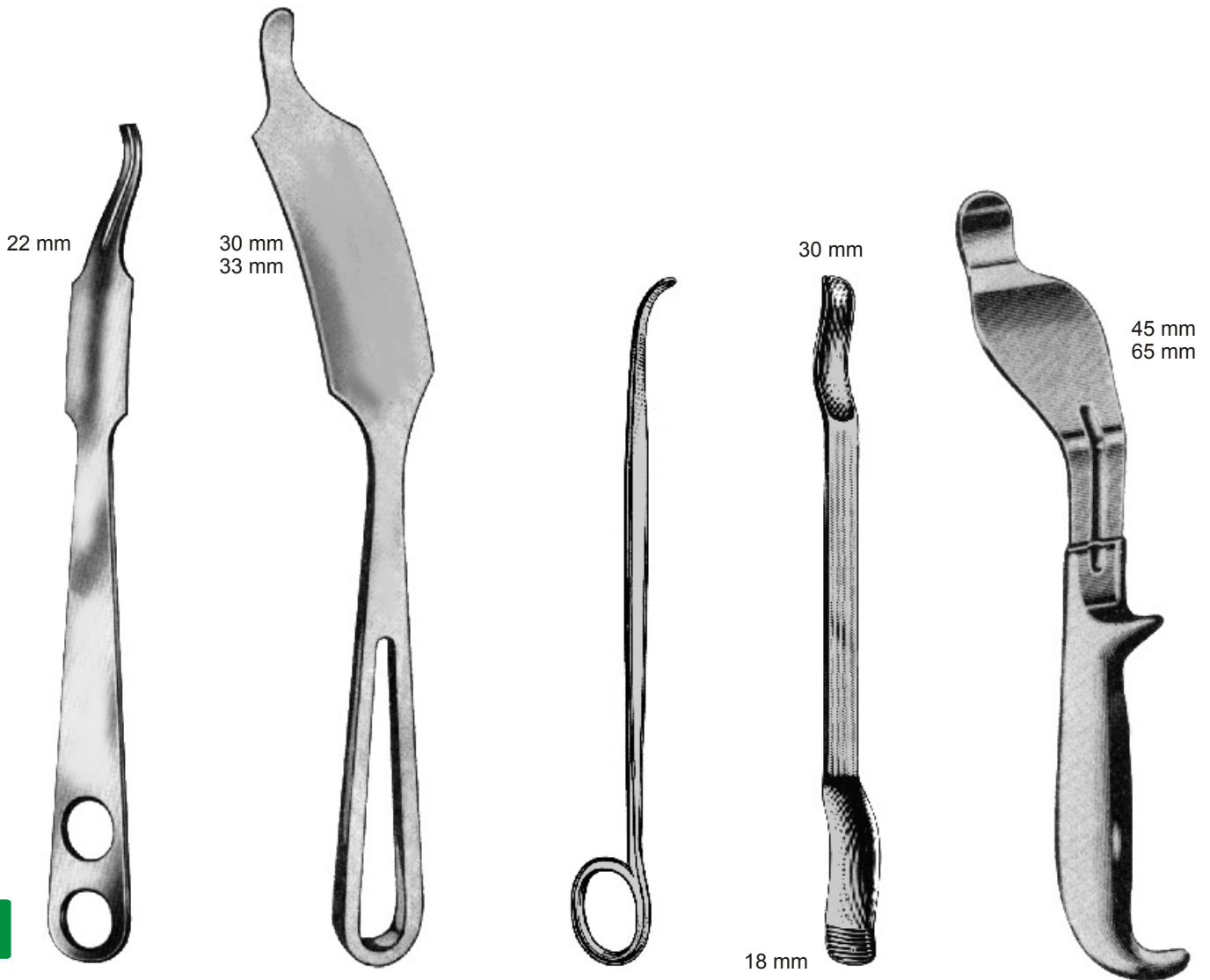

27

Lange-Hohmann

27.3670-22
 25,0 cm/10"

Lange-Hohmann modif.

27.3671-30 30 mm
 26,5 cm/10½"

27.3671-33 33 mm
 28,0 cm/11½"

Lane

27.3673-21
 21,5 cm/8½"

Murphy-Lane

27.3674-34
 34,0 cm/13½"

Bennett

24,0 cm/9½"

27.3675-45 45 mm
 27.3675-65 65 mm



38 mm

Blount

27.3676-01
26,0 cm/10¼"

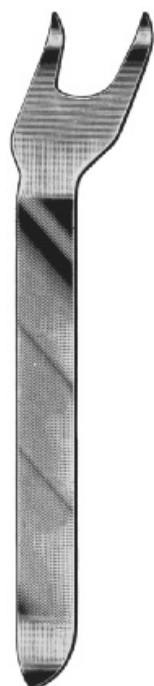

Blount

27.3676-02
26,0 cm/10¼"



Meniskushaken
Meniscus retractors
Ecarteurs pour le ménisque
Separadores para menisco

Blount

27.3677-18
17,5 cm/7"



Spinalhaken
Spinal retractors
Ecarteurs spinaux
Separadores espinales

Taylor
16,5 cm/6½"

27.3678-07 75 x 30 mm
27.3678-10 100 x 30 mm

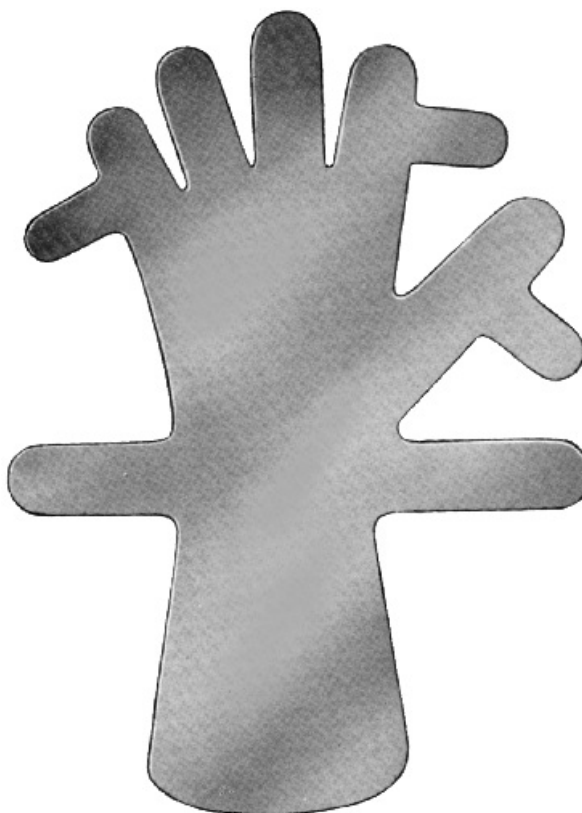

Bleihände
Lead hands
Main de plomb
Mano de plomo

27.3679-01
für Kinder
for children
pour enfants
para niños

27.3679-02
für Erwachsene
for adults
pour adultes
para adultos



28 mmØ
340 g (12 oz.)

Williger

27.3680-28
24,0 cm/9½"

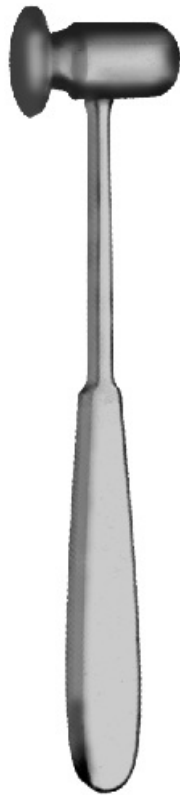

27.3681-25
25 mmØ
120 g (4¼ oz.)

27.3681-30
30 mmØ
180 g (6½ oz.)

27.3681-35
35 mmØ
260 g (9 oz.)

Doyen

21,0 cm/8¼"

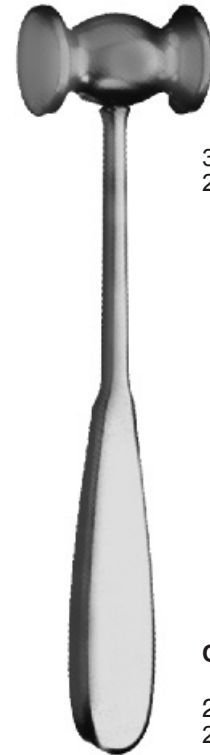

30 mmØ
220 g (7¾ oz.)

Collin

27.3682-30
20,0 cm/8"



25 mmØ
260 g (9 oz.)

Lucae

27.3683-25
19,0 cm/7½"



20 mmØ
140 g (5 oz.)

bleigefüllt
lead filled
rempli de plomb
relleno de plomo

27.3684-01
16,5 cm/6½"



20 mmØ
140 g (5 oz.)

Messing massiv
solid brass
laiton solide
latón macizo

27.3684-02
16,5 cm/6½"

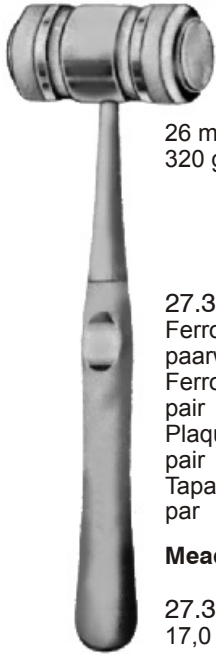

26 mmØ
320 g (11¼ oz.)

27.3685-02
Ferrozellbacken allein,
paarweise
Ferozell jaws only,
pair
Plaques en matière Ferrozell,
pair
Tapas de Ferrozell sueltas,
par

Mead

27.3685-17
17,0 cm/6¾"



22 mmØ
200 g (7 oz.)

27.3686-01
bleigefüllt
lead filled
rempli de plomb
relleno de plomo

27.3686-02
Stahl, massiv
Steel, solid
Acier, solide
Acero, macizo

Partsch
18,0 cm/7"



25 mmØ
140 g (5 oz.)

27.3687-02
Ferrozellbacken allein,
paarweise
Ferozell jaws only,
pair
Plaques en matière Ferrozell,
pair
Tapas de Ferrozell sueltas,
par

27.3687-25
18,5 cm/7¼"



30 mmØ
240 g (8¾ oz.)

Stahl, massiv
mit Leichtmetallgriff
Steel solid
with light metal handle
Acier solide
avec manche en métal léger
Acero, macizo,
con mango de metal ligero

Cottle

27.3688-30
18,5 cm/7¼"



27 mmØ
140 g (5 oz.)

Hajek

27.3689-27
21,5 cm/8½"



30 mmØ
300 g (10½ oz.)

Bergmann

27.3690-30
23,5 cm/9¼"

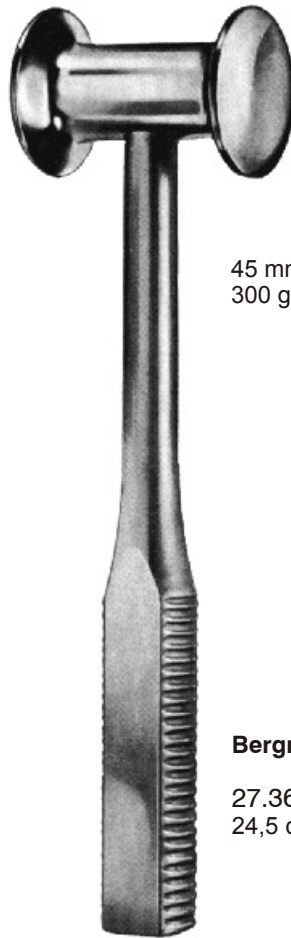

45 mmØ
300 g (10½ oz.)

Bergmann

27.3690-45
24,5 cm/9¾"



40 mmØ
550 g (19 oz.)

Ombredanne

27.3691-40
24,0 cm/9½"

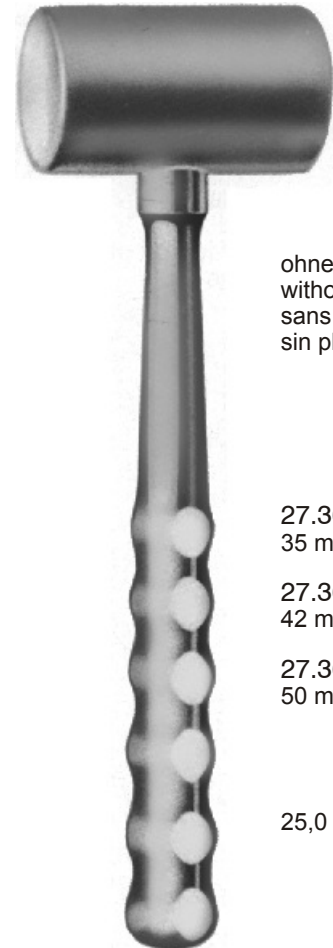

ohne Blei
without lead
sans plomb
sin plomo

27.3692-35
35 mmØ

27.3692-42
42 mmØ

27.3692-50
50 mmØ

25,0 cm/10"



42 mmØ

30 mmØ

400 g (14 oz.)

Stahl, massiv
mit Leichtmetallgriff
Steel solid
with light metal handle
Acier solide
avec manche en métal léger
Acero, macizo,
con mango de metal ligero

27.3693-42
24,0 cm/9½"



30 mmØ
510 g (18 oz.)



27.3695
26,0 cm/10¼"



450 g (1 lb.)

Stahl, massiv
Steel, solid
Acier, solide
Acero, macizo

27.3694-01
26,5 cm/10½"



900 g (2 lb.)

Stahl, massiv
Steel, solid
Acier, solide
Acero, macizo

27.3694-02
26,5 cm/10½"



30 mmØ
125 g (4 oz.)

Ferrozell, massiv
Ferrozell, solid
Ferrozell, solide
Ferrozell, macizo

27.3696-18
18,0 cm/7"



27.3700-01
gerade
straight
droite
recta



20,0 cm/8"



27.3700-02
aufgebogen
curved on flat
courbe vers le haut
curva sobre el plano



27.3701-14
14,0 cm/5½"

Sequesterzangen
Sequestum Forceps
Pince à séquestre
Pinza para secuestros

27

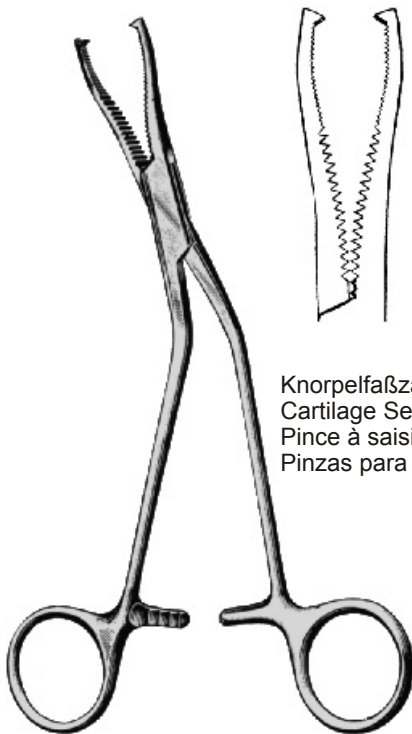

Dingmann

27.3702
19,0 cm/7½"

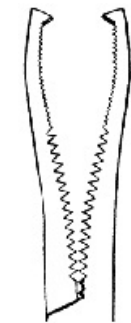

Knorpelfaßzange
Cartilage Seizing Forceps
Pince à saisir cartilages
Pinzas para coger cartílagos



27.3703
12,0 cm/4¾"



Lewin

27.3704-17
17,5 cm/7"

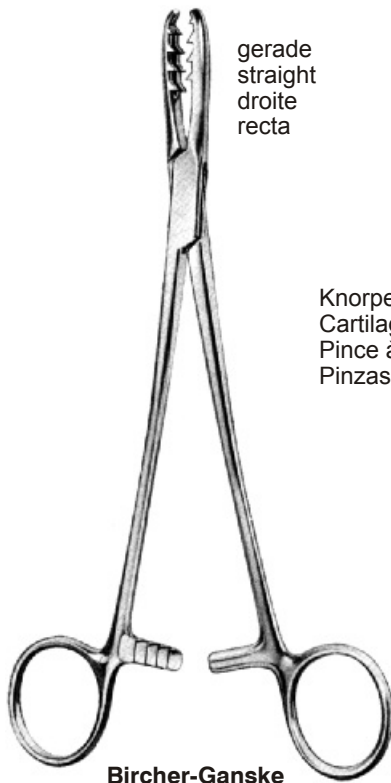

gerade
 straight
 droite
 recta

Bircher-Ganske

27.3705-01
 20,0 cm/8"



gebogen
 curved
 courbe
 curva

Bircher-Ganske

27.3705-02
 20,0 cm/8"

Knorpelfaßzangen
 Cartilage Seizing Forceps
 Pince à saisir cartilages
 Pinzas para coger cartilagos



Setter

27.3706-16
 16,0 cm/6¼"
 27.3706-24
 24,0 cm/9½"



Semb

ohne Sperre
 without ratchet
 sans crémaillère
 sin cremallera

27.3707
 19,0 cm/7½"



Semb

mit Sperre
 with ratchet
 avec crémaillère
 con cremallera

27.3708
 19,0 cm/7½"



Van Buren

27.3709
23,0 cm/9"



Langenbeck

27.3710
21,0 cm/8¼"



Farabeuf

27.3711
23,0 cm/9"
27.3712
26,0 cm/10¼"



Fergusson

27.3713
21,0 cm/8¼"

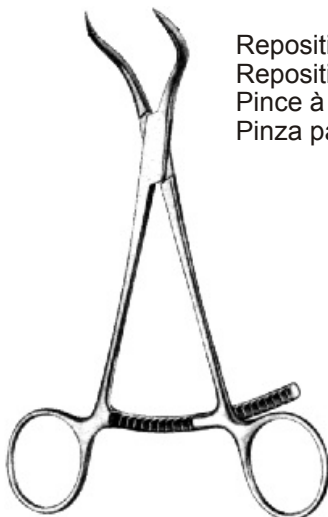

Repositionszange
Reposition Forceps
Pince à réduction
Pinza para reposición

27.3714
13,5 cm/5¼"



Farabeuf-Lambotte

27.3715
26,0 cm/10¼"
mit Sperre
with ratchet
avec crémaillère
con cremallera



27.3716-20
20,0 cm/8"

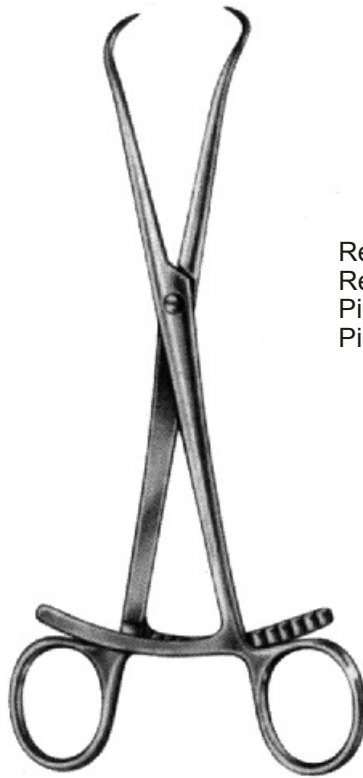

27.3717-01
20,0 cm/8"

Repositionszangen
Reposition Forceps
Pince à reduction
Pinza para reposición

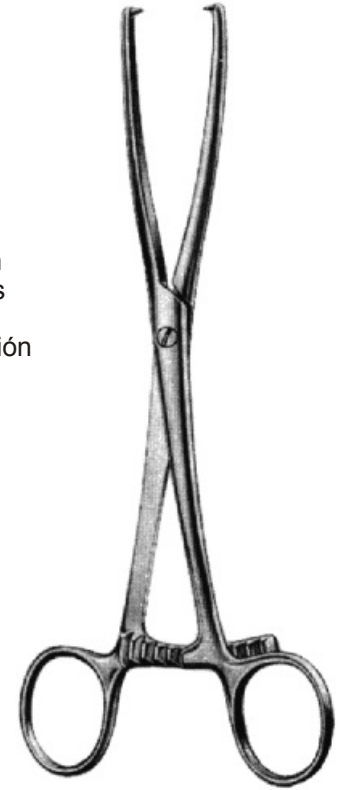

27.3717-02
21,0 cm/8¼"

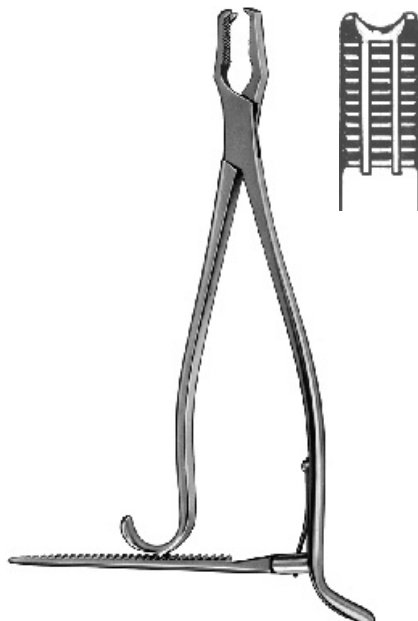

Baby-Kern

27.3718
15,0 cm/6"
mit Sperre
with ratchet
avec crémaillère
con cremallera

27.3719
15,0 cm/6"
ohne Sperre
without ratchet
sans crémaillère
sin cremallera



Kern

27.3718-17
17,0 cm/6³/₄"

27.3719-17
17,0 cm/6³/₄"

27.3720
21,0 cm/8¹/₄"

27.3721
21,0 cm/8¹/₄"

mit Sperre
with ratchet
avec crémaillère
con cremallera

ohne Sperre
without ratchet
sans crémaillère
sin cremallera



27

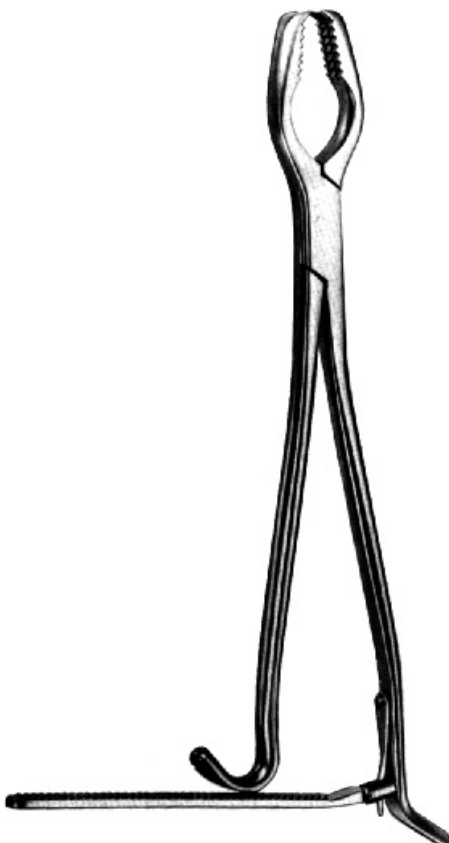

Lane

27.3722
33,0 cm/13"

27.3723
33,0 cm/13"

27.3724
45,0 cm/17³/₄"

27.3725
45,0 cm/17³/₄"

mit Sperre
with ratchet
avec crémaillère
con cremallera

ohne Sperre
without ratchet
sans crémaillère
sin cremallera





Lambotte

27.3727 22,0 cm/8³/₄"
27.3728 26,0 cm/10¹/₄"
27.3729 33,0 cm/13"

gerade
straight
droite
recta



Lambotte

27.3730 19,0 cm/7¹/₂"
27.3731 23,0 cm/9"
27.3732 26,0 cm/10¹/₄"

rechtswärts gebogen
right angled
courbe à droite
curva a la derecha



Lambotte

27.3733 22,0 cm/8³/₄"
27.3734 27,0 cm/10³/₄"
27.3735 30,0 cm/11³/₄"

verstellbar
adjustable
ajustable
ajustable

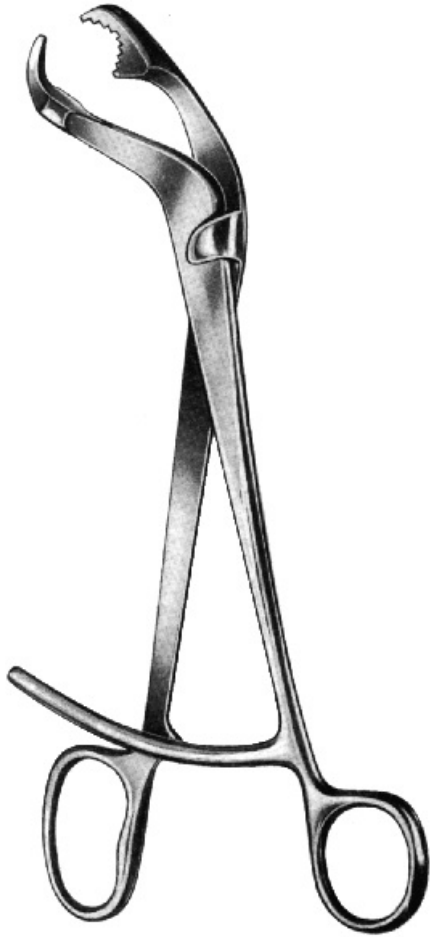

Verbrugge

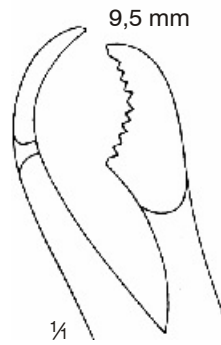

Fig. 1
27.3736
25,0 cm/10"

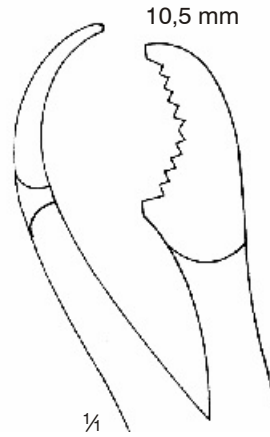

Fig. 2
27.3737
26,0 cm/10¼"

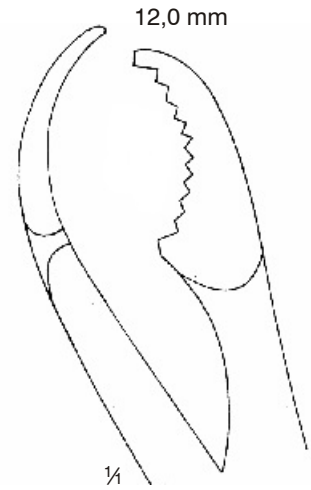
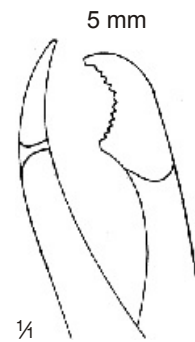

Fig. 3
27.3738
27,0 cm/10¾"



Verbrugge-Baby



27.3739
17,5 cm/7"



Verbrugge

Fig. 00	27.3740	15,0 cm/6"	2,5 mm
Fig. 0	27.3741	19,0 cm/7½"	6,5 mm
Fig. 1	27.3742	24,0 cm/9½"	9,5 mm
Fig. 2	27.3743	26,0 cm/10¼"	10,0 mm
Fig. 3	27.3744	28,0 cm/11"	11,0 mm

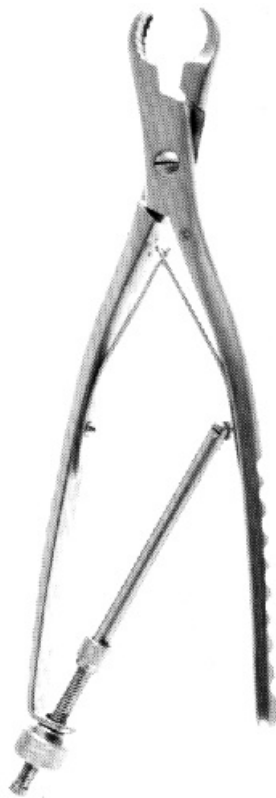

Ulrich

27.3745	23,0 cm/9"
27.3746	25,0 cm/10"
27.3747	28,0 cm/11"

gerade
 straight
 droite
 recta



Ulrich

27.3748	28,0 cm/11"
---------	-------------

seitwärts gebogen
 curved sideways
 courbe sur le côté
 curva al lado



Luer
15,0 cm/6"



Fig. 1
27.3750-01



Fig. 2
27.3750-02



Fig. 3
27.3750-03



Lempert
19,0 cm/7½"



27.3751-19
gerade
straight
droite
recta



27.3752-19
gebogen
curved
courbe
curva

27

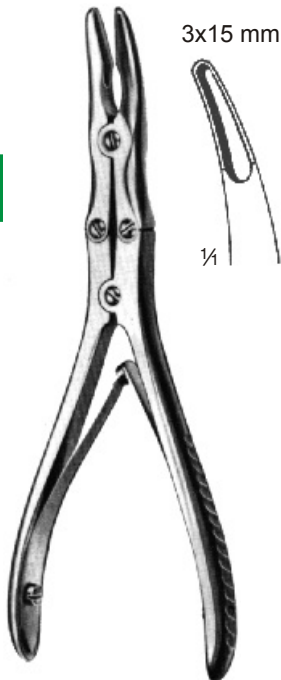

Beyer
27.3753
18,0 cm/7"



Ruskin
18,0 cm/7"



27.3754
gerade
straight
droite
recta



27.3755
gebogen
curved
courbe
curva



Röttgen-Ruskin
27.3754-23
23,0 cm/9"







27.3754-23
gerade
straight
droite
recta





27.3755-23
gebogen
curved
courbe
curva

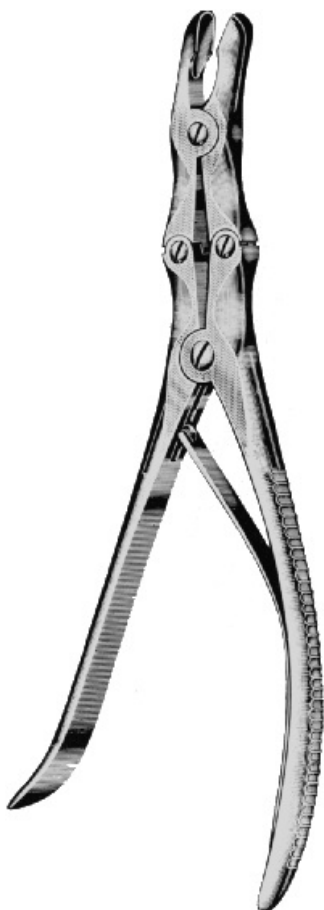

	10 mm	10 mm	17 mm	17 mm
				
¼				
	27.3756 22,0 cm/8¾"	27.3757 22,0 cm/8¾"	27.3756-27 27,0 cm/10¾"	27.3757-27 27,0 cm/10¾"
	gerade straight droite recta	gebogen curved courbe curva	gerade straight droite recta	gebogen curved courbe curva

Stille-Luer



	4 mm	8 mm
		
¼		
	27.3758-04	27.3758-08

Leksell-Stille

24,0 cm/9½"

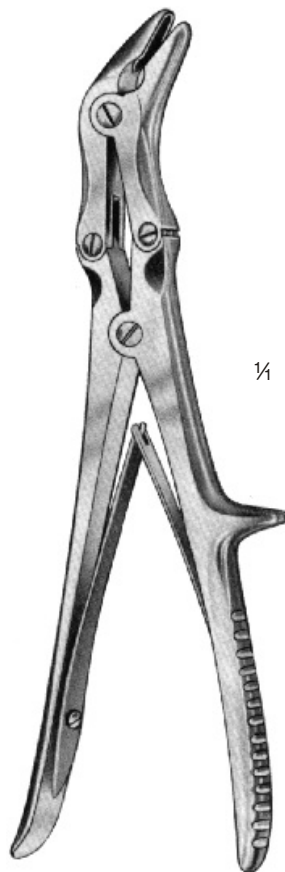

	7 mm
	
¼	

Stille

27.3758-23
23,0 cm/9"



27.3759

gerade
straight
droite
recta



27.3760

gebogen
curved
courbe
curva

Luer
17,0 cm/6³/₄"



Luer-Friedmann

27.3761
14,0 cm/5¹/₂"

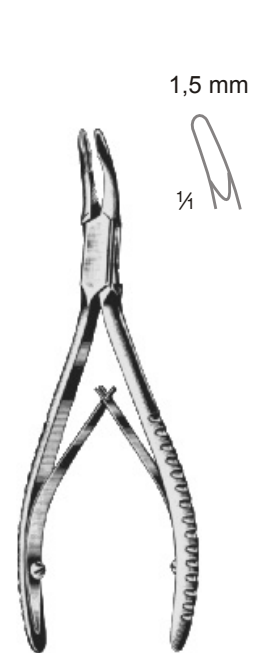

Micro-Friedmann

27.3761-02
14,0 cm/5¹/₂"

27



Mini-Friedmann

27.3761-03
12,0 cm/5"

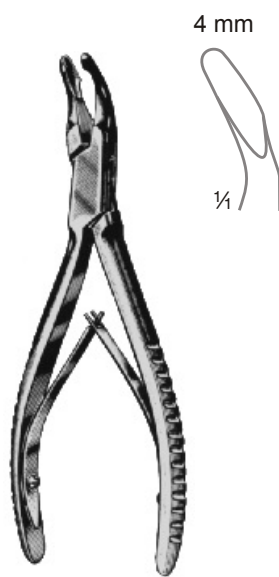

Cleveland

27.3762
14,0 cm/5¹/₂"

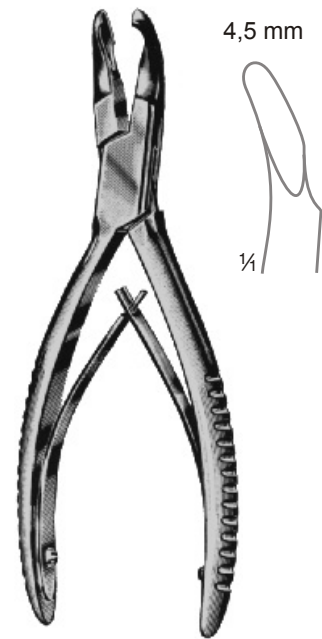

Cleveland

27.3763
17,0 cm/6³/₄"

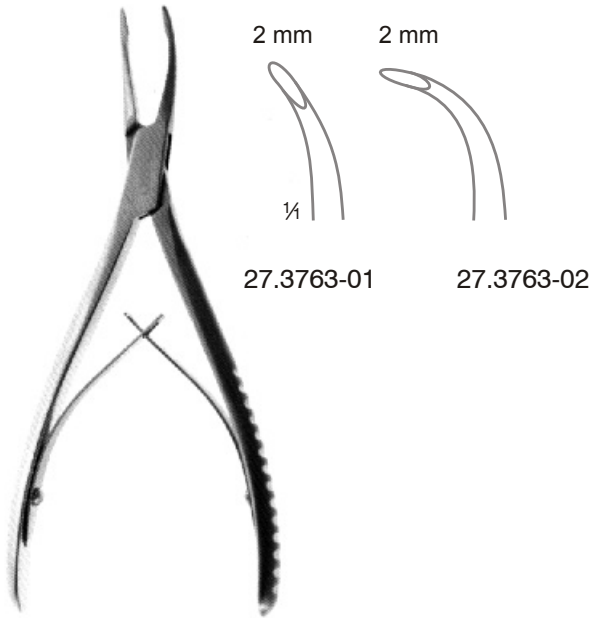

2 mm

2 mm

1/4

27.3763-01

27.3763-02

Stellbrink
 17,0 cm/6³/₄"

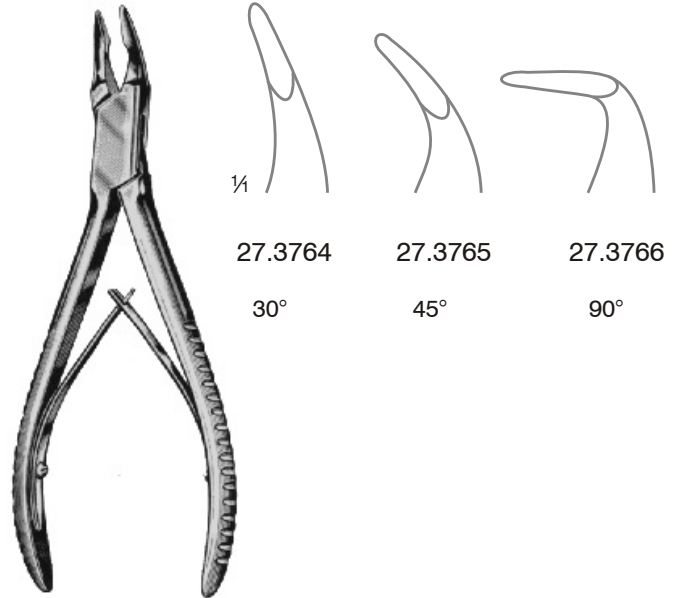

1/4

27.3764

27.3765

27.3766

30°

45°

90°

Blumenthal
 15,5 cm/6"

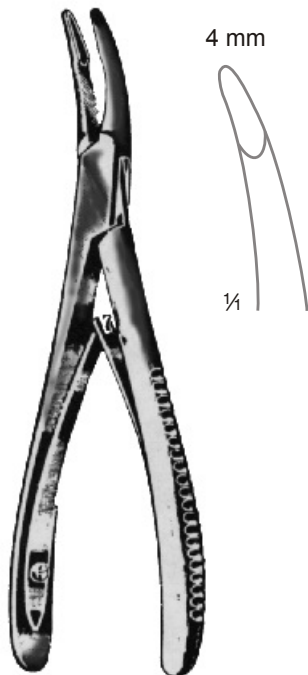

4 mm

1/4

Zaufal

27.3767
 17,0 cm/6³/₄"

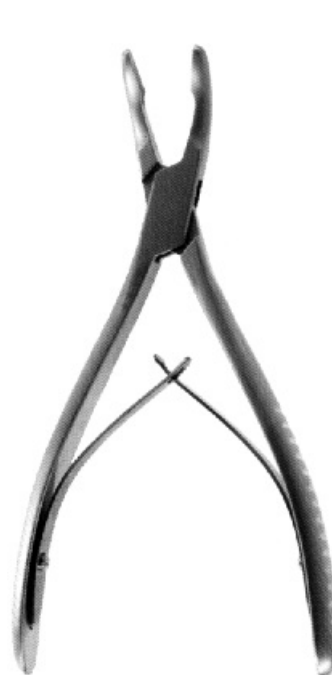

4 mm

4 mm

1/4

27.3768

27.3769

gerade
 straight
 droite
 recta

gebogen
 curved
 courbe
 curva

Jansen
 17,0 cm/6³/₄"

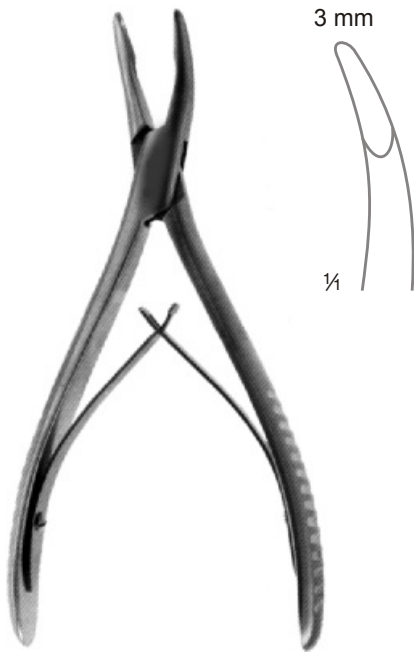

Bayer

27.3770
18,0 cm/7"

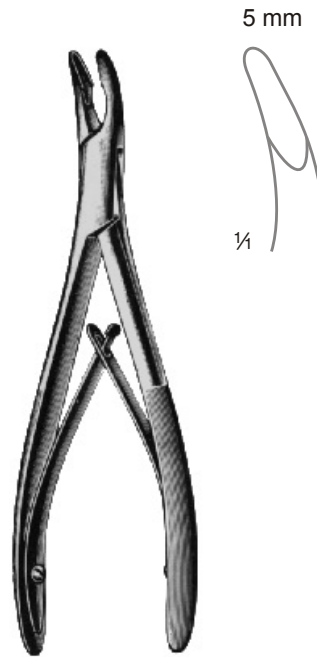

Bane (Hartmann)

27.3771
17,0 cm/6 3/4"

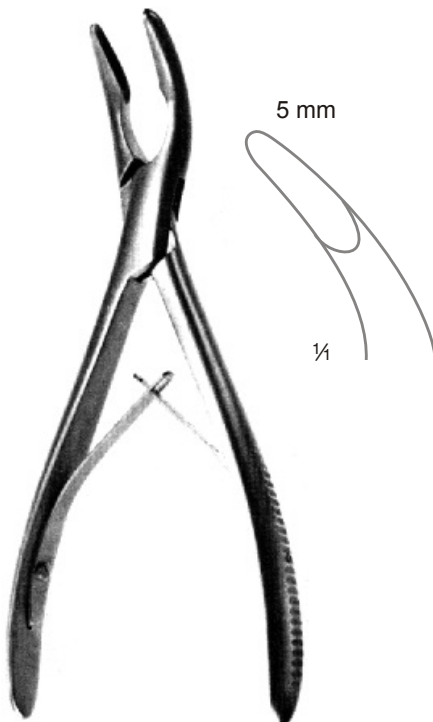

Olivecrona

27.3772
19,0 cm/7 1/2"

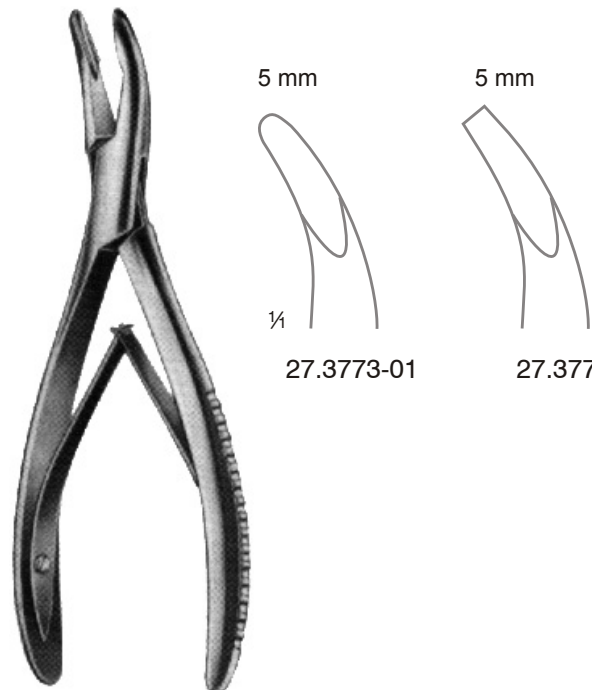

Mead

16,5 cm/6 1/2"

27.3773-01

27.3773-02

27



Adson

27.3774
 20,0 cm/8"

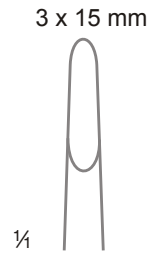

3 x 15 mm

27.3775
 gerade
 straight
 droite
 recta



3 x 15 mm

27.3776
 gebogen
 curved
 courbe
 curva

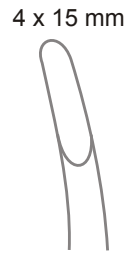

4 x 15 mm

27.3777
 gebogen
 curved
 courbe
 curva

Böhler
 15,0 cm/6"



5 x 15 mm

Zaufal-Jansen

27.3778
 18,0 cm/7"

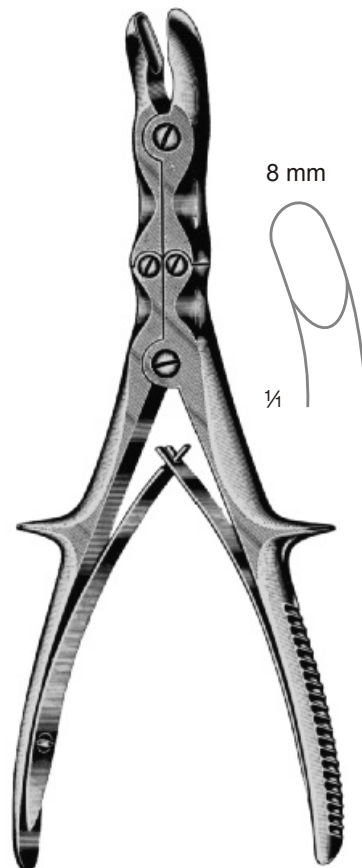

8 mm

Stille-Ruskin

27.3779
 23,0 cm/9"

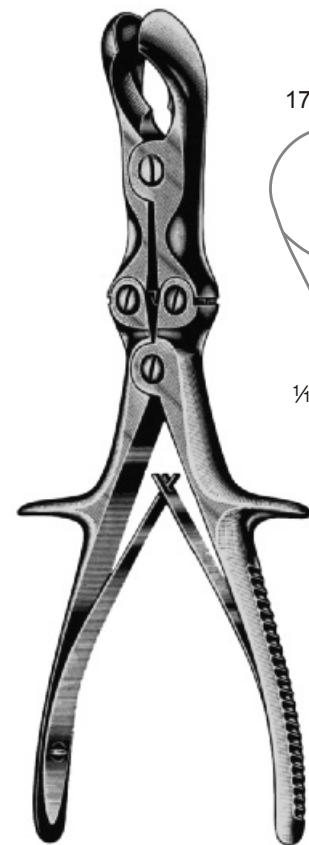



17 mm

Semb

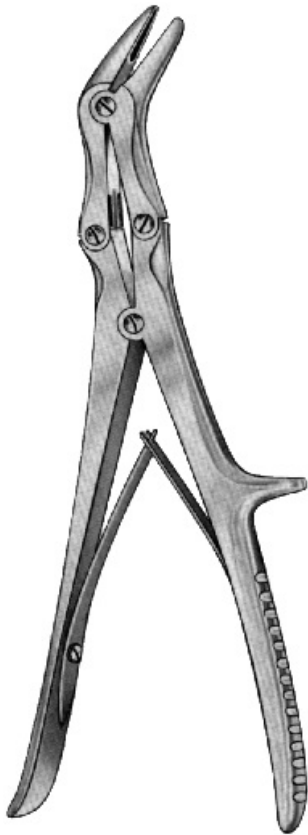
27.3780
 22,5 cm/8¾"





2 x 10 mm	3 x 10 mm	4 x 10 mm
		
27.3781	27.3782	27.3783

seitwärts gebogen
curved sideways
courbe sur le côté
curva al lado

Echlin
23,0 cm/9"



3 mm	3 mm	3 mm
		
27.3784 19,0 cm/7½"	27.3785 19,0 cm/7½"	27.3786 19,0 cm/7½"
27.3787 24,0 cm/9½"	27.3788 24,0 cm/9½"	27.3789 24,0 cm/9½"
gerade straight droite recta	leicht gebogen slightly curved courbe légèrement curva ligeramente	stark gebogen fully curved courbe fortement curva fuertemente

Smith-Petersen



Sauerbruch
 30,0 cm/11³/₄"

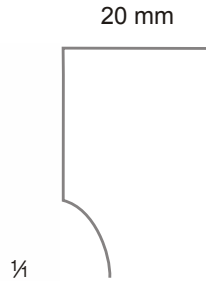

20 mm

27.3790



20 mm

27.3791

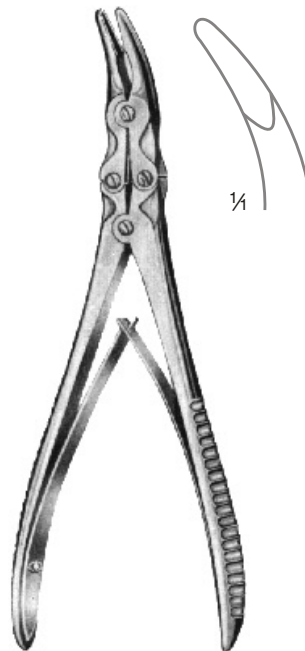

Mayfield

27.3792
 17,0 cm/6³/₄"



3,5 mm

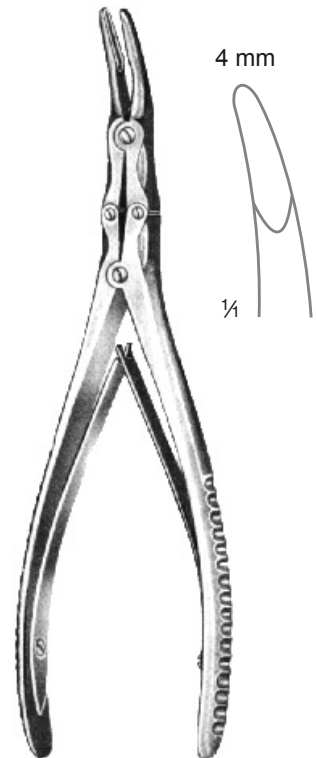

Marquardt

27.3793
 20,0 cm/8"



4 mm



gerade
straight
droite
recta

27.3814 14,0 cm/5½"
27.3817 17,0 cm/6¾"
27.3819 19,0 cm/7½"
27.3822 22,0 cm/8¾"

Liston



gebogen
curved
courbe
curva

27.3824
27.3827
27.3829
27.3832



27.3838
gerade
straight
droite
recta



27.3839
gebogen
curved
courbe
curva

Liston-Mini
15,0 cm/6"



gerade
straight
droite
recta

Stille-Liston

27.3840
27,0 cm/10½"



27.3841
27,0 cm/10½"
gebogen
curved
courbe
curva



Liston-Key

27.3842
27,0 cm/10½"



Stille-Liston

27.3843
27,0 cm/10½"



¼
27.3844
 15,0 cm/6"



27.3845
 17,0 cm/6¾"

Cleveland
 gebogen
 curved
 courbe
 curva



¼
27.3846
 gerade
 straight
 droite
 recta



27.3847
 nach vorn gebogen
 curved forward
 courbe en avant
 curva hacia delante



27.3848
 nach hinten gebogen
 curved backward
 courbe en arrière
 curva hacia atrás

Böhler
 15,0 cm/6"



¼
27.3849
 gebogen
 curved
 courbe
 curva

Mc Indoe
 17,0 cm/6¾"



Ruskin
18,0 cm/7"



27.3850
gerade
straight
droite
recta



27.3851
gebogen
curved
courbe
curva



Ruskin-Liston
18,0 cm/7"



27.3852
gerade
straight
droite
recta



27.3853
gebogen
curved
courbe
curva



Semb

27.3854
23,0 cm/9"

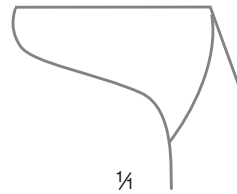

seitwärts gebogen
sideways curved
courbe sur le côté
curva al lado

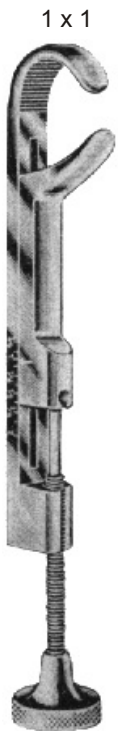

Lowman

27.3855-12 12,0 cm/4³/₄"
 27.3855-18 18,0 cm/7"
 27.3855-20 20,0 cm/8"



Lowman

27.3856-12 12,0 cm/4³/₄"
 27.3856-18 18,0 cm/7"
 27.3856-20 20,0 cm/8"
 27.3856-22 22,0 cm/8³/₄"

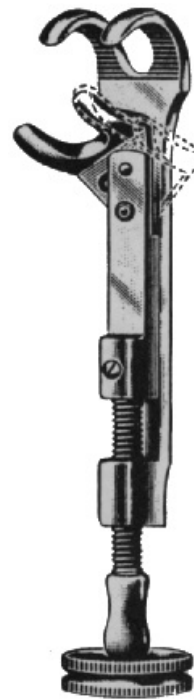

Lowman-Baby

27.3857-13
 13,0 cm/4³/₄"

Lowman-Hoglund

27.3857-18
 18,0 cm/7"



Gerster

27.3858
 15,0 cm/6"

Distraktionsklammer
 Traction bar
 Clamp porte-os
 Barra de tracción

**Herz-, Thorax- und Gefäß-Chirurgie
Cardiovascular and Thoracic Surgery
Chirurgie cardiovasculaire et Thoracoplastie
Cirugía cardiovascular y Toracoplástica**



mit ziehendem Schnitt
 with eccentric sliding blade
 avec lame glissante
 con hoja de retroacción



28.3859
 22,0 cm/8³/₄"

Rippenschere
 Rib Shears
 Costotomes
 Cizallas para costillas



28.3860-19 19,5 cm/7³/₄"
 28.3860-23 22,5 cm/9"

Knochenschere
 Bone Shears
 Cisailles pour os
 Cizallas para huesos



Gluck

28.3861
 21,0 cm/8³/₄"

Rippenschere
 Rib Shears
 Costotomes
 Cizallas para costillas

Griffe mit Gummiüberzug
Handles with rubber cover
Manches avec couverture en caoutchouc
Mangos con cubierta de goma



28

Bethune

28.3863
34,0 cm/13½"



Giertz-Stille

28.3864
27,0 cm/10½"



Brunner

32,0 cm/12½"

28.3865
für die rechte Hand
for the right hand
pour la main droite
para la mano derecha

28.3866
für die linke Hand
for the left hand
pour la main gauche
para la mano izquierda

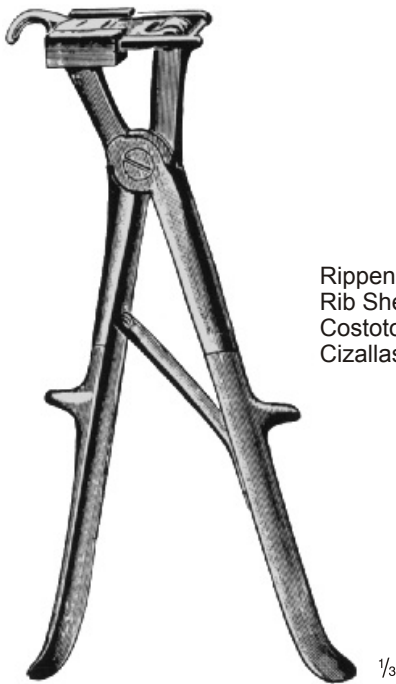

Rippenschere
 Rib Shears
 Costotomes
 Cizallas para costillas

Sauerbruch

28.3867
 26,0 cm/10¼"



Rippenschere
 Rib Shears
 Costotomes
 Cizallas para costillas

Sauerbruch-Frey

28.3868
 36,0 cm/14"



Sternumschere
 Sternum scissors
 Cisailles à sternum
 Tijeras de esternón

Lebsche

28.3869
 25,0 cm/10"



Sternummeißel
 Sternum chisel
 Burin à sternum
 Cincel de esternón

Lebsche

28.3871
 24,5 cm/9¾"



Aluminium
Aluminium
Aluminium
Aluminio

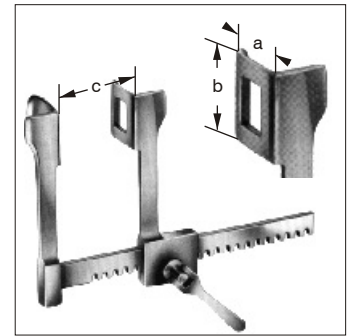

Finocchietto-Infant

	a	b	c
28.3880	10 mm	15 mm	70 mm



Aluminium
Aluminium
Aluminium
Aluminio

Finocchietto-Baby-Haight

	a	b	c
28.3881	31 mm	31 mm	80 mm

28



Aluminium
Aluminium
Aluminium
Aluminio

Finocchietto

	a	b	c
28.3882-01	30 mm	45 mm	140 mm
28.3882-02	40 mm	62 mm	175 mm
28.3882-03	64 mm	65 mm	175 mm

Rippenperrer aus Aluminium
Rib Spreaders from Aluminium
Ecarteurs des côtes en aluminium
Separadores costales de aluminio



Aluminium
 Aluminium
 Aluminium
 Aluminio

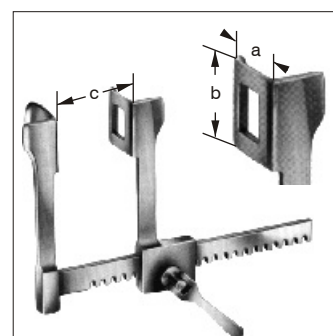

Burford	für Kinder for children pour enfants para niños	mit 2 Paar Valven with 2 pairs of blades avec 2 paires de valves con 2 pares de valvas	
	a	b	c
28.3884	41 mm 30 mm	42 mm 42 mm	130 mm



Aluminium
 Aluminium
 Aluminium
 Aluminio

Burford	für Erwachsene for adults pour adultes para adultos	mit 2 Paar Valven with 2 pairs of blades avec 2 paires de valves con 2 pares de valvas	
	a	b	c
28.3885-01	65 mm 47 mm	62 mm 62 mm	165 mm
28.3885-02	65 mm 47 mm	62 mm 62 mm	250 mm
28.3885-03	65 mm 47 mm	62 mm 62 mm	290 mm

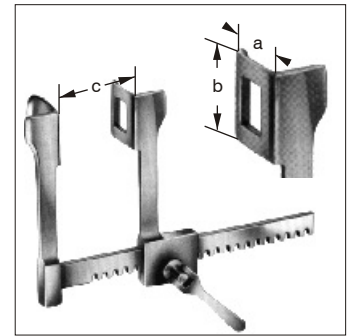

Aluminium
Aluminium
Aluminium
Aluminio

für Säuglinge
for newborns
pour bébés
para recién nacidos

Cooley

	a	b	c
28.3887-01	12 mm	16 mm	70 mm



Aluminium
Aluminium
Aluminium
Aluminio

für Kinder
for children
pour enfants
para niños

Cooley

	a	b	c
28.3887-02	15 mm	30 mm	100 mm

28



Aluminium
Aluminium
Aluminium
Aluminio

für Erwachsene
for adults
pour adultes
para adultos

Cooley

	a	b	c
28.3887-03	21 mm	44 mm	140 mm
28.3887-04	30 mm	50 mm	185 mm

Rippenstarrer aus Aluminium
Rib Spreaders from Aluminium
Ecarteurs des côtes en aluminium
Separadores costales de aluminio



Aluminium
 Aluminium
 Aluminium
 Aluminio

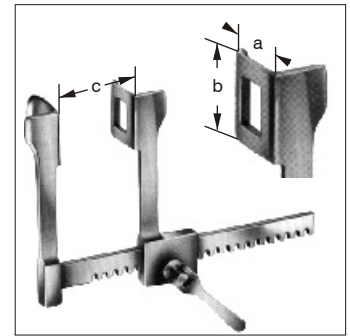

für Säuglinge
 for newborns
 pour bébés
 para recién nacidos

Castañeda	a	b	c
28.3890-01	10,5 mm	32 mm	65 mm

für Kinder
 for children
 pour enfants
 para niños

Castañeda	a	b	c
28.3890-02	12 mm	45 mm	70 mm
28.3890-03	15 mm	60 mm	100 mm

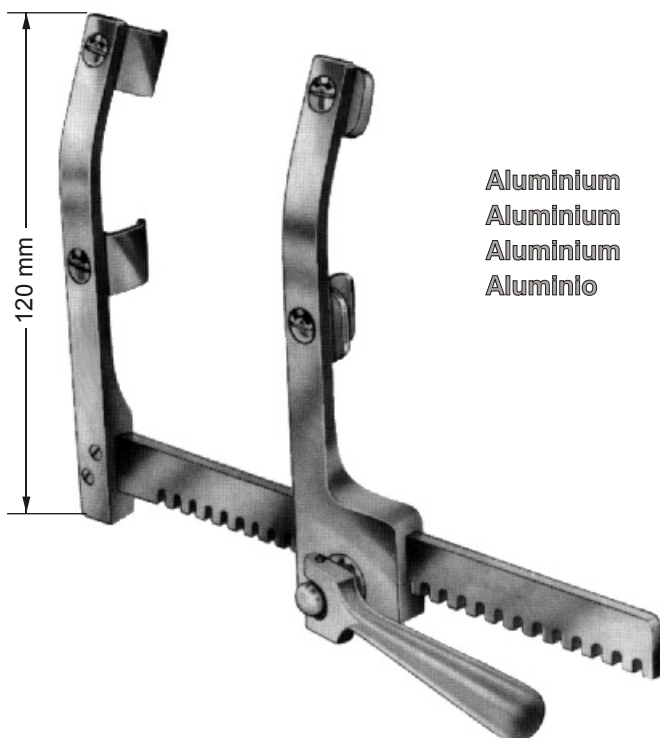

Aluminium
 Aluminium
 Aluminium
 Aluminio

Morse	a	b	c
28.3892	20 mm	20 mm	165 mm

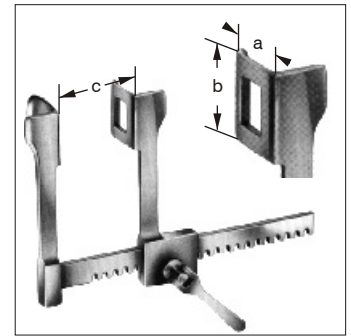
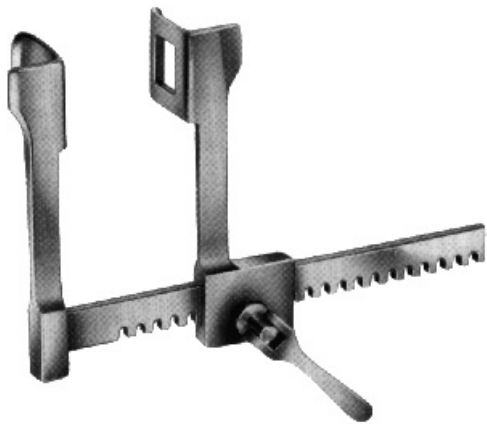

Finocchietto-Baby

	a	b	c
28.3900	19 mm	20 mm	75 mm

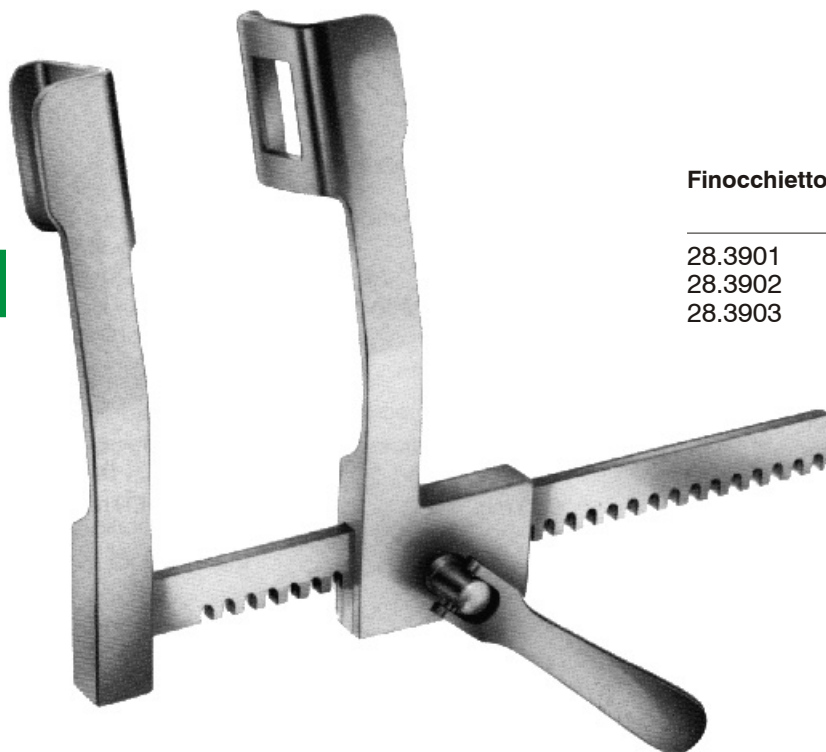

Finocchietto

	a	b	c
28.3901	40 mm	45 mm	165 mm
28.3902	45 mm	65 mm	200 mm
28.3903	65 mm	65 mm	250 mm

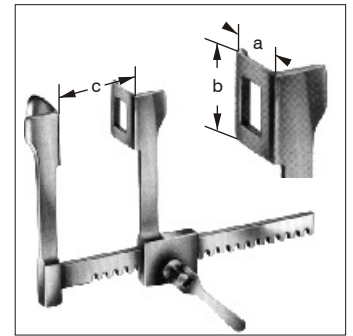
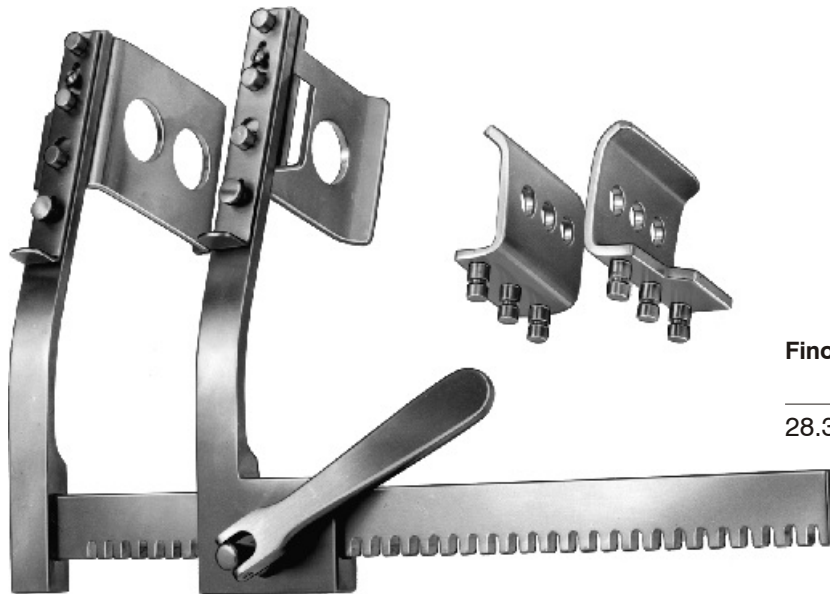

Finocchietto-Burford

mit 2 Paar Valven
 with 2 pairs of blades
 avec 2 paires de valves
 con 2 pares de valvas

	a	b	c
28.3904	80 mm 40 mm	67 mm 67 mm	250 mm



Tuffier

	a	b	c
28.3905	50 mm	45 mm	165 mm

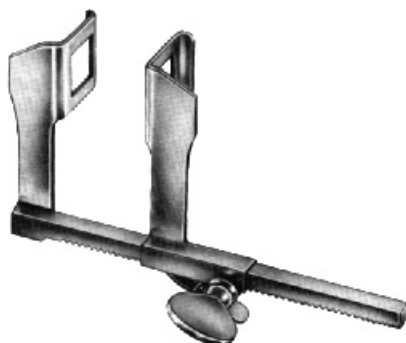

Haight

	a	b	c
28.3906	30 mm	30 mm	90 mm

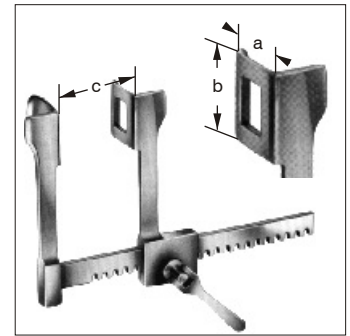

Cooley für Kinder
for children
pour enfants
para niños

	a	b	c
28.3907-01	21 mm	45 mm	145 mm

28



Cooley für Erwachsene
for adults
pour adultes
para adultos

	a	b	c
28.3907-02	32 mm	50 mm	190 mm

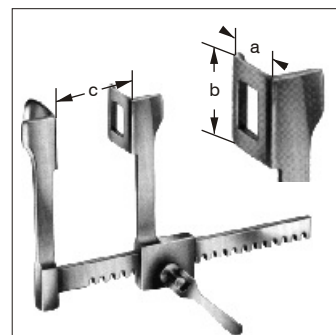
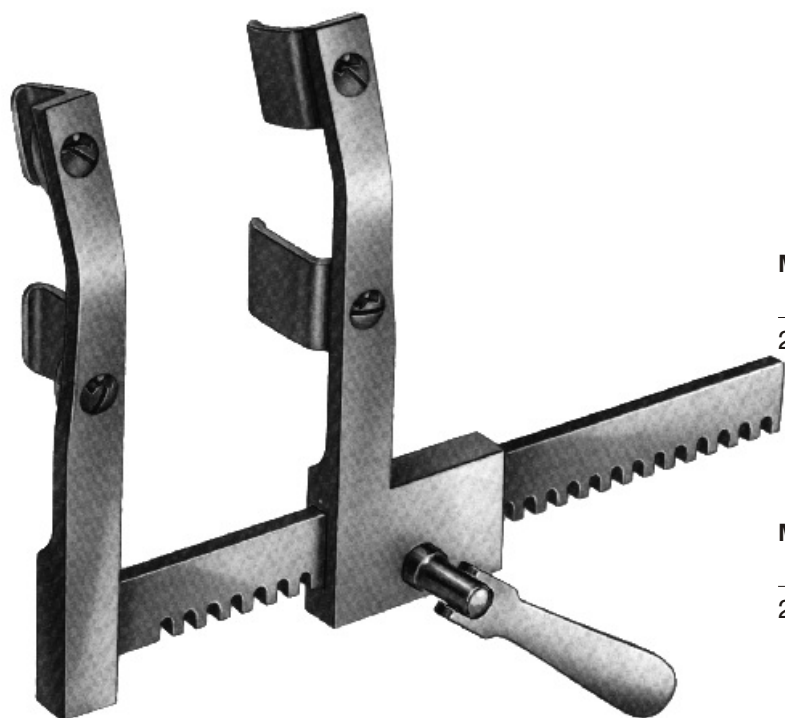

für Kinder
 for children
 pour enfants
 para niños

Morse	a	b	c
28.3908-01	12 mm	20 mm	200 mm

für Erwachsene
 for adults
 pour adultes
 para adultos

Morse	a	b	c
28.3908-02	19 mm	19 mm	200 mm



Morse-Favaloro	a	b	c
28.3908-03	38 mm	28 mm	200 mm

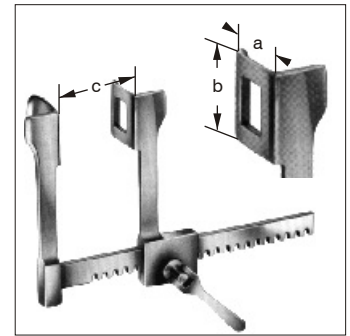

mit 1 Paar zusätzlich abnehmbaren Valven
with 1 pair of additional detachable blades
avec 1 paire de valves démontables, supplémentaire
con 1 par de valvas desmontables, adicional

a	b
40 mm	50 mm

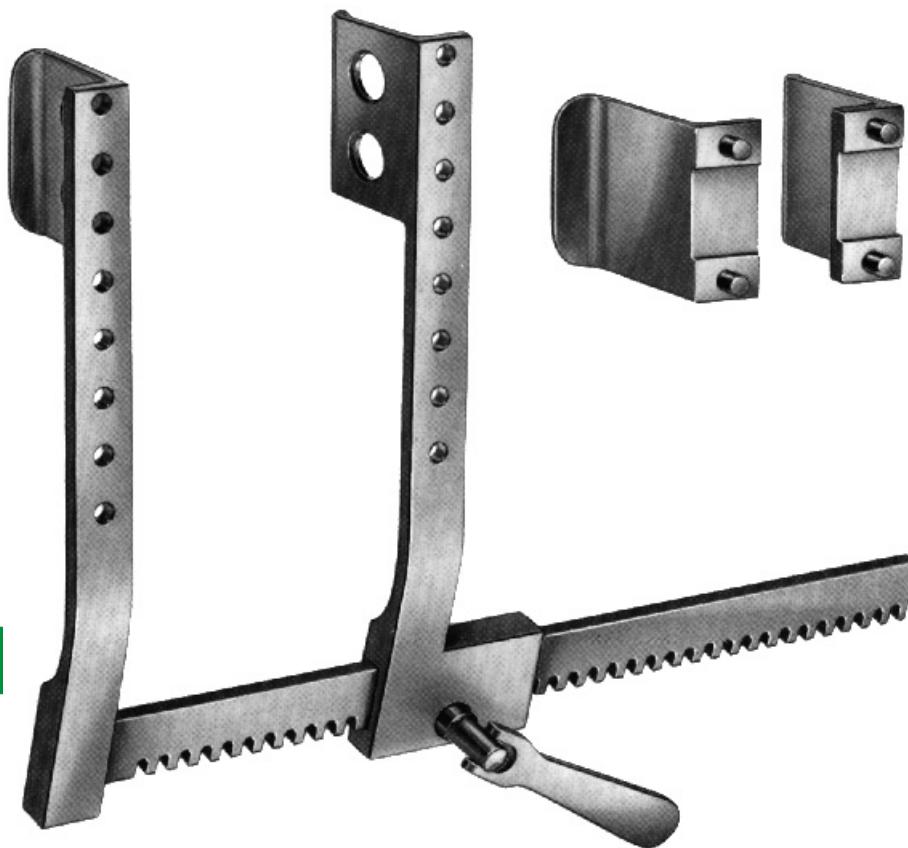

28

Harken

	a	b	c
28.3909	45 mm	65 mm	250 mm



Bailey-Gibbon

28.3910
16,0 cm/6¼"

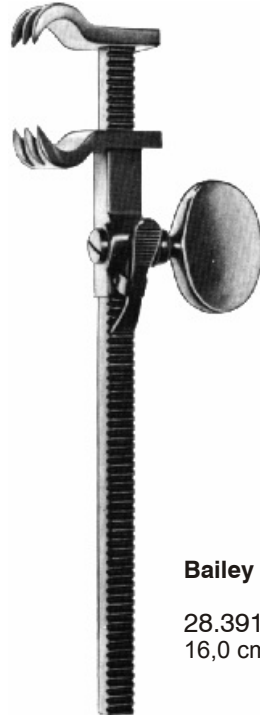

Bailey

28.3911
16,0 cm/6¼"



Bailey-Baby

28.3912
14,0 cm/5½"



Lungenspatel
Lung Spatulas
Spatules pulmonaires
Espátulas pulmonares

28

Allison

28.3920-27 40 mm
27,0 cm/11"

28.3920-32 65 mm
32,0 cm/12½"



25 mm/1"

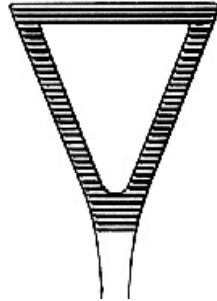

gerade
straight
droite
recta

Duval

28.4052 28.4054
20,0 cm/8" 23,0 cm/9¼"



25 mm/1"

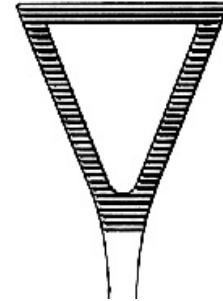

gebogen
curved
courbe
curva

Lovelace

28.4053
20,0 cm/8"



13 mm/½"



28.4057
20,0 cm/8"

25 mm/1"

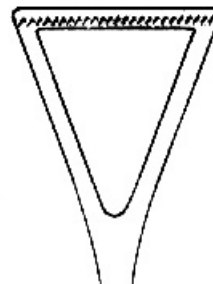

28.4058
20,0 cm/8"

28.4059
23,0 cm/9¼"

Collin



Price-Thomas

28.4060
22,5 cm/9"

Bronchusklemmen
Bronchus Clamps
Pinces-clamps à bronches
Pinzas-clamps para bronquios

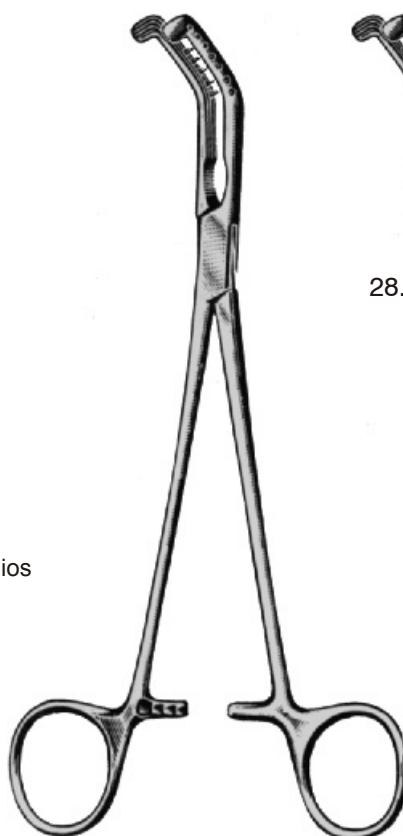

Price-Thomas
22,5 cm/9"

Bronchusklemmen
Bronchus Clamps
Pinces-clamps à bronches
Pinzas-clamps para bronquios

28.4061-01

28.4061-02

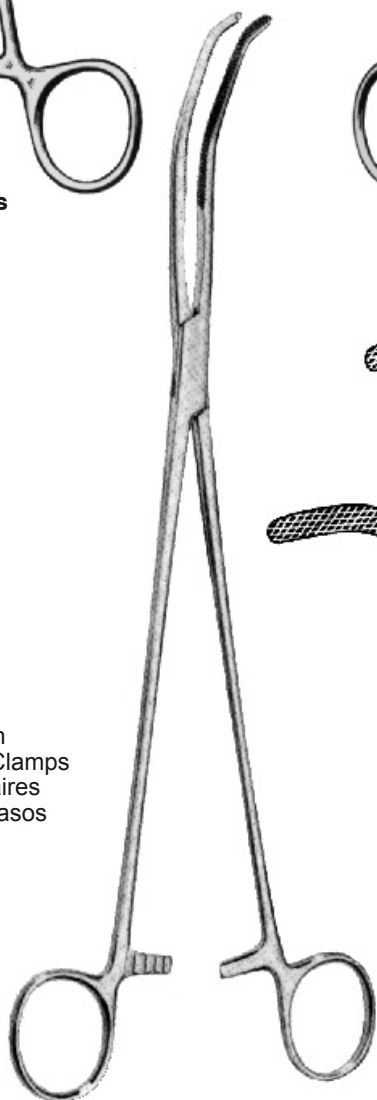

Satinsky
26,5 cm/10½"

Gefäßklemmen
Blood Vessel Clamps
Pinces vasculaires
Clamps para vasos

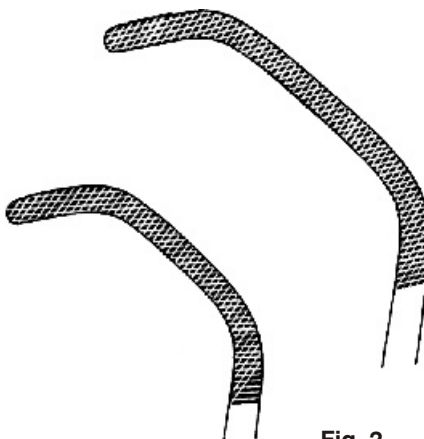
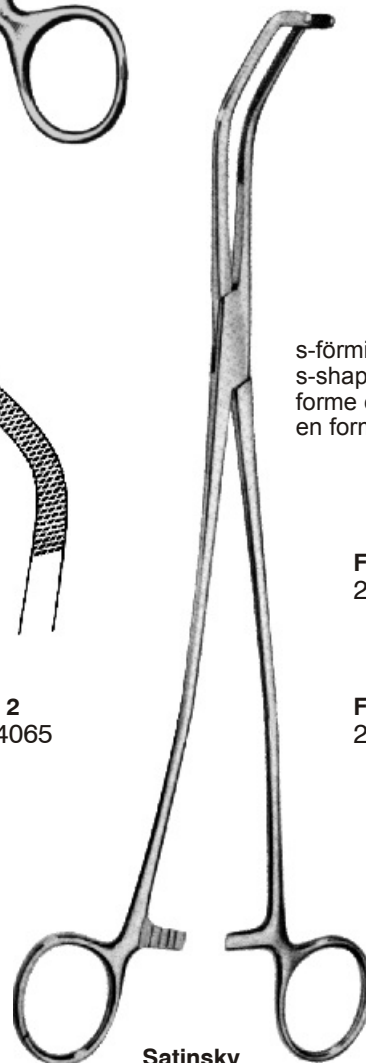

Fig. 1
28.4064

Fig. 2
28.4065



Satinsky
26,5 cm/10½"

s-förmig
s-shaped
forme en S
en forma de S

Fig. 1
28.4066

Fig. 2
28.4067

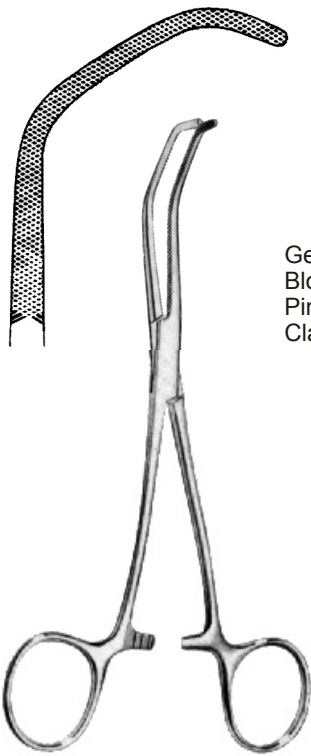

Baby-Satinsky

28.4068
15,0 cm/6"

Gefäßklemmen
Blood Vessel Clamps
Pinces vasculaires
Clamps para vasos

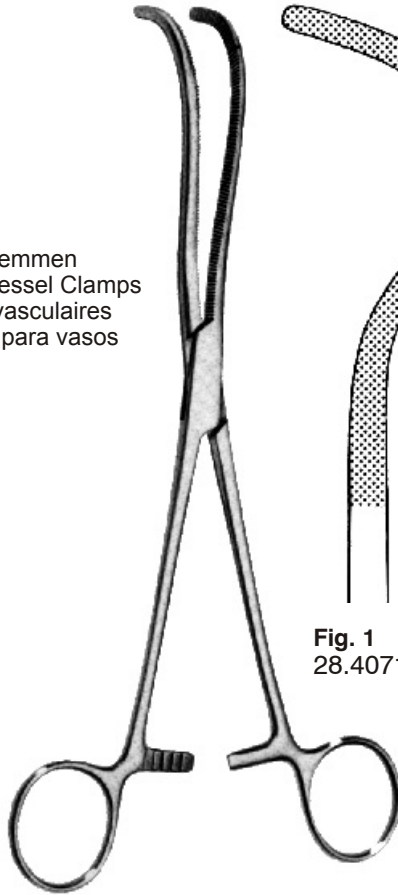

Fig. 1
28.4071

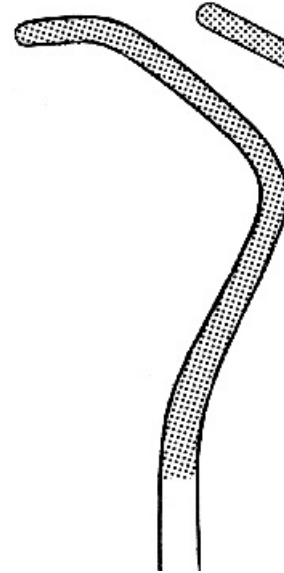

Fig. 2
28.4072

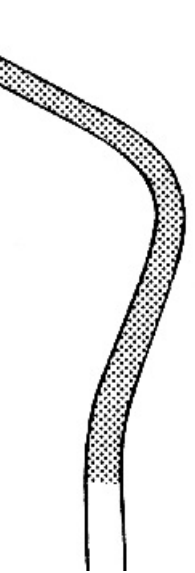

Fig. 3
28.4073

Harken
24,0 cm/9½"

Gefäßdilatoren
Vascular Dilators
Dilatateurs vasculaires
Dilatadores vasculares

biegsam
malleable
malléable
flexible

28



19,0 cm/7½"



28.4080-05
0,5 mmØ



28.4080-10
1,0 mmØ



28.4080-15
1,5 mmØ



28.4080-20
2,0 mmØ



28.4080-25
2,5 mmØ



28.4080-30
3,0 mmØ



28.4080-35
3,5 mmØ



28.4080-40
4,0 mmØ



28.4080-45
4,5 mmØ



28.4080-50
5,0 mmØ



28.4080-70
7,0 mmØ

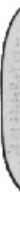

28.4080-90
9,0 mmØ

**Tracheotomie
Tracheotomy
Trachéotomie
Traqueotomía**

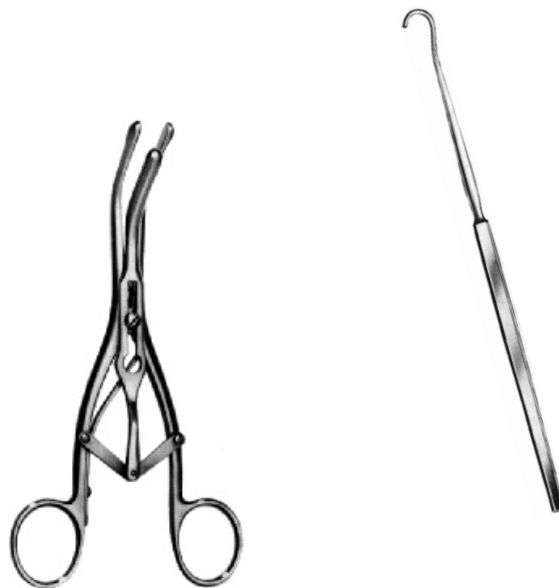

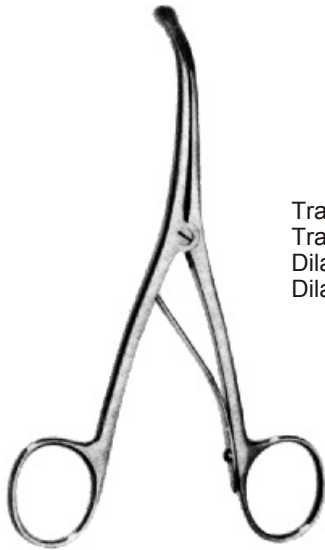

Trousseau

29.4100
14,0 cm/5½"

Tracheal-Dilatatoren
Trachea Dilators
Dilatateurs pour la trachéotomie
Dilatadores para la tráquea

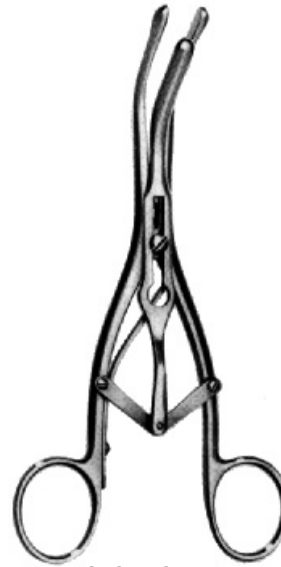

Laborde

29.4101
14,0 cm/5½"

Tracheal-Häkchen, Trachea Retractors, Crochets pour la trachéotomie, Ganchos para la tráquea



links
left
gauche
izquierda

1/2

Bose

29.4110-01
16,0 cm/6¼"



rechts
right
droit
derecha

1/2

Bose

29.4110-02
16,0 cm/6¼"



spitz
sharp
pointu
agudo

1/2

Iterson

29.4112-01
16,0 cm/6¼"

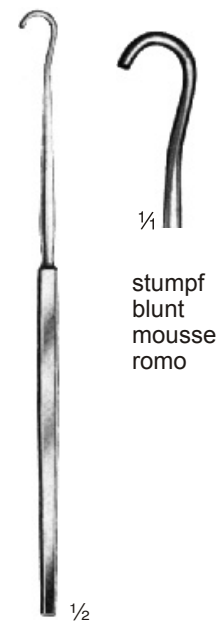

stumpf
blunt
mousse
romo

1/2

Iterson

29.4112-02
16,0 cm/6¼"

Tracheal-Häkchen

Trachea Retractors

Crochets pour la trachéotomie

Ganchos para la tráquea

Schilddrüsenhaken

Thyroid Gland Retractor

Ecarteur pour la thyroïde

Separador para la glándula tiroidea



Jackson

29.4113
15,0 cm/6"

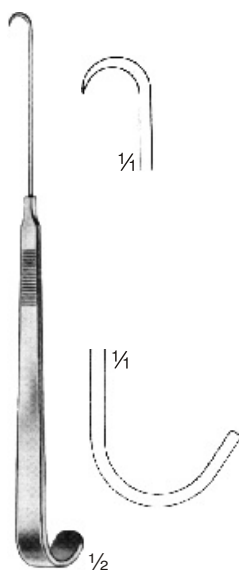

News

29.4114
15,0 cm/6"

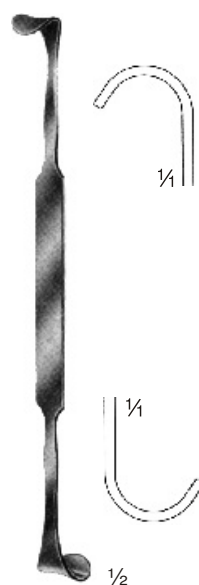

Rose

29.4115
13,5 cm/5"

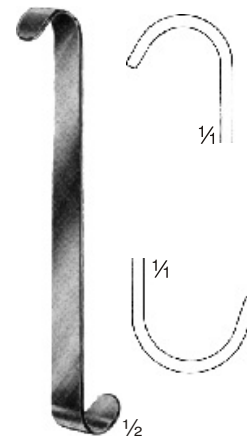

Luer

29.4116
11,0 cm/4 1/2"



Lukens

29.4117
17,0 cm/6 3/4"

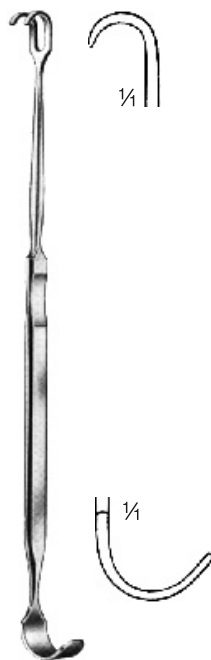

Jackson

29.4118
17,0 cm/6 3/4"



Schoenborn

29.4119
21,0 cm/8 1/4"

Schilddrüsenhaken
Thyroid Gland Retractor
Ecarteur pour la thyroïde
Separador para la glándula tiroidea

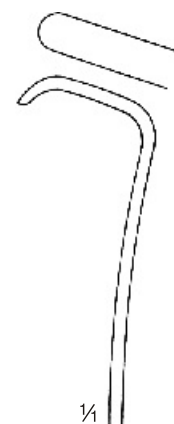

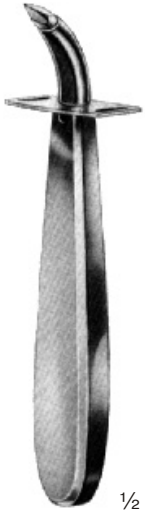

1/2

Uckermann
13,0 cm/5"



29.4120-07
7,5 mmØ



29.4120-09
9 mmØ

Tracheal-Trokare
Trachea Trocars
Trocarts pour la trachéotomie
Trocares para la tráquea



Kropffaßzange
Goitre Grasping Forceps
Pinces à goitre
Pinzas cogger-bocio

Lahey

29.4150-15
15,0 cm/6"

29.4150-20
20,0 cm/8"

Tracheal-Kanülen
Trachea Tubes
Canules pour la trachéotomie
Cánulas traqueales



Chevalier-Jackson

Fig.	L mm	Ø mm	Neusilber German silver Maillechort Plata nueva	Silber Silver Argent Plata
0	45	4	29.4130-01	29.4130-02
1	50	5	29.4131-01	29.4131-02
2	55	6	29.4132-01	29.4132-02
3	60	7	29.4133-01	29.4133-02
4	65	8	29.4134-01	29.4134-02
5	70	9	29.4135-01	29.4135-02
6	75	10	29.4136-01	29.4136-02
7	80	11	29.4137-01	29.4137-02
8	85	12	29.4138-01	29.4138-02
9	90	13	29.4139-01	29.4139-02

Narkose
Anaesthesia
Anesthésie
Anestesia





McIntosh

30.4200
Laryngoskopie-Besteck, bestehend aus:
Laryngoscope set, consisting of:
Trousse à laryngoscopie, composée de:
Juego para laryngoscopia, compuesto de:

Etui, case, boîte, estuche (30.4205-03)
Griff, handle, manche, mango (30.4225-01)
Spatel, blades, spatules, hojas
Fig. 1 (30.4203-01)
Fig. 2 (30.4203-02)
Fig. 3 (30.4203-03)



McIntosh

30.4202
Laryngoskopie-Besteck, bestehend aus:
Laryngoscope set, consisting of:
Trousse à laryngoscopie, composée de:
Juego para laryngoscopia, compuesto de:

Etui, case, boîte, estuche (30.4205-04)
Griff, handle, manche, mango (30.4225-01)
Spatel, blades, spatules, hojas
Fig. 1 (30.4203-01)
Fig. 2 (30.4203-02)
Fig. 3 (30.4203-03)
Fig. 4 (30.4203-04)

30.4205-03
Etui allein, passend für McIntosh Spatel und Griff
Case only, for McIntosh blades and handle
Boîte seule, pour McIntosh spatules et manche
Estuche solo, para McIntosh hojas y mango
Fig. 1 (30.4203-01)
Fig. 2 (30.4203-02)
Fig. 3 (30.4203-03)

30.4205-04
Etui allein, passend für McIntosh Spatel und Griff
Case only, for McIntosh blades and handle
Boîte seule, pour McIntosh spatules et manche
Estuche solo, para McIntosh hojas y mango
Fig. 1 (30.4203-01)
Fig. 2 (30.4203-02)
Fig. 3 (30.4203-03)
Fig. 4 (30.4203-04)

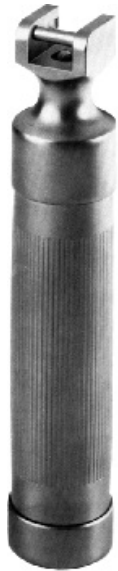

30.4225-01

Griff
Handle
Manche
Mango



30.4227-01

Ersatzbirne klein, 2,5 V
Spare bulb small, 2,5 V
Lampe de rechange petite, 2,5 V
Bombilla de repuesto pequeña, 2,5 V



30.4227-02

Ersatzbirne groß, 2,5 V
Spare bulb large, 2,5 V
Lampe de rechange grande, 2,5 V
Bombilla de repuesto grande, 2,5 V

McIntosh

← 75 mm →



Fig. 0
30.4203-00

← 90 mm →



Fig. 1
30.4203-01

← 110 mm →



Fig. 2
30.4203-02

← 130 mm →



Fig. 3
30.4203-03

← 150 mm →



Fig. 4
30.4203-04

Miller

30.4210
Laryngoskopie-Besteck, bestehend aus:
Laryngoscope set, consisting of:
Trousse à laryngoscopie, composée de:
Juego para laryngoscopia, compuesto de:

Etui, case, boîte, estuche (30.4213)
Griff, handle, manche, mango (30.4225-01)
Spatel, blades, spatules, hojas
Fig. 0 (30.4212-00)
Fig. 1 (30.4212-01)
Fig. 2 (30.4212-02)
Fig. 3 (30.4212-03)
Fig. 4 (30.4212-04)

30.4213
Etui allein, passend für Miller Spatel und Griff
Case only, for Miller blades and handle
Boîte seule, pour Miller spatules et manche
Estuche solo, para Miller hojas y mango
Fig. 0 (30.4212-00)
Fig. 1 (30.4212-01)
Fig. 2 (30.4212-02)
Fig. 3 (30.4212-03)
Fig. 4 (30.4212-04)

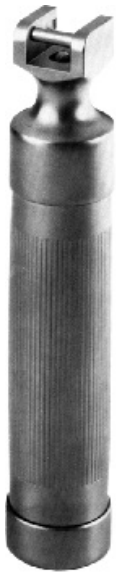

30.4225-01

Griff
Handle
Manche
Mango



30.4227-01

Ersatzbirne klein, 2,5 V
Spare bulb small, 2,5 V
Lampe de rechange petite, 2,5 V
Bombilla de repuesto pequeña, 2,5 V



30.4227-02

Ersatzbirne groß, 2,5 V
Spare bulb large, 2,5 V
Lampe de rechange grande, 2,5 V
Bombilla de repuesto grande, 2,5 V

Miller

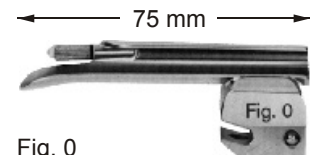

Fig. 0
30.4212-00



Fig. 1
30.4212-01

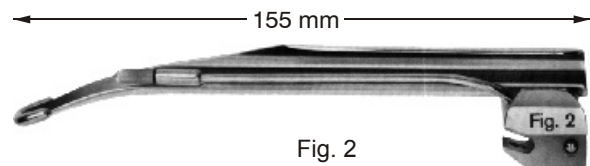

Fig. 2
30.4212-02

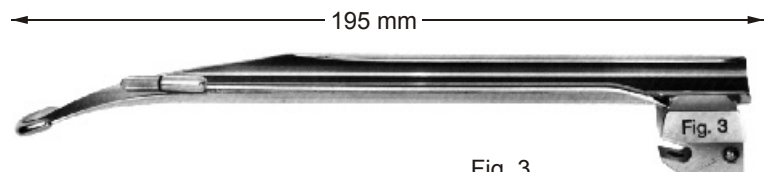

Fig. 3
30.4212-03

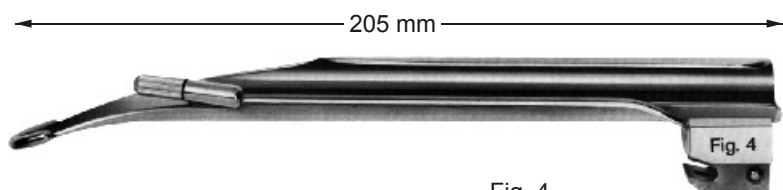

Fig. 4
30.4212-04

Etuis auf Anfrage erhältlich
 Cases available on request
 Boîtes sont disponibles à demande
 Estuches están disponibles a pregunta

Foregger



30.4227-01

Ersatzbirne klein, 2,5 V
 Spare bulb small, 2,5 V
 Lampe de rechange petite, 2,5 V
 Bombilla de repuesto pequeña, 2,5 V

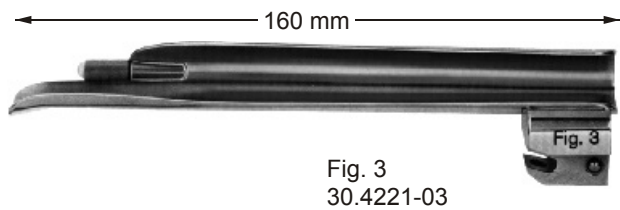

30.4227-02

Ersatzbirne groß, 2,5 V
 Spare bulb large, 2,5 V
 Lampe de rechange grande, 2,5 V
 Bombilla de repuesto grande, 2,5 V

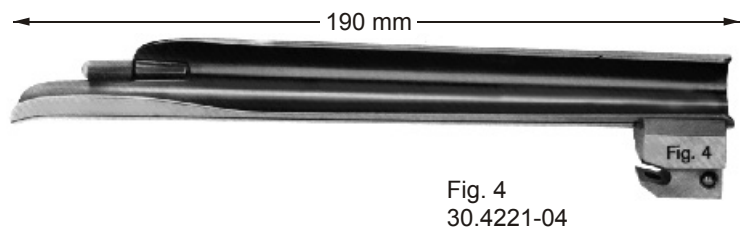

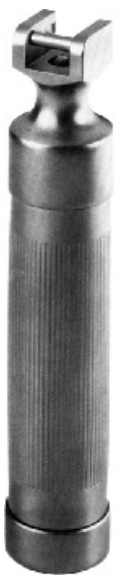

30.4225-01
30 mmØ



30.4225-02
30 mmØ



30.4225-03
18 mmØ

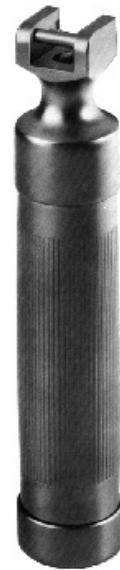

30.4226
30 mmØ



Griff mit Trafoanschluß
Handle with transformer connection
Manche avec connexion de transformation
Mango con conexión al transformador

McIntosh

McIntosh

30.4240

Laryngoskopie-Besteck, bestehend aus:
 Laryngoscope set, consisting of:
 Trousse à laryngoscopie, composée de:
 Juego para laryngoscopia, compuesto de:

Etui, case, boîte, estuche (30.4205-03)
 Griff, handle, manche, mango (30.4266-01)
 Spatel, blades, spatules, hojas
 Fig. 1 (30.4243-01)
 Fig. 2 (30.4243-02)
 Fig. 3 (30.4243-03)

30.4205-03

Etui allein, passend für McIntosh Spatel und Griff
 Case only, for McIntosh blades and handle
 Boîte seule, pour McIntosh spatules et manche
 Estuche solo, para McIntosh hojas y mango
 Fig. 1 (30.4243-01)
 Fig. 2 (30.4243-02)
 Fig. 3 (30.4243-03)

30.4205-04

Etui allein, passend für McIntosh Spatel und Griff
 Case only, for McIntosh blades and handle
 Boîte seule, pour McIntosh spatules et manche
 Estuche solo, para McIntosh hojas y mango
 Fig. 1 (30.4243-01)
 Fig. 2 (30.4243-02)
 Fig. 3 (30.4243-03)
 Fig. 4 (30.4243-04)

← 75 mm →

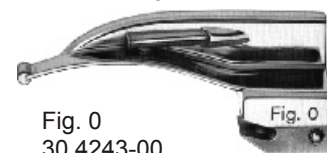

Fig. 0
30.4243-00

← 90 mm →



Fig. 1
30.4243-01

← 110 mm →



Fig. 2
30.4243-02

← 130 mm →



Fig. 3
30.4243-03

← 150 mm →



Fig. 4
30.4243-04



Miller

30.4250

Laryngoskopie-Besteck, bestehend aus:
Laryngoscope set, consisting of:
Trousse à laryngoscopie, composée de:
Juego para laryngoscopia, compuesto de:

Etui, case, boîte, estuche (30.4213)
Griff, handle, manche, mango (30.4266-01)
Spatel, blades, spatules, hojas
Fig. 0 (30.4253-00)
Fig. 1 (30.4253-01)
Fig. 2 (30.4253-02)
Fig. 3 (30.4253-03)
Fig. 4 (30.4253-04)

30.4213

Etui allein, passend für Miller Spatel und Griff
Case only, for Miller blades and handle
Boîte seule, pour Miller spatules et manche
Estuche solo, para Miller hojas y mango
Fig. 0 (30.4253-00)
Fig. 1 (30.4253-01)
Fig. 2 (30.4253-02)
Fig. 3 (30.4253-03)
Fig. 4 (30.4253-04)

Miller

75 mm



Fig. 0
30.4253-00

100 mm

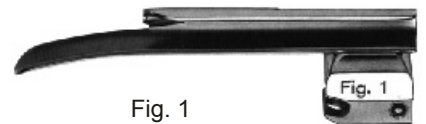

Fig. 1
30.4253-01

155 mm



Fig. 2
30.4253-02

195 mm



Fig. 3
30.4253-03

205 mm



Fig. 4
30.4253-04

Etuis auf Anfrage erhältlich
Cases available on request
Boîtes sont disponibles à demande
Estuches están disponibles a pregunta

Foregger

92 mm



Fig. 0
30.4263-00

115 mm



Fig. 1
30.4263-01

130 mm



Fig. 2
30.4263-02

160 mm



Fig. 3
30.4263-03

190 mm



Fig. 4
30.4263-04



30.4267

640 mA
Halogenlampe für Kaltlichtgriffe
Halogen-light for cold light handles
Halogen lampe pour manches de lumière froide
Halogen-lámpara para mangos de luz fría



30.4266-01
30 mmØ



30.4266-02
18 mmØ



30.4268
30 mmØ



mit 1,4 m Kabel
with 1,4 m cable
avec 1,4 m câble
con 1,4 m cable

30.4270-01
220 V

30.4270-02
110 V

Griff mit Trafoanschluß
Handle with transformer connection
Manche avec connexion de transformation
Mango con conexión al transformador

Transformator
Transformer
Transformateur
Transformador

30

**Magen und Darm
Stomach, Intestine
Estomac, Intestin
Estómago, Intestino**

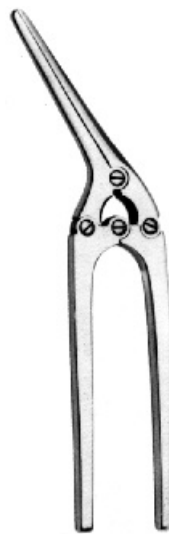



 4:5

31.4300 15,0 cm/6"

 5:6

31.4302 15,0 cm/6"
 31.4303 19,0 cm/7½"
 31.4304 25,0 cm/10"
 31.4313 22,0 cm/8¾"

 3:4

31.4308 15,0 cm/6"

Allis



 4:5

4:5

Allis-Baby

31.4301-13 13,0 cm/5"
 31.4301-14 14,0 cm/5½"



 9:10

9:10

Allis-Adair

31.4305 15,5 cm/6"

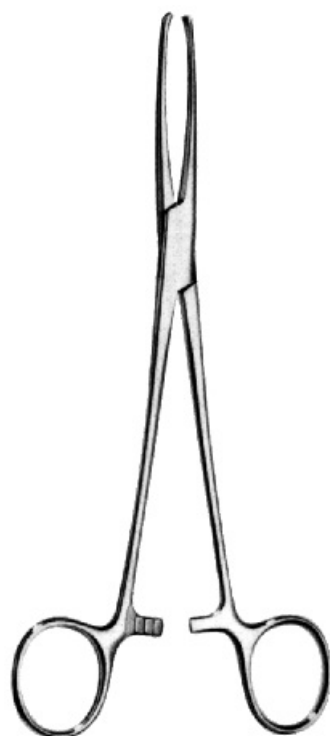

Judd-Allis

31.4306 15,0 cm/6"
 31.4307 19,0 cm/7½"

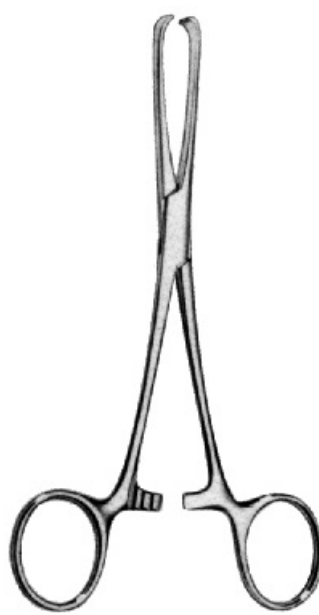

Boys-Allis

31.4309 15,0 cm/6"



Thoms-Allis

31.4310 20,0 cm/8"



Lockwood-Allis

31.4311 16,0 cm/6¼"
31.4312 20,0 cm/8"



atraumatisch
atraumatic
atraumatique
atraumática

Allis

31.4315-15 15,5 cm/6¼"
31.4315-20 20,0 cm/8"
31.4315-22 22,0 cm/9"
31.4315-25 25,0 cm/10"



Babcock

31.4319 14,0 cm/5½" (Baby)
31.4320 16,0 cm/6¼"
31.4321 18,0 cm/7"
31.4322 20,0 cm/8"
31.4323 24,0 cm/9½"

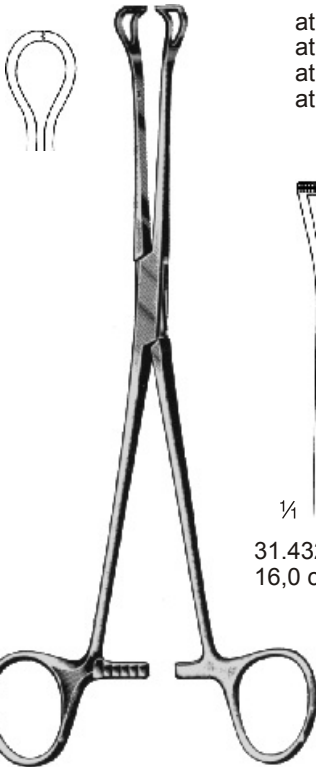

atraumatisch
atraumatic
atraumatique
atraumática

31.4324-16
16,0 cm/6¼"

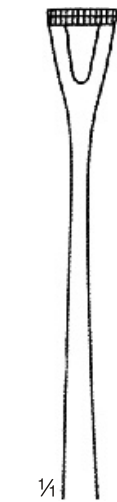

31.4324-21
21,0 cm/8¼"

Darmfaßzange
Intestinal Forceps
Pinces pour saisir l'intestin
Pinzas para coger intestinos

Babcock



Darmfaßzange
Intestinal Forceps
Pinces pour saisir l'intestin
Pinzas para coger intestinos

Williams

31.4330 20,0 cm/8"



Pyloruspreizer
 Pylorus spreader
 Ecarteur du pylore
 Separador para piloro

Benson

31.4332 15,5 cm/6"



Doyen

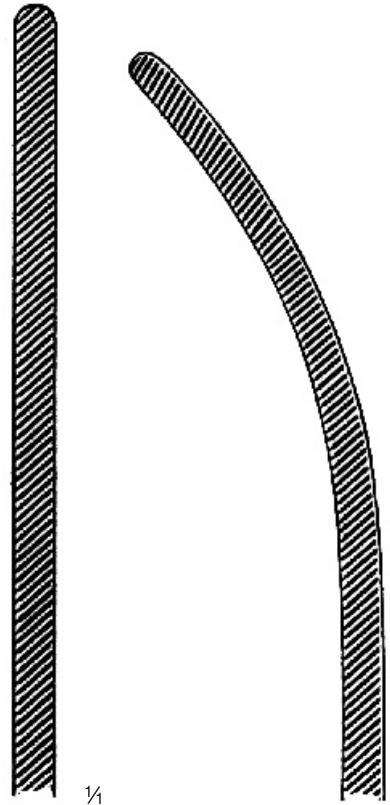

31.4399	17,0 cm/6 ³ / ₄ "	31.4400
31.4401	21,0 cm/8 ¹ / ₄ "	31.4403
31.4402	23,0 cm/9"	31.4404

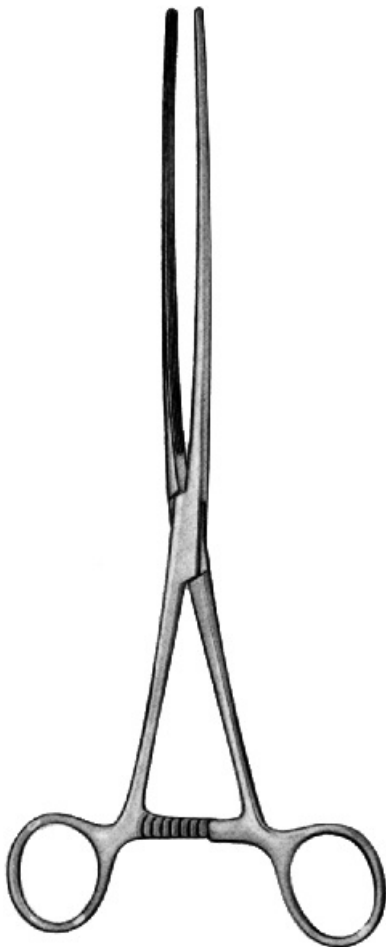

Mayo-Robson

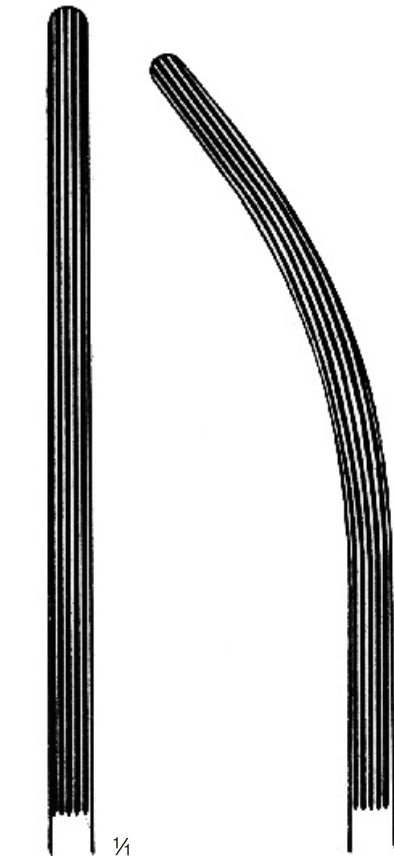

31.4405	21,0 cm/8 ¹ / ₄ "	31.4408
31.4406	23,0 cm/9"	31.4409
31.4407	25,0 cm/10"	31.4410



Kocher



¼

31.4411-22 22,0 cm/8¾"
31.4411-25 25,0 cm/10"
31.4411-28 28,0 cm/11"



Darmklemmen
Intestinal Clamp Forceps
Pinces-clamps intestinales
Pinzas-clamps intestinales

31.4412-22
31.4412-25
31.4412-28

Anastomosenklemmen
Anastomosis Clamp Forceps
Pinces-clamps pour l'anastomose
Pinzas-clamps para anastomosis

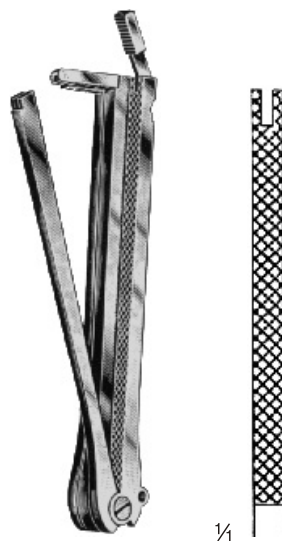

¼

De Martel-Wolfson

Maullänge
Length of jaw
Longueur du mors
Longitud de boca

	cm	in.	
Satz zu 3 Klemmen	5	2	31.4415-05
Set of 3 clamps	7	2¾	31.4415-07
Jeu de 3 clamps	10	4	31.4415-10

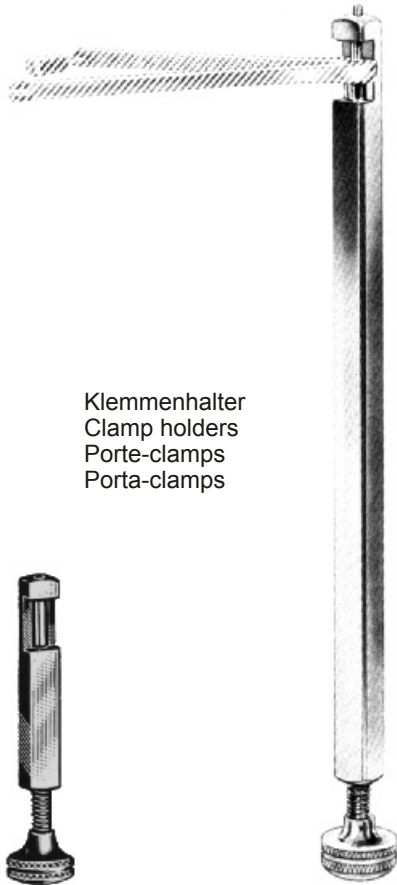

Klemmenhalter
 Clamp holders
 Porte-clamps
 Porta-clamps

De Martel-Wolfson

31.4416-08
 8,5 cm/3½"

De Martel-Wolfson

31.4416-23
 23,0 cm/9"



Klemmschließzange
 Clamp Closing Forceps
 Pinces pour fermer les clamps
 Pinzas para cerrar clamps

De Martel-Wolfson

31.4417-26
 26,0 cm/10¼"

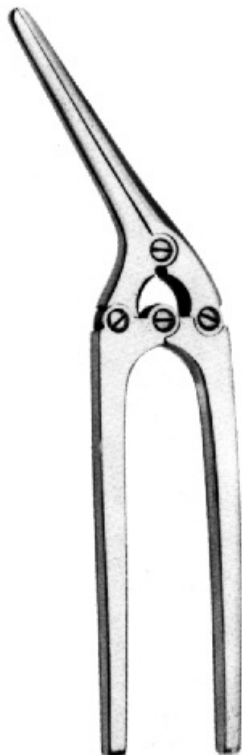

Darm- und Magenquetschklemme
 Intestinal and Stomach Clamp
 Pinces-clamps pour l'intestin et l'estomac
 Pinzas-clamps intestinales y estomacales

ohne Stift
 without pin
 sans cheville
 sin espiga

mit Stift
 with pin
 avec cheville
 con espiga

31.4420 15,0 cm/6"
 31.4422 21,0 cm/8¼"
 31.4424 29,0 cm/11½"
 31.4426 35,0 cm/13¾"

31.4421
 31.4423
 31.4425
 31.4427

Payr

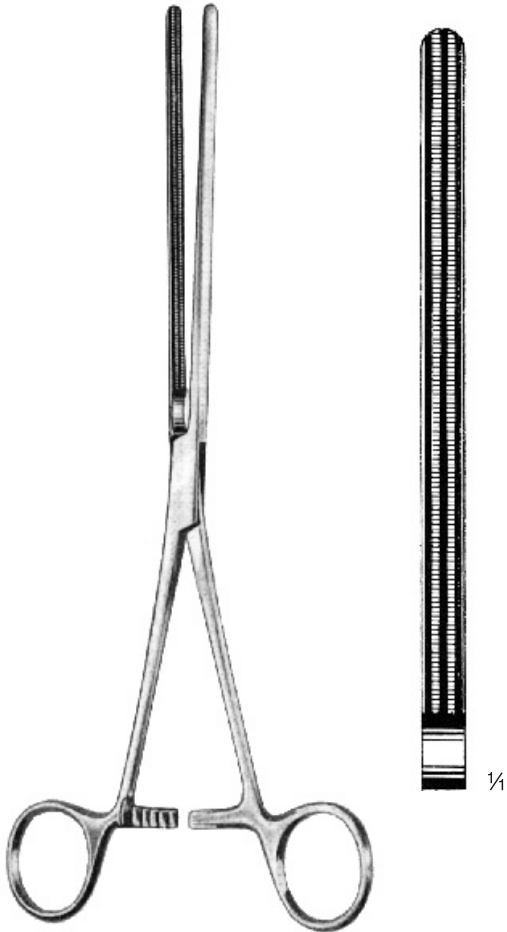

Doyen

- 31.4430-13 13,0 cm/5¼"
- 31.4430-16 16,0 cm/6¼"
- 31.4430-18 18,0 cm/7"
- 31.4430-21 21,0 cm/8½"
- 31.4430-23 23,0 cm/9"

atraumatisch
atraumatic
atraumatique
atraumática



Doyen

- 31.4431-13 13,0 cm/5¼"
- 31.4431-16 16,0 cm/6¼"
- 31.4431-18 18,0 cm/7"
- 31.4431-21 21,0 cm/8½"
- 31.4431-23 23,0 cm/9"

atraumatisch
atraumatic
atraumatique
atraumática



Mayo-Robson

atraumatisch
atraumatic
atraumatique
atraumática



31.4432-25
25,0 cm/10"

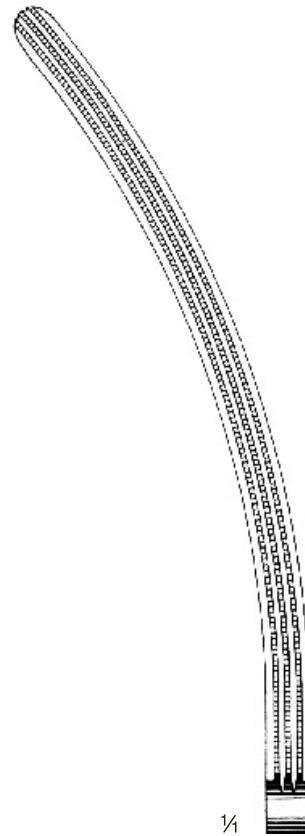

31.4433-25
25,0 cm/10"



Kocher

atraumatisch
atraumatic
atraumatique
atraumática

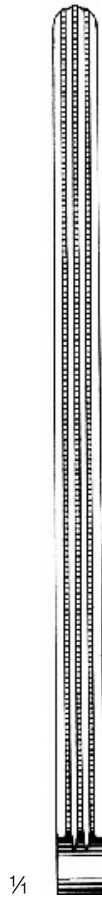

¼

31.4434-22 22,0 cm/8¾"
31.4434-25 25,0 cm/10"
31.4434-28 28,0 cm/11"



¼

31.4435-22 22,0 cm/8¾"
31.4435-25 25,0 cm/10"
31.4435-28 28,0 cm/11"

**Galle, Niere, Urologie
Bile, Kidney, Urology
Bile, Rein, Urologie
Vesícula biliar, Riñon, Urología**





Fig. 1

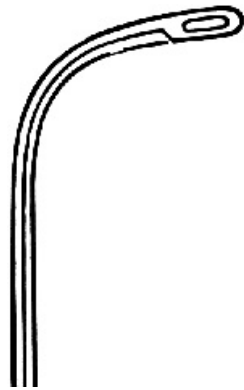

Fig. 2

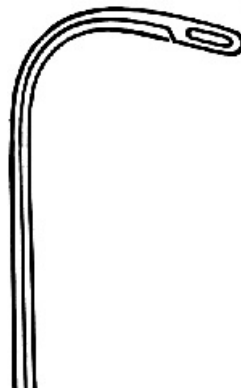

Fig. 3

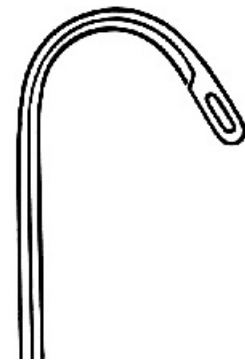

Fig. 4

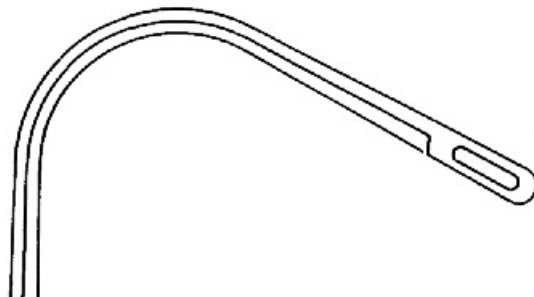

Fig. 5

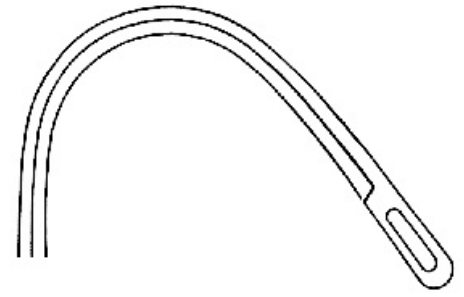
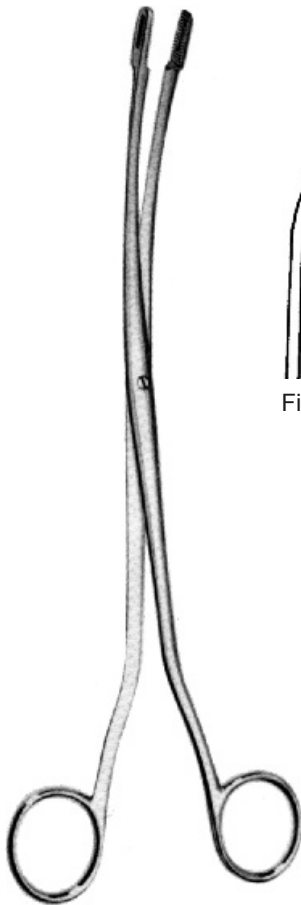
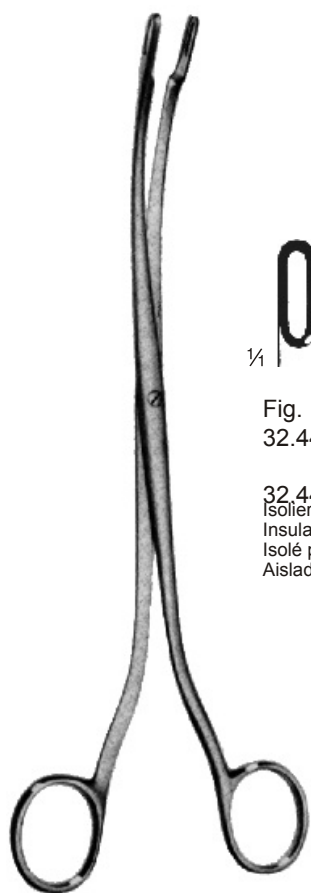

Fig. 6



Randall

Fig. 1	32.4450	23,0 cm/9"
Fig. 2	32.4451	22,0 cm/8¾"
Fig. 3	32.4452	22,0 cm/8¾"
Fig. 4	32.4453	22,0 cm/8¾"
Fig. 5	32.4454	19,0 cm/7½"
Fig. 6	32.4455	19,0 cm/7½"



Desjardins
 23,0 cm/9"



Fig. 1
 32.4460



Fig. 2
 32.4461

32.4460L
 Isoliert für Laser- und Elektrochirurgie
 Insulated for Laser- and Electrosurgery
 Isolé pour les interventions au laser et électrochirurgical
 Aislado para láser y electrocirugía



Blake
 20,0 cm/8"



32.4462
 gerade
 straight
 droite
 recta

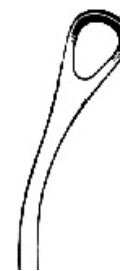

32.4463
 gebogen
 curved
 courbe
 curva

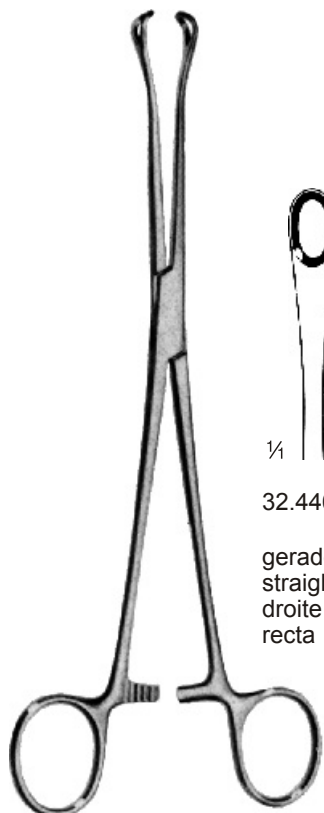

Mayo-Blake
 20,0 cm/8"



32.4464
 gerade
 straight
 droite
 recta

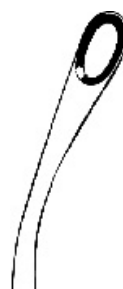

32.4465
 gebogen
 curved
 courbe
 curva



Mixer

32.4466
 22,0 cm/8¾"

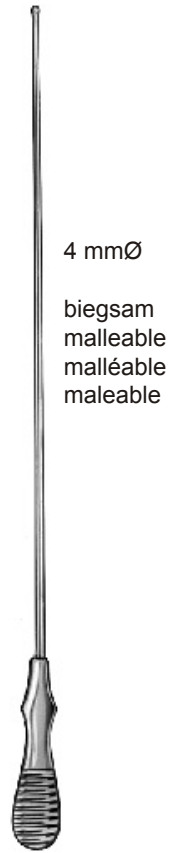

4 mmØ
biegsam
malleable
malléable
maleable

Mayo

32.4470
32,0 cm/12½"



4 mm 5 mm 6 mm
¼
32.4471 32.4472 32.4473

federnd
elastic
élastique
elástica

Desjardins
28,0 cm/11"



biegsam
malleable
malléable
maleable

Gallengangdilatoren
Bile Duct Dilators
Dilatateurs à voies biliaires
Dilatadores para conducto biliar

¼

32

32.4481 32.4483 32.4485 32.4487 32.4489 32.4491 32.4493
32.4482 32.4484 32.4486 32.4488 32.4490 32.4492

Bakes
30,0 cm/12"

aus Kupfer
of copper
en cuivre
de cobre



4 mm



Fig. 1
32.4501

7 mm



Fig. 2
32.4502

9 mm



Fig. 3
32.4503

15 mm



Fig. 4
32.4504

Luer-Koerte
26,0 cm/10¹/₄"

biegsam
malleable
malléable
maleable



Luer-Koerte
32,0 cm/12³/₄"

biegsam
malleable
malléable
maleable

2,5 mm



1/4

Fig. 000
32.4505-01

3,2 mm



Fig. 00
32.4505-02

3,6 mm



Fig. 0
32.4505-03

5,5 mm



Fig. 1
32.4505-04

6,7 mm



Fig. 2
32.4505-05

8,0 mm



Fig. 3
32.4505-06

11 mm



Fig. 4
32.4505-07

15 mm



Fig. 5
32.4505-08



6 mm



Fig. 1
32.4511

7 mm



Fig. 2
32.4512

8 mm



Fig. 3
32.4513

9 mm



¼
Fig. 4
32.4514

Desjardins
30,0 cm/12"

federnd
elastic
élastique
elástica



Moore

32.4520
28,0 cm/11"



Mayo

32.4525
28,0 cm/11"



Metallkatheter
 Metal Catheters
 Sondes métalliques
 Sondas metálicas

für Männer
 for male
 pour hommes
 para hombres

29,0 cm/11½"



für Frauen
 for female
 pour femmes
 para mujeres

16,0 cm/6¼"

Katheter-Einführungsinstrument
 Catheter introducing instrument
 Instrument pour introduire des sondes
 Instrumento para introducir catéteres



Charr.

32.4600-06	6
32.4600-08	8
32.4600-10	10
32.4600-12	12
32.4600-14	14
32.4600-16	16
32.4600-18	18
32.4600-20	20
32.4600-22	22
32.4600-24	24

Charr.

32.4602-06	6
32.4602-07	7
32.4602-08	8
32.4602-09	9
32.4602-10	10
32.4602-11	11
32.4602-12	12
32.4602-13	13
32.4602-14	14
32.4602-15	15
32.4602-16	16
32.4602-18	18
32.4602-20	20
32.4602-22	22
32.4602-24	24

Guyon

32.4604
 36,5 cm/14½"

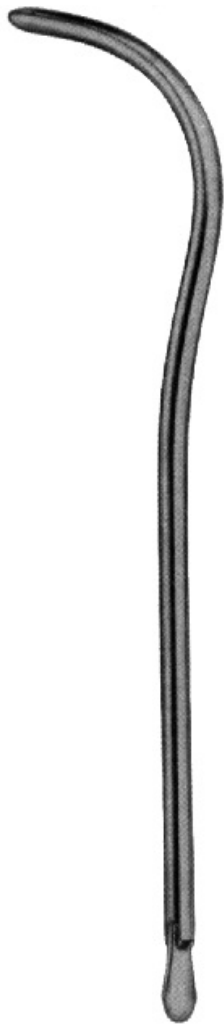

Guyon

ohne Innengewinde
without internal thread
sans filet
sin rosca interior

Béniqué Nr.		Charr.
24	32.4610-24	12
25	32.4610-25	
26	32.4610-26	13
27	32.4610-27	
28	32.4610-28	14
29	32.4610-29	
30	32.4610-30	15
31	32.4610-31	
32	32.4610-32	16
33	32.4610-33	
34	32.4610-34	17
35	32.4610-35	
36	32.4610-36	18
37	32.4610-37	
38	32.4610-38	19
39	32.4610-39	
40	32.4610-40	20
41	32.4610-41	
42	32.4610-42	21
43	32.4610-43	
44	32.4610-44	22
45	32.4610-45	
46	32.4610-46	23
47	32.4610-47	
48	32.4610-48	24
49	32.4610-49	
50	32.4610-50	25
51	32.4610-51	
52	32.4610-52	26
53	32.4610-53	
54	32.4610-54	27
55	32.4610-55	
56	32.4610-56	28
57	32.4610-57	
58	32.4610-58	29
59	32.4610-59	
60	32.4610-60	30

mit Innengewinde
with internal thread
avec filet
con rosca interior

Béniqué Nr.		Charr.
24	32.4611-24	12
25	32.4611-25	
26	32.4611-26	13
27	32.4611-27	
28	32.4611-28	14
29	32.4611-29	
30	32.4611-30	15
31	32.4611-31	
32	32.4611-32	16
33	32.4611-33	
34	32.4611-34	17
35	32.4611-35	
36	32.4611-36	18
37	32.4611-37	
38	32.4611-38	19
39	32.4611-39	
40	32.4611-40	20
41	32.4611-41	
42	32.4611-42	21
43	32.4611-43	
44	32.4611-44	22
45	32.4611-45	
46	32.4611-46	23
47	32.4611-47	
48	32.4611-48	24
49	32.4611-49	
50	32.4611-50	25
51	32.4611-51	
52	32.4611-52	26
53	32.4611-53	
54	32.4611-54	27
55	32.4611-55	
56	32.4611-56	28
57	32.4611-57	
58	32.4611-58	29
59	32.4611-59	
60	32.4611-60	30

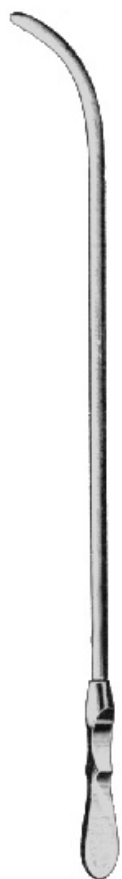

Dittel
35,0 cm/14"

gebogen
curved
courbe
curva

Charr.

32.4613-06	6
32.4613-07	7
32.4613-08	8
32.4613-09	9
32.4613-10	10
32.4613-11	11
32.4613-12	12
32.4613-13	13
32.4613-14	14
32.4613-15	15
32.4613-16	16
32.4613-17	17
32.4613-18	18
32.4613-19	19
32.4613-20	20
32.4613-21	21
32.4613-22	22
32.4613-23	23
32.4613-24	24
32.4613-25	25
32.4613-26	26
32.4613-27	27
32.4613-28	28
32.4613-29	29
32.4613-30	30
32.4613-31	31
32.4613-32	32
32.4613-33	33
32.4613-34	34
32.4613-35	35
32.4613-36	36

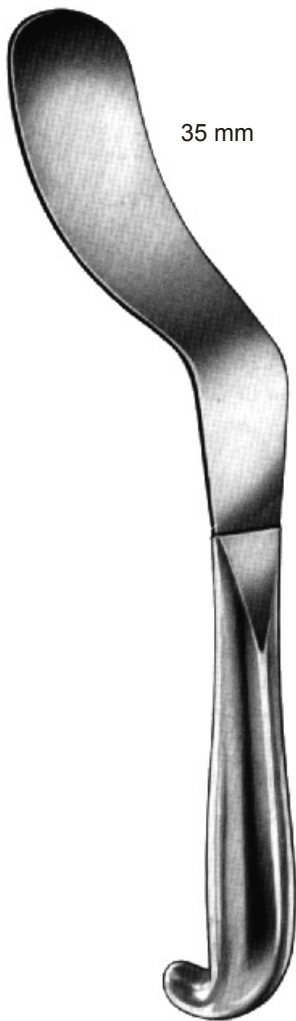

35 mm

Legue

32.4620
27,0 cm/10½"



56 mm

Kocher

32.4621
26,0 cm/10¼"



67 mm

Kocher

32.4622
26,0 cm/10¼"

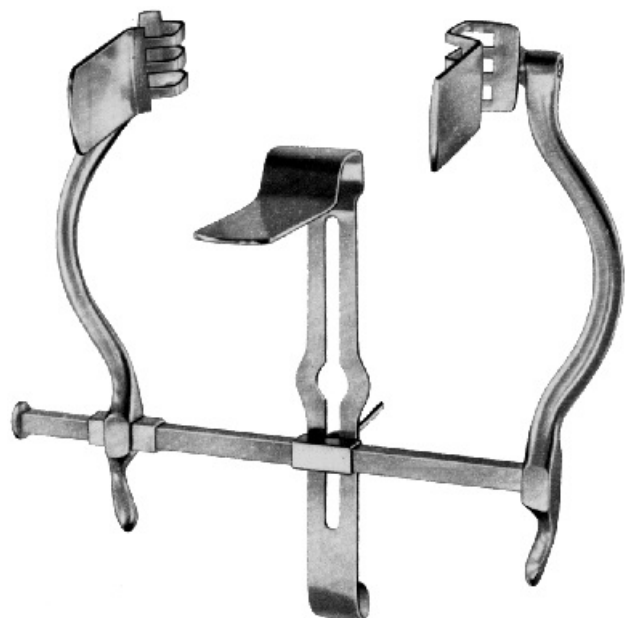

Judd-Masson
 32.4625

110 mm	73 x 28 mm	73 x 28 mm
Spreizweite	Seitliche Valven	Mittelvalve
Spread	Lateral blades	Center blade
Ecartement	Valves latérales	Valve centrale
Apertura de la hoja	Valvas laterales	Valva central



Millin

32.4626-00

32.4626-10

Sperrer
 Spreader
 Ecarteur
 Separador

bestehend aus:
 consisting of:
 composé de:
 compuesto de:

Seitliche Valven, Lateral blades
 Valves latérales, Valvas laterales
 32.4626-57 57 x 25 mm
 32.4626-80 80 x 25 mm

Mittelvalve, Center blade
 Valve centrale, Valva central
 32.4626-99 120 x 45 mm



Legueu
 32.4627

95 mm	28 x 60 mm	70 x 32 mm
Spreizweite	Seitliche Valven	Mittelvalve
Spread	Lateral blades	Center blade
Ecartement	Valves latérales	Valve centrale
Apertura de la hoja	Valvas laterales	Valva central

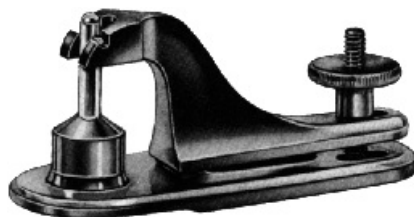

Beschneidungsinstrumente
Circumcision Instruments
Instrumentos de circuncisión
Instrumentos para circuncisión

32.4648-08	8 mm
32.4648-11	11 mm
32.4648-13	13 mm
32.4648-16	16 mm
32.4648-21	21 mm
32.4648-26	26 mm
32.4648-32	32 mm

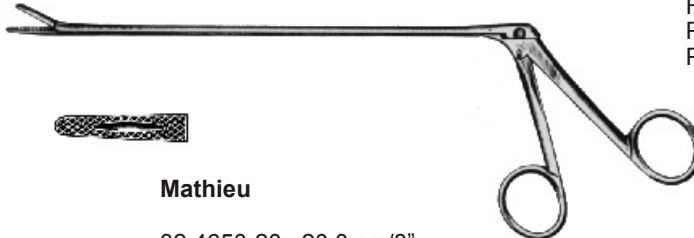

Fremdkörperzangen
Foreign Body Forceps
Pinces à corps étrangers
Pinzas para cuerpos extraños

Mathieu

32.4650-20	20,0 cm/8"
32.4650-28	28,0 cm/11"

Penisklemmen
Penis Seizing Forceps
Compresseurs de l'urètre
Compresores uretrales



Strauss

32.4656	11,0 cm/4½"
---------	-------------



Stockmann

32.4657	8,0 cm/3¼"
---------	------------

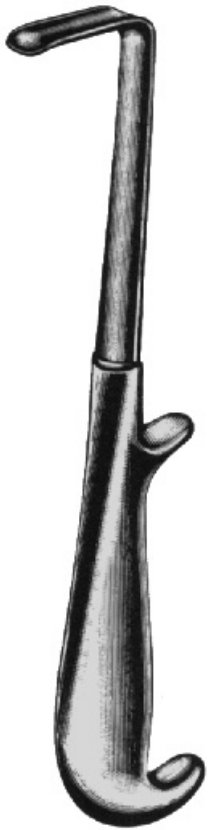

Young

32.4660
21,5 cm/8½"



Young

32.4661
21,0 cm/8½"

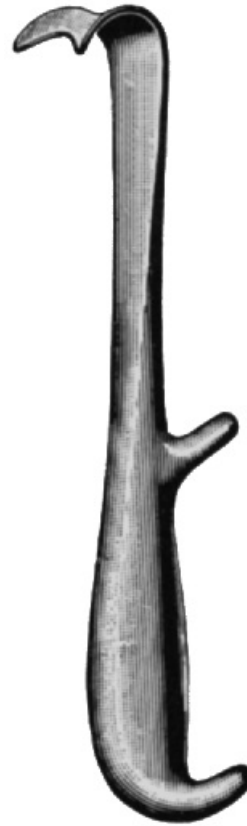

Young

32.4662
22,0 cm/8¾"



Young

32.4663
21,0 cm/8½"

atraumatisch
atraumatic
atraumatique
atraumática

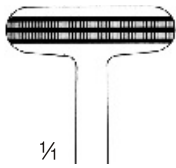

¼
32.4670
23,5 cm/9¼"



32.4671
24,5 cm/9¾"

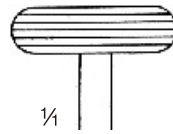

¼
Fig. 1
32.4672-01
23,0 cm/9"



Fig. 2
32.4672-02
23,0 cm/9"

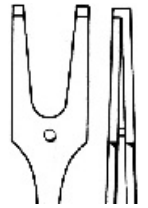
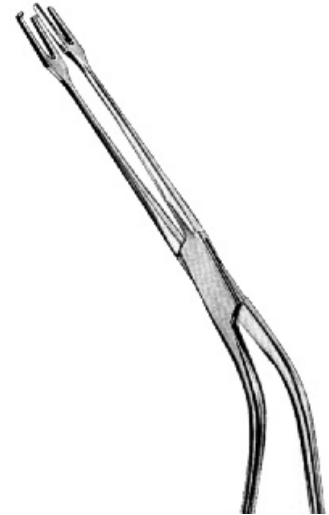
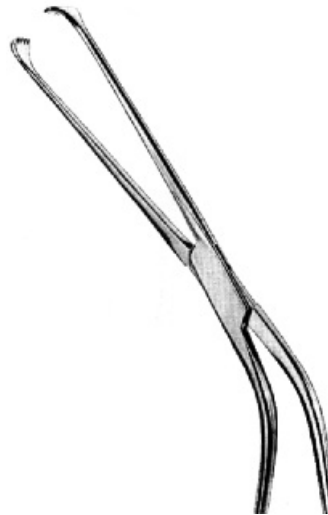

Fig. 3
32.4672-03
24,0 cm/9½"



Millin



Gynäkologie, Geburtshilfe
Gynecology, Obstetrics
Gynécologie, Accouchement
Ginecología, Obstetricia





Kristeller

33.4700

70 x 15 mm
Satz, set, jeu, juego

für Kinder
for children
pour enfants
para niños

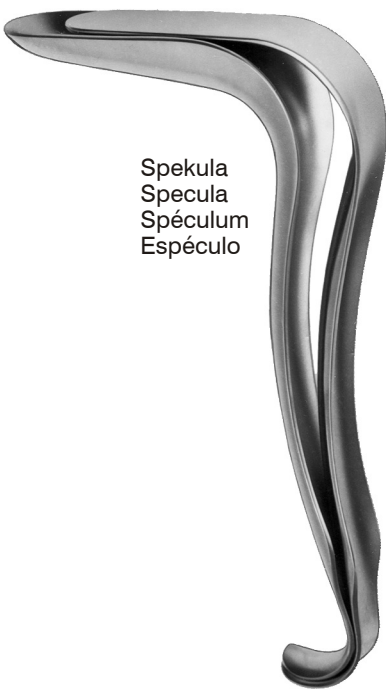

Spekula
Specula
Spéculum
Espéculo

Halter
Retractor
Valve
Valva

Satz aus je 1 Spekula und 1 Halter
Set of 1 specula and 1 retractor
Jeu de 1 spéculum et 1 valve
Juego de 1 espéculo y 1 valva

Fig. 1 33.4701

Fig. 2 33.4702

Fig. 3 33.4703

Spekula
Specula
Spéculum
Espéculo

Fig. 1 33.4701-01 70 x 27 mm

Fig. 2 33.4702-02 80 x 30 mm

Fig. 3 33.4703-03 90 x 36 mm

Halter
Retractor
Valve
Valva

Fig. 1 33.4701-11 75 x 23 mm

Fig. 2 33.4702-12 85 x 26 mm

Fig. 3 33.4703-13 100 x 32 mm

Kristeller
kurzes Modell
short model
modèle court
modelo corto

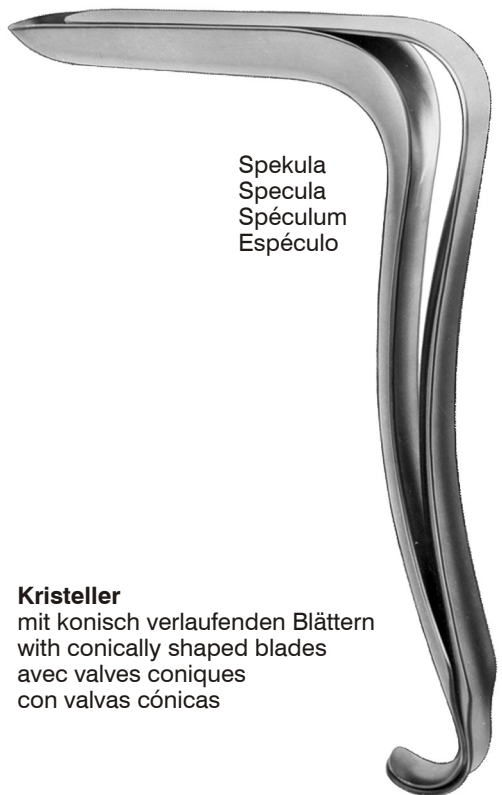

Spekula
 Specula
 Spéculum
 Espéculo

Halter
 Retractor
 Valve
 Valva

Kristeller
 mit konisch verlaufenden Blättern
 with conically shaped blades
 avec valves coniques
 con valvas cónicas

Satz aus je 1 Spekula und 1 Halter
 Set of 1 specula and 1 retractor
 Jeu de 1 spéculum et 1 valve
 Juego de 1 espéculo y 1 valva

Fig. 00 33.4709
Fig. 0 33.4710

Spekula
 Specula
 Spéculum
 Espéculo

Fig. 00 33.4709-01 105 x 18 mm
Fig. 0 33.4710-01 105 x 21 mm

Halter
 Retractor
 Valve
 Valva

Fig. 00 33.4709-11 110 x 14 mm
Fig. 0 33.4710-11 110 x 17 mm

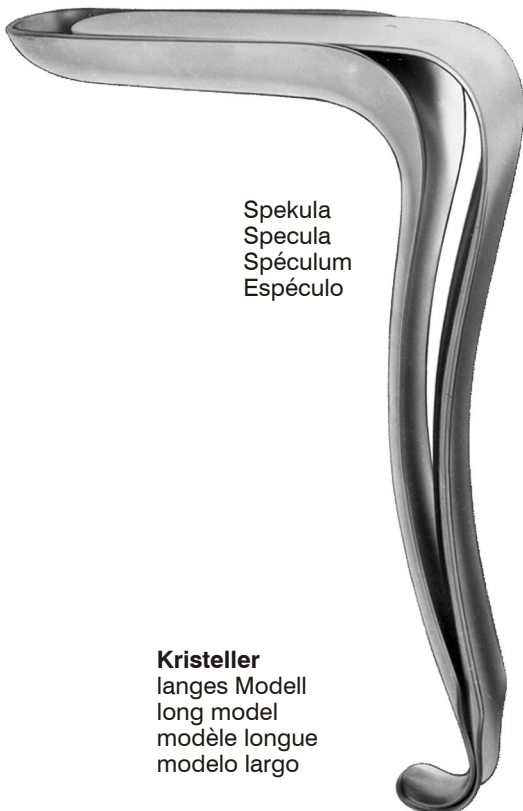

Spekula
 Specula
 Spéculum
 Espéculo

Halter
 Retractor
 Valve
 Valva

Kristeller
 langes Modell
 long model
 modèle long
 modelo largo

Satz aus je 1 Spekula und 1 Halter
 Set of 1 specula and 1 retractor
 Jeu de 1 spéculum et 1 valve
 Juego de 1 espéculo y 1 valva

Fig. 1 33.4721
Fig. 2 33.4722
Fig. 3 33.4723

Spekula
 Specula
 Spéculum
 Espéculo

Fig. 1 33.4721-01 105 x 26 mm
Fig. 2 33.4722-02 105 x 28 mm
Fig. 3 33.4723-03 105 x 33 mm

Halter
 Retractor
 Valve
 Valva

Fig. 1 33.4721-11 115 x 22 mm
Fig. 2 33.4722-12 115 x 24 mm
Fig. 3 33.4723-13 115 x 29 mm

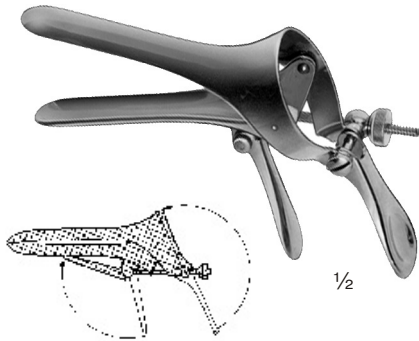

Cusco

33.4800 85 x 17 mm
für Jungfrauen
for virgins
pour vierges
para virgenes

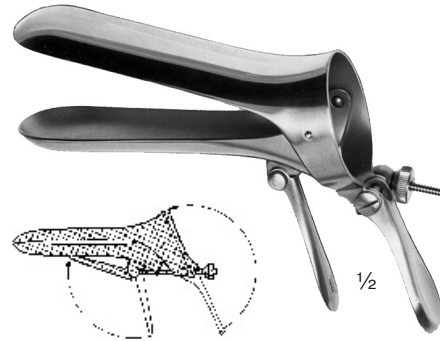

Cusco

Fig. 1 33.4801 75 x 32 mm
Fig. 2 33.4802 85 x 35 mm
Fig. 3 33.4803 100 x 35 mm

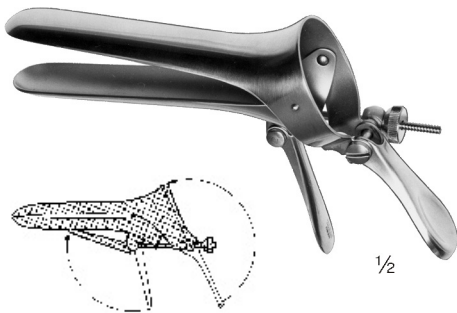

Cusco

Fig. 1 33.4805 90 x 23/25 mm
Fig. 2 33.4806 100 x 25/27 mm
Fig. 3 33.4807 110 x 27/30 mm

Schweizer Modell
Swiss pattern
Modèle suisse
Modelo suizo



Grave

Fig. 1 33.4811 85 x 33 mm
Fig. 2 33.4812 95 x 33 mm
Fig. 3 33.4813 105 x 33 mm



Seyffert
 23,0 cm/9"

- 33.4816-01 100 x 17 mm
- 33.4816-02 110 x 33 mm

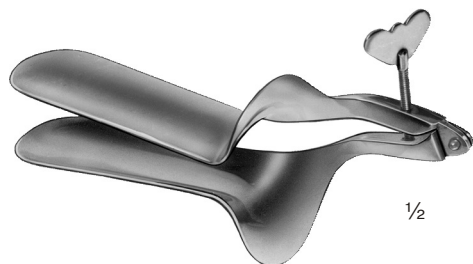

Collin

- Fig. 1** 33.4821 90 x 29 mm
- Fig. 2** 33.4822 95 x 35 mm
- Fig. 3** 33.4823 110 x 40 mm

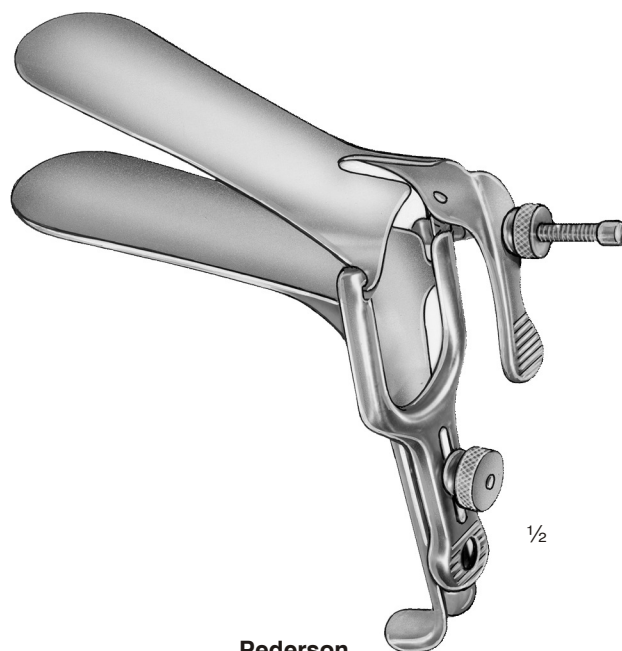

Pederson

- Fig. 1** 33.4824 75 x 13 mm
- Fig. 2** 33.4825 100 x 22 mm
- Fig. 3** 33.4826 120 x 25 mm



Grave

- Fig. 1** 33.4811L 85 x 33 mm
Fig. 2 33.4812L 95 x 33 mm
Fig. 3 33.4813L 105 x 33 mm



Pederson

- Fig. 1** 33.4824L 75 x 13 mm
Fig. 2 33.4825L 100 x 22 mm
Fig. 3 33.4826L 120 x 25 mm



Semm

- Fig. 1** 33.4827 95 x 14/18 mm
- Fig. 2** 33.4828 100 x 20/25 mm
- Fig. 3** 33.4829 105 x 27/35 mm

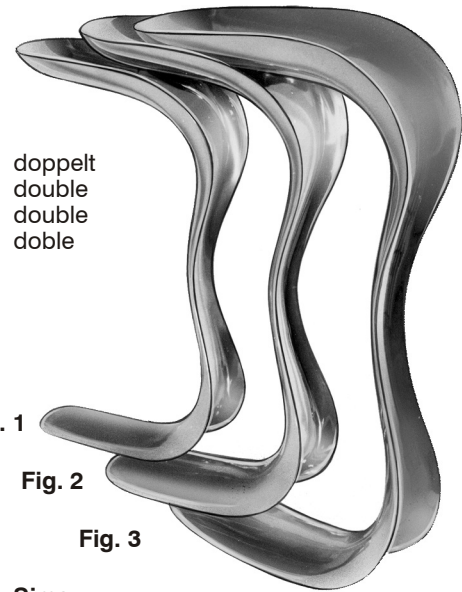

doppelt
 double
 double
 double

Fig. 1

Fig. 2

Fig. 3

Sims

- Fig. 1** 33.4831 25 x 30 mm
- Fig. 2** 33.4832 30 x 35 mm
- Fig. 3** 33.4833 35 x 40 mm



Spekula
 Specula
 Spéculum
 Espéculo

- Fig. 1** 33.4834-01 70 x 40 mm
- Fig. 2** 33.4834-02 90 x 40 mm



Halter
 Retractor
 Valve
 Valva

- Fig. 1** 33.4835-01 70 x 33 mm
- Fig. 2** 33.4835-02 90 x 33 mm

Kallmorgen

Satz aus je 1 Spekula und 1 Halter
 Set of 1 specula and 1 retractor
 Jeu de 1 spéculum et 1 valve
 Juego de 1 espéculo y 1 valva

- Fig. 1** 33.4836-01 17,0 cm/6³/₄"
- Fig. 2** 33.4836-02 20,0 cm/8"



1/2

Breisky

29,0 cm/11 1/2"

33.4837-20	100 x 20 mm
33.4837-25	100 x 25 mm
33.4837-30	100 x 30 mm
33.4837-35	100 x 35 mm
33.4837-40	100 x 40 mm

32,0 cm/12 1/2"

33.4838-20	130 x 20 mm
33.4838-25	130 x 25 mm
33.4838-30	130 x 30 mm
33.4838-35	130 x 35 mm
33.4838-40	130 x 40 mm

35,0 cm/13 3/4"

33.4839	155 x 40 mm
---------	-------------



1/2

Doyen

33.4840 70 x 30 mm
24,0 cm/9 1/2"



Spekula
 Specula
 Spéculum
 Espéculo

Halter
 Retractor
 Valve
 Valva

Mathieu

21,0 cm/8¼"

Spekula
 Specula
 Spéculum
 Espéculo

33.4840-01 95 x 17-30 mm

Halter
 Retractor
 Valve
 Valva

33.4840-02 95 x 17-26 mm

½

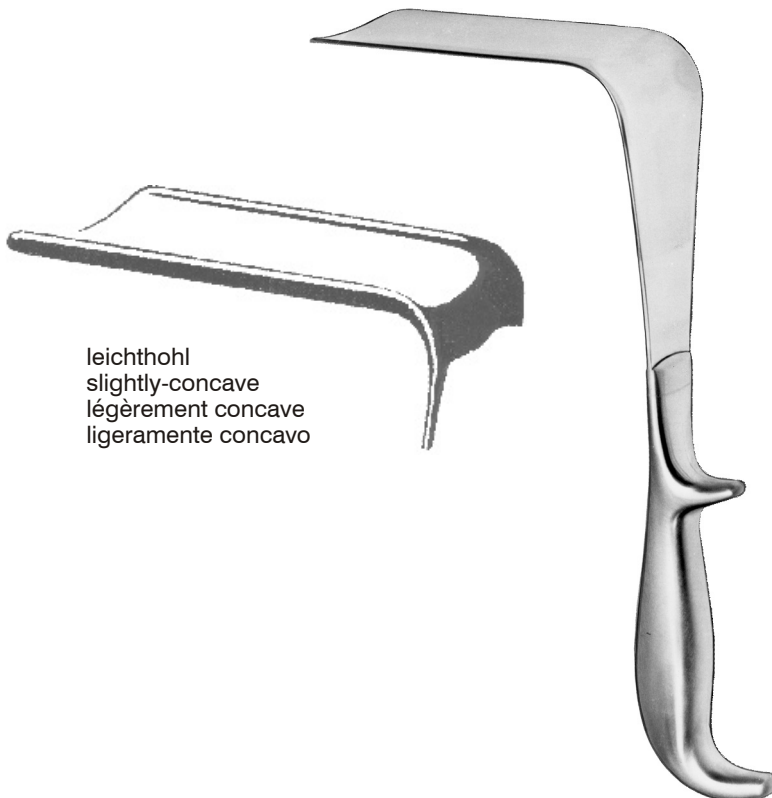

leichthohl
 slightly-concave
 légèrement concave
 ligeramente concavo

Doyen

- Fig. 1 33.4841 60 x 35 mm
- Fig. 2 33.4842 90 x 35 mm
- Fig. 3 33.4843 120 x 35 mm
- Fig. 4 33.4844 160 x 35 mm

- Fig. 1 33.4851 60 x 45 mm
- Fig. 2 33.4852 90 x 45 mm
- Fig. 3 33.4853 120 x 45 mm
- Fig. 4 33.4854 160 x 45 mm

- Fig. 1 33.4861 60 x 60 mm
- Fig. 2 33.4862 90 x 60 mm
- Fig. 3 33.4863 120 x 60 mm
- Fig. 4 33.4864 160 x 60 mm

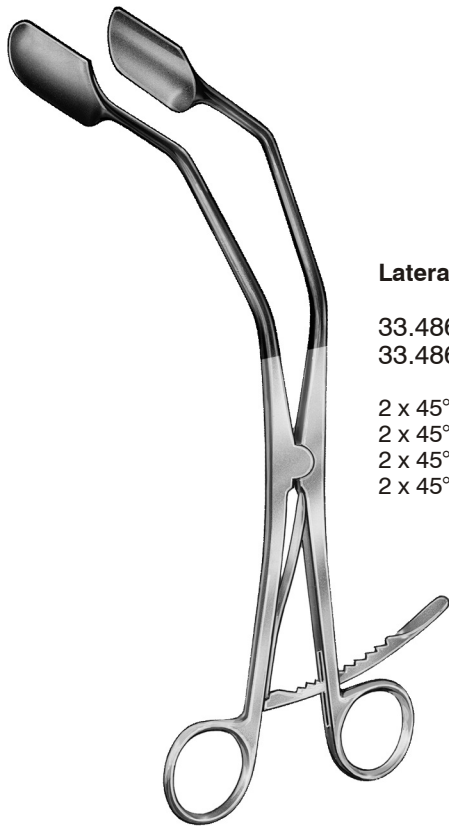

Lateral Retraktor

33.4865
33.4865L

2 x 45° gebogen
2 x 45° curved
2 x 45° courbe
2 x 45° curva

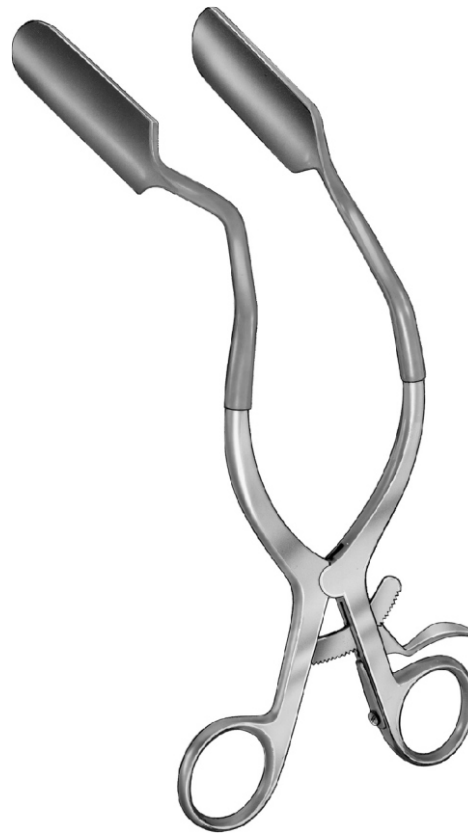

Lateral Retraktor

33.4866
33.4866L

2 x 45° gebogen
2 x 45° curved
2 x 45° courbe
2 x 45° curva

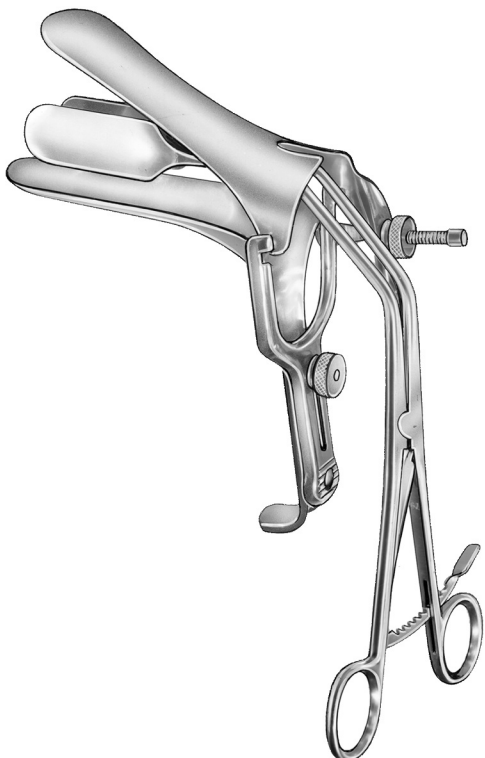

Der Lateral Vaginal-Retraktor erweitert Ihr Blickfeld und den Arbeitsbereich.

The Lateral Vaginal Retractor improves access and viewing of the cervix during a procedure.

Le spéculum latéral élargit votre angle visuel et votre sphère du travail.

El espéculo lateral amplia su campo visual y su zona de trabajo.

75 x 38 mm



Auvard

33.4870

mit abnehmbaren Gewicht
 with detachable weight
 avec poids démontable
 con peso desmontable

33.4871

mit festem Gewicht
 with fixed weight
 avec poids fixe
 con peso fijo



Scherbak

33.4873-00

Satz bestehend aus Gewicht (33.4873-40),
 Griff und 5 Blättern

Set consisting of weight (33.4873-40),
 handle and 5 blades

Jeu composé de poids (33.4873-40),
 manche et 5 valves

Juego compuesto de peso (33.4873-40),
 mango y 5 valvas

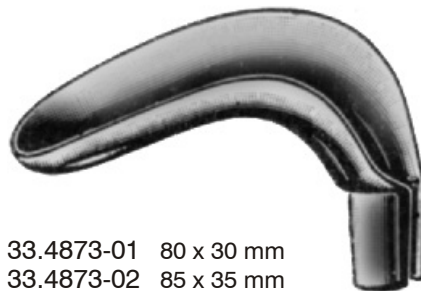

33.4873-01 80 x 30 mm

33.4873-02 85 x 35 mm

33.4873-03 90 x 40 mm

33.4873-10

Griff allein

Handle only

Manche seul

Mango suelto



33.4873-40 400 g

33.4873-80 800 g

Gewicht allein

Weight only

Poids seul

Peso suelto

33.4873-04 55 x 40/60 mm

33.4873-05 70 x 45/70 mm



Kogan
28 cm/11"

mit Sperre
with ratchet
avec crémaillère
con cremallera

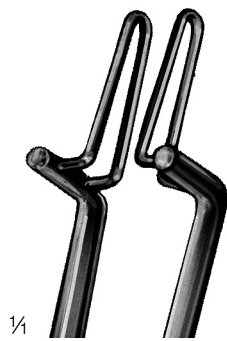

4 x 23 mm
33.4875
33.4875L

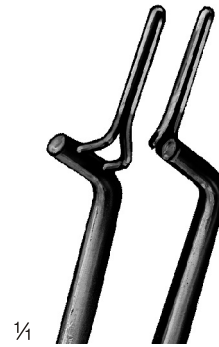

3 x 23 mm
33.4877
33.4877L

6 x 23 mm
33.4876
33.4876L

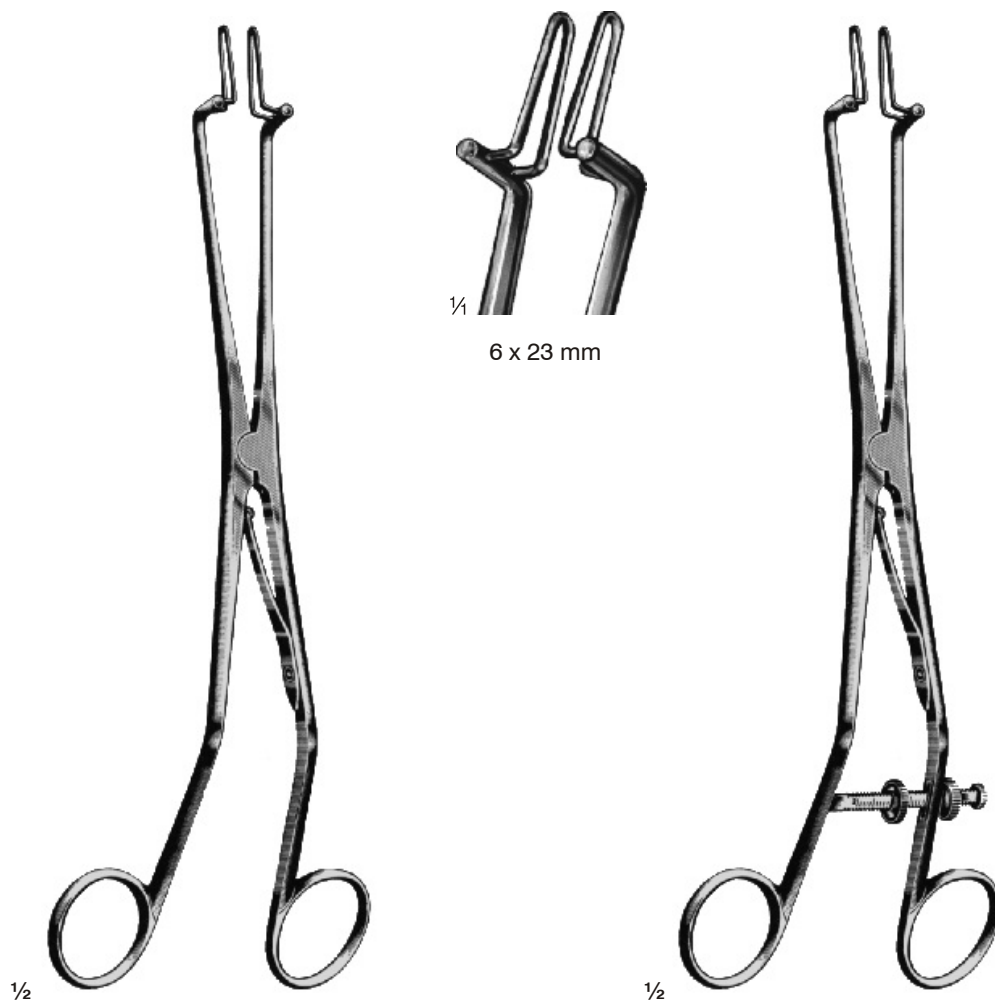

Kogan

33.4878
24 cm/9 1/2"

ohne Sperre
without ratchet
sans crémaillère
sin cremallera

Kogan

33.4879
24 cm/9 1/2"

mit Schraubensperre
with screw ratchet
avec crémaillère de vis
con cremallera de tornillo

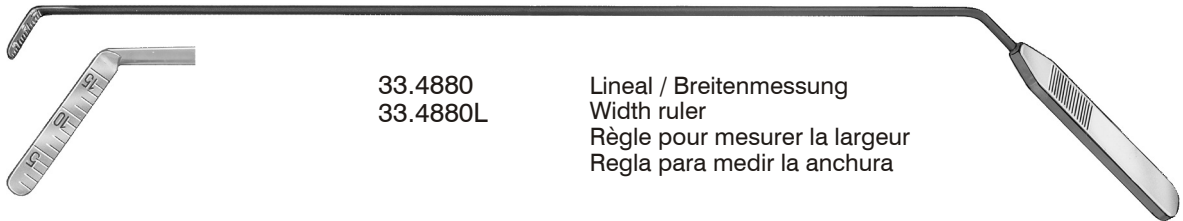

33.4880
33.4880L

Lineal / Breitenmessung
Width ruler
Règle pour mesurer la largeur
Regla para medir la anchura

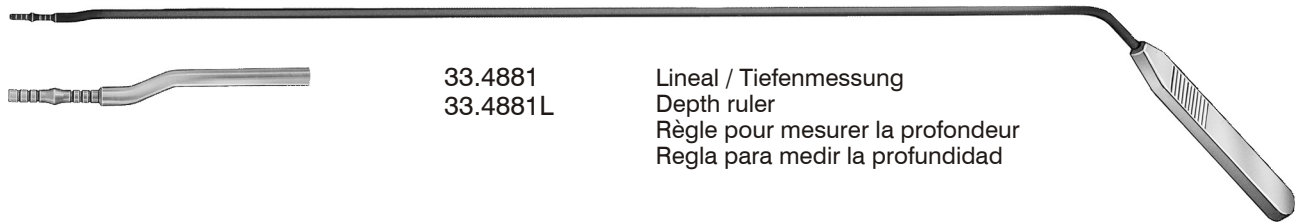

33.4881
33.4881L

Lineal / Tiefenmessung
Depth ruler
Règle pour mesurer la profondeur
Regla para medir la profundidad



33.4884
33.4884L

Emmett
Haken
Hook
Crochet
Gancho



33.4885
33.4885L

Laser Haken
Laser hook
Crochet à laser
Gancho para láser



33.4886
33.4886L

Iris Haken
Iris hook
Crochet à iris
Gancho para iris



33.4887
33.4887L

Haken, 2 Krallen
Hook, 2 claws
Crochet, 2 griffes
Gancho, 2 garras



	mm
33.4729-03	3
33.4729-04	4
33.4729-05	5
33.4729-06	6
33.4729-07	7
33.4729-08	8
33.4729-09	9
33.4729-10	10
33.4729-11	11
33.4729-12	12
33.4729-13	13
33.4729-14	14
33.4729-15	15
33.4729-16	16
33.4729-17	17
33.4729-18	18
33.4729-19	19
33.4729-20	20
33.4729-21	21
33.4729-22	22
33.4729-23	23

Hegar
mit gerieftem Griff und Rinne
with serrated handle and groove
avec manche strié et cannelure
con mango estriado y acanaladura



	mm		mm
33.4730	1	33.4760	1,5
33.4731	2	33.4761	2,5
33.4732	3	33.4762	3,5
33.4733	4	33.4763	4,5
33.4734	5	33.4764	5,5
33.4735	6	33.4765	6,5
33.4736	7	33.4766	7,5
33.4737	8	33.4767	8,5
33.4738	9	33.4768	9,5
33.4739	10	33.4769	10,5
33.4740	11	33.4770	11,5
33.4741	12	33.4771	12,5
33.4742	13	33.4772	13,5
33.4743	14	33.4773	14,5
33.4744	15	33.4774	15,5
33.4745	16	33.4775	16,5
33.4746	17	33.4776	17,5
33.4747	18	33.4777	18,5
33.4748	19	33.4778	19,5
33.4749	20	33.4779	20,5
33.4750	21	33.4780	21,5
33.4751	22	33.4781	22,5
33.4752	23	33.4782	23,5
33.4753	24		
33.4754	25		
33.4755	26		
33.4756	27		
33.4757	28		
33.4758	29		
33.4759	30		

Hegar
mit glattem Muldengriff
with sloped handle
avec manche aplati
con mango aplanado

Satz		Stück per Satz
Set		Pieces per set
Jeu		Pièces par jeu
Juego	mm	Piezas por juego
33.4901	4-17	14
33.4902	1-26	26



Hegar

mit glattem Muldengriff in Ledertasche
with sloped handle in leather pouch
avec manche aplati en pochette de cuir
con mango aplanado en estuche de cuero

Satz Set Jeu Juego	mm	Stück per Satz Pieces per set Pièces par jeu Piezas por juego
33.4903	4-17	14



Hegar

mit glattem Muldengriff in Metalletui
with sloped handle in metal case
avec manche aplati en boîte de métal
con mango aplanado en estuche de metal

Satz Set Jeu Juego	mm	Stück per Satz Pieces per set Pièces par jeu Piezas por juego
33.4904	4-17	14
33.4905	1-26	26

Metalletui allein, für: Metal case only, for: Boîte de métal seule, pour: Estuche de metal suelto, para:	mm	Stück Pieces Pièces Piezas
33.4904-10	4-17	14
33.4905-10	1-26	26



Hegar
doppelt
double
double
doble

	mm
33.4784	1/2
33.4785	3/4
33.4786	5/6
33.4787	7/8
33.4788	9/10
33.4789	11/12
33.4790	13/14
33.4791	15/16
33.4792	17/18
33.4793	19/20
33.4794	21/22
33.4795	23/24
33.4796	25/26

Satz Set Jeu Juego	mm	Stück per Satz Pieces per set Pièces par jeu Piezas por juego
33.4908	3/4 - 17/18	8
33.4909	1/2 - 25/26	13



Hegar

doppelt, double, double, doble
in Stofftasche, in canvas roll,
en pochette à toile, en estuche de tela

Satz Set Jeu Juego	mm	Stück per Satz Pieces per set Pièces par jeu Piezas por juego
33.4910	3/4 - 17/18	8



Hegar

doppelt, double, double, doble
in Metalletui, in metal case,
en boîte de métal, en estuche de metal

Satz Set Jeu Juego	mm	Stück per Satz Pieces per set Pièces par jeu Piezas por juego
33.4911	3/4 - 17/18	8
33.4912	1/2 - 25/26	13

Metalletui allein, für:
Metal case only, for:
Boîte de métal seule, pour:
Estuche de metal suelto, para:

	mm	Stück Pieces Pièces Piezas
33.4908-10	3/4 - 17/18	8
33.4909-10	1/2 - 25/26	13

Uterusdilatoren
Uterine-Dilators
Dilatateurs utérins
Dilatadores uterinos

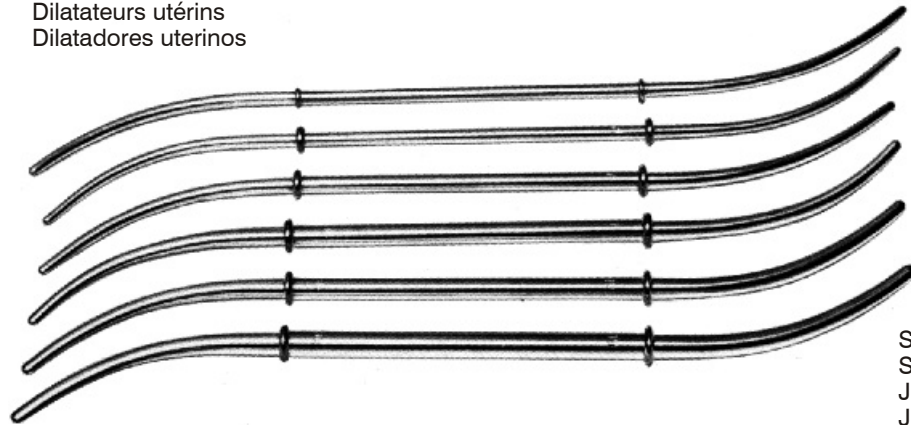

Amerikanische Skala
American scale
Echelle américaine
Escala americana

Hank		mm
Fig. 9/10	33.4913-09	4,5/5
Fig. 11/12	33.4913-11	5,5/6
Fig. 13/14	33.4913-13	6,5/7
Fig. 15/16	33.4913-15	7,5/8
Fig. 17/18	33.4913-17	8,5/9
Fig. 19/20	33.4913-19	9,5/10

Satz Set Jeu Juego	mm	Stück per Satz Pieces per set Pièces par jeu Piezas por juego
33.4913-00	9/10 - 19/20	6

Uterussonden
Uterine Sounds
Hystéromètres
Histerómetros



Sims
32 cm/12½"

33.4920

starr, graduiert in cm
rigid, graduated in cm
rigide, gradué en cm
rigido, graduado en cm

33.4921

biegsam, graduiert in cm
malleable, graduated in cm
malléable, gradué en cm
maleable, graduado en cm



biegsam
malleable
malléable
maleable

Martin

33.4923
32 cm/12½"

Uterus-Depressor
Uterine depressor
Depresseur utérin
Depresor uterino



Braun

33.4924
27,5 cm/11"



S-förmig
 S-shaped
 forme en S
 en forma de S

Duplay

33.4949
 25,0 cm/10"



spitz
 sharp
 pointue
 aguda

33.4950

33.4950L

Isoliert für Laser- und Elektrochirurgie
 Insulated for Laser- and Electrosurgery
 Isolé pour les interventions au laser et électrochirurgical
 Aislado para láser y electrocirugía

Schröder-Braun

25,0 cm/10"



stumpf
 blunt
 mousse
 roma

33.4952

33.4952L



Braun

33.4951
 25,0 cm/10"

Skene

33.4953
 24,0 cm/9½"



Staude-Moore

33.4954
17,0 cm/6¾"

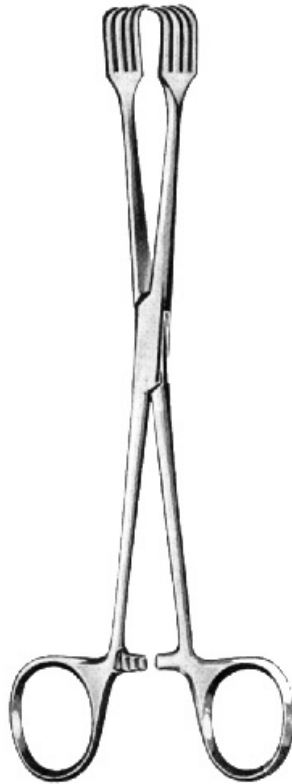

Czerny

33.4959
20,0 cm/8"

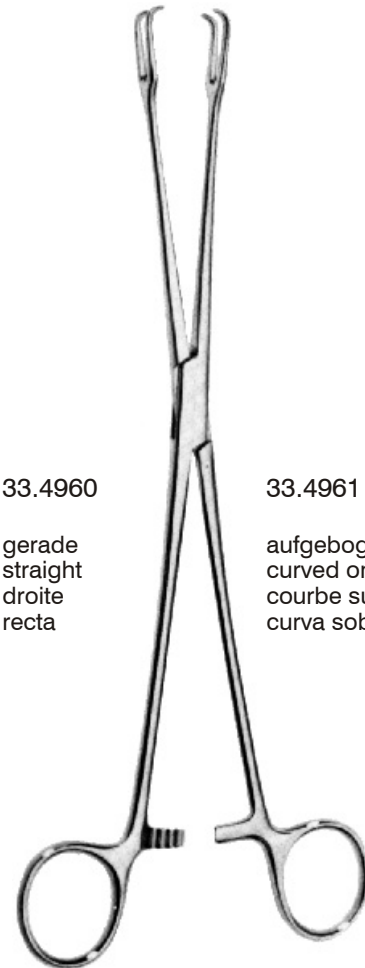

33.4960

gerade
straight
droite
recta

33.4961

aufgebogen
curved on flat
courbe sur le plat
curva sobre el plano

Schröder
24,0 cm/9½"

Hakenzangen

Tenaculum Forceps

Pinces à griffes

Pinzas para coger el cuello del útero



Teale

33.4962
23,0 cm/9"

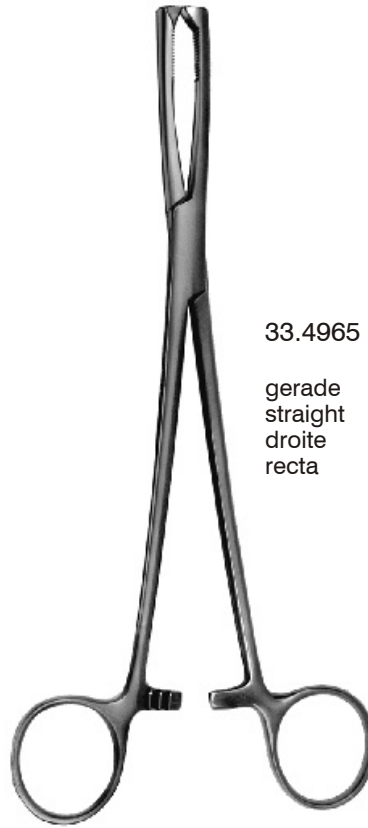

Jakobs
21,0 cm/8¼"

33.4965

gerade
straight
droite
recta

33.4966

aufgebogen
curved on flat
courbe sur le plat
curva sobre el plano

33.4967

seitwärts gebogen
curved sideways
courbe sur le côté
curva lateral

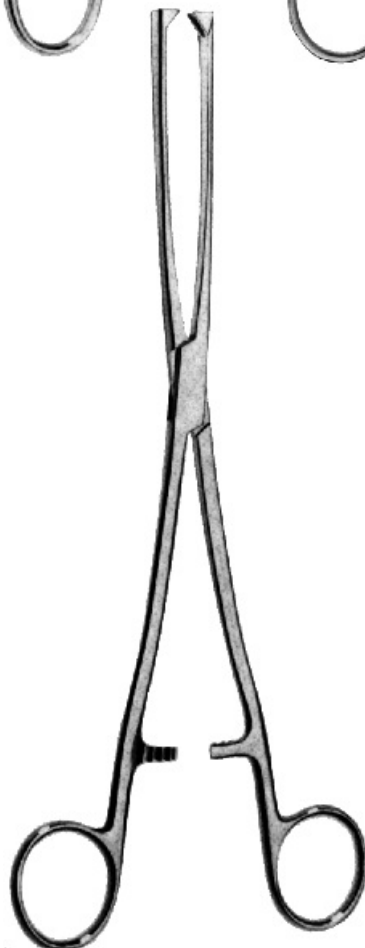

gerade
straight
droite
recta

6 mm

33.4970



seitwärts gebogen
curved sideways
courbe sur le côté
curva lateral

8 mm

33.4971



33.4973

10 mm

33.4972



33.4974

33.4975

Museux
24,0 cm/9½"

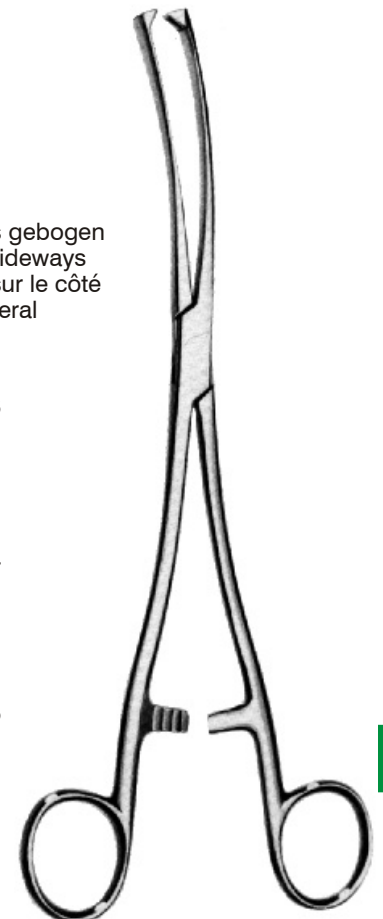

Uterus-Polypenzangen
Uterine Polypus Forceps
Pinces à polypes utérins
Pinzas para polipos uterinos

Uterus-Polypenzangen
Uterine Polypus Forceps
Pinces à polypes utérins
Pinzas para polipos uterinos



Noto

33.4989
27,0 cm/10½"

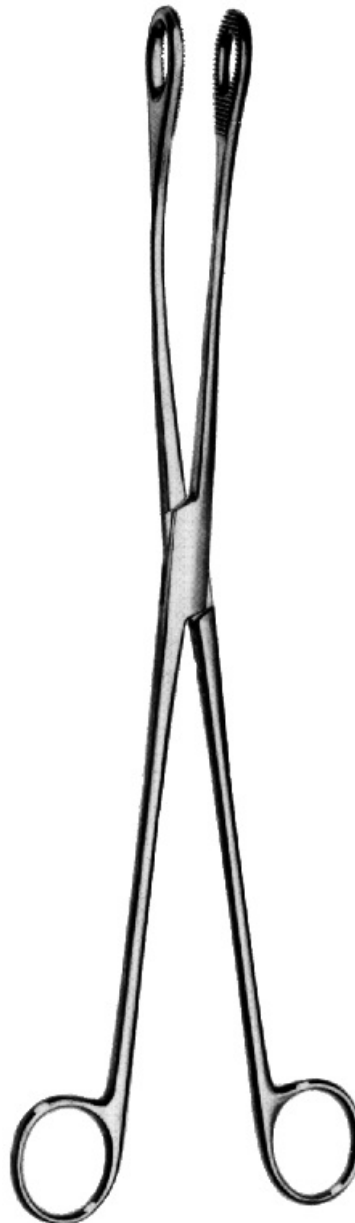

Kelly

33.4990
32,0 cm/12½"

Ovarien-Faßzange
Ovarian Elevating Forceps
Pinces pour les ovaires
Pinzas para ovarios



Doyen

33.4995
20,0 cm/8"

Uterus-Faßzangen
Uterine Elevating Forceps
Pinces hystérolabes
Pinzas para el útero

Myomheber
Myoma Screw
Tracteur de fibrome
Tiramiomas

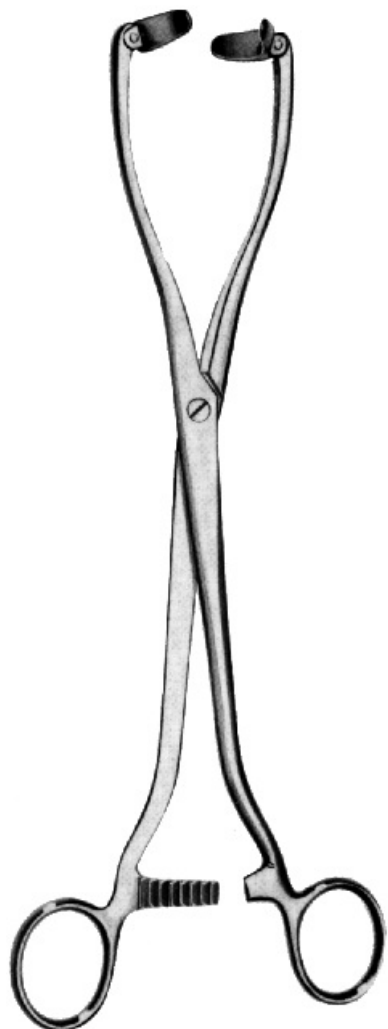

Collin

33.5000
25,0 cm/10"

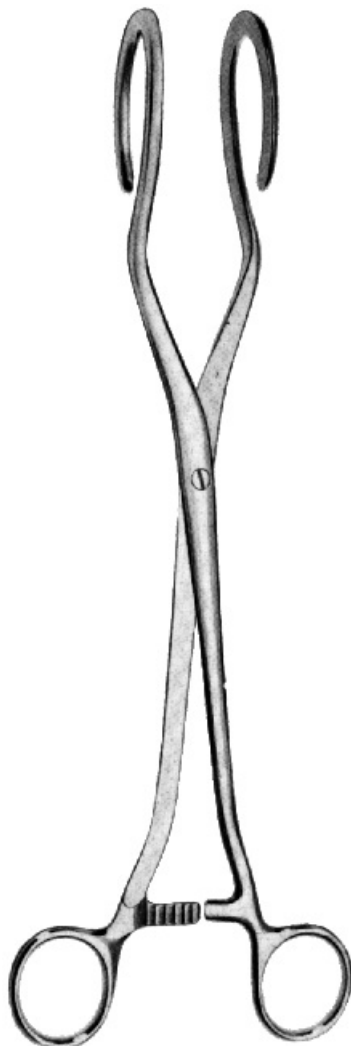

Dartigues

33.5001
27,0 cm/10½"

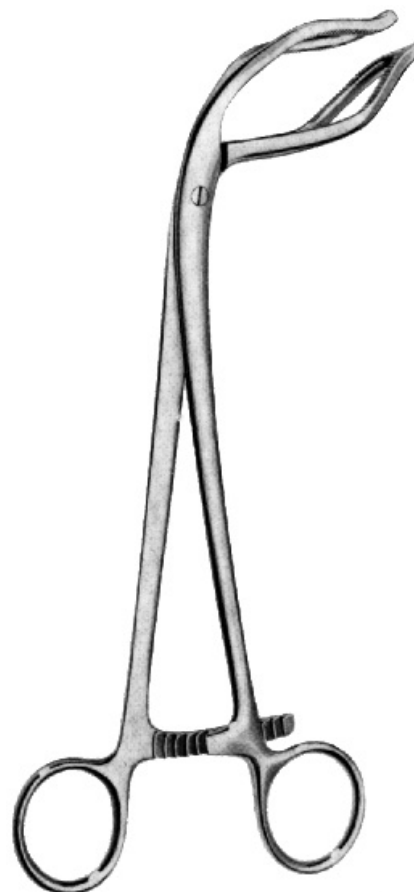

Sommer

33.5002
23,0 cm/9"

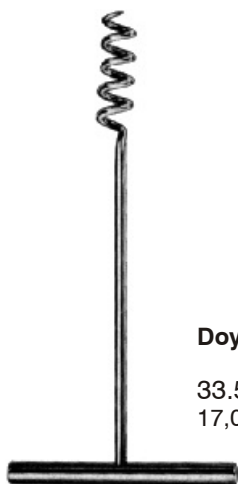

Doyen

33.5010-01
17,0 cm/6¾"

Myomheber
Myoma Screw
Tracteur de fibrome
Tiramiomas

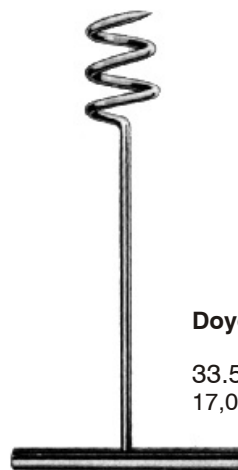

Doyen

33.5010-02
17,0 cm/6¾"

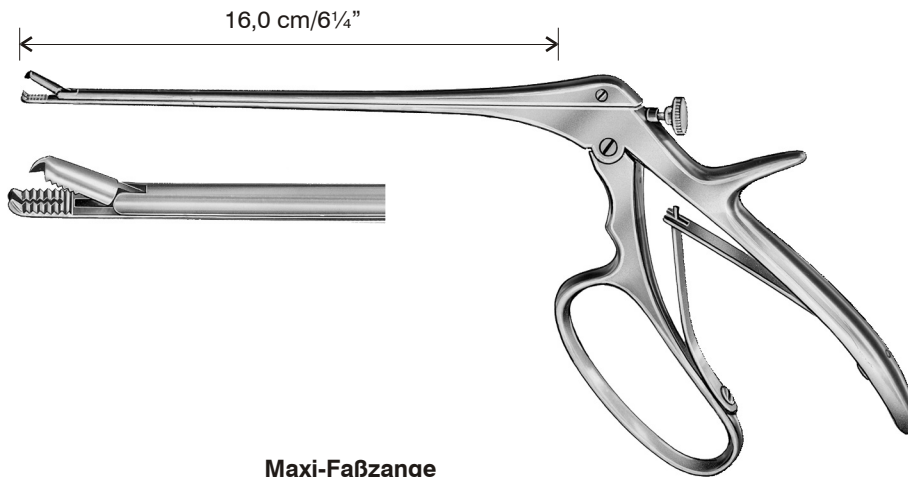

Maxi-Faßzange
Maxi Grasper
Maxi pince pour saisir
Maxi pinza para coger

33.5015

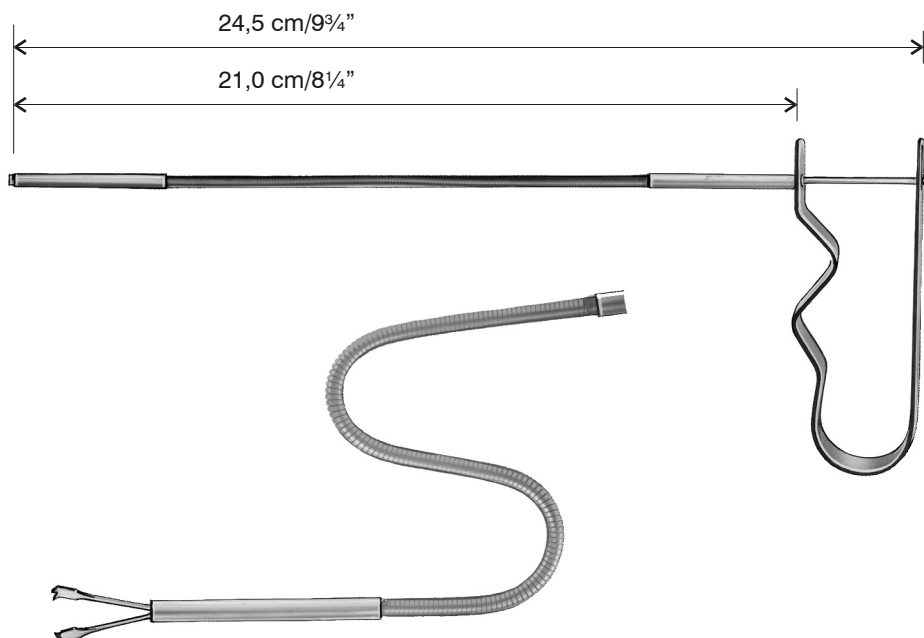

Flexible IUD Faßzange
Serpentine Grasper flexible IUD
Pince flexible IUD
Pinza flexible D.I.U

33.5018

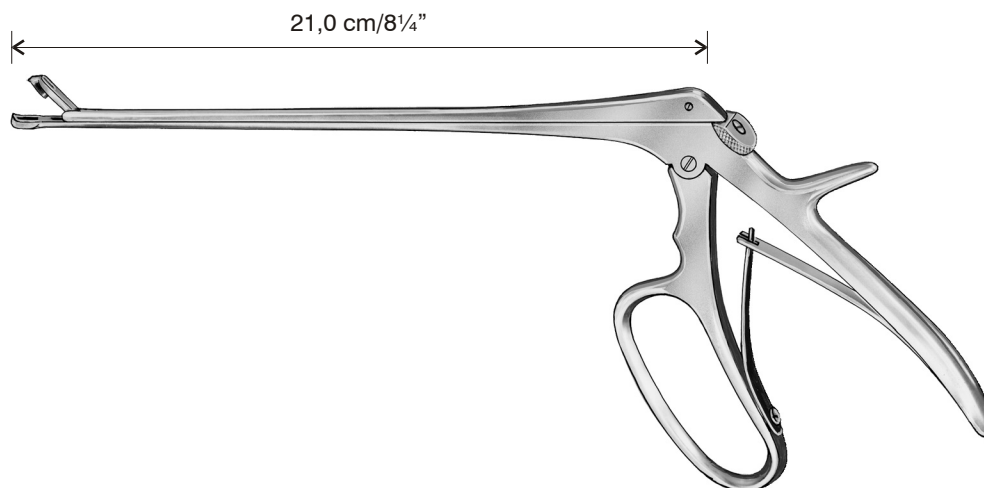

3 x 9 mm

Tischler-Kevorkian

33.5020



3 x 7 mm

Tischler

33.5021



2,3 x 4 mm

Baby-Tischler

33.5022



2,3 x 4 mm

Mini-Tischler

33.5023



3 x 9 mm

Kevorkian

33.5024

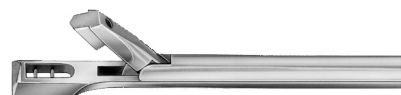

3 x 7 mm

Coppelson

33.5025

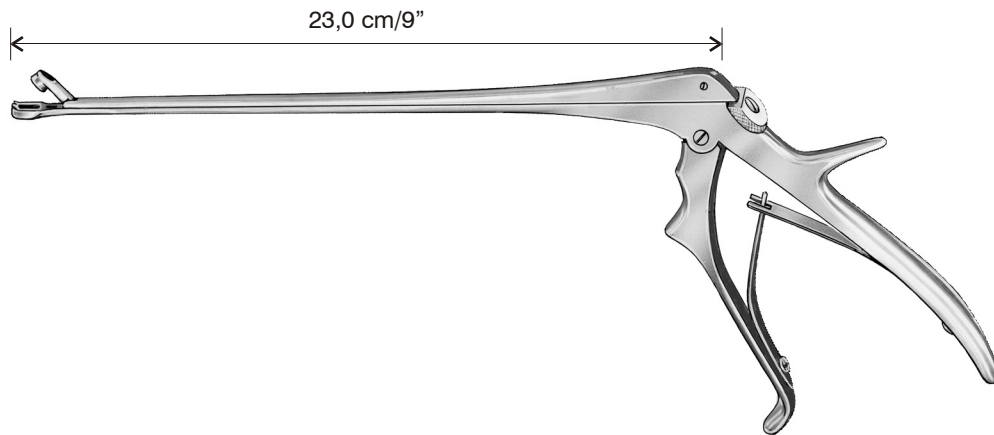

○ 3 x 5 mm

Burke

33.5026



○ 4 x 6,5 mm

Baggish

33.5027
gezahnt
toothed
dentelée
dentada

Biopsiezangen

Biopsy Punches

Pinces emporte-pièces à biopsie

Pinzas para biopsia

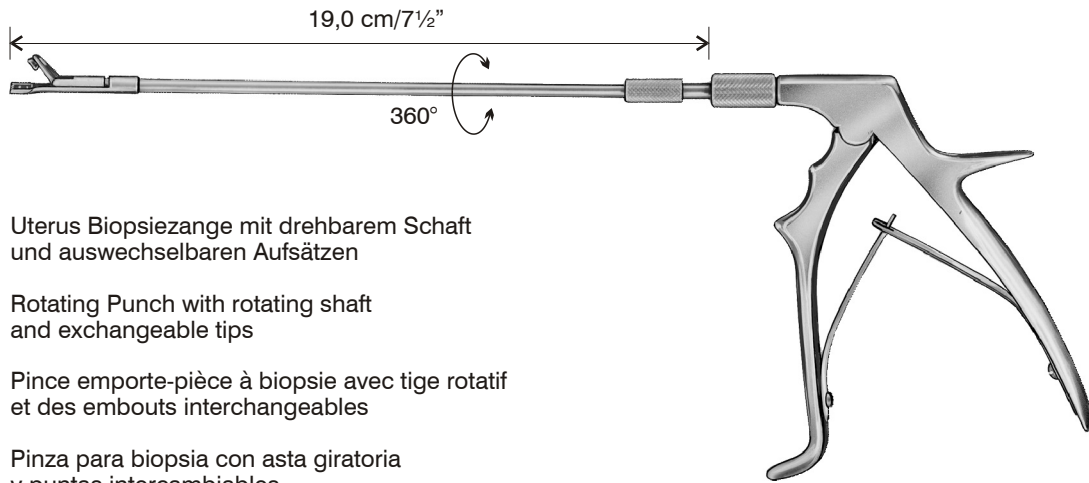

Uterus Biopsiezange mit drehbarem Schaft und auswechselbaren Aufsätzen

Rotating Punch with rotating shaft and exchangeable tips

Pince emporte-pièce à biopsie avec tige rotatif et des embouts interchangeables

Pinza para biopsia con asta giratoria y puntas intercambiables



○ 3 x 7 mm

Uni-Tischler

gerade
straight
droite
recta

33.5028-01
komplett, complete
complet, completo



○ 3 x 7 mm

Uni-Tischler

abwärts gebogen
downwards curved
courbe vers le bas
curva hacia abajo

33.5028-02
komplett, complete
complet, completo



○ 3 x 7 mm

Uni-Tischler

aufwärts gebogen
upwards curved
courbe vers le haut
curva hacia arriba

33.5028-03
komplett, complete
complet, completo



□ 2,3 x 4 mm

Uni-Townsend

gerade
straight
droite
recta

33.5029-01
komplett, complete
complet, completo



□ 2,3 x 4 mm

Uni-Townsend

abwärts gebogen
downwards curved
courbe vers le bas
curva hacia abajo

33.5029-02
komplett, complete
complet, completo



□ 2,3 x 4 mm

Uni-Townsend

aufwärts gebogen
upwards curved
courbe vers le haut
curva hacia arriba

33.5029-03
komplett, complete
complet, completo



○ 3 x 5 mm

Uni-Oval

33.5030
komplett, complete
complet, completo



□ 3 x 9 mm

Uni-Kevorkian

33.5031
komplett, complete
complet, completo



○ 3 x 4 mm

Uni-Burke

33.5032
komplett, complete
complet, completo



△ 3,8 x 6 mm

Schuhmacher

33.5032-38
komplett, complete



Uni-Griff mit Ring
Handle with ring
Manche avec anneau
Mango con anillo

33.5033

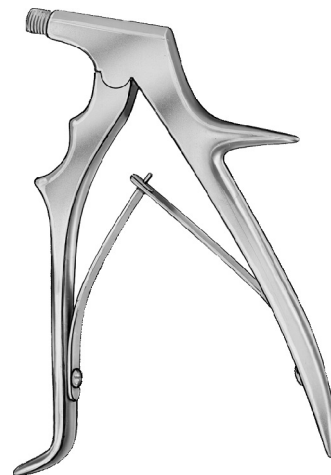

Uni-Griff
Handle
Manche
Mango

33.5034



3 x 7 mm

Uni-Tischler gerade
straight
droite
recta

33.5035-01
Aufsatz allein mit Rohr
Tip only with tube
Embout seul avec tubes-rallonge
Punta sola con tubo de extensión

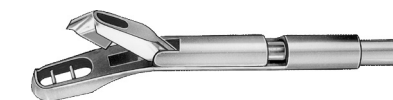

3 x 7 mm

Uni-Tischler abwärts gebogen
downwards curved
courbe vers le bas
curva hacia abajo

33.5035-02
Aufsatz allein mit Rohr
Tip only with tube
Embout seul avec tubes-rallonge
Punta sola con tubo de extensión



3 x 7 mm

Uni-Tischler aufwärts gebogen
upwards curved
courbe vers le haut
curva hacia arriba

33.5035-03
Aufsatz allein mit Rohr
Tip only with tube
Embout seul avec tubes-rallonge
Punta sola con tubo de extensión



2,3 x 4 mm

Uni-Townsend gerade
straight
droite
recta

33.5036-01
Aufsatz allein mit Rohr
Tip only with tube
Embout seul avec tubes-rallonge
Punta sola con tubo de extensión



2,3 x 4 mm

Uni-Townsend abwärts gebogen
downwards curved
courbe vers le bas
curva hacia abajo

33.5036-02
Aufsatz allein mit Rohr
Tip only with tube
Embout seul avec tubes-rallonge
Punta sola con tubo de extensión



2,3 x 4 mm

Uni-Townsend aufwärts gebogen
upwards curved
courbe vers le haut
curva hacia arriba

33.5036-03
Aufsatz allein mit Rohr
Tip only with tube
Embout seul avec tubes-rallonge
Punta sola con tubo de extensión



3 x 5 mm

Uni-Oval

33.5037
Aufsatz allein mit Rohr
Tip only with tube
Embout seul avec tubes-rallonge
Punta sola con tubo de extensión



3 x 9 mm

Uni-Kevorkian

33.5038
Aufsatz allein mit Rohr
Tip only with tube
Embout seul avec tubes-rallonge
Punta sola con tubo de extensión



3 x 4 mm

Uni-Burke

33.5039
Aufsatz allein mit Rohr
Tip only with tube
Embout seul avec tubes-rallonge
Punta sola con tubo de extensión

33



3,8 x 6 mm

Schuhmacher

33.5039-38

Aufsatz allein mit Rohr
Tip only with tube
Embout seul avec tubes-rallonge
Punta sola con tubo de extensión

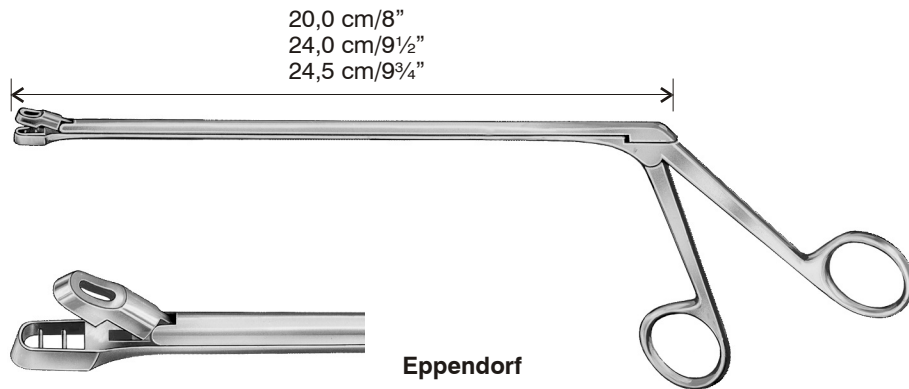

□ 4,5 x 8 mm

Eppendorf

33.5040
 20,0 cm/8"



□ 4,5 x 8 mm

Wittner

33.5041
 20,0 cm/8"
 gebogen, curved
 courbe, curva

Wittner

33.5042
 20,0 cm/8"
 gerade, straight
 droite, recta



△ 4 mm = Fig. 1

△ 6 mm = Fig. 2

Schumacher

Fig. 1
 33.5043
 24,0 cm/9 1/2"

Schumacher

Fig. 2
 33.5044
 24,0 cm/9 1/2"



□ 3 x 9 mm

Kevorkian

33.5049
 24,5 cm/9 1/2"

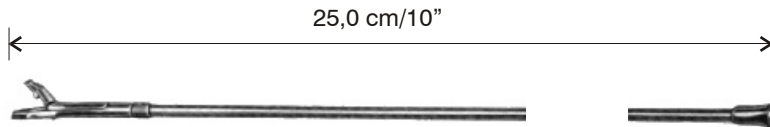

Schuhmacher

33.5047
komplett, complete
complet, completo



Schuhmacher

33.5048
Aufsatz allein
Tip only
Embout seul
Punta sola

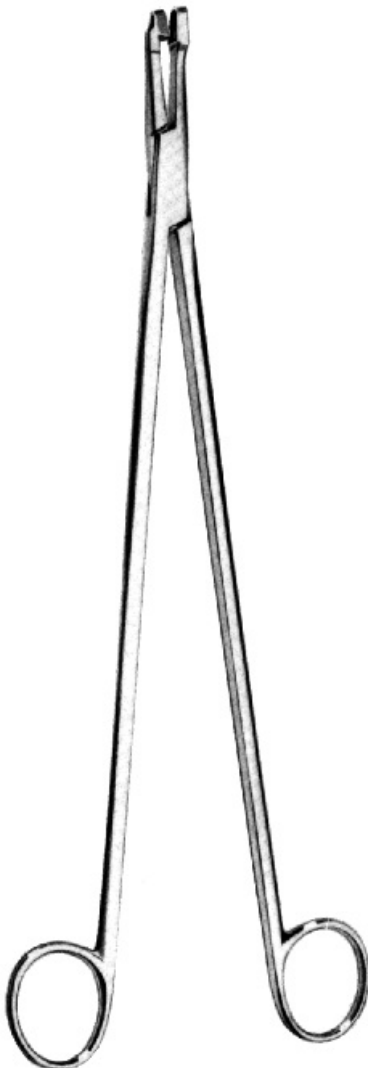

Schubert

33.5051 21,0 cm/8¼"
33.5052 29,0 cm/11½"

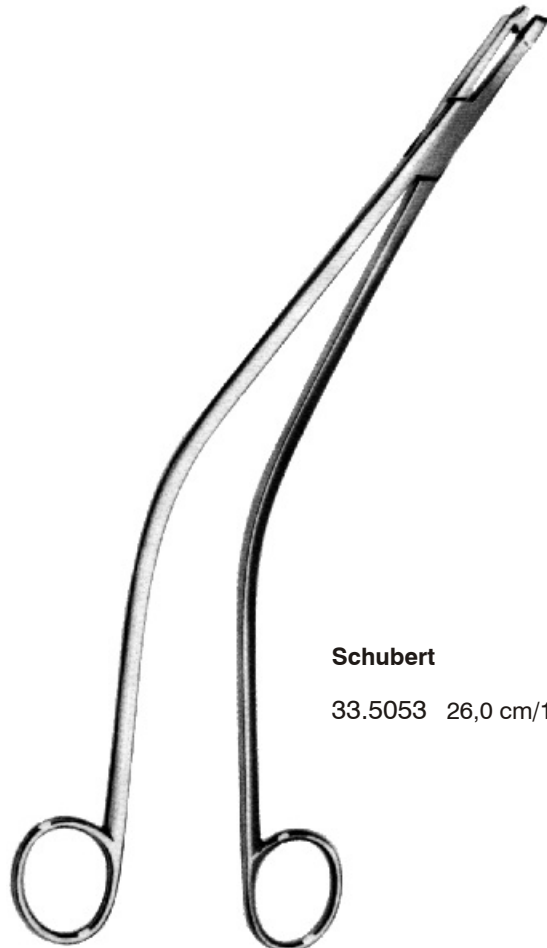

Schubert

33.5053 26,0 cm/10¼"



Tischler

33.5054
27,0 cm/10½"

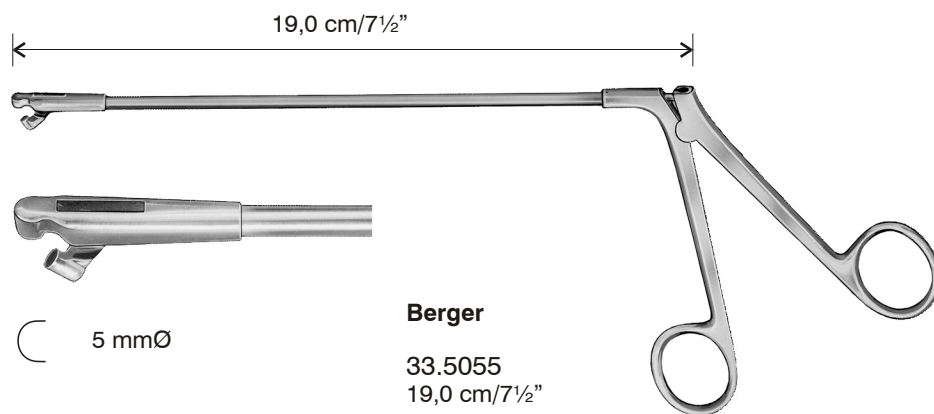

Berger

33.5055
19,0 cm/7½"



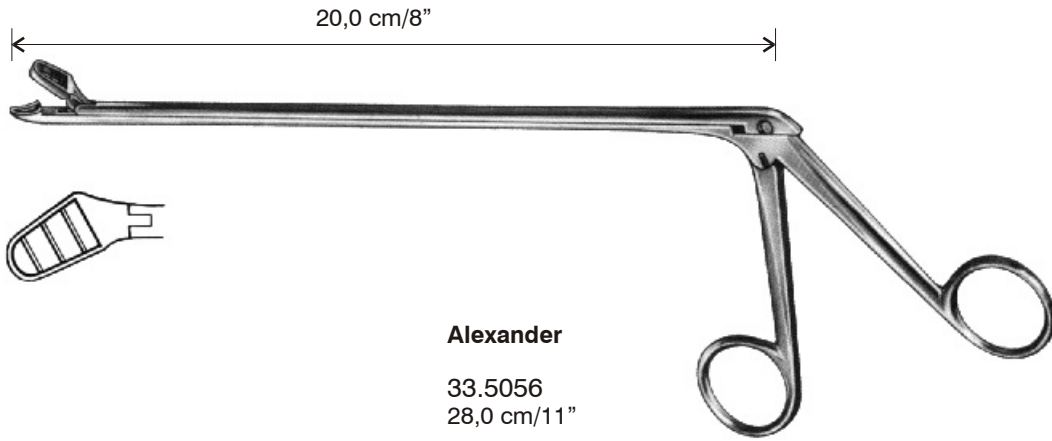

Alexander

33.5056
28,0 cm/11"

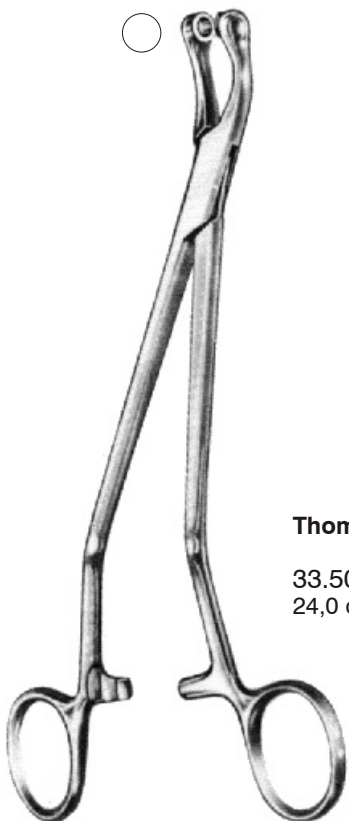

Thoms-Gaylor

33.5057
24,0 cm/9½"



33.5058
eckig
angular
angulaire
angular



33.5059
rund
round
ronde
redonda

Van Doren
24,0 cm/9½"



Novak
 23 cm/9"

- Fig. 1 1 mm = 33.5060-01
- Fig. 2 2 mm = 33.5060-02
- Fig. 3 3 mm = 33.5060-03
- Fig. 4 4 mm = 33.5060-04



Randall

33.5061
 24 cm/9½"

Ø 4 mm



Rotokürette

33.5062
 30 cm/11¼"

Ø 4,5 mm

Rotokürette
 Rotating curette
 Curette à rotation
 Cureta rotatoria

arbeitet drehend
 works rotating
 fonctionne avec rotation
 trabaja rotatoria



Kevorkian

33.5063
 30 cm/11¼"

1 mm

schmal
 narrow
 étroite
 estrecha



Kevorkian

33.5064
2,5 mm
ohne Korb, eckig
without basket, angular
sans panier, angulaire
sin cesta, angular



Kevorkian

33.5065
2,2 mm
mit Korb, rund
with basket, round
avec panier, ronde
con cesta, redonda



Kevorkian-Young

33.5066
2,5 mm
mit Korb, eckig
with basket, angular
avec panier, angulaire
con cesta, angular

Kevorkian
30,0 cm/11³/₄"



4 mm

Luer-Lock

Novak-Schoeckaert

33.5067
24,0 cm/9¹/₂"



4 mm

Mod. Muenchen

33.5068
27,0 cm/10¹/₂"

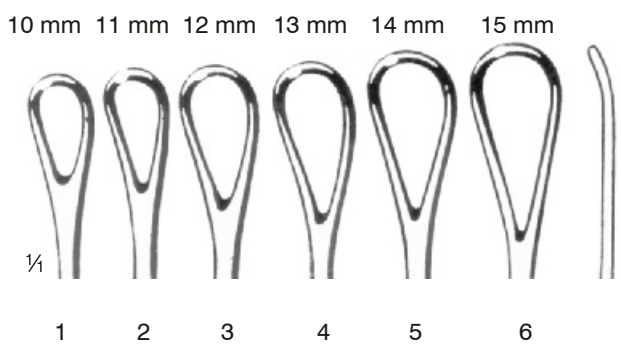

Thomas
 28,0 cm/11"

stumpf, biegsam, glatt
 blunt, malleable, smooth
 mousse, malléable, lisse
 roma, maleable, lisa

- Fig. 1 33.5071
- Fig. 2 33.5072
- Fig. 3 33.5073
- Fig. 4 33.5074
- Fig. 5 33.5075
- Fig. 6 33.5076

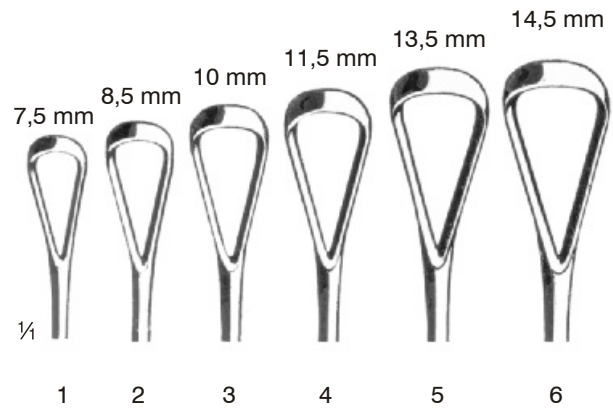

Sims
 25,0 cm/10"

scharf, biegsam sharp, malleable tranchante, malléable cortante, maleable	scharf, fest sharp, rigid tranchante, rigide cortante, rigida	stumpf, biegsam blunt, malleable mousse, malléable roma, maleable	stumpf, fest blunt, rigid mousse, rigide roma, rigida
--	--	--	--

Fig. 1	33.5081	33.5091	33.5101	33.5111
Fig. 2	33.5082	33.5092	33.5102	33.5112
Fig. 3	33.5083	33.5093	33.5103	33.5113
Fig. 4	33.5084	33.5094	33.5104	33.5114
Fig. 5	33.5085	33.5095	33.5105	33.5115
Fig. 6	33.5086	33.5096	33.5106	33.5116

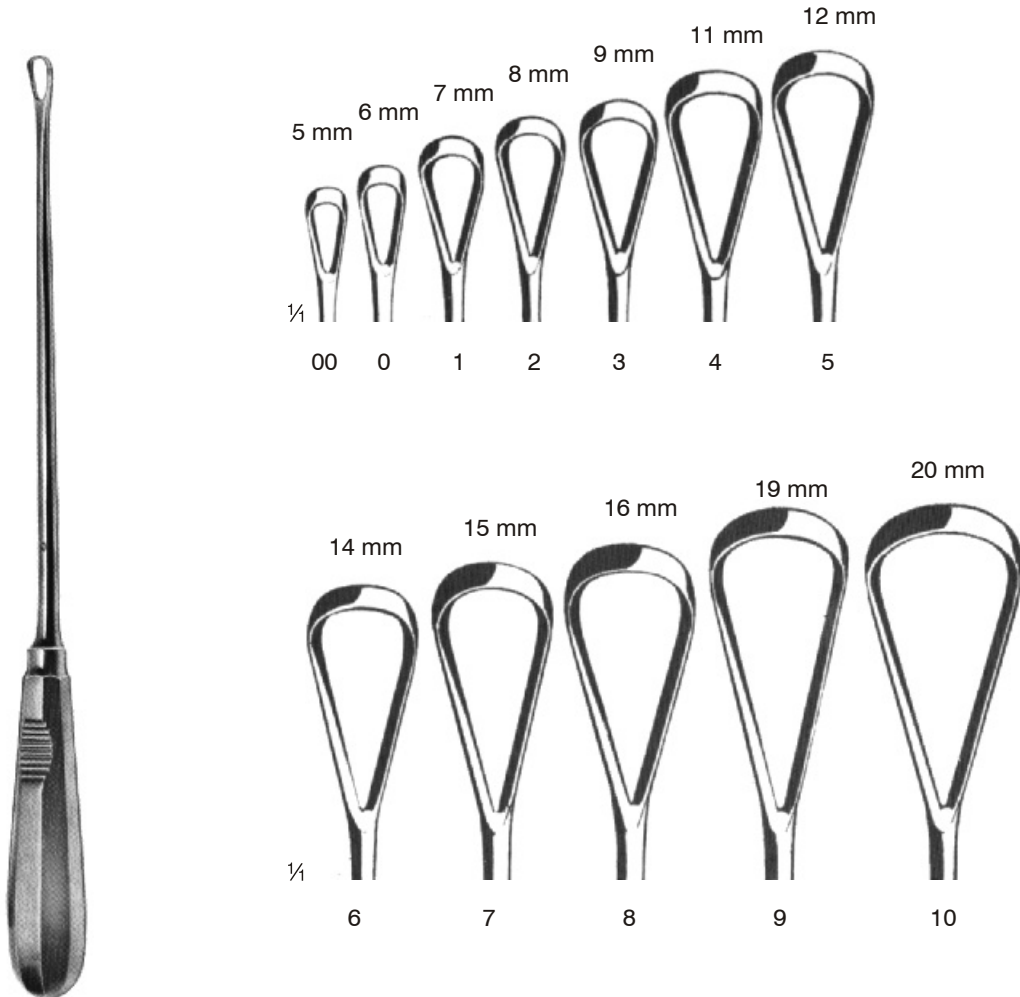

Recamier
31,0 cm/12¼"

	mm	scharf, biegsam sharp, malleable tranchante, malléable cortante, maleable	scharf, fest sharp, rigid tranchante, rigide cortante, rigida	stumpf, biegsam blunt, malleable mousse, malléable roma, maleable	stumpf, fest blunt, rigid mousse, rigide roma, rigida
Fig. 00	5	33.5120-20	33.5130-20	33.5140-20	33.5150-20
Fig. 0	6	33.5120-00	33.5130-00	33.5140-00	33.5150-00
Fig. 1	7	33.5120-01	33.5130-01	33.5140-01	33.5150-01
Fig. 2	8	33.5120-02	33.5130-02	33.5140-02	33.5150-02
Fig. 3	9	33.5120-03	33.5130-03	33.5140-03	33.5150-03
Fig. 4	11	33.5120-04	33.5130-04	33.5140-04	33.5150-04
Fig. 5	12	33.5120-05	33.5130-05	33.5140-05	33.5150-05
Fig. 6	14	33.5120-06	33.5130-06	33.5140-06	33.5150-06
Fig. 7	15	33.5120-07	33.5130-07	33.5140-07	33.5150-07
Fig. 8	16	33.5120-08	33.5130-08	33.5140-08	33.5150-08
Fig. 9	19	33.5120-09	33.5130-09	33.5140-09	33.5150-09
Fig. 10	20	33.5120-10	33.5130-10	33.5140-10	33.5150-10
Fig. 11	21	33.5120-11	33.5130-11	33.5140-11	33.5150-11
Fig. 12	23	33.5120-12	33.5130-12	33.5140-12	33.5150-12
Fig. 13	25	33.5120-13	33.5130-13	33.5140-13	33.5150-13
Fig. 14	30	33.5120-14	33.5130-14	33.5140-14	33.5150-14
Fig. 15	35	33.5120-15	33.5130-15	33.5140-15	33.5150-15
Fig. 16	40	33.5120-16	33.5130-16	33.5140-16	33.5150-16

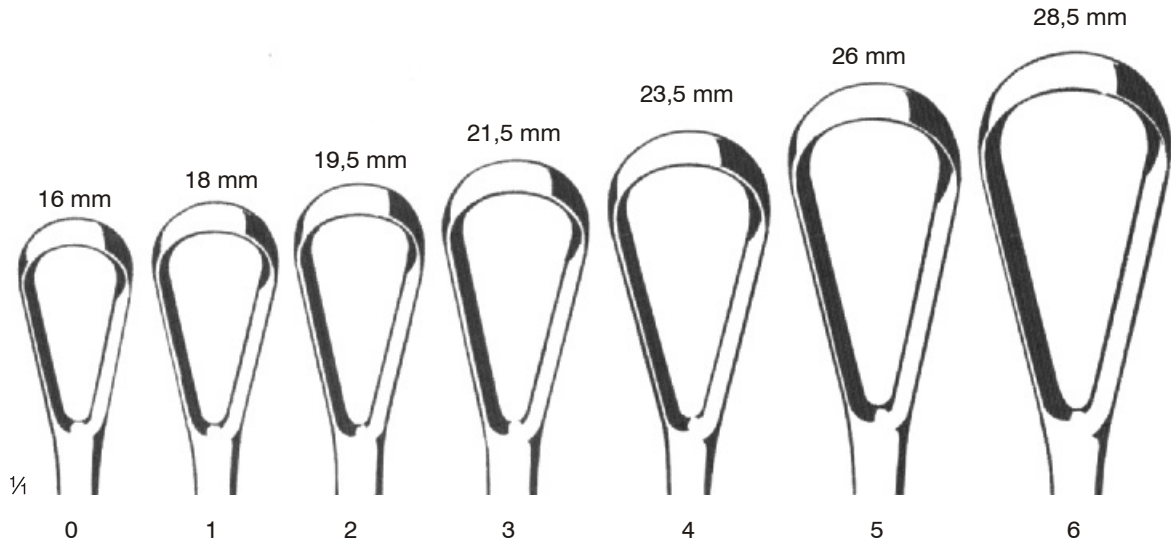

Bumm
 28,0 cm/11"

scharf, biegsam sharp, malleable tranchante, malléable cortante, maleable	stumpf, biegsam blunt, malleable mousse, malléable roma, maleable
--	--

Fig. 0	33.5160	33.5170
Fig. 1	33.5161	33.5171
Fig. 2	33.5162	33.5172
Fig. 3	33.5163	33.5173
Fig. 4	33.5164	33.5174
Fig. 5	33.5165	33.5175
Fig. 6	33.5166	33.5176

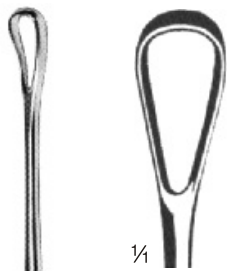

doppelt, scharf-stumpf
double, sharp-blunt
double, tranchante-mousse
doble, cortante-roma



Blake

33.5180
27,0 cm/10½"

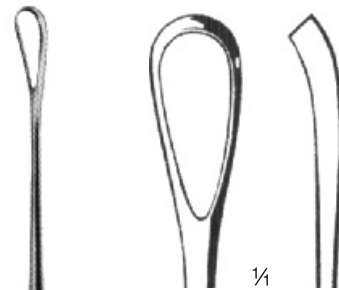

doppelt, scharf-stumpf
double, sharp-blunt
double, tranchante-mousse
doble, cortante-roma



Zweifel

33.5181
31,0 cm/12¼"



Simon
 25,0 cm/10"

scharf, fest
 sharp, rigid
 tranchante, rigide
 cortante, rígida

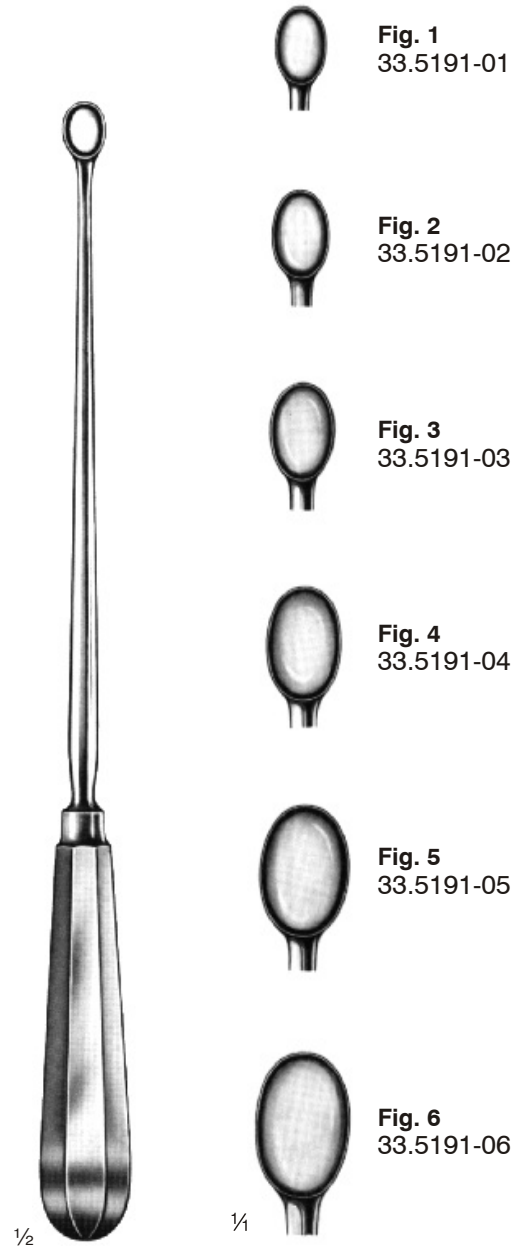

Schroeder
 30,0 cm/12"

scharf, fest
 sharp, rigid
 tranchante, rigide
 cortante, rígida

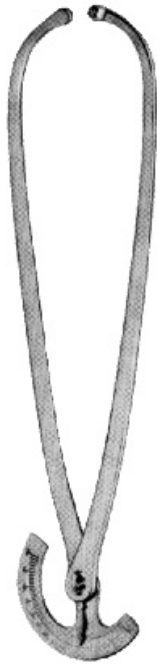

Collin
33.5301
35,0 cm/13¾"



Martin
33.5302
34,0 cm/13½"



Naegele
33.5310 36,0 cm/14"
33.5311 40,0 cm/16"



Simpson-Braun
33.5318 30,0 cm/12"
33.5320 33,0 cm/13"
33.5321 36,0 cm/14"



Simpson-Luikart
33.5323 36,0 cm/14"



Kielland

33.5325 41,0 cm/16"



Kielland-Luikart

33.5327 40,0 cm/15¾"



Piper

33.5330 44,0 cm/17¼"



Elliot

33.5333 38,0 cm/15"

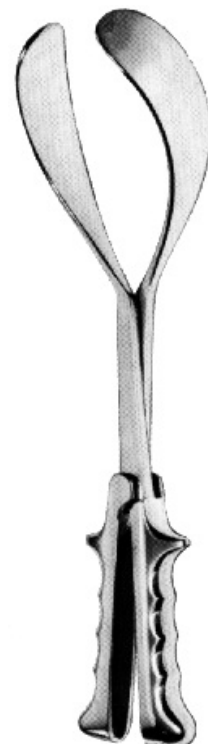

Mc Lean-Tucker

33.5338 39,0 cm/15½"

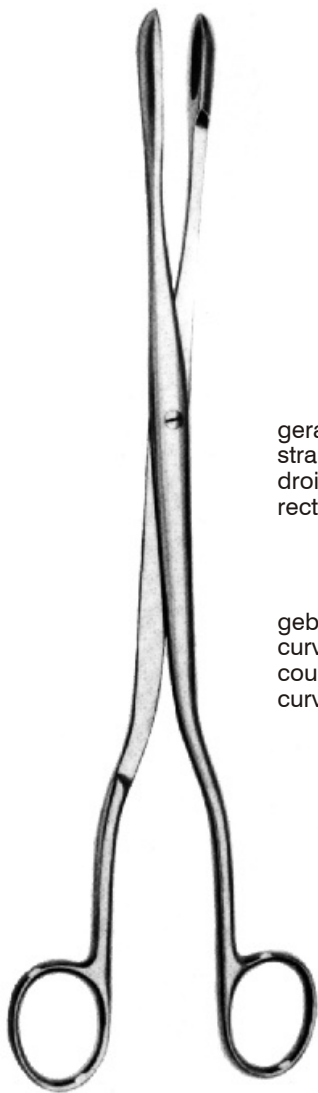

Winter
28,0 cm/11"



33.5380
gerade
straight
droite
recta



33.5381



33.5382

gebogen
curved
courbe
curva

33.5385

33.5386

33.5387

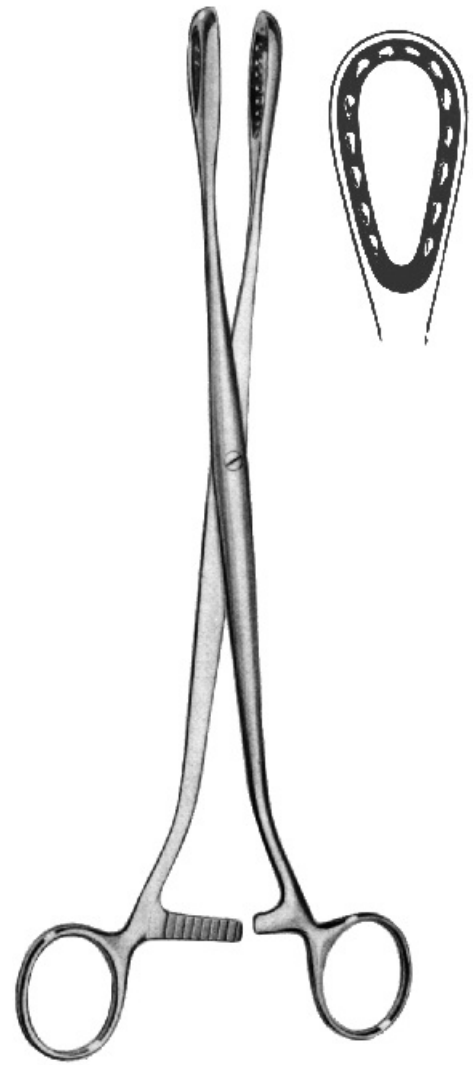

Saenger
27,0 cm/10½" 33.5391

33.5390
gerade
straight
droite
recta

gebogen
curved
courbe
curva

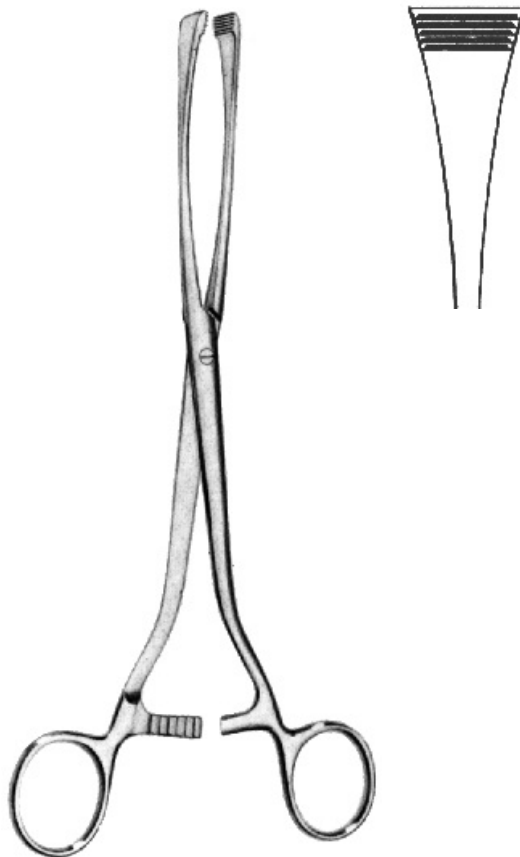

Green-Armytage

33.5395
21,0 cm/8¼"

**HNO-Instrumente
ENT-Instruments
Instruments ORL
Instrumental ORL**



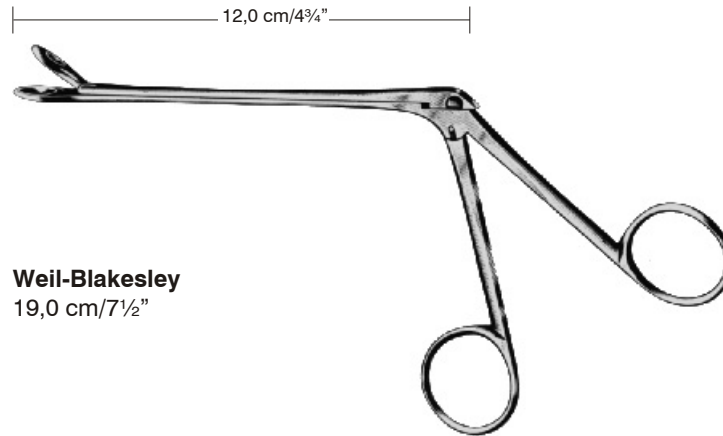

Weil-Blakesley
 19,0 cm / 7 1/2"



gerade straight droite recta	Standard	mit Absaugrohr with suction tube avec tube d'aspiration con tubo de aspiración
2,5 mm	34.5401	34.5421
3,6 mm	34.5402	34.5422
4,8 mm	34.5403	34.5423
5,3 mm	34.5404	34.5424
6,3 mm	34.5405	34.5425

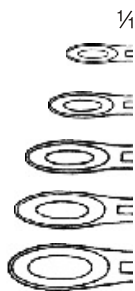

45° aufgebogen 45° curved upwards 45° courbe en haut 45° curva arriba	Standard	mit Absaugrohr with suction tube avec tube d'aspiration con tubo de aspiración
2,5 mm	34.5406	34.5426
3,6 mm	34.5407	34.5427
4,8 mm	34.5408	34.5428
5,3 mm	34.5409	34.5429
6,3 mm	34.5410	34.5430

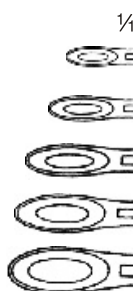

90° aufgebogen 90° curved upwards 90° courbe en haut 90° curva arriba	Standard	mit Absaugrohr with suction tube avec tube d'aspiration con tubo de aspiración
2,5 mm	34.5411	34.5431
3,6 mm	34.5412	34.5432
4,8 mm	34.5413	34.5433
5,3 mm	34.5414	34.5434
6,3 mm	34.5415	34.5435

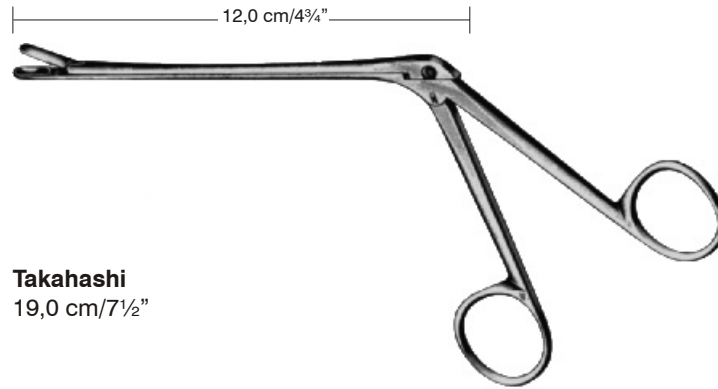

Takahashi
19,0 cm / 7 1/2"



	gerade straight droite recta	Standard	mit Absaugrohr with suction tube avec tube d'aspiration con tubo de aspiración
Fig. 1	2,5 mm	34.5416	34.5436
Fig. 2	4,0 mm	34.5417	34.5437

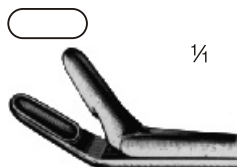

	45° aufgebogen 45° curved upwards 45° courbe en haut 45° curva arriba	Standard	mit Absaugrohr with suction tube avec tube d'aspiration con tubo de aspiración
Fig. 1	2,5 mm	34.5418	34.5438
Fig. 2	4,0 mm	34.5419	34.5439

Nasenzangen (Doppellöffel)

Nasal Forceps (Biopsy Forceps)

Pinces pour le nez (Pinces emporte-pièce à biopsie)

Pinzas para la nariz (Pinzas para biopsia)

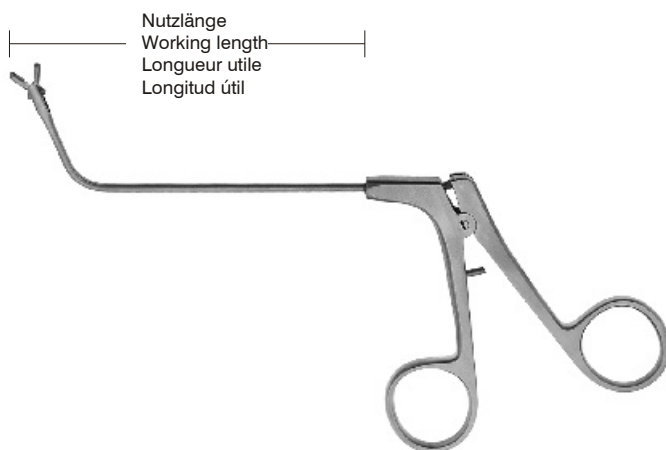

¼



34.5440
gerade
straight
droite
recta

¼



34.5441
70° aufgebogen
70° curved upwards
70° courbe en haut
70° curva arriba

¼



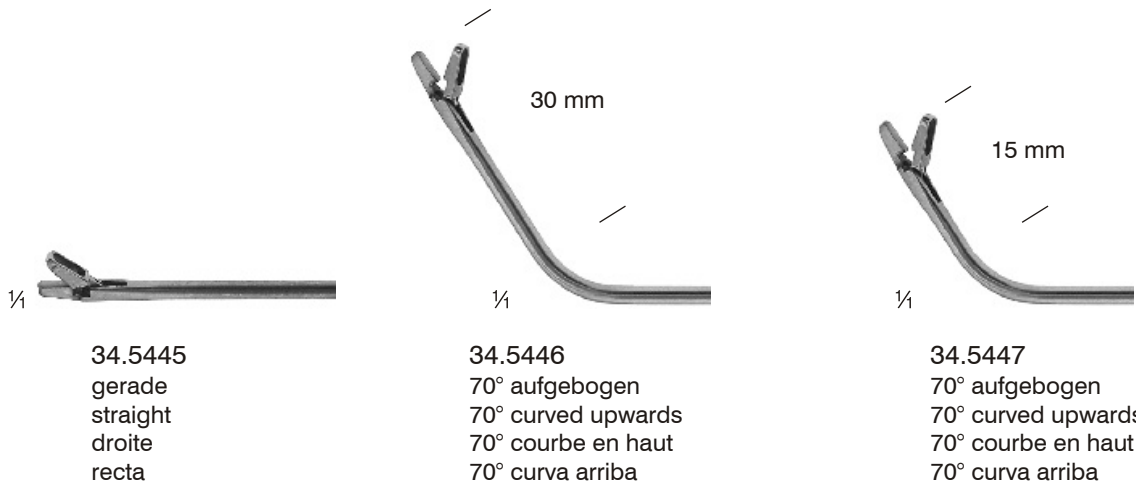
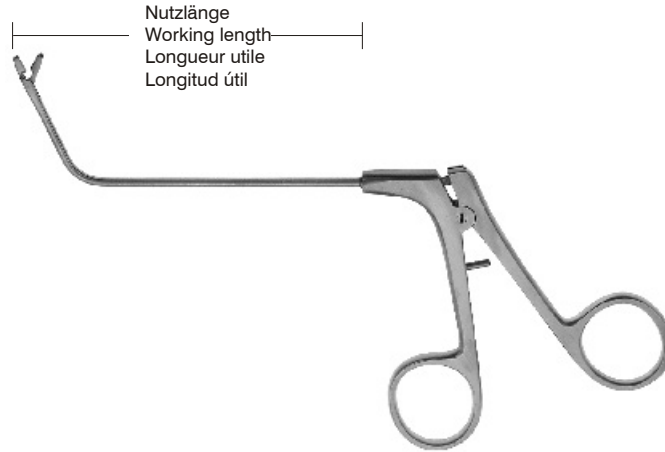

34.5442
110° aufgebogen
110° curved upwards
110° courbe en haut
110° curva arriba

	Maul Jaw Mors Boca	Nutzlänge Working length Longueur utile Longitud útil
34.5440	3 x 4,5 mm	110 mm
34.5441	3 x 4,5 mm	80 mm
34.5442	3 x 4,5 mm	70 mm

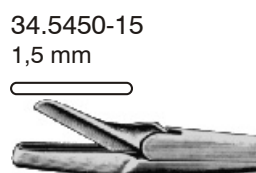
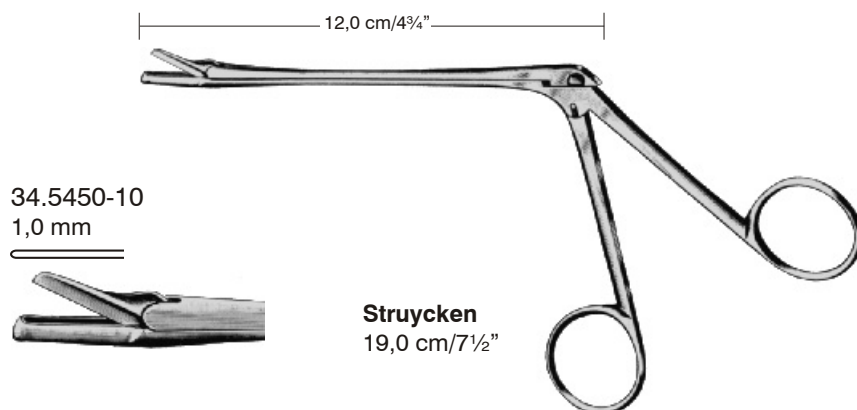

	Maul Jaw Mors Boca	Nutzlänge Working length Longueur utile Longitud útil
34.5445	1,5 x 5 mm	110 mm
34.5446	1,5 x 5 mm	80 mm
34.5447	1,5 x 5 mm	80 mm

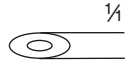

	Bißbreite Width of bite Grandeur de coupe Ancho de la boca	Schaftlänge, Length of shaft Longueur de tige, Largo del asta		Schaftlänge, Length of shaft Longueur de tige, Largo del asta	
		13,0 cm/5"	17,0 cm/6 3/4"	13,0 cm/5"	17,0 cm/6 3/4"
	3 x 8 mm	34.5452-13	34.5452-17	34.5455-13	34.5455-17
	4 x 10 mm	34.5453-13	34.5453-17	34.5456-13	34.5456-17
	5 x 12 mm	34.5454-13	34.5454-17	34.5457-13	34.5457-17

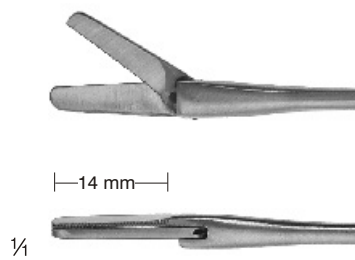
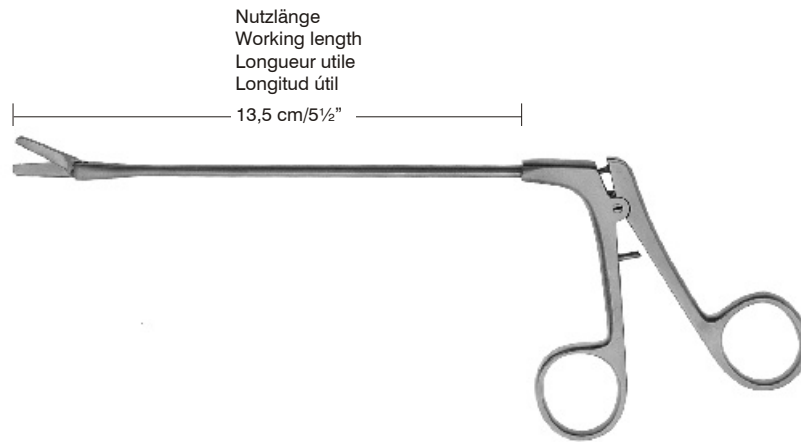

34.5460
gerade
straight
droite
recta

1 Schneide gezahnt
1 Blade toothed
1 Tranchant dentelé
1 Filo dentado

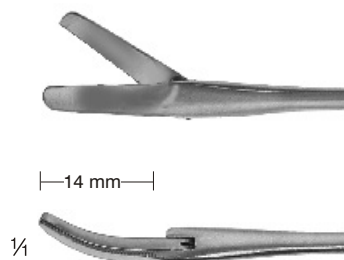

34.5461
nach rechts gebogen
curved to the right
courbe à droite
curva hacia la derecha

1 Schneide gezahnt
1 Blade toothed
1 Tranchant dentelé
1 Filo dentado

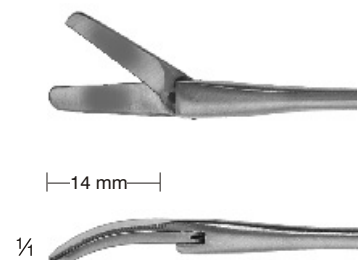

34.5462
nach links gebogen
curved to the left
courbe à gauche
curva hacia la izquierda

1 Schneide gezahnt
1 Blade toothed
1 Tranchant dentelé
1 Filo dentado

gezahnt
toothed
dentelés
dentadas



Caplan

34.5470
20,0 cm/8"

gezahnt
toothed
dentelés
dentadas



Killian

34.5471
21,0 cm/8½"



Rubin

34.5472-01
21,0 cm/8½"

TC-Rubin

34.5472-02
21,0 cm/8½"

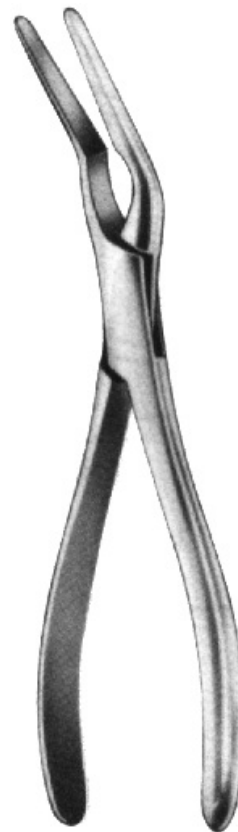

Asch

34.5473
22,0 cm/8¾"



Hartmann
16,5 cm/6½"

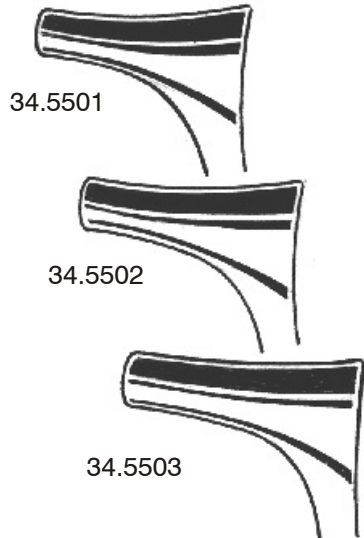

Hartmann-Halle
15,0 cm/6"

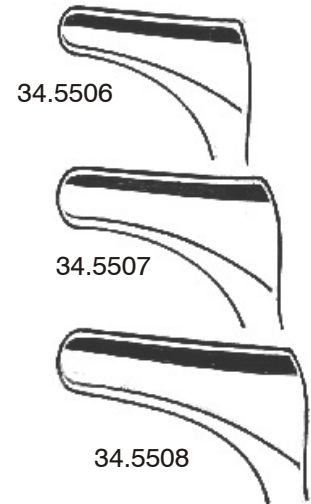

Tieck-Halle

34.5510
13,5 cm/5¼"



Tieck-Halle

34.5511
13,5 cm/5¼"



Cottle
16,5 cm/6½"

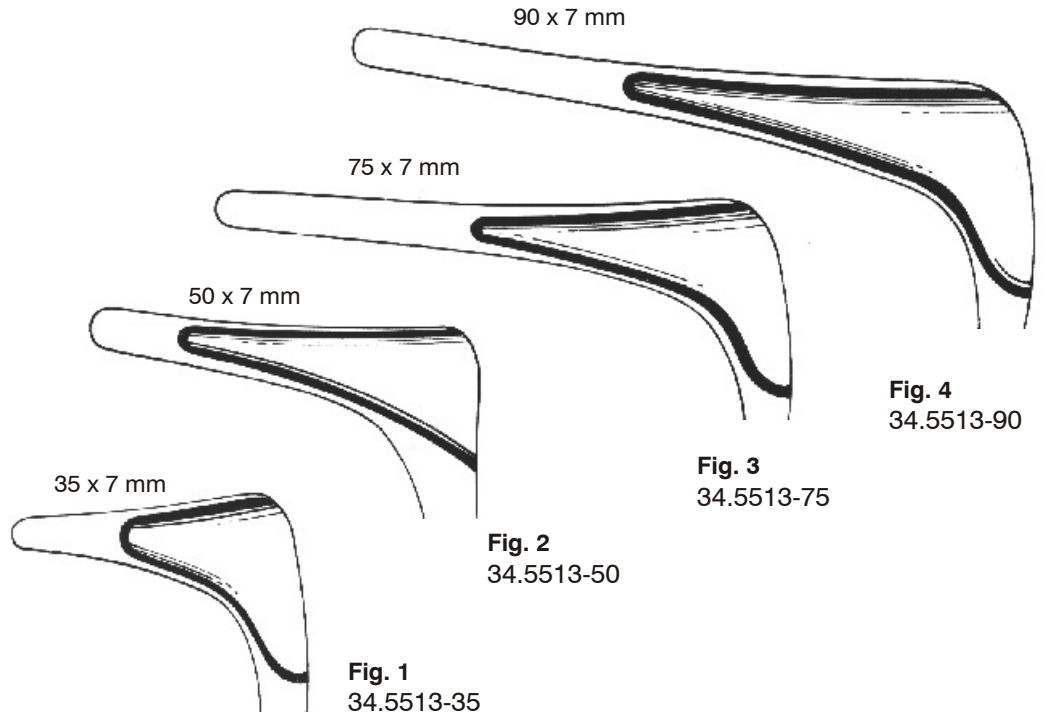

Fig. 1
34.5513-35

Fig. 2
34.5513-50

Fig. 3
34.5513-75

Fig. 4
34.5513-90



Cottle
14,0 cm/5½"

Schwarz verchromt
black chromium plated
chromé en noir
cromado en negro

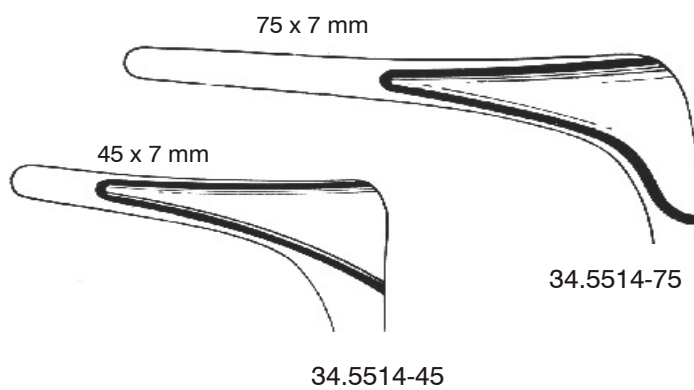

34.5514-45

34.5514-75



Killian
 13,0 cm/5"



34.5515
 35 mm

34.5516
 50 mm

34.5517
 75 mm

34.5518
 90 mm



Thudichum (Goldsmith)
 6,5 cm/2½"



Fig. 1
 34.5522-01

Fig. 2
 34.5522-02

Fig. 3
 34.5522-03

Fig. 4
 34.5522-04



Fig. 5
 34.5522-05

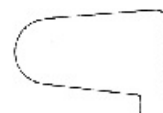

Fig. 6
 34.5522-06



Fig. 7
 34.5522-07



Krause

34.5530
26,0 cm/10¼"



Krause-Voss

34.5531
26,0 cm/10¼"

Stahldraht für Polypenschnürer
Steel wire for nasal snares
Anses en fil d'acier pour serre-nœuds
Alambre de acero para polipótomos



34.6018 0,3 mmØ
Pack à 12 Stück
Pack of 12 pieces
Paquet à 12 pièces
Paquete con 12 piezas



10 m / 33ft.
34.5532-30 0,3 mmØ
34.5532-40 0,4 mmØ



Hartmann

34.5549 13,0 cm/5"
34.5550 16,0 cm/6¼"

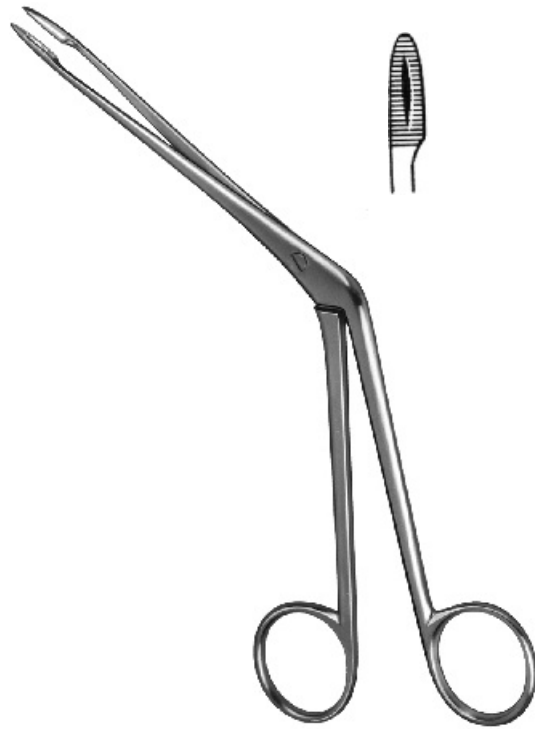

Hartmann

34.5551 20,0 cm/8"



Heymann-Knight

34.5552 18,0 cm/7"



Littauer

34.5553 18,0 cm/7"



Troeltsch (Wilde)

- 34.5554 11,0 cm/4½"
- 34.5555 12,0 cm/4¾"
- 34.5556 15,0 cm/6"
- 34.5557 18,0 cm/7"



Troeltsch (Wilde) 1 x 2

- 34.5559 12,0 cm/4¾"
- 34.5560 15,0 cm/6"



bajonettförmig
bayonet-shaped
en forme de baïonette
en forma de bayoneta

Jansen

- 34.5562 16,0 cm/6½"
- 34.5563 18,0 cm/7"

Grünwald-Jansen

- 34.5564 20,0 cm/8"



Lucae

- 34.5565 14,0 cm/5½"



Lucae 1 x 2

- 34.5566 14,0 cm/5½"



Cottle

- 34.5567 14,0 cm/5½"

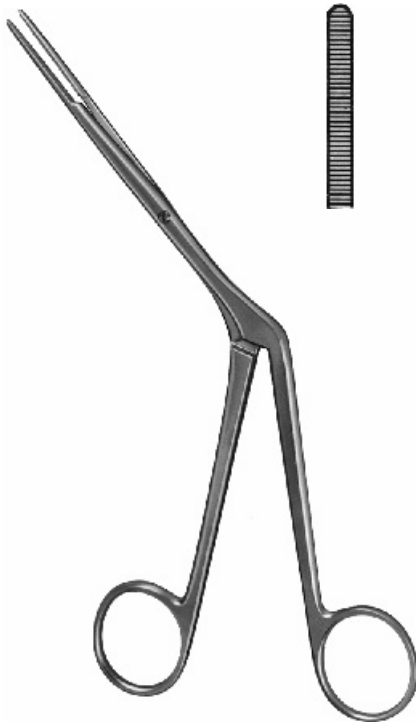

Westmacott

34.5568 20,0 cm/8"



Graig

34.5569 18,0 cm/7"

Nasen-Septumzange
 Nasal Septum Forceps
 Pinces pour la cloison nasale
 Pinzas para el tabique nasal

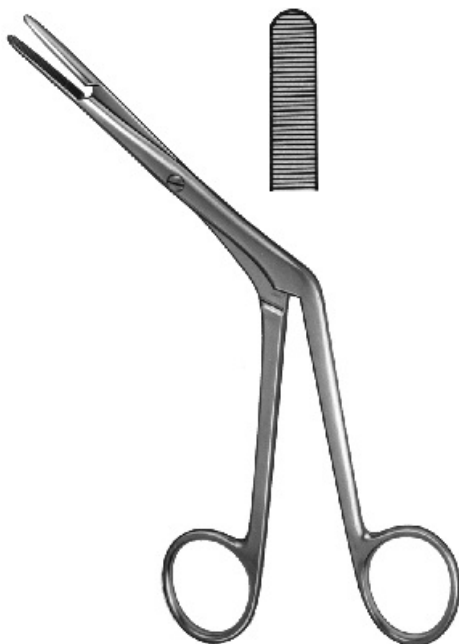

Killian

34.5570 17,0 cm/6³/₄"



Knight

34.5571-18 18,0 cm/7"

Septumzange
 Septum Forceps
 Pince pour la cloison nasale
 Pinza para el tabique nasal



Luc

20,0 cm/8"

Fig. 1
 34.5573-01

Fig. 2
 34.5573-02

Siebbeinzange
 Ethmoid Forceps
 Pince ethmoïdales
 Pinza para etmoides

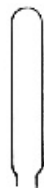

durchschneidend
through-cutting
coupantes des deux côtés
bocas cortantes la una en la otra

Middleton-Jansen

34.5574-01
19,0 cm/7½"



Löffelmaul
spoon-shaped jaw
mors en forme d'un cuiller
con boca en forma de cucharilla

Middleton-Jansen

34.5574-02
19,0 cm/7½"

Keilbeinstanzen

Sphenoid Punches

Pinces emporte-pièces pour sinus sphénoïdal

Pinzas cortantes para seno esfenoidal

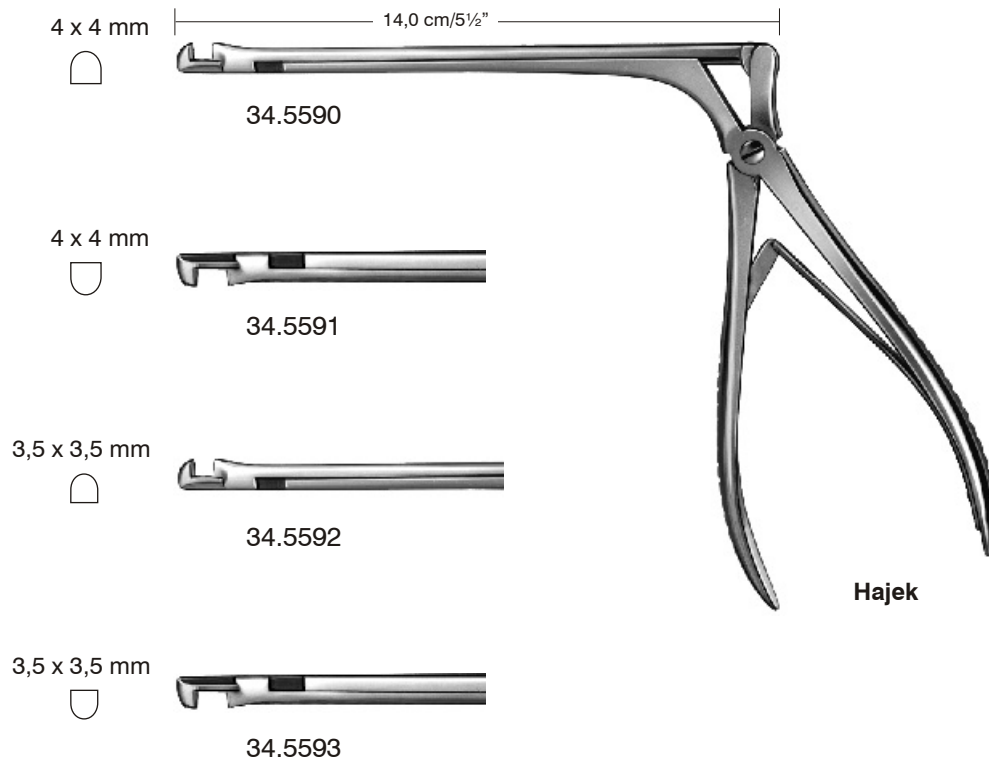

Kieferhöhlenstanze
Antrum Punch Forceps
Pinces emporte-pièces pour sinus maxillaire
Pinzas cortantes para seno maxilar

34.5596
4 mm

34.5597
5 mm

34.5598
6 mm



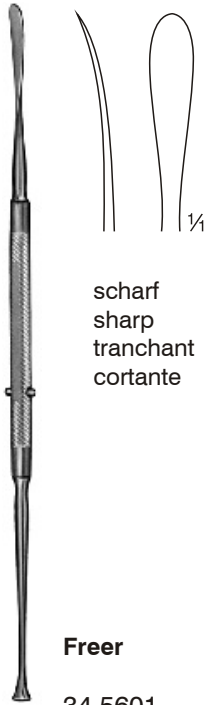

scharf
sharp
tranchant
cortante

Freer

34.5601

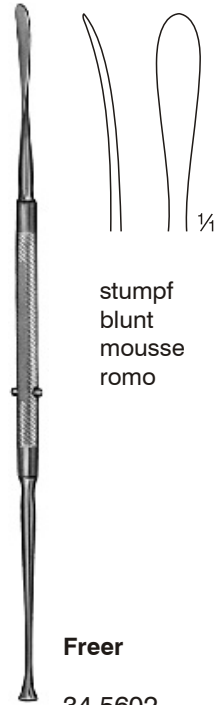

stumpf
blunt
mousse
romo

Freer

34.5602

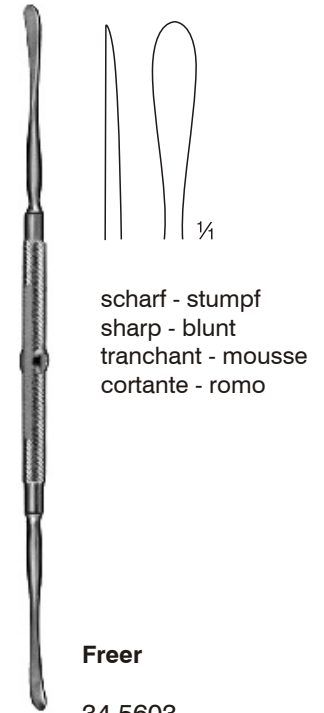

scharf - stumpf
sharp - blunt
tranchant - mousse
cortante - romo

Freer

34.5603

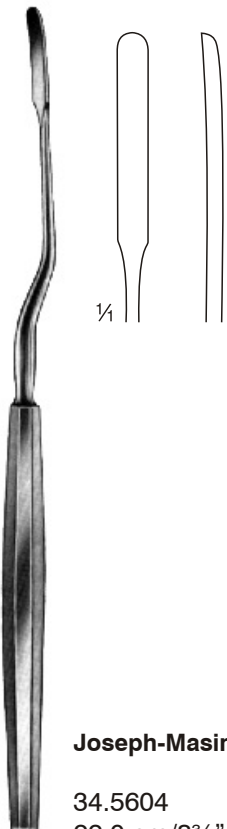

Joseph-Masing

34.5604
22,0 cm/8³/₄"

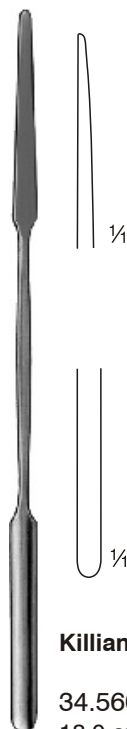

Killian

34.5605
18,0 cm/7"

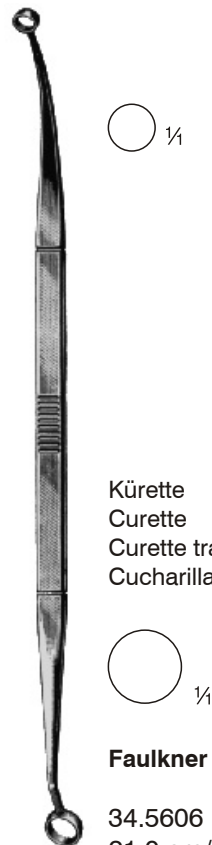

Kürette
Curette
Curette tranchante
Cucharilla cortante

Faulkner

34.5606
21,0 cm/8¹/₄"

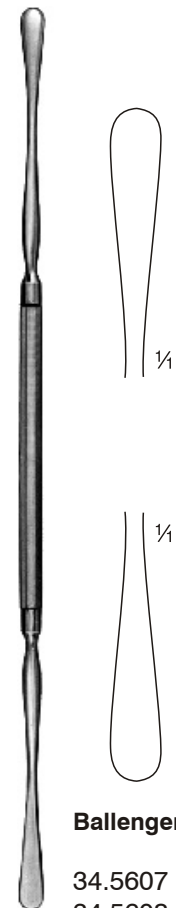

Ballenger-Hajek

34.5607 19,0 cm/7¹/₂"
34.5608 22,0 cm/8³/₄"

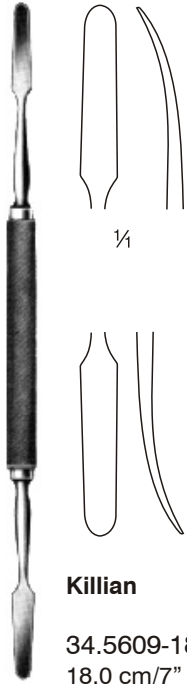

Killian

34.5609-18
 18,0 cm/7"

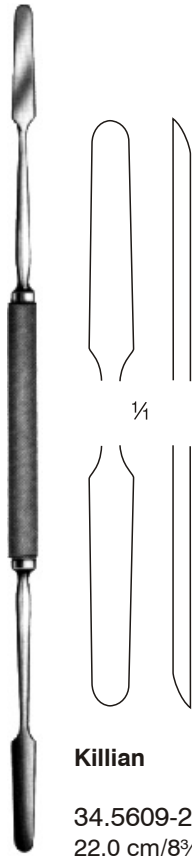

Killian

34.5609-22
 22,0 cm/8³/₄"

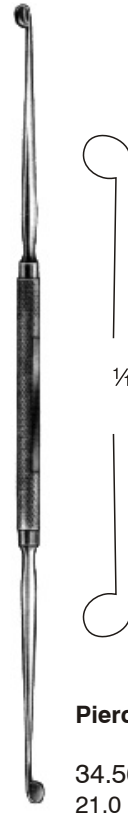

Pierce

34.5610
 21,0 cm/8¹/₂"

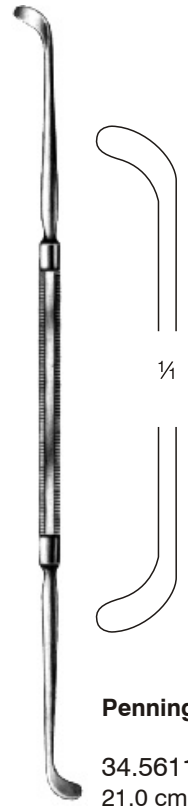

Pennington

34.5611
 21,0 cm/8¹/₂"

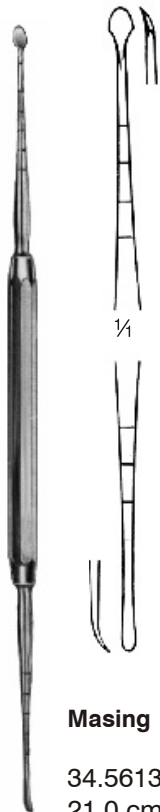

Masing

34.5613
 21,0 cm/8¹/₂"

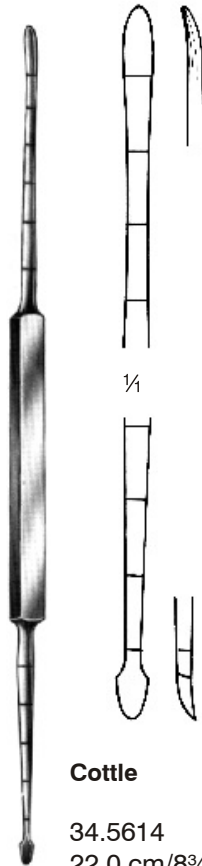

Cottle

34.5614
 22,0 cm/8³/₄"

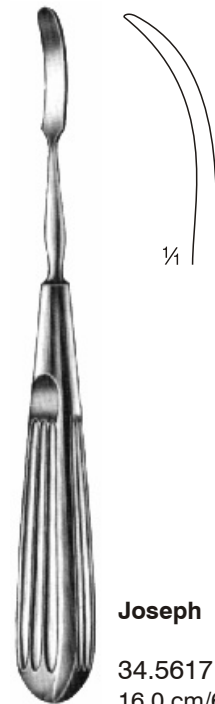

Joseph

34.5617
 16,0 cm/6¹/₄"

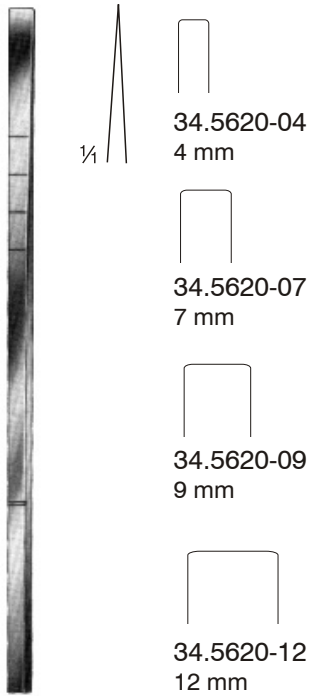

Cottle
18,0 cm/7"

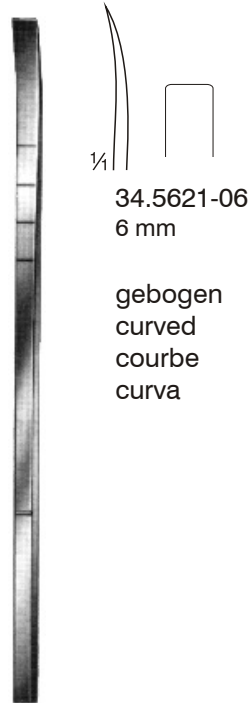

Cottle
18,0 cm/7"

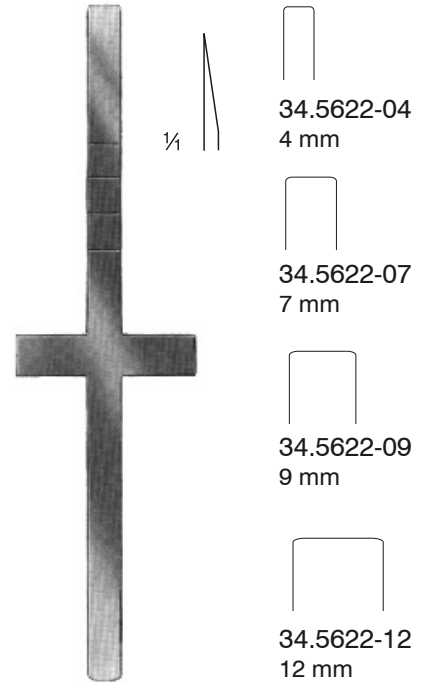

Cottle
18,0 cm/7"

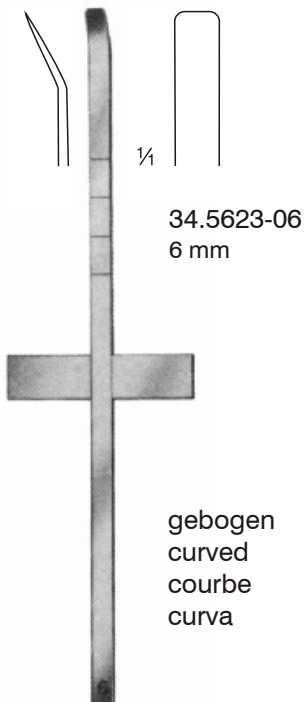

Cottle
18,0 cm/7"

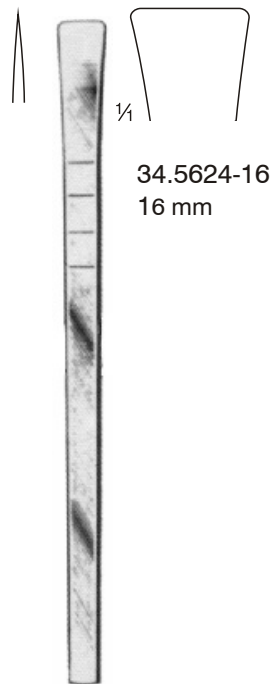



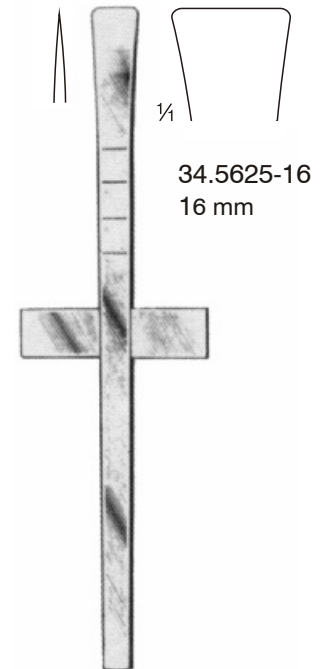

Cottle
18,0 cm/7"

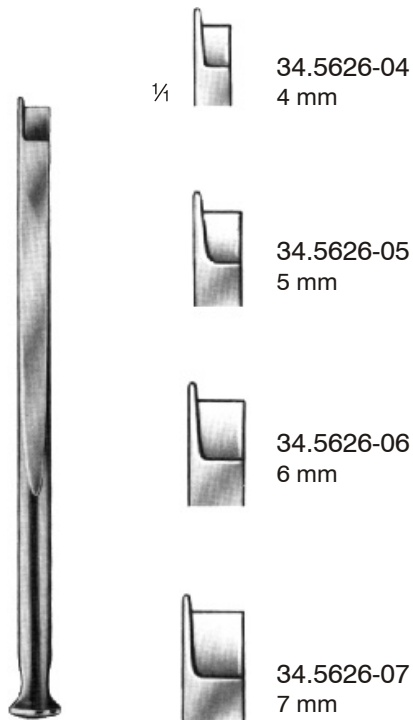

Cottle
18,0 cm/7"



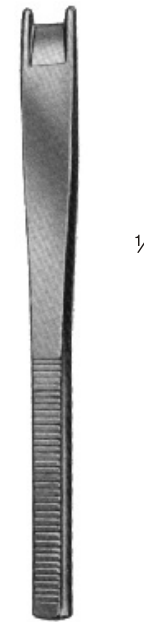

Fomon
 17,0 cm/6¾"

- ¼  34.5626-04
4 mm
- ¼  34.5626-05
5 mm
- ¼  34.5626-06
6 mm
- ¼  34.5626-07
7 mm

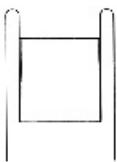
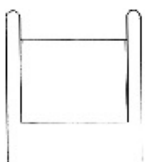

Cinelli
 16,0 cm/6½"

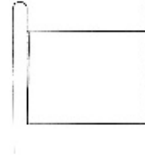
- ¼  34.5627-10
10 mm
- ¼  34.5627-14
14 mm
- ¼  34.5627-12
12 mm
- ¼  34.5627-16
16 mm

Flachmeißel
 Chisel
 Ciseaux-burin
 Cincel

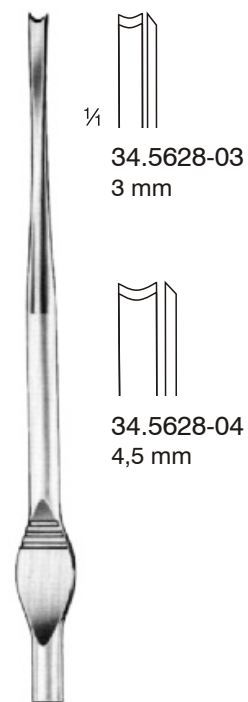



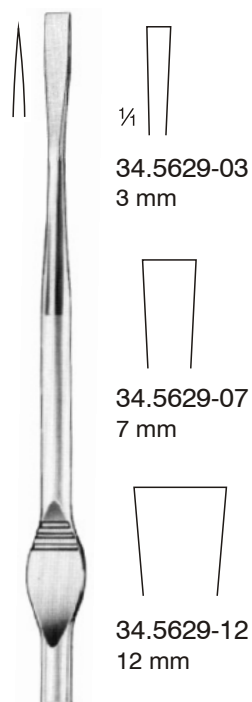

Walter
 19,0 cm/7¾"

- ¼  34.5628-03
3 mm
- ¼  34.5628-04
4,5 mm



Walter
 19,0 cm/7¾"

- ¼  34.5629-03
3 mm
- ¼  34.5629-04
4 mm
- ¼  34.5629-07
7 mm
- ¼  34.5629-09
9 mm
- ¼  34.5629-12
12 mm

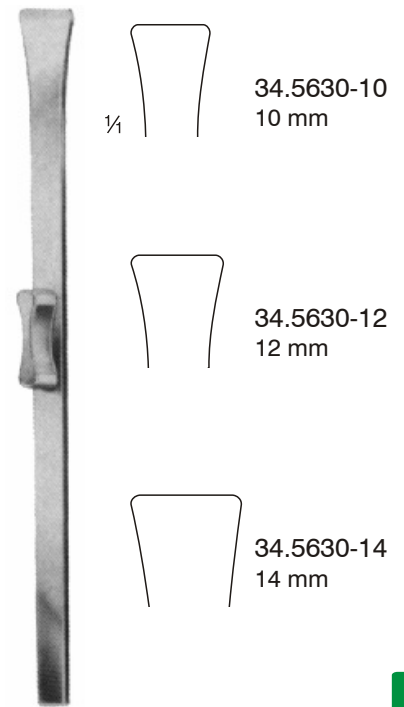

Rubin
 18,0 cm/7"

- ¼  34.5630-10
10 mm
- ¼  34.5630-12
12 mm
- ¼  34.5630-14
14 mm



gerade
straight
droit
recto

Silver

34.5631-01
18,0 cm/7"



rechts
right
à droite
a la derecha

Silver

34.5631-02
18,0 cm/7"



links
left
à gauche
a la izquierda

Silver

34.5631-03
18,0 cm/7"

Flachmeißel, Chisels
Ciseaux-burins, Cinceles

4 mm



gerade
straight
droit
recto

34

Freer

34.5632-01
16,0 cm/6½"

4 mm



gebogen
curved
courbe
curvo

Freer

34.5632-02
16,0 cm/6½"

6 mm



Freer

34.5633
15,0 cm/6"

5 mm



Killian

34.5634-01
17,0 cm/6¾"

5 mm



Killian-Claus

34.5634-02
17,0 cm/6¾"

Septum-Hohlmeißel, Septum Gouges, Septum gouges, Septum gubias



Joseph
19,0 cm/7½"

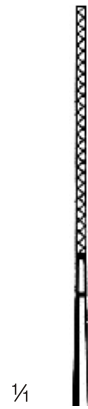

Fig. 1
34.5635-01

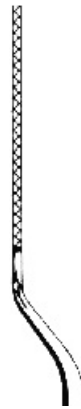

Fig. 2
34.5635-02



Fig. 3
34.5635-03

bajonettförmig
bayonet-shaped
en forme de baïonnette
en forma de bayoneta

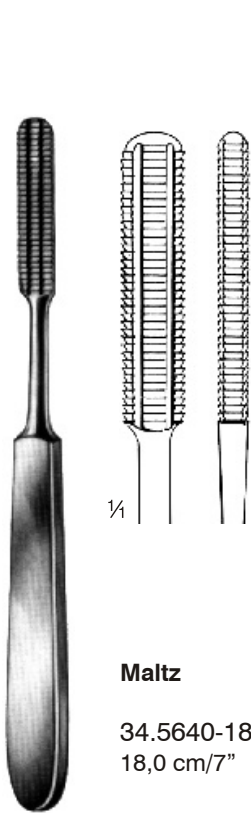

Fig. 1
34.5636-01

Fig. 2
34.5636-02

rechtwinklig
right-angled
rectangulaire
en ángulo recto

Joseph
17,0 cm/6¾"



Maltz
34.5640-18
18,0 cm/7"

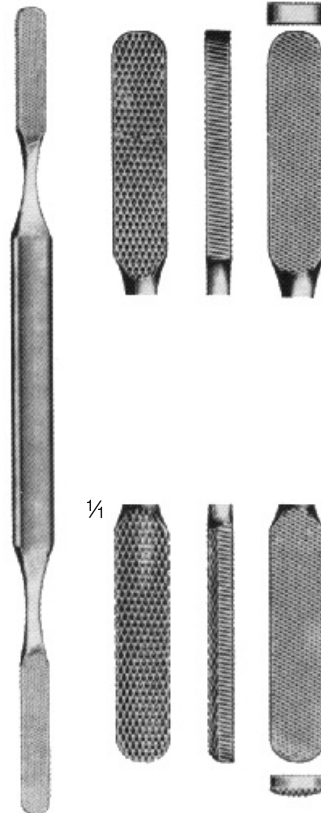

Fomon
34.5641-21
21,0 cm/8¼"

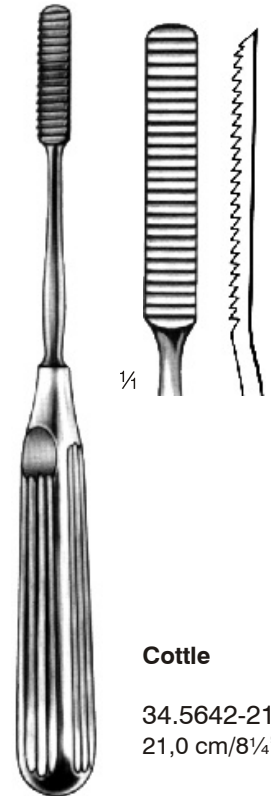

Cottle
34.5642-21
21,0 cm/8¼"

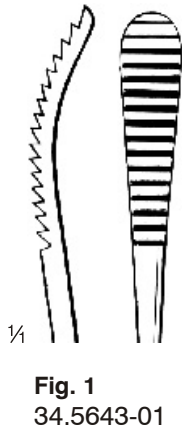

Fig. 1
34.5643-01

Aufricht
21,0 cm/8¼"

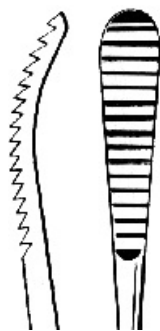

Fig. 2
34.5643-02



Fig. 1
34.5644-01

Wiener
18,0 cm/7"



Fig. 2
34.5644-02

Nasenflügelhaken

Hooks for posterior nares

Crochets pour les ailes du nez

Separadores nasales



Fig. 1
34.5650-01



Fig. 2
34.5650-02



Fig. 3
34.5650-03



Joseph

34.5651-15
15,0 cm/6"



Cottle

34.5652-16
16,0 cm/6 1/4"



Choanenhaken
Hook for posterior nares
Crochet boutoné pour
les ailes du nez
Gancho para las coanas

Cottle

34.5654-22
22,0 cm/8 3/4"



Fomon

34.5655-17
17,0 cm/6 3/4"



Aufricht

34.5656-19
19,0 cm/7 1/2"



Aufricht

34.5658-14
13,5 cm/5 1/4"



Kilner

34.5659-10
10,0 cm/4"



Converse

34.5660-12
12,0 cm/4 3/4"



Freer

34.5661-15
15,0 cm/6"



Joseph

16,0 cm/6 1/4"



34.5663-02
2 mm



34.5663-05
5 mm



34.5663-07
7 mm



34.5663-10
10 mm



Fomon

34.5664-16
16,0 cm/6 1/4"



Cottle-Neivert

34.5665-20
20,0 cm/8"



Cottle

15,0 cm/6"

1/4



Fig. 1
34.5667-01

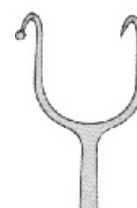

Fig. 2
34.5667-02



Fig. 3
34.5667-03



Cottle

34.5668-14
 14,0 cm/5½"



Neivert

34.5669-16
 16,0 cm/6¼"



Cottle

34.5670-15
 15,0 cm/6"



Cottle

34.5671-15
 15,0 cm/6"



Ballenger
 20,0 cm/8"



34.5680-03
 3 mm

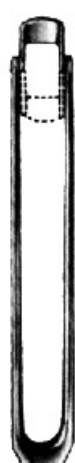

34.5680-04
 4 mm



34.5680-05
 5 mm

gerade
 straight
 droit
 recto



Ballenger
 20,0 cm/8"



34.5681-03
 3 mm



34.5681-04
 4 mm



34.5681-05
 5 mm

bajonettförmig
 bayonet-shaped
 en forme de baïonnette
 en forma de bayoneta



Joseph
15,0 cm/6"



Fig. 1
34.5685-01



Fig. 2
34.5685-02



Fomon

34.5686-16
16,0 cm/6½"



Cottle

34.5687-15
15,0 cm/6"



Joseph

34.5688-15
15,0 cm/6"



Converse

34.5689-16
16,0 cm/6½"



Cottle

34.5690-15
15,0 cm/6"



Vogel
 34.5700
 21,0 cm/8 1/4"



Beckmann
 22,0 cm/8 3/4"



Fig. 1
 34.5701

Fig. 2
 34.5702

Fig. 3
 34.5703

Fig. 4
 34.5704

Fig. 5
 34.5705



Barnhill
 21,0 cm/8 1/4"



Fig. 1
 34.5711

Fig. 2
 34.5712

Fig. 3
 34.5713

Fig. 4
 34.5714



St. Clair-Thomson
 21,0 cm/8 1/4"



Fig. 1
 34.5721

Fig. 2
 34.5722

Fig. 3
 34.5723

Fig. 4
 34.5724



La Force
25,0 cm/10"



Fig. 1



Fig. 2



Fig. 3

1/4

mit gelochter Klinge
with perforated blade
à lame perforée
con hoja perforada

Fig. 1 34.5731
Fig. 2 34.5732
Fig. 3 34.5733

Ersatzklingen
Spare blades
Lames de rechange
Hojas de repuesto

Fig. 1 34.5735
Fig. 2 34.5736
Fig. 3 34.5737



Heister

34.5803
 13,0 cm/5"

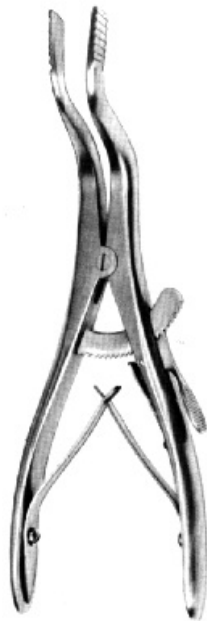

Roser-König

34.5807
 16,0 cm/6¼"



Denhart

34.5810
 12,0 cm/4¾"



Molt

34.5814 11,0 cm/4½"
 34.5815 14,0 cm/5½"



Whitehead

34.5821 11,0 cm/4½"
 34.5823 13,0 cm/5"
 34.5825 15,0 cm/6"



Jennings

34.5830 9,0 cm/3½"
 34.5831 11,0 cm/4½"
 34.5833 13,0 cm/5"
 34.5835 15,0 cm/6"

Davis-Boyle

Zungenspatel allein, Tongue Depressor only
Abaisse-langue seule, Abaja-lengua suelta



Fig. 1
34.5841
21 x 30 mm

Fig. 2
34.5842
23 x 65 mm

Fig. 3
34.5843
24 x 80 mm

Fig. 4
34.5844
25 x 93 mm

Fig. 5
34.5845
26 x 108 mm



Davis-Boyle

Griff allein, Handle only
Manche seul, Mango suelto

34.5840-01	34.5840-02	34.5840-03
für Erwachsene	für Jugendliche	für Kinder
for adults	for young people	for children
pour adultes	pour jeunes gens	pour enfants
para adultos	para menores	para niños

34.5846

Paar Silikoneinlagen allein
Pair of silicon inserts only
Paire de protection translucid seule
Par de silicon piezas solo

Davis-Boyle

34.5839

Satz, komplett mit:
Griff 34.5840-02, 2 Silikoneinlagen
5 auswechselbaren Zungenspateln 34.5841 - 34.5845

Set, complete with:
handle 34.5840-02, 2 silicon inserts
5 interchangeable tongue depressors 34.5841 - 34.5845

Jeu, complet avec:
manche 34.5840-02, une paire de protection translucid
5 abaisse-langues interchangeables 34.5841 - 34.5845

Juego, completo con:
mango 34.5840-02, un par de silicon piezas
5 abaja-lenguas intercambiables 34.5841 - 34.5845



Mc Ivor

Zungenspatel allein, Tongue Depressor only
Abaisse-langue seule, Abaja-lengua suelta

Fig. 1
34.5851
23 x 70 mm

Fig. 2
34.5852
25 x 86 mm

Fig. 3
34.5853
26 x 100 mm



Mc Ivor

34.5850
Griff allein, Handle only
Manche seul, Mango suelto

Mc Ivor

34.5849

Satz, komplett mit:
Griff 34.5850
3 auswechselbaren Zungenspateln 34.5851 - 34.5853

Set, complete with:
handle 34.5850
3 interchangeable tongue depressors 34.5851 - 34.5853

Jeu, complet avec:
manche 34.5850
3 abaisse-langues interchangeables 34.5851 - 34.5853

Juego, completo con:
mango 34.5850
3 abaja-lenguas intercambiables 34.5851 - 34.5853



Negus

Zungenspatel allein, Tongue Depressor only
Abaisse-langue seule, Abaja-lengua suelta

Fig. 1
34.5861
28 x 70 mm

Fig. 2
34.5862
30 x 80 mm

Fig. 3
34.5863
33 x 95 mm



Davis-Boyle

Griff allein, Handle only
Manche seul, Mango suelto

34.5840-01	34.5840-02	34.5840-03
für Erwachsene	für Jugendliche	für Kinder
for adults	for young people	for children
pour adultes	pour jeunes gens	pour enfants
para adultos	para menores	para niños

34.5846

Paar Silikoneinlagen allein
Pair of silicon inserts only
Paire de protection translucid seule
Par de silicon piezas solo

Negus

34.5859

Satz, komplett mit:
Griff 34.5840-02, 2 Silikoneinlagen
3 auswechselbaren Zungenspateln 34.5861 - 34.5863

Set, complete with:
handle 34.5840-02, 2 silicon inserts
3 interchangeable tongue depressors 34.5861 - 34.5863

Jeu, complet avec:
manche 34.5840-02, une pair de protection translucid compris
3 abaisse-langues interchangeables 34.5861 - 34.5863

Juego, completo con:
mango 34.5840-02, un par de silicon piezas
3 abaja-lenguas intercambiables 34.5861 - 34.5863

Kilner-Doughty (Russel-Davis)

Zungenspatel allein, Tongue Depressor only
Abaisse-langue seule, Abaja-lengua suelta



Fig. 1
34.5871
28 x 65 mm

Fig. 2
34.5872
32 x 75 mm

Fig. 3
34.5873
37 x 80 mm

Fig. 4
34.5874
40 x 90 mm

Fig. 5
34.5875
45 x 100 mm



Kilner-Doughty (Russel-Davis)

34.5870
Griff allein, Handle only
Manche seul, Mango suelto

Kilner-Doughty (Russel-Davis)

34.5869

Satz, komplett mit:
Griff 34.5870

3 auswechselbaren Zungendrückern 34.5871 - 34.5873
2 beweglichen auswechselbaren Zahnplatten
1 Gaumenplatte für Zahnlose

Set, complete with:
handle 34.5870

3 interchangeable tongue depressors 34.5871 - 34.5873
2 adjustable and exchangeable tooth plates
1 palatal support for toothless people

Jeu, complet avec:
manche 34.5870

3 abaisse-langues interchangeables 34.5871 - 34.5873
2 supports mobiles et interchangeables des dents
1 support du palais pour édentés

Juego, completo con:
mango 34.5870

3 abaja-lenguas intercambiables 34.5871 - 34.5873
2 soportes de dientes móviles e intercambiables
1 soporte de paladar para desdentados

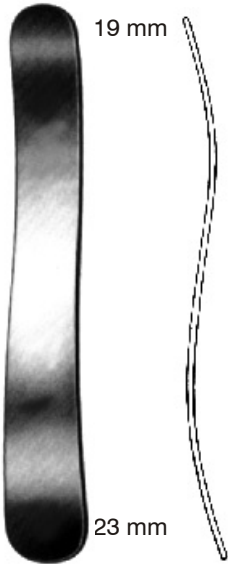

34.5883
14,0 cm/5½"

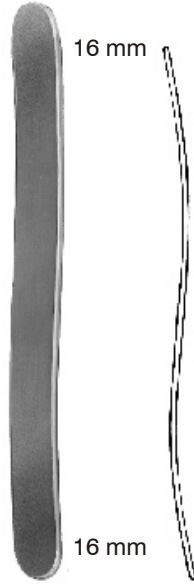

Buchwald
34.5884
14,5 cm/5¾"

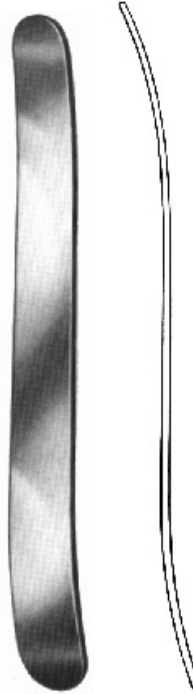

Buchwald
34.5888
18,0 cm/7"



Bruenings
34.5890
19,0 cm/7½"



massiv
solid
massif
macizo

Tobold
34.5891
14,5 cm/5¾"



34.5892
14,0 cm/5½"

34.5893
15,0 cm/6"

Wieder



Doyen
34.5894 13,0 cm/5"
34.5895 16,0 cm/6¼"



Andrew
34.5896
11,0 cm/4½"



Collin

34.5900 17,0 cm/6³/₄"
34.5901 19,0 cm/7¹/₂"

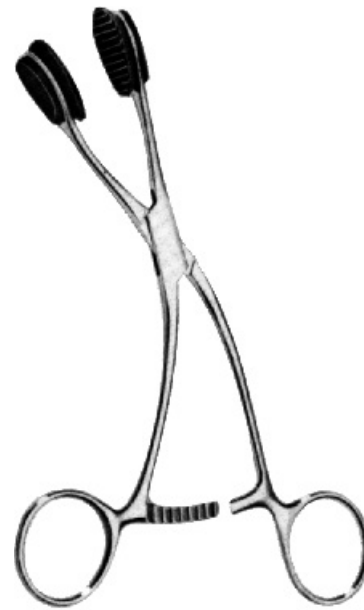

Young

34.5907 16,0 cm/6¹/₄"

34.5907-02

Paar Ersatzgummi
Pair of replacement rubber inserts
Paire de caoutchouc de rechange
Par de goma de recambio

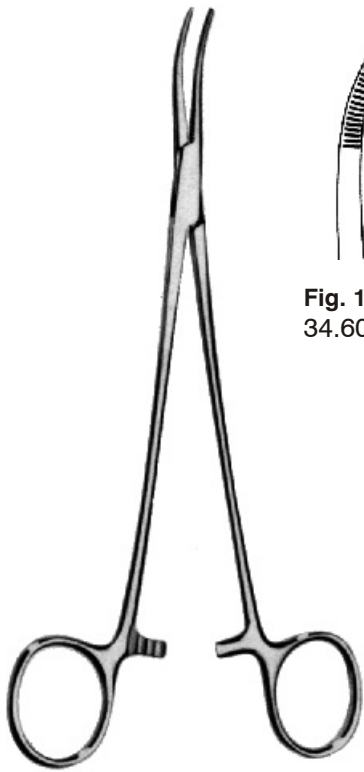

Fig. 1
34.6001



Fig. 2
34.6002



Schnidt
19,0 cm/7½"



Fig. 1
34.6003



Fig. 2
34.6004



Schnidt
19,0 cm/7½"

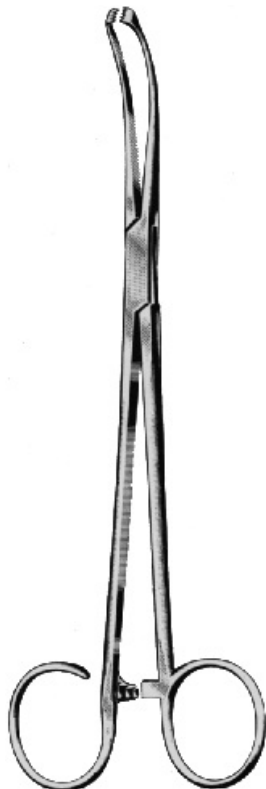

White

34.6005
18,0 cm/7"



Blohmke

34.6006
20,0 cm/8"



Tonsillenschnürer

Tonsil Snares

Serre-noeuds pour l'ablation des amygdales

Cierra-nudos para amígdalas



Bruenings

34.6010
28,0 cm/11"



Eves

34.6011
28,0 cm/11"



Eves

34.6012
28,0 cm/11"

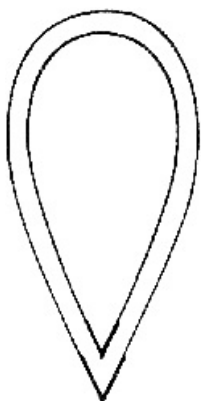

34.6010-40 0,4 mmØ/40 mm
34.6010-50 0,4 mmØ/50 mm
Drahtschlingen gelötet für Bruenings
(Bündel à 100 Stück)
Snare wires for Bruenings, soldered
(package of 100 pieces)
Anses soudées pour Bruenings
(paquet à 100 pièces)
Asas soldadas para Bruenings
(paquete con 100 piezas)



34.6018 0,3 mmØ/100 mm
34.6019 0,3 mmØ/90 mm
Drahtschlingen, geschnitten
(Pack à 12 Stück)
Snare wires, cut
(pack of 12 pieces)
Anses coupées
(paquet à 12 pièces)
Asas preparadas
(paquete con 12 piezas)

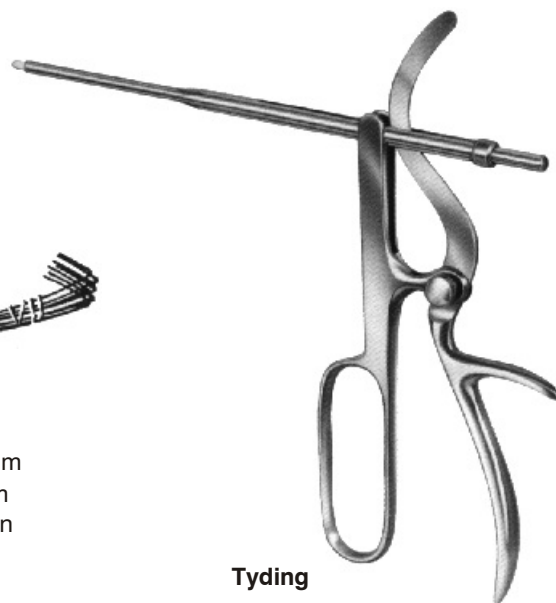

Tyding

34.6013
mit 1 geraden Aufsatz
with 1 straight tip
avec 1 guide-ansa droit
con 1 guía-asa recta



Tonsillenmesser und -enukleator
Tonsil Knives and Enucleators
Bistouris et Enucleateurs pour amygdales
Bisturías y Enucleadores para amígdalas

Carpenter

34.6020-01
25,0 cm/10"

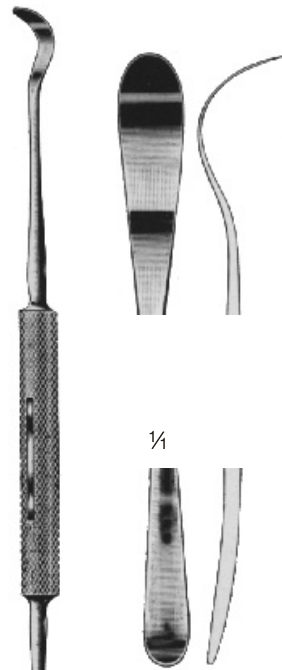

Carpenter

34.6020-02
24,0 cm/9½"



Tonsillendissektor und -retractor
Tonsil Dissector and Retractor
Dissecteur et Retracteur pour amygdales
Disecador y Separador para amígdalas

Hurd

34.6021
22,5 cm/9"

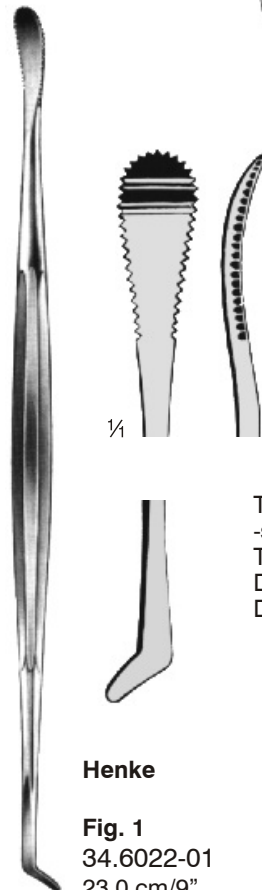

Tonsillendissektor und
-separator
Tonsil Dissector
Dissecteur pour amygdales
Disecador para amígdalas

Henke

Fig. 1
34.6022-01
23,0 cm/9"

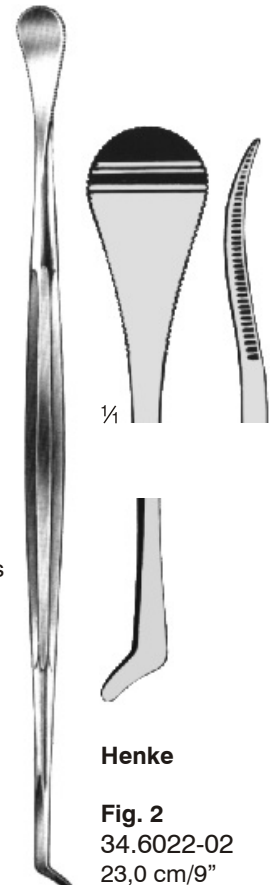

Henke

Fig. 2
34.6022-02
23,0 cm/9"



Fig. 1



Fig. 2



Fig. 3



Sluder-Ballenger

Sluder-Ballenger

34.6025
mit Aufsatz Fig. 1
with tip Fig. 1
avec lame Fig. 1
con hoja Fig. 1

34.6026
mit Aufsatz Fig. 1, Fig. 2
with tip Fig. 1, Fig. 2
avec lame Fig. 1, Fig. 2
con hoja Fig. 1, Fig. 2

34.6027
mit Aufsatz Fig. 1, Fig. 2, Fig. 3
with tip Fig. 1, Fig. 2, Fig. 3
avec lame Fig. 1, Fig. 2, Fig. 3
con hoja Fig. 1, Fig. 2, Fig. 3

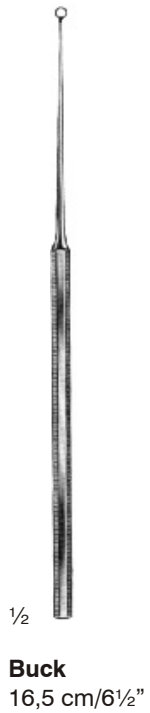

gerade, straight, droite, recta

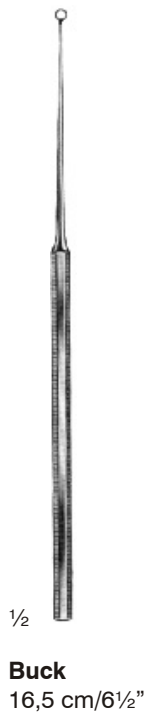
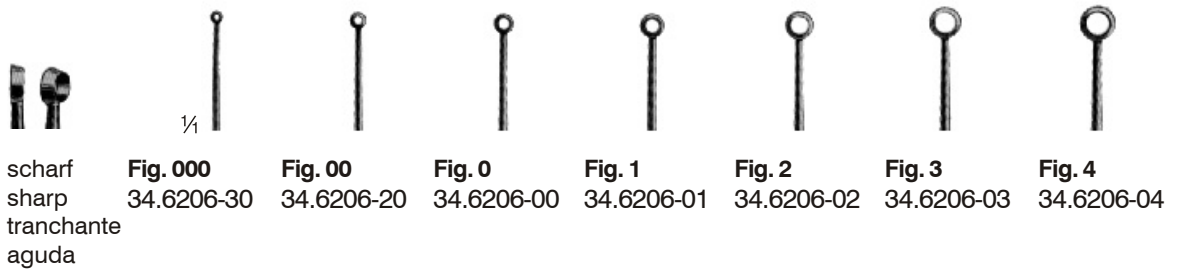
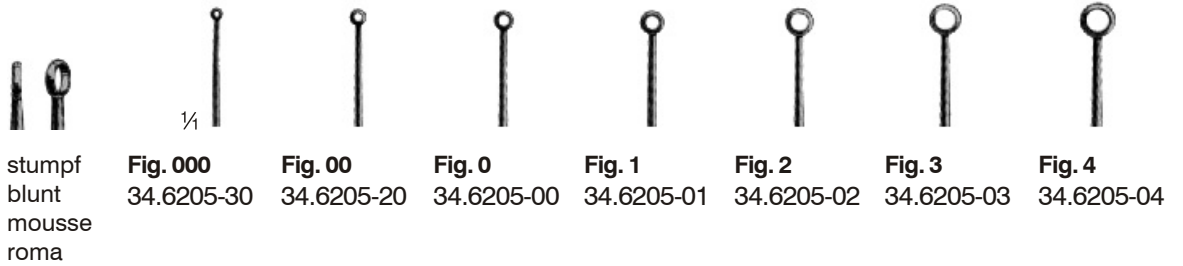

gebogen, curved, courbe, curva

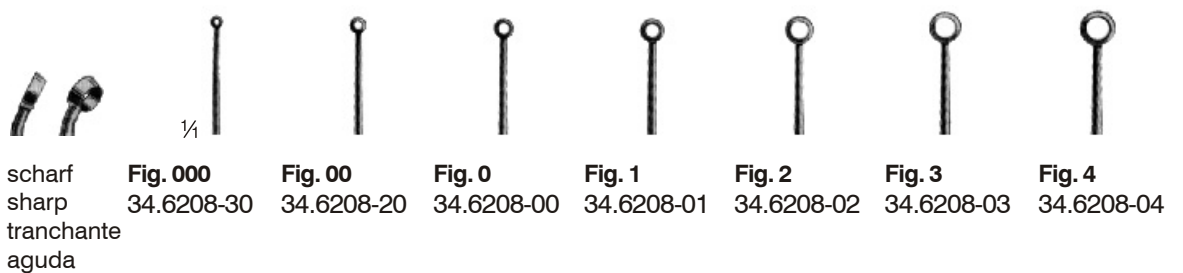
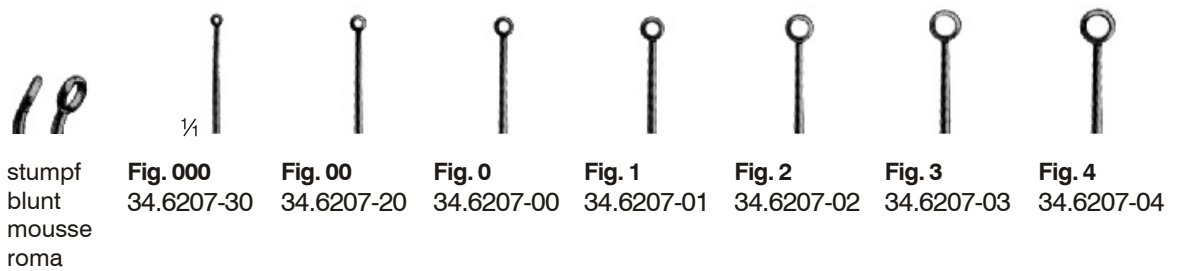

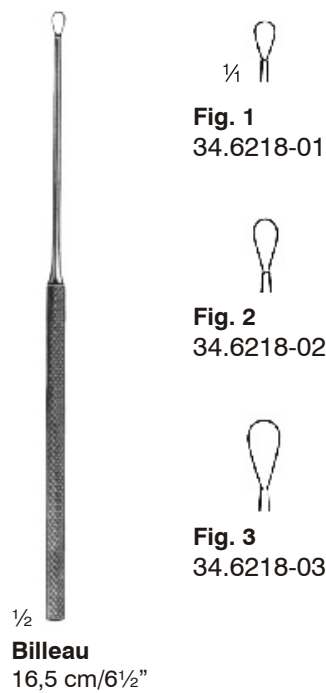
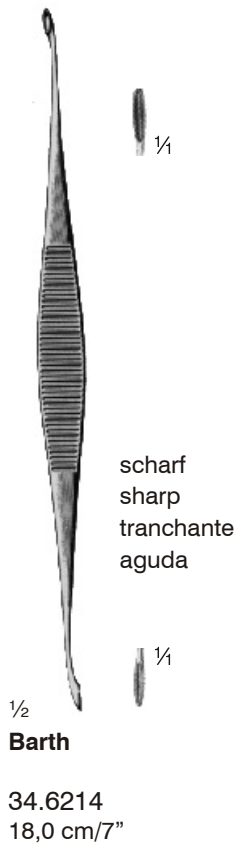
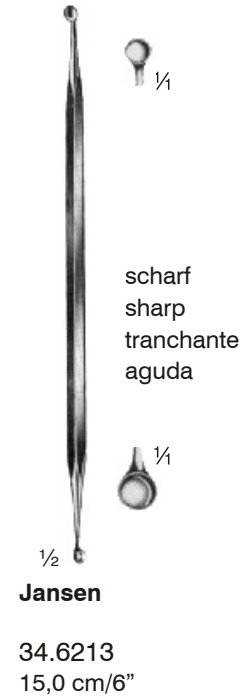
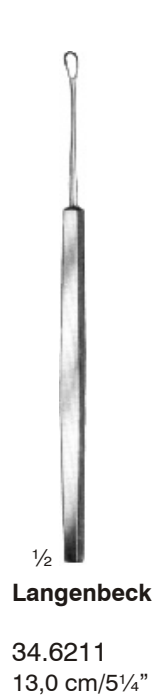
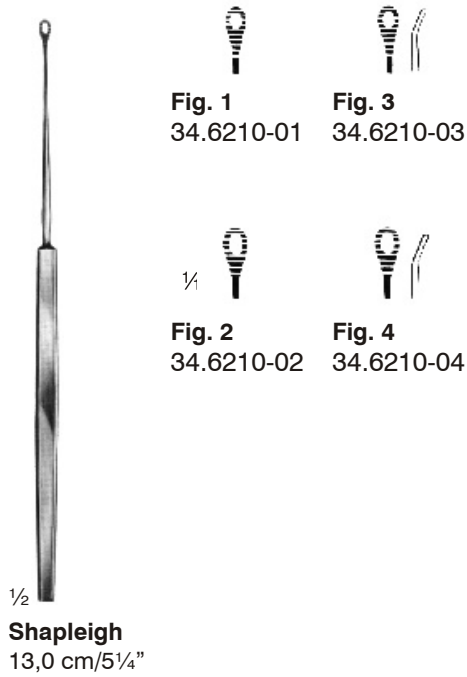

Ohrschlingen
 Ear Loops
 Anses auriculaires
 Asas auriculares

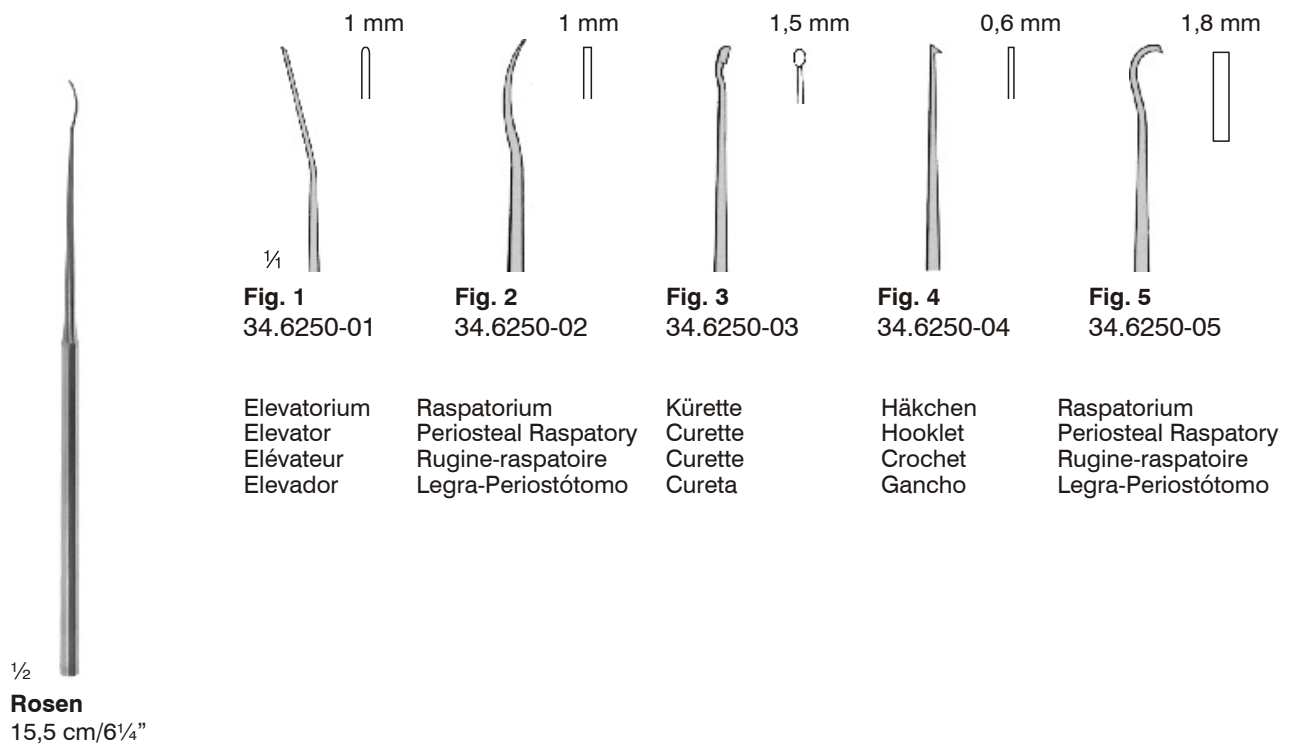
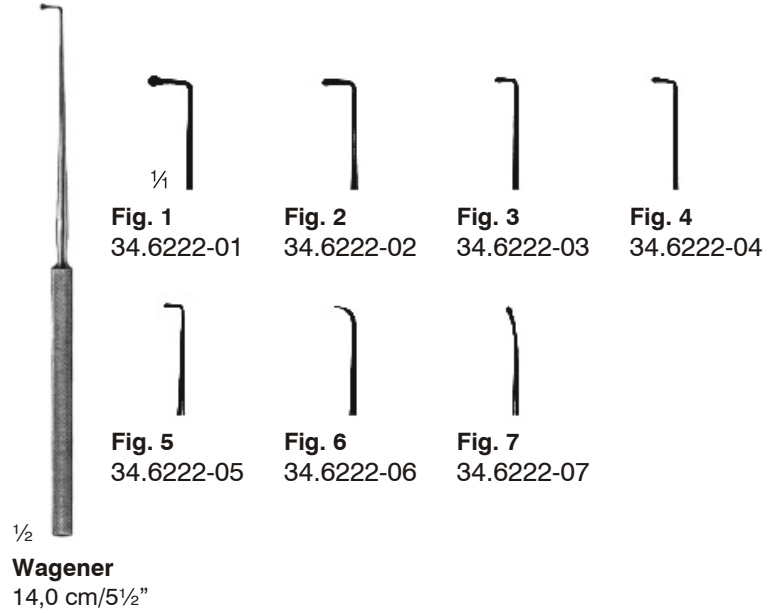
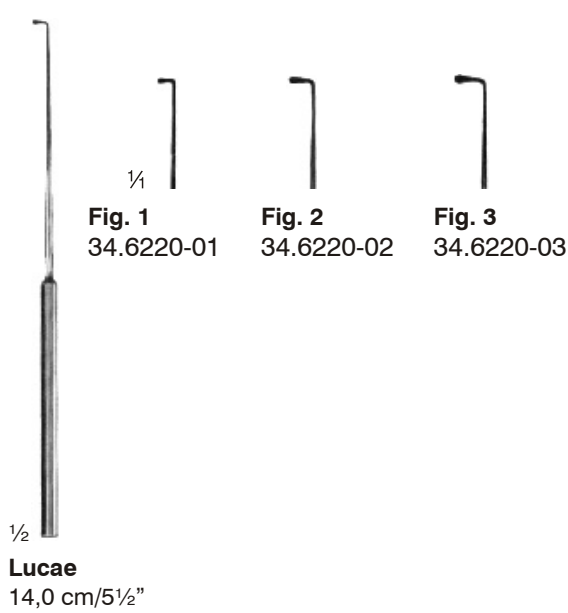

Parazentesenadeln, Paracentesis Needles, Aiguilles à paracentèse, Agujas para paracentesis



Lucae(Royce)

Fig. 1
 34.6290-01
 18,0 cm/7"



Lucae(Royce)

Fig. 2
 34.6290-02
 18,0 cm/7"

Nadel quergestellt
 Needle horizontal position
 Aiguille en position horizontale
 Aguja en posición horizontal

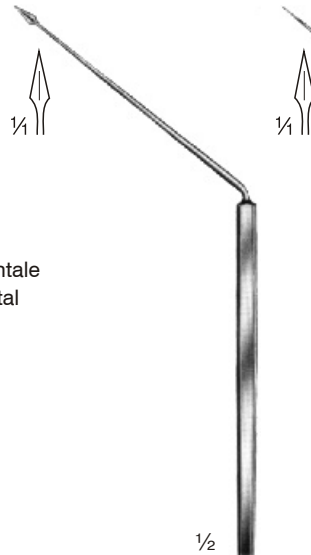

Politzer

Fig. 1
 34.6291-01
 16,5 cm/6½"

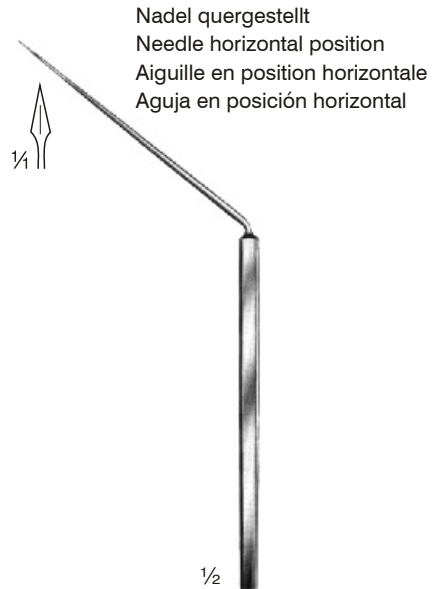

Politzer

Fig. 2
 34.6291-02
 16,5 cm/6½"

Nadel quergestellt
 Needle horizontal position
 Aiguille en position horizontale
 Aguja en posición horizontal

Trommelfellmesser, Tympanum Knives, Couteaux à tympan, Cuchillos para tímpano



Sexton

Fig. 1
 34.6298-01
 18,0 cm/7"



Sexton

Fig. 2
 34.6298-02
 17,0 cm/6¾"



Sexton

Fig. 3
 34.6298-03
 17,0 cm/6¾"

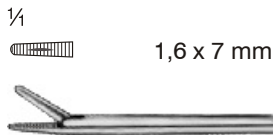
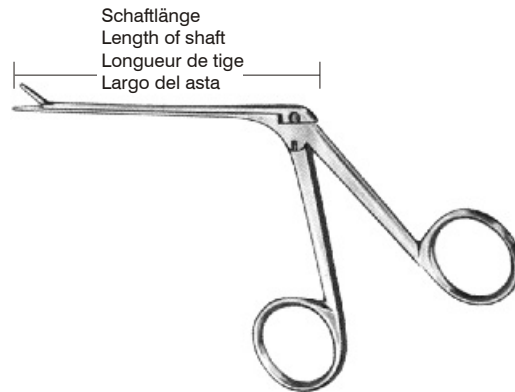

Hartmann-Wullstein

34.6400 8,5 cm/3¼"
Schaftlänge
Length of shaft
Longueur de tige
Largo del asta

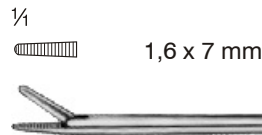

Hartmann

34.6401-08 8,0 cm/3½"
34.6401-14 14,0 cm/5½"
34.6401-16 16,0 cm/6¼"
Schaftlänge
Length of shaft
Longueur de tige
Largo del asta

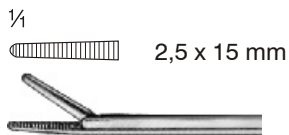

Hartmann-Noyes

34.6406 8,0 cm/3½"
Schaftlänge
Length of shaft
Longueur de tige
Largo del asta

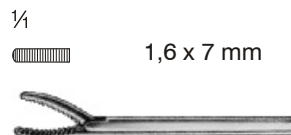

Hartmann-Weingärtner

34.6407 8,0 cm/3½"
Schaftlänge
Length of shaft
Longueur de tige
Largo del asta

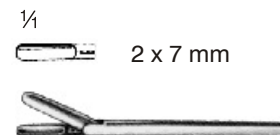

Hartmann

34.6408 8,0 cm/3½"
Schaftlänge
Length of shaft
Longueur de tige
Largo del asta

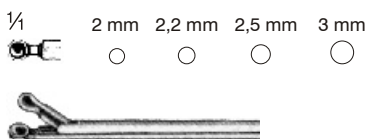

Löffelmaul

Spoon-shaped jaw
Mors en forme d'un cuiller
Boca en forma de cucharilla

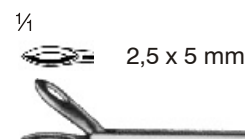

Struempel

34.6410 8,0 cm/3½"
Schaftlänge
Length of shaft
Longueur de tige
Largo del asta

Hartmann-Noyes

34.6409-20 2 mm 8,0 cm/3½"
34.6409-22 2,2 mm Schaftlänge
34.6409-25 2,5 mm Length of shaft
34.6409-30 3 mm Longueur de tige
Largo del asta

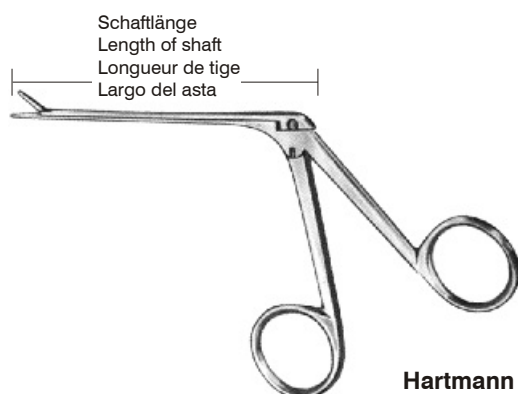

Hartmann

mittelfein

Schaft 1,2 x 1,8 mm
 Shaft 1,2 x 1,8 mm
 Tige 1,2 x 1,8 mm
 Asta 1,2 x 1,8 mm

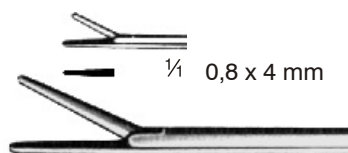

34.6420-01 7,5 cm/3"
 glatt
 smooth
 lisse
 lisa
 Schaftlänge
 Length of shaft
 Longueur de tige
 Largo del asta

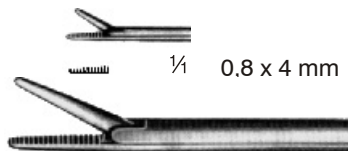

34.6421-01 7,5 cm/3"
 gerieft
 serrated
 strié
 estriada
 Schaftlänge
 Length of shaft
 Longueur de tige
 Largo del asta

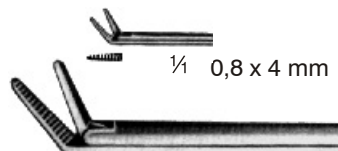

34.6421-02 7,5 cm/3"
 gerieft
 serrated
 strié
 estriada
 Schaftlänge
 Length of shaft
 Longueur de tige
 Largo del asta

Schaft 1,8 x 2,6 mm
 Shaft 1,8 x 2,6 mm
 Tige 1,8 x 2,6 mm
 Asta 1,8 x 2,6 mm

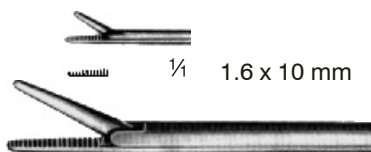

34.6422 8,0 cm/3½"
 gerieft
 serrated
 strié
 estriada
 Schaftlänge
 Length of shaft
 Longueur de tige
 Largo del asta

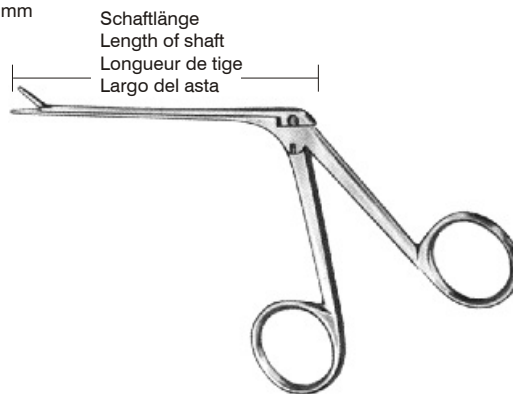

Bellucci

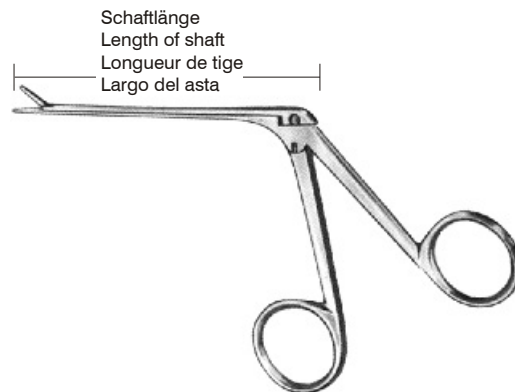

sehr fein

Schaft 0,8 x 1,8 mm
Shaft 0,8 x 1,8 mm
Tige 0,8 x 1,8 mm
Asta 0,8 x 1,8 mm

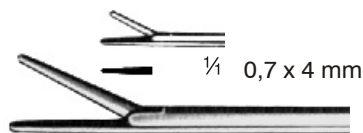

34.6430-01 8,0 cm/3 1/2"
glatt
smooth
lisse
lisa
Schaftlänge
Length of shaft
Longueur de tige
Largo del asta

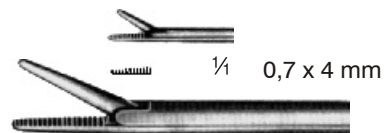

34.6430-02 8,0 cm/3 1/2"
gerieft
serrated
strié
estriada
Schaftlänge
Length of shaft
Longueur de tige
Largo del asta

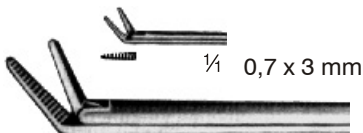

34.6430-03 8,0 cm/3 1/2" nach oben abgewinkelt
gerieft
serrated
strié
estriada
Schaftlänge
Length of shaft
Longueur de tige
Largo del asta
angular upwards
coudée vers le haut
angulada hacia arriba

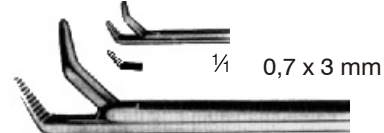

34.6430-04 8,0 cm/3 1/2" nach rechts abgewinkelt
gerieft
serrated
strié
estriada
Schaftlänge
Length of shaft
Longueur de tige
Largo del asta
angular to the right
coudée vers la droite
angulada a la derecha

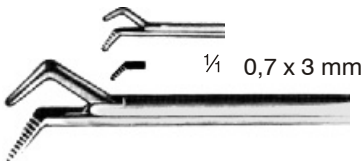

34.6430-05 8,0 cm/3 1/2" nach links abgewinkelt
gerieft
serrated
strié
estriada
Schaftlänge
Length of shaft
Longueur de tige
Largo del asta
angular to the left
coudée vers la gauche
angulada a la izquierda

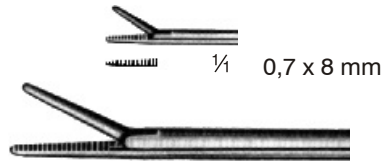

34.6430-06 8,0 cm/3 1/2"
gerieft
serrated
strié
estriada
Schaftlänge
Length of shaft
Longueur de tige
Largo del asta

superfein

Schaft 0,6 x 1,5 mm
Shaft 0,6 x 1,5 mm
Tige 0,6 x 1,5 mm
Asta 0,6 x 1,5 mm

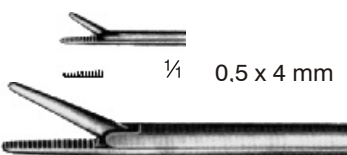

34.6431-01 8,0 cm/3 1/2"
gerieft
serrated
strié
estriada
Schaftlänge
Length of shaft
Longueur de tige
Largo del asta

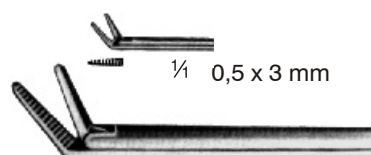

34.6431-02 8,0 cm/3 1/2" nach oben abgewinkelt
gerieft
serrated
strié
estriada
Schaftlänge
Length of shaft
Longueur de tige
Largo del asta
angular upwards
coudée vers le haut
angulada hacia arriba

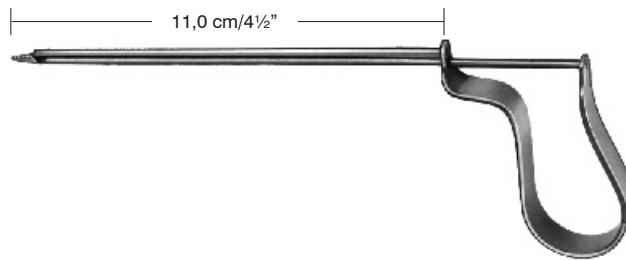

Buck

34.6466
11,0 cm/4 1/2"

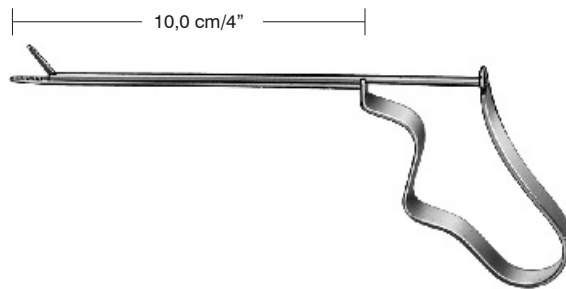

Quire

34.6467
10,0 cm/4"

Augeninstrumente
Ophthalmological Instruments
Instrumentos oftalmologicos
Instrumentos para oftalmologia

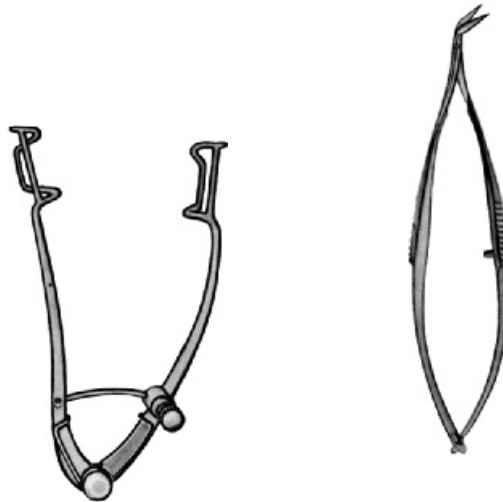



Fixierpinzette
 Fixation Forceps
 Pince à fixation
 Pinzas de fijación

Elschnig

35.7000
 10,5 cm/4¼"



Fischer

35.7001
 7,0 cm/2¾"

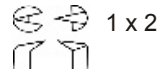

Gill

35.7002
 7,5 cm/3"



Zähne unten
 Teeth downwards
 Dents vers le bas
 Dientes hacia abajo

Gill-Hess

35.7003
 7,5 cm/3"



35.7004
 Zähne seitwärts
 Teeth lateral
 Dents latérales
 Dientes laterales

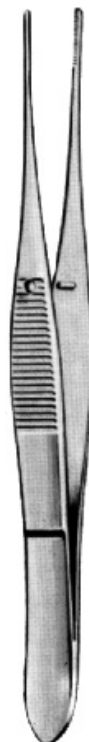

Graefe
 10,0 cm/4"
 0,9 mm

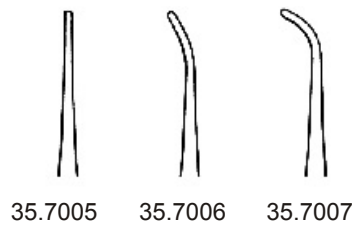

35.7005 35.7006 35.7007

gerieft
 serrated
 striée
 estriadas

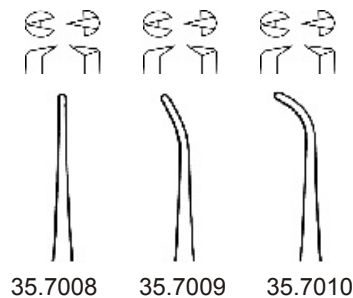

35.7008 35.7009 35.7010



ohne Sperre
without ratchet
sans crémaillère
sin cremallera

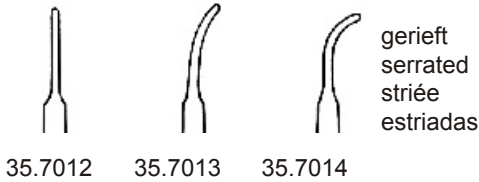

35.7012 35.7013 35.7014

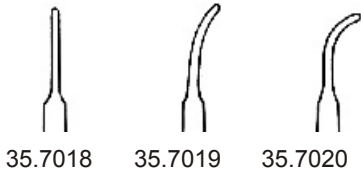

35.7018 35.7019 35.7020

Stevens
10,5 cm/4¼"



mit Sperre
with ratchet
avec crémaillère
con cremallera

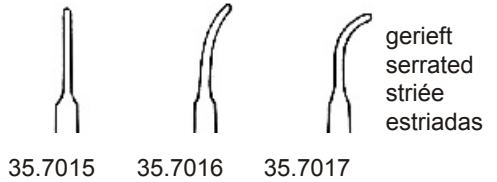

35.7015 35.7016 35.7017

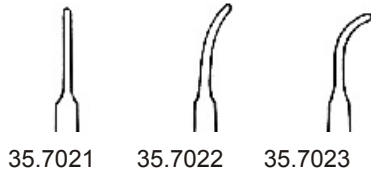

35.7021 35.7022 35.7023

Stevens
10,5 cm/4¼"

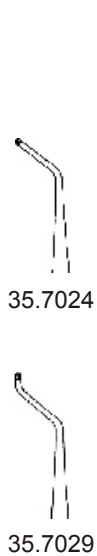
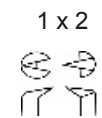

35.7029

Hess
7,0 cm/2¾"

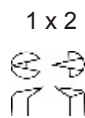

ohne Stift
without pin
sans cheville
sin perno

35.7025-01
7,0 cm/2¾"

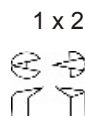

mit Stift
with pin
avec cheville
con perno

Mod. Bonn
35.7025-02
7,0 cm/2¾"



35.7026-01
0,8 mm
gerieft
serrated
striée
estriadas

35.7026-02
0,4 mm
gerieft
serrated
striée
estriadas

Bishop-Harmon
8,5 cm/3½"



35.7027-01
0,8 mm

35.7027-02
0,4 mm

Bishop-Harmon
8,5 cm/3½"

Kapselpinzetten, Capsular Forceps, Pinces capsulaires, Pinzas capsulares



Gill-Arruga

35.7050
7,5 cm/3"

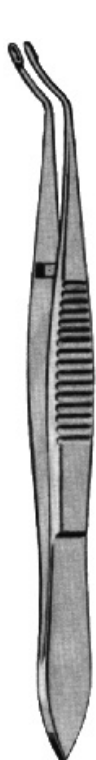

Arruga

35.7051
9,5 cm/3¾"



Schweiger

35.7052
10,0 cm/4"



Pley

35.7053
9,0 cm/3½"

Kapselsauger
Erisophakes
Aspirateurs capsulaires
Aspirador capsular



Dastoor

35.7054
6,0 cm/2½"

Fadenpinzetten, Suture Forceps, Pinces à sutures, Pinzas para sutura

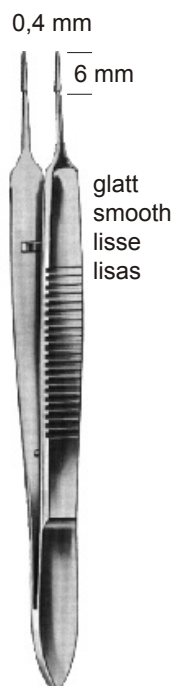

McPherson

35.7055-01
8,5 cm/3½"



McPherson

35.7055-02
8,5 cm/3½"

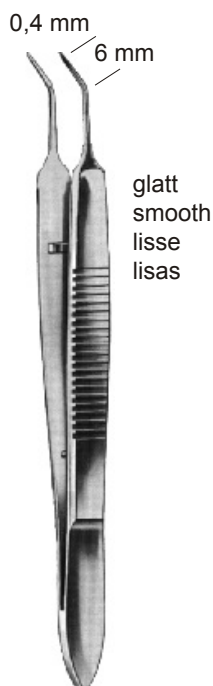

McPherson

35.7056-01
8,5 cm/3½"

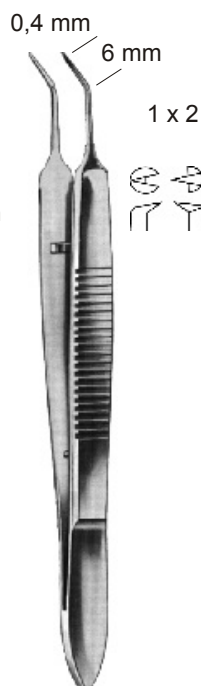

McPherson

35.7056-02
8,5 cm/3½"

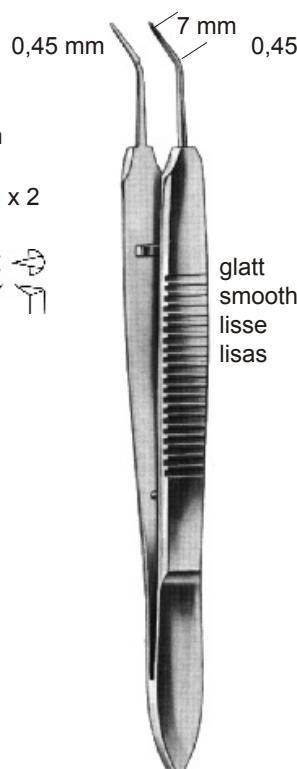

McPherson

35.7058-01
10,0 cm/4"

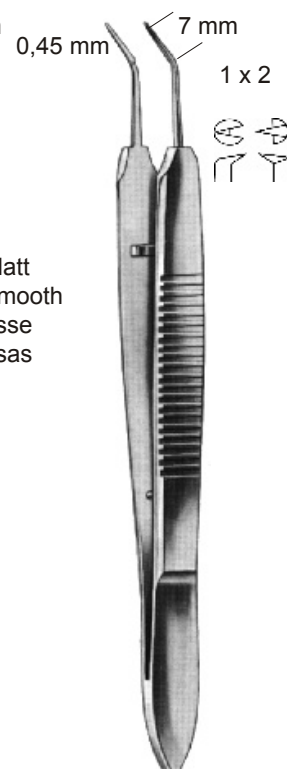

McPherson

35.7058-02
10,0 cm/4"



ohne Schloß
without catch
sans arrêt
sin cierre

Graefe

35.7060
11,0 cm/4½"



mit Schloß
with catch
avec arrêt
con cierre

Graefe

35.7061
11,0 cm/4½"

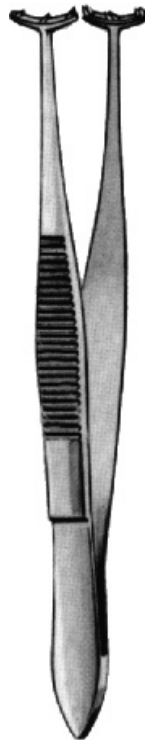

Barraquer

35.7062
10,0 cm/4"

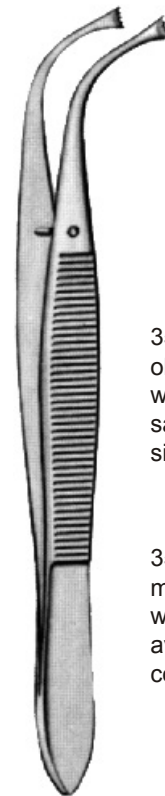

35.7063
ohne Schloß
without catch
sans arrêt
sin cierre

Noyes

11,0 cm/4½"

35.7064
mit Schloß
with catch
avec arrêt
con cierre



Jess

35.7065
10,0 cm/4"

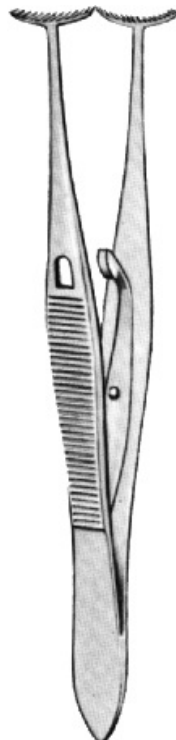

Green

10,0 cm/4"

35.7066 5 mm
35.7067 10 mm
mit Schloß
with catch
avec arrêt
con cierre

35.7068 5 mm
35.7069 10 mm
ohne Schloß
without catch
sans arrêt
sin cierre

2 x 2



Castroviejo 2 x 2

9,0 cm/3¾"

Nahtpinzetten
Suture Forceps
Pinces à sutures
Pinzas para sutura

35.7070
gerade
straight
droite
rectas

35.7071
gebogen
curved
courbe
curvas



Strabismuspinzette
Strabismus Forceps
Pinces à strabisme
Pinzas para estrabismo

Bonaccolto

35.7080
10,0 cm/4"



1 x 2
Nahtpinzetten
Suture Forceps
Pinces à sutures
Pinzas para sutura

35.7084
0,5 mm
35.7085
1,0 mm
gerade
straight
droite
rectas

Castroviejo
10,0 cm/4"



1 x 2
Nahtpinzetten
Suture Forceps
Pinces à sutures
Pinzas para sutura

35.7086
0,5 mm
35.7087
1,0 mm
gebogen
curved
courbe
curvas

Castroviejo
10,0 cm/4"

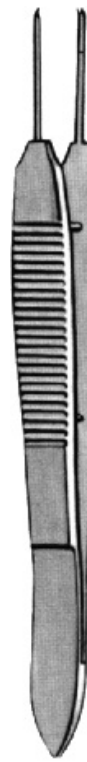

1 x 2
Nahtpinzetten
Suture Forceps
Pinces à sutures
Pinzas para sutura

35.7088-05
0,5 mm
35.7088-09
0,9 mm
35.7088-15
1,5 mm
gerade
straight
droite
rectas

Castroviejo
10,0 cm/4"

1 x 2



Nahtpinzetten
Suture Forceps
Pinces à sutures
Pinzas para sutura

St. Martin

35.7089
7,0 cm/2¾"



gerieft
serrated
striée
estriadas

Strabismuspinzette
Strabismus Forceps
Pinces à strabisme
Pinzas para estrabismo

35.7090
11,0 cm/4½"



1 x 2
gerieft
serrated
striée
estriadas

Strabismuspinzette
Strabismus Forceps
Pinces à strabisme
Pinzas para estrabismo

35.7091
11,0 cm/4½"

Chalazionspinzetten, Chalazion Forceps, Pinces à chalazion, Pinzas para chalación

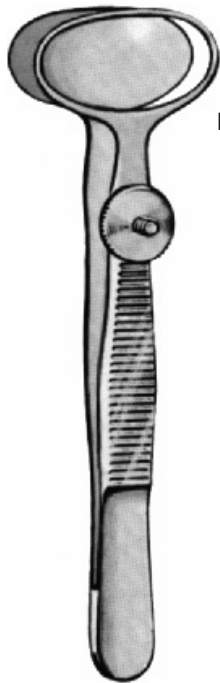

Desmarres
9,0 cm/3½"

Fig. 3

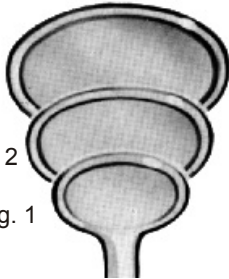

Fig. 2

Fig. 1

Fig. 1
35.7100
20 mm

Fig. 2
35.7101
25 mm

Fig. 3
35.7102
30 mm



Ayer

35.7103
9,0 cm/3½"

mit Schraube
with screw
avec vis
con tornillo

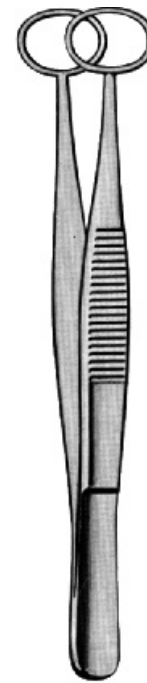

Prince

35.7110
9,0 cm/3½"

Trachompinzette
Trachoma Forceps
Pince pour le trachome
Pinzas para tracoma



10,0 cm/4"

Strabismuspinzette
Strabismus Forceps
Pinces à strabisme
Pinzas para estrabismo



Zähne
Teeth
Griffes
Dientes

35.7112	1 x 2
35.7113	2 x 3
35.7114	3 x 4

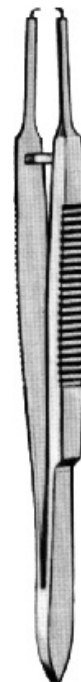

Castroviejo

1 x 1
9,0 cm/3½"

Nahtpinzette
Suture Forceps
Pinces à sutures
Pinzas para sutura

35.7115
mit Schloß
with catch
avec arrêt
con cierre

35.7116
ohne Schloß
without catch
sans arrêt
sin cierre

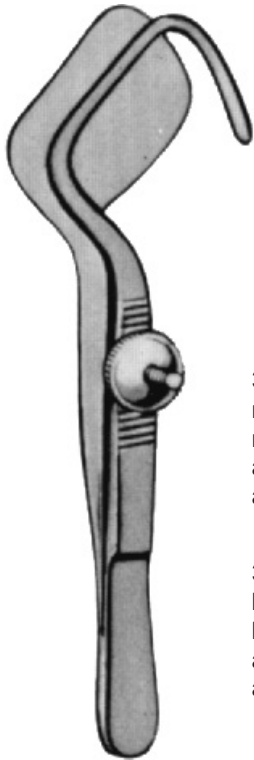

Entropiumpinzetten
 Entropium Forceps
 Pincès à entropion
 Pinzas para entropión

35.7120
 rechts
 right
 à droite
 a la derecha

35.7121
 links
 left
 à gauche
 a la izquierda

Snellen
 10,0 cm/4"

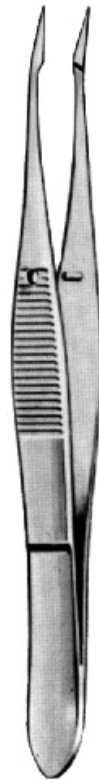

Barraquer

35.7130
 10,5 cm/4¼"

Cilienpinzetten, Cilia Forceps
 Pincès à épiler les cils, Pinzas para depilación



Bennett

35.7131
 7,0 cm/2¾"



Beer

35.7133 8,0 cm/3¼"
 35.7134 9,0 cm/3½"

Cilienpinzetten, Cilia Forceps
 Pincès à épiler les cils, Pinzas depilatorias



Gradle

35.7135
 9,5 cm/3¾"

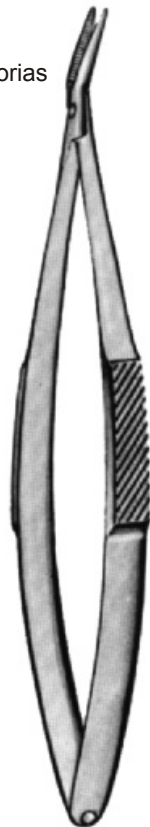

Beupré

35.7136
 12,0 cm/4¾"



1 x 2

 0,2 mm
Knüpfpinzette
 Suture Tying Forceps
 Pincès à poser des ligatures
 Pinzas para poner ligaduras

35.7140
 9,5 cm/3¾"



Bowman

zylindrisch
cylindrical
cylindrique
cilindrico

Fig.	Ø mm	Neusilber German Silver Maillechort Plata nueva	Silber Silver Argent Plata
000/00	0,8 / 0,7	35.7149	35.7159
00/0	0,9 / 0,8	35.7150	35.7160
0/1	1,0 / 0,9	35.7151	35.7161
1/2	1,1 / 1,0	35.7152	35.7162
2/3	1,2 / 1,1	35.7153	35.7163
3/4	1,3 / 1,2	35.7154	35.7164
4/5	1,4 / 1,3	35.7155	35.7165
5/6	1,5 / 1,4	35.7156	35.7166
6/7	1,6 / 1,5	35.7157	35.7167
7/8	1,7 / 1,6	35.7158	35.7168

gebalt
 curved blade
 lame courbe
 hoja curva



Fig. 1
 35.7180



Fig. 2
 35.7181



Fig. 3
 35.7182



Fig. 4
 35.7183



Fig. 5
 35.7184



Fig. 6
 35.7185

spitz
 pointed blade
 lame pointue
 hoja aguda



Fig. 7
 35.7186



Fig. 8
 35.7187



Fig. 9
 35.7188



Fig. 10
 35.7189



Fig. 11
 35.7190

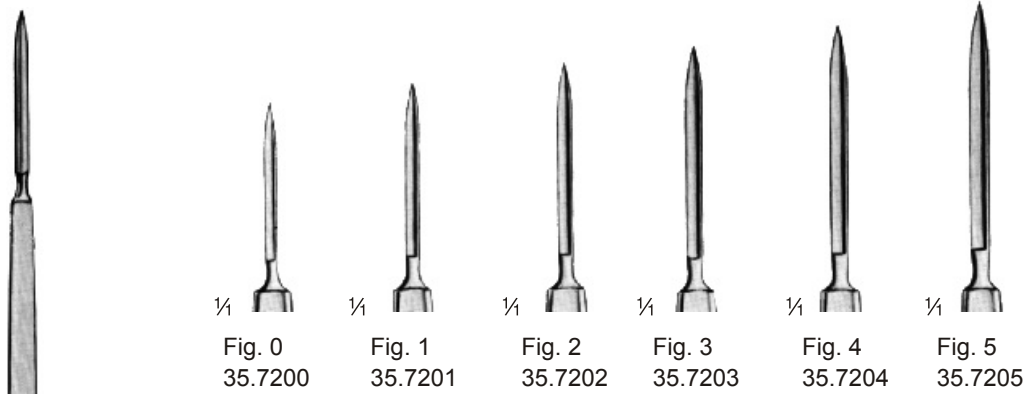

Fig. 12
 35.7191



12,5 cm/5"

Starmesser, Cataract Knives, Couteaux à cataracte, Cuchillos para catarata



Starmesser, Cataract Knives, Couteaux à cataracte, Cuchillos para catarata

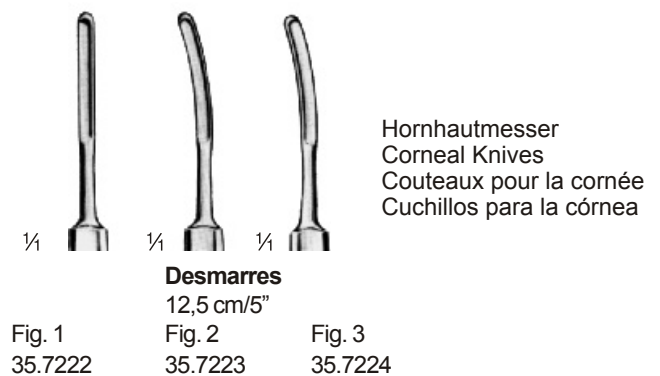
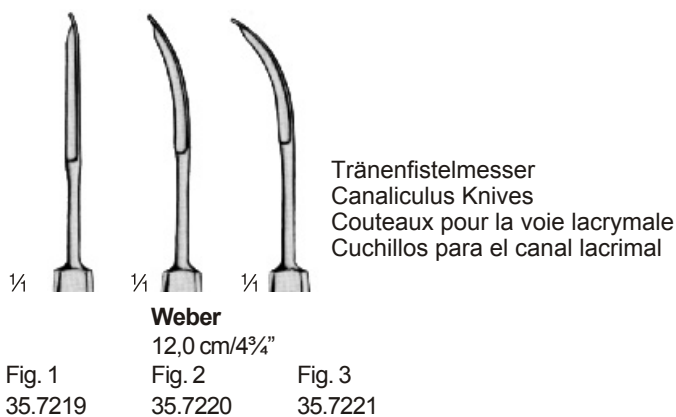
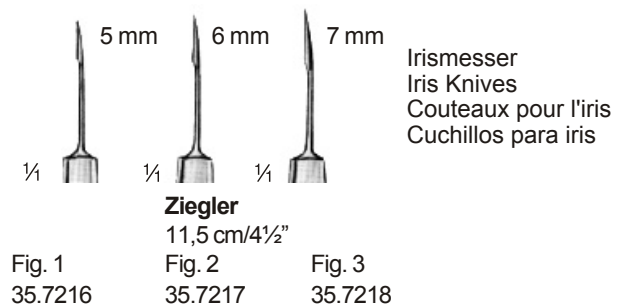
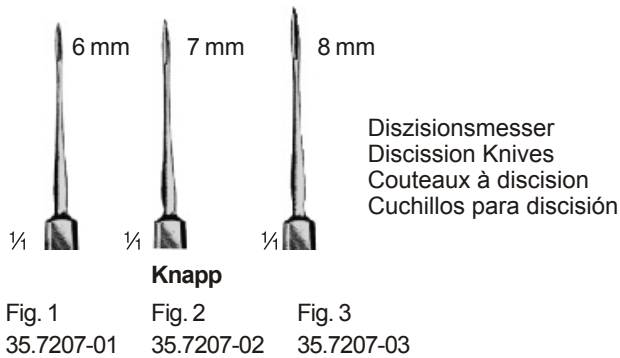
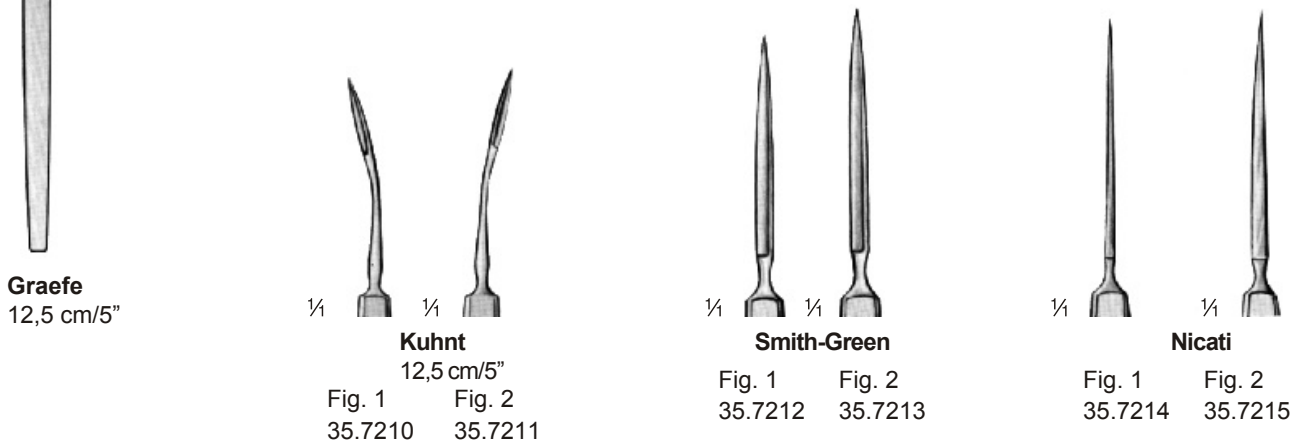

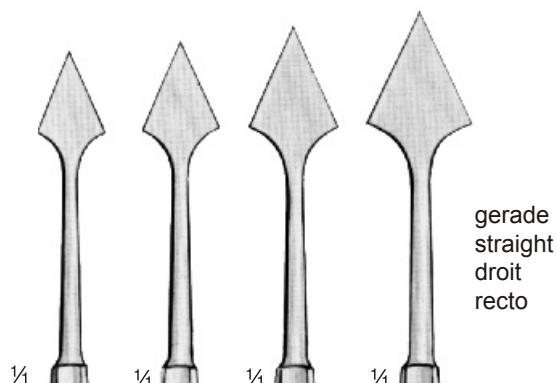

gerade
straight
droit
recto

Jaeger
13,5 cm/5³/₄"

Fig. 1 35.7230 Fig. 2 35.7231 Fig. 3 35.7232 Fig. 4 35.7233

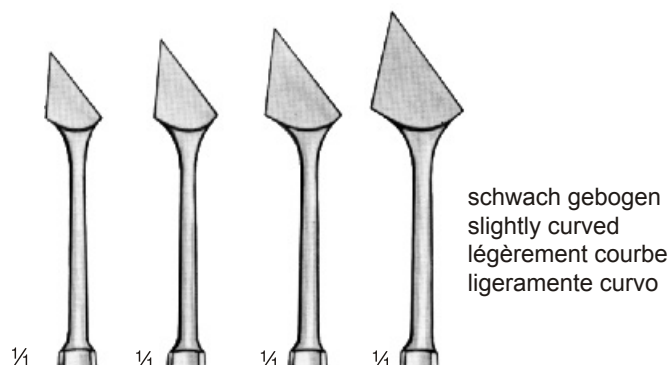

schwach gebogen
slightly curved
légèrement courbe
ligeramente curvo

Jaeger
13,5 cm/5³/₄"

Fig. 1 35.7234 Fig. 2 35.7235 Fig. 3 35.7236 Fig. 4 35.7237

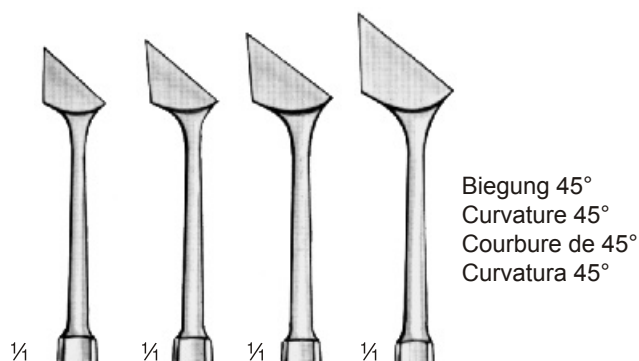

Biegung 45°
Curvature 45°
Courbure de 45°
Curvatura 45°

Jaeger
13,5 cm/5³/₄"

Fig. 1 35.7238 Fig. 2 35.7239 Fig. 3 35.7240 Fig. 4 35.7241

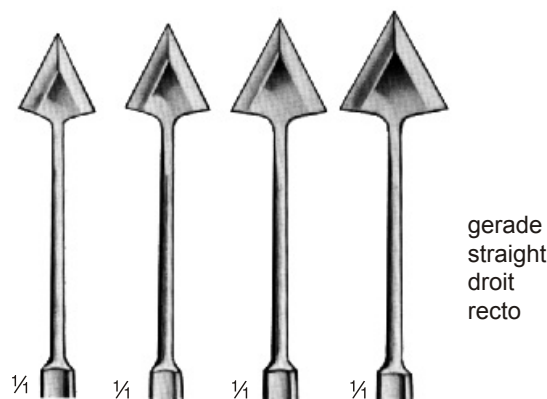

gerade
straight
droit
recto

Jaeger-Grieshaber
13,5 cm/5³/₄"

Fig. 1 35.7242 Fig. 2 35.7243 Fig. 3 35.7244 Fig. 4 35.7245



schwach gebogen
slightly curved
légèrement courbe
ligeramente curvo

Jaeger-Grieshaber
13,5 cm/5³/₄"

Fig. 1 35.7246 Fig. 2 35.7247 Fig. 3 35.7248 Fig. 4 35.7249

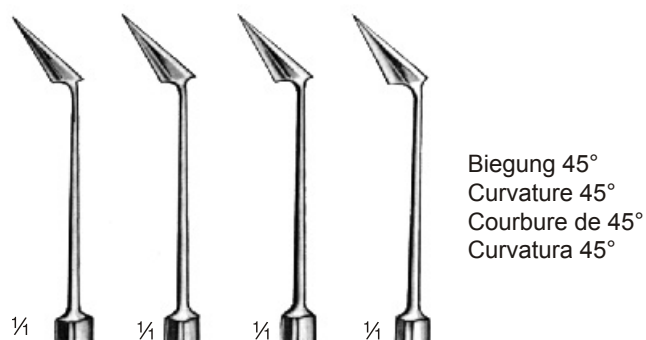

Biegung 45°
Curvature 45°
Courbure de 45°
Curvatura 45°

Wessely-Grieshaber
13,5 cm/5³/₄"

Fig. 1 35.7250 Fig. 2 35.7251 Fig. 3 35.7252 Fig. 4 35.7253

Starnadel
Cataract Needle
Aiguille à cataracte
Aguja para catarata

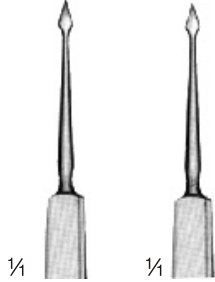

35.7254	35.7255
12,0 cm/4¾"	12,0 cm/4¾"
gerade	gebogen
straight	curved
droite	courbe
recta	curva

Fremdkörpernadel
Foreign Body Needle
Aiguille à corps étrangers
Aguja para cuerpos extraños

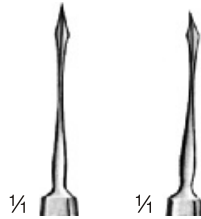

35.7256	35.7257
12,0 cm/4¾"	12,0 cm/4¾"
gerade	gebogen
straight	curved
droite	courbe
recta	curva

Fremdkörper-Hohlmeißel
Gouge for foreign bodies
Gouge pour corps étrangers
Gubia para cuerpos extraños



Meyer
H7261
12,0 cm/4¾"



Fremdkörperschlinge und Magnet
Foreign Body Remover and Magnetic Eye Probe
Anse et aimant pour corps étrangers
Asa e imán para cuerpos extraños

35.7258

Nadel und Flachmeißel
Needle and Chisel
Aiguille et burin
Aguja y cincel



flacher Griff
flat handle
manche plat
mango llano

Dix

35.7266

Nadel und Hohlmeißel
Needle and Gouge
Aiguille et gouge
Aguja y gubia



flacher Griff
flat handle
manche plat
mango llano

Dix

35.7267

Nadel und Flachmeißel
Needle and Chisel
Aiguille et burin
Aguja y cincel



runder Griff
round handle
manche ronde
mango redondo

Dix

35.7268

Nadel und Hohlmeißel
Needle and Gouge
Aiguille et gouge
Aguja y gubia



runder Griff
round handle
manche ronde
mango redondo

Dix

35.7269



Starmesser und Flachmeißel
 Cataract Knife and Chisel
 Couteaux à cataracte et burin
 Cuchillo para catarata y cincel

Graefe

35.7270



Nadel und Flachmeißel
 Needle and Chisel
 Aiguille et burin
 Aguja y cincel

Graefe

35.7271



Nadel und Hohlmeißel
 Needle and Gouge
 Aiguille et gouge
 Aguja y gubia

Graefe

35.7272

Augenhäkchen, Eye Hooks, Crochets pour les yeux, Ganchos para los ojos



scharf
 sharp
 pointu
 agudo

Guthrie

12,0 cm/4¾"

Fig. 1

35.7273



scharf
 sharp
 pointu
 agudo

Guthrie

13,0 cm/5¼"

Fig. 2

35.7274



scharf
 sharp
 pointu
 agudo

Graefe

12,0 cm/4¾"

Fig. 1

35.7275



stumpf
 blunt
 mousse
 romo

Graefe

12,0 cm/4¾"

Fig. 2

35.7276



scharf
 sharp
 pointu
 agudo

Fig. 1

35.7277



stumpf
 blunt
 mousse
 romo

Fig. 2

35.7278

Wiener

12,5 cm/5"



scharf
 sharp
 pointu
 agudo

Fig. 1

35.7280



scharf
 sharp
 pointu
 agudo

Fig. 2

35.7281

Jaeger

13,0 cm/5¼"

Schielhaken, Strabismus Hooks, Crochets à strabisme, Ganchos para estrabismo



Graefe

stumpf
blunt
mousse
romo



Fig. 1
35.7282
13,0 cm/5¼"



Fig. 2
35.7283
14,0 cm/5½"



Fig. 3
35.7284
15,0 cm/6"

Tränenkanal-Dilatatoren, Lachrymal Dilators, Dilatateurs pour le canal lacrymal, Dilatadores para canal lacrimal

spitz
sharp
pointu
agudo



Wilder
11,0 cm/4½"

Fig. 1
35.7287

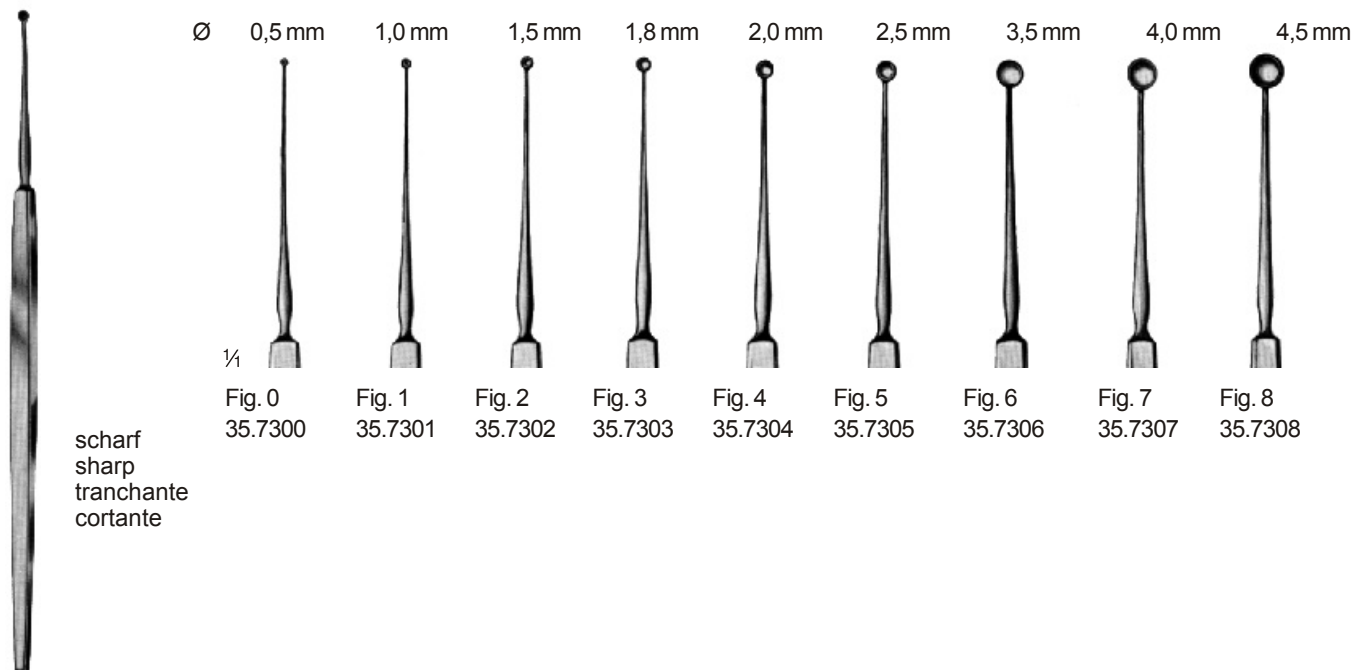

Fig. 2
35.7288



Fig. 3
35.7289

Chalazionslöffel, Chalazion Currettes, Currettes à chalazion, Cucharillas para chalazión



Meyhoefer

13,0 cm/5¼"

Exenterationslöffel, Exenteration Scoops, Currettes pour exentération, Cucharillas para exenteración

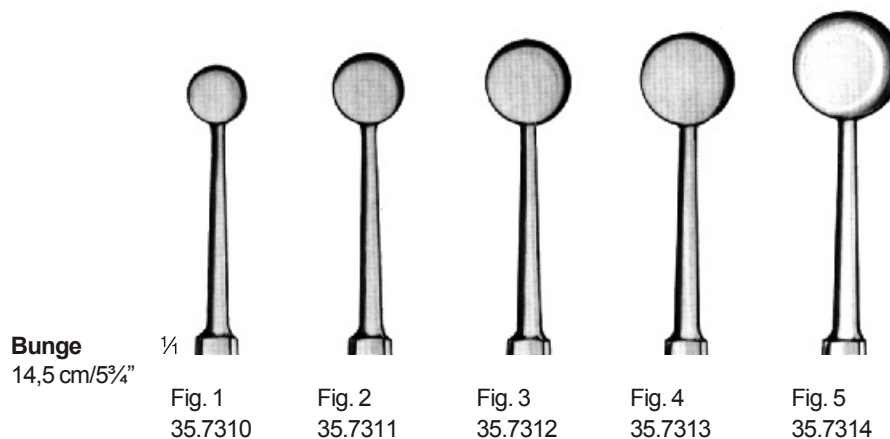

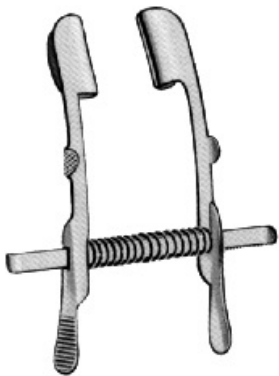

Mellinger-Beard

35.7330 35.7331
5,0 cm/2" 7,0 cm/2³/₄"
für Kinder für Erwachsene
for children for adults
pour enfants pour adultes
para niños para adultos

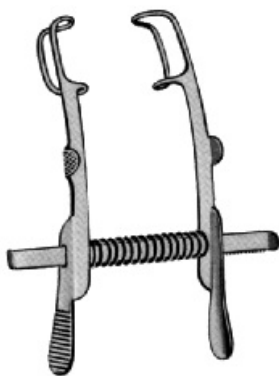

Mellinger

35.7332 35.7333
5,0 cm/2" 7,0 cm/2³/₄"
für Kinder für Erwachsene
for children for adults
pour enfants pour adultes
para niños para adultos

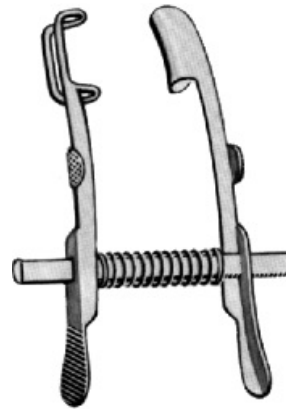

Mellinger-Axenfeld

35.7334
7,0 cm/2³/₄"
rechts
to the right
à droite
a la derecha

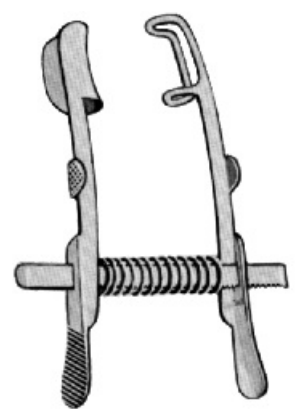

Mellinger-Axenfeld

35.7335
7,0 cm/2³/₄"
links
to the left
à gauche
a la izquierda



Murdock

35.7336
5,0 cm/2"

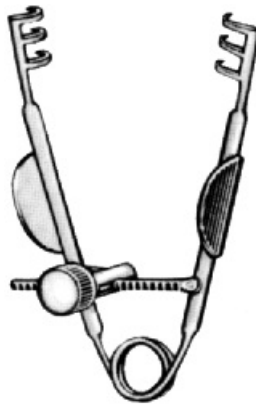

Mueller

35.7337
7,0 cm/2³/₄"

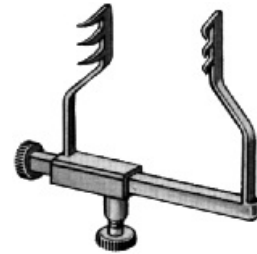

Goldstein

35.7338
3,0 cm/1¹/₄"



Park-Guyton

35.7339
8,0 cm/3¹/₄"

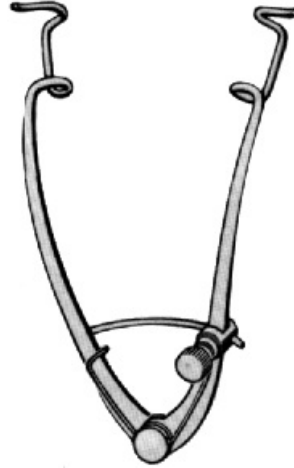

Knapp-Clark

35.7340
8,0 cm/3¹/₄"

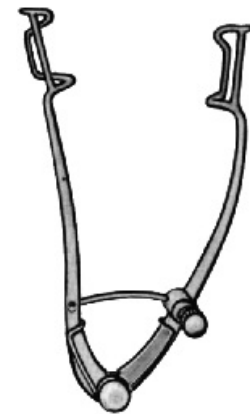

Williams

35.7341 35.7342
7,0 cm/2³/₄" 8,0 cm/3¹/₄"
für Kinder für Erwachsene
for children for adults
pour enfants pour adultes
para niños para adultos



Lister-Burch

35.7343
 8,0 cm/3¼"



Alm

35.7344	7,0 cm/2¾"	35.7345
35.7346	10,0 cm/4"	35.7347
scharf		stumpf
sharp		blunt
pointu		mousse
agudo		romo



Stevenson

35.7348
 7,0 cm/2¾"

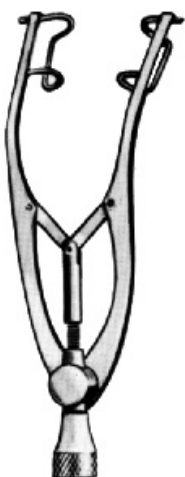

Castroviejo

35.7349
 8,0 cm/3¼"



Lancaster

35.7350
 7,0 cm/2¾"



Bowman

35.7351
 7,0 cm/2¾"

Lidhalter, Lid Retractor, Ecarteurs à paupières, Separadores de párpados



6 mm

für Kinder
for children
pour enfants
para niños

Desmarres

35.7360
13,0 cm/5¼"



Fig. 1
35.7361 12 mm

Fig. 2
35.7362 14 mm

Fig. 3
35.7363 16 mm

Fig. 4
35.7364 18 mm

Desmarres
13,0 cm/5¼"

Markierungszirkel, Marker graduated, Marqueur gradué, Marcador graduado

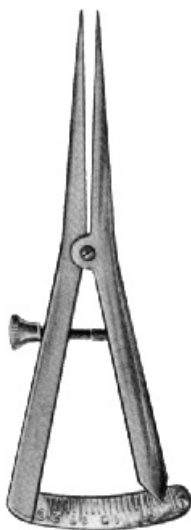

Messbereich
Measuring Range
Echelle
Alcance de medición

35.7370 15 mm

35.7371 20 mm

Castroviejo

Nachstarscheren, Secondary Cataract Scissors
 Ciseaux pour la cataracte secondaire, Tijeras para catarata secundaria

Mikro-Scheren
 Micro Scissors
 Micro-Ciseaux
 Micro Tijeras



gerade
 straight
 droits
 rectas

Vannas

35.7380
 8,0 cm/3¼"



gebogen
 curved
 courbes
 curvas

Vannas

35.7381
 8,0 cm/3¼"



seitwärts abgewinkelt
 angular on side
 coudé à la côté
 acodada lateral

Vannas

35.7382
 8,0 cm/3¼"



Mc Clure

35.7383
 10,0 cm/4"

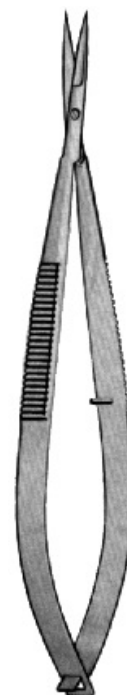

Mc Clure

35.7384
 11,0 cm/4½"

Mikro-Hornhautscheren, Micro Corneal Scissors, Micro-Ciseaux pour la corneé, Micro Tijeras para córnea



links
 to the left
 à gauche
 a la izquierda

Troutman

35.7385
 10,0 cm/4"



rechts
 to the right
 à droite
 a la derecha

Troutman

35.7386
 10,0 cm/4"



links
 to the left
 à gauche
 a la izquierda

Troutman

35.7387
 10,0 cm/4"

mit Sperre
 with ratchet
 avec arrêt
 con cierre



rechts
 to the right
 à droite
 a la derecha

Troutman

35.7388
 10,0 cm/4"

Hornhautscheren, Corneal Scissors, Ciseaux pour la corneé, Tijeras para córnea



links
to the left
à gauche
a la izquierda

Katzin

35.7389
10,0 cm/4"



rechts
to the right
à droite
a la derecha

Katzin

35.7390
10,0 cm/4"



links
to the left
à gauche
a la izquierda

Katzin

35.7391
10,0 cm/4"

mit Sperre
with ratchet
avec arrêt
con cierre



rechts
to the right
à droite
a la derecha

Katzin

35.7392
10,0 cm/4"

Hornhautscheren
Corneal Scissors
Ciseaux pour la corneé
Tijeras para córnea

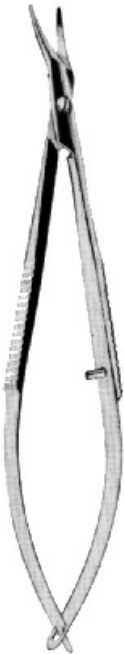

Mc Guire

35.7393
10,0 cm/4"

Iridektomieschere
Iridectomy Scissors
Ciseaux à iridectomie
Tijeras para iridectomia



Noyes

35.7394
12,0 cm/4¾"

Hornhautscheren
Corneal Scissors
Ciseaux pour la corneé
Tijeras para córnea



Castroviejo

35.7395
9,0 cm/3½"

seitwärts abgewinkelt
angular on side
coudé à la côté
acodada lateral

Sehnenschere
Tenotomy Scissors
Ciseaux à ténotomie
Tijeras para tenotomía



spitz
pointed
pointus
agudos

Westcott

35.7396
11,0 cm/4½"

stumpf
blunt
mousses
romos

Westcott

35.7397
11,0 cm/4½"

Iridektomiescheren, Iridectomy Scissors, Ciseaux à iridectomie, Tijeras para iridectomia

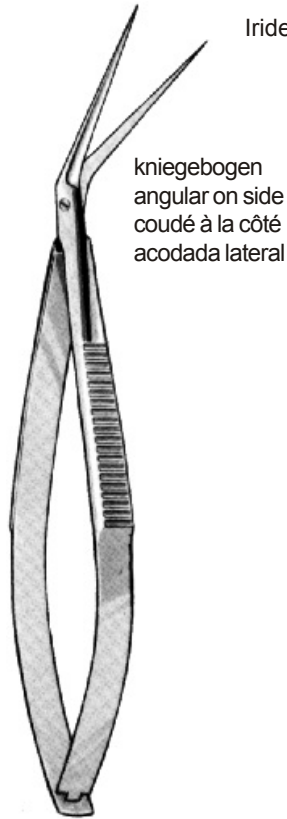

kniegebogen
 angular on side
 coudé à la côté
 acodada lateral

35.7398
 11,0 cm/4½"



gebogen
 curved
 courbes
 curvas

35.7399
 11,0 cm/4½"

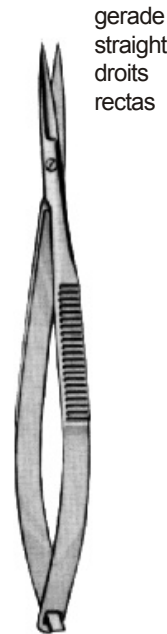

gerade
 straight
 droits
 rectas

35.7400
 9,0 cm/3½"



35.7401
 9,0 cm/3½"
 gebogen
 curved
 courbes
 curvas



35.7402
 9,0 cm/3½"
 kniegebogen
 angular on side
 coudé à la côté
 acodada lateral

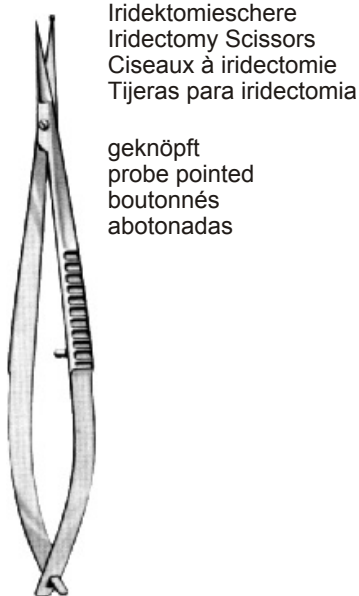

Iridektomieschere
 Iridectomy Scissors
 Ciseaux à iridectomie
 Tijeras para iridectomia

geknöpft
 probe pointed
 boutonés
 abotonadas

35.7403
 9,0 cm/3½"



35.7404
 18,0 cm/7"

Iridektomiescheren
 Iridectomy Scissors
 Ciseaux à iridectomie
 Tijeras para iridectomia



35.7404
 gerade
 straight
 droits
 rectas



35.7405
 gebogen
 curved
 courbes
 curvas



35.7406
 gerade
 straight
 droits
 rectas



35.7407
 gebogen
 curved
 courbes
 curvas

Rundgriffschere, langes Modell
 Micro Scissors with round handle, extra long
 Ciseaux avec manche ronde, modèle long
 Tijeras con mango redondo, modelo largo

Iridektomiescheren
Iridectomy Scissors
Ciseaux à iridectomie
Tijeras para iridectomia



Fig. 1
35.7408



Fig. 2
35.7409



Fig. 3
35.7410

Noyes
12,0 cm/4¾"

Hornhautscheren
Corneal Scissors
Ciseaux pour la corneé
Tijeras para córnea

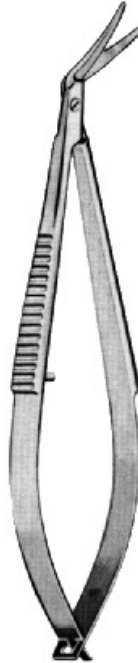

links
to the left
à gauche
a la izquierda

Castroviejo

35.7411
11,0 cm/4½"

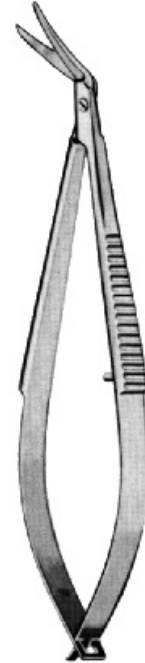

rechts
to the right
à droite
a la derecha

Castroviejo

35.7412
11,0 cm/4½"

Hornhautscheren, Corneal Scissors, Ciseaux pour la corneé, Tijeras para córnea



gebogen
curved
courbes
curvas

Castroviejo

35.7413
9,0 cm/3½"



links
to the left
à gauche
a la izquierda

Castroviejo

35.7414
11,0 cm/4½"

feines Modell
delicate pattern
modèle fin
modelo fino



rechts
to the right
à droite
a la derecha

Castroviejo

35.7415
11,0 cm/4½"

Iridektomiescheren, Iridectomy Scissors, Ciseaux à iridectomie, Tijeras para iridectomia

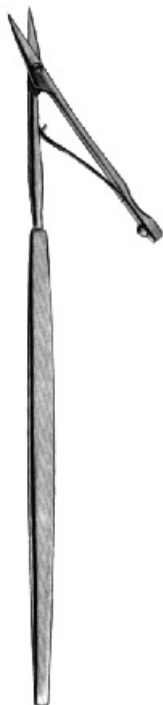

Noyes

35.7416
 15,0 cm/6"



Wecker

11,0 cm/4½"



Fig. 1
 35.7417



Fig. 2
 35.7418



Fig. 3
 35.7419



Fig. 4
 35.7420



Fig. 5
 35.7421



Fig. 6
 35.7422

fein
 delicate
 fins
 finos

Hornhautscheren
 Corneal Scissors
 Ciseaux pour la corneé
 Tijeras para córnea

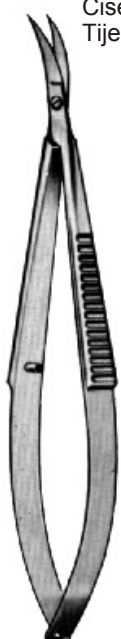

spitz
 pointed
 pointus
 agudos

Castroviejo

35.7423
 10,0 cm/4"



stumpf
 blunt
 mousses
 romos

Castroviejo

35.7424
 10,0 cm/4"

Iridektomiescheren
 Iridectomy Scissors
 Ciseaux à iridectomie
 Tijeras para iridectomia

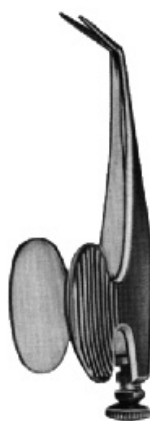

Barraquer
 5,5 cm/2¼"



Fig. 1
 35.7425



Fig. 4
 35.7428



Fig. 2
 35.7426



Fig. 5
 35.7429



Fig. 3
 35.7427



Fig. 6
 35.7430

fein
 delicate
 fins
 finos



Reill



35.7432-01
14,0 cm/5½"
gerade
straight
droits
rectas



35.7432-02
15,5 cm/6¼"
gebogen
curved
courbes
curvas



35.7432-03
15,5 cm/6¼"
gebogen
curved
courbes
curvas

1 Schneide gezahnt
1 blade saw edge
1 lame dentelée
1 hoja dentada



Vannas
16,0 cm/6¼"



35.7433-01
gerade
straight
droits
rectas



35.7433-02
gebogen
curved
courbes
curvas



10,0 cm/4"

spitz / spitz
sharp / sharp
pointus / pointus
agudas / agudas



35.7434-01
gerade
straight
droits
rectas



35.7434-02
gebogen
curved
courbes
curvas

sehr fein
very delicate
très fins
muy finos



kantige Ausführung
square shanks
modèle anguleux
modelo anguloso

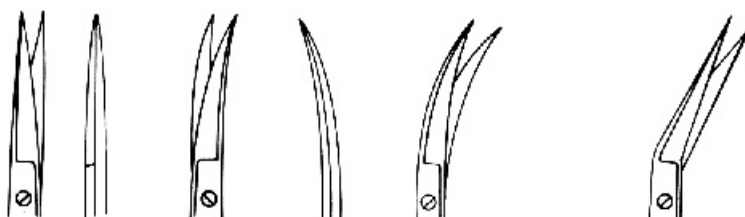

	gerade straight droits rectas	gebogen curved courbes curvas	seitwärts gebogen curved sideways courbe à la côté curva lateral	seitwärts abgewinkelt angular on side coudé à la côté acodada lateral
9,0 cm/3½"	35.7450	35.7451	35.7452	35.7453
10,5 cm/4¼"	35.7454	35.7455	35.7456	35.7457
11,5 cm/4¾"	35.7458	35.7459	35.7460	35.7461



runde Ausführung
round shanks
modèle rond
modelo redondo

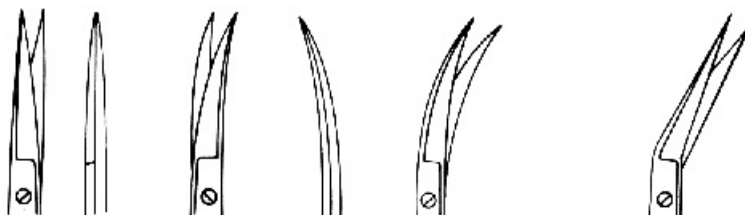

	gerade straight droits rectas	gebogen curved courbes curvas	seitwärts gebogen curved sideways courbe à la côté curva lateral	seitwärts abgewinkelt angular on side coudé à la côté acodada lateral
9,0 cm/3½"	35.7470	35.7471	35.7472	35.7473
10,5 cm/4¼"	35.7474	35.7475	35.7476	35.7477
11,5 cm/4¾"	35.7478	35.7479	35.7480	35.7481



Irisschere
Iris Scissors
Ciseaux pour l'iris
Tijeras para iris

Graefe

35.7483
10,5 cm/4¼"



Augenschere
Eye Scissors
Ciseaux oculaires
Tijeras oculares

Le Grange

35.7485
10,5 cm/4¼"

Sehnenscheren, Tenotomy Scissors, Ciseaux à ténatomie, Tijeras para tenotomía



Stevens
spitz
pointed
pointus
agudas



35.7490 10,0 cm/4"
35.7492 11,0 cm/4½"
gerade
straight
droits
rectas



35.7491
35.7493
gebogen
curved
courbes
curvas



Stevens
stumpf
blunt
mousses
romas



35.7494 10,0 cm/4"
35.7496 11,0 cm/4½"
gerade
straight
droits
rectas

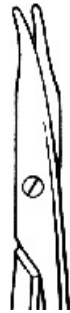

35.7495
35.7497
gebogen
curved
courbes
curvas



spitz
 pointed
 pointus
 agudas

35.7500
 35.7501
 gerade
 straight
 droits
 rectas

9,0 cm/3½"
 10,5 cm/4¼"

35.7502
 35.7503
 gebogen
 curved
 courbes
 curvas



spitz
 pointed
 pointus
 agudas

35.7504
 gerade
 straight
 droits
 rectas

9,5 cm/3¾"

35.7505
 gebogen
 curved
 courbes
 curvas

A	
Abdominal Retractors	265-275
Abdominal Spatulas	276,277
Adenoid Curettes	473
Adenotomes	474
Adlerkreutz Tissue Forceps	30
Adson Bone Rongeur Forceps	339
Adson Brown Tissue Forceps	31
Adson Dressing Forceps	26
Adson Drill Guider and Dura Protecting Forceps	281
Adson Forceps With TC Jaws	166
Adson Hand Bone Twist Drills Extension Piece	286
Adson Hemostatic Forceps	53
Adson Needle Holders	186
Adson Nerve Hooks	122
Adson Periosteal Raspatories	311
Adson Retractors	262,263
Adson Suction Tubes	215
Adson Tissue Forceps	30
Adson-Baby Retractors	261
Adson-Tonnis Dissecting Scissors	151
Alan Parks Anal Retractors	94
Alexander Biopsy Punches	432
Alexander Bone Chisels	292
Alexander Gouges	292
Alexander Periosteal Raspatories	308
Allis Tissue Grasping Forceps	379,380
Allis Tissue Seizing Forceps With TC Jaws	175
Allis-Adair Tissue Grasping Forceps	379
Allis-Baby Tissue Grasping Forceps	379
Allison Lung Spatulas	359
Alm Eye Specula	511
Aluminium Tuning Forks	20
Amputating Knives	83
Amputating Saws	279,280
Anal Retractors	93,94
Analpreizer Rectal Speculums	93
Anastomosis Clamp Forceps	382
Anderson-Adson Retractors	264
Andrew Tongue Depressors	480
Anestophone Stethoscopes	8
Anusscopes	90-92
Arruga Capsular Forceps	497
Arruga Eye Needle Holders	187
Arruga Needle Holder With TC Jaws	167
Arthur Splinter Forceps	44
Asch Septum Forceps	452
Atrauma Forceps	35
Aufricht Hooks for Posterior Snares	469
Aufricht Nasal Rasps	468
Autopsy Knives	86
Auvarad Vaginal Specula	411
Ayer Chalazion Forceps	500
B	
Babcock Intestinal Forceps	380
Babcock Tissue Grasping Forceps	380
Babcock Tissue Seizing Forceps, TC Jaws	175
Babinsky Percussion Hammers	3
Baby Crile Hemostatic Forceps	52
Baby-Adson Hemostatic Forceps	53
Baby-Collin Abdominal Retractors	266
Baby-Duplex Stethoscopes	7
Baby-Kern Bone Holding Forceps	329
Baby-Lexer Dissecting Scissors	143
Baby-Olsen-Hegar Needle Holder TC Jaws	174
Baby-Olsen-Hegar Needle Holders	184
Baby-Roux Retractors	257
Baby-Satinsky Blood Vessel Clamps	362
Baby-Senn-Miller Retractors	255
Baby-Tischler Biopsy Punches	425
Backhaus Towel Forceps	62
Baggish Biopsy Punches	426
Bailey Rib Contractors	359
Bailey-Baby Rib Contractors	359
Bailey-Gibbon Rib Contractors	359
Bainbridge Hemostatic Forceps	50
Bakes Bile Duct Dilators	390
Balfour Abdominal Retractors	268,269
Balfour-Baby Abdominal Retractors	268
Ballenger Swivel Knives	471
Ballenger-Hajek Septum Elevators	462
Bamhill Adenoid Curettes	473
Bandage Scissors	159,160
Bane (Hartmann) Bone Rongeur Forceps	338
Barr Rectal Speculum	93
Barraquer Cilia Forceps	501
Barraquer Eye Needle Holders	187
Barraquer Fixation Forceps	498
Barraquer Iridectomy Scissors	517
Barraquer Needle Holder With TC Jaws	167
Barth Ear Curettes	487
Baumgartner Needle Holder With TC Jaws	170
Beaupré Cilia Forceps	501
Beckmann Adenoid Curettes	473
Beckmann Retractors	262
Beckmann-Adson Retractors	264
Beckmann-Eaton Retractors	264
Beer Cilia Forceps	41
Bellucci Ear Polypus Forceps	491
Bengolea Hemostatic Forceps	56
Bennett Bone Levers	320
Bensaude Anusscopes	91
Benson Pylorus spreader	381
Berger Biopsy Punches	431
Bergmann Bandage Scissors	160
Bergmann Mallets	324
Berliner Percussion Hammers	3
Bernhard Towel Forceps	63
Bethune Rib Shears	348
Beyer Bone Rongeur Forceps	334,338
Bile Duct Dilators	390
Billeau Ear Loops	487
Biopsy Curettes	433,434
Biopsy Forceps	447,448
Biopsy Punches	425-432
Bircher Meniscotomy Knives	316
Bircher-Ganske Cartilage Seizing Forceps	327
Bishop-Harmon Iris Forceps	496
Bladder Retractors	396,397
Blake Gall Stone Forceps	389
Blake Uterine Curettes	438
Blohmke Tonsil Seizing Forceps	482
Blood Pressure Manometers	9,10
Blood vessel Clamps	361,362
Blount Bone Levers	321
Blount Meniscus Retractors	321
Blumenthal Bone Rongeur Forceps	337
Bohler Bone Cutting Forceps	343
Bohler Bone Rongeur Forceps	339
Bohler Extension Bows	283
Bonaccolto Strabismus Forceps	499
Bone Chisels	291-299
Bone Curettes	300-305
Bone Cutting Forceps	342-344
Bone Drills	281
Bone Files	314,315
Bone Holding Clamps	345
Bone Holding Forceps	326-333
Bone Levers	317-321
Bone Rongeur Forceps	334-341
Bone Shears	347,349
Bonney Tissue Forceps	33
Bose Trachea Retractors	364
Bottcher Tonsil Scissors	152
Bowman Eye Specula	511
Bowman Lachrymal Probes	502
Boys-Allis Tissue Grasping Forceps	379
Bozemann Cotton Swab Forceps	67
Bozemann Needle Holder With TC Jaws	174
Bozemann-Douglas Cotton Swab Forceps	67
Brain Knives	85
Brain Spatulas	109
Brand Tendon Seizing Instruments	313
Braun Tenaculum Forceps	419
Braun Uterine Depressors	418
Braun-Steadler Perineum Scissors	147
Breisky Vaginal Specula	408
Brochus Clamps	361
Bronchial Scissors	151
Brophy Dressing Forceps	28
Brophy Tissue Forceps	32
Brown Needle Holders	182
Bruenings Ear Specula	15
Bruenings Tongue Depressors	480
Bruenings Tonsil Snares	483
Brunner Ligature Conductors	204
Brunner Retractors	251,252
Brunner Rib Shears	348
Brunner-Ferrozell Ligature Conductors	206
Bruns Bandage Scissors	160
Bruns Bone Curettes	300,301
Buchwald Tongue Depressors	480
Buck Ear Curettes	486
Buck Foreign Body Levers	493
Buck Percussion Hammers	4
Buelau Trocars	211

Buie Rectal Aspiration Cannulas	100	Cottle Nasal Specula	454
Bulldog Clamps	46	Cottle Rhinoplastic and Nasal Knives	472
Bumm Uterine Curettes	437	Cottle Septum and Periosteal Elevators	463
Bunge Exenteration Scoops	509	Cottle-Neivert Hooks for Posterior nares	470
Bunnell Hand Bone Drills	284	Cotton Applicators	101,225
Bunnell Tendon Passing Instruments	313	Cotton Swab Forceps	66-68
Bunnell Tendon Stripper	313	Cover Glass Forceps	42
Burford Rib Spreaders from Aluminium	351	Crafoord Hemostatic Forceps	55
Burke Biopsy Punches	426	Crafoord Lobectomy Scissors	149
Busch Umbilical Scissors	148	Cranial Opening Instruments	104
C		Crile Hemostatic Forceps	51
Caliper Measuring Instruments	6	Crile Needle Holders	186
Cannulas	217	Crile Nerve Hooks	121
Caplan Nasal Scissors	451	Crile Retractors	231
Capsular Forceps	497	Crile-Rankin Hemostatic Forceps	51
Capsule Forceps	400	Crile-Wood Needle Holder With TC Jaws	170
Cardiophone Stethoscopes	8	Crile-Wood Needle Holders	182,184
caroll Measuring Instruments	5	Crutchfield Cervical Traction Tong	105
Caroll Tendon Seizing Instruments	313	Cuching Hand Bone Twist Drills Extensional	286
Carpenter Tonsil Knives and Enuclators	484	Cusco Vaginal Specula	404
Caspar Exploration/Coagulation Hooks	110	Cushing Brain Spatulas	109
Caspar Laminectomy Rongeurs	124	Cushing Decompression hook	232
Castaneda Rib Spreaders from Aluminium	353	Cushing Dressing Forceps	28
Castroviejo Corneal Scissors	514,516,517	Cushing Dura Hooks	122
Castroviejo Eye Needle Holders	187	Cushing Forceps With TC Jaws	166
Castroviejo Eye Specula	511	Cushing Intervertebral Disc Rongeurs	126
Castroviejo Marker graduated	512	Cushing Nerve Hooks	121
Castroviejo Needle Holder With TC Jaws	167	Cushing Retractors	230
Castroviejo Suture Forceps	498-500	Cushing Tissue Forceps	32
Cataract Needle	506	Cuticle Instruments	136
Catheter Introducing Forceps	219	Cuticle Nippers	136
Catlin Amputating Knives	83	Czemy Rectal Specula	95
Cervical Traction Tongs	105	Czerny Tenaculum Forceps	420
Chalazion Curettes	509	D	
Charriere Amputating and Resection Saws	279	Dahlgren Scull-Cutting Forceps	104
Cheatle Sterilizing Forceps	69	Dandy Crile Hemostatic Forceps	52
Cheisea Eaton Anoscopes	91	Dandy Dissecting Scissors	151
Cheron Cotton Swab Forceps	68	Dandy Nerve Hooks	121
Chevalier-Jackson Trachea Tubes	366	Darmschere Enterotomy Scissors	154
Chir.Pinzette Forceps With TC Jaws	166	Dartigues Uterine Elevating Forceps	423
Chisels	466	Dastoor Erisophakes	497
Cilia Forceps	41,501	Daubenspeck Bone Curettes	303
Cinelli Nasal Osteotomes	465	Davidson Retractors	250
Circumcision Instruments	398	Davis Dura Dissectors	118
Clamp Closing Forceps	383	Davis Sterilizing Forceps	69
Clamp Forceps	60,61	Davis-Boyle Mouth Gags	476,478
Clamp Holders	383	De Bakey Abdominal Retractors	274
Clar Head Lamps	11	De Bakey Atrauma Forceps	35
Cleveland Bone Cutting Forceps	343	De Bakey Needle Holder With TC Jaws	170
Cleveland Bone Rongeur Forceps	336	De Bakey Suction Tubes	218
Clip Applying Forceps	107,108	De La Roza Ligature Needles	203
Clips	107	De Martel-Wolfson Anastomosis Clamp Forceps	382
Cloward Intervertebral Disc Rongeurs	123	De Martel-Wolfson Clamp Closing Forceps	383
Cloward Lamina Spreaders	106	De Martel-Wolfson Clamp Holders	383
Cloward Laminectomy Spreaders	133	De Vilbiss Scull-Cutting Forceps	104
Coakley Trocars	213	Dean Tonsil Scissors	152
Colclough (Richter) Disc Rongeurs	129,130	Deaver Operating Scissors	141
Cold Light source and accessories	102	Deaver Retractors	246,247
Collier Needle Holders	182	Dejerine Percussion Hammers	4
Collin Abdominal Retractors	266	Denhart Mouth Gags	475
Collin Clip Applying Forceps	195	Denis-Browne Abdominal Retractors	271
Collin Cotton Swab Forceps	68	Derf Needle Holder With TC Jaws	168
Collin Lung Grasping Forceps	360	Derf Needle Holders	182
Collin Mallets	322	Dermal Punches	71
Collin Measuring Instruments	5	Dermatomes	72
Collin Operating Knives	78	Deschamps Ligature Needles	197-201
Collin Pelvimeters	440	Desjardins Gall Stone Forceps	389
Collin Retractors	256	Desjardins Gall Stone Probes	390
Collin Tongue Holding Forceps	481	Desjardins Gall Stone Scoops	392
Collin Uterine Elevating Forceps	423	Desmarres Chalazion Forceps	500
Collin Vaginal Specula	405	Desmarres Corneal Knives	504
Collin-Loktite Abdominal Retractors	265,266	Desmarres Lid Retractor	512
Comedo Extractors	74	Dieffenbach Bulldog Clamps	46
Comprimeter	14	Dieffenbach Operating Knives	78
Cone Retractors	261	Dilating Bougies	394,395
Converse Hooks for Posterior Snares	469	Dingmann Cartilage Seizing Forceps	326
Converse Rhinoplastic and Nasal Knives	472	Diplomat Presameter	9
Cooley Rib Spreaders	356	Directors	100,223,224
Cooley Rib Spreaders from Aluminium	352	Dissecting Forceps	57
Coopelson Biopsy Punches	425	Dissecting Scissors	142-145,150,154
Cooper Ligature Needles	202	Dissectors	484
Corneal Scissors	514,516,517	Dittel Dilating Bougies	395
Coryllos Retractors	249	Dix Needle and Chisel	506
Cottle Hooks for Posterior Snares	469,471	Dix Needle and Gouge	506
Cottle Mallets	323	Douglas Cilia Forceps	41
Cottle Nasal and Ear Dressing Forceps	458	Doyen Dissecting Scissors	143
Cottle Nasal Osteotomes	464	Doyen Intestinal Clamp Forceps	381,384
Cottle Nasal Rasps	468	Doyen Mallets	322

Doyen Myoma Screw	423	Fomon Rhinoplastic and Nasal Knives	472
Doyen Periosteal Raspatories	308	Forceps with TC Jaws	166
Doyen Retractors	243	Foregger Laryngoscopes	371
Doyen Tongue Depressors	480	Foregger Laryngoscopes, cold light	376
Doyen Towel Forceps	62	Foreign Body Forceps	398
Doyen Uterine Elevating Forceps	422	Foreign Body Instruments	506,507
Doyen Vaginal Specula	408,409	Foreign Body Levers	493
Doyen-Stille Retractors	241	Foreign Body Needle	506
Dressing Forceps	25-28,66,67,459	Foreign Body Remover and Magnetic Eye Probe	506
Dressing Forceps Delicate	36	Fox Lupus Curettes	73
Dressing Forceps With TC Jaws	165	Frankenfeld Rectal Snare	100
Dubois Cephalotomy Scissors	147	Frankfeldt Cotton Applicators	101
Duplay Polypus and Dressing Forceps	67	Franz Abdominal Retractors	270
Duplay Tenaculum Forceps	419	Frazier Abdominal Retractors	275
Duplex Stethoscopes	7	Frazier Dura Dissectors	118
Dura Dissectors	116-118	Frazier Dura Hooks	122
Dura Hooks	122	Frazier Suction Tubes	215,216
Duval Lung Grasping Forceps	360	Freer Chisels	466
Duval Tissue Seizing Forceps With TC Jaws	175	Freer Hooks for Posterior Snares	470
E		Freer Septum Elevators	462
Ear Curettes	486,487	Freer Septum Gouges	466
Ear Hooks	488	French Needle Holder With TC Jaws	168
Ear Loops	487	French Tuning Forks	18
Ear Polypus Forceps	490,491	French-Mathieu Needle Holder With TC Jaws	172
Ear Specula	15	Fritsch Retractors	242
Echlin Bone Rongeur Forceps	340	Frontal Wire Cutter Pliers	290
Eder Cotton Applicators	101	G	
Elevators	312	Galea Hooks	115
Elliot Obstetrical Forceps	441	Gall Stone Forceps	389
Elschnig Iris Forceps	495	Gall Stone Probes	390
Emmett Laser Instruments	414	Gall Stone Scoops	391,392
Empire Blood Pressure Manometers	9	Gallaher Bone Files	314
Endarterectomy Strippers	226	Gelpi-Loktite Abdominal Retractors	274
Endospecula	412,413	Gemini Dissecting Forceps	57
Engel Plaster Cast Instrument	162	Gerald Dressing Forceps	27
engl-Mod Dressing Forceps	26	Gerald Tissue Forceps	31
Enterotomy Scissors	154	Gerster Bone Holding Clamps	345
Entropium Forceps	501	Giertz-Stille Rib Shears	348
Enucleators	484	Gigli Saw Handle	104
Eppendorf Biopsy Punches	429	Gigli Saw Three-fold	104
Errico Hand Bone Twist Drills Extension Piece	286	Gill Iris Forceps	495
Esmarch Bandage Scissors	159	Gill-Arruga Capsular Forceps	497
Esmarch Plaster-of-Paris Knives	161	Gill-Hess Iris Forceps	495
Eves Tonsil Snares	483	Gillies Hooklets	73
Examination and Measuring Instruments	5,6	Gillies Needle Holder With TC Jaws	174
Exenteration Scoops	509	Gillies Needle Holders	183
Exploration/Coagulation Hooks	110	Gillies Tissue Forceps	31
Extension Bows	283	Gillies-Baby Needle Holder With TC Jaws	174
Eye Hooks	507	Gluck Rib Shears	347
Eye Knives	503,504	Goldmann-Fox Operating Scissors	141
Eye Needle Holders with TC Jaws	167	Goldstein Eye Specula	510
Eye Scissors	520	Good Tonsil Scissors	152
Eye Specula	510,511	Gosset Abdominal Retractors	267
F		Gouges	291-299
Farabeuf Bone Holding Forceps	328	Gradle Cilia Forceps	501
Farabeuf Periosteal Raspatories	306	Graefe Cataract Knife and Chisel	507
Farabeuf Retractors	256	Graefe Cataract Knives	504
Farabeuf-Lambotte Bone Holding Forceps	328	Graefe Eye Hooks	507
Farrell Cotton Applicators	225	Graefe Fixation Forceps	498
Faulkner Septum Elevators	462	Graefe Iris Forceps	495
Faure Clamp Forceps	61	Graefe Iris Scissors	520
Feilchenfeld Splinter Forceps	39	Graefe Needle and Chisel	507
Feldmann Tourniquet	138	Graefe Needle and Gouge	507
Ferguson Needles	194	Graefe Strabismus Hooks	508
Fergusson Bone Holding Forceps	328	Graham Dura Hooks	122
Fergusson Suction Tubes	216	Graig Nasal Septum Forceps	459
Ferris-Smith-Kerrison Rongeurs	127,128	Grasping Forceps	424
Fine Swiss Tweezers	24	Grave Vaginal Specula	404,406
Finger nail Drill Set	138	Grazil Operating Scissors	140
Finger Ring Saw Blades	138	Green Fixation Forceps	498
Finger Ring Saws	138	Green Tubing Clamps	64
Finocchietto Rib Spreaders	354	Green-Armytage Uterine Hemostasis Forceps	443
Finocchietto Rib Spreaders from Aluminium	350	Gross Dressing Forceps	66
Finocchietto-Baby Rib Spreaders	354	Grunwald-Jansen Nasal, Ear Dressing Forceps	458
Finocchietto-Baby-Haight Rib Spreaders of Al	350	Guide Needles	214
Finocchietto-Burford Rib Spreaders	355	Guthrie Eye Hooks	507
Finocchietto-Infant Rib Spreaders of Aluminium	350	Guyon Catheter Introducing Instrument	393
Finocchietto Needle Holder With TC Jaws	170	Guyon Dilating Bougies	394
Finocchietto Needle Holders	185	Gynecological Scissors	146
Finsen Retractors	258	H	
Fisch Micro Hooks	112	Haberer Abdominal and Intestinal Spatulas	276
Fischer Iris Forceps	495	Haemorrhoidal Forceps	89
Fixation Forceps	498	Haemorrhoidal Ligators	88,89
Flat Nose Pliers	288,289	Haglund-Stille Plaster Cast Instrument	163
Foerster Sponge Holding Forceps	68	Haight Rib Spreaders	355
Fomon Hooks for Posterior Snares	469,470	Hajek Mallets	323
Fomon Nasal Osteotomes	465	Hajek Sphenoid Punches	461
Fomon Nasal Rasps	468	Halle Bone Curettes	304

Halle Dura Hooks	122	Jaeger Keratomes	505
Halogen-Light for Cold Light Handles	377	Jaeger-Grieshaber Keratomes	505
Halsey Needle Holder With TC Jaws	171	Jakobs Tenaculum Forceps	421
Halsey Needle Holders	182	Jakobson Buttoned Probe	113
Halsted-Mosquito Hemostatic Forceps	47	Jakobson Micro Vessel Knives	114
Hand Bone Drills	284-287	Jakobson Twin Probe	113
Handles for Rectal Biopsy Specimen Forceps	99	Janet Syringes	221
Hank Uterine-Dilators	418	Jansen Bone Rongeur Forceps	337
Harken Blood Vessel Clamps	362	Jansen Ear Curettes	487
Harken Rib Spreaders	358	Jansen Nasal and Ear Dressing Forceps	458
Harrington Retractors	247	Jansen Periosteal Raspatories	309
Hartmann Ear Polypus Forceps	490	Jansen Retractors	258
Hartmann Ear Specula	15	Jennings Mouth Gags	475
Hartmann Hemostatic Forceps	46	Jess Fixation Forceps	498
Hartmann Nasal Polypus Forceps	457	Jobson-Horne Cotton Applicators	225
Hartmann Nasal Specula	453	John Hopkins Bulldog Clamps	46
Hartmann Tuning Forks	16	Jones Towel Forceps	62
Hartmann-Halle Nasal Specula	453	Joseph Bone Files	314
Hartmann-Noyes Ear Polypus Forceps	490	Joseph Delicate Operating Scissors	148
Hartmann-Weingartner Ear Polypus Forceps	490	Joseph Hooks for Posterior Snares	469,470
Hartmann-Wullstein Ear Polypus Forceps	490	Joseph Nasal Saws	467
Head Lamps	11	Joseph Periosteal Raspatories	312
Heaney Clamp Forceps	60	Joseph Rhinoplastic and Nasal Knives	472
Heaney Needle Holder With TC Jaws	171	Joseph Septum and Periosteal Elevators	463
Heaney Needle Holders	185	Joseph-Masing Septum Elevators	462
Heaney-Ballentine Clamp Forceps	60	Judd-Allis Tissue Grasping Forceps	379
Heath Wire Cutting Scissors	153	Judd-Masson Bladder Retractors	397
Hegar Needle Holder With TC Jaws	169	K	
Hegar Uterine-Dilators	415-417	Kader Abdominal and Intestinal Spatulas	277
Hegar-Baumgartner Needle Holders	183	Kallmorgen Retractors	407
Hegenbarth Clip Applying Forceps	195	Kallmorgen Vaginal Specula	407
Heifetz Brain Spatulas	109	Kalt Eye Needle Holders	187
Heifetz Tumor Forceps	40	Kalt Needle Holder With TC Jaws	167
Heiss Hemostatic Forceps	54	Kantrowitz Hemostatic Forceps	59
Heister Mouth Gags	475	Katzin Corneal Scissors	514
Helferich-Bier Amputating and Resection Saws	280	Keith Muscular, Skin Sutures	190
Hemostatic Forceps	46-56,58,59	Kelly Delicate Scissors	146
Henke Tonsil Dissectors	484	Kelly Hemostatic Forceps	51
Henning Plaster Cast Instrument	162	Kelly Protoscopes	92
Hess Iris Forceps	496	Kelly Retractors	239,255
Hessberg Ligature Needles	203	Kelly Sphincteroscopes	92
Heymann Nasal Scissors	152	Kelly Uterine Polypus Forceps	422
Heymann-Knight Nasal Polypus Forceps	457	Kelly-Rankin Hemostatic Forceps	51
Hibbs Bone Chisels	298	Keratomes	505
Hibbs Gouges	299	Kern Bone Holding Forceps	330
Hibbs Osteotomes	298,299	Kerrison Antrum Punch Forceps	461
Hirschmann Anuscopes	90	Kevorkian Biopsy Curettes	433,434
Hoen Dura Dissectors	118	Kevorkian Biopsy Punches	425,429
Hohmann Bone Levers	318,319	Kevorkian-Young Biopsy Curettes	434
Hoizbach Abdominal Retractors	265	Key Periosteal Raspatories	308
Holscher Nerve Root Retractors	120	Keyes Dermal Punches	71
Holtzheimer Retractors	258	Keyes Set Dermal Punches	71
Hook Osteotomes	298	Kidney Stone Forceps	388
Hooklets	73	Kielland Obstetrical Forceps	441
Hooks for Posterior Snares	469-471	Kielland-Luikart Obstetrical Forceps	441
Hopkins Plaster-of-Paris Knives	161	Killian Nasal Forceps	459
Horsley Dura Dissectors	119	Killian Nasal Scissors	451
Hosel Retractors	244	Killian Nasal Specula	455
Howarth Periosteal Raspatories	307	Killian Septum and Periosteal Elevators	463
Hudson Hand Bone Drills	286	Killian Septum Elevators	462
Hudson Hand Bone Twist Drills Extension Piece	286	Killian Septum Gouges	466
Hunter Splinter Forceps	39	Killian-Claus Septum Gouges	466
Hurd Tonsil Dissectors and Retractors	484	Kilner Dissecting Scissors	148
Hylli Periosteal Raspatories	309	Kilner Hooklets	73
Hysterectomy Forceps	60,61	Kilner Hooks for Posterior Snares	469
Hystero-Salpingography Instruments	13	Kilner-Doughty Mouth Gags	479
I		Kirschner Abdominal Retractors	271
Inge Lamina Spreaders	106	Kirschner Extension Bows	283
Intervertebral Disc Rongeurs	123,125-130	Kirschner(Amerikanische Mod.) Extension Bows	283
Intestinal Clamp Forceps	381,382,384-386	Klapp Tendon Sheath Retractors	231
Intestinal Forceps	379,380	Klima-Rosegger Cannulas	217
Intestinal Needles	192	Knapp Discission Knives	504
Intestinal Spatulas	276,277	Knapp-Clark Eye Specula	510
Iowa Cannulas	217	Knight Septum Froceps	459
Iridectomy Scissors	514-517	Knowles Bandage Scissors	159
Iris Forceps	495,496	Kocher Bladder Retractors	396
Iris Hook	414	Kocher Hemostatic Forceps	49
Iris Scissors	519,520	Kocher Intestinal Clamp Forceps	382,386
Iris Scissors "Ribbon type"	521	Kocher Ligature Conductors	206
Irisschere Scissors with TC edges	178	Kocher Retractors	234,237,240,243
Irisschere Supercut Scissors	157	Kocher-Wagner Retractors	254
Israel Retractors	236	Koenig Tuning Forks	19
Itersen Trachea Retractors	364	Koerte Abdominal and Intestinal Spatulas	277
Ives-Fansler Anuscopes	92	Koerte Retractors	235
J		Kogan Endospecula	412,413
Jackson Trachea Retractors	365	Konig Ligature Conductors	205
Jacobs Three-Jaw Chuck	284	Koos Micro Vessel Knives	114
Jaeger Eye Hooks	507	Kraus Micro Vessel Knives	114

Krause Nasal Polypus Snare	456	Lorenz Bandage Scissors	159
Krause Trocars	213	Lorna Towel Forceps	63
Krause-Voss Nasal Polypus Snare	456	Love Nerve Root Retractors	119
Krayenbuhl Nerve and Vessel Hooks	111	Love-Gruenwald Intervertebral Disc Rongeurs	126
Kristeller Retractors	402,403	Lovelace Hemostatic Forceps	52
Kristeller Vaginal Specula	402,403	Lovelace Lung Grasping Forceps	360
Kronecker Ligature Needles	202	Lowmann Bone Holding Clamps	345
Kuehne cover Glass Forceps	42	Lowmann-Baby Bone Holding Clamps	345
Kuempel Abdominal and Intestinal Spatulas	277	Lowmann-Hoglund Bone Holding Clamps	345
Kuhnt Cataract Knives	504	Luc Ethmoid Forceps	459
L			
La Force Adenotomes	474	Lucae Ear Hooks	488
Laborde Trachea Dilators	364	Lucae Mallets	322
Lachrymal Dilators	508	Lucae Nasal and Ear Dressing Forceps	458
Lachrymal Probes	502	Lucae Paracentesis Needles	489
Lahey Goitre Grasping Forceps	366	Lucae Tuning Forks	17
Lahey Hemostatic Forceps	59	Lucas Bone Chisels	293
Lahey Retractors	239	Lucas Gouges	293
Lambotte Bone Holding Forceps	331	Luer Bone Rongeur Forceps	334,336
Lambotte Osteotomes	293	Luer Lock Cannulas	217
Lambotte Periosteal Raspatories	307	Luer Lock Syringes	220
Lamina Spreaders	106	Luer Syringes	220
Laminectomy Rongeurs	124	Luer Trachea Retractors	365
Laminectomy Spreaders	131-133	Luer-Friedmann Bone Rongeur Forceps	336
Lancaster Eye Specula	511	Luer-Koerte Gall Stone Scoops	391
Landau Trocars	212	Luer-Lock joint Syringe	221
Lane Bone Holding Forceps	330	Lukens Trachea Retractors	365
Lane Bone Levers	320	Lung grasping Forceps	34,360
Lane Screw Drivers	282	Lung Spatulas	359
Lane Tissue Forceps	33	Lupus Curettes	73
Lane Towel Forceps	63	M	
Lange-Hohmann Bone Levers	320	M.G.H Needle Holders	183
Lange-Hohmann modif Bone Levers	320	Magill Catheter Introducing Forceps	219
Langenbeck Amputating and Resection Saws	279	Magill-Baby Catheter Introducing Forceps	219
Langenbeck Amputating Knives	83	Maier Polypus and Dressing Forceps	67
Langenbeck Bone Holding Forceps	328	Mallets	322-325
Langenbeck Elevators	312	Mallets of Solid Brass	322
Langenbeck Periosteal Raspatories	306	Mallets of Solid Ferrozell	325
Langenbeck Resection Knives	84	Mallets of Solid Steel	325
Langenbeck Retractors	237,238	Mallets with Lead Filled	322
Langenbeck-Kocher Retractors	237	Mallets without Lead	324
Larry Rectal Director	100	Maltz Nasal Rasps	468
Laryngeal Mirrors	2	Marker Graduated	512
Laryngoscope Handle, Transformer Connection	372,377	Markham-Meyering Abdominal Retractors	273
Laryngoscope Handles	372	Marquardt Bone Rongeur Forceps	341
Laryngoscope Handles, cold light	377	Martel Conductor for wire saws	104
Laryngoscopes	368-371	Martin Pelvimeters	440
Laryngoscopes , cold light	373-376	Martin Retractors	248
Laser Hook	414	Martin Uterine Sounds	418
Laser Instruments	414	Martini Bone Curettes	302
Lateral Vaginal Retractor	410	Masing Septum and Periosteal Elevators	463
Lateral Wire Cutter Pliers	290	Masson Needle Holder With TC Jaws	173
Laufe Haemorrhoidal Forceps	89	Masson Needle Holders	185
Le Grange Eye Scissors	520	Mathieu Foreign Body Forceps	398
Lead Hands	321	Mathieu Needle Holder With TC Jaws	171,172
Lebsche Sternum Scissors	349	Mathieu Needle Holders	186
Legue Bladder Retractors	396	Mathieu Retractors	256,409
Legueu Bladder Retractors	397	Mathieu Vaginal Specula	409
Leksell-Stille Bone Rongeur Forceps	335	Matson Periosteal Raspatories	308
Lempert Bone Curettes	304	Maxi Grasping Forceps	424
Lempert Bone Rongeur Forceps	334	Mayfield Bone Rongeur Forceps	341
Lengenbeck Ear Curettes	487	Mayo Dissecting Scissors	142
Leriche Hemostatic Forceps	53	Mayo Gall Stone Probes	390
Lewin Bone Holding Forceps	326	Mayo Gall Stone Scoops	392
Lexer Bone Chisels	296	Mayo Needles	194
Lexer Gouges	297	Mayo Scissors with TC edges	177
Lexer Osteotomes	297	Mayo Supercut Scissors	155
Lichtwitz Trocars	212	Mayo-Blake Gall Stone Forceps	389
Lid Retractor	512	Mayo-Harrington Dissecting Scissors	142
Ligature Forceps	57	Mayo-Hegar Needle Holder With TC Jaws	168
Ligature Guides	111	Mayo-Hegar Needle Holders	183
Ligature Scissors	153	Mayo-Lexer Dissecting Scissors	143
Ligaturschere Scissors	153	Mayo-Lexer Scissors with TC edges	177
Lister Bandage Scissors	159	Mayo-Lexer Supercut Scissors	155
Lister Scissors with TC edges	176	Mayo-Noble Dissecting Scissors	142
Lister Sinus Forceps	66	Mayo-Robson Intestinal Clamp Forceps	381,385
Lister Supercut Scissors	157	Mayo-Stille Dissecting Scissors	142
Lister-Burch Eye Specula	511	Mayo-Stille Scissors with TC edges	177
Lister-Excentric Bandage Scissors	160	Mayo-Stille Supercut Scissors	155
Liston Amputating Knives	83	Mc Clure Micro Scissors	513
Liston Bone Cutting Forceps	342	Mc Guire Corneal Scissors	514
Liston-Key Bone Cutting Forceps	342	Mc Indoe Bone Cutting Forceps	343
Liston-Mini Bone Cutting Forceps	342	Mc Indoe Cartilage Scissors	150
Littauer Cilia Forceps	41	Mc Indoe Dressing Forceps	26
Littauer Ligature Scissors	153	Mc Ivor Mouth Gags	477
Littauer Nasal Polypus Forceps	457	Mc Kenzie Brain Clip Carrier	107
Lockhart-Mummery Fistula Probes	224	Mc Kenzie Clip Applying Forceps	108
Lockwood-Allis Tissue Grasping Forceps	380	Mc Kenzie Silver Wire in coils	107
		Mc Lean-Tucker Obstetrical Forceps	441

McDonald Elevators	312	Muscular, Skin Sutures	189-191
McGivney Haemorrhoidal Forceps	89	Museux Tenaculum Forceps	421
McIntosh Laryngoscopes	368,369	Myoma Screw	423
McIntosh Laryngoscopes, cold light	373	N	
Mckenzie Hand Bone Twist Drills Extension Piece	286	Nabatoff Varicose Vein Probe Set	226
McPherson Suture Forceps	497	Naegele Obstetrical Forceps	440
Mead Bone Rongeur Forceps	338	Nail File	135
Mead Mallets	323	Nail Instruments	135-138
Mellinger Eye Specula	510	Nail Nippers	136,137
Mellinger-Axenfeld Eye Specula	510	Nail Scissors	137
Mellinger-Beard Eye Specula	510	Narath Ligature Needles	203
Menghini Cannulas	217	Nasal Cutting Forceps	445,446,449
Meniscotomy Knives	316	Nasal Forceps	447,448,458,459
Metal Catheters	393	Nasal Knives	472
Metal Rule Measuring Instruments	6	Nasal Osteotomes	464-466
Metzenbaum (Strabismus) Dissecting Scissors	145	Nasal Polypus Forceps	457
Metzenbaum (Strabismus) Scissors with TC edg	177	Nasal Polypus Snares	456
Metzenbaum (Strabismus) Supercut Scissors	157	Nasal Rasps	468
Metzenbaum Dissecting Scissors	144	Nasal Saws	467
Metzenbaum Scissors with TC edges	178	Nasal Scissors	152
Metzenbaum Supercut Scissors	156	Nasal Scissors	450,451
Metzenbaum-Fino Dissecting Scissors	145	Nasal Specula	453-455
Metzenbaum-Fino Scissors with TC edges	178	Needle holders with TC jaws	168-174
Metzenbaum-Fino Supercut Scissors	157	Neff Meniscotomy Knives	316
Metzenbaum-Lahey Dissecting Scissors	145	Negus Hemostatic Forceps	58
Meyer Gouge for Foreign Bodies	506	Negus Mouth Gags	478
Meyerding Abdominal Retractors	273	Neivert Hooks for Posterior nares	471
Meyerding Retractors	229,253	Nelson Lung Grasping Forceps	34
Meyerding-Scoville Laminectomy Blades	132	Nelson Trocars	211
Meyhoefer Chalazion Curettes	509	Nerve and Vessel Hooks	111
Michel Clip Applying Forceps	195	Nerve Hooks	121,122
Michel Suture Clips	196	Nerve Root Retractors	119,120
Micro Ear Polypus Forceps	492	Neurological Tuning Forks	19
Micro Forks	113	Neurosurgical Scissors	151
Micro Hooks	112	News Trachea Retractors	365
Micro Raspatories	112,113	Nicati Cataract Knives	504
Micro Scissors	513,515,518	Noto Uterine Polypus Forceps	422
Micro Scoops	113	Novak Biopsy Curettes	433
Micro Vessel Knives	114	Novak-Schoeckaert Biopsy Curettes	434
Micro-Friedmann Bone Rongeur Forceps	336	Noyes Fixation Forceps	498
Microscope Forceps	39	Noyes Iridectomy Scissors	514,516,517
Middeldorpf Retractors	241,242	Nurses Set	135
Middleton-Jansen Septum Forceps	460	O	
Mikulicz Clamp Forceps	61	Obstetrical Forceps	440,441
Mikulicz Retractors	251	Obstetrics Scissors	147,148
Miller Laryngoscopes	370	Ochsner Trocars	211
Miller Laryngoscopes, cold light	374,375	Ochsner-Kocher Hemostatic Forceps	49
Milligan Retractors	260	Oldberg Intervertebral Disc Rongeurs	125
Millin Bladder Retractors	397	Olivecrona Bone Rongeur Forceps	338
Millin Capsule Forceps	400	Olivecrona Brain Spatulas	109
Mini-Friedmann Bone Rongeur Forceps	336	Olivecrona Cranial Opening	104
Mini-Gemini Dissecting Forceps	57	Olivecrona Dura Dissectors	117
Mini-Hohmann Bone Levers	317	Olivecrona-Toennis Clip Applying Forceps	108
Mini-Lambotte Osteotomes	292	Ollier Retractors	235
Mini-Langenbeck Retractors	231	Olsen-Hegar Needle Holder With TC Jaws	169,173
Mini-Lexer Gouges	297	Olsen-Hegar Needle Holders	184
Mini-Lexer Osteotomes	297	Ombredanne Mallets	324
Minimus III Blood Pressure Manometers	10	Ombredanne Towel Forceps	63
Mini-Roux Retractors	257	Operating Knives	76-78
Mini-Tischler Biopsy Punches	425	Operating Scissors	140,141,146
Miscellaneous Ear Instruments	488	Operating Scissors with TC edges	176
Mittelfein Ear Polypus Forceps	491	Osteotomes	291
Mixer Gall Stone Forceps	389	O'Sullivan-O'Connor Abdominal Retractors	272
Mixer Hemostatic Forceps	58	Overholt-Geissendoerfer Hemos Forceps	54
Mixer Hemostatic Forceps	59	Ovum Forceps	442
Mixer Operating Scissors	141	P	
Mixer-Baby Hemostatic Forceps	58	Paracentesis Needles	489
Mixer-O'Shaughnessy Hemostatic Forceps	58	Parametrium Scissors with TC edges	176
Mock Cannulas	217	Parker Retractors	257
Mod. Bonn Iris Forceps	496	Parker-Langenbeck Retractors	256
Mod. Muenchen Biopsy Curettes	434	Park-Guyton Eye Specula	510
Mod. Russ Lung Grasping Forceps	34	Partsch Bone Chisels	291
Mod.mayo-Russ Lung grasping Forceps	34	Partsch Gouges	291
Modell Tubingen Retractors	248	Partsch Mallets	323
Moeltgen Measuring Instruments	5	Payr Intestinal and Stomach Clamp	383
Mollison Retractors	261	Payr Ligature Conductors	206
Molt Mouth Gags	475	Pean Hemostatic Forceps	48
Moore Gall Stone Scoops	392	Pean Trocars	212
Moore Hand Bone Drills	284	Pederson Vaginal Specula	405,406
Morgan Protoscopes	90	Peers Towel Forceps	62
Morse Rib Spreaders	357	Peet Splinter Forceps	44
Morse Rib Spreaders from Aluminium	353	Pelvimeters	440
Morse-Favaloro Rib Spreaders	357	Penfield Dura Dissectors	116
Mouth Gags	475-479	Pennington Hemostatic Forceps	53
Moynihan Clamp Forceps	60	Pennington Septum and Periosteal Elevators	463
Mueller Eye Specula	510	Percussion Hammers	3,4
Murdock Eye Specula	510	Percy Amputating and Resection Saws	280
Murphy-Lane Bone Levers	320	Periosteal Elevators	463

Periosteal Raspatories	306-312	Rubin Nasal Osteotomes	465
Perthes Bone Drills	281	Rubin Septum Forceps	452
Pierce Septum and Periosteal Elevators	463	Rubin TC Septum Forceps	452
Pierce Trocars	212	Rudd Haemorrhoidal Ligators	89
Pin Cutters With TC Inserts	179,180	Rumel Hemostatic Forceps	55
Pinard Stethoscopes	7	Ruskin Bone Cutting Forceps	344
Piper Obstetrical Forceps	441	Ruskin Bone Rongeur Forceps	334
Placenta Forceps	442	Ruskin-Liston Bone Cutting Forceps	344
Plaster Cast Instruments	162,163	Russel-Davis Mouth Gags	479
Plaster Spatula	225	Rust Amputating and Resection Saws	280
Plaster-of-Paris knives	161	Rydel-Seiffer Tuning Forks	18
Plaster-of-Paris Shears	161	S	
Plester Retractors	260	Saalfeld Comedo Extractors	74
Plester Suction Tubes	216	Sachs Dura Dissectors	118
Pley Capsular Forceps	497	Sachs Dura Hooks	122
Politzer Paracentesis Needles	489	Saenger Ovum Forceps	442
Polypus Forceps	66,67	Salenius Meniscotomy Knives	316
Poole Suction Tubes	218	Sarot Hemostatic Forceps	55
Post Mortem Knives	85	Sarot Needle Holder With TC Jaws	173
Pottos-Smith Dressing Forceps	27	Sarot Needle Holders	183
Pottos-Smith Tissue Forceps	33	Satinsky Blood Vessel Clamps	361
Potts-Smith Forceps With TC Jaws	166	Satinsky Vascular Scissors	150
Potts-Smith Vascular Scissors	149,150	Satterlee Amputating and Resection Saws	279
Precisa Blood Pressure Manometers	10	Sauerbruch Bone Rongeur Forceps	341
Presbyterian Tubing clamps	64	Sauerbruch Retractors	238,250
Price-Thomas Brochus Clamps	361	Sauerbruch Rib Shears	349
Prince Tonsil Scissors	152	Sauerbruch-Frey Rib Shears	349
Prince Trachoma Forceps	500	Scalp Contour Retractors	259
Probes	223,224	Scalpel Blades	81,82
Proctoscopes	90-92	Scalpel Handles	79,80
Prostatic Retractors	399	Schadel Towel Forceps	62
Providence Hospital Hemostatic Forceps	52	Schamberg Comedo Extractors	74
Putti Rasps	315	Schede Bone Curettes	300
Pylorus Spreader	381	Scherbak Vaginal Specula	411
Q		Schink Dermatomes	72
Quervain Elevators	312	Schioetz Tonometer	12
Quire Foreign Body Levers	493	Schlesinger Intervertebral Disc Rongeurs	123
R		Schmieden Dura Scissors	151
Rabiner Percussion Hammers	4	Schmieden Ligature Conductors	205
Ragnell-Davis Retractors	255	Schmieden Ligature Needles	202
Ralk Hand Bone Drills	285	Schmieden-Dick Ligature Needles	202
Ralk Splinter Forceps	44	Schmieden-Payr Ligature Conductors	205
Rampley Sponge Holding Forceps	69	Schmidt Tonsil Seizing Forceps	482
Randall Biopsy Curettes	433	Schoenborn Thyroid Gland Retractor	365
Randall Kidney Stone Forceps	388	Schroder Tenaculum Forceps	420
Raney Forceps for Scalp Clips	107	Schroder Uterine Curettes	439
Raney Scalp Clips	107	Schroder-Braun Tenaculum Forceps	419
Rasps	315	Schubert Biopsy Punches	430
Reamers	281	Schuhmacher Biopsy Punches	427,428,430
Recamier Uterine Curettes	436	Schultze Hystero-Salpingography	13
Rectal Biopsy Specimen Forceps	97,98	Schumacher Biopsy Punches	429
Rectal Snares	100	Schumacher Umbilical Scissors	148
Rectal Specula	93,95,96	Schweiger Capsular Forceps	497
Reill Micro Scissors	518	Scissors with TC edges	176-178
Reiner Plaster-of-Paris Knives	161	Scoville Laminectomy Spreaders	131
Reposition Bone Holding Forceps	328,329	Scoville Laminectomy Spreaders Blades	132
Resection Knives	84	Scoville Laminectomy Spreaders Hooks	132
Resection Saws	279,280	Scoville Nerve Root Retractors	120
Retractors	228-264,484	Scoville-Haverfield Laminectomy Spreaders	131
Reverdin Abdominal and Intestinal Spatulas	276	Screw Drivers	282
Reverdin Needles	207,208	Screw Nut Wrench	283
Reynolds Dissecting Scissors	150	Secondary Cataract Scissors	513
Rhinoplastic Knives	472	Sedillot Periosteal Raspatories	306
Rib Contractors	359	Sehr Fein Micro Ear Polypus Forceps	492
Rib Shears	347-349	Seiler Nasal Scissors	152
Rib Spreaders	354-358	Semb Bone Cutting Forceps	344
Rib Spreaders from Aluminium	350-353	Semb Bone Holding Forceps	327
Ricard Abdominal Retractors	265	Semb Bone Rongeur Forceps	339
Richardson Retractors	239	Semb Periosteal Raspatories	309
Richardson-Eastman Retractors	240	Semken Dressing Forceps	26
Richter Operating Scissors	141	Semken Tissue Forceps	30
Rigby Abdominal Retractors	273	Semm Vaginal Specula	407
Rirap Stethoscopes	8	Senn-Green Retractors	255
Roberts Hemostatic Forceps	55	Senn-Miller Retractors	255
Rochester-Carmalt Hemostatic Forceps	50	Septum Elevators	462,463
Rochester-Pean Hemostatic Forceps	48	Septum Forceps	452,460
Roeder Towel Forceps	62	Septum Gouges	466
Rogge Sterilizing Forceps	69	Sequestum Bone Holding Forceps	326
Rose Trachea Retractors	365	Serpentine Grasper Flexible IUD	424
Rosen Curette	488	Set of 5 Aluminium Tuning Forks	21
Rosen Elevators	488	Set of 6 Aluminium Tuning Forks	22
Rosen Hooklets	488	Set of 8 Aluminium Tuning Forks	22
Rosen Periosteal Raspatory	488	Setter Bone Holding Forceps	327
Roser Directors	224	Seutin Plaster-of-Paris Shears	161
Roser-Konig Mouth Gags	475	Sexton Tympanum Knives	489
Rotokurette Biopsy Curettes	433	Seyffert Vaginal Specula	405
Rottgen-Ruskin Bone Rongeur Forceps	334	Shapleigh Ear Curettes	487
Roux Retractors	257	Siebold Utrine Scissors	146

Silver Dematomes	72	Taylor Spinal Retractors	321
Silver Nasal Osteotomes	466	Teale Tenaculum Forceps	421
Simon Bone Curettes	303	Temple-Fay Abdominal Retractors	275
Simon Retractors	248	Tenaculum Forceps	419-421
Simon Uterine Curettes	439	Tendon Instruments	313
Simpson-Braun Obstetrical Forceps	440	Thomas Towel Forceps	64
Simpson-Luikart Obstetrical Forceps	440	Thomas Uterine Curettes	435
Sims (Bodenhammer) Rectal Specula	95	Thoms-Allis Tissue Grasping Forceps	379
Sims Operating Scissors	146	Thoms-Gaylor Biopsy Punches	432
Sims Rectal Specula	95,96	Thudichum (Goldsmith) Nasal Specula	455
Sims Uterine Curettes	435	Thyroid Gland Retractor	365
Sims Uterine Sounds	418	Tieck-Halle Nasal Specula	453
Sims Vaginal Specula	407	Tischler Biopsy Punches	425,431
Singley-Tuttle Lung Grasping Forceps	34	Tischler-Kevorkian Biopsy Punches	425
Sistrunck Nail Splitting Scissors	153	Tissue Forceps	29-33
Skene Tenaculum Forceps	419	Tissue Forceps Delicate	37
Sluder-Ballenger Tonsillectomes	485	Tissue Grasping Forceps	379,380
Smedberg Hand Bone Drills	285	Tissue Seizing Forceps with TC Jaws	175
Smillie Menisectomy Knives	316	Tobold Tongue Depressors	480
Smith Bandage Scissors	159	Toe and Finger Nail Forceps	138
Smith-Buie Anal Retractors	93	Toennis Dura Dissectors	117
Smith-Green Cataract Knives	504	Toennis Dura Hooks	122
Smith-Petersen Bone Chisels	296	Tongue Depressors	480
Smith-Petersen Bone Rongeur Forceps	340	Tongue Holding Forceps	481
Smith-Petersen Osteotomes	295	Tonnis Dissecting Scissors	150
Smithwick Nerve Hooks	121	Tonnis-Adson Scissors with TC edges	178
Snellen Entropium Forceps	501	Tonometer	12
Somer Uterine Elevating Forceps	423	Tonsil Knives	484
Spencer Ligature Scissors	153	Tonsil Scissors	152
Spencer-Wells Hemostatic Forceps	52	Tonsil Seizing Forceps	482
Sphenoid Punches	461	Tonsil Snares	483
Sphincteroscopes	92	Tonsillectomes	485
Spinal Bone Curettes	305	Towel Forceps	62-64
Splinter Forceps	38,39,44	Trachea Dilators	364
Sponge Holding Forceps	68,69	Trachea Retractors	364,365
Spratt Bone Curettes	300,305	Trachea Trocars	366
Spurling Intervertebral Disc Rongeurs	126	Trachea Tubes	366
St. Clair-Thomson Adenoid Curettes	473	Transformer	377
St. Martin Suture Forceps	499	Traube Percussion Hammers	3
Stacke Probes	223	Trocars	210-213
Standard Pocket Cases	196	Troeltsch (Wilde) Nasal, Ear Dressing Forceps	458
Staude-Moore Tenaculum Forceps	420	Troemner Percussion Hammers	3
Steel Wire For Nasal Snares	456,483	Trousseau Trachea Dilators	364
Steel Wire For Rectal Snares	100	Troutman Micro Corneal Scissors	513
Stellbrink Bone Rongeur Forceps	337	Tubing Clamps	64,65
Sterilizing Forceps	69	Tubinger Modell Retractors	261
Stethoscopes	7,8	Tuffier Abdominal and Intestinal Spatulas	276
Stevens Iris Forceps	496	Tuffier Rib Spreaders	355
Stevens Supercut Scissors	157	Tumor Forceps	40
Stevens Tenotomy Scissors	520	Tuning Forks	16,22
Stevenson Eye Specula	511	Tyding Tonsil Snares	483
Stieglitz Splinter Forceps	44	Tympanum Knives	489
Stille Bone Chisels	294	U	
Stille Bone Rongeur Forceps	335	Uckermann Cotton Applicators	225
Stille Gouges	294,295	Uckermann Trachea Trocars	366
Stille Hand Bone Drills	287	Ulrich Bone Holding Forceps	333
Stille Osteotomes	294,295	Ulrich Cotton Swab Forceps	66
Stille Plaster-of-Paris Shears	161	Uni-Burke Biopsy Punches	427,428
Stille-Liston Bone Cutting Forceps	342	Uni-Kevorkian Biopsy Punches	427,428
Stille-Luer Bone Rongeur Forceps	335	Uni-Oval Biopsy Punches	427,428
Stille-Ruskin Bone Rongeur Forceps	339	Uni-Tischler Biopsy Punches	427,428
Stockmann Penis Seizing Forceps	398	Uni-Townsend Biopsy Punches	427,428
Strabismus Forceps	499,500	Universal Interchangeable Handles For ..	99
Strabismus Forceps	499,500	Rectal Biopsy Specimen Forceps	
Strabismus Hooks	508	Universal Trocars	210
Strandell-Stille Retractors	232	Universal Wire Cutting Scissors	153
Stratte Needle Holder With TC Jaws	171	Universal Wire Cutting Scissors with TC edges	179
Stratte Needle Holders	185	Unna Comedo Extractors	74
Strauss Penis Seizing Forceps	398	Unna-Vidal Comedo Extractors	74
Struempel Ear Polypus Forceps	490	USA Mod. Umbilical Scissors	148
Strully Vascular Scissors	151	USA Modell Plaster Cast Instrument	163
Struycken Nasal Cutting Forceps	449	USA-Mod Dressing Forceps	26
Suction Tubes	100,215-218	USA-Mod Tissue Forceps	29
Super Fein Micro Ear Polypus Forceps	492	Uterine Curettes	435-439
Supercut Scissors	155-157	Uterine Depressors	418
Surgical Needles	188	Uterine Dilators	415-418
Suture Forceps	497-500	Uterine Elevating Forceps	422,423
Suture Tying Forceps	501	Uterine Hemostasis Forceps	443
Swivel Knives	471	Uterine Polypus Forceps	422
Syringes	220,221	Uterine Sounds	418
T		V	
Takahashi Nasal Cutting Forceps	446	Vaginal Specula	402-409,411
Tape Measuring Instruments	6	Van Buren Bone Holding Forceps	328
Taps with Cross Handle	282	Van Doren Biopsy Punches	432
Taylor Tissue Forceps	32,33	Vannas Micro Scissors	518
Taylor Dressing Forceps	27	Vannas Secondary Cataract Scissors	513
Taylor Laminectomy Spreaders Blades	132	Varicose Vein Probe Set	226
Taylor Percussion Hammers	3	Vascular Dilators	362

Vascular Scissors	149-151
Vein and Eye Needles	193
Verbrugge Bone Holding Forceps	332,333
Verbrugge-Baby Bone Holding Forceps	332
Verres Cannulas	217
Vidal Lupus Scraper	73
Virchow Autopsy Knives	86
Virchow Brain Knife	85
Vogel Adenoid Curettes	473
Volkman Bone Curettes	300,301,304
Volkman Retractors	232-234

W

Wachenfeldt Clip Applying Forceps	195
Wagener Ear Hooks	488
Wagner Laminectomy Rongeurs	125
Wagner Periosteal Raspatories	307
Walb Post Mortem Knife	85
Waldmann Perineum Scissors	147
Walter Chisels	465
Walter-Carmalt Splinter Forceps	39
Walton Interchangeable Handles For ..	99
Rectal Biopsy Specimen Forceps	
Wangensteen Forceps With TC Jaws	167
Wangensteen Needle Holder With TC Jaws	170
Wangensteen Needle Holders	185
Wartenberg Examination Instruments	5
Wassmund Retractors	235
Watson-Cheyne Directors	224
Waugh Dressing Forceps	28
Waugh Tissue Forceps	32
Weber Canaliculus Knives	504
Webster Needle Holder With TC Jaws	171
Webster Needle Holders	182
Wecker Iridectomy Scissors	517
Weil-Blakesley Nasal Cutting Forceps	445
Weiss Amputating and Resection Saws	280
Weitlaner-Baby Retractors	259
Weitlaner-Loktite Retractors	259
Weitlaner-Wullstein Retractors	259
Wertheim Clamp Forceps	60,61
Wertheim Dissecting Scissors	145
Wertheim-Cullen Clamp Forceps	60
Wessely-Griehaber Keratomes	505
Westcott Tenotomy Scissors	514
Westmacott Nasal Forceps	459
White Tonsil Seizing Forceps	482
Whitehead Mouth Gags	475
Wieder Tongue Depressors	480
Wiener Eye Hooks	507
Wiener Nasal Rasps	468
Wilde Nasal Cutting Forceps	449
Wilder Lachrymal Dilators	508
Williams Eye Specula	510
Williams Intestinal Forceps	380
Williger Bone Curettes	301,302
Williger Elevators	312
Williger Mallets	322
Williger Periosteal Raspatories	307
Winter Placenta Forceps	442
Wire Cutters With TC Inserts	179,180
Wire Cutting Pliers	289,290
Wire Cutting Scissors	153
Wire Strainer	283
Wittner Biopsy Punches	429
Wolff Lupus Curettes	73
Wolff Plaster Cast Instrument	162
Woodruff Ligature Needles	203
Wullstein Suction Tubes	215
Wundsparklammern Suture Clips	196

Y

Yankauer Suction Tubes	218
Yasargil Galea Hooks	115
Yasargil Ligature Guides	111
Yasargil Micro Raspatories	112
Yasargil Micro Raspatories	113
Yasargil Micro Scoopes	113
Yasargil Micro Vessel Knives	114
Yasargil Pituitary Rongeurs	125
Yasargil Suture Pusher	113
Yasargil Tumor Forceps	40
Yoeman (Turrell) Rectal Biopsy Forceps	98
Yoeman Interchangeable Handles For ..	99
Rectal Biopsy Specimen Forceps	
Yoeman Rectal Biopsy Specimen Forceps	97
Young Prostatic Retractors	399
Young Tongue Holding Forceps	481

Z

Zaufal Bone Rongeur Forceps	337
Zaufal-Jansen Bone Rongeur Forceps	339
Zenker Ligature Forceps	57
Zenker Retractors	245
Ziegler Iris Knives	504
Zweifel Uterine Curettes	438

Cat. Nr. Cat.-No Kat.-Nr. No. ref.	Biz. Page Seite Pagina	Cat. Nr. Cat.-No Kat.-Nr. No. ref.	Biz. Page Seite Pagina	Cat. Nr. Cat.-No Kat.-Nr. No. ref.	Biz. Page Seite Pagina	Cat. Nr. Cat.-No Kat.-Nr. No. ref.	Biz. Page Seite Pagina
11.8	2	11.135	13	12.225	25	12.332	29
11.9	2	11.136	14	12.226	25	12.333	29
11.10	2	11.150	15	12.227	25	12.334	29
11.11	2	11.151	15	12.230	25	12.340	29
11.12	2	11.152	15	12.231	25	12.341	29
11.13	2	11.153	15	12.232	25	12.342	29
11.14	2	11.154	15	12.233	25	12.343	29
11.15	2	11.155	15	12.234	25	12.344	29
11.16	2	11.156	15	12.235	25	12.345	29
11.17	2	11.157	15	12.236	25	12.346	29
11.18	2	11.160	15	12.237	25	12.347	29
11.19	2	11.161	15	12.241	25	12.350	29
11.20	2	11.162	15	12.242	25	12.351	29
11.25	2	11.163	15	12.247	25	12.352	29
11.28	2	11.164	15	12.248	25	12.353	29
11.29	2	11.180-00	16	12.249	25	12.354	29
11.30	2	11.180-01	16	12.250	26	12.355	29
11.31	2	11.180-02	16	12.251	26	12.356	29
11.32	2	11.180-03	16	12.252	26	12.357	29
11.33	2	11.180-04	16	12.253	26	12.371	30
11.34	2	11.180-05	16	12.254	26	12.372	30
11.35	2	11.180-06	16	12.255	26	12.373	30
11.36	2	11.180-07	16	12.256	26	12.374-15	30
11.37	2	11.180-08	16	12.257	26	12.374-20	30
11.38	2	11.180-09	16	12.260	26	12.374-25	30
11.39	2	11.181-00	17	12.261	26	12.375-15	30
11.40	2	11.181-01	17	12.262	26	12.375-20	30
11.45	3	11.181-02	17	12.263	26	12.375-25	30
11.46	3	11.181-03	17	12.265	26	12.381	30
11.47	3	11.181-04	17	12.266	26	12.382	30
11.48	3	11.181-05	17	12.267	26	12.384	30
11.49	3	11.181-06	17	12.271	26	12.384-15	30
11.50	4	11.182-01	18	12.272	26	12.385	30
11.51	4	11.182-02	18	12.274	26	12.385-15	30
11.52	4	11.183-01	18	12.275	26	12.386	31
11.53	4	11.184-01	19	12.277	26	12.387	31
11.56	5	11.185-01	19	12.280	27	12.388	31
11.57	5	11.186-01	19	12.281	27	12.389	31
11.58	5	11.186-02	19	12.282	27	12.390	32
11.59	5	11.187-00	20	12.283	27	12.391	32
11.60	5	11.187-01	20	12.284	27	12.392	32
11.61	6	11.187-02	20	12.285	27	12.393	32
11.62	6	11.187-03	20	12.288	27	12.394	32
11.64	6	11.187-04	20	12.289	27	12.395	32
11.65	6	11.188-00	21	12.290	27	12.396	32
11.66	6	11.189-05	21	12.291	27	12.397	32
11.67	6	11.189-06	22	12.292	27	12.398	33
11.68	6	11.189-08	22	12.293	27	12.399	33
11.69	6	12.101	24	12.294	28	12.400	33
11.70	6	12.102	24	12.295	28	12.401	33
11.71	7	12.103	24	12.296	28	12.402	33
11.72	7	12.104	24	12.297	28	12.403	33
11.73	7	12.105	24	12.298	28	12.404	33
11.75	7	12.106	24	12.299	28	12.405	33
11.76	7	12.107	24	12.300	29	12.407	33
11.77	8	12.199	25	12.301	29	12.408	33
11.78	8	12.200	25	12.302	29	12.409	33
11.79	8	12.201	25	12.303	29	12.410	33
11.80	9	12.202	25	12.304	29	12.411	33
11.81	9	12.203	25	12.305	29	12.412	33
11.82	9	12.204	25	12.306	29	12.413	34
11.83	9	12.205	25	12.307	29	12.414	34
11.84	10	12.206	25	12.308	29	12.415	34
11.85	10	12.207	25	12.310	29	12.416	34
11.86	11	12.209	25	12.311	29	12.417	34
11.118	11	12.210	25	12.312	29	12.419	34
11.119	11	12.211	25	12.313	29	12.420-16	35
11.120	11	12.212	25	12.314	29	12.420-20	35
11.121	11	12.213	25	12.315	29	12.420-24	35
11.122	11	12.214	25	12.316	29	12.420-30	35
11.123	11	12.215	25	12.317	29	12.421-16	35
11.124	11	12.216	25	12.321	29	12.421-20	35
11.125	11	12.217	25	12.322	29	12.421-24	35
11.126	11	12.220	25	12.323	29	12.421-30	35
11.127	11	12.221	25	12.327	29	12.422-16	35
11.130	12	12.222	25	12.328	29	12.422-20	35
11.131	12	12.223	25	12.329	29	12.422-24	35
11.132	12	12.224	25	12.331	29	12.422-30	35

Cat. Nr. Cat.-No Kat.-Nr. No. ref.	Biz. Page Seite Pagina	Cat. Nr. Cat.-No Kat.-Nr. No. ref.	Biz. Page Seite Pagina	Cat. Nr. Cat.-No Kat.-Nr. No. ref.	Biz. Page Seite Pagina	Cat. Nr. Cat.-No Kat.-Nr. No. ref.	Biz. Page Seite Pagina
12.423-16	35	13.478	44	14.585	49	14.669-20	56
12.423-20	35	13.479	44	14.586	49	14.670-20	56
12.423-24	35	13.480	44	14.587	49	14.667-26	56
12.423-30	35	13.481	44	14.589	49	14.668-26	56
12.424-16	35	13.482	44	14.591	50	14.669-26	56
12.424-20	35	13.483	44	14.593	50	14.670-26	56
12.424-24	35	13.484	44	14.595	50	14.671-18	57
12.424-30	35	14.497	46	14.596	50	14.671-22	57
12.425	36	14.498	46	14.597	50	14.671-25	57
12.426	36	14.499	46	14.598	50	14.671-28	57
12.427	36	14.500	46	14.599	50	14.672-13	57
12.428	37	14.501	46	14.600	50	14.672-14	57
12.429	37	14.502	46	14.601	51	14.672-16	57
12.430	37	14.503	46	14.602	51	14.672-18	57
12.431	38	14.504	46	14.603	51	14.672-20	57
12.432	38	14.505	46	14.604	51	14.672-23	57
12.433	38	14.506	46	14.605	51	14.672-25	57
12.434	38	14.507	46	14.606	51	14.672-28	57
12.435	38	14.508	46	14.607	51	14.673-01	57
12.436	38	14.509	46	14.608	51	14.673-02	57
12.437	38	14.510	47	14.609	51	14.675	58
12.438	38	14.511	47	14.610	51	14.675-18	58
12.439	38	14.512	47	14.611	52	14.676	58
12.440	38	14.513	47	14.612	52	14.677	58
12.441	38	14.514	47	14.614	52	14.678	58
12.442	38	14.515	47	14.615	52	14.679	58
12.443	38	14.516	47	14.617	52	14.680	58
12.444	38	14.517	47	14.618	52	14.681	58
12.445	38	14.518	47	14.619	52	14.682	58
12.446	38	14.519	47	14.620	52	14.684-18	59
12.447	38	14.520	47	14.621	52	14.684-24	59
12.448	38	14.521	47	14.622	52	14.684-28	59
12.449	38	14.522	47	14.623	52	14.685	59
12.450	38	14.523	47	14.624	52	14.686	59
12.451	38	14.525	47	14.625	52	14.687	59
12.452	38	14.526	47	14.626	52	14.692	59
12.453	38	14.527	47	14.627	52	14.693	59
12.454	38	14.528	47	14.628	52	14.712	60
12.455	38	14.529	47	14.629	52	14.713	60
12.456	38	14.530	47	14.630	52	14.716	60
12.457	38	14.531	48	14.631	52	14.717	60
12.458	38	14.532	48	14.632	52	14.722	60
12.459	38	14.533	48	14.634	53	14.723	60
12.460	38	14.535	48	14.635	53	14.730	60
12.461	38	14.538	48	14.636	53	14.732	60
12.462	38	14.540	48	14.637	53	14.733	60
12.463	38	14.541	48	14.640	53	14.734	61
12.464	38	14.542	48	14.641	53	14.735	61
12.465	38	14.543	48	14.642	53	14.737	61
12.466	38	14.544	48	14.643	53	14.738	61
12.467	38	14.545	48	14.644	54	14.739	61
12.468	38	14.546	48	14.645	54	14.740	61
12.469	38	14.547	48	14.646	54	14.761	62
12.470	38	14.549	48	14.650-01	54	14.762	62
12.471	39	14.551	48	14.650-02	54	14.763	62
12.472	39	14.552	48	14.650-03	54	14.764	62
12.473	39	14.553	48	14.650-04	54	14.770	62
12.474	39	14.554	48	14.650-05	54	14.771	62
12.475	39	14.555	48	14.650-06	54	14.772	62
12.476	39	14.556	48	14.650-07	54	14.773	62
12.477	39	14.557	48	14.651-01	54	14.774	62
12.485	39	14.559	48	14.651-02	54	14.775	62
12.486	39	14.561	49	14.651-03	54	14.776	62
12.487-03	40	14.563	49	14.651-04	54	14.777	62
12.487-05	40	14.566	49	14.651-05	54	14.778	63
12.488-03	40	14.568	49	14.651-06	54	14.780	63
12.488-05	40	14.571	49	14.651-07	54	14.781	63
12.489-03	40	14.572	49	14.655	55	14.782	63
12.489-05	40	14.573	49	14.656	55	14.783	63
12.491	41	14.574	49	14.657	55	14.785	63
12.492	41	14.575	49	14.658	55	14.786	63
12.493	41	14.576	49	14.660	55	14.787	63
12.494-01	41	14.577	49	14.661	55	14.788	63
12.494-02	41	14.579	49	14.662	55	14.788-10	64
12.495-01	42	14.581	49	14.665	55	14.788-13	64
12.495-02	42	14.582	49	14.666	55	14.789	64
12.495-03	42	14.583	49	14.667-20	56	14.790	64
12.496	42	14.584	49	14.668-20	56	14.791	65

Cat. Nr. Cat.-No Kat.-Nr. No. ref.	Biz. Page Seite Pagina	Cat. Nr. Cat.-No Kat.-Nr. No. ref.	Biz. Page Seite Pagina	Cat. Nr. Cat.-No Kat.-Nr. No. ref.	Biz. Page Seite Pagina	Cat. Nr. Cat.-No Kat.-Nr. No. ref.	Biz. Page Seite Pagina
14.792	65	15.966	74	16.1136	82	17.1225-04	96
14.793	65	15.967	74	16.1171	83	17.1230-28	97
14.796	65	15.968-11	74	16.1172	83	17.1230-35	97
14.797	65	15.968-14	74	16.1173	83	17.1230-42	97
14.798	65	15.969	74	16.1174	83	17.1231-28	97
14.821	66	15.970	74	16.1175	83	17.1231-35	97
14.822	66	16.1001	76	16.1176	83	17.1231-42	97
14.825	66	16.1002	76	16.1177	83	17.1233-33	98
14.826	66	16.1003	76	16.1178	83	17.1233-40	98
14.827	66	16.1004	76	16.1179	83	17.1233-01	98
14.851	66	16.1005	76	16.1185	83	17.1233-02	98
14.852	66	16.1006	76	16.1186	83	17.1234-33	98
14.853	66	16.1007	76	16.1187	83	17.1234-40	98
14.854	66	16.1008	76	16.1188	83	17.1234-01	98
14.855	67	16.1009	76	16.1189	84	17.1234-02	98
14.856	67	16.1010	76	16.1190	84	17.1235-33	98
14.857	67	16.1011	76	16.1191	84	17.1235-40	98
14.858	67	16.1012	76	16.1194-11	85	17.1235-01	98
14.861	67	16.1013	76	16.1194-14	85	17.1235-02	98
14.862	67	16.1014	76	16.1194-17	85	17.1236-33	98
14.865	67	16.1015	76	16.1195-16	85	17.1236-40	98
14.866	67	16.1016	76	16.1195-20	85	17.1236-01	98
14.867	67	16.1017	76	16.1195-24	85	17.1236-02	98
14.868	67	16.1018	76	16.1196	86	17.1240-01	99
14.869	67	16.1026	77	16.1197	86	17.1240-02	99
14.871	68	16.1027	77	16.1198	86	17.1240-03	99
14.873	68	16.1032	77	16.1199	86	17.1245-01	100
14.881	68	16.1036	77	17.1201-08	88	17.1245-02	100
14.882	68	16.1037	77	17.1201-10	88	17.1246-15	100
14.883	68	16.1038	77	17.1202-08	88	17.1250-31	100
14.884	68	16.1040	77	17.1202-10	88	17.1250-03	100
14.885	68	16.1046	77	17.1202-01	88	17.1251-36	101
14.886	68	16.1060	77	17.1202-02	88	17.1252-28	101
14.887	68	16.1061	77	17.1203-05	88	17.1252-38	101
14.888	68	16.1062	77	17.1203-01	89	17.1253-28	101
14.889	68	16.1063	77	17.1203-12	89	17.1253-38	101
14.890	68	16.1071	78	17.1204-01	89	17.1261-35	102
14.891	68	16.1072	78	17.1204-02	89	17.1261-45	102
14.892	68	16.1073	78	17.1205-20	89	17.1261-60	102
14.893	68	16.1074	78	17.1207-01	90	17.1262-35	102
14.894	68	16.1075	78	17.1207-02	90	17.1262-45	102
14.897	69	16.1076	78	17.1207-03	90	17.1262-60	102
14.898	69	16.1081	78	17.1207-04	90	17.1265-01	102
14.901	69	16.1082	78	17.1207-05	90	17.1265-02	102
14.902	69	16.1083	78	17.1207-06	90	17.1265-03	102
14.903	69	16.1084	78	17.1207-10	90	17.1265-04	102
14.906	69	16.1085	78	17.1208-01	90	17.1265-05	102
14.907	69	16.1086	78	17.1208-02	90	17.1265-06	102
14.908	69	16.1087	78	17.1208-03	90	17.1265-07	102
14.909	69	16.1088	78	17.1208-04	90	17.1265-08	102
14.910	69	16.1089	78	17.1209-22	91	17.1266-01	102
15.922	71	16.1091	79	17.1209-30	91	17.1266-02	102
15.923	71	16.1092	79	17.1210-22	91	17.1266-03	102
15.924	71	16.1092G	79	17.1210-30	91	17.1266-04	102
15.925	71	16.1095	79	17.1211-21	92	17.1266-05	102
15.926	71	16.1096	79	17.1211-25	92	18-1320-30	104
15.927	71	16.1096G	79	17.1212-01	92	18-1320-40	104
15.928	71	16.1097	80	17.1212-02	92	18-1320-50	104
15.929	71	16.1097K	80	17.1212-03	92	18-1320-60	104
15.930	71	16.1098	80	17.1212-04	92	18-1320-70	104
15.950	72	16.1099	80	17.1213-22	92	18.1321-30	104
15.951	72	16.1110	81	17.1214-22	92	18.1321-40	104
15.952	72	16.1111	81	17.1215-01	93	18.1321-50	104
15.953	72	16.1112	81	17.1215-02	93	18.1322-50	104
15.960-01	73	16.1113	81	17.1215-10	93	18.1323-00	104
15.960-02	73	16.1114	81	17.1216-17	93	18.1324-30	104
15.961-15	73	16.1115	81	17.1218-15	93	18.1324-33	104
15.962-14	73	16.1116	81	17.1220-00	94	18.1328-20	104
15-964-01	73	16.1117	81	17.1220-01	94	18.1329-21	104
15-964-02	73	16.1118	82	17.1220-02	94	18.1340-00	105
15-964-03	73	16.1119	82	17.1220-03	94	18.1340-01	105
15-964-04	73	16.1120	82	17.1220-04	94	18.1341-01	105
15-965-01	73	16.1121	82	17.1223-22	95	18.1341-02	105
15-965-02	73	16.1122	82	17.1224-01	95	18.1341-04	105
15-965-03	73	16.1123	82	17.1224-02	95	18.1341-05	105
15-965-04	73	16.1124	82	17.1225-01	96	18.1345-16	106
15-965-05	73	16.1125	82	17.1225-02	96	18.1345-17	106
15-965-06	73	16.1134	82	17.1225-03	96	18.1345-27	106

Cat. Nr. Cat.-No Kat.-Nr. No. ref.	Biz. Page Seite Pagina	Cat. Nr. Cat.-No Kat.-Nr. No. ref.	Biz. Page Seite Pagina	Cat. Nr. Cat.-No Kat.-Nr. No. ref.	Biz. Page Seite Pagina	Cat. Nr. Cat.-No Kat.-Nr. No. ref.	Biz. Page Seite Pagina
18-1350-01	107	18-1415-02	119	18-1480-03	127	18-1512-18	130
18-1350-02	107	18-1415-03	119	18-1480-04	127	18-1513-18	130
18-1351-00	107	18-1416-01	120	18-1480-05	127	18-1514-18	130
18-1352-00	107	18-1416-02	120	18-1480-06	127	18-1515-18	130
18-1353-00	107	18-1417-24	120	18-1481-01	127	18-1516-18	130
18-1354-00	107	18-1420-19	121	18-1481-02	127	18-1512-20	130
18-1360-15	108	18-1421-19	121	18-1481-03	127	18-1513-20	130
18-1360-19	108	18-1420-28	121	18-1481-04	127	18-1514-20	130
18-1361-15	108	18-1421-28	121	18-1481-05	127	18-1515-20	130
18-1361-19	108	18-1423-17	121	18-1481-06	127	18-1516-20	130
18-1362-14	108	18-1423-21	121	18-1482-01	127	18-1522-15	130
18-1364-01	109	18-1422-20	121	18-1482-02	127	18-1523-15	130
18-1364-02	109	18-1424-20	121	18-1482-03	127	18-1524-15	130
18-1364-03	109	18-1425-01	122	18-1482-04	127	18-1525-15	130
18-1364-04	109	18-1425-02	122	18-1482-05	127	18-1526-15	130
18-1365-08	109	18-1426-13	122	18-1482-06	127	18-1522-18	130
18-1365-11	109	18-1426-18	122	18-1483-01	127	18-1523-18	130
18-1365-14	109	18-1428-14	122	18-1483-02	127	18-1524-18	130
18-1365-17	109	18-1430-15	122	18-1483-03	127	18-1525-18	130
18-1365-20	109	18-1431-18	122	18-1483-04	127	18-1526-18	130
18-1366-01	109	18-1432-16	122	18-1483-05	127	18-1522-20	130
18-1366-02	109	18-1438-20	122	18-1483-06	127	18-1523-20	130
18-1366-03	109	18-1440-01	123	18-1486-01	127	18-1524-20	130
18-1366-04	109	18-1440-02	123	18-1486-02	127	18-1525-20	130
18-1367-01	109	18-1440-03	123	18-1486-03	127	18-1526-20	130
18-1367-02	109	18-1441-02	123	18-1486-04	127	18-1540-00	131
18-1367-03	109	18-1441-03	123	18-1486-05	127	18-1540-01	131
18-1367-04	109	18-1441-04	123	18-1486-06	127	18-1541-00	131
18-1369-01	110	18-1442-02	124	18-1487-01	127	18-1541-01	131
18-1369-02	110	18-1442-03	124	18-1487-02	127	18-1543-50	132
18-1369-03	110	18-1442-04	124	18-1487-03	127	18-1543-70	132
18-1369-04	110	18-1443-02	124	18-1487-04	127	18-1543-75	132
18-1370-02	111	18-1443-03	124	18-1487-05	127	18-1544-50	132
18-1370-03	111	18-1443-04	124	18-1487-06	127	18-1544-70	132
18-1370-04	111	18-1444-02	124	18-1488-01	127	18-1544-75	132
18-1371-02	111	18-1444-03	124	18-1488-02	127	18-1545-01	132
18-1371-03	111	18-1444-04	124	18-1488-03	127	18-1545-02	132
18-1371-04	111	18-1445-02	124	18-1488-04	127	18-1545-03	132
18-1372-19	112	18-1445-03	124	18-1488-05	127	18-1545-04	132
18-1373-19	112	18-1445-04	124	18-1488-06	127	18-1546-01	132
18-1374-00	112	18-1446-02	124	18-1489-01	127	18-1547-01	132
18-1374-04	112	18-1446-03	124	18-1489-02	127	18-1547-02	132
18-1374-05	112	18-1446-04	124	18-1489-03	127	18-1547-03	132
18-1374-06	112	18-1447-02	124	18-1489-04	127	18-1547-04	132
18-1375-01	113	18-1447-03	124	18-1489-05	127	18-1548-01	132
18-1375-02	113	18-1447-04	124	18-1489-06	127	18-1548-02	132
18-1375-03	113	18-1447-20	125	18-1484-01	128	18-1549-01	132
18-1375-04	113	18-1448-18	125	18-1484-02	128	18-1549-02	132
18-1376-19	113	18-1449-18	125	18-1484-03	128	18-1550-01	132
18-1377-19	113	18-1450-12	126	18-1484-04	128	18-1550-02	132
18-1378-19	113	18-1450-15	126	18-1484-05	128	18-1550-03	132
18-1379-19	114	18-1450-18	126	18-1484-06	128	18-1560-01	133
18-1380-01	114	18-1451-12	126	18-1485-01	128	18-1560-00	133
18-1380-02	114	18-1451-15	126	18-1485-02	128	18-1561-40	133
18-1380-03	114	18-1451-18	126	18-1485-03	128	18-1561-45	133
18-1381-19	114	18-1452-12	126	18-1485-04	128	18-1561-50	133
18-1382-19	114	18-1452-15	126	18-1485-05	128	18-1561-55	133
18-1395-01	115	18-1452-18	126	18-1485-06	128	18-1561-60	133
18-1395-02	115	18-1460-12	126	18-1502-15	129	18-1562-01	133
18-1401-01	116	18-1460-15	126	18-1503-15	129	18-1562-00	133
18-1401-02	116	18-1460-18	126	18-1504-15	129	18-1562-40	133
18-1401-03	116	18-1461-12	126	18-1505-15	129	18-1562-45	133
18-1401-04	116	18-1461-15	126	18-1506-15	129	18-1562-50	133
18-1401-05	116	18-1461-18	126	18-1502-18	129	18-1562-55	133
18-1403-01	117	18-1462-12	126	18-1503-18	129	18-1562-60	133
18-1403-02	117	18-1462-15	126	18-1504-18	129	19-1620	135
18-1404-01	117	18-1462-18	126	18-1505-18	129	19-1621	135
18-1404-02	117	18-1470-12	126	18-1506-18	129	19-1622	135
18-1404-03	117	18-1470-15	126	18-1502-20	129	19-1625	135
18-1404-04	117	18-1470-18	126	18-1503-20	129	19-1628	136
18-1406-01	118	18-1471-12	126	18-1504-20	129	19-1629	136
18-1406-02	118	18-1471-15	126	18-1505-20	129	19-1630	136
18-1407-24	118	18-1471-18	126	18-1506-20	129	19-1631	136
18-1410-01	118	18-1472-12	126	18-1512-15	130	19-1632	136
18-1410-02	118	18-1472-15	126	18-1513-15	130	19-1633	137
18-1410-03	118	18-1472-18	126	18-1514-15	130	19-1634	137
18-1411-20	119	18-1480-01	127	18-1515-15	130	19-1635	137
18-1415-01	119	18-1480-02	127	18-1516-15	130	19-1636	137

Cat. Nr. Cat.-No Kat.-Nr. No. ref.	Biz. Page Seite Pagina	Cat. Nr. Cat.-No Kat.-Nr. No. ref.	Biz. Page Seite Pagina	Cat. Nr. Cat.-No Kat.-Nr. No. ref.	Biz. Page Seite Pagina	Cat. Nr. Cat.-No Kat.-Nr. No. ref.	Biz. Page Seite Pagina
19.1638	137	20.1774	141	20.1880	145	20.1968	154
19.1639	137	20.1775	141	20.1881	145	20.1969	154
19.1640	137	20.1776	141	20.1882	145	20.1970	154
19.1641	138	20.1777-01	141	20.1884	145	20.1791-SC	155
19.1642	138	20.1777-02	141	20.1885	145	20.1793-SC	155
19.1643	138	20.1780	141	20.1886	145	20.1796-SC	155
19.1644	138	20.1781	141	20.1887-01	145	20.1798-SC	155
19.1650	138	20.1783	141	20.1887-02	145	20.1801-SC	155
19.1651	138	20.1785	141	20.1888	145	20.1802-SC	155
19.1652	138	20.1786	141	20.1889	145	20.1803-SC	155
19.1653	138	20.1791	142	20.1890	145	20.1804-SC	155
20.1701	140	20.1792	142	20.1891	145	20.1817-SC	155
20.1702	140	20.1793	142	20.1892	145	20.1818-SC	155
20.1703	140	20.1794	142	20.1893	146	20.1821-SC	156
20.1704	140	20.1796	142	20.1895	146	20.1822-SC	156
20.1705	140	20.1797	142	20.1896	146	20.1851-SC	156
20.1706	140	20.1798	142	20.1898	146	20.1852-SC	156
20.1707	140	20.1799	142	20.1899	146	20.1880-SC	157
20.1708	140	20.1801	142	20.1901	146	20.1884-SC	157
20.1709	140	20.1802	142	20.1902	146	20.1888-SC	157
20.1711	140	20.1802-21	142	20.1904	146	20.1889-SC	157
20.1712	140	20.1803	142	20.1905-16	146	20.1979-SC	157
20.1713	140	20.1804	142	20.1905-18	146	20.1980-SC	157
20.1714	140	20.1804-21	142	20.1906-16	146	20.1981-SC	157
20.1715	140	20.1806	142	20.1906-18	146	20.7458-SC	157
20.1716	140	20.1808	142	20.1907	146	20.7459-SC	157
20.1717	140	20.1810	142	20.1908	147	20.7496-SC	157
20.1718	140	20.1811	142	20.1909	147	20.7497-SC	157
20.1719	140	20.1812	143	20.1910	147	21.1971	159
20.1721	140	20.1813	143	20.1910-18	147	21.1972	159
20.1722	140	20.1814	143	20.1911	147	21.1973	159
20.1723	140	20.1815	143	20.1912	148	21.1974	159
20.1724	140	20.1817	143	20.1913	148	21.1975	159
20.1725	140	20.1818	143	20.1914	148	21.1976	159
20.1726	140	20.1819	143	20.1915	148	21.1976G	159
20.1727	140	20.1820	143	20.1916	148	21.1977	159
20.1728	140	20.1821	144	20.1917	148	21.1978	159
20.1729	140	20.1822	144	20.1918	148	21.1979	159
20.1731	140	20.1823	144	20.1919	148	21.1980	159
20.1732	140	20.1824	144	20.1920	149	21.1981	159
20.1733	140	20.1825	144	20.1922-01	149	21.1982	159
20.1734	140	20.1826	144	20.1922-02	149	21.1983	159
20.1735	140	20.1827	144	20.1922-03	149	21.1984	160
20.1736	140	20.1831	144	20.1922-04	149	21.1985	160
20.1737	140	20.1832	144	20.1923	150	21.1986S	160
20.1738	140	20.1833	144	20.1924	150	21.1987S	160
20.1739	140	20.1834	144	20.1925	150	21.1988	160
20.1741	140	20.1835	144	20.1926	150	21.1989	160
20.1742	140	20.1836	144	20.1927	150	21.1990	161
20.1743	140	20.1837	144	20.1928	150	21.1995	161
20.1744	140	20.1841	144	20.1929	151	21.1996	161
20.1745	140	20.1842	144	20.1930	151	21.1997	161
20.1746	140	20.1843	144	20.1931	151	21.1998	161
20.1747	140	20.1844	144	20.1932	151	21.1999	161
20.1748	140	20.1845	144	20.1933	151	21.2000	161
20.1749	140	20.1846	144	20.1934	151	21.2021	161
20.1751	140	20.1847	144	20.1935	152	21.2022	161
20.1752	140	20.1851	144	20.1937	152	21.2024	161
20.1753	140	20.1852	144	20.1940	152	21.2028	162
20.1754	140	20.1853	144	20.1941	152	21.2032	162
20.1755	140	20.1854	144	20.1942	152	21.2033	162
20.1756	140	20.1855	144	20.1943	152	21.2034	162
20.1757	140	20.1856	144	20.1945	153	21.2036	163
20.1758	140	20.1857	144	20.1946	153	21.2037	163
20.1759	140	20.1861	144	20.1947	153	22.2001	165
20.1761	140	20.1862	144	20.1948	153	22.2002	165
20.1762	140	20.1863	144	20.1949	153	22.2003	165
20.1763	140	20.1864	144	20.1950	153	22.2004	165
20.1764	140	20.1865	144	20.1951	153	22.2005	165
20.1765	140	20.1866	144	20.1952	153	22.2006	165
20.1766	140	20.1867	144	20.1954	153	22.2007	165
20.1767	140	20.1871	144	20.1955	153	22.2008	166
20.1768	140	20.1872	144	20.1956-15	153	22.2009	166
20.1769	140	20.1873	144	20.1961	154	22.2010	166
20.1770	140	20.1874	144	20.1963	154	22.2011	166
20.1771	140	20.1875	144	20.1965	154	22.2012	166
20.1772	140	20.1876	144	20.1966	154	22.2013	166
20.1773	141	20.1877	144	20.1967	154	22.2014-14	166

Cat. Nr. Cat.-No Kat.-Nr. No. ref.	Biz. Page Seite Pagina	Cat. Nr. Cat.-No Kat.-Nr. No. ref.	Biz. Page Seite Pagina	Cat. Nr. Cat.-No Kat.-Nr. No. ref.	Biz. Page Seite Pagina	Cat. Nr. Cat.-No Kat.-Nr. No. ref.	Biz. Page Seite Pagina
22.2014-16	166	22.2236	172	23.2312	182	23.2440-06	189
22.2014-18	166	22.2237	172	23.2314	182	23.2440-07	189
22.2014-20	166	22.2238	172	23.2314	182	23.2440-08	189
22.2014-25	166	22.2239	172	23.2318	182	23.2440-09	189
22.2015	166	22.2240	173	23.2319	182	23.2440-10	189
22.2016	166	22.2241	173	23.2322	183	23.2440-11	189
22.2017	166	22.2242	173	23.2324	183	23.2440-12	189
22.2018	166	22.2244	173	23.2329	183	23.2440-13	189
22.2019	166	22.2245	173	23.2330	183	23.2440-14	189
22.2095-14	167	22.2246	173	23.2331	183	23.2440-15	189
22.2096-14	167	22.2247	174	23.2332	183	23.2440-16	189
22.2097-14	167	22.2248	174	23.2333	183	23.2441-30	189
22.2098-14	167	22.2250	174	23.2334	183	23.2441-20	189
22.2099-14	167	22.2251	174	23.2335	183	23.2441-00	189
22.2099-18	167	22.2252	174	23.2351	183	23.2441-01	189
22.2099-21	167	22.2253-11	174	23.2352	183	23.2441-02	189
22.2100-14	167	22.2253-16	174	23.2353	183	23.2441-03	189
22.2100-18	167	22.2254	175	23.2354	183	23.2441-04	189
22.2100-21	167	22.2255	175	23.2355	183	23.2441-05	189
22.2101-14	167	22.2256	175	23.2356-01	184	23.2441-06	189
22.2101-18	167	22.2257	175	23.2356-02	184	23.2441-07	189
22.2101-21	167	22.2258	175	23.2357	184	23.2441-08	189
22.2102-14	167	22.2260	176	23.2358	184	23.2441-09	189
22.2102-18	167	22.2261	176	23.2257N	184	23.2441-10	189
22.2102-21	167	22.2262	176	23.2258N	184	23.2441-11	189
22.2104	167	22.2263	176	23.2359	184	23.2441-12	189
22.2105	167	22.2264	176	23.2360	184	23.2441-13	189
22.2106	167	22.2265	176	23.2361	184	23.2441-14	189
22.2110	167	22.2268-22	176	23.2362	184	23.2441-15	189
22.2111	167	22.2268-23	176	23.2363	184	23.2441-16	189
22.2113	168	22.2269	176	23.2365	185	23.2442-30	189
22.2114	168	22.2270	177	23.2367	185	23.2442-20	189
22.2115	168	22.2271	177	23.2370	185	23.2442-00	189
22.2116	168	22.2272	177	23.2372	185	23.2442-01	189
22.2117	168	22.2273	177	23.2373	185	23.2442-02	189
22.2118	168	22.2274	177	23.2375	185	23.2442-03	189
22.2119	168	22.2275	177	23.2377	185	23.2442-04	189
22.2192	168	22.2276	177	23.2382	186	23.2442-05	189
22.2199	168	22.2277	177	23.2384	186	23.2442-06	189
22.2200	168	22.2278-01	177	23.2385	186	23.2442-07	189
22.2201	168	22.2278-02	177	23.2386	186	23.2442-08	189
22.2202	168	22.2279-01	177	23.2387	186	23.2442-09	189
22.2203	168	22.2279-02	177	23.2388	186	23.2442-10	189
22.2204	168	22.2280	178	23.2389	186	23.2442-11	189
22.2205	168	22.2281	178	23.2390	186	23.2442-12	189
22.2206	169	22.2282	178	23.2391	186	23.2442-13	189
22.2207	169	22.2283	178	23.2392	186	23.2442-14	189
22.2208	169	22.2284	178	23.2393	186	23.2442-15	189
22.2209	169	22.2285	178	23.2394	186	23.2442-16	189
22.2210	169	22.2286	178	23.2397	186	23.2443-30	189
22.2211	170	22.2287	178	23.2398	186	23.2443-20	189
22.2212	170	22.2280F	178	23.2388K	186	23.2443-00	189
22.2213	170	22.2281F	178	23.2389K	186	23.2443-01	189
22.2214	170	22.2282F	178	23.2405-14	187	23.2443-02	189
22.2215	170	22.2283F	178	23.2405-18	187	23.2443-03	189
22.2216	170	22.2284F	178	23.2405-21	187	23.2443-04	189
22.2217	170	22.2285F	178	23.2406-14	187	23.2443-05	189
22.2218	170	22.2286F	178	23.2406-18	187	23.2443-06	189
22.2228	170	22.2287F	178	23.2406-21	187	23.2443-07	189
22.2216D	170	22.2288	178	23.2407-14	187	23.2443-08	189
22.2217D	170	22.2289-01	178	23.2408-14	187	23.2443-09	189
22.2218D	170	22.2289-02	178	23.2419-14	187	23.2443-10	189
22.2228D	170	22.2290	179	23.2420-14	187	23.2443-11	189
22.2219	171	22.2291	179	23.2401	187	23.2443-12	189
22.2220	171	22.2292	179	23.2402	187	23.2443-13	189
22.2221	171	22.2293	179	23.2410	187	23.2443-14	189
22.2222	171	22.2294-16	179	23.2412	187	23.2443-15	189
22.2223	171	22.2296-01	180	23.2413	187	23.2443-16	189
22.2224	171	22.2296-02	180	23.2417	187	23.2446-30	189
22.2225	171	22.2296-03	180	23.2418	187	23.2446-20	189
22.2226	171	22.2297-18	180	23.2440-30	189	23.2446-00	189
22.2227	171	22.2298-16	180	23.2440-20	189	23.2446-01	189
22.2231	172	22.2298-18	180	23.2440-00	189	23.2446-02	189
22.2232	172	23.2301	182	23.2440-01	189	23.2446-03	189
22.2233-17	172	23.2305	182	23.2440-02	189	23.2446-04	189
22.2233-20	172	23.2306	182	23.2440-03	189	23.2446-05	189
22.2234	172	23.2310	182	23.2440-04	189	23.2446-06	189
22.2235	172	23.2311	182	23.2440-05	189	23.2446-07	189

Cat. Nr. Cat.-No Kat.-Nr. No. ref.	Biz. Page Seite Pagina	Cat. Nr. Cat.-No Kat.-Nr. No. ref.	Biz. Page Seite Pagina	Cat. Nr. Cat.-No Kat.-Nr. No. ref.	Biz. Page Seite Pagina	Cat. Nr. Cat.-No Kat.-Nr. No. ref.	Biz. Page Seite Pagina
23.2486-00	193	23.2555-02	203	24.2652	212	24.2683	218
23.2486-01	193	23.2556-01	203	24.2655	212	24.2689	219
23.2486-02	193	23.2556-02	203	24.2656	212	24.2690	219
23.2486-03	193	23.2557-22	203	24.2657	212	24.2691	219
23.2487-01	193	23.2560-01	204	24.2660	213	24.2692-01	220
23.2487-02	193	23.2560-02	204	24.2661	213	24.2692-02	220
23.2487-03	193	23.2560-03	204	24.2662-08	214	24.2692-05	220
23.2487-04	193	23.2560-04	204	24.2662-10	214	24.2692-10	220
23.2487-05	193	23.2561-01	205	24.2662-12	214	24.2692-20	220
23.2488-20	193	23.2561-02	205	24.2662-14	214	24.2692-50	220
23.2488-00	193	23.2562-01	205	24.2662-16	214	24.2693-01	220
23.2488-01	193	23.2562-02	205	24.2662-18	214	24.2693-02	220
23.2488-02	193	23.2562-03	205	24.2663-08	214	24.2693-05	220
23.2488-03	193	23.2563-01	206	24.2663-10	214	24.2693-10	220
23.2490-01	194	23.2563-02	206	24.2663-12	214	24.2693-20	220
23.2490-02	194	23.2564-25	206	24.2663-14	214	24.2693-50	220
23.2490-03	194	23.2565-01	206	24.2663-16	214	24.2694-01	220
23.2490-04	194	23.2565-02	206	24.2663-18	214	24.2694-02	220
23.2490-05	194	23.2565-03	206	24.2664-08	214	24.2694-05	220
23.2490-06	194	23.2566-18	206	24.2664-10	214	24.2694-10	220
23.2491-01	194	23.2566-27	206	24.2664-12	214	24.2694-20	220
23.2491-02	194	23.2570-01	207	24.2664-14	214	24.2694-50	220
23.2491-03	194	23.2570-02	207	24.2664-16	214	24.2695-01	220
23.2491-04	194	23.2570-03	207	24.2664-18	214	24.2695-02	220
23.2491-05	194	23.2570-04	207	24.2668-12	215	24.2695-05	220
23.2491-06	194	23.2571-01	207	24.2668-15	215	24.2695-10	220
23.2492-01	194	23.2571-02	207	24.2669-00	215	24.2695-20	220
23.2492-02	194	23.2571-03	207	24.2669-01	215	24.2695-50	220
23.2492-03	194	23.2571-04	207	24.2669-04	215	24.2696-02	221
23.2492-04	194	23.2572-01	208	24.2669-06	215	24.2696-05	221
23.2493-01	194	23.2572-02	208	24.2669-08	215	24.2696-10	221
23.2493-02	194	23.2572-03	208	24.2670-06	215	24.2697-02	221
23.2493-03	194	23.2572-04	208	24.2670-07	215	24.2697-05	221
23.2493-04	194	24.2603	210	24.2670-08	215	24.2697-10	221
23.2500	195	24.2604	210	24.2670-09	215	24.2698-05	221
23.2505	195	24.2606	210	24.2670-10	215	24.2698-07	221
23.2508	195	24.2607	210	24.2670-11	215	24.2698-10	221
23.2509	195	24.2610	210	24.2670-12	215	24.2698-15	221
23.2511	195	24.2611	210	24.2670-15	215	24.2698-20	221
23.2515	195	24.2612	210	24.2671-09	216	24.2698-25	221
23.2516	196	24.2613	210	24.2671-15	216	24.2699-05	221
23.2518	196	24.2614	210	24.2672-00	216	24.2699-07	221
23.2519-01	196	24.2615	210	24.2672-06	216	24.2699-10	221
23.2519-02	196	24.2616	210	24.2672-07	216	24.2699-15	221
23.2519-03	196	24.2620	210	24.2672-08	216	24.2699-20	221
23.2519-04	196	24.2621	210	24.2672-09	216	24.2699-25	221
23.2519-05	196	24.2622	210	24.2672-10	216	25.2701	223
23.2519-06	196	24.2623	210	24.2672-11	216	25.2703	223
23.2519-07	196	24.2624	210	24.2672-12	216	25.2704	223
23.2519-08	196	24.2625	210	24.2672-15	216	25.2706	223
23.2530-20	197	24.2626	210	24.2673-05	216	25.2708	223
23.2531-20	197	24.2630	210	24.2673-06	216	25.2710	223
23.2532-20	197	24.2631	210	24.2673-07	216	25.2715-14	223
23.2533-20	197	24.2632	210	24.2673-08	216	25.2715-16	223
23.2534-20	198	24.2633	210	24.2673-09	216	25.2715-18	223
23.2535-20	198	24.2634	210	24.2673-10	216	25.2715-20	223
23.2536-20	198	24.2635	210	24.2674	217	25.2711	223
23.2537-20	198	24.2636	210	24.2675-03	217	25.2713	223
23.2538-21	199	24.2637-07	211	24.2675-06	217	25.2714	223
23.2539-21	199	24.2637-09	211	24.2676-01	217	25.2716	223
23.2540-21	199	24.2637-11	211	24.2676-02	217	25.2718	223
23.2541-21	199	24.2637-12	211	24.2676-03	217	25.2720	223
23.2542-24	200	24.2640-10	211	24.2676-04	217	25.2725	223
23.2543-24	200	24.2640-12	211	24.2676-05	217	25.2731	223
23.2544-27	200	24.2640-14	211	24.2676-06	217	25.2733	223
23.2545-27	200	24.2640-16	211	24.2676-07	217	25.2734	223
23.2546-27	201	24.2640-18	211	24.2676-08	217	25.2736	223
23.2547-27	201	24.2640-20	211	24.2677-14	217	25.2738	223
23.2548-28	201	24.2640-22	211	24.2677-18	217	25.2740	223
23.2549-28	201	24.2640-24	211	24.2678-01	217	25.2745	223
23.2550-01	202	24.2640-26	211	24.2678-02	217	25.2751	223
23.2550-02	202	24.2640-28	211	24.2678-03	217	25.2753	223
23.2551-01	202	24.2641-08	211	24.2679-00	217	25.2754	223
23.2551-02	202	24.2641-10	211	24.2679-01	217	25.2756	223
23.2552-32	202	24.2642-01	212	24.2680A	218	25.2760	223
23.2553-21	202	24.2642-02	212	24.2680	218	25.2761	223
23.2554-15	203	24.2644	212	24.2681	218	25.2763	223
23.2555-01	203	24.2651	212	24.2682	218	25.2764	223

Cat. Nr. Cat.-No Kat.-Nr. No. ref.	Biz. Page Seite Pagina	Cat. Nr. Cat.-No Kat.-Nr. No. ref.	Biz. Page Seite Pagina	Cat. Nr. Cat.-No Kat.-Nr. No. ref.	Biz. Page Seite Pagina	Cat. Nr. Cat.-No Kat.-Nr. No. ref.	Biz. Page Seite Pagina
25.2766	223	26.2920-10	230	26.3079	237	26.3136-26	248
25.2768	223	26.2920-12	230	26.3080	237	26.3137-25	248
25.2770	223	26.2920-14	230	26.3085	237	26.3138-01	249
25.2773	223	26.2920-16	230	26.3086	237	26.3138-02	249
25.2774	223	26.2920-18	230	26.3087	237	26.3138-03	249
25.2776	223	26.2921-08	230	26.3088	237	26.3139-01	250
25.2780	223	26.2921-10	230	26.3089	237	26.3139-02	250
25.2781	223	26.2921-12	230	26.3090	237	26.3140-25	250
25.2782-13	224	26.2921-14	230	26.3091	237	26.3141	251
25.2782-18	224	26.2921-16	230	26.3092	237	26.3142	251
25.2785	224	26.2921-18	230	26.3093	237	26.3143	251
25.2786-01	224	26.2922	231	26.3094	237	26.3144-08	251
25.2786-02	224	26.2923	231	26.3095	237	26.3144-10	251
25.2786-03	224	26.2924-01	231	26.3096	237	26.3144-12	251
25.2786-04	224	26.2924-02	231	26.3097	237	26.3144-13	251
25.2800-13	225	26.2925-10	231	26.3098	237	26.3144-14	251
25.2800-14	225	26.2925-20	231	26.3081	238	26.3144-16	251
25.2812-09	225	26.2925-17	231	26.3082	238	26.3144-18	251
25.2814-01	225	26.2925-22	231	26.3083	238	26.3145-08	252
25.2814-09	225	26.2926-02	232	26.3084	238	26.3145-10	252
25.2814-12	225	26.2926-03	232	26.3099-01	238	26.3145-12	252
25.2816-11	225	26.2926-04	232	26.3099-02	238	26.3145-14	252
25.2818-12	225	26.2926-06	232	26.3099-03	238	26.3145-16	252
25.2818-15	225	26.2927-02	232	26.3100	239	26.3145-18	252
25.2818-18	225	26.2927-03	232	26.3101	239	26.3146-16	253
25.2820-18	225	26.2927-04	232	26.3102	239	26.3146-25	253
25.2822	225	26.2927-06	232	26.3103	239	26.3146-50	253
25.2850-00	226	26.2930-01	232	26.3104	239	26.3149-01	254
25.2850-70	226	26.2930-02	232	26.3105	239	26.3149-02	254
25.2850-02	226	26.2931	232	26.3106	240	26.3149-03	254
25.2850-50	226	26.3001	233	26.3106-01	240	26.3149-04	254
25.2850-60	226	26.3002	233	26.3106-02	240	26.3151	255
25.2850-03	226	26.3003	233	26.3107-01	240	26.3152	255
25.2850-06	226	26.3004	233	26.3107-02	240	26.3153-01	255
25.2850-09	226	26.3006	233	26.3108-01	240	26.3153-02	255
25.2850-12	226	26.3011	233	26.3108-02	240	26.3154	255
25.2850-15	226	26.3012	233	26.3108-03	240	26.3155	255
25.2852-50	226	26.3013	233	26.3109-01	241	26.3156	255
25.2852-02	226	26.3014	233	26.3109-02	241	26.3157	255
25.2852-03	226	26.3016	233	26.3109-03	241	26.3158	255
25.2852-04	226	26.3021	233	26.3110-01	241	26.3160	256
25.2852-06	226	26.3022	233	26.3110-02	241	26.3161	256
25.2852-07	226	26.3023	233	26.3110-03	241	26.3162	256
25.2852-08	226	26.3024	233	26.3111	242	26.3164	256
25.2852-10	226	26.3026	233	26.3112	242	26.3165	256
25.2852-12	226	26.3031	233	26.3113	242	26.3166	257
25.2852-14	226	26.3032	233	26.3114	242	26.3167	257
26.2901	228	26.3033	233	26.3115-01	242	26.3168	257
26.2902	228	26.3034	233	26.3115-02	242	26.3169	257
26.2903	228	26.3036	233	26.3115-03	242	26.3170-00	257
26.2904	228	26.3040	234	26.3116-80	243	26.3171	257
26.2911	228	26.3041	234	26.3116-85	243	26.3172	257
26.2912	228	26.3043	234	26.3118-01	243	26.3173	257
26.2913	228	26.3051	234	26.3118-02	243	26.3176-01	258
26.2914	228	26.3052	234	26.3118-03	243	26.3176-02	258
26.2915-01	228	26.3053	234	26.3119-01	244	26.3177-01	258
26.2915-02	228	26.3054	234	26.3119-02	244	26.3177-02	258
26.2915-03	228	26.3056	234	26.3119-03	244	26.3178-01	258
26.2915-04	228	26.3061	234	26.3119-04	244	26.3178-02	258
26.2916-01	228	26.3062	234	26.3119-05	244	26.3179-01	258
26.2916-02	228	26.3063	234	26.3119-06	244	26.3179-02	258
26.2916-03	228	26.3064	234	26.3120-01	245	26.3181	259
26.2916-04	228	26.3066	234	26.3120-02	245	26.3183	259
26.2917-01	229	26.3067	235	26.3120-03	245	26.3186	259
26.2917-02	229	26.3068	235	26.3120-04	245	26.3189	259
26.2917-03	229	26.3069-03	235	26.3121	246	26.3191	259
26.2917-04	229	26.3069-04	235	26.3122	246	26.3193	259
26.2918-01	229	26.3070-20	235	26.3123	246	26.3196	259
26.2918-02	229	26.3074-04	236	26.3124	246	26.3199	259
26.2918-03	229	26.3074-05	236	26.3125	246	26.3202-01	259
26.2918-04	229	26.3074-06	236	26.3126	246	26.3202-02	259
26.2919-01	229	26.3074-07	236	26.3127	247	26.3203	259
26.2919-02	229	26.3075-55	237	26.3128	247	26.3204-01	259
26.2919-03	229	26.3075-60	237	26.3129	247	26.3204-02	259
26.2919-04	229	26.3075-63	237	26.3132	247	26.3205	260
26.2919-05	229	26.3076	237	26.3133	247	26.3206-01	260
26.2919-06	229	26.3077	237	26.3135-01	248	26.3206-02	260
26.2920-08	230	26.3078	237	26.3135-02	248	26.3207	260

Cat. Nr. Cat.-No Kat.-Nr. No. ref.	Biz. Page Seite Pagina	Cat. Nr. Cat.-No Kat.-Nr. No. ref.	Biz. Page Seite Pagina	Cat. Nr. Cat.-No Kat.-Nr. No. ref.	Biz. Page Seite Pagina	Cat. Nr. Cat.-No Kat.-Nr. No. ref.	Biz. Page Seite Pagina
26.3208	260	26.3340-45	272	27.3428-35	282	27.3461-08	291
26.3210-01	261	26.3340-70	272	27.3428-36	282	27.3461-10	291
26.3210-02	261	26.3342	273	27.3428-40	282	27.3461-12	291
26.3211-01	261	26.3343-01	273	27.3428-45	282	27.3461-14	291
26.3211-02	261	26.3343-02	273	27.3428-65	282	27.3461-16	291
26.3212-01	261	26.3344-01	273	27.3430-01	283	27.3462-03	291
26.3212-02	261	26.3344-02	273	27.3430-02	283	27.3462-04	291
26.3213-01	261	26.3344-03	273	27.3430-03	283	27.3462-05	291
26.3213-02	261	26.3344-04	273	27.3430-04	283	27.3462-06	291
26.3216	261	26.3345-09	274	27.3430-05	283	27.3462-08	291
26.3217	261	26.3345-11	274	27.3431-01	283	27.3462-10	291
26.3218	261	26.3345-14	274	27.3431-02	283	27.3462-12	291
26.3219	261	26.3345-18	274	27.3432-01	283	27.3462-14	291
26.3220-01	262	26.3346-18	274	27.3432-02	283	27.3462-16	291
26.3220-02	262	26.3348	274	27.3433-18	283	27.3463-02	291
26.3221-01	262	26.3349	274	27.3433-19	283	27.3463-03	291
26.3221-02	262	26.3350	275	27.3434-01	283	27.3463-04	291
26.3222-01	262	26.3351	275	27.3434-02	283	27.3463-05	291
26.3222-02	262	26.3360	276	27.3438-00	284	27.3463-06	291
26.3223-01	263	26.3361	276	27.3438-03	284	27.3463-07	291
26.3223-02	263	26.3362	276	27.3439-00	284	27.3463-08	291
26.3224-01	263	26.3365	276	27.3440-00	284	27.3464-02	291
26.3224-02	263	26.3366	276	27.3440-01	284	27.3464-03	291
26.3225	264	26.3367	276	27.3441-00	285	27.3464-04	291
26.3226-00	264	26.3368-06	276	27.3441-01	285	27.3464-05	291
26.3226-01	264	26.3368-09	276	27.3442-00	285	27.3464-06	291
26.3226-02	264	26.3368-12	276	27.3442-01	285	27.3464-07	291
26.3226-03	264	26.3368-17	276	27.3443-00	286	27.3464-08	291
26.3228	264	26.3368-20	276	27.3443-27	286	27.3465-02	291
26.3305-28	265	26.3368-25	276	27.3443-01	286	27.3465-03	291
26.3305-30	265	26.3369	276	27.3443-02	286	27.3465-04	291
26.3307	265	26.3371	277	27.3443-03	286	27.3465-05	291
26.3308	265	26.3372-20	277	27.3443-04	286	27.3465-06	291
26.3309	266	26.3372-30	277	27.3443-05	286	27.3465-07	291
26.3310	266	26.3372-40	277	27.3443-06	286	27.3465-08	291
26.3311	266	26.34	277	27.3443-07	286	27.3466-02	291
26.3312	266	26.3376-30	277	27.3443-08	286	27.3466-03	291
26.3313-18	266	26.3376-40	277	27.3443-09	286	27.3466-04	291
26.3313-27	266	26.3376-50	277	27.3444-00	287	27.3466-05	291
26.3313-38	266	26.3376-60	277	27.3444-01	287	27.3466-06	291
26.3313-40	266	26.3376-70	277	27.3444-02	287	27.3466-07	291
26.3313-45	266	27.3400-00	279	27.3444-03	287	27.3466-08	291
26.3313-60	266	27.3400-12	279	27.3444-04	287	27.3467-04	292
26.3315	267	27.3400-15	279	27.3444-05	287	27.3467-06	292
26.3316	267	27.3400-18	279	27.3444-06	287	27.3467-08	292
26.3317	267	27.3401-00	279	27.3444-07	287	27.3467-10	292
26.3318	267	27.3401-20	279	27.3444-08	287	27.3467-12	292
26.3320	268	27.3402	279	27.3444-09	287	27.3467-14	292
26.3321	268	27.3403-27	279	27.3444-10	287	27.3468-04	292
26.3323	268	27.3403-30	279	27.3444-11	287	27.3468-06	292
26.3324	269	27.3403-34	279	27.3444-12	287	27.3468-08	292
26.3325	269	27.3403-65	279	27.3450-01	288	27.3468-10	292
26.3326-01	269	27.3403-70	279	27.3450-02	288	27.3468-12	292
26.3326-02	269	27.3403-75	279	27.3451-19	288	27.3468-14	292
26.3326-03	269	27.3404-00	280	27.3452-14	288	27.3469-03	292
26.3313-38	270	27.3404-65	280	27.3453-14	288	27.3469-04	292
26.3330-00	270	27.3404-66	280	27.3454-01	289	27.3469-06	292
26.3330-10	270	27.3404-68	280	27.3454-02	289	27.3469-08	292
26.3331-00	270	27.3405-35	280	27.3454-03	289	27.3469-10	292
26.3335-45	270	27.3406-00	280	27.3454-04	289	27.3469-12	292
26.3335-50	270	27.3406-06	280	27.3455-16	289	27.3469-15	292
26.3335-60	270	27.3406-08	280	27.3456-14	289	27.3470-03	292
26.3335-00	271	27.3406-12	280	27.3457-23	290	27.3470-04	292
26.3335-10	271	27.3406-15	280	27.3458-21	290	27.3470-06	292
26.3335-40	271	27.3406-18	280	27.3459-45	290	27.3470-08	292
26.3335-60	271	27.3407-00	280	27.3459-56	290	27.3470-10	292
26.3335-78	271	27.3410-14	281	27.3459-90	290	27.3470-12	292
26.3335-80	271	27.3411-14	281	27.3460-03	291	27.3470-15	292
26.3335-98	271	27.3412-01	281	27.3460-04	291	27.3471-08	293
26.3335-99	271	27.3412-02	281	27.3460-05	291	27.3471-10	293
26.3336-00	271	27.3413-15	281	27.3460-06	291	27.3471-13	293
26.3336-10	271	27.3420-25	282	27.3460-08	291	27.3471-15	293
26.3336-01	271	27.3420-35	282	27.3460-10	291	27.3471-20	293
26.3336-02	271	27.3421-25	282	27.3460-12	291	27.3471-25	293
26.3336-03	271	27.3422-25	282	27.3460-14	291	27.3471-30	293
26.3336-04	271	27.3428-25	282	27.3460-16	291	27.3471-38	293
26.3340-00	272	27.3428-27	282	27.3461-04	291	27.3471-44	293
26.3340-10	272	27.3428-30	282	27.3461-06	291	27.3471-50	293

Cat. Nr. Cat.-No Kat.-Nr. No. ref.	Biz. Page Seite Pagina	Cat. Nr. Cat.-No Kat.-Nr. No. ref.	Biz. Page Seite Pagina	Cat. Nr. Cat.-No Kat.-Nr. No. ref.	Biz. Page Seite Pagina	Cat. Nr. Cat.-No Kat.-Nr. No. ref.	Biz. Page Seite Pagina
27.3472-08	293	27.3486-15	296	27.3523	300	27.3595-05	305
27.3472-10	293	27.3487-05	296	27.3524	300	27.3595-06	305
27.3472-13	293	27.3487-10	296	27.3525	300	27.3596-30	305
27.3472-15	293	27.3487-15	296	27.3526	300	27.3596-20	305
27.3472-20	293	27.3488-04	297	27.3527	300	27.3596-10	305
27.3472-25	293	27.3488-06	297	27.3528	300	27.3596-01	305
27.3472-30	293	27.3488-08	297	27.3530	300	27.3596-02	305
27.3472-38	293	27.3488-10	297	27.3531	300	27.3596-03	305
27.3472-44	293	27.3488-12	297	27.3532	300	27.3596-04	305
27.3472-50	293	27.3489-04	297	27.3533	300	27.3596-05	305
27.3473-04	293	27.3489-06	297	27.3534	300	27.3596-06	305
27.3473-06	293	27.3489-08	297	27.3535	300	27.3597-30	305
27.3473-03	293	27.3489-10	297	27.3536	300	27.3597-20	305
27.3473-05	293	27.3489-12	297	27.3537	300	27.3597-10	305
27.3476-04	294	27.3490-05	297	27.3538-20	301	27.3597-01	305
27.3477-06	294	27.3490-07	297	27.3538-10	301	27.3597-02	305
27.3477-08	294	27.3490-10	297	27.3538-01	301	27.3597-03	305
27.3477-10	294	27.3490-15	297	27.3538-02	301	27.3597-04	305
27.3477-12	294	27.3490-20	297	27.3540	301	27.3597-05	305
27.3477-15	294	27.3490-25	297	27.3541	301	27.3597-06	305
27.3478-10	294	27.3490-30	297	27.3542	301	27.3598-30	305
27.3478-15	294	27.3491-05	297	27.3543	301	27.3598-20	305
27.3478-20	294	27.3491-07	297	27.3544	301	27.3598-10	305
27.3478-25	294	27.3491-10	297	27.3545	301	27.3598-01	305
27.3479-06	294	27.3491-15	297	27.3546	301	27.3598-02	305
27.3479-08	294	27.3491-20	297	27.3547	301	27.3598-03	305
27.3479-10	294	27.3491-25	297	27.3548	301	27.3598-04	305
27.3479-12	294	27.3491-30	297	27.3550	301	27.3598-05	305
27.3479-15	294	27.3492-03	298	27.3551	301	27.3598-06	305
27.3479-20	294	27.3492-05	298	27.3552	301	27.3600	306
27.3479-25	294	27.3492-06	298	27.3555	301	27.3601	306
27.3479-30	294	27.3492-08	298	27.3556	301	27.3602	306
27.3480-06	295	27.3492-09	298	27.3557	301	27.3603-01	306
27.3480-08	295	27.3493-06	298	27.3558	302	27.3603-02	306
27.3480-10	295	27.3493-13	298	27.3561	302	27.3604	306
27.3480-12	295	27.3493-19	298	27.3562	302	27.3605	306
27.3480-15	295	27.3493-25	298	27.3563	302	27.3606-10	307
27.3480-20	295	27.3493-32	298	27.3571	302	27.3606-15	307
27.3480-25	295	27.3494-06	298	27.3572	302	27.3606-20	307
27.3480-30	295	27.3494-13	298	27.3573	302	27.3606-25	307
27.3481-06	295	27.3494-19	298	27.3581-01	303	27.3607-06	307
27.3481-08	295	27.3494-25	298	27.3581-02	303	27.3607-08	307
27.3481-10	295	27.3494-32	298	27.3581-03	303	27.3608	307
27.3481-12	295	27.3495-03	299	27.3581-04	303	27.3609	307
27.3481-15	295	27.3495-05	299	27.3581-05	303	27.3610	307
27.3481-20	295	27.3495-06	299	27.3581-06	303	27.3611-08	307
27.3481-25	295	27.3495-08	299	27.3582-20	303	27.3611-17	307
27.3481-30	295	27.3495-09	299	27.3582-10	303	27.3612	308
27.3482-06	295	27.3496-06	299	27.3582-01	303	27.3613	308
27.3482-09	295	27.3496-13	299	27.3582-02	303	27.3614-06	308
27.3482-13	295	27.3496-19	299	27.3583-30	303	27.3614-12	308
27.3482-16	295	27.3496-25	299	27.3583-20	303	27.3614-19	308
27.3482-19	295	27.3496-32	299	27.3583-10	303	27.3614-25	308
27.3482-25	295	27.3497-06	299	27.3583-01	303	27.3615	308
27.3482-32	295	27.3497-13	299	27.3584-30	303	27.3617	308
27.3483-06	295	27.3497-19	299	27.3584-20	303	27.3616	308
27.3483-09	295	27.3497-25	299	27.3584-10	303	27.3618	308
27.3483-13	295	27.3497-32	299	27.3584-01	303	27.3619-01	309
27.3483-16	295	27.3500	300	27.3585-00	304	27.3619-02	309
27.3483-19	295	27.3501	300	27.3585-01	304	27.3619-03	309
27.3483-25	295	27.3502	300	27.3585-02	304	27.3619-04	309
27.3483-32	295	27.3503	300	27.3585-03	304	27.3619-05	309
27.3484-06	296	27.3504	300	27.3585-04	304	27.3620	309
27.3484-09	296	27.3505	300	27.3591-01	304	27.3621	309
27.3484-13	296	27.3506	300	27.3591-02	304	27.3622-01	310
27.3484-16	296	27.3507	300	27.3591-03	304	27.3622-02	310
27.3484-19	296	27.3508	300	27.3594-01	304	27.3622-03	310
27.3484-25	296	27.3509	300	27.3594-02	304	27.3623	310
27.3484-32	296	27.3510	300	27.3594-03	304	27.3624	310
27.3485-06	296	27.3511	300	27.3594-04	304	27.3625	310
27.3485-09	296	27.3512	300	27.3594-05	304	27.3626	311
27.3485-13	296	27.3513	300	27.3595-30	305	27.3627	311
27.3485-16	296	27.3514	300	27.3595-20	305	27.3628	311
27.3485-19	296	27.3515	300	27.3595-10	305	27.3629-01	311
27.3485-25	296	27.3516	300	27.3595-01	305	27.3629-02	311
27.3485-32	296	27.3520	300	27.3595-02	305	27.3629-03	311
27.3486-05	296	27.3521	300	27.3595-03	305	27.3629-04	311
27.3486-10	296	27.3522	300	27.3595-04	305	27.3630	312

Cat. Nr. Cat.-No Kat.-Nr. No. ref.	Biz. Page Seite Pagina	Cat. Nr. Cat.-No Kat.-Nr. No. ref.	Biz. Page Seite Pagina	Cat. Nr. Cat.-No Kat.-Nr. No. ref.	Biz. Page Seite Pagina	Cat. Nr. Cat.-No Kat.-Nr. No. ref.	Biz. Page Seite Pagina
27.3631	312	27.3686-01	323	27.3755	334	27.3856-12	345
27.3632	312	27.3686-02	323	27.3754-23	334	27.3856-18	345
27.3633	312	27.3687-02	323	27.3755-23	334	27.3856-20	345
27.3634-20	312	27.3687-25	323	27.3756	335	27.3856-22	345
27.3635	312	27.3688-30	323	27.3757	335	27.3857-13	345
27.3636	312	27.3689-27	323	27.3756-27	335	27.3857-18	345
27.3640-01	313	27.3690-30	324	27.3757-27	335	27.3858	345
27.3640-02	313	27.3690-45	324	27.3758-04	335	28.3859	347
27.3640-03	313	27.3691-40	324	27.3758-08	335	28.3860-19	347
27.3640-04	313	27.3692-35	324	27.3758-23	335	28.3860-23	347
27.3640-05	313	27.3692-42	324	27.3759	336	28.3861	347
27.3642	313	27.3692-50	324	27.3760	336	28.3863	348
27.3644-15	313	27.3693-42	325	27.3761	336	28.3864	348
27.3644-19	313	27.3694-01	325	27.3761-02	336	28.3865	348
27.3644-24	313	27.3694-02	325	27.3761-03	336	28.3866	348
27.3645	313	27.3695	325	27.3762	336	28.3867	349
27.3647-01	314	27.3696-18	325	27.3763	336	28.3868	349
27.3647-02	314	27.3700-01	326	27.3763-01	337	28.3869	349
27.3647-03	314	27.3700-02	326	27.3763-02	337	28.3871	349
27.3648-01	314	27.3701-14	326	27.3764	337	28.3880	350
27.3648-02	314	27.3702	326	27.3765	337	28.3881	350
27.3648-03	314	27.3703	326	27.3766	337	28.3882-01	350
27.3650	314	27.3704-17	326	27.3767	337	28.3882-02	350
27.3651	314	27.3705-01	327	27.3768	337	28.3882-03	350
27.3652	315	27.3705-02	327	27.3769	337	28.3884	351
27.3653	315	27.3706-16	327	27.3770	338	28.3885-01	351
27.3654	315	27.3706-24	327	27.3771	338	28.3885-02	351
27.3655-01	316	27.3707	327	27.3772	338	28.3885-03	351
27.3655-02	316	27.3708	327	27.3773-01	338	28.3887-01	352
27.3655-03	316	27.3709	328	27.3773-02	338	28.3887-02	352
27.3656-01	316	27.3710	328	27.3774	339	28.3887-03	352
27.3656-02	316	27.3711	328	27.3775	339	28.3887-04	352
27.3657-18	316	27.3712	328	27.3776	339	28.3890-01	353
27.3658-01	316	27.3713	328	27.3777	339	28.3890-02	353
27.3658-02	316	27.3714	328	27.3778	339	28.3890-03	353
27.3659-01	316	27.3715	328	27.3779	339	28.3892	353
27.3659-02	316	27.3716-20	329	27.3780	339	28.3900	354
27.3660-03	317	27.3717-01	329	27.3781	340	28.3901	354
27.3661-05	317	27.3717-02	329	27.3782	340	28.3902	354
27.3662-07	317	27.3718	329	27.3783	340	28.3903	354
27.3664-06	317	27.3719	329	27.3784	340	28.3904	355
27.3664-08	317	27.3718-17	330	27.3785	340	28.3905	355
27.3665-15	317	27.3719-17	330	27.3786	340	28.3906	355
27.3666-15	318	27.3720	330	27.3787	340	28.3907-01	356
27.3667-08	318	27.3721	330	27.3788	340	28.3907-02	356
27.3667-10	318	27.3722	330	27.3789	340	28.3908-01	357
27.3666-17	318	27.3723	330	27.3790	341	28.3908-02	357
27.3666-18	318	27.3724	330	27.3791	341	28.3908-03	357
27.3667-42	318	27.3725	330	27.3792	341	28.3909	358
27.3667-65	319	27.3727	331	27.3793	341	28.3910	359
27.3668-43	319	27.3728	331	27.3814	342	28.3911	359
27.3669-22	319	27.3729	331	27.3817	342	28.3912	359
27.3669-24	319	27.3730	331	27.3819	342	28.3920-27	359
27.3669-34	319	27.3731	331	27.3822	342	28.3920-32	359
27.3670-22	320	27.3732	331	27.3824	342	28.4052	360
27.3671-30	320	27.3733	331	27.3827	342	28.4053	360
27.3671-33	320	27.3734	331	27.3829	342	28.4054	360
27.3673-21	320	27.3735	331	27.3832	342	28.4057	360
27.3674-34	320	27.3736	332	27.3838	342	28.4058	360
27.3675-45	320	27.3737	332	27.3839	342	28.4059	360
27.3675-65	320	27.3738	332	27.3840	342	28.4060	361
27.3676-01	321	27.3739	332	27.3841	342	28.4061-01	361
27.3676-02	321	27.3740	333	27.3842	342	28.4061-02	361
27.3677-18	321	27.3741	333	27.3843	342	28.4064	361
27.3678-07	321	27.3742	333	27.3844	343	28.4065	361
27.3678-10	321	27.3743	333	27.3845	343	28.4066	361
27.3679-01	321	27.3744	333	27.3846	343	28.4067	361
27.3679-02	321	27.3745	333	27.3847	343	28.4068	362
27.3680-28	322	27.3746	333	27.3848	343	28.4071	362
27.3681-25	322	27.3747	333	27.3849	343	28.4072	362
27.3681-30	322	27.3748	333	27.3850	344	28.4073	362
27.3681-35	322	27.3750-01	334	27.3851	344	28.4080-05	362
27.3682-30	322	27.3750-02	334	27.3852	344	28.4080-10	362
27.3683-25	322	27.3750-03	334	27.3853	344	28.4080-15	362
27.3684-01	322	27.3751-19	334	27.3854	344	28.4080-20	362
27.3684-02	322	27.3752-19	334	27.3855-12	345	28.4080-25	362
27.3685-02	323	27.3753	334	27.3855-18	345	28.4080-30	362
27.3685-17	323	27.3754	334	27.3855-20	345	28.4080-35	362

Cat. Nr. Cat.-No Kat.-Nr. No. ref.	Biz. Page Seite Pagina	Cat. Nr. Cat.-No Kat.-Nr. No. ref.	Biz. Page Seite Pagina	Cat. Nr. Cat.-No Kat.-Nr. No. ref.	Biz. Page Seite Pagina	Cat. Nr. Cat.-No Kat.-Nr. No. ref.	Biz. Page Seite Pagina
28.4080-40	362	30.4253-01	375	31.4431-13	384	32.4602-13	393
28.4080-45	362	30.4253-02	375	31.4431-16	384	32.4602-14	393
28.4080-50	362	30.4253-03	375	31.4431-18	384	32.4602-15	393
28.4080-70	362	30.4253-04	375	31.4431-21	384	32.4602-16	393
28.4080-90	362	30.4263-00	376	31.4431-23	384	32.4602-18	393
29.4100	364	30.4263-01	376	31.4432-25	385	32.4602-20	393
29.4101	364	30.4263-02	376	31.4433-25	385	32.4602-22	393
29.4110-01	364	30.4263-03	376	31.4434-22	386	32.4602-24	393
29.4110-02	364	30.4263-04	376	31.4434-25	386	32.4610-24	394
29.4112-01	364	30.4267	377	31.4434-28	386	32.4610-25	394
29.4112-02	364	30.4266-02	377	31.4435-22	386	32.4610-26	394
29.4113	365	30.4268	377	31.4435-25	386	32.4610-27	394
29.4114	365	30.4270-01	377	31.4435-28	386	32.4610-28	394
29.4115	365	30.4270-02	377	32.4450	388	32.4610-29	394
29.4116	365	31.4300	379	32.4451	388	32.4610-30	394
29.4117	365	31.4301-13	379	32.4452	388	32.4610-31	394
29.4118	365	31.4301-14	379	32.4453	388	32.4610-32	394
29.4119	365	31.4302	379	32.4454	388	32.4610-33	394
29.4120-07	366	31.4303	379	32.4455	388	32.4610-34	394
29.4120-09	366	31.4304	379	32.4460	389	32.4610-35	394
29.4130-01	366	31.4305	379	32.4461	389	32.4610-36	394
29.4130-02	366	31.4306	379	32.4462	389	32.4610-37	394
29.4131-01	366	31.4307	379	32.4463	389	32.4610-38	394
29.4131-02	366	31.4309	379	32.4464	389	32.4610-39	394
29.4132-01	366	31.4310	379	32.4465	389	32.4610-40	394
29.4132-02	366	31.4313	379	32.4466	389	32.4610-41	394
29.4133-01	366	31.4311	380	32.4470	390	32.4610-42	394
29.4133-02	366	31.4312	380	32.4471	390	32.4610-43	394
29.4134-01	366	31.4315-15	380	32.4472	390	32.4610-44	394
29.4134-02	366	31.4315-20	380	32.4473	390	32.4610-45	394
29.4135-01	366	31.4315-22	380	32.4481	390	32.4610-46	394
29.4135-02	366	31.4315-25	380	32.4482	390	32.4610-47	394
29.4136-01	366	31.4319	380	32.4483	390	32.4610-48	394
29.4136-02	366	31.4320	380	32.4484	390	32.4610-49	394
29.4137-01	366	31.4321	380	32.4485	390	32.4610-50	394
29.4137-02	366	31.4322	380	32.4486	390	32.4610-51	394
29.4138-01	366	31.4323	380	32.4487	390	32.4610-52	394
29.4138-02	366	31.4324-16	380	32.4488	390	32.4610-53	394
29.4139-01	366	31.4324-21	380	32.4489	390	32.4610-54	394
29.4139-02	366	31.4330	380	32.4490	390	32.4610-55	394
29.4150-15	366	31.4332	381	32.4491	390	32.4610-56	394
29.4150-20	366	31.4399	381	32.4492	390	32.4610-57	394
30.4200	368	31.4400	381	32.4493	390	32.4610-58	394
30.4202	368	31.4401	381	32.4501	391	32.4610-59	394
30.4203-01	368	31.4402	381	32.4502	391	32.4610-60	394
30.4203-02	368	31.4403	381	32.4503	391	32.4611-24	394
30.4203-03	368	31.4404	381	32.4504	391	32.4611-25	394
30.4203-04	368	31.4405	381	32.4501-01	391	32.4611-26	394
30.4205-03	368	31.4406	381	32.4501-02	391	32.4611-27	394
30.4205-04	368	31.4407	381	32.4501-03	391	32.4611-28	394
30.4225-01	368	31.4408	381	32.4501-04	391	32.4611-29	394
30.4203-00	369	31.4409	381	32.4501-05	391	32.4611-30	394
30.4227-01	369	31.4410	381	32.4501-06	391	32.4611-31	394
30.4227-02	369	31.4411-22	382	32.4501-07	391	32.4611-32	394
30.4210	370	31.4411-25	382	32.4501-08	391	32.4611-33	394
30.4212-00	370	31.4411-28	382	32.4511	392	32.4611-34	394
30.4212-01	370	31.4412-22	382	32.4512	392	32.4611-35	394
30.4212-02	370	31.4412-25	382	32.4513	392	32.4611-36	394
30.4212-03	370	31.4412-28	382	32.4514	392	32.4611-37	394
30.4212-04	370	31.4415-05	382	32.4520	392	32.4611-38	394
30.4213	370	31.4415-07	382	32.4525	392	32.4611-39	394
30.4221-00	371	31.4415-10	382	32.4600-06	393	32.4611-40	394
30.4221-01	371	31.4416-08	383	32.4600-08	393	32.4611-41	394
30.4221-02	371	31.4416-23	383	32.4600-10	393	32.4611-42	394
30.4221-03	371	31.4417-26	383	32.4600-12	393	32.4611-43	394
30.4221-04	371	31.4420	383	32.4600-14	393	32.4611-44	394
30.4225-02	372	31.4421	383	32.4600-16	393	32.4611-45	394
30.4225-03	372	31.4422	383	32.4600-18	393	32.4611-46	394
30.4226	372	31.4423	383	32.4600-20	393	32.4611-47	394
30.4240	373	31.4424	383	32.4600-22	393	32.4611-48	394
30.4243-00	373	31.4425	383	32.4600-24	393	32.4611-49	394
30.4243-01	373	31.4426	383	32.4602-06	393	32.4611-50	394
30.4243-02	373	31.4427	383	32.4602-07	393	32.4611-51	394
30.4243-03	373	31.4430-13	384	32.4602-08	393	32.4611-52	394
30.4243-04	373	31.4430-16	384	32.4602-09	393	32.4611-53	394
30.4266-01	373	31.4430-18	384	32.4602-10	393	32.4611-54	394
30.4250	374	31.4430-21	384	32.4602-11	393	32.4611-55	394
30.4253-00	375	31.4430-23	384	32.4602-12	393	32.4611-56	394

Cat. Nr. Cat.-No Kat.-Nr. No. ref.	Biz. Page Seite Pagina	Cat. Nr. Cat.-No Kat.-Nr. No. ref.	Biz. Page Seite Pagina	Cat. Nr. Cat.-No Kat.-Nr. No. ref.	Biz. Page Seite Pagina	Cat. Nr. Cat.-No Kat.-Nr. No. ref.	Biz. Page Seite Pagina
32.4611-57	394	33.4710-01	403	33.4870	411	33.4755	415
32.4611-58	394	33.4709-11	403	33.4871	411	33.4756	415
32.4611-59	394	33.4710-11	403	33.4873-00	411	33.4757	415
32.4611-60	394	33.4721	403	33.4873-01	411	33.4758	415
32.4613-06	395	33.4722	403	33.4873-02	411	33.4759	415
32.4613-07	395	33.4723	403	33.4873-03	411	33.4760	415
32.4613-08	395	33.4721-01	403	33.4873-04	411	33.4761	415
32.4613-09	395	33.4722-02	403	33.4873-05	411	33.4762	415
32.4613-10	395	33.4723-03	403	33.4873-10	411	33.4763	415
32.4613-11	395	33.4721-11	403	33.4873-40	411	33.4764	415
32.4613-12	395	33.4722-12	403	33.4873-80	411	33.4765	415
32.4613-13	395	33.4723-13	403	33.4875	412	33.4766	415
32.4613-14	395	33.4800	404	33.4875L	412	33.4767	415
32.4613-15	395	33.4801	404	33.4876	412	33.4768	415
32.4613-16	395	33.4802	404	33.4876L	412	33.4769	415
32.4613-17	395	33.4803	404	33.4877	412	33.4770	415
32.4613-18	395	33.4805	404	33.4877L	412	33.4771	415
32.4613-19	395	33.4806	404	33.4878	413	33.4772	415
32.4613-20	395	33.4807	404	33.4879	413	33.4773	415
32.4613-21	395	33.4811	404	33.4880	414	33.4774	415
32.4613-22	395	33.4812	404	33.4880L	414	33.4775	415
32.4613-23	395	33.4813	404	33.4881	414	33.4776	415
32.4613-24	395	33.4816-01	405	33.4881L	414	33.4777	415
32.4613-25	395	33.4816-02	405	33.4884	414	33.4778	415
32.4613-26	395	33.4821	405	33.4884L	414	33.4779	415
32.4613-27	395	33.4822	405	33.4885	414	33.4780	415
32.4613-28	395	33.4823	405	33.4885L	414	33.4781	415
32.4613-29	395	33.4824	405	33.4886	414	33.4782	415
32.4613-30	395	33.4825	405	33.4886L	414	33.4901	415
32.4613-31	395	33.4826	405	33.4887	414	33.4902	415
32.4613-32	395	33.4811L	406	33.4887L	414	33.4903	416
32.4613-33	395	33.4812L	406	33.4729-03	415	33.4904	416
32.4613-34	395	33.4813L	406	33.4729-04	415	33.4905	416
32.4613-35	395	33.4824L	406	33.4729-05	415	33.4904-10	416
32.4613-36	395	33.4825L	406	33.4729-06	415	33.4905-10	416
32.4620	396	33.4826L	406	33.4729-07	415	33.4784	417
32.4621	396	33.4827	407	33.4729-08	415	33.4785	417
32.4622	396	33.4828	407	33.4729-09	415	33.4786	417
32.4625	397	33.4829	407	33.4729-10	415	33.4787	417
32.4626-00	397	33.4831	407	33.4729-11	415	33.4788	417
32.4626-10	397	33.4832	407	33.4729-12	415	33.4789	417
32.4626-57	397	33.4833	407	33.4729-13	415	33.4790	417
32.4626-80	397	33.4834-01	407	33.4729-14	415	33.4791	417
32.4626-99	397	33.4834-02	407	33.4729-15	415	33.4792	417
32.4627	397	33.4835-01	407	33.4729-16	415	33.4793	417
32.4648-08	398	33.4835-02	407	33.4729-17	415	33.4794	417
32.4648-11	398	33.4836-01	407	33.4729-18	415	33.4795	417
32.4648-13	398	33.4836-02	407	33.4729-19	415	33.4796	417
32.4648-16	398	33.4837-20	408	33.4729-20	415	33.4908	417
32.4648-21	398	33.4837-25	408	33.4729-21	415	33.4909	417
32.4648-26	398	33.4837-30	408	33.4729-22	415	33.4910	417
32.4648-32	398	33.4837-35	408	33.4729-23	415	33.4911	417
32.4650-20	398	33.4837-40	408	33.4729-24	415	33.4912	417
32.4650-28	398	33.4838-20	408	33.4730	415	33.4908-10	417
32.4656	398	33.4838-25	408	33.4731	415	33.4909-10	417
32.4657	398	33.4838-30	408	33.4732	415	33.4913-00	418
32.4660	399	33.4838-35	408	33.4733	415	33.4913-09	418
32.4661	399	33.4838-40	408	33.4734	415	33.4913-11	418
32.4662	399	33.4839	408	33.4735	415	33.4913-13	418
32.4663	399	33.4840	408	33.4736	415	33.4913-15	418
32.4670	400	33.4840-01	409	33.4737	415	33.4913-17	418
32.4671	400	33.4840-02	409	33.4738	415	33.4913-19	418
32.4672-01	400	33.4841	409	33.4739	415	33.4920	418
32.4672-02	400	33.4842	409	33.4740	415	33.4921	418
32.4672-03	400	33.4843	409	33.4741	415	33.4923	418
33.4700	402	33.4844	409	33.4742	415	33.4924	418
33.4701	402	33.4851	409	33.4743	415	33.4949	419
33.4702	402	33.4852	409	33.4744	415	33.4950	419
33.4703	402	33.4853	409	33.4745	415	33.4950L	419
33.4701-01	402	33.4854	409	33.4746	415	33.4951	419
33.4702-02	402	33.4861	409	33.4747	415	33.4952	419
33.4703-03	402	33.4862	409	33.4748	415	33.4952L	419
33.4701-11	402	33.4863	409	33.4749	415	33.4953	419
33.4702-12	402	33.4864	409	33.4750	415	33.4954	420
33.4703-13	402	33.4865	409	33.4751	415	33.4959	420
33.4709	403	33.4865L	410	33.4752	415	33.4960	420
33.4710	403	33.4866	410	33.4753	415	33.4961	420
33.4709-01	403	33.4866L	410	33.4754	415	33.4962	421

Cat. Nr. Cat.-No Kat.-Nr. No. ref.	Biz. Page Seite Pagina	Cat. Nr. Cat.-No Kat.-Nr. No. ref.	Biz. Page Seite Pagina	Cat. Nr. Cat.-No Kat.-Nr. No. ref.	Biz. Page Seite Pagina	Cat. Nr. Cat.-No Kat.-Nr. No. ref.	Biz. Page Seite Pagina
33.4965	421	33.5073	435	33.5140-13	436	34.5407	445
33.4966	421	33.5074	435	33.5140-14	436	34.5408	445
33.4967	421	33.5075	435	33.5140-15	436	34.5409	445
33.4970	421	33.5076	435	33.5140-16	436	34.5410	445
33.4971	421	33.5081	435	33.5150-20	436	34.5411	445
33.4972	421	33.5082	435	33.5150-00	436	34.5412	445
33.4973	421	33.5083	435	33.5150-01	436	34.5413	445
33.4974	421	33.5084	435	33.5150-02	436	34.5414	445
33.4975	421	33.5085	435	33.5150-03	436	34.5415	445
33.4989	422	33.5086	435	33.5150-04	436	34.5416	446
33.4990	422	33.5091	435	33.5150-05	436	34.5417	446
33.4995	422	33.5092	435	33.5150-06	436	34.5418	446
33.5000	423	33.5093	435	33.5150-07	436	34.5419	446
33.5001	423	33.5094	435	33.5150-08	436	34.5421	445
33.5002	423	33.5095	435	33.5150-09	436	34.5422	445
33.5010-01	423	33.5096	435	33.5150-10	436	34.5423	445
33.5010-02	423	33.5101	435	33.5150-11	436	34.5424	445
33.5015	424	33.5102	435	33.5150-12	436	34.5425	445
33.5018	424	33.5103	435	33.5150-13	436	34.5426	445
33.5020	425	33.5104	435	33.5150-14	436	34.5427	445
33.5021	425	33.5105	435	33.5150-15	436	34.5428	445
33.5022	425	33.5106	435	33.5150-16	436	34.5429	445
33.5023	425	33.5111	435	33.5160	437	34.5430	445
33.5024	425	33.5112	435	33.5161	437	34.5431	445
33.5025	425	33.5113	435	33.5162	437	34.5432	445
33.5026	426	33.5114	435	33.5163	437	34.5433	445
33.5027	426	33.5115	435	33.5164	437	34.5434	445
33.5028-01	427	33.5116	435	33.5165	437	34.5435	445
33.5028-02	427	33.5120-20	436	33.5166	437	34.5436	446
33.5028-03	427	33.5120-00	436	33.5170	437	34.5437	446
33.5029-01	427	33.5120-01	436	33.5171	437	34.5438	446
33.5029-02	427	33.5120-02	436	33.5172	437	34.5439	446
33.5029-03	427	33.5120-03	436	33.5173	437	34.5440	447
33.5031	427	33.5120-04	436	33.5174	437	34.5441	447
33.5032	427	33.5120-05	436	33.5175	437	34.5442	447
33.5033	427	33.5120-06	436	33.5176	437	34.5445	448
33.5032-38	427	33.5120-07	436	33.5180	438	34.5446	448
33.5035-01	428	33.5120-08	436	33.5181	438	34.5447	448
33.5035-02	428	33.5120-09	436	33.5190-01	439	34.5450-10	449
33.5035-03	428	33.5120-10	436	33.5190-02	439	34.5450-15	449
33.5036-01	428	33.5120-11	436	33.5190-03	439	34.5452-13	449
33.5036-02	428	33.5120-12	436	33.5190-04	439	34.5452-17	449
33.5036-03	428	33.5120-13	436	33.5190-05	439	34.5453-13	449
33.5037	428	33.5120-14	436	33.5190-06	439	34.5453-17	449
33.5038	428	33.5120-15	436	33.5191-01	439	34.5454-13	449
33.5039	428	33.5120-16	436	33.5191-02	439	34.5454-17	449
33.5039-38	428	33.5130-20	436	33.5191-03	439	34.5455-13	449
33.5040	429	33.5130-00	436	33.5191-04	439	34.5455-17	449
33.5041	429	33.5130-01	436	33.5191-05	439	34.5456-13	449
33.5042	429	33.5130-02	436	33.5191-06	439	34.5456-17	449
33.5043	429	33.5130-03	436	33.5301	440	34.5457-13	449
33.5044	429	33.5130-04	436	33.5302	440	34.5457-17	449
33.5049	429	33.5130-05	436	33.5310	440	34.5460	450
33.5047	430	33.5130-06	436	33.5311	440	34.5461	450
33.5048	430	33.5130-07	436	33.5318	440	34.5462	450
33.5051	430	33.5130-08	436	33.5320	440	34.5470	451
33.5052	430	33.5130-09	436	33.5321	440	34.5471	451
33.5053	430	33.5130-10	436	33.5323	440	34.5472-01	452
33.5054	431	33.5130-11	436	33.5325	441	34.5472-02	452
33.5055	431	33.5130-12	436	33.5327	441	34.5473	452
33.5056	432	33.5130-13	436	33.5330	441	34.5501	453
33.5057	432	33.5130-14	436	33.5333	441	34.5502	453
33.5058	432	33.5130-15	436	33.5338	441	34.5503	453
33.5059	432	33.5130-16	436	33.5380	442	34.5506	453
33.5060-01	433	33.5140-20	436	33.5381	442	34.5507	453
33.5060-02	433	33.5140-00	436	33.5382	442	34.5508	453
33.5060-03	433	33.5140-01	436	33.5385	442	34.5510	453
33.5060-04	433	33.5140-02	436	33.5386	442	34.5511	453
33.5061	433	33.5140-03	436	33.5387	442	34.5513-35	454
33.5062	433	33.5140-04	436	33.5390	442	34.5513-50	454
33.5063	433	33.5140-05	436	33.5391	442	34.5513-75	454
33.5064	434	33.5140-06	436	33.5395	443	34.5513-90	454
33.5065	434	33.5140-07	436	34.5401	445	34.5514-45	454
33.5066	434	33.5140-08	436	34.5402	445	34.5514-75	454
33.5067	434	33.5140-09	436	34.5403	445	34.5515	455
33.5068	434	33.5140-10	436	34.5404	445	34.5516	455
33.5071	435	33.5140-11	436	34.5405	445	34.5517	455
33.5072	435	33.5140-12	436	34.5406	445	34.5518	455

Cat. Nr. Cat.-No Kat.-Nr. No. ref.	Biz. Page Seite Pagina	Cat. Nr. Cat.-No Kat.-Nr. No. ref.	Biz. Page Seite Pagina	Cat. Nr. Cat.-No Kat.-Nr. No. ref.	Biz. Page Seite Pagina	Cat. Nr. Cat.-No Kat.-Nr. No. ref.	Biz. Page Seite Pagina
34.5522-01	455	34.5628-03	465	34.5722	473	34.6022-02	484
34.5522-02	455	34.5628-04	465	34.5723	473	34.6025	485
34.5522-03	455	34.5629-03	465	34.5724	473	34.6026	485
34.5522-04	455	34.5629-04	465	34.5731	474	34.6027	485
34.5522-05	455	34.5629-07	465	34.5732	474	34.6205-30	486
34.5522-06	455	34.5629-09	465	34.5733	474	34.6205-20	486
34.5522-07	455	34.5630-10	465	34.5735	474	34.6205-00	486
34.5530	456	34.5630-12	465	34.5736	474	34.6205-01	486
34.5531	456	34.5630-14	465	34.5737	474	34.6205-02	486
34.5532-30	456	34.5631-01	466	34.5803	475	34.6205-03	486
34.5532-40	456	34.5631-02	466	34.5807	475	34.6205-04	486
34.6018	456	34.5631-03	466	34.5810	475	34.6206-30	486
34.5549	457	34.5632-01	466	34.5814	475	34.6206-20	486
34.5550	457	34.5632-02	466	34.5815	475	34.6206-00	486
34.5551	457	34.5633	466	34.5821	475	34.6206-01	486
34.5552	457	34.5634-01	466	34.5823	475	34.6206-02	486
34.5553	457	34.5634-02	466	34.5825	475	34.6206-03	486
34.5554	458	34.5635-01	467	34.5830	475	34.6206-04	486
34.5555	458	34.5635-02	467	34.5831	475	34.6207-30	486
34.5556	458	34.5635-03	467	34.5833	475	34.6207-20	486
34.5557	458	34.5636-01	467	34.5835	475	34.6207-00	486
34.5559	458	34.5636-02	467	34.5839	476	34.6207-01	486
34.5560	458	34.5641-18	468	34.5840-01	476	34.6207-02	486
34.5562	458	34.5641-21	468	34.5840-02	476	34.6207-03	486
34.5563	458	34.5642-21	468	34.5840-03	476	34.6207-04	486
34.5565	458	34.5643-01	468	34.5841	476	34.6208-30	486
34.5566	458	34.5643-02	468	34.5842	476	34.6208-20	486
34.5567	458	34.5644-01	468	34.5843	476	34.6208-00	486
34.5568	459	34.5644-02	468	34.5844	476	34.6208-01	486
34.5569	459	34.5650-01	469	34.5845	476	34.6208-02	486
34.5570	459	34.5650-02	469	34.5846	476	34.6208-03	486
34.5571-18	459	34.5650-03	469	34.5849	477	34.6208-04	486
34.5573-01	459	34.5651-15	469	34.5850	477	34.6210-01	487
34.5573-02	459	34.5652-16	469	34.5851	477	34.6210-02	487
34.5574-01	460	34.5654-22	469	34.5852	477	34.6210-03	487
34.5574-02	460	34.5655-17	469	34.5853	477	34.6210-04	487
34.5590	461	34.5656-19	469	34.5859	478	34.6211	487
34.5591	461	34.5658-14	469	34.5861	478	34.6213	487
34.5592	461	34.5659-10	469	34.5862	478	34.6214	487
34.5593	461	34.5660-12	469	34.5863	478	34.6218-01	487
34.5596	461	34.5661-15	470	34.5869	479	34.6218-02	487
34.5597	461	34.5663-02	470	34.5870	479	34.6218-03	487
34.5598	461	34.5663-05	470	34.5871	479	34.6220-01	488
34.5601	462	34.5663-07	470	34.5872	479	34.6220-02	488
34.5602	462	34.5663-10	470	34.5873	479	34.6220-03	488
34.5603	462	34.5664-16	470	34.5874	479	34.6222-01	488
34.5604	462	34.5665-20	470	34.5875	479	34.6222-02	488
34.5605	462	34.5667-01	470	34.5883	480	34.6222-03	488
34.5606	462	34.5667-02	470	34.5884	480	34.6222-04	488
34.5607	462	34.5667-03	470	34.5888	480	34.6222-05	488
34.5608	462	34.5668-14	471	34.5890	480	34.6222-06	488
34.5609-18	463	34.5669-16	471	34.5891	480	34.6222-07	488
34.5609-22	463	34.5670-15	471	34.5892	480	34.6250-01	488
34.5610	463	34.5671-15	471	34.5893	480	34.6250-02	488
34.5611	463	34.5680-03	471	34.5894	480	34.6250-03	488
34.5613	463	34.5680-04	471	34.5895	480	34.6250-04	488
34.5614	463	34.5680-05	471	34.5896	480	34.6250-05	488
34.5617	463	34.5681-03	471	34.5900	481	34.6290-01	489
34.5620-04	464	34.5681-04	471	34.5901	481	34.6290-02	489
34.5620-07	464	34.5681-05	471	34.5907	481	34.6291-01	489
34.5620-09	464	34.5685-01	472	34.5907-02	481	34.6291-02	489
34.5620-12	464	34.5685-02	472	34.6001	482	34.6298-01	489
34.5621-06	464	34.5686-16	472	34.6002	482	34.6298-02	489
34.5622-04	464	34.5687-15	472	34.6003	482	34.6298-03	489
34.5622-07	464	34.5688-15	472	34.6004	482	34.6400	490
34.5622-09	464	34.5689-16	472	34.6005	482	34.6401-08	490
34.5622-12	464	34.5690-15	472	34.6006	482	34.6401-14	490
34.5623-06	464	34.5700	473	34.6010	483	34.6401-16	490
34.5624-16	464	34.5701	473	34.6011	483	34.6406	490
34.5625-16	464	34.5702	473	34.6012	483	34.6407	490
34.5626-04	465	34.5703	473	34.6013	483	34.6408	490
34.5626-05	465	34.5704	473	34.6019	483	34.6409-20	490
34.5626-06	465	34.5705	473	34.6010-40	483	34.6409-22	490
34.5626-07	465	34.5711	473	34.6010-50	483	34.6409-25	490
34.5627-10	465	34.5712	473	34.6020-01	484	34.6409-30	490
34.5627-12	465	34.5713	473	34.6020-02	484	34.6410	490
34.5627-14	465	34.5714	473	34.6021	484	34.6420-01	491
34.5627-16	465	34.5721	473	34.6022-01	484	34.6421-01	491

Cat. Nr. Cat.-No Kat.-Nr. No. ref.	Biz. Page Seite Pagina	Cat. Nr. Cat.-No Kat.-Nr. No. ref.	Biz. Page Seite Pagina	Cat. Nr. Cat.-No Kat.-Nr. No. ref.	Biz. Page Seite Pagina	Cat. Nr. Cat.-No Kat.-Nr. No. ref.	Biz. Page Seite Pagina
34.6421-02	491	35.7101	500	35.7234	505	35.7347	511
34.6422	491	35.7102	500	35.7235	505	35.7348	511
34.6430-01	492	35.7103	500	35.7236	505	35.7349	511
34.6430-02	492	35.7110	500	35.7237	505	35.7350	511
34.6430-03	492	35.7112	500	35.7238	505	35.7351	511
34.6430-04	492	35.7113	500	35.7239	505	35.7360	512
34.6430-05	492	35.7114	500	35.7240	505	35.7361	512
34.6430-06	492	35.7115	500	35.7241	505	35.7362	512
34.6431-01	492	35.7116	500	35.7242	505	35.7363	512
34.6431-02	492	35.7120	501	35.7243	505	35.7364	512
34.6466	493	35.7121	501	35.7244	505	35.7349	512
34.6467	493	35.7130	501	35.7245	505	35.7370	512
35.7000	495	35.7131	501	35.7246	505	35.7371	512
35.7001	495	35.7133	501	35.7247	505	35.7380	513
35.7002	495	35.7134	501	35.7248	505	35.7381	513
35.7003	495	35.7135	501	35.7249	505	35.7382	513
35.7004	495	35.7136	501	35.7250	505	35.7383	513
35.7005	495	35.7140	501	35.7251	505	35.7384	513
35.7006	495	35.7149	502	35.7252	505	35.7385	513
35.7007	495	35.7150	502	35.7253	505	35.7386	513
35.7008	495	35.7151	502	35.7254	506	35.7387	513
35.7009	495	35.7152	502	35.7255	506	35.7388	513
35.7010	495	35.7153	502	35.7256	506	35.7389	514
35.7012	496	35.7154	502	35.7257	506	35.7390	514
35.7013	496	35.7155	502	35.7258	506	35.7391	514
35.7014	496	35.7156	502	35.7261	506	35.7392	514
35.7015	496	35.7157	502	35.7266	506	35.7393	514
35.7016	496	35.7158	502	35.7267	506	35.7394	514
35.7017	496	35.7159	502	35.7268	506	35.7395	514
35.7018	496	35.7160	502	35.7269	506	35.7396	514
35.7019	496	35.7161	502	35.7270	507	35.7397	514
35.7020	496	35.7162	502	35.7271	507	35.7398	515
35.7021	496	35.7163	502	35.7272	507	35.7399	515
35.7022	496	35.7164	502	35.7273	507	35.7400	515
35.7023	496	35.7165	502	35.7274	507	35.7401	515
35.7024	496	35.7166	502	35.7275	507	35.7402	515
35.7025-01	496	35.7167	502	35.7276	507	35.7403	515
35.7025-02	496	35.7168	502	35.7277	507	35.7404	515
35.7026-01	496	35.7180	503	35.7278	507	35.7405	515
35.7026-02	496	35.7181	503	35.7280	507	35.7406	515
35.7027-01	496	35.7182	503	35.7281	507	35.7407	515
35.7027-02	496	35.7183	503	35.7282	508	35.7408	516
35.7029	496	35.7184	503	35.7283	508	35.7409	516
35.7050	497	35.7185	503	35.7284	508	35.7410	516
35.7051	497	35.7186	503	35.7287	508	35.7411	516
35.7052	497	35.7187	503	35.7288	508	35.7412	516
35.7053	497	35.7188	503	35.7289	508	35.7413	516
35.7054	497	35.7189	503	35.7300	509	35.7414	516
35.7055-01	497	35.7190	503	35.7301	509	35.7415	516
35.7055-02	497	35.7191	503	35.7302	509	35.7416	517
35.7056-01	497	35.7200	504	35.7303	509	35.7417	517
35.7056-02	497	35.7201	504	35.7304	509	35.7418	517
35.7058-01	497	35.7202	504	35.7305	509	35.7419	517
35.7058-02	497	35.7203	504	35.7306	509	35.7420	517
35.7060	498	35.7204	504	35.7307	509	35.7421	517
35.7061	498	35.7205	504	35.7308	509	35.7422	517
35.7062	498	35.7207-01	504	35.7310	509	35.7423	517
35.7063	498	35.7207-02	504	35.7311	509	35.7424	517
35.7064	498	35.7207-03	504	35.7312	509	35.7425	517
35.7065	498	35.7210	504	35.7313	509	35.7426	517
35.7066	498	35.7211	504	35.7314	509	35.7427	517
35.7067	498	35.7212	504	35.7330	510	35.7428	517
35.7068	498	35.7213	504	35.7331	510	35.7429	517
35.7069	498	35.7214	504	35.7332	510	35.7430	517
35.7070	498	35.7215	504	35.7333	510	35.7432-01	518
35.7071	498	35.7216	504	35.7334	510	35.7432-02	518
35.7080	499	35.7217	504	35.7335	510	35.7432-03	518
35.7084	499	35.7218	504	35.7336	510	35.7433-01	518
35.7085	499	35.7219	504	35.7337	510	35.7433-02	518
35.7086	499	35.7220	504	35.7338	510	35.7434-01	518
35.7087	499	35.7221	504	35.7339	510	35.7434-02	518
35.7088-05	499	35.7222	504	35.7340	510	35.7450	519
35.7088-09	499	35.7223	504	35.7341	510	35.7451	519
35.7088-15	499	35.7224	504	35.7342	510	35.7452	519
35.7089	499	35.7230	505	35.7343	511	35.7453	519
35.7090	499	35.7231	505	35.7344	511	35.7454	519
35.7091	499	35.7232	505	35.7345	511	35.7455	519
35.7100	500	35.7233	505	35.7346	511	35.7456	519

Cat. Nr.
Cat.-No
Kat.-Nr.
No. ref.

Biz.
Page
Seite
Pagina

Cat. Nr.
Cat.-No
Kat.-Nr.
No. ref.

Biz.
Page
Seite
Pagina

Cat. Nr.
Cat.-No
Kat.-Nr.
No. ref.

Biz.
Page
Seite
Pagina

Cat. Nr.
Cat.-No
Kat.-Nr.
No. ref.

Biz.
Page
Seite
Pagina

35.7457.....	519
35.7458.....	519
35.7459.....	519
35.7460.....	519
35.7461.....	519
35.7470.....	519
35.7471.....	519
35.7472.....	519
35.7473.....	519
35.7474.....	519
35.7475.....	519
35.7476.....	519
35.7477.....	519
35.7478.....	519
35.7479.....	519
35.7480.....	519
35.7481.....	519
35.7483.....	520
35.7485.....	520
35.7490.....	520
35.7491.....	520
35.7492.....	520
35.7493.....	520
35.7494.....	520
35.7495.....	520
35.7496.....	520
35.7497.....	520
35.7500.....	521
35.7501.....	521
35.7502.....	521
35.7503.....	521
35.7504.....	521
35.7505.....	521

Surgical instruments
chirurgische instrumenten
instrumental quirurgicos