



www.vdo.net.au

Catalogue V20

VDO



We're focused on providing our customers with the best possible instrumentation – a goal that we've pursued since 1920. We continue to work to deliver the functionality, durability, and high quality finish that have earned our products a best-in-class reputation, worldwide. At the same time, we strive to continually pursue innovations that make our instrumentation more efficient, affordable, and useful to the people who own and operate vehicles and equipment that feature our products.

While we're aware of the vital role of our instruments as a human-machine interface and the importance of factors such as ergonomics, cost, and reliability, we haven't neglected aesthetics.

From rugged analogue gauges to sophisticated, flexible CAN bus platforms, we're working to give our customers choice, flexibility, and style for all their monitoring needs.

www.continental-aftermarket.com

SingleViu 2

Introduction	2
Speedometers	3
Tachourmeters	3
Level Gauges	4
Pressure Gauges	4
Temperature Gauges	5
Voltmeters	5
Ammeters	5
Accessories	5

Cockpit Vision 6

Speedometers	6
Tachometers	7
Tachourmeters	7
Fuel Gauges	8
Pressure Gauges, electrical	9
Pressure Gauges, mechanical	10
Boost Gauges, mechanical	11
Turbo Charger Gauge, mechanical	11
Vacuum Gauge, mechanical	11
Temperature Gauges, mechanical	12
Temperature Gauges, electrical	12
Exhaust Temperature / Pyrometer, electrical	13
Voltmeter	12
Ammeters, with internal shunt	12
Ammeters, with external shunt	13
Clock	13

Cockpit International 16

Speedometers	16
Tachourmeters	16
Tachometers	16
Fuel Gauges	17
Pressure Gauges, mechanical	18
Pressure Gauges, mechanical dual pointer	18
Pressure Gauges, electrical	20
Temperature Gauges, electrical	21
Temperature Gauges, mechanical	22
Exhaust Gas Temperature/Pyrometer, electrical	22
Ammeters, with internal shunt	23
Voltmeters	23
Hourmeters, rectangular	23
Hourmeters, round	24

Electronic Interfaces 24

Resistive Adjustable Switch Box	24
Resistive Gauge Conversion Box	24
Frequency Amplifier & Divider	25
Frequency Amplifier & Multiplier/Divider	25
Frequency Switch Box	25

Audio Visual 26

Monitors	26
Cameras	27
Radios	28
Speakers	29

Senders & Switches 30

Pressure Senders w/ Warning Contact	30
Oil Pressure Senders	31
Pressure Switches	32
Pressure Switches Heavy Duty	33
Temperature Switches	34
Temperature Senders w/ Warning Contact	34
Temperature Senders	35
Threaded Adapters	36
T-Piece Adapters	36
Speed & RPM Senders	37
Speed & RPM Sender Accessories	37
Fuel Level Senders	38
Fuel Level Sender Accessories	39
Vehicle Sender Application Listing	40

Accessories 51

Low Coolant Alarm	51
Digital Hand Held Tachometers	52
Tyre Pressure Gauge	52
Gauge Check	52
Oil Pump	52
Globes & Globe Holders	53
Gauge Mounting Hardware	53
Gauge Connectors	53

Misc 54

Part Number Index	54
Common Conversion Tables	56
VDO Warranty Policy	57



SingleViu

The all new SingleViu range builds on the reliability that VDO has been known for while adding advanced modern functionality. Featuring RGB LED illumination, stepper motor operation with 240deg dial sweep, built in warning light and IP67 rating. SingleViu gauges will accept both analogue and J1939 signals, ensuring compatibility in more applications than ever before! Available in 52mm, 80mm & 100mm. For more information on customisation, please contact your authorised VDO service agent.

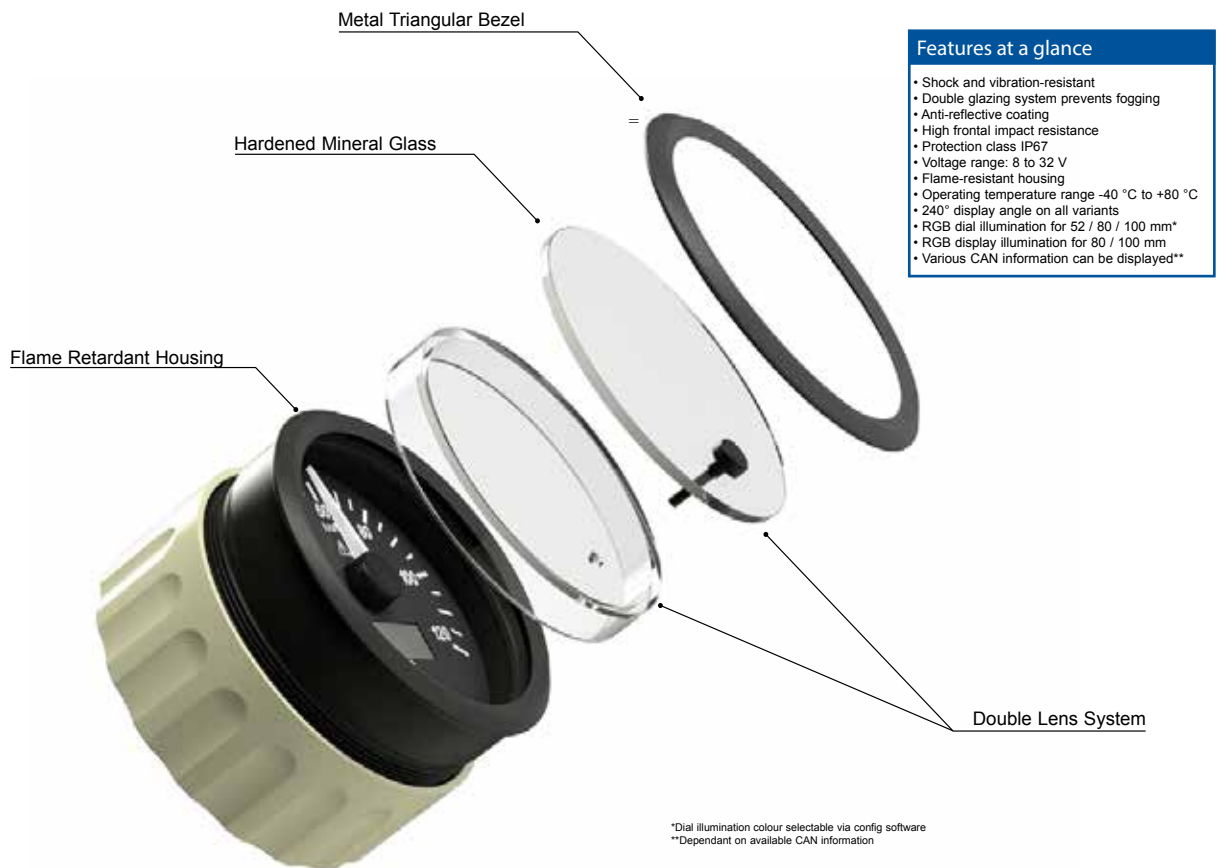

Features at a glance

- Shock and vibration-resistant
- Double glazing system prevents fogging
- Anti-reflective coating
- High frontal impact resistance
- Protection class IP67
- Voltage range: 8 to 32 V
- Flame-resistant housing
- Operating temperature range -40 °C to +80 °C
- 240° display angle on all variants
- RGB dial illumination for 52 / 80 / 100 mm*
- RGB display illumination for 80 / 100 mm
- Various CAN information can be displayed**

*Dial illumination colour selectable via config software
**Dependant on available CAN information



Speedometer

Part No.	Range	Size	Signal
A2C3832890030	0 - 60km/h	80/85mm	Pulse
A2C3832910030	0 - 120km/h	80/85mm	Pulse
A2C3832940030	0 - 200km/h	80/85mm	Pulse
A2C3832950030	0 - 300km/h	80/85mm	Pulse
A2C3832860030	0 - 120km/h	100mm	Pulse
A2C3832840030	0 - 200km/h	100mm	Pulse
A2C3832830030	0 - 300km/h	100mm	Pulse

White illumination & analogue signal as standard. 8 & 12 pin flying lead harness included.
80mm gauges incorporate stepped lip and can be fitted to 85mm cutout.



Tachourmeter

Part No.	Range	Size	Signal
A2C3833030030*	0 - 4000 RPM	52mm	J1939
A2C3832960030	0 - 2000 RPM	80/85mm	Pulse
A2C3832970030	0 - 2500 RPM	80/85mm	Pulse
A2C3832980030	0 - 3000 RPM	80/85mm	Pulse
A2C3832990030	0 - 4000 RPM	80/85mm	Pulse
A2C3833000030	0 - 5000 RPM	80/85mm	Pulse
A2C3833010030	0 - 6000 RPM	80/85mm	Pulse
A2C3833020030	0 - 8000 RPM	80/85mm	Pulse
A2C3832820030	0 - 2500 RPM	100mm	Pulse
A2C3832810030	0 - 3000 RPM	100mm	Pulse
A2C3832800030	0 - 4000 RPM	100mm	Pulse
A2C3832790030	0 - 5000 RPM	100mm	Pulse

White illumination & analogue signal as standard. 8 & 12 pin flying lead harness included.
80mm gauges incorporate stepped lip and can be fitted to 85mm cutout.

*52mm tachometer does not have LCD/Hourcounter & supports CAN only.





Level			
Part No.	Type (Symbol)	Range	Signal
A2C3833550030	AdBlue (ISO 0245+DEF)	0 - 1	3 - 180 Ω
A2C3832750030	AdBlue (ISO 0245+DEF)	E - F	240 - 33 Ω
A2C3833310030	Fuel (ISO 0245)	0 - 1	3 - 180 Ω
A2C3833110030	Fuel (ISO 0245)	0 - 1	90 - 5 Ω
A2C3833120030	Fuel (ISO 0245)	E - F	3 - 180 Ω
A2C3833130030	Fuel (ISO 0245)	E - F	240 - 33 Ω
A2C3833140030	Fuel (ISO 0245)	E - F	0 - 90 Ω
A2C3833150030	Fuel (ISO 0245)	E - F	90 - 5 Ω
A2C3916300030	Fuel (ISO 0245)	E - F	0 - 5 V

White illumination & analogue signal as standard. 8 pin flying lead harness included.

Pressure			
Part No.	Type (Symbol)	Range	Signal
A2C3833440030	Brake ('AIR')	0 - 10 Bar	10 - 180 Ω
A2C3833450030	Brake (ISO 1402)	0 - 10 Bar	10 - 180 Ω
A2C3833271030	Brake (ISO 1402)	0 - 16 Bar	0.5 - 4.5 V
A2C3833348030	Brake (ISO 1402)	0 - 150 PSI	3 - 180 Ω
A2C3832730030	Brake (ISO 1402)	0 - 250 PSI	0.5 - 4.5 V
A2C1800310030	Brake (ISO 1405 '1')	0 - 10 Bar	0 - 5 V
A2C1800330030	Brake (ISO 1406 '2')	0 - 10 Bar	0 - 5 V
A2C1800340030	Brake (ISO 0238 'P')	0 - 10 Bar	0 - 5 V
A2C3833460030	Transmission (ISO 1167)	0 - 25 Bar	0 - 5 V
A2C3832720030	Transmission (ISO 1167)	0 - 30 Bar	10 - 180 Ω
A2C3833500030	Transmission (ISO 1167)	0 - 400 PSI	0.5 - 4.5 V
A2C3832740030	Transmission (ISO 1167)	0 - 500 PSI	10 - 180 Ω
A2C3833160030	Engine Oil (ISO 0248)	0 - 5 Bar	10 - 180 Ω
A2C3833170030	Engine Oil (ISO 0248)	0 - 10 Bar	10 - 180 Ω
A2C3833230030	Engine Oil (ISO 0248)	0 - 80 PSI	240 - 33 Ω
A2C3833190030	Engine Oil (ISO 0248)	0 - 80 PSI	10 - 180 Ω
A2C3832690030	Engine Oil (ISO 0248)	0 - 10 Bar	0.5 - 4.5 V
A2C3833240030	Engine Oil ('OIL')	0 - 150 PSI	10 - 180 Ω
A2C3833300030	Engine Oil (ISO 0248)	0 - 150 PSI	10 - 180 Ω
A2C3832700030	Engine Oil (ISO 0248)	0 - 150 PSI	0.5 - 4.5 V
A2C3833490030	Turbo (ISO 2107)	0 - 2 Bar	10 - 180 Ω
A2C3833470030	Turbo (ISO 2107)	0 - 60 PSI	10 - 180 Ω

White illumination & analogue signal as standard. 8 pin flying lead harness included.

Temperature

Part No.	Type (Symbol)	Range	Signal
A2C3833320030	Water (ISO 0246)	40 - 120 °C	287 - 23 Ω
A2C3833330030	Water (ISO 1380)	40 - 120 °C	287 - 23 Ω
A2C3833350030	Water (ISO 0246)	100 - 250 °F	287 - 23 Ω
A2C3833380030	Engine Oil (ISO 2426)	50 - 150 °C	323 - 18 Ω
A2C3833390030	Engine Oil (ISO 1375)	50 - 150 °C	323 - 18 Ω
A2C3833410030	Engine Oil (ISO 2426)	100 - 300 °F	323 - 18 Ω
A2C3833510030	Hydraulic Oil (ISO 1414)	40 - 120 °C	287 - 23 Ω
A2C3916310030	Hydraulic Oil (ISO 1414)	0 - 250 °F	287 - 23 Ω
A2C3833520030	Cylinder Head	60 - 200 °C	482 - 14 Ω
A2C3833530030	Cylinder Head	150 - 400 °F	482 - 14 Ω
A2C3833050030	Pyrometer (ISO 1383)	0 - 1000 °C	4 - 37 mV
A2C3833304030	Pyrometer (ISO 1383)	0 - 2000 °F	4 - 37 mV

White illumination & analogue signal as standard. 8 pin flying lead harness included.

Ammeter / Voltmeter

Part No.	Type (Symbol)	Range	Signal
A2C3833090030	AMP (ISO 0247)	-30A - +30A	-60 - +60mV
A2C3833080030	AMP (ISO 0247)	-60A - +60A	-60 - +60mV
A2C3833070030	AMP (ISO 0247)	-100A - +100A	-60 - +60mV
A2C3833060030	AMP (ISO 0247)	-150A - +150A	-60 - +60mV
A2C3832770030	VOLT (ISO 0247)	8V - 16V	12 V
A2C3832780030	VOLT (ISO 0247)	16V - 32V	24 V

White illumination & analogue signal as standard. 8 pin flying lead harness included.

Accessories

Part No.	Description
2910000301300	Viewline adapter cable 8 pin
2910000301400	Viewline adapter cable 14 pin
2910000301500	WWG/Oceanline adapter cable - suit all variants
2910000301600	CANcockpit adapter cable - one req. per gauge
2910000484200	8 pin terminated flying harness for 52mm
2910000484300	12 pin terminated flying harness for 80/100mm
2910000954200	8 pin connector kit incl. terminals for 52mm
2910000954300	8+12 pin connector kit incl. terminals for 80/100mm



COCKPIT VISION

THRU DIAL ILLUMINATION

Cockpit Vision is the pinnacle of instrument technology. It represents latest advances in instrument illumination and installation techniques. Using fibre-optic technology to illuminate the pointer and VDO's Trioptic through dial lighting we achieve superb night time illumination.

SPEEDOMETER

Illumination through dial and pointer.

Field adjustable to suit 500 to 400,000 imp/km by pulse setting, or auto-calibration function through LCD readout via reset button.

Compatible with hall effect, inductive or blocking oscillator senders.

Illumination 12V included. For 24V application, use globe 240.053 (2 required)



Speedometer - DISCONTINUED 2021 - SEE SINGLEVIU ALTERNATIVES

Part No.	Range	Size	Voltage
437015028	0 - 200km/h	80mm	12/24V
SingleViu alternative - A2C3832940030			
437015025	0 - 200km/h	85mm	12/24V
SingleViu alternative - A2C3832940030			
437015029	0 - 200km/h	100mm	12/24V
SingleViu alternative - A2C3832840030			
437015022	0 - 300km/h	100mm	12/24V
SingleViu alternative - A2C3832830030			

Note: 8 pin plug kit part no. 340.824 recommended. Not included in kit.

Speedometer - 140mm

Part No.	Range	Size	Voltage
437015038	0 - 125km/h	140mm	12V
437025002	0 - 125km/h	140mm	24V

Note: 140mm Speedometer Impulse Ratio programmable 1,000-60,000 imp/

Km. 8 pin plug kit part no. 340.824 recommended. Not included in kit.

Please note:

Cockpit Vision & Cockpit International speedometers and tachometers will be discontinued from Q1 2021 or while stocks last. Please see the SingleViu range for suitable alternatives or contact your VDO sales agent for more information.

TACHOMETER

Suitable for most petrol and diesel engines. Field programmable to suit 4, 6 or 8 cyl./4 stroke ignition and alternator pick-up (terminal "W"). Single phase, not suitable for star point or magneto system. For standard points ignition system, add a 1N4004 diode in series with the signal wire (cathode towards tacho). Illumination 12V included.

Tachometer - Electronic

Part No.	Range	Size	Voltage
333015037	0 - 4000rpm	52mm	12V
333015031	0 - 8000rpm	52mm	12V
333015038	0 - 4000rpm	80mm	12V
333015032	0 - 7000rpm	80mm	12V
333015046	0 - 10000rpm	80mm	12V
333015033	0 - 7000rpm	85mm	12V
333015034	0 - 8000rpm	100mm	12V

Note: 8 pin plug kit part no. 340.824 recommended. Not included in kit.



TACHOURMETER

Suitable for most petrol and diesel engines. Adjustable through LCD and reset button. Field programmable to suit 1-12 cyl. 4-stroke or 1-4 cyl. 2-stroke engines. ignition and alternator pick-up ("W" terminal). Also suitable for signal from generator or inductive sender unit but not suitable for magneto ignition system. Incorporated hourmeter shows true engine hours. Operating hours 99,999.9. Pulse range 0.5-200 pulses per rev. Illumination 12V included. For 24V application use globe 240.053 (2 required).

Tachourmeter - DISCONTINUED 2021 - SEE SINGLEVIU ALTERNATIVES

Part No.	Range	Size	Voltage
333015035	0 - 7000rpm	85mm	12/24V
SingleViu alternative - A2C3833020030 (8k RPM)			
333015047	0 - 3000rpm	100mm	12/24V
SingleViu alternative - A2C3832810030			

Note: 8 pin plug kit part no. 340.824 recommended. Not included in kit.



Please note:

Cockpit Vision & Cockpit International speedometers and tachourmeters will be discontinued from of Q1 2021 or while stocks last. Please see the SingleViu range for suitable alternatives or contact your VDO sales agent for more information.

FUEL GAUGES

Suitable for use with most petrol, diesel fuel, and LPG systems.
Illumination 12V included. For 24V application add N05801180 dropping resistor & globe



Fuel Gauge - Float Arm			52mm
Part No.	Description	Specifications	Voltage
301010011	Fuel gauge (float arm)	3 - 180 ohms	12V
301.001	Fuel gauge (float arm)	3 - 180 ohms	24V
301.105	Fuel gauge for USA application	240 - 33 ohms	12V
301010010	Fuel gauge Also suitable for most LPG tank senders	5 - 90 ohms	12V

Note: 3 pin plug kit part no. 240.030 recommended. Not included in kit.

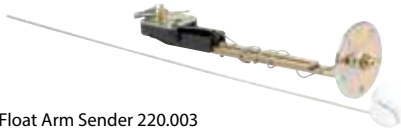

Adjustable Float Arm Sender 220.003

Sender - Adjustable Float Arm		
Part No.	Specifications	Length
220.003	3 - 180 ohms	150 - 600mm
220.004	5 - 90 ohms	150 - 600mm
220.005	240 - 33 ohms	150 - 600mm

Note: Full range of fuel level senders on page 48



Fuel Gauge - Tubular (Adjustable Range)				
Part No.	Description	Ohms		Voltage
		Empty	Full	
301010009	Fuel gauge (tubular)	110/50	2 ohms	12V

Note: 3 pin plug kit part no. 240.030 recommended. Not included in kit.



Tubular Tank Sender

Tubular Type Sender

See complete listing of tubular type senders on page 63.

Note: Mounting kit part no. N05801432 not included in kit.



Fuel Gauge -			
Part No.	Description	Specifications	Voltage
301010015	Suits OE senders	73 - 10 ohms	12V
Holden	HJ - HX - HZ - LH - LX		
Ford	XR - XT - XW - XY - XA - XB - XC - 2F - 2G - 2H		

500 Kpa PRESSURE GAUGE, electrical

Suitable for use with most petrol, diesel fuel, and LPG systems. Illumination
12V included, for 24V use globe 800005003 and N05801180 resistor

Electric Pressure Gauge - 500Kpa			52mm
Part No.	Description	Specifications	Voltage
350010016	Oil pressure symbol on dial	500Kpa 10-184 ohms	12V

Note: 3 pin plug kit part no. 240.030 recommended. Not included in kit.



Sender			10-180 ohms
Part No.	Range	Thread	Terminal
360.001	500Kpa	1/8"-27NPTF	Spade
360.004	500Kpa	1/4"-18NPTF	Button
360.016	500Kpa	1/8"-28BSBT	Button
360.018	500Kpa	1/8"-27NPTF	M4 thread
360081030049K	5 Bar / 7 psi SW N/C	1/8"-27NPTF	M4 thread

Refer to your engine manufacturers manual for correct oil pressure ratings.

Note: 500 Kpa = 5 Bar = 72.5 psi



Sender 360.001

1000 Kpa PRESSURE GAUGE, electrical

Electric Pressure Gauge - 1,000Kpa			52mm
Part No.	Description	Specifications	Voltage
350010017	1000kPa	10 - 180 OHMS	12V
350020001	1000kPa	10 - 180 OHMS	24V

Note: 3 pin plug kit part no. 240.030 recommended. Not included in kit.



Senders			10-180 ohms
Part No.	Range	Thread	Terminal
360.002	1000kPa	1/8"-27NPTF	Spade
360.019	1000kPa	1/8"-27NPTF	M4 thread
360081030052C	10 Bar / 7 psi SW	1/8"-27NPTF	M4 thread

Refer to your engine manufacturers manual for correct oil pressure ratings.

Note: 1000 Kpa = 10 Bar = 145 psi



Sender 360.002



Sender 360.086



Oil line kit 230.012



Nut and cone 230.008



Engine fitting 230.024



Nut and cone 230.025

PSI PRESSURE GAUGE, electrical

Suitable for most vehicles.

Illumination 12V included, for 24V use globe 800005003 & drop resistor N

Pressure Gauge - 100psi			52mm
Part No.	Description	Specification	Voltage
350010021	Oil Gauge	100psi	12V
360.086	Sender 100psi	1/8"-27NPTF	12/24V

Note: 3 pin plug kit part no. 240.030 recommended. Not included in kit.

Pressure Gauge - 400psi			52mm
Part No.	Range	Specification	Voltage
350010001	Trans Gauge	400psi	12V
360081038003C	Sender 400psi	1/8"-27NPTF	12/24V
360081038008C	Sender 400psi	1/8"-27NPTF	12/24V

Refer to your engine manufacturers manual for correct oil pressure ratings.

Note: 2800 Kpa = 28 Bar = 406 psi

* (0 - 25 Bar Sender is insulated return and can be used for 400 Psi gauge application)

PRESSURE GAUGES, mechanical

Suitable for most vehicles.

Supplied with nut and cone to suit 3/16" PVC tubing.

Illumination 12V included, for 24V use globe 800005003.

Pressure Gauge - Air, Oil & Water		52mm
Part No.	Range	Size
150077027	0 - 100psi	52mm
150077026	0 - 150psi	52mm
150077020	0 - 700Kpa	52mm

Accessories	
Part No.	Description
230.012	1.8m fitting kit - 3/16" PVC tubing & engine fitting
230.013	5m fitting kit - 3/16" PVC tubing & engine fitting

Fitting Kit	
Part No.	Description
230.008	Nut and cone for 3/16" PVC Tubing, M12x1.5 thread
230.024	Engine fitting 1/8"-27NPTF male, 3/16" tubing
230.025	Nut and cone 1/8"-27NPTF nut
230.015	Air/Fuel pressure restrictor

BOOST GAUGES, mechanical

Suitable for diesel vehicles.

Supplied with nut and cone to suit 3/16" PVC tubing.

Illumination 12V included, for 24V use globe 800005003.

Boost Gauge		52mm
Part No.	Range	Size
150077010	0-15 psi	52mm
150077011	0-30 psi	52mm

Note: Use airline kit 230.012 or 230.013



TURBO CHARGER GAUGE, mechanical

Suitable for petrol vehicles.

Supplied with nut and cone to suit 3/16" PVC tubing.

Illumination 12V included, for 24V use globe 800005003.

Turbo Charger Gauge		52mm
Part No.	Range	Size
150077004	-30" Hg/+25psi	52mm

Hg = Negative 30 inches of vacuum of mercury.

Note: Use airline kit 230.012 or 230.013



VACUUM GAUGE, mechanical

Suitable for most vehicles.

Supplied with nut and cone to suit 3/16" PVC tubing. Illumination

12V included, for 24V use globe 800005003.

Vacuum Gauge		52mm
Part No.	Range	Size
150077005	-30-0" Hg	52mm

Hg = Negative 30 inches of vacuum of mercury.

Note: Use airline kit 230.012 or 230.013



Accessories	
Part No.	Description
230.013	5m fitting kit - 3/16" PVC tubing & engine fitting



TEMPERATURE GAUGE, electric

Suitable for most vehicles.
12V Illumination included.



a.



b.



c.



a.



d.



Temperature Gauge - Water			52mm
Part No.	Description	Specifications	Voltage
310010014	Water temp. symbol on dial	40 - 120°C 287-23 ohms	12V
310020001	Water temp.	40 - 120°C	24V

Note: 3 pin plug kit part no. 240.030 recommended. Not included with gauge.

Recommended Temperature Sender				
Part No.	Range	Thread	Terminal	Body Type
320.002	40 - 120°C	1/8"-27NPTF	button	a
320.093	40 - 120°C	1/8"-27NPTF	M4 thread	b
320.022	40 - 120°C	1/2"-14NPTF	spade	c
320.004	40 - 120°C	M16x1.5mm	button	a

For more senders, see page 35

Temperature Gauge - Oil			52mm
Part No.	Description	Specifications	Voltage
310010015	Engine oil temp. symbol on dial	50 - 150°C 323-18 ohms	12V
310020002	Oil temp.	50 - 150°C	24V

Note: 3 pin plug kit part no. 240.030 recommended. Not included with gauge.

Temperature Sender				
Part No.	Range	Thread	Terminal	Body Type
320.021	50 - 150°C	1/8"-27NPTF	button	a
320.092	50 - 150°C	1/8"-27NPTF	M4 thread	b

For more senders, see page 35

TEMPERATURE GAUGE, mechanical

Suitable for most vehicles.

12V Illumination included, for 24V use globe 800005003.

Temperature is transmitted via fluid filled capillary tube.

Temperature Gauge - Water		52mm
Part No.	Range	Capillary Length
180077022	40 - 120°C	1600mm
180077023	40 - 120°C	2600mm
180077021	40 - 120°C	4000mm

Note: Thermo well included - Replacement Part No. 180.059

Temperature Gauge - Oil		52mm
Part No.	Range	Capillary Length
180077020	50 - 150°C	1600mm
180077019	50 - 150°C	4000mm

Note: Thermo well included - Replacement Part No. 180.059



Thermowell 180.059

EXHAUST TEMPERATURE / PYROMETER, electrical

Suitable for most exhaust systems.

Thermocouple connection is by 1/4"-18NPTF compression fitting.

Temperature is transmitted via K-type compensating cable.

Illumination 12V included.

Pyrometer - Electrical Kit		52mm
Part No.	Range	Voltage
310.159	0 - 900°C (37.6mV@900°C)	12V

Note: Cutting or adding length of loom will not affect calibration.

Spare Parts for 310.159 exhaust temperature/pyrometer kit	
Part No.	Description
310015009	Instrument
320.714	Thermocouple 1/4"-18 NPTF non bonded junction "K" type to be fitted 100mm after the turbo
240.035	Loom, 5m
320.059	Weld boss 1/4"-18 NPTF

Note: p/n 320.714 probe length = 62 mm, adjustable. Loom length ~ 500 mm



Thermocouple 320.714



VOLTMETER

Suitable for most engines/vehicles where battery and charging systems need to be monitored.

Voltmeter		52mm
Part No.	Range	Voltage
332010004	8 - 16V	12V
332020001	18 - 32V	24V

Note: Plug and pin kit part no. 240.031 recommended. Not included in kit.

AMMETERS, with internal shunt

Suitable for most engines which require battery and charging system monitoring.

Voltage independent - suitable for 12V or 24V.

Ammeters with internal shunt are easily identified by the heavy duty threaded terminals on the back of the instrument.

Illumination 12V included, for 24V use globe 800005003.

Ammeter with Internal Shunt - metal body			52mm
Part No.	Description	Specifications	Voltage
190077006	30-0-30 amp gauge	use 6mm wire	12V
190077007	60-0-60 amp gauge	use 6mm wire	12V

AMMETERS, with external shunt

Suitable for monitoring high output charging system or remote installation.

Illumination 12V included.

Ammeter with External Shunt			52mm
Part No.	Description	Specifications	Voltage
190.504	150-0-150 ammeter kit		12V
190075004	Gauge only - 52mm		
190.080	Shunt only - 150 amps	50mV @ 150 amps	

Note: For installation use 10mm wire.

CLOCK, analogue

Suitable for most vehicles.

Features LED illumination and quartz movement for high accuracy.

Clock		52mm
Part No.		Voltage
370.001	LED Illumination	12/24V

WIRING DIAGRAMS

80/85/100mm Speedo & Tachourmeter

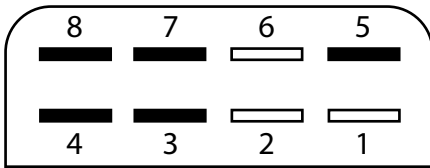

- 1) Not Used
 - 2) Not Used
 - 3) Ground
 - 4) +12/24V Switched
- *model dependant

- 5) +12/24V Battery*
- 6) Not Used
- 7) Two-wire Sensor Ground
- 8) Signal Input

80/85/100mm Tachometer

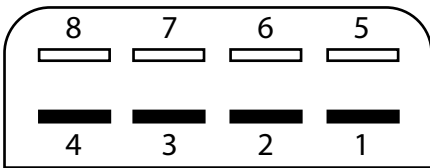

- 1) +24V Switched*
 - 2) +12V Switched*
 - 3) Ground
 - 4) Signal Input
- *model dependant

- 5) Not Used
- 6) Not Used
- 7) Not Used
- 8) Not Used

52mm Tachometer

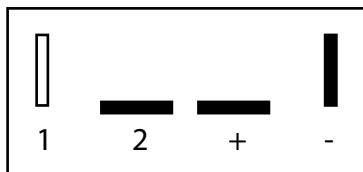

- 1) Not Used
- 2) Signal Input

- +) +12V Switched
-) Ground

52mm Ammeter & Pyrometer

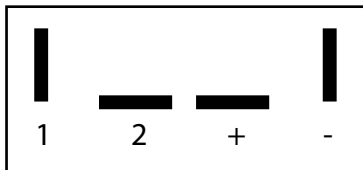

- 1) Signal +
- 2) Signal -

- +) +12V Switched
-) Ground

*Note: Pyro sensor positive is Yellow, Negative is Red.

52mm Level, Temperature, Pressure & Voltage

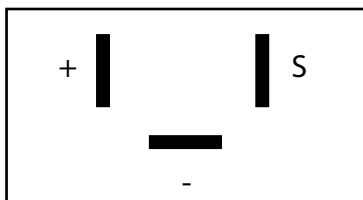

- +) +12/24V Switched*
 - S) Signal (not used on volt meters)
 -) Ground
- *model dependant

For additional information or other installation data, please contact us.



COCKPIT INTERNATIONAL

OLD STYLE LIGHTING AROUND THE EDGE OF THE DIAL

SPEEDOMETER

Floodlit illumination. 12V globes included, for 24V, use 240.053 (2 required)

Field adjustable to suit 500 to 400,000 imp/km by pulse setting, or auto-calibration function through LCD readout via reset button.

Compatible with hall effect, inductive or blocking oscillator senders.

Speedometer - DISCONTINUED 2021 - SEE SINGLEVIU ALTERNATIVES

Part No.	Range	Size	Voltage
437035016	0 - 120km/h	85mm	12/24V

[SingleViu alternative - A2C3832910030](#)

TACHOMETER

Suitable for most petrol and diesel engines. Field programmable to 4, 6 or 8 cyl./4-stroke ignition and alternator pick-up ("W" terminal).

Single phase not suitable for star point or magneto system.

Illumination included.

Tachometer

Part No.	Range	Size	Voltage
333035002	4000rpm	80mm	12V
333045002	4000rpm	80mm	24V
333035004	3000rpm	85mm	12V
333055001	3000rpm	100mm	12V
333065001	3000rpm	100mm	24V

Note: 8 pin plug kit part no. 340.824 recommended. Not included in kit.

TACHOURMETER

Suitable for most petrol and diesel engines. Adjustable through LCD and reset button. Field programmable to suit 1-12 cyl. 4-stroke or 1-4 cyl. 2-stroke engines. ignition and alternator pick-up ("W" terminal). Also suitable for signal from generator or inductive sender unit but not suitable for magneto ignition system. Incorporated hourmeter shows engine hours. Pulse range 0.5-200 pulses per rev. 12V globes included. For 24V application use globe #240.053 (2 required).

Tachourmeter - DISCONTINUED 2021 - SEE SINGLEVIU ALTERNATIVES

Part No.	Range	Size	Voltage
333035010	3000rpm	80mm	12/24V

[SingleViu alternative - A2C3832980030](#)

333035011	4000rpm	80mm	12/24V
-----------	---------	------	--------

[SingleViu alternative - A2C3832990030](#)

333035025	3000rpm	85mm	12/24V
-----------	---------	------	--------

[SingleViu alternative - A2C3832980030](#)

333035013	4000rpm	85mm	12/24V
-----------	---------	------	--------

[SingleViu alternative - A2C3832990030](#)

333055002	3000rpm	100mm	12/24V
-----------	---------	-------	--------

[SingleViu alternative - A2C3832810030](#)

Please note:

Cockpit Vision & Cockpit International speedometers and tachourmeters will be discontinued from Q1 2021 or while stocks last. Please see the SingleViu range for suitable alternatives or contact your VDO sales agent for more information.

FUEL GAUGES, electrical

Suitable for use with most petrol, diesel fuel, and LPG systems.

Fuel Gauge - 3-180 ohms		52mm	
Part No.	Range	Size	Voltage
301030001	0-1/1	52mm	12V
301040001	0-1/1	52mm	24V

Note: 3 pin plug kit part no. 240.030 recommended. Not included in kit.

Sender - Adjustable Float Arm		
Part No.	Specifications	Length
220.003	3 - 180 ohms	150 - 600mm

Note: Mounting kit part no. N05801432 not included in kit.

Arm Type Fuel Sender

See complete listing of arm type fuel senders on page 62.

Note: Mounting kit part no. N05801432 not included in kit.
Suitable for 3 - 180 and 10 - 180 Ohms

Reed Switch Sender Fuel & Water

Just for 3 - 180 ohms gauges.

See complete listing of arm reed switch senders on page 62.

Note: Mounting kit part no. N05801432 not included in kit.
Suitable for 3 - 180 and 10 - 180 Ohms

Fuel Gauge - Tubular		52 mm	
Part No.	Range	Size	Voltage
301030002	0-1/1	52mm	12V
301040002	0-1/1	52mm	24V

Note: 3 pin plug kit part no. 240.030 recommended. Not included in kit.
With ISO symbol.
For tubular tank units, adjustable resistance.

Tubular Type Sender

See complete listing of tubular type senders on page 63.

Note: Mounting kit part no. N05801432 not included in kit.

Accessories		
Part No.	Description	PCD
N05801432	Flange mounting kit	54mm

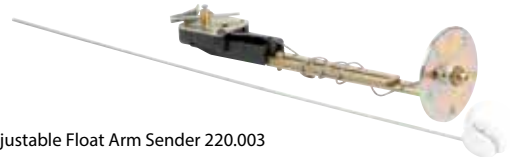

Adjustable Float Arm Sender 220.003



Arm Type Fuel Sender

Reed Switch Sender

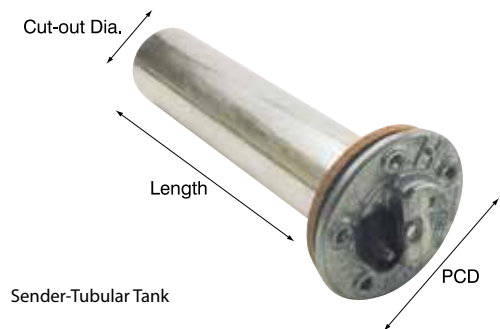

Sender-Tubular Tank



PRESSURE GAUGES, mechanical

Suitable for most vehicles and machines. Can be used on most non-aggressive gases and liquids. Supplied with nut and cone for 3/16" PVC tubing.

Illumination 12V included, for 24V use globe 800005003.

Pressure Gauge		52mm
Part No.	Range	Voltage
150035020	0 - 1000Kpa	12V
150035022	0 - 2500Kpa	12V



PRESSURE GAUGES, mechanical dual pointer

Suitable for most vehicles and machines running dual brake pressure systems.

Two independent pointers indicate separate pressures on one scale.

Illumination 12V and 24V globes included.



Dual Pressure Gauge		
Part No.	Range	Size
150.316	0 - 1000Kpa	60mm
151.910	0 - 150 psi	52mm
230.068	Nut and cone for 150.316 (2x required)	
230.025	Nut and cone for 150.910 (2x required)	



Oil line kit 230.012



Nut and cone 230.008



Engine fitting 230.024



Nut and cone 230.025

Accessories	
Part No.	Description
230.012	1.8m fitting kit - 3/16" PVC tubing & engine fitting
230.013	5m fitting kit - 3/16" PVC tubing & engine fitting
230.008	Nut and cone for 3/16" PVC tubing, M12x1.5 thread
230.024	Engine fitting 1/8"-27NPTF male, 3/16" PVC tubing

PRESSURE GAUGES, electrical

Suitable for most vehicles and machines. Illumination 12V or 24V included.
Note: Not recommended for petrol.

Pressure Gauge - Engine Oil Pressure		52mm
Part No.	Range	Voltage
350030016	0 - 500Kpa	12V
350040016	0 - 500Kpa	24V
350030003	0 - 5Bar	12V
350040003	0 - 5Bar	24V

Note: 3 pin plug kit part no. 240.030 recommended. Not included in kit.
With ISO symbol.
500Kpa = 5Bar = 72.5 psi

Sender - 500Kpa			10-180 ohms
Part No.	Range	Thread	Terminal
360.001	500Kpa	1/8"-27NPTF	Spade
360.004	500Kpa	1/4"-18NPTF	Button
360.016	500Kpa	1/8"-28BSBT	Button
360.018	500Kpa	1/8"-27NPTF	M4 thread

Note: 500 Kpa = 5 Bar = 72.5 psi
Refer to your engine manufacturers manual for correct oil pressure ratings.

Pressure Gauge - Engine Oil Pressure		52mm
Part No.	Range	Voltage
350030017	0 - 1000Kpa	12V
350040017	0 - 1000Kpa	24V
350030004	0 - 10Bar	12V
350040004	0 - 10Bar	24V

Note: 3 pin plug kit part no. 240.030 recommended. Not included in kit.
With ISO symbol.
1000Kpa = 10 Bar = 145 psi

Senders			10-180 ohms
Part No.	Range	Thread	Terminal
360.002	1000Kpa	1/8"-27NPTF	Spade
360.019	1000Kpa	1/8"-27NPTF	M4 thread
360081030052C	10 Bar / 7 psi SW	1/8"-27NPTF	M4 thread

Refer to your engine manufacturers manual for correct oil pressure ratings.

Note: 1000 Kpa = 10 Bar = 145 psi

Pressure Gauge - Transmission Oil Pressure		52mm
Part No.	Range	Voltage
350030005	0 - 25bar	12V
350040005	0 - 25bar	24V

Note: 3 pin plug kit part no. 240.030 recommended. Not included in kit.
2500Kpa = 25bar = 406psi

Senders		Insulated Return 2 terminal
Part No.	Description	Specifications
360081038003C	0 - 25 bar 400 psi single station insulated return	1/8"-27 NPTF

For thread adaptors see page 61. For additional pressure senders see page 30-31.
For calibration specs, see page 88.



Sender 360.001



Sender 360.002



Sender 360 081 038 003C



a.



b.



c.



d.



e.



TEMPERATURE GAUGES, electrical

Suitable for most vehicles and machines.

Illumination 12V or 24V included.

For matching sender units refer to page 60.

Temperature Gauge - Water		52mm	
Part No.	Range	Size	Voltage
310030002	40 - 120°C	52mm	12V
310040002	40 - 120°C	52mm	24V

Note: 3 pin plug kit part no. 240.030 recommended. Not included in kit.

With ISO symbol.

40 - 120°C = 100 - 250°F

Senders				
Part No.	Range	Thread	Terminal	Body Type
320.002	40 - 120°C	1/8"-27NPTF	button	a
320.093	40 - 120°C	1/8"-27NPTF	M4 thread	b
320.022	40 - 120°C	1/2"-14NPTF	spade	c
320.004	40 - 120°C	M16x1.5mm	button	a

Note: 40 - 120°C = 100 - 250°F

For thread adaptors see page 36. For calibration specs, see page 35

Temperature Gauge - Engine Oil		52mm	
Part No.	Range	Size	Voltage
310030003	50 - 150°C	52mm	12V
310040003	50 - 150°C	52mm	24V

Note: 3 pin plug kit part no. 240.030 recommended. Not included in kit.

With ISO symbol.

50 - 150°C = 120 - 300°F

Sender				
Part No.	Range	Thread	Terminal	Body Type
320.021	50 - 150°C	1/8"-27NPTF	button	a
320.092	50 - 150°C	1/8"-27NPTF	M4 thread	b

Note: 3 pin plug kit part no. 240.030 recommended. Not included in kit.

50 - 150°C = 120 - 300°F

For calibration specs, see page 88.

Temperature Gauge - Transmission Oil		52mm	
Part No.	Range	Size	Voltage
310030004	60 - 200°C	52mm	12V
310040004	60 - 200°C	52mm	24V

Note: 3 pin plug kit part no. 240.030 recommended. Not included in kit.

With ISO symbol.

60 - 200°C = 140 - 392°F

Sender				
Part No.	Range	Thread	Terminal	Body Type
320.006	60 - 200°C	1/8"-27NPTF	button	a
320.020	60 - 200°C	1/8"-27NPTF	button	e

For calibration specs, see page 88.

TEMPERATURE GAUGES, mechanical

Suitable for most vehicles and machines.

Process connection is 1/8"-27NPTF threaded removable thermowell.

Temperature is transmitted via fluid-filled capillary tube.

Coil up excess capillary tubing - do not cut to shorten!

Illumination 12V included. For 24V application use globe part no. 240.053.

Temperature Gauge		52mm
Part No.	Range	Capillary Length
180035002	40 - 120°C	1600mm
180035004	40 - 120°C	2600mm
180035005	40 - 120°C	4000mm
180035008	50 - 150°C	2600mm



PYROMETER, electrical

Suitable for most exhaust systems.

Thermocouple connection is by 1/4"-18NPTF compression fitting.

Illumination 12V included.

For 24V application use dropping resistor part no. N05801180 and globe part no. 240.053.

Pyrometer - Electric Kit		52mm
Part No.	Range	Voltage
397015003	0 - 900°C (37.6mV@900°C)	12V

Complete kit - consisting of instrument, thermocouple, 5m loom & weld boss.

Note: Cutting or adding length of loom will not effect calibration.

Spare Parts for 397 015 003 Pyrometer Kit	
Part No.	Description
310035001	Instrument 0 - 900°C (37.6mv) 52mm
320.714	Thermocouple 1/4" NPTF non bonded junction "K" type
240.035	Loom, 5 meter
320.059	Weld boss 1/4"-18 NPTF
800005002	Globe & Socket 12V (800005003 Globe & Socket 24V not incl.)

Note: p/n 320.714 probe length = 62 mm, adjustable. Loom length ~ 500 mm



Thermocouple 320.714



AMMETERS, with internal shunt

Suitable for most engines which requires battery charging system, monitoring. Voltage independent - suitable for 12V or 24V.

Ammeters with internal shunt are easily identified by the heavy duty threaded terminals. Heavy duty wire must be used for wiring.

Illumination 12V included. For 24V application use globe #240.053.

Ammeter with Internal Shunt		52mm
Part No.	Range	Voltage
190037002	60-0-60 amp	12V
190037003	100-0-100 amp	12V



VOLTMETERS

Suitable for all engines and machines.

Monitors charge and battery condition.

Dial colour coded.

Illumination 12V or 24V included.



Voltmeter		52mm
Part No.	Range	Voltage
332030001	8 - 16V	12V
332040001	18 - 32V	24V

Note: 2 pin plug kit part no. 240.031 recommended. Not included in kit. With ISO symbol.



331032004

HOURMETERS, round

Suitable for all vehicles and machines.

Available with 360° minute hand sweep or as hour counters only.

12V globe included.

Hourmeter - Black bezel			52mm
Part No.	Range	Illumination	Voltage
331032004	0 - 99999.9hrs	Non-Illuminated	12V



331032001

Hourmeter - Black bezel			52mm
Part No.	Range	Illumination	Voltage
331032001	0 - 99999.9hrs	Non-illuminated	12V
331810012004	0 - 99999.9hrs	Illuminated	12V
331810012007	0 - 99999.9hrs	Illuminated	24V

Hourmeters - Counter type - Black bezel 52mm			
Part No.	Range	Illumination	Voltage
331.601	0 - 99999.9hrs	Not illuminated	10/80V

(3-hole mounting, Flange 71mm)



331.601

Hourmeter - Counter type - With Operation Indicator - Chrome bezel 52m			
Part No.	Range	Illumination	Voltage
331.602	0 - 99999.9hrs	Not illuminated	10/80V



331.602

Hourmeter - Counter type - With Operation Indicator - Black bezel 52m			
Part No.	Range	Illumination	Voltage
331.600	0 - 99999.9hrs	Not illuminated	10/80V



331.600

HOURMETERS, rectanuglar

Suitable for all vehicles and machines.

Overall Dimension 53 X 32mm.

Hourmeter			
Part No.	Range	Size	Voltage
331.534	0 - 99999.9hrs	37mm x 25mm	10/80V



HOURMETER, LCD (RE-SETTABLE)

Hourmeter			
Part No.	Range	Illumination	Voltage
331.535	0 - 99999.9hrs	Not illuminated	10/27V





Switch Box 410.060



Switch Box 410.061



Switch Box 410.063

*Converts any resistance range from 0 – 1,000 OHMS or 1,000 – 0 OHMS

GAUGE WARNING LIGHT INTERFACE

Designed to be used in conjunction with VDO electric temp or pressure gauges with senders, or can be used using VDO senders only (extra resistor 1K, 1W required).

Ideal for switching warning lams, buzzers, external relays, thermofan and other devices.

Features 5 amp N/O or N/C Relay contact output.

Adjustable Electronic Switch Boxes		12/24V
Part No.	Description	Specification
410.060	Suitable for 1 warning function 1 input - 1 output	2000-10 ohms input 5 amp relay output
410.061	Suitable for 3 separate warning functions	2000-10 ohms input Transistor Output 3 input - 3 output

GAUGE OHMS CONVERSION BOX 12/24V

The 410.063 has been designed to correct the problem that occurs when an original vehicle sender is not available to match a particular gauge and vice versa. Another example is where the level sender in an LPG tank can be used to accurately drive the original (petrol) fuel gauge in a vehicle. Or the unit could be automatically switched to read between petrol and gas.

It can also 'copy' the signal from an existing gauge/sender combination so that the fuel level may also be observed at a different location. In this case, one sender can be used to drive three or four matching gauges. Because the unit is effectively a 'resistance converter' it can also be used on temperature or pressure gauges to correct where the original sender is no longer available for a gauge.

A further advantage is the 8 point conversion curve built in to the unit. This allows it to be used where the resistance graph is a curve, as in large and irregular shaped fuel tanks on trucks and off-road vehicles.

Setting up is extremely simple and can be done on site with almost all applications. Alternately the modules can be pre-programmed if necessary to fit a particular application.

Suitable for 12/24V applications.

Signal Ampifier/Divider		12/24V
Part No.	Description	
410.063	Gauge ohm range conversion box	

ELECTRONIC RATIO BOX

The VDO Electronic Ratio Box is designed to divide or multiply an input frequency by a fixed ratio. The input signal could be a speedometer or tachometer signal from a magnetic pickup, alternator pickup or Hall effect sender. Typical applications include correcting the speedometer on a vehicle which has had the diff ratio changed, or calibrating a tachometer which has no calibration adjustment.

Suitable for 12/24V applications.

Signal Amplifier/Divider		12/24V
Part No.	Description	Specification
411.105	Electronic Ratio box	Input: Hall effect, 0.7-10V p-p
		Inductive, 1.5-50V
	Output:	Square wave 0-10V p-p or V supply
	Output:	Triangular wave output



Switch Box 411.105

SIGNAL AMPLIFIER/DIVIDER

The VDO Signal Amplifier/Divider is a general purpose module designed to work with most speedometer and tachometer signals. This box will amplify a low voltage signal to a 10V peak to peak square wave. This can be useful when a signal is too low to drive a speedometer, tacho, cruise control or any other such device or to utilise a two wire inductive sender where a hall effect signal is required. The output signal may also be divided in frequency by a factor or 1, 2, 4, 8, or 16 to allow easier integration to another instrument.

Signal Amplifier/Divider		12/24V
Part No.	Description	Specification
411.096	Signal amplifier/divider programmable	Signal input: 2+V p-p 0-10khz Output: 10.0V square wave



Signal Amplifier 411.096

MULTI-FREQUENCY SWITCH BOX

The VDO Speed & RPM switch has been designed to work with all standard ignition systems, and will provide a negative output once a predetermined Speed/RPM has been reached. In standard format the signal will turn off once the input signal falls below the pre-set point.

RPM Switch		
Part No.	Description	Specification
660.990	12/24V RPM switch	3 amp relay output RPM range 0-12000 rpm
	*Will work off alternator	4/6/8cyl
411.101	12/24V RPM switch	Switch range 2Hz - 9,990 Hz 5 amp relay contact output, 2 channels. Sine & Square wave inputs.



Switch Box 660.990



Switch Box 411.101



2910002302700 - 1080P Monitor



2910002314400 - 1080P DVR



2910002304700 - 1080P Camera

MONITORS & MONITOR KITS

New range for 2020 including High Definition 1080P variants.

All monitor models feature 12/24V operation, PAL/NTSC camera support, external input switching (reverse etc) and built-in regulated camera power supply.

All cameras are IP69K rated and feature infrared night vision (range varies).

Full High Definition (FHD) 1080P Camera Systems - NEW FOR 2020!

Part No.	Description
2910002302700	HD 1080P 10.1" Touch Screen Monitor
2910002302800	HD 1080P 10.1" Quad View Touch Screen Monitor
2910002304700	HD 1080P Heavy Duty Camera 130° with 10m IR
2910002314400	HD 1080P 4CH Digital Video Recorder with GPS

Monitor & Camera Kits

Part No.	Description
2910000300600	7" Monitor with 120° IP69K CMOS Camera
2910000117200	7" Monitor with 120° IP69K CCD Camera
2910000117300	7" IP69K Monitor with 120° IP69K CCD Camera
2910000117500	7" Wireless Monitor with 120° IP69K CCD Camera
2910000244200	7" Wireless Quad Monitor with 4x 120° CCD Cameras
2910000117400	9" Monitor with 120° IP69K CCD H/D Camera



2910000244200



2910000300600



2910000117500



2910000299900



2910000979800

Monitors

Part No.	Description
2910000299900	7" Monitor, 3 input, 1024x600 res
2910000118100	7" Monitor, 3 input, 1024x600 res, touch sense buttons
2910000118200	9" Monitor, 3 input, 800x480 res, touch sense buttons
2910001187300	7" Monitor, 3 input, 800x480 res, IP69K, touch screen
2910000979800	7" Quad View, 4 input, 800x480 res
2910000118400	7" Quad View, 4 input, 800x480 res, IP69K, touch screen
2910000118500	9" Quad View, 4 input, 800x480 res, touch sense buttons
2910000118600	7" Wireless Monitor, 4ch input, 800x480 res
2910000244300	7" Wireless Quad View Monitor, 800x480 res

CAMERAS & ACCESSORIES

Wired Cameras		
Part No.	Description	Features
2910000118700	Light Duty Wired Camera	120° Angle, CMOS, PAL, IP69K, 10m IR, Grey
2910000854700	Light Duty Wired Camera	120° Angle, CMOS, NTSC, IP69K, 10m IR, Black
2910000119000	Heavy Duty Wired Camera	120° Angle, CCD, PAL, IP69K, 10m IR, Grey
2910000118800	Extra Heavy Duty Wired Camera	150° Angle, CCD, PAL, IP69K, 10m IR, Grey, Motorised Shutter
2910000119100	Heavy Duty Side View Camera	150° Angle, CCD, PAL, IP69, 5m IR, Black



2910000118700



2910000854700



2910000118800



2910000119100

Wireless Cameras		
Part No.	Description	Features
2910000119500	Wireless Heavy Duty Camera	120° Angle, CCD, PAL, IP69K, 10m IR, Suit 2910000118600 only
2910000119600	Wireless Heavy Duty Camera	120° Angle, CCD, PAL, IP69K, 10m IR, Suit 2910000244300 Quad only
2910000814500	Wireless Forklift Tine Camera	45° Angle, CCD, PAL, IP69K, Metal Body, Suit 2910000244300 Quad only



2910000814500



2910000119500

Camera Accessories		
Part No.	Description	Features
2910000814500	Rechargeable Battery Pack	IP65, 7800mAh, 8 hour charge, 14 hour run, Suits all wireless cameras
Part No. TBA	AC Wall Charger for Battery Pack	
2910000120200	Wireless Camera Conversion Kit	Convert wired camera system to wireless, 1 set required per camera
2910000120100	Wireless Camera Receiver	Add wireless camera to wired camera system, 1 required per camera
2910000120000	Wireless Camera Transmitter	Add wired camera to wireless camera system, 1 required per camera
2910000463400	3M Camera Extension Cable	Suits all current VDO wired cameras and monitors
2910000119600	5M Camera Extension Cable	Suits all current VDO wired cameras and monitors
2910000119700	10M Camera Extension Cable	Suits all current VDO wired cameras and monitors
2910000119800	20M Camera Extension Cable	Suits all current VDO wired cameras and monitors



Camera Battery Pack



Wireless Transceiver Kit



Camera Extension Cable



RADIOS

RDS Tuner, USB, AUX, MP3/WMA

Part No.	Model No.	Illumination	Voltage
101.270	TR711U-BU	Bue	12V
101.271	TR722U-BU	Blue	24V
A2C6253521466	TR7422U-OR/19	Orange	24V

1 Din, 188x58.5x114.7, RDS Clock, 4x10w
Battery Back Up. Steering Wheel Control,
Front AUX input & Front USB.

RDS Tuner, USB, AUX, MP3/WMA, Bluetooth

Part No.	Model No.	Illumination	Voltage
101.264	TR712UB-BU	Blue	12V
101.265	TR722UB-BU	Blue	24V
A2C6253521366	TR7412UB-OR	Orange	12V
A2C6253521566	TR7423UB-OR/19	Orange	24V

1 Din, 188x58.5x114.7, RDS Clock, 4x10w
Battery Back Up. Steering Wheel Control,
Front AUX input & Front USB.

DAB+/RDS Tuner, USB, AUX, MP3/WMA, Bluetooth

Part No.	Model No.	Illumination	Voltage
2910000430600	TRD7412UB-OR	Orange	12V

1 Din, 188x58.5x114.7, RDS Clock, 4x10w
Battery Back Up. Steering Wheel Control,
Rear AUX input & Front USB.

RDS Tuner, USB, AUX, CD, MP3/WMA

Part No.	Model No.	Illumination	Voltage
101.268	CD716U-BU	Blue	12V
101.269	CD726U-BU	Blue	24V
A2C6253520766	CD7426U-OR/19	Orange	24V

1 Din, 188x58.5x114.7, RDS Clock, 4x10w
Battery Back Up. Steering Wheel Control,
Rear AUX input & Front USB.

DAB+/RDS Tuner, USB, AUX, CD, MP3/WMA, Bluetooth

Part No.	Model No.	Illumination	Voltage
101.266	CDD718UB-BU	Blue	12V
101.267	CDD728UB-BU	Blue	24V
2910000080600	CD7416UB-OR	Orange	12V
2910000080900	CD7426UB-OR/19	Orange	24V
A2C6253520866	CDD7418UB-OR	Orange	12V
A2C6253520966	CDD7428UB-OR/19	Orange	24V

1 Din, 188x58.5x114.7, RDS Clock, 4x10w
Battery Back Up. Steering Wheel Control,
Rear AUX input & Front USB.

SPEAKERS

Pair of Speakers

Part No.	Description	Watts
101.350	Pair of speakers 100mm 2 way	50 Watts

2-way coaxial system
 2 Black grilles with VDO logo and zinc plating pre-treatment
 Diameter: 100 mm
 Power handling: 12 – 50 Watts
 Frequency range: 120 – 18,000 Hz
 Sensitivity dB/W/m: 90
 Mounting kit
 101.350 is labelled HP1021



Pair of Speakers

Part No.	Description	Watts
101.351	Pair of speakers 130mm 2 way	60 Watts

2-way coaxial system
 2 Black grilles with VDO logo and zinc plating pre-treatment
 Diameter: 130 mm
 Power handling: 15 – 60 Watts
 Frequency range: 100 – 18,000 Hz
 Sensitivity dB/W/m: 89
 Mounting kit
 101.351 is labelled HP1321



Pair of Speakers

Part No.	Description	Watts
101.352	Pair of speakers 130mm 2 way white grilles	60 Watts

2-way coaxial system
 2 white grilles with VDO logo and zinc plating pre-treatment
 Diameter: 130 mm
 Power handling: 15 – 60 Watts
 Frequency range: 100 – 18,000 Hz
 Sensitivity dB/W/m: 88
 Mounting kit
 101.352 is labelled HPW1321



Pair of Speakers

Part No.	Description	Watts
101.353	Pair of speakers 130mm 2 way white grilles	150 Watts

Pair of uniblock waterproof speakers
 ABS ABS777B with treatment against UB (ASA)
 2 speakers per box
 2 way coaxial system
 Diameter: 130 mm
 Power handling: 30 – 150 Watts
 Frequency range: 80 – 20,000 Hz
 Sensitivity dB/W/m: 87
 Mounting kit : with rubber gasket, screws and Iso cables
 101.353 is labelled 051-018-011



OIL PRESSURE SENDER / SWITCHES

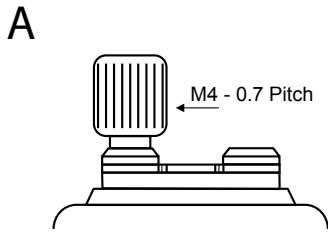

Pressure Sender - Oil / Air				Single Station	
Part No.	Range Bar (Psi)	Thread Size	Switch Point Bar (Psi)	Picture	Ohms Range
360081032025C	0 - 2 Bar (30)	1/8"-27NPTF	---	B	10 - 180
360081032011C	0 - 2 Bar (30)	M 12x1.5	---	B	10 - 180

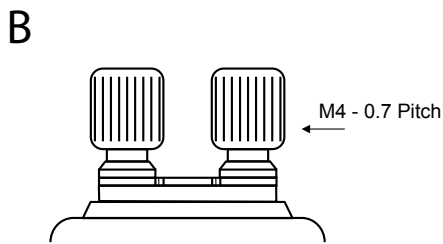

Pressure Sender - Oil / Air				Single Station	
Part No.	Range Bar (Psi)	Thread Size	Switch Point Bar (Psi)	Picture	Ohms Range
360081032001C	0 - 5 Bar (75)	1/8"-27NPTF	---	B	10 - 180
360081032002C	0 - 5 Bar (75)	M10x1.0	---	B	10 - 180

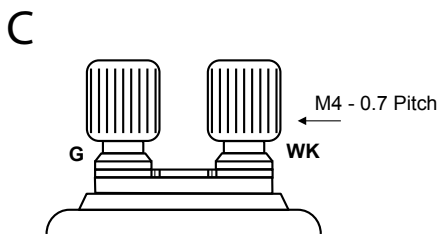

Pressure Sender & Switch - Oil / Air				Single Station	
Part No.	Range Bar (Psi)	Thread Size	Switch Point Bar (Psi)	Picture	Ohms Range
360081030001K	0 - 5 Bar (75)	M10x1.0	0.25 Bar (3.5)	C	10 - 180
360081030002K	0 - 5 Bar (75)	M10x1.0	0.5 Bar (7)	C	10 - 180
360081030028K	0 - 5 Bar (75)	M14x1.5	0.5 Bar (7)	C	10 - 180
360081030049K	0 - 5 Bar (75)	1/8"-27NPTF	0.5 Bar (7)	C	10 - 180
360081030014C	0 - 5 Bar (75)	M10x1.0	0.6 bar (8.5)	C	10 - 180
360081030010C	0 - 5 Bar (75)	1/8"-27NPTF	1.4 Bar (11.5)	C	10 - 180
360081039002C	0 - 5 Bar (75)	1/8"-27NPTF	11.5 Psi	D	10 - 180
360081039004C	0 - 5 Bar (75)	1/8"-27NPTF	10 Psi	D	10 - 180

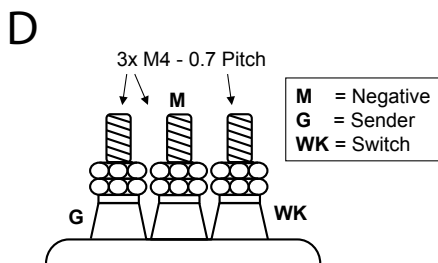

M = Negative
G = Sender
WK = Switch

Pressure Sender & Switch - Oil / Air				Single Station	
Part No.	Range Bar (Psi)	Thread Size	Switch Point Bar (Psi)	Picture	Ohms Range
360081030009K	0 - 10 Bar (150)	M10x1.0	0.5 Bar (7)	C	10 - 180
360081030022C	0 - 10 Bar (150)	M12x1.5	0.5 Bar (7)	C	10 - 180
360081030052C	0 - 10 Bar (150)	1/8"-27NPTF	0.5 Bar (7)	C	10 - 180
360081030039C	0 - 10 Bar (150)	M10x1.0	0.75 Bar (10.7)	C	10 - 180
360081030015C	0 - 10 Bar (150)	1/8"-27NPTF	0.8 Bar (11.5)	C	10 - 180
360081030017C	0 - 10 Bar (150)	M10x1.0	0.9 Bar (12)	C	10 - 180
360081039003	0 - 10 Bar (150)	1/8"-27NPTF	0.8 Bar (11.5)	D	10 - 180

Pressure Sender - Oil / Air				Single Station	
Part No.	Range Bar (Psi)	Thread Size	Switch Point Bar (Psi)	Picture	Ohms Range
360081038008C	0 - 30 Bar (400)	1/8"-27NPTF	---	B	10 - 180
360081032014C	0 - 10 Bar (150)	1/8"-27NPTF	---	B	10 - 180
360081038003C	0 - 25 Bar (350)	1/8"-27NPTF	---	B	10 - 180

Pressure Sender - Oil / Air				Dual Station	
Part No.	Range Bar (Psi)	Thread Size	Switch Point Bar (Psi)	Picture	Ohms Range
362081001001K	0 - 5 Bar (75)	1/8"-27NPTF	---	B	5 - 90
362081001002K	0 - 10 Bar (150)	1/8"-27NPTF	---	B	5 - 90
362081003002K	0 - 10 Bar (150)	1/8"-27NPTF	---	A	5 - 90
362081002001K	0 - 25 Bar (350)	1/8"-27NPTF	---	B	5 - 90
362081004001C	0 - 25 Bar (350)	1/8"-27NPTF	---	A	5 - 90

OIL PRESSURE SENDERS

Oil Pressure Senders for various applications						
Part No.	Gauge KPa	Gauge PSI	Ohms	Light Switch KPa	Thread	Terminal
360.001	500 KPa	75psi	10-180 ohms	-	1/8"27NPTF	Blade (F)
360.002	1000 KPa	150psi	10-184 ohms	-	1/8"27NPTF	Blade (F)
360.003	700 KPa	100psi	73-10 ohms	-	1/4"18NPT	Blade (F)
360.004	500 KPa	75 psi	10-180 ohms	-	1/4"18NPT	Blade (F)
360.005	500 KPa	75 psi	73-10 ohms	-	1/4"18NPT	Blade (F)
360.006	600 KPa	87 psi	292-40 ohms	-	1/8"-28BSP	Blade (F)
360.008	800 KPa	116 psi	0-90 ohms	-	1/8"-27NPTF	M4 Post (K)
360.013	700 KPa	100psi	10-180 ohms	-	1/4"18NPT	Button (G)
360.014	600 KPa	87 psi	10-180 ohms	-	1/8"27NPTF	Blade (F)
360.016	500 KPa	75 psi	10-180 ohms	-	1/8"28BSP	Button (G)
360.017	600 KPa	87 psi	10-180 ohms	50 KPa	1/8"28BSP	Bullet & Button (J)
360.018	500 KPa	75 psi	10-180 ohms	-	1/8"27NPTF	M4 Post (K)
360.019	1000 KPa	150 psi	10-184 ohms	-	1/8"27NPTF	M4 Post (K)
360.020	600 KPa	87 psi	10-180 ohms	-	1/8"27NPTF	M4 Post (K)
360.022	500 KPa	75 psi	10-183 ohms	30 KPa	M10 x 1.0	M4 Post (B)
360.024	875 KPa	125 psi	0-5 volt (ecu)	-	M14x1.5	3 pin plug
360.048	10 bar	150 psi	0-5 Volts	-	M12x1.5	4 pin Bayonet
360.050	5 bar	80 psi	240-33 ohms	-	1/8"-27NPT	M4 Post (K)
360.086	700KPa	100 psi	10-180 ohms	-	1/8"27NPTF	M4 Post (K)

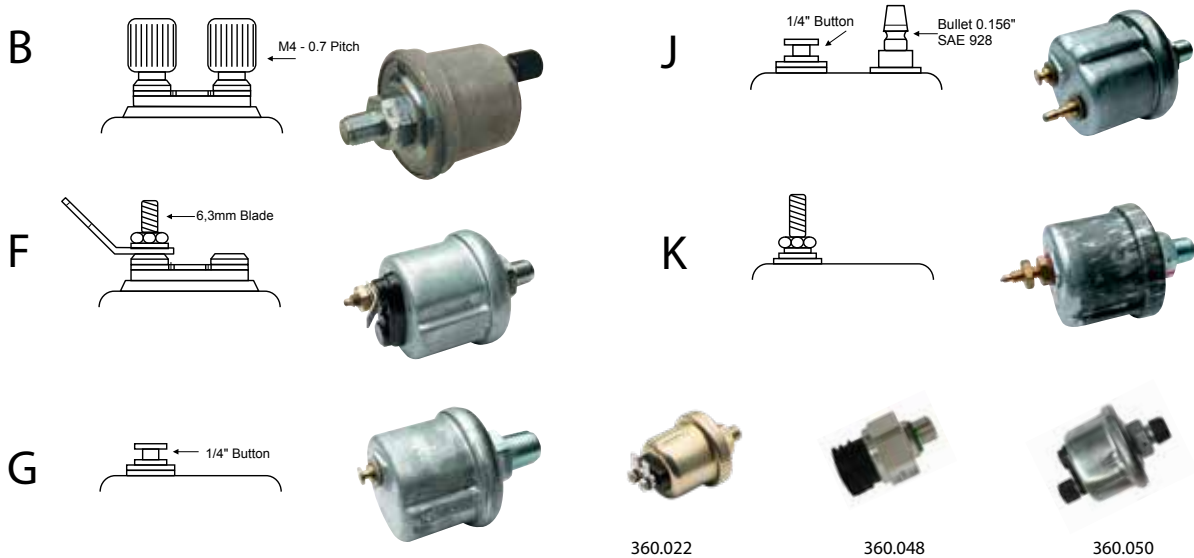

NOT SURE?

VDO Gauge Check can be found on page 52. Handy workshop tool used to test gauges and measure variable resistance required for replacement senders. Simply connect to the sender terminals and use the dial to simulate gauge movement. Resistance can then be recorded to help match with the correct replacement sender.



PRESSURE SWITCHES

VDO Pressure Switches are robust, compact and designed to operate in harsh environments at various pressures and in extended duty applications.

Because of its special internal design, this switch can tolerate high pressure spikes inherent in many pressure systems. The switch is factory calibrated but in the case that adjustment is needed in the field, the switch offers an adjustment screw to facilitate any fine tuning required within the given set point range. The standard polyimide diaphragm (Kapton), makes it compatible with many gases, oils, jet fuels and similar hydrocarbons media. Standard screw type electrical terminals are available. Also included with the switch are screw to blade converters.

The overall ruggedness of the VDO Pressure Switch makes it a popular choice for many OEM and aftermarket

230 Series Pressure Switches - Heavy Duty Stainless Steel - Single Pole Double Throw (SPDT)

Part No.	Description	Preset	Range	Thread Type
230.990	Press Sw 3 Term NC/NO 1.1 - 3psi	15psi	1.1 - 3psi	1/8"-27NPFT
230.993	Press Sw 3 Term NC/NO 3.1 - 7psi	150psi	3.1 - 7psi	1/8"-27NPFT

Working Pressure



330 Series Pressure Switches - Medium Duty Brass - Single Pole Single Throw (SPST)

Part No.	Description	Preset	Range	Thread Type
330.102	Press Sw 2 Term N/O 1.1 - 3psi	2psi	1.1 - 3psi N/O	1/8"-27NPFT
330.102C	Press Sw 2 Term N/C 1.1 - 3psi	2psi	1.1 - 3psi N/C	1/8"-27NPFT
330.104	Press Sw 2 Term N/O 3.1 - 7psi	4psi	3.1 - 7psi N/O	1/8"-27NPFT
330.104C	Press Sw 2 Term N/C 3.1 - 7psi	4psi	3.1 - 7psi N/C	1/8"-27NPFT
330.110	Press Sw 2 Term N/O 8 - 13psi	10psi	8 - 13psi N/O	1/8"-27NPFT
330.110C	Press Sw 2 Term N/C 8 - 13psi	10psi	8 - 13psi N/C	1/8"-27NPFT
330.115	Press Sw 2 Term N/O 14 - 24psi	15psi	14 - 24psi N/O	1/8"-27NPFT
330.115C	Press Sw 2 Term N/C 14 - 24psi	15psi	14 - 24psi N/C	1/8"-27NPFT
330.135	Press Sw 2 Term N/O 25 - 50psi	35psi	25 - 50psi N/O	1/8"-27NPFT
330.135C	Press Sw 2 Term N/C 25 - 50psi	35psi	25 - 50psi N/C	1/8"-27NPFT
330.160	Press Sw 2 Term N/O 51 - 90psi	60psi	51 - 90psi N/O	1/8"-27NPFT
330.160C	Press Sw 2 Term N/C 51 - 90psi	60psi	51 - 90psi N/C	1/8"-27NPFT
330.1100	Press Sw 2 Term N/O 91 - 150psi	100psi	91 - 150psi N/O	1/8"-27NPFT
330.1100C	Press Sw 2 Term N/C 91 - 150psi	100psi	91 - 150psi N/C	1/8"-27NPFT



SPST - 2 Terminals

N/O = Contacts are open and will close above set point.

N/C = Contacts are closed and will open above set point.

Working pressure: 150psi for 0.5 - 24psi, 250psi for 25 - 150psi.

Burst pressure: 750psi for 0.5 - 24psi, 1250psi for 25 - 150psi.



430 Series Pressure Switches - Medium Duty Brass - Single Pole Double Throw (SPDT)

Part No.	Description	Preset	Range	Thread Type
430.102	Press Sw 3 Term NC/NO 1.1 - 3psi	2psi	1.1 - 3psi	1/8"-27NPFT
430.104	Press Sw 3 Term NC/NO 3.1 - 7psi	4psi	3.1 - 7psi	1/8"-27NPFT
430.110	Press Sw 3 Term NC/NO 8 - 13psi	10psi	8 - 13psi	1/8"-27NPFT
430.115	Press Sw 3 Term NC/NO 14-24 psi	15psi	14 - 24psi	1/8"-27NPFT
430.135	Press Sw 3 Term NC/NO 25-50 psi	35psi	25 - 50psi	1/8"-27NPFT
430.160	Press Sw 3 Term NC/NO 51-90 psi	60psi	51 - 90psi	1/8"-27NPFT
430.1100	Press Sw 3 Term NC/NO 91-150 psi	100psi	91 - 150psi	1/8"-27NPFT



SPDT - 3 Terminals

Cover

Part No.	Description
330.100	Rubber dust boot to suit 230, 330 & 430 series universal pressure switches

OIL PRESSURE SWITCHES

Oil Pressure Switches - Light Duty					
Part No.	Thread Type	Terminal	Switch Kpa	Switch	Voltage
231.081	1/4"-18NPTF	Button	25 kpa	NC	12/24v
231.082	1/8"-27NPTF	Spade	21 kpa	NC	12/24v
231.083	1/8"-27NPTF	Button	55 kpa	NC	12/24v
231.084	1/8"-28BSPT	Button	21 kpa	NC	12/24v
231.085	M10x1.0	Spade	25 kpa	NC	12/24v
231.086	1/8"-28BSPT	Bullet	21 kpa	NC	12/24v
231.087	M14x1.5	Spade	21 kpa	NC	12/24v
231.088	1/4"-18NPTF	Plug (3 pin)	ECU	ECU	5v
231.102	1/8"-28BSPT	Spade	50 kpa	NC	12/24v
231.106	1/4"-18NPTF	Spade	40 kpa	NC	12/24v

Full range of threaded adapters on page 36

Universal Pressure Switches - Heavy Duty					
Part No.	Switch Point Bar (Psi)	Thread Type	Terminals	Picture	Switch
230.044	0.5 Bar (7) Fixed	1/8"-27NPTF	Screw x 2	M	N/C
		Insulated Return			
230.041	0.7 Bar (10) Fixed	1/8"-27NPTF	Screw x 1	M	N/C
		Earth Return			
230.043	0.7 Bar (10) Fixed	1/8"-27NPTF	Screw x 1	M	N/O
		Earth Return			



TEMPERATURE SWITCHES

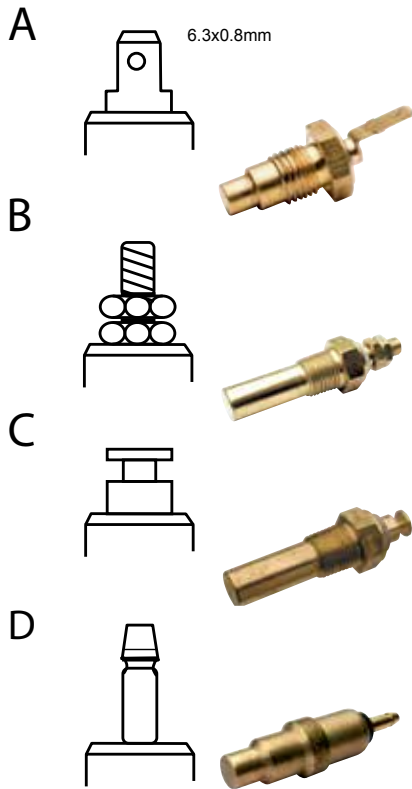

Temp Switch - Normally Open Contact - Single Terminal 3 Watt

Part No.	Switch Point	Thread Size	Term.	Body Length	Max Temp.	Probe Diam.
232011017087D	40±3°C	M14x1.5	D	29 mm	120	10
232011017038D	55±3°C	M14x1.5	A	29 mm	120	10
232011017017D	85±3°C	M14x1.5	A	29 mm	120	10
230.046	90±3°C	M10x1.5	B	38.5 mm	120	6.9
232011017016D	95±3°C	M14x1.5	A	29 mm	150	10
230.051	95±3°C	1/2-14 NPTF	A	29 mm	120	10
230.045	96±3°C	1/8-27 NPTF	B	33 mm	120	10
232011017080D	97±3°C	M14x1.5	A	29 mm	120	10
232011017034D	100±3°C	M14x1.5	A	29 mm	160	10
232011017041D	105±3°C	1/2-14 NPTF	A	29 mm	120	10
232011017010D	110±3°C	M14x1.5	A	29 mm	160	10
232011017032D	120±3°C	M14x1.5	A	29 mm	130	10
232011017103D	130±3°C	M14x1.5	A	29 mm	150	10
232011005027D	150±5°C	M10x1.5	C	38.5 mm	200	6.9
232011005017D	150±5°C	M10x1.5	B	38.5 mm	200	6.9
232011005004D	170±5°C	M10x1.5	B	38.5 mm	220	6.9

Note: All above switches are normally open (N/O)

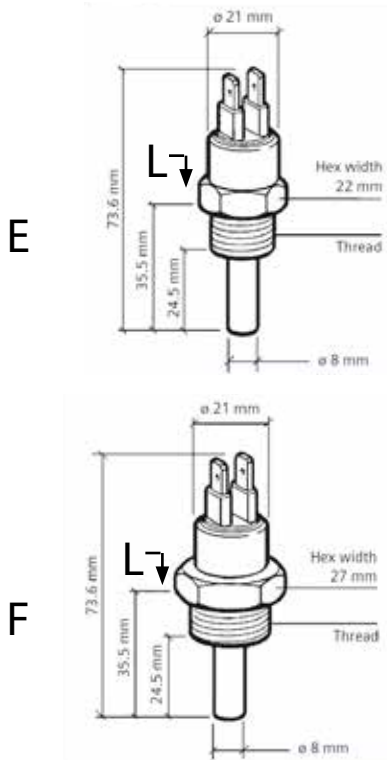

Temp Switch - N/O Contact (except * N/C) Dual Terminal 100 Watt

Part No.	Switch Point	Thread Size	Term.	Body Length L	Max Temp.	Probe Diam.
X10232001002	82±3°C	M18x1.5	E	35.5 mm	110	8
X10232001003	86±3°C	M18x1.5	E	35.5 mm	110	8
X10232001004	92±3°C	M18x1.5	E	35.5 mm	110	8
X10232001005	96±3°C	M18x1.5	E	35.5 mm	110	8
X10232001006	96±3°C	1/2-14 NPTF	E	43.5 mm	110	8
X10232001007	96±3°C	M14x1.5	E	35.5 mm	110	8
X10232001008	96±3°C	M22x1.5	F	35.5 mm	110	8
X10232001009	100±3°C	M18x1.5	E	35.5 mm	110	8
230.112NO	70±3°C	1/8-27NPTF	E	30.0 mm	110	8
230.113NC	75±3°C	1/8-27NPTF	E	30.0 mm	110	8
230.114NC	95±3°C	1/8-27NPTF	E	30.0 mm	110	8
230.115NO	95±3°C	1/8-27NPTF	E	30.0 mm	110	8
230.115NC	105±3°C	1/8-27NPTF	E	30.0 mm	120	8

Note: Temp Switches 230.112 to 230.115 include a rubber boot.



230.079

Temp Control Switch 100 Watt

Part No.	Switch Point	Thread Size	Term.	Body Length L	Max Temp	Probe Diam.
230.079	95±3°C	1/2-14 BSP	E	13 mm	120	12
230.080	102±3°C	1/2-14 BSP	E	13 mm	120	12

Note: VDO Switches are N/O (normally open) with the exception of p/n 230.xxx marked "NC"

TEMPERATURE SENDERS & SWITCHES

Temp Sender & Switch N/O			40 - 120 Deg. C		
Part No.	Switch Point	Thread Size	Term	Body Length	Ohms Range 40-120 °C
323803001004D	90±3°C	M14x1.5	H	40mm	287-23 ohms
323803001006D	96±3°C	M14x1.5	H	40mm	287-23 ohms
323803001008D	110±3°C	M14x1.5	H	40mm	287-23 ohms
323803001011D	95±3°C	5/8-18 NF-3	H	40mm	287-23 ohms
323803001002D	98±3°C	5/8-18 NF-3	H	40mm	287-23 ohms
323803001019D	95±3°C	1/2-14 NPTF	H	40mm	287-23 ohms
323803001013D	106±3°C	M14x1.5	H	40mm	287-23 ohms

Note: All temp switches are N/O (normally open) rated 3 Watts

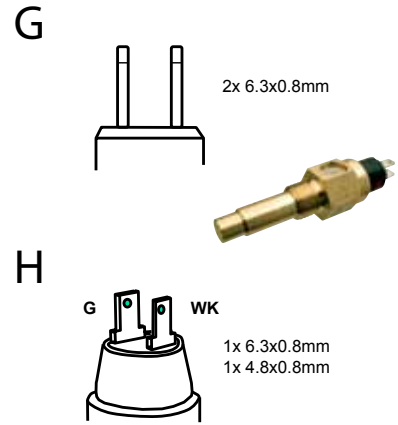

TEMPERATURE SENDERS

Temp Sender		40 - 120 Deg. C		
Part No.	Thread Size	Term	Body Length	Ohms Range 40-120 °C
323801001006K	M14x1.5	A	29mm	287-23 ohms
323801001040N	M16x1.5	A	29mm	287-23 ohms
323801001010K	1/2-14 NPTF	A	29mm	287-23 ohms
323801001008N	5/8-18 UNF-3A	A	29mm	287-23 ohms
323805001001K	M14x1.5	G	29mm	287-23 ohms
323805001015N	M18x1.5	G	29mm	287-23 ohms
323805001004K	1/2-14 NPTF	G	29mm	287-23 ohms
323805001005N	3/8-18 NPTF	G	29mm	287-23 ohms
323805001002C	5/8-18 UNF-3A	G	29mm	287-23 ohms

Temp Sender - Dual Station (2 gauges)		40 - 120 Deg. C		
Part No.	Thread Size	Term	Body Length	Ohms Range 40-120 °C
325805003001C	1/4-18NPT	G	40mm	144-12 ohms

Temp Sender - Various Applications							
Part No.	Range	Ohms (Ω)	Ω@ 100°C	Thread	Body Length	Insulator	Terminal
320.002	40-120°C	287-23	38.6	1/8"-27 NPTF	29.0mm	white	button
320.004	40-120°C	287-23	38.6	M16x1.5	29.0mm	white	button
320.006	60-200°C	550-14	148.8	1/8"- 27 NPTF	29.0mm	red	button
320.020	60-200°C	550-14	148.8	1/8"-27 NPTF	10.5mm	black	button
320.021	50-150°C	323-18	62.2	1/8"-27 NPTF	29.0mm	yellow	button
320.022	40-120°C	287-23	38.6	1/2"-14 NPTF	29.0mm	white	spade
320.039	40-120°C	145-17	31.5	use old nut	17.0mm	black	bullet
320.043	40-120°C	184-17	32.0	M16x1.5	22.0mm	black	spade
320.044	40-120°C	313-22	41.2	M16x1.5	27.0mm	black	spade
320.046	40-120°C	380-30	54.0	5/8"-18 UNF	29.0mm	red	spade
320.067	40-120°C	232-22	65.9	M8x0.75	22.0mm	black	bullet
320.068	40-120°C	175-20	32.4	M16x1.5	22.0mm	black	bullet
320.088	40-120°C	192-30	52.0	1/8"-28 BSPT	22.0mm	black	spade
320.092	50-150°C	323-18	62.2	1/8"-27NPTF	29.0mm	green	thread
320.093	40-120°C	287-23	38.6	1/8"-27NPTF	29.0mm	black	thread
320.107	250°F	450-30		1/8"-27NPT			spade

Note: Not all the above temperature senders are suitable for cockpit gauges. Some temp senders are used in OEM applications.





Thermowell 180.059

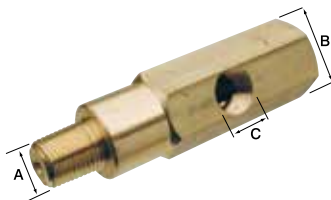

SENDER THREAD ADAPTORS

Suitable for pressure sensor & some temperature senders & switches with 1/8"-27NPTF thread. Mechanical temperature gauges with 1/8"-27NPTF thermowell (180.059). Oil line kits (230.012 & 230.013) for mechanical pressure gauges.

Adaptors Brass			
Part No.	Internal Thread	External Thread	Overall Length
320.050	1/8"-27NPTF	1/4"-18NPTF	20mm
320.051	1/8"-27NPTF	3/8"-18NPTF	20mm
320.053	1/8"-27NPTF	1/2"-14NPTF	20mm
320.052	1/8"-27NPTF	5/8"-18UNF	20mm
320.054	1/8"-27NPTF	M14x1.5	20mm
320.055	1/8"-27NPTF	M16x1.5	20mm
320.056	1/8"-27NPTF	M18x1.5	20mm

Adaptors Brass			
Part No.	Internal Thread	External Thread	Overall Length
320.058	5/8"-18UNF	1/2"-14NPTF	20mm
320.101	1/4"-14NPTF	1/2"-14NPTF	20mm

Adaptors Brass			
Part No.	Internal Thread	External Thread	Overall Length
320.105	M12x1.5	1/8"NPT	30mm

To suit mechanical pressure gauges

Adaptors Stainless Steel			
Part No.	Internal Thread	External Thread	Overall Length
320.074	1/8"-27NPTF	1/8"BSPT	30mm
320.075	1/4"-18NPTF	3/8"BSPT	30mm
320.076	1/8"-27NPT	M12x1.25	30mm

Adaptors Brass			
Part No.	Internal Thread	External Thread	Overall Length
180.059	Thermowell	1/8"-27NPTF	40mm

To suit mechanical temperature gauges

T-PIECE ADAPTORS, brass

Suits oil line kits and oil pressure sender units with 1/8"-27 NPTF male thread, while at the same time retaining the existing oil warning light switch.

Adaptors Brass				
Part No.	Thread A	Thread B	Thread C	Length
230.031	1/8"-27NPTF	1/8"-27NPTF	1/8"-27NPTF	66mm
230.032	1/4"-18NPTF	1/4"-18NPTF	1/8"-27NPTF	66mm
230.033	M10x1.0	M10x1.0	1/8"-27NPTF	66mm
230.035	M14x1.5	M14x1.5	1/8"-27NPTF	66mm
230.036	1/8"-28BSPT	1/8"-28BSPT	1/8"-27NPTF	66mm



SPEED SENSORS - HALL EFFECT

Mechanically driven - Requires male drive pilot or drive key adaptor						
Part No.	Voltage	Thread	Pic	Type	Imp/Rev	Plug Kit
K46004	12V	7/8"-18UNF	1	H/E	8	K72221
K46020	12/24V	M22x1.5	1	H/E	8	K72221
K46021	12/24V	7/8"-18UNF	1	H/E	8	K72221
K70450	12V	M22x1.5	2	H/E	8	K72222
K70451	12V	7/8"18UNF	2	H/E	8	K72222
340.808	12V	M22x1.5	3	H/E	8	N/A
340808001004G		7/8"18UNF	4	Gen	4	N/A

DRIVE KEYS

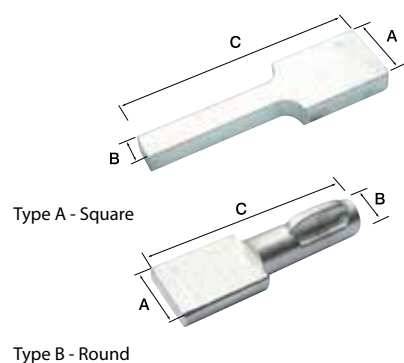

Drive Keys - To suit mechanically driven hall effect & generator sensors				
Part No.	Dimension A Diam.	Dimension B	Dimension C	Type
K72103	2.6 x 8mm	2.6mm	26mm	Type A
K72113	2.6 x 8mm	5.2mm	26mm	Type A
230.061	3.0 x 8mm	3.0mm	26mm	Type B
230.062	2.6 x 8mm	3.8mm	26mm	Type B
230.063	2.6 x 8mm	4.7mm	26mm	Type B
230.064	2.6 x 8mm	5.0mm	26mm	Type B

SPEED SENSORS - PROXIMITY



Proximity Senders (Hall Effect) - 4 Blade Bayonet Type				
Part No.	Imp/Rpm	Thread	Length	Voltage
K70452	2 x 8 (180 out of Phase)	M18x1.5	90mm	12V
K70453	2 x 8 (180 out of Phase)	M18x1.5 (Volvo Type)	25mm	12V
340216001024	2 x 8 (180 out of Phase)	M18x1.5 (Volvo Type)	63mm	12V
215950003101	2 x 8 (180 out of Phase)	M18x1.5	20mm	12V
215950004301	2 x 8 (180 out of Phase)	M18x1.5	25mm	12V
215950004501	2 x 8 (180 out of Phase)	M18x1.5	35mm	12V
215920102301	2 x 8 (180 out of Phase)	M18x1.5	25mm	12V

RPM SENSORS - PROXIMITY

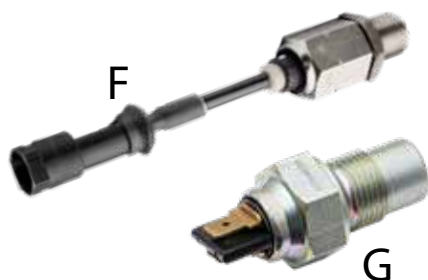

2 Wire Reluctor (Inductive)						
Part No.	Thread Size	L1 mm	L2 mm	L3 mm	L4 mm	Picture
340.007	M18x1.5		25			F
340.008	3/4-16 UNF-2A		44			G
340.009	M18x1.5		84			G
340804007019	M18x1.5	18.2	70.7	71.8 ± 0.1	79.7	G



Adjustable lever arm sender 220.00x



Plastic senders do not include gasket. Use 2250234 or 36373/9A

LEVER ARM LEVEL SENDERS

Fully adjustable universal		PCD 54mm
Part No.	Description	Range E-F
220.003	150 - 535mm adjustable	3-180 Ohms
220.004	150 - 535mm adjustable	0-90 Ohms
220.005	150 - 535mm adjustable	240-33 Ohms

Adjustable height, adjustable float - Insulated return		PCD 54mm
Part No.	Description	Range E-F
226801015001C	150 - 600mm adjustable	3-180 Ohms

Fixed height, adjustable float - Insulated return		PCD 54mm
Part No.	Description	Range E-F
A2C59510171	Lever Arm fuel sender	3 -180 Ohms
A2C59510165	Lever Arm fuel sender w/ low switch	3 -180 Ohms

REED SWITCH LEVEL SENDERS

Vertical arrangement allows use in tanks with limited space ie. baffles or walls. All stainless body offers compatibility with harsh fuels, detergents and water and only one moving part means the sensing element is not exposed, ensuring significantly longer life compared to exposed variable resistor style senders. All reed switch senders include NBR gasket and weatherproof mating connector.



Reed Switch Senders			PCD 54mm
Part No.	Range E - F	Length	LFW
220.150-180	3-180 Ohms	150 mm	
220.180-180	3-180 Ohms	180 mm	
220.230-180	3-180 Ohms	230 mm	Yes
220.250-180	3-180 Ohms	250 mm	Yes
220.260-180	3-180 Ohms	260 mm	Yes
220.270-180	3-180 Ohms	270 mm	Yes
220.300-180	3-180 Ohms	300 mm	Yes
220.330-180	3-180 Ohms	330 mm	Yes
220.350-180	3-180 Ohms	350 mm	Yes
220.600-180	3-180 Ohms	600 mm	Yes
220.660-180	3-180 Ohms	660 mm	Yes
220.900-180	3-180 Ohms	900 mm	Yes

Note: 'LFW' - Low fuel warning - Normally open switch (N/O).

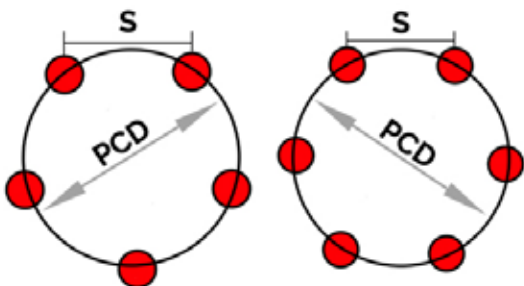

TIP:
PCD stands for Pitch Circle Diameter. It is the measurement of the circular centre line of all mounting holes. PCD can be estimated by measuring the distance between two adjacent holes (S). For 5 holes, multiply this value by 1.7012. For 6 holes, multiply this value by 2.

TUBULAR FLOAT LEVEL SENDERS

Tubular Float - 41mm cut-out dia.			PCD 54 mm
Part No.	Sender Length	Resistance at Full	Resistance at Empty
224011000015G	150mm	4.5	69
224011000018G	180mm	3	64
224011000020G	200mm	3	68
224011000022G	220mm	3	80
224011000024G	240mm	3	65.5
224011000026G	260mm	2.5	72
224011000028G	280mm	2.5	75.5
224011000030G	300mm	2.5	82.8
224011000034G	340mm	2.5	74
224011000038G	380mm	2.5	73
224011000040G	400mm	2.5	74.9
224011000045G	450mm	2.5	84.3
224011000050G	500mm	2.5	75.4
224011000055G	550mm	2.5	77.6
224011000060G	600mm	2.5	85.3
224011000065G	650mm	2.5	82.2
224011000070G	700mm	2	81.6
224011000075G	750mm	2	82
224011000080G	800mm	2	68.5

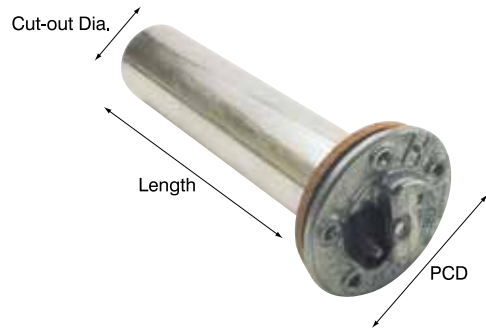

FUEL LEVEL SENDER ACCESSORIES

Accessories		
Part No.	Description	PCD
2250234	Gasket - cork (suit diesel only)	54mm
36373/9A	Gasket - neoprene rubber	54mm
220.777	Gasket - neoprene rubber	68mm
2251016	Gasket - neoprene rubber	80mm
N05801432	Flange mounting kit for soft tanks	54mm
CTA0200KIT	Tank flange reducer 6-5 Hole	68mm
CTA0201KIT	Tank flange reducer 6-5 Hole	68mm
CTA0202KIT	Tank flange reducer 6-5 Hole	80mm

Note: CTA020x reducers suit 54mm PCD sender. Includes large gasket and mounting hardware. Sender & sender gasket not included.

Neoprene Rubber Gasket 36373/9A



Flange Mounting Kit N05801432
Suits all 54mm PCD senders for installation in plastic/fibreglass tanks.



Tank adapter plate CTA020x
For insatllation of new 54mm PCD sender in a 68mm/80mm application.



NOT SURE?

VDO Gauge Check can be found on page 52. Handy workshop tool used to test gauges and measure variable resistance required for replacement senders. Simply connect to the sender terminals and use the dial to simulate gauge movement. Resistance can then be recorded to help match with the correct replacement sender.



VEHICLE SENDERS APPLICATION LISTING

AUDI					Oil	Temp	Pressure
Model	Series	Year	Engine	Capacity	Light	Sender	Sender
80	CC, 1.8E Quattro, 2.0 & 2.0S	86-87	4 Cyl	1.8L, 2.0L			360.022
A4	4D Hatchback, Turbo	95-01	4 Cyl	1.8L			360.022

CHRYSLER					Oil	Temp	Pressure
Model	Series	Year	Engine	Capacity	Light	Sender	Sender
Valiant	All	62-81	6 Cyl, 8 Cyl	All	231.083	320.002	360.001
Charger	All	62-81	6 Cyl, 8 Cyl	All	231.083	320.002	360.001
Centura	KB	75-77	4 Cyl	2.0L	230.089		
Centura	KB, KC	75-78	6 Cyl	3.5L, 4.0L	231.083		
Galant	All	71-77	4 Cyl	All	231.083		

DAEWOO					Oil	Temp	Pressure
Model	Series	Year	Engine	Capacity	Light	Gauge	Gauge
Cielo	1.5 SOHC	94-95	4 Cyl	1.5L		320.008	
Cielo	1.5 SOHC, 1.5 DOHC	95-98	4 Cyl	1.5L		320.095	
Kalos	1.5L SOHC	03-04	4 Cyl	1.5L		320.098	
Lacetti	All	03-04	4 Cyl	1.8L		320.095	
Lanos	All	97-03	4 Cyl	1.5L, 1.6L		320.095	
Leganza	All	97-02	4 Cyl	2.0L, 2.2L		320.095	
Matiz	All	99-04	3 Cyl	0.8L		320.095	
Nubira	J100	97-99	4 Cyl	1.6L		320.098	
Nubira	J100	97-99	4 Cyl	2.0L		320.099	
Nubira	J150	99-03	4 Cyl	2.0L		320.095	
Tacuma	Wagon	00-04	4 Cyl	2.0L		320.095	

DAIHATSU					Oil	Temp	Pressure
Model	Series	Year	Engine	Capacity	Light	Sender	Sender
Applause	A101	89-99	4 Cyl	1.6L	231.084		
Charade	G10, G11, G11 Turbo	80-87	3 Cyl	1.0L	231.084	320.068	
Charade	G100, G100 Turbo	87-93	3 Cyl	1.0L	231.084	320.068	
Charade	G102	88-93	4 Cyl	1.3L	231.084	320.068	

FORD					Oil	Temp	Pressure
Model	Series	Year	Engine	Capacity	Light	Sender	Sender
Capri	All	74-84	4 Cyl, 6 Cyl	1.6L, 3.0L		320.067	
Courier	PC 4WD	87-98	4 Cyl	2.6L	231.084	320.067	
Courier	PE, PG, PH	99-on	4 Cyl	2.6L	231.084	320.067	
Courier	PH	99-on	4 Cyl	2.6L	231.084	320.067	
Econovan	1.4L, 1.8L	84-97	4 Cyl	1.4L, 1.8L	231.084		
Econovan	1.6L	84-97	4 Cyl	1.6L	231.084	320.068	
Econovan	1.8L, 2.0L	03-06	4 Cyl	1.8L, 2.0L		320.067	
Econovan	Diesel	81-84	4 Cyl	2.2L	231.084	320.068	
Econovan	Diesel	84-90	4 Cyl	2.2L	231.084		
Econovan	Diesel	90-97	4 Cyl	2.2L	231.084	320.067	
F100, F250, F350	RWD, 4WD	70-90	6 Cyl	4.1L	231.106		
F100	4WD EFI, RWD EFI	85-87	8 Cyl	4.9L	231.106		
F150	4WD EFI, RWD EFI,	87-90	8 Cyl	4.9L	231.106		
F250	RWD Carb,	87-90	8 Cyl	4.9L	231.106		
F350	RM RWD EFI	01-02	8 Cyl	5.4L	231.106		

VEHICLE SENDERS APPLICATION LISTING

FORD (cont.)					Oil	Temp	Pressure
Model	Series	Year	Engine	Capacity	Light	Sender	Sender
Fairlane	ZA, ZG	67-76	6 Cyl, 8 Cyl	4.1L, 4.9L	231.081		
Fairlane	ZJ, ZK, EFI, Carb.	79-83	6 Cyl, 8 Cyl	4.1L, 4.9L	231.106		
Fairlane	ZH	76-79	8 Cyl	4.9L, 5.8L	231.081		360.003
Fairlane	ZL Leaded	84-86	6 Cyl	4.1L	231.106		
Fairlane	ZL Unleaded	86-88	6 Cyl	4.1L	231.106		
Fairlane	NA, NC, NF, NL	88-98	6 Cyl	3.9L, 4.0L	231.081		
Fairlane	NC, NF, NL	91-98	8 Cyl	5.0L	231.106		
Fairlane	AU, AU II	99-02	6 Cyl	3.9L, 4.0L	231.081		
Fairlane	BA, BF, XR6, XR8, UTE	03-07	6 Cyl, 8 Cyl	4.0L, 5.0L			360.001
Falcon	XK, XP, XR, XT, XW, XY	60-72	6 Cyl, 8 Cyl	All	231.081		
Falcon	XL, XM,	61-65	6 Cyl	All	231.081		
Falcon	XT Carb, XW Carb, XW GTHO Phase 1 & 2, XY Carb, XY GTHO Phase 3	68-72	8 Cyl	5.0L, 5.8L, 4.9L	231.081		
Falcon	XA, XB, XC, XC Carb	72-79	6 Cyl, 8 Cyl	All	231.081		360.003
Falcon	XD, XE, UTE	79-84		3.3L, 4.1L	231.106		360.013
Falcon	XF, UTE, EFI Carb	84-88	6 Cyl	4.1L	231.106		360.013
Falcon	EA, EA II, EB, ED	89-94	6 Cyl, 8 Cyl	3.2L, 3.9L, 4.0L, 5.0L	231.106		360.013
Falcon	EF, EFII, EL	94-98	6 Cyl	4.0L	231.106		
Falcon	EF, EFII, EL	94-98	8 Cyl	5.0L	231.106		
Falcon	AU, AUII, AUIII, UTE, XR6, XR6 UTE	98-02	6 Cyl,	4.0L	231.106		
Falcon	AU, AUII, AUIII, XR8, UTE, XR8 UTE, AU TE50	98-02	8 Cyl	5.0L	231.106		
Falcon	XH Ute / Van	96-98	6 Cyl, 8 Cyl	4.0L, 5.0L	231.106		
Festiva	WA	91-93	4 Cyl	1.3L	231.084		
Festiva	WA	93-94	4 Cyl	1.3L	231.084		
Festiva	WB, WD	94-97	4 Cyl	1.3L	231.102		
Festiva	WF	94-03	4 Cyl	1.3L	231.084 231.102		
Festiva	WD, WF	97-01	4 Cyl	1.5L	231.102		
Laser	KA, KB, KC, KF, TX3, 4WD	81-91	4 Cyl	1.6L	231.084		320.067
Laser	KC, KH, KJ, TX3	91-99	4 Cyl	1.6L	231.082		
Laser	KA, KB Incl Turbo	81-85	4 Cyl	1.3L, 1.5L			320.067
Laser	KC, KC Carb	85-87	4 Cyl	1.3L			320.067
Laser	KC Carb	85-87	4 Cyl	1.6L	231.084		320.067
Laser	KE Carb	87-90	4 Cyl	1.3L			320.067
Laser	KE Carb, EFI	87-90	4 Cyl	1.6L	231.084		
Laser	KE Carb, EFI	89-90	4 Cyl	1.6L	231.084		320.067
Laser	KE EFi Turbo, EFI 16V 4x4 Turbo	87-90	4 Cyl	1.6L			320.067
Laser	KE EFi Turbo, EFI 16V 4x4 Turbo	88-90	4 Cyl	1.6L			320.067
Laser	KF Carb, EFI, EFI 16V	90-91	4 Cyl	1.6L, 1.8L			320.097
Laser	KF EFI Turbo	90-91	4 Cyl	1.8L	231.102		320.097
Laser	KH, TX3 EFI	91-94	4 Cyl	1.6L			320.097
Laser	KH TX3 EFI Turbo	91-93	4 Cyl	1.8L	231.084		320.097
Laser	KJ EFI	94-96	4 Cyl	1.6L			320.097
Laser	KJ EFI	96-98	4 Cyl	1.6L, 1.8L			
Laser	KJ EFI	94-96	4 Cyl	1.8L			320.097
Laser	KN	99-01	4 Cyl	1.6L			

VEHICLE SENDERS APPLICATION LISTING

FORD (cont.)					Oil	Temp	Pressure
Model	Series	Year	Engine	Capacity	Light	Sender	Sender
Laser	KN	99-01	4 Cyl	1.8L			
Laser	KQ	01-02	4 Cyl	1.6L, 1.8L, 2.0L			
LTD	FD	83-84	6 Cyl	4.1L	231.106		
LTD	FE	84-88	6 Cyl	4.1L	231.106		
LTD	DA (MPI)	88-91	6 Cyl	3.9L	231.106		
LTD	DC	91-94	6 Cyl, 8 Cyl	4.0L, 5.0L	231.106		
LTD	DF	94-96	6 Cyl, 8 Cyl	4.0L, 5.0L	231.106		
LTD	DL	96-98	6 Cyl, 8 Cyl	4.0L, 5.0L	231.106		
LTD	AU, AU II	98-02	6 Cyl, 8 Cyl	4.0L, 5.0L	231.106		
Maverick	(Carb)	88-93	6 Cyl	4.2L			
Meteor	GA, GB, GC	82-85	4 Cyl	1.5L, 1.6L	231.084		
Meteor	GC	85-87	4 Cyl	1.6L	231.084		
Probe	ST, SU, SV	94-98	V6	2.5L			
Raider	UV	91-96	4 Cyl	2.6L			
Telstar	AR (Carb), AT(Carb)	83-89	4 Cyl	2.0L	231.084	320.067	
Telstar	AS Inc TX5, Turbo	85-87	4 Cyl	2.0L	231.084	320.067	
Telstar	AT EFI Inc TX5, Turbo	87-89	4 Cyl	2.2L	231.084	320.067	
Telstar	AV, AV EFI-Turbo	90-92	4 Cyl	2.2L			
Telstar	AX DOHC, AY DOHC	92-96	4 Cyl, 6 Cyl	2.0L, 2.5L			
Trader	0409, 0509	79-89	4 Cyl	2.0L, 3.0L, 3.5L	231.084		
Trader	0711, 0811 Diesel	81-95	4 Cyl	4.1L	231.084		
Trader	0811, 0812, Turbo Diesel	87-92	4 Cyl	3.5L	231.084		
Transit		73-81	6 Cyl	4.1L	231.081		

HOLDEN					Oil	Temp	Pressure
Model	Series	Year	Engine	Capacity	Light	Sender	Sender
Apollo	JK, JL Carb	89-93	4 Cyl	2.0L	231.102		
Apollo	JK, JL (EFI)	89-91	4 Cyl	2.0L	231.102		
Astra	LB, LC	84-89	4 Cyl	1.5L, 1.6L	231.087	320.039	
Astra	LD	87-89	4 Cyl	1.6L	231.087	320.039	
Barina	MB, MF, ML	85-91	4 Cyl	1.3L	231.084		
Barina	MH	91-94	4 Cyl	1.3L	231.084		
Camira	JB, JD, JE	82-89	4 Cyl	1.6L, 1.8L, 2.0L	231.087		
Commodore	VC, VH	80-81	4 Cyl	1.9L	231.081		
Commodore	VB, VC, VH, VK EFI	78-86	6 Cyl	2.8L, 3.3L	231.081		360.004
Commodore	VB, VC, VH, VK EFI	78-86	8 Cyl	3.3L	231.081		360.004
Commodore	VL, VL Turbo	86-88	6 Cyl	3.0L			360.017
Commodore	VN, VP, VQ, VR	88-95	6 Cyl, 8 Cyl	3.8L, 5.0L	231.088		
Commodore	VS, VS Supercharged, Ute	95-96	6 Cyl	3.8L,	231.088		
Commodore	VS Series II	96-98	8 Cyl	5.0L	231.088		
Commodore	VT, VT I Supercharged, GTS	97-99	6 Cyl	3.8L,	231.088		
Commodore	VT	97-99	8 Cyl	5.0L	231.088		
Commodore	VT II	99-00	8 Cyl	5.7L	231.088		
Commodore	Ute VG, VX, VY, VU	97-04	6 Cyl, 8 Cyl	3.8L, 5.0L	231.088		
Commodore	VX	00-01	6 Cyl	3.8L	231.088		
Commodore	VX	00-01	8 Cyl	5.7L			
Commodore	VX Series II	01-02	6 Cyl	3.8L	231.088		
Commodore	VX Series II	01-02	8 Cyl	5.7L			
Commodore	VY	02-03	6 Cyl	3.8L	231.088		
Commodore	VY	02-03	8 Cyl	5.7L			
Commodore	VY Series II	03-04	6 Cyl	3.8L	231.088		

VEHICLE SENDERS APPLICATION LISTING

Holden (cont.)					Oil	Temp	Pressure
Model	Series	Year	Engine	Capacity	Light	Sender	Sender
Commodore	VY Series II	03-04	8 Cyl	5.7L			
Commodore	VZ	04-06	6 Cyl	3.6L			
Commodore	VZ	04-06	8 Cyl	5.7L,6.0L			
Commodore	VE	06-09	6 Cyl	3.6L			
Commodore	VE	06-09	8 Cyl	6.0L			
Commodore	VE Series II	09-13	6 Cyl	6.0L			
Gemini	TX, TC, TE, TF, TG	75-85	4 Cyl	1.6L, 1.8L D	231.084		
Gemini	RB FWD	75-85	4 Cyl	1.6L, 1.8L D	231.084		
Drover	QB	85-87	4 Cyl	1.3L		320.044	
Holden	EH, HD, HR, HK, HT	53-68	6 Cyl	All	231.084	320.002	
Holden	HK, HT, HG, HQ	68-76	6 Cyl	All	231.084	320.002	360.004
Holden	HJ, HX, HZ, WB	76-85	8 Cyl	All	231.081		360.005
Jackaroo	UBS16, UBS17 Petrol, Diesel	85-92	4 Cyl	2.6L	231.084		
Jackaroo	UBS81, UBS521 Turbo Diesel	81-88	4 Cyl	2.2L	231.084		
Jackaroo	UBS55 Turbo Diesel	88-92	4 Cyl	2.8L	231.084		
Jackaroo	UBS69 Turbo Diesel	92-98	4 Cyl	3.1L	231.084		
Jackaroo	UBS73 Turbo Diesel	98-04	4 Cyl	3.0L	231.084		
Monaro	VX, VY, CV6 Supercharged	01-04	6 Cyl	3.8L	231.088		360.004
Monaro	VY	02-04	8 Cyl	5.7L			
Monaro	VZ	04-06	8 Cyl	5.7L			
Nova	LE, LF, EFI	89-94	4 Cyl	1.4L, 1.6L, 1.8L	231.084		
Rodeo	KB25, KB26, KB40, KB41	78-82	4 Cyl	1.4L, 1.6L	231.084		
Rodeo	KB47, KB48, KB49	83-84	4 Cyl	1.8L, 1.9L, 2.3L	231.084		
Rodeo	KB43, KB49	85-88	4 Cyl	2.3L	231.084		
Rodeo	TFR54, TFS54	88-93	4 Cyl	2.5L	231.084		
Rodeo	TFR25	98-98	4 Cyl	2.3L	231.084		
Rodeo	Diesel	79-82	4 Cyl	2.0L	231.084		
Rodeo	KBD42, KBD43, KBD47	83-88	4 Cyl	2.0L	231.084	320.067	
Rodeo	KBD27, KBD28	83-88	4 Cyl	2.2L	231.084		
Rodeo	Diesel	91-01	4 Cyl	2.8L	231.084		
Rodeo	RA03	03-on	4 Cyl	3.0L	231.084		
Rodeo	RA Turbo Diesel	03-06	4 cyl	3.0L	231.084		
Rodeo	RA	03-06	6 cyl	3.5L	231.086	320.044	
Statesman	VQ	90-94	8 Cyl	5.0L	231.088		
Statesman	VR	93-95	6 Cyl, 8 Cyl	3.8L, 5.0L, 5.7L	231.088		
Statesman	VS	95-96	6Cyl, 8Cyl	3.8L, 5.0L, 5.7L	231.088		
Statesman	WH	99-01	6 Cyl	3.8L	231.088		
Statesman	WH (inc. Grange)	99-01	8 Cyl	5.7L			
Statesman	WH Series II (inc. Grange)	01-03	8 Cyl	5.7L			
Statesman	WK	03-04	6 Cyl	3.8L	231.088		
Statesman	WK	03-04	8 Cyl	5.7L			
Statesman	WL	04-06	6 Cyl	3.6L			
Statesman	WL	04-06	8 Cyl	5.7L			
Statesman	WL	04-06	8 Cyl	6.0L			
Statesman	WM - I + II	06-10	6 Cyl	3.6L			
Statesman	WM - I + II	06-10	8 Cyl	6.0L, 6.2L			
Sunbird	LX, UC	76-80	4 Cyl	1.9L	231.081	320.004	
Torana	LH, LX	74-76	4 Cyl	1.9L	231.087		
Torana	LC, LH, LJ, LX, UC	69-79	6 Cyl	All	231.081		
Torana	LH, LX	69-79	8 Cyl	All	231.081		360.005

VEHICLE SENDERS APPLICATION LISTING

HONDA					Oil	Temp	Pressure
Model	Series	Year	Engine	Capacity	Light	Sender	Sender
Accord	SJD, SJFR	77-78	4 Cyl	1.6L	231.086	320.068	
Civic	ED, EE	87-91	4 Cyl	1.5L	231.086	320.068	
Civic	EG, EH	91-95	4 Cyl	1.5L, 1.6L	231.086	320.068	
Civic	EK4, VTi R	91-95	4 Cyl	1.5L, 1.6L	231.086	320.068	
Concerto	MA EX-I	88-93	4 Cyl	1.6L	231.086	320.068	
Legend	KA7, KA8, KA9	91-96	6 Cyl	2.7L, 3.2L	231.102	320.068	
Legend	KA9	96-05	6 Cyl	3.5L	231.102		
Odyssey	RA1	95-97	4 Cyl	2.2L	231.086	320.068	
Prelude	BA8, BB2	91-96	4 Cyl	2.2L, 2.3L	231.086	320.068	

HYUNDAI					Oil	Temp	Pressure
Model	Series	Year	Engine	Capacity	Light	Sender	Sender
Accent		00-02	4 Cyl	1.5L		320.067	
Accent	LC,LS	00-06	4 Cyl	1.6L			
Accent	MC	06-09	4 Cyl VVT	1.6L			
Coupe RD, RDII	FX, SX, SFX	96-02	4 Cyl	1.8L, 2.0L		320.067	
Elantra	XD	00-03	4 Cyl	1.8L, 2.0L			
Elantra	XD MY04	03-06	4 Cyl	2.0L			
Elantra Elite	HD	06-on	4 Cyl VVT	2.0L			
Elantra	Lavita	01-03	4 Cyl	1.8L			
Excel	X1 (Carb)	86-89	4 Cyl	1.5L		320.067	
Excel	X2,	90-94	4 Cyl	1.5L		320.067	
Excel	X3 SOHC	94-98	4 Cyl	1.5L		320.067	
Excel	X3, DOHC	98-00	4 Cyl	1.4L			
Getz	TB	02-05	4 Cyl	1.5L		320.067	
Getz	TB	03-05	4 Cyl	1.3L			
Getz	TB MY06	05-07	4 Cyl	1.4L			
Getz	TB MY06	05-on	4 Cyl	1.6L			
Getz	TB SXi	06-on	4 Cyl	1.6L			
Lantra	KF2, KF3	91-95	4 Cyl	1.6L, 1.8L		320.044	
Lantra	J2	95-98	4 Cyl	1.8L		320.044	
Lantra	L3	99-00	4 Cyl	1.8L, 2.0L		320.067	
Santa - Fe	CM	06-09	4 Cyl T/D	2.2L			
S-Coupe	UE2, UE3	90-91	4 Cyl	1.5L		320.044	
S-Coupe	UE3, UE4	92-95	4 Cyl	1.5L		320.044	
S-Coupe	UE3, UE4	92-95	4 Cyl	1.5L		320.044	
Sonata	AF2, AF3	89-92	4 Cyl	2.4L		320.067	
Sonata	AF2, AF3	90-93	4 Cyl	2.4L		320.044	
Sonata	DF2, DF4	93-96	4 Cyl	2.0L	213.137	320.044	
Sonata	DF3, DF4	93-98	6 Cyl	3.0L		320.044	
Sonata	EF	98-00	4 Cyl	2.0L		320.067	
Sonata	EF	98-01	6 Cyl	2.5L		320.067	
Sonata	EF-B	01-05	4 Cyl	2.4L		320.044	
Trajjet	GLS Wagon	00-07	6 Cyl	2.7L			
Tucson	Elite Wagon	04-on	4 Cyl, 6 Cyl	2.0L, 2.7L			

VEHICLE SENDERS APPLICATION LISTING

KIA					Oil	Temp	Pressure
Model	Series	Year	Engine	Capacity	Light	Sender	Sender
Carens		00-02	4 Cyl	1.8L DOHC	231.102		
Carnival	UP	99-06	6 Cyl	2.5L	231.102	320.067	
Pregio Van		02-on	4 Cyl	2.7L		320.067	
Rio	BC	00-on	4 Cyl	1.5L	231.102		
Shuma	FB	99-01	4 Cyl	1.8L	231.102	320.067	
Spectra	5D Hatch	01-04	4 Cyl	1.8L	231.102		
Sportage	JA	96-04	4 Cyl	2.0L	231.102	320.067	

LEXUS					Oil	Temp	Pressure
Model	Series	Year	Engine	Capacity	Light	Sender	Sender
ES300	VCV10R	92-96	6 Cyl	3.0L		320.067	
ES300	MCV20R	96-on	6 Cyl	3.0L		320.088	
GS300	JZS160R	97-05	6 Cyl	3.0L			

MAZDA					Oil	Temp	Pressure
Model	Series	Year	Engine	Capacity	Light	Sender	Sender
1.2L - 1.8L,		68-77	4 Cyl	1.5L, 1.6L, 1.8L	231.084		
B1500, B1600	Petrol	70-82	4 Cyl	1.5L, 1.6L, 1.8L	231.084		
B1800	Petrol	70-82	4 Cyl	1.5L, 1.6L, 1.8L	231.084		
B2000	Petrol	82-88	4 Cyl	2.0L	231.084		
B2200	Bravo Incl. MANUAL (Carb)	88-93	4 Cyl	2.2L	231.102		
B2200	Bravo Incl. AUTO	88-91	4 Cyl	2.2L	231.102		
B2500, B2600	RWD, 4WD, Diesel, Turbo Diesel	96-on	4 Cyl	2.5L, 2.6L	231.102		
B2600 EFI	Bravo, 4WD	90-02	4 Cyl	2.6L	231.084		
Capella		70-78	4 Cyl	1.6L	231.084		
E1300, E1400		78-86	4 Cyl	1.3L, 1.5L	231.084		
E1600		78-86	4 Cyl	1.6L	231.084		
E2000		98-on	4 Cyl	2.0L	231.102		
E2500		97-on	4 Cyl	2.5L	231.102		
121	CD2	76-79	4 Cyl	1.8L	231.084	320.068	
121	DA	87-90	4 Cyl	1.3L	231.102	320.088	
121	DB1031,	90-97	4 Cyl	1.3L	231.102	320.088	
323	FA, BD, BF, BW, 4WD, Turbo	77-89	4 Cyl	1.3L, 1.5L, 1.6L	231.102		
323	BG, BJ, Astina, Protege`	89-04	4 Cyl	1.6L, 1.8L	231.102	320.067	
626	CB2	78-83	4 Cyl	2.0L	231.084		
626	GC Diesel, GD-Turbo	84-91	4 Cyl	2.0L, 2.2L	231.084		
626	GV10-Wagon, GE, GF	88-02	4 Cyl	2.0L, 2.2L	231.102	320.067	
626	GE	92-97	6 Cyl	2.5L	231.102	320.067	
808		72-78	4 Cyl	1.3L, 1.6L	231.084		
929	HBSHE	82-87	4 Cyl	2.0L	231.084		
929	HC10E1, HC10E2	87-91	6 Cyl	3.0L	231.084		
929	HC10E2 - 4WS	90-96	6 Cyl	3.0L	231.102	320.067	
MPV	LV	93-94	6 Cyl	3.0L	231.084	320.067	
MPV	LV II	94-99	6 Cyl	3.0L	231.084	231.067	
MX5	NA (DOHC)	93-98	4 Cyl	1.8L	231.102	320.067	
MX5	NB (DOHC), Incl Turbo	98-05	4 Cyl	1.8L	231.102	320.067	
MX6	GD Turbo, 2WD, 4WD	87-97	4 Cyl, 6 Cyl	2.0L, 2.2L, 2.5L	231.102	320.067	
MX6	GE10, GE20, 2WD, 4WD	94-97	4 Cyl, 6 Cyl	2.0L, 2.2L, 2.5L	231.102	320.067	

VEHICLE SENDERS APPLICATION LISTING

MAZDA (cont.)					Oil	Temp	Pressure
Model	Series	Year	Engine	Capacity	Light	Sender	Sender
Premacy	CP Wagon	01-03	4 Cyl	1.8L	231.102		
R100		69-71	Rotary Eng		231.084		
RX2, 3, 4, 5		70-79	Rotary Eng	1.1L, 1.3L	231.084		
RX7	SA22 Series 1, 2, 3	79-85	Rotary Eng	1.1L	231.084		
RX7	FC10 IV	86-89	Rotary Eng	1.3L		320.067	
T2000		81-82	4 Cyl	2.0L		320.067	
T3500, T4000	Diesel, Turbo	84-00	4 Cyl, 6 Cyl	3.5L, 4.0L	231.084	320.067	
T4100	Diesel	84-91	4 Cyl	4.0L, 4.1L		320.067	
T4600	Diesel	92-on	4 Cyl	4.6L	231.084	320.067	
Traveller	L, LX, LT, 1800, 2000	86-88	4 Cyl	1.8L			
Eunos 30X	EC DOHC	96-97	6 Cyl	1.8L	231.102	320.067	
Eunos 500	CA	92-96	6 Cyl	2.0L	231.102	320.044	
Eunos 500	CA	96-99	6 Cyl	2.0L	231.102	320.067	
Eunos 800	TA	94-96	6 Cyl	2.5L		320.038	
Eunos 800M	TA	94-96	6 Cyl	2.3L		320.038	
Eunos 800M	TA3, TA5, TB3	96-00	6 Cyl	2.3L	231.102	320.067	
Eunos Millenia		00-02	6 Cyl	2.3L	231.102	320.067	

MERCEDES-BENZ					Oil	Temp	Pressure
Model	Series	Year	Engine	Capacity	Light	Sender	Sender
190	E 1.8, E 2.0, E 2.3	82-87	4 Cyl	1.8L, 2.0L, 2.3L	231.087	320.035	
190, 190D	E 1.8, E 2.0, E 2.3	88-93	4 Cyl	1.8L, 2.0L, 2.3L	231.087	320.035	
200D, 220D, 240D, 140, 160	E, CE, TD, TE	74-86	4 Cyl	1.8L, 2.0L, 2.3L	231.087	320.002	

MITSUBISHI					Oil	Temp	Pressure
Model	Series	Year	Engine	Capacity	Light	Sender	Sender
3000 GT		92-96	6 Cyl	3.0L	231.102	320.044	
Fuso Canter	FC212, FC432	81-92	4 Cyl	2.6L	230.089	320.067	
Challenger		98-on	6 Cyl	3.0L, 3.5L	230.089	320.067	
Colt	RA, RB, RC	80-84	4 Cyl	1.4L, 1.5L	230.089		
Colt	RC, RD, RE	84-90	4 Cyl	1.4L, 1.5L	231.102		
Galant	HG	89-90	4 Cyl	2.0L	231.102	320.044	
L200	MA, MB, MD 4WD	79-86	4 Cyl	2.0L, 2.3L	230.089		
L200	MC, MD	82-86	4 Cyl	1.6L	231.102		
L300 Express	SA, SB, SC, SD, SE 4WD	80-86	4 Cyl	1.6L, 1.8L	231.102		
Starwagon	SJ, 4WD, EFI, Diesel	86-94	4 Cyl	2.0L, 2.4L	231.102		
Starwagon	SF (EFI), SG (EFI), SH (EFI)	86-94	4 Cyl	2.4L	231.102		
Express / Starwagon	SF, SG, SH, SJ, 4WD, EFI, Diesel	86-94	4 Cyl	2.0L, 2.4L	231.102		
Express/ Starwagon	SJ	94-04	4 Cyl	2.0L, 2.4L	231.102	320.044	
Express/ Starwagon	WA, EFI	94-98	4 Cyl, 6 Cyl	2.0L, 2.4L, 3.0L	231.102	320.044	
Lancer	CA, CB, CC	88-96	4 Cyl	1.5L, 1.6L, 1.8L	231.102	320.044	
Lancer	CC	92-96	4 Cyl	1.8L	231.102	320.067	
Lancer	CE, CG	96-04	4 Cyl	1.5L, 1.6L, 1.8L	231.102	320.067	
Magna	TM, TN, TP, TR	85-94	4 Cyl	2.6L	231.084	320.067	
Magna	TM, TN, TP, TR	85-94	6 Cyl	3.0L	231.102	320.067	
Magna	TS Carb, TS EFI	94-97	4 Cyl	2.6L	231.084	320.044	

VEHICLE SENDERS APPLICATION LISTING

MITSUBISHI (cont.)						Oil	Temp	Pressure
Model	Series	Year	Engine	Capacity	Light	Sender	Sender	
Magna	TS, EFI	94-97	6 Cyl	3.0L	231.102	320.044		
Magna	TE, TF, EFI	96-97	4 Cyl	2.4L		320.067		
Magna	TF, EFI	97-99	6 Cyl	3.0L	231.102	320.067		
Magna	TH, TJ	99-03	6 Cyl	3.0L, 3.5L	231.102	320.067		
Magna	TL, TW	03-04	6 Cyl	3.0L	231.102	320.067		
Mirage	CE	96-05	4 Cyl	1.5L		320.067		
Nimbus	UA, UB	84-87	4 Cyl	2.0L	231.102	320.038		
Nimbus	UC	87-92	4 Cyl	2.0L		320.038		
Nimbus	UC	87-92	4 Cyl	2.0L	231.102	320.038		
Nimbus	UF	92-98	4 Cyl	2.4L	231.102	320.038		
Nimbus	UG	98-04	4 Cyl	2.4L		320.067		
Outlander	ZE, LS-XLS	03-04	4 Cyl	2.4L		320.067		
Pajero	NA, NB, NC, ND	83-87	4 Cyl	2.6L	231.102			
Pajero	ND Auto	86-87	4 Cyl	2.6L	231.102	320.038		
Pajero	NE, NF, NG	87-91	4 Cyl	2.6L	231.102	320.038		
Pajero	NK,	96-00	6 Cyl	3.5L	231.102	320.067		
Pajero	NL	96-00	6 Cyl	3.0L, 3.5L	231.102	320.067		
Pajero	NJ	93-96	6 Cyl	2.8L	231.102	320.044		
Pajero	NH, Intercooler	91-93	6 Cyl	2.5L	231.102			
Pajero iO	QA	99-03	4 Cyl	1.8L	231.102			
Scorpion	GE	78-79	4 Cyl	2.0L				
Scorpion	GJ, GK, GL	80-85	4 Cyl	2.6L				
Sigma	GE, GH, GJ, GK	77-85	4 Cyl	1.6L, 2.0L	231.102			
Sigma	GK, GN	84-87	4 Cyl	1.6L, 2.0L	231.102			
Triton	ME, MF, MG, MH, MJ, Petrol	86-94	4 Cyl	2.6L	231.102			
Triton	ME, MF, MG, MH, MJ, Diesel	86-96	4 Cyl, 6 Cyl	2.5L, 3.0L	231.102			
Triton	MH, MJ, 4WD	90-96	6 Cyl	3.0L	231.102	320.038		
Triton	MK, 4WD	96-05	6 Cyl	3.0L		320.067		
Verada	KR, KS	91-94	6 Cyl	3.0L	231.102			
Verada	KE, KF, KH, KJ, KL, KW	96-05	6 Cyl	3.0L, 3.5L				

NISSAN						Oil	Temp	Pressure
Model	Series	Year	Engine	Capacity	Light	Sender	Sender	
120Y	B210	74-79	4 Cyl	1.2L	231.086			
180B, 200B	610, 810	72-81	4 Cyl	1.8L	231.086			
240, 260, 280	C, K, Z, ZX	70-84	6 Cyl	2.4L, 2.6L, 2.8L	231.086			
300ZX	Z31 Turbo	84-89	6 Cyl	3.0L	231.086			
520, 620, 720	RWD, FWD, Petrol, Diesel	71-85	4 Cyl	1.5L, 1.8L, 2.2L, 2.3L	231.086			
Bluebird	Series I, II	81-85	4 Cyl	2.0L				
Gazelle	S12	84-88	4 Cyl	2.0L	231.086			
Infinity	Q45	93-97	8 Cyl	4.5L		320.039		
Maxima	J30 SOHC FWD	90-92	6 Cyl	3.0L				
Maxima	A31 SOHC FWD	93-95	6 Cyl	3.0L		320.039		
Maxima	A32 DOHC FWD	95-99	6 Cyl	3.0L		320.096		
Maxima	A33 DOHC FWD	99-03	6 Cyl	3.0L		320.096		
Micra	K11E	95-97	4 Cyl	1.3L				
Navara	2X4, 4X4, Petrol, Diesel	86-88	4 Cyl	2.0L, 2.4L	231.086			
Navara	D21 Diesel DI 4WD, RWD	86-98	4 Cyl	2.5L		320.104		
Navara	D21 RWD	86-95	4 Cyl	2.0L		320.104		

VEHICLE SENDERS APPLICATION LISTING

NISSAN (cont.)					Oil	Temp	Pressure
Model	Series	Year	Engine	Capacity	Light	Sender	Sender
Navara	D21 Carb 4WD, RWD	86-92	4 Cyl	2.4L		320.039	
Navara	D22 Diesel RWD, 4WD	97-99	4 Cyl	3.2L		320.096	
Navara	D22 DIESEL RWD	97-99	4 Cyl	2.7L		320.096	
Navara	D22 SOHC	97-99	4 Cyl	2.4L		320.096	
Navara	D21 SOHC 4WD, RWD EFI	92-97	4 Cyl	2.4L		320.039	
Navara	D21 Diesel DI 4WD, RWD	88-92	4 Cyl	2.5L		320.039	
Navara	D21 Diesel DI 4WD, RWD	88-97	4 Cyl	2.7L		320.039	
Navara	D21 SOHC MPFI	92-97	6 Cyl	3.0L		320.039	
Navara	D22 Series II 4WD, RWD	99-01	4 Cyl	2.4L		320.096	
Navara	D22 Series II Diesel 4WD, RWD	99-01	4 Cyl	3.2L		320.096	
Navara	D22	99-01	6 Cyl	3.0L		320.096	
Navara	D22 Diesel Turbo	01-on	4 Cyl	3.0L		320.096	
Navara	D22 SOHC	03-06	6 Cyl	3.3L		320.096	
Nomad	GC22	97-92	4 Cyl	2.4L			
NX/NX-R	B13	91-95	4 Cyl	2.0L		320.039	
Pathfinder	Carb	86-92	4 Cyl	2.4L		320.039	
Pathfinder	D21 Carb 4WD MPFI	92-95	6 Cyl	3.0L			
Pathfinder	R50 Series I	95-98	6 Cyl	3.3L		320.096	
Pathfinder	R50 Series II	99-05	6 Cyl	3.3L		320.096	
Patrol	G60, MQ	65-87	6 Cyl	2.8L, 4.0L	231.086	320.039	
Patrol	G60, MQ, Turbo	80-87	6 Cyl	3.3L	231.086	320.090	
Patrol	GQ OHV Diesel Series I	87-93	6 Cyl	4.2L			
Patrol	GQ OHV Diesel, Series I, Series II	88-97	6 Cyl	4.2L			
Patrol	GQ OHC Carb	88-95	6 Cyl	4.2L			
Patrol	GQ OHC Carb	92-99	6 Cyl	4.2L			
Patrol	GQ Series II OHV EFI	92-97	6 Cyl	4.2L		320.039	
Patrol	GQ Series II SOHC Carb	92-97	6 Cyl	3.0L			
Patrol	GQ Series II SOHC Turbo Diesel	95-97	6 Cyl	2.8L		320.039	
Patrol	GU OHV Diesel	99-00	6 Cyl	4.2L			
Patrol	GU SOHC MPFI	97-00	6 Cyl	4.5L			
Patrol	GU SOHC Turbo Diesel	98-00	6 Cyl	2.8L		320.096	
Pintara	R31 Sedan RWD	86-90	4 Cyl	2.0L		320.096	
Pintara	U12 Sedan FWD	89-92	4 Cyl	2.0L		320.096	
Pintara	U12 SOHC	89-92	4 Cyl	2.4L			
Prairie	M10 SOHC Carb	82-86	4 Cyl	1.5L	231.084	320.039	
Pulsar	N10	80-81	4 Cyl	1.4L	231.086		
Pulsar	N12, EXA - ET	83-87	4 Cyl	1.5L	231.102		
Silvia	Imported S12 Turbo	84-88	4 Cyl	1.8L			
Skyline	C210	78-81	6 Cyl	2.4L	231.086		
Stanza	A10	78-83	4 Cyl	1.6L	231.086		
Terrano II	R20, R20 Turbo Diesel	97-00	4 Cyl	2.4L, 2.7L			
Urvan	E20, E23	74-82	4 Cyl	1.6L, 2.0L	231.086		
Urvan	E24, Diesel	87-92	4 Cyl	2.7L	231.086		
X Trail	T30 DOHC	01-03	4 Cyl	2.5L		320.096	

SUBARU					Oil	Temp	Pressure
Model	Series	Year	Engine	Capacity	Light	Sender	Sender
Brumby		78-94	4 Cyl	1.6L, 1.8L	231.102	320.043	
DL, GL, Leone		76-95	4 Cyl	1.6L, 1.8L	231.102	320.043	
Fiori		89-92	4 Cyl		231.102		
Forester		97-02	4 Cyl	2.0L	231.102	320.067	

VEHICLE SENDERS APPLICATION LISTING

SUBARU (cont.)						Oil	Temp	Pressure
Model	Series	Year	Engine	Capacity	Light	Sender	Sender	Sender
Impreza	LX, GX, AWD	93-98	4 Cyl	1.6L, 1.8L	231.102	320.067		
Impreza	GX, RV, RX	00-on	4 Cyl	2.0L	231.102	320.067		
Impreza	WRX, Turbo	94-on	4 Cyl	2.0L	231.102	320.067		
Liberty	All	91-03	4 Cyl	2.0L, 2.2L, 2.5L	231.102	320.067		
Liberty	BC/BD	89-97	4 Cyl	2.2L	231.102	320.067		
Liberty	BD/BF Turbo	92-93	4 Cyl	2.0L	231.102	320.067		
Liberty	BD/BG	96-00	4 Cyl	2.5L	231.102	320.067		
Liberty		98-on	4 Cyl	2.0L	231.102	320.067		
Liberty		98-on	4 Cyl	2.5L	231.102	320.067		
Outback		96-00	4 Cyl	2.5L	231.102	320.067		
Vortex	XT, Turbo	85-89	4 Cyl	1.8L	231.102	320.043		

SUZUKI						Oil	Temp	Pressure
Model	Series	Year	Engine	Capacity	Light	Sender	Sender	Sender
Sierra	SJ413	84-98	4 Cyl	1.3L		320.044		
Carry	ST80, ST90	78-85	4 Cyl			320.068		
Swift	SOHC, GTi, Carb. & EFI, 4WD	84-00	3 Cyl, 4 Cyl	All		320.044		
Vitara	SOHC, Carb. & EFI	88-98	4 Cyl	1.6L		320.044		
X90	4X4 EL	96-98	4 Cyl	1.6L		320.067		

TOYOTA						Oil	Temp	Pressure
Model	Series	Year	Engine	Capacity	Light	Sender	Sender	Sender
4Runner	YN60, YN63, YN130	84-90	4 Cyl	2.0L, 2.2L		320.044		
4Runner	RN130R	90-96	4 Cyl	2.4L		320.044		
4Runner	LN60, LN61, Diesel	84-89	4 Cyl	2.4L, 2.8L	231.084	320.044		
Camry	SV11, SV20	83-89	4 Cyl	1.8L, 2.0L	231.102	320.044		
Camry	SV21, SV22	87-91	4 Cyl	2.0L	231.102	320.067		
Camry	SDV10, SXV10	93-98	4 Cyl	2.2L				
Camry	VZV20, VZV21	88-93	6 Cyl	2.5L	231.102			
Camry Vienta	VZV20, VZV21	88-93	6 Cyl	2.5L	231.102			
Celica	RA23, RA28, TA22, TA23	71-77	4 Cyl	1.6L, 2.0L		320.043		
Celica	RA60R, SA63	81-84	4 Cyl	2.0L		320.044		
Celica	ST184R	89-94	4 Cyl	2.2L	231.102			
Celica	ST185R	90-92	4 Cyl	2.0L	231.102	320.044		
Celica	ST204R, SX, ZR	94-99	4 Cyl	2.2L		320.088		
Celica	ST205, GT	94-94	4 Cyl	2.0L				
Corolla	KE10	66-70	4 Cyl	1.1L		320.043		
Corolla	KE20	70-74	4 Cyl	1.2L	231.102	320.043		
Corolla	KE30, KE35, KE36, KE50	74-78	4 Cyl	1.2L	231.102	320.043		
Corolla	KE38, KE55	78-79	4 Cyl	1.3L	231.102	320.043		
Corolla	KE38, KE55, KE70R	78-85	4 Cyl	1.3L	231.102	320.044		
Corolla	AE71, AE80, AE82, DOHC	78-89	4 Cyl	1.3L, 1.6L	231.102			
Corolla	AE90	89-92	4 Cyl	1.4L				
Corolla	AE92, Carb	89-92	4 Cyl	1.4L	231.084	320.067		
Corolla	AE92, AE92R, EFI, 4WD	89-94	4 Cyl	1.6L	231.084	320.067		
Corolla	AE93	92-94	4 Cyl	1.8L		320.088		
Corolla	AE95R, 4WD	88-95	4 Cyl	1.6L	231.084	320.067		
Corolla	AE101R, AE102R, AE102X, AE112	94-01	4 Cyl	1.8L		320.088		
Corona	RT40, RT72, RT80, RT81	64-74	4 Cyl	1.5L, 1.6L, 1.9L	231.084	320.043		
Corona	MX10, MX13, MX22, MX23, RT104	72-79	4 Cyl	2.0L, 2.3L, 2.6L	231.084	320.043		
Corona	RT104, RT118, XT130	77-83	4 Cyl	2.0L, 2.3L, 2.6L	231.084	320.043		

VEHICLE SENDERS APPLICATION LISTING

TOYOTA (cont.)					Oil	Temp	Pressure
Model	Series	Year	Engine	Capacity	Light	Sender	Sender
Corona	RT132	79-82	4 Cyl	2.0L		320.044	
Corona	RT133	82-83	4 Cyl	2.0L	231.102	320.044	
Cressida	MX73R	84-85	6 Cyl	2.8L	231.084	320.044	
Cressida	MX73R-DOHC	85-88	6 Cyl	2.8L	231.084	320.044	
Cressida	MX83R	90-93	6 Cyl	3.0L	231.084	320.044	
Crown	RS56, MS65, MS83, MS85, MS111	68-80	4Cyl, 6 Cyl	2.0L, 2.8L		320.043	
Crown	MS112	80-83	6 Cyl	2.8L	231.084	320.044	
Crown	MS123	83-87	6 Cyl	2.8L	231.084	320.044	
Crown	MS125	83-88	6 Cyl	2.8L	231.084	320.044	
Estima	TCR10W, TCR11W, TCR20W	93-99	4 Cyl	2.4L			
Hiace	RH: 10, 11, 15, 16, 20, 30, 32	67-85	4 Cyl	1.5L, 1.6L		320.043	
Hiace	YH: 50, 51, 53, 60, 61, 63, 71, 73	83-89	4 Cyl	1.8L, 2.0L, 2.2L		320.044	
Hiace	RZH103R, RXZH113R, EFI	98-05	4 Cyl	2.4L			
Hiace	LH: 20, 30, 50, 51, 60, 61, 70, 71	81-89	4 Cyl Diesel	2.2L, 2.4L		320.044	
Hiace	LH103R, LH113R, LH125R	89-00	4 Cyl Diesel	2.8L	231.084		
Hiace	LHR172R, LHR184R	99-05	4 Cyl Diesel	3.0L	231.084		
Hilux	YN: 55, 56, 57, 58, 65, 67	83-88	4 Cyl	1.6L, 1.8L, 2.0L, 2.2L		320.044	
Hilux	RN85R, RN90R, RN105R	90-92	4 Cyl	2.4L	231.102		
Hilux	All 2.2L engines	78-83	4 Cyl Diesel	2.2L			
Hilux	All 2.4L engines	83-91	4 Cyl Diesel	2.4L	231.084	320.044	
Hilux	LN86R, LN106R, LN 107R	88-97	4 Cyl Diesel	2.8L	231.084	320.044	
Hilux	LN147R, LN167R, LN172R	97-05	4 Cyl Diesel	3.0L	231.084	320.044	
Kluger	MCU28R	03-on	6 Cyl	3.3L			
Landcruiser	FJ: 40, 45, 55, FJ60	70-75	6 Cyl	3.9L	231.102	320.043	
Landcruiser	FJ: 40, 45, 55, FJ60	75-84	6 Cyl	4.2L	231.102	320.043	
Landcruiser	FJ60 Petrol	80-84	6 Cyl	4.2L	231.104		
Landcruiser	HJ60 Diesel	81	6 Cyl	4.0L	231.104		
Landcruiser	BJ70 Diesel	84-90	6 Cyl	3.4L	231.102		
Landcruiser	FJ62	84-90	6 Cyl	4.0L		320.044	
Landcruiser	FJ70,FJ73, FJ80	84-91	6 Cyl	4.0L	231.084	320.044	
Landcruiser	FZJ80R	92-98	6 Cyl	4.5L	231.084		
Landcruiser	UZJ100R	00-on	8 Cyl	4.7L	231.104	320.088	
Landcruiser	UZJ100	98-07			231.084		
Landcruiser	HZJ75RV	90-91	6 Cyl	4.2L	231.084	320.094	
Landcruiser	HZJ78R, HZJ79R	04-on	6 Cyl	4.2L	231.084	320.094	
Landcruiser	FZJ80, HZJ80, HDJ80	95-98	6 Cyl	4.5L, 4.2L, 4.2LTD	231.084	320.094	
Landcruiser	FZJ105,	98-07	6 Cyl	4.5L	231.084	320.094	
Landcruiser	HZJ105 Diesel	98-07	6 Cyl	4.2L	231.084	320.094	
Landcruiser	VDJ76R	07-on	8 Cyl	4.5L		320.094	
Landcruiser	VDJ78R/VDJ79R	07-on	8 Cyl	4.5L	231.104		
Lexen	All models VN-VS	89-97	6 Cyl	3.8L	231.088		
Lightace	KM20, KM36	80-92	4 Cyl	1.3L, 1.5L	231.102	320.044	
Lightace	YM21, YM30, YM40, YM41	84-88	4 Cyl	1.8L, 2.0L	231.102	320.044	
Lightace	All models with 1C engine	83-92	4 Cyl Diesel	1.8L	231.084	320.044	
MR2	SW20R	90-94	4 Cyl	2.0L	231.102	320.044	
MR2	SW20R	95-99	4 Cyl	2.0L	231.102		
MR2	ZZW30R	00-on	4 Cyl	2.0L	231.104		
Paseo	EL44R, EL54R	91-95	4 Cyl	1.5L	231.104	320.067	

VEHICLE SENDERS APPLICATION LISTING

TOYOTA (cont.)					Oil	Temp	Pressure
Model	Series	Year	Engine	Capacity	Light	Sender	Sender
Paseo	EL44R, EL54R	95-99	4 Cyl	1.5L	231.104	320.088	
Prado	RZJ95R, RZJ120R	96-04	4 Cyl	2.7L	231.104	320.088	
Prado	VZJ95R, GRJ120R	99-04	6 Cyl	3.4L, 4.0L	231.104		
Prado	KZJ95R, KZJ120R	99-04	6 Cyl	3.4L, 4.0L	231.104	320.088	
Prius	NHW11R, NHW20R	01-on	4 Cyl	1.5L	231.104		
RAV4	SX10R, SXA11R	94-00	4 Cyl	2.0L	231.104		
RAV4	ACA20R, ACA21R, ACA22R, ACA23R	94-00	4 Cyl	2.0L, 2.4L	231.104		
Soarer	JZZ30, JZZ31	91-00	6 Cyl	2.5L, 3.0L	231.104		
Soarer	UZZ30, UZZ31, UZZ32	91-00	8 Cyl	2.5L, 3.0L, 4.0L	231.104		
Spacia	YR22R	93-98	4 Cyl	2.2L	231.104		
Spacia	SR40R	98-01	4 Cyl	2.0L	231.104		
Starlet	EP91R	96-99	4 Cyl	1.3L	231.104	320.067	
Tarago	YR20	83-84	4 Cyl	1.8L		320.044	
Tarago	CR21	83-88	4 Cyl Diesel	2.0L	231.084	320.044	
Tarago	TCR10R, TCR11R	90-00	4 Cyl	2.4L	231.104		
Tarago	TCR20R, TCR21R	90-03	4 Cyl	2.4L	231.102	320.044	
Tarago	ACR30R	00-on	4 Cyl	2.4L	231.104		

NOT SURE?

VDO Gauge Check can be found on page 52. Handy workshop tool used to test gauges and measure variable resistance required for replacement senders. Simply connect to the sender terminals and use the dial to simulate gauge movement. Resistance can then be recorded to help match with the correct replacement sender.



105.001

LOW COOLANT ALARM

The Low Coolant Alarm monitors current continuity while the low water level probe is submerged in water. The location of the probe in the radiator or header tank determines the critical water level. Warning occurs within a few seconds of this level being reached. The warning light and buzzer can only be cancelled by switching off the engine and includes a delay to avoid premature triggering.

Low Water Alarm

Part No.	Description	Voltage
410.007	Low Coolant Warning Kit	12/24V

Kit contents - Electronic module, 30mm probe, solder bush, threaded bush, LED warning lamp, buzzer, wiring connector & terminals.



Accessories

Part No.	Description	Specification
410.006	Electronic Module	110 X 67 X 35mm
230.058	Water level probe	30mm Long
230.059	Water level probe	90mm Long
230.016	Soldering Bush	
230.017	Threaded Bush	M14 X1.5 Round.



DT2236



105.001



Globe & holder 800005002

WORKSHOP TOOLS

Digital Hand Held Tachometers

Part No.	Description
DT2236	Digital Hand Held Tachometer (Photo/Mech)

Accessories

Part No.	Description
DT2234/36TAPE	Spare Reflective tape for phototach

Gauge Check

Part No.	Description
105.001	Tester for resistive gauges 2-500 ohms

Used to check functionality and confirm the resistance range of most gauges for more accurate sensor matching.

*Not suitable for capacitive, bi-metallic or 0-5V systems.

TYRE PRESSURE GAUGE

For the conscientious driver who likes to retain a consistent Tyre pressure. Supplied in a handy leather pouch. Dual scale bar/psi.

Tyre Pressure Gauge

Part No.	Range
150.050	0 - 4.5bar (0 - 64psi)

OIL PUMP

Electric Oil pump suitable for engine or gear oil.

Oil pump 12V

Part No.	Description
405040001001	160 Litres per hour

Note: 100°C to 150°C working temperature, 4 bar pressure.
Polarity is written on the socket.

GLOBES & HOLDERS

T10 Wedge Globe & Holder to suit most Cockpit Vision & International Gauges

Part No.	Description	Specification
800005002	12V Globe & Holder	12V 3W
800005003	24V Globe & Holder	24V 3W
240.052	Globe Only	12V 2W
240.053	Globe Only	24V 2W

Note: 52mm Level, Pressure & Temp gauges use 1x 3W globe
80, 85, 100mm Speedos & Tachos use 2x 2W globes

GAUGE MOUNTING HARDWARE

Suitable for Vision range of instruments.

Clamp Rings & Stud Kits	
Part No.	Description
800.005.015	Spin lock clamp ring for 52mm instruments
800.005.005	Spin lock clamp ring for 80mm instruments
800.005.006	Spin lock clamp ring for 85mm instruments
800.005.007	Spin lock clamp ring for 100mm instruments
600.402	Stud kit for 52mm electric gauges (not for speedo, tachometer, ammeter or pyrometer)



Spin lock clamp 800.005.015



Stud kit 600.402

GAUGE MOUNTING BRACKETS

Suitable for 52mm instruments.

Various Mounting Hardware	
Part No.	Description
230.001	45deg. Single Bracket
230.005	90deg. Single Bracket
230.006	90deg. Double Bracket
230.007	90deg. Triple Bracket
230.037	15deg. Single Spacer
230.038	52mm blanking cap - Plastic
230.004	60-52mm Reduction Ring - Metal



Bracket 230.001



Single gauge panel 230.005



Angled spacer 230.037



Blank 230.038



Reduction ring 230.004



Twin gauge panel 230.006

WIRING ACCESSORIES

Wiring Kits		
Part No.	Description	Specifications
240.030	3 way plug kit	Plug + 3
	Suit electric pressure, temp & volt gauges	terminals
340.824	8 way plug kit	Plug + 8
	Suit 80, 85 & 100mm speedos & tachos	terminals

PART NUMBER INDEX

Part Number to Page Index

Part No.	Page	Part No.	Page	Part No.	Page	Part No.	Page
101.264	28	230.063	37	320.101	36	430.110	32
101.265	28	230.064	37	320.105	36	430.1100	32
101.266	28	230.068	18	320.107	35	430.115	32
101.267	28	230.079	34	320.714	13, 21	430.135	32
101.268	28	230.080	34	330.100	32	430.160	32
101.269	28	230.990	32	330.102	32	600.402	53
101.270	28	230.993	32	330.104	32	660.990	25
101.271	28	231.081	33	330.110	32	2250234	39
101.350	29	231.082	33	330.1100	32	2251016	39
101.351	29	231.083	33	330.115	32	150035020	18
101.352	29	231.084	33	330.135	32	150035022	18
101.353	29	231.085	33	330.160	32	150077004	11
105.001	52	231.086	33	331.534	23	150077005	11
150.050	52	231.087	33	331.535	23	150077010	11
150.316	18	231.088	33	331.600	23	150077011	11
151.910	18	231.102	33	331.601	23	150077020	10
180.059	36	231.106	33	331.602	23	150077026	10
190.080	14	240.030	53	340.007	37	150077027	10
190.504	14	240.035	13, 21	340.008	37	180035002	21
220.003	8, 17, 38	240.052	52	340.009	37	180035004	21
220.004	8, 38	240.053	52	340.808	37	180035005	21
220.005	8, 38	240.733	13	340.824	53	180035008	21
220.777	39	301.001	8	360.001	9, 19, 31	180077019	13
230.001	53	301.105	8	360.002	9, 19, 31	180077020	13
230.004	53	310.159	13	360.003	31	180077021	13
230.005	53	320.002	12, 20, 35	360.004	9, 19, 31	180077022	13
230.006	53	320.004	12, 20, 35	360.005	31	180077023	13
230.007	53	320.006	20, 35	360.006	31	190037002	22
230.008	10, 18	320.020	20, 35	360.008	31	190037003	22
230.012	10, 18	320.021	12, 20, 35	360.013	31	190075004	14
230.013	10, 11, 18	320.022	12, 20, 35	360.014	31	190077006	14
230.015	10	320.039	35	360.016	9, 19, 31	190077007	14
230.016	51	320.043	35	360.017	31	301010009	8
230.017	51	320.044	35	360.018	9, 19, 31	301010010	8
230.024	10, 18	320.046	35	360.019	9, 19, 31	301010011	8
230.025	10, 18	320.050	36	360.020	31	301010015	8
230.031	36	320.051	36	360.022	31	301030001	17
230.032	36	320.052	36	360.024	31	301030002	17
230.033	36	320.053	36	360.048	31	301040001	17
230.035	36	320.054	36	360.050	31	301040002	17
230.036	36	320.055	36	360.086	10, 31	310010014	12
230.037	53	320.056	36	370.001	14	310010015	12
230.038	53	320.058	36	410.006	51	310015009	13
230.041	33	320.059	13, 21	410.007	51	310020001	12
230.043	33	320.067	35	410.060	24	310020002	12
230.044	33	320.068	35	410.061	24	310030002	20
230.045	34	320.074	36	410.063	24	310030003	20
230.046	34	320.075	36	411.096	25	310030004	20
230.051	34	320.076	36	411.101	25	310035001	21
230.058	51	320.088	35	411.105	25	310040002	20
230.061	37	320.092	12, 20, 35	430.102	32	310040003	20
230.062	37	320.093	12, 20, 35	430.104	32	310040004	20

PART NUMBER INDEX

Part Number to Page Index							
Part No.	Page	Part No.	Page	Part No.	Page	Part No.	Page
331032001	22	215950004301	37	220.230-180	38	323801001040N	35
331032004	22	215950004501	37	220.250-180	38	323803001002D	35
332010004	14	331810012004	22	220.260-180	38	323803001004D	35
332020001	14	331810012007	22	220.270-180	38	323803001006D	35
332030001	22	340216001024	37	220.300-180	38	323803001008D	35
332040001	22	340804007019	37	220.330-180	38	323803001011D	35
333015031	7	360081039003	30	220.350-180	38	323803001013D	35
333015032	7	405040001001	52	220.600-180	38	323803001019D	35
333015033	7	2910000080900	28	220.660-180	38	323805001001K	35
333015034	7	2910000117200	26	220.900-180	38	323805001002C	35
333015035	7	2910000117300	26	224011000015G	39	323805001004K	35
333015037	7	2910000117400	26	224011000018G	39	323805001005N	35
333015038	7	2910000117500	26	224011000020G	39	323805001015N	35
333015046	7	2910000118100	26	224011000022G	39	325805003001C	35
333015047	7	2910000118200	26	224011000024G	39	330.102C	32
333035002	16	2910000118400	26	224011000026G	39	330.104C	32
333035004	16	2910000118500	26	224011000028G	39	330.1100C	32
333035010	16	2910000118600	26	224011000030G	39	330.110C	32
333035011	16	2910000118700	27	224011000034G	39	330.115C	32
333035013	16	2910000118800	27	224011000038G	39	330.135C	32
333035025	16	2910000119000	27	224011000040G	39	330.160C	32
333045002	16	2910000119100	27	224011000045G	39	340808001004G	37
333055001	16	2910000119500	27	224011000050G	39	360081030001K	30
333055002	16	2910000119600	27	224011000055G	39	360081030002K	30
333065001	16	2910000119700	27	224011000060G	39	360081030009K	30
350010001	10	2910000119800	27	224011000065G	39	360081030010C	30
350010016	9	2910000120000	27	224011000070G	39	360081030014C	30
350010017	9	2910000120100	27	224011000075G	39	360081030015C	30
350010021	10	2910000120200	27	224011000080G	39	360081030017C	30
350020001	9	2910000244200	26	226801015001C	38	360081030022C	30
350030003	19	2910000244300	26	230 059	51	360081030028K	30
350040003	19	2910000299900	26	230.112NO	34	360081030039C	30
350030004	19	2910000300600	26	230.113NC	34	360081030049K	9, 30
350040004	19	2910000301300	5	230.114NC	34	360081030052C	9, 19, 30
350030005	19	2910000301400	5	230.115NC	34	360081032001C	30
350040005	19	2910000301500	5	230.115NO	34	360081032011C	30
350030016	19	2910000301600	5	232011005004D	34	360081032014C	30
350030017	19	2910000463400	27	232011005017D	34	360081032025C	30
350040016	19	2910000484200	5	232011005027D	34	360081038003C	10, 19, 30
350040017	19	2910000484300	5	232011017010D	34	360081038008C	10, 30
397015003	21	2910000814500	27	232011017016D	34	360081039002C	30
437015022	6	2910000854700	27	232011017017D	34	360081039004C	30
437015025	6	2910000954200	5	232011017032D	34	362081001001K	30
437015028	6	2910000954300	5	232011017034D	34	362081001002K	30
437015029	6	2910000979800	26	232011017038D	34	362081002001K	30
437015038	6	2910001187300	26	232011017041D	34	362081003002K	30
437025002	6	2910002302700	26	232011017080D	34	362081004001C	30
437035016	16	2910002302800	26	232011017087D	34	36373/9A	39
800005002	21, 52	2910002304700	26	232011017103D	34		
800005003	52	2910002314400	26	323801001006K	35		
215920102301	37	220.150-180	38	323801001008N	35		
215950003101	37	220.180-180	38	323801001010K	35		

Continued
Over -->

PART NUMBER INDEX

Part Number to Page Index			
Part No.	Page	Part No.	Page
800.005.005	53	A2C3833310030	4
800.005.006	53	A2C3833320030	5
800.005.007	53	A2C3833330030	5
800.005.015	53	A2C3833348030	4
A2C1800310030	4	A2C3833350030	5
A2C1800330030	4	A2C3833380030	5
A2C1800340030	4	A2C3833390030	5
A2C3832690030	4	A2C3833410030	5
A2C3832700030	4	A2C3833440030	4
A2C3832720030	4	A2C3833450030	4
A2C3832730030	4	A2C3833460030	4
A2C3832740030	4	A2C3833470030	4
A2C3832750030	4	A2C3833490030	4
A2C3832770030	5	A2C3833500030	4
A2C3832780030	5	A2C3833510030	5
A2C3832790030	3	A2C3833520030	5
A2C3832800030	3	A2C3833530030	5
A2C3832810030	3	A2C3833550030	4
A2C3832820030	3	A2C3916300030	4
A2C3832830030	3	A2C3916310030	5
A2C3832840030	3	A2C59510165	38
A2C3832860030	3	A2C59510171	38
A2C3832890030	3	A2C6253520766	28
A2C3832910030	3	A2C6253521466	28
A2C3832940030	3	A2C6253521566	28
A2C3832950030	3	CTA0200KIT	39
A2C3832960030	3	CTA0201KIT	39
A2C3832970030	3	CTA0202KIT	39
A2C3832980030	3	DT2234/36TAPE	52
A2C3832990030	3	DT2236	52
A2C3833000030	3	K46004	37
A2C3833010030	3	K46020	37
A2C3833020030	3	K46021	37
A2C3833030030	3	K70450	37
A2C3833050030	5	K70451	37
A2C3833060030	5	K70452	37
A2C3833070030	5	K70453	37
A2C3833080030	5	K72103	37
A2C3833090030	5	K72113	37
A2C3833110030	4	K72221	37
A2C3833120030	4	K72222	37
A2C3833130030	4	N05801432	17, 39
A2C3833140030	4	X10232001002	34
A2C3833150030	4	X10232001003	34
A2C3833160030	4	X10232001004	34
A2C3833170030	4	X10232001005	34
A2C3833190030	4	X10232001006	34
A2C3833230030	4	X10232001007	34
A2C3833240030	4	X10232001008	34
A2C3833271030	4	X10232001009	34
A2C3833300030	4		
A2C3833304030	5		

TEMPERATURE CHARTS

Range 40 - 120 Deg. C		Range 50 - 150 Deg. C	
Deg. C	Ohms	Deg. C	Ohms
20	676.9	40	481.5
30	439	60	221.2
40	291.5	75	128
50	197.3	82.5	102
60	134	87.5	89.3
70	97.1	92.5	76.8
80	70.1	97.5	66
87	54	102.5	58
94	45	107.5	50
100	38.5	115	41
107	32.5	125	32.2
114	28	135	26
120	22.4	145	21
130	17.4	160	15.1
140	13.8	180	10.2

PRESSURE CHARTS

Range 0 - 2 Bar (200 Kpa)		Range 0 - 5 Bar (500 Kpa)	
Bar	Ohms	Bar	Ohms
0	9.63	0	10.65
0.3	37.45	0.75	37.8
0.5	55.69	1.25	55.65
0.7	73.7	1.75	73.3
0.9	91.4	2.25	90.83
1.05	104.53	2.675	105.6
1.15	113.2	2.875	112.44
1.25	121.8	3.125	121
1.35	130.36	3.5	133.77
1.45	138.85	3.75	142.2
1.55	147.3	4	150.62
1.65	155.6	4.25	158.97
1.75	163.9	4.5	167.3
1.85	172.2	4.75	175.55
2	184.4	5	183.77

Range 0 - 10 Bar (1000 Kpa)		Range 0 - 25 Bar (2500 Kpa)	
Bar	Ohms	Bar	Ohms
0	10.241	0	9.9
1.2	35.4	3	36.7
2	51.55	5	53.4
2.8	67.15	7	69.21
3.5	80.37	9	84.25
4.1	91.4	10.6	95.75
4.7	102.1	12.2	106.83
5.3	112.52	13.8	117.5
5.9	122.64	15.4	127.82
6.5	132.47	17	137.8
7.1	142	18.6	147.5
7.7	151.24	20.2	156.93
8.4	161.65	21.8	166.14
9.2	173.04	23.4	175.17
10	183.9	25	184.03

CONVERSION TABLES

Temperature	
Celsius	Fahrenheit
40	104
50	122
60	140
70	158
80	176
90	194
100	212
110	230
120	248

Pressure		
Kpa	PSI	BAR
10	1.45	0.1
50	7.25	0.5
100	14.5	1
200	29	2
350	50.7	3.5
600	86.9	6
850	123	8.5
1750	254	17.5
2500	363	25

Thread Sizes & Turns Per Inch		
Thread	Size	Diameter
NPT	1/8"-27	10.287mm
	1/4"-18	13.716mm
	3/8"-18	17.145mm
	1/2"-14	21.336mm
BSP	1/8"-28	9.728mm
	1/4"-19	13.157mm
	3/8"-19	16.662mm
SAE(UNF)	1/2"-14	20.995mm
	5/8"-18	15.875mm

Continental Automotive Singapore Pte Ltd
80 Boon Keng Rd, Continental Building,
Singapore 339780
Tel (Australia): 03 9468 1151
enquiries.au@continental-corporation.com
www.vdo-apac.com
VDO - A Trademark of the Continental Corporation



The information provided in this brochure contains only general descriptions or performance characteristics, which do not always apply as described in case of actual use or which may change as a result of further development of the products. This information is merely a technical description of the product. This information is not meant or intended to be a special guarantee for a particular quality or a particular durability. An obligation to provide the respective characteristics shall only exist if expressly agreed in the terms of contract. We reserve the right to make changes in availability as well as technical changes without prior notice.

The illustrations, information and specifications presented and referred to in this catalogue are believed to be correct at the time of publication; however accuracy cannot be absolutely guaranteed.

Continental reserves the right to make changes without notice or obligation, in the specifications, design, colour or materials, and to change or discontinue models.