



DESIGNJET T7100 and T7100 Monochrome printer series

Using your printer

© 2010 Hewlett-Packard Development
Company, L.P.

1st edition

Legal notices

The information contained in this document is subject to change without notice. The only warranties for HP products and services are set forth in the express warranty statements accompanying such products and services. Nothing contained in other sections different from the express warranty should be construed as constituting an additional warranty. HP shall not be liable for technical and editorial errors or omissions contained herein.

Trademarks

Adobe®, Acrobat®, Adobe Photoshop®, and PostScript® are trademarks of Adobe Systems Incorporated.

Microsoft® and Windows® are U.S. registered trademarks of Microsoft Corporation.

PANTONE®* is *Pantone, Inc.'s check-standard trademark for color.

Table of contents

1 Introduction	1
Safety precautions	2
Product models	2
Using this guide	3
The printer's main features	4
The printer's main components	4
The Embedded Web Server's main components	9
The HP Utility's main features	10
The printer's internal prints	10
Turn the printer on and off	11
2 Connectivity and software instructions	12
Choose which connection method to use	13
Connect to a network (Windows)	13
Connect directly to a computer (Windows)	14
Uninstall the printer driver (Windows)	14
Connect to a network (Mac OS)	14
Connect directly to a computer (Mac OS)	17
Uninstall the printer software (Mac OS)	18
3 Personalize the printer	20
Change the language of the front-panel display	21
Access the HP Utility	21
Access the Embedded Web Server	21
Change the language of the HP Utility	22
Change the language of the Embedded Web Server	22
Change the sleep mode setting	22
Turn the buzzer on and off	22
Change the front-panel display contrast	22
Change the units of measurement	23
Configure network settings	23
Change the graphic language setting	24
Paper suitability options	25
4 Handle the paper	26
Overview	27
Load a roll into the printer	30

Unload a roll from the printer	34
View information about the paper	35
Perform paper advance calibration	35
Download paper presets	37
Cancel the drying time	37
Change the drying time	37
Printing paper info	38
Feed and cut the paper	38
Store the paper	39
Order paper	39
5 Handle the ink system	44
Ink system components	45
Ink system tips	47
Work with ink system components	48
Order ink supplies	67
6 Use of multiple rolls	69
The uses of a multiroll printer	70
How the printer allocates jobs to paper rolls	70
7 Use of the stacker	72
Install the stacker	73
Uninstall the stacker	73
Using paper with the stacker	73
Stacker messages	74
Change the temperature	74
Change paper rolls while using the stacker	74
Clean the exterior of the stacker	74
Clean the stacker rollers	75
Move or store the stacker	75
8 Print options	77
Create a print job	78
Select print quality	79
Print a draft	80
High-quality printing	81
Select paper size	82
Select margins options	83
Print on loaded paper	84
Rescale a print	84
Preview a print	85
Print 16-bit color images	85
Change the treatment of overlapping lines	86
Print crop lines	86
Rotate an image	86

Print in gray shades	88
Use paper economically	88
Nest jobs to save paper	89
Use ink economically	91
Roll protection	91
Unattended printing/overnight printing	91
9 Color management	93
Introduction	94
How colors are represented	94
A summary of the color management process	94
Color calibration	94
Color management from printer drivers	96
Color management from printer drivers (PostScript)	99
Color management from the Embedded Web Server	101
Color management from the front panel	103
10 Job queue management	105
Embedded Web Server job queue page	106
Job preview	106
Turn off the job queue	107
Select when to print a job in the queue	107
Identify a job in the queue	107
Prioritize a job in the queue	108
Delete a job from the queue	108
Reprint or copy a job in the queue	108
Job status messages	108
11 Retrieve printer usage information	110
Get printer accounting information	111
Check printer usage statistics	111
Check ink and paper usage for a job	111
12 Practical printing examples	113
Overview	114
Print a draft for revision with the correct scale	114
Print a project	116
Print a presentation	127
Print and scale from Microsoft Office	132
13 Maintain the printer	139
Clean the exterior of the printer	140
Clean the platen	140
Clean the paper-advance sensor window	142
Lubricate the printhead carriage	142
Maintain the ink cartridges	143

Perform preventive maintenance	143
Move or store the printer	144
Update the printer firmware	144
Secure disk erase	145
14 Accessories	146
Order accessories	146
15 Troubleshoot print-quality issues	147
General advice	148
Troubleshooting tools	148
Lines are too thick, too thin or missing	149
Lines appear stepped or jagged	150
Lines print double or in the wrong colors	150
Lines are discontinuous	151
Lines are blurred	151
Line lengths are inaccurate	152
The whole image is blurry or grainy	153
The paper is not flat	153
The print is scuffed or scratched	154
Ink marks on the paper	154
Black ink comes off when you touch the print	155
Vertical lines of different colors	155
White spots on the print	156
Colors are inaccurate	156
The output is completely blank	158
The output contains only a partial print	158
The image is clipped	159
The image is in one portion of the printing area	159
The image is unexpectedly rotated	160
The print is a mirror image of the original	160
The print is distorted or unintelligible	160
One image overlays another on the same print	160
Pen settings seem to have no effect	160
The image has a wood-grain appearance (aeroworms)	161
16 Troubleshoot paper issues	162
The paper has jammed	162
Prints do not stack correctly in the bin	163
17 Troubleshoot ink-system issues	164
Cannot insert an ink cartridge	165
Cannot insert a printhead	165
Cannot insert the maintenance cartridge	165
Front panel recommends reseating or replacing a printhead	165

18 Troubleshoot stacker issues	166
Paper scrolling	167
The trailing edge of the paper curling up	167
The paper is not completely ejected	167
The front panel displays that the stacker is disconnected	168
19 Troubleshoot other issues	169
The printer is not printing	170
A job has not been printed	170
The software application slows down or stalls while generating the print job	170
The printer seems slow	171
Communication failures between computer and printer	171
Cannot access the Embedded Web Server	172
“Out-of-memory” error message	172
The platen rollers squeak	173
Cannot access the HP Utility	175
Print job canceled and purged when held for preview	175
Printer alerts	175
20 Get help	177
Introduction	178
HP Professional Services	178
HP Instant Support	179
HP Proactive Support	179
Customer Self Repair	179
HP Customer Care	180
HP Designjet Online	183
Other sources of information	184
Appendix A Front-panel menus	185
Paper menu	186
Job management menu	187
Ink menu	188
Setup menu	189
Image quality maintenance menu	192
Connectivity menu	193
Internal prints menu	194
Information menu	195
Appendix B Front-panel error messages	196
Appendix C Printer specifications	200
Functional specifications	201
Physical specifications	202
Memory specifications	203
Power specifications	203

Environmental specifications	203
Acoustic specifications	203

Glossary	204
-----------------------	------------

Index	206
--------------------	------------

1 Introduction

- [Safety precautions](#)
- [Product models](#)
- [Using this guide](#)
- [The printer's main features](#)
- [The printer's main components](#)
- [The Embedded Web Server's main components](#)
- [The HP Utility's main features](#)
- [The printer's internal prints](#)
- [Turn the printer on and off](#)

Safety precautions

The following precautions ensure the correct use of the printer and prevent printer damage. Use these precautions at all times.

- Use the power supply voltage that is specified on the nameplate. To avoid overloading the printer's electrical outlet, do not use the outlet for multiple devices.
- Make sure that the printer is well-grounded. Failure to ground the printer can result in electrical shock, fire, and susceptibility to electromagnetic interference.
- Do not disassemble or repair the printer yourself, unless authorized by HP (see [Customer Self Repair on page 179](#)). Contact your local HP Service Representative for service. See [HP Customer Care on page 180](#).
- Use only the electrical cord that HP supplied with the printer. Do not damage, cut, or repair the power cord. A damaged power cord creates a risk of fire and electric shock. Replace a damaged power cord with an HP-approved power cord.
- Do not allow metal or liquids (except those used in HP Cleaning Kits) to touch the internal parts of the printer. Doing so can cause fire, electric shock, or other serious hazards.
- Turn off the printer and unplug the power cable from the power outlet in any of the following cases:
 - When you place your hands inside the printer
 - If smoke or an unusual smell emanates from the printer
 - If the printer is making an unusual noise that does not occur during normal operation
 - If a piece of metal or a liquid (not part of cleaning and maintenance routines) touches internal parts of the printer
 - During an electrical (thunder or lightning) storm
 - During a power failure

Product models

This guide covers the following product models, normally referring to them by their short names for brevity.

Full name	Short name	Part numbers
HP Designjet T7100	T7100	CQ105A, CQ106A
HP Designjet T7100 with PostScript upgrade	T7100ps	CQ105A, CQ106A + CQ745A
HP Designjet T7100 Monochrome	T7100 Mono	CQ101A, CQ102A
HP Designjet T7100 Monochrome with PostScript upgrade	T7100ps Mono	CQ101A, CQ102A + CQ745A

Using this guide

The *HP Start-up Kit* DVD includes this guide, which is the most complete source of information about this product, and is organized into the following chapters.

Introduction

This chapter provides a brief introduction to the printer and its documentation for new users.

Use and maintenance

These chapters help you carry out normal printer procedures and include the following topics:

- [Connectivity and software instructions on page 12](#)
- [Personalize the printer on page 20](#)
- [Handle the paper on page 26](#)
- [Handle the ink system on page 44](#)
- [Print options on page 77](#)
- [Color management on page 93](#)
- [Practical printing examples on page 113](#)
- [Maintain the printer on page 139](#)

Troubleshooting

These chapters help you solve problems that might occur while printing and include the following topics:

- [Troubleshoot print-quality issues on page 147](#)
- [Troubleshoot ink-system issues on page 164](#)
- [Troubleshoot paper issues on page 162](#)
- [Troubleshoot other issues on page 169](#)

Support

This chapter describes the various sources of information and help you can consult.

- [Get help on page 177](#)

Appendices

The appendices contain reference information on various aspects of your printer.

- [Front-panel menus on page 185](#)
- [Front-panel error messages on page 196](#)
- [Printer specifications on page 200](#)

Glossary

This chapter contains definitions of printing and HP terms that are used in this documentation.

Index

In addition to the table of contents, an alphabetical index is included to help you to find topics quickly.

Warnings and Cautions

Symbols are used in this manual to ensure the proper use of the printer and to prevent printer damage. Follow the instructions that are marked with these symbols.

-
- ⚠ **WARNING!** Failure to follow the guidelines that are marked with this symbol could result in serious personal injury or death.
 - ⚠ **CAUTION:** Failure to follow the guidelines that are marked with this symbol could result in minor personal injury or damage to the product.
-

The printer's main features

Your printer is a color inkjet printer designed for printing high-quality images on paper up to 1067 mm (42 in) wide. Some major features of the printer are shown below:

- Print resolution of up to 2400 × 1200 optimized dots per inch (dpi) from a 1200 × 1200 dpi input, when using photo paper, the **Best** print-quality option, and the **Maximum resolution for the photo paper** option
- Two rolls (three rolls in some configurations) loaded at once provide automatic, fast and easy switching between different rolls, or long runs of unattended printing
- A six-ink system in the 7100 and a two-ink system in the 7100 Mono printer
- Accurate and consistent color reproduction with automatic color calibration in the 7100 printer
- Two black printheads enable the printer to print grayscale jobs fast with unusually good quality.
- Paper flexibility and automatic easy load, including information and presets that are available at the front panel or remotely
- High productivity features such as job previewing, nesting and autorotate
- EconoMode for printing economically
- Ink and paper usage accounting for different types of print
- Manage your printer remotely using the Embedded Web Server (see [The Embedded Web Server's main components on page 9](#)) or the HP Utility (see [The HP Utility's main features on page 10](#))

The printer's main components

The following views illustrate the main components of the HP Designjet T7100 printer.

-
- ⚠ **WARNING!** Do not try to disassemble, repair or manipulate the roll door or the rear door. Your fingers or hand may become trapped.
-

Front view

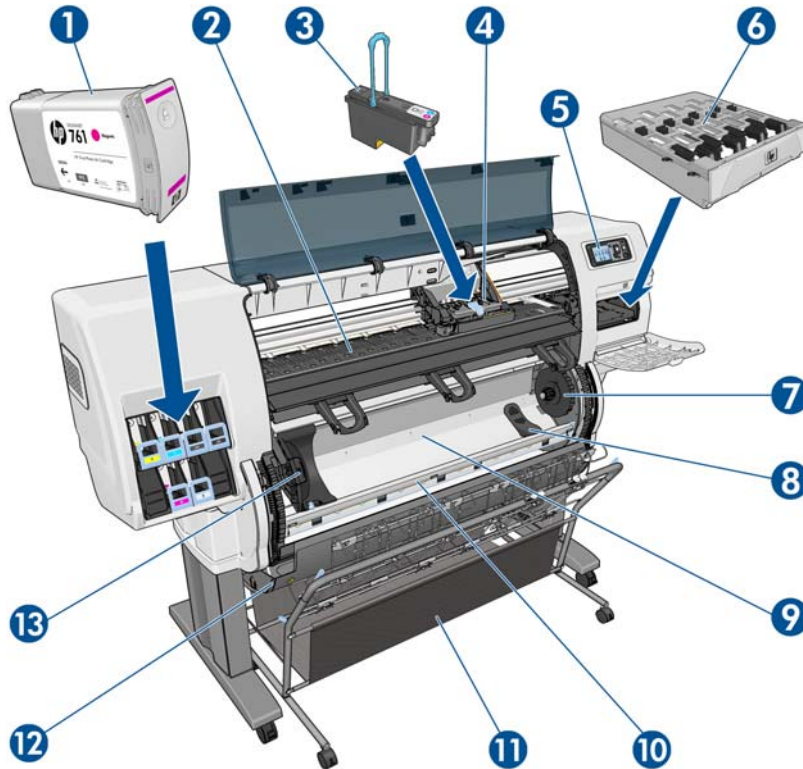

1. Ink cartridge
2. Platen
3. Printhead
4. Printhead carriage
5. Front panel
6. Maintenance cartridge
7. Right hub
8. Roll support
9. HP Smart Roll-Loading System
10. Paper feed brake
11. Bin/Basket
12. Roll door
13. Left hub

Rear view

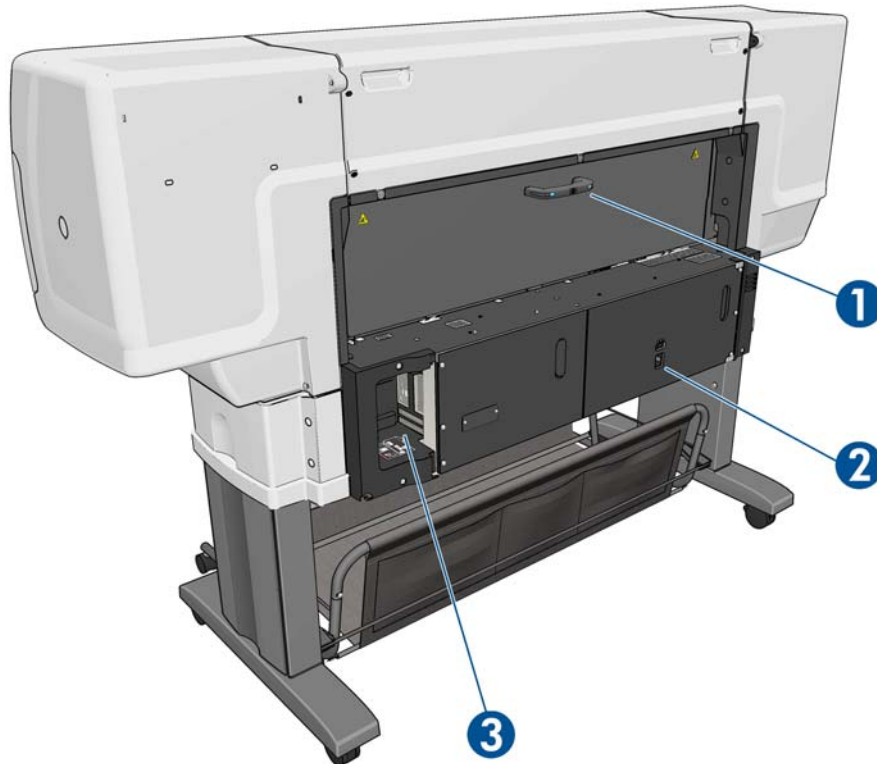

1. Rear door handle
2. Power switch and socket
3. Sockets for communication cables and optional accessories

The bin/basket

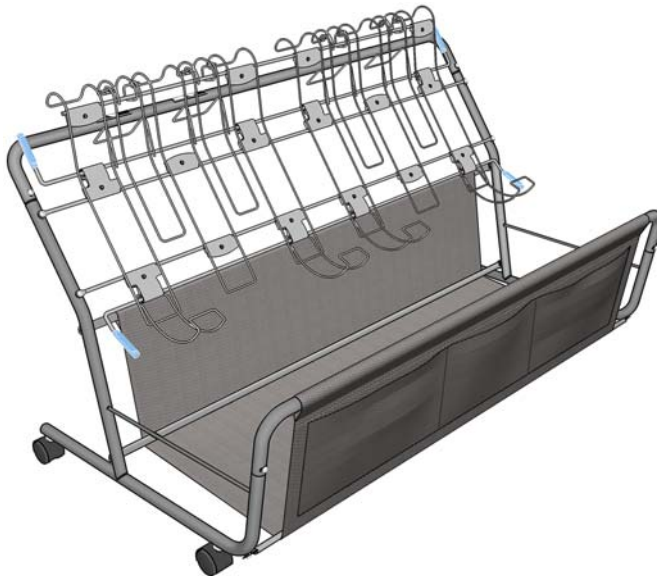

The bin/basket is provided to store finished prints. It can be used in several different ways.

- To stack A0 or E paper sizes only, supported by wire loops. For this purpose, the top handles should be up and the bottom handles should be down.
- To stack A1 or D paper sizes only, supported by wire loops. For this purpose, the top handles should be down; the bottom handles are irrelevant.
- To hold mixed paper sizes in the basket at the bottom. For this purpose, the top and bottom handles should be up.

Before stacking A0/E or A1/D paper sizes, ensure that the bin/basket is correctly positioned below the paper output: push it up against the printer until it comes to a definite stop.

The bin/basket has wheels and can easily be moved around when detached from the printer.

The front pockets may be used to store core adaptors and printer documentation.

The front panel

Your printer's front panel is located on the front of the printer, on the right-hand side. It has the following important functions:

- It is used to perform certain operations, such as loading and unloading paper
- It displays up-to-date information about the status of the printer, the ink cartridges, the printheads, the maintenance cartridge, the paper, the print jobs, and other parts and processes
- It gives guidance on using the printer
- It displays warning and error messages, when appropriate, with audible alerts to call attention
- It can be used to change the values of printer settings and the operation of the printer

 **NOTE:** Settings in the Embedded Web Server or in the printer driver override front panel settings.

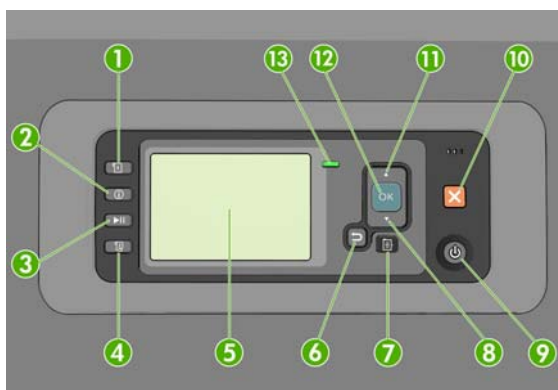

The front panel has the following components, starting with the four direct-access keys:

1. **Paper loading** key starts the paper loading process: see [Load a roll into the printer on page 30](#).
2. **View information** key. By pressing this key repeatedly, you can see information about the loaded papers, the ink levels, the printer's connection to the computer and the printhead status. See [Printing paper info on page 38](#).
3. **Pause printing** key pauses printing after finishing the current page. Press the key again to restart printing. This can be useful, for instance, when you want to change or load a roll of a different paper type.

4. **Form feed and cut key:** see [Feed and cut the paper on page 38](#).
5. **Front-panel display** displays errors, warnings and information on using your printer.
6. **Back key:** To go to the previous step in a procedure or interaction. To go to the upper level, or leave the option in the menu, or when given an option.
7. **Menu key:** Press to return to the main menu of the front-panel display. If you are already on the main menu it will display the status screen.
8. **Down key:** To go down in a menu or option, or to decrease a value, for example when configuring the front-panel display contrast or the IP address.
9. **Power key:** To turn the printer off or on, it also has a light to indicate the printer's status. If the power key light is off the printer is off. If the power key light is blinking green, the printer is starting up. If the power key light is green on, the printer is on. If the power key light is amber on, the printer is in standby. If the power key light is blinking amber, the printer needs attention.
10. **Cancel key:** To abort a procedure or interaction.
11. **Up key:** To go up in a menu or option, or to increase a value, for example when configuring the front-panel display contrast or the IP address.
12. **OK key:** To confirm an action while in a procedure or interaction. To enter in a submenu in the menu. To select a value when given an option. If the status screen is displayed, this key takes you to the main menu.
13. **Status light:** Indicates the printer's status. If the **Status** light is solid green, the printer is ready. If it is flashing green, the printer is busy. If it is solid amber, there is a system error. If it is flashing amber, the printer needs attention.

To **highlight** an item in the front-panel display, press the **Up** or **Down** key until the item is highlighted.

To **select** an item in the front-panel display, first highlight it and then press the **OK** key.

When this guide shows a series of front-panel display items like this: **Item1 > Item2 > Item3**, it means that you should select **Item1**, then select **Item2**, then select **Item3**.

For detailed information on the front-panel menus, see [Front-panel menus on page 185](#).

For an annotated list of front-panel error messages, see [Front-panel error messages on page 196](#).

Information about specific uses of the front panel can be found throughout this guide.

Printer software

The following software is provided with your printer:

- HP-GL/2 printer driver for Windows operating systems
- PostScript printer driver for Windows, Linux and Mac OS operating systems (with the PostScript upgrade)
- HP Utility (see [The HP Utility's main features on page 10](#))
- The Embedded Web Server, which runs in the printer and enables you to use a Web browser on any computer to check the ink levels and the printer status (see [The Embedded Web Server's main components on page 9](#))

 **TIP:** See <http://hplipopensource.com/hplip-web/index.html> if you are using Linux.

The Embedded Web Server's main components

The Embedded Web Server is a Web server running inside the printer. Users can obtain printer information, manage settings and presets, and troubleshoot problems through the Embedded Web Server. It also allows service engineers to retrieve internal information that helps diagnose printer problems.

Access the Embedded Web Server remotely by using an ordinary Web browser running on any computer. Its features and functionality are organized within three tabs. Buttons near the top of each tabs page provide access to online help and supplies reordering.

Main tab

The **Main** tab provides information about the following items:

- Print jobs and managing the print queue
- Supplies status
- Paper and ink usage and accounting
- PANTONE®* emulation

Setup tab

The **Setup** tab includes options to complete these tasks:

- Define printer, network and security settings
- Send accounting reports and notifications of warnings and errors through email
- Update firmware
- Upload paper presets
- Set the date and time

Support tab

The **Support** tab contains options to complete these functions:

- Use the Embedded Web Server Print Quality Troubleshooting wizard to help resolve some of the most common print quality issues
- Browse helpful information from a variety of sources
- Access HP Designjet links for technical support with your printer, driver and accessories
- Access service support pages that show current and historical data on the usage of your printer
- Troubleshoot image-quality

The HP Utility's main features

The HP Utility provides an easy-to-use interface that allows the user to manage and access various printer features and functionality.

- Manage the printer, including single-point color control with the HP Color Center.
- Gain access to the online HP Knowledge Center.
- View the status of the ink cartridges, the printheads and the paper.
- Manage, install, and create International Color Consortium (ICC) profiles (with the PostScript upgrade only).
- Access and use embedded profiles (with the PostScript upgrade only).
- Update the printer's firmware. See [Update the printer firmware on page 144](#).
- Calibrate the printer and display.
- Change various printer settings (on the Settings tab).
- Configure network settings

The printer's internal prints

The internal prints provide various kinds of information about your printer. You can request these prints from the front panel without using a computer.

Before requesting any internal print, make sure that paper is loaded and that the **Ready** message appears on the front-panel display.

To print an internal print, select the  icon, **Internal prints**, and then select the type of internal print that you want.

The following internal prints are available:

- Demo: shows some of the capabilities of the printer
- Menu map: shows details of all the front-panel menus
- Configuration: shows all the current front-panel settings
- Usage report: shows estimates of the total number of prints, number of prints by paper type, number of prints by print-quality option, and total amount of ink used per color. The accuracy of these estimates is not guaranteed.
- HP-GL/2 palette: shows the color or grayscale definitions in the currently-selected color palette
- PostScript font list: lists the PostScript fonts that are installed in the printer (with the PostScript upgrade only)
- Service information: provides information that service engineers require

Turn the printer on and off

TIP: The printer can be left powered on without wasting energy. Leaving it on improves response time and overall system reliability. When the printer has not been used for a certain period of time (the default time is determined by Energy Star), it saves power by going into sleep mode. However, any interaction with the printer's front-panel display, or sending a new job to print, returns it to active mode, and it can resume printing immediately. To change the sleep mode time, see [Change the sleep mode setting on page 22](#).

NOTE: In sleep mode, the printer performs maintenance service to the printheads from time-to-time. This avoids long preparation times after long idle periods. Therefore, it is strongly recommended to leave the printer powered on or in sleep mode to avoid wasting ink and time.

The printer has three levels of power consumption.

- Plugged in: the power cord is plugged into the back of the printer
- Switched on: the switch at the back of the printer is in the on position
- Powered on: the **Power** key on the front panel shows a green light

If you wish to turn the printer on or off or reset the printer, the normal and recommended method is to use the **Power** key on the front panel.



However, if you plan to store the printer indefinitely or the **Power** key does not seem to work, you are recommended to power it off using the **Power** key, and then also switch off the power switch at the rear.

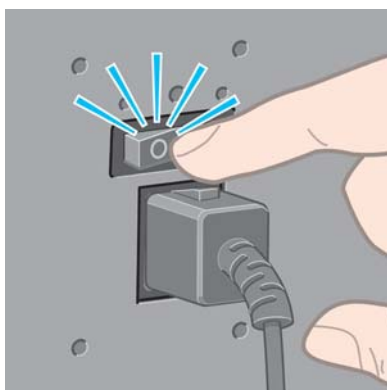

To turn it back on, use the power switch at the rear.

When the printer is powered back on, it takes about three minutes to initialize and check and prepare the printheads. Preparing the printheads takes about one minute and 15 seconds. However, if the printer has been off for six weeks or more, preparing the printheads could take up to 45 minutes.

2 Connectivity and software instructions

- [Choose which connection method to use](#)
- [Connect to a network \(Windows\)](#)
- [Connect directly to a computer \(Windows\)](#)
- [Uninstall the printer driver \(Windows\)](#)
- [Connect to a network \(Mac OS\)](#)
- [Connect directly to a computer \(Mac OS\)](#)
- [Uninstall the printer software \(Mac OS\)](#)

Choose which connection method to use

The following methods can be used to connect your printer.

Connection type	Speed	Cable length	Other factors
Gigabit Ethernet	Very fast; varies according to network traffic	Long: 100 m (328 ft)	Requires extra equipment (switches).
Jetdirect print server (optional accessory)	Moderate; varies according to network traffic	Long: 100 m (328 ft)	Requires extra equipment (switches). Useful for wireless or AppleTalk connection, and for Novell printing.
USB 2.0 (optional accessory)	Very fast	Short: 5 m (16 ft)	

 **NOTE:** The speed of any network connection depends on all components used in the network, which may include network interface cards, hubs, routers, switches and cables. If any one of these components is not capable of high-speed operation, you will find that you have a low-speed connection. The speed of your network connection can also be affected by the total amount of traffic from other devices on the network.

NOTE: There are various possible ways of connecting the printer to a network, but only one of them can be active at a time; with the exception of the Jetdirect print server, which can be active at the same time as one other network connection.

Connect to a network (Windows)

Once the network cable is connected and the printer is powered up, it automatically obtains an IP address. You need to perform the following steps to configure the printer in the network:

1. Go to your printer's front panel and select the Connectivity menu icon , then **Gigabit Ethernet** or **Jetdirect EIO**, then **View configuration**.
2. Note the IP address of your printer.
3. Insert the *HP Start-Up Kit* DVD into your computer. If the DVD does not autorun, run the **setup.exe** program in the root folder of the DVD.
4. Press the **Software Installation** button.
5. Press the **Express Network Install** button.
6. The configuration program will look for printers connected to your network. When the search has finished, a list of printers will be displayed. Identify your printer by its IP address and select it from the list.

If your printer does not appear in the list, select **Help me find my network printer** and click **Next**. In the next screen, give the IP address of your printer.

Connect directly to a computer (Windows)

You can connect your printer directly to a computer without going through a network, by using the printer's USB 2.0 socket.

1. **Do not connect the computer to the printer yet.** You must first install the printer driver software on the computer, as follows.
2. Insert the *HP Start-Up Kit* DVD into your DVD drive. If the DVD does not autorun, run the **setup.exe** program in the root folder of the DVD.
3. Press the **Software Installation** button.
4. Press the **Custom Install** button.
5. Follow the instructions on your screen to set up the printer. The following notes will help you to understand the screens and make appropriate choices.
 - You may see a message warning that the installer will have to communicate through the Windows Firewall to search for printers on the network. As you intend to set up a direct connection, select **Continue installation without searching the network** and click **Next**.
 - When asked how the printer is connected, choose **USB cable**.
 - When prompted to do so, connect your computer to the printer, using a USB cable. Ensure that the printer is switched on.

Uninstall the printer driver (Windows)

1. Insert the *HP Start-Up Kit* DVD into your DVD drive. If the DVD does not autorun, run the **setup.exe** program in the root folder of the DVD.
2. Press the **Software Installation** button.
3. Press the **Modify Installation** button, and follow the instructions on your screen to uninstall the printer driver.

Connect to a network (Mac OS)

You can connect your printer to a network under Mac OS by using the following methods:

- Bonjour
- TCP/IP

 **NOTE:** The printer does not support AppleTalk.

Before you begin, check your equipment:

- The printer should be set up and on.
- The Ethernet hub or router should be on and functioning correctly.
- All computers on the network should be on and connected to the network.
- The printer should be connected to the network.

Now you can proceed to install the printer software and connect your printer.

Bonjour connection

1. Go to your printer's front panel and select the Connectivity menu icon , then **Gigabit Ethernet** or **Jetdirect EIO**, then **View configuration**. Note the mDNS service name of your printer.
2. Insert the *HP Start-up Kit* DVD into your DVD drive.
3. Open the DVD icon on your desktop.

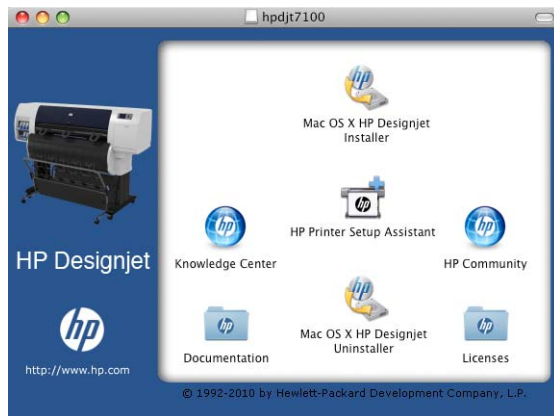

4. Open the **Mac OS X HP Designjet Installer** icon.
5. Follow the instructions on your screen. You are recommended to use the **Easy Install** option.
6. The printer software is installed, including the printer driver and the HP Utility.
7. When the software has been installed, the HP Printer Setup Assistant starts automatically, to set up a connection to your printer. Follow the instructions on your screen.
8. When you reach the Select Printer screen, look for your printer's mDNS service name (which you noted in step [1](#)) in the Printer Name column.

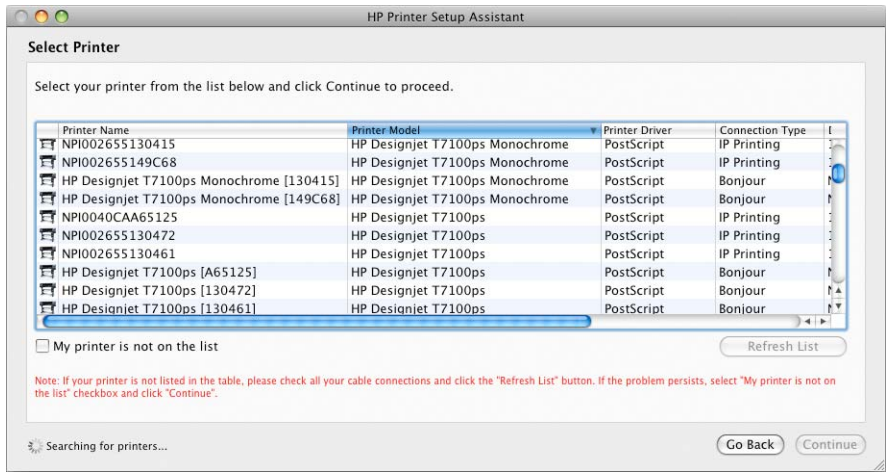

- If you find the right printer name, scroll sideways to see the Connection Type column, and check that it shows **Bonjour**. Then highlight that line. Otherwise, continue searching further down the list.
- If you cannot find your printer name with a **Bonjour** connection type, check the box **My printer is not in the list**.

Click **Continue**.

9. Continue following the instructions on the screen. When you reach the Printer Queue Created screen, click **Quit** to exit, or **Create New Queue** if you want to connect another printer to the network.

10. When the HP Printer Setup Assistant has finished, you can remove the DVD from the DVD drive.

If the printer driver is already installed, the HP Printer Setup Assistant can be run at any time from the DVD.

TCP/IP connection

1. Go to your printer's front panel and select the Connectivity menu icon , then **Gigabit Ethernet** or **Jetdirect EIO**, then **View configuration**.
2. Note the URL of your printer.
3. Insert the *HP Start-up Kit DVD* into your DVD drive.
4. Open the DVD icon on your desktop.

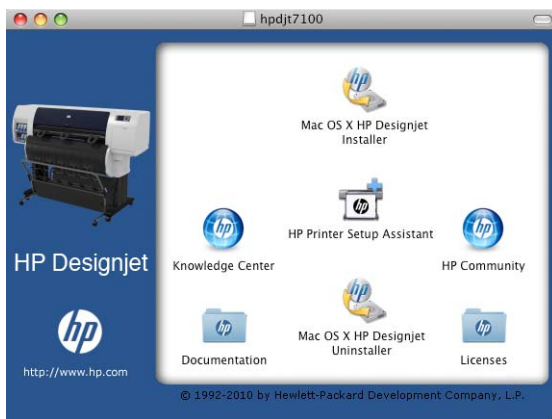

5. Open the **Mac OS X HP Designjet Installer** icon.
6. Follow the instructions on your screen. You are recommended to use the **Easy Install** option.
7. The printer software is installed, including the printer driver and the HP Utility.
8. When the software has been installed, the HP Printer Setup Assistant starts automatically, to set up a connection to your printer. Follow the instructions on your screen.
9. When you reach the Select Printer screen, look for your printer's URL (which you noted in step 1) in the Printer Name column.
 - If you find the right printer name, scroll sideways to see the Connection Type column, and check that it shows **IP Printing**. Then highlight that line. Otherwise, continue searching further down the list.
 - If you cannot find your printer name with an **IP Printing** connection type, check the box **My printer is not in the list**.

Click **Continue**.

10. Continue following the instructions on the screen. When you reach the Printer Queue Created screen, click **Quit** to exit, or **Create New Queue** if you want to connect another printer to the network.
11. When the HP Printer Setup Assistant has finished, you can remove the DVD from the DVD drive.

If the printer driver is already installed, the HP Printer Setup Assistant can be run at any time from the DVD.

Connect directly to a computer (Mac OS)

You can connect your printer directly to a computer without going through a network, by using the printer's built-in USB 2.0 socket.

1. Make sure the printer is either turned off or disconnected from the computer.
2. Insert the *HP Start-up Kit* DVD into your DVD drive.
3. Open the DVD icon on your desktop.

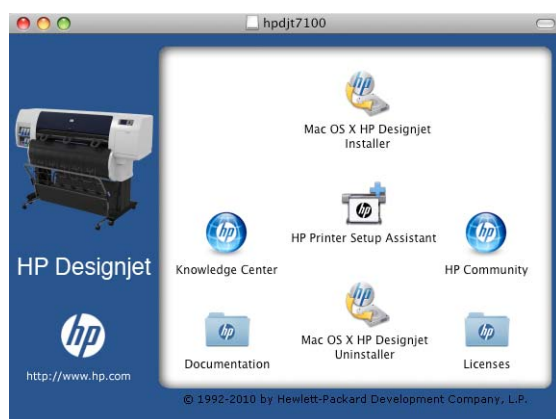

4. Open the **Mac OS X HP Designjet Installer** icon.
5. Follow the instructions on your screen. You are recommended to use the **Easy Install** option.

6. The printer software is installed, including the printer driver and the HP Utility.
7. When the software has been installed, the HP Printer Setup Assistant starts automatically, to set up a connection to your printer.
8. Make sure that the printer is turned on and connected to the computer with a certified USB cable.

 **NOTE:** The use of non-certified USB cables can lead to connectivity problems. Only cables certified by the USB Implementor's Forum (<http://www.usb.org/>) should be used with this printer.

9. In the HP Printer Setup Assistant, click **Continue**.
10. In the list of printers that appears, select the entry that uses the connection type USB, and click **Continue**.
11. The following screen displays information about your printer's installation, where the name of the printer can be modified. Make any changes you wish to make, and click **Continue**.
12. Your printer is now connected. In the Printer Queue Created screen, click **Quit** to exit, or **Create New Queue** if you want to connect another printer.
13. When the HP Printer Setup Assistant has finished, you can remove the DVD from the DVD drive.

If the printer driver is already installed, the HP Printer Setup Assistant can be run at any time from the DVD.

Sharing the printer

If your computer is connected to a network, you can make your directly connected printer available to other computers on the same network.

1. Double-click the System Preferences icon on the Dock menu bar on your desktop.
2. Go to **Sharing**, select **Printer Sharing**, and then check the printer(s) that you want to share.
3. Your printer now automatically appears in the list of shared printers displayed by any other computer running Mac OS and connected to your local network.

Any other people wishing to share your printer must install the printer software on their own computers.

Anyone sharing your printer will be able to send print jobs, but will not be able to receive information from the printer—which affects printer alerts, printer status reports, paper management, printer administration and troubleshooting.

You may find that sharing your directly connected printer with other users will slow down your computer unacceptably.

 **TIP:** The best way to share the printer over a network is to connect the printer not to any computer, but to the network. See [Connect to a network \(Mac OS\) on page 14](#).

Uninstall the printer software (Mac OS)

1. Insert the *HP Start-up Kit* DVD into your DVD drive.
2. Open the DVD icon on your desktop.
3. Open the **Mac OS X HP Designjet Uninstaller**, and follow the instructions on your screen to uninstall the printer software.

To delete the print queue:

1. From the system preferences, select the **Print & Fax** dialog.
2. Select the name of the printer and click the – button.

3 Personalize the printer

- [Change the language of the front-panel display](#)
- [Access the HP Utility](#)
- [Access the Embedded Web Server](#)
- [Change the language of the HP Utility](#)
- [Change the language of the Embedded Web Server](#)
- [Change the sleep mode setting](#)
- [Turn the buzzer on and off](#)
- [Change the front-panel display contrast](#)
- [Change the units of measurement](#)
- [Configure network settings](#)
- [Change the graphic language setting](#)
- [Paper suitability options](#)

Change the language of the front-panel display

There are two possible ways to change the language of the front-panel menus and messages.

- If you can understand the current front-panel display language, select the Setup menu icon , then **Front panel options** > **Select language**.
- If you cannot understand the current front-panel display language, start with the printer powered off. At the front panel, press the **OK** key and hold it down. While holding the **OK** key down, press the **Power** key and hold it down. Continue to hold down both keys until the green light on the right side of the front-panel display starts flashing, and then release both keys. You can expect a delay of about one second. If the green light starts flashing without any delay, you may need to start again.

Whichever method you used, the language selection menu should now appear on the front-panel display. Highlight your preferred language with the **Up** and **Down** keys, then press the **OK** key.

When you have selected your preferred language, turn off the printer with the **Power** key and then turn it on again. The front panel will appear in the selected language.

Access the HP Utility

The HP Utility enables you to manage your printer from a computer with a USB, TCP/IP or Jetdirect connection.

- **Under Windows**, start the HP Utility from your desktop shortcut or from **Start** > **All Programs** > **Hewlett-Packard** > **HP Utility** > **HP Utility**. This launches the HP Utility, showing the printers installed on your computer.
- **Under Mac OS**, launch the HP Utility from your dock shortcut or by selecting **STARTUP_DISK** > **Library** > **Printers** > **hp** > **Utilities** > **HP Utility**. This launches the HP Utility, showing the printers installed on your computer.

When you select your printer in the left pane, everything that appears in the right pane is specific to that printer.

If you have followed these instructions but failed to get through to the HP Utility, see [Cannot access the HP Utility on page 175](#).

Access the Embedded Web Server

The Embedded Web Server enables you to manage your printer remotely using an ordinary Web browser running on any computer.

To access the Embedded Web Server directly, you must have a TCP/IP connection to your printer. However, you can access the Embedded Web Server indirectly through the HP Utility, if you connect to your printer with a USB connection.

The following browsers are known to be compatible with the Embedded Web Server:

- Internet Explorer 6 and later, for Windows
- Safari 2 and later, for Mac OS X
- Firefox 1.5 and later

To access the Embedded Web Server on any computer, open your Web browser and give the IP address of your printer.

You can find your printer's IP address by selecting the Connectivity menu icon , then **Gigabit Ethernet** or **Jetdirect EIO**, then **View configuration**.

If you have followed these instructions but failed to get through to the Embedded Web Server, see [Cannot access the Embedded Web Server on page 172](#).

Change the language of the HP Utility

The HP Utility can work in the following languages: English, Portuguese, Spanish, Catalan (Windows only), French, Italian, German, Russian, Simplified Chinese, Traditional Chinese, Korean and Japanese.

- **Under Windows**, select **Tools** > **Set Language** and select a language from the list.
- **Under Mac OS**, the language is changed as for any other application. In **System Preferences**, select **International** and re-launch the application.

Change the language of the Embedded Web Server

The Embedded Web Server can work in the following languages: English, Portuguese, Spanish, Catalan, French, Italian, German, Russian, Simplified Chinese, Traditional Chinese, Korean and Japanese. It uses whichever language you have specified in your Web browser's options. If you have specified a language that it cannot support, it works in English.

To change the language, you must change your Web browser's language setting. For example, in Internet Explorer version 6, go to the **Tools** menu and select **Internet Options, Languages**. Then ensure that the language you want is at the top of the list in the dialog box.

Change the sleep mode setting

If the printer is left switched on but unused for a certain period of time, it goes automatically into sleep mode to save power. To change the time the printer waits before it goes into sleep mode, go to the front panel and select the Setup menu icon , then **Front panel options** > **Sleep mode wait time**. Highlight the wait time you want and then press the **OK** key. You can set the time from 1 to 240 minutes. The default time is 30 minutes.

Turn the buzzer on and off

To turn the printer's buzzer on or off, go to the front panel and select the Setup menu icon , then **Front panel options** > **Enable buzzer**, and highlight on or off and press the **OK** key. By default, the buzzer is set to on.

Change the front-panel display contrast

To change the contrast of the front-panel display, select the Setup menu icon , then **Front panel options** > **Select display contrast**, and enter a value using the **Up** or **Down** key. Press the **OK** key to set the value. The default contrast is set to 50.

Change the units of measurement

To change the units of measurement in the front-panel display, select the Setup menu icon , then **Front panel options > Select units**, and select **English** or **Metric**. By default the units are set to metric.

Configure network settings

You can view and configure the network settings from the HP Utility. Under Windows, select the **Settings** tab, then **Network Settings**. Under Mac OS, select **Configuration > Network Settings**. The following settings are available.

- **IP Configuration method:** specify the way to set an IP address, selecting **BOOTP**, **DHCP**, **Auto IP** or **Manual**.
- **Host name:** specify an IP name for the network device. The name may contain up to 32 ASCII characters.
- **IP address:** specify the IP address on the print server. Duplicate IP addresses on a TCP/IP network are not allowed.

 **NOTE:** If you change the current IP address and click **Apply**, the browser loses the current connection to the print server because it is pointing to the old address. To reconnect, browse to the new IP address.

- **Subnet mask:** specify a subnet mask, which is a 32-bit number applied to an IP address to determine which bits specify the network and subnet and which bits uniquely specify the node.
- **Default gateway:** specify the IP address of a router or computer that is used to connect to other networks or sub-networks. If none exist, use the IP address of the computer or the IP address of the print server.
- **Domain name:** specify the name of the DNS domain in which the print server resides (for example, support.hp.com).

 **NOTE:** The domain name does not include the host name: it is not the fully qualified domain name, such as printer1.support.hp.com.

- **Idle timeout:** specify the number of seconds that an idle connection is allowed to remain open; 30 is the default value. If set to zero, the timeout is disabled and TCP/IP connections remain open until closed by the other node (such as a workstation) on the network
- **Default IP:** specify the IP address to use when the print server is unable to obtain an IP address from the network when powered on or when reconfigured to use BOOTP or DHCP.
- **Send DHCP requests:** specify whether DHCP requests are transmitted when a legacy default IP address or a default Auto IP is assigned.

To configure the same network settings from the front panel, select the Connectivity menu icon , then **Gigabit Ethernet** or **Jetdirect EIO > Modify configuration**.

You have various other options available from the Connectivity menu icon.

- **USB:** view information about the USB connection
- **Jetdirect EIO:** view information, configure and reset the Jetdirect connection

- **Advanced > Select I/O timeout:** specify the number of seconds that an idle connection is allowed to remain open, 270 is the default value, if set to zero, the timeout is disabled
- **Advanced > Allow SNMP:** specify whether SNMP is permitted
- **Advanced > Embedded Web Server > Allow EWS:** specify whether the Embedded Web Server is enabled
- **Advanced > Web Services > HP Utility software:** view the HP Utility software settings
- **Advanced > Web Services > Color and paper management:** view the color and paper management settings

Change the graphic language setting

You can change the graphic language setting from the HP Utility with the following steps.

1. **Under Windows,** select the **Settings** tab then **Printer settings > Printing preferences.**

Under Mac OS, select **Configuration** then **Printer settings > Configure printer settings > Printing preferences.**

2. Select one of the following options.

- Select **Automatic** to let the printer determine which type of file it is receiving. This is the default setting; it works for most software applications. You should not normally need to change it.
- Select **HP-GL/2** only if you are sending a file of that type directly to the printer, without going through a printer driver.
- Select **PDF** only if you are sending a file of that type directly to the printer, without going through a printer driver (with the PostScript upgrade only).
- Select **PostScript** only if you are sending a file of that type directly to the printer, without going through a printer driver (with the PostScript upgrade only).
- Select **TIFF** only if you are sending a file of that type directly to the printer, without going through a printer driver (with the PostScript upgrade only).
- Select **JPEG** only if you are sending a file of that type directly to the printer, without going through a printer driver (with the PostScript upgrade only).

You can change the graphic language setting from the front panel. Select the Setup menu icon , then **Printing preferences > Select graphic language.** Select the desired option and press the **OK** key to set the value.

 **NOTE:** If the graphic language is set from the HP Utility, it overrides the front panel setting.

Paper suitability options



Paper mismatch action

If the paper currently loaded in the printer is not suitable for a particular job, the printer can either put the job on hold until some suitable paper is loaded, or it can ignore the problem and print the job on the unsuitable paper. There are several ways in which the loaded paper may be considered unsuitable:

- The paper type is not as specified for the job
- The paper source (roll 1, roll 2 or roll 3) specified for the job has no paper loaded
- The paper size is smaller than specified for the job

You can set the printer's behavior in such cases from the front panel.

- Select the Setup menu icon , then **Job management options > Paper mismatch action > Print anyway** if you want such jobs to print on whatever paper is loaded. This is the default option.

 **NOTE:** The printer will print the job on the selected roll regardless of the size and type of the roll: if the roll is too narrow for the job, the job will be clipped.
- Select the Setup menu icon , then **Job management options > Paper mismatch action > Put job on hold** if you want such jobs to be put on hold. The printer will send an alert whenever a job is put on hold.

When a job is put on hold for paper, it is kept in the printer queue until some suitable paper is loaded and you select it to be printed again. Meanwhile, other jobs with different requirements can continue printing.

Roll switching options

If two rolls are loaded, both of which are suitable for the job, the roll will be chosen according to your preferences. These can be set from the front panel: select the Setup menu icon , then **Printing preferences > Paper options > Roll switching options**. The following options are available:

- **Minimize paper waste.** If this option is chosen, the printer will choose the narrowest roll that meets all the criteria, to avoid wasting paper due to trimming. This is the default option.
- **Minimize roll changes.** If this option is chosen, the printer will choose the roll that is currently active, to avoid wasting time with a roll switch. To change the active roll, select the Paper menu icon , then **Select active roll**.
- **Use roll with less paper.** If this option is chosen, the printer will choose the roll that has the least paper.

 **NOTE:** This option is effective only if you have enabled **Printing paper info** (see [Printing paper info on page 38](#)). Otherwise, it has the same effect as **Minimize paper waste**.

- **Match exact size.** If this option is chosen, a roll will be chosen only if its width matches the job's width exactly.

 **NOTE:** If nesting is on (see [Nest jobs to save paper on page 89](#)), the roll switching options are ignored and the printer behaves as though **Minimize paper waste** has been chosen.

4 Handle the paper

- [Overview](#)
- [Load a roll into the printer](#)
- [Unload a roll from the printer](#)
- [View information about the paper](#)
- [Perform paper advance calibration](#)
- [Download paper presets](#)
- [Cancel the drying time](#)
- [Change the drying time](#)
- [Printing paper info](#)
- [Feed and cut the paper](#)
- [Store the paper](#)
- [Order paper](#)

Overview

Paper is only a subset of the portfolio of printing materials that the printer can handle. You can also print on a wide variety of films, textiles and fabrics, self-adhesive materials, and banner and sign materials. Throughout this guide, however, these materials are generally referred to as paper.

 **NOTE:** Because the front panel has limited space, the names of the HP paper might be abbreviated and might not appear in the front panel exactly as they are shown on the packaging label.

NOTE: Because the complete list of supported paper is very long, only the most common paper types appear in the front panel. If you want to see an HP paper type that does not appear on the front panel, download the preset to the printer from <http://www.hp.com/go/designjet>. See [Download paper presets on page 37](#).

Use paper

Choosing the correct paper type for your needs is an essential step in ensuring good print quality. For best printing results, use only recommended HP paper (see [Supported paper types on page 28](#)), HP papers have been developed and thoroughly tested to ensure reliable performance. All printing components (printer, ink system, and paper) have been designed to work together to offer trouble-free operation and ensure optimal print quality.

Here are some additional tips about paper usage:

- Allow all paper types to adapt to room conditions, out of the packaging, for 24 hours before using them for printing.
- Handle film and photo paper by the edges, or wear cotton gloves. Skin oils can be transferred to the paper, leaving fingerprint marks.
- Keep the paper tightly wound on the roll throughout the loading and unloading procedures. To make sure that the roll stays tightly wound, consider using tape to adhere the lead edge of the roll to the core just before removing the roll from the printer. You can keep the roll taped during storage. If the roll starts to unwind, it can become difficult to handle.

 **NOTE:** The use of tape to adhere the lead edge of the roll is especially important for 76.2-mm (3-in) cores, in which the inherent stiffness of the printing material can cause the material to loosen and unwind from its core.

- Whenever you load a roll, the front panel prompts you to specify the paper type that you are loading. For good print quality, it is essential to specify this correctly. Make sure that the paper name that is printed on the packaging label matches the description on the front panel.

If you cannot find a specific paper on the front-panel display, go to <http://www.hp.com/go/designjet/supplies> to download the latest paper preset to your printer, or select the paper description that best matches the paper name printed on the packaging label.

- The quality of some images might be reduced if you use a paper type that is unsuitable for your image. This is especially important to consider when printing on fiber-based papers such as HP Universal Coated Paper, HP Coated Paper, HP Heavyweight Coated Paper and HP Universal Heavyweight Coated Paper. Printing images that contain high-saturation area fills on fiber-based papers can create unwanted wavy patterns as a result of paper expansion. This can ultimately contribute to more severe problems. Consider using Super Heavyweight Coated Paper and other cockle-free papers when printing high-saturation area fills.
- Make sure that the appropriate print-quality setting (Best, Normal, or Fast) is selected. You can set the print quality in the driver, in the Embedded Web Server, or on the front panel. Driver or

Embedded Web Server settings override front panel settings. The combination of paper type and print-quality settings tells the printer how to place the ink on the paper—for example, the ink density and halftoning method. See [Select print quality on page 79](#).

- Although the ink systems that are supplied with this printer have good light-fastness, colors will eventually fade or change if exposed to sunlight over a long period of time
- If the paper type shown on the front panel does not correspond to the paper that you intend to use, take one of the following actions:
 - Reload the roll into the printer and select the correct paper type. See [Unload a roll from the printer on page 34](#) and [Load a roll into the printer on page 30](#).
 - Use the Embedded Web Server or the HP Utility to reconfigure the paper type for the roll.
 - At the printer's front panel, select the  icon, and then select **View loaded paper > Change paper type**.

 **NOTE:** The paper advance calibration is not performed when the paper type is changed from the front panel.

Drying time

With some paper types and under certain environmental conditions, the ink needs some time to dry before the paper is unloaded. The following settings are available for each paper type:

- **Automatic:** the printer automatically determines the appropriate drying time, based on the paper you have selected and the current temperature. If any drying time is required, a “drying time to go” countdown appears on the front panel.
- **Extended:** the default drying time is extended. This can be used if you find that the default drying time is sufficient to dry the ink.
- **Reduced:** the default drying time is reduced. This can be used if you want to get prints as fast as possible, and you find that the reduced drying time causes no significant problem in your environment.
- **None:** no drying time is provided. This can be used, for example, if you are manually removing the prints as quickly as the printer is producing them.
- **Manual:** this allows you to specify the drying time (in seconds).

To change the drying time, see [Change the drying time on page 37](#).

Supported paper types

The following table lists the most common HP paper types that are suitable for use with your printer, and shows the name that you should select on the front panel when loading each paper type. If you want to use an HP paper that does not appear on the front panel, go to <http://www.hp.com/go/designjet/supplies> and download the appropriate paper preset. You only need to download a preset once; the printer stores it for future use and it subsequently appears in the front panel.

For the part numbers, widths, and weights of these papers, see [Order paper on page 39](#).

 **NOTE:** This list is likely to change over the course of time. For the latest information, visit <http://www.hp.com/go/designjet/supplies/>.

Table 4-1 Supported paper types

Paper type	Product name	Front-panel name
Bond and Coated Paper	HP Coated Paper	HP Coated Paper
	HP Universal Bond Paper	HP Universal Bond Paper
	HP Bright White Inkjet Bond Paper	HP Bright White Inkjet Bond Paper
	HP Recycled Bond Paper	HP Recycled Bond Paper
	Plain paper (inkjet or LED) from 60 to 80 g/m ²	Plain paper
	Bright white bond paper	Bright White Bond Paper
	Coated or plain paper (inkjet or LED) from 90 to 110 g/m ²	Coated Paper
	Heavyweight coated or plain paper (inkjet or LED) above 110 g/m ²	Heavyweight Coated Paper
	Recycled bond paper	Recycled Bond Paper
Technical Paper	Natural tracing paper	Natural Tracing Paper
	Translucent bond	Translucent Bond
	Vellum	Vellum
Photo Paper	HP Universal High-Gloss Photo Paper	HP Universal High-Gloss Photo Paper
	Photo glossy paper for dye-based inks	Photo Gloss Paper
	Photo semi-glossy or satin paper for dye-based inks	Photo Semi-Gloss/Satin Paper
	Photo matte paper	Photo Matte Paper
Film	Transparent or clear film	Transparent/Clear Film
	Matte film	Matte Film
Backlit Material	Backlit material	Backlit Material
Self-Adhesive Material	Adhesive paper	Adhesive Paper
	Adhesive polypropylene satin	Adhesive Polypropylene Satin

Load a roll into the printer

1. At the printer's front panel, select the  icon, and then select **Paper load > Load roll**.

Paper load

- ▶ Load roll 1
- ▶ Load roll 2
- ▶ Load roll 3

2. Select the roll that you intend to load using the **Up** and **Down** keys. The printer puts all rolls on standby.
3. If the selected roll is currently loaded, the printer automatically unloads it, printing the barcode if **Printing paper info** is enabled (see [Printing paper info on page 38](#)). Remove the unloaded roll.
4. If **Printing paper info** is not enabled, the front panel asks you to select the paper type (see [Supported paper types on page 28](#)).
5. Open the roll door with its blue handle when prompted by the front panel.

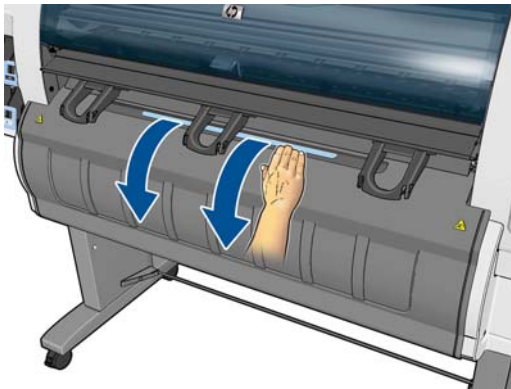

6. Check that the hubs are the correct size for the roll you want to load. If necessary, change them.
7. Move the left hub to the left by pressing the blue lever.

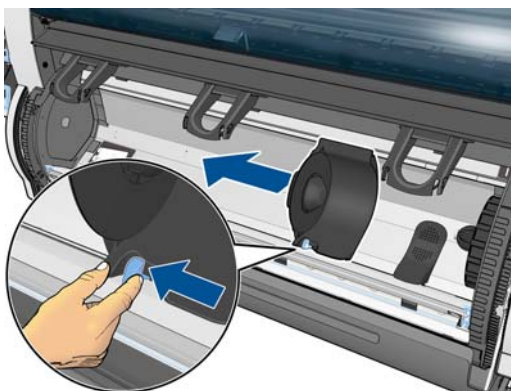

8. Put the roll into the cavity with the paper edge on the near side facing downwards.

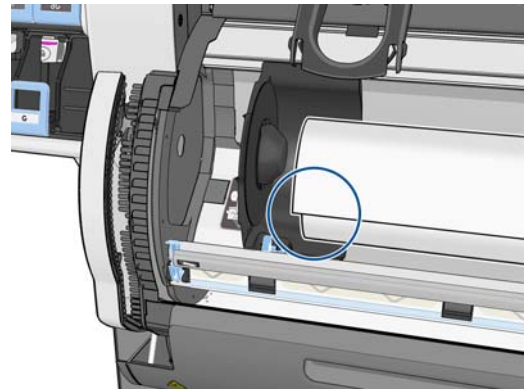
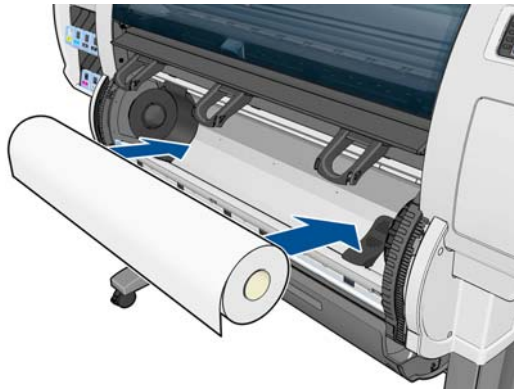

9. Insert the right side of the roll onto the right hub. Check that the roll is in contact with the disc.

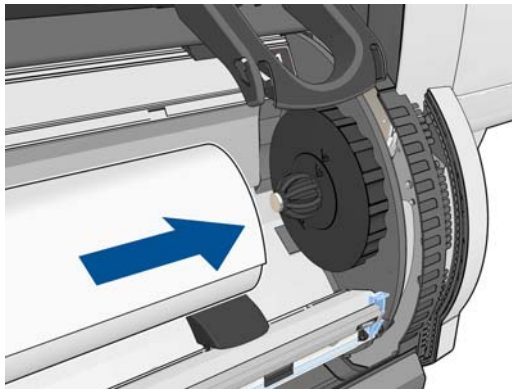

10. Push the left hub onto the left end of the roll. Check that the hub disc is aligned with the green mark.

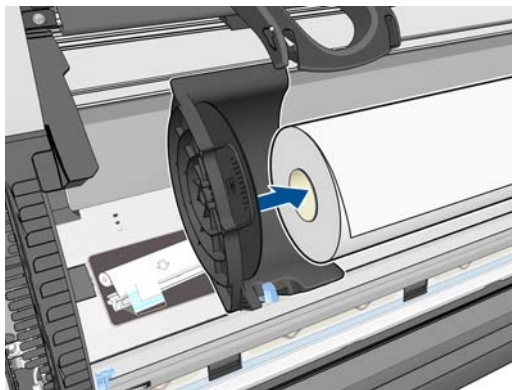

11. Check that there is no gap between the roll and either of the hubs.

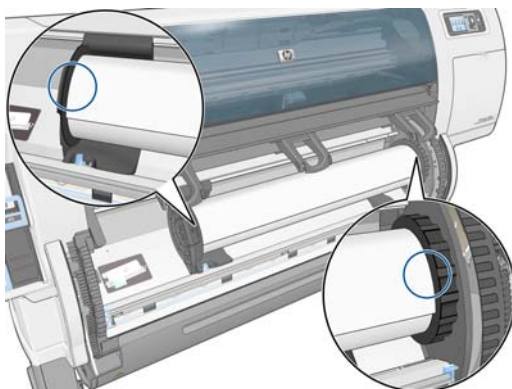

12. Pull some paper from the roll.
13. If you need to trim the leading edge of the paper, you can use a sharp knife (not supplied with the printer) to cut along the slot in the paper feed brake.

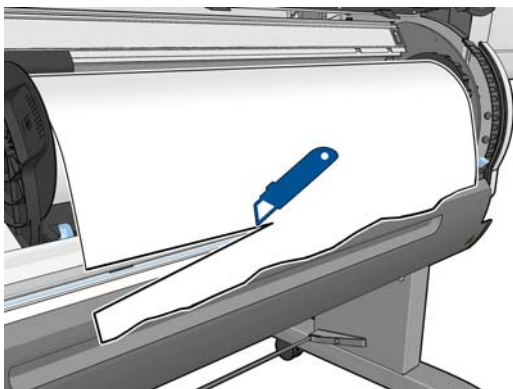

14. Open the paper feed brake.

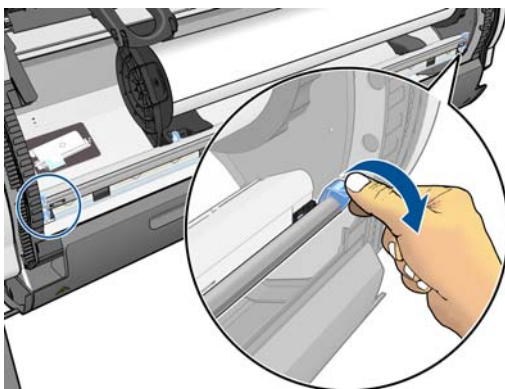

15. Advance the paper to the blue zone.

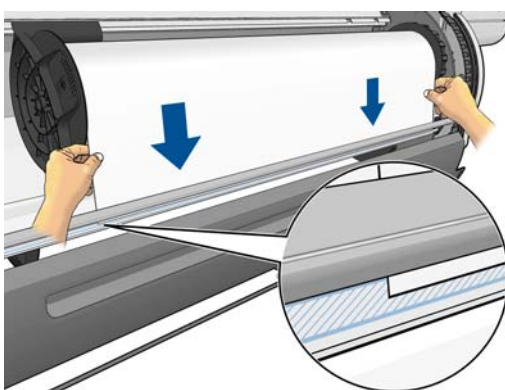

- 16.** Close the paper feed brake. Check that the paper edge is still in the blue zone.

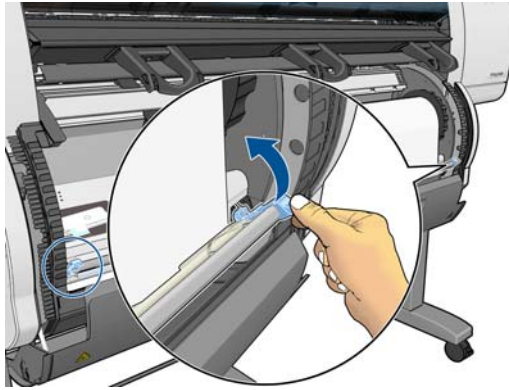

- 17.** Close the roll door.

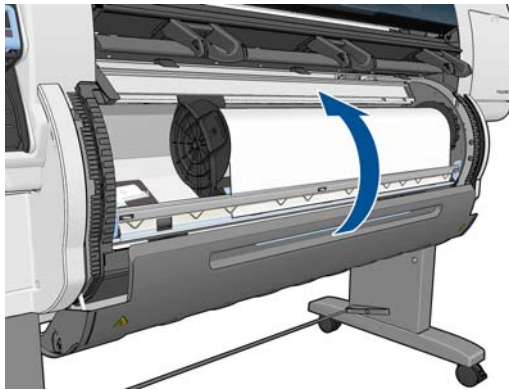

18. If the paper that you are using has a barcode printed on the leading edge of the roll, and **Printing paper info** is enabled, the printer automatically reads the information.



If **Printing paper info** is enabled and no barcode is detected on the roll that is being loaded, the front panel asks you to enter the paper type and the length of the roll you are loading. Select the paper category and paper type of the roll. If it is not clear which paper category or paper type to select, see [Supported paper types on page 28](#).

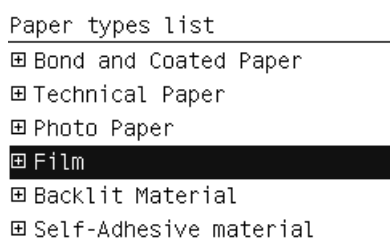

Select the length of the roll.

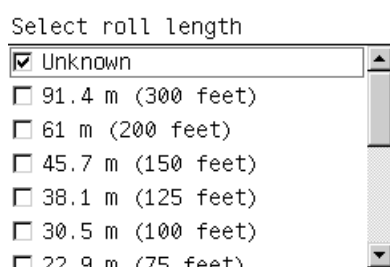

19. The printer performs some paper calibrations, after which the roll is ready for use.

 **NOTE:** During initial printer setup, printhead alignment and color calibration are performed automatically after the roll is loaded into the printer.

If you experience a problem while loading the paper, follow the instructions on the front panel to load successfully. If you cancel the load, the paper will be unloaded. Here are some problems that can occur:

- Paper not found. Check that the paper type is supported (perhaps it's transparent).
- Right edge of roll too far from blue line. Check that the paper is correctly aligned with the right hub.
- Back door unexpectedly opened. Do not open the back door during a roll load.
- End of roll reached. In this case, the paper is ejected at the front of the printer.

Unload a roll from the printer

1. At the printer's front panel, select the  icon, and then select **Unload paper**.
2. All rolls are put on standby, and the paper is unloaded. If **Printing paper info** is enabled, the barcode is printed on the paper edge (see [Printing paper info on page 38](#)).
3. Wait until the front panel asks you to open the roll door, then open it.

4. Wind any trailing paper manually onto the roll.
5. Move the left hub to the left by pressing the blue lever.
6. Remove the roll.
7. Close the roll door.

View information about the paper

On the printer's front panel, select the  icon, and then select **View paper source**.

The following information appears on the front panel:

- The roll status
- The paper type that you have selected
- The width of the paper in millimeters (estimated by the printer)
- The length of the paper in millimeters (estimated by the printer)
- The color calibration status
- The paper advance calibration status

If no paper is loaded, the message **Out of paper** appears.

The same information appears on the Embedded Web Server's Supplies page.

Perform paper advance calibration

The printer is calibrated to advance correctly when printing all the papers that appear on the front panel. When you select the type of loaded paper, the printer adjusts the rate at which it advances the paper while printing. However, to fine-tune the image quality of your print, you may need to calibrate the rate at which the paper advances. See [Troubleshoot print-quality issues on page 147](#) to determine whether paper-advance calibration is the solution for your issue.

Accurate paper advance controls proper placement of dots on the paper. If the paper is not advanced correctly, light or dark bands appear in the printed image and the grain in the image might increase.

The printer starts paper advance calibration automatically if accurate paper advance is particularly important for the loaded paper type. This can happen after the paper is loaded or after printhead replacement.

To check the paper advance calibration status of the paper, select the  icon, and then select **View loaded paper > View paper details**. The status appears:

- **DEFAULT:** The default calibration set in the factory is used. Unless you experience print-quality problems such as banding or graininess, HP recommends that you do not recalibrate the paper advance.
- **RECOMMENDED:** The paper supports automatic advance calibration, but has not yet been calibrated, or its calibration has become obsolete. HP recommends that you perform paper advance calibration to optimize the values.
- **OK:** The paper has already been calibrated. However, you may need to repeat the calibration if you experience print-quality problems such as banding or graininess.

 **NOTE:** Whenever you update the printer firmware, the paper-advance calibration values are reset to the factory default. See [Update the printer firmware on page 144](#).

NOTE: Colored papers, glossy canvas, and transparent materials such as translucent bond, clear film, natural tracing paper, and vellum are not suitable for paper-advance calibration.

Overview of the paper advance procedure

1. On the front panel, select the  icon, and then select **Image quality maintenance > Paper advance calibration > Calibrate paper advance**. The printer automatically calibrates the paper-advance and prints a paper advance calibration image.

2. Wait until the front panel shows the status screen, and then reprint your image.

 **NOTE:** The calibration procedure takes approximately six minutes. The front-panel display shows any errors in the process.

If you are satisfied with your image, continue using this calibration for your paper type. If you see improvement in your image, continue with the next step. If you are dissatisfied with the calibration, return to the default calibration. See [Return to the default calibration on page 37](#).

3. To fine-tune the calibration, select the  icon, and then select **Image quality maintenance > Paper advance calibration > Adjust paper advance**.

4. Select the percentage of change from -5‰ to +5‰. To correct light banding, decrease the percentage. To correct dark banding, increase the percentage.

 **TIP:** This can also be useful for fine-tuning the total length of the print. Bear in mind that 1‰ means a change of 1 mm per meter, or 1 mil per inch.

5. Press the **OK** button on the front panel to save the value.
6. Wait until the front panel shows the status screen, and then reprint your image.

Return to the default calibration

Returning to the default calibration sets all the paper-advance calibration to zero. To return to the default paper advance-calibration value, you must reset the calibration.

1. On the front panel, select the  icon, and then select **Image quality maintenance** > **Paper advance calibration** > **Reset paper advance**.
2. Wait until the front panel shows that the operation has been successfully completed before you press the **Back** button to return to the **Ready** screen.

Download paper presets

Each supported paper type has its own characteristics. The printer changes the way it prints on each different paper type. For example, some might need more ink and some might require a longer drying time. The printer requires a description of the requirements of each paper type. This description is called the “paper preset”.

The paper preset contains the ICC profile, which describes the color characteristics of the paper. It also contains information about other characteristics and requirements of the paper that are not directly related to color. Existing paper presets for your printer are installed in the printer's software.

Your printer contains paper presets for only the most commonly used paper types. If you buy a paper type for which your printer has no preset, you cannot select that paper type in the front panel.

You can assign a preset for a new paper type in three ways:

- Use an HP factory paper preset by selecting the closest category and type on the front panel or in the HP Utility

 **NOTE:** Because colors might not be accurate, this method is not recommended for high-quality prints.

- Go to <http://www.hp.com/go/designjet/downloads> and click the **HP Designjet ICC/Paper presets and PANTONE tables** link. Select from the **HP Designjet paper presets** drop-down menu.

 **NOTE:** HP provides presets for HP paper types only. If you do not find the paper preset that you want on the Web, it might have been added to the latest firmware for your printer. Check the firmware release notes for information. See [Update the printer firmware on page 144](#).

Cancel the drying time

Press the **Form Feed and Cut** button  on the front panel.

△ **CAUTION:** A print that has not dried sufficiently can suffer from quality problems.

Change the drying time

You can use the HP Utility to change the drying time for a particular paper type, to accommodate special printing conditions.

1. Open the HP Color Center.
2. Select **Paper preset management**.

3. Select **Change printing properties**.
4. Select the paper category.
5. Select the paper type.
6. Choose a drying time from the Dry Time drop-down menu.

 **NOTE:** The text box to the right of the drop-down menu will not display the time in seconds when the **Automatic** option is selected (it is selected by default for all paper types). This is because the **Automatic** option means that the printer will calculate the optimal drying time for you depending on the temperature at printing time, and therefore it cannot be known in advance.

You can turn off all drying time for all paper types by selecting the  icon, then **Print retrieval > Select drying time > Off**.

For more information about drying time, see [Drying time on page 28](#).

Printing paper info

The **Printing paper info** option is enabled by default; it allows the printer to estimate the remaining roll length by reading a barcode that is printed on the leading edge of the roll whenever the paper is unloaded.



When you load a new, unused roll, there is no barcode already printed on it, so the front panel will ask you for the length. The length printed on the barcode at unloading time is calculated from the length you declare at the start, minus the length that has been printed.

 **NOTE:** If you declare at loading time that the length of the roll is unknown, then **Printing paper info** is disabled and no barcode is printed.

To disable the **Printing paper info** option, select the  icon in the printer's front panel, and then select **Printing preferences > Paper options > Disable printing paper info**. In this case, the length will not be requested, and the barcode will be neither printed nor read.

Feed and cut the paper

If you press the **Form feed and cut** key  on the front panel, the printer advances the paper and makes a straight cut across the front edge. There are at least two possible reasons why you may want to do this.

- To trim the leading edge of the paper if it is damaged or not straight.
- To cancel the waiting time and print the available pages immediately, if the printer is waiting to nest more pages.

 **NOTE:** The printheads are serviced after each print, and the paper cannot be cut until the process completes, so you may notice a delay.

 **CAUTION:** Remove the cut piece from the output tray. If strips or short prints are left in the output tray, the printer could jam.

Store the paper

The following are tips for storing paper:

- Always keep unused rolls wrapped in the plastic wrap to prevent discoloration. Rewrap partially used rolls if they are not being used.
- Do not stack rolls.
- Allow all paper types to adapt to room conditions out of the packaging for 24 hours before printing.
- Handle film and glossy paper by the edges or wear cotton gloves. Skin oils can be transferred to the paper, leaving fingerprint marks.
- Keep the paper tightly wound on the roll throughout the loading and unloading procedures. If the roll starts to unwind, it can become difficult to handle.

Order paper

The following paper types are currently provided for use with your printer.

 **NOTE:** This list is likely to change over the course of time. For the latest information, see <http://www.hp.com/go/designjet/supplies/>.

Key to geographic availability:

- (A) indicates papers that are available in Asia (excluding Japan)
- (J) indicates papers that are available in Japan
- (C) indicates papers that are available in China only
- (E) indicates papers that are available in Europe, the Middle East, and Africa
- (L) indicates papers that are available in Latin America
- (N) indicates papers that are available in North America

If the part number is not followed by parentheses, the paper is available in all regions.

All papers listed are compatible with the T7100, but only the papers marked with * in the first column are compatible with the T7100 Mono.

Table 4-2 Paper

Paper type	g/m ²	Length	Width	Part numbers
HP Bond and Coated Paper				
HP Super Heavyweight Plus Matte Paper	210	30.5 m (100 ft)	610 mm (24 in)	Q6626A
			914 mm (36 in)	Q6627A
			1067 mm (42 in)	Q6628A

Table 4-2 Paper (continued)

Paper type	g/m ²	Length	Width	Part numbers
HP Heavyweight Coated Paper	131	30.5 m (100 ft)	610 mm (24 in)	C6029C (AEJN)
			914 mm (36 in)	C6030C
			1067 mm (42 in)	C6569C
		67.5 m (225 ft)	1067 mm (42 in)	Q1956A (EN)
HP Universal Heavyweight Coated Paper	120	30.5 m (100 ft)	610 mm (24 in)	Q1412A (AEJN)
			914 mm (36 in)	Q1413A
			1067 mm (42 in)	Q1414A (AEJN)
HP Coated Paper *	90	45.7 m (150 ft)	420 mm (16.54 in)	Q1443A (J)
			594 mm (23.39 in)	Q1442A (EJ)
			610 mm (24 in)	C6019B
			841 mm (33.11 in)	Q1441A (EJ)
			914 mm (36 in)	C6020B
			1067 mm (42 in)	C6567B
		91.4 m (300 ft)	914 mm (36 in)	C6980A
HP Universal Coated Paper *	95	45.7 m (150 ft)	610 mm (24 in)	Q1404A (AEJN)
			914 mm (36 in)	Q1405A (AEJN)
			1067 mm (42 in)	Q1406A
HP Bright White Inkjet Bond Paper *	90	45.7 m (150 ft)	420 mm (16.54 in)	Q1446A (J)
			594 mm (23.39 in)	Q1445A (EJ)
			610 mm (24 in)	C1860A (LN), C6035A (AEJ)
			841 mm (33.11 in)	Q1444A (EJ)
			914 mm (36 in)	C1861A (LN), C6036A (AEJ)
		91.4 m (300 ft)	914 mm (36 in)	C6810A
HP Universal Bond Paper *	80	45.7 m (150 ft)	594 mm (23.39 in)	Q8003A (AJ)
			610 mm (24 in)	Q1396A
			914 mm (36 in)	Q1397A
			1067 mm (42 in)	Q1398A
		175 m (574 ft)	594 mm (23.39 in)	Q8004A (AEJ)
			841 mm (33.11 in)	Q8005A (AEJ)
			914 mm (36 in)	Q8751A (ELN)

Handle the paper

Table 4-2 Paper (continued)

Paper type	g/m²	Length	Width	Part numbers
HP Recycled Bond Paper *	80	45.7 m (150 ft)	420 mm (16.54 in)	CG892A (E)
			610 mm (24 in)	CG889A (EN)
			914 mm (36 in)	CG890A (EN)
			1067 mm (42 in)	CG891A (EN)
HP Technical Paper				
HP Special Inkjet Paper *	90	45.7 m (150 ft)	610 mm (24 in)	51631D (ELN)
			914 mm (36 in)	51631E
HP Natural Tracing Paper *	90	45.7 m (150 ft)	594 mm (23.39 in)	Q1439A (J)
			610 mm (24 in)	C3869A (AE)
			914 mm (36 in)	C3868A (AE)
HP Translucent Bond Paper *	67	45.7 m (150 ft)	610 mm (24 in)	C3860A (AJN)
			914 mm (36 in)	C3859A (LN)
HP Vellum Paper *	75	45.7 m (150 ft)	610 mm (24 in)	C3862A (N)
			914 mm (36 in)	C3861A (LN)
HP Film (technical and graphic)				
HP Clear Film *	174	22.9 m (75 ft)	610 mm (24 in)	C3876A (AEJN)
			914 mm (36 in)	C3875A
HP Matte Film *	160	38.1 m (125 ft)	610 mm (24 in)	51642A (AEJN)
			914 mm (36 in)	51642B
HP Photographic Paper				
HP Premium Matte Photo Paper	210	30.5 m (100 ft)	610 mm (24 in)	CG459A
			914 mm (36 in)	CG460A
HP Everyday Pigment Ink Gloss Photo Paper	235	30.5 m (100 ft)	610 mm (24 in)	Q8916A
			914 mm (36 in)	Q8917A
			1067 mm (42 in)	Q8918A
HP Everyday Pigment Ink Satin Photo Paper	235	30.5 m (100 ft)	610 mm (24 in)	Q8920A
			914 mm (36 in)	Q8921A
			1067 mm (42 in)	Q8922A
HP Professional Satin Photo Paper	300	15.2 m (50 ft)	610 mm (24 in)	Q8759A
HP Premium Plus Gloss Photo Paper	280	15.2 m (50 ft)	610 mm (24 in)	Q5488A (EN)
HP Premium Plus Satin Photo Paper	280	15.2 m (50 ft)	458 mm (18 in)	Q7920A (N)
			610 mm (24 in)	Q5491A (EN)

Table 4-2 Paper (continued)

Paper type	g/m ²	Length	Width	Part numbers
HP Premium Instant-dry Gloss Photo Paper	260	30.5 m (100 ft)	914 mm (36 in)	Q7993A
			1067 mm (42 in)	Q7995A
			22.9 m (75 ft)	610 mm (24 in)
HP Premium Instant-dry Satin Photo Paper	260	30.5 m (100 ft)	914 mm (36 in)	Q7994A
			1067 mm (42 in)	Q7996A
			22.9 m (75 ft)	610 mm (24 in)
HP Universal Instant-dry Gloss Photo Paper	190	30.5 m (100 ft)	610 mm (24 in)	Q6574A
			914 mm (36 in)	Q6575A
			1067 mm (42 in)	Q6576A
			61 m (200 ft)	1067 mm (42 in)
HP Universal Instant-dry Semi-gloss Photo Paper	190	30.5 m (100 ft)	610 mm (24 in)	Q6579A
			914 mm (36 in)	Q6580A
			1067 mm (42 in)	Q6581A
			61 m (200 ft)	1067 mm (42 in)
HP Universal High-gloss Photo Paper	190	30.5 m (100 ft)	610 mm (24 in)	Q1426A (AEJN)
			914 mm (36 in)	Q1427A (AEJN)
			1067 mm (42 in)	Q1428A (AEJN)
HP Universal Semi-gloss Photo Paper	190	30.5 m (100 ft)	610 mm (24 in)	Q1420A (AEJN)
			914 mm (36 in)	Q1421A (AEJN)
			1067 mm (42 in)	Q1422A (AEJN)
HP Backlit Material				
HP Premium Vivid Color Backlit Film	285	30.5 m (100 ft)	914 mm (36 in)	Q8747A
			1067 mm (42 in)	Q8748A
HP Self-Adhesive Material				
HP Universal Adhesive Vinyl	290	20.1 m (66 ft)	914 mm (36 in)	Q8676A (EN)
			1067 mm (42 in)	Q8677A (EN)
HP Colorfast Adhesive Vinyl	328	12.2 m (40 ft)	914 mm (36 in)	C6775A
HP Adhesive-backed Polypropylene	128	50 m (164 ft)	914 mm (36 in)	Q8044A (C)
			1067 mm (42 in)	Q8884A (C)
HP Self-adhesive Gloss Polypropylene	120	36.6 m (120 ft)	914 mm (36 in)	Q8834A
			1067 mm (42 in)	Q8835A
HP Everyday Adhesive Matte Polypropylene	180	22.9 m (75 ft)	610 mm (24 in)	CG843A
			914 mm (36 in)	CG824A
			1067 mm (42 in)	CG825A

Handle the paper

Table 4-2 Paper (continued)

Paper type	g/m ²	Length	Width	Part numbers
HP Banner and Sign Material				
HP Durable Semi-gloss Display Film	255	15.2 m (50 ft)	914 mm (36 in)	Q6620B (EN)
HP Opaque Scrim	486	15.2 m (50 ft)	610 mm (24 in)	Q8675A (N)
			914 mm (36 in)	Q1898B (AEN)
			1067 mm (42 in)	Q1899B (AEN)
HP Matte Polypropylene	130	22.9 m (75 ft)	914 mm (36 in)	Q1903A (AEN)
			1067 mm (42 in)	Q1904A (AEN)
HP Everyday Matte Polypropylene	120	30.5 m (100 ft)	610 mm (24 in)	CH022A (EN)
			914 mm (36 in)	CH023A (EN)
			1067 mm (42 in)	CH025A (EN)
			61 m (200 ft)	CH024A (N)
HP Durable Banner with Du Pont Tyvek	140	22.9 m (75 ft)	914 mm (36 in)	CG821A
			1067 mm (42 in)	CG822A

Non-recommended paper types

In many cases, paper types that HP does not support might be compatible with your printer. However, the following paper types are unlikely to give satisfactory results:

- Photo paper that swells
- Brochure paper

5 Handle the ink system

- [Ink system components](#)
- [Ink system tips](#)
- [Work with ink system components](#)
- [Order ink supplies](#)

Ink system components

Ink cartridges

The T7100 printer's six ink cartridges provide black, yellow, magenta, cyan, gray and dark gray ink to the printheads. The T7100 Mono printer has two ink cartridges, black and dark gray.





Ink cartridges require no maintenance or cleaning. When each ink cartridge is shaken vigorously before installation, and inserted correctly into its slot, the ink will flow to the printheads. Because the printheads control the amount of ink that is transferred to the page, high-quality printing results continue even when the ink levels are getting low.

△ **CAUTION:** Avoid touching pins, leads, and circuitry when handling ink cartridges because these elements are sensitive to electrostatic discharge. Such devices are called ESD-sensitive devices. See [Glossary on page 204](#). Electrostatic discharges are one of the main hazards to electronics products. This type of damage can reduce the life expectancy of the device.

Replace ink cartridges

To check the ink levels in the ink cartridges:

- Press the  key repeatedly until you see the ink levels, or
- Select the  icon, then **Ink cartridge information**.

Ink levels

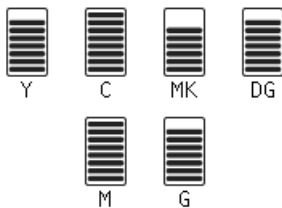

The front panel warns you when cartridge ink level is low. When a cartridge is empty, the printer stops printing and the front panel provides an explanation.

MK cartridge is out of ink

Replace MK cartridge/s

Press **MK** to start cartridge replacement



HP recommends that you replace the empty cartridge with a new HP cartridge. See [Order ink supplies on page 67](#), [Remove an ink cartridge on page 48](#), and [Insert an ink cartridge on page 50](#).

Although it is possible to use refilled or non-HP ink cartridges, either choice has several serious disadvantages:

- There is some risk of damaging the printer. In this case the printer warranty will not be valid for any printer repairs that are related to the cartridge, nor for any problems due to ink contamination.
- You will invalidate the warranty of all printheads of the same color used in the printer subsequently, unless and until the whole ink system (including ink tubes) is replaced.
- Print quality may be impaired.
- The printer will be unable to estimate the ink level in the cartridge, and will report it as empty.

If you decide to use refilled or non-HP ink cartridges, you will need to follow these instructions to make the printer use a cartridge that it believes to be empty.

1. Install the cartridge in the printer (see [Insert an ink cartridge on page 50](#)).
2. The front panel will complain that the cartridge is empty, and the cartridge removal process will start. Press the **Cancel** key to stop this automatic process.
3. At the front panel, select the  icon; highlight **Replace ink cartridges**, but do not select it.
4. Press the **Cancel** key and the **Up** key at the same time, and hold them down for at least two seconds.
5. The front panel will display a series of warning messages. In response to each message, press the **Cancel** key to cancel the process, or the **OK** key to confirm that you wish to continue.

When you have pressed **OK** in response to all warning messages, the front panel will give the usual ink cartridge status display, but the refilled or non-HP cartridge will be shown as empty with a warning sign.

Printheads

The printheads are connected to the ink cartridges. They use jet action to put ink on the paper. Each printhead has two ink-cartridge connection points and two sets of nozzles, which means that each printhead can print in two different colors. For example, the printhead below prints in magenta and yellow.

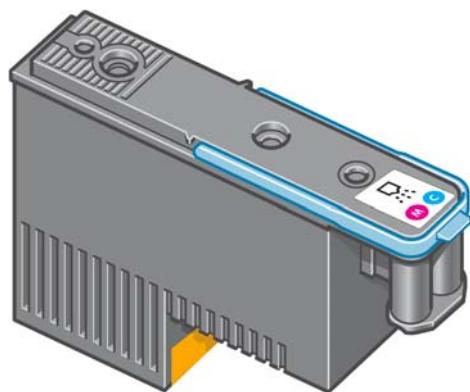

The printheads are extremely durable and do *not* need to be replaced every time an ink cartridge is replaced. They provide excellent results even when the ink cartridges contain a low level of ink.

To maintain optimum print quality, the printheads are automatically tested at regular intervals, and automatically serviced when necessary. This takes a little time and can occasionally delay printing.

When a printhead eventually needs to be replaced, the front panel will display a message.

To check the status of the printheads:

- Press the ⓘ key repeatedly until you see the printheads' status, or
- Select the  icon, then **Printhead information**.

△ **CAUTION:** Avoid touching pins, leads, and circuitry when handling ink cartridges because these elements are sensitive to electrostatic discharge. Such devices are called ESD-sensitive devices. See [Glossary on page 204](#). Electrostatic discharges are one of the main hazards to electronics products. This type of damage can reduce the life expectancy of the device.

Maintenance cartridge

Use the maintenance cartridge to clean and maintain the printheads, ensure the best possible print quality, and seal the printheads when they are not in use to prevent them from drying out.

 **NOTE:** The maintenance cartridge contains liquid. Therefore, store any maintenance cartridges upright and on a flat surface.



Ink system tips

For best results, always follow these guidelines:

- Install the ink cartridges, printheads, and maintenance cartridge before the install-by date, which is printed on the packaging. The expiration for the ink cartridges is the manufacturing date marked on the cartridge plus 30 months.
- Follow the instructions on the front panel during installation.
- Allow the printer and the maintenance cartridge to clean the printheads automatically.
- Avoid unnecessary removal of the ink cartridges and printheads.
- The ink cartridges should never be removed while the printer is printing. They should be removed only when the printer is ready for you to replace them. The front panel guides you through the removal and installation procedures (or see [Remove an ink cartridge on page 48](#) and [Insert an ink cartridge on page 50](#)).
- Make sure that you comply with all applicable laws and regulations when disposing of ink system consumables.

 **NOTE:** Shake the ink cartridges vigorously before installing them. See [Insert an ink cartridge on page 50](#).

Work with ink system components

Remove an ink cartridge

Ink cartridges should be removed for the following two reasons:

- The ink cartridge is very low and you want to replace it with a full cartridge for unattended printing. You can use the remaining ink in the first cartridge at a more convenient time.
- The ink cartridge is empty or faulty, and you must replace it to continue printing.

```
MK cartridge is out of ink
```

```
Replace MK cartridge/s
```

```
Press MK to start  
cartridge  
replacement
```



△ **CAUTION:** The procedure to remove an ink cartridge must be initiated from the front panel. Do not remove an ink cartridge until the front panel prompts you.

CAUTION: Remove an ink cartridge only if you are ready to insert another one.

△ **WARNING!** Make sure that the printer wheels are locked (the brake lever is pressed down) to prevent the printer from moving.

1. At the front panel, select the  icon, then select **Replace ink cartridges**.

```
Ink  
▶ View ink levels  
▶ View Printhead status  
▶ Replace ink cartridges  
▶ Replace printheads  
▶ Replace maintenance ctg.  
▶ Replace ink absorber  
⊞ Ink cartridge information
```

2. Grip the blue tab in front of the cartridge that you want to remove.



3. Pull the blue tab down and then pull it outwards, towards you.

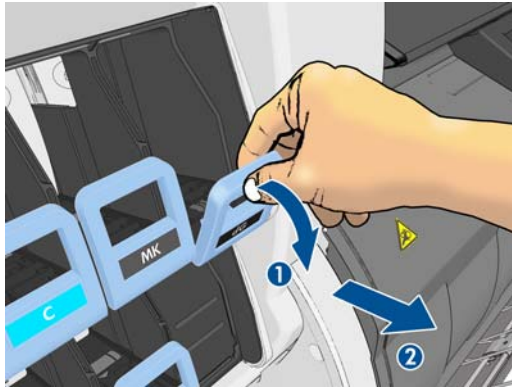

4. The cartridge comes out, in its drawer.



5. Lift the cartridge out of its drawer.

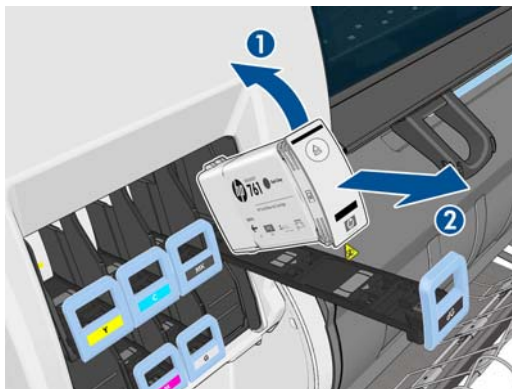

NOTE: Avoid touching the end of the cartridge that is inserted into the printer, because the connection might be coated with ink.

NOTE: If necessary, store a partially-used ink cartridge in the same position as if it were inserted in the printer. Avoid using a partially-used cartridge that has been stored on its end.

6. The front-panel display identifies the missing ink cartridge.

Ink cartridge missing.
Install ink cartridge

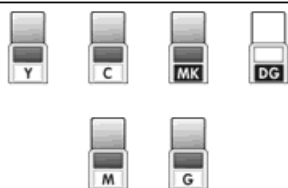

Insert an ink cartridge

1. Pick up the new ink cartridge and find the label that identifies the ink color. Hold the ink cartridge so that you can see the label at the top of the side that is facing you.
2. Check that the colored label above the empty slot in the printer matches the color of the label on the cartridge.
3. Shake the cartridge vigorously for about 15 seconds.
4. Insert the ink cartridge into the cartridge drawer.



5. Slide the drawer and cartridge into the slot until they lock into position.

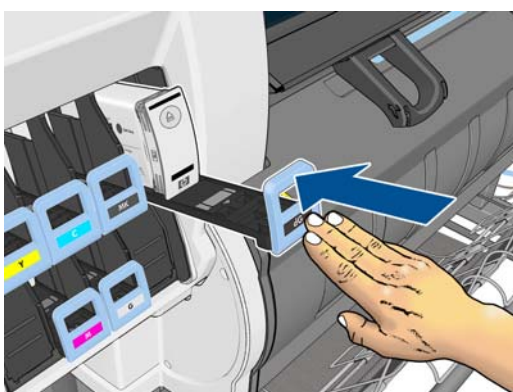

If you have difficulty, see [Cannot insert an ink cartridge on page 165](#).

6. The front-panel display confirms that all cartridges have been correctly inserted.

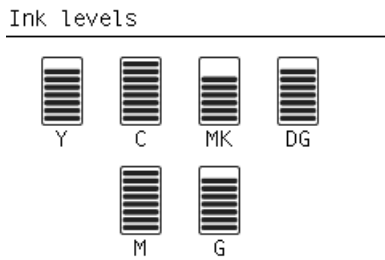

Remove a printhead

- ⚠ **WARNING!** Make sure that the printer wheels are locked (the brake lever is pressed down) to prevent the printer from moving.

Printhead replacement must be performed after the printer has been turned on with the hard power switch at the back of the printer.

1. At the front panel, select the  icon, then select **Replace printheads**.

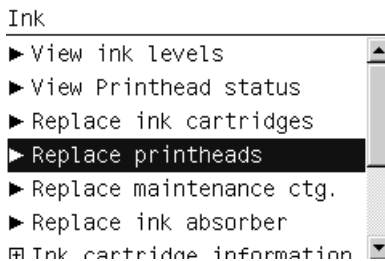

2. The printer moves the carriage into the correct position.

- ⚠ **CAUTION:** If the carriage remains in the removal position for more than 3 minutes without inserting or removing any printheads, it will attempt to return back to its home position to the right.

3. When the carriage has stopped moving, the front panel prompts you to open the printer window.

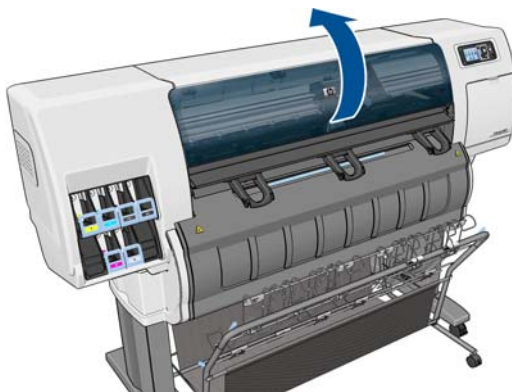

4. Locate the carriage on the right side of the printer.

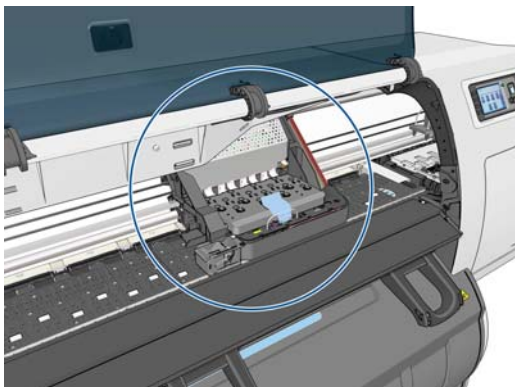

5. Pull up and release the latch on top of the carriage.

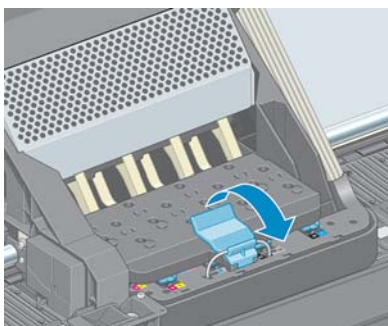

6. Lift up the cover. This provides access to the printheads.

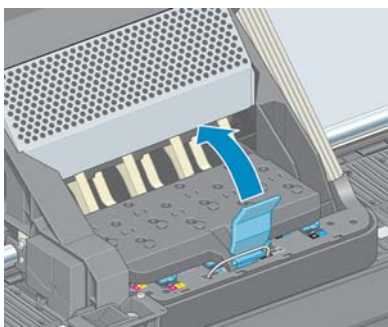

7. To remove a printhead, lift up the blue handle.

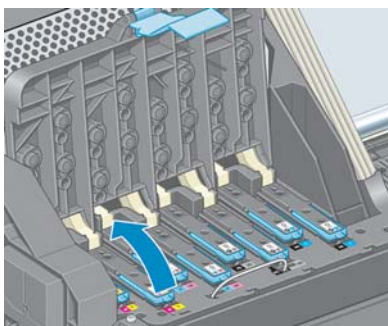

8. Using the blue handle, gently disengage the printhead.

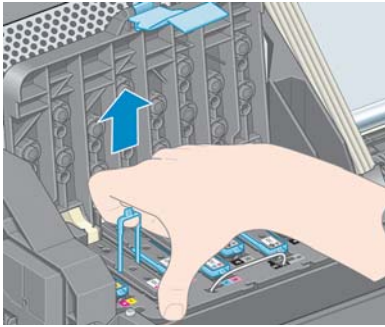

9. Gently pull the blue handle upward until the printhead is released from the carriage.

△ **CAUTION:** Do not pull abruptly. That action can damage the printhead.

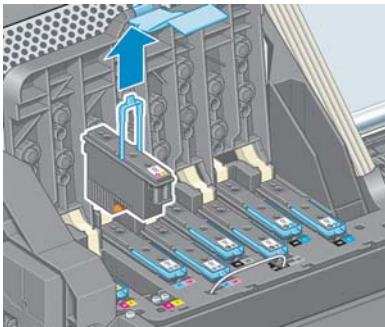

10. The front-panel display identifies the missing printhead.

Lift printhead cover.
Install missing printheads

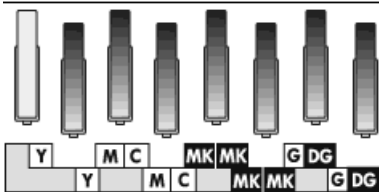

Insert a printhead

1. Remove the orange protective caps by pulling them down.

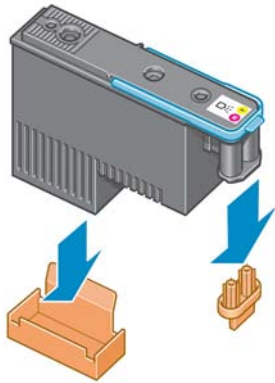

2. The printhead is designed to prevent you from accidentally inserting it into the wrong slot. Check that the colored label on the printhead matches the colored label of the carriage slot into which the printhead is to be inserted.
3. Insert the new printhead into its correct slot in the carriage.

△ **CAUTION:** Insert the printhead slowly and vertically, straight down. It can be damaged if you insert it too quickly, or at an angle, or if you rotate it as you insert it.

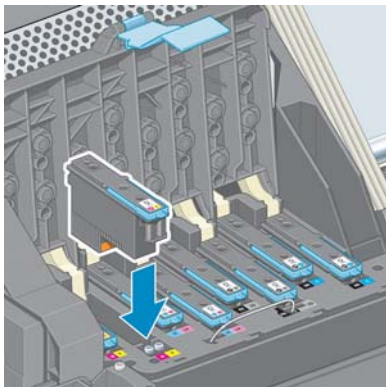

4. Push down as indicated by the arrow.

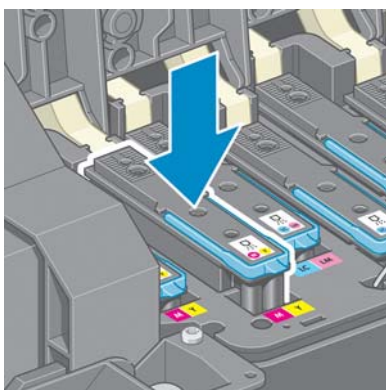

△ **CAUTION:** You might feel some resistance when installing the new printhead, so you need to press it down firmly but smoothly. You should hear a beep and see confirmation on the front-panel display that the printhead has been inserted. If you have difficulty, see [Cannot insert a printhead on page 165](#).

5. Insert all of the other printheads that need to be installed, and close the carriage cover.

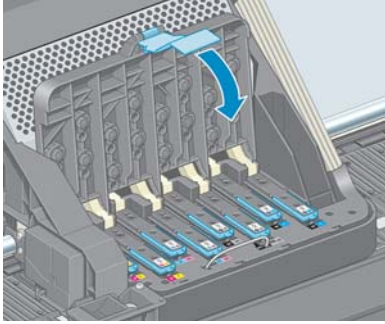

6. Make sure that the end of the blue handle catches the wire loop on the near side of the carriage.

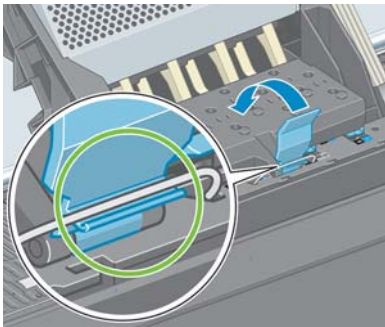

7. Lower the handle to rest on the carriage cover.

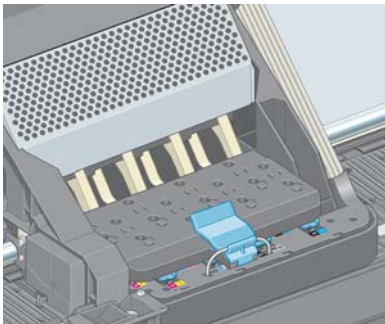

When all of the printheads have been inserted correctly and the printer has accepted them, the printer beeps.

 **NOTE:** If the printer does not beep when you insert the printhead and the **Replace** message appears on the front-panel display, you might need to reinsert the printhead.

8. Close the printer window.

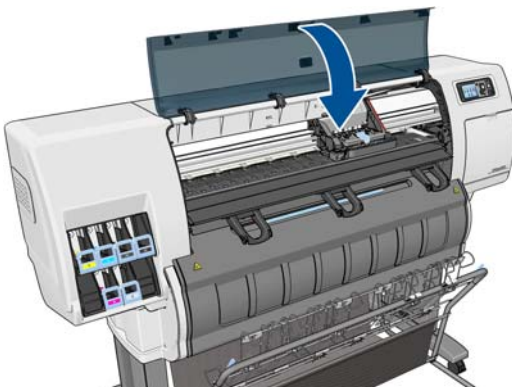

9. The front-panel display confirms that all of the printheads are correctly inserted, and the printer starts checking and preparing the printheads. The default routine process, when all printheads are changed, takes about 18 minutes. If the printer identifies a problem when preparing the printheads, the process takes longer, up to 30 minutes. For a single printhead insertion, the time varies between 10 and 20 minutes.
10. After all printheads are checked and prepared, the printhead realignment procedure runs automatically if paper is loaded. See [Align the printheads on page 59](#).
11. Depending on the paper type, the paper advance calibration procedure may run automatically if paper is loaded. See [Perform paper advance calibration on page 35](#).

Clean (recover) the printheads

Periodic printhead cleaning is performed automatically, as long as the printer is kept turned on. However, you should clean the printheads if you are experiencing poor image quality and cannot resolve the issues by other methods. This ensures that there is fresh ink in the nozzles and helps to prevent nozzle clogs.

If you have printed the printhead status plot, you know which colors are failing. Clean the pair of printheads that are not performing adequately. If you are not sure which printheads to clean, clean all of the printheads.

To clean the printheads, go to the printer's front panel and select the Image Quality Maintenance menu icon , select **Clean printheads**, and then select which printheads you want to clean. You can clean all of the printheads or only some of them.

Cleaning all printheads takes about 5 minutes. Cleaning any two printheads takes about 3 minutes.

 **NOTE:** Cleaning all printheads uses more ink than cleaning a single pair.

NOTE: HP recommends that you purge the ink from the printheads before printing a job if the printer has been turned off for more than six weeks or if you are experiencing inconsistent colors from print to print after long storage periods. Purging the ink from the printheads helps to ensure maximum color consistency; it is *not* a remedy for poor printhead health.

Clean the electrical connections on a printhead

It is possible that the printer will not recognize a printhead after it has been installed. This can happen when ink builds up on the electrical connections between the printhead and the printhead carriage. Under these circumstances, HP recommends that you clean the electrical connections on the printhead. However, routine cleaning of the connections when no problems are apparent is *not* recommended.

Use an absorbent lint-free cloth, slightly dampened with isopropyl alcohol, to clean the electrical interconnects on both the printhead carriage and the printhead if the **Reseat** or **Replace** message persists next to the printhead on the front-panel display.

1. Open the printhead carriage latch and extract the printhead that is causing the problem, as indicated on the front panel. See [Remove a printhead on page 51](#).

2. Cover your finger with the cloth and insert it into the printhead slot at the back.

△ **CAUTION:** If the carriage remains in the central part of the printer for more than 7 minutes, it attempts to return to its home position to the right.

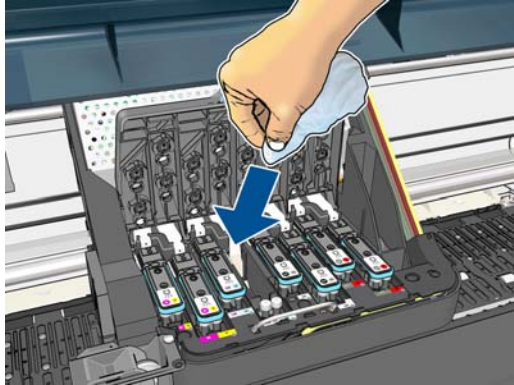

3. Rub the cloth against the electrical contacts with a *light* force along the entire depth of the flex connector. Try to avoid picking up any ink deposit that may have accumulated on the bottom surface of the slot.

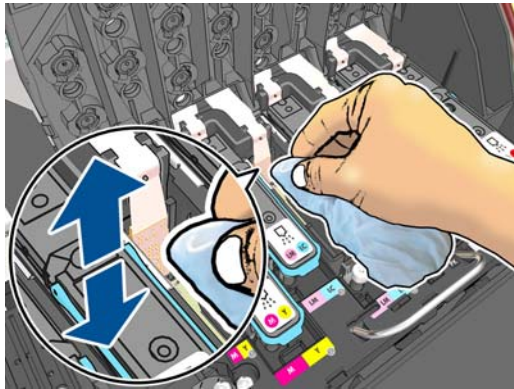

4. Take special care to clean all contacts thoroughly, including the ones at the lowest point of the connector.
5. Using the same cloth, clean the strip of electrical contacts on the printhead (unless the printhead is new). Avoid touching the printhead nozzles.

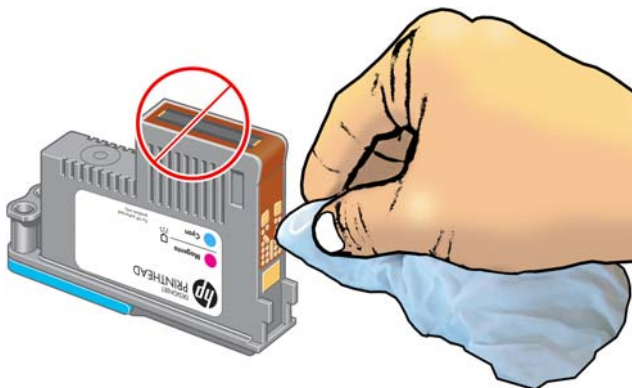

△ **CAUTION:** Do not touch the surface of the printhead that contains the nozzles, because the nozzles are easily damaged.

6. After waiting a few moments to allow both connectors to dry, replace the printhead into the printhead carriage. See [Insert a printhead on page 54](#).
7. Wash or dispose of the cloth. Take care to prevent the transfer of ink onto hands and clothing.

If the front panel continues to show the **Reset** or **Replace** message, replace the printhead or contact your HP customer service representative.

Clean the printhead drop detector

The printhead drop detector is a sensor that detects which nozzles on the printheads are not printing, so that other nozzles can substitute for them. If particles block the sensor (such as fibers, hair or small pieces of paper), print quality is affected.

When the front panel displays a warning message that the drop detector needs cleaning, you are recommended to clean it. If you do not clean it immediately, the printer continues working normally, but the front panel display continues to show the warning.

△ **CAUTION:** Wear gloves to avoid getting ink on your hands.

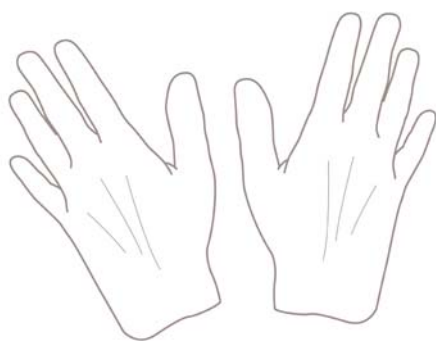

1. On the printer's front panel, select the  icon, then select **Replace printheads**.
2. Turn off the printer at the front panel.
3. To avoid an electric shock, switch the printer off and unplug it.
4. Open the printer window.

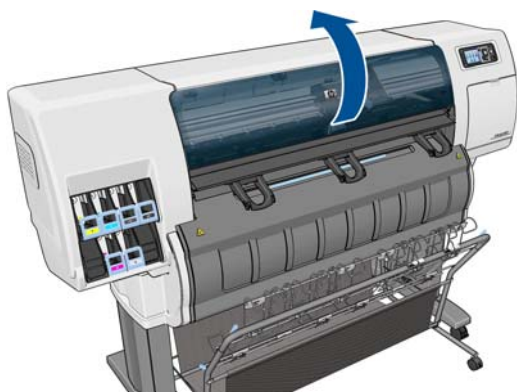

5. Find the printhead drop detector to the right of the printhead carriage.

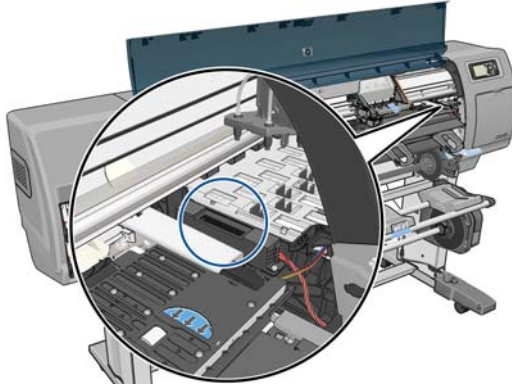

6. Remove any debris blocking the printhead drop detector.
7. With a dry, lint-free cloth, wipe the surface of the drop detector to remove any non-visible debris.

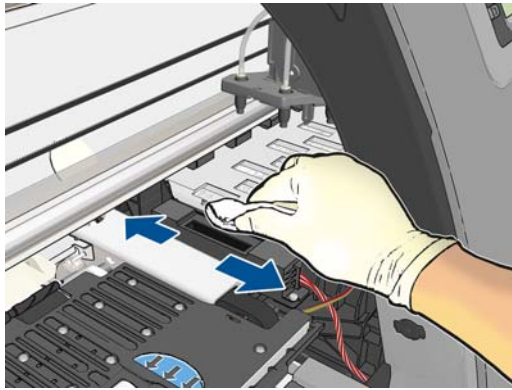

8. Close the printer window.

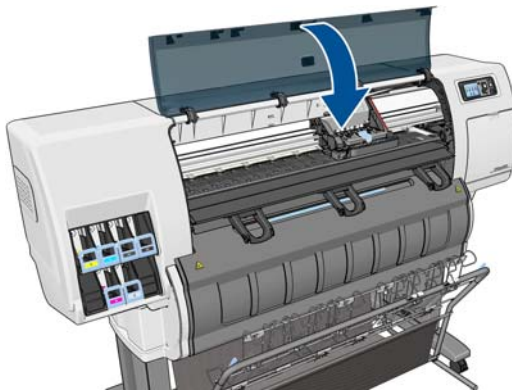



9. Plug in and switch on the printer.
10. Power the printer on at the front panel.

Align the printheads

Precise alignment between printheads is essential for accurate colors, smooth color transitions and sharp edges in graphical elements. Your printer has an automatic printhead alignment process which runs whenever a printhead has been accessed or replaced.

If the paper has jammed or you are experiencing problems with color accuracy, you may need to align the printheads.

 **NOTE:** If the paper has jammed, it is recommended that you reinsert the printheads and initiate the realignment procedure with the Image Quality Maintenance menu .

△ **CAUTION:** Do not use transparent or semi-transparent paper to align the printheads.

Reinsert printheads procedure

1. If the realignment process is running and the wrong paper is loaded, press the **Cancel** key on the front panel.

△ **CAUTION:** Do not print if the realignment process has been canceled. You can restart the alignment with the Image Quality Maintenance menu procedure.

2. Load the paper you wish to use, see [Handle the paper on page 26](#). It should be at least 420 mm (16.54 in) wide.

△ **CAUTION:** Do not use transparent or semi-transparent paper to align the printheads.

3. Remove and re-insert all the printheads, see [Remove a printhead on page 51](#) and [Insert a printhead on page 54](#). This starts the printhead alignment procedure.
4. Ensure the window is closed, as a strong light source near the printer during printhead realignment can affect alignment.
5. The process takes about six minutes. Wait until the front-panel display shows the process complete before using the printer.



 **NOTE:** The printer prints a calibration image. Do not worry about the image. The front-panel display shows any errors in the process.

Image Quality Maintenance menu procedure

1. Load the paper you wish to use, see [Handle the paper on page 26](#). It should be at least 420 mm (16.54 in) wide.

△ **CAUTION:** Do not use transparent or semi-transparent paper to align the printheads.

2. From the front panel, select the Image Quality Maintenance menu icon , then **Align printheads**. The printer checks to see if it has enough paper to run the realignment.
3. If the loaded paper is satisfactory, the printer runs the realignment and prints a realignment pattern. Ensure the window is closed, as a strong light source near the printer during printhead realignment can affect alignment.
4. The process takes about five minutes. Wait until the front-panel display shows the process complete before using the printer.

Scanning errors during alignment

If the alignment process fails, a Scanning problems message appears on the front panel. This means that the alignment has not completed successfully. Therefore the printer is not aligned and the alignment should be repeated before printing with good image quality. Possible reasons for failure:



- The paper used was not acceptable; repeat the alignment with a different paper type.
- The printheads are not clean; see [Clean \(recover\) the printheads on page 56](#).
- The window was open; repeat the alignment with the window closed.

If the problem persists after correcting these potential problems, there may be a failure in the scanning system requiring repair, or the printheads may need to be replaced.

The Image Diagnostics Print

The Image Diagnostics Print consists of patterns designed to highlight printhead reliability problems. It helps you to check the performance of the printheads that are currently installed in your printer, and whether any printhead suffers from clogging or other problems.

To print the Image Diagnostics Print:

1. Use the same paper type that you were using when you detected a problem.
2. Use the [View information](#) key  on the front panel to check that the selected paper type is the same as the paper type loaded into the printer.
3. At the printer's front panel, select the Image Quality Maintenance menu icon  then **Print diagnostic image**.

It takes about two minutes to print the Image Diagnostics Print.

The print is divided into two parts, both of which test printhead performance.

- Part 1 (top) consists of rectangles of pure colors, one for each printhead. This part represents the print quality that you will get from each color.
- Part 2 (bottom) consists of small dashes, one for each nozzle on each printhead. This part complements the first, and aims more specifically to detect how many faulty nozzles each printhead has.

Please look carefully at the print. The names of the colors are shown above the rectangles and in the center of the patterns of dashes.

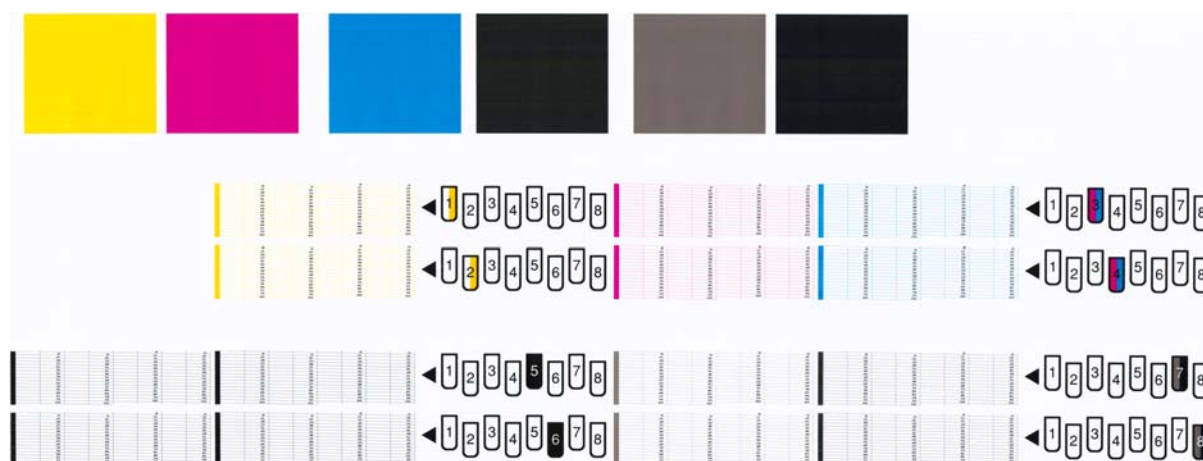

First look at the upper part of the print (part 1). Each colored rectangle should be a uniform color without any horizontal lines across it.

Then look at the bottom part of the print (part 2). For each individual colored pattern, check that most of the dashes are present.

If you see horizontal lines in part 1 and also missing dashes in part 2 for the same color, the printhead responsible needs cleaning. However, if the rectangles look solid, do not worry about just a few missing dashes in part 2; these are acceptable because the printer can compensate for a few clogged nozzles.

Here is an example of a gray printhead in a good state:

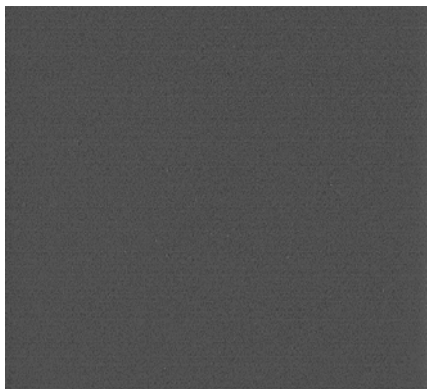

And here is an example of the same printhead in a bad state:

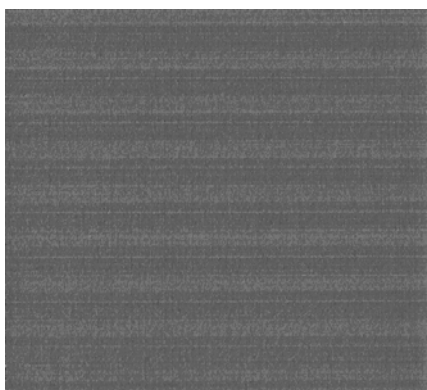

Corrective action

1. Clean any faulty printheads (see [Clean \(recover\) the printheads on page 56](#)). Then reprint the Image Diagnostics Print to see whether the problem has been solved.
2. If the problem remains, clean the printheads again, and reprint the Image Diagnostics Print to see whether the problem has been solved.
3. If the problem remains, consider cleaning your printheads manually (see [Clean \(recover\) the printheads on page 56](#)). You could also try reprinting your current print job, in case it now prints satisfactorily.
4. If the problem remains, try cleaning the printhead drop detector. The printer normally notifies you when this is necessary, but it may be worth trying even if the printer has not suggested it. See [Clean the printhead drop detector on page 58](#).
5. If the problem still remains, replace any persistently faulty printheads (see [Handle the ink system on page 44](#)), or contact HP Support (see [HP Customer Care on page 180](#)).

Remove the maintenance cartridge

A message appears on the front panel when you must change the maintenance cartridge. Follow these precautions when removing a maintenance cartridge:

- Be careful not to get ink on your hands. Ink might be on, around, and inside the replaced maintenance cartridge.
- Always handle and store the replaced maintenance cartridge upright to avoid spilling any ink.

- △ **CAUTION:** A message appears on the front panel when the maintenance cartridge is almost full and again when it is completely full and must be changed. You can ignore the alert and continue printing by pressing the OK button on the front panel. However, HP strongly recommends that you change the maintenance cartridge when prompted. Ignoring the alert can result in serious damage to the printer.
- △ **WARNING!** Make sure that the printer wheels are locked (the brake lever is pressed down) to prevent the printer from moving.

1. At the front panel, select the  icon, then select **Replace maintenance ctg.**

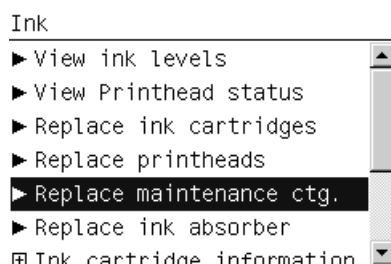

2. The maintenance cartridge is located in a slot underneath the front panel, at the front of the printer. Open the door.

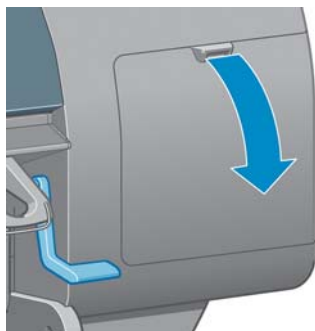

3. The maintenance cartridge has a handle on the front. To remove the cartridge, press inward and upward as indicated by the arrow, until the cartridge is released.

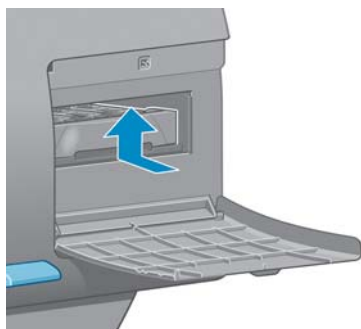

4. Lift up the maintenance cartridge to remove it from the slot, and slide it out.

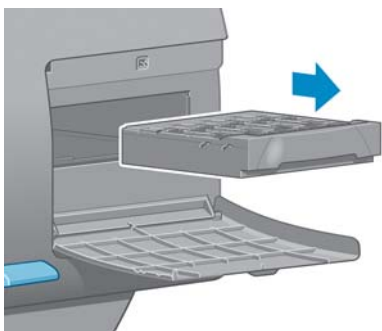

See also [Insert the maintenance cartridge on page 64](#).

Insert the maintenance cartridge

The plastic bag in which the new maintenance cartridge comes can be used to dispose of the old maintenance cartridge.

1. Insert the maintenance cartridge into the slot, in the direction indicated by the arrow.

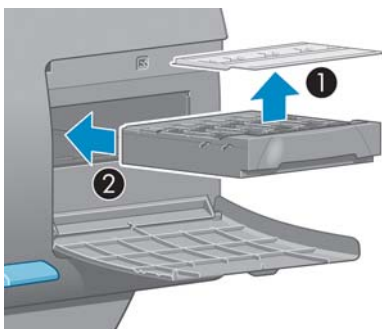

2. When the maintenance cartridge has been pushed all the way in, press inwards and downwards as indicated, until it clicks into place.

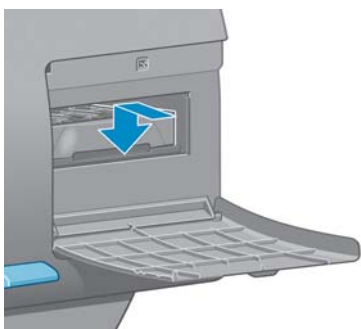

If you have difficulty, see [Cannot insert the maintenance cartridge on page 165](#).

 **NOTE:** The front panel will not show the new maintenance cartridge until the door is closed.

- When you have inserted the maintenance cartridge into the printer, close the door.

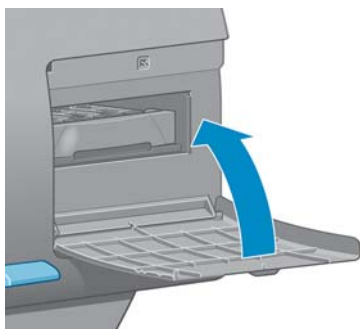

NOTE: The printer needs all the ink cartridges, printheads and maintenance cartridge to be installed before it can continue.

- If no paper is loaded, the front panel will instruct you to load some.

NOTE: Make sure that the printer window and the door to the right are closed after you replace the supplies. The printer will not print while these are open.

Check the status of the ink system

- Access the Embedded Web Server. See [Access the Embedded Web Server on page 21](#).
- Go to the Supplies page on the **Main** tab.

Printer status: ✔ Color Calibration ✔

Main Setup Support

Job center
Job queue
Stored jobs in printer
Submit job
Status
Supplies
History
Usage
Accounting

Supplies

Y C MK DG M G

Paper source	Type	Width	Length
Roll 1	HP Coated Paper	Arch D	Unknown
Roll 2	Photo Gloss Paper	-	Unknown

Buy paper now

Ink cartridge	Status	Ink level*	Capacity	Warranty status	HP Order Information
Y HP 761 Yellow	OK	205 ml	400 ml	In warranty	CM992A
C HP 761 Cyan	OK	388 ml	400 ml	In warranty	CM994A
MK HP 761 Matte black	OK	93 ml	400 ml	In warranty	CM991A
DG HP 761 Dark Gray	OK	389 ml	400 ml	In warranty	CM996A
M HP 761 Magenta	OK	71 ml	400 ml	In warranty	CM993A
G HP 761 Gray	Very low	23 ml	400 ml	In warranty	CM995A



Printheads

The Supplies page shows you the status of the ink cartridges (including the ink levels), the printheads, the maintenance cartridge, and the loaded paper.

Check the status of the ink cartridges

You can view information about your ink cartridges using the front panel or the HP Utility.

Front-panel procedure



1. At the front panel:
 - Press the  key twice, or
 - Select the  icon, then **Ink cartridge information**.
2. Select the cartridge about which you want information.
3. The front panel shows the following information:
 - Color
 - Product name
 - Product number
 - Serial number
 - Status
 - Ink level, if known
 - Total ink capacity in milliliters
 - Expiration date
 - Warranty status
 - Manufacturer

HP Utility procedures

- In the HP Utility for Windows, go to the **Overview** tab. The status of each cartridge appears when you select **Supply Status > Cartridges**.
- In the HP Utility for Mac OS, select **Information > Printer Status**.

Check the status of a printhead

The printer automatically checks and services the printheads after each print. Follow these steps to get more information on your printheads.

1. At the front panel:
 - Press the  key three times, or
 - Select the  icon, then **Printhead information**.
2. Select the printhead for which you want to see information.
3. The front panel shows the following information:
 - Colors
 - Product name
 - Product number

- Serial number
- Status (See [Front-panel error messages on page 196.](#))
- Volume of ink it has used

You can also get most of this information without leaving your computer by using the HP Utility.

 **NOTE:** If the status is **See warranty note**, this indicates that non-HP ink is being used. Printer service or repairs required as a result of using non-HP ink are not covered under warranty. See the *Legal Information* document for detailed warranty implications.

Order ink supplies

You can order the following ink supplies for your printer.

Table 5-1 Ink cartridges (T7100)

Cartridge	Part number
HP 762 Matte Black 400 ml Ink Cartridge	CM991A
HP 762 Yellow 400 ml Ink Cartridge	CM992A
HP 762 Magenta 400 ml Ink Cartridge	CM993A
HP 762 Cyan 400 ml Ink Cartridge	CM994A
HP 762 Gray 400 ml Ink Cartridge	CM995A
HP 762 Dark Gray 400 ml Ink Cartridge	CM996A
HP 762 Matte Black 775 ml Ink Cartridge	CM997A

Table 5-2 Ink cartridges (T7100 Mono)

Cartridge	Part number
HP 762 Matte Black 400 ml Ink Cartridge	CM991S
HP 762 Dark Gray 400 ml Ink Cartridge	CM996S
HP 762 Matte Black 775 ml Ink Cartridge	CM997S or CN072A
HP 762 Dark Gray 775 ml Ink Cartridge	CN073A

Table 5-3 Printheads (T7100)

Printhead	Part number
HP 762 Yellow Printhead	CH645A
HP 762 Magenta & Cyan Printhead	CH646A
HP 762 Gray and Dark Gray Printhead	CH647A
HP 762 Matte Black & Matte Black Printhead	CH648A

Table 5-4 Printheads (T7100 Mono)

Printhead	Part number
HP 762 Matte Black & Matte Black Printhead	CH648A
HP 762 Dark Gray Printhead	CN074A

Table 5-5 Maintenance cartridge

Maintenance cartridge	Part number
HP 761 Maintenance Cartridge (for 7100)	CH649A
HP 762 Maintenance Cartridge (for 7100 Mono)	CM998A

6 Use of multiple rolls

- [The uses of a multiroll printer](#)
- [How the printer allocates jobs to paper rolls](#)

The uses of a multiroll printer

A multiroll printer can be useful in several different ways:

- The printer can automatically switch between different paper types according to your needs.
- The printer can automatically switch between different paper widths according to your needs. This enables you to save paper by printing smaller images on narrower paper.
- If you load two or more identical rolls into the printer, you can leave it printing unattended for a long time, because it can switch from one roll to another automatically when the first is exhausted. See [Unattended printing/overnight printing on page 91](#).

There are two concepts to help you when working with multiple rolls.

- The active roll is the roll that is currently loaded and will be printed on by default unless the printer has some reason to switch rolls. To change the active roll, select the Paper menu icon , then **Select active roll**.
- A protected roll is protected from use unless the roll number or its paper type are specifically requested. See [Roll protection on page 91](#).

The current status of all rolls is shown on the front panel's status screen.

Ready

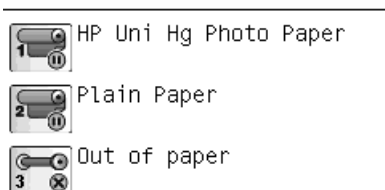

How the printer allocates jobs to paper rolls

When you submit a print job from the Embedded Web Server or the printer driver, you can specify (using the **Paper type** or **Type is** option) that you want it to be printed on a particular paper type; you can even specify (using the **Paper source**, **Source is** or **Paper Feed** option) that you want it to be printed on a particular roll (1 or 2). The printer will try to satisfy these requirements, and it will also look for a paper roll large enough to print the image without clipping.

- If both rolls are suitable for the job, the roll will be chosen according to the roll switching policy. See [Roll switching options on page 25](#).
- If just one of the rolls is suitable for the job, it will be printed on that roll.
- If neither roll is suitable for the job, it will be held in the job queue with the status “On hold for paper”, or printed on an unsuitable roll, depending on the paper mismatch action. See [Paper mismatch action on page 25](#).

The printer driver for Windows will tell you which paper types and widths are currently loaded in the printer, and on which rolls.

Here are some settings that might be used in typical situations:

- With different paper types loaded:
 - **Type is:** select the paper type you require
 - **Source is:** Automatically select / Predetermined
 - **Roll switching policy:** doesn't matter
- With different paper widths loaded:
 - **Type is:** Any
 - **Source is:** Automatically select / Predetermined
 - **Roll switching policy:** Minimize paper waste

 **TIP:** You can also save paper in some cases by rotating or nesting your images. See [Use paper economically on page 88](#).

- With identical rolls loaded:
 - **Type is:** Any
 - **Source is:** Automatically select / Predetermined
 - **Roll switching policy:** Minimize roll changes

Job allocation with nesting

If nesting is on (see [Nest jobs to save paper on page 89](#)), the printer assumes that your main aim is to save paper. Therefore, the roll switching options are ignored and the printer behaves as though **Minimize paper waste** has been chosen. See [Roll switching options on page 25](#).

If the paper mismatch action is set to **Print anyway**, jobs can be nested together on any roll, even if the roll does not match the paper source or paper type specified in the job settings. To respect these job settings, set the paper mismatch action to **Put job on hold**. See [Paper mismatch action on page 25](#).

 **TIP:** If you have a roll intended for special purposes only, or with particularly expensive paper, you can use roll protection to prevent jobs from using that roll by accident. See [Roll protection on page 91](#).

7 Use of the stacker

The stacker is an optional accessory. It stacks prints flat, on top of one another, instead of letting them fall into the bin.

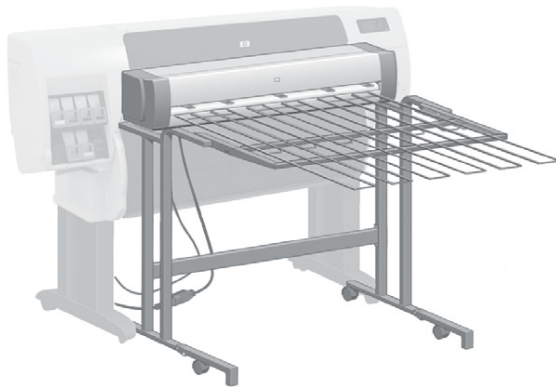



- [Install the stacker](#)
- [Uninstall the stacker](#)
- [Using paper with the stacker](#)
- [Stacker messages](#)
- [Change the temperature](#)
- [Change paper rolls while using the stacker](#)
- [Clean the exterior of the stacker](#)
- [Clean the stacker rollers](#)
- [Move or store the stacker](#)

Install the stacker

1. Connect the cables between the stacker and the printer.



2. Switch on the stacker.
3. Select the  icon on the printer's front panel, then **Accessories > Stacker > Install stacker**. The front panel will prompt you to attach the stacker to the printer.
4. There are two latches on the stacker that engage with the printer deflectors. To attach the stacker to the printer, attach first one side and then the other (because less force is required that way).

 **NOTE:** The stacker operates on cut sheets of paper. When it is switched on, the cutter is automatically enabled. It cannot work if the cutter is turned off or if the printing material cannot be cut (canvas, for example).

Uninstall the stacker

1. To uninstall the stacker, select the  icon on the printer's front panel, then **Accessories > Stacker > Uninstall stacker**.
2. The front panel will then prompt you to detach the stacker from the printer. Pull the stacker from one side to detach it on that side, then detach the other side.
3. Disconnect the stacker cables.

Using paper with the stacker

The stacker can handle cut sheets of paper between 420 mm (A3 portrait) (16.5 in) and 1189 mm (A0 portrait) (46.8 in) in length. Shorter prints will be enlarged to the minimum length with extra white space; longer prints risk falling off the stacker.

Some printing materials are not compatible with the stacker, including:

- Matte and clear film
- Glossy paper (except instant-dry glossy paper, which may be used)
- Heavyweight coated paper
- Canvas

When printing in Fast mode on Translucent Bond, Vellum or Natural Tracing Paper, there could be some ink transfer marks in highly inked areas. Select Normal or Best mode to avoid this problem. See [Select print quality on page 79](#).

 **NOTE:** You will have to remove the accumulated pile of cut sheets from the stacker every now and then.

NOTE: If you retrieve just one job from the stack, try to leave the stack in a tidy condition, otherwise you may experience stacking problems and paper jams.

Stacker messages

You may see the following messages when using the stacker.

- **Remove the stacker:** You must uninstall the stacker before printing, because there is no paper loaded that is compatible with it.
- **Hold for stacker removal:** You must uninstall the stacker before printing the current job, because the paper type specified for the job is not compatible with the stacker, and the paper mismatch action is **Hold for paper**.
- **Hold for paper:** The paper mismatch action is **Hold for paper**, and the paper type specified for the job is not loaded.
- **Load paper for next job:** No paper is loaded.

Change the temperature

 **NOTE:** This option is only available if the stacker is installed on the printer.

The stacker contains a heated roller to remove the curl from the paper. To change the temperature of the roller, select the  icon on the printer's front panel, then **Accessories > Stacker > Select temperature**. There are three options:

- **Normal** is the default and recommended setting.
- **High** sets the roller to a higher temperature, which may be useful for particularly stiff paper.
- **Low** sets the roller to a lower temperature, which may be useful for paper with a particularly sensitive coating.

Change paper rolls while using the stacker

1. Remove the stack of cut paper from the stacker in order to make the stacker easier to handle.
2. Detach the stacker from the printer: first one side, then the other.
3. Change the rolls in the normal way: see [Unload a roll from the printer on page 34](#) and [Load a roll into the printer on page 30](#).

Clean the exterior of the stacker

See [Clean the exterior of the printer on page 140](#).

Clean the stacker rollers

⚠ **WARNING!** The stacker becomes hot during use. Before cleaning, switch it off and give it time to cool.

Ink tends to stick to the main stacker roller and the small output rollers, which should therefore be cleaned regularly using a fabric cloth dampened with water.

The frequency with which cleaning is needed depends to some extent on the paper type in use.

- For plain, coated or heavyweight coated paper, once a month may be sufficient.
- For translucent, vellum, glossy or natural tracing paper, cleaning may be required once a week even with the slowest print modes.

Move or store the stacker

Before moving or storing the stacker, take a couple of steps to reduce the amount of space it occupies.

1. Undo the screws at either side of the stacker tray, and let the tray hang vertically.



2. Remove the pin from each leg extension, and rotate the leg extension upwards.



8 Print options

- [Create a print job](#)
- [Select print quality](#)
- [Print a draft](#)
- [High-quality printing](#)
- [Select paper size](#)
- [Select margins options](#)
- [Print on loaded paper](#)
- [Rescale a print](#)
- [Preview a print](#)
- [Print 16-bit color images](#)
- [Change the treatment of overlapping lines](#)
- [Print crop lines](#)
- [Rotate an image](#)
- [Print in gray shades](#)
- [Use paper economically](#)
- [Nest jobs to save paper](#)
- [Use ink economically](#)
- [Roll protection](#)
- [Unattended printing/overnight printing](#)

Create a print job

In order to print something, you must send it to the printer. This constitutes a print job, which is entered into the printer's print queue. There are two main ways of sending a print job to the printer:

- To print directly from a program, use the program's **Print** command as usual. When you select your HP Designjet printer, the printer driver is invoked to send your job to the printer.
- If you have a file that is already in a supported graphical format, you can use the Embedded Web Server to send it directly to the printer without going through a printer driver (see below).

Using the Embedded Web Server to print files

From the HP Utility or the Embedded Web Server, select **Submit Job** in the Job Center group. You will see the window below.

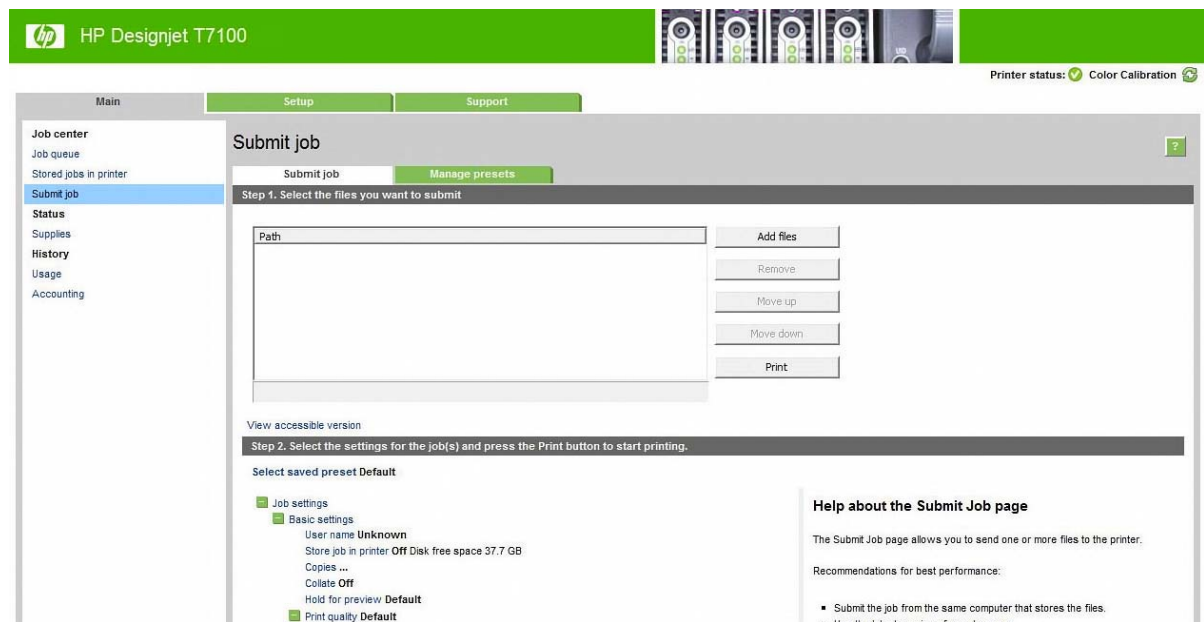

Press the **Add files** button to choose the files from your computer that you want to print. The files must be in one of the following formats:

- HP-GL/2
- RTL
- CALS/G4
- PDF (with the PostScript upgrade only)
- PostScript (with the PostScript upgrade only)
- TIFF (with the PostScript upgrade only)
- JPEG (with the PostScript upgrade only)

NOTE: When you print to a file, the file should be in one of the above formats, but its name may have an extension such as **.plt** or **.prn**.

If the files are not in one of these formats, they will not be printed successfully.

If the jobs have been generated with the appropriate settings (such as page size, rotation, resizing and number of copies), you can just press the **Print** button and they will be sent to the printer.

If you need to specify printing settings, go to the **Job settings** section and select the options you need. Each option has explanatory text on the right, so that you can understand the behavior of each setting. Remember that, if you leave the setting as **Default**, the setting saved in the job will be used. If the job contains no setting, the setting in the printer will be used.

Printing stored jobs

When you print a file with the Embedded Web Server, you can mark the job to be stored permanently in the printer.

If you select **Stored jobs in printer** in the **Main** tab of the Embedded Web Server, you will see a list of the stored jobs. The information displayed for each job includes:

- The name of the job
- The size of the job
- The date and time when the job was received by the printer
- The name given by the person who submitted the job

You can click on the title of any column to sort the list by the information in that column.

You can select one or more jobs in the list and perform the following operations on them by using the buttons at the top of the list.

- **Print:** The selected jobs are printed with the original settings. You will be able to see the progress of your jobs on the **Job queue** page.
- **Advanced print:** The settings of the selected jobs are displayed, and you can modify them. You can save the new settings by pressing the **Save** button, and print the jobs by pressing the **Print** button.

The value of a setting is shown only if it has the same value in all of the selected jobs. Otherwise, a hyphen is shown.

- **Delete:** The selected jobs are permanently deleted from the printer.

Select print quality

The printer has various print-quality options because best-quality printing requires some loss of speed, while fast printing implies some reduction in print quality.

Therefore, the standard print-quality selector is a slider that allows you to choose between quality and speed.

Alternatively, you can select from the custom options: **Best**, **Normal** and **Fast**. If you select **Fast**, you can also select **EconoMode**, which uses a lower rendering resolution and consumes less ink. It therefore increases printing speed even further, but reduces print quality. **EconoMode** can be selected only from the custom options (not from the slider).

There are also two supplementary custom options that may have an effect on print quality: **Maximum detail** and **More passes**. See [High-quality printing on page 81](#).

 **NOTE:** In the Windows driver dialog, the rendering and printing resolutions for your job are displayed in the **Paper/Quality** tab. In the Mac OS Print dialog, they are displayed in the **Summary** panel.

You can select print-quality options in the following ways:

- **In the Windows driver dialog:** go to the **Paper/Quality** tab and look at the Print Quality section. If you select **Standard Options**, you will see a simple slider with which you can select speed or quality. If you select **Custom Options**, you will see the more specific options described above.
- **In the Mac OS X 10.4 Print dialog:** go to the **Image Quality** panel and look at the Quality Options section. If you select **Standard** quality options, you will see a simple slider with which you can select speed or quality. If you select **Custom** quality options, you will see the more specific options described above.
- **In the Mac OS X 10.5 Print dialog:** go to the **Paper/Quality** panel and look at the Quality Options section. If you select **Standard** quality options, you will see a simple slider with which you can select speed or quality. If you select **Custom** quality options, you will see the more specific options described above.
- **On the Embedded Web Server's Submit Job page:** select **Basic settings > Print quality**. If you then select **Standard options**, you can choose between **Speed** and **Quality**. If you select **Custom options**, you will see the more specific options described above.
- **Using the front panel:** select the Setup menu icon , then **Printing preferences > Print quality**.

 **NOTE:** If you have set the print quality from your computer, that overrides the print-quality setting in the front panel.

 **NOTE:** You cannot change the print quality of pages that the printer is already receiving or has already received (even if they have not started to print yet).

Print a draft

You can specify fast draft-quality printing in the following ways:

- **In the Windows driver dialog:** go to the **Paper/Quality** tab and look at the Print Quality section. Move the print-quality slider to the extreme left ('Speed').
- **In the Mac OS X 10.4 Print dialog:** go to the **Image Quality** panel and move the print-quality slider to the extreme left ('Speed').
- **In the Mac OS X 10.5 Print dialog:** go to the **Paper/Quality** panel and move the print-quality slider to the extreme left ('Speed').
- **On the Embedded Web Server's Submit Job page:** select **Basic settings > Print quality > Standard options > Speed**.
- **Using the front panel:** select the Setup menu icon , then **Printing preferences > Print quality > Select quality level > Fast**.

You can specify even faster draft-quality printing by using EconoMode, as follows. This is intended mainly for documents containing only text and line drawings.

- **In the Windows driver dialog:** go to the **Paper/Quality** tab and look at the Print Quality section. Select **Custom Options**, then set the quality level to **Fast** and check the **EconoMode** box.
- **In the Mac OS X 10.4 Print dialog:** go to the **Image Quality** panel and set the quality options to **Custom**, then set quality to **Fast** and check the **EconoMode** box.
- **In the Mac OS X 10.5 Print dialog:** go to the **Paper/Quality** panel and set the quality options to **Custom**, then set quality to **Fast** and check the **EconoMode** box.
- **On the Embedded Web Server's Submit Job page:** select **Basic settings > Print quality > Custom**. Set **Quality level** to **Fast**, and **EconoMode** to **On**.

High-quality printing

You can specify high-quality printing in the following ways:

- **In the Windows driver dialog:** go to the **Paper/Quality** tab and look at the Print Quality section. Move the print-quality slider to the extreme right ('Quality').
- **In the Mac OS X 10.4 Print dialog:** go to the **Image Quality** panel and move the print-quality slider to the extreme right ('Quality').
- **In the Mac OS X 10.5 Print dialog:** go to the **Paper/Quality** panel and move the print-quality slider to the extreme right ('Quality').
- **On the Embedded Web Server's Submit Job page:** select **Basic settings > Print quality > Standard options > Quality**.
- **Using the front panel:** select the Setup menu icon , then **Printing preferences > Print quality > Select quality level > Best**.

Printing is bidirectional by default (the printheads print when travelling in both directions across the paper), but you can choose **Unidirectional** printing for a further small improvement in quality at the expense of speed. This option is not available if you have chosen **Fast** print quality.

If you have a high-resolution image

If your image has a resolution greater than the rendering resolution (which you can see in the driver's **Paper/Quality** tab under Windows), print sharpness may be improved by selecting the **Maximum Detail** option. This option is available only if you are printing on glossy paper and you have selected **Best** print quality.

- **In the driver dialog (Mac OS Print dialog):** select custom instead of standard print-quality options, then check the **Maximum Detail** box.
- **On the Embedded Web Server's Submit Job page:** select **Basic settings > Print quality > Custom**. Set **Quality level** to **Best**, and **Maximum detail** to **Yes**.

 **NOTE:** The **Maximum Detail** option results in slower printing with photo papers, but it does not increase the amount of ink used.

If you have printhead problems

If your printheads have an excessive number of clogged nozzles (which may cause banding or white streaks on your prints), print quality can be improved by selecting the **More Passes** option.

- **In the driver dialog (Mac OS Print dialog):** select custom instead of standard print-quality options, then check the **More Passes** box.
- **On the Embedded Web Server's Submit Job page:** select **Basic settings > Print quality > Custom**. Set **Quality level** to **Best**, and **More passes** to **Yes**.

 **NOTE:** The **More Passes** option results in slower printing, but it does not increase the amount of ink used.

 **TIP:** Instead of using this option, consider using the Image Diagnostics Print to identify the printhead or printheads that are causing the problem, and then clean or replace them. See [The Image Diagnostics Print on page 61](#).

Select paper size

The paper size can be specified in the following ways.

 **NOTE:** The paper size specified here should be the paper size in which the document was created. It is possible to rescale the document to a different size for printing. See [Rescale a print on page 84](#).

- **In the Windows driver dialog:** select the **Paper/Quality** tab, then select your paper size from the Document Size list.
- **In the Mac OS Page Setup dialog:** select your printer in the **Format for** popup menu, then **Paper Size**.

 **NOTE:** If your application offers no **Page Setup** dialog, please use the **Print** dialog.

- **On the Embedded Web Server's Submit Job page:** select **Advanced settings > Paper > Page size > Standard**.
- **Using the front panel:** select the Setup menu icon , then **Printing preferences > Paper options > Select paper size**.

 **NOTE:** If you have set the paper size from your computer, that overrides the paper size setting in the front panel.

NOTE: If you have disabled skew checking, the paper length is estimated as four times the width.

 **TIP:** If your document is 330 × 483 mm (13 × 19 in), designed to fit on sheet paper of the same size, select the document size **Super B/A3**.



Custom paper sizes

To choose a non-standard paper size not shown in the list of paper sizes:

- **Under Windows**, there are three different ways:
 - In the driver dialog, press the **Custom** button in the **Paper/Quality** tab, then specify the name and the dimensions of your new paper size, then click **Save** to save your new paper size. In the PostScript driver, to see your new custom size in the list of custom sizes, you need to exit the printer properties, then reenter them (and use the **More** button if necessary).



 **NOTE:** The driver will not allow you to create a paper size whose width exceeds its length.

 - From the **Start** menu, select **Printers**, then from the **File** menu select **Server Properties**. In the **Forms** tab, check the **Create a new form** box, specify the name and dimensions of the new form, then click **Save Form**.

 **NOTE:** Such forms are not available when using a shared printer that is connected to a different computer.
 - **In the Mac OS Page Setup dialog:** select **Paper Size > Manage Custom Sizes**.
-
-  **NOTE:** If your application offers no **Page Setup** dialog, please use the **Print** dialog.
- **On the Embedded Web Server's Submit Job page:** select **Advanced settings > Paper > Page size > Custom**.

Select margins options

By default, the printer leaves a 5 mm (0.02 in) margin between the edges of your image and the edges of the paper, although the top margin is set to 11.5 mm (0.45 in) when printing on glossy paper. You can change this behavior in several ways.

- **In the Windows driver dialog:** select the **Paper/Quality** tab and then the **Margins/Layout** button.
-
-  **TIP:** In the Windows PostScript driver, make sure you have made the right choice from the **Document size** list. You should select a 'no margins' document size if you intend to use the **Override** or **Clip contents by margins** options.
-
- **In the Mac OS X Print dialog:** select the **Margins/Layout** panel.
 - **On the Embedded Web Server's Submit Job page:** select **Advanced settings > Paper > Layout/Margins**.
 - **Using the front panel:** select the Setup menu icon , then **Printing preferences > Margins > Select margins**.

 **NOTE:** If you have set the margins from your computer, that overrides any margin setting in the front panel.

You will then see at least some of the following options.

 **NOTE:** Under Mac OS, the available margins options depend on the paper size selected in the Page Setup dialog. For instance, for oversize printing you must select a paper size name that includes the word “oversize”.

- **Standard.** Your image will be printed on a page of the size you have selected, with a 5 mm (0.02 in) margin between the edges of the image and the edges of the paper. The image should be small enough to fit between the margins.
- **Oversize.** Your image will be printed on a page slightly larger than the size you have selected. If you cut off the margins, you will be left with a page of the size you selected, with no margins remaining between your image and the edges of the paper.
- **Clip contents by margins.** Use this option when your image has white borders and a size equal to that of the paper you have selected. The printer will use the white borders for its 5 mm (0.02 in) margins and you will get a page of size equal to that which is selected in the driver.

Print on loaded paper

To print a job on whichever paper is loaded in the printer, select **Any** in the Paper Type option of your printer driver.

- **In the Windows driver dialog:** select the **Paper/Quality** tab, then select **Any** in the Paper Type drop-down list.
- **In the Mac OS X 10.4 Print dialog:** select the **Image Quality** panel, then select **Any** in the Paper Type drop-down list.
- **In the Mac OS X 10.5 Print dialog:** select the **Paper/Quality** panel, then select **Any** in the Paper Type drop-down list.

 **NOTE:** **Any** is the default Paper Type selection.

Rescale a print

You can send an image to the printer at a certain size but tell the printer to rescale it to a different size (normally larger). This may be useful if your software does not support large formats.

You can rescale an image in the following ways:

- **In the Windows driver dialog:** go to the **Features** tab and look at the Resizing Options section.
 - The **Print document on** option adjusts the image size to the paper size you have selected. For example, if you have selected ISO A2 as the paper size and you print an A3-sized image, it is enlarged to fit the A2 paper. If the ISO A4 paper size is selected, the printer reduces a larger image to fit the A4 size.
 - The **% of actual size** option enlarges the printable area of the original paper size (the page minus the margins) by the percentage indicated, then adds the margins to create the output paper size.
- **In the Mac OS Print dialog:** select the **Finishing** panel, then **Print document on** to adjust the image size to the paper size you have selected. For example, if you have selected ISO A2 as the paper size and you print an A3-sized image, it is enlarged to fit the A2 paper. If the ISO A4 paper size is selected, the printer reduces a larger image to fit the A4 size.

- **On the Embedded Web Server's Submit Job page:** select **Advanced settings > Resizing**.
 - The **Standard** and **Custom** options adjust the image size to the standard or custom paper size you have selected. For example, if you have selected ISO A2 as the paper size and you print an A3-sized image, it is enlarged to fit the A2 paper. If the ISO A4 paper size is selected, the printer reduces a larger image to fit the A4 size.
 - The **% of actual size** option enlarges the printable area of the original paper size (the page minus the margins) by the percentage indicated, then adds the margins to create the output paper size.
- **Using the front panel:** select the Setup menu icon , then **Printing preferences > Paper options > Resize**.

Preview a print

Previewing a print on the screen allows you to check the layout of the print before printing, which may help you to avoid wasting paper and ink on a bad print.

- To preview a print under Windows, you have the following options:
 - Use your application's print preview option.
 - Check the **Show preview before printing** option, which you can find in the driver's **Paper/Quality** tab and **Features** tab. The preview may be provided in different ways, depending on your printer and printer driver.
- To preview a print under Mac OS, you have the following options:
 - Use your application's print preview option.
 - Click the **Preview** button at the bottom of the Print dialog box. This is the basic print preview provided by Mac OS.
 - Check the **Show print preview** option, which you can find in the driver's **Printing** dialog, in the **Finishing** panel.
- To preview a print using the Embedded Web Server, select **Basic settings > Hold for preview**.

Print 16-bit color images

In a 16-bit image, each of the three primary colors is encoded by a 16-bit value, so that each pixel takes up 48 bits.

If you print your 16-bit color images through a printer driver, they will be reduced to 8-bit colors before they reach the printer.

In order to send a 16-bit color image to the printer, you must save it as a 16-bit color TIFF or JPEG file, then send the file directly to the printer without using a printer driver (see [Using the Embedded Web Server to print files on page 78](#)). In this case, color management is done on the 16-bit color image, and is therefore done more accurately. The image is still reduced to 8-bit colors for final printing.

 **TIP:** Some applications refuse to save a 16-bit color image in JPEG format; others automatically reduce it to 8-bit colors. A TIFF file generally gives a higher-quality result, and is recommended.

Change the treatment of overlapping lines

 **NOTE:** This topic applies only when printing an HP-GL/2 job.

The merge option controls the overlapping lines in an image. There are two settings:

- Off: where the lines cross, only the color of the top line is printed. This is the default setting.
- On: where the lines cross, the colors of the two lines merge.

To turn merge on, go to the front panel and select the Setup menu icon , then **Printing preferences > HP-GL/2 options > Enable merge**. You can set the merge option from your software in some applications. Settings in your software override the front-panel settings.

Print crop lines

Crop lines indicate where the paper should be cut to reduce it to your selected page size. You can print crop lines automatically with individual jobs in the following ways:

- **In the Windows driver dialog:** select the **Features** tab, then **Enable crop lines**.
- **In the Mac OS Print dialog:** go to the **Finishing** panel and select **Enable crop lines**.
- **On the Embedded Web Server's Submit Job page:** select **Advanced settings > Roll options > Enable crop lines**.
- **Using the front panel:** select the Setup menu icon , then **Printing preferences > Paper options > Enable crop lines > On**.

To print crop lines with nested jobs (see [Nest jobs to save paper on page 89](#)), you must select a different option:

- **In the Embedded Web Server:** select **Job management > Use crop lines when nest is enabled > On**.
- **Using the front panel:** select the Setup menu icon , then **Job management > Nest options > Enable crop lines > On**.

Rotate an image

By default, images are printed with their shorter sides parallel to the leading edge of the paper, like this:

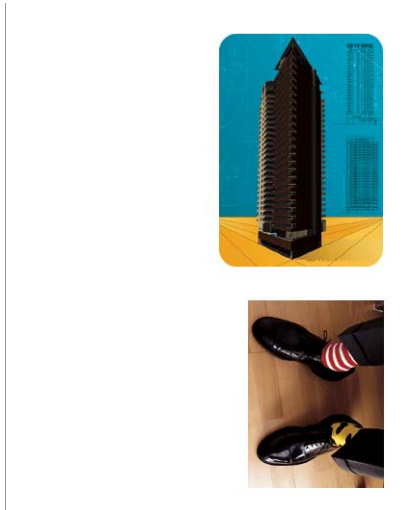

You may wish to rotate your images by 90 degrees in order to save paper, like this:

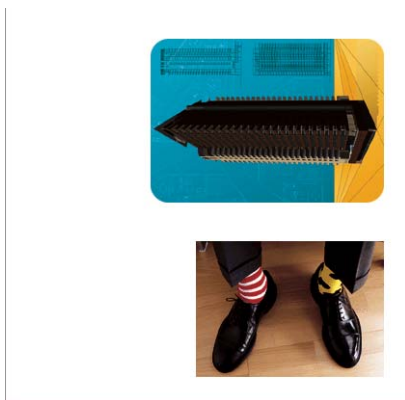

You can do this in the following ways:

- **In the Windows driver dialog:** select the **Features** tab, then **Rotate by 90 degrees**.
- **In the Mac OS Print dialog:** go to the **Finishing** panel and select **Rotate by 90 degrees**.
- **On the Embedded Web Server's Submit Job page:** select **Advanced settings > Roll options > Rotate**.
- **In the front panel:** select the Setup menu icon , then **Printing preferences > Paper options > Rotate**.

 **NOTE:** If rotation is set from your computer, it overrides the setting in the front panel.

NOTE: When you rotate a job, the page length may be increased to avoid clipping, because the top and bottom margins are usually larger than the side margins.

NOTE: If you rotate an image to landscape whose original orientation was portrait, the paper may not be wide enough for the image. For example, rotating a portrait D/A1-size image on D/A1-size paper by 90 degrees will probably exceed the width of the paper. If you are using the Embedded Web Server, the preview screen will confirm this with a warning triangle.

Autorotate

The **Autorotate** option automatically rotates jobs by 90 degrees if doing so will save paper.

Autorotation allows you to defer the decision of rotating a page until printing time. This may be useful if you routinely work with different roll sizes and want to ensure that jobs will not be clipped or waste unnecessary paper width if and when roll conditions change.

 **TIP:** Autorotation is particularly useful when combined with the **Minimize paper waste** roll switching option (see [Roll switching options on page 25](#)).

To enable autorotation:

- **In the Windows driver dialog:** select the **Features** tab, then **Autorotate**.
- **In the Mac OS Print dialog:** go to the **Finishing** panel and select **Autorotate**.
- **On the Embedded Web Server's Submit Job page:** select **Advanced settings > Roll options > Autorotate**.
- **In the front panel:** select the Setup menu icon , then **Job management > Autorotate**.

 **NOTE:** If autorotation is set from your computer, it overrides the setting in the front panel.

NOTE: The autorotate decision requires known job dimensions. Therefore, printing does not start until the job has been completely processed, regardless of the **When to Start Printing** setting (see [Select when to print a job in the queue on page 107](#)); and, if you request **Autorotate** and **Remove blank areas**, only the latter will be done.

 **TIP:** Once the job is rendered and ready for reprints, autorotation may take a few minutes, depending on job dimensions and resolution. To speed up autorotated reprints, send the job to render when the roll configuration meets your planned scenario, and leave last-minute autorotation only to correct unexpected changes in roll conditions. This applies to TIFF/JPEG/PS/PDF jobs only.

Print in gray shades

You can convert all colors in your image to shades of gray in the following ways:

- **In your application program:** many programs provide this option.
- **In the Windows driver dialog:** go to the **Color** tab and look at the Color Options section. Select **Print in Grayscale**.
- **In the Mac OS X Print dialog:** go to the **Color Options** panel and select **Grayscale** from the Mode drop-down list.
- **On the Embedded Web Server's Submit Job page:** select **Color > Color/Grayscale > Print in grayscale**.

Use paper economically

Here are some recommendations for making economical use of paper:

- If you are printing relatively small images or document pages, you can use nesting to print them side by side instead of one after another. See [Nest jobs to save paper on page 89](#).
- If you are printing multipage documents with relatively small pages, you can print up to 16 of them on one sheet of paper. Use the **Pages per sheet** option in the **Features** tab (Windows driver) or the **Layout** panel (Mac OS driver).

- You may be able to save some paper by using the following options:
 - **In the Windows driver dialog:** select the **Features** tab and then **Remove Blank Areas** and/or **Rotate by 90 degrees** or **Autorotate**.
 - **In the Mac OS Print dialog:** select the **Finishing** panel, then **Remove Blank Areas** and/or **Rotate by 90 degrees** or **Autorotate**.
 - **On the Embedded Web Server's Submit Job page:** select **Advanced settings > Roll options > Remove blank areas** and/or **Rotate**.
- If you check the print preview on your computer before printing, you can sometimes avoid wasting paper on prints containing obvious mistakes. See [Preview a print on page 85](#).

The **Remove Blank Areas** option removes blank areas from the top and bottom of the print, so that less paper is used in printing. If you are using HP-GL/2, this option also removes blank areas from the sides of the print.

Nest jobs to save paper

Nesting means automatically printing images or document pages side by side on the paper, rather than one after the other. This is done to avoid wasting paper.

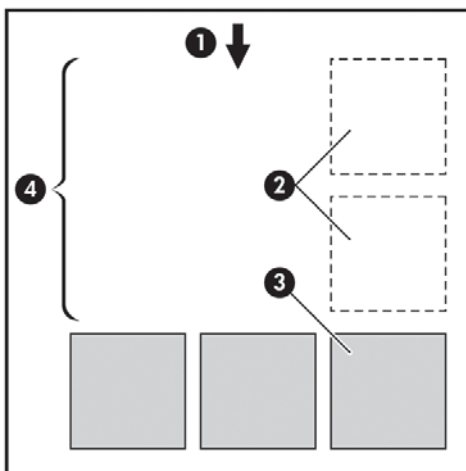

1. Direction of paper flow
2. Nesting off
3. Nesting on
4. Paper saved by nesting

How to use nesting

Here are some general guidelines for using nesting:

- To enable nesting, use the front panel (Job Management menu) or the Embedded Web Server (Setup tab).
- If you are working with batches of jobs with the same format, choose nesting **In order**. This will close the nest as the first file with a new format arrives.

- If you are working with mixed file formats, choose nesting **Optimized**. This option will nest compatible pages in the queue, allowing for a gap of up to 3 incompatible pages before closing the nest (See nesting compatibility below).
- For the jobs you want nested together, choose common values you will be using and create presets. You can use the Embedded Web Server's **Manage Presets** tab to save your presets.

 **NOTE:** If you have a multiroll printer with nesting enabled, your printer will do its best to save paper. This means that the roll on which less paper is wasted will be chosen regardless of the roll switching option you have selected (see [Roll switching options on page 25](#)).

NOTE: The printer will nest up to eight compatible jobs in a row.

 **TIP:** Use the paper mismatch action **Print anyway** to minimize paper waste by skipping paper source or paper type restrictions. For a more fine-grained nesting of jobs based on desired paper source or type, use the **Put job on hold** paper mismatch action.

TIP: If you have a roll that is expensive or for special purposes only, use roll protection so that jobs with unspecified paper type and source will not be able to use your special roll (see [Roll protection on page 91](#)).

Nesting wait time

When a job is ready to print, if **Nesting** is enabled, the printer will wait for more jobs to arrive in order to nest them together. You can change this waiting time from the front panel: select the Setup menu icon , then **Job management options > Nest options > Select wait time**.

You can also cancel nest waiting by pressing the **Form feed and cut** key on the front panel.

Nesting compatibility

Because nested pages must be printed all at the same time, they are required to share a common printing format before they can be nested together. If you routinely work with one or two file formats, and print most of your jobs with the same settings, you don't need to take any extra action to ensure nesting compatibility. Otherwise, if you want to minimize paper waste using nesting:

- Save your settings in presets, using the Embedded Web Server's **Manage presets** tab. You can save:
 - Print-quality settings (**Print quality, Max detail, More passes**)
 - Color and color adjustment settings (see [Color adjustment options on page 97](#))
 - Layout and mechanical settings (**Margins, Mirror, Cutter**)
- All pages must be in one or other of the following three groups (a single nest must contain members of only one group):
 - TIFF and JPEG, which can nest together even with different input profiles
 - PostScript and PDF
 - HP-GL/2 using the same color space (sRGB/aRGB/dRGB)

 **NOTE:** CALS/G4 pages do not nest.

NOTE: JPEG and TIFF pages with resolutions greater than 300 dpi may not nest with other pages in some cases.

Use ink economically

Here are some recommendations for making economical use of ink.

- For draft prints, use plain paper and move the print-quality slider to the left end of the scale ('Speed'). For further economy, select custom print quality options, then select **Fast** and **EconoMode**.
- Clean the printheads only when needed, and clean only those printheads that need cleaning. Cleaning the printheads can be useful, but it uses ink.
- Leave the printer permanently turned on so that it can maintain the printheads in good condition automatically. This regular printhead maintenance uses a small amount of ink. However, if it is not done, the printer may need to use much more ink later to restore the health of the printheads.
- Wide prints make more efficient use of ink than narrow prints, because printhead maintenance uses some ink, and its frequency is related to the number of passes made by the printheads. Therefore, nesting jobs can save ink as well as saving paper (see [Nest jobs to save paper on page 89](#)).

Roll protection

If you choose to protect a roll, jobs will be printed on it only if the job explicitly specifies the roll number or the paper type loaded on the roll. This may be useful, for example, in the following cases.

- To stop people from accidentally printing unimportant jobs on expensive paper.
- To avoid printing on a particular roll when printing from AutoCAD without interacting with the HP printer driver.

To protect a roll, go to the front panel and select the Setup menu icon , then **Printing preferences > Paper options > Roll protection**.

 **NOTE:** If you protect a roll, then later unload the current roll and load a new one, the new roll remains protected. You are protecting the roll number, not one specific roll of paper. That roll number will remain protected until you cancel the protection.

 **TIP:** If you print without specifying a roll number or paper type, you will not be able to print on any protected roll.



Unattended printing/overnight printing

Here are some recommendations to help you to deal with a long queue of printing jobs.

- If feasible, use brand-new long rolls of paper.
- If you want to print on partly-used rolls, you can check the paper type and the remaining length in the Embedded Web Server or in the front panel, to confirm that you have enough paper to print all your jobs.

 **NOTE:** Information on the remaining length is available only if you told the printer the length of the roll when you loaded it, or if the printer read the length of the roll from the barcode printed on it.

- Load two rolls of paper suitable for your jobs. If the printer finishes one roll, it will automatically switch to the other.

- Check that you have paper wide enough to print all of your jobs. Any jobs that are too wide may be put “on hold for paper” if the paper mismatch action is set to **Put job on hold** (see [Paper mismatch action on page 25](#)).
- Check the ink levels remaining in your ink cartridges.
- When you have submitted your print jobs, you can use the Embedded Web Server from a remote location to monitor their status.
- Drying time should be set to **Automatic**.
- For high throughput, select the Setup menu icon , then **Printing preferences > Paper options > Roll switching options > Minimize roll changes** or **Use roll with less paper**.
- For economical use of paper, select the Setup menu icon , then **Printing preferences > Paper options > Roll switching options > Minimize paper waste** and **Autorotate On**.

9 Color management

- [Introduction](#)
- [How colors are represented](#)
- [A summary of the color management process](#)
- [Color calibration](#)
- [Color management from printer drivers](#)
- [Color management from printer drivers \(PostScript\)](#)
- [Color management from the Embedded Web Server](#)
- [Color management from the front panel](#)

Introduction

Your printer has been engineered with advanced hardware and software features to ensure predictable and dependable results.

- Gray, dark gray, and matte black inks provide neutral grays on all paper types

Color printers only

- Color calibration for consistent colors
- Color emulation of other HP Designjet printers

If you have a T7100 Mono printer, you should read the sections below on color management and color adjustment options; you can probably ignore the other sections of this chapter.

How colors are represented

All devices that display color use a color model to represent color in numerical terms. Most monitors use the RGB (Red-Green-Blue) color model, while most printers use the CMYK (Cyan-Magenta-Yellow-black) color model.

An image can be converted from one color model to another, but in general the conversion is not perfect. Your printer uses the RGB color model: the same color model that is used by your monitor.

This simplifies but does not completely solve the problem of matching colors. Each device represents colors a little differently from another device, even if they use the same color model. However, software can adjust the colors in an image according to the characteristics of the particular device, using a color profile of the device, in order to achieve correct colors.

A summary of the color management process

To get the accurate and consistent colors that you want, you should follow these steps for each paper type that you use.

1. Color-calibrate the paper type, for consistent colors. Calibration should be repeated every now and then (see [Color calibration on page 94](#)). In addition, you may wish to calibrate immediately before a particularly important print job for which color consistency is vital.
2. When printing, select the correct color preset for the paper type you are using.

Color calibration

Color calibration enables your printer to produce consistent colors with the particular printheads, inks and paper type that you are using, and under your particular environmental conditions. After color calibration, you can expect to get similar prints from any two different printers situated in different geographical locations.

Some paper types cannot be calibrated. For all other paper types, calibration should be done in any of the following circumstances:

- Whenever a printhead is replaced
- Whenever a new paper type is introduced that has not yet been calibrated with the current set of printheads
- Whenever the environmental conditions (temperature and humidity) change significantly

You can check the color calibration status of the currently loaded paper at any time by pressing the [View information](#) key on the front panel. The status may be one of the following:

- **PENDING:** the paper has not been calibrated.



 **NOTE:** Whenever you update the printer's firmware, the color calibration status of all papers is reset to **PENDING**.

- **OBSOLETE:** the paper has been calibrated, but the calibration is now out of date because a printhead has been replaced, and should be repeated.
- **DONE:** the paper has been calibrated, and the calibration is up to date.
- **DISABLED:** this paper cannot be calibrated.

 **NOTE:** Color calibration cannot be performed on plain paper, nor on any kind of transparent material.

You can also check the color calibration status by using the HP Utility.

You can start color calibration in the following ways:

- From the HP Utility for Windows: select **Color Center > Calibrate paper**, and choose the paper to be calibrated.
- From the HP Utility for Mac OS: select **Paper Preset Management** from the HP Color Center group, choose the paper to be calibrated, press the  button and select **Calibrate Paper**.
- From the front panel: select the Image Quality Maintenance menu icon , then **Calibrate color**.

The calibration process is fully automatic and can be performed unattended after you have loaded paper of the type you wish to calibrate—which should be A4 or any larger size. The paper on the active roll will be calibrated; you should ensure that the roll you want to calibrate is active. To change the active roll, select the Paper menu icon , then **Select active roll**.

The process takes about 3–5 minutes and consists of the following steps.

1. A calibration chart is printed, which contains patches of each ink used in your printer.



2. The chart is allowed to dry for a period of time that depends on the paper type, so that the colors have time to stabilize.

3. The chart is scanned and measured.
4. From the measurements, the printer calculates the necessary correction factors to apply for consistent color printing on that paper type. It also calculates the maximum amount of each ink that can be applied to the paper.

Color management from printer drivers

Color management options

The aim of color management is to reproduce colors as accurately as possible on all devices: so that, when you print an image, you see very similar colors as when you view the same image on your monitor.

There are two basic approaches to color management for your printer:

- **Application-Managed Colors:** in this case your application program must convert the colors of your image to the color space of your printer and paper type, using the ICC profile embedded in the image and the ICC profile of your printer and paper type.
- **Printer-Managed Colors:** in this case your application program sends your image to the printer without any color conversion, and the printer converts the colors to its own color space. The details of this process depend on the graphics language that you are using.
 - **PostScript (with the PostScript upgrade):** the PostScript interpreter module inside the printer performs the color conversion using the profiles stored in the printer and any additional profiles sent with the PostScript job. This kind of color management is done when you are using the PostScript driver and you specify printer color management or when you send a PostScript, PDF, TIFF or JPEG file directly to the printer through the Embedded Web Server. In either case you have to select the profiles to use as default (in case the job doesn't specify any) and the rendering intent to apply.
 - **Non-PostScript (HP-GL/2, RTL):** the color management is done using a set of stored color tables. ICC profiles are not used. This method is somewhat less versatile than the alternatives, but is a little simpler and faster, and can produce good results with standard HP paper types. This kind of color management is done when you are using a non-PostScript driver and you specify printer color management, or when you send an HP-GL/2 or RTL file directly to the printer through the Embedded Web Server.

 **NOTE:** There are only two color spaces that the printer can convert to its own color space using the stored color tables: Adobe RGB and sRGB if you are using Windows, Adobe RGB if you are using Mac OS.

You are recommended to consult the Knowledge Center (see [Knowledge Center on page 178](#)) to see how to use the color management options of your particular application.

To choose between **Application-Managed Colors** and **Printer-Managed Colors**:

- **In the Windows driver dialog:** select the **Color** tab.
- **In the Mac OS Print dialog:** select the **Color Options** panel.
- **In some applications:** you can make this choice in the application.

Printer emulation

If you want to print a particular job and to see approximately the same colors that you would get from printing the same job on a different HP Designjet printer, you can use the emulation mode provided by your printer.

 **NOTE:** This option is available only when printing an HP-GL/2, PostScript or PDF job. It will work correctly only when printing on plain, coated or heavyweight coated paper.

- **In the Windows driver dialog:** select the **Color** tab, then **Printer Managed Colors**, then select **Printer Emulation** from the Source Profile list. You can then select from the Emulated Printer list.
- **In the Mac OS Print dialog:** select the **Color Options** panel, then select from the Printer Emulation list.

Color adjustment options

The aim of color management is to print accurate colors. If you perform color management correctly, then you should be able to print accurate colors with no need of any manual color adjustments.

However, manual adjustments may be useful in the following situations:

- If your color management is not working correctly for some reason
- If you want colors that are subjectively pleasing rather than accurate

The printer driver provides different adjustment facilities depending on whether you are printing in color or in grayscale. If you are printing in pure black and white, there are no color adjustment options.

Printing in color

You can adjust the colors of your print in similar ways under Windows and Mac OS:

- **In the Windows driver dialog:** select the **Color** tab, ensure that the **Advanced color adjustments** box is checked, then press the **Settings** button beside it.
- **In the Mac OS X 10.5 or 10.6 Print dialog:** select the **Color Options** panel, select **Color** from the Mode list, then press the **Adjust** button.
- **In the Mac OS X 10.4 Print dialog:** select the **Color Options** panel, then **Lightness and Hue**.

Under either operating system, you will then be able to make adjustments using a lightness slider and three color sliders.

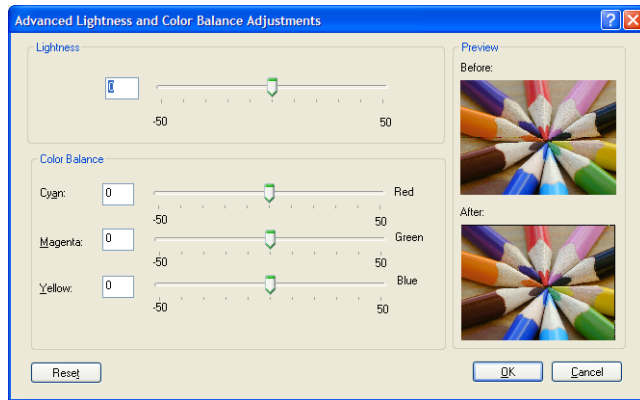

- The lightness slider simply makes the whole print lighter or darker.
- The color sliders can be used to fade or emphasize each of the primary colors in the print. The primary colors may be red, green and blue; or cyan, magenta and yellow; depending on the color model used in the image.

The **Reset** button restores each slider to its default central position.

Printing in grayscale

You can adjust the gray balance of your print in similar ways under Windows and Mac OS:

- **In the Windows driver dialog:** select the **Color** tab, ensure that the **Advanced color adjustments** box is checked, then press the **Settings** button beside it.
- **In the Mac OS X 10.5 and 10.6 Print dialog:** select the **Color Options** panel, select **Grayscale** from the Mode list, then press the **Adjust** button.
- **In the Mac OS X 10.4 Print dialog:** select the **Color Options** panel, then **Print in Grayscale**, then the **Gray balance** tab.

Under either operating system, you will then be able to make adjustments using separate controls for highlights, midtones and shadows.

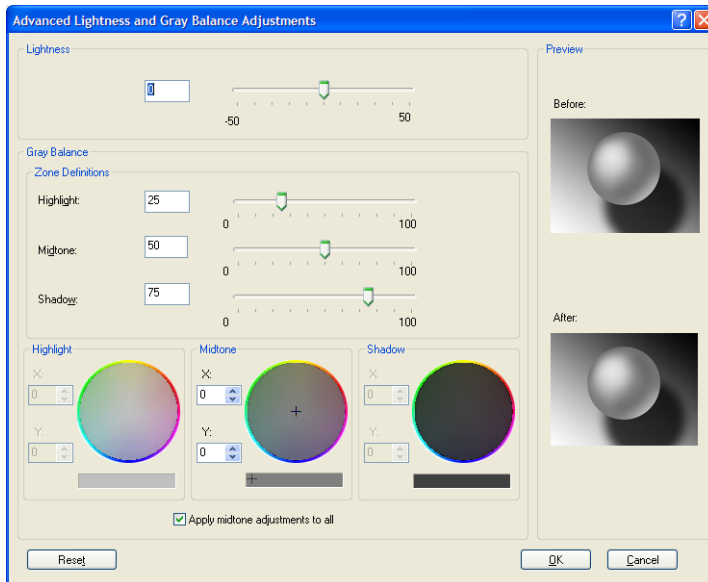

- The lightness slider simply makes the whole print lighter or darker. This slider is available in the same window as the other grayscale controls, except under Mac OS X 10.4, where it is available by selecting **Lightness and Hue**.
- The zone definition sliders can be used to define what you mean by highlight, midtone and shadow.
- The other controls for highlight, midtone and shadow can be used to adjust the gray balance of highlights, midtones and shadows respectively.

The **Reset** button restores each control to its default setting.

Color management from printer drivers (PostScript)

This facility is available when printing with the PostScript driver.

HP Professional PANTONE Emulation

When you use a named PANTONE color in an image, your application will normally send to the printer a CMYK or RGB approximation to that color. But the application does not take the printer or the paper type into account, it merely produces a generic approximation of the PANTONE color, which will look different on different printers and on different papers.

HP Professional PANTONE Emulation can do a much better job by taking into account the characteristics of the printer and the paper type. The results look as similar to the original PANTONE colors as is possible on a given printer using a given paper type. This technology is designed to produce emulations similar to those set up manually by prepress professionals.

To use HP Professional PANTONE Emulation, all you have to do is to turn it on. In fact, it is normally on by default.

- **In the Windows PostScript driver dialog:** go to the **Color** tab and select **HP Professional PANTONE Emulation**.
- **In the Mac OS Print dialog:** go to the **Color Options** panel and select **HP Professional PANTONE Emulation**.

You can also use the Embedded Web Server to print a swatch book showing emulations of PANTONE colors as made by your printer, together with a measure of the color difference (ΔE) between each

emulation and the original PANTONE spot color. So HP Professional PANTONE Emulation not only provides the closest match that can be achieved on your printer; it also gives clear information on how close the emulation is to the original spot color. See [Printing PANTONE swatch books on page 103](#).

Color emulation

Your printer can emulate the color behavior of other devices: RGB devices such as monitors, and CMYK devices such as presses and printers.

You can set color emulation in the following ways:

- **In the Windows PostScript driver dialog:** select the **Color** tab, and **Printer Managed Colors**.
- **In the Mac OS Print dialog:** select the **Color Options** panel, then select **Printer** from the Color Management list.

For a good emulation, the printer needs a specification of the colors these devices can reproduce. The standard way of encapsulating such information is in ICC profiles. As part of the solution, we provide the most common standards for the different devices.

The options are as follows.

CMYK color emulation

A traditional workflow defines color in the CMYK space. For best results, the colors must be adjusted to the printer, because different printers will produce different colors from the same CMYK data. If the image file you are printing was not created specifically for your printer, it will require some readjustment, which can be done using one of the following options provided with your printer.

- **None (Native):** no emulation. The printer will use its default internal conversion from CMYK to RGB, without following any color standard. This does not imply that results will be bad
- **U.S. Web Coated (SWOP) 2** uses specifications designed to produce quality separations using U.S. inks under the following printing conditions: 300% total area of ink coverage, negative plate, coated publication-grade stock.
- **U.S. Web Uncoated 2** uses specifications designed to produce quality separations using U.S. inks under the following printing conditions: 260% total area of ink coverage, negative plate, uncoated white offset stock.
- **U.S. Sheetfed Coated 2** uses specifications designed to produce quality separations using U.S. inks under the following printing conditions: 350% total area of ink coverage, negative plate, bright white offset stock.
- **U.S. Sheetfed Uncoated 2** uses specifications designed to produce quality separations using U.S. inks under the following printing conditions: 260% total area of ink coverage, negative plate, uncoated white offset stock.
- **Europe ISO Coated FOGRA27** is designed to produce quality separations for standard ISO 12647 printing under the following printing conditions: 350% total ink coverage, positive film, coated paper.
- **Euroscale Uncoated 2** uses specifications designed to produce quality separations using Euroscale inks under the following printing conditions: 260% total area of ink coverage, positive plate, uncoated white offset stock.

- **Japan Web Coated (Ad)** uses specifications developed by the Japan Magazine Publisher Association for digital proofing of images in the Japanese magazine/advertising market.
- **Japan Color 2001 Coated** uses the Japan Color 2001 specification for type 3 (coated) paper. It is designed to produce quality separations using 350% total ink coverage, positive film and coated paper.
- **Japan Color 2001 Uncoated** uses the Japan Color 2001 specification for type 4 (uncoated) paper. It is designed to produce quality separations using 310% total ink coverage, positive film and uncoated paper.
- **Japan Color 2002 Newspaper** uses the Japan Color 2002 for Newspapers specification. It is designed to produce quality separations using 240% total ink coverage, positive film and standard newsprint paper.
- **JMPA:** Japanese standard for offset press.
- **Toyo** is designed to produce quality separations for Toyo printing presses.
- **DIC** is designed to produce quality separations for Dainippon Ink Company printing presses.

 **NOTE:** These options have no effect if the application is defining its own CMYK space, known as calibrated CMYK or CIEBasedDEFG in PostScript terminology.

RGB color emulation

Your printer is provided with the following color profiles:

- **None (Native):** no emulation, for use when the color conversion is done by the application or operating system, and therefore the data arrive at the printer already color-managed.
- **sRGB IEC61966-2.1** emulates the characteristics of the average PC monitor. This standard space is endorsed by many hardware and software manufacturers, and is becoming the default color space for many scanners, printers and software applications.
- **ColorMatch RGB** emulates the native color space of Radius Pressview monitors. This space provides a smaller gamut alternative to Adobe RGB (1998) for print production work.
- **Apple RGB** emulates the characteristics of the average Apple monitor, and is used by a variety of desktop publishing applications. Use this space for files that you plan to display on Apple monitors, or for working with old desktop publishing files.
- **Adobe RGB (1998)** provides a fairly large gamut of RGB colors. Use this space if you need to do print production work with a broad range of colors.

Color management from the Embedded Web Server

Submit Job options

When you send jobs to the printer using the Embedded Web Server's **Submit Job** page, you have the following color management options.

If you leave an option set to **Default**, the setting saved in the job will be used. If the job contains no setting, the front-panel setting in the printer will be used.

- **Color/Grayscale:** you can choose to print in color, in shades of gray or in pure black and white.
- **Default RGB source profile:** you can choose from a selection of RGB source profiles recognized by the printer.
- **Printer emulation:** you can choose to emulate a different HP Designjet printer. Default: **Off** (no printer emulation).

PostScript or PDF jobs only

- **Default CMYK source profile:** you can choose from a selection of CMYK source profiles recognized by the printer. Default: **Europe ISO Coated FOGRA27**.
- **Rendering intent:** you can select the rendering intent.
- **Black point compensation:** you can turn black point compensation on or off.
- **HP Professional PANTONE Emulation:** you can turn HP Professional PANTONE Emulation on or off.

Rendering intent

Rendering intent is one of the settings used when doing a color transformation. As you probably know, some of the colors you want to print may not be reproducible by the printer. The rendering intent allows you to select one of four different ways of handling these so-called out-of-gamut colors.

- **Saturation (graphics):** best used for presentation graphics, charts or images made up of bright, saturated colors.
- **Perceptual (images):** best used for photographs or images in which colors blend together. It tries to preserve the overall color appearance.
- **Relative colorimetric (proofing):** best used when you want to match a particular color. This method is mainly used for proofing. It guarantees that, if a color can be printed accurately, it will be printed accurately. The other methods will probably provide a more pleasing range of colors but do not guarantee that any particular color will be printed accurately. It maps the white of the input space to the white of the paper on which you are printing.
- **Absolute colorimetric (proofing):** the same as relative colorimetric, but without mapping the white. This rendering is also used mainly for proofing, where the goal is to simulate the output of one printer (including its white point).

Perform black point compensation

The black point compensation option controls whether to adjust for differences in black points when converting colors between color spaces. When this option is selected, the full dynamic range of the source space is mapped into the full dynamic range of the destination space. It can be very useful in preserving shadows when the black point of the source space is darker than that of the destination space. This option is allowed only when the **Relative colorimetric** rendering intent is selected (see [Rendering intent on page 102](#)).

Printing PANTONE swatch books

You can use the Embedded Web Server to print a swatch book showing emulations of PANTONE colors as made by your printer, together with a measure of the color difference (ΔE) between each emulation and the original PANTONE spot color.

To print a swatch book, select the Embedded Web Server's **Main** tab, then **HP Professional PANTONE Emulation**. Select the PANTONE stock to emulate, and one or more strips of PANTONE colors that you want to print. You can select color strips from more than one PANTONE stock. When you have selected all the colors you want, press the **Next** button. The next window displays your selection; you can press **Print** to print that selection, or **Back** to change the selection.

HP Professional PANTONE emulation hp HP Sample Printer	HP Professional PANTONE emulation hp HP Sample Printer
 PANTONE RGB 252 252 9 Yellow C ΔE 13.29	 PANTONE RGB 246 207 243 217 C ΔE 3.98
 PANTONE RGB 252 249 8 Yellow 012 C ΔE 16.15	 PANTONE RGB 249 135 235 218 C ΔE 3.17
 PANTONE RGB 251 92 10 Orange 021 C ΔE 9.81	 PANTONE RGB 245 51 215 219 C ΔE 5.73
 PANTONE RGB 246 65 68 Warm Red C ΔE 7.03	 PANTONE RGB 244 19 182 Rubine Red C ΔE 6.29
 PANTONE RGB 243 41 74 Red 032 C ΔE 8.94	 PANTONE RGB 210 7 167 220 C ΔE 3.83
 PANTONE RGB 244 19 182 Rubine Red C ΔE 6.29	 PANTONE RGB 184 6 146 221 C ΔE 4.09
 PANTONE RGB 246 56 230 Rhodamine Red C ΔE 11.16 1.1 C	 PANTONE RGB 134 8 107 222 C ΔE 1.68 19 C
HP Sample Paper sample print mode	HP Sample Paper sample print mode

Color management from the front panel

You can color-calibrate the loaded paper type from the front panel by selecting the Image Quality Maintenance menu icon , then **Calibrate color**. See [Color calibration on page 94](#).

The other color options in the front panel can all be found by selecting the Setup menu icon , then **Printing preferences > Color options**.

 **NOTE:** These front panel settings can all be overridden by the printer driver or Embedded Web Server job submission settings.

- **Color/Grayscale:** you can choose to print in color or in shades of gray. Default: **Print in color**.
- **Select RGB source profile:** you can choose from a selection of RGB source profiles recognized by the printer. Default: **sRGB (HP)**.
- **Emulate printer:** you can choose to emulate a different HP Designjet printer. Default: **Off** (no printer emulation).

 **TIP:** If you have old HP-GL/2 or PostScript files made for a different HP Designjet printer, you can send them to the printer and use the front panel to turn on the appropriate emulation mode.

PostScript or PDF jobs only

- **Select CMYK source profile:** you can choose from a selection of CMYK source profiles recognized by the printer. Default: **Europe ISO Coated FOGRA27**.
- **Select rendering intent:** you can select the rendering intent. Default: **Perceptual**.
- **Black point compensation:** you can turn black point compensation on or off. Default: **On**.
- **HP Professional PANTONE Emulation:** you can turn HP Professional PANTONE Emulation on or off. Default: **On**.

10 Job queue management

- [Embedded Web Server job queue page](#)
- [Job preview](#)
- [Turn off the job queue](#)
- [Select when to print a job in the queue](#)
- [Identify a job in the queue](#)
- [Prioritize a job in the queue](#)
- [Delete a job from the queue](#)
- [Reprint or copy a job in the queue](#)
- [Job status messages](#)

Embedded Web Server job queue page

You can manage your printer's job queue from the HP Utility, see [Access the HP Utility on page 21](#), or the printer's Embedded Web Server, see [Access the Embedded Web Server on page 21](#).

The job queue page shows all jobs that are available in the printer job queue. It includes jobs that are being received, parsed, rendered, printed and already printed.

The following information is displayed for each job:

- **Preview:** Click the icon to see the job preview. The job preview is available once the job is processed.
- **File name:** Click the file name to see the properties of the job.
- **Status:** Gives the current job status.
- **Pages:** Number of pages in the job.
- **Copies:** Number of copies printed.
- **Date:** Date and time the printer received the job.
- **User:** The user's name.

Jobs in the queue can be sorted by any of the information items (except Preview) by clicking on the title of the corresponding column. You can perform the following operations on one or all jobs in the queue:

- **Cancel:** Cancels the selected jobs. You are asked to confirm before the job is canceled. The job remains stored in the printer, but it is not printed unless you click **Reprint**.
- **Hold:** Holds the selected jobs until you click **Continue** to print.
- **Continue:** All selected jobs, which are on hold, continue printing.
- **Reprint:** Prints more copies of a job. Type the number of copies (default 1, maximum 99) and click **Print**.
- **Move to front:** Sends all selected jobs to the top of the job queue.
- **Delete:** Deletes selected jobs from the job queue. You are asked to confirm before the job is deleted.
- **Refresh:** Refreshes the page, ensuring the information is updated.

 **NOTE:** The job queue page does not automatically update.

Job preview

The printer samples all incoming jobs and generates a JPEG file that can be served as a preview of the job. This preview is available for all kinds of jobs supported by the printer.

 **TIP:** Do not send a job for preview with more than 64 pages.

Job preview is available once the job is processed. To access the preview page, click the magnifying glass icon, which appears in the Preview column on the job queue page. The preview page shows the following job details along with a thumbnail preview of the job:

- **File name:** The file name of the job.
- **Loaded paper:** The type of paper loaded in the printer.
- **Job dimensions:** The dimensions of the job.

To see a larger preview of the job, click either the job thumbnail or the magnifying glass icon, which appears on the right hand side of the printer image.

 **NOTE:** Browsers without the Macromedia plug-in show the job image as yellow shaded. Browsers that have the Macromedia flash plug-in version 7 and above shows an enhanced preview of the job image inside the paper loaded in the printer.

Turn off the job queue

You can turn off the queue from the Embedded Web Server, select **Setup tab > Printer settings > Job management > Queue** and select **Off**; or from the front panel: select the Setup menu icon



, then **Job management options > Enable queue > On/Off**.

Select when to print a job in the queue

 **NOTE:** The When To Start Printing options cannot be used with PostScript jobs.

You can select at what point you want to print a file you have in the queue. From the Embedded Web Server, select **Setup tab > Printer settings > Start printing**; or, from the front panel, select the Setup menu icon , then **Job management options > When to start printing**.

There are three options you can select:

- When **After Processing** is selected, the printer waits until the whole page has been processed and then it starts to print. This is the slowest setting but ensures the best print quality in large or complex prints.
- When **Immediately** is selected, the printer prints the page as it is processed. This is the quickest setting, but the printer may stop halfway through a print to process data. This setting is not recommended for complex images with dense color.
- When **Optimized** is selected (this is the default setting), the printer calculates the best time to begin printing the page. It is usually the best compromise between the **After Processing** and **Immediately** settings.

Identify a job in the queue

The best way to look at the queue is in the Embedded Web Server (**Main tab > Job queue**), where you can manage the queue and get full information on every job (by clicking the name of the file).

However, you can also manage the queue from the front panel. To do so, select the Job Queue menu icon , then **Job queue**, where you can see a list of the jobs in the queue.

Each has an identifier, comprising:

<position in queue>: <image name>

The job currently being printed has a pointing hand icon, jobs already printed have a check mark, canceled jobs have crosses, processing jobs have a clock and jobs on hold have a warning.

Prioritize a job in the queue

To make any job in the queue the next one to be printed, select it and choose **Reprint** (in the Embedded Web Server) or **Move to front** (in the front panel).

If nesting is turned on, the prioritized job may still be nested with others. If you really want this job to be printed next, and on its own on the roll, first turn nesting off and then move it to the front of the queue as described above.

Delete a job from the queue

Under normal circumstances, there is no need to delete a job from the queue after printing it, as it is removed from the queue as more files are sent. However, if you have sent a file in error, and want to avoid any chance of it being reprinted, you can simply delete it, by selecting it and choosing **Delete** (in the Embedded Web Server or in the front panel).

In the same way, you can delete a job that has not been printed yet.

If the job is currently being printed (Status = **printing** in the Embedded Web Server, or it is the first job in the queue in the front panel), and you want both to cancel the job and to delete it, first click the Cancel icon in the Embedded Web Server, or press the **Cancel** key on the front panel, and then delete it from the queue.

Reprint or copy a job in the queue

To reprint or make extra copies of any job in the queue, select the job in the Embedded Web Server and click the **Reprint** icon, then specify the number of copies you want. The job is moved to the top of the queue. To make more than one print of a non-printed job in the queue from the front panel, select the job and choose **Copies**, then specify the number of copies required and press the **Select** key. This overrides any value set by your software.

 **NOTE:** If **Rotate** was **On** when you sent the file, every copy is rotated.

You can reprint an already-printed job from the front panel. Select the Job Queue menu icon , then select the job from the queue, then select **Reprint**.

Job status messages

These are the possible job status messages, approximately in the order in which they may be seen:

- **Receiving:** the printer is receiving the job from the computer
- **Waiting to process:** the job has been received by the printer and is waiting to be rendered (for jobs submitted through the Embedded Web Server only)
- **Processing:** the printer is parsing and rendering the job
- **Rotating:** the job is already rendered, but it is being rotated (autorotate is on) to save paper.

- **Preparing to print:** the printer is performing writing system checks before printing the job
- **Waiting to print:** the job is waiting for the print engine to become free to proceed with printing
- **Waiting for nest:** the printer is set up with nesting on and is waiting for other jobs in order to complete the nest and proceed with printing
- **On hold:** the job was sent with the **on hold for preview** option and is on hold

 **TIP:** Do not send a job for preview with more than 64 pages.

 **NOTE:** If the printer hangs up while printing a job, and the queue facility is turned on, the partially printed job appears in the queue as **on hold** when the printer is next turned on. When you resume the job, it starts printing at the page it was interrupted.

- **On hold for paper:** the job can't be printed because paper is not loaded in the printer. Load the required paper, see [Handle the paper on page 26](#), and click **Continue** to resume the job
- **On hold for accounting:** the job can't be printed because the printer requires all jobs to have an account ID: enter the account ID and then click **Continue** to resume the job
- **Printing**
- **Drying**
- **Cutting paper**
- **Ejecting page**
- **Canceling:** the job is being canceled, but remains in the printer job queue
- **Deleting:** the job is being deleted from the printer
- **Printed**
- **Canceled:** the job has been canceled by the printer
- **Canceled by user**
- **Empty job:** the job does not contain anything to print

Remove a hold

When the printer puts a job on hold you receive an alert, see [Printer alerts on page 175](#), which explains why the job is on hold. Follow the instructions on the screen to remove the hold and continue printing.

11 Retrieve printer usage information

- [Get printer accounting information](#)
- [Check printer usage statistics](#)
- [Check ink and paper usage for a job](#)

Get printer accounting information

There are various different ways of getting accounting information from your printer.

- View printer usage statistics for the whole lifetime of the printer, see [Check printer usage statistics on page 111](#).
- View ink and paper usage for each of your recent jobs by using the HP Utility, see [Check ink and paper usage for a job on page 111](#). If the HP Utility is not available, see [Access the HP Utility on page 21](#).
- Use a third-party application to request printer status, printer usage or job accounting data from the printer through the Internet. The printer provides data in XML to the application whenever requested. HP provides a Software Development Kit to facilitate the development of such applications.

Check printer usage statistics

There are two ways to check your printer's usage statistics.

 **NOTE:** The accuracy of the usage statistics is not guaranteed.

Printer statistics with the HP Utility

1. Access the HP Utility, see [Access the HP Utility on page 21](#).
2. Under Windows, go to the **Overview** tab and click on the **Printer usage** link.
Under Mac OS, select **Information** > **Printer Usage** and click on the **Lookup** button.

Printer statistics with the Embedded Web Server

1. Access the Embedded Web Server, see [Access the Embedded Web Server on page 21](#).
2. Go to the **Main** tab.
3. Select **History** > **Usage**.

Check ink and paper usage for a job

There are two ways to check ink and paper usage for a job.

 **NOTE:** The accuracy of the usage statistics is not guaranteed.

Ink and paper statistics with the HP Utility

1. Access the HP Utility, see [Access the HP Utility on page 21](#).
2. Select **Job center** to view information regarding the most recent jobs.
3. Under Windows, click on the **Accounting** link.

Under Mac OS, select **Job Accounting** and click on the **Look Up** button.

Ink and paper statistics with the Embedded Web Server

1. Access the Embedded Web Server, see [Access the Embedded Web Server on page 21](#).
2. Go to the **Main** tab.
3. Select **History** > **Accounting**.

12 Practical printing examples

- [Overview](#)
- [Print a draft for revision with the correct scale](#)
- [Print a project](#)
- [Print a presentation](#)
- [Print and scale from Microsoft Office](#)

Overview

The following step-by-step instructions for printing jobs that use specific software are similar to those at the HP Knowledge Center on the Web. Consult the Knowledge Center at <http://www.hp.com/go/T7100/knowledgecenter/> or <http://www.hp.com/go/T7100mono/knowledgecenter/> for the most up-to-date information and for additional printing examples, including RIP scenarios.

Print a draft for revision with the correct scale

This section demonstrates how to print a draft for revision with the correct scale from Adobe Acrobat.

Using Adobe Acrobat

1. In the Acrobat window, bring the mouse cursor to the bottom left corner of the document pane to check the size of the job.

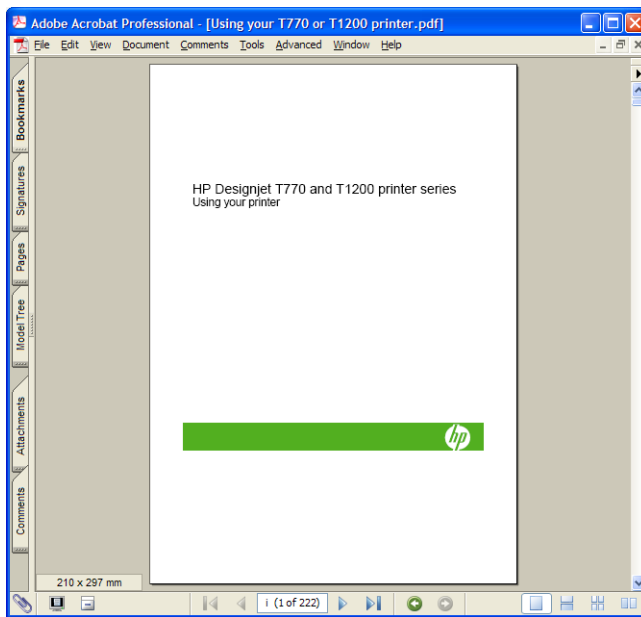

2. Select **File > Print** and ensure that **Page Scaling** is set to **None**.

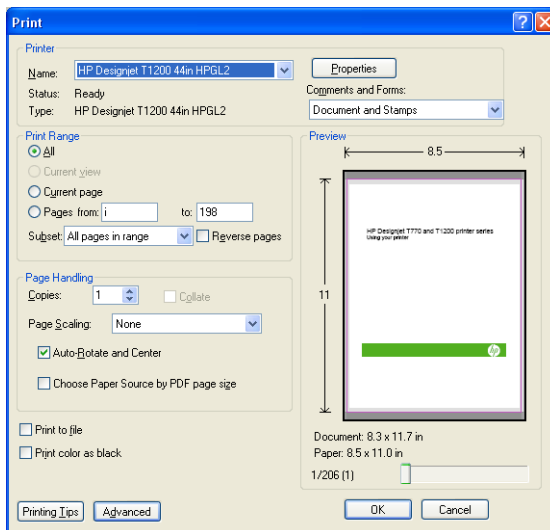

NOTE: The page size will **not** be automatically selected according to the drawing size.

- Press the **Properties** button and then select the **Paper/Quality** tab.

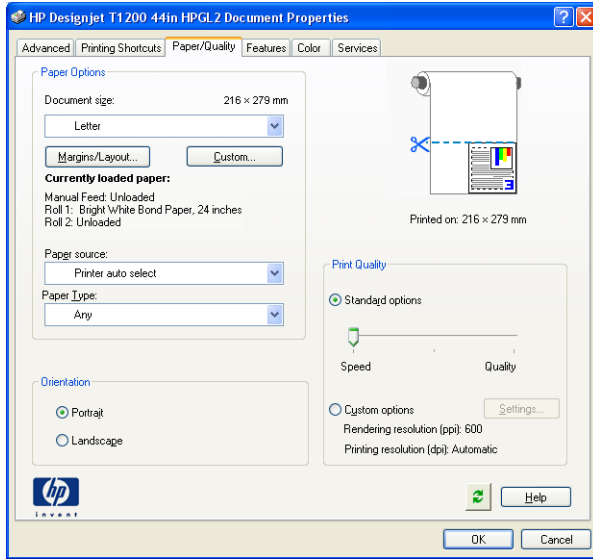

- Choose whatever **Document Size** and **Print Quality** you want to use. If you want to define a new custom paper size, press the **Custom** button.

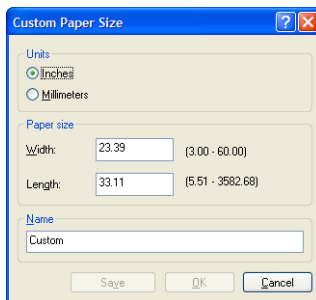

- Press the **Margins/Layout** button and select a layout option.

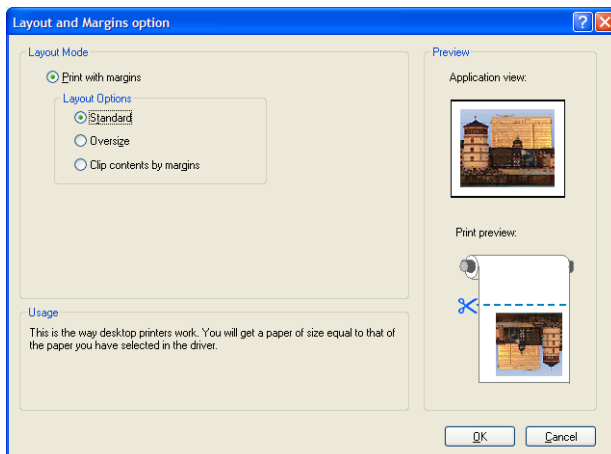

If the job is 10 mm smaller in both dimensions than the page size you have chosen, select **Standard margins**. See [Select margins options on page 83](#).

If the job is the same size as the page you have chosen, but has at least 5 mm of white space around the edges, select **Clip contents by margins**.

If the job is the same size as the page you have chosen, and does not have 5 mm of white space around the edges, select **Oversize**. The final output will be larger than the page you selected, but you can cut the print to the correct size without losing any of it.

6. Select the **Features** tab, and then **Autorotate**.

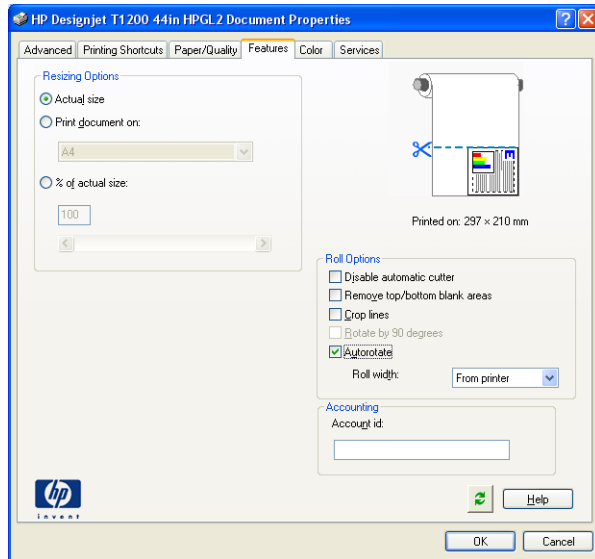

7. Click **OK**, and check that the print preview in the Print dialog box seems correct.

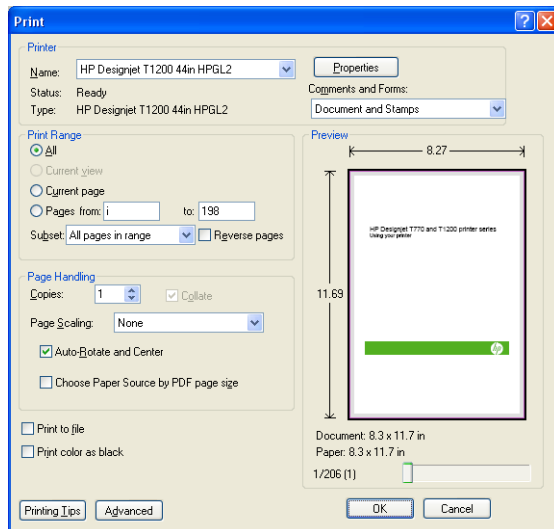

Print a project

This section demonstrates how to print a project from Autodesk Design Review, AutoCAD and the printer's Embedded Web Server.

Using Autodesk Design Review

Autodesk Design Review offers the **Use HP Instant Printing** option. This needs to be enabled once, after which it is taken as the default printing option until it is disabled.

Enabling HP Instant Printing from Autodesk Design Review

1. Start Autodesk Design Review and select **File > Print**.

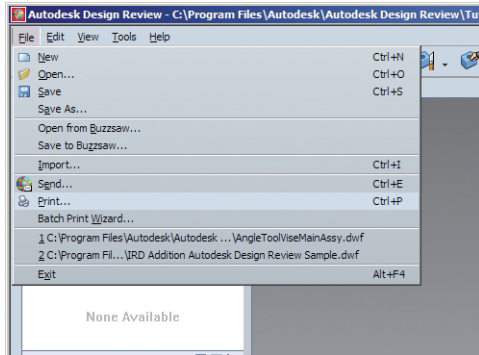

Alternatively, click the Print icon on the toolbar.

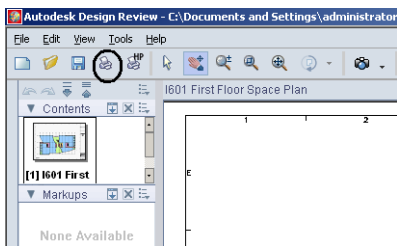

2. In the **Print** dialog box, check the **Use HP Instant Printing** box. You can select your printer and paper size here, or in the next window.

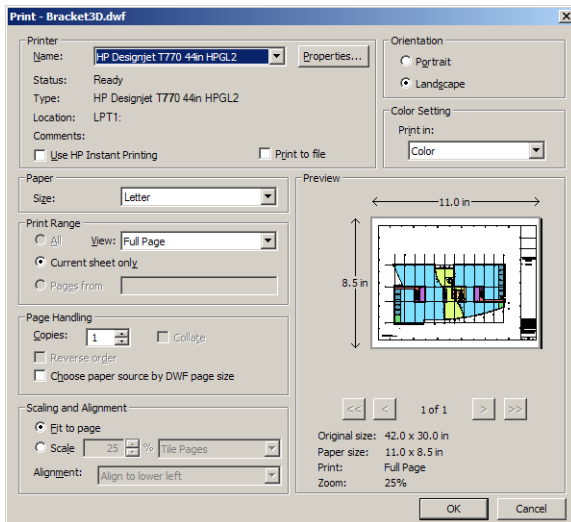

3. Ensure that the printer and paper size are correct, then click **OK** to start printing.

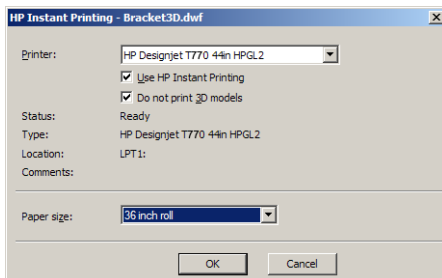

Enabling HP Instant Printing from the Batch Print Wizard

1. Make sure you have installed the Batch Print Wizard. Start Autodesk Design Review and select **File > Batch Print Wizard**.

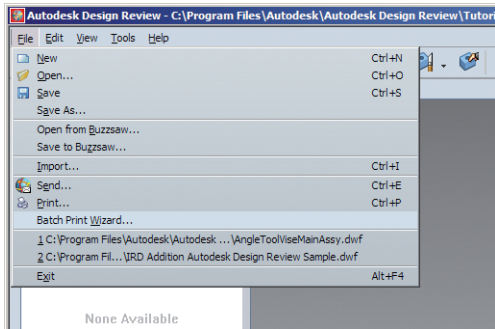

2. In the **Welcome** box, click **Next**.

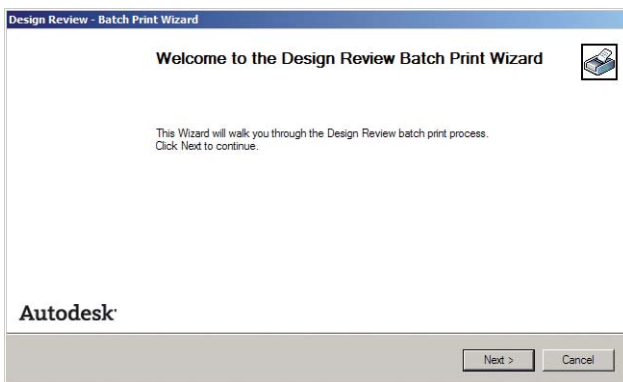

3. Select the DWF files to print, then click **Next**.

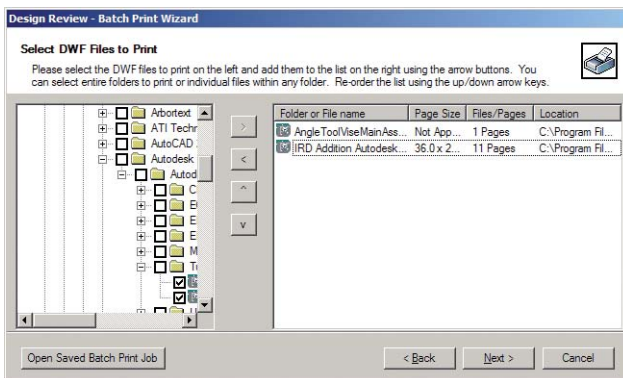

- Use the **Shift** key if you want to select multiple files to configure. Then click **Print Setup**, and the printing configuration will be applied to all the files you have selected..

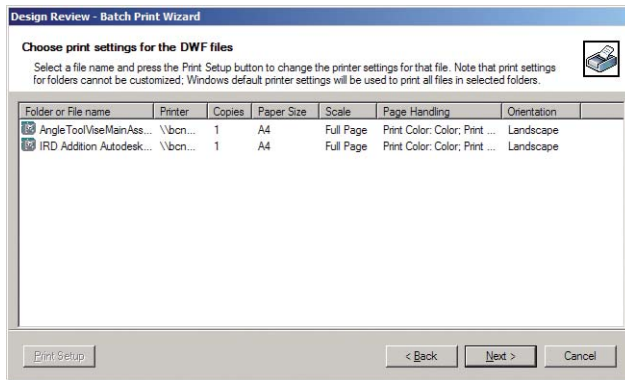

- In the **Print** dialog box, check the **Use HP Instant Printing** box. You can select your printer and paper size here, or in the next window.

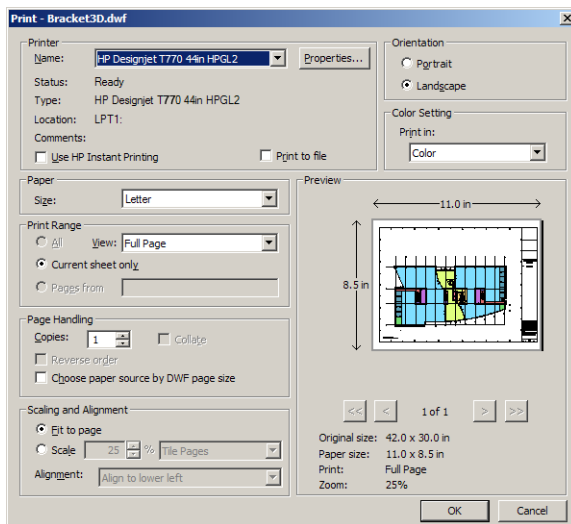

- Ensure that the printer and paper size are correct, then click **OK**. The paper size is automatically preselected.

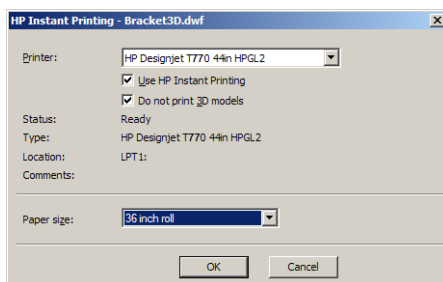

- Back in the **Choose print settings** box, click **Next**.

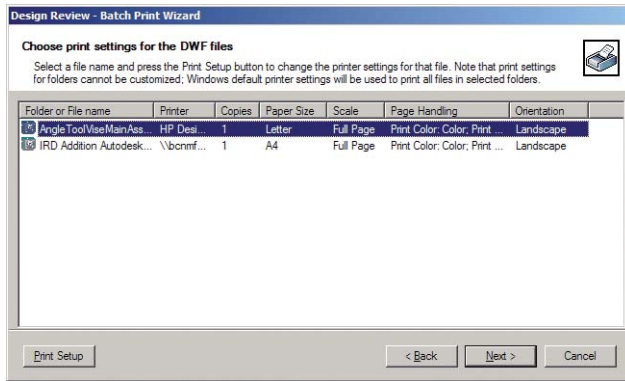

- Save or start the batch print job.

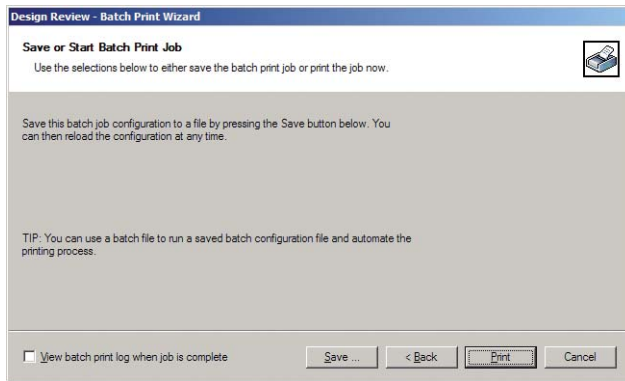

Using HP Instant Printing

- Make sure **Use HP Instant Printing** has been selected. To print, click the Print icon in the toolbar or select **File > Print**. Choose your preferred printing settings and click **OK**.

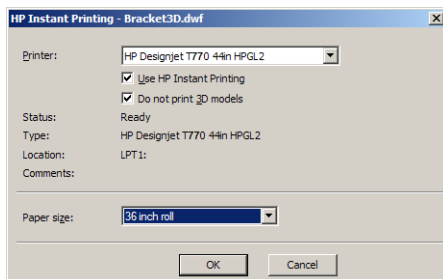

- Alternatively, Use HP Instant Printing can be launched directly from its own toolbar icon. In this case, it starts immediately, using the settings you defined previously.

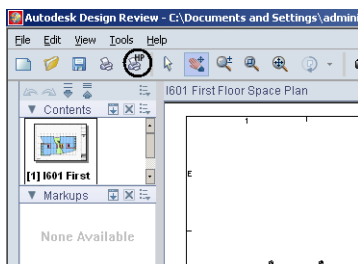

Using AutoCAD

1. The AutoCAD window can show a model or layout. Normally a layout is printed rather than the model.

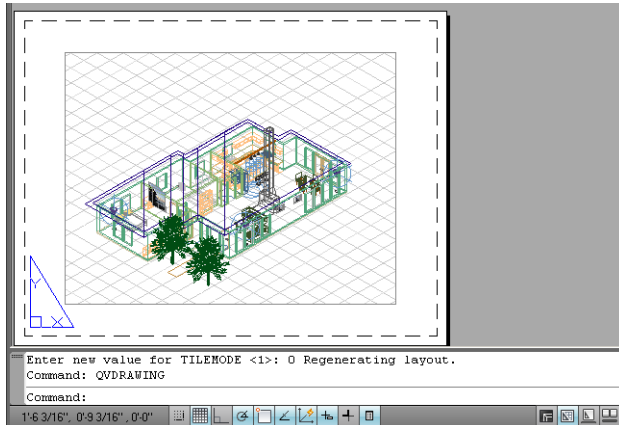

2. Click the Plot icon at the top of the window.

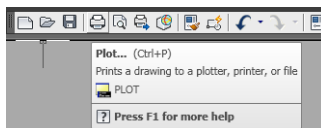

3. The Plot window opens.

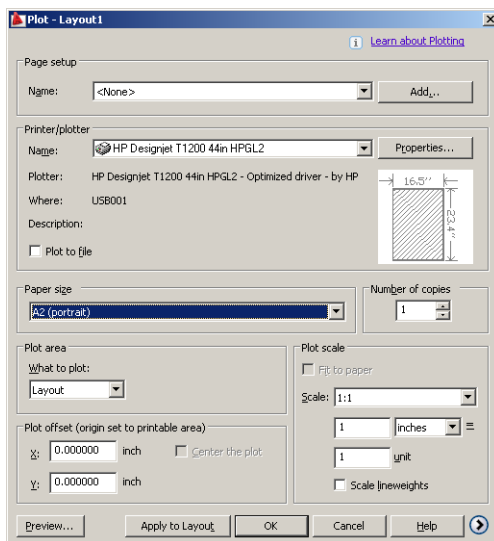

4. You can see further options by pressing the circular button in the lower right corner of the window.

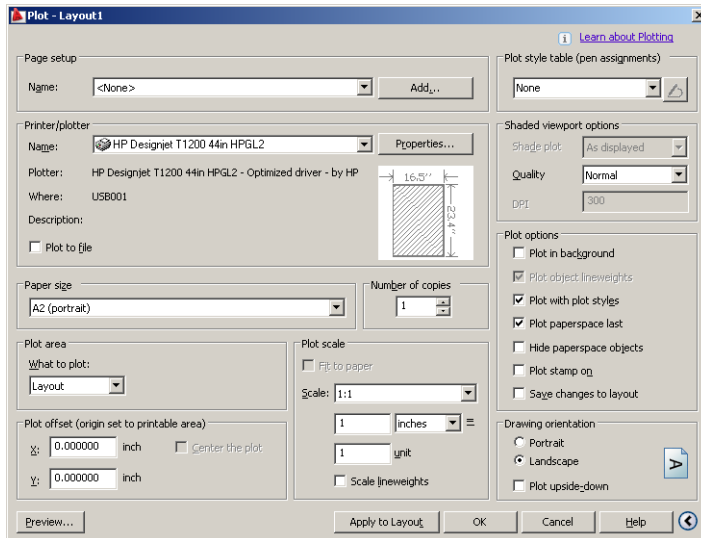

NOTE: The Quality option here does not refer to the final print quality but to the quality of AutoCAD viewport objects that are sent for printing.

5. Press the **Properties** button.

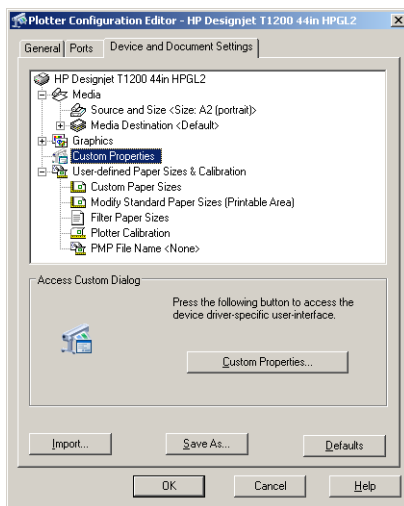

6. Select the **Device and Document Settings** tab, and press the **Custom Properties** button.

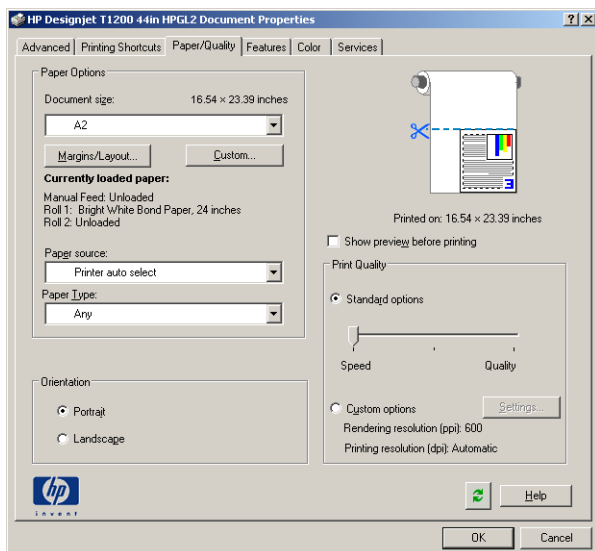

7. In the **Paper/Quality** tab, check the **Show preview before printing** box, and select the paper type that you intend to use.

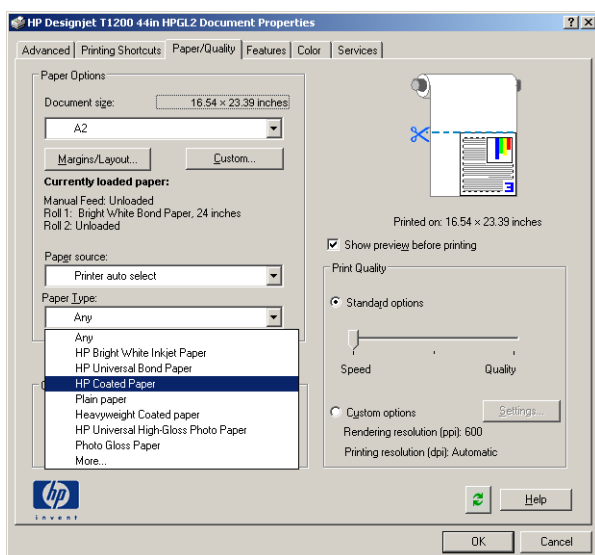

NOTE: If you select neither the paper source nor the paper type, the printer will not print on any protected roll (see [Roll protection on page 91](#)).

8. Select the print quality (your own choice between speed and quality of printing).

9. Press the **Margins/Layout** button and select a layout option.

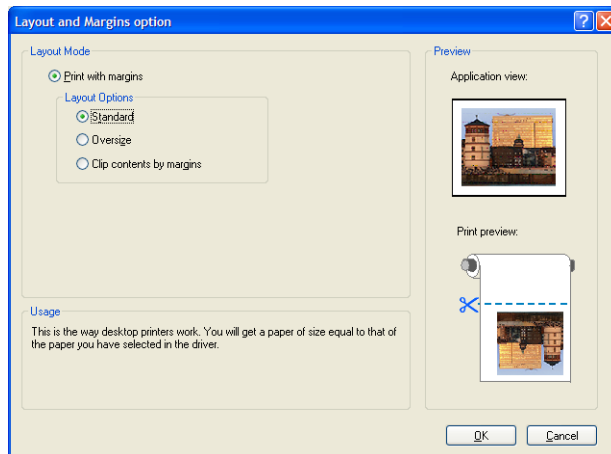

If the job is 10 mm smaller in both dimensions than the page size you have chosen, select **Standard margins**. See [Select margins options on page 83](#).

If the job is the same size as the page you have chosen, but has at least 5 mm of white space around the edges, select **Clip contents by margins**.

If the job is the same size as the page you have chosen, and does not have 5 mm of white space around the edges, select **Oversize**. The final output will be larger than the page you selected, but you can cut the print to the correct size without losing any of it.

10. Select the **Features** tab, then select the **Autorotate** option and the **Crop lines** option. Autorotation can help to avoid wasting paper, and the crop lines will show you where to cut the paper after printing.

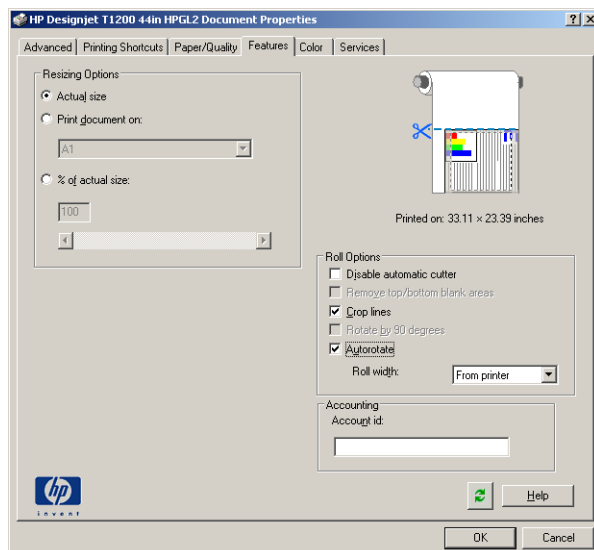

11. Press the **OK** button and save your configuration changes to a PC3 file.

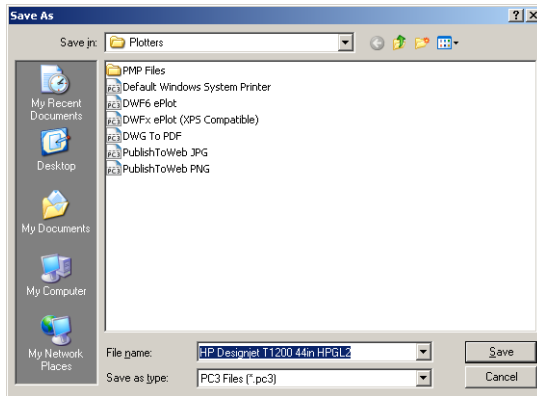

12. When you have pressed the **OK** button in the Plot window, the printer will construct a print preview.

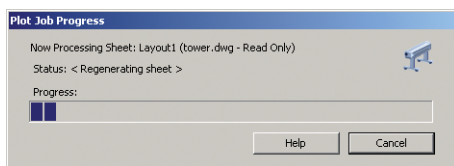

Preview in progress

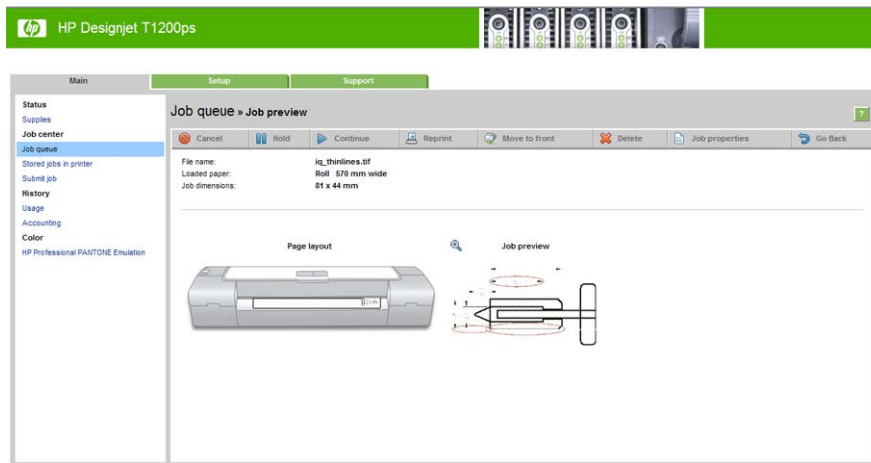

Using the Embedded Web Server to submit files

From the HP Utility or the Embedded Web Server, select **Job Center** > **Submit Job**. With some Web browsers, you will see the window below; with other Web browsers, the mechanism for adding files is slightly different.

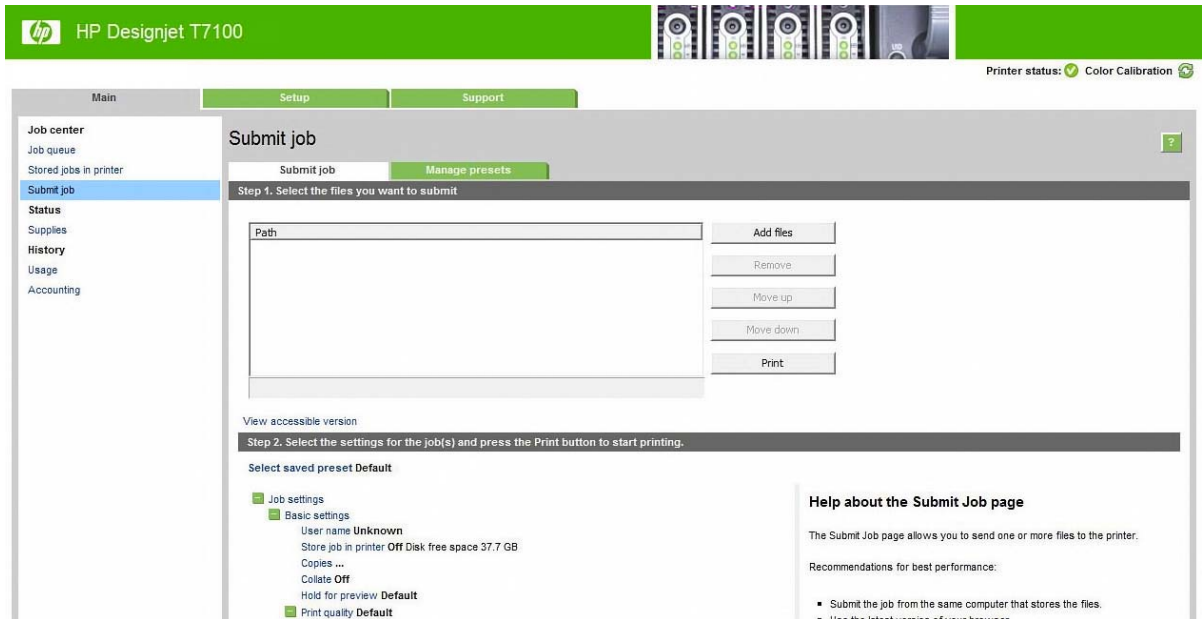

Press the **Add files** button (or **Choose File, Add another file**) to choose the files from your computer that you want to print. The files must be in one of the following formats:

- HP-GL/2
- RTL
- CALS/G4
- PDF (with the PostScript upgrade only)
- PostScript (with the PostScript upgrade only)
- TIFF (with the PostScript upgrade only)
- JPEG (with the PostScript upgrade only)

NOTE: When you print to a file, the file should be in one of the above formats, but its name may have an extension such as **.plt** or **.prn**.

If the files are not in one of these formats, they will not be printed successfully.

If the jobs have been generated with the appropriate settings (such as page size, rotation, resizing and number of copies), you can just press the **Print** button and the project will be sent to the printer.

If you need to specify printing settings, go to the **Job settings** section and select the options you need. Each option has explanatory text on the right, so that you can understand the behavior of each setting. Remember that, if you leave the setting as **Default**, the setting saved in the job will be used. If the job contains no setting, the setting in the printer will be used.

Using printer emulation

Printer emulation can be requested by selecting **Advanced settings > Color > Color management > Printer emulation**.

You can select **Off** (no printer emulation) or the name of the printer model that you want to emulate.

This setting will apply to jobs that do not contain any printer emulation setting saved in the job.

Using clip contents by margins

You can select this margins option from **Advanced settings > Paper > Layout/Margins > Print with margins > Layout > Clip contents by margins**.

Use this option when the contents to be printed have white borders and a size equal to that of the paper you have selected. The printer will use the white border for its margins and you will get a page of size equal to that which is selected in the driver.

Print a presentation

This section demonstrates how to print a presentation from AutoCAD and from Photoshop.

Using AutoCAD

1. Open the AutoCAD file and select a layout.

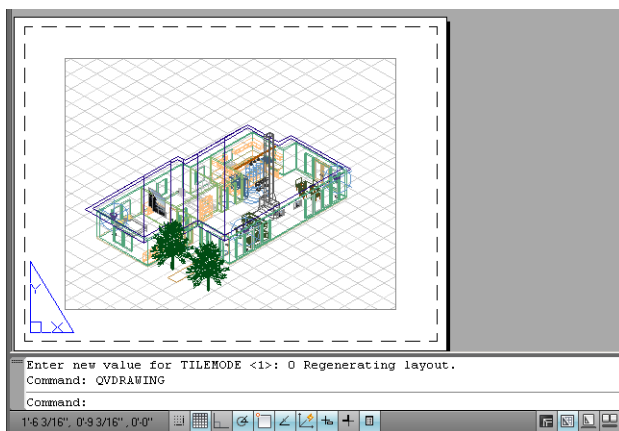

2. Click the Plot icon at the top of the window.

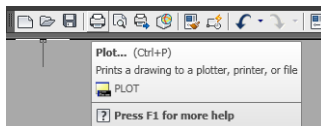

3. Ensure that the correct printer is selected, then press the **Properties** button.

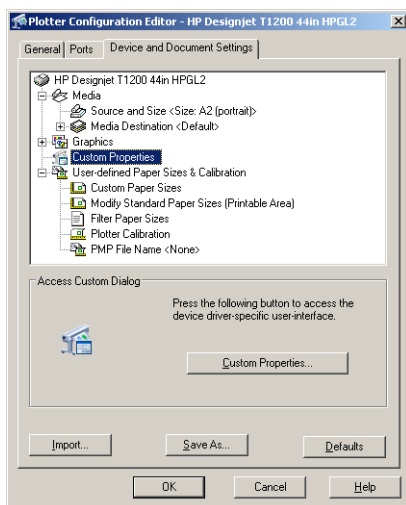

4. Select the **Device and Document Settings** tab, and press the **Custom Properties** button.

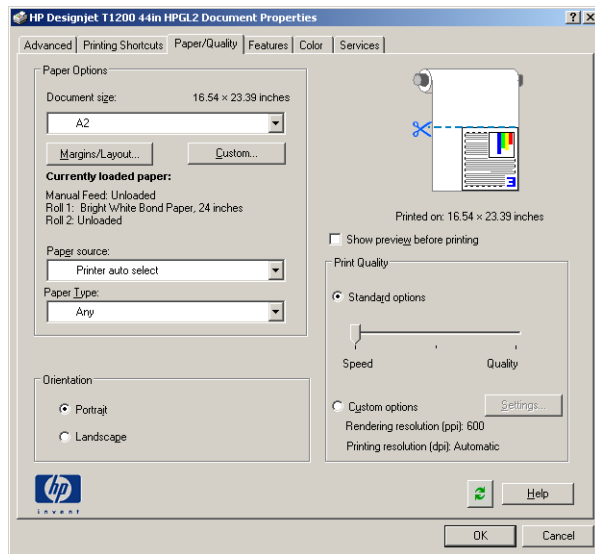

5. In the **Paper/Quality** tab, check the **Show preview before printing** box, and select the paper type that you intend to use.

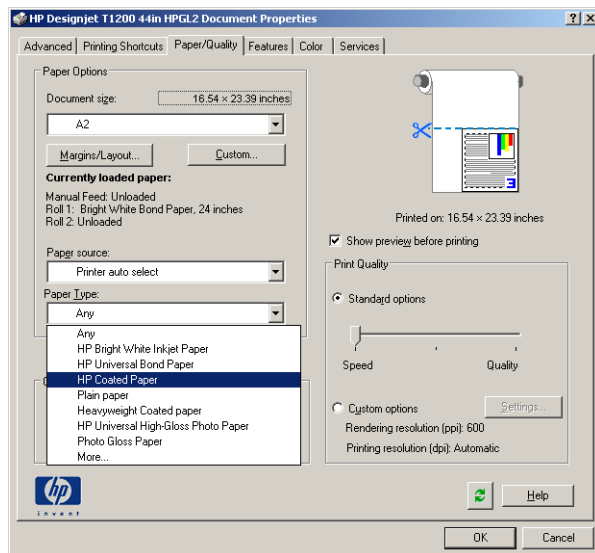

 **NOTE:** If you select neither the paper source nor the paper type, the printer will not print on any protected roll (see [Roll protection on page 91](#)).

6. Select the print quality (your own choice between speed and quality of printing).

7. Press the **Margins/Layout** button and select a layout option.

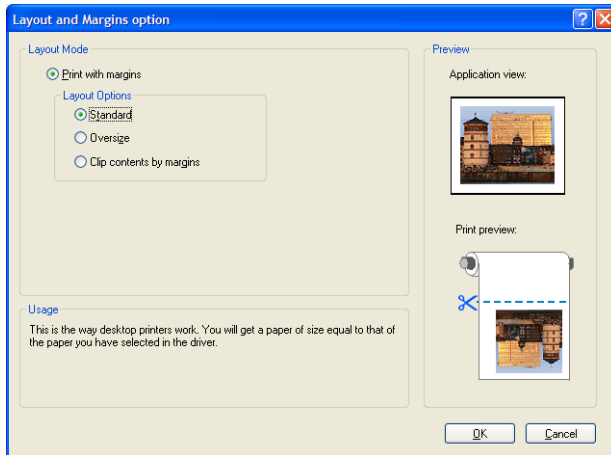

If the job is 10 mm smaller in both dimensions than the page size you have chosen, select **Standard margins**. See [Select margins options on page 83](#).

If the job is the same size as the page you have chosen, but has at least 5 mm of white space around the edges, select **Clip contents by margins**.

If the job is the same size as the page you have chosen, and does not have 5 mm of white space around the edges, select **Oversize**. The final output will be larger than the page you selected, but you can cut the print to the correct size without losing any of it.

8. Select the **Features** tab, then select the **Autorotate** option and the **Crop lines** option. Autorotation can help to avoid wasting paper, and the crop lines will show you where to cut the paper after printing.

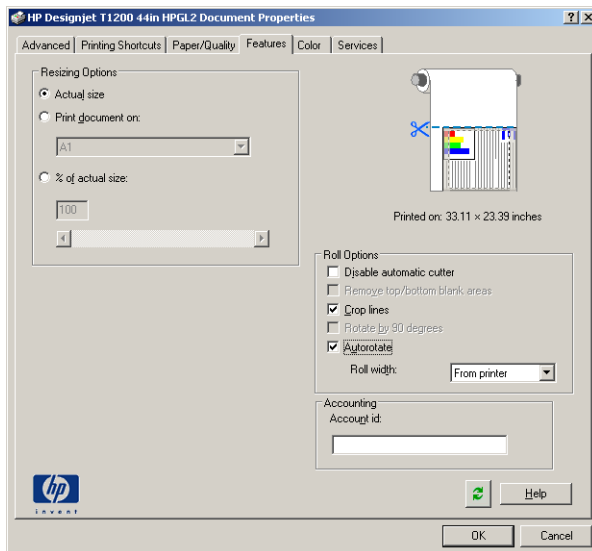

- Press the **OK** button and save your configuration changes to a PC3 file.

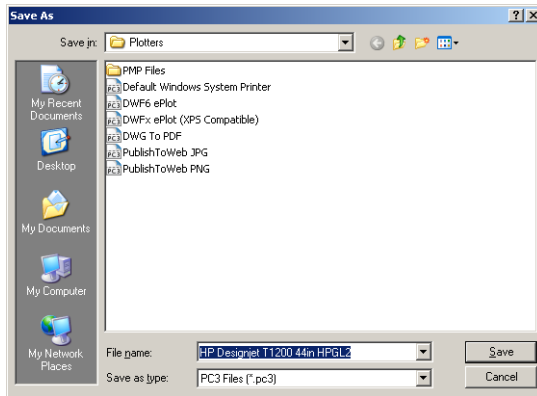

- When you have pressed the **OK** button in the Plot window, the printer will construct a print preview.

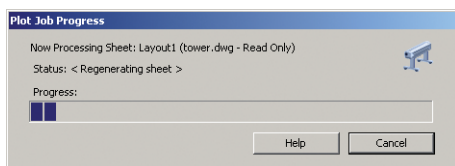

Preview in progress

Status: Waiting to receive the job...

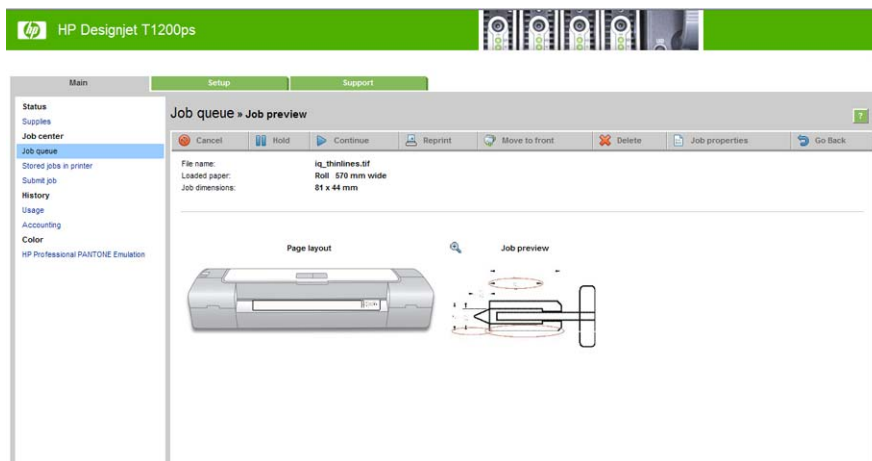

Using Adobe Photoshop

- Select **File > Page Setup > Printer**, select your printer and click **OK**.

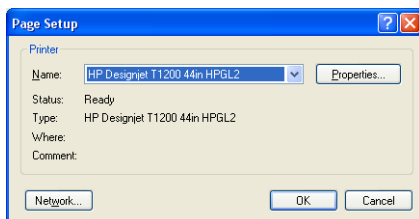

2. Choose from the available paper sizes.

If you do not find the paper size that you intend to use, select **Printer > Properties > Paper/Quality > Custom > Paper Size**. Enter the width, the length and the name of your custom paper size. Press the **Save** and **OK** buttons.

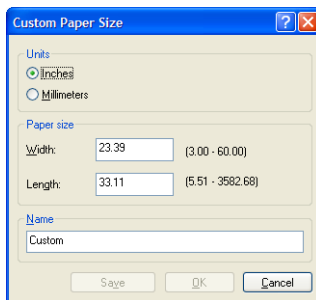
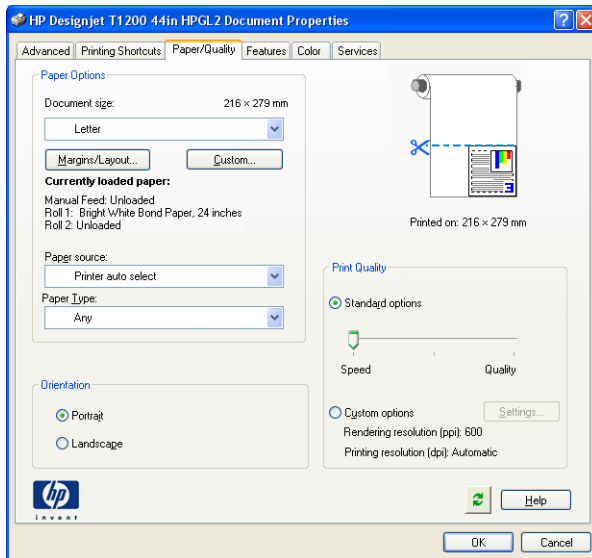

3. Select **File > Print with Preview**.



4. Select **Print > Properties**. In the Document Properties window, select **Paper Source, Paper Type** and **Print Quality**.

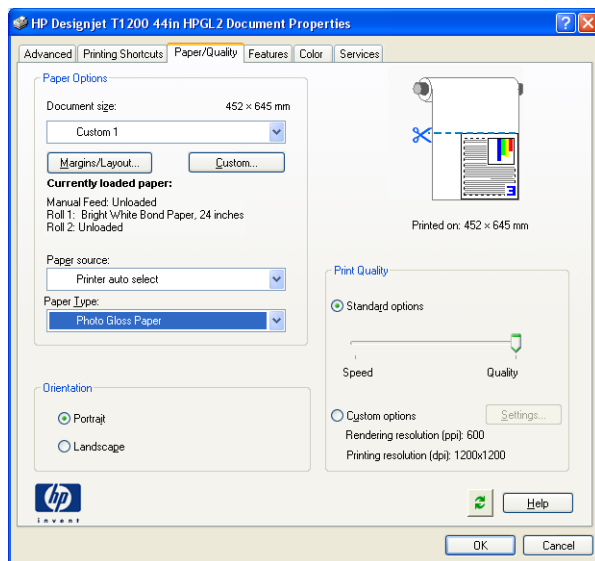

5. In the **Color** tab, the default color management option is **Printer Managed Colors**, and this is the correct option because you have already selected **Let Printer Determine Colors** in Photoshop.

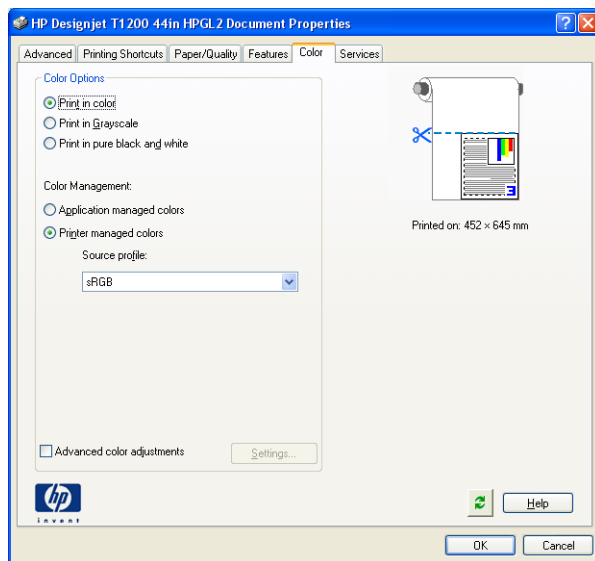

Print and scale from Microsoft Office

This section demonstrates how to print and scale from Microsoft Office.

Using PowerPoint

1. Select the Office Button, then **Print**, and select the name of your printer.

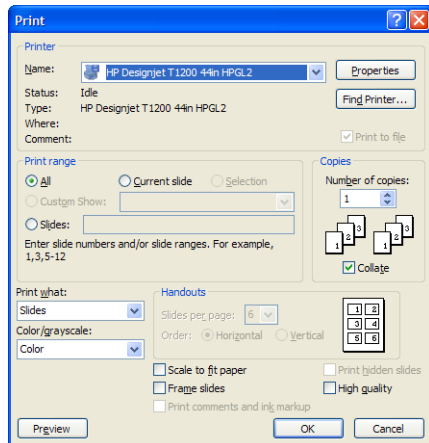

2. Select **Properties > Features > Print document on** to scale the document to a particular size.

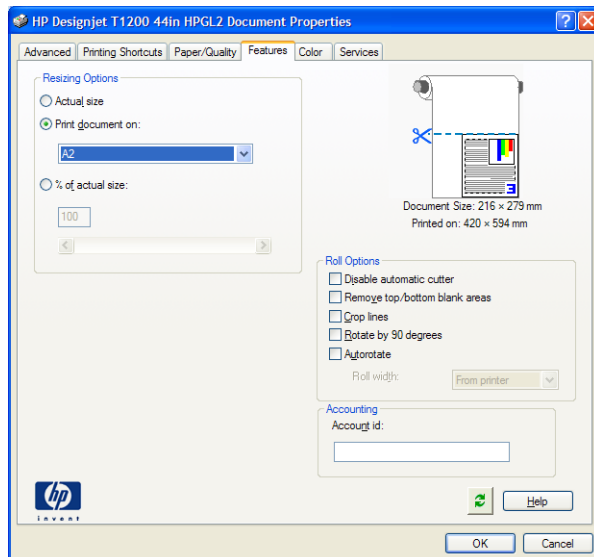

3. Select the **Paper/Quality** tab, then select **Paper Source** and **Paper Type**.

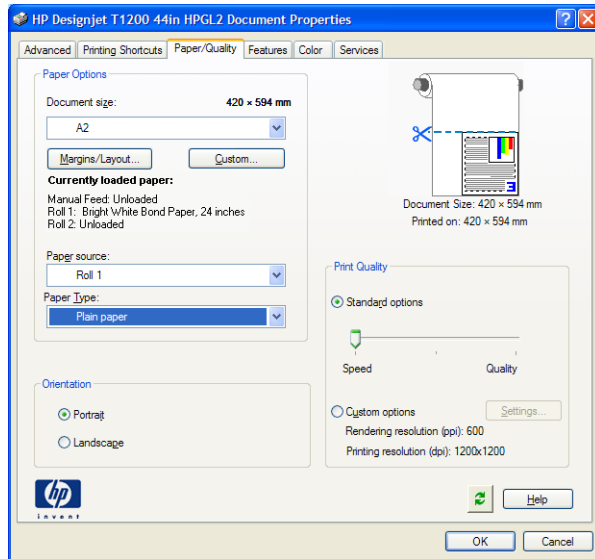

4. Select **Margins/Layout**, then select **Clip contents by margins** to keep the size.

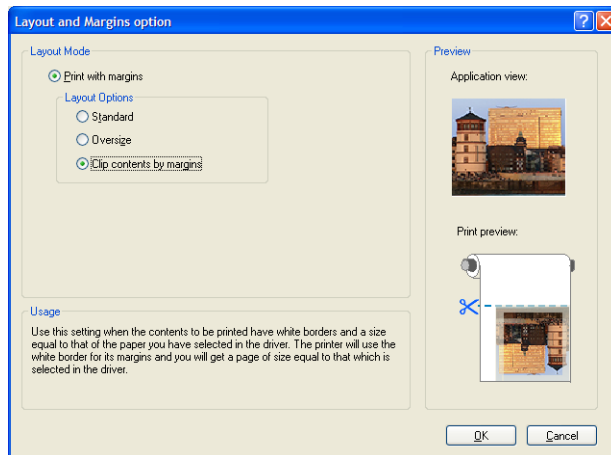

Using Project

1. Select **File > Page Setup > Print**.

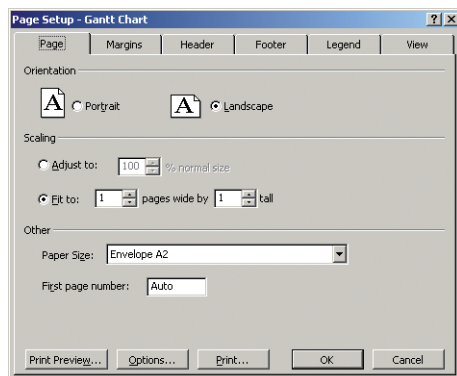

2. Select your printer's name, then **Close**.

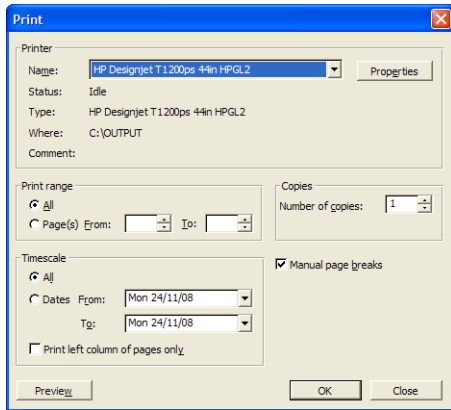

3. Select **Page Setup**, and choose the **Paper Size** you want.

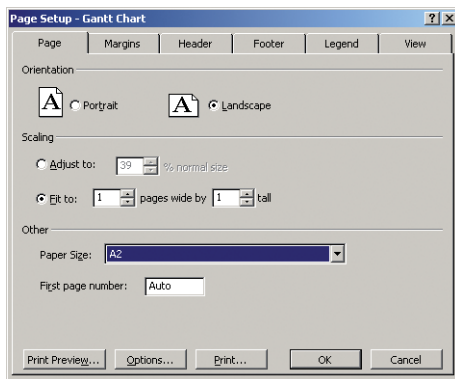

4. Select **Options** to go to the printer driver. The default options in the **Paper/Quality** tab are probably suitable: **Paper source: Printer auto select** and **Paper Type: Any**.

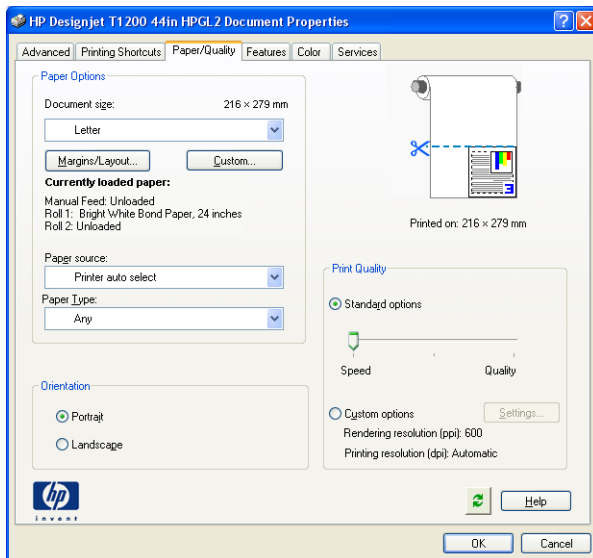

5. Select **Features > Print document on** to scale the document to a particular size. Alternatively, you can scale the document in Project.

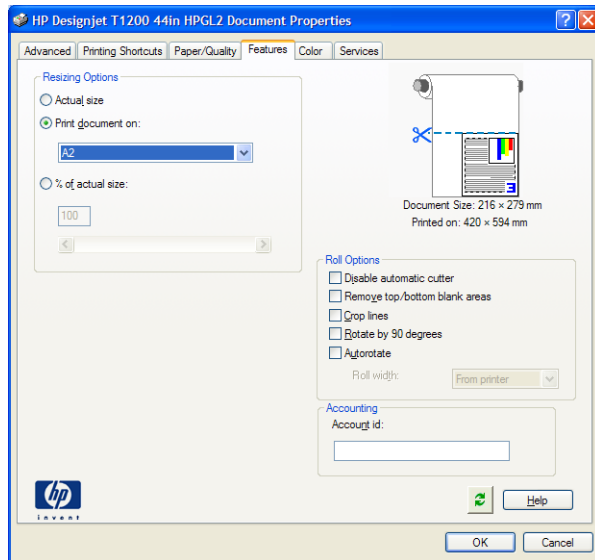

Using Excel

1. Select the Office Button, then **Print**. Select your printer's name, then click **Close**.

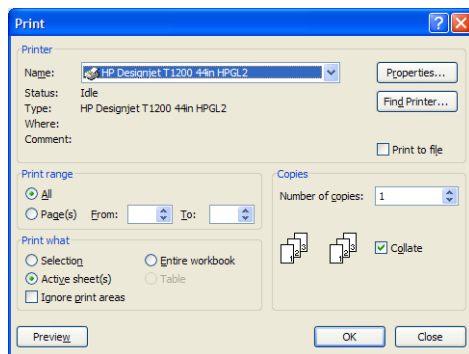

2. Select the **Page Layout** tab, then **Size**, and choose the paper size you want.

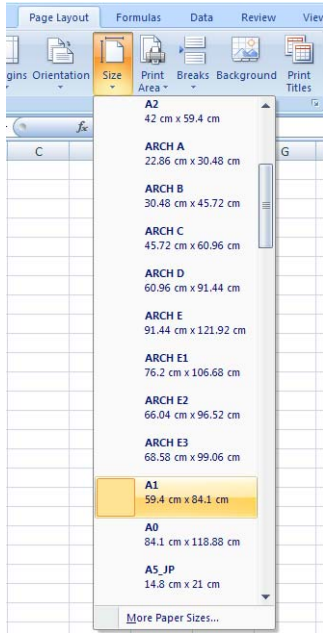

3. Select the Office Button, then **Print > Properties** to go to the printer driver. In the **Paper/Quality** tab, select **Paper source**, **Paper Type** and **Print Quality**.

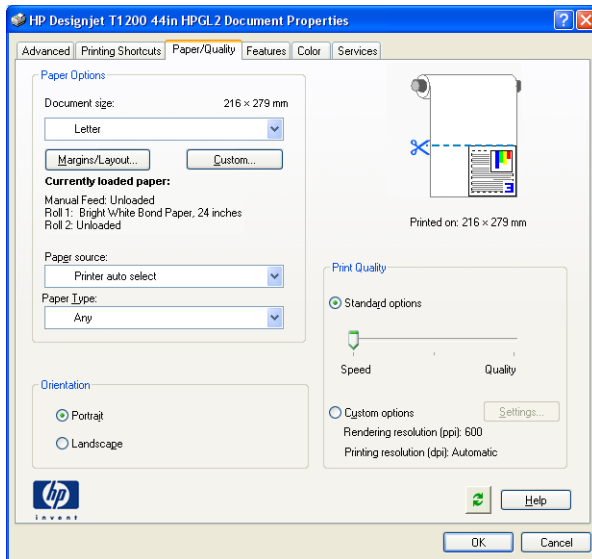

4. Select **Features > Print document on** to scale the document to a particular size. Alternatively, you can scale the document in Excel.

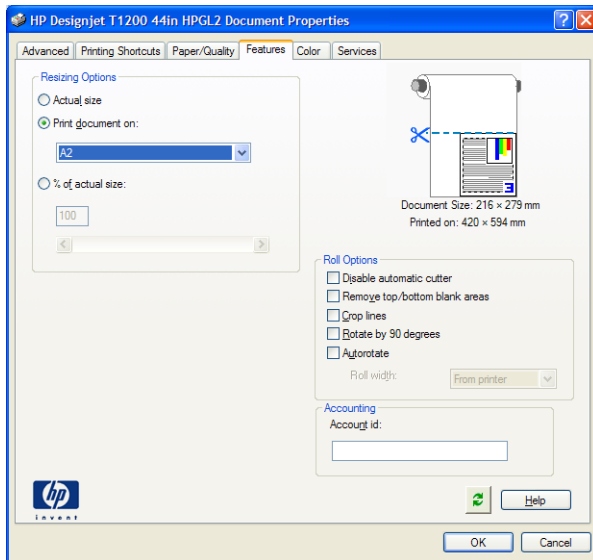

13 Maintain the printer

- [Clean the exterior of the printer](#)
- [Clean the platen](#)
- [Clean the paper-advance sensor window](#)
- [Lubricate the printhead carriage](#)
- [Maintain the ink cartridges](#)
- [Perform preventive maintenance](#)
- [Move or store the printer](#)
- [Update the printer firmware](#)
- [Secure disk erase](#)

Clean the exterior of the printer

Use a damp sponge or a soft cloth and a mild household cleaner such as non-abrasive liquid soap to clean the outside of the printer and all other parts of the printer that you regularly touch as part of normal operation (for example, ink cartridge drawer handles).

- ⚠ **WARNING!** To avoid an electric shock, make sure that the printer is turned off and unplugged before you clean it. Do not let water get inside the printer.
- ⚠ **CAUTION:** Do not use abrasive cleaners on the printer.

Clean the platen

You should clean your printer's platen every few months, or when necessary.

- 📖 **NOTE:** If you print on wide paper after having printed on narrower paper, you might find that the left side of the platen has become dirty. If this contaminated section of the platen is not cleaned, it might leave marks on the back of the paper.
- ⚠ **WARNING!** Be careful not to damage the paper-advance sensor when cleaning the platen. The sensor is the very small rectangular window found near the sixth platen roller from the right. See [Clean the paper-advance sensor window on page 142](#).

Follow these instructions to clean the platen.

1. Unload all paper from the printer. See [Unload a roll from the printer on page 34](#).
2. Open the printer window.

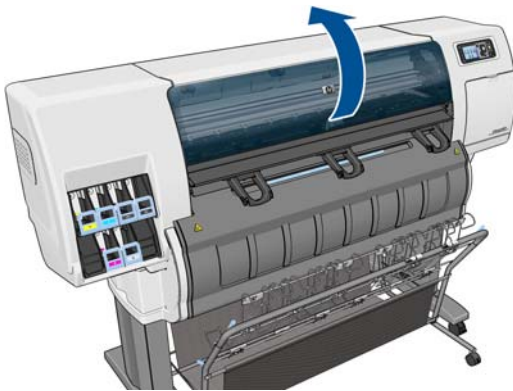

3. With a dry brush, remove ink deposits from the cutter groove.

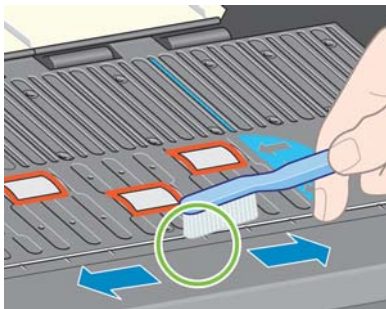

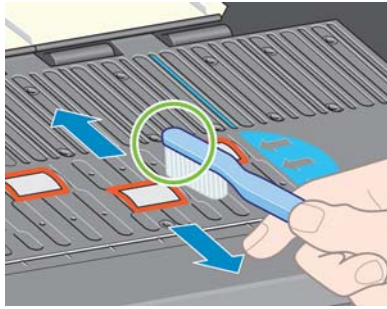

4. With the same dry brush, remove ink deposits from the platen surface.

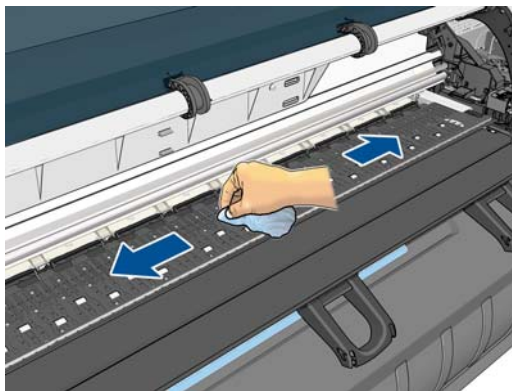

5. Use a clean, absorbent lint-free cloth that has been slightly dampened with isopropyl alcohol to wipe loosened ink deposits from the platen.

 **NOTE:** Isopropyl alcohol is not provided in the Maintenance Kit.



 **CAUTION:** Do not use commercial cleaners or abrasive cleaners. Do not wet the platen directly, because you will leave too much moisture behind.

6. Use the damp cloth to clean the cutter ramp.

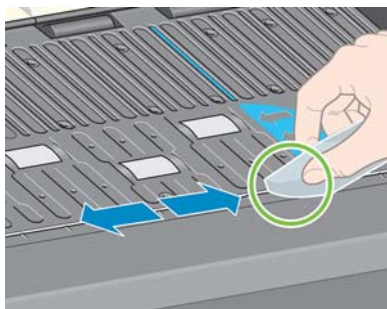

7. Use a dry cloth to clean the exposed part of the wheels. Ideally, you should clean the entire circumference of these wheels.

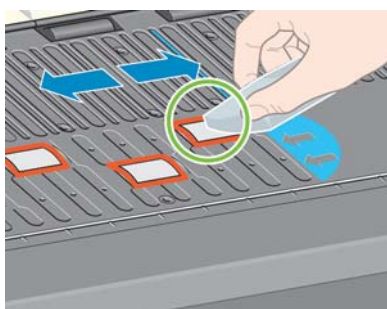

Clean the paper-advance sensor window

The paper advance sensor is the very small rectangular window (less than 1 cm² in size and shown in the following graphic) near the sixth platen roller from the right.

HP recommends that you clean the paper-advance sensor window every 10 months, and whenever you experience print-quality issues.

1. Unload the paper using the front-panel procedure. See [Unload a roll from the printer on page 34](#).
2. Wipe the sensor window with cotton swabs, slightly dampened with isopropyl alcohol, to remove ink or dust. If the sensor window is heavily coated with ink, you may need to apply some pressure while wiping, helping the cotton to absorb the ink.

 **NOTE:** Do not dampen the cotton swabs with water, because it does not evaporate quickly enough, and may pass through the window to the sensor itself.

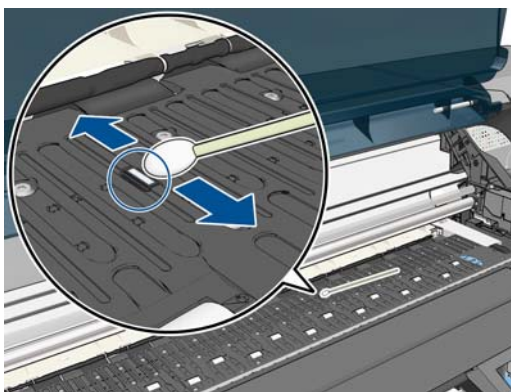

3. Under ambient light, a clean sensor window shows a violet-colored reflection that extends uniformly across the entire surface. To see this reflection, look closely at the sensor window and slightly change your viewing angle.
4. Continue cleaning with fresh swabs until the cotton stays clean and the sensor window looks clean.
5. Wait 3–4 minutes before reloading the paper to ensure that the alcohol has evaporated completely.

Lubricate the printhead carriage

The printhead carriage occasionally (about once a year) needs lubrication so that it continues to slide easily along the slider rod.

1. To gain access to the carriage, go to the front panel and select the  icon, and then select **Replace printheads**. The carriage slides to the middle section of the printer.

△ **CAUTION:** If the carriage remains in the central part of the printer for more than 7 minutes, it attempts to return to its home position on the right.

2. Take the bottle of oil from the Maintenance Kit that can be ordered for your printer.

3. Open the printer window and apply a few drops of the oil to the pads on either side of the carriage.

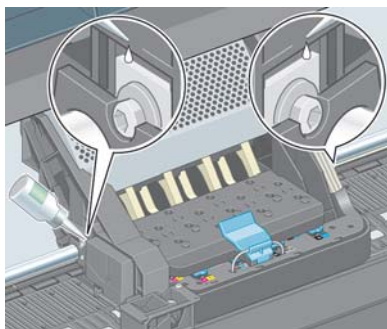

4. Apply a few drops of oil directly to the slider rod on either side of the carriage.

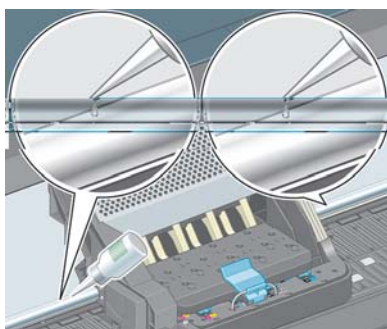

5. Close the printer window.

Maintain the ink cartridges

During the normal lifetime of a cartridge, no specific maintenance is required. However, in order to maintain the best print quality, you should replace a cartridge when it has reached its expiration date, which is the manufacturing date marked on the cartridge plus 30 months.

Perform preventive maintenance

During the life of your printer, components that are used constantly can wear out.

To avoid having these components degrade to the point that the printer breaks down, the printer keeps track of the number of cycles that the printer carriage makes across the axis of the printer, and also monitors the total quantity of ink used.

The printer uses these numbers to track the need for preventive maintenance, and displays one of the following messages on the front panel:

- Maintenance #1 required
- Maintenance #2 required

These messages mean that some components are nearing the end of their lives. You can continue printing for quite some time, depending on your use of the printer. However, HP strongly recommends that you contact your customer service representative and arrange for a preventive maintenance visit. The service engineer can then replace the worn parts onsite, which will prolong the life of the printer.

The benefits of arranging a service engineer's visit when these messages appear on the front panel are two-fold:

- The printer components can be replaced at a time that is convenient for you, and so will not disturb your daily workflow.
- When the service engineer performs a preventive maintenance visit, replaces several parts at once. This eliminates the need for repeat visits.

Move or store the printer

If you need to move your printer or store it for an extended period of time, prepare it correctly to avoid possible damage.

1. Do not remove the ink cartridges, printheads, or printhead cleaners.
2. Make sure that no paper is loaded.
3. Make sure that the printhead carriage is located in the service station (at the right end of the printer).
4. Make sure that the **Ready** message appears on the front panel.
5. Turn off the power by using the **Power** button on the front panel.
6. Also switch off the power switch at the rear of the printer.
7. Disconnect the power cable and any cables that connect the printer to a network, a computer, or a scanner.

 **NOTE:** If the printer or ink cartridges are moved from a cold location to a warm and humid location, water from the atmosphere can condensate on the printer parts and cartridges and can result in ink leaks and printer errors. In this case, HP recommends that you wait at least 3 hours before turning on the printer or installing the ink cartridges, to allow the condensate to evaporate.

 **TIP:** Because preparing and purging the printheads uses both time and ink, you are strongly recommended to leave the printer always on or in sleep mode, whenever possible, to maintain the health of the printheads. In both cases, the printer wakes up from time to time to maintain the printheads. Thus you can avoid going through lengthy preparation processes before using your printer.

Update the printer firmware

The printer's various functions are controlled by software that resides in the printer, also known as firmware.

From time to time, firmware updates from Hewlett-Packard become available. These updates increase the printer's functionality and enhance its features.

Firmware updates can be downloaded from the Internet and installed in your printer in the following ways. Use the method that you find most convenient.

- In Windows, open the HP Utility, select your printer, click the **Support** tab, and then select **Firmware Update**.
- In Mac OS, open the HP Utility, select **Support** and then select **Firmware Update**.
- Through the printer's Embedded Web Server, click the **Setup** tab and then select **Firmware update**.

Follow the onscreen instructions to download the firmware file and store it on your hard disk. Then select the downloaded file and click **Update**.

The firmware includes a set of the most commonly used paper presets. Extra paper presets can be downloaded separately; see [Download paper presets on page 37](#).

If you experience very slow progress while uploading the firmware file to the printer, the reason could be that you are using a proxy server. In that case, try bypassing the proxy server and accessing the Embedded Web Server directly.

- In Internet Explorer 6 for Windows, go to **Tools > Internet Options > Connections > LAN Settings**, and select the **Bypass proxy server for local addresses** check box. Alternatively, for more precise control, click the **Advanced** button and add the printer's IP address to the list of exceptions, for which the proxy server is not used.
- In Safari for Mac OS, go to **Safari > Preferences > Advanced** and click the **Proxies: Change Settings** button. Add the printer's IP address or its domain name to the list of exceptions, for which the proxy server is not used.

Secure disk erase

The printer's hard disk is used as a temporary storage area for print jobs. The Secure Disk Erase facility can completely erase your information from the hard disk to protect it from unauthorized access. You can choose to erase particular files, or the whole hard disk.

Secure Disk Erase provides three different levels of security:

- **Non-Secure Fast Erase:** all pointers to the information are erased. The information itself remains on the hard disk until the disk space it occupies is needed for other purposes, and it is then overwritten. While it remains on the disk, it is difficult for most people to access, but may be accessed using software designed for the purpose. This is the normal method in which files are erased on most computer systems; it is the fastest method but the least secure.
- **Secure Fast Erase:** all pointers to the information are erased, and the information itself is also overwritten with a fixed character pattern. This method is slower than Non-Secure Fast Erase, but more secure. It may still be possible to access fragments of the erased information by using special tools to detect residual magnetic traces.
- **Secure Sanitizing Erase:** all pointers to the information are erased, and the information itself is repetitively overwritten using an algorithm designed to eliminate any residual traces. This is the slowest method, but the most secure. Secure Sanitizing Erase meets the US Department of Defense 5220-22.m requirements for clearing and sanitization of disk media. This is the default security level when using Secure Disk Erase.

Secure Disk Erase is one of the facilities provided by Web JetAdmin, which is HP's free Web-based print management software. See <http://www.hp.com/go/webjetadmin/>.

If you have difficulty in using Secure Disk Erase from Web JetAdmin, please contact HP Support. See [HP Customer Care on page 180](#).

 **NOTE:** If you choose to erase the whole hard disk, you may be asked to restart the printer several times during the process, which will take about 6 hours with Secure Disk Erase or 24 hours with Secure Sanitizing Erase.

14 Accessories

Order accessories

The following accessories can be ordered for your printer.

Name	Product number
HP Designjet T7100 Roll Upgrade	CQ743A
HP Designjet T7100 Stacker 220 V	CQ742A
HP Designjet T7100 Stacker 110 V	CQ742B
HP Designjet HD Scanner	CQ654A
HP Designjet External Hard Disk	CN501A
HP Jetdirect 635n IPv6/IPsec Print Server	J7961A
HP Designjet PostScript/PDF Upgrade Kit	CQ745A
Serif Poster Designer for HP	CN088A
SCP Reprocontrol for HP (1 printer)	CN454A
SCP Reprocontrol for HP (2 printers)	CN455A
HP Designjet Z6100/Z6200 User Maintenance Kit	Q6715A

The following software can be downloaded for your printer.

Name	Download from
HP Instant Printing Pro	http://www.hp.com/go/hpinstantprintingutilitypro/
Serif PosterPro	http://www.hp.com/go/PosterDesignerPro/

15 Troubleshoot print-quality issues

- [General advice](#)
- [Troubleshooting tools](#)
- [Lines are too thick, too thin or missing](#)
- [Lines appear stepped or jagged](#)
- [Lines print double or in the wrong colors](#)
- [Lines are discontinuous](#)
- [Lines are blurred](#)
- [Line lengths are inaccurate](#)
- [The whole image is blurry or grainy](#)
- [The paper is not flat](#)
- [The print is scuffed or scratched](#)
- [Ink marks on the paper](#)
- [Black ink comes off when you touch the print](#)
- [Vertical lines of different colors](#)
- [White spots on the print](#)
- [Colors are inaccurate](#)
- [The output is completely blank](#)
- [The output contains only a partial print](#)
- [The image is clipped](#)
- [The image is in one portion of the printing area](#)
- [The image is unexpectedly rotated](#)
- [The print is a mirror image of the original](#)
- [The print is distorted or unintelligible](#)
- [One image overlays another on the same print](#)
- [Pen settings seem to have no effect](#)
- [The image has a wood-grain appearance \(aeroworms\)](#)

General advice

Use the following approach when you have any print-quality problem:

- To achieve the best performance from your printer, use only genuine HP supplies and accessories, whose reliability and performance have been thoroughly tested to give trouble-free performance and best-quality prints. For details of recommended papers, see [Order paper on page 39](#).
 - Make sure that the paper type that you select on the front panel is the same as the paper type that is loaded in the printer. Make sure that the paper type has been calibrated. Also make sure that the paper type that you select in your software is the same as the paper type that you loaded in the printer.
-
- △ **CAUTION:** If you have the wrong paper type selected, you might experience poor print quality and incorrect colors, and damage to the printheads might occur.
-
- Make sure that you are using the most appropriate print-quality settings for your purposes. See [Select print quality on page 79](#). You are likely to see lower print quality if you have moved the print-quality slider to the **Fast** end of the scale, or set the custom quality level to **Fast**.
 - Make sure that your environmental conditions (temperature, humidity) are in the recommended range. See [Environmental specifications on page 203](#).
 - Make sure that your ink cartridges and printheads have not passed their expiration dates. See [Maintain the ink cartridges on page 143](#).
 - Avoid touching the paper while printing is in progress.

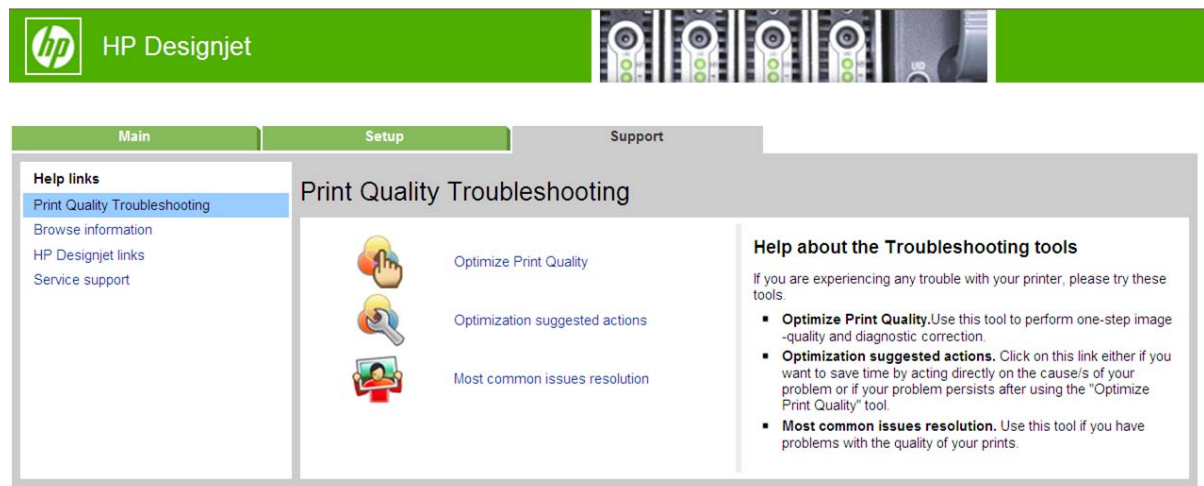

Troubleshooting tools

To access the troubleshooting tools in the Embedded Web Server, select the **Support** tab. The first two tools can also be accessed from the front panel's Image quality maintenance menu.



Optimize print quality



This option ensures that printer and supplies are adjusted to deliver optimum print quality. Click **Next** to execute all calibration and recovery routines automatically. The whole process consumes 80 cm of paper and may take up to 20 minutes.

 **NOTE:** This option can also be selected from the front panel. From the main menu, select , then **Optimize print quality**.

Optimization suggested actions

This option suggests a series of recommended actions to improve print quality, based on the results of internal checks. These actions may include reseating a printhead, changing paper to run a specific calibration, cleaning some printer component, etc. Execute them in the proposed order.

 **TIP:** Use this option if you want to save time by acting directly on the causes of your problem, or if your problem persists after the automatic **Optimize print quality** process.

 **NOTE:** This option can also be selected from the front panel. From the main menu, select , then **Optimization suggested actions**.

Most-common issues resolution

This option is designed to help you resolve some of the most common print-quality issues that users encounter in large-format printing:

- Dark or light horizontal lines across the image (banding)
- Graininess
- Poor line quality
- Inaccurate colors

In the first window, select the print-quality issue that you are experiencing and click **Next**.

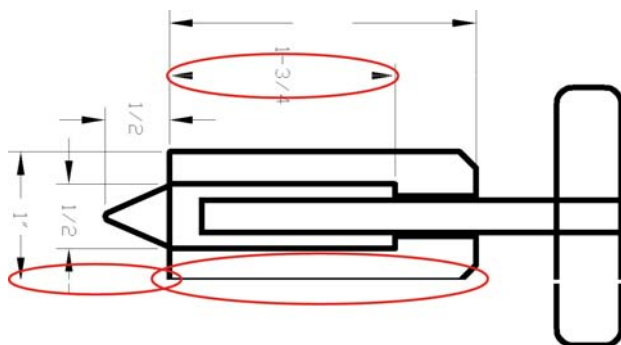

A list of suggestions for corrective action appears along with help to guide you through each action.

Lines are too thick, too thin or missing



1. Check that the paper type you have loaded corresponds to the paper type selected in the front panel and in your software. To check on the front panel, use the [View information](#) key .
2. Check that you are using appropriate print-quality settings for your purposes (see [Print options on page 77](#)). Select the custom print-quality options in the driver dialog, and try turning on the **Maximum detail** option (if available). You may wish to reprint your job at this point in case the problem has been solved.
3. If the resolution of your image is greater than the printing resolution, you may notice a loss of line quality. If you are using the HP-GL/2 and HP RTL driver for Windows, you can find the **Max. Application Resolution** option in the driver dialog's **Advanced** tab, under **Document**

Options > Printer Features. If you change this option, you may wish to reprint your job at this point in case the problem has been solved.

4. If lines are too thin or missing, print the Image Diagnostics Print. See [The Image Diagnostics Print on page 61](#).
5. If the problem remains, go to the front panel and select the Ink menu icon , then **Printhead information** to see the printhead alignment status. If the status is PENDING, you should align the printheads. See [Align the printheads on page 59](#). After alignment, you may wish to reprint your job in case the problem has been solved.
6. Go to the front panel and press the **View information** key  to see the paper advance calibration status. If the status is DEFAULT or RECOMMENDED, you should perform paper advance calibration: see [Perform paper advance calibration on page 35](#).

If the problem persists despite all the above actions, contact your customer service representative for further support.

Lines appear stepped or jagged

If lines in your image appear stepped or jagged when printed:



1. The problem may be inherent in the image. Try to improve the image with the application you are using to edit it.
2. Check that you are using appropriate print-quality settings. See [Print options on page 77](#).
3. Select the custom print-quality options in the driver dialog, and turn on the **Maximum detail** option (if available).

Lines print double or in the wrong colors

This problem can have various visible symptoms:

- Colored lines are printed double, in different colors.

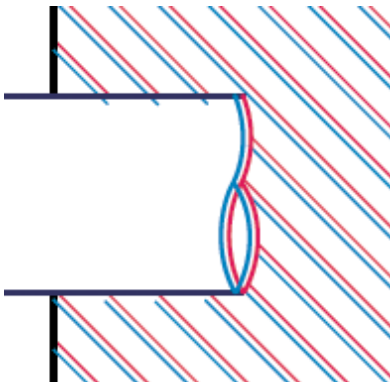

- The borders of colored blocks are wrongly colored.

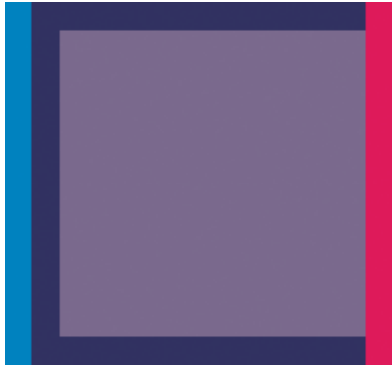

To correct this kind of problem:

1. Reseat the printheads by removing them and then reinserting them. See [Remove a printhead on page 51](#) and [Insert a printhead on page 54](#).
2. Align the printheads. See [Align the printheads on page 59](#).

Lines are discontinuous

If your lines are broken in the following way:



1. Check that you are using appropriate print-quality settings. See [Print options on page 77](#).
2. Reseat the printheads by removing them and then reinserting them. See [Remove a printhead on page 51](#) and [Insert a printhead on page 54](#).
3. Align the printheads. See [Align the printheads on page 59](#).

Lines are blurred



Humidity can cause ink to soak into the paper, making the lines blurred and fuzzy. Try the following:

1. Check that your environmental conditions (temperature, humidity) are suitable for high-quality printing. See [Environmental specifications on page 203](#).
2. Check that the paper type selected in the front panel is the same as the paper type you are using. To check on the front panel, use the [View information](#) key .
3. Try changing to a heavier paper type, such as HP Heavyweight Coated Paper or HP Super Heavyweight Plus Matte Paper.
4. Select a paper type that is slightly thinner than the paper you have loaded; this will persuade the printer to use less ink. Here are some example paper types in ascending order of thickness: Plain Paper, Coated Paper, Heavyweight Coated Paper, Super Heavyweight Plus Matte Paper.
5. If you are using glossy paper, try changing to a different type of glossy paper.
6. Align the printheads. See [Align the printheads on page 59](#).

Line lengths are inaccurate

If you have measured your printed lines and find that the lengths are not sufficiently accurate for your purposes, you can try to improve line length accuracy in the following ways.



1. Print on HP Matte Film, for which your printer's line length accuracy is specified. See [Functional specifications on page 201](#).

Polyester film is about ten times more dimensionally stable than paper. However, using film that is thinner or thicker than HP Matte Film will reduce line length accuracy.

2. Set the Print Quality slider to **Quality**.
3. Maintain the room at a steady temperature between 10 and 30°C (50 and 86°F).
4. Load the roll of film and let it rest for five minutes before printing.
5. If you are still not satisfied, try recalibrating the paper advance. See [Perform paper advance calibration on page 35](#).

The whole image is blurry or grainy



1. Check that the paper type you have loaded corresponds to the paper type selected in the front panel and in your software. To check on the front panel, use the [View information](#) key .
2. Check that you are printing on the correct side of the paper.
3. Check that you are using appropriate print-quality settings (see [Print options on page 77](#)). In some cases, you can overcome a print-quality problem merely by selecting a higher print-quality level. For instance, if you have set the Print Quality slider to **Speed**, try setting it to **Quality**. If you change the print-quality settings, you may wish to reprint your job at this point in case the problem has been solved.
4. Go to the front panel and select the Ink menu icon , then **Printhead information** to see the printhead alignment status. If the status is PENDING, you should align the printheads. See [Align the printheads on page 59](#). After alignment, you may wish to reprint your job in case the problem has been solved.
5. Go to the front panel and press the [View information](#) key  to see the paper advance calibration status. If the status is DEFAULT or RECOMMENDED, you should perform paper advance calibration: see [Perform paper advance calibration on page 35](#).

If the problem persists despite all the above actions, contact your customer service representative for further support.

The paper is not flat

If the paper does not lie flat when it comes out of the printer, but has shallow waves in it, you are likely to see defects in the printed image, such as vertical stripes. This can happen when you use thin paper that becomes saturated with ink.



1. Check that the paper type you have loaded corresponds to the paper type selected in the front panel and in your software. To check on the front panel, use the [View information](#) key .
2. Try changing to a thicker paper type, such as HP Heavyweight Coated Paper or HP Super Heavyweight Plus Matte Paper.
3. Select a paper type that is slightly thinner than the paper you have loaded; this will persuade the printer to use less ink. Here are some example paper types in ascending order of thickness: Plain Paper, Coated Paper, Heavyweight Coated Paper, Super Heavyweight Plus Matte Paper.

The print is scuffed or scratched

The black ink pigment can be scuffed or scratched when touched by a finger, a pen or some other object. This is particularly noticeable on coated paper.

Glossy paper may be extremely sensitive to the basket or to anything else that it contacts soon after printing, depending on the amount of ink used and the environmental conditions at the time of printing.

To reduce the risk of scuffs and scratches:

- Handle prints carefully.
- Avoid stacking prints on top of each other.
- Catch your prints as they are cut from the roll and do not let them fall into the basket. Alternatively, leave a sheet of paper in the basket so that freshly printed sheets do not make direct contact with the basket.

Ink marks on the paper

If a lot of ink is used on plain or coated paper, the paper absorbs the ink quickly and expands. As the printheads move over the paper, the printheads may come into contact with the paper and smear the printed image. This problem is normally seen only on cut sheets of paper (not on roll paper).

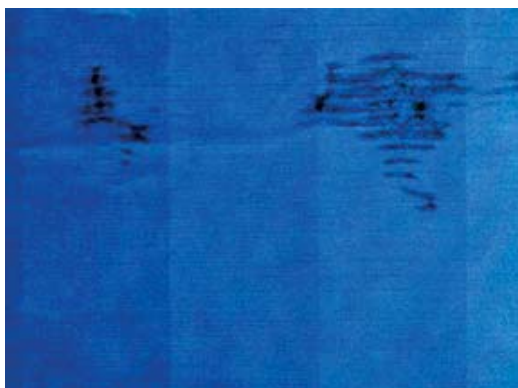

Whenever you notice this problem, cancel the printing job immediately. Press the [Cancel](#) key and also cancel the job from your computer application. Soaked paper can damage the printheads.

Try the following suggestions to avoid this problem:

1. Check that the paper type you have loaded corresponds to the paper type selected in the front panel and in your software. To check on the front panel, use the [View information](#) key (i).
2. Use a recommended paper type (see [Order paper on page 39](#)) and the correct print settings.
3. Try changing to a thicker paper type, such as HP Heavyweight Coated Paper and HP Super Heavyweight Plus Matte Paper.
4. Select a paper type that is slightly thinner than the paper you have loaded; this will persuade the printer to use less ink. Here are some example paper types in ascending order of thickness: Plain Paper, Coated Paper, Heavyweight Coated Paper, Super Heavyweight Plus Matte Paper.
5. Try to increase the margins by relocating the image to the center of the page using your software application.

Black ink comes off when you touch the print

This problem may be caused by printing with matte black ink on glossy paper. The printer will not use matte black ink if it knows that the paper will not retain it. To be sure of avoiding matte black ink, you can select Photo Glossy Paper as the paper type (in the Photo Paper category).

Vertical lines of different colors

If your print has vertical bands of different colors along it:

1. Try using thicker paper, choosing from the recommended paper types such as HP Heavyweight Coated Paper and HP Super Heavyweight Paper. See [Order paper on page 39](#).
2. Try using higher print-quality settings (see [Print options on page 77](#)). For instance, if you have set the Print Quality slider to **Speed**, try setting it to **Quality**.

White spots on the print

You may notice white spots on the print. This is probably due to paper fibers, dust or loose coating material. To avoid this problem:

1. Try cleaning the paper manually with a brush before printing, to remove any loose fibers or particles.
2. Always keep the cover of your printer closed.
3. Protect your paper rolls by storing them in bags or boxes.

Colors are inaccurate

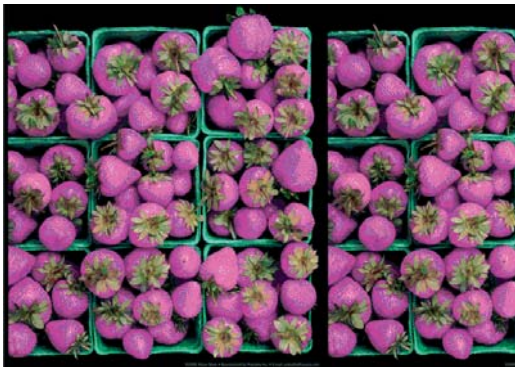

If the colors of your print do not match your expectations, try the following remedies:

1. Check that the paper type you have loaded corresponds to the paper type that you selected on the front panel and in your software. At the same time, check the color-calibration status. If the status is RECOMMENDED or OBSOLETE, you should perform color calibration. See [Color calibration on page 94](#). If you have made any changes, reprint your job if the problem has been solved.
2. Check that you are printing on the correct side of the paper.
3. Make sure that you are using the appropriate print-quality settings. See [Select print quality on page 79](#). If you have selected the **EconoMode** or **Speed** options, you might not get accurate colors. If you change the print-quality settings, reprint your job if the problem has been solved.
4. If you are using Application Color Management, make sure that the color profile that you are using corresponds to the selected paper type and print-quality settings. If you have doubts about which color settings to use, see [Color management on page 93](#).
5. If the problem consists of color differences between your print and your monitor, follow the instructions in the “How to calibrate your monitor” section of the HP Color Center. Reprint your job if the problem has been solved.
6. Print the Image Diagnostics Print. See [The Image Diagnostics Print on page 61](#).

If the problem persists, contact your customer service representative for further support. See [Get help on page 177](#).

PANTONE* colors are inaccurate

See [HP Professional PANTONE Emulation on page 99](#).

Colors between different HP Designjets do not match

If you print an image on two different printer models (for instance, on an HP Designjet T7100 printer series and an HP Designjet 4500 printer series), the colors of the two prints might not match well.

Matching two printing devices that use different ink chemistry, paper chemistry, and printheads is unlikely to be completely successful. Use the information provided here to attempt to make one printer match another.

Print with PostScript drivers

The situation describes printing with the PostScript driver installed for that printer. In this example, we are using an HP Designjet T7100 printer series and an HP Designjet 4500 printer series.

1. Check that both printers have the most recent firmware version. See [Update the printer firmware on page 144](#).
2. Check that you have the most recent printer driver for both printers. Download the latest versions for any HP printer from <http://www.hp.com/go/designjet>.
3. Make sure that Color Calibration is turned on. On the front panel of the HP Designjet T7100, select the  icon, and then select **Image quality maintenance > Enable color calibration > On**.
4. Load the printers with the same type of paper.
5. Check that the Paper Type setting on the front panel corresponds to the paper that you have loaded.
6. Use your normal settings to print your image on the HP Designjet 4500.
7. Now prepare to print the same image on the HP Designjet T7100.

In your software, set the color space of the image to emulate the HP Designjet 4500 and the specific paper type that you used in that printer. The data sent to the driver must be already converted to this emulation color space, which is a CMYK color space. See the online help for the software program to find information about how to do this. In this way, the T7100 will emulate the colors that the 4500 can produce when printing on that paper type.

8. In the PostScript driver for the HP Designjet T7100, go to the Color Management section and set the CMYK input profile to the same HP Designjet 4500 color space that you selected in the software (the emulation color space).
9. Print the image on the HP Designjet T7100.

Print with HP-GL/2 drivers



The situation describes printing with the HP-GL/2 driver installed for that printer.

1. Check that both printers have the most recent firmware version. See [Update the printer firmware on page 144](#).
2. Check that you have the most recent printer drivers for both printers. You can download the latest versions for any HP printer from <http://www.hp.com/go/designjet>.
3. Make sure that Color Calibration is turned on. On the front panel of the HP Designjet T7100 printer series, select the  icon, then **Image quality maintenance > Enable color calibration > On**.

4. Load the printers with the same type of paper.
5. Check that the Paper Type setting on the front panel corresponds to the paper you have loaded.
6. In the HP-GL/2 driver for the HP Designjet T7100, click the **Color** tab, and select **Printer Emulation** from the list of color management options. Then select the HP Designjet 4500 from the list of emulated printers.
7. In the HP-GL/2 driver for the HP Designjet 4500, click the **Options** tab, and then select **Manual Color > Color Control > Match Screen**. Also click the **Paper Size** tab, and then select **Paper Type**.

Print the same HP-GL/2 file

The situation describes how to produce an HP-GL/2 file (also known as a PLT file) with the HP-GL/2 driver installed for one printer that you intend to send to another printer.

1. Check that both printers have the most recent firmware version. See [Update the printer firmware on page 144](#).
2. Make sure that Color Calibration is turned on. At the front panel of the HP Designjet T7100, select the  icon, then **Image quality maintenance > Enable color calibration > On**.
3. Load the printers with the same type of paper.
4. Check that the Paper Type setting on the front panel corresponds to the paper you have loaded.
5. If you have an HP-GL/2 file for an HP Designjet 4500 and you want to print it on an HP Designjet T7100, use the Embedded Web Server or the front panel.
 - Through the Embedded Web Server: leave the color options set to **Default**.
 - On the front panel: select the  icon, and then select **Setup > Printing preferences > Color options > Emulate printer > HP Designjet 4500 Series**.

For other HP Designjet printers, set both printers to match the screen colors (sRGB, if that is available), as when printing with separate HP-GL/2 drivers.

The output is completely blank

If the front-panel graphic language setting is **Automatic** (the default), try the other settings: **PostScript** for a PostScript file, **HP-GL/2** for an HP-GL/2 file, and so on. Then send the file again.

When you have finished this particular print, remember to reset the graphic language to **Automatic**.

The output contains only a partial print

- If you pressed **Cancel** before the printer received all the data, you ended the data transmission and will have to print the page again.
- The **I/O timeout** setting might be too short. This setting determines how long the printer waits for the computer to send more data, before deciding that the job is finished. On the front panel, increase the **I/O timeout** setting to a longer period and then send the print again by selecting the  icon, and then selecting **Connectivity > Advanced > Select I/O timeout**.

- A communications problem between your computer and the printer might exist. Check your USB or network cable.
- Check that your software settings are correct for your current page size (for example, long-axis prints).
- If you are using network software, make sure that it has not timed out.

The image is clipped

Clipping normally indicates a discrepancy between the actual printable area on the loaded paper and the printable area as described by your software. You can often identify this kind of problem before printing by previewing your print. See [Preview a print on page 85](#).

- Check the actual printable area for the paper size that you have loaded.
printable area = paper size – margins
- Check what your software understands to be the printable area (which it might cite as "printing area" or "imageable area"). For example, some software programs assume standard printable areas that are larger than those used in this printer.
- If you have defined a custom page size that has very narrow margins, the printer might impose its own minimal margins and clip your image slightly. You might want to use a larger paper size. See [Select margins options on page 83](#).
- If your image contains its own margins, you might be able to print it successfully by using the **Clip contents by margins** option. See [Select margins options on page 83](#).
- If you are trying to print a very long image on a roll, make sure that your software can print an image of that size.
- You might have asked to rotate the page to landscape orientation on a paper size that is not sufficiently wide.
- If necessary, reduce the size of the image or document in your software, so that it fits between the margins

Other explanations exist for a clipped images. Some programs, such as Adobe Photoshop, Adobe Illustrator, and CorelDRAW, use an internal 16-bit coordinate system which means that they cannot handle an image of more than 32,768 pixels. If you try to print a larger image, the bottom of the image will be clipped. To print the entire image, try these suggestions:

- If you are using an HP-GL/2 driver, you can reduce the resolution so that the whole image requires fewer than 32,768 pixels. The Windows driver includes an option called **16-bit App. Compatibility**, which reduces the resolution automatically. The option is on the **Advanced** tab, under **Document Options > Printer Features**.
- Save the file in another format, such as TIFF or EPS, and open it in another program.
- Use a RIP to print the file.

The image is in one portion of the printing area

- In the software, have you selected a page size that is too small?
- Does your software read the image as being in one portion of the page?

The image is unexpectedly rotated

On the front panel, select the  icon, and then select **Setup > Printing preferences > Paper options > Rotate**. Check that the setting is what you wanted.

For non-PostScript files: if **Nesting** is **On**, pages are sometimes automatically rotated to save paper. See [Nest jobs to save paper on page 89](#).

The print is a mirror image of the original

On the front panel, select the  icon, and then select **Setup > Printing preferences > Paper options > Enable mirror image**. Check that the setting is what you wanted.



The print is distorted or unintelligible

- The interface cable that is connecting your printer to your network (or to your computer) might be faulty. Try another cable.
- On the front panel, select the  icon, and then select **Setup > Printing preferences > Select graphics language**. If the language setting is **Automatic** (the default), try the other settings: **PostScript** for a PostScript file, **HP-GL/2** for an HP-GL/2 file, on so on. Then send the file again.
- Depending on the software, drivers, and RIPs that you are using with your printer, different ways to solve this problem exist. Refer to the vendor's user documentation for details.

One image overlays another on the same print

The **I/O timeout** setting might be too long. On the front panel, decrease the setting and print again. Select the  icon, and then select **Connectivity > Advanced > Select I/O timeout**.

Pen settings seem to have no effect

- You have changed the settings on the front panel by selecting the  icon followed by **Setup > Printing preferences > HP-GL/2 > Define palette**, but did not select that palette in **Setup > Printing preferences > HP-GL/2 > Select palette**.
- To enable the software-driven pen settings, go to the front panel and select the  icon followed by **Setup > Printing preferences > HP-GL/2 > Select palette > Software**.

The image has a wood-grain appearance (aeroworms)



Aeroworms are wavy, horizontal bands produced by air-induced dot placement error (DPE). In extreme cases, aeroworms give the image a wood-grain appearance. The problem occurs most commonly on print jobs that are set for low-quality and high-speed. It does not occur when the custom print-quality setting is set to “best.”

To eliminate aeroworms, select a higher IQ print setting. See [Select print quality on page 79](#).

16 Troubleshoot paper issues

The paper has jammed

If a paper jam occurs, follow the instructions on the front panel.

These are the steps to follow:

1. Open the window.
2. The printer may ask whether you see jammed paper. If you reply no, the printer will offer to run a diagnostic to check whether there is a problem with the carriage.
3. Move the carriage aside and remove jammed paper from the platen.
4. Go to the rear of the printer and open the rear door.
5. Cut the paper with a sharp knife along the line indicated, and remove all the paper that you can find.
6. Close the rear door.
7. If printer still detects paper present, it will ask you to try again. If it still detects paper after the retry, it will offer to run a diagnostic to check whether there is a problem with the paper sensor.
8. Restart the printer.
9. Reload the paper.

If you are using self-adhesive paper and performing frequent roll switches, you may start to see paper jams in the paper input path. This problem can be caused by adhesive deposited from the edge of the paper onto the conical surface of the paper sensor. To solve this particular problem, use a soft cotton cloth to clean all the adhesive from the paper sensor.

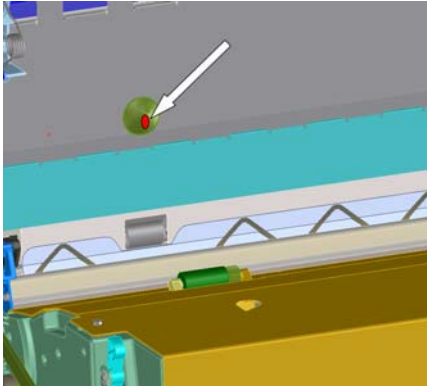

Prints do not stack correctly in the bin

- Paper often tends to curl near the end of a roll, which can cause stacking problems. Load a new roll, or remove prints manually as they are completed.
- If you are mixing prints or nesting sets of several different sizes, you might experience stacking problems because of the different sizes of paper in the bin.

17 Troubleshoot ink-system issues

- [Cannot insert an ink cartridge](#)
- [Cannot insert a printhead](#)
- [Cannot insert the maintenance cartridge](#)
- [Front panel recommends reseating or replacing a printhead](#)

Cannot insert an ink cartridge

1. Check that you have the correct type of cartridge (model number).
2. Check that the colored label on the cartridge is the same color as the label on the slot.
3. Check that the cartridge is correctly oriented, the arrow on the front of the ink cartridge should face upwards.

△ **CAUTION:** Never clean inside the ink cartridge slots.

Cannot insert a printhead

1. Check that you have the correct type of printhead (model number).
2. Check that you have removed the protective caps and the clear protective tape from the printhead.
3. Check that the colored label on the printhead is the same color as the label on the slot.
4. Check that the printhead is correctly oriented (compare with the others).
5. Check that you have closed and latched the printhead cover.

Cannot insert the maintenance cartridge

Check that the maintenance cartridge is of the correct type and correctly oriented.

Front panel recommends reseating or replacing a printhead

1. Remove the printhead and check that its protective film has been removed.
2. Clean the electrical connections between the printhead and the carriage. See [Clean the electrical connections on a printhead on page 56](#).
3. Reinsert the printhead into the carriage and check the front panel message.
4. If the problem persists, insert a new printhead.

18 Troubleshoot stacker issues

- [Paper scrolling](#)
- [The trailing edge of the paper curling up](#)
- [The paper is not completely ejected](#)
- [The front panel displays that the stacker is disconnected](#)

Paper scrolling

When printing in Fast mode with highly curled paper, the paper may scroll when ejected to the stacker tray. To avoid this problem, you are recommended to switch to Normal mode or use a paper roll with a 76.2-mm (3-in) core.

The trailing edge of the paper curling up

Use the **Optimize for images** setting: see [Select print quality on page 79](#).

The paper is not completely ejected

Check for any obstruction in the paper path, such as loose objects or other pieces of paper.

The front panel displays that the stacker is disconnected

If the front panel constantly or intermittently claims that the stacker is disconnected from the printer, there may be a problem with the height of the stacker. Use the following procedure to adjust the height of the stacker.

1. Using an hexagonal wrench, loosen the upper hexagonal nut on both of the stacker's wheels that are closest to the printer.

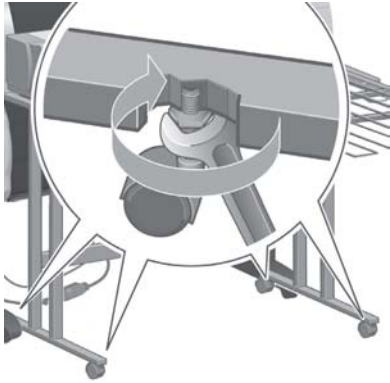

2. Adjust the height of the stacker by rotating the lower hexagonal nut clockwise or anti-clockwise.



3. When the correct height has been achieved, tighten the upper hexagonal nut.

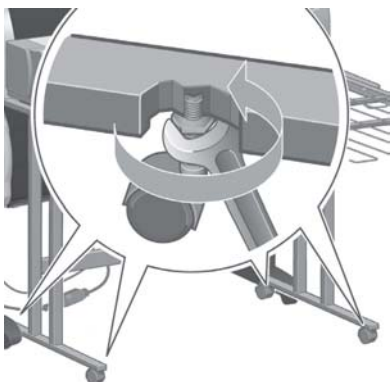

19 Troubleshoot other issues

- [The printer is not printing](#)
- [A job has not been printed](#)
- [The software application slows down or stalls while generating the print job](#)
- [The printer seems slow](#)
- [Communication failures between computer and printer](#)
- [Cannot access the Embedded Web Server](#)
- [“Out-of-memory” error message](#)
- [The platen rollers squeak](#)
- [Cannot access the HP Utility](#)
- [Print job canceled and purged when held for preview](#)
- [Printer alerts](#)

The printer is not printing

Possible reasons why a file you have sent from your computer is not printing when expected, include the following:

- A problem with the electrical power might exist. If the printer is not performing and the front panel does not respond, check that the power cable is correctly connected and that the electrical socket is functioning.
- An unusual electromagnetic phenomena may exist, such as strong electromagnetic fields or severe electrical disturbances. Such occurrences can cause the printer to behave strangely, or even stop working. Turn off the printer by using the **Power** button on the front panel, wait until the electromagnetic environment has returned to normal, and then turn the printer on again. If the problems persist, contact your customer service representative.
- The graphic language setting might be incorrectly set.
- The correct printer driver might not have been installed in your computer.
- One of the following paper scenarios might exist:
 - The paper name that appears on the front panel does not reflect the paper that is loaded in the printer.
 - There is not a sufficient amount of paper on the loaded roll to print the entire job.

Under these conditions, one print job might be printed, while another print job is held in the print queue. To resolve this issue, unload the roll from the printer and load a new roll, using the front panel to guide you through the process.

- The nesting setting might be **On** and the printer is waiting for the nest timeout to expire. Under this condition, the front panel shows the remaining time.
- You might have requested a print preview in your printer driver. Under this condition, the preview appears in a Web browser.

A job has not been printed

These are some possible reasons why a particular job may not be printed.

- The job specifies a paper type that is not loaded.
- The job specifies a paper source that has no paper loaded.
- The job is wider than the loaded paper.
- The stacker is installed, and the loaded paper is not compatible with it.
- The job specifies no paper type nor paper source, and the roll is protected.

The software application slows down or stalls while generating the print job

Large quantities of data might be necessary to generate a high-quality large-format print job. This can cause your software program to slow down significantly or stall. Lowering the print resolution may help to avoid this scenario, however, lowering the print resolution reduces image quality.

In the Windows HP-GL/2 driver, click the **Advanced** tab, select **Document options > Printer features**, and then set **Max. Application resolution** to 300.

The printer seems slow

Here are some possible explanations:

- Did you set the print quality to **Best**? Images printed with the **Best** print-quality setting require more time to print.
- Did you specify the correct paper type when loading the paper? Check that the paper type that appears on the front panel matches the paper that is loaded in the printer.
- Is your printer connected to a network? Check that all components used in the network (network interface cards, hubs, routers, switches, and cables) are capable of high-speed operation. Is there a lot of traffic from other devices on the network?
- Did you set the drying time to **Extended**? Try changing the drying time to **Automatic**. See [Change the drying time on page 37](#).
- Are the printheads in good condition? Printing time might increase when a printhead needs cleaning. Check the printhead status on the front panel or through the Embedded Web Server. Clean or replace printheads if necessary.
- Do your image contain high-density, black fills? Printing time might increase for images containing high-density, black fills.

Communication failures between computer and printer

Some symptoms are:

- The front-panel display does not show the **Receiving** message when you have sent an image to the printer.
- Your computer shows an error message when you try to print.
- Your computer or printer stalls when transferring data.
- Your printed output shows random or inexplicable errors (misplaced lines, partial graphics, and so on).

To solve a communication problem:



- Make sure that you have selected the correct printer in your software program.
- Make sure that the printer works correctly when printing from other software programs.
- Remember that large images usually require more time to receive, process, and print.
- If the printer is connected to your computer by a USB cable, try disconnecting and reconnecting the cable.
- If the printer is connected to your computer through any other intermediate devices, such as switch boxes, buffer boxes, cable adapters, or cable converters, remove the intermediate device and try connecting the printer directly to your computer.

- Try another interface cable. See [Choose which connection method to use on page 13](#).
- Make sure that the graphic language setting is correctly set.

Cannot access the Embedded Web Server

If you have not done so already, please read [Access the Embedded Web Server on page 21](#).

 **NOTE:** If you connect your printer directly to your computer with a USB cable, use the HP Utility.

1. Go to the front panel and select the  icon.
2. Select **Connectivity Menu > Advanced > Embedded Web Server > Allow EWS > On**.
3. If you have a TCP/IP connection to your printer, go to the front panel and select the  icon, and then select **Connectivity Menu**.
4. Select the type of connection you are using.
5. Select **View Information**.
6. The information should read: **IP enabled: Yes**. If it does not, you might need to use a different connection.

If you still cannot access the Embedded Web Server, turn the printer off with the [Power](#) button on the front panel and then turn it on again.

If you experience very slow progress while trying to access the Embedded Web Server, the problem could be that you are using a proxy server. Try bypassing the proxy server and accessing the Embedded Web Server directly.

- In Internet Explorer 6 for Windows, go to **Tools > Internet Options > Connections > LAN Settings**, and select the **Bypass proxy server for local addresses** check box. You can also click the **Advanced** button to add the printer's IP address to the list of exceptions, for which the proxy server is not used.
- In Safari for Mac OS, go to **Safari > Preferences > Advanced** and click the **Proxies: Change Settings** button. Add the printer's IP address or its domain name to the list of exceptions, for which the proxy server is not used.

“Out-of-memory” error message

There is no direct relationship between the size of a file in your computer and the amount of memory needed to print the file. Because of file compression and other factors, it is difficult to estimate how much memory is needed to print a job. It is possible that the printer will lack sufficient memory to print a certain job, despite having printed larger jobs in the past. Adding memory to your printer is one solution.

If you are using the Windows HP-GL/2 driver, printer memory problems can often be resolved by clicking the **Advanced** tab, selecting **Document options**, selecting **Printer features**, and then selecting **Print job as raster**.

 **NOTE:** If you select this option, the time needed to process the job in your computer might be considerably longer.

The platen rollers squeak

It might be necessary to oil the rollers. Locate the oil bottle in the maintenance kit that can be ordered for your printer.

1. Turn off the printer by using the **Power** button on the front panel.
2. Open the printer window.

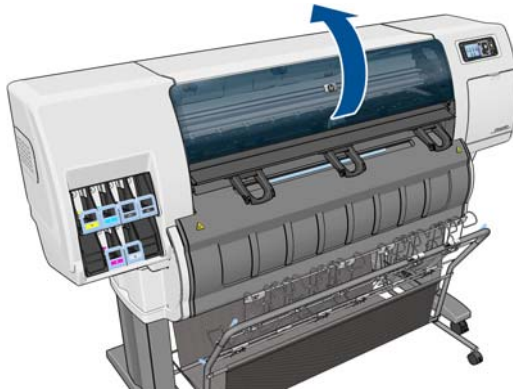

3. Locate the small holes in the platen near some of the rollers.

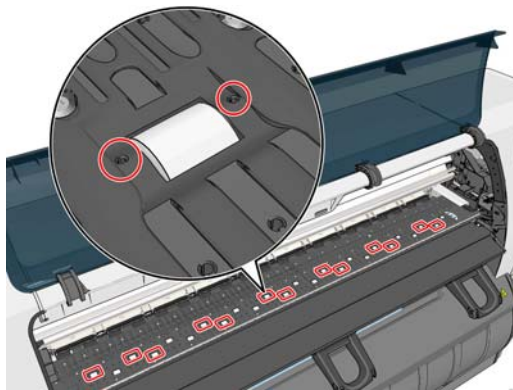

- Put three drops of oil into each hole in the platen.

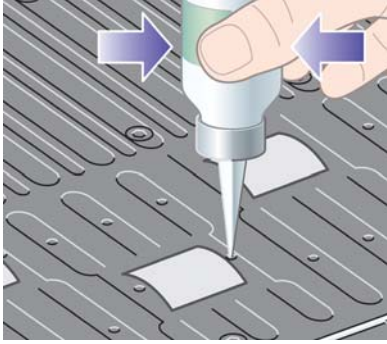

 **NOTE:** Be careful not to spill oil onto the platen.

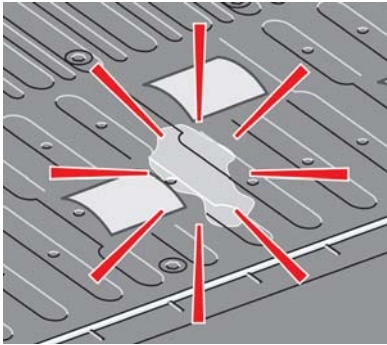

- If oil spills onto the platen, wipe the platen clean by using the cloth that was supplied with the maintenance kit.

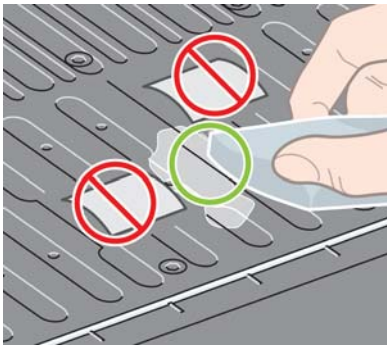

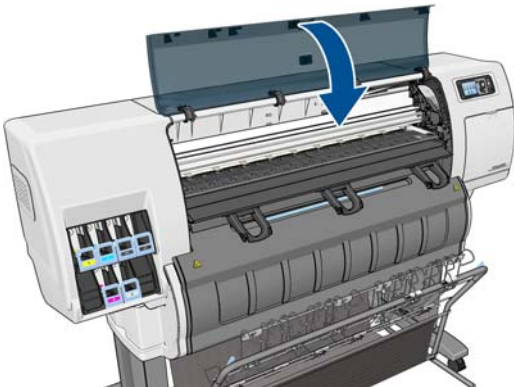

- Lower the printer window.



Cannot access the HP Utility

If you have not done so already, please read [Access the HP Utility on page 21](#).

1. Go to the front panel and select the  icon.
2. Select **Connectivity Menu > Advanced > Web services > HP Utility Software > Enable**.
3. If you have a TCP/IP connection to your printer, go to the front panel and select the  icon again.
4. Select the type of connection you are using.
5. Select **View Information**.

If you still cannot connect, turn the printer off by using the **Power** button on the front panel and then turn it on again.

Print job canceled and purged when held for preview

The printer can store up to 64 pages for preview. If the job that you selected for preview contains more than 64 pages, the job will be canceled and purged without notification when the printer starts to process the sixty-fifth page. If you want to preview a job that has more than 64 pages, click the Continue button before the printer starts to process the sixty-fifth page. Because the preview image is ready as soon as the first page is processed, you should have enough time to check the preview image.

Printer alerts

Your printer can communicate two types of alerts:

- **Errors:** Mainly alerting you to the fact that the printer is unable to print. However, in the driver, errors can also alert you to conditions that could ruin the print, such as clipping, even if the printer is able to print.
- **Warnings:** Alert you when the printer needs attention either for an adjustment, such as a calibration or for a possible unprintable situation, such as a preventive maintenance or low ink.

There are four different alert communicators within your printer's system.

- **Front-panel display:** The front panel shows only the most relevant alert at a time. It generally requires the user to press the **OK** key for confirmation, but in the case of a warning, it disappears after a timeout. There are permanent alerts, such as "ink cartridge low on ink", that reappear when the printer becomes idle and there is not another more severe alert.
- **Embedded Web Server:** The upper-right corner of the Embedded Web Server window shows the printer status. If there is an alert in the printer, the status shows the alert text.
- **Driver:** The driver shows alerts. The driver warns about job configuration settings that may produce a problem in the final output. If the printer is not ready to print, it displays a warning.
- **HP Utility:** To see alerts, go to the **Overview** tab and review the **Items needing attention** list on the right-hand side.

By default, alerts are displayed only when you are printing and there are printing problems, for example: cartridge low or out of ink or printer out of paper. If alerts are enabled and there is a problem that prevents printing, you see a pop-up window, which explains why the printer is not going to print. Follow the instructions to achieve your required result.

 **NOTE:** There are environments that do not support bidirectional communication, for example: a Windows computer connected to the printer with USB. In those cases, alerts do not reach the job owner.

20 Get help

- [Introduction](#)
- [HP Professional Services](#)
- [HP Instant Support](#)
- [HP Proactive Support](#)
- [Customer Self Repair](#)
- [HP Customer Care](#)
- [HP Designjet Online](#)
- [Other sources of information](#)

Introduction

HP Customer Care offers award-winning support to ensure that you get the most from your HP Designjet. HP Customer Care provides comprehensive, proven support expertise and new technologies to give you unique end-to-end support. Services include setup and installation, troubleshooting tools, warranty upgrades, repair and exchange services, phone and Web support, software updates, and self-maintenance services. For more information about HP Customer Care, go to: <http://www.hp.com/go/designjet/>.

HP Professional Services

Knowledge Center

Enjoy a world of dedicated services and resources to ensure you always get the best performance from your HP Designjet products and solutions.

Join the HP community at the Knowledge Center, your large-format printing community, for 24x7 access to:

- Multimedia tutorials
- Step-by-step how-to guides
- Downloads: the latest product firmware, drivers, software, paper presets, etc.
- Technical support: online troubleshooting, customer care contacts and more
- Workflows and detailed advice for completing various printing tasks from particular software applications
- Forums for direct contact with the experts, both HP and your colleagues
- Warranty tracking online, for your peace of mind
- Latest product information: products, supplies, accessories, software, etc.
- Supplies Center for all you need to know about ink and paper

The Knowledge Center can be found at the following locations, depending on your product:

- <http://www.hp.com/go/T7100/knowledgecenter/>
- <http://www.hp.com/go/T7100mono/knowledgecenter/>

By customizing your registration for the products you have purchased and your type of business, and by setting your communication preferences, you decide the information you need.

HP Start-up Kit

The HP Start-up Kit is the DVD that comes with your product; it contains the product's software and documentation.

HP Care Packs and Warranty Extensions

HP Care Packs and Warranty Extensions allow you to extend your product's warranty beyond the standard period.

They include remote support. On-site service is also provided if necessary, with two alternative response-time options.

- Next business day
- Same business day, within four hours (may not be available in all countries)

For more information on HP Care Packs, please visit <http://www.hp.com/go/printservices/>.

HP Installation

The HP Installation service unpacks, sets up and connects the product for you.

This is one of the HP Care Pack services; for more information, please visit <http://www.hp.com/go/printservices/>.

HP Instant Support

HP Instant Support Professional Edition is HP's suite of troubleshooting tools that collect diagnostic information from your printer and match it with intelligent solutions from HP's knowledge bases, allowing you to resolve problems as quickly as possible.

To start an HP Instant Support session, click on the link in the **Support** tab of your printer's Embedded Web Server. See [Access the Embedded Web Server on page 21](#).

To use HP Instant Support, the following conditions must be met:

- Because HP Instant Support is accessible only through the Embedded Web Server, you must have a TCP/IP connection to your printer.
- Because HP Instant Support is a Web-based service, you must have access to the World Wide Web,

HP Instant Support is currently available in English, Korean, Simplified Chinese, and Traditional Chinese.

For more information about HP Instant Support, go to: <http://www.hp.com/go/ispe/>.

HP Proactive Support

HP Proactive Support is a troubleshooting support tool that identifies, diagnoses, and resolves issues you might encounter when using your commercial imaging and printing products. HP Proactive Support is embedded into multiple HP software programs including the HP Utility, allowing you to easily and conveniently monitor, update and maintain all of your HP printers.

For more information about HP Proactive Support, go to: <http://www.hp.com/go/proactivesupport>.

Customer Self Repair

HP's Customer Self Repair program offers our customers the fastest service under either warranty or contract. It enables HP to ship replacement parts directly to you (the end user) so that you can replace them. Using this program, you can replace parts at your own convenience.

Convenient, easy to use

- An HP Support Specialist will diagnose and assess whether a replacement part is required to address a defective hardware component.
- Replacement parts are express-shipped; most in-stock parts are shipped the very same day you contact HP.
- Available for most HP products currently under warranty or contract.
- Available in most countries.

For more information about Customer Self Repair, see <http://www.hp.com/go/selfrepair/>.

HP Customer Care

As your strategic support partner, we make it our business to help keep your business running smoothly. HP Customer Care offers award-winning support to ensure that you get the most from your HP Designjet.

HP Customer Care provides comprehensive, proven support expertise and leverages new technologies to give customers unique end-to-end support. Services include setup and installation, troubleshooting tools, warranty upgrades, repair and exchange services, phone and Web support, software updates, and self-maintenance services. To find out more about HP Customer Care, go to <http://www.hp.com/go/designjet/>. For the most current contact information, click on the **Contact HP** link or call the appropriate telephone number below.

What to do before you call:

- Review the troubleshooting suggestions in this guide.
- Review the relevant driver documentation supplied with this printer (for users sending PostScript files or those using Microsoft Windows).
- If you have installed third-party software drivers and RIPs, refer to their documentation.
- If the problem appears to be related to your software program, first contact your software vendor.
- If you call one of the Hewlett-Packard offices, have the following information available to help us answer your questions more quickly:
 - The printer you are using (the product number and the serial number, found on the label at the back of the printer on the front panel: select the  icon, and then **View printer information**).
 - The printer's Service ID (also in the **View printer information** option.)
 - If there is an error code on the front panel, make note of it.
 - The brand name and model number of the computer you are using
 - Any special equipment or software you are using (for example, spoolers, networks, switch-boxes, modems, or special software drivers)
 - The part number of the network cable you are using and the name of the store through which it was purchased
 - The type of interface used on your printer (USB or network)

- The software name and version you are using
- Print out the service information prints. You may be asked to fax them to the support center helping you.

On the front panel: select the  icon, and then select **Internal prints > Service information prints > Print all pages**.

Through the Embedded Web Server: go to the **Service support** page in the **Support** tab, and then select **Printer information > Print all pages**.

Telephone numbers

For an up-to-date list of HP Support telephone numbers, go to http://welcome.hp.com/country/us/en/wwcontact_us.html. If you do not have access to the Web, try one of the numbers below.

- Algeria: 213 17 63 80
- Argentina: 0 800 777 HP INVENT, local 5411 4778 8380
- Australia: 13 10 47
- Austria: 0810 00 10 00
- Bahrain: 800 171
- Belgium: (0) 78 600 600
- Bolivia: 0 800 1110, local 54 11 4708 1600
- Brazil: 0800 157 751, local 55 11 3747 7799
- Canada: 1 800 HP INVENT
- Caribbean: 1 800 711 2884
- Central America: 1 800 711 2884
- Chile: 800 HP INVENT, 123 800 360 999
- China: 800 810 59 59, 10 6564 59 59
- Colombia: 01 8000 51 HP INVENT, local 571 606 9191
- Czech Republic: 420 261 307 310
- Denmark: 70 11 77 00
- Ecuador: 999 119, 1 800 225 528
- Egypt: 202 532 5222
- Finland: 0203 53232
- France: 08 26 10 49 49
- Germany: 0180 52 58 143
- Greece: 210 6073603, 801 11 22 55 47
- Guadeloupe: 0800 99 00 11, 877 219 8791

- Guatemala: 1 800 999 5105, 1 800 711 2884
- Hong Kong: 852 3002 8555
- Hungary: 06 1 382 1111
- India: 1 600 112 267
- Indonesia: 350 3408
- Ireland: 1 890 946500
- Israel: 09 830 4848
- Italy: 02 3859 1212
- Jamaica: 0 800 711 2884
- Japan: software 0120 014121, hardware 0120 742594
- Korea: 82 1588 3003
- Luxembourg: 27 303 303
- Malaysia: 1 800 80 5405
- Martinique: 0 800 99 00, 877 219 8671
- Mexico: 01 800 472 6684, local 5258 9922
- Middle East: 4 366 2020
- Morocco: 2240 4747
- Netherlands: 0900 1170 000
- New Zealand: 09 365 9805
- Norway: 800 62 800
- Paraguay: 00 811 800, 800 711 2884
- Panama: 001 800 711 2884
- Peru: 0 800 10111
- Philippines: 632 888 6100
- Poland: 22 566 6000
- Portugal: 213 164 164
- Puerto Rico: 1 800 652 6672
- RSA: 27 11 258 9301, local 086 000 1030
- Romania: 40 21 315 4442
- Russia: 095 797 3520, 812 3467 997
- Saudi Arabia: 6272 5300
- Slovakia: 2 50222444

- South Africa: 0800 001 030
- Spain: 902 010 333
- Sweden: 077 130 30 00
- Switzerland: 0848 80 20 20
- Taiwan: 886 2 872 28000
- Thailand: 0 2353 9000
- Tunisia: 71 89 12 22
- Turkey: 216 444 71 71
- UAE: 800 4520, 04 366 2020
- Ukraine: 44 4903520
- United Kingdom: 0870 842 2339
- United States: 1 800 HP INVENT
- Uruguay: 54 11 4708 1600
- Venezuela: 0 800 HP INVENT, local 58 212 278 8000
- Vietnam: 84 8 823 45 30
- West Africa (French): 351 213 17 63 80

HP Designjet Online

HP offers dedicated services and resources to ensure you always get the best performance from your HP Designjet products and solutions.

Register at HP Designjet Online, your large-format printing community at <http://www.hp.com/go/designjet/> for unrestricted access to:

- Downloads of the latest printer firmware, drivers, software, paper presets, and so on
- Technical support, including online troubleshooting, customer care contacts, and more
- Forums for direct contact with the experts, both HP and your colleagues
- Warranty tracking online, for your peace of mind
- Technical documentation and training videos
- Latest product information about printers, supplies, accessories, software, and so on
- Supplies Center for all you need to know about ink and paper

You decide the information you need by customizing your registration for the products you have purchased and your type of business, and by setting your communication preferences.

Register at HP Designjet Online for the best performance.

HP Designjet Online is available in English, German, French, Italian, Spanish, Portuguese, Japanese, Korean, Simplified Chinese, and Traditional Chinese.

Other sources of information

More information is available from the following sources:

- The Embedded Web Server provides information about your printer status, technical support, online documentation, and so on. See [Printer software on page 8](#).
- See <http://hplipopensource.com/hplip-web/index.html> if you are using Linux.
- The printer assembly document that came with your printer

A Front-panel menus

This appendix lists the options in the front-panel menu system.

 **NOTE:** Firmware updates may introduce changes to the menu system, in which case this appendix will become out of date in some respects.

To print a more graphical and up-to-date diagram of the front-panel menus, go to the front panel and select the  icon, then **User information prints > Print menu map**.

- [Paper menu](#)
- [Job management menu](#)
- [Ink menu](#)
- [Setup menu](#)
- [Image quality maintenance menu](#)
- [Connectivity menu](#)
- [Internal prints menu](#)
- [Information menu](#)

Key to table notations

[E] available also in the Embedded Web Server

[J] depends on the state of the job queue or of the selected job

[P] available only with the PostScript upgrade

Paper menu



Paper load	Load roll1	
	Load roll2	
	Load roll3	
Paper unload	Unload roll1	
	Unload roll2	
	Unload roll3	
Select active roll	Active roll 1	
	Active roll 2	
	Active roll 3	
View paper source		
Change active paper type	(select paper category and type)	
Paper types list	(select paper category and type)	View paper details
Move paper		

Load roll displays illustrations of the loading process. These options are locked if paper is already loaded.

Unload roll displays illustrations of the unloading process. These options are locked if no paper is loaded.

View paper source shows information about the loaded paper. The information shown is Status, Paper vendor, Paper type, Width, Length, Color calibration.

Change active paper type displays a list of paper types from which you can choose. This option is locked if no paper is loaded.

Paper types list displays a list of installed paper types, grouped by category, each of which you can view or delete. **View paper details** will display the Paper type, Category, Vendor, Erasable status, Revision, Grammage, Uses Photo/Matte Black and Created from.

Move paper displays an interactive dialogue for moving the paper backwards and forwards. This option is locked if no paper is loaded.

Job management menu



Reprint last job		
Pause (or Resume) printing		
Job queue	Queue is empty [J]	
	(select job) [J]	View information
		Continue
		Move to front
		Copies
		Reprint
		Cancel
		Delete

Job queue displays the jobs in the job queue. Jobs remain in the queue after being printed.

View information displays the following information about the selected job: Name, Status, Date, Printed copies and Pages.

Continue releases for printing a job that is on hold.

Move to front moves the selected job to the front of the queue, so that it will be printed as soon as the current job finishes.

Ink menu



View ink levels	
View printhead status	
Replace ink cartridges	
Replace printheads	
Replace maintenance cartridge	
Ink cartridge information	View (color) ink cartridge
Printhead information	View (colors) printhead
Maintenance cartridge information	
Clean encoder strip	

View ink levels displays the ink levels of all cartridges in the printer. A blinking cartridge in the display indicates warns you that the ink level is low.

View printhead status displays the warranty or health status of all printheads in the printer. If the printhead is still under warranty, the word WARRANTY is shown, otherwise the health status is shown.

View (color) ink cartridge displays the following information about the selected ink cartridge: Color, Product name, Product number, Serial number, Status, Ink level (ml), Capacity (ml), Expiration date, Manufacturer and Warranty status.

View (colors) printhead displays the following information about the selected printhead: Color, Product name, Product number, Serial number, Status, Ink fired (ml) and Warranty status.

Maintenance cartridge information displays the following information about the maintenance cartridge: Status, Level (%) and Product number.

Setup menu



Printing preferences	Select graphics language [E]
	Print quality
	Select quality level
	Enable maximum detail
	Enable economode
	Color options
	Color/Grayscale
	Select RGB source profile
	Emulate printer
	Select CMYK source profile [P]
	Select rendering intent [P]
	Black point compensation [P]
	HP professional PANTONE® emulation [P]
	Black options
	Black/Grayscale
	Paper options
	Select paper size
	Remove top/bottom blanks
	Resize
	Rotate
	Enable mirror image
	Enable crop lines
	Roll switching
	Roll matching
	Enable printing paper info
	Roll protection
	Margins
	Select margins layout [E]
	HP-GL/2 options
	Select palette
	Define palette
	Enable merge
	PS options [P]
	Select encoding
	High-quality transparencies
	Reduce line width
	Select altitude
Print retrieval	Select drying time

Job management options	Enable queue [E]	
	When to start printing [E]	
	Nest options	Enable nesting [E]
		Select wait time
		Enable crop lines [E]
		Oversize nested job margin
	Autorotate	
	Max. number of printed jobs [E]	
	Select job recovery mode	
	Paper mismatch action	
Front panel options	Select language	
	Select display contrast	
	Enable buzzer	
	Select units [E]	
	Date and time options	View current device time [E]
		Set date [E]
		Set time [E]
		Set time zone [E]
	Enable sleep mode	
	Sleep mode wait time	
Resets	Reset encoder cleaning	
	Restore factory settings	
External hard disk	Install (or Uninstall) external hard disk	
Accessories	Stacker	Install (or Uninstall) stacker
		View stacker information
		Select temperature
		Cleaning procedure
	Other accessories	Install other accessories

Enable crop lines appears in two places in the menu: under **Paper options** (which applies to individual jobs) and under **Nest options** (which applies to nested jobs). The default value is Off in both cases.

Select palette allows you to choose between Software, Palette A, Palette B and Factory.

Define palette allows you to define the Palette A, Palette B and Factory palettes. To do so, select one of the pens, between 0 and 15, after which you can change the width or color of the pen. The width can vary from 0.13 mm (0.0051 in) to 12.0 mm (0.47 in) and the color can vary from 0 to 255.

Manual drying time allows you to choose a drying time from 1 to 1800 s. The default value is 100 s.

Enable nesting allows you to choose between Off, In order and Optimized order. In order to enable nesting, **When to start printing** has to be set to **After processing**.

Image quality maintenance menu



Optimize print quality	
Optimization actions	
Calibrate color	
Align printheads	
Print diagnostic image	
Paper advance calibration	Calibrate paper advance
	Adjust paper advance
	Reset paper advance
Clean printheads	Clean all
	Clean (colors)
Enable color calibration	

Connectivity menu



Gigabit Ethernet	View information	
	View configuration	
	Modify configuration	
	Restore factory settings	
USB	View information	
Jetdirect EIO	View information	
	View configuration	
	Modify configuration	
	Restore factory settings	
Advanced	Select I/O timeout	
	Allow SNMP	
	Embedded Web Server	Allow EWS
		Reset EWS access control
	Web Services	Printer Utility software
		Color and paper management
	Restore factory settings	

View information shows whether the interface is installed, whether the IP address is enabled and whether printing is enabled through this interface. It also displays the MAC address.

View configuration shows the following information: Link state, IP address, Configuration mode, Subnet mask, Default gateway, mDNS service name and the MAC address.

Modify configuration allows you to change the IP address, subnet mask, default gateway and idle timeout. You can also view the host name string and choose an IP address configuration method from BOOTP, DHCP, Auto IP and Manual.

Printer utility software allows you to enable or disable the use of the HP Utility.

Internal prints menu



Demo prints	Print drawing demo
	Print rendering demo
	Print GIS map
User information prints	Print menu map
	Print configuration
	Print usage report
	Print HP-GL/2 palette
	Print PS font list [P]
Service information prints	Print current information
	Print usage information
	Print event logs
	Print calibration status
	Print connectivity configuration
	Print all pages

Information menu



View printer information

Product certifications

Printer logs

System errors

System warnings

Printheads

Ink cartridges

View printer information displays general printer information including Product name, Product number, Serial number, Service ID, Language, Memory, Disk capacity and Firmware version.

B Front-panel error messages

Under certain circumstances, a front-panel error message appears. Follow the advice in the Recommendation column to resolve the error.

If an error message appears on the front panel that is *not* included in this list, and you are in doubt over the correct response, contact HP Support. See [HP Customer Care on page 180](#).

Table B-1 Text messages

Message	Recommendation
[Color] cartridge has expired	Replace the cartridge. See Remove an ink cartridge on page 48 and Insert an ink cartridge on page 50 .
[Color] cartridge is missing	Insert a cartridge of the correct color. See Insert an ink cartridge on page 50 .
[Color] cartridge is out of ink	Replace the cartridge. See Remove an ink cartridge on page 48 and Insert an ink cartridge on page 50 .
[Color] printhead #[n] error: not present	Insert the correct printhead. See Insert a printhead on page 54 .
[Color] printhead #[n] error: please remove	Remove the incorrect printhead and insert a new printhead of the correct type (color and number). See Remove a printhead on page 51 and Insert a printhead on page 54 .
[Color] printhead #[n] error: replace	Remove the non-functional printhead and insert a new printhead. See Remove a printhead on page 51 and Insert a printhead on page 54 .
[Color] printhead #[n] error: reseal	Remove and reinsert the same printhead, or try cleaning the electrical connections. If necessary, insert a new printhead. See Front panel recommends reseating or replacing a printhead on page 165 .
[Color] printhead #[n] out of warranty	The printhead's warranty has ended, because of the length of time it has been in operation or because of the volume of ink used. See the <i>Legal Information</i> .
[Color] printhead #[n] warranty warning	The printhead's warranty may be invalidated by the use of the wrong kind of ink. See the <i>Legal Information</i> .
[Warning] internal failure: Unable to create print	The internal print files are not available in the printer. Load the internal print files through the Embedded Web Server.
IO error	Restart the printer. If the problem persists, contact HP Support. See HP Customer Care on page 180 .
IO warning	Try again; if the problem persists, contact HP Support. See HP Customer Care on page 180 .
PDL Error: Ink system not ready	Clean the printheads. See Clean (recover) the printheads on page 56 .

Table B-1 Text messages (continued)

Message	Recommendation
PDL Error: Job clipped	The image is too large for the paper or for the printer. Load larger paper if possible, or reduce the image size.
PDL Error: memory full	Restart the printer and try resending the job; if necessary, reduce the complexity of the job.
PDL Error: out of paper	Load more paper.
PDL Error: parsing error	The print job is unintelligible to the printer. Try to recreate and resend it. Check your cable connections.
PDL Error: print mode error	The paper type or print quality specified for the job are incorrect. Change the loaded paper type or the print settings.
PDL Error: printing error	Try sending the job again.
PDL Error: virtual memory full	Restart the printer and try resending the job; if necessary, reduce the complexity of the job.
Replace [color] ink cartridge	The cartridge is out of ink; replace it. See Remove an ink cartridge on page 48 and Insert an ink cartridge on page 50 .
Replace faulty [color] ink cartridge	The cartridge is faulty; replace it. See Remove an ink cartridge on page 48 and Insert an ink cartridge on page 50 .
Reseat [color] cartridge	Remove and reinsert the same cartridge. See Remove an ink cartridge on page 48 and Insert an ink cartridge on page 50 .
Update: failed. Invalid file	Make sure that you have selected the correct firmware update file. Then try again to perform the update.

Under certain circumstances, a front-panel numeric error message appears. Follow the advice in the Recommendation column to resolve the error.

If an error message appears on the front panel that is *not* included in this list, turn off the printer and then turn it back on. If the problem persists, contact HP Support. See [HP Customer Care on page 180](#).

Table B-2 Numeric error messages

Error code	Recommendation
26.n.01 (where n = the subject ink cartridge number)	Remove the subject ink cartridge and reinstall it in the printer. If the error persists, replace the subject ink cartridge. If the problem persists, contact HP Support. See HP Customer Care on page 180 .
29.01	The maintenance cartridge is not inserted correctly. Open the maintenance cartridge door on the right side of the printer, make sure that the maintenance cartridge is correctly seated, and then close the door. If the problem persists, replace the maintenance cartridge. If the problem persists, contact HP Support. See HP Customer Care on page 180 .

Table B-2 Numeric error messages (continued)

Error code	Recommendation
61.01	<p>The file format is incorrect and the printer cannot process the job. Try the following remedies:</p> <ul style="list-style-type: none">• Turn off the printer by using the Power button on the front panel and the power switch at the back of the printer, and then disconnect the power cord—then reconnect the power cord and turn on the printer.• Make sure that the graphic language setting is correct. See Change the graphic language setting on page 24.• Resubmit the file to the printer.• Check that your printer firmware is up to date. See Update the printer firmware on page 144. <p>If the problem persists, contact HP Support. See HP Customer Care on page 180.</p>
61.04	<p>Install the latest firmware release. See Update the printer firmware on page 144.</p>
61.08	<p>The paper type has changed, please resubmit the job.</p>
61.08.1	<p>The job cannot be printed because it is password-protected.</p>
61.08.2	<p>The job cannot be printed because it contains errors.</p>
63.04	<p>An input/output problem has occurred with the network card. Try the following remedies:</p> <ul style="list-style-type: none">• Make sure that the network cable is correctly connected to the network card.• Check that your printer firmware is up to date. See Update the printer firmware on page 144. <p>If the problem persists, contact HP Support. See HP Customer Care on page 180.</p>
71.08	<p>Out of memory. Data lost. In the HP-GL/2 and HP RTL driver, select the Advanced tab, Document options, Printer features, then enable the Send job as bitmap option before resubmitting the job.</p>
74.01	<p>An error occurred when uploading the firmware update file. Try the following remedies:</p> <ul style="list-style-type: none">• Turn off the printer by using the Power button on the front panel and the power switch at the back of the printer, and then disconnect the power cord—then reconnect the power cord and turn on the printer.• Try again to upload the firmware update file to the printer. See Update the printer firmware on page 144. <p>If the problem persists, contact HP Support. See HP Customer Care on page 180.</p>
76.03	<p>The Resource Area is full. Please use the Hard Disk Recovery utility.</p>

Table B-2 Numeric error messages (continued)

Error code	Recommendation
77.04	<p>An Embedded Web Server internal software error has occurred. Try the following remedies:</p> <ul style="list-style-type: none"><li data-bbox="679 353 1461 439">• Turn off the printer by using the Power button on the front panel and the power switch at the back of the printer, and then disconnect the power cord—then reconnect the power cord and turn on the printer.<li data-bbox="679 465 1374 521">• Check that your printer firmware is up to date. See Update the printer firmware on page 144. <p>If the problem persists, contact HP Support. See HP Customer Care on page 180.</p>
81.01, 81.03, 86.01	<p>Open the printer window and make sure that there are no obstacles restricting the movement of the drive roller. If the paper has jammed and is restricting the movement of the drive roller, lift the paper load lever and clear the obstruction. If the problem persists, contact HP Support. See HP Customer Care on page 180.</p>

C Printer specifications

- [Functional specifications](#)
- [Physical specifications](#)
- [Memory specifications](#)
- [Power specifications](#)
- [Environmental specifications](#)
- [Acoustic specifications](#)

Functional specifications

Table C-1 HP No. 762 ink supplies

	T7100	T7100 Mono
Printheads	Yellow, magenta/cyan, gray/dark gray, black/black	Black/black, dark gray
Ink cartridges	Black, yellow, magenta, cyan, gray, dark gray	Black, dark gray
Maintenance cartridge	Non-color-specific	Non-color-specific

Table C-2 Paper sizes

	Minimum	Maximum
Width	280 mm (11 in)	1067 mm (42 in)
Length	420 mm (16.5 in)	91 m (300 ft)
Roll diameter		180 mm (7.08 in)

 **NOTE:** The printer can cope with paper rolls that vary from their nominal width by up to 3 mm in either direction (wider or narrower).

Table C-3 Print resolution (using Windows HP-GL/2 driver)

Print quality	Maximum resolution for photo paper	Rendering resolution	Printing resolution
Best	On	1200×1200	2400×1200 (HP Premium Instant-dry Photo Gloss, HP Premium Instant-dry Photo Satin, HP Universal Instant-dry Photo Gloss, HP Universal Instant-dry Photo Semi-Gloss, Photo Gloss Paper, Photo Semi-Gloss/Satin Paper, Photo Matte Paper) 1200×1200 (other)
Best	Off	600×600	600×1200 (HP Premium Instant-dry Photo Gloss, HP Premium Instant-dry Photo Satin, HP Universal Instant-dry Photo Gloss, HP Universal Instant-dry Photo Semi-Gloss, Photo Gloss Paper, Photo Semi-Gloss/Satin Paper, Photo Matte Paper) 1200×1200 (other)

Table C-3 Print resolution (using Windows HP-GL/2 driver) (continued)

Print quality	Maximum resolution for photo paper	Rendering resolution	Printing resolution
Normal	n/a	600×600	600×1200 (HP Premium Instant-dry Photo Gloss, HP Premium Instant-dry Photo Satin, HP Universal Instant-dry Photo Gloss, HP Universal Instant-dry Photo Semi-Gloss, Photo Gloss Paper, Photo Semi-Gloss/Satin Paper, Photo Matte Paper) 1200×1200 (other)
Fast	n/a	300×300	600×1200 (plain paper, bright white bond paper, HP Premium Instant-dry Photo Gloss, HP Premium Instant-dry Photo Satin, HP Universal Instant-dry Photo Gloss, HP Universal Instant-dry Photo Semi-Gloss, Photo Gloss Paper, Photo Semi-Gloss/Satin Paper, Photo Matte Paper) 1200×1200 (other)

Table C-4 Margins

Side margins	5 mm (0.197 in)
Top margin (leading edge)	5 mm (0.197 in); 11.5 mm (0.453 in) for glossy paper
Bottom margin (trailing edge)	5 mm (0.197 in)

Table C-5 Mechanical accuracy

±0.1% of the specified vector length or ±0.1 mm (whichever greater) at 23°C (73°F), 50-60% relative humidity, on A0 printing material in **Best** or **Normal** mode with HP Matte Film.

Table C-6 Graphic languages supported

HP Designjet T7100 Printer	HP-GL/2, RTL, CALS/G4
HP Designjet T7100ps Printer	HP-GL/2, RTL, CALS/G4, Adobe PostScript level 3, Adobe PDF 1.7, TIFF, JPEG

Physical specifications

Table C-7 Printer physical specifications

Weight (including stand)	187 kg (412 lb)
Width	1970 mm (77.5 in)
Depth	690 mm (27.2 in)
Height	1370 mm (53.9 in)

Memory specifications

Table C-8 Memory specifications

T7100 & T7100 Mono memory (DRAM)	1024MB
T7100ps & T7100ps Mono memory (DRAM)	1536MB
Hard disk	160GB
External hard disk accessory	160GB

Power specifications

Table C-9 Printer power specifications

Input voltage	100–127 Vac / 220–240 Vac \pm 10%, autoranging
Frequency	50–60 Hz
Current	5 A / 3 A
Power consumption	270 W maximum

Environmental specifications

Table C-10 Printer environmental specifications

Relative humidity range for best print quality	20–80%, depending on paper type
Temperature range for best print quality	15 to 30°C (59 to 86°F), depending on paper type
Temperature range for printing	5 to 40°C (41 to 104°F)
Temperature range when not in operation	–20 to +55°C (–4 to +131°F)
Maximum altitude when printing	3000 m

 **NOTE:** If the printer or ink cartridges are moved from a cold location to a warm and humid location, water from the atmosphere can condensate on the printer parts and cartridges and can result in ink leaks and printer errors. In this case, HP recommends that you wait at least 3 hours before turning on the printer or installing the ink cartridges, to allow the condensate to evaporate.

Acoustic specifications

Table C-11 Printer acoustic specifications

Idle sound power	\leq 5.8 B (A)
Operating sound power	\leq 7.0 B (A)
Idle sound pressure	\leq 38 dB (A)
Operating sound pressure	\leq 53 dB (A)

Glossary

Bonjour

Apple Computer's trade name for its implementation of the IETF Zeroconf specification framework, a computer network technology that is used in Apple Mac OS X 10.2 and later. Use it to discover the services that are available on a local area network (LAN). It was originally known as Rendezvous.

CALS/G4

CALS (Continuous Acquisition and Life-cycle Support) is an initiative of the US Department of Defense for electronically capturing military documentation and linking related information. The initiative has developed a number of standard specifications (protocols) for the exchange of electronic data with commercial suppliers. These standards are often referred to as simply "CALS". CALS standards have been adopted by several other allied nations.

Color accuracy

The ability to print colors that match the original image as closely as possible, given the fact that all devices have a limited color gamut and might not be able to match certain colors precisely.

Color consistency

The ability to print the same colors in a particular print job, from print to print and from printer to printer.

Color model

A system of representing colors by numbers. An example of such a system is RGB or CMYK.

Color space

A color model in which each color is represented by a specific set of numbers. Many different color spaces can use the same color model: for instance, monitors generally use the RGB color model, but they have different color spaces, because a particular set of RGB numbers results in different colors on different monitors.

Cutter

A printer component that slides back and forth across the platen to cut the paper.

ESD

ElectroStatic Discharge. Static electricity is common in daily life. It is the spark when touching the car door, or the cling of clothing. Although controlled static electricity has some useful benefits, uncontrolled electrostatic discharges are one of the main hazards to the electronics products. Therefore, to prevent damage some precautions are needed when setting up the product, or handling ESD sensitive devices. This type of damage may reduce the life expectancy of the device. One way to minimize uncontrolled ESDs, and therefore reduce this type of damage is by touching any exposed grounded part of the product (mainly metal parts) before handling ESD sensitive devices (such as the printheads or ink cartridges). Additionally, to reduce the generation of electrostatic charge in your body try to avoid working in a carpeted area, and keep your body movements to a minimum when handling ESD sensitive devices. Also, avoid working in low humidity environments.

Ethernet

A popular computer networking technology for local area networks.

Firmware

Software that controls your printer's functionality and is stored semi-permanently in the printer (it can be updated).

Gamut

The range of colors and density values reproducible on an output device, such as a printer or monitor.

HP-GL/2

Hewlett-Packard Graphics Language 2: a language defined by HP to describe vector graphics.

I/O

Input/Output: this term describes the passing of data between one device and another.

ICC

The International Color Consortium, a group of companies that have agreed on a common standard for color profiles.

Ink cartridge

A removable printer component that stores ink of a particular color and provides it to the printhead.

IP address

A unique identifier that identifies a particular node on a TCP/IP network. It consists of four integers separated by dots.

Jetdirect

HP's brand name for its series of print servers that allow a printer to be connected directly to a local area network.

LED

Light-Emitting Diode: a semiconductor device that emits light when electrically stimulated.

MAC address

Media Access Control address: a unique identifier used to identify a particular device on a network. It is a lower-level identifier than the IP address. Thus, a device may have both a MAC address and an IP address.

Nozzle

One of many tiny holes in a printhead through which ink is deposited onto the paper.

Paper

A thin, flat material made to be written or printed on; most commonly made from fibers of some kind which are pulped, dried, and pressed.

Platen

The flat surface within the printer over which the paper passes while it is being printed on.

Printer driver

Software that converts a print job in a generalized format into data suitable for a particular printer.

Printhead

A removable printer component that takes ink of one or more colors from the corresponding ink cartridge(s) and deposits it on the paper, through a cluster of nozzles.

Rendezvous

Apple Computer's original name for its networking software later known as Bonjour.

TCP/IP

Transmission Control Protocol/Internet Protocol: the communications protocols on which the Internet is based.

USB

Universal Serial Bus: a standard serial bus designed to connect devices to computers.

Index

Symbols/Numerics

16-bit color images 85

A

accessories
 order 146
accounting 111
acoustic specifications 203
alerts
 errors 175
 warnings 175
application hangs up 170
Autodesk Design Review
 print from 116

B

banding problems 35
bin
 stacking problems 163
bin/basket 6
black and white 88
black point compensation 102
blank page 158
blurred lines 151
buzzer on/off 22

C

calibration
 color 94
carriage lubrication 142
clean the paper advance sensor
 window 142
clean the platen 140
clean the printer 140
clipped at bottom 158
clipped image 159
color
 adjustment options 97
 advantages 94
 calibration 94
 CMYK 94
 emulation 100
 printer emulation 97

 profile 94
 RGB 94
color accuracy
 between printers 157
 PANTONE 156
color management
 from drivers 96
 from EWS 101
 from front panel 103
 from PS drivers 99
 options 96
 process 94
communication problems 171
components of Embedded Web
 Server 9
components of printer 4
connect the printer
 choosing a method 13
 Mac OS direct 17
 Mac OS network 14
 Windows direct 14
 Windows networking 13
contrast in front panel 22
crop lines 86
Customer Care 178, 180
Customer Self Repair 179

D

Designjet Online 179, 183
disk erase 145
distorted print 160
downloading paper presets 37
draft for revision, print 114
draft printing 80
drying time
 canceling 37
 changing 37
 overview 28

E

economize
 on ink 91
 on paper 88

Embedded Web Server
 access 21
 cannot access 172
 ink and paper usage 111
 ink system status 65
 job preview 106
 job queue 106
 language 22
 main components 9
 printer usage statistics 111
environmental specifications 203

F

features of printer 4
firmware update 144
front panel 7
front view 5
front-panel
 contrast 22
 language 21
 units 23
front-panel error messages
 all 196
front-panel key
 form feed and cut 8
 paper loading 7
 pause printing 7
 view information 7
front-panel option
 align printheads 60
 allow EWS 172
 autorotate 88
 black point compensation 104
 calibrate color 95
 CMYK source profile 104
 color/grayscale 104
 emulate printer 104
 enable buzzer 22
 enable crop lines 86
 enable merge 86
 form feed and cut 38
 ink cartridge information 66
 modify configuration 23

- PANTONE emulation 104
- paper mismatch action 25
- print diagnostic image 61
- print quality 80
- printhead
 - information 66, 150, 153
- remove blank areas 89
- rendering intent 104
- reprint 108
- resize 85
- RGB source profile 104
- roll protection 91
- roll switching options 25
- rotate 87
- select active roll 25
- select display contrast 22
- select graphics language 24
- select I/O timeout 158, 160
- select language 21
- select margins 83
- select paper size 82
- select units 23
- sleep mode wait time 22
- view configuration 13, 15
- functional specifications 201

G

- glossary 204
- graininess 153
- graphic language 24
- graphic languages 202
- gray shades 88

H

- hard disk erase 145
- hard disk specification 203
- hold for preview
 - print job canceled and purged 175
- HP Care Packs 178
- HP Customer Care 178, 180
- HP Designjet Online 179, 183
- HP Installation 179
- HP Instant Support 179
- HP Start-up Kit 178
- HP Utility
 - access 21
 - cannot access 175
 - language 22
 - main features 10

I

- image diagnostics print 61

- image problems
 - blank page 158
 - clipped at bottom 158
 - clipped image 159
 - distorted print 160
 - overlapping images 160
 - pen settings ineffective 160
 - small image 159
 - unexpected mirror image 160
 - unexpected rotation 160
 - unintelligible print 160

ink

- economical use of 91
- usage 111

ink cartridge

- about 45
- cannot insert 165
- inserting 50
- maintenance 143
- ordering 67
- refilling 45
- removing 48
- specification 201
- status 65

- ink system status 65

- ink system tips 47

- Instant Support 179

- internal prints 10

- IP address 22

J

job

- create 78
- stored 79
- submit 78

- job not printed 170

job preview

- Embedded Web Server 106

job queue

- Embedded Web Server 106

- job status 108

K

- Knowledge Center 178

L

- language 21
- line length accuracy 152
- line thickness 149
- loading roll into printer 30
- lubricate the carriage 142
- lubricating the platen rollers 173

M

- maintenance 143
- maintenance cartridge
 - about 47
 - inserting 64
 - removing 62
 - specification 201
- margins
 - specification 202
- maximum detail 81
- mechanical accuracy 202
- memory error 172
- memory specifications 203
- Microsoft Office
 - print from 132
- mirror image unexpected 160
- misaligned colors 150
- models, product 2
- more passes 82
- move the printer 144
- multiroll printing 69

N

- nesting 89
- network settings 23

O

- on/off 11

order

- accessories 146
- ink cartridges 67
- maintenance cartridges 68
- paper 39
- printheads 68

- out-of-memory error 172

- overlapping images 160

- overlapping lines 86

- overnight printing 91

P

- page size 82

- PANTONE emulation 99

- PANTONE swatch book 103

paper

- advance 35, 38
- displaying information 35, 38
- economical use of 88
- feed and cut 38
- not flat 153
- overview 27
- print on loaded paper 84
- select type 84
- size 82

- tips 27, 39
- usage 111
- paper advance calibration 35
- paper jam 162
- paper mismatch action 25
- paper presets
 - downloading 37
- paper sizes (max & min) 201
- paper suitability 25
- paper types
 - front-panel names 28
 - supported 28
- pen settings ineffective 160
- physical specifications 202
- power on/off 11
- power specifications 203
- presentation, print 127
- preventive maintenance 143
- preview a print 85
- print file 78
- print job
 - create 78
 - ink usage 111
 - nesting 89
 - paper usage 111
 - stored 79
 - submit 78
- print on loaded paper 84
- print preview 85
- print quality
 - changing 79
- print resolution 201
- print-quality problems
 - black ink comes off 155
 - blurred lines 151
 - colors inaccurate 156
 - discontinuous lines 151
 - general 148
 - graininess 153
 - inaccurate line lengths 152
 - ink marks 154
 - line thickness 149
 - misaligned colors 150
 - paper not flat 153
 - scratching 154
 - scuffing 154
 - stepped lines 150
 - troubleshooting tools 148
 - vertical lines of different
 - colors 155
 - white spots 156
 - wood-grain appearance 161
- printer does not print 170

- printer software
 - Mac OS uninstall 18
 - Windows direct install 14
 - Windows network install 13
 - Windows uninstall 14
- printer's main components 4
- printer's main features 4
- printhead
 - about 46
 - aligning 59
 - cannot insert 165
 - cleaning 56
 - cleaning connections 56
 - inserting 54
 - ordering 68
 - recovery 56
 - removing 51
 - reseal, reseal 165
 - specification 201
 - status 66
- printhead cleaner
 - cannot insert 165
- printhead drop detector
 - clean 58
- product models 2
- project, print 116
- protect a roll 91

Q

- quality, high 81

R

- rear view 6
- refilling ink cartridges 45
- rendering intent 102
- reprint a job 108
- rescale a print 84
- resolution 201
- roll paper
 - loading into the printer 30
 - unloading 34
- roll protection 91
- roll switching options 25
- roller lubrication 173
- rotating an image 86
- rotation unexpected 160

S

- safety precautions 2
- scale a print 84
- scratched prints 154
- scuffed prints 154
- secure disk erase 145
- sleep mode wait time 22

- slow printing 171
- small image 159
- software 8
- specifications
 - acoustic 203
 - environmental 203
 - functional 201
 - graphic languages 202
 - hard disk 203
 - ink supplies 201
 - margins 202
 - mechanical accuracy 202
 - memory 203
 - paper size 201
 - physical 202
 - power 203
 - print resolution 201
- squeaky rollers 173
- stacker
 - change rolls 74
 - change the temperature 74
 - clean the exterior 74
 - clean the rollers 75
 - install 73
 - messages 74
 - move 75
 - paper not completely
 - ejected 167
 - paper scrolls 167
 - stacker disconnected 168
 - store 75
 - trailing edge curls 167
 - uninstall 73
 - using paper 73
- stacking problems in bin 163
- statistics
 - ink cartridge 65
 - printer usage 111
- status 108
- stepped lines 150
- store the printer 144
- stored job 79
- submit job 78
- support services
 - HP Care Packs 178
 - HP Customer Care 178, 180
 - HP Designjet Online 179, 183
 - HP Instant Support 179
 - HP Start-up Kit 178
 - Knowledge Center 178
 - product installation 179
 - warranty extensions 178
- supported papers 28
- switch on/off 11

T

telephone numbers 181
turn on/off 11

U

unattended printing 91
unintelligible print 160
unloading roll from printer 34
using this guide 3

W

warranty extensions 178