



PRODUCT CATALOG 2023

KNX building control

For more information, visit:
[siemens.com/knx](https://www.siemens.com/knx)

Smart home
and building
solutions.
Global. Secure.
Connected.



SIEMENS

GAMMA KNX

Building Control

GAMMA instabus from Siemens is based on the worldwide KNX standard for home and Building Control, which guarantees interoperability with all certified KNX devices on the market. As a leading manufacturer Siemens offers a comprehensive product portfolio consisting of intelligent KNX devices and allows networked applications. Lighting, solar protection, heating, ventilation, and air-conditioning can be controlled by display and operation units.



Contents

- 1 Display and operation units**
 - Overview and selection tools
 - Pushbuttons
 - Pushbutton accessories
 - Room temperature controllers with integrated sensor and operation
 - Multifunction device
 - Room thermostats
 - Touch panels
 - Visualization, server
 - Visualization, software
- 2 Output devices**
 - Overview and selection tools
 - Binary output devices
- 3 Input devices**
 - Overview and selection tools
 - Binary input devices
- 4 Combination devices**
 - Overview and selection tools
 - Input/Output devices
- 5 Lighting**
 - Overview and selection tools
 - Dimmers
 - Switching/dimming actuators
 - Light level controls
- 6 Solar protection, anti-glare protection, utilization of daylight**
 - Overview and selection tools
 - Anti-glare/solar protection actuators
 - Central weather/solar protection systems
- 7 Heating, ventilation and air conditioning - room temperature control**
 - Overview and selection tools
 - Room thermostats
 - Room temperature controllers with integrated sensing and operation
 - Room temperature controllers with integrated sensing
 - Room temperature controllers with detached operation
 - Room sensors with KNX
 - Room sensors without KNX
 - Actuators with KNX
 - Actuators without KNX
 - Other products
- 8 Heating, ventilation and air conditioning - primary control**
 - Overview and selection tools
 - Communicating controllers - Synco™ 700
- 9 Modular installation system, room control box**
 - Overview and selection tools
 - Room control box
 - Junction box (UL/NEMA) devices
- 10 Gateways, interface converters**
 - Overview and selection tools
 - KNX/Ethernet
 - KNX/DALI
 - KNX/BACnet
 - KNX/USB
 - KNX/LOGO!
- 11 Physical sensors**
 - Overview and selection tools
 - with KNX connection
 - without KNX connection
- 12 Control and automation devices**
 - Overview and selection tools
 - Logic and control functions
 - Programmable logic controllers
- 13 System products and accessories**
 - Overview and selection tools
 - System products
- 14 Technical Information and Application Examples**
 - Technical Information
 - Application Examples
- 15 Appendix**
 - Catalog notes
 - Ordering information

Content

Future-proof building automation
based on KNX

Building Control
GAMMA instabus
Product catalog 2023

GAMMA-TD:
Technical Product Database



HIT Portal:
Online Catalog



© Siemens 2022

Display and operation units	1
Output devices	2
Input devices	3
Combination devices	4
Lighting	5
Solar protection, anti-glare protection, utilization of daylight	6
Heating, ventilation and air-conditioning – room temperature control	7
Heating, ventilation and air-conditioning – primary control	8
Modular installation system, room control box	9
Gateways, interface converters	10
Physical sensors	11
Control and automation devices	12
System products and accessories	13
Technical information and application examples	14
Appendix	15

Dear customers

Smart infrastructure from Siemens intelligently connects energy systems, buildings and industries to adapt and evolve the way we live and work. We work together with customers and partners to create an ecosystem that intuitively responds to the needs of people and helps customers to better use resources. It helps our customers to thrive, communities to progress and supports sustainable development.

With smart buildings, we're freeing ourselves from rigid, silent, passive structures and developing a new understanding of building technologies. We're creating a living space that intuitively responds to people's needs and ultimately adapts itself to our changing requirements.



Smart buildings interact with their residents, systems, and environment. They learn from previous experience and adapt themselves to people.

At the same time, buildings generate huge amounts of data that is worth understanding. Thanks to our many years of experience and our flexible automation systems, we can work with you to acquire and analyze your data and derive meaningful knowledge. With the help of our intelligent control, security, and energy management systems, we help you optimally use your resources. We assist schools and hospitals in achieving effective goals, while also increasing comfort, efficiency, durability, and security.

This catalog presents the KNX portfolio and gives for example a detailed and comprehensive overview on the GAMMA instabus products, KNX thermostats as well as Synco products. With its extensive product portfolio range, GAMMA instabus ensures efficient and economical operation across the entire lifecycle of a building. The GAMMA instabus and Synco products provide optimal comfort solutions and energy-efficient applications.

The interaction between lighting, solar protection, heating, ventilation and air-conditioning helps to achieve the greatest possible energy savings. Additionally, Building Control GAMMA instabus offers compliance with the KNX standard and the highest levels of flexibility.



Two blue slanted bars above the text.

Making smart buildings real

A consistent strategy: Smart Infrastructure

siemens.
com/
smartinfra-
structure



When intelligent energy meets smart buildings, the world around us can adapt and respond intuitively.

Smart infrastructure from Siemens makes the world a more connected and caring place – where resources are valued, where the impact on the world is taken into account, and where sustainable energy is delivered reliably and efficiently. It provides the flexible infrastructure to allow society to evolve and respond to changing conditions. Technology

and human ingenuity come together to be at one with the environment and to care for our world. We do this from the macro to the micro level, from physical products, components, and systems to connected, cloud-based digital offerings and services. Siemens offers a broad portfolio of grid control and automation, low- and medium-voltage power distribution, switching, and control, as well as building automation, fire safety and security, HVAC control, and energy solutions.



Smart grids

Making grids smarter with energy intelligence creates new opportunities in a changing ecosystem. It empowers customers to master the decentralized landscape.

Smart buildings

With the power of data and technology, smart buildings create an ecosystem where they interact, learn, and adapt to changing conditions and needs of different stakeholders along their life cycle.

Smart power distribution

The integration of power supply into industrial and building automation systems is key. Across a broad spectrum of hardware and software, smart electrification solutions meet the demand with the needed resilience, asset efficiency and sustainability.

Grid edge

The new dimension between intelligent grids, smart buildings, and prosumers is opening up space for new business opportunities and greater sustainability.

eMobility charging

The future of transportation is eMobility. Energize your journey with solutions from Siemens.

Energy efficient room and Building Control

Building Control

GAMMA instabus from Siemens is based on the worldwide KNX standard for home and Building Control, which guarantees interoperability with all certified KNX devices on the market. The comprehensive product portfolio consists of smart field devices and enables networked applications. GAMMA instabus offers products for lighting, solar protection, display and operation, energy monitoring, system products as well as heating, ventilation and air-conditioning.

With the GAMMA instabus portfolio and Synco primary control, it's possible to reach efficiency class A in buildings according to the BACS Energy Performance Classes EN 15232 or other energy labels. Through the standardized commissioning software (ETS) and products for different installation standards (IEC and UL/NEMA) ensure applications for the worldwide markets. So, if GAMMA instabus operates a building, the lifecycle costs are low.

Lighting

In the area of lighting, the GAMMA instabus product portfolio offers compact KNX/DALI Gateways as well as LED dimmers. Many sensors are available for detecting presence and motion and for controlling lighting levels.

Heating, ventilation and air-conditioning (HVAC)

For heating, ventilation, and air-conditioning (HVAC) in rooms and buildings, the GAMMA instabus product portfolio offers room temperature controllers, thermal drives actuators, and actuating drives.

Solar protection

For controlling solar protection, door and window contact drives, the GAMMA product portfolio offers solar protection actuators and weather stations to measure light, temperature, wind and rain.

System products

The GAMMA instabus system products – including power supply units, IP routers, IP interfaces, line couplers, gateways, and automation controllers – ensure the safe and reliable operation of the KNX installation.

Display and operation

The GAMMA instabus product portfolio offers various alternatives for the display and operation of lighting, solar protection, and HVAC: Starting from easy pushbuttons and room thermostat, multi functional room operation units to web based systems.

Monitoring

Monitoring enables to measure, compare and evaluate electrical power and performance, heat flow volume, consumption of gas, water and oil in various line and bar charts.

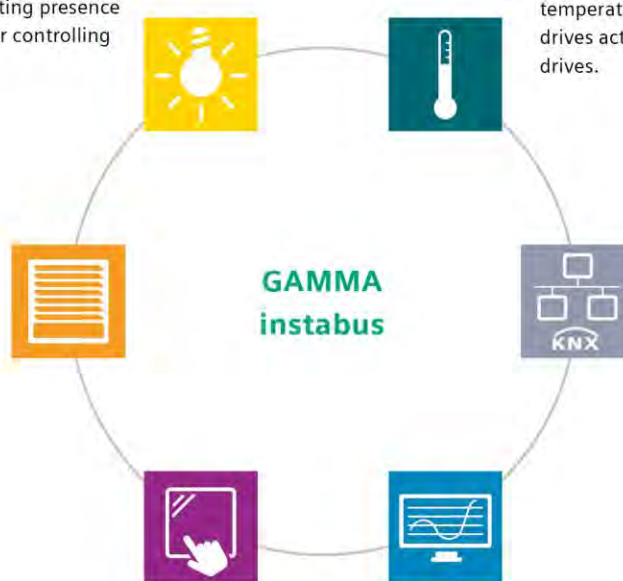

Technical documentation for KNX products at a glance

From planning and implementation to building operation, our technical product database supports you with every KNX project. Whether it's technical datasheets, ETS files, or additional software, you'll find all the documents bundled on one website.

The screenshot displays the Siemens GAMMA-TD website interface. At the top, there are navigation icons for KNX, a search bar, and a 'Suchen' button. Below this, a table lists various technical products with columns for 'Artikelnr.', 'Produkt / Applikation (Text)', and several technical specifications (VD, ETS4/5, TPI, SMA, APB, SW, AUS, CE, FAQ, Datum). The table includes entries like 'STC7 21', 'STC7 220-0', 'STG1 11', and 'SWG1 118-2AB11'. To the right of the table, there are sections for 'Weitere Links' (including links to product literature, service, and training) and a 'Glossar' (Glossary) section.

siemens.com/
gamma-td



1. Everything for the planning phase

Electrical planners require specific product information that can easily be found here:

- CAD data
- EPLAN macros
- Schematic diagrams
- Ground plans

2. Optimally prepared during the project phase

System integrators and professional installers can refer to the following documents:

- ETS project files
- Application descriptions
- Technical product information
- Operating and installation instructions
- Tender texts
- Certificates
- Different firmware versions per device

3. Old and new in one location

The database not only covers the latest devices but also provides you with all the documents you need to optimally operate existing buildings in which discontinued KNX products are already installed:

- Product information
- Datasheets
- ETS project files

4. Training course content

For selected KNX products, web-based training courses are available that cover special functions and possible parameterizations. These courses supplement Siemens technical courses and provide additional support during commissioning.

Tools and apps for every phase of your project

HIT Portal

Supports the European energy efficiency standard EN 15232. This tool provides more than 300 preconfigured standard HVAC configurations classified according to their energy saving potential. This allows users to select the application that best matches their requirements. Documents linked to the applications describe the conditions that have to be met to ensure compliance with one of the energy efficiency classes defined in EN 15232.

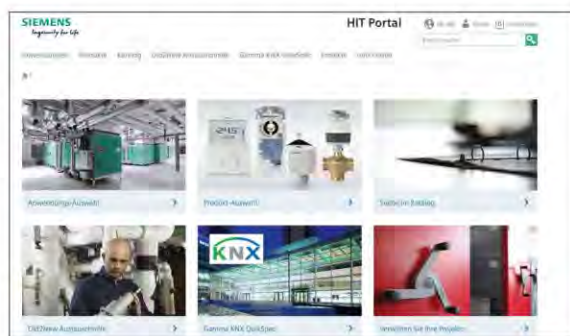

ETS – Engineering Tool Software

ETS is configuration and commissioning software for devices that conform to the worldwide open KNX standard for home and building control. The ETS software is a manufacturer-independent commissioning tool for electrical installers, system administrators, and building planners that runs on Windows®-based computers and is made available by the KNX Association.



KNX Online Training Videos – YouTube

This YouTube channel provides e-learnings for the Siemens GAMMA – KNX building control system.

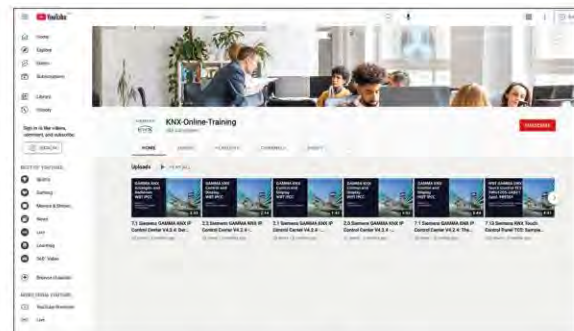

ETS Apps

Some users want additional functions when using KNX. With the ETS apps you can realize even more creative ideas to make your automation project even more attractive. The ETS apps offer limitless possibilities, but are still compatible with the entire KNX system. Owners of the ETS who desire additional capabilities only need to download, install, and license the apps to take advantage of the extra features.



SIOS – Siemens Industry Online System

The Siemens Industry Online System (SIOS) is an Internet portal containing technical information about all KNX products from Siemens. You can download operating and installation instructions, descriptions of individual applications, VD files, technical product information, tender texts as well as CE certificates. This makes the SIOS the go-to destination for all your questions about KNX products.



Siemens Youtube Channel

On the official Siemens channel on YouTube you can watch the latest videos of the company. Siemens videos show the wide range of our expertise, from energy efficiency to sustainable cities, industrial productivity, as well as Next-Generation Healthcare.



Industry Mall

All automation, drive and installation products, including products from the HVAC and GAMMA portfolios, are listed in the Industry Mall, a consolidated information and order platform.



Smart Information Delivery

This portal provides online access to product information like brochures, guides, specifications and data sheets for building technology.



UNDERSTANDING THE LANGUAGE OF BUILDINGS

Building information modeling (BIM)

**Benefits at a glance:**

- Fast download of all data
- Support for 2D and 3D planning
- Simple product search and download
- Visualize data before downloading
- Regular plug-in update to keep data current
- Continuous expansion of BIM data

BIM is the equivalent of digitalization in the construction industry:

A digitally supported process for planning, constructing and operating buildings that enables a significant productivity increase in the construction industry.

BIM helps to plan, build and operate buildings with greater insight. BIM data combined with real-time building data will enhance predictive data analytics over the building lifecycle. This enables significant gains around productivity, efficiency, reliability and overall quality.

Siemens owes its success in delivering digital services to its strengths and competencies in building management and predictive data analytics, supported by reliable and secure infrastructure. With our trusted domain and IT expertise, we have built long-standing credibility around all disciplines of building technologies. With our proven domain and IT expertise, we have been a credible partner for all building technologies systems for many years.

Siemens BIM-compliant product data: the basis of the BIM process

Siemens BIM-compliant product data allows easy integration of the data into authoring processes. With more than 5,000 products already available and more to come, Siemens is setting the benchmark for BIM-compliant product data.



Graphic: IP Control Center – digital in BIM

siemens.
com/bim



bimcatalogs.
partcommu-
nity.com



siemens-bt.
partcommu-
nity.com



GAMMA instabus – New products



Presence detectors WIDE UP 258Dx1

The new presence detectors record brightness, temperature, humidity, and CO₂ levels, and control not only lighting systems but also ventilation and heating systems. In this way, they make it possible to create optimal ambient conditions in a room and guarantee the precise recording, monitoring, and control of energy consumption, for maximum comfort and energy efficiency.



Communicating thermostat range RDG200

This new device is a compact thermostat with built-in sensors for CO₂, temperature, and relative humidity and it ensures a comfortable room climate. The Green Leaf function makes it especially easy to monitor costs while optimizing energy efficiency. The controller can also be integrated in various building automation systems (KNX, Designo, Synco).

Acvatix SSA KNX actuator

The new SSA room actuator with KNX is quiet and versatile. It comes preconfigured and ready for immediate installation. The IP54 protection rating enables all installation directions, including overhead installation. Thanks to manual operation or override, valves and actuators can be easily tested independently of the system. The new LED status display shows different operating states and ensures fast and error-free commissioning. With a noise level lower than 28 dB in "night mode," the SSA actuator is ideal for use in hotels, recording studios, meeting rooms, and libraries.



Touch Control TC5 UP 205/21

The new and slim room unit Touch Control TC5 is a stylish eye-catcher in every room thanks to its high-quality glass surface and makes a smart room control easier than ever. The 5-inch color display is based on the intuitive operating concept of wiping and touching and can be easily personalized. The TC5 supports all KNX control functions in the room: from lighting, to solar protection, up to HVAC applications. Due to the customizable scene control and timer functions, the device is optimally suited for functional buildings such as offices and hotels.

Binary inputs N 262, N 263

The new N 262 and N 263 binary inputs are available in a width of 4 MU (4 binary inputs) and 8 MU (8 binary inputs), each as a potential-free and a voltage-loaded variant. The harmonized housing concept of the new generation of DIN-rail mounted devices has also been implemented for the binary inputs: Terminals, housing type, width and color match the overall design, supported by a clear direct operating level with status LEDs on the front of the device.



Flush-mounted actuators UP 511, UP 562, UP 525

The Switching Actuators UP 511S32, Switching/Sunblind Actuator UP 562S32 and Universal Dimmer UP 525S32 have been designed for space-saving and flexible flush-mounting installation, decentralized installation in false ceilings, floor tanks, electrical columns and cable ducts or installation in an electrical distributor with mounting rail. The hardware features three binary inputs, opening up new possibilities for complex control requirements and sophisticated applications, such as the simultaneous connection of two buttons or switches, an additional window or door contact, or a suitable sensor.

Available in combination with **DELTA frames**

DELTA miro Aluminum



Natural/
aluminum metallic



Yellow oxide/
titanium white

DELTA style

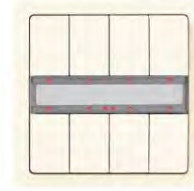

Titanium white



Platinum metallic

DELTA line



Titanium white



Aluminum metallic

DELTA miro Glas



Crystal green/
aluminum metallic



White/
titanium white



Black/
aluminum metallic



Orient/
titanium white



Arena/
titanium white

DELTA miro Color



Titanium white



Aluminum metallic

DELTA miro wood



Maple red



Maple



Certified training options

KNX – a strong partner for your success

KNX – the worldwide standard for home and building control – enables on demand and cross-discipline control of room temperature and energy management as well as lighting and shading. Installed by qualified Building Control technicians, the intelligent networking of building automation products offers completely new ways to increase energy efficiency, security and comfort.

The certified training program from Siemens provides you with comprehensive and in-depth knowledge on every aspect of KNX. The GAMMA training kit offers you an extremely simple self-instruction option for training in a wide range of functions and applications, as well as for consolidating your knowledge and abilities in the KNX field – leading you step by step to success.

Practical learning made easy

With our wide range of courses and practical trainings you can gain the extra edge you need to take the lead in the market. For your certified training and future-proof specialization, we offer you a wide choice of courses:

- KNX Basic Course (with Certification)
- KNX Advanced Course (with Certification)
- KNX/DALI
- Diagnostics and troubleshooting for KNX, IP, and DALI
- IP network basics and HTML5 Web visualization (IPBWV)
- IP Basics KNXnet/IP

Web based training courses

Via our GAMMA-TD you will find our extensive range of online training courses not only product-related but also function-related.



siemens.com/
knx-training



KNX Training with the GAMMA Training Kit (GTK)



A fully equipped GAMMA training case is suitable for the organization of mobile KNX classes for system integrators, electrical installers, and planners alike. The training cases offer the option of mounting four additional modules individually. The standard modules provide a pushbutton mounted with a configurable push-button interface and a room control unit.

All GAMMA Training Kits are robust and built as a trolley for a safe and easy transportation of the technical equipment. To order the GAMMA Training Kit and the Operation and Function Modules, please contact your local sales for receiving an offer.

Contact and support

Further information can be found here:



**KNX Building Control
GAMMA instabus:**

[siemens.com/knx](https://www.siemens.com/knx)



SIOS:

[siemens.com/sios](https://www.siemens.com/sios)



Technical documentation:

[siemens.com/gamma-td](https://www.siemens.com/gamma-td)



Web based trainings:

[siemens.com/web-based-training](https://www.siemens.com/web-based-training)



HIT Portal:

[siemens.com/hit](https://www.siemens.com/hit)

Support

Mail:

support.automation@siemens.com;

Website:

[siemens.com/automation/support-request](https://www.siemens.com/automation/support-request)

Stock no.	Product no.	Product Title	Data sheet	Page
4AC2402	4AC2402	Electronic power supply unit, 350 mA		395
5TC7220-0	5TC72200	Surface-mounting motion detector, AC 230 V 50 Hz		357
5TC7220-1	5TC72201	Flush-mounting motion detector, AC 230 V 50 Hz		357
5TG1111-0	5TG11110	Frame, DELTA miro color, plastic, titanium white (similar to RAL 9010), single	A6V10332363	50
5TG1111-1	5TG11111	Frame, DELTA miro color, plastic, aluminum metallic (similar to RAL 9006), single	A6V10332364	50
5TG1111-2	5TG11112	Frame, DELTA miro color, plastic, carbon metallic (similar to RAL7016), single	A6V10332365	51
5TG1112-0	5TG11120	Frame, DELTA miro color, plastic, titanium white (similar to RAL 9010), Double	A6V10332366	50
5TG1112-1	5TG11121	Frame, DELTA miro color, plastic, aluminum metallic (similar to RAL 9006), double	A6V10332367	50
5TG1112-2	5TG11122	Frame, DELTA miro color, plastic, carbon metallic (similar to RAL7016), double	A6V10332368	51
5TG1113-0	5TG11130	Frame, DELTA miro color, plastic, titanium white (similar to RAL 9010), triple	A6V10332369	50
5TG1113-1	5TG11131	Frame, DELTA miro color, plastic, aluminum metallic (similar to RAL 9006), triple	A6V10332370	50
5TG1113-2	5TG11132	Frame, DELTA miro color, plastic, carbon metallic (similar to RAL7016), triple	A6V10332371	51
5TG1114-0	5TG11140	Frame, DELTA miro color, plastic, titanium white (similar to RAL 9010), quadruple	A6V10332372	50
5TG1114-1	5TG11141	Frame, DELTA miro color, plastic, aluminum metallic (similar to RAL 9006), quadruple	A6V10332373	50
5TG1114-2	5TG11142	Frame, DELTA miro color, plastic, carbon metallic (similar to RAL7016), quintuple	A6V10332374	51
5TG1115-0	5TG11150	Frame, DELTA miro color, plastic, titanium white (similar to RAL 9010), quintuple	A6V10332375	50
5TG1115-1	5TG11151	Frame, DELTA miro color, plastic, aluminum metallic (similar to RAL 9006), quintuple	A6V10332376	50
5TG1115-2	5TG11152	Frame, DELTA miro color, plastic, carbon metallic (similar to RAL7016), quintuple,	A6V10332377	51
5TG1121-0	5TG11210	Frame, DELTA miro aluminum, real aluminum, natural, single	A6V10332378	54
5TG1121-3	5TG11213	Frame, DELTA miro aluminum, real aluminum, yellow oxide, single	A6V10332381	54
5TG1122-0	5TG11220	Frame, DELTA miro aluminum, real aluminum, natural, double	A6V10332382	54
5TG1122-3	5TG11223	Frame, DELTA miro aluminum, real aluminum, yellow oxide, double	A6V10332385	54
5TG1123-0	5TG11230	Frame, DELTA miro aluminum, real aluminum, natural, triple	A6V10332386	54
5TG1123-3	5TG11233	Frame, DELTA miro aluminum, real aluminum, yellow oxide, triple	A6V10332389	54
5TG1124-0	5TG11240	Frame, DELTA miro aluminum, real aluminum, natural, quadruple	A6V10332390	54
5TG1124-3	5TG11243	Frame, DELTA miro aluminum, real aluminum, yellow oxide, quadruple	A6V10332393	54
5TG1125-0	5TG11250	Frame, DELTA miro aluminum, real aluminum, natural, quintuple	A6V10332394	54
5TG1125-3	5TG11253	Frame, DELTA miro aluminum, real aluminum, yellow oxide, quintuple	A6V10332397	54
5TG1201	5TG1201	Frame, DELTA miro glass, real glass, crystal green, single	A6V10332406	52
5TG1201-1	5TG12011	Frame, DELTA miro glass, real glass, white, single	A6V10332402	52
5TG1201-2	5TG12012	Frame, DELTA miro glass, real glass, black, single	A6V10332403	52
5TG1201-3	5TG12013	Frame, DELTA miro glass, real glass, orient, single	A6V10332404	53
5TG1201-4	5TG12014	Frame, DELTA miro glass, real glass, arena, single	A6V10332405	53
5TG1202	5TG1202	Frame, DELTA miro glass, real glass, crystal green, double	A6V10332411	52
5TG1202-1	5TG12021	Frame, DELTA miro glass, real glass, white, double	A6V10332407	52
5TG1202-2	5TG12022	Frame, DELTA miro glass, real glass, black, double	A6V10332408	52
5TG1202-3	5TG12023	Frame, DELTA miro glass, real glass, orient, double	A6V10332409	53
5TG1202-4	5TG12024	Frame, DELTA miro glass, real glass, arena, double	A6V10332410	53
5TG1203	5TG1203	Frame, DELTA miro glass, real glass, crystal green, triple	A6V10332416	52
5TG1203-1	5TG12031	Frame, DELTA miro glass, real glass, white, triple	A6V10332412	52
5TG1203-2	5TG12032	Frame, DELTA miro glass, real glass, black, triple	A6V10332413	52

Type Overview

Stock no.	Product no.	Product Title	Data sheet	Page
5TG1203-3	5TG12033	Frame, DELTA miro glass, real glass, orient, triple	A6V10332414	53
5TG1203-4	5TG12034	Frame, DELTA miro glass, real glass, arena, triple	A6V10332415	53
5TG1204	5TG1204	Frame, DELTA miro glass, real glass, crystal green, quadruple	A6V10332421	52
5TG1204-1	5TG12041	Frame, DELTA miro glass, real glass, white, quadruple	A6V10332417	52
5TG1204-2	5TG12042	Frame, DELTA miro glass, real glass, black, quadruple	A6V10332418	52
5TG1204-3	5TG12043	Frame, DELTA miro glass, real glass, orient, quadruple	A6V10332419	53
5TG1204-4	5TG12044	Frame, DELTA miro glass, real glass, arena, quadruple	A6V10332420	53
5TG1205	5TG1205	Frame, DELTA miro glass, real glass, crystal green, quintuple	A6V10332426	52
5TG1205-1	5TG12051	Frame, DELTA miro glass, real glass, white, quintuple	A6V10332422	52
5TG1205-2	5TG12052	Frame, DELTA miro glass, real glass, black, quintuple	A6V10332423	52
5TG1205-3	5TG12053	Frame, DELTA miro glass, real glass, orient, quintuple	A6V10332424	53
5TG1205-4	5TG12054	Frame, DELTA miro glass, real glass, arena, quintuple	A6V10332425	53
5TG1321	5TG1321	Frame, DELTA style, titanium white (similar to RAL 9010), single	A6V10332430	55
5TG1321-1	5TG13211	Frame, DELTA style, platinum metallic, single	A6V10332429	55
5TG1322	5TG1322	Frame, DELTA style, titanium white (similar to RAL 9010), double	A6V10332432	55
5TG1322-1	5TG13221	Frame, DELTA style, platinum metallic, double	A6V10332431	55
5TG1323	5TG1323	Frame, DELTA style, titanium white (similar to RAL 9010), triple	A6V10332434	55
5TG1323-1	5TG13231	Frame, DELTA style, platinum metallic, triple	A6V10332433	55
5TG1324	5TG1324	Frame, DELTA style, titanium white (similar to RAL 9010), quadruple	A6V10332436	55
5TG1324-1	5TG13241	Frame, DELTA style, platinum metallic, quadruple	A6V10332435	55
5TG1325	5TG1325	Frame, DELTA style, titanium white (similar to RAL 9010), quintuple	A6V10332438	55
5TG1325-1	5TG13251	Frame, DELTA style, platinum metallic, quintuple	A6V10332437	55
5TG1327	5TG1327	DELTA style titanium white int. frame 55	A6V1033244	55
5TG1327-1	5TG13271	DELTA style platinum met. int. frame 55	A6V10332260	55
5TG2551-0	5TG25510	Frames, DELTA line, Titanium white (similar to RAL 9010), single	A6V10332469	45
5TG2551-1	5TG25511	Frames, DELTA line, with labeling field, titanium white (similar to RAL 9010), single	A6V10332470	46
5TG2551-3	5TG25513	Frames, DELTA line, aluminum metallic (similar to RAL 9006), single	A6V10332471	46
5TG2551-4	5TG25514	Frames, DELTA line, with labeling field, aluminum metallic (similar to RAL 9006), single	A6V10332472	48
5TG2551-6	5TG25516	Frames, DELTA line, carbon metallic (similar to RAL 7016), single	A6V10332473	46
5TG2551-7	5TG25517	Frames, DELTA line, with labeling field, carbon metallic (similar to RAL 7016), single	A6V10332474	49
5TG2552-0	5TG25520	Frames, DELTA line, Titanium white (similar to RAL 9010), double	A6V10332475	45
5TG2552-1	5TG25521	Frames, DELTA line, with labeling field, titanium white (similar to RAL 9010), double, horizontal	A6V10332476	46
5TG2552-2	5TG25522	Frames, DELTA line, with labeling field, titanium white (similar to RAL 9010), double, vertical	A6V10332477	46
5TG2552-3	5TG25523	Frames, DELTA line, aluminum metallic (similar to RAL 9006), double	A6V10332478	46
5TG2552-4	5TG25524	Frames, DELTA line, with labeling field, aluminum metallic (similar to RAL 9006), double, horizontal	A6V10332479	48
5TG2552-5	5TG25525	Frames, DELTA line, with labeling field, aluminum metallic (similar to RAL 9006), double, vertical	A6V10332480	48
5TG2552-6	5TG25526	Frames, DELTA line, carbon metallic (similar to RAL 7016), double	A6V10332481	46
5TG2552-7	5TG25527	Frames, DELTA line, with labeling field, carbon metallic (similar to RAL 7016), double, horizontal	A6V10332482	49
5TG2552-8	5TG25528	Frames, DELTA line, with labeling field, carbon metallic (similar to RAL 7016), double, vertical	A6V10332483	49
5TG2553-0	5TG25530	Frames, DELTA line, Titanium white (similar to RAL 9010), triple	A6V10332484	45
5TG2553-1	5TG25531	Frames, DELTA line, with labeling field, titanium white (similar to RAL 9010), triple, horizontal	A6V10332485	46
5TG2553-2	5TG25532	Frames, DELTA line, with labeling field, titanium white (similar to RAL 9010), triple, vertical	A6V10332486	46
5TG2553-3	5TG25533	Frames, DELTA line, aluminum metallic (similar to RAL 9006), triple	A6V10332487	46
5TG2553-6	5TG25536	Frames, DELTA line, carbon metallic (similar to RAL 7016), triple	A6V10332488	46

Stock no.	Product no.	Product Title	Data sheet	Page
5TG2554-0	5TG25540	Frames, DELTA line, Titanium white (similar to RAL 9010), quadruple	A6V10332489	45
5TG2554-1	5TG25541	Frames, DELTA line, with labeling field, titanium white (similar to RAL 9010), quadruple, horizontal	A6V10332490	46
5TG2554-2	5TG25542	Frames, DELTA line, with labeling field, titanium white (similar to RAL 9010), quadruple, vertical	A6V10332491	46
5TG2554-3	5TG25543	Frames, DELTA line, aluminum metallic (similar to RAL 9006), quadruple	A6V10332492	46
5TG2554-6	5TG25546	Frames, DELTA line, carbon metallic (similar to RAL 7016), quadruple	A6V10332493	46
5TG2555-0	5TG25550	Frames, DELTA line, Titanium white (similar to RAL 9010), quintuple	A6V10332494	45
5TG2555-3	5TG25553	Frames, DELTA line, aluminum metallic (similar to RAL 9006), quintuple	A6V10332495	46
5TG2555-6	5TG25556	Frames, DELTA line, carbon metallic (similar to RAL 7016), quintuple	A6V10332496	46
5TG2581-0	5TG25810	Frames, DELTA line, electrical white (similar to RAL 1013), single	A6V10332498	45
5TG2581-1	5TG25811	Frames, DELTA line, with labeling field, electrical white (similar to RAL 1013), single	A6V10332499	48
5TG2582-0	5TG25820	Frames, DELTA line, electrical white (similar to RAL 1013), double	A6V10332500	45
5TG2582-1	5TG25821	Frames, DELTA line, with labeling field, electrical white (similar to RAL 1013), double, horizontal	A6V10332501	48
5TG2582-2	5TG25822	Frames, DELTA line, with labeling field, electrical white (similar to RAL 1013), double, vertical	A6V10332502	48
5TG2583-0	5TG25830	Frames, DELTA line, electrical white (similar to RAL 1013), triple	A6V10332503	45
5TG2583-1	5TG25831	Frames, DELTA line, with labeling field, electrical white (similar to RAL 1013), triple, horizontal	A6V10332504	48
5TG2583-2	5TG25832	Frames, DELTA line, with labeling field, electrical white (similar to RAL 1013), triple, vertical	A6V10332505	48
5TG2584-0	5TG25840	Frames, DELTA line, electrical white (similar to RAL 1013), quadruple	A6V10332506	45
5TG2584-1	5TG25841	Frames, DELTA line, with labeling field, electrical white (similar to RAL 1013), quadruple, horizontal	A6V10332507	48
5TG2584-2	5TG25842	Frames, DELTA line, with labeling field, electrical white (similar to RAL 1013), quadruple, vertical	A6V10332508	48
5TG2585-0	5TG25850	Frames, DELTA line, electrical white (similar to RAL 1013), quintuple	A6V10332509	45
5TG2861	5TG2861	Surface-mounting enclosure, for flush-mounting devices, DELTA line, electrical white, single	A6V10332332	57
5TG2862	5TG2862	Surface-mounting enclosure, for flush-mounting devices, DELTA line, electrical white, double	A6V10332333	57
5TG2863	5TG2863	Surface-mounting enclosure, for flush-mounting devices, DELTA line, electrical white, triple	A6V10331234	57
5TG2901	5TG2901	Surface-mounting enclosure, for flush-mounting devices, DELTA line, DELTA style, titanium white, single	A6V10332513	57
5TG2902	5TG2902	Surface-mounting enclosure, for flush-mounting devices, DELTA line, DELTA style, titanium white, double	A6V10332514	57
5TG2903	5TG2903	Surface-mounting enclosure, for flush-mounting devices, DELTA line, DELTA style, titanium white, triple	A6V10332515	57
5TG7318	5TG7318	LED light insert		139
5WG1117-2AB12	UP 117/12	Bus transceiver modules, mounting depth 18 mm	A6V10416065	392
5WG1117-2CB12	UP 117C12	Bus Coupling Unit (BTM), NEMA	A6V11808813	392
5WG1118-4AB01	AP 118/01	Control Module Box	A6V11438329	295
5WG1120-1AB02	N 120/02	Choke, 640 mA	A6V10416067	395
5WG1125-1AB02	N 125/02	Power supply unit DC 29 V, 160 mA with additional unchoked output, N 125/02	A6V10416069	394
5WG1125-1AB12	N 125/12	Power supply unit DC 29 V, 320 mA with additional unchoked output, N 125/12	A6V10416069	394
5WG1125-1AB22	N 125/22	Power supply unit DC 29 V, 640 mA with additional unchoked output, N 125/22	A6V10416069	394
5WG1125-4AB23	RL 125/23	Decentralized power supply, 80 mA, AC 230 V	A6V11535388	296
5WG1125-4CB23	JB 125C23	Decentralized Power Supply, 80 mA, AC 120 V	A6V11808808	305
5WG1140-1AB13	N 140/13	Line/backbone coupler	A6V10416071	396
5WG1141-1AB03	N 141/03	KNX/DALI Gateway plus, 1 channel	A6V10466084	167

Type Overview

Stock no.	Product no.	Product Title	Data sheet	Page
5WG1141-1AB21	N 141/21	KNX/DALI Gateway Twin plus, 2 channels	A6V10466084	167
5WG1141-1AB31	N 141/31	KNX/DALI Gateway Twin	A6V10466084	168
5WG1141-2AB71	UP 141/71	DALI Push button interface 4fold	A6V11786002	171
5WG1143-1AB01	N 143/01	IP Gateway KNX/BACnet	A6V10466141	329
5WG1146-1AB03	N 146/03	IP Router Secure	A6V11656735	321
5WG1148-1AB12	N 148/12	USB Interface	A6V11535346	330
5WG1148-1AB23	N 148/23	IP Interface Secure	A6V11689764	321
5WG1152-1AB01	N 152/01	IP Control Center	A6V10417875	85
5WG1190-8AD01	S 190/01	Overvoltage protection, as fine protection for bus devices	A6V10416502	400
5WG1193-8AB01	S 193/01	Bus terminal, 2-pole, 4 plug-in connectors, red/dark gray		399
5WG1201-2DB12	UP 201/12	Touch sensor, single, without status LED, GAMMA arina, white	A6V10438647	44
5WG1201-2DB13	UP 201/13	Touch sensor, single, with status LED, GAMMA arina, white	A6V10438647	44
5WG1201-2DB23	UP 201/23	Touch sensor, single, with status LED, GAMMA Arina, Black	A6V10438647	44
5WG1201-2DB43	UP 201/43	Touch sensor, single, with status LED, GAMMA Arina, Ash gold	A6V10438647	44
5WG1202-2DB12	UP 202/12	Touch sensor, double, without status LED, GAMMA arina, white	A6V10438647	44
5WG1202-2DB13	UP 202/13	Touch sensor, double, with status LED, GAMMA arina, white	A6V10438647	44
5WG1202-2DB23	UP 202/23	Touch sensor, double, with status LED, GAMMA Arina, Black	A6V10438647	44
5WG1202-2DB43	UP 202/43	Touch sensor, double, with status LED, GAMMA Arina, Ash gold	A6V10438647	44
5WG1203-2DB12	UP 203/12	Touch sensor, quadruple, without status LED, GAMMA arina, white	A6V10438647	44
5WG1203-2DB13	UP 203/13	Touch sensor, quadruple, with status LED, GAMMA arina, white	A6V10438647	44
5WG1203-2DB14	UP 203/14	Touch sensor with status LED, scene controller and room temperature sensor, GAMMA arina, white	A6V10438647	44
5WG1203-2DB23	UP 203/23	Touch sensor, quadruple, with status LED, GAMMA Arina, Black	A6V10438647	44
5WG1203-2DB43	UP 203/43	Touch sensor, quadruple, with status LED, GAMMA Arina, Ash gold	A6V10438647	44
5WG1205-2AB21	UP 205/21	Touch Control TC5, 5 inch touch panel, black	A6V12259028	61
5WG1220-2AB21	UP 220/21	Pushbutton interface 2 x potential-free contact, output for LED control	A6V10416089	127
5WG1220-2DB31	UP 220D31	Pushbutton interface 4 x potential-free contact, output for LED control	A6V10416090	127
5WG1221-2DB12	UP 221/12	Pushbutton, single, without status LED, titanium white, i-system	A6V10416094	40
5WG1221-2DB13	UP 221/13	Pushbutton, single, with status LED, titanium white, i-system	A6V10416094	40
5WG1221-2DB32	UP 221/32	Pushbutton, single, without status LED, aluminum metallic, i-system	A6V10416094	40
5WG1221-2DB33	UP 221/33	Pushbutton, single, with status LED, aluminum metallic, i-system	A6V10416094	40
5WG1222-2DB12	UP 222/12	Pushbutton, double, without status LED, titanium white, i-system	A6V10416094	40
5WG1222-2DB13	UP 222/13	Pushbutton, double, with status LED, titanium white, i-system	A6V10416094	40
5WG1222-2DB32	UP 222/32	Pushbutton, double, without status LED, aluminum metallic, i-system	A6V10416094	40
5WG1222-2DB33	UP 222/33	Pushbutton, double, with status LED, aluminum metallic, i-system	A6V10416094	40
5WG1223-2AB14	UP 223/14	Pushbutton, triple, with status LED, with scene controller, with room temperature sensor, titanium white, i-system	A6V10416093	41
5WG1223-2AB34	UP 223/34	Pushbutton, triple, with status LED, with scene controller, with room temperature sensor, aluminum metallic, i-system	A6V10416093	41
5WG1223-2DB12	UP 223/12	Pushbutton, triple, without status LED, titanium white, i-System	A6V10416094	40
5WG1223-2DB13	UP 223/13	Pushbutton, triple, with status LED, titanium white, i-System	A6V10416094	40
5WG1223-2DB32	UP 223/32	Pushbutton, triple, without status LED, aluminum metallic, i-system	A6V10416094	40
5WG1223-2DB33	UP 223/33	Pushbutton, triple, with status LED, aluminum metallic, i-system	A6V10416094	40
5WG1227-2AB11	UP 227	Room Control Unit, i-system	A6V10416250	59
5WG1237-2KB11	UP 237K11	Temperature controller, titanium white	A6V10416253	58
5WG1254-3EY02	AP 254/02	Dual sensor for brightness measurement, temperature measurement, sun protection control, lighting control	A6V10416100	182
5WG1255-2DB21	UP 255D21	Brightness Sensor with constant light level controller	A6V10489482	180
5WG1255-7AB11	S 255/11	IR remote control	A6V11786011	181
5WG1257-3AB22	AP 257/22	Weather center (GPS), 8 facade sectors, sun tracking	A6V10416104	199
5WG1257-3AB51	AP 257/51	Weather station	A6V11418967	200
5WG1257-3AB61	AP 257/61	Weather station	A6V11418967	200
5WG1258-2DB12	UP 258D12	Presence Detector with brightness sensor	A6V10489482	180
5WG1258-2DB31	UP 258D31	Presence Detector WIDE with temperature measurement	A6V11895382	176

Stock no.	Product no.	Product Title	Data sheet	Page
5WG1258-2DB41	UP 258D41	Presence Detector WIDE pro with temperature and relative humidity measurement	A6V11895382	177
5WG1258-2DB51	UP 258D51	Presence Detector WIDE multi with temperature, humidity and CO2 measurement	A6V11895382	177
5WG1258-2DB61	UP 258D61	Presence Detector WIDE DualTech with temperature measurement	A6V11895378	178
5WG1258-2EB22	UP 258E22	Presence Detector / Motion detector with constant light level control	A6V10489482	179
5WG1258-7EB01	AP 258E01	Surface Mounting Enclosure	A6V10416111	180
5WG1258-7EB11	AP 258E11	Surface Mounting Box Type B		181
5WG1258-8AB12	S 258/12	Mounting plate		181
5WG1260-4AB23	RL 260/23	Binary Input 4 x AC/DC 12...230 V	A6V10416114	126
5WG1260-4CB23	JB 260C23	Binary Input 4 x AC/DC 12...230 V	A6V11786003	126
5WG1262-1DB31	N 262D31	Binary input, 4 x dry contacts	A6V12316424	125
5WG1262-1DB51	N 262D51	Binary input, 8 x dry contacts	A6V12316424	125
5WG1262-1EB01	N 262E01	Binary input device 8 x potential-free contacts	A6V10416116	124
5WG1262-1EB11	N 262E11	Binary input device 16 x potential-free contacts	A6V10416117	124
5WG1263-1DB31	N 263D31	Binary input, 4 x AC/DC 10...230 V	A6V12316430	125
5WG1263-1DB51	N 263D51	Binary input, 8 x AC/DC 10...230 V	A6V12316430	125
5WG1263-1EB11	N 263E11	Binary input device 16 x AC 12...230 V / DC 12...115 V	A6V10416119	124
5WG1264-1EB11	N 264E11	Binary input device 8 x AC/DC 12...230 V + 8 x potential-free contacts	A6V10416120	124
5WG1281-8UB12	S 281U12	Frame 68 - 4 x 4, titanium white (similar to RAL 9010), for 4" x 4" Box (double gang box)		56
5WG1285-2DB12	UP 285/12	Pushbutton, single, without status LED, titanium white, DELTA style	A6V11619332	42
5WG1285-2DB13	UP 285/13	Pushbutton, single, with status LED, titanium white, DELTA style	A6V10416123	42
5WG1285-2DB42	UP 285/42	Pushbutton, single, without status LED, platinum metallic, DELTA style	A6V10416123	42
5WG1285-2DB43	UP 285/43	Pushbutton, single, with status LED, platinum metallic, DELTA style	A6V10416123	42
5WG1286-2DB12	UP 286/12	Pushbutton, double, without status LED, titanium white, DELTA style	A6V10416123	42
5WG1286-2DB13	UP 286/13	Pushbutton, double, with status LED, titanium white, DELTA style	A6V10416123	42
5WG1286-2DB42	UP 286/42	Pushbutton, double, without status LED, platinum metallic, DELTA style	A6V10416123	42
5WG1286-2DB43	UP 286/43	Pushbutton, double, with status LED, platinum metallic, DELTA style	A6V10416123	42
5WG1287-2AB14	UP 287/14	Pushbutton, quadruple, with status LED, titanium white, DELTA style	A6V10416122	43
5WG1287-2AB44	UP 287/44	Pushbutton, quadruple, with status LED, platinum metallic, DELTA style	A6V10416122	43
5WG1287-2DB12	UP 287/12	Pushbutton, quadruple, without status LED, titanium white, DELTA style	A6V10416123	42
5WG1287-2DB13	UP 287/13	Pushbutton, quadruple, with status LED, titanium white, DELTA style	A6V10416123	42
5WG1287-2DB42	UP 287/42	Pushbutton, quadruple, without status LED, platinum metallic, DELTA style	A6V10416123	42
5WG1287-2DB43	UP 287/43	Pushbutton, quadruple, with status LED, platinum metallic, DELTA style	A6V10416123	42
5WG1290-7AB11	S 290/11	Door/window contact, white	A6V11793756	268
5WG1305-1AB01	N 305/01	Scene-/Event Controller	A6V10416128	377
5WG1501-1AB01	N 501/01	Combination blind actuator, 4 x AC 230 V, 6 A, 8 x binary inputs	A6V10416147	129
5WG1502-1AB02	N 502/02	Combi switching actuator 8 x AC 230 V, 16 A, 8 x binary inputs	A6V10416148	116
5WG1510-2AB03	UP 510/03	Binary Output 2 x AC 230 V, 10 A, with mounting frame and BTI interface	A6V10416151	110
5WG1510-2AB13	UP 510/13	Binary Output 2 x AC 230 V, 10 A	A6V10416152	110
5WG1510-2AB23	RS 510/23	Binary Output, 2 x AC 230 V, 10 A (resistive load)	A6V10416153	111
5WG1510-2KB23	RS 510K23	Thermo Drive Actuator, 2 x 1.5 A, AC 24...230 V / DC 24 V	A6V10532363	304
5WG1510-4CB23	JB 510C23	Binary Output, 2 x AC 120...277 V, 10 A (resistive load)	A6V11786004	112
5WG1511-2SB32	UP 511S32	Switch actuator 1 x AC 230 V, 16 A	A6V12632887	117
5WG1512-1AB11	N 512/11	Switch actuator, main module, 3 x AC 230/400 V, 16 AX, C load, Load-check	A6V10416157	107
5WG1512-1AB21	N 512/21	Switch actuator submodule, 3 x AC 230/400 V, 16AX, C load, load-check	A6V10416158	108
5WG1512-1CB01	N 512C01	Load switch, 8 x AC 120 V / AC 277 V / AC 347 V, 20 A, C load (cUL listed)	A6V10416156	106
5WG1512-4AB23	RL 512/23	Switching actuator 1 x AC 230 V, 16 AX, C load	A6V10416159	113
5WG1512-4CB23	JB 512C23	Switching actuator 1 x AC 120...277 V, 20 A or 1 x AC 347 V, 15 AX, C load	A6V11786007	114
5WG1513-1AB11	N 513/11	Switch actuator, main module, 3 x AC 230/400 V, 20 AX, C load, Load-check	A6V10416160	107

Type Overview

Stock no.	Product no.	Product Title	Data sheet	Page
5WG1513-1AB21	N 513/21	Switch actuator submodule, 3 x AC 230/400 V, 20 AX, C load, load-check	A6V10416161	108
5WG1513-4CB23	JB 513C23	Binary Output 3 x 6 A, AC 120...277 V	A6V11786008	115
5WG1513-4DB23	RL 513D23	Binary Output 3 x 6 A, AC 230 V	A6V11375522	109
5WG1520-2AB03	UP 520/03	Shutter Blind Actuator, 1 x AC 230 V, 6 A, with mounting frame and BTI interface	A6V10416166	198
5WG1520-2AB13	UP 520/13	Shutter Blind Actuator UP, 1 x AC 230 V, 6 A	A6V10416167	198
5WG1520-2AB23	RS 520/23	Shutter Blind Actuator RS, 1 x AC 230 V, 6 A	A6V10416164	197
5WG1520-4CB23	JB 520C23	Shutter Blind Actuator, 1 x AC 120 V, 6 A	A6V11786009	193
5WG1521-4AB23	RL 521/23	Shutter Blind Actuator, 2 x AC 230 V, 6 A	A6V10416169	195
5WG1521-4CB23	JB 521C23	Shutter Blind Actuator, 2 x AC 120 V, 6 A	A6V11786010	196
5WG1523-1AB03	N 523/03	Roller shutter actuator, 4 x AC 230 V, 6 A	A6V10416172	189
5WG1525-1DB11	N 525D11	Switch/dim actuator, 2x DALI Broadcast	A6V11914230	169
5WG1525-1EB01	N 525E01	Switch/dim actuator, 8 x DALI, 8 ECGs per DALI output	A6V10416176	170
5WG1525-2AB03	UP 525/03	Universal dimmer 1 x AC 230 V, 10 ... 250 VA, with mounting frame and BTI interface	A6V10416178	165
5WG1525-2AB13	UP 525/13	Universal dimmer 1 x AC 230 V, 10...250 VA	A6V10416180	165
5WG1525-2AB23	RS 525/23	Universal dimmer 1 x AC 230 V, 10...250 VA, (R,L,C load)	A6V10416181	164
5WG1525-2SB32	UP 525S32	Universal dimmer, 1-fold	A6V12632898	132
5WG1525-4CB23	JB 525C23	Universal Dimmer, 1 x AC 120 V, 10...125 VA (R,L,C load)	A6V11808810	313
5WG1526-4CB23	JB 526C23	Switch/dim actuator, 2 x AC 277 V, 20 A, 1...10 V	A6V11786012	174
5WG1526-4DB23	RL 526D23	Switch/dim actuator, 2 x AC 230 V, 6 A, 1...10 V	A6V12021343	173
5WG1527-4CB23	JB 527C23	Switch/dim actuator, 1 x AC 277 V, 20 A, 1...10 V	A6V11786013	175
5WG1528-1CB01	N 528C01	Universal dimmer 2 x 150 VA, AC 120 V	A6V11642308	162
5WG1528-1DB01	N 528D01	Universal dimmer 2 x 300 VA, AC 230 V	A6V10892651	161
5WG1530-1DB31	N 530D31	Switching actuator 4 x AC 230 V, 6 AX, C-Load	A6V11252211	101
5WG1530-1DB51	N 530D51	Switching actuator 8 x AC 230 V, 6 AX, C-Load	A6V11252211	101
5WG1530-1DB61	N 530D61	Switching actuator 12 x AC 230 V, 6 AX, C-Load	A6V11252211	101
5WG1532-1DB31	N 532D31	Switching actuator 4 x AC 230 V, 10 AX, C-Load	A6V11252211	102
5WG1532-1DB51	N 532D51	Switching actuator 8 x AC 230 V, 10 AX, C-Load	A6V11252211	102
5WG1532-1DB61	N 532D61	Switching actuator 12 x AC 230 V, 10 AX, C-Load	A6V11252211	102
5WG1534-1DB31	N 534D31	Switching actuator 4 x AC 230 V, 16/20 AX, C-Load	A6V11252211	103
5WG1534-1DB51	N 534D51	Switching actuator 8 x AC 230 V, 16/20 AX, C-Load	A6V11252211	103
5WG1534-1DB61	N 534D61	Switching actuator 12 x AC 230 V, 16/20 AX, C-Load	A6V11252211	103
5WG1535-1DB31	N 535D31	Switching actuator, 4 x AC 230 V, 16/20 AX, C-Load, Load Check	A6V11252209	104
5WG1535-1DB51	N 535D51	Switching actuator, 8 x AC 230 V, 16/20 AX, C-Load, Load Check	A6V11252211	105
5WG1535-1DB61	N 535D61	Switching actuator, 12 x AC 230 V, 16/20 AX, C-Load, Load Check	A6V11252209	105
5WG1536-1DB31	N 536D31	Switch/dim actuator, 4 x AC 230 V, 10 AX, 1...10 V	A6V11632775	172
5WG1536-1DB51	N 536D51	Switch/dim actuator, 8 x AC 230 V, 10 AX, 1...10 V	A6V11632775	173
5WG1543-1DB31	N 543D31	Solar protection actuator, 4 x AC 230 V, 6 A, with end position detection	A6V11986596	191
5WG1543-1DB51	N 543D51	Solar protection actuator, 8 x AC 230 V, 6 A, with end position detection	A6V11986596	191
5WG1554-1DB31	N 554D31	Universal dimmer 4 x 300 VA / 1 x 1000 VA, AC 230 V	A6V11418996	163
5WG1562-1AB11	N 562/11	Switch actuator, main module, 3 x AC 230/400 V, 10 AX, C load, Load-check	A6V10416187	107
5WG1562-1AB21	N 562/21	Switch actuator submodule, 3 x AC 230/400 V, 10 AX, C load, Load-check	A6V10416188	108
5WG1562-2SB32	UP 562S32	Switch/solar protection actuator 2 x AC 230 V, Σ 16 A	A6V12632892	118
5WG1562-7AB02	AP 562/02	Electromotive valve actuator with LED valve position indication	A6V10416192	258
5WG1567-1AB22	N 567/22	Switch actuator, 16 x AC 230 V, 10 A	A6V10416196	106
5WG1588-2AB13	UP 588/13	Touch Panel, AC 230 V, 50 Hz	A6V11637841	83
5WG1588-2AB23	UP 588/23	Touch Panel, AC/DC 24 V	A6V11637841	83
5WG1588-8AB12	S 588/12	Design frame for touch panel UP 588/..3, aluminium	A6V11637841	83
5WG1588-8AB13	S 588/13	Design frame for touch panel UP 588/..3, stainless steel design	A6V11637841	83
5WG1588-8AB14	S 588/14	Design frame for touch panel UP 588/..3, glass black	A6V11637841	84
5WG1588-8AB15	S 588/15	Design frame for touch panel UP 588/..3, glass white	A6V11637841	84
5WG1588-8EB01	UP 588E01	Flush-type box for all touch panel UP 588	A6V11637841	84

Stock no.	Product no.	Product Title	Data sheet	Page
5WG1592-8AB01	M 592/01	Mounting case		118
5WG1641-3AB01	AP 641/01	Room Control Box	A6V10416220	295
6AV2132-0HA00-0AA1	LOGO! 8 12/24 V + KP300	LOGO! 8 12/24 V + KP300 Basic Starter Kit		386
6AV2132-0KA00-0AA1	LOGO! 8 12/24 V + KTP400	LOGO! 8 12/24 V + KTP400 Basic Starter Kit		386
6AV2132-3GB00-0AA1	LOGO! 8 12/24 V + KTP700	LOGO! 8 12/24 V + KTP700 Basic Starter Kit		386
6BK1700-0BA20-0AA0	LOGO! CMK2000	Communication Module LOGO! CMK2000	A6V11642346	331
6ED1052-1FB08-0BA1	LOGO! 8 230 RCE	Basic Module LOGO! 8 230 RCE		379
6ED1052-1MD08-0BA1	LOGO! 8 12/24 RCE	Basic Module LOGO! 8 12/24 RCE		379
6ED1055-1FB00-0BA2	LOGO! DM 8 230 R	Expansion Modules LOGO! DM 8 230 R		380
6ED1055-1FB10-0BA2	LOGO! DM 16 230 R	Expansion Module LOGO! DM 16 230 R		381
6ED1055-1MA00-0BA2	LOGO! AM2	Expansion Module LOGO! AM2		381
6ED1055-1MB00-0BA2	LOGO! DM8 12/24 R	Expansion Module LOGO! DM8 12/24 R		380
6ED1055-1MD00-0BA2	LOGO! AM2 RTD	Expansion Module LOGO! AM2 RTD		381
6ED1055-1MM00-0BA2	LOGO! AM2 AQ	Expansion Module LOGO! AM2 AQ		382
6ED1055-1NB10-0BA2	LOGO! DM16 24 R	Expansion Module LOGO! DM16 24 R		380
6ED1057-3BA01-0AA8	LOGO! 8 12/24 V Starter Kit	LOGO! 8 12/24 V Starter Kit		386
6ED1057-3BA03-0AA8	LOGO! 8 230 V Starter Kit	LOGO! 8 230 V Starter Kit		386
6ED1057-3BA11-0AA8	LOGO! 8 TDE Starter Kit	LOGO! 8 TDE Starter Kit		386
6ED1058-0BA08-0YA1	LOGO! Soft Comfort V8	LOGO! Soft Comfort V8		386
6EP3320-6SB00-0AY0	LOGO!POWER 12 V/0,9 A	LOGO! Power 12 V/0.9 A		383
6EP3321-6SB00-0AY0	LOGO!POWER 12 V/1,9 A	LOGO! Power 12 V/1.9 A		383
6EP3322-6SB00-0AY0	LOGO!POWER 12 V/4,5 A	LOGO! Power 12 V/4.5 A		384
6EP3330-6SB00-0AY0	LOGO!POWER 24 V/0,6 A	LOGO! Power 24 V/0.6 A		384
6EP3331-6SB00-0AY0	LOGO!POWER 24 V/1,3 A	LOGO! Power 24 V/1.3 A		385
6EP3332-6SB00-0AY0	LOGO!POWER 24 V/2,5 A	LOGO! Power 24 V/2.5 A		385
6EP3333-6SB00-0AY0	LOGO!POWER 24 V/4 A	LOGO! Power 24 V/4 A		386
6GK7177-1MA20-0AA0	LOGO! CSM 12/24	Communication Module LOGO! CSM 12/24		378
BPZ:OZW772.01	OZW772.01	Web server for 1 Synco device	N5701	86
BPZ:OZW772.04	OZW772.04	Web server for 4 Synco devices	N5701	86
BPZ:OZW772.16	OZW772.16	Web server for 16 Synco devices	N5701	86
BPZ:OZW772.250	OZW772.250	Web server for 250 Synco devices	N5701	86
BPZ:QAA2012	QAA2012	Room temperature sensor Pt1000	N1745	257
BPZ:QAA2061	QAA2061	Room temperature sensor DC 0...10 V	N1749	256

Type Overview

Stock no.	Product no.	Product Title	Data sheet	Page
BPZ:QAA2061D	QAA2061D	Room temperature sensor DC0...10 V, with display	N1749	256
BPZ:QAA2071	QAA2071	Room temperature sensor 4...20mA	N1749	358
BPZ:QAC2012	QAC2012	Outside sensor Pt1000	N1811	269
BPZ:QAC3161	QAC3161	Outside/room temperature sensor DC0...10 V	N1814	257
BPZ:QAD2012	QAD2012	Strap-on temperature sensor Pt1000	N1801	256
BPZ:QAP1030.200	QAP1030.200	Cable temperature sensor PVC 2 m, NTC 10k	N1831	352
BPZ:QAW740	QAW740	Room unit with KNX bus	N1633	282
BPZ:QAX30.1	QAX30.1	Room unit with sensor and PPS2 interface	N1741	250
BPZ:QAX31.1	QAX31.1	Room unit with sensor, setpoint adjuster and PPS2 interface	N1741	250
BPZ:QAX32.1	QAX32.1	Room unit with sensor, setpoint and operating mode selector and PPS2 interface	N1641	251
BPZ:QAX33.1	QAX33.1	Room unit with sensor, setpoint and operating mode selector, fan speed selection, and PPS2 interface	N1642	251
BPZ:QAX34.3	QAX34.3	Room unit with sensor, setpoint and operating mode selector, display and PPS2 interface	N1640	251
BPZ:QFA1000	QFA1000	Room hygrostat, setpoint setting range 30...90 % r.h., setpoint adjuster inside device	N1518	363
BPZ:QFA1001	QFA1001	Room hygrostat, setpoint setting range 30...90 % r.h., external setpoint adjustment	N1518	363
BPZ:QFA2000	QFA2000	Room sensor for humidity (DC0...10 V)	N1857	361
BPZ:QFA2060	QFA2060	Room sensor for humidity (DC0...10 V) and temperature (DC0...10 V)	N1857	362
BPZ:QFA2060D	QFA2060D	Room sensor for humidity (DC0...10 V) and temperature (DC0...10 V), with digital Display	N1857	362
BPZ:QLS60	QLS60	Solar sensor	N1943	371
BPZ:QPA2000	QPA2000	Room air quality sensor CO ₂	N1961	366
BPZ:QPA2002	QPA2002	Room air quality sensor CO ₂ +VOC	N1961	366
BPZ:QPA2060	QPA2060	Room air quality sensor CO ₂ +temperature	N1961	366
BPZ:QPA2062	QPA2062	Room air quality sensor CO ₂ +temperature+rel. air humidity	N1961	367
BPZ:QPA2062D	QPA2062D	Room air quality sensor CO ₂ +temperature+rel. air humidity with display	N1961	367
BPZ:RMH760B-1	RMH760B-1	Heating controller	N3133	277
BPZ:RMK770-1	RMK770-1	Boiler sequence controller	N3132	278
BPZ:RMU710B-1	RMU710B-1	Universal controller, 1 control loop	N3150	279
BPZ:RMU720B-1	RMU720B-1	Universal controller, 2 control loops	N3150	279
BPZ:RMU730B-1	RMU730B-1	Universal controller, 3 control loops	N3150	279
BPZ:RMZ780	RMZ780	Module connector	N3138	284
BPZ:RMZ782B	RMZ782B	Heating circuit module	N3136	283
BPZ:RMZ783B	RMZ783B	DHW module	N3136	284
BPZ:RMZ785	RMZ785	Universal module (8UI)	N3146	282
BPZ:RMZ787	RMZ787	Universal module (4UI, 4DO)	N3146	282
BPZ:RMZ788	RMZ788	Universal module (4UI, 2AO, 2DO)	N3146	282
BPZ:RMZ789	RMZ789	Universal module (6UI, 2AO, 4DO)	N3146	282
BPZ:RMZ790	RMZ790	Plug-in type operator unit	N3111	281
BPZ:RMZ791	RMZ791	Detached operator unit with 3 m cable	N3112	281
BPZ:RMZ792	RMZ792	Bus operator unit	N3113	281
BPZ:RXB21.1/FC-10	RXB21.1/FC-10	Room controller for 3-speed fan	N3873	248
BPZ:RXB21.1/FC-11	RXB21.1/FC-11	Room controller for 3-speed fan	N3873	248
BPZ:RXB22.1/FC-12	RXB22.1/FC-12	Room controller with 3-speed fan and electric heating coil	N3873	248
BPZ:RXB24.1/CC-02	RXB24.1/CC-02	Room controller for chilled ceilings and radiators	N3874	248
BPZ:RXZ20.1	RXZ20.1	Terminal cover for RXB2..	N3834	250
BPZ:RXZ30.1	RXZ30.1	Terminal cover for RXB3..	N3840	250
P54593-Y195-A300	CCA-M-RENOPLUS	Reno plus option		88
P55802-Y108-A100	CCA-CMPT-ELEC	Feature set for Desigo CC Compact Electrical		87
P55802-Y108-A500	CCA-CMPT-ELEC-U	Upsell Desigo CC Compact ELEC to Desigo CC		88

Stock no.	Product no.	Product Title	Data sheet	Page
P55802-Y124-A412	CCA-100-SCADA	Add 100 SCADA data points		87
P55802-Y124-A452	CCA-500-SCADA	Add 500 SCADA data points		87
P55802-Y127-A300	CCA-OP-GRAPH-ED	Graphic Editor option		88
P55802-Y128-A300	CCA-OP-FLX-BIM	Flex BIM viewer		88
P55802-Y133-A300	CCA-P2-DRIVE	Apogee P2 driver		88
P55802-Y139-A300	CCA-OP-ECAR	e-Car integration option		88
P55802-Y152-A411	CCA-10-METER	Add 10 meter data points		87
P55802-Y156-A415	CCA-100000-ELEC	Add 100'000 electrical data points		87
P55802-Y156-A434	CCA-30000-ELEC	Add 30'000 electrical data points		87
P55802-Y156-A452	CCA-500-ELEC	Add 500 electrical data points		87
P55802-Y156-A453	CCA-5000-ELEC	Add 5'000 electrical data points		87
P55802-Y157-A412	CCA-100-BA	Add 100 building automation data points		87
P55802-Y157-A452	CCA-500-BA	Add 500 building automation data points		87
P55802-Y158-A412	CCA-100-FIRE	Add 100 fire detection data points		87
P55802-Y158-A452	CCA-500-FIRE	Add 500 fire detection data points		87
P55802-Y180-A410	CCA-1-INT-TK	Add one integration token		88
S55174-A177	STA121	Electrothermal actuator, 110N, 1m, AC/DC24V, 2P, NC	A6V12968650	263
S55174-A178	STA321	Electrothermal actuator, 110N, 1m, AC230V, 2P, NC	A6V12968650	263
S55174-A179	STP121	Electrothermal actuator, 110N, 1m, AC/DC24V, 2P, NO	A6V12968650	264
S55174-A180	STP321	Electrothermal actuator, 110N, 1m, AC230V, 2P, NO	A6V12968650	264
S55174-A181	STA121.L20	Electrothermal actuator, 110N, 2m, AC/DC24V, 2P, NC	A6V12968650	263
S55174-A182	STA321.L20	Electrothermal actuator, 110N, 2m, AC230V, 2P, NC	A6V12968650	263
S55174-A183	STP121.L20	Electrothermal actuator, 110N, 2m, AC/DC24V, 2P, NO	A6V12968650	264
S55174-A184	STP321.L20	Electrothermal actuator, 110N, 2m, AC230V, 2P, NO	A6V12968650	264
S55174-A185	STA121.L50	Electrothermal actuator, 110N, 5m, AC/DC24V, 2P, NC	A6V12968650	263
S55174-A186	STA321.L50	Electrothermal actuator, 110N, 5m, AC230V, 2P, NC	A6V12968650	263
S55174-A187	STP121.L50	Electrothermal actuator, 110N, 5m, AC/DC24V, 2P, NO	A6V12968650	264
S55174-A188	STP321.L50	Electrothermal actuator, 110N, 5m, AC230V, 2P, NO	A6V12968650	264
S55174-A195	STA121.L20H	Electrothermal actuator, 110N, 2m, AC/DC24V, 2P, NC	A6V12968650	263
S55174-A196	STA321.L20H	Electrothermal actuator, 110N, 2m, AC230V, 2P, NC	A6V12968650	263
S55180-A105	SSA331.00	Electromotoric actuators 100 N for valves with 1.2...6.5 mm stroke	A6V11858276	265
S55180-A106	SSA131.00	Electromotoric actuators 100 N for valves with 1.2...6.5 mm stroke	A6V11858276	265
S55180-A107	SSA161.05	Electromotoric actuators 100 N for valves with 1.2...6.5 mm stroke	A6V11858276	265
S55180-A108	SSA161.05HF	Electromotoric actuators 100 N for valves with 1.2...6.5 mm stroke	A6V11858278	265
S55180-A109	SSA161E.05HF	Electromotoric actuators 100 N for valves with 1.2...6.5 mm stroke	A6V11858278	265
S55180-A110	SSA151.05HF	Electromotoric actuators 100 N for valves with 1.2...6.5 mm stroke	A6V11858278	265
S55180-A111	SSA118.09HKN	Electromotoric actuators 100 N for valves with 1.2..6.5 mm stroke	A6V11858280	258
S55181-A103	SSA911.01ZB	Radiator valve actuator ZigBee	A6V12789814	266
S55370-C100	RMS705B-1	Switching and monitoring device	N3124	280
S55370-C162	RMB795B-1	Central control unit for room controllers and room thermostats	N3122	267
S55373-C121	RXB39.1/FC-13	Room controller for fan-coil applications with KNX communication	N3875	249
S55499-D134	GDB181.1E/KN	VAV compact controller KNX, AC 24 V, 5 Nm, 150 s, 300 Pa	N3547	259
S55499-D135	GLB181.1E/KN	VAV compact controller KNX, AC 24 V, 10 Nm, 150 s, 300 Pa	N3547	259
S55499-D190	GDB111.1E/KN	Rotary air damper actuators 5 Nm, without spring return	A6V11566316	260
S55499-D198	GLB111.1E/KN	Rotary air damper actuators 10 Nm, without spring return	A6V11566316	260
S55499-D203	GDB111.9E/KN	Electromotoric rotary actuator KNX for control ball valves up to DN25	A6V10725318	261
S55499-D207	GLB111.9E/KN	Electromotoric rotary actuator KNX for control ball valves up to DN50	A6V10725318	262
S55499-D263	GLB181.1EMKN	VAV compact controller, AC 24 V, 10 Nm, Multipack with KNX	N3547	259
S55499-D505	GDB181.1EMKN	VAV compact controller KNX, multipack 18 pcs. incl. ASK78.12	N3547	259
S55624-H103	QMX3.P30	Room sensor KNX for temperature, white	N1602	242
S55624-H104	QMX3.P70	Room sensor KNX for temperature, humidity, CO2, white	N1602	246

Type Overview

Stock no.	Product no.	Product Title	Data sheet	Page
S55624-H105	QMX3.P34	Room operator unit KNX with temperature sensor, segmented backlit display, touchkeys, white	N1602	64
S55624-H106	QMX3.P74	Room operator unit KNX with sensors for temperature, humidity, CO ₂ , segmented backlit display, touchkeys, white	N1602	70
S55624-H107	QMX3.P02	Room operator unit KNX with temperature sensor, configurable touchkeys, LED display, white	N1602	62
S55624-H108	QMX3.P37	Room operator unit KNX with temperature sensor, segmented backlit display, configurable touchkeys, LED display, white	N1602	66
S55624-H110	QMX3.MP1	Basic plate for conduit and cavity wall box	N1602	71
S55624-H116	QMX3.P40	Room sensor KNX for temperature and humidity, white	N1602	244
S55624-H123	QMX3.P30-1BSC	Room sensor KNX for temperature, black	N1602	243
S55624-H124	QMX3.P40-1BSC	Room sensor KNX for temperature and humidity, black	N1602	245
S55624-H125	QMX3.P70-1BSC	Room sensor KNX for temperature, humidity, CO ₂ , black	N1602	247
S55624-H126	QMX3.P34-1BSC	Room operator unit KNX with temperature sensor, segmented backlit display, touchkeys, black	N1602	65
S55624-H127	QMX3.P74-1BSC	Room operator unit KNX with sensors for temperature, humidity, CO ₂ , segmented backlit display, touchkeys, black	N1602	71
S55624-H128	QMX3.P02-1BSC	Room operator unit KNX with temperature sensor, configurable touchkeys, LED display, black	N1602	63
S55624-H129	QMX3.P37-1BSC	Room operator unit KNX with temperature sensor, segmented backlit display, configurable touchkeys, LED display, black	N1602	67
S55624-H143	QMX3.P44	Room operator unit KNX with sensors for temperature, humidity, segmented backlit display, touchkeys, white	N1602	68
S55624-H144	QMX3.P44-1BSC	Room operator unit KNX with sensors for temperature, humidity, segmented backlit display, touchkeys, black	N1602	69
S55720-S119	QPA1000	Room air quality sensor VOC	N1961	365
S55720-S133	AQR2531ANW	Front module with passiv temperature measurement, LG-Ni1000	N1408	239
S55720-S136	AQR2532NNW	Front module for base modules, temperature (active)	N1411	238
S55720-S137	AQR2530NNW	Front module for base module, without sensor	N1411	238
S55720-S141	AQR2535NNW	Front module for base modules, humidity and temperature (active)	N1411	239
S55720-S142	AQR2540NF	Base module for temperature and humidity measurement, 70.8 x 70.8 mm	N1410	360
S55720-S146	AQR2547NF	Base module with integrated VOC measurement, 70.8 x 70.8 mm	N1410	369
S55720-S147	AQR2546NF	Base module with integrated CO ₂ measurement, 70.8 x 70.8 mm	N1410	369
S55720-S148	AQR2548NF	Base module with integrated CO ₂ and VOC measurement, 70.8 x 70.8 mm	N1410	370
S55720-S161	AQR2500NF	Mounting plate EU (CEE/VDE)	N1408	60
S55720-S163	AQR2500NG	Mounting plate IT (3 modular)	N1408	60
S55720-S203	AQR2570NF	Base module for temperature and / or humidity measurement, with KNX / PL-Link, 70.8 x 70.8	N1411	240
S55720-S204	AQR2570NH	Base module for temperature and / or humidity measurement, with KNX / PL-Link, 83 x 83	N1411	240
S55720-S205	AQR2570NG	Base module for temperature and / or humidity measurement, with KNX / PL-Link, 110 x 64	N1411	240
S55720-S206	AQR2570NJ	Base module for temperature and / or humidity measurement, with KNX / PL-Link, 64 x 110	N1411	240
S55720-S207	AQR2576NF	Base module for CO ₂ measurement, with KNX / PL-Link, 70.8 x 70.8 mm	N1411	241
S55720-S208	AQR2576NH	Base module for CO ₂ measurement, with KNX / PL-Link, 83 x 83 mm	N1411	241
S55720-S209	AQR2576NG	Base module for CO ₂ measurement, with KNX / PL-Link, 110 x 64 mm	N1411	241
S55720-S210	AQR2576NJ	Base module for CO ₂ measurement, with KNX / PL-Link, 64 x 110 mm	N1411	241
S55720-S219	AQR2535NNWQ	Front module for base module, humidity and temperature, with LED	N1411	239
S55720-S453	QPA1004	Room air quality sensor CO ₂	A6V101099173	365
S55720-S454	QPA1064	Room air quality sensor CO ₂ / temperature	A6V101099173	365
S55720-S457	QSA2700	Fine dust sensor, 0-10V & Modbus	A6V11160938	368
S55720-S458	QSA2700D	Fine dust sensor +display, 0-10V, Modbus	A6V11160938	368

Stock no.	Product no.	Product Title	Data sheet	Page
S55770-T293	RDF600KN	Flush mount KNX room thermostat for 2-/4-pipe FCU with on/off output and 2x universal input, fit for both round and square conduit boxes	N3076	73
S55770-T348	RDG405KN	Room thermostat for temperature and air quality control with KNX communications, AC 24 V, VAV heating and cooling systems	N3192	82
S55770-T350	RDF800KN	Flush mount touch KNX room thermostat for 2-/4-pipe FCU with on/off output and 2x universal input, fit for both round and square conduit boxes	N3174	72
S55770-T375	QXA2100	Condensation monitor	A6V10741072	271
S55770-T376	QXA2101	Condensation monitor with remote sensor head (cable length 1 m)	A6V10741072	271
S55770-T400	RDF600KN/S	Flush mount KNX room thermostat for 2-/4-pipe FCU with on/off output, KNX switching group, four buttons for switching lights and blinds and 2x universal input, fit for both round and square conduit boxes	N3076	73
S55770-T407	RDF870KN	Flush mount touch KNX PM2.5 & CO2 & Ventilation Controls with on/off or ECM fans selectable and 2x DC 0-10 V input, fit for both round and square conduit boxes	A6V11439454	74
S55770-T409	RDG200KN	KNX communicating room thermostat. Outputs modulating (PWM / 3-pos.) or on/off. Fan coil (3-speed / DC fan), universal applications	A6V11545853	76
S55770-T410	RDG204KN	KNX communicating room thermostat with CO2 sensor. Outputs modulating (PWM / 3-pos.) or on/off. Fan coil (3-speed / DC fan), universal applications	A6V11545853	78
S55770-T412	RDG260KN	KNX communicating room thermostat. Outputs modulating (DC) or on/off. Fan coil (3-speed / DC fan) or universal applications	A6V11545853	79
S55770-T413	RDG264KN	KNX communicating room thermostat with CO2 sensor. Outputs modulating (DC) or on/off. Fan coil (3-speed / DC fan) or universal applications	A6V11545853	81
S55770-T429	RDF800KN/VB	Flush mount touch KNX room thermostat for 2-/4-pipe FCU with on/off output and 2x universal input, fit for both round and square conduit boxes, black	N3174	72
S55770-T430	RDF600KN/VB	Flush mount KNX room thermostat for 2-/4-pipe FCU with on/off output and 2x universal input, fit for both round and square conduit boxes, black	N3076	73
S55770-T452	RDG200KN/BK	KNX communicating room thermostat in black. Outputs modulating (PWM / 3-pos.) or on/off. Fan coil (3-speed / DC fan), universal applications	A6V11545853	77
S55770-T453	RDG260KN/BK	KNX communicating room thermostat in black. Outputs modulating (DC) or on/off. Fan coil (3-speed / DC fan) or universal applications	A6V11545853	80
S55800-Y100	ACS790	Commissioning and plant operating software	N5649	285
S55800-Y101	OCI702	USB - KNX Service interface	A6V10438951	286

Display and operation units



Overview and selection tools		30
Pushbuttons	Pushbuttons bus transceiver module (BTM)	40
	Pushbuttons flush-mounted	44
Pushbutton accessories	Frames DELTA line	45
	Frames DELTA miro color	50
	Frames DELTA miro glass	52
	Frames DELTA miro aluminium	54
	Frames DELTA style	55
	Frames GAMMA UL/NEMA	56
	Wall-mounted enclosures	57
Room temperature controllers with integrated sensor and operation	i-system	58
Multifunction device	Flush-mounted	59
	Wall-mounted	62
Room thermostats	Flush-mounted	72
	Wall-mounted	75
Touch panels		83
Visualization, server		85
	Accessories for N 152/01	85
Visualization, software		87
	Data points	87
	Options	88

Display and operation units

Overview and selection tools

Modular bus transceiver module and flush-mounting actuator

A key feature of the GAMMA instabus is its uniform bus transceiver module. The bus transceiver module (BTM) can be used as a stand-alone unit, as well as a combined version in various devices of the flush-mounting actuator range.

Implementation of the BTI interface (Bus Transceiver Interface) with the bus transceiver module (BTM) ensures maximum flexibility and an impressive range of functions. Bus coupling units (BTM) and flush-mounting actuators with integrated bus transceiver modules (BTM) enable the use of GAMMA display/operator interfaces, such as pushbuttons, room temperature controllers and operation units in a wide range of designs. Thus, all GAMMA instabus operator interfaces with BTI interface in the design lines i-system and DELTA style can be combined with either a bus transceiver module (BTM) or a flush-mounting actuator with bus transceiver module (BTM).

This reduces planning work and facilitates installation and commissioning. The application programs of the flush-mounting actuators are identical to those of the functionally equivalent devices from the modular room control range. This means that all devices have the same standard application program - regardless of mounting type - whether flush-mounting, with or without mounting frame - or whether designed for installation in the room control box and automation module box.

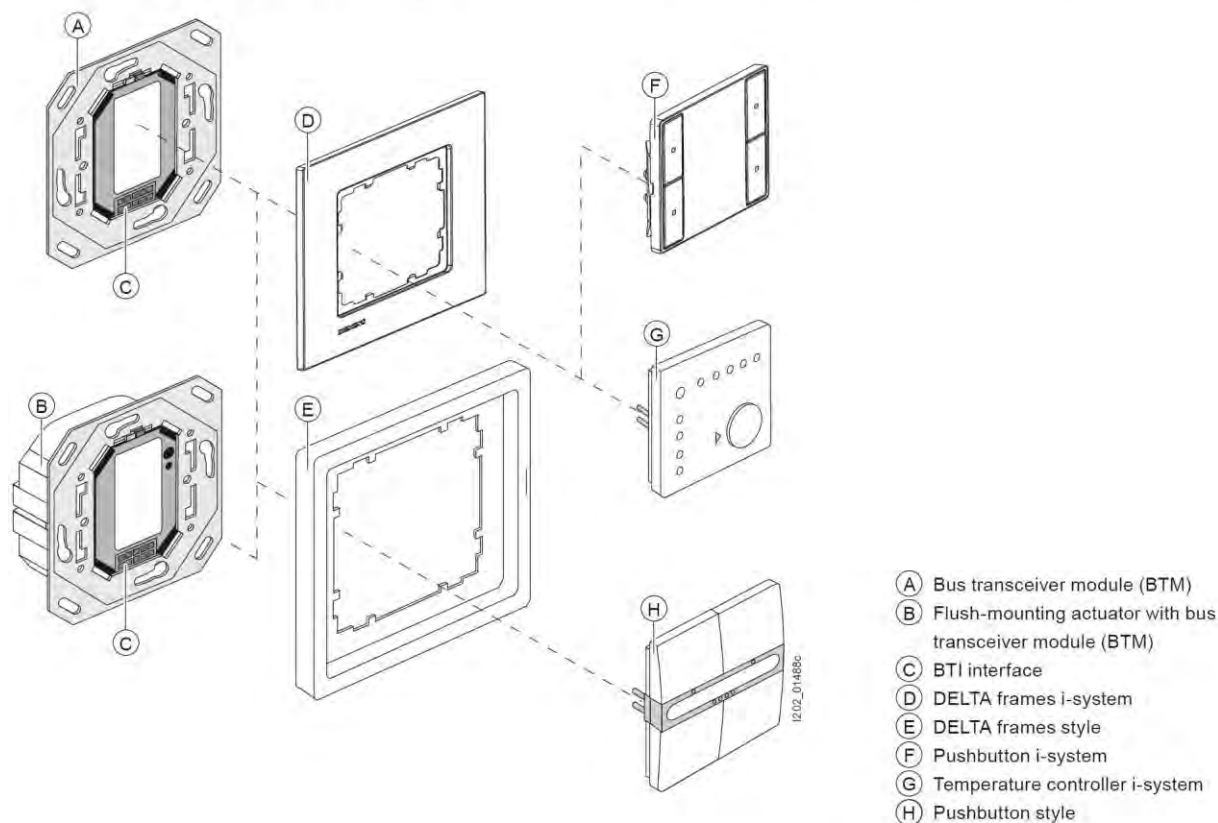

GAMMA arina-Taster

Touch sensors GAMMA arina – in a matching design program

The attractive design of the touch sensors GAMMA arina is harmonized with the switch and socket program DELTA arina. GAMMA arina was designed in China for the Asian market. This design line consists of several switches and a communicative KNX thermostat. The arina program is a complete comprehensive solution for room automation. Switches, sockets and data outlets in the arina program together with intelligent display and operation units generate a coordinated, harmonious appearance in the room.

Harmony in variety and function

The parameters of the touch sensors GAMMA arina conform to the parameters and functions of the existing program DELTA i-system and style. The installers and system integrators can parameterize with a continuous, harmonious application program in the usual structure. With the touch sensors GAMMA arina all standard functions in a room can be controlled.

There are 1-fold, 2-fold and 4-fold sensors, with orientation lights, with or without status LED to choose. The 4-fold touch sensors can be featured with a temperature sensor. Therefore the integration into a room temperature control is possible. With the integrated scene control a complete scene can be controlled with a single touch.

Technical structure

The touch sensors GAMMA arina are designed as a compact mono block version. A separate bus connection is not necessary. The structure and installation of the touch sensors GAMMA arina are similar to the product line arina. The device block is square shaped and can only be picked up from a square shaped installation box (86 x 86 millimeters). The program is issued to the UK installation standard or for the area Asia Pacific/ China.

The touch sensors GAMMA arina are installed in a mounting frame. They can be mounted in single or multiple frames. The multiple mounting frames must be ordered separately.

Note:

The touch sensors GAMMA arina are not designed for round installation boxes in accordance with DIN / VDE.

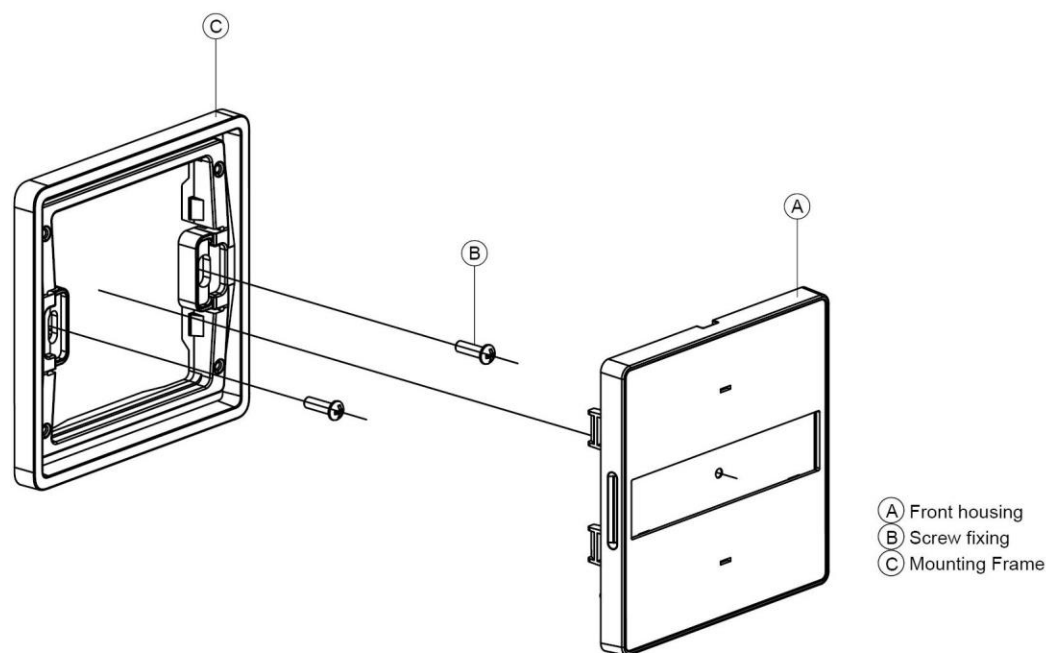

Display and operation units

Overview and selection tools

Visualization with a PC



Visualization with a tablet



Web visualization for a KNX system

The IP Control Center N 152 allows web visualization of KNX systems on various web-based operating devices. The visualization controller can be used to design intuitive operating and display interfaces for PCs, laptops, tablets or smartphones on an individual basis.

Up to 1250 values and states can be set for the various building and room functions, as well as a high-performance application module and the scope also includes an annual time switch program with an astronomic calendar, while the scene control allows you to call up and record up to 5000 scenes and events. A range of data points, e.g. consumption values and weather records can also be shown in the form of curve or bar charts, while data can be monitored and stored to facilitate fault diagnosis and via an interface, IP devices can be controlled using TCP/UDP commands. Alarm notifications are signaled both visually and audibly as well as being managed in an alarm history. Alarm notifications can also be sent as recorded trend data or monitor data by email.

Your choice of web content can be shown, such as news or weather forecasts, as well as scope to display images or films from IP cameras.

The commissioning process is performed with the ETS, while a graphic editor and smart editor are permanently installed in the device to help when developing projects.

The web editor allows wide-ranging display and operating elements to be arranged using the drag-and-drop approach, while the user interface can be individually configured with personal or pre-existing elements from a comprehensive library. The scope also extends to six different selectable styles and building views and floor plans can be depicted as background images.

The Smart Editor allows you to develop visualizations specially tailored for mobile browsers on smartphones or tablets, swiftly and intuitively.

Visualization with a smartphone



A clear model project is available via download for the IP Control Center.

For applications in industrial environment, e.g. installation in a control board, are powerful operation terminals SIMATIC ITC from 12" to 22" available. For further information see:

www.siemens.com/simatic-thin-client

Display and operation units Overview and selection tools

Desigo CC™ Compact for Electrical Applications

Desigo CC™ Compact for Electrical Applications offers full integration of lighting and all other electrical assets through KNX protocol, while also supporting in the southbound open standards such as BACnet, OPC, Modbus, and many more. Options are available for dedicated, browser-based, and Windows desktop app clients using the same user interface. Additionally, web interfaces provide increased flexibility for operation and future extensions such as mobile applications for tablets and smartphones.

User interface



State-of-art management station improving the energy efficiency, safety and reliability of electrical equipment in buildings.

Visualization and management of all systems from one location and easy control of building from everywhere



- Centralized management lighting system
- Intuitive light symbols with embedded applications
- Light symbols with graphic commanding functionality
- Scenarios operation
- Easy scheduler definition
- Remote access through web and mobile app

Easy to engineer, commission and maintain



- Simplified integration through ETS project import and KNX discovery functionality
- Engineering Efficiency through automatic hierarchical views creation has defined in ETS
- Unique tool for management engineering and commissioning
- Specific libraries for GAMMA devices, such as the KNX/DALI GW N 141 which include an automatic error and test decodification
- Diagnostic functionality for devices in the KNX network
- Support of KNX IP Secure
- Ease of commissioning and engineering through an automatic installation and project configuration procedure

Display and operation units

Overview and selection tools

Intelligent room control with the KNX Touch Control TC5

Not only beautiful, but also smart: The modern and slim room unit Touch Control TC5 from the GAMMA instabus product line is a stylish eye-catcher in every room thanks to its high-quality glass surface and makes a smart room control easier than ever. The 5-inch color display is based on the intuitive operating concept of typing and swiping and can be easily adapted to the local needs. The TC5 supports all KNX control functions in the room: from lighting, to solar protection, up to HVAC applications. Due to the customizable scene control and timer functions, the device is optimally suited for functional buildings such as offices and hotels.

The smart way to a productive and healthy working environment



Slim design:

The color touch panel of the TC5 offers not only visually a modern design, but with its intuitive and simple user interface a comfortably stay in rooms and buildings.



Best lighting:

With the KNX Touch Control TC5 it is possible to switch and dim lighting as well as RGB- and RGBW-LEDs and to adjust color temperature and brightness.



Optimum indoor air quality:

The KNX Touch Control TC5 gives users all options to create a healthy room atmosphere and to control the fan coil unit, chilled ceiling, VRF application and floor heating as well as the air ventilation according to PM2.5 or CO2 values.

Display and operation units Overview and selection tools

Pushbuttons bus transceiver module (BTM)

Design	i-system							DELTA style						
	UP 221/..2	UP 221/..3	UP 222/..2	UP 222/..3	UP 223/..2	UP 223/..3	UP 223/..4	UP 285/..2	UP 285/..3	UP 286/..2	UP 286/..3	UP 287/..2	UP 287/..3	UP 287/..4
Type	909301													
Application program ¹⁾	909301													
Enclosure data														
Dimensions														
• Width [mm]	55							68						
• Height [mm]	55							68						
• Depth [mm]	11							14						
Display/control elements														
Individual pushbuttons	2	2	4	4	6	6	6	2	2	4	4	8	8	8
Pushbutton pairs	1	1	2	2	3	3	3	1	1	2	2	4	4	4
Operation (v: vertical, h: horizontal)	h	h	h	h	h	h	h	v	v	v	v	v	v	v
LED per pushbutton pair for status indication		2		2		2	2		2		2		2	2
LED for orientation light (ON/OFF configurable/dimmable)	■	■	■	■	■	■	■	■	■	■	■	■	■	■
LED brightness configurable and controllable via object	■	■	■	■	■	■	■	■	■	■	■	■	■	■
Bus connection														
For plugging onto a bus transceiver module (BTM) or a flush-mounting actuator with bus transceiver module (BTM)	■	■	■	■	■	■	■	■	■	■	■	■	■	■
Inputs														
Integrated room temperature sensor							■							■
Input functions														
Switching														
Switching ON/OFF/OVER	■	■	■	■	■	■	■	■	■	■	■	■	■	■
Pushbutton function (bell function)	■	■	■	■	■	■	■	■	■	■	■	■	■	■
Dimming														
Dimming with stop telegram (4-bit)	■	■	■	■	■	■	■	■	■	■	■	■	■	■
• Short button press, ON/OFF	■	■	■	■	■	■	■	■	■	■	■	■	■	■
• Long button press, BRIGHTER/DARKER	■	■	■	■	■	■	■	■	■	■	■	■	■	■
One-pushbutton dimming	■	■	■	■	■	■	■	■	■	■	■	■	■	■
Value transmission														
8 bit/percent/16 bit	■	■	■	■	■	■	■	■	■	■	■	■	■	■
Brightness value	■	■	■	■	■	■	■	■	■	■	■	■	■	■
Temperature value	■	■	■	■	■	■	■	■	■	■	■	■	■	■
Positively driven operation	■	■	■	■	■	■	■	■	■	■	■	■	■	■
Time-delayed transmission of a second telegram, depending on main function	■	■	■	■	■	■	■	■	■	■	■	■	■	■
Button deactivation	■	■	■	■	■	■	■	■	■	■	■	■	■	■
Shutter/blind														
Shutter/blind control	■	■	■	■	■	■	■	■	■	■	■	■	■	■
• Short button press, slat OPEN/CLOSED or STOP	■	■	■	■	■	■	■	■	■	■	■	■	■	■
• Long button press, UP/DOWN	■	■	■	■	■	■	■	■	■	■	■	■	■	■
One-pushbutton sun protection	■	■	■	■	■	■	■	■	■	■	■	■	■	■
Scene														
Integrated 8-bit scene control (channels)							8							8
Assignments per channel							8							8
Store and call up scene, 8-bit	■	■	■	■	■	■	■	■	■	■	■	■	■	■
Store and call up scene, 1-bit	■	■	■	■	■	■	■	■	■	■	■	■	■	■
Short or long button press (store/call up scene), configurable	■	■	■	■	■	■	■	■	■	■	■	■	■	■
Status														
LED on/off/flashing depending on the value (1 bit/8 bit/16 bit)		■		■		■	■		■		■		■	■
Pushbutton operation display configurable via LED		■		■		■	■		■		■		■	■

¹⁾ For current application programs, see www.siemens.com/gamma-td

Display and operation units

Overview and selection tools

Pushbuttons flush-mounted							
Design	GAMMA arina						
							
Type	UP 201/..2	UP 201/..3	UP 202/..2	UP 202/..3	UP 203/..2	UP 203/..3	UP 203/..4
Application program ¹⁾	910301						
Enclosure data							
Dimensions							
• Width [mm]	86						
• Height [mm]	86						
• Depth [mm]	14,6						
Display/control elements							
Individual pushbuttons	2	2	4	4	8	8	8
Pushbutton pairs	1	1	2	2	4	4	4
Operation (v: vertical, h: horizontal)	v	v	v	v	v	v	v
LED per pushbutton pair for status indication	2						
LED for orientation light (ON/OFF configurable/dimmable)	■	■	■	■	■	■	■
LED brightness configurable and controllable via object	■	■	■	■	■	■	■
Bus connection							
Monoblock	■	■	■	■	■	■	■
Inputs							
Integrated room temperature sensor							■
Input functions							
Switching							
Switching ON/OFF/OVER	■	■	■	■	■	■	■
Pushbutton function (bell function)	■	■	■	■	■	■	■
Dimming							
Dimming with stop telegram (4-bit)	■	■	■	■	■	■	■
• Short button press, ON/OFF	■	■	■	■	■	■	■
• Long button press, BRIGHTER/DARKER	■	■	■	■	■	■	■
One-pushbutton dimming	■	■	■	■	■	■	■
Value transmission							
8 bit/percent/16 bit	■	■	■	■	■	■	■
Brightness value	■	■	■	■	■	■	■
Temperature value	■	■	■	■	■	■	■
Positively driven operation	■	■	■	■	■	■	■
Time-delayed transmission of a second telegram, depending on main function	■	■	■	■	■	■	■
Button deactivation	■	■	■	■	■	■	■
Shutter/blind control							
• Short button press, slat OPEN/CLOSED or STOP	■	■	■	■	■	■	■
• Long button press, UP/DOWN	■	■	■	■	■	■	■
One-pushbutton sun protection	■	■	■	■	■	■	■
Scene							
Integrated 8-bit scene control (channels)							8
Assignments per channel							8
Store and call up scene, 8-bit	■	■	■	■	■	■	■
Store and call up scene, 1-bit	■	■	■	■	■	■	■
Short or long button press (store/call up scene), configurable	■	■	■	■	■	■	■
Status							
LED on/off/flashing depending on the value (1 bit/8 bit/16 bit)	■	■	■	■	■	■	■
Pushbutton operation display configurable via LED	■	■	■	■	■	■	■

¹⁾ For current application programs, see www.siemens.com/gamma-td

Display and operation units

Overview and selection tools

Room temperature controller



Type	 RDF600KN...	 RDF600KN/S	 RDF800KN...	 RDF870KN	 RDG200KN	 RDG204KN	 RDG260KN	 RDG264KN	 RDG405KN	 UP 237K i-system
Design										
Wall mounted					■	■	■	■	■	
Semi-Flush Mounted	■	■	■	■						■
For VDE/CEE box	■	■	■	■						■
For British Standard box	■	■	■	■						
Housing										
Digital display	■	■	■	■	■	■	■	■	■	
Touch Screen Display			★	■						
LED indicators										■
Setpoint rotary knob					■	■	■	■	■	■
Operating mode button	■	■			■	■	■	■	■	■
Green Leaf					■	■	■	■		
Fan speed button	■	■			■	■	■	■	■	
Buttons for light and blind control		★								
Bus connection										
Integrated bus coupling units	■	■	■	■	■	■	■	■	■	
For plugging onto a bus coupling units (BTM)										■
Power supply										
Bus-powered electronic										■
Terminal voltage AC 230 V	■	■	■	■	■	■				
Terminal voltage AC 24 V					■	■	■	■	■	
Integrated sensor										
Room temperature sensor	■	■	■	■	■	■	■	■	■	■
Humidity sensor					■		■			
CO2 sensor						★		★		
Inputs										
Multifunctional inputs digital/analog	2	2	2	2	3	3	3	3	2	
Input DC 0...10 V				■					1	
Outputs										
ON/OFF (PWM) Triac (H/C)					★	★			■	
ON/OFF Relay (H/C)	★	★	■				■	■		
Analog outputs DC 0...10 V (H/C)				■ ¹⁾			★	★	■	
3-stage Relay (fan)	■	■	■		■	■	■	■		
Analog DC 0...10 V (fan)				■	■	■	■	■		
Applications										
Fancoil 2-/4-pipe with/without electrical heater	■	■	■		■	■	■	■		
Fancoil with Radiator					■	■	■	■		
Heating / Cooling 2-/4-pipe			■		■	■	■	■		■
Heating / Cooling with 6-port valve							★	★		
Humidity control					■	■	■	■		
Indoor Air Quality				★ ²⁾		★		★	■	
Heat Pump System	■	■	■				■	■		■
VAV with electrical heater and radiator / Heat Cool coil									■	
Commissioning Tool					■	■	■	■		
Functionalities										
2-position control	■	■	■	■ ⁵⁾	■	■	■	■	■	■
Modulating control	■ ³⁾	■ ³⁾	■ ³⁾	■ ⁵⁾	■	■	■	■	■	■
2-stage control sequence for heating or cooling	■ ⁴⁾	■ ⁴⁾	■ ⁴⁾		■	■	■	■	■	■
Operating mode										
Comfort, Economy, Protection	■	■	■	■ ⁵⁾	■	■	■	■	■	■
Pre-Comfort										■
Manual / Auto operating mode	■	■	■	■ ⁵⁾	■	■	■	■	■	■

¹⁾ available for 1-/3-/4-stage Relay (fan) ²⁾ PM2.5 or CO₂ or both controls plus display VOC ³⁾ modulating output only for 2-pipe applications ⁴⁾ only for 2-stage heating ⁵⁾ only fan control functions

■ valid for all variants ★ main feature

Display and operation units

Overview and selection tools

Multifunction devices							
Type	 UP227	 UP 205/21	 QMX3.P34	 QMX3.P44	 QMX3.P74	 QMX3.P02	 QMX3.P37
Mounting							
Wall mounted			■	■	■	■	■
Flush mounted	■ ¹⁾	■					
Display-/operating elements							
Display	■	■	■	■	■		■
Capacitive buttons	■						■
LED indicators per button						■	■
LED indicators central	■	■					
Proximity sensor		■					
Sensors							
Temperature	■	■	■	■	■	■	■
Humidity				■	■		
Air quality CO ₂					■		
Bus interface							
- Integrated bus coupling unit	■	■	■	■	■	■	■
Power supply							
- KNX bus voltage	■	■	■	■	■	■	■
- Additional power supply DC 24 V		■					
Functionalities							
Switching ON/OFF/OVER	■	■				■	■
Pushbutton function (bell function)	■						
Dimming	■	■				■	■
Send Values							
- 8 bit/value		■					
- 8 bit/percent	■	■				■	■
- 16 bit	■						
- Brightness value	■						
- Temperature value	■	■					
- Wind speed value	■						
Display value							
- 1 bit	■						
- 8 bit/percent/16 bit	■						
- Brightness value	■	■					
- Temperature value	■	■	■	■	■		■
- Humidity value		■					
- Air Quality (PM2.5, PM10, VOC, CO ₂ , AQI)		■					
- Wind speed value	■	■					
- Metering values		■					
- Text messages	■						
Alarmhandling	■	■					
Forced control	■	■					
Shutter-/blind control	■	■				■	■
Call and save scene, 1 bit	■						
Call and save scene, 8 bit	■	■				■	■
Button deactivation	■		■	■	■		■
Deactivation of the display via password protection		■					
Time switch schedules	■	■					

¹⁾ Design line i-system

Display and operation units Overview and selection tools

Multifunction devices

Type	 UP227	 UP 205/21	 QMX3.P34	 QMX3.P44	 QMX3.P74	 QMX3.P02	 QMX3.P37
Room temperature controller functionality							
Setpoint value setting, absolute	■	■	■	■	■		■
Setpoint value shifting	■	■	■	■	■		■
Setting operating modes	■	■	■	■	■		■
Setting comfort prolongation	■	■	■	■	■		■
Heating/Cooling	■	■	■	■	■		■
Two-point control	■	■	■	■	■		■
Continuous control	■	■	■	■	■		■
Two-level heating and cooling (sequenz)	■		■	■	■		■
Applications							
Radiator	■	■	■	■	■	■	■
Underfloor heating	■	■	■	■	■	■	■
Fancoil	■	■					
Threshold control for humidity			■	■	■	■	■
Threshold control for air quality		■	■	■	■	■	■

¹⁾ Design line i-system

Display and operation units

Pushbuttons

Pushbuttons bus transceiver module (BTM)

UP 22..



Pushbutton, i-system

- Pushbutton in pair
- Horizontal operation
- Per pushbutton selectable function
- LED for orientation light
- Labeling field
- Connectable bus coupling unit (BTM) or flush-mounted actuators via BTI



Range overview UP 22..

Product Title	Dimensions (WxHxD) [mm]	Stock no.	Product no.
Pushbutton, single, without status LED, titanium white, i-system	55 x 55 x 11	5WG1221-2DB12	UP 221/12
Pushbutton, single, with status LED, titanium white, i-system	55 x 55 x 11	5WG1221-2DB13	UP 221/13
Pushbutton, single, without status LED, aluminum metallic, i-system	55 x 55 x 11	5WG1221-2DB32	UP 221/32
Pushbutton, single, with status LED, aluminum metallic, i-system	55 x 55 x 11	5WG1221-2DB33	UP 221/33
Pushbutton, double, without status LED, titanium white, i-system	55 x 55 x 11	5WG1222-2DB12	UP 222/12
Pushbutton, double, with status LED, titanium white, i-system	55 x 55 x 11	5WG1222-2DB13	UP 222/13
Pushbutton, double, without status LED, aluminum metallic, i-system	55 x 55 x 11	5WG1222-2DB32	UP 222/32
Pushbutton, double, with status LED, aluminum metallic, i-system	55 x 55 x 11	5WG1222-2DB33	UP 222/33
Pushbutton, triple, without status LED, titanium white, i-System	55 x 55 x 11	5WG1223-2DB12	UP 223/12
Pushbutton, triple, with status LED, titanium white, i-System	55 x 55 x 11	5WG1223-2DB13	UP 223/13
Pushbutton, triple, without status LED, aluminum metallic, i-system	55 x 55 x 11	5WG1223-2DB32	UP 223/32
Pushbutton, triple, with status LED, aluminum metallic, i-system	55 x 55 x 11	5WG1223-2DB33	UP 223/33

The bus transceiver module (BTM) (see Chapter System Products and Accessories) or flush-mounting actuator with bus transceiver module (BTM) must be ordered separately. The matching design frame must be ordered separately. See Chapter Display and Operation Units – Pushbutton accessories.

Pushbutton with scene controller and room temperature sensor, i-system

UP 223/..4

- Pushbutton in 3 pairs
- Horizontal operation
- Per pushbutton selectable function, scene controller
- LED for orientation light
- Labeling field
- Temperature sensor
- Connectable bus coupling unit (BTM) or flush-mounted actuators via BTI



Data sheet

A6V10416510

**Range overview UP 223/..4**

Product Title	Dimensions (WxHxD) [mm]	Stock no.	Product no.
Pushbutton, triple, with status LED, with scene controller, with room temperature sensor, titanium white, i-system	55 x 55 x 11	5WG1223-2AB14	UP 223/14
Pushbutton, triple, with status LED, with scene controller, with room temperature sensor, aluminum metallic, i-system	55 x 55 x 11	5WG1223-2AB34	UP 223/34

The bus transceiver module (BTM) (see Chapter System Products and Accessories) or flush-mounting actuator with bus transceiver module (BTM) must be ordered separately. The matching design frame must be ordered separately. See Chapter Display and Operation Units - Pushbutton accessories.

Display and operation units

Pushbuttons

Pushbuttons bus transceiver module (BTM)

UP 28..



Pushbutton, DELTA style

- Pushbutton in pair
- Vertical operation
- Per pushbutton selectable function
- LED for orientation light
- Labeling field
- Connectable bus coupling unit (BTM) or flush-mounted actuators via BTI



Range overview UP 28..

Product Title	Dimensions (WxHxD) [mm]	Stock no.	Product no.
Pushbutton, single, without status LED, titanium white, DELTA style	68 x 68 x 14	5WG1285-2DB12	UP 285/12
Pushbutton, single, with status LED, titanium white, DELTA style	68 x 68 x 14	5WG1285-2DB13	UP 285/13
Pushbutton, single, without status LED, platinum metallic, DELTA style	68 x 68 x 14	5WG1285-2DB42	UP 285/42
Pushbutton, single, with status LED, platinum metallic, DELTA style	68 x 68 x 14	5WG1285-2DB43	UP 285/43
Pushbutton, double, without status LED, titanium white, DELTA style	68 x 68 x 14	5WG1286-2DB12	UP 286/12
Pushbutton, double, with status LED, titanium white, DELTA style	68 x 68 x 14	5WG1286-2DB13	UP 286/13
Pushbutton, double, without status LED, platinum metallic, DELTA style	68 x 68 x 14	5WG1286-2DB42	UP 286/42
Pushbutton, double, with status LED, platinum metallic, DELTA style	68 x 68 x 14	5WG1286-2DB43	UP 286/43
Pushbutton, quadruple, without status LED, titanium white, DELTA style	68 x 68 x 14	5WG1287-2DB12	UP 287/12
Pushbutton, quadruple, with status LED, titanium white, DELTA style	68 x 68 x 14	5WG1287-2DB13	UP 287/13
Pushbutton, quadruple, without status LED, platinum metallic, DELTA style	68 x 68 x 14	5WG1287-2DB42	UP 287/42
Pushbutton, quadruple, with status LED, platinum metallic, DELTA style	68 x 68 x 14	5WG1287-2DB43	UP 287/43

The bus transceiver module (BTM) (see Chapter System Products and Accessories) or flush-mounting actuator with bus transceiver module (BTM) must be ordered separately. The matching design frame must be ordered separately. See Chapter Display and Operation Units - Pushbutton accessories.

Pushbuttons bus transceiver module (BTM)

Pushbutton with scene controller and room temperature sensor, DELTA style

UP 287/..4

- Pushbutton in 4 pairs
- Vertical operation
- Per pushbutton selectable function, scene controller
- LED for orientation light
- Labeling field
- Temperature sensor
- Connectable bus coupling unit (BTM) or flush-mounted actuators via BTM

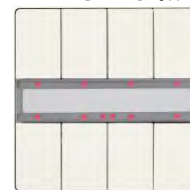

Data sheet

A6V10416538



Range overview UP 287/..4

Product Title	Dimensions (WxHxD) [mm]	Stock no.	Product no.
Pushbutton, quadruple, with status LED, titanium white, DELTA style	68 x 68 x 14	5WG1287-2AB14	UP 287/14
Pushbutton, quadruple, with status LED, platinum metallic, DELTA style	68 x 68 x 14	5WG1287-2AB44	UP 287/44

The bus transceiver module (BTM) (see Chapter System Products and Accessories) or flush-mounting actuator with bus transceiver module (BTM) must be ordered separately. The matching design frame must be ordered separately. See Chapter Display and Operation Units - Pushbutton accessories.

Display and operation units

Pushbuttons

Pushbuttons flush-mounted

UP 20..



Touch Sensors GAMMA arina

- Pair of touch areas for vertical operation
- Per touch area selectable function
- LED for orientation light
- Labeling field
- Integrated bus coupling unit



Range overview UP 20..

Product Title	Dimensions (WxHxD) [mm]	Stock no.	Product no.
Touch sensor, single, without status LED, GAMMA arina, white	86 x 86 x 14.6	5WG1201-2DB12	UP 201/12
Touch sensor, single, with status LED, GAMMA arina, white	86 x 86 x 14.6	5WG1201-2DB13	UP 201/13
Touch sensor, single, with status LED, GAMMA Arina, Black	86 x 86 x 14.6	5WG1201-2DB23	UP 201/23
Touch sensor, single, with status LED, GAMMA Arina, Ash gold	86 x 86 x 14.6	5WG1201-2DB43	UP 201/43
Touch sensor, double, without status LED, GAMMA arina, white	86 x 86 x 14.6	5WG1202-2DB12	UP 202/12
Touch sensor, double, with status LED, GAMMA arina, white	86 x 86 x 14.6	5WG1202-2DB13	UP 202/13
Touch sensor, double, with status LED, GAMMA Arina, Black	86 x 86 x 14.6	5WG1202-2DB23	UP 202/23
Touch sensor, double, with status LED, GAMMA Arina, Ash gold	86 x 86 x 14.6	5WG1202-2DB43	UP 202/43
Touch sensor, quadruple, without status LED, GAMMA arina, white	86 x 86 x 14.6	5WG1203-2DB12	UP 203/12
Touch sensor, quadruple, with status LED, GAMMA arina, white	86 x 86 x 14.6	5WG1203-2DB13	UP 203/13
Touch sensor, quadruple, with status LED, GAMMA Arina, Black	86 x 86 x 14.6	5WG1203-2DB23	UP 203/23
Touch sensor, quadruple, with status LED, GAMMA Arina, Ash gold	86 x 86 x 14.6	5WG1203-2DB43	UP 203/43

The suitable mounting frame is already included in the package.

UP 203/14



Touch sensor with status LED, scene controller and room temperature sensor, GAMMA arina, white

- Pair of touch areas for vertical operation
- Per touch area selectable function
- LED for orientation light
- Labeling field
- Room temperature sensor
- Integrated bus coupling unit



Data sheet

A6V10438647

Dimensions (W x H x D)

86 x 86 x 14 mm

Stock no.	Product no.
5WG1203-2DB14	UP 203/14

The suitable mounting frame is already included in the package.

Display and operation units

Pushbutton accessories

Frames DELTA line

Frames, DELTA line, Titanium white (similar to RAL 9010)

5TG255..-0

Frames, DELTA line, Titanium white (similar to RAL 9010), for combinations, for horizontal and vertical mounting



Range overview 5TG255..-0

Product Title	Dimensions (W x H)	Stock no.	Product no.
Frames, DELTA line, Titanium white (similar to RAL 9010), single	80 x 80 mm	5TG2551-0	5TG25510
Frames, DELTA line, Titanium white (similar to RAL 9010), double	151 x 80 mm	5TG2552-0	5TG25520
Frames, DELTA line, Titanium white (similar to RAL 9010), triple	222 x 80 mm	5TG2553-0	5TG25530
Frames, DELTA line, Titanium white (similar to RAL 9010), quadruple	293 x 80 mm	5TG2554-0	5TG25540
Frames, DELTA line, Titanium white (similar to RAL 9010), quintuple	364 x 80 mm	5TG2555-0	5TG25550

Frames, DELTA line, Electrical white (similar to RAL 1013)

5TG258..-0

Frames, DELTA line, Electrical white (similar to RAL 1013), for combinations, for horizontal and vertical mounting



Range overview 5TG258..-0

Product Title	Dimensions (W x H)	Stock no.	Product no.
Frames, DELTA line, electrical white (similar to RAL 1013), single	80 x 80 mm	5TG2581-0	5TG25810
Frames, DELTA line, electrical white (similar to RAL 1013), double	151 x 80 mm	5TG2582-0	5TG25820
Frames, DELTA line, electrical white (similar to RAL 1013), triple	222 x 80 mm	5TG2583-0	5TG25830
Frames, DELTA line, electrical white (similar to RAL 1013), quadruple	293 x 80 mm	5TG2584-0	5TG25840
Frames, DELTA line, electrical white (similar to RAL 1013), quintuple	364 x 80 mm	5TG2585-0	5TG25850

Display and operation units

Pushbutton accessories

Frames DELTA line

5TG255..-3

Frames, DELTA line, aluminum metallic (similar to RAL 9006)



Frames, DELTA line, Aluminum metallic (similar to RAL 9006), for combinations, for horizontal and vertical mounting

Range overview 5TG255..-3

Product Title	Dimensions (W x H)	Stock no.	Product no.
Frames, DELTA line, aluminum metallic (similar to RAL 9006), single	80 x 80 mm	5TG2551-3	5TG25513
Frames, DELTA line, aluminum metallic (similar to RAL 9006), double	151 x 80 mm	5TG2552-3	5TG25523
Frames, DELTA line, aluminum metallic (similar to RAL 9006), triple	222 x 80 mm	5TG2553-3	5TG25533
Frames, DELTA line, aluminum metallic (similar to RAL 9006), quadruple	293 x 80 mm	5TG2554-3	5TG25543
Frames, DELTA line, aluminum metallic (similar to RAL 9006), quintuple	364 x 80 mm	5TG2555-3	5TG25553

5TG255..-6

Frames, DELTA line, carbon metallic (similar to RAL 7016)



Frames, DELTA line, Carbon metallic (similar to RAL 7016), for combinations, for horizontal and vertical mounting

Range overview 5TG255..-6

Product Title	Dimensions (W x H)	Stock no.	Product no.
Frames, DELTA line, carbon metallic (similar to RAL 7016), single	80 x 80 mm	5TG2551-6	5TG25516
Frames, DELTA line, carbon metallic (similar to RAL 7016), double	151 x 80 mm	5TG2552-6	5TG25526
Frames, DELTA line, carbon metallic (similar to RAL 7016), triple	222 x 80 mm	5TG2553-6	5TG25536
Frames, DELTA line, carbon metallic (similar to RAL 7016), quadruple	293 x 80 mm	5TG2554-6	5TG25546
Frames, DELTA line, carbon metallic (similar to RAL 7016), quintuple	364 x 80 mm	5TG2555-6	5TG25556

5TG255..a

Frames, DELTA line, with labeling field, Titanium white (similar to RAL 9010)



Frames, DELTA line, with labeling field, Titanium white (similar to RAL 9010), for combinations, for horizontal and vertical mounting

Range overview 5TG255..a

Product Title	Dimensions (W x H)	Stock no.	Product no.
Frames, DELTA line, with labeling field, titanium white (similar to RAL 9010), single	80 x 80 mm	5TG2551-1	5TG25511
Frames, DELTA line, with labeling field, titanium white (similar to RAL 9010), double, horizontal	151 x 80 mm	5TG2552-1	5TG25521
Frames, DELTA line, with labeling field, titanium white (similar to RAL 9010), double, vertical	80 x 151 mm	5TG2552-2	5TG25522
Frames, DELTA line, with labeling field, titanium white (similar to RAL 9010), triple, horizontal	222 x 80 mm	5TG2553-1	5TG25531

Display and operation units

Pushbutton accessories

Frames DELTA line

Range overview 5TG255..a

Product Title	Dimensions (W x H)	Stock no.	Product no.
Frames, DELTA line, with labeling field, titanium white (similar to RAL 9010), triple, vertical	80 x 222 mm	5TG2553-2	5TG25532
Frames, DELTA line, with labeling field, titanium white (similar to RAL 9010), quadruple, horizontal	293 x 80 mm	5TG2554-1	5TG25541
Frames, DELTA line, with labeling field, titanium white (similar to RAL 9010), quadruple, vertical	80 x 293 mm	5TG2554-2	5TG25542

For individual labeling we recommend our labeling tool which is for free.

Download: www.siemens.com/gamma-labels

Display and operation units

Pushbutton accessories

Frames DELTA line

5TG258..

Frames, DELTA line, with labeling field, Electrical white (similar to RAL 1013)



Frames, DELTA line, with labeling field, Electrical white (similar to RAL 1013), for combinations, for horizontal and vertical mounting

Range overview 5TG258..

Product Title	Dimensions (W x H)	Stock no.	Product no.
Frames, DELTA line, with labeling field, electrical white (similar to RAL 1013), single	80 x 80 mm	5TG2581-1	5TG25811
Frames, DELTA line, with labeling field, electrical white (similar to RAL 1013), double, horizontal	151 x 80 mm	5TG2582-1	5TG25821
Frames, DELTA line, with labeling field, electrical white (similar to RAL 1013), double, vertical	80 x 151 mm	5TG2582-2	5TG25822
Frames, DELTA line, with labeling field, electrical white (similar to RAL 1013), triple, horizontal	222 x 80 mm	5TG2583-1	5TG25831
Frames, DELTA line, with labeling field, electrical white (similar to RAL 1013), triple, vertical	80 x 222 mm	5TG2583-2	5TG25832
Frames, DELTA line, with labeling field, electrical white (similar to RAL 1013), quadruple, horizontal	293 x 80 mm	5TG2584-1	5TG25841
Frames, DELTA line, with labeling field, electrical white (similar to RAL 1013), quadruple, vertical	80 x 293 mm	5TG2584-2	5TG25842

For individual labeling we recommend our labeling tool which is for free.

Download: www.siemens.com/gamma-labels

5TG255..b

Frames, DELTA line, with labeling field, aluminum metallic (similar to RAL 9006)



Frames, DELTA line, with labeling field, Aluminum metallic (similar to RAL 9006), for combinations, for horizontal and vertical mounting

Range overview 5TG255..b

Product Title	Dimensions (W x H)	Stock no.	Product no.
Frames, DELTA line, with labeling field, aluminum metallic (similar to RAL 9006), single	80 x 80 mm	5TG2551-4	5TG25514
Frames, DELTA line, with labeling field, aluminum metallic (similar to RAL 9006), double, horizontal	151 x 80 mm	5TG2552-4	5TG25524
Frames, DELTA line, with labeling field, aluminum metallic (similar to RAL 9006), double, vertical	80 x 151 mm	5TG2552-5	5TG25525

For individual labeling we recommend our labeling tool which is for free.

Download: www.siemens.com/gamma-labels

Display and operation units Pushbutton accessories Frames DELTA line

Frames, DELTA line, with labeling field, Carbon metallic (similar to RAL 7016)

5TG255..c

Frames, DELTA line, with labeling field, Carbon metallic (similar to RAL 7016), for combinations, for horizontal and vertical mounting



Range overview 5TG255..c

Product Title	Dimensions (W x H)	Stock no.	Product no.
Frames, DELTA line, with labeling field, carbon metallic (similar to RAL 7016), single	80 x 80 mm	5TG2551-7	5TG25517
Frames, DELTA line, with labeling field, carbon metallic (similar to RAL 7016), double, horizontal	151 x 80 mm	5TG2552-7	5TG25527
Frames, DELTA line, with labeling field, carbon metallic (similar to RAL 7016), double, vertical	80 x 151 mm	5TG2552-8	5TG25528

For individual labeling we recommend our labeling tool which is for free.

Download: www.siemens.com/gamma-labels

Display and operation units

Pushbutton accessories

Frames DELTA miro color

5TG111..-0 **Frame, DELTA miro color, plastic, titanium white (similar to RAL 9010)**

Frames, DELTA miro color, plastic, Titanium white (similar to RAL 9010), for combinations, for horizontal and vertical mounting

Range overview 5TG111..-0

Product Title	Dimensions (W x H)	Stock no.	Product no.
Frame, DELTA miro color, plastic, titanium white (similar to RAL 9010), single	90 x 90 mm	5TG1111-0	5TG11110
Frame, DELTA miro color, plastic, titanium white (similar to RAL 9010), Double	90 x 161 mm	5TG1112-0	5TG11120
Frame, DELTA miro color, plastic, titanium white (similar to RAL 9010), triple	90 x 232 mm	5TG1113-0	5TG11130
Frame, DELTA miro color, plastic, titanium white (similar to RAL 9010), quadruple	90 x 303 mm	5TG1114-0	5TG11140
Frame, DELTA miro color, plastic, titanium white (similar to RAL 9010), quintuple	90 x 374 mm	5TG1115-0	5TG11150

5TG111..-1 **Frame, DELTA miro color, plastic, aluminum metallic (similar to RAL 9006)**



Frames, DELTA miro color, plastic, Aluminum metallic (similar to RAL 9006), for combinations, for horizontal and vertical mounting

Range overview 5TG111..-1

Product Title	Dimensions (W x H)	Stock no.	Product no.
Frame, DELTA miro color, plastic, aluminum metallic (similar to RAL 9006), single	90 x 90 mm	5TG1111-1	5TG11111
Frame, DELTA miro color, plastic, aluminum metallic (similar to RAL 9006), double	90 x 161 mm	5TG1112-1	5TG11121
Frame, DELTA miro color, plastic, aluminum metallic (similar to RAL 9006), triple	90 x 232 mm	5TG1113-1	5TG11131
Frame, DELTA miro color, plastic, aluminum metallic (similar to RAL 9006), quadruple	90 x 303 mm	5TG1114-1	5TG11141
Frame, DELTA miro color, plastic, aluminum metallic (similar to RAL 9006), quintuple	90 x 374 mm	5TG1115-1	5TG11151

Display and operation units Pushbutton accessories Frames DELTA miro color

Frame, DELTA miro color, plastic, carbon metallic (similar to RAL7016)

5TG111..-2

Frames, DELTA miro color, plastic, Carbon metallic (similar to RAL 7016), for combinations, for horizontal and vertical mounting



Range overview 5TG111..-2

Product Title	Dimensions (W x H)	Stock no.	Product no.
Frame, DELTA miro color, plastic, carbon metallic (similar to RAL7016), single	90 x 90 mm	5TG1111-2	5TG11112
Frame, DELTA miro color, plastic, carbon metallic (similar to RAL7016), double	90 x 161 mm	5TG1112-2	5TG11122
Frame, DELTA miro color, plastic, carbon metallic (similar to RAL7016), triple	90 x 232 mm	5TG1113-2	5TG11132
Frame, DELTA miro color, plastic, carbon metallic (similar to RAL7016), quintuple	90 x 303 mm	5TG1114-2	5TG11142
Frame, DELTA miro color, plastic, carbon metallic (similar to RAL7016), quintuple,	90 x 374 mm	5TG1115-2	5TG11152

Display and operation units

Pushbutton accessories

Frames DELTA miro glass

5TG120..

Frames, DELTA miro glass, real glass, crystal green



Frames, DELTA miro glass, real glass, crystal green, for combinations, for horizontal and vertical mounting

Range overview 5TG120..

Product Title	Dimensions (W x H)	Stock no.	Product no.
Frame, DELTA miro glass, real glass, crystal green, single	90 x 90 mm	5TG1201	5TG1201
Frame, DELTA miro glass, real glass, crystal green, double	90 x 161 mm	5TG1202	5TG1202
Frame, DELTA miro glass, real glass, crystal green, triple	90 x 232 mm	5TG1203	5TG1203
Frame, DELTA miro glass, real glass, crystal green, quadruple	90 x 303 mm	5TG1204	5TG1204
Frame, DELTA miro glass, real glass, crystal green, quintuple	90 x 374 mm	5TG1205	5TG1205

5TG120..-1

Frames, DELTA miro glass, real glass, white



Frames, DELTA miro glass, real glass, white, for combinations, for horizontal and vertical mounting

Range overview 5TG120..-1

Product Title	Dimensions (W x H)	Stock no.	Product no.
Frame, DELTA miro glass, real glass, white, single	90 x 90 mm	5TG1201-1	5TG12011
Frame, DELTA miro glass, real glass, white, double	90 x 161 mm	5TG1202-1	5TG12021
Frame, DELTA miro glass, real glass, white, triple	90 x 232 mm	5TG1203-1	5TG12031
Frame, DELTA miro glass, real glass, white, quadruple	90 x 303 mm	5TG1204-1	5TG12041
Frame, DELTA miro glass, real glass, white, quintuple	90 x 374 mm	5TG1205-1	5TG12051

5TG120..-2

Frames, DELTA miro glass, real glass, black



Frames, DELTA miro glass, real glass, black, for combinations, for horizontal and vertical mounting

Range overview 5TG120..-2

Product Title	Dimensions (W x H)	Stock no.	Product no.
Frame, DELTA miro glass, real glass, black, single	90 x 90 mm	5TG1201-2	5TG12012
Frame, DELTA miro glass, real glass, black, double	90 x 161 mm	5TG1202-2	5TG12022
Frame, DELTA miro glass, real glass, black, triple	90 x 232 mm	5TG1203-2	5TG12032
Frame, DELTA miro glass, real glass, black, quadruple	90 x 303 mm	5TG1204-2	5TG12042
Frame, DELTA miro glass, real glass, black, quintuple	90 x 374 mm	5TG1205-2	5TG12052

Display and operation units Pushbutton accessories Frames DELTA miro glass

Frames, DELTA miro glass, real glass, orient

5TG120..-3

Frames, DELTA miro glass, real glass, orient, for combinations, for horizontal and vertical mounting



Range overview 5TG120..-3

Product Title	Dimensions (W x H)	Stock no.	Product no.
Frame, DELTA miro glass, real glass, orient, single	90 x 90 mm	5TG1201-3	5TG12013
Frame, DELTA miro glass, real glass, orient, double	90 x 161 mm	5TG1202-3	5TG12023
Frame, DELTA miro glass, real glass, orient, triple	90 x 232 mm	5TG1203-3	5TG12033
Frame, DELTA miro glass, real glass, orient, quadruple	90 x 303 mm	5TG1204-3	5TG12043
Frame, DELTA miro glass, real glass, orient, quintuple	90 x 374 mm	5TG1205-3	5TG12053

Frames, DELTA miro glass, real glass, arena

5TG120..-4

Frames, DELTA miro glass, real glass, arena, for combinations, for horizontal and vertical mounting



Range overview 5TG120..-4

Product Title	Dimensions (W x H)	Stock no.	Product no.
Frame, DELTA miro glass, real glass, arena, single	90 x 90 mm	5TG1201-4	5TG12014
Frame, DELTA miro glass, real glass, arena, double	90 x 161 mm	5TG1202-4	5TG12024
Frame, DELTA miro glass, real glass, arena, triple	90 x 232 mm	5TG1203-4	5TG12034
Frame, DELTA miro glass, real glass, arena, quadruple	90 x 303 mm	5TG1204-4	5TG12044
Frame, DELTA miro glass, real glass, arena, quintuple	90 x 374 mm	5TG1205-4	5TG12054

Display and operation units

Pushbutton accessories

Frames DELTA miro aluminium

5TG112..-0

Frame, DELTA miro aluminum, real aluminum, natural



Frames, DELTA miro aluminum, real aluminum, natural, for combinations, for horizontal and vertical mounting

Range overview 5TG112..-0

Product Title	Dimensions (W x H)	Stock no.	Product no.
Frame, DELTA miro aluminum, real aluminum, natural, single	90 x 90 mm	5TG1121-0	5TG11210
Frame, DELTA miro aluminum, real aluminum, natural, double	90 x 161 mm	5TG1122-0	5TG11220
Frame, DELTA miro aluminum, real aluminum, natural, triple	90 x 232 mm	5TG1123-0	5TG11230
Frame, DELTA miro aluminum, real aluminum, natural, quadruple	90 x 303 mm	5TG1124-0	5TG11240
Frame, DELTA miro aluminum, real aluminum, natural, quintuple	90 x 374 mm	5TG1125-0	5TG11250

5TG112..-3

Frame, DELTA miro aluminum, real aluminum, yellow oxide



Frames, DELTA miro aluminum, real aluminum, yellow oxide, for combinations, for horizontal and vertical mounting

Range overview 5TG112..-3

Product Title	Dimensions (W x H)	Stock no.	Product no.
Frame, DELTA miro aluminum, real aluminum, yellow oxide, single	90 x 90 mm	5TG1121-3	5TG11213
Frame, DELTA miro aluminum, real aluminum, yellow oxide, double	90 x 161 mm	5TG1122-3	5TG11223
Frame, DELTA miro aluminum, real aluminum, yellow oxide, triple	90 x 232 mm	5TG1123-3	5TG11233
Frame, DELTA miro aluminum, real aluminum, yellow oxide, quadruple	90 x 303 mm	5TG1124-3	5TG11243
Frame, DELTA miro aluminum, real aluminum, yellow oxide, quintuple	90 x 374 mm	5TG1125-3	5TG11253

Display and operation units Pushbutton accessories Frames DELTA style

Frame, DELTA style, titanium white (similar to RAL 9010)

5TG132..

Frames, DELTA style, Titanium white (similar to RAL 9010), for combinations, for horizontal and vertical mounting



Range overview 5TG132..

Product Title	Dimensions (W x H)	Stock no.	Product no.
Frame, DELTA style, titanium white (similar to RAL 9010), single	82 x 82 mm	5TG1321	5TG1321
Frame, DELTA style, titanium white (similar to RAL 9010), double	82 x 153 mm	5TG1322	5TG1322
Frame, DELTA style, titanium white (similar to RAL 9010), triple	82 x 224 mm	5TG1323	5TG1323
Frame, DELTA style, titanium white (similar to RAL 9010), quadruple	82 x 295 mm	5TG1324	5TG1324
Frame, DELTA style, titanium white (similar to RAL 9010), quintuple	82 x 366 mm	5TG1325	5TG1325

Frame, DELTA style, platinum metallic

5TG132..-1

Frames, DELTA style, Platinum metallic (similar to RAL 9007), for combinations, for horizontal and vertical mounting



Range overview 5TG132..-1

Product Title	Dimensions (W x H)	Stock no.	Product no.
Frame, DELTA style, platinum metallic, single	82 x 82 mm	5TG1321-1	5TG13211
Frame, DELTA style, platinum metallic, double	82 x 153 mm	5TG1322-1	5TG13221
Frame, DELTA style, platinum metallic, triple	82 x 224 mm	5TG1323-1	5TG13231
Frame, DELTA style, platinum metallic, quadruple	82 x 295 mm	5TG1324-1	5TG13241
Frame, DELTA style, platinum metallic, quintuple	82 x 366 mm	5TG1325-1	5TG13251

DELTA style int. frame 55

5TG1327..

DELTA style intermediate frame 68x68 mm for installing devices with cover plate 55x55 mm

Range overview 5TG1327..

Product Title	Stock no.	Product no.
DELTA style titanium white int. frame 55	5TG1327	5TG1327
DELTA style platinum met. int. frame 55	5TG1327-1	5TG13271

Display and operation units

Pushbutton accessories

Frames GAMMA UL/NEMA

S 281U12



Frame 68 - 4 x 4, titanium white (similar to RAL 9010), for 4" x 4" Box (double gang box)

- For user operation interfaces in the design DELTAstyle
- For mounting on a bus coupling unit (BTM) UP 117C12 for NEMA wall boxes

Dimensions (W x H x D)

120 x 120 x 9.5 mm



Stock no.

Product no.

5WG1281-8UB12

S 281U12

Display and operation units Pushbutton accessories Wall-mounted enclosures

Surface-mounting enclosures for flush-mounting devices, DELTA line, DELTA style, titanium white

5TG290..

Flame-retardant base plate, for combinations, for horizontal and vertical mounting

Range overview 5TG290..

Product Title	Dimensions (WxHxD) [mm]	Stock no.	Product no.
Surface-mounting enclosure, for flush-mounting devices, DELTA line, DELTA style, titanium white, single	84 x 84 x 42.5	5TG2901	5TG2901
Surface-mounting enclosure, for flush-mounting devices, DELTA line, DELTA style, titanium white, double	84 x 155 x 42.5	5TG2902	5TG2902
Surface-mounting enclosure, for flush-mounting devices, DELTA line, DELTA style, titanium white, triple	84 x 226 x 42.5	5TG2903	5TG2903

Surface-mounting enclosures for flush-mounting devices, DELTA line, Electrical white

5TG286..

Flame-retardant base plate, for combinations, for horizontal and vertical mounting

Range overview 5TG286..

Product Title	Dimensions (WxHxD) [mm]	Stock no.	Product no.
Surface-mounting enclosure, for flush-mounting devices, DELTA line, electrical white, single	84 x 84 x 42.5	5TG2861	5TG2861
Surface-mounting enclosure, for flush-mounting devices, DELTA line, electrical white, double	84 x 155 x 42.5	5TG2862	5TG2862
Surface-mounting enclosure, for flush-mounting devices, DELTA line, electrical white, triple	84 x 226 x 42.5	5TG2863	5TG2863

Display and operation units

Room temperature controllers with integrated sensor and operation i-system

UP 237K..



Temperature controller, i-system

- Integrated room temperature sensors
- Control can be set as a two-point control and/or continuous-action control (P or PI algorithm), for heating only, for cooling only, or for heating and cooling mode
- Operating modes that can be switched via KNX: comfort mode, pre-comfort mode, energy-saving mode and frost or heat protection mode
- Presence pushbutton to locally switch between comfort and pre-comfort mode or comfort and energy-saving mode and to extend comfort mode after operating energy-saving or protection mode
- Pushbutton for switching over between manual and automatic mode
- The room temperature setpoint value for comfort mode can be set via an interchangeable rotary button (+/-) on the controller and via the KNX
- Basic setpoint of the room temperature for comfort mode which can be set via the KNX
- Setpoint value for comfort mode in °C which can be set via an interchangeable rotary button on the controller
- Adjustable dead zone between the heating setpoint and the cooling setpoint for comfort mode
- Two-level heating or cooling
- Output of the control variable(s) either as an on/off switch command or as a positioning command in the range of 0...100 %
- 5 LEDs to display manual mode and the current operating modes
- 4 LEDs to display heating/cooling valve open, dew point alarm and open window
- For plugging onto a bus transceiver module (BTM) or a flush-mounting actuator with bus transceiver module (BTM)

Data sheet

A6V10416651

Ranger overview UP 237K..

Product Title	Dimensions (WxHxD) [mm]	Stock no.	Product no.
Temperature controller, titanium white	55 x 55 x 16	5WG1237-2KB11	UP 237K11

The bus transceiver module (BTM) (see Chapter System Products and Accessories) or flush-mounting actuator with bus transceiver module (BTM) must be ordered separately. The matching design frame must be ordered separately. See Chapter Display and Operation Units - Pushbutton accessories.

Display and operation units

Multifunction device

Flush-mounted

UP 227



Room Control Unit, i-system

- Multifunctional display-/control panel for KNX with Dot-Matrix LCD display 96 x 128 pixels
- 8 capacitive touch buttons for horizontal operation
- For the display and control of at least 10 adjustable room control functions: Switching toggle/On/Off, Dimming, Door bell function On/Off, Solar protection control; send 1 Byte/2 Byte value; display 1 Bit/1 Byte/2 Byte value; Forced control; display text messages; warning and alarm messaging; recall and save scenes; warning and alarm messaging
- Room control functions lockable via KNX-bus
- Green/red LED as orientation light, as status indication, as a response to pressing a button respectively to the signalling of alarm reports
- A signaler for acoustical alarm reports respectively as a status of the touch operation
- Integrated room temperature sensor
- Evaluation and weighting of an external inside temperature sensor
- Room temperature control configurable as two-step control and/or continuous control, for exclusive heating operation, exclusive cooling operation or heating and cooling operation
- Selectable operating modes over the KNX: Comfort, Pre-comfort, Energy-savings and protection
- Local indication
 - Of the active operating modes or automatic- respectively manual mode
 - Inside temperature or outside temperature
 - Heating or cooling mode
 - Dew point alarm
 - Open window
- Local switching between
 - Manual- and automatic mode
 - Comfort, pre-comfort, energy-saving- and protection mode
- Adjustable time-limited extension of the comfort mode
- Adjustable room temperature setpoint shifting for comfort mode
- Via KNX set basic setpoint value of the room temperature for comfort mode
- An outside temperature based temperature setpoint value tracing in the cooling operation
- Adjustable dead zone between the heating setpoint value and the cooling setpoint value for comfort mode
- Transmission of controller output(s) either as On/Off switching commands or as control commands in the range 0...100 %
- Local display of the manually selected fan rotational speed respectively of the automatic adjustment of the fan rotational speed
- Adjustable fan rotational speed respectively automatic adjustment of the fan rotational speed on the controller
- Weekly schedule programme for controller- operating modes, automatic mode and at the least 8 room control functions
- At the least 40 schedule tasks and Display and set of the date and time
- User control of LCD background lighting and Background color
- Display system settings and room temperature controller in the languages: German, English, French, Italian od Spanish
- User setting of at least 3 operating languages also Integrated bus coupling unit, bus connection via bus terminal possible
- Flush mounted device for the mounting in an flush wall box Ø 60 mm, for fixing on the mounting plate AQR2500NF via lateral springs (separately specified)

The matching design frame must be ordered separately. See chapter Display and Operation Units - Pushbuttons accessories.

The mounting plate AQR2500.. must be ordered separately.

Data sheet A6V10416250
 Dimensions (W x H x D) 55 x 55 x 37.2 mm

Stock no. Product no.
 5WG1227-2AB11 UP 227

Display and operation units

Multifunction device

Flush-mounted

Accessories for UP 227

AQR2500NF



Mounting plate EU (CEE/VDE)

- Mounting plates to plug onto the front module

Data sheet

Mechanical design

Dimensions (W x H x D)

Warranty

N1408

EU (CEE/VDE)

71 x 71 x 45 mm

60 WarrantyMonths

Stock no.

Product no.

S55720-S161

AQR2500NF

AQR2500NG



Mounting plate IT (3 modular)

- Mounting plates to plug onto the front module

Data sheet

Mechanical design

Dimensions (W x H x D)

Warranty

N1408

IT (3 modular)

71 x 71 x 45 mm

60 WarrantyMonths

Stock no.

Product no.

S55720-S163

AQR2500NG

Display and operation units

Multifunction device

Flush-mounted

Touch Control TC5, 5 inch touch panel, black

UP 205/21

- Aluminium and glas housing
 - Capacitive touch colour display 5", 480 x 854 pixels
 - LED colour light strip as orientation light, respectively to signal alarms
 - Integrated room temperature sensor
 - Micro SD card reader for on-site customization of wallpaper, screen saver and icons
 - Connection to external power supply DC 24 V
 - Flush mounted device for mounting in a flush wall box 60 mm Ø, for screw fixing
 - Mounting plate included in gift box
- Up to 15 configurable function pages
 - 2 configurable home pages for navigation
 - Room control functions switching, dimming, tunable white, RGB, solar protection, HVAC
 - Up to 120 channels for each individual function
 - Switching functions toggle, switching on/off
 - Dimming control page for colour lights: 3-color RGB light, 4-color RGBW light, optional with brightness and colour temperature adjustment
 - Solar protection functions for curtains, roller shutters and venetian blinds
 - Room temperature control configurable as two-step control and/or continuous control, for heating and/or cooling operation
 - Manual or automatic ventilation control
 - VRF interface
 - Up to 8 configurable sets of event functions with 3 different data type options for each output
 - Up to 8 inputs for logical operations: AND, OR, XOR, gate forwarding, threshold and format conversion
 - Up to 16 daily or weekly schedules
 - Display of date, time and temperature
 - Up to 10 display pages for external sensor readings: temperature, relative humidity, PM2.5, PM10, CO2, VOC, AQI, brightness and wind speed
 - Up to 10 display pages for energy metering values



Data sheet A6V12259028
 Dimensions (W x H x D) 86 x 148.8 x 11.5 mm

Stock no. Product no.
 5WG1205-2AB21 UP 205/21

Display and operation units

Multifunction device

Wall-mounted

QMX3.P02



Room operator unit KNX with temperature sensor, configurable touchkeys, LED display, white

Functions:

- Temperature sensor
- Configurable touchkeys with LED display
- Switching and control of lighting, blinds, scenes
- Window for labels
- Temperature control, adjustable as PWM control and/or modulating control (PID algorithm), for pure heating mode, pure cooling mode, heating and cooling mode
- Operating modes switchable via KNX and/or display: Comfort mode, Pre-Comfort, energy savings and protection mode
- Adjustable commissioning and control parameters for radiated heating, slow and fast, floor heating slow and fast
- Integrated bus coupling unit
- 3 independently adjustable switching values for CO2 concentration and relative air humidity for air quality control
- Actuating variable for 1, 2, or 3-stage fans (humidity and CO2)
- Actuating variable for 1, 2, or 3-point positioning signal (humidity and CO2)
- Setpoint for room temperature and relative humidity and CO2 concentration adjustable via KNX

Data sheet	N1602
Voltage supply	KNX bus
Measuring range, temperature	0...50 °C
Sensing element, temperature	NTC
Display	LED
Communication	KNX PL-Link
	KNX S-Mode
Color	White
Degree of protection	IP30
Dimensions (W x H x D)	88.4 x 133.4 x 18 mm
Weight (net)	0.19 kg
Warranty	24 WarrantyMonths

Stock no.	Product no.
S55624-H107	QMX3.P02

Display and operation units Multifunction device Wall-mounted

Room operator unit KNX with temperature sensor, configurable touchkeys, LED display, black

QMX3.P02-1BSC



Functions:

- Temperature sensor
- Configurable touchkeys with LED display
- Switching and control of lighting, blinds, scenes
- Window for labels
- Temperature control, adjustable as PWM control and/or modulating control (PID algorithm), for pure heating mode, pure cooling mode, heating and cooling mode
- Operating modes switchable via KNX and/or display: Comfort mode, Pre-Comfort, energy savings and protection mode
- Adjustable commissioning and control parameters for radiated heating, slow and fast, floor heating slow and fast
- Integrated bus coupling unit
- 3 independently adjustable switching values for CO₂ concentration and relative air humidity for air quality control
- Actuating variable for 1, 2, or 3-stage fans (humidity and CO₂)
- Actuating variable for 1, 2, or 3-point positioning signal (humidity and CO₂)
- Setpoint for room temperature and relative humidity and CO₂ concentration adjustable via KNX

Data sheet	N1602
Voltage supply	KNX bus
Measuring range, temperature	0...50°C
Sensing element, temperature	NTC
Communication	KNX PL-Link KNX S-Mode
Color	Black
Degree of protection	IP30
Dimensions (W x H x D)	88.4 x 133.4 x 18 mm
Warranty	24 WarrantyMonths

Stock no.

Product no.

S55624-H128

QMX3.P02-1BSC

Display and operation units

Multifunction device

Wall-mounted

QMX3.P34



Room operator unit KNX with temperature sensor, segmented backlit display, touchkeys, white

Functions:

- Temperature sensor
- Segmented backlit display and touchkeys
- Temperature control, adjustable as PWM control and/or modulating control (PID algorithm), for pure heating mode, pure cooling mode, heating and cooling mode
- Operating modes switchable via KNX and/or display: Comfort mode, Pre-Comfort, energy savings and protection mode
- Adjustable commissioning and control parameters for radiated heating, slow and fast, floor heating slow and fast
- Integrated bus coupling unit
- 3 independently adjustable switching values for CO2 concentration and relative air humidity for air quality control
- Actuating variable for 1, 2, or 3-stage fans (humidity and CO2)
- Actuating variable for 1, 2, or 3-point positioning signal (humidity and CO2)
- Setpoint for room temperature and relative humidity and CO2 concentration adjustable via KNX

Data sheet	N1602
Voltage supply	KNX bus
Measuring range, temperature	0...50 °C
Sensing element, temperature	NTC
Communication	KNX PL-Link KNX S-Mode
Color	White
Degree of protection	IP30
Dimensions (W x H x D)	88.4 x 133.4 x 18 mm
Weight (net)	0.21 kg
Warranty	24 WarrantyMonths

Stock no.	Product no.
S55624-H105	QMX3.P34

Display and operation units Multifunction device Wall-mounted

Room operator unit KNX with temperature sensor, segmented backlit display, touchkeys, black

QMX3.P34-1BSC



Functions:

- Temperature sensor
- Segmented backlit display and touchkeys
- Temperature control, adjustable as PWM control and/or modulating control (PID algorithm), for pure heating mode, pure cooling mode, heating and cooling mode
- Operating modes switchable via KNX and/or display: Comfort mode, Pre-Comfort, energy savings and protection mode
- Adjustable commissioning and control parameters for radiated heating, slow and fast, floor heating slow and fast
- Integrated bus coupling unit
- 3 independently adjustable switching values for CO2 concentration and relative air humidity for air quality control
- Actuating variable for 1, 2, or 3-stage fans (humidity and CO2)
- Actuating variable for 1, 2, or 3-point positioning signal (humidity and CO2)
- Setpoint for room temperature and relative humidity and CO2 concentration adjustable via KNX

Data sheet	N1602
Voltage supply	KNX bus
Measuring range, temperature	0...50°C
Sensing element, temperature	NTC
Communication	KNX PL-Link KNX S-Mode
Color	Black
Degree of protection	IP30
Dimensions (W x H x D)	88.4 x 133.4 x 18 mm
Warranty	24 WarrantyMonths

Stock no.

Product no.

S55624-H126

QMX3.P34-1BSC

Display and operation units

Multifunction device

Wall-mounted

QMX3.P37



Room operator unit KNX with temperature sensor, segmented backlit display, configurable touchkeys, LED display, white

Functions:

- Temperature sensor
- Segmented backlit display and touchkeys
- Configurable touchkeys with LED display
- Switching and control of lighting, blinds, scenes
- Window for labels
- Temperature control, adjustable as PWM control and/or modulating control (PID algorithm), for pure heating mode, pure cooling mode, heating and cooling mode
- Operating modes switchable via KNX and/or display: Comfort mode, Pre-Comfort, energy savings and protection mode
- Adjustable commissioning and control parameters for radiated heating, slow and fast, floor heating slow and fast
- Integrated bus coupling unit
- 3 independently adjustable switching values for CO₂ concentration and relative air humidity for air quality control
- Actuating variable for 1, 2, or 3-stage fans (humidity and CO₂)
- Actuating variable for 1, 2, or 3-point positioning signal (humidity and CO₂)
- Setpoint for room temperature and relative humidity and CO₂ concentration adjustable via KNX

Data sheet	N1602
Operating voltage	DC 21 V
Voltage supply	KNX bus
Measuring range, temperature	0...50 °C
Sensing element, temperature	NTC
Display	LED
Communication	KNX PL-Link KNX S-Mode
Color	White
Degree of protection	IP30
Dimensions (W x H x D)	88.4 x 133.4 x 18 mm
Weight (net)	0.216 kg
Warranty	24 WarrantyMonths

Stock no.	Product no.
S55624-H108	QMX3.P37

Display and operation units Multifunction device Wall-mounted

Room operator unit KNX with temperature sensor, segmented backlit display, configurable touchkeys, LED display, black

QMX3.P37-1BSC



Functions:

- Temperature sensor
- Segmented backlit display and touchkeys
- Configurable touchkeys with LED display
- Switching and control of lighting, blinds, scenes
- Window for labels
- Temperature control, adjustable as PWM control and/or modulating control (PID algorithm), for pure heating mode, pure cooling mode, heating and cooling mode
- Operating modes switchable via KNX and/or display: Comfort mode, Pre-Comfort, energy savings and protection mode
- Adjustable commissioning and control parameters for radiated heating, slow and fast, floor heating slow and fast
- Integrated bus coupling unit
- 3 independently adjustable switching values for CO₂ concentration and relative air humidity for air quality control
- Actuating variable for 1, 2, or 3-stage fans (humidity and CO₂)
- Actuating variable for 1, 2, or 3-point positioning signal (humidity and CO₂)
- Setpoint for room temperature and relative humidity and CO₂ concentration adjustable via KNX

Data sheet	N1602
Voltage supply	KNX bus
Measuring range, temperature	0...50 °C
Sensing element, temperature	NTC
Communication	KNX PL-Link KNX S-Mode
Color	Black
Degree of protection	IP30
Dimensions (W x H x D)	88.4 x 133.4 x 18 mm
Warranty	24 WarrantyMonths

Stock no.

Product no.

S55624-H129

QMX3.P37-1BSC

Display and operation units

Multifunction device

Wall-mounted

QMX3.P44



Room operator unit KNX with sensors for temperature, humidity, segmented backlit display, touchkeys, white

Functions:

- multisensor for temperature and humidity
- Segmented backlit display and touchkeys
- Temperature control, adjustable as PWM control and/or modulating control (PID algorithm), for pure heating mode, pure cooling mode, heating and cooling mode
- Operating modes switchable via KNX and/or display: Comfort mode, Pre-Comfort, energy savings and protection mode
- Adjustable commissioning and control parameters for radiated heating, slow and fast, floor heating slow and fast
- Integrated bus coupling unit
- 3 independently adjustable switching values for CO₂ concentration and relative air humidity for air quality control
- Actuating variable for 1, 2, or 3-stage fans (humidity and CO₂)
- Actuating variable for 1, 2, or 3-point positioning signal (humidity and CO₂)
- Setpoint for room temperature and relative humidity and CO₂ concentration adjustable via KNX

Data sheet	N1602
Voltage supply	KNX bus
Measuring range	NTC: 0...50 °C Humidity: 10%...95 % r.F.
Measuring range, temperature	0...50 °C
Sensing element, temperature	NTC
Communication	KNX PL-Link KNX S-Mode
Color	White
Degree of protection	IP30
Dimensions (W x H x D)	88.4 x 133.4 x 18 mm
Weight (net)	0.21 kg
Warranty	24 WarrantyMonths

Stock no.	Product no.
S55624-H143	QMX3.P44

Display and operation units Multifunction device Wall-mounted

Room operator unit KNX with sensors for temperature, humidity, segmented backlit display, touchkeys, black

QMX3.P44-1BSC



Functions:

- Multisensor for temperature and humidity
- Segmented backlit display and touchkeys
- Temperature control, adjustable as PWM control and/or modulating control (PID algorithm), for pure heating mode, pure cooling mode, heating and cooling mode
- Operating modes switchable via KNX and/or display: Comfort mode, Pre-Comfort, energy savings and protection mode
- Adjustable commissioning and control parameters for radiated heating, slow and fast, floor heating slow and fast
- Integrated bus coupling unit
- 3 independently adjustable switching values for CO₂ concentration and relative air humidity for air quality control
- Actuating variable for 1, 2, or 3-stage fans (humidity and CO₂)
- Actuating variable for 1, 2, or 3-point positioning signal (humidity and CO₂)
- Setpoint for room temperature and relative humidity and CO₂ concentration adjustable via KNX

Data sheet	N1602
Voltage supply	KNX bus
Measuring range	NTC: 0...50 °C Humidity: 10%...95 % r.F.
Measuring range, temperature	0...50 °C
Sensing element, temperature	NTC
Communication	KNX PL-Link KNX S-Mode
Color	Black
Degree of protection	IP30
Dimensions (W x H x D)	88.4 x 133.4 x 18 mm
Weight (net)	0.21 kg
Warranty	24 WarrantyMonths

Stock no.

Product no.

S55624-H144

QMX3.P44-1BSC

Display and operation units

Multifunction device

Wall-mounted

QMX3.P74



Room operator unit KNX with sensors for temperature, humidity, CO₂, segmented backlit display, touchkeys, white

Functions:

- multisensor for temperature, humidity and CO₂
- Segmented backlit display and touchkeys
- Temperature control, adjustable as PWM control and/or modulating control (PID algorithm), for pure heating mode, pure cooling mode, heating and cooling mode
- Operating modes switchable via KNX and/or display: Comfort mode, Pre-Comfort, energy savings and protection mode
- Adjustable commissioning and control parameters for radiated heating, slow and fast, floor heating slow and fast
- Integrated bus coupling unit
- 3 independently adjustable switching values for CO₂ concentration and relative air humidity for air quality control
- Actuating variable for 1, 2, or 3-stage fans (humidity and CO₂)
- Actuating variable for 1, 2, or 3-point positioning signal (humidity and CO₂)
- Setpoint for room temperature and relative humidity and CO₂ concentration adjustable via KNX

Data sheet	N1602
Voltage supply	KNX bus
Measuring range	400... 10000 ppm CO ₂
Sensing element	Temperature sensor, CO ₂ sensor, relative humidity sensor
Measuring range, temperature	0... 50 °C
Sensing element, temperature	NTC
Communication	KNX PL-Link KNX S-Mode
Color	White
Degree of protection	IP30
Dimensions (W x H x D)	88.4 x 133.4 x 18 mm
Weight (net)	0.22 kg
Warranty	24 WarrantyMonths

Stock no.	Product no.
S55624-H106	QMX3.P74

Display and operation units

Multifunction device

Wall-mounted

Room operator unit KNX with sensors for temperature, humidity, CO₂, segmented backlit display, touchkeys, black

QMX3.P74-1BSC

Functions:

- Multisensor for temperature, humidity and CO₂
- Segmented backlit display and touchkeys
- Temperature control, adjustable as PWM control and/or modulating control (PID algorithm), for pure heating mode, pure cooling mode, heating and cooling mode
- Operating modes switchable via KNX and/or display: Comfort mode, Pre-Comfort, energy savings and protection mode
- Adjustable commissioning and control parameters for radiated heating, slow and fast, floor heating slow and fast
- Integrated bus coupling unit
- 3 independently adjustable switching values for CO₂ concentration and relative air humidity for air quality control
- Actuating variable for 1, 2, or 3-stage fans (humidity and CO₂)
- Actuating variable for 1, 2, or 3-point positioning signal (humidity and CO₂)
- Setpoint for room temperature and relative humidity and CO₂ concentration adjustable via KNX



Data sheet	N1602
Voltage supply	KNX bus
Measuring range	400...10000 ppm CO ₂
Sensing element	Temperature sensor, CO ₂ sensor, relative humidity sensor
Measuring range, temperature	0...50°C
Sensing element, temperature	NTC
Communication	KNX PL-Link KNX S-Mode
Color	Black
Degree of protection	IP30
Dimensions (W x H x D)	88.4 x 133.4 x 18 mm
Warranty	24 WarrantyMonths

Stock no.

Product no.

S55624-H127

QMX3.P74-1BSC

Accessories for QMX3..

Basic plate for conduit and cavity wall box

QMX3.MP1

Basic plate for conduit box / cavity wall box with 68 mm diameter hole

20 pcs. per package

Data sheet	N1602
Dimensions (W x H x D)	80.5 x 115 mm
Warranty	60 WarrantyMonths



Stock no.

Product no.

S55624-H110

QMX3.MP1

Display and operation units

Room thermostats

Flush-mounted

RDF8..KNX Flush Mount

Flush mount touch screen KNX room thermostat for 2-/4-pipe FCU with on/off outputs, 2x universal input and electrical heater application, fit for both round and square conduit boxes



- Operating modes: Comfort, Economy and Protection
- For heating and/or cooling applications
- 2 or 3-position control outputs
- Output for 1-speed or 3-speed fan
- 2 multifunctional inputs for keycard contact, external room / return air temperature (QAH11.1, QAA32), heat / cool changeover, window contact on/off, dewpoint monitor, electrical heater enabled, fault contact, presence detector
- Automatic or manual heating/cooling changeover
- Adjustable commissioning and control parameters
- Minimum and maximum setpoint limitation
- Color of housing: Ivory white or black
- Backlit display

Application selectable:

- 2-pipe system
- 2-pipe system with electrical heater
- 4-pipe system

Data sheet	N3174
Power consumption	6 VA
Setpoint setting range	5...40 °C
Switching differential	0.5...6 K
Communication	Bus: KNX (S-mode and LTE mode with Synco 700)
Analog inputs, number	2
Relay outputs	Fan: N.O. contacts, non-floating Valve: N.O. contacts, non-floating
Relay outputs, number	5
Relay output, switching voltage	AC 230 V
Relay output, switching current	5 (2) A
Degree of protection	IP30
Dimensions (W x H x D)	86 x 86 x 47 mm

Range overview RDF8..KNX Flush Mount

Product Title	Operating voltage [V]	Stock no.	Product no.
Flush mount touch KNX room thermostat for 2-/4-pipe FCU with on/off output and 2x universal input, fit for both round and square conduit boxes, black	AC 230	S55770-T429	RDF800KN/VB
Flush mount touch KNX room thermostat for 2-/4-pipe FCU with on/off output and 2x universal input, fit for both round and square conduit boxes	AC 230	S55770-T350	RDF800KN

Flush mount KNX room thermostat for 2-/4-pipe FCU with on/off outputs, 2x universal input and electrical heater application, fit for both round and square conduit boxes

RDF6..KNX Flush Mount



Flush-mount room thermostat with LCD for fan coil units and compressors in DX-type equipment

- KNX communications
- For heating and/or cooling applications
- 2 or 3-position control outputs
- Output for 1-speed or 3-speed fan
- 2 multifunctional inputs for keycard contact, external room / return air temperature (QAH11.1, QAA32), heat / cool changeover, operation mode changeover, window contact on/off, dewpoint monitor, electrical heater enabled, fault contact, presence detector
- Operating modes: Comfort, Economy and Protection
- Automatic or manual heating/cooling changeover
- Adjustable commissioning and control parameters
- Minimum and maximum setpoint limitation
- Backlit display
- Color of housing: signal white (RAL 9003) or black
- Independent function for window contact, presence detector (standard presence and hotel presence)

Application selectable:

- 2-pipe system
- 2-pipe system with electrical heater
- 4-pipe system

Data sheet	N3076
Power consumption	2 VA
Switching differential	0.5...6 K
Communication	KNX
Analog inputs, number	2
Relay outputs	Fan: N.O. contacts, non-floating Valve: N.O. contacts, non-floating
Relay outputs, number	5
Relay output, switching voltage	AC 230 V
Relay output, switching current	5 (2) A
Type of fixing	With screws on recessed round conduit box diameter min. 60 mm
Dimensions (W x H x D)	86 x 86 x 46 mm

Range overview RDF6..KNX Flush Mount

Product Title	Operating voltage [V]	Stock no.	Product no.
Flush mount KNX room thermostat for 2-/4-pipe FCU with on/off output and 2x universal input, fit for both round and square conduit boxes	AC 230	S55770-T293	RDF600KN
Flush mount KNX room thermostat for 2-/4-pipe FCU with on/off output, KNX switching group, four buttons for switching lights and blinds and 2x universal input, fit for both round and square conduit boxes	AC 230	S55770-T400	RDF600KN/S
Flush mount KNX room thermostat for 2-/4-pipe FCU with on/off output and 2x universal input, fit for both round and square conduit boxes, black	AC 230	S55770-T430	RDF600KN/VB

Display and operation units

Room thermostats

Flush-mounted

RDF870KN



Flush mount touch KNX PM2.5 & CO2 & Ventilation Controls with on/off or ECM fans selectable and 2x DC 0-10 V input, fit for both round and square conduit boxes

- AC 230 V operating voltage, large, backlit display
- Display and setpoint adjustment for PM2.5 and CO2 control
- Display of room temperature, outside temperature, VOC (volatile organic compound) and RH (relative humidity)
- Support 1-/3-/4-speed On/Off fan or DC fan output
- Two multifunctional inputs for external passive and DC 0...10 V sensors
- Operating modes: Comfort, Economy and Protection
- KNX S-Mode
- KNX commissioning via ETS or local control parameters
- KNX integration into Desigo via group (ETS) or individual addressing
- KNX integration into third-party system via group addressing (ETS)
- Mounting on recessed square 86 mm box or round 60 mm with 60 mm fixing centers and minimum 40 mm depth
- Color of housing: Ivory white (RAL 9001)

Application selectable:

- PM2.5 control only
- CO2 control only
- PM2.5 & CO2 controls (CO2 higher priority in control)
- Ventilation control

2x sensor inputs are selectable:

- 0: No function
- 1: Temperature (AI) (NTC 10k)
- 2: Temperature (AI) (0...10 V)
- 3: PM2.5 (AI) µg/m³ (0...10 V)
- 4: CO2 (AI) ppm (0...10 V)
- 5: VOC (AI) % (0...10 V)
- 6: VOC (AI) mg/m³ (0...10 V)
- 7: RH (AI) % (0...10 V)
- 8: Alarm input (DI)
- 9: Dummy AI (0...10 V) (RU only)

Data sheet	A6V11439454
Operating voltage	AC 230 V 230 V
Power consumption	7 VA 2.5 W
Communication	KNX S-Mode
Analog outputs	DC 0...10 V for ECM fan output
Relay outputs	Fan: N.O. contacts, non-floating Valve: N.O. contacts, non-floating
Degree of protection	IP30
Dimensions (W x H x D)	86 x 86 x 46.8 mm
Color	White
Warranty	24 WarrantyMonths

Stock no.	Product no.
S55770-T407	RDF870KN

Room thermostats RDG2.. with KNX communications

RDG2..KN

- KNX communications
- 3 multifunctional inputs for keycard contact, external room / return air temperature (NTC3K; QAH11.1, QAA32 or LG-Ni1000 sensors), heat / cool changeover, operation mode changeover, window contact on/off, dewpoint monitor, electrical heater enabled, fault contact, presence detector
- Operating modes: Comfort, Economy and Protection
- Automatic or manual DC fan or 1-/3-speed
- Automatic or manual heating / cooling changeover
- Adjustable commissioning and control parameters
- Minimum and maximum setpoint limitation
- Backlit display
- Green leaf function
- Local weekly time program (with 3 Comfort periods per day)
- Manager /Subordinate (M/S) function
- Delta temperature control for district heating and cooling
- Commissioning via Smartphone APP "PCT Go", local HMI or KNX tools.

Data sheet	A6V11545853
Setpoint setting range	5...40 °C
Switching differential	Heating: 0.5...6 K; Cooling: 0.5...6 K
Communication	Bus: KNX (S-mode and LTE with Synco)
Analog output, signal	DC 0...10 V
Relay output, switching current	5 (4) A
Type of fixing	Wall mounting with screws
Degree of protection	IP30
Dimensions (W x H x D)	92 x 134 x 25 mm

Display and operation units

Room thermostats

Wall-mounted

RDG200KN



KNX communicating room thermostat. Outputs modulating (PWM / 3-pos.) or on/off. Fan coil (3-speed / DC fan), universal applications

- Built-in temperature and humidity sensors
- For applications with 2-position (on/off or PWM) or 3-position control outputs
- For applications with 3-speed or DC0...10 V fan
- AC 230 V or AC 24 V power supply.

Application selectable:

- 2-pipe system
- 2-pipe system with electrical heater
- 2-pipe system and radiator / floor heating
- 2-pipe / 2-stage heating or cooling systems
- 4-pipe system
- 4-pipe system with electrical heater
- 4-pipe / 2-stage heating and cooling system (selectable also for 2-stage cooling / 1-stage heating or 2-stage heating / 1-stage cooling)

Data sheet	A6V11545853
Operating voltage	AC 24 V AC 230 V
Analog inputs, number	3
Analog outputs	Fan. 1 (DC0...10 V)
Analog outputs, number	1
Digital inputs, number	3
Relay outputs	Fan: 1- or 3-speed
Relay output, switching voltage	AC 24 V or 230 V
Triac outputs	Valve, el. heater 2-position, PWM, 3-position
Triac outputs, number	4
Triac output, switching voltage	AC 24...230 V
Triac output, switching current	1 A

Stock no.	Product no.
S55770-T409	RDG200KN

Display and operation units

Room thermostats

Wall-mounted

KNX communicating room thermostat in black. Outputs modulating (PWM / 3-pos.) or on/off. Fan coil (3-speed / DC fan), universal applications

- Built-in temperature and humidity sensors
- Black color device RAL9011
- For applications with 2-position (on/off or PWM) or 3-position control outputs
- For applications with 3-speed or DC 0...10 V fan
- AC 230 V or AC 24 V power supply.

Application selectable:

- 2-pipe system
- 2-pipe system with electrical heater
- 2-pipe system and radiator / floor heating
- 2-pipe / 2-stage heating or cooling systems
- 4-pipe system
- 4-pipe system with electrical heater
- 4-pipe / 2-stage heating and cooling system (selectable also for 2-stage cooling / 1-stage heating or 2-stage heating / 1-stage cooling)

Data sheet	A6V11545853
Operating voltage	AC 24 V AC 230 V
Analog inputs, number	3
Analog outputs	Fan. 1 (DC 0...10 V)
Analog outputs, number	1
Digital inputs, number	3
Relay outputs	Fan: 1- or 3-speed
Relay output, switching voltage	AC 24 V or 230 V
Triac outputs	Valve, el. heater 2-position, PWM, 3-position
Triac outputs, number	4
Triac output, switching voltage	AC 24...230 V
Triac output, switching current	1 A

RDG200KN/BK



Stock no.

Product no.

S55770-T452

RDG200KN/BK

Display and operation units

Room thermostats

Wall-mounted

RDG204KN

**KNX communicating room thermostat with CO2 sensor. Outputs modulating (PWM / 3-pos.) or on/off. Fan coil (3-speed / DC fan), universal applications**

- Built-in temperature, humidity and CO2 sensors
- Indoor air quality monitoring and controlling (CO2) via fresh air damper
- Display of CO2 value in ppm (parts per million) or with text
- For applications with 2-position (on/off or PWM) or 3-position control outputs
- For applications with 3-speed or DC 0...10 V fan
- AC 230 V or AC 24 V power supply.

Application selectable:

- 2-pipe system
- 2-pipe system with electrical heater
- 2-pipe system and radiator / floor heating
- 2-pipe / 2-stage heating or cooling
- 4-pipe system
- 4-pipe system with electrical heater
- 4-pipe / 2-stage heating and cooling system (selectable also for 2-stage cooling / 1-stage heating or 2-stage heating / 1-stage cooling)

Data sheet	A6V11545853
Operating voltage	AC 24 V AC 230 V
Analog inputs, number	3
Analog outputs	Fan, fresh air damper: 2 (DC 0...10 V)
Analog outputs, number	2
Digital inputs, number	3
Relay outputs	Fan: 1- or 3-speed
Relay output, switching voltage	AC 24 V or 230 V
Triac outputs	Valve, el. heater, fresh air damper 2-position, PWM, 3-position
Triac outputs, number	4
Triac output, switching voltage	AC 24...230 V
Triac output, switching current	1 A

Stock no. Product no.

S55770-T410

RDG204KN

Display and operation units

Room thermostats

Wall-mounted

KNX communicating room thermostat. Outputs modulating (DC) or on/off. Fan coil (3-speed / DC fan) or universal applications

RDG260KN

- Built-in temperature and humidity sensors
- For applications with DC control outputs and DC or 3-speed fan output
- For applications with 2-position control output with DC fan output
- AC or DC 24 V operating voltage

Application selectable:

- 2-pipe system
- 2-pipe system with electrical heater
- 2-pipe system and radiator / floor heating
- 2-pipe / 2-stage heating or cooling system
- 4-pipe system
- 4-pipe system with electrical heater
- 4-pipe / 2-stage heating and cooling system (selectable also for 2-stage cooling / 1-stage heating or 2-stage heating / 1-stage cooling)
- 4-pipe system with 6-port ball valves and PICV
- Heating / cooling with 6-port ball valves



Data sheet	A6V11545853
Operating voltage	AC/DC 24 V
Analog inputs, number	3
Analog outputs	Valve, el. heater: 4 Fan: 1 (DC0...10 V)
Analog outputs, number	5
Digital inputs, number	3
Relay outputs	Valve, compressor or el. heater: 2 outputs, 2-position Fan: 1- or 3-speed
Relay output, switching voltage	AC 24...230 V

Stock no.

Product no.

S55770-T412

RDG260KN

Display and operation units

Room thermostats

Wall-mounted

RDG260KN/BK



KNX communicating room thermostat in black. Outputs modulating (DC) or on/off. Fan coil (3-speed / DC fan) or universal applications

- Built-in temperature and humidity sensors
- Black color device RAL9011
- For applications with DC control outputs and DC or 3-speed fan output
- For applications with 2-position control output with DC fan output
- AC or DC 24 V operating voltage

Application selectable:

- 2-pipe system
- 2-pipe system with electrical heater
- 2-pipe system and radiator / floor heating
- 2-pipe / 2-stage heating or cooling system
- 4-pipe system
- 4-pipe system with electrical heater
- 4-pipe / 2-stage heating and cooling system (selectable also for 2-stage cooling / 1-stage heating or 2-stage heating / 1-stage cooling)
- Heating / cooling with 6-port ball valves

Data sheet	A6V11545853
Operating voltage	AC/DC 24 V
Analog inputs, number	3
Analog outputs	Valve, el. heater: 4 Fan: 1 (DC 0...10 V)
Analog outputs, number	5
Digital inputs, number	3
Relay outputs	Valve, compressor or el. heater: 2 outputs, 2-position Fan: 1- or 3-speed
Relay output, switching voltage	AC 24...230 V

Stock no. Product no.

S55770-T453

RDG260KN/BK

Display and operation units

Room thermostats

Wall-mounted

KNX communicating room thermostat with CO2 sensor. Outputs modulating (DC) or on/off. Fan coil (3-speed / DC fan) or universal applications

RDG264KN



- Built-in temperature, humidity and CO2 sensors
- Indoor air quality monitoring and controlling (CO2) via fresh air damper
- Display of CO2 value in ppm (parts per million) or with text
- For applications with DC control outputs and DC or 3-speed fan output
- For applications with 2-position control output with DC fan output
- AC or DC 24 V operating voltage

Application selectable:

- 2-pipe system
- 2-pipe system with electrical heater
- 2-pipe system and radiator / floor heating
- 2-pipe / 2-stage heating or cooling system
- 4-pipe system
- 4-pipe system with electrical heater
- 4-pipe / 2-stage heating and cooling system (selectable also for 2-stage cooling / 1-stage heating or 2-stage heating / 1-stage cooling)
- Heating / cooling with 6-port ball valves

Data sheet	A6V11545853
Operating voltage	AC/DC 24 V
Analog inputs, number	3
Analog outputs	Valve, el. heater: 4 Fan, fresh air damper: 1 (DC0...10 V)
Analog outputs, number	6
Digital inputs, number	3
Relay outputs	Valve, compressor or el. heater: 2 outputs, 2-position Fan: 1- or 3-speed
Relay output, switching voltage	AC 24...230 V

Stock no.

Product no.

S55770-T413

RDG264KN

Display and operation units

Room thermostats

Wall-mounted

RDG405KN

Room thermostat for temperature and air quality control with KNX communications, AC 24 V, VAV heating and cooling systems

- KNX communications
- Output DC 0...10 V for VAV actuator and auxiliary output ON/OFF, PWM or 3-position or 3-position for VAV actuator and auxiliary output DC 0...10 V
- 2 multifunctional inputs for keycard contact, external room / return air temperature (1x, QAH11.1, QAA32), heat / cool changeover, operation mode changeover, window contact on/off, dewpoint monitor, electrical heater enabled, fault contact, presence detector
- 1 input DC 0...10 V for damper position feedback, for CO2 sensor
- Operating modes: Comfort, Economy and Protection
- Modulating PI control
- Control depending on the room or the return air temperature and air quality
- Automatic or manual heating / cooling changeover
- Adjustable commissioning and control parameters
- Minimum and maximum setpoint limitation
- Minimum and maximum limitation of air flow signal
- Output signal inversion (DC 0...10 V) as an option
- Backlit display

Application selectable:

- Single-duct system
- Single-duct system with electrical heater
- Single-duct system and radiator / floor heating
- Single-duct system with heating / cooling coil

Data sheet	N3192
Operating voltage	AC 24 V
Power consumption	2 VA
Setpoint setting range	5...40 °C
Switching differential	Heating: 0.5...6 K; Cooling: 0.5...6 K
Communication	Bus: KNX (S-mode and LTE mode with Synco 700)
Analog inputs, number	2
Analog outputs	VAV actuator, electric heater, valve
Analog outputs, number	1
Analog output, signal	DC 0...10 V
Analog output, current	1 mA
Digital inputs, number	1
Triac outputs	VAV actuator, valve, el. heater
Triac outputs, number	2-position, PWM, 3-position
Triac output, switching voltage	24 V
Triac output, switching current	1 A
Type of fixing	Wall mounting with screws
Degree of protection	IP30
Dimensions (W x H x D)	93 x 128 x 30.8 mm
Warranty	24 WarrantyMonths

Stock no.	Product no.
S55770-T348	RDG405KN

Touch Panel

- Multifunctional display/operating device for the KNX, with 320 x 240 pixels, 5.7" TFT color display and touch screen
- Dimming of LED background lighting over the operator interface
- For the display and operation of at least 210 communication objects on at least 20 display pages
- An additional page for the display and acknowledgement of at least 16 alarms
- Time program as weekly program for at least 110 communication objects and at least 10 switching tasks per weekday
- Presence simulation for at least 50 communication objects
- A trend module for storing and displaying graphics of the status values
- 1-bit or 8-bit scene control for at least 64 scenes
- At least 32 AND/OR operations, each comprising up to at least 4 communication objects
- At least 16 reference conditions for tripping one switching task respectively
- Individual password protection for each display page
- Buffered real-time clock and display of time and date
- Selection of at least 4 different design templates as operator and display interface
- Display of a loadable image as a start screen page or with display of a slideshow containing at least 100 loadable images instead of a start screen page
- USB interface for loading images and symbols
- USB cable, 1 m long and a transfer rate of 480 MBit/sec.
- Pushbutton for device reset
- Integrated bus coupling units, Bus connection via bus terminal
- Flush-mounting device in flush-mounting/hollow-wall box

UP 588/..3

The matching design frame and the flush-mounting/hollow-wall box must be ordered separately.

Range overview 588/..3

Product Title	Dimensions (WxHxD) [mm]	Stock no.	Product no.
Touch Panel, AC 230 V, 50 Hz	161.5 x 135 x 64	5WG1588-2AB13	UP 588/13
Touch Panel, AC/DC 24 V	161.5 x 135 x 64	5WG1588-2AB23	UP 588/23

Design frame for touch panel UP 588/..3, aluminium

Design frames aluminium for UP 588/3

Data sheet A6V11637841
Dimensions (W x H x D) 194 x 156 x 5 mm

S 588/12

Stock no. 5WG1588-8AB12
Product no. **S 588/12**

Design frame for touch panel UP 588/..3, stainless steel design

Design frames stainless steel for UP 588/3

Data sheet A6V11637841
Dimensions (W x H x D) 194 x 156 x 5 mm

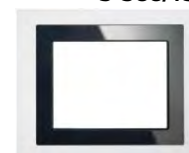
S 588/13

Stock no. 5WG1588-8AB13
Product no. **S 588/13**

Display and operation units

Touch panels

S 588/14



Design frame for touch panel UP 588/..3, glass black

Design frames black glass for UP 588/3 touch panels

Data sheet A6V11637841
Dimensions (W x H x D) 194 x 156 x 5 mm

Stock no. Product no.

5WG1588-8AB14 **S 588/14**

S 588/15



Design frame for touch panel UP 588/..3, glass white

Design frames white glass for UP 588/3 touch panels

Data sheet A6V11637841
Dimensions (W x H x D) 194 x 156 x 5 mm

Stock no. Product no.

5WG1588-8AB15 **S 588/15**

UP 588E01



Flush-type box for all touch panel UP 588

Flush-mounting/hollow-wall boxes for UP 588 touch panels

Data sheet A6V11637841
Dimensions (W x H x D) 161.5 x 135 x 64 mm

Stock no. Product no.

5WG1588-8EB01 **UP 588E01**

IP Control Center

Visualisation controller for full-graphic visualizations on web-compatible end devices such as PCs, tablets and smart phones with a standard web browser.

For communication between KNX devices and PCs and, in connection with a LAN-/WLAN modem or DSL router, for remote access to a KNX installation, for usage as an interface for the ETS 3/4/5 and as an interface for a visualization, with usage of the KNXnet/IP protocol, with the following simultaneously usable functions:

- Web server for operating and monitoring up to 1250 statuses and values transmitted by the KNX network, which can be displayed using a standard browser on PCs, tablets, or smartphones connected to the IP network
- Special web-configuration page for a firmware update, to set the IP configuration, SMTP server, security settings, password protection, certificates, Sonos module, API connection and restart
- Graphical web editor for a creation of fully graphical visualization with control and display elements, configurable in various styles
- Smart editor for the creation of a visualisation, tuned for mobile browsers, smartphones, tablets with control and display elements, configurable in various styles and layouts
- Annual timer, with astronomical calendar, for 300 time switch schedules with up to 30 time switch commands per time switch schedule
- Scene module with up to 5000 scenes or events
- Chart module for recording and reporting of up to 10 data points
- Monitoring module for monitoring and storage of up to 1000 events into a ring buffer
- IP interface for control of up to 20 IP-devices via up to 20 TCP/UDP commands per IP-device
- Fully graphical logic module with up to 1000 logic functions
- Alarm function for up to 250 different alarms
- E-mail function, with up to 20 contacts, for transmission of chart data from chart module, logged data from monitoring module or alarm data
- Data point management for viewing, managing, editing and categorizing all available data points
- Module for controlling SONOS loudspeakers
- Module for controlling the Philips HUE LED lighting system
- Ethernet interface 10/100 Mbits/s with RJ45 socket for connection to the IP network using the Internet Protocol
- 2 LED displays for IP connection/communication and for error messages
- Integrated bus connector and bus terminal for connection to a KNX network
- Power supply of the electronics by an external voltage source for AC/DC 24 V, 50 mA
- Series installation device for mounting on support rails TH35 DIN EN 60715

Data sheet	A6V10417875
Dimensions (W x H x D)	90 x 72 x 55 mm
Dimension width (1 MW = 18 mm)	4 MW

N 152/01



Stock no.	Product no.
5WG1152-1AB01	N 152/01

Accessories for N 152/01

Product Title	Stock no.	Product no.
Electronic power supply unit, 350 mA	4AC2402	4AC2402
LOGO! Power 24 V/1.3 A	6EP3331-6SB00-0AY0	LOGO!POWER 24 V/1,3 A

Display and operation units

Visualization, server

OZW772..



Web server for Synco devices

Web server OZW772 allows for remote plant control and monitoring via the web.

- Operate web browser via PC/laptop and Smartphone
- Operate ACS (PC/laptop with ACS plant operating software)
- Connections: USB and Ethernet
- Display fault messages in the web browser
- Send fault messages to a maximum of 4 e-mail recipients
- Periodically send system reports to e-mail recipients
- Visualize the plants in the web browser based on standard plant diagrams and customized plant web pages
- Acquire and display consumption data
- Send consumption data file to 2 email recipients
- Function "Energy indicator" to monitor data points for energy-related limit values, or "Green limits"
- Web services for external applications via Web API (Web Application Programming Interface)
- Encrypted with https and TLS for e-mails
- Record of trends, display and dispatch to 2 e-mail recipients
- Integration up to 237 S-Mode data points of KNX devices (not OZW772.01)
- Direct commissioning with web browser or ACS service tool
- Easy and secure remote access and plant overview with Synco IC Remote Access - a web-based service for secure remote access (www.siemens-syncoic.com)

Internet portal Synco IC offers simple and secure access to your plants

- Simple and fast set up of access via the Internet (fixed net- or mobile router)
- The portal provides additional functions:
 - Manage one or multiple plants
 - Central user management
 - Display of plant overview, state of Energy indicators and alarms
 - Send alarm notifications per e-mail
 - Secured communications through encryption (https)

Web servers OZW772.01, OZW772.04, OZW772.16, OZW772.250 can connect 1, 4, 16, or 250 KNX devices from the product ranges Synco 700, Synco RXB, and RDG/RDF room thermostats, and the QAX Synco living central apartment units.

Data sheet	N5701
Operating voltage	Power pack: AC 230 V Web server: DC 24 V
Communication	KNX TP (twisted pair) Ethernet, RJ45 plug socket (shielded) USB V2.0
Mounting	On DIN rails With Screws
Degree of protection	IP30
Dimensions (W x H x D)	87.5 x 90 x 40 mm

Range overview OZW772..

Product Title	Stock no.	Product no.
Web server for 1 Synco device	BPZ:OZW772.01	OZW772.01
Web server for 4 Synco devices	BPZ:OZW772.04	OZW772.04
Web server for 16 Synco devices	BPZ:OZW772.16	OZW772.16
Web server for 250 Synco devices	BPZ:OZW772.250	OZW772.250

Feature set for Desigo CC Compact Electrical

CCA-CMPT-ELEC



Desigo CC™ Compact for Electrical Applications offers full integration of lighting and all other electrical assets through KNX protocol, while also supporting in the southbound open standards such as BACnet, OPC, Modbus, and many more. Options are available for dedicated, browser-based, and Windows desktop app clients using the same user interface. Additionally, web interfaces provide increased flexibility for operation and future extensions such as mobile applications for tablets and smartphones.

The feature set for Desigo CC Compact Electrical includes the following

Functionality:

- Event Management & Journaling
- Graphic Viewer
- Scheduler, time based reactions, macros
- Logics (events/COV based Reactions, Scripts)
- Trend Viewer
- Remote Notification (E-Mail, Pager, SMS)
- Reports
- Log Viewer
- Operator Tasks
- Advanced Reporting
- Datamate (Apogee tool)
- Long Term Storage & Archiving: Included 4 (max. 4) standard archive groups, 1 for each type of records (activities, events, incidents and values)

Connectivity:

- Standard drivers (KNX, BACnet, OPC, Modbus, SNMP, S7 max. 8 PLC)
- Integration Token (10 included)
- Mobile App and/or Web Service sessions (maximum 5)
- Building X Connector (for Building X application, such as Operations Manager)

Clients:

- 3 clients (maximum 3)

Data Points:

- 500 Electrical data points included, more points can be ordered
- No Building Automation points are included but can be ordered up to a maximum of 500
- No Fire data points are included but can be ordered up to a maximum of 500
- No SCADA data points are included but can be ordered up to a maximum of 500
- No meter data points are included but can be ordered up to a maximum of 30

Warranty

12 WarrantyMonths

	Stock no.	Product no.
	P55802-Y108-A100	CCA-CMPT-ELEC

Data points

Product Title	Stock no.	Product no.
Add 100 building automation data points	P55802-Y157-A412	CCA-100-BA
Add 500 building automation data points	P55802-Y157-A452	CCA-500-BA
Add 100 fire detection data points	P55802-Y158-A412	CCA-100-FIRE
Add 500 fire detection data points	P55802-Y158-A452	CCA-500-FIRE
Add 100 SCADA data points	P55802-Y124-A412	CCA-100-SCADA
Add 500 SCADA data points	P55802-Y124-A452	CCA-500-SCADA
Add 10 meter data points	P55802-Y152-A411	CCA-10-METER
Add 500 electrical data points	P55802-Y156-A452	CCA-500-ELEC
Add 5'000 electrical data points	P55802-Y156-A453	CCA-5000-ELEC
Add 30'000 electrical data points	P55802-Y156-A434	CCA-30000-ELEC
Add 100'000 electrical data points	P55802-Y156-A415	CCA-100000-ELEC

Display and operation units

Visualization, software

Options

Product Title	Stock no.	Product no.
e-Car integration option	P55802-Y139-A300	CCA-OP-ECAR
Flex BIM viewer	P55802-Y128-A300	CCA-OP-FLX-BIM
Graphic Editor option	P55802-Y127-A300	CCA-OP-GRAPH-ED
Apogee P2 driver	P55802-Y133-A300	CCA-P2-DRIVE
Reno plus option	P54593-Y195-A300	CCA-M-RENOPLUS
Add one integration token	P55802-Y180-A410	CCA-1-INT-TK
Upsell Desigo CC Compact ELEC to Desigo CC	P55802-Y108-A500	CCA-CMPT-ELEC-U

Output devices



Overview and selection tools		90
Binary output devices	Switching actuators/DIN rail mounted devices	100
	Modular switching actuators/DIN rail mounted devices	107
	Switching actuators/Modular installation system	109
	Combination switching actuators	116

Output devices

Overview and selection tools

2

The binary output devices from Siemens can be flexibly used in many applications. The extensive product range for all standard loads (AC1, AC3, AX, C-Load) includes modular extensible switching actuators with integrated load current detection.

Usage of load types AC1, AC3, AX and C load

The industrial and building control sector have seen the establishment of a range of different switching capacities and outputs. These tend to be specific to the respective applications and are specified in the corresponding national and international standards. The tests are defined such that they reproduce typical applications, such as motor loads (industry) or fluorescent lamps (buildings).

The AC1 and AC3 details are switching capacity specifications which have become established in the industrial sector:

- AC1: refers to the switching of predominantly resistive loads (p.f. = 0.8)
- AC3: refers to an (inductive) motor load (p.f. = 0.45)

These switching capacities are defined in the standard EN 60947-4-1. „Contactors and motor starters – Electromechanical contactors and motor starters“. The standard describes starters and/or contactors, which are originally used in industrial applications.

The designation AX has become established in building controls:

- AX: refers to a (capacitive) fluorescent lamp load

Switchable capacitive loads (200 μ F, 140 μ F, 70 μ F or 35 μ F), at a load of 200 μ F “C load”, and are mentioned in conjunction with fluorescent lamp loads. This switching capacity refers to the standard EN 60669 „Switches for household and similar fixed electrical installations – Particular requirements“, which is primarily implemented for applications in building control. For 6A devices a test with 70 μ F and for 10A devices a test with 140 μ F is required. The switching capacity declarations AC and AX are directly comparable with each other.

Modular switching actuators



The modular design of the GAMMA instabus switching actuators guarantees the flexible design for each case of application. Up to four switching actuator extensions can be connected to the 6-pin interface on the main module using a jumper. In this manner, a 3-fold switching actuator can be extended to 6/9/12 or 15-fold switching actuators and flexibly adapted to the number and size of loads to be switched. The variety of the functionality of the application software covers a broad spectrum: Ranging from multistage fan control, operating hours and switching cycle counters to scene control, thermal actuator control up to load recognition and monitoring of load current per channel.

The extensive application program controls both the outputs of the main units and the outputs of all connected expansions. This includes:

- Recording and monitoring of load current per output for load failure or overload
- Detection of a significant equipment failure
- Preventive detection of failures due to continuous monitoring of the current
- Detection of load circuit interruption
- Simultaneous switching of all three outputs
- Implementation of a rotational speed stated as a percentage, in 1 to 3-stage switching commands (fan speed control)
- Implementation of a valve position stated as a percentage in a pulse width modulated switching command (thermal drive control)
- Switching operation and operating hours counter with limit monitoring per output
- Integrated 8-bit scene control, with each output assignable to up to 8 scenes

Diagram of 15-fold switching actuator

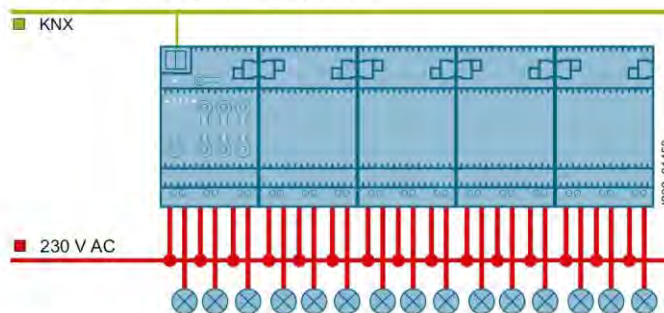

The depicted diagram is an example of schematic interconnection and connection of individual switching actuator modules. All modules labeled 10 AX, 16 AX and 20 AX are compatible and therefore can be used together. Detailed information is available on our Internet page with technical documentation: www.siemens.de/gamma-td



Switching Actuators N 53x

The new DIN Switching Actuators N 53x are intended for installation in distribution boxes or small cabinets and are installed by snapping onto a 35 mm top hat rail according to EN 60715-TH35.

All nine switching actuators have the following common features.

- The rated contact operating voltage of the switching actuators is AC 230 V
- The products are equipped with maintenance-free terminals
- The terminals are designed for connection and through-wiring of untreated single-core, stranded or multi-core conductors, 0.5 ... 2.5 mm². Stranded and multi-core conductors can be pushed into the terminals without ferrules
- One relay contact per output as switching element (ON/OFF)
- Per output there is a mechanical display of the switching status via a slide switch, which can also be used for direct manual operation (ON/OFF switching) of the switching output
- The electronics of the devices are powered via the bus voltage
- All switching actuators are connected to the bus via bus terminal block
- The device has a red LED for indicating activation of addressing mode or device operation
- The housing is of plastic, N-system
- Color RAL 7035 (light grey)
- DIN rail mounted device for mounting on rail TH35 according to DIN EN 60715
- Type of protection: IP 20

Output devices

Overview and selection tools

2

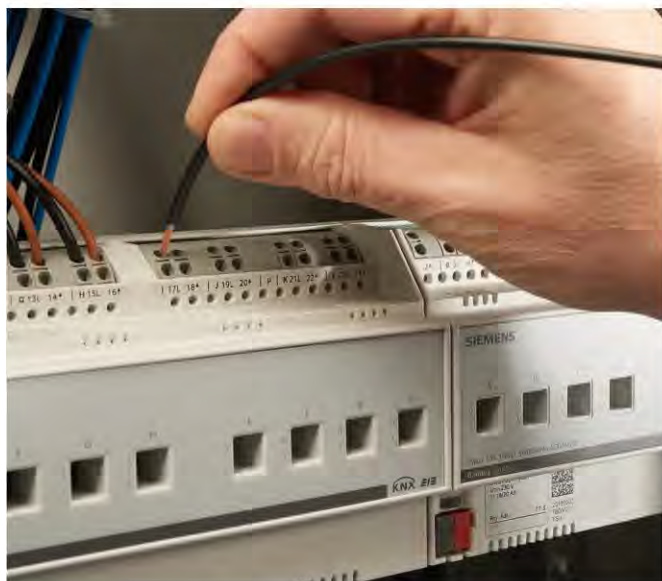

Automation functions

The switching actuators provide many control functions per output. The basic function of the new DIN rail mounted devices is switching with status feedback. Very powerful relays are also employed for switching capacitive loads. Via ETS configuration the basic function can be expanded by control functions (logic, timer, scenes, central switching control), override functions (manual ON, continuous OFF, blocking, forced control) up to diagnostic functions (counting of operating hours and switching cycles without and with threshold monitoring).

The extent of the control, override and diagnostic functions is illustrated in detail below.

Control functions

The new switching actuators provide automation of lighting or control of motors. These control functions are available for that purpose:

- Switching input: control input for ON respectively OFF commands
- Control value input: A control value input with configurable thresholds for On and Off switching can be used as an alternative to a switching input. The control value input is a control input for an analog control value e.g. temperature, percent value, power, illuminance and integer numbers. The control value input is transformed via an upper and a lower threshold into an ON respectively an OFF command.
- Alternatively available operating types:
 - Normal operation
 - Timer operation
 - Flashing operation
- Logic operations (AND, OR, NAND, XOR, NOR, FILTER, TRIGGER)
- Central switching
- 8-bit scene control
- day / night operation

Each output of the actuator can be individually set to one of these operating modes:

- Normal operation
- Timer operation
- Flashing operation

In the operation mode „normal operation“ the timer functions for delayed On and Off switching and timer night mode operation are available.

In the operation mode „timer operation“ the functions timer day operation and timer night operation are available. In the operation mode „Flashing“ the output is cyclically turned on and off with configurable on and off duty cycles. In timer day or night operation switching On of the output can be time limited (e.g. for cleaning lighting), if applicable with warning before switching off via off and on switching of the output (single flashing).

Per output there is an integrated 8-bit scene control with each output assignable to up to 8 scenes.

Override control functions

To realize special functions which have a higher priority than standard control functions. Up to seven different override function blocks can be activated to override the control functions.

Per actuator output up to seven different override functions (1 to 7) can be freely selected. The override control function 7 has the highest priority, the override function 1 the lowest. For each one of the activated override functions one of the following functions can be chosen:

- Manual override ON
- Permanent OFF
- Blocking function
- Central override
- User-defined override function
- Forced control

This allows to flexibly configure a different priority dependent override for each actuator output. For the override functions a control valve input can be selected instead of a switching control input. Override functions can be used to address special cases in room and building control like fire alarm, evacuation or maintenance work.

For instance, in case of a fire by switching off loads the ignition respectively support energy for the fire is removed. In case of evacuation the evacuation route lighting can be force controlled switched on. To avoid person and property damage during maintenance work an output can be switched off and switching on of the output can be blocked during maintenance.

Diagnostic functions

The diagnostic functions support supervisory systems with their display, monitoring and archiving functions. For this purpose these diagnostic functions are available:

- Device function: The switching actuator cyclically sends a function signal allowing a supervisory system to control its function.
- Status indication: Sending of the switching status can be activated per output. The current status can be read via the bus or transmitted cyclically.
- Status retrieval: For all outputs sending the current status can be triggered via a central status retrieval object. With a single message a visualization (e.g. IP Control Center) can update its status information and display.
- Switching cycle count with or without threshold monitoring: The switching cycle count can be activated per output. The number of switching cycles can be read via the bus. This allows for monitoring of the switching cycles and a switching cycle dependent maintenance. If the threshold monitoring is activated the device sends a signal onto the bus when the set threshold is reached. The exceedance of the threshold is automatically signaled respectively this can be sent as an email by the IP Control Center or can be displayed by a warning light.
- Operating hour count with or without threshold monitoring: The operating hour count can be activated per output. The number of operating hours can be read via the bus. This allows for monitoring of the operating hours and an operating hour dependent maintenance, e.g. if after 10,000 hours of operation lamps shall be replaced. If the threshold monitoring is activated the device sends a signal onto the bus when the set threshold is reached. The exceedance of the threshold is automatically signaled respectively this can be sent as an email by the IP Control Center or can be displayed by a warning light.

• Load Check (only Type N 535)

With switching actuators of type N 535, the load check can optionally be measured and the status sent via the bus. The load check can also be monitored with regard to exceedance or falling short of load check limit values. An adjustment factor and offset value can be specified.

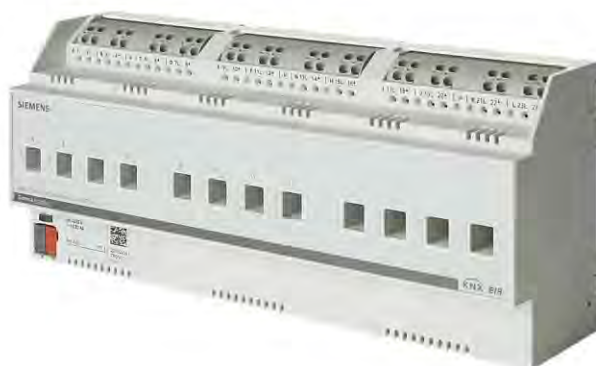

The control, override and diagnostic functions can be realized in the device itself without additional control modules or a controller. With these functions the switching actuators are getting into the functional class of a micro-PLC with powerful relays.



Output devices

Overview and selection tools

2

	Switching actuators										Modular switching actuators					
											Main modules			Expansions		
																
Type	N 530D31	N 530D51	N 530D61	N 532D31	N 532D51	N 532D61	N 534D31	N 534D51	N 534D61	N 535D51	N 562/11	N 512/11	N 513/11	N 562/21	N 512/21	N 513/21
Enclosure data																
Design	N	N	N	N	N	N	N	N	N	N	N	N	N	N	N	N
Modular installation devices for mounting on TH35 EN 60715 mounting rail	■	■	■	■	■	■	■	■	■	■	■	■	■	■	■	■
Interface for connection of a switch actuator expansion											■	■	■	■	■	■
Dimensions																
Width (1 MW = 18 mm)	4 MW	8 MW	12 MW	4 MW	8 MW	12 MW	4 MW	8 MW	12 MW	8 MW	3 MW	3 MW	3 MW	3 MW	3 MW	3 MW
Display/control elements																
Direct operation (local operation)											■	■	■	■ ¹⁾	■ ¹⁾	■ ¹⁾
Mechanical local operation	■	■	■	■	■	■	■	■	■	■						
Mechanical switching position indication	■	■	■	■	■	■	■	■	■	■						
LED for indicating direct operation											■	■	■			
LED for indicating the selected device											■	■	■			
LED for status indication per output											■	■	■	■ ¹⁾	■ ¹⁾	■ ¹⁾
Power supply																
Bus-powered electronics	■	■	■	■	■	■	■	■	■	■	■	■	■	■ ¹⁾	■ ¹⁾	■ ¹⁾
Bus connection																
Integrated bus coupling units	■	■	■	■	■	■	■	■	■	■	■	■	■			
Bus connection via bus terminal	■	■	■	■	■	■	■	■	■	■	■	■	■			
Outputs																
Load output																
Floating relay contacts	4	8	12	4	8	12	4	8	12	8	3	3	3	3	3	3
Rated contact voltage, AC [V]	230	230	230	230	230	230	230	230	230	230	230	230	230	230	230	230
Rated contact current																
• AX (200 µF) acc. to EN 50428 [AX]	6 ³⁾	6 ³⁾	6 ³⁾	10 ²⁾	10 ²⁾	10 ²⁾	16	16	16	16	10 ²⁾	16	20	10 ²⁾	16	20
• AC1 (p.f. = 0.8) acc. to EN 50428 [A]	10	10	10	16	16	16	20 ⁴⁾	20 ⁴⁾	20 ⁴⁾	20 ⁴⁾	16	16	20	16	16	20
• AC3 (p.f. = 0.45) acc. to DIN EN 60497-4-1 [A]	6	6	6	8	8	8	16	16	16	16	10	16	16	10	16	16
• DC 24 V (resistive load) [A]	10	10	10	10	10	10	10	10	10	10	10	16	20	10	16	20
Three-phase switching (3 outputs simultaneously)											■	■	■	■	■	■

¹⁾ Via main module²⁾ 140 µF³⁾ 70 µF⁴⁾ 20 A only up to 35 °C ambient temperature and neighboring channel current-free

...Continuation of the table	Switching actuators										Modular switching actuators					
	N 530D31	N 530D51	N 530D61	N 532D31	N 532D51	N 532D61	N 534D31	N 534D51	N 534D61	N 535D51	Main modules			Expansions		
Type											N 562/11	N 512/11	N 513/11	N 562/21	N 512/21	N 513/21
Application program ¹⁾	9A0101	9A0201	9A0301	9A0101	9A0201	9A0301	9A0101	9A0201	9A0301	9A0903	982002			2)		
Output functions																
Max. number of group addresses	2000	2000	2000	2000	2000	2000	2000	2000	2000	2000	511	511	511			
Max. number of assignments	2000	2000	2000	2000	2000	2000	2000	2000	2000	2000	511	511	511			
Max. number of expansion modules that can be butt-mounted											4	4	4			
Blocking function	■	■	■	■	■	■	■	■	■	■						
Configurable behavior in the event of a bus voltage failure	■	■	■	■	■	■	■	■	■	■	■	■	■	■	■	■
Configurable behavior in the event of a bus voltage recovery	■	■	■	■	■	■	■	■	■	■	■	■	■	■	■	■
Behavior in the event of mains voltage failure																
• Unchanged switching state of outputs	■	■	■	■	■	■	■	■	■	■	■	■	■	■	■	■
Heating control																
Controlling electrothermal actuators											■	■	■	■	■	■
Scene control																
Integrated 8-bit scene control	■	■	■	■	■	■	■	■	■	■	■	■	■	■	■	■
Scenes to be integrated per channel	8	8	8	8	8	8	8	8	8	8	8	8	8	8	8	8
Time functions																
OFF delay	■	■	■	■	■	■	■	■	■	■	■	■	■	■	■	■
ON delay	■	■	■	■	■	■	■	■	■	■	■	■	■	■	■	■
Timer mode (automatic stairwell switch)	■	■	■	■	■	■	■	■	■	■	■	■	■	■	■	■
Night mode (lighting for cleaning)	■	■	■	■	■	■	■	■	■	■	■	■	■	■	■	■
Warning of impending OFF	■	■	■	■	■	■	■	■	■	■	■	■	■	■	■	■
Logical functions																
Positively driven operation	■	■	■	■	■	■	■	■	■	■	■	■	■	■	■	■
Logic function (1 object)	■	■	■	■	■	■	■	■	■	■	■	■	■	■	■	■
Logic function (2 objects)	■	■	■	■	■	■	■	■	■	■	■	■	■	■	■	■
Can be inverted per output (NO contact/NC contact)	■	■	■	■	■	■	■	■	■	■	■	■	■	■	■	■
Status																
Transmitting status per channel	■	■	■	■	■	■	■	■	■	■	■	■	■	■	■	■
Operating hours counter with limit monitoring per channel	■	■	■	■	■	■	■	■	■	■	■	■	■	■	■	■
Switching cycle counter with limit monitoring per channel	■	■	■	■	■	■	■	■	■	■	■	■	■	■	■	■
Load current recording / monitoring per channel											■	■	■	■	■	■

¹⁾ For current application programs, see www.siemens.com/gamma-td.

²⁾ Via main module

Output devices

Overview and selection tools

2

Binary output devices

	N 567/22	N 512C01	N 502/02	UP 510/03	UP 510/13	RS 510/23	RL512/23	RL513D23	UP 511S32	UP 562S32
Type										
Enclosure data										
Design	N	N	N	UP	UP	RS	RL	RL	UP	UP
Modular installation devices for mounting on TH35 EN 60715 mounting rail	■	■	■							
For installation in flush-mounting switch and socket boxes with Ø 60 mm				■	■				■	■
Modular installation device for mounting in AP 118 automation module box or AP 641 room control box ¹⁾						■	■	■		
Modular installation in mounting case M 592/01 ²⁾									■	■
10-pole BTI socket (BTI - Bus Transceiver Interface) for plugging of bus terminal devices with BTI connector				■						
Dimensions										
• Width/Ø [mm] (1 MW = 18 mm)	8 MW	8 MW	8 MW	71	50	50.2	47.8	47.8	48	48
• Height [mm]				71	50.9	48.8	86.5	86.5	50	50
• Depth [mm]				42	41.3	35.5	36.2	36.2	28	28
Mounting type										
Screw fixing				■						
Display/control elements										
Direct operation (local operation)	■		■							
Mechanical local operation		■								
Mechanical switching position indication		■								
LED for status indication per output	■		■							
LED for indicating direct operation	■		■							
Power supply										
Bus-powered electronics		■		■	■	■	■	■	■	■
Electronics powered via an integrated power supply unit for supply voltage AC 230 V	■		■							
Bus connection										
Integrated bus coupling units	■	■	■	■	■	■	■	■	■	■
Bus connection via bus terminal	■	■	■	■	■	■	■	■	■	■
Bus connection via contact system to data rail	■	■	■							
Outputs										
Load output										
Floating relay contacts	16 ³⁾	8	8 ³⁾	2	2	2	1	2	1	2
Rated contact voltage, AC [V]	230	230 ⁴⁾	230	230	230	230	230	230	230	230
Rated contact current [A]	10	16	16	10	10	10	16	20	16	∑ 16 ⁵⁾
Inputs										
Max. cable length, unshielded, twisted [m]			100						10	10
Pushbutton inputs										
For signal input (floating contacts)			8						3	3
For voltage input AC/DC 12...230 V			8							

¹⁾ The AP 641 room control box and AP 118 automation module box must be ordered separately, see Chapter Quick-assembly system - Room control box - Module boxes

²⁾ The M 592/01 mounting device must be ordered separately, see Chapter Combination devices

³⁾ Except channel A

⁴⁾ Also available as cUL version: AC 120 V / AC 277V / AC 347 V, 20 A, Order No.: 5WG1512-1CB01

⁵⁾ The sum applies to both load outputs

...Continuation of the table

Type	N 567/22	N 512C01	N 502/02	UP 510/03	UP 510/13	RS 510/23 ²⁾	RL 512/23 ³⁾	RL 513/23 ⁴⁾	UP 511S32	UP 562S32
	981C01	908301	981601	982E01	982E01	982E01	982D01	982F02	20DF22	20DE22
Application program¹⁾										
Output functions										
Max. number of group addresses	106	49	120	120	120	120	120	120	1600	1600
Max. number of assignments	106	49	120	120	120	120	120	120	1600	1600
Blocking function									■	■
Configurable behavior in the event of a bus voltage failure			■	■	■	■	■	■	■	■
Configurable behavior in the event of a bus voltage recovery		■	■	■	■	■	■	■	■	■
Configurable behavior in the event of a mains voltage recovery	■		■							
Behavior in the event of mains voltage failure										
• Unchanged switching state of outputs	■	■	■	■	■	■	■	■	■	■
Scene control										
Integrated 8-bit scene control	■		■	■	■	■	■	■	■	■
Scenes to be integrated per channel	8		8	8	8	8	8	8	64	64
Time functions										
OFF delay	■	■	■	■	■	■	■	■	■	■
ON delay	■	■	■	■	■	■	■	■	■	■
Timer mode (automatic stairwell switch)	■	■	■	■	■	■	■	■	■	■
Night mode (lighting for cleaning)	■		■	■	■	■	■	■		
Warning of impending OFF	■	■	■	■	■	■	■	■		
Logical functions										
Positively driven operation		■		■	■	■	■	■	■	■
Logic function (1 object)	■	■	■						■	■
Logic function (2 objects)				■	■	■	■	■	■	■
Can be inverted per output (NO contact/NC contact)		■	■	■	■	■	■	■	■	■
Status										
Transmitting status per channel	■	■	■	■	■	■	■	■	■	■

¹⁾ For current application programs, see www.siemens.com/gamma-td²⁾ Identical functions as JB 510C23³⁾ Identical functions as JB 512C23⁴⁾ Identical functions as JB 513C23

Output devices

Overview and selection tools

2

Load data for switching actuators per channel

Type	N 530D31 N 530D51 N 530D61			N 532D31 N 532D51 N 532D61			N 534D31 N 534D51 N 534D61 N 535D51			N 562/11 N 562/21		N 512/11 N 512/21		N 513/11 N 513/21		N 512C01 ¹⁾	
Contact current																	
Rated current, AC [A]	6 AX			10 AX			16/20 AX			10 AX ³⁾		16 AX		20 AX		16	
AC1 operation (p.f. = 0.8) [A]	10			16			16			16		16		20		16	
AC3 operation (p.f. = 0.45) [VA]	2300			2500			3680			2300		3680		3680		3680	
24 V DC (resistive load) [A]	6			10			10			10		16		20		10	
Maximum switch-on peak current																	
• t = 150 µs [A]	400			400			600			450		450		450		600	
• t = 250 µs [A]	320			320			480			350		350		350		480	
• t = 600 µs [A]	200			200			300			220		220		2200		300	
Contact voltage																	
Rated voltage, AC [V]	230			230			230			230		230		230		230	
Service life																	
Mechanical service life Switching operations in millions	1			1			1			1		1		1		1	
Electrical service life Switching operations in millions	2)			2)			2)			0.1		0.1		0.1		2)	
Power loss																	
Maximum power loss per device at rated power [W]	1	2	2	2	4	6	3	6	8	3	3	3	3	3	3	9	
Switching capacities/load types, loads																	
Resistive load [W]	2300			3680			3680			3680		3680		4600		3680	
Minimum switching capacity [V/mA]	12/100			12/100			12/100			12/100		12/100		12/100		12/100	
DC switching capacity [VA]	24/6			24/10			24/10			24/10		24/16		24/20		24/10	
Maximum capacitive load [µF]	70			140			200			200		200		200		200	
Incandescent lamps																	
Incandescent lamps [W]	2300			3680			3680			2300		3680		3680		3680	
Halogen lamp 230 V [W]	2300			3680			3680			2300		3680		3680		3680	
LV halogen lamp with conventional transformer (inductive) [VA]	500			500			2000			1200		2000		2000		2000	
T5/T8 fluorescent lamps																	
Uncorrected [VA]	1380			2300			3680			2300		3680		3680		3680	
Parallel corrected (at max. possible C) [W]	1300 (140 µF)			1300 (140 µF)			2500 (200 µF)			1500		2500		2500		2500 (200 µF)	
DUO circuit [VA]	1380			2300			3680			1500		3680		3680		3680	
Compact lamps																	
Uncorrected [VA]	1380			1600			3680			1600		3680		3680		3680	
Parallel corrected (at max. possible C) [W]	1100 (140 µF)			1100 (140 µF)			3000 (200 µF)			1100		2500		2500		3000 (200 µF)	

¹⁾ Also available as UL version: 120 V AC, 20 A, Stock no.: 5WG1512-1CB01

²⁾ On request

³⁾ Further information see chapter Output devices

⁴⁾ The number of ECG types takes into account the use of miniature circuit breakers with characteristic B
For complete technical specifications, see: www.siemens.com/gamma-td

... Continuation of the table

Type	N 567/22	N 502/02	UP 510/03 UP 510/13 RS 510/23	RL 512/23	RL513D23	UP 511S32	UP 562S32
Contact current							
Rated current, AC [A]	10	16	10	16 AX	10	16	∑ 16 ²⁾
AC1 operation (p.f. = 0.8) [A]	¹⁾	¹⁾	¹⁾	¹⁾	¹⁾	10	∑ 10 ²⁾
AC3 operation (p.f. = 0.45) [VA]	500	500	500	3680	500	1380	∑ 1380 ²⁾
DC 24 V (resistive load) [A]	10	¹⁾	¹⁾	¹⁾	¹⁾	¹⁾	¹⁾
Maximum switch-on peak current							
• t = 150 μs [A]	200	200	200	450	200		
• t = 200 μs [A]						800	800
• t = 250 μs [A]	160	160	160	320	160		
• t = 600 μs [A]	100	100	100	220	100		
• t = 20 ms [A]						165	165
Contact voltage							
Rated voltage, AC [V]	230	230	230	230	230	230	230
Service life							
Mechanical service life Switching operations in millions	30	30	10	1	10	3	3
Electrical service life Switching operations in millions	0.1	0.1	0.1	0.1	0.1		
Power loss							
Maximum power loss per device at rated power [W]	9	13	3	3	3		
Switching capacities/load types, loads							
Resistive load [W]	2300	3680	2300	3680	2300	2500	∑ 2500 ²⁾
Minimum switching capacity [V/mA]	24/100	24/100	24/10	12/100	24/10		
DC switching capacity [VA]	24/10	24/16	30/10	24/16	30/10		
Maximum capacitive load [μF]	35	35	35	200	35	140	∑ 140 ²⁾
Incandescent lamps							
Incandescent lamps [W]	1000	1000	1000	3680	1000	2300	∑ 2300 ²⁾
Halogen lamp 230 V [W]	1000	1000	1000	3680	1000	2300	∑ 2300 ²⁾
LV halogen lamp with conventional transformer (inductive) [VA]	500	500	200 ... 500	2000	200 ... 500	1200	∑ 1200 ²⁾
T5/T8 fluorescent lamps							
Uncorrected [VA]	500	500	500	3680	500		
Parallel corrected (at max. possible C) [W]	2 x 58	2 x 58	2 x 58	2500	2 x 58		
DUO circuit [VA]	1000	1000	1000	3680	1000		
Compact lamps							
Uncorrected [VA]	500	500	500	3680	500	1000	∑ 1000 ²⁾
Parallel corrected (at max. possible C) [W]	300 (35 μF)	300 (35 μF)	300 (35 μF)	2500	300	1160	∑ 1160 ²⁾

¹⁾ On request²⁾ The sum applies to both load outputsFor complete technical specifications, see: www.siemens.com/gamma-td

Output devices

Binary output devices

Switching actuators/DIN rail mounted devices

2

N 53x/..



Switching actuator

- One relay contact per output as switching element
- Rated contact operating voltage AC 230 V
- Rated contact frequency: 50/60 Hz
- Per output with mechanical display of the switching status via slide switches, which can also be used for direct manual operation of the switching output
- Maintenance-free terminals for connection and through-wiring of untreated single-core, stranded or multi-core conductors, 0.5 ... 2.5 mm²
- One phase terminal per output
- Bus-powered electronics
- Integrated bus coupling unit, bus connection via bus terminal block
- Red LED for display of the activation of the addressing mode as well as the operational readiness
- Housing: plastic, color RAL 7035 (light grey), N-system
- DIN rail mounted device for mounting on rail TH35 according to DIN EN 60715
- Type of protection: IP 20

Per output

- Selectable operating mode (normal mode, time switch mode, flashing mode)
- Selectable relay mode (NC/NO)
- Variable On and Off delay times
- Two selectable logic operations (AND, OR, NAND, NOR, XOR, FILTER, TRIGGER)
- Selectable sending of status objects on request, cyclically and/or automatically after a change
- Selectable switching state on bus voltage failure
- Selectable start value of the switching object on bus voltage recovery
- Optional addition of a night mode object for time-limited switching On of the output, i.e. the illumination, at night
- Variable On period at night or time switch mode
- Selectable addition of an object to change the On period at night or time switch mode
- Selectable post-triggering (1x, 2x, 3x, 4x, 5x) of the On period in time switch mode
- Selectable warning signal prior to imminent switching-off by brief off and on switching (flashing) at night or in time switch mode and/or via an optional warning object

Per output selectable functions:

- For manual override ON
 - For permanent OFF switching
 - Blocking of the output
 - For switching on or off in forced mode
 - Counting of operating hours and threshold monitoring
 - Counting of load cycles and threshold monitoring
 - Integrated 8-bit scene control with up to 8 scenes per output
-
- Construction site function switching
 - Object for monitoring of device function
 - Object for targeted retrieval of status values

Switching actuator 4 x AC 230 V, 6 AX, C-Load**N 530D31**

Rated contact current according to DIN EN 60669: 6 AX (70 µF fluorescent lamp load), 10 A (resistive load)

Data sheet A6V11252211
Dimensions (W x H x D) 72 x 90 x 61 mm
Dimension width (1 MW = 18 mm) 4 MW



Stock no.	Product no.
5WG1530-1DB31	N 530D31

Switching actuator 8 x AC 230 V, 6 AX, C-Load**N 530D51**

Rated contact current according to DIN EN 60669: 6 AX (70 µF fluorescent lamp load), 10 A (resistive load)

Data sheet A6V11252211
Dimensions (W x H x D) 144 x 90 x 61 mm
Dimension width (1 MW = 18 mm) 8 MW



Stock no.	Product no.
5WG1530-1DB51	N 530D51

Switching actuator 12 x AC 230 V, 6 AX, C-Load**N 530D61**

Rated contact current according to DIN EN 60669: 6 AX (70 µF fluorescent lamp load), 10 A (resistive load)

Data sheet A6V11252211
Dimensions (W x H x D) 216 x 90 x 61 mm
Dimension width (1 MW = 18 mm) 12 MW



Stock no.	Product no.
5WG1530-1DB61	N 530D61

Output devices

Binary output devices

Switching actuators/DIN rail mounted devices

2

N 532D31



Switching actuator 4 x AC 230 V, 10 AX, C-Load

Rated contact current according to DIN EN 60669: 10 AX (140 µF fluorescent lamp load), 10 A (resistive load)

Data sheet

A6V11252211

Dimensions (W x H x D)

72 x 90 x 61 mm

Dimension width (1 MW = 18 mm)

4 MW



Stock no.	Product no.
5WG1532-1DB31	N 532D31

N 532D51



Switching actuator 8 x AC 230 V, 10 AX, C-Load

Rated contact current according to DIN EN 60669: 10 AX (140 µF fluorescent lamp load), 10 A (resistive load)

Data sheet

A6V11252211

Dimensions (W x H x D)

144 x 90 x 61 mm

Dimension width (1 MW = 18 mm)

8 MW



Stock no.	Product no.
5WG1532-1DB51	N 532D51

N 532D61



Switching actuator 12 x AC 230 V, 10 AX, C-Load

Rated contact current according to DIN EN 60669: 10 AX (140 µF fluorescent lamp load), 10 A (resistive load)

Data sheet

A6V11252211

Dimensions (W x H x D)

216 x 90 x 61 mm

Dimension width (1 MW = 18 mm)

12 MW



Stock no.	Product no.
5WG1532-1DB61	N 532D61

Output devices

Binary output devices

Switching actuators/DIN rail mounted devices

2

Switching actuator 4 x AC 230 V, 16/20 AX, C-Load

N 534D31

Rated contact current according to DIN EN 60669: 16 AX / 20 AX (200 µF fluorescent lamp load)

Data sheet	A6V11252211
Dimensions (W x H x D)	72 x 90 x 61 mm
Dimension width (1 MW = 18 mm)	4 MW



Stock no.	Product no.
5WG1534-1DB31	N 534D31

Switching actuator 8 x AC 230 V, 16/20 AX, C-Load

N 534D51

Rated contact current according to DIN EN 60669: 16 AX / 20 AX (200 µF fluorescent lamp load)

Data sheet	A6V11252211
Dimensions (W x H x D)	144 x 90 x 61 mm
Dimension width (1 MW = 18 mm)	8 MW



Stock no.	Product no.
5WG1534-1DB51	N 534D51

Switching actuator 12 x AC 230 V, 16/20 AX, C-Load

N 534D61

Rated contact current according to DIN EN 60669: 16 AX / 20 AX (200 µF fluorescent lamp load)

Data sheet	A6V11252211
Dimensions (W x H x D)	216 x 90 x 61 mm
Dimension width (1 MW = 18 mm)	12 MW



Stock no.	Product no.
5WG1534-1DB61	N 534D61

Output devices

Binary output devices

Switching actuators/DIN rail mounted devices

2

N 535D..1



Switching actuator with load current detection

- One relay contact per output as switching element with load current measurement
 - Rated contact operating voltage AC 230 V
 - Rated contact frequency: 50/60 Hz
 - Per output with mechanical display of the switching status via slide switches, which can also be used for direct manual operation of the switching output
 - Maintenance-free terminals for connection and through-wiring of untreated single-core, stranded or multi-core conductors, 0.5 ... 2.5 mm²
 - One phase terminal per output
 - Fluorescent lamp load according to DIN EN 60669: 16 AX / 20AX (200 µF) at AC 230 V
 - Bus-powered electronics
 - Housing: plastic, color RAL 7035 (light grey), N-system
 - DIN rail mounted device for mounting on rail TH35 according to DIN EN 60715
 - Type of protection: IP 20
- One switching and status object per output
 - Selectable operating mode (normal mode, time switch mode, flashing mode),
 - Selectable relay mode NC contact / NO contact, On and Off delay times, control value input object
 - Logic operation (AND/OR/NAND/NOR/EXOR/FILTER/TRIGGER)
 - Selectable sending of status objects on request, cyclically and/or after a change
 - Selectable switching state on bus voltage failure and value of the switching object on bus voltage recovery
 - Night mode for time-limited switching On of the output, and hence the illumination, at night
 - Variable On period at night or time switch mode, time limit in timer switch mode, warning signal prior to imminent switching-off
 - Manual override, permanent OFF switching, forced control, locking mode
 - Counting of operating hours and counting of load cycles with threshold monitoring
 - Measurement of load current values with threshold monitoring and monitoring of contact faults
 - Integrated 8-bit scene control and linking of each output into up to 8 scenes
 - Surveillance of device function

Rated current

20 A

N 535D31



Switching actuator, 4 x AC 230 V, 16/20 AX, C-Load, Load Check

- Rated contact current according to DIN EN 60669: 16 AX / 20 AX (200 µF fluorescent lamp load)
- all functions as N 535D..1

Data sheet

A6V11252209

Dimensions (W x H x D)

72 x 55 x 90 mm

Dimension width (1 MW = 18 mm)

4 MW



Stock no.

Product no.

5WG1535-1DB31

N 535D31

Switching actuator, 8 x AC 230 V, 16/20 AX, C-Load, Load Check

- Rated contact current according to DIN EN 60669: 16 AX / 20 AX (200 µF fluorescent lamp load)
- all functions as N 535D..1

Data sheet A6V11252211
Dimensions (W x H x D) 144 x 55 x 90 mm
Dimension width (1 MW = 18 mm) 8 MW

N 535D51



Stock no.	Product no.
5WG1535-1DB51	N 535D51

Switching actuator, 12 x AC 230 V, 16/20 AX, C-Load, Load Check

- DIN rail mounted device for mounting on rail TH35 according to DIN EN 60715
- all functions as N 535D..1

Data sheet A6V11252209
Dimensions (W x H x D) 216 x 55 x 90 mm
Dimension width (1 MW = 18 mm) 12 MW

N 535D61



Stock no.	Product no.
5WG1535-1DB61	N 535D61

Output devices

Binary output devices

Switching actuators/DIN rail mounted devices

2

N 567/..



Switch actuator

- One potential-free relay contact per output channel
- Electronics powered via an integrated power supply unit for AC 230 V
- Pushbutton for switching between bus operation and local operation
- A yellow LED indicating local operation
- 1 red LED per output channel to indicate switch status
- One pushbutton per output channel to activate the output through a UM-function in local operating mode
- Operational with an AC 230 V supply, (even with no bus voltage and faulty or not activated bus communication)
- Choice between identical or individually parameterized outputs
- Operating mode selectable for each channel (normal operation, time switch operation)
- Adjustable switching on/off delay
- Selectable logic link (AND/OR) between two communication objects and presettable logic operator for bus voltage return
- Possibility to add an additional night operation object per output channel for time limited activation of output (lighting) at night
- Selectable warning signal prior to imminent switching off in form of three times short off/on switching (flashing)
- Possibility to add one additional status indicator object per output channel, sending of status objects on request and/or automatically after change
- Possibility to add additional object to drive the integrated 8-bit scene controller, integrated 8 bit scene control and linking each output channel to up to 8 scenes
- Unchanged switch state for all output channels in case of power failure
- Selectable switch state after return of power for each output channel
- Integrated bus coupling units, bus connection via bus terminal or contact system to data rail, only 50% of standard busload
- Modular installation devices for mounting on TH35 EN 60715 mounting rail

Data sheet

A6V10416608

Range overview N 567/..

Product Title	Dimensions (WxHxD) [mm]	Dimension width (1 MW = 18 mm)	Stock no.	Product no.
Switch actuator, 16 x AC 230 V, 10 A	60 x 144 x 90	8 MW	5WG1567-1AB22	N 567/22

N 512..01



Load switch

- 8 Floating relay contacts
- Switching contacts can also be operated manually via slide switches
- Can be inverted per output (NO contact/NC contact)
- Configurable timer mode with configurable on/off delay
- Logic operation (AND/OR) of two communication objects and adjustable start value of operation in the event of bus voltage recovery
- Status object
- Positively driven operation
- Switching option on bus voltage failure and bus voltage recovery
- Bus-powered electronics
- Integrated bus coupling units, Bus connection via bus terminal or contact system to data rail
- Modular installation devices for mounting on TH35 EN 60715 mounting rail

Data sheet

A6V11786005

Range overview N 512..01

Product Title	Dimensions (WxHxD) [mm]	Dimension width (1 MW = 18 mm)	Stock no.	Product no.
Load switch, 8 x AC 120 V / AC 277 V / AC 347 V, 20 A, C load (cUL listed)	90 x 144 x 55	8 MW	5WG1512-1CB01	N 512C01

Switch actuator, main module

N 5../11



- 3 Floating relay contacts
- Rated contact voltage, AC 230V
- Interface for connecting a switching actuator submodule and software for controlling up to 4 switching actuator submodules
- Selectable 3-phase switching function (simultaneous switching of 3 outputs)
- Direct operation (local operation)
- LED for indicating direct operation
- LED for indicating the selected device
- LED for status indication per output
- Selectable 1- to 3-stage fan speed control function
- Function for controlling thermo-electrical drives
- Integrated 8-bit scene control
- Time functions: off delay, on delay, timer mode (automatic stairwell switch), night mode (lighting for cleaning), Warning of impending off
- Logical functions: Positively driven operation, Logic function (2 objects), Can be inverted per output (NO contact/NC contact)
- Per channel: transmitting status, Operating hours counter with limit monitoring, Switching cycle counter with limit monitoring, Load current recording, Load current monitoring
- Power supply for its own electronics and for the electronics of the connected switching actuator submodules via the bus voltage
- Bus connection via bus terminal

Range overview N 562/11, N 512/11, N 513/11

Product Title	Dimensions (WxHxD) [mm]	Dimension width (1 MW = 18 mm)	Stock no.	Product no.
Switch actuator, main module, 3 x AC 230/400 V, 10 AX, C load, Load-check	90 x 54 x 60	3 MW	5WG1562-1AB11	N 562/11
Switch actuator, main module, 3 x AC 230/400 V, 16 AX, C load, Load-check	60 x 54 x 90	3 MW	5WG1512-1AB11	N 512/11
Switch actuator, main module, 3 x AC 230/400 V, 20 AX, C load, Load-check	90 x 54 x 60	3 MW	5WG1513-1AB11	N 513/11

Output devices

Binary output devices

Modular switching actuators/DIN rail mounted devices

2

N 5../21



Switch actuator, submodule

- 3 Floating relay contacts
- Rated contact voltage, AC 230 V
- Interface for connecting a switching actuator submodule and software for controlling up to 4 switching actuator submodules
- Selectable 3-phase switching function (simultaneous switching of 3 outputs)
- Direct operation (local operation via main module)
- LED for indicating direct operation for each output via main module
- Selectable 1- to 3-stage fan speed control function
- Function for controlling thermo-electrical drives
- Integrated 8-bit scene control
- Time functions: off delay, on delay, Timer mode (automatic stairwell switch), Night mode (lighting for cleaning), Warning of impending off
- Logical functions: Positively driven operation, Logic function (2 objects), Can be inverted per output (NO contact/NC contact)
- Per channel: transmitting status, Operating hours counter with limit monitoring, Switching cycle counter with limit monitoring, Load current recording, Load current monitoring
- Power supply for its own electronics and for the electronics of the connected switching actuator submodules via the bus voltage
- Bus connection via bus terminal

Range overview N 562/21, N 512/21, N 513/21

Product Title	Dimensions (WxHxD) [mm]	Dimension width (1 MW = 18 mm)	Stock no.	Product no.
Switch actuator submodule, 3 x AC 230/400 V, 10 AX, C load, Load-check	90 x 54 x 60	3 MW	5WG1562-1AB21	N 562/21
Switch actuator submodule, 3 x AC 230/400 V, 16AX, C load, load-check	60 x 54 x 90	3 MW	5WG1512-1AB21	N 512/21
Switch actuator submodule, 3 x AC 230/400 V, 20 AX, C load, load-check	90 x 54 x 60	3 MW	5WG1513-1AB21	N 513/21

Binary Output 3 x 6 A, AC 230 V

- 3 floating relay contact
 - One relay contact per output as switching element
 - Contact rated current according to DIN EN 60669-1: 6 A (resistive load)
 - Bus-powered electronics
 - Integrated bus coupling unit, bus connection via bus terminal block
 - Type of protection: IP 20
 - Rated contact operating voltage AC 230 V
 - Rated contact frequency: 50/60 Hz
 - Screw-less terminals for connection and through-wiring of untreated single-core, stranded or multi-core conductors, 0.5...2.5 mm²
 - For mounting in AP 118 automation module box or AP 641 room control box
- For each output:
 - Selectable operating mode (normal mode, time switch mode)
 - Selectable relay mode (NO contact / NC contact)
 - Status object as an optional addition
 - Variable On and Off delay times
 - Selectable logic operation (AND/OR) of two communication objects
 - Selectable switching state at bus voltage failure and recovery
 - Optional addition of a night mode object for time-limited switching On of the output (and hence the illumination) at night
 - Variable On period at night or time switch mode
 - Selectable post-triggering of the On period (On period extension) in time switch mode
 - Selectable warning signal prior to imminent switching-off by means of three-times short off and on switching (flashing) at night or in time switch mode
 - Selectable function:
 - Including additional communication object for manual override of an output
 - Selectable forced control, including additional communication object for switching an output on or off in forced mode
 - Selectable counting of operating hours and with threshold monitoring of the operating hours
 - Selectable counting of load cycles and with threshold monitoring of the load cycles
 - Integrated 8-bit scene control and linking of each output into up to 8 scenes

The AP 641 room control box and AP 118 automation module box must be ordered separately.
See chapter Modular Installation System - Room control box - Module boxes.

Data sheet	A6V11375522
Rated voltage	AC 230 V
Rated current	6 A
Number of channels	3
Dimensions (W x H x D)	86.5 x 47.8 x 36.2 mm

RL 513D23



Stock no.	Product no.
5WG1513-4DB23	RL 513D23

Output devices

Binary output devices

Switching actuators/Modular installation system

2

UP 510/..3



Binary Output 2 x AC 230 V, 10 A

- Rated contact voltage AC 230 V
- 2 floating relay contacts
- Rated contact current 10 A
- Screwless terminals for connection and through-wiring of untreated single-core, stranded or multi-core conductors, 0.5...2.5 mm²
- Bus-powered electronics
- Integrated bus coupling units, bus connection via bus terminal
- For insertion in flush-mounting switch and socket boxes 60 mm in diameter and 60 mm deep
- Configurable behavior in the event of a bus voltage failure/recovery
- Unchanged switching state of outputs in the event of system voltage failure
- Integrated 8-bit scene control
- Time functions: off delay, on delay, timer mode (automatic stairwell switch), night mode (lighting for cleaning), Warning of impending off
- Logical functions: Positively driven operation, logic function (1 object), logic function (2 objects), can be inverted per output (NO contact/NC contact)
- Transmitting status per channel

Range overview UP 510/..3

Product Title	Dimensions (WxHxD) [mm]	Stock no.	Product no.
Binary Output 2 x AC 230 V, 10 A, with mounting frame and BTI interface	71 x 71 x 42	5WG1510-2AB03	UP 510/03
Binary Output 2 x AC 230 V, 10 A	50 x 50.9 x 41.3	5WG1510-2AB13	UP 510/13

Binary Output, 2 x AC 230 V, 10 A (resistive load)

RS 510/23



- Rated contact frequency: 50/60 Hz
 - 2 floating relay contacts
 - Contact rated current according to DIN EN 60669-1: 10 A (resistive load)
 - Bus-powered electronics
 - Integrated bus coupling unit, bus connection via bus terminal
 - Type of protection: IP 20
 - Rated contact voltage AC 230 V
 - Screw-less terminals for connection and through-wiring of untreated single-core, stranded or multi-core conductors, 0.5 ... 2.5 mm²
 - With bus connection module
 - Modular installation device for mounting in AP 118 automation module box or AP 641 room control box
- For each output:
 - Selectable operating mode (normal mode/time switch mode)
 - Selectable relay mode (NO contact/NC contact)
 - Status object as optional addition
 - Variable On and Off delay times
 - Selectable logic operation (AND/OR) of two communication objects
 - Selectable switching state at bus voltage failure and recovery
 - Optional addition of night mode object for time-limited switching On of the output (and hence the illumination) at night
 - Variable On period at night or time switch mode
 - Selectable post-triggering of the On period (On period extension) in time switch mode
 - Selectable warning signal prior to imminent switching-off by means of three-times short off and on switching (flashing) at night or in time switch mode
 - Selectable function:
 - Including additional communication object for manual override of an output
 - Forced control, including additional communication object for switching an output on or off in forced mode
 - Counting of operating hours and with threshold monitoring of the operating hours
 - Counting of load cycles and with threshold monitoring of the load cycles
 - Integrated 8-bit scene control and linking of each output into up to 8 scenes

The AP 641 room control box and AP 118 automation module box must be ordered separately.
See chapter Modular Installation System - Room control box - Module boxes.

Data sheet	A6V10416153
Rated voltage	AC 230 V
Rated current	10 A
Number of channels	2
Dimensions (W x H x D)	50.2 x 48.8 x 35.5 mm

Stock no.	Product no.
SWG1510-2AB23	RS 510/23

Output devices

Binary output devices

Switching actuators/Modular installation system

2

JB 510C23

**Binary Output, 2 x AC 120...277 V, 10 A (resistive load)**

- 2 floating relay contacts
 - Rated contact frequency: 50/60 Hz
 - Contact rated current according to DIN EN 60669-1: 10 A (resistive load)
 - Bus-powered electronics
 - Integrated bus coupling unit, bus connection via bus terminal
 - Type of protection: IP 20
 - Rated contact operating voltage AC 120...277 V
 - As built-in device with 1/2 inch thread connection for mounting to or in a UL/NEMA Junction Box with feedthrough of the function wires through the 1/2 inch threaded connector
-
- For each output:
 - Selectable operating mode (normal mode/time switch mode)
 - Selectable relay mode (NO contact/NC contact)
 - Status object as optional addition
 - Variable On and Off delay times
 - Selectable logic operation (AND/OR) of two communication objects
 - Selectable switching state at bus voltage failure and recovery
 - Optional addition of night mode object for time-limited switching On of the output (and hence the illumination) at night
 - Variable On period at night or time switch mode
 - Selectable post-triggering of the On period (On period extension) in time switch mode
 - Selectable warning signal prior to imminent switching-off by means of three-times short off and on switching (flashing) at night or in time switch mode
 - Selectable function:
 - Including additional communication object for manual override of an output
 - Forced control, including additional communication object for switching an output on or off in forced mode
 - Counting of operating hours and with threshold monitoring of the operating hours
 - Counting of load cycles and with threshold monitoring of the load cycles
 - Integrated 8-bit scene control and linking of each output into up to 8 scenes

Data sheet

A6V11786004

Dimensions (W x H x D)

70 x 90 x 44.6 mm

Stock no.

Product no.

5WG1510-4CB23

JB 510C23

Switching actuator 1 x AC 230 V, 16 AX, C load

RL 512/23



- One relay contact as switching element
 - Bus-powered electronics
 - Integrated bus coupling unit, Bus connection via bus terminal block
 - Type of protection: IP 20
 - Rated contact voltage AC 230 V
 - Rated contact frequency: 50/60 Hz
 - Rated contact current 16 AX / 20 A
 - Screw-less terminals for connection and through-wiring of untreated single-core, stranded or multi-core conductors, 0.5...2.5 mm²
 - For mounting in AP 118 automation module box or AP 641 room control box
-
- Selectable operating mode (normal mode, time switch mode)
 - Selectable relay mode (NO contact / NC contact)
 - Status object as an optional addition
 - Variable On and Off delay times
 - Selectable logic operation (AND/OR) of two communication objects
 - Selectable switching state at bus voltage failure and recovery
 - Optional addition of a night mode object for time-limited switching On of the output (and hence the illumination) at night
 - Variable On period at night or time switch mode
 - Selectable post-triggering of the On period (On period extension) in time switch mode
 - Selectable warning signal prior to imminent switching-off by means of three-times short off and on switching (flashing) at night or in time switch mode
 - Selectable function:
 - Including additional communication object for manual override of an output
 - Selectable forced control, including additional communication object for switching an output on or off in forced mode
 - Selectable counting of operating hours with threshold monitoring of the operating hours
 - Selectable counting of load cycles with threshold monitoring of the load cycles
 - Integrated 8-bit scene control and linking of each output into up to 8 scenes

The AP 641 room control box and AP 118 automation module box must be ordered separately.
See chapter Modular Installation System - Room control box - Module boxes.

Data sheet	A6V10416159
Rated voltage	AC 230 V
Rated current	16 A
Number of channels	1
Dimensions (W x H x D)	86.5 x 47.8 x 36.2 mm

Stock no.	Product no.
5WG1512-4AB23	RL 512/23

Output devices

Binary output devices

Switching actuators/Modular installation system

2

JB 512C23

**Switching actuator 1 x AC 120...277 V, 20 A or 1 x AC 347 V, 15 AX, C load**

- One relay contact as switching element
 - Bus-powered electronics
 - Integrated bus coupling unit, Bus connection via bus terminal block
 - Type of protection: IP 20
 - Rated contact operating voltage AC 120...277 V, AC 347 V
 - Rated contact frequency: 50/60 Hz
 - Fluorescent lamp load acc. to DIN EN 60669-1: 20 AX (200 µF) at AC 120/277 V, 15 AX (200 µF) at AC 347 V
 - As built-in device with 1/2 inch thread connection for mounting to or in a UL/NEMA Junction Box with feedthrough of the function wires through the 1/2 inch threaded connector
-
- Selectable operating mode (normal mode, time switch mode)
 - Selectable relay mode (NO contact / NC contact)
 - Status object as an optional addition
 - Variable On and Off delay times
 - Selectable logic operation (AND/OR) of two communication objects
 - Selectable switching state at bus voltage failure and recovery
 - Optional addition of a night mode object for time-limited switching On of the output (and hence the illumination) at night
 - Variable On period at night or time switch mode
 - Selectable post-triggering of the On period (On period extension) in time switch mode
 - Selectable warning signal prior to imminent switching-off by means of three-times short off and on switching (flashing) at night or in time switch mode
 - Selectable function:
 - Including additional communication object for manual override of an output
 - Selectable forced control, including additional communication object for switching an output on or off in forced mode
 - Selectable counting of operating hours with threshold monitoring of the operating hours
 - Selectable counting of load cycles with threshold monitoring of the load cycles
 - Integrated 8-bit scene control and linking of each output into up to 8 scenes

Data sheet

A6V11786007

Dimensions (W x H x D)

70 x 90 x 44.6 mm

Stock no.

Product no.

5WG1512-4CB23

JB 512C23

Binary Output 3 x 6 A, AC 120...277 V

JB 513C23



- 3 floating relay contact
 - One relay contact per output as switching element
 - Contact rated current according to DIN EN 60669-1: 6 A (resistive load)
 - Bus-powered electronics
 - Integrated bus coupling unit, bus connection via bus terminal block
 - Type of protection: IP 20
 - One relay contact per output as switching element
 - Rated contact operating voltage AC 120...277 V
 - Rated contact frequency: 50/60 Hz
 - As built-in device with 1/2 inch thread connection for mounting to or in a UL/NEMA Junction Box with feedthrough of the function wires through the 1/2 inch threaded connector
-
- For each output:
 - Selectable operating mode (normal mode, time switch mode)
 - Selectable relay mode (NO contact / NC contact)
 - Status object as an optional addition
 - Variable On and Off delay times
 - Selectable logic operation (AND/OR) of two communication objects
 - Selectable switching state at bus voltage failure and recovery
 - Optional addition of a night mode object for time-limited switching On of the output (and hence the illumination) at night
 - Variable On period at night or time switch mode
 - Selectable post-triggering of the On period (On period extension) in time switch mode
 - Selectable warning signal prior to imminent switching-off by means of three-times short off and on switching (flashing) at night or in time switch mode
 - Selectable function:
 - Including additional communication object for manual override of an output
 - Selectable forced control, including additional communication object for switching an output on or off in forced mode
 - Selectable counting of operating hours and with threshold monitoring of the operating hours
 - Selectable counting of load cycles and with threshold monitoring of the load cycles
 - Integrated 8-bit scene control and linking of each output into up to 8 scenes

Data sheet

A6V11786008

Dimensions (W x H x D)

70 x 90 x 44.6 mm

Stock no.

Product no.

5WG1513-4CB23

JB 513C23

Output devices

Binary output devices

Combination switching actuators

2

N 502/02



Combi switching actuator 8 x AC 230 V, 16 A, 8 x binary inputs

- 8 inputs AC/DC 12...230 V
- 8 relay contact outputs
- Rated contact voltage AC 230 V
- Rated contact operating current 16 A, p.f. = 1
- Electronics power supply via an integrated power supply unit for AC 230 V
- Device functional even without bus connection or if bus voltage absent or bus communication interrupted or not yet activated
- Push button to switch between bus and direct mode
- Push button for each output to switch the output in direct mode via a toggling function by a short actuation and for changing the output mode between remote control relay and time switch relay by holding down the push button for some seconds
- Device preset at the factory for direct switching of an output through a toggling function via the input of the same name
- Selectable function for each input when using the Engineering Tool Software (ETS):
 - Switching status / binary value transmission
 - Switching, short / long operation
 - Single button dimming, single button sun protection control, 1-button group control (sequence control)
 - 1-bit scene control
 - 8-bit scene control, 8-bit value, edge-triggered, 8-bit value, short / long operation
 - 16-bit floating point value, edge-triggered, 16-bit value, short / long operation, 16-bit value, edge-triggered, 16-bit floating point value, short / long operation
- Selectable function for each pair of inputs:
 - 2-button dimming with stop telegram or with cyclical sending
 - 2-pushbutton shutter/blind control
- Selectable blocking / releasing of each input via a corresponding blocking object
- Sending of the input objects after a change of status
- Selectable logic operation (AND/OR) for one input with a further communication object and with variable start value of the logic operation at bus voltage recovery
- Setting by means of the ETS, whether all outputs are to be configured identically or individually
- Selectable mode for each output (normal mode, time switch mode)
- Optional addition of a night mode object for each output for time-limited switching On of the output (and hence the illumination) at night
- Variable On and Off delay times for each output
- Variable On period in night mode or in time switch mode
- Selectable warning signal prior to imminent switching-off by means of three-times short off and on switching (flashing) in night mode or in time switch mode
- Optional status object per output for status reporting
- Sending of status objects on request and/or automatically after a change
- Integrated 8-bit scene control and linking of each output with up to 8 scenes
- Selectable switching state for each output at mains or bus power failure as well as after bus or mains voltage recovery
- Integrated bus coupling unit with only half a standard bus load
- Bus connection via bus terminal or contact system to data rail
- Modular installation devices for mounting on TH35 EN 60715 mounting rail

Data sheet	A6V10416148
Rated voltage	AC 230 V
Rated current	16 A
Number of channels	8
Number of inputs potentialfree	8
Dimensions (W x H x D)	90 x 144 x 60 mm
Dimension width (1 MW = 18 mm)	8 MW

Stock no.	Product no.
5WG1502-1AB02	N 502/02

Switch actuator 1 x AC 230 V, 16 A

UP 511S32



- One relay contact per output
- Rated contact operating voltage: AC 230V
- Rated contact frequency: 50/60 Hz
- Rated contact current: 16 A
- Screw terminals for connection of untreated single-core conductors, stranded without conductor sleeve 0.5 to 4 mm², stranded with conductor sleeve 0.5 to 2.5 mm²
- 3 binary inputs for potential-free contacts, determination of switching status via voltage generated in the device
- Poll voltage of the inputs: approx. 5 V
- Max. 10 m length of connecting cables, preferably J-Y(St)Y, pre-assembled YY6x0.6
- Bus-powered electronics
- Integrated bus coupling unit
- Mounting in appliance boxes according to DIN 49073 or in mounting case M 592/01 (accessories)
- KNX Data Secure compatible
- Updateable with Siemens Firmware Download Tool
- Switching output optionally directly operable via input 1 or input 1 and 2
- Adjustable functions of switching output: status feedback, active status signalling function, adjustable as NO or NC contact, adjustable preferred position after download, adjustable preferred position in case of bus voltage failure and recovery, cyclical monitoring of switching output, adjustable switch-on and switch-off delay, staircase function, 8-bit scene control, logic operations, operating hours counting with limit value monitoring, disabling function or forced control, central switching function
- Adjustable functions of each input: switching, dimming, colour temperature control, solar protection control, sending values (1 byte, 2 byte, 3 byte, 6 byte), scene control, pair of inputs operation, controller extension (operating mode switchover, presence function, setpoint shift)
- Adjustable debounce time per input
- Adjustable locking of each input via locking object
- 8 logic functions (logic gate, value converter, disabling element, comparator, limit value switch)

Data sheet A6V12632887
Dimensions (W x H x D) 48 x 50 x 28 mm

Stock no.	Product no.
5WG1511-2SB32	UP 511S32

Output devices

Binary output devices

Combination switching actuators

2

UP 562S32

Switch/solar protection actuator 2 x AC 230 V, Σ 16 A

- One relay contact per output
- Rated contact operating voltage: AC 230 V
- Rated contact frequency: 50/60 Hz
- Rated contact current: Σ 16 A
- Screw terminals for connection of untreated single-core conductors, stranded without conductor sleeve 0.5 to 4 mm², stranded with conductor sleeve 0.5 to 2.5 mm²
- 3 binary inputs for potential-free contacts, determination of switching status via voltage generated in the device
- Poll voltage of the inputs: approx. 5 V
- Max. 10 m length of connecting cables, preferably J-Y(St)Y, pre-assembled YY6x0.6
- Bus-powered electronics
- Integrated bus coupling unit
- Mounting in appliance boxes according to DIN 49073 or in mounting case M 592/01 (accessories)
- KNX Data Secure compatible
- Updateable with Siemens Firmware Download Tool
- Adjustable functions per switching output: status feedback, adjustable as NO or NC contact, cyclical monitoring, adjustable switch-on and switch-off delay, staircase function, scene control, logic operations, operating hours counting, disabling function or forced control, central switching function
- Adjustable functions of solar protection channel: adjustable operating modes: venetian blind with slats, shutter/awning, venting louver/roof window, direct movement to a position of the sunblind and the slats, status feedback, adjustable behaviour in case of alarm (wind, rain, frost), adjustable solar protection or heating/cooling automatic, scene control, disabling function, forced control
- Adjustable preferred position after download, in case of bus voltage failure and recovery
- Adjustable functions of each input: switching, dimming, colour temperature control, solar protection control, sending values, scene control, pair of inputs operation, controller extension (operating mode switchover, presence function, setpoint shift), adjustable debounce time, locking of each input
- 8 logic functions

Data sheet

A6V12632892

Dimensions (W x H x D)

48 x 50 x 28 mm

Stock no.

Product no.

5WG1562-2SB32

UP 562S32

Accessories for UP 5..S32

M 592/01



Mounting case

- One mounting location for a flush-mounted actuator type UP 511S32, UP 562S32 or UP 525S32
- Separate wiring space and strain relief for function wiring
- Housing for mounting on DIN rail TH35 DIN EN 60715
- Housing with screw fastening for installation in cable ducts, under raised floors or for surface mounting under a ceiling
- Housing: plastic
- Type of protection: IP 20

Dimensions (W x H x D)

97 x 53 x 36 mm

Stock no.

Product no.

5WG1592-8AB01

M 592/01

Input devices



Overview and selection tools		120
Binary input devices	Binary inputs/DIN rail mounted devices	124
	Binary inputs/Modular installation system	126
	Pushbutton interface	127
	Combination actuators	128

Input devices

Overview and selection tools

3

Binary input devices

Type	N 262D31	N 262D51	N 262E11	N 263D31	N 263D51	N 263E11	N 264E11	RL 260/23	UP 220/21	UP 220D31	N 501/01	N 502/02	UP 511S32	UP 562S32	UP 525S32
Enclosure data															
Design	N	N	N	N	N	N	N	RL	UP	UP	N	N	UP	UP	UP
Modular installation devices for mounting on TH35 EN 60715 mounting rail	■	■	■	■	■	■	■				■	■			
For inserting into flush-mounting switch and socket boxes with Ø = 60 mm									■	■			■	■	■
Modular installation device for mounting in AP 118 automation module box or AP 641 room control box ¹⁾								■							
Built-in device in mounting housing M 592/01 ²⁾													■	■	■
Dimensions															
• Width [mm] (1 MW = 18 mm)	4 MW	8 MW	6 MW	4 MW	8 MW	6 MW	6 MW	47.8	42	42	8 MW	8 MW	48	48	48
• Height [mm]								86.5	42	42			50	50	50
• Depth [mm]								36.2	8.5	8.5			28	28	28
Display/control elements															
LED for status indication per input	■	■	■	■	■	■	■				■	■			
Power supply															
Bus-powered electronics	■	■		■	■			■	■	■			■	■	■
Electronics powered via an integrated power supply unit for supply voltage AC 230 V			■			■	■				■	■			
Bus connection															
Integrated bus coupling units	■	■	■	■	■	■	■	■	■	■	■	■	■	■	■
Bus connection via contact system to data rail			■			■	■				■	■			
Bus connection via bus terminal	■	■	■	■	■	■	■	■	■	■	■	■	■	■	■
Inputs															
Max. cable length, unshielded, twisted [m]	100	100	100	100	100	100	100	100	10	10	100	100	10	10	10
Pushbutton inputs															
For signal input (floating contacts)	4	8	16				8		2 ³⁾	4 ³⁾			3	3	3
Determination of switching state by means of the voltage generated in the device	■	■	■				■		■	■			■	■	■
For voltage input				■	■	■	■	■			■	■			
• AC/DC 10...230 V				4	8										
• AC/DC 12...230 V							8 ⁴⁾	4			8	8			
• AC 12...230 V/DC 12...115 V						16 ⁴⁾									

¹⁾ The AP 641 room control box and AP 118 automation module box must be ordered separately, see Chapter Quick-assembly system - Room control box-Module boxes

²⁾ The M 592/01 mounting device must be ordered separately, see Chapter Combination devices

³⁾ Inputs, alternatively can be used as outputs for controlling LEDs up to a maximum of 2 mA

⁴⁾ The pushbutton inputs are mutually insulated from the base

... Continuation of the table

Type	N 262D31	N 262D51	N 262E11	N 263D31	N 263D51	N 263E11	N 264E11	RL 260/23 ²⁾	UP 220/Z1	UP 220D31	N 501/01	N 502/02	UP 511S32	UP 562S32	UP 525S32	
Application program ¹⁾	9A1301	9A1401	980D03	9A1301	9A1401	980D03	980D03	983101	982303	982204	981701	981601	20DF22	20DE22	303122	
Input functions																
Max. number of group addresses	2000	2000	97	2000	2000	97	97	120	120	120	220	120	1600	1600	1600	
Max. number of assignments	2000	2000	97	2000	2000	97	97	120	120	120	220	120	1600	1600	1600	
Telegram rate limitations	■	■	■	■	■	■	■						■	■	■	
Configurable debounce time	■	■	■	■	■	■	■						■	■	■	
Locking of inputs using blocking objects	■	■	■	■	■	■	■	■	■	■	■	■	■	■	■	
Adjustable duration of long button press	■	■	■	■	■	■	■	■	■	■	■	■	■	■	■	
Configurable contact type (NO contact/NC contact)	■	■	■	■	■	■	■	■	■	■	■	■	■	■	■	
Transmission parameters																
Adjustable cyclic transmission	■	■	■	■	■	■	■	■	■	■	■	■				
Configurable transmission in the event of changes to the input	■	■	■	■	■	■	■	■			■	■				
Configurable transmission in the event of bus voltage recovery	■	■	■	■	■	■	■	■	■	■	■	■	■	■	■	
Configurable event-controlled transmission								■	■							
Switching																
Switching ON/OFF																
• Rising edge	■	■	■	■	■	■	■	■	■	■	■	■	■	■	■	
• Falling edge	■	■	■	■	■	■	■	■	■	■	■	■	■	■	■	
• Rising and falling edge	■	■	■	■	■	■	■	■	■	■	■	■	■	■	■	
• Short/long button press can be evaluated	■	■	■	■	■	■	■	■	■	■	■	■	■	■	■	
Switching OVER																
• Rising edge	■	■	■	■	■	■	■	■	■	■	■	■	■	■	■	
• Falling edge	■	■	■	■	■	■	■	■	■	■	■	■	■	■	■	
• Rising and falling edge	■	■	■	■	■	■	■	■	■	■	■	■	■	■	■	
Value transmission																
Data types ³⁾	■	■		■	■								■	■	■	
Dimming																
1-pushbutton dimming	■	■	■	■	■	■	■	■	■	■	■	■	■	■	■	
2-pushbutton dimming with stop telegram (4 bit)	■	■	■	■	■	■	■	■	■	■	■	■	■	■	■	
2-pushbutton dimming with cyclic transmission (4 bit)	■	■		■	■			■	■	■	■	■	■	■	■	
2-pushbutton dimming with value setting (8 bit)	■	■		■	■			■	■	■			■	■	■	
Short/long button press can be evaluated	■	■	■	■	■	■	■	■	■	■	■	■	■	■	■	
Colour temperature adjustment	■	■		■	■								■	■	■	
Shutter/blind																
1-pushbutton shutter/blind control	■	■	■	■	■	■	■	■	■	■	■	■	■	■	■	
2-pushbutton shutter/blind control	■	■	■	■	■	■	■	■	■	■	■	■	■	■	■	
Short/long button press can be evaluated	■	■	■	■	■	■	■	■	■	■	■	■	■	■	■	
Scene																
Store and call up scene, 8-bit	■	■	■	■	■	■	■	■	■	■	■	■	■	■	■	
Store and call up scene, 1-bit in conjunction with scene module	■	■	■	■	■	■	■	■	■	■	■	■				
Pulse counting																
Pulse counting with/without limit value monitoring	■	■	■	■	■	■	■	■	■	■	■	■	■	■	■	
Difference counting	■	■		■	■										■	
Setting controller operating modes (Comfort, Standby, Night mode, Protection)																
													■	■	■	
Group control																
1-pushbutton group control	■	■	■	■	■	■	■	■	■	■	■	■				

¹⁾ For current application programs, see www.siemens.com/gamma-td²⁾ Identical functions as JB 260C23³⁾ See application program description for the product

Input devices

Overview and selection tools

Developed for a wide range of applications

Binary inputs serve as an interface for operating KNX installations via potential-free binary signals or live operating points, which are detected by conventional switches, pushbuttons, or motion detectors, for example.

Similarly, the binary inputs are used to detect switching or system states or to count pulses.

Direct operation via the high-quality membrane keypad makes it possible to simulate the input states already during commissioning, without operating devices or sensors being physically connected.

The binary inputs N 262 and N 263 are available in a construction width of 4 or 8 wide-range, each as a potential-free and voltage-loaded variant. The harmonized housing concept of the current generation of DIN-rail mounted devices has also been implemented for the binary inputs: maintenance-free terminals, housing design, width and color correspond to the overall appearance, supported by a clear direct operating level with status LEDs on the front of the device.



With the wide-range inputs of 10...230 V, the separate earth connections per channel ensure maximum flexibility of use for the installer. In addition, different voltage potentials and phases can be wired. In addition to applications such as switching and dimming lighting or controlling blinds, the units also support sophisticated tasks such as colored light control or differential counting of pulses. Logical links per channel form the basis for intelligent applications. These devices are reliable in operation and support efficient planning, installation, commissioning, and maintenance.

Functions and application examples

Conventional pushbuttons or switches trigger switching and control commands depending on the actuators used in the interaction.

Dimming, switching, and controlling in indoor rooms

Binary inputs operate and control in one application with suitable actuators room functions for lighting and solar protection.

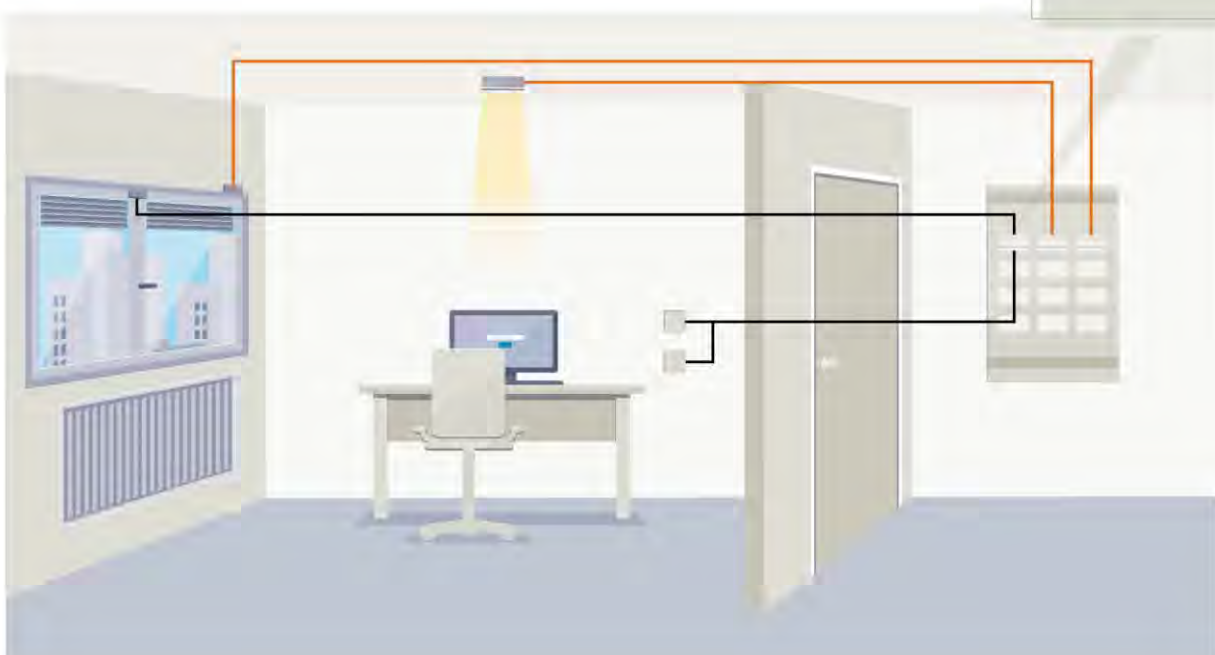

Access control with difference counting

Two binary inputs can be used to implement differential pulse counting, which makes it possible to implement access control for a maximum number of persons.



Input devices

Binary input devices

Binary inputs/DIN rail mounted devices

N 26..E/..1

Binary input device

- Length of unshielded connecting cable per input of max. 100 m
- LED per binary input for status display
- Input functions: Telegram rate limitations, configurable debounce time, locking of inputs using blocking objects, adjustable duration of long button press, Configurable contact type (NO contact/NC contact)
- Transmission parameters: Adjustable cyclic transmission, Configurable transmission in the event of changes to the input, Configurable transmission in the event of bus voltage recovery
- Short/long button press can be evaluated
- Switching on/off/over
- Value transmission 8 bit, 16 bit
- Dimming: single button dimming, 2-pushbutton dimming with stop telegram (4 bit)
- 1-/2-pushbutton shutter/blind control
- Store and call up scene, 1-bit in conjunction with scene module
- Pulse counting with/without limit value monitoring (8 bit, 16 bit, 32 bit)
- 1-pushbutton group control
- Integrated power supply for AC 230 V to supply the electronics
- Integrated bus coupling units, Bus connection via contact system to data rail, bus connection via bus terminal



Range overview N26..E/..1

Product Title	Dimension width (1 MW = 18 mm)	Stock no.	Product no.
Binary input device 8 x potential-free contacts	6 MW	5WG1262-1EB01	N 262E01
Binary input device 16 x potential-free contacts	6 MW	5WG1262-1EB11	N 262E11
Binary input device 16 x AC 12...230 V / DC 12...115 V	6 MW	5WG1263-1EB11	N 263E11
Binary input device 8 x AC/DC 12...230 V + 8 x potential-free contacts	6 MW	5WG1264-1EB11	N 264E11

Input devices

Binary input devices

Binary inputs/DIN rail mounted devices

Binary inputs

- Per input direct operation function on the device for simulation of input status and indication of the input status via LED
- Button on the device front for deactivation of the direct mode operation and LED to indicate activation direct mode operation
- Maintenance-free terminals for connection and through-wiring of untreated single-core, stranded or multi-core conductors, 0.5 ... 2.5 mm²
- Max. 100 m length of the connection lines with twisted pair cables
- Bus-powered electronics
- Housing: plastic, color RAL 7035 (light grey), N-system
- DIN rail mounted device for mounting on rail TH35 according to DIN EN 60715
- Type of protection: IP 20

- One input-object per input for sending after change of the switching state
- Adjustable debounce time per input
- Adjustable locking of each input via an corresponding locking object
- Adjustable functions of each input: Send switching state/binary value with adjustable cyclically sending, switch edge, 1-button dimming, 1-button solar protection control, scene control, send values, pulse counting with adjustable threshold value detection, forced control, effect controller, group control, multi-touch control, colour temperature control
- Depending on the selected main function, adjustable further functions, as additional telegram with adjustable transmission delay
- Adjustable functions per pair of inputs: 2-button dimming with stop telegram, 2-button dimming with cyclical transmission, 2-button solar protection control, 2-button value transmission variable, differential counting with adjustable threshold value detection
- Two logic operations per input (AND/OR/NAND/NOR/FILTER/TRIGGER)
- Adjustable transmission time for status objects after bus voltage recovery and transmission delay between status objects
- Adjustable behaviour after download
- Surveillance of device function

N 26..D..1



3

Range overview N 26..D..1

Product Title	Dimension width (1 MW = 18 mm)	Stock no.	Product no.
Binary input, 4 x dry contacts	4 MW	5WG1262-1DB31	N 262D31
Binary input, 8 x dry contacts	8 MW	5WG1262-1DB51	N 262D51
Binary input, 4 x AC/DC 10...230 V	4 MW	5WG1263-1DB31	N 263D31
Binary input, 8 x AC/DC 10...230 V	8 MW	5WG1263-1DB51	N 263D51

Input devices

Binary input devices

Binary inputs/Modular installation system

RL 260/23



Binary Input 4 x AC/DC 12...230 V

- 4 Inputs for AC/DC 12...230 V
 - Max. cable length, unshielded, twisted 100 m
 - Bus-powered electronics
 - Integrated bus coupling unit, with bus connection via bus terminal block
 - Type of protection: IP 20
 - Screw-less terminals for connection and through-wiring of untreated single-core, stranded or multi-core conductors, 0.5...2.5 mm²
 - For mounting in AP 118 automation module box or AP 641 room control box
-
- The following functions can be selected per input:
 - Switching state/send binary value/Transmission of the input objects after change
 - Switch edge, short/long switch, 8-bit value edge, 8-bit value short/long
 - Dimming, shading control, single button group control
 - 1/8-bit scene control
 - 16-bit floating-point value edge and 16-bit floating-point short/long
 - Pulse counting with/without limit value monitoring (8/16/32 Bit)
 - The following functions can be selected per input pair:
 - 2-pushbutton dimming with stop telegram and 2-pushbutton shading control
 - Optional blocking of each input by means of the respective blocking object
 - Optional cyclic transmission of input objects

The AP 641 room control box and AP 118 automation module box must be ordered separately. See Chapter Modular Installation System - Room control box - Module boxes.

Data sheet

A6V10416114

Stock no.

Product no.

5WG1260-4AB23

RL 260/23

JB 260C23



Binary Input 4 x AC/DC 12...230 V

- 4 Inputs for AC/DC 12...230 V
 - Max. cable length, unshielded, twisted 100 m
 - Bus-powered electronics
 - Integrated bus coupling unit, with bus connection via bus terminal block
 - Type of protection: IP 20
 - As built-in device with 1/2 inch thread connection for mounting to or in a UL/NEMA Junction Box with feedthrough of the function wires through the 1/2 inch threaded connector
-
- The following functions can be selected per input:
 - Switching state/send binary value/Transmission of the input objects after change
 - Switch edge, short/long switch, 8-bit value edge, 8-bit value short/long
 - Dimming, shading control, single button group control
 - 1/8-bit scene control
 - 16-bit floating-point value edge and 16-bit floating-point short/long
 - Pulse counting with/without limit value monitoring (8/16/32 Bit)
 - The following functions can be selected per input pair:
 - 2-pushbutton dimming with stop telegram and 2-pushbutton shading control
 - Optional blocking of each input by means of the respective blocking object
 - Optional cyclic transmission of input objects

Data sheet

A6V11786003

Stock no.

Product no.

5WG1260-4CB23

JB 260C23

Pushbutton interface

- Inputs / outputs each configurable for potential-free contacts or for control of an LED
- Generation of the sensing voltage for potential-free contacts
- For inserting into flush-mounting switch and socket boxes with $\varnothing = 60$ mm
- Inputs max. 10 m cable length, unshielded, twisted
- Input functions: Locking of inputs using blocking objects, Adjustable duration of long button press, Configurable contact type (NO contact/NC contact)
- Transmission parameters: Adjustable cyclic transmission, Configurable transmission in the event of bus voltage recovery
- Short/long button press can be evaluated
- Switching on/off/toggle
- Value transmission 8 Bit, 16 Bit
- Single button dimming
- 2-pushbutton dimming with stop telegram (4 bit)
- 1-/2-pushbutton shutter/blind control
- Szene store and call up scene: 8 Bit, in conjunction with scene module 1 Bit
- Pulse counting with/without limit value monitoring (8 bit, 16 bit, 32 bit)
- 1-pushbutton group control
- Bus-powered electronics
- Integrated bus coupling unit, bus connection via bus terminal

UP 220/..



Range overview UP 220/..

Product Title	Stock no.	Product no.
Pushbutton interface 2 x potential-free contact, output for LED control	5WG1220-2AB21	UP 220/21
Pushbutton interface 4 x potential-free contact, output for LED control	5WG1220-2DB31	UP 220D31

Recommendation: LED light insert, for switches and pushbutton inserts, red, 1.5V DC, 1 mA

Input devices

Binary input devices

Combination actuators

N 502/02



Combi switching actuator 8 x AC 230 V, 16 A, 8 x binary inputs

- 8 inputs AC/DC 12...230 V
- 8 relay contact outputs
- Rated contact voltage AC 230 V
- Rated contact operating current 16 A, p.f. = 1
- Electronics power supply via an integrated power supply unit for AC 230 V
- Device functional even without bus connection or if bus voltage absent or bus communication interrupted or not yet activated
- Push button to switch between bus and direct mode
- Push button for each output to switch the output in direct mode via a toggling function by a short actuation and for changing the output mode between remote control relay and time switch relay by holding down the push button for some seconds
- Device preset at the factory for direct switching of an output through a toggling function via the input of the same name
- Selectable function for each input when using the Engineering Tool Software (ETS):
 - Switching status / binary value transmission
 - Switching, short / long operation
 - Single button dimming, single button sun protection control, 1-button group control (sequence control)
 - 1-bit scene control
 - 8-bit scene control, 8-bit value, edge-triggered, 8-bit value, short / long operation
 - 16-bit floating point value, edge-triggered, 16-bit value, short / long operation, 16-bit value, edge-triggered, 16-bit floating point value, short / long operation
- Selectable function for each pair of inputs:
 - 2-button dimming with stop telegram or with cyclical sending
 - 2-pushbutton shutter/blind control
- Selectable blocking / releasing of each input via a corresponding blocking object
- Sending of the input objects after a change of status
- Selectable logic operation (AND/OR) for one input with a further communication object and with variable start value of the logic operation at bus voltage recovery
- Setting by means of the ETS, whether all outputs are to be configured identically or individually
- Selectable mode for each output (normal mode, time switch mode)
- Optional addition of a night mode object for each output for time-limited switching On of the output (and hence the illumination) at night
- Variable On and Off delay times for each output
- Variable On period in night mode or in time switch mode
- Selectable warning signal prior to imminent switching-off by means of three-times short off and on switching (flashing) in night mode or in time switch mode
- Optional status object per output for status reporting
- Sending of status objects on request and/or automatically after a change
- Integrated 8-bit scene control and linking of each output with up to 8 scenes
- Selectable switching state for each output at mains or bus power failure as well as after bus or mains voltage recovery
- Integrated bus coupling unit with only half a standard bus load
- Bus connection via bus terminal or contact system to data rail
- Modular installation devices for mounting on TH35 EN 60715 mounting rail

Data sheet	A6V10416148
Rated voltage	AC 230 V
Rated current	16 A
Number of channels	8
Number of inputs potentialfree	8
Dimensions (W x H x D)	90 x 144 x 60 mm
Dimension width (1 MW = 18 mm)	8 MW

Stock no.	Product no.
5WG1502-1AB02	N 502/02

Combination blind actuator, 4 x AC 230 V, 6 A, 8 x binary inputs

N 501/01



- 8 inputs for DC or AC in the range from 12 to 230 V
- 8 relay contact outputs locked in pairs against each other for controlling 4 x AC 230 V sunblind drives
- Contact rated voltage AC 230 V
- Contact rated current 6 A, p.f. = 1
- Electronics powered by a AC 230 V integrated power supply
- Device functional even without bus connection or if the bus communication fails
- Preset on delivery for direct output control for each blind button function via momentary contact switches connected to the inputs
- Key for switching between bus and direct mode
- Button for each relay contact output, for switching the output in direct mode
- Selectable function for each input when using the ETS:
 - Switching status, send binary value
 - Switching on leading edge, switching Short/Long
 - 1-pushbutton dimming, sunblind control, group control
 - 1-bit/8-bit scene control
 - 8-bit/16-bit value leading edge, Short/Long
 - 16-bit floating point value leading edge, Short/Long
- Or for each pair of inputs:
 - Acting directly on the corresponding outputs as blind button
 - 2-button dimming with stop telegram or with cyclical sending
 - 2-pushbutton sunblind control
- Selectable blocking of each input via a corresponding blocking object
- Sending of input objects after change
- Selectable cyclical input object sending
- Individual or shared configuration of actuator channels
- Communication objects for each blind channel for driving the sun protection into the end positions or for stopping the procedure and adjusting the blind slats in steps
- Communication objects for setting position of slats and blinds in percentage information
- Automatic opening of the blind slats to a preconfigured nominal setting after uninterrupted driving down of the blind from the top to the bottom end position, with integrated 1-bit scene control for storing and calling up (reproduction) of 2 interim blind and slat settings
- Integrated 1-bit/8-bit scene control, 8 scenes can be integrated per channel
- Optional "Sun" object for integration in a sunlight tracking control system
- Differentiation between automatic and manual mode and with automatic switchover from automatic to manual mode for the channel in question by pressing a bus button for manual control of the corresponding sun protection
- Manual mode taking precedence over automatic position commands
- Optional central command for each device or each channel for switching the relevant channels to automatic mode and driving the sun protection into the up or down end position
- Alarm: move to safety position, Locking in this position for as long as alarm is active
- Travel lock (e. g. for cleaning the outer shutter/blinds)
- Status objects for each channel for querying or for automatic sending of sun protection and slat settings as a percentage value
- Optional status objects for reporting that the up or down position has been reached
- Integrated bus coupling unit, Bus connection via bus terminal or contact system to data rail
- Modular installation devices for mounting on TH35 EN 60715 mounting rail



Data sheet	A6V10416147
Rated voltage	AC 230 V
Rated current	6 A
Number of channels	4
Number of inputs potentialfree	8
Dimensions (W x H x D)	90 x 144 x 60 mm
Dimension width (1 MW = 18 mm)	8 MW

Stock no.	Product no.
5WG1501-1AB01	N 501/01

Input devices

Binary input devices

Combination actuators

UP 511S32



Switch actuator 1 x AC 230 V, 16 A

- One relay contact per output
- Rated contact operating voltage: AC 230 V
- Rated contact frequency: 50/60 Hz
- Rated contact current: 16 A
- Screw terminals for connection of untreated single-core conductors, stranded without conductor sleeve 0.5 to 4 mm², stranded with conductor sleeve 0.5 to 2.5 mm²
- 3 binary inputs for potential-free contacts, determination of switching status via voltage generated in the device
- Poll voltage of the inputs: approx. 5 V
- Max. 10 m length of connecting cables, preferably J-Y(St)Y, pre-assembled YY6x0.6
- Bus-powered electronics
- Integrated bus coupling unit
- Mounting in appliance boxes according to DIN 49073 or in mounting case M 592/01 (accessories)
- KNX Data Secure compatible
- Updateable with Siemens Firmware Download Tool
- Switching output optionally directly operable via input 1 or input 1 and 2
- Adjustable functions of switching output: status feedback, active status signalling function, adjustable as NO or NC contact, adjustable preferred position after download, adjustable preferred position in case of bus voltage failure and recovery, cyclical monitoring of switching output, adjustable switch-on and switch-off delay, staircase function, 8-bit scene control, logic operations, operating hours counting with limit value monitoring, disabling function or forced control, central switching function
- Adjustable functions of each input: switching, dimming, colour temperature control, solar protection control, sending values (1 byte, 2 byte, 3 byte, 6 byte), scene control, pair of inputs operation, controller extension (operating mode switchover, presence function, setpoint shift)
- Adjustable debounce time per input
- Adjustable locking of each input via locking object
- 8 logic functions (logic gate, value converter, disabling element, comparator, limit value switch)

Data sheet

A6V12632887

Dimensions (W x H x D)

48 x 50 x 28 mm

Stock no.

Product no.

5WG1511-2SB32

UP 511S32

Switch/solar protection actuator 2 x AC 230 V, Σ 16 A

UP 562S32



- One relay contact per output
- Rated contact operating voltage: AC 230V
- Rated contact frequency: 50/60 Hz
- Rated contact current: Σ 16 A
- Screw terminals for connection of untreated single-core conductors, stranded without conductor sleeve 0.5 to 4 mm², stranded with conductor sleeve 0.5 to 2.5 mm²
- 3 binary inputs for potential-free contacts, determination of switching status via voltage generated in the device
- Poll voltage of the inputs: approx. 5 V
- Max. 10 m length of connecting cables, preferably J-Y(St)Y, pre-assembled YY6x0.6
- Bus-powered electronics
- Integrated bus coupling unit
- Mounting in appliance boxes according to DIN 49073 or in mounting case M 592/01 (accessories)
- KNX Data Secure compatible
- Updateable with Siemens Firmware Download Tool
- Adjustable functions per switching output: status feedback, adjustable as NO or NC contact, cyclical monitoring, adjustable switch-on and switch-off delay, staircase function, scene control, logic operations, operating hours counting, disabling function or forced control, central switching function
- Adjustable functions of solar protection channel: adjustable operating modes: venetian blind with slats, shutter/awning, venting louver/roof window, direct movement to a position of the sunblind and the slats, status feedback, adjustable behaviour in case of alarm (wind, rain, frost), adjustable solar protection or heating/cooling automatic, scene control, disabling function, forced control
- Adjustable preferred position after download, in case of bus voltage failure and recovery
- Adjustable functions of each input: switching, dimming, colour temperature control, solar protection control, sending values, scene control, pair of inputs operation, controller extension (operating mode switchover, presence function, setpoint shift), adjustable debounce time, locking of each input
- 8 logic functions

Data sheet A6V12632892
Dimensions (W x H x D) 48 x 50 x 28 mm

Stock no.	Product no.
5WG1562-2SB32	UP 562S32

Input devices

Binary input devices

Combination actuators

UP 525S32



Universal dimmer, 1-fold

- One output for switching and dimming resistive, inductive and capacitive loads
 - Automatic or manual adjustment to leading edge or trailing edge control, depending on the type of load
 - Electronic protection against open-circuit, short circuit and temperature rise
 - Rated contact operating voltage: AC 230 V
 - Rated contact frequency: 50/60 Hz
 - Power rating: 1...200 W LEDs, 20...230 W conventional lamps
 - Screw terminals for connection of untreated single-core conductors, stranded without conductor sleeve 0.5 to 4 mm², stranded with conductor sleeve 0.5 to 2.5 mm²
 - 3 binary inputs for potential-free contacts, determination of switching status via voltage generated in the device
 - Poll voltage of the inputs: approx. 5 V
 - Max. 10 m length of connecting cables, preferably J-Y(St)Y, pre-assembled YY6x0.6
 - Bus-powered electronics
 - Integrated bus coupling unit
 - Mounting in appliance boxes according to DIN 49073 or in mounting case M 592/01 (accessories)
- KNX Data Secure compatible
 - Updateable with Siemens Firmware Download Tool
 - Dimming output optionally directly operable via input 1 or input 1 and 2
 - Adjustable functions of dimming output: status feedback, adjustable brightness limit values, adjustable dimming curves for optimising the dimming behaviour of lamps, adjustable switch-on and dimming behaviour, adjustable switch-on and switch-off delay, staircase function, scene control, logic operations, operating hours counting, disabling function or forced control, central function
 - Message in case of short-circuit, overload/mains voltage failure and type of load
 - Adjustable preferred behaviour after download, in case of bus voltage failure and recovery
 - Adjustable functions of each input: switching, dimming, colour temperature control, solar protection control, sending values, scene control, pair of inputs operation, controller extension (operating mode switchover, presence function, setpoint shift)
 - Adjustable debounce time per input
 - Adjustable locking of each input via locking object
 - 8 logic functions (logic gate, value converter, disabling element, comparator, limit value switch)

Data sheet

A6V12632898

Dimensions (W x H x D)

48 x 50 x 28 mm

Stock no.

Product no.

5WG1525-2SB32

UP 525S32

Accessories for UP 5..S32

M 592/01



Mounting case

- One mounting location for a flush-mounted actuator type UP 511S32, UP 562S32 or UP 525S32
- Separate wiring space and strain relief for function wiring
- Housing for mounting on DIN rail TH35 DIN EN 60715
- Housing with screw fastening for installation in cable ducts, under raised floors or for surface mounting under a ceiling
- Housing: plastic
- Type of protection: IP 20

Dimensions (W x H x D)

97 x 53 x 36 mm

Stock no.

Product no.

5WG1592-8AB01

M 592/01

Combination devices



4

Overview and selection tools	134
Input/Output devices	137
Accessories for UP 220/..	139
Accessories for UP 5..S32	142

Combination devices

Overview and selection tools

The optimal solution for decentralized installation

The UP 511S32 switching actuator, the UP 562S32 switching/solar protection actuator and the UP 525S32 universal dimmer are designed for space-saving and flexible flush mounting in a device box to DIN 49073.

By means of a mounting housing M 592/01, which can be ordered as an accessory, a completely decentralized installation in false ceilings, floor tanks, electrical columns and cable ducts or the installation in an electrical distributor with top-hat rail can be realized.

The equipment of the combination units with three binary inputs enables the simultaneous connection of e.g. two push-buttons or switches, an additional window or door contact or a suitable sensor. Standard functions such as switching, dimming, solar protection control, sending values and scene control as well as sophisticated functions such as color temperature control, setting of operating modes and setpoint temperatures for room temperature controllers can be operated via these inputs.

The flush-mounted actuators offer different switching and dimming outputs depending on the device version:



Switch actuator UP 511S32:

- A relay contact at the output as a switching element for AC 230 V, 16 A, for switching electrical loads.

Switch actuator/solar protection actuator UP 562S32:

- Two relay contacts for AC 230 V, Σ 16 A, for switching electrical loads or for controlling motors (110...230 V AC) for sunshades, such as venetian blinds, roller shutters, venetian blinds, awnings, curtains, as well as ventilation flap drives with AC motors

Universal dimmer UP 525S32:

- One output for switching and dimming resistive, inductive or capacitive loads

All flush-mounted actuators offer 6 central functions, operating hours counting and locking functions in addition to the respective standard functions.

A logic module with eight internal functions offers comprehensive links for a wide range of applications in any project.

To ensure that the actuators always work error-free in the future, firmware updates via the Siemens Firmware Download Tool reliably keep the products at the latest functional status.

Thanks to KNX Data Secure encryption, the actuators are not only a versatile but also a particularly secure option for networked KNX installations.

KNX Data Secure

KNX Data Secure signs and encrypts communication in the KNX network and ensures secure data transmission of telegrams. The communication during commissioning processes with the ETS and the runtime communication between devices and to visualizations is thus secured.

The concept ensures that all or only selected KNX telegrams are authenticated and encrypted, regardless of the medium. This protects the combination devices from unauthorized manipulation of the configuration. Fail-safe operation of building functions, trouble-free visualizations and function logic is always guaranteed.

Functions and application examples

Flush-mounted actuators have been developed with their most versatile applications for decentralized installation options:

Lighting

The lighting can be switched (UP 511S32 for one lighting circuit, UP 56S32 for two lighting circuits) and dimmed (UP 525S32) via conventional pushbuttons connected to the binary inputs.

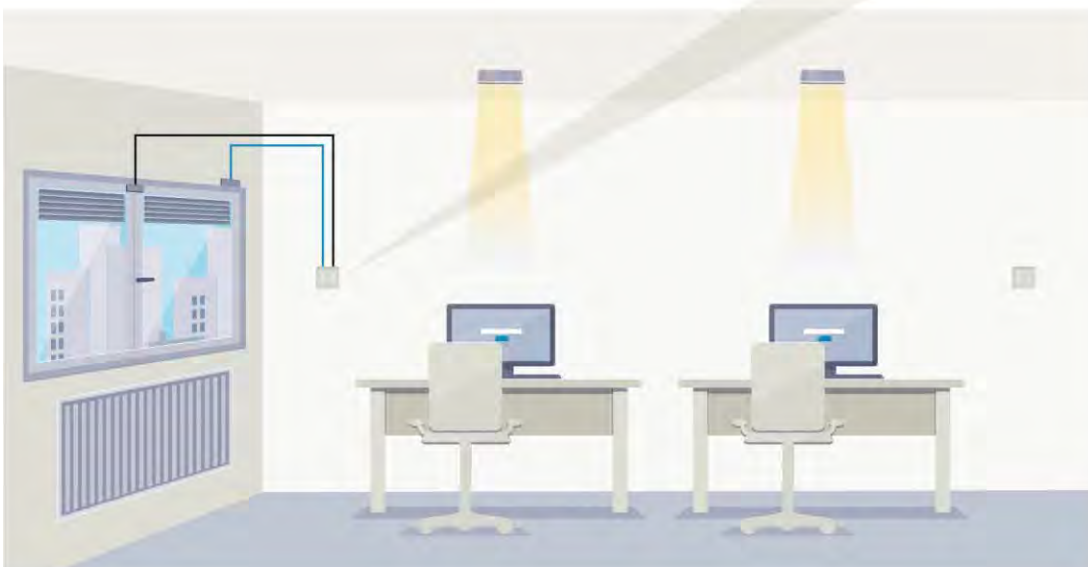
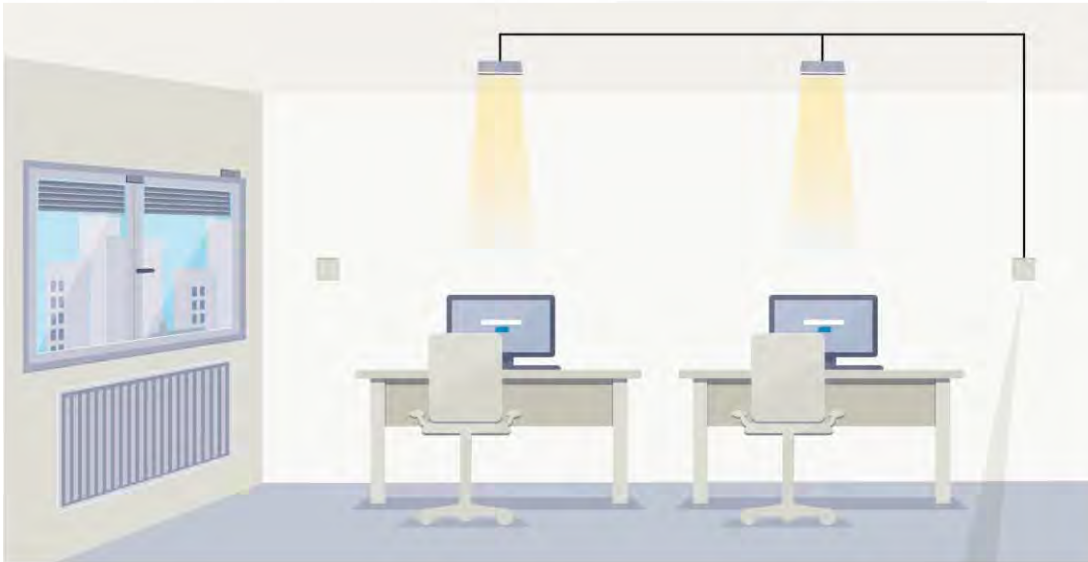

Solar protection

The blinds are moved UP and DOWN via a pushbutton connected to the binary inputs. The third binary input provides the status for a window contact.

Combination devices

Overview and selection tools

4

Input/output devices								
Type	N 501/01	N 502/02	N 528C01	UP 220/21	UP 220D31	UP 511532	UP 562532	UP 525532
Application program ¹⁾	981701	981601		982303	982204	20DF22	20DE22	303122
Enclosure data								
Design	N	N	N	UP	UP	UP	UP	UP
Modular installation device for mounting on TH35 EN 60715 mounting rail.	■	■						
For installation in flush-mounting switch and socket boxes with Ø = 60 mm			■	■	■	■	■	■
Built-in device in mounting housing M 592/01 ²⁾						■	■	■
Dimensions								
• Width/Ø [mm] (1 MW = 18 mm)	8 MW	8 MW	4 MW	Ø 42	Ø 42	48	48	48
• Height [mm]						50	50	50
• Depth [mm]				8.5	8.5	28	28	28
Display/control elements								
LED for status indication per input	■	■						
LED for status indication per output	■	■	■					
LED for operation/status display	■	■						
Pushbuttons for local operation on the device	■	■						
Power supply								
Electronics powered via an integrated power supply unit for supply voltage AC 230 V	■	■						
Bus-powered electronics			■	■	■	■	■	■
Bus-dependent operation possible	■	■ ³⁾						
Bus connection								
Integrated bus coupling units	■	■	■	■	■	■	■	■
Bus connection via bus terminal	■	■	■	■	■	■	■	■
Bus connection via contact system to data rail	■	■						
Outputs								
Load output								
Floating relay contact		8 ⁴⁾				1	2	
Electrically interlocked relays (for reversing direction of rotation)	4							
Dimming aoutput								1
Load types								
Rated contact voltage, AC [V]	230	230	120			230	230	230
Rated contact current [A]	6	16				16	∑ 16 ⁵⁾	1
Protection								
Electronic protection of outputs against overload and short circuit			■					■
Inputs								
Max. cable length, unshielded, twisted [m]	100	100		10	10	10	10	10
For signal input (floating contact)				2 ^{6/7)}	4 ^{6/7)}	3	3	3
Determination of switching state by means of the voltage generated in the device				■	■	■	■	■
For voltage input AC/DC 12...230 V	8	8						

¹⁾ For current application programs, see www.siemens.com/gamma-td

²⁾ The M 592/01 mounting device must be ordered separately, see Chapter Combination devices

³⁾ Each input affects the output of the same name, adjustable as timer or impulse relay

⁴⁾ Except channel A

⁵⁾ The sum applies to both load outputs

⁶⁾ The inputs are mutually insulated from the base

⁷⁾ Inputs, alternatively can be used as outputs for controlling LEDs up to a maximum of 2 mA

Combi switching actuator 8 x AC 230 V, 16 A, 8 x binary inputs

N 502/02



4

- 8 inputs AC/DC 12...230 V
- 8 relay contact outputs
- Rated contact voltage AC 230 V
- Rated contact operating current 16 A, p.f. = 1
- Electronics power supply via an integrated power supply unit for AC 230 V
- Device functional even without bus connection or if bus voltage absent or bus communication interrupted or not yet activated
- Push button to switch between bus and direct mode
- Push button for each output to switch the output in direct mode via a toggling function by a short actuation and for changing the output mode between remote control relay and time switch relay by holding down the push button for some seconds
- Device preset at the factory for direct switching of an output through a toggling function via the input of the same name
- Selectable function for each input when using the Engineering Tool Software (ETS):
 - Switching status / binary value transmission
 - Switching, short / long operation
 - Single button dimming, single button sun protection control, 1-button group control (sequence control)
 - 1-bit scene control
 - 8-bit scene control, 8-bit value, edge-triggered, 8-bit value, short / long operation
 - 16-bit floating point value, edge-triggered, 16-bit value, short / long operation, 16-bit value, edge-triggered, 16-bit floating point value, short / long operation
- Selectable function for each pair of inputs:
 - 2-button dimming with stop telegram or with cyclical sending
 - 2-pushbutton shutter/blind control
- Selectable blocking / releasing of each input via a corresponding blocking object
- Sending of the input objects after a change of status
- Selectable logic operation (AND/OR) for one input with a further communication object and with variable start value of the logic operation at bus voltage recovery
- Setting by means of the ETS, whether all outputs are to be configured identically or individually
- Selectable mode for each output (normal mode, time switch mode)
- Optional addition of a night mode object for each output for time-limited switching On of the output (and hence the illumination) at night
- Variable On and Off delay times for each output
- Variable On period in night mode or in time switch mode
- Selectable warning signal prior to imminent switching-off by means of three-times short off and on switching (flashing) in night mode or in time switch mode
- Optional status object per output for status reporting
- Sending of status objects on request and/or automatically after a change
- Integrated 8-bit scene control and linking of each output with up to 8 scenes
- Selectable switching state for each output at mains or bus power failure as well as after bus or mains voltage recovery
- Integrated bus coupling unit with only half a standard bus load
- Bus connection via bus terminal or contact system to data rail
- Modular installation devices for mounting on TH35 EN 60715 mounting rail

Data sheet	A6V10416148
Rated voltage	AC 230 V
Rated current	16 A
Number of channels	8
Number of inputs potentialfree	8
Dimensions (W x H x D)	90 x 144 x 60 mm
Dimension width (1 MW = 18 mm)	8 MW

Stock no.	Product no.
5WG1502-1AB02	N 502/02

Combination devices

Input/Output devices

N 501/01



Combination blind actuator, 4 x AC 230 V, 6 A, 8 x binary inputs

- 8 inputs for DC or AC in the range from 12 to 230 V
- 8 relay contact outputs locked in pairs against each other for controlling 4 x AC 230 V sunblind drives
- Contact rated voltage AC 230 V
- Contact rated current 6 A, p.f. = 1
- Electronics powered by a AC 230 V integrated power supply
- Device functional even without bus connection or if the bus communication fails
- Preset on delivery for direct output control for each blind button function via momentary contact switches connected to the inputs
- Key for switching between bus and direct mode
- Button for each relay contact output, for switching the output in direct mode
- Selectable function for each input when using the ETS:
 - Switching status, send binary value
 - Switching on leading edge, switching Short/Long
 - 1-pushbutton dimming, sunblind control, group control
 - 1-bit/8-bit scene control
 - 8-bit/16-bit value leading edge, Short/Long
 - 16-bit floating point value leading edge, Short/Long
- Or for each pair of inputs:
 - Acting directly on the corresponding outputs as blind button
 - 2-button dimming with stop telegram or with cyclical sending
 - 2-pushbutton sunblind control
- Selectable blocking of each input via a corresponding blocking object
- Sending of input objects after change
- Selectable cyclical input object sending
- Individual or shared configuration of actuator channels
- Communication objects for each blind channel for driving the sun protection into the end positions or for stopping the procedure and adjusting the blind slats in steps
- Communication objects for setting position of slats and blinds in percentage information
- Automatic opening of the blind slats to a preconfigured nominal setting after uninterrupted driving down of the blind from the top to the bottom end position, with integrated 1-bit scene control for storing and calling up (reproduction) of 2 interim blind and slat settings
- Integrated 1-bit/8-bit scene control, 8 scenes can be integrated per channel
- Optional "Sun" object for integration in a sunlight tracking control system
- Differentiation between automatic and manual mode and with automatic switchover from automatic to manual mode for the channel in question by pressing a bus button for manual control of the corresponding sun protection
- Manual mode taking precedence over automatic position commands
- Optional central command for each device or each channel for switching the relevant channels to automatic mode and driving the sun protection into the up or down end position
- Alarm: move to safety position, Locking in this position for as long as alarm is active
- Travel lock (e. g. for cleaning the outer shutter/blinds)
- Status objects for each channel for querying or for automatic sending of sun protection and slat settings as a percentage value
- Optional status objects for reporting that the up or down position has been reached
- Integrated bus coupling unit, Bus connection via bus terminal or contact system to data rail
- Modular installation devices for mounting on TH35 EN 60715 mounting rail

Data sheet	A6V10416147
Rated voltage	AC 230 V
Rated current	6 A
Number of channels	4
Number of inputs potentialfree	8
Dimensions (W x H x D)	90 x 144 x 60 mm
Dimension width (1 MW = 18 mm)	8 MW

Stock no.	Product no.
5WG1501-1AB01	N 501/01

Pushbutton interface

- Inputs / outputs each configurable for potential-free contacts or for control of an LED
- Generation of the sensing voltage for potential-free contacts
- For inserting into flush-mounting switch and socket boxes with $\varnothing = 60$ mm
- Inputs max. 10 m cable length, unshielded, twisted
- Input functions: Locking of inputs using blocking objects, Adjustable duration of long button press, Configurable contact type (NO contact/NC contact)
- Transmission parameters: Adjustable cyclic transmission, Configurable transmission in the event of bus voltage recovery
- Short/long button press can be evaluated
- Switching on/off/toggle
- Value transmission 8 Bit, 16 Bit
- Single button dimming
- 2-pushbutton dimming with stop telegram (4 bit)
- 1-/2-pushbutton shutter/blind control
- Szene store and call up scene: 8 Bit, in conjunction with scene module 1 Bit
- Pulse counting with/without limit value monitoring (8 bit, 16 bit, 32 bit)
- 1-pushbutton group control
- Bus-powered electronics
- Integrated bus coupling unit, bus connection via bus terminal

UP 220/..



4

Range overview UP 220/..

Product Title	Stock no.	Product no.
Pushbutton interface 2 x potential-free contact, output for LED control	5WG1220-2AB21	UP 220/21
Pushbutton interface 4 x potential-free contact, output for LED control	5WG1220-2DB31	UP 220D31

Recommendation: LED light insert, for switches and pushbutton inserts, red, 1.5V DC, 1 mA

Accessories for UP 220/..

Product Title	Stock no.	Product no.
LED light insert	5TG7318	5TG7318

Combination devices

Input/Output devices

UP 511S32



Switch actuator 1 x AC 230 V, 16 A

- One relay contact per output
- Rated contact operating voltage: AC 230 V
- Rated contact frequency: 50/60 Hz
- Rated contact current: 16 A
- Screw terminals for connection of untreated single-core conductors, stranded without conductor sleeve 0.5 to 4 mm², stranded with conductor sleeve 0.5 to 2.5 mm²
- 3 binary inputs for potential-free contacts, determination of switching status via voltage generated in the device
- Poll voltage of the inputs: approx. 5 V
- Max. 10 m length of connecting cables, preferably J-Y(St)Y, pre-assembled YY6x0.6
- Bus-powered electronics
- Integrated bus coupling unit
- Mounting in appliance boxes according to DIN 49073 or in mounting case M 592/01 (accessories)
- KNX Data Secure compatible
- Updateable with Siemens Firmware Download Tool
- Switching output optionally directly operable via input 1 or input 1 and 2
- Adjustable functions of switching output: status feedback, active status signalling function, adjustable as NO or NC contact, adjustable preferred position after download, adjustable preferred position in case of bus voltage failure and recovery, cyclical monitoring of switching output, adjustable switch-on and switch-off delay, staircase function, 8-bit scene control, logic operations, operating hours counting with limit value monitoring, disabling function or forced control, central switching function
- Adjustable functions of each input: switching, dimming, colour temperature control, solar protection control, sending values (1 byte, 2 byte, 3 byte, 6 byte), scene control, pair of inputs operation, controller extension (operating mode switchover, presence function, setpoint shift)
- Adjustable debounce time per input
- Adjustable locking of each input via locking object
- 8 logic functions (logic gate, value converter, disabling element, comparator, limit value switch)

Data sheet

A6V12632887

Dimensions (W x H x D)

48 x 50 x 28 mm

Stock no.

Product no.

5WG1511-2SB32

UP 511S32

Switch/solar protection actuator 2 x AC 230 V, Σ 16 A

UP 562S32



4

- One relay contact per output
- Rated contact operating voltage: AC 230V
- Rated contact frequency: 50/60 Hz
- Rated contact current: Σ 16 A
- Screw terminals for connection of untreated single-core conductors, stranded without conductor sleeve 0.5 to 4 mm², stranded with conductor sleeve 0.5 to 2.5 mm²
- 3 binary inputs for potential-free contacts, determination of switching status via voltage generated in the device
- Poll voltage of the inputs: approx. 5 V
- Max. 10 m length of connecting cables, preferably J-Y(St)Y, pre-assembled YY6x0.6
- Bus-powered electronics
- Integrated bus coupling unit
- Mounting in appliance boxes according to DIN 49073 or in mounting case M 592/01 (accessories)
- KNX Data Secure compatible
- Updateable with Siemens Firmware Download Tool
- Adjustable functions per switching output: status feedback, adjustable as NO or NC contact, cyclical monitoring, adjustable switch-on and switch-off delay, staircase function, scene control, logic operations, operating hours counting, disabling function or forced control, central switching function
- Adjustable functions of solar protection channel: adjustable operating modes: venetian blind with slats, shutter/awning, venting louver/roof window, direct movement to a position of the sunblind and the slats, status feedback, adjustable behaviour in case of alarm (wind, rain, frost), adjustable solar protection or heating/cooling automatic, scene control, disabling function, forced control
- Adjustable preferred position after download, in case of bus voltage failure and recovery
- Adjustable functions of each input: switching, dimming, colour temperature control, solar protection control, sending values, scene control, pair of inputs operation, controller extension (operating mode switchover, presence function, setpoint shift), adjustable debounce time, locking of each input
- 8 logic functions

Data sheet A6V12632892
 Dimensions (W x H x D) 48 x 50 x 28 mm

	Stock no.	Product no.
	5WG1562-2SB32	UP 562S32

Combination devices

Input/Output devices

UP 525S32



Universal dimmer, 1-fold

- One output for switching and dimming resistive, inductive and capacitive loads
 - Automatic or manual adjustment to leading edge or trailing edge control, depending on the type of load
 - Electronic protection against open-circuit, short circuit and temperature rise
 - Rated contact operating voltage: AC 230 V
 - Rated contact frequency: 50/60 Hz
 - Power rating: 1...200 W LEDs, 20...230 W conventional lamps
 - Screw terminals for connection of untreated single-core conductors, stranded without conductor sleeve 0.5 to 4 mm², stranded with conductor sleeve 0.5 to 2.5 mm²
 - 3 binary inputs for potential-free contacts, determination of switching status via voltage generated in the device
 - Poll voltage of the inputs: approx. 5 V
 - Max. 10 m length of connecting cables, preferably J-Y(St)Y, pre-assembled YY6x0.6
 - Bus-powered electronics
 - Integrated bus coupling unit
 - Mounting in appliance boxes according to DIN 49073 or in mounting case M 592/01 (accessories)
- KNX Data Secure compatible
 - Updateable with Siemens Firmware Download Tool
 - Dimming output optionally directly operable via input 1 or input 1 and 2
 - Adjustable functions of dimming output: status feedback, adjustable brightness limit values, adjustable dimming curves for optimising the dimming behaviour of lamps, adjustable switch-on and dimming behaviour, adjustable switch-on and switch-off delay, staircase function, scene control, logic operations, operating hours counting, disabling function or forced control, central function
 - Message in case of short-circuit, overload/mains voltage failure and type of load
 - Adjustable preferred behaviour after download, in case of bus voltage failure and recovery
 - Adjustable functions of each input: switching, dimming, colour temperature control, solar protection control, sending values, scene control, pair of inputs operation, controller extension (operating mode switchover, presence function, setpoint shift)
 - Adjustable debounce time per input
 - Adjustable locking of each input via locking object
 - 8 logic functions (logic gate, value converter, disabling element, comparator, limit value switch)

Data sheet

A6V12632898

Dimensions (W x H x D)

48 x 50 x 28 mm

Stock no.

Product no.

5WG1525-2SB32

UP 525S32

Accessories for UP 5..S32

M 592/01



Mounting case

- One mounting location for a flush-mounted actuator type UP 511S32, UP 562S32 or UP 525S32
- Separate wiring space and strain relief for function wiring
- Housing for mounting on DIN rail TH35 DIN EN 60715
- Housing with screw fastening for installation in cable ducts, under raised floors or for surface mounting under a ceiling
- Housing: plastic
- Type of protection: IP 20

Dimensions (W x H x D)

97 x 53 x 36 mm

Stock no.

Product no.

5WG1592-8AB01

M 592/01

Lighting



5

Overview and selection tools	144
Dimmers	161
	Accessories for UP 5..S32
	166
Switching/dimming actuators	DALI control output
	Control output 1...10 V DC
	172
Light level controls	176
	Accessories for UP 258..
	180

Lighting

Overview and selection tools



Channel bundling of up to four channels for high output

Strong illumination can be realized by bundling channels up to 100 VA. Bundling two channels increases the output to 300 VA and 500 VA. Bundling three channels increases the output to 750 VA and four channels to 1,000 VA. Adjacent channels can be bundled as follows: A+B|C|D, A|B+C|D, A|B|C+D, A +B|C+D, A+B+C|D, A|B+C+D and A+B +C+D.

5

Universal dimmer for LEDs and conventional illuminants

The universal dimmer N 554 in the new design with DIN rail-mounted devices expands the Siemens GAMMA instabus lighting control product range. Its four independent channels enable the new product to deliver seamless dimming adjustment for dimmable LED retrofit bulbs and bulbs in all other dimmable categories, with no minimum load. The universal dimmer's front panel makes it easy to check and operate. Channel bundling allows outputs to be combined so the load can be increased up to 1,000 VA.

Intuitive front panel



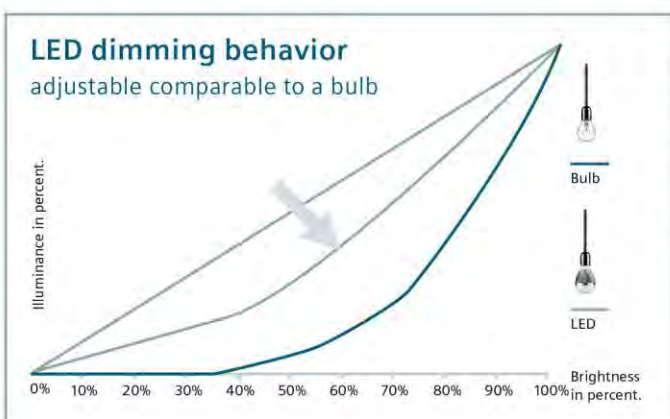









Status LEDs and push-buttons permit convenient operation at the front panel to check the installation. With one click, users can switch and dim the ballasts, configure the channel bundling, and detect faults. Channel bundling can be adjusted directly, without ETS.



Adjustable dimming curves

For greater comfort and flexibility, the universal dimmer offers the option to adjust the dimming behavior of LEDs so that it resembles that of conventional bulbs. The graph shows the typical dimming behavior of an LED compared with a bulb. In the ETS, users can adjust the setting of the LED dimming curve to parametrize the control of brightness relative to dimness. These bulbs can be dimmed brighter or darker in the mid-dim region.

Dimmers

						
Type	N 528D01 N 528C01	N 554D31	UP 525/03	UP 525/13	RS 525/23	UP 525S32
Enclosure data						
Design	N	N	UP	UP	RS	UP
Modular installation devices for mounting on TH35 EN 60715 mounting rail	■	■				
For installation in flush-mounting switch and socket boxes with Ø = 60 mm			■	■		■
10-pole BTI socket (BTI - Bus Transceiver Interface) for plugging of bus terminal devices with BTI connector			■			
Modular installation device for mounting in AP 118 automation module box or AP 641 room control box ¹⁾					■	
Built-in device in mounting housing M 592/01 ²⁾						■
Dimensions						
• Width/Ø [mm] (1 MW = 18 mm)	4 MW	8MW	71	50	50	48
• Height [mm]			71	41.3	35	50
• Depth [mm]			41.5	50.9		28
Mounting type						
Screw fixing			■			
Power supply						
Bus-powered electronics	■	■	■	■	■	■
Power loss						
Max. power loss [W]	6	7	2	2	2	
Bus connection						
Integrated bus coupling units	■	■	■	■	■	■
Bus connection via bus terminal	■	■	■	■	■	■
Outputs						
Load output						
Number of channels	2	4	1	1	1	1
Load type						
Load						
Contact rated voltage, AC [V]	230 or 120	230	230	230	230	230
Dimmer output [VA]	0... 300 ³⁾ or 0...150	0... 300 ⁴⁾	10... 250	10... 250	10... 250	20... 230
Connected load						1...200
Protection						
Electronic protection of outputs against overload and short circuit	■	■	■	■	■	■

¹⁾ The AP 641 room control box and AP 118 automation module box must be ordered separately, see Chapter Quick-assembly system - Room control box - Module boxes

²⁾ The M 592/01 mounting device must be ordered separately, see Chapter Combination devices







³⁾ Max. 500 VA or 250 VA one channel only used

⁴⁾ With channel bundling up to 500, 750, 1000 VA

Lighting

Overview and selection tools

Continuation of the table ...

						
Type	N 528D01 N 528C01	N 554D31	UP 525/03	UP 525/13	RS 525/23	UP 525S32
Application program ¹⁾	9839xx ¹⁾	910A01	982C01	982C01	982C01	303122
Output functions						
Max. number of group addresses	127	2000	120	120	120	1600
Max. number of assignments	127	2000	120	120	120	1600
Blocking function	■	■	■	■	■	■
Configurable behavior in the event of a bus voltage failure	■	■	■	■	■	■
Configurable behavior in the event of a bus voltage recovery	■	■	■	■	■	■
Switching						
Switching ON/OFF	■	■	■	■	■	■
Configurable starting value	■	■	■	■	■	■
Blocking object per channel	■	■	■	■	■	■
Dimming						
BRIGHTER/DARKER dimming	■	■	■	■	■	■
Adjustable dimming range	■	■	■	■	■	■
Minimum dimming value (basic brightness)	■	■	■	■	■	■
Maximum dimming value	■	■	■	■	■	■
Configurable dimming curves						■
Adjustable dimming curves		6				■
Dim or startup 8-bit value	■	■	■	■	■	■
Logic gates per channel		2				■
Time functions						■
Scenes						
8-bit scene	■	■	■	■	■	■
Scenes to be integrated per channel	8	8	8	8	8	64
Linking functions (AND, OR)						■
Status						
Transmitting switch and dimming status	■	■	■	■	■	■
Fault indications overload/short circuit/ overtemperature on bus		■				■
Counting of operating hours						■

¹⁾ For current application programs, see www.siemens.com/gamma-td

KNX and DALI – a strong team

The Digital Addressable Lighting Interface (DALI) was introduced in 2004 to replace the classic 1...10 V interface on the market. The manufacturer neutral DALI bus is a system control electronic control gear (ballast or ECG) in lighting technology. International standard IEC 62386 specifies the DALI communication interface. In addition to ECGs, the DALI interface also supports selected sensors.



DALI communication allows all DALI devices to be simultaneously controlled with same command (broadcast). When controlled via broadcast, all DALI devices respond as if they were jointly controlled via one 1...10 V interface. A second control method under DALI is to assign a DALI device to one of up to 16 groups (group addressing) or to control each individual DALI device (individual addressing).

DALI is not limited to receiving just switching and dimming commands, but can also report status information on lighting status or fault states, e.g. in the event a luminaire or ECG fails.

DALI can assign DALI devices to up to 16 scenes. The specific settings for each scene are then stored in the individual DALI devices and can be started with a single command allowing complex scenes or very fast command processing. And yet the expense of dimming with KNX and DALI does not exceed 1...10 V. In fact, if you compare wiring expenses for DALI and 1...10 V as well as the difference in costs for materials and work, you can implement a project with DALI at approximately one third less than with 1...10 V. In the simplest level, a control device for lighting control with DALI can include a brightness sensor, presence detector, or a combination of brightness sensor/presence detector that controls a group of luminaires by occupancy and daylight. For these simple, local applications, where DALI from one sensor is used as the interface to one or more DALI devices, the broadcast is used as a replace for classic control via 1...10 V. In this regard, these applications are not considered networked systems.

In just one DALI line, up to 64 individual DALI ECGs (slaves) can be connected by the connected control device/gateway (master). The ECG receives an address generated automatically during DALI commissioning and in another commissioning step, receives a short address of 0...63 based on the initial address. The device assignment is random since the address assignment is automatic and the individual ECG/luminaires must be initially identified as the commissioning process proceeds. Individual ECG are addressed either based on the short address (individual control) or based on a DALI group address (group addressing). To this end, any number of ECG from one line may be assigned in up to 16 DALI groups. The group addressing in the DALI system ensures that switching and dimming actions are executed by the various luminaires within a system at the same time (i.e. without delay). Individual luminaire values can be compiled in individual DALI ECG, in addition to addressing by short addresses and group addresses and initiated via scene addressing.

With the release of DALI edition 2 all DALI devices will be tested and certified properly. Especially ECGs will be more compatible to KNX/DALI Gateways caused by these standardized tests. The DiIA is responsible for the DALI-2 certification program. The KNX/DALI Gateways from Siemens have successfully completed this DALI-2 certification process.

Additional information on DALI is available in the DALI technical manual at: <https://www.dali-alliance.org/>

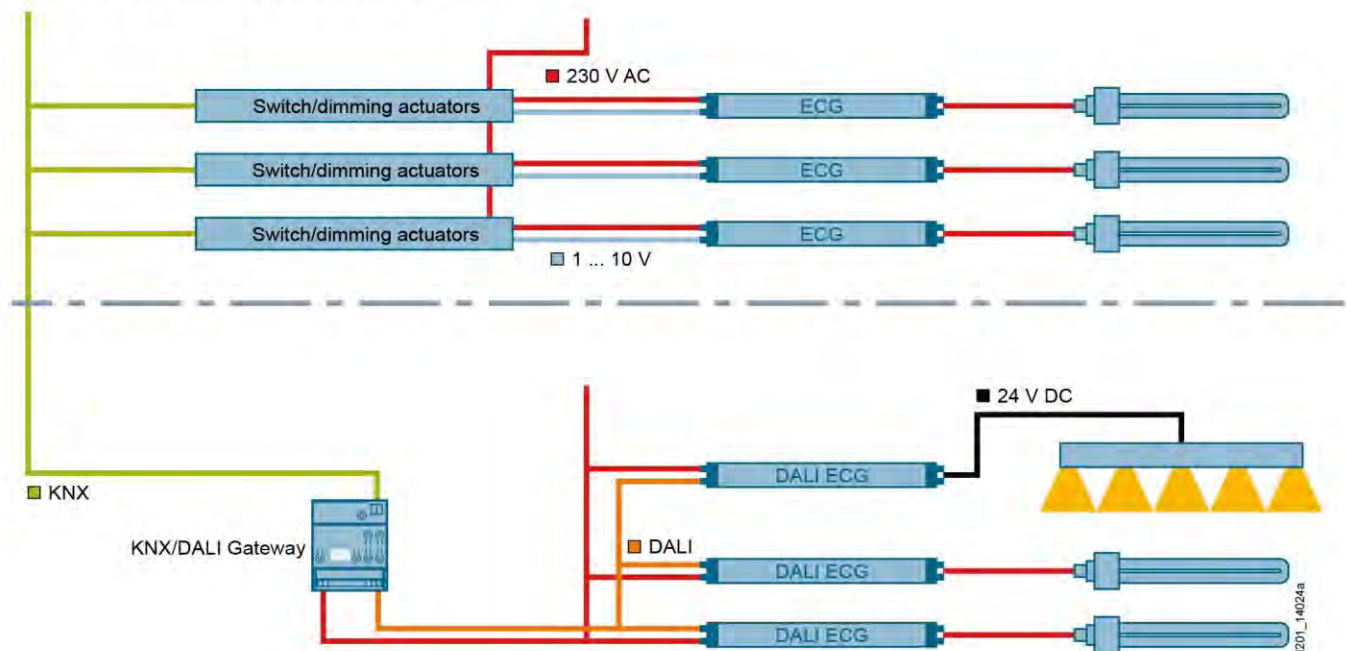
Compare 1...10 V control system to DALI with KNX

Lighting

Overview and selection tools

Wiring of lighting groups 1...10 V control with KNX

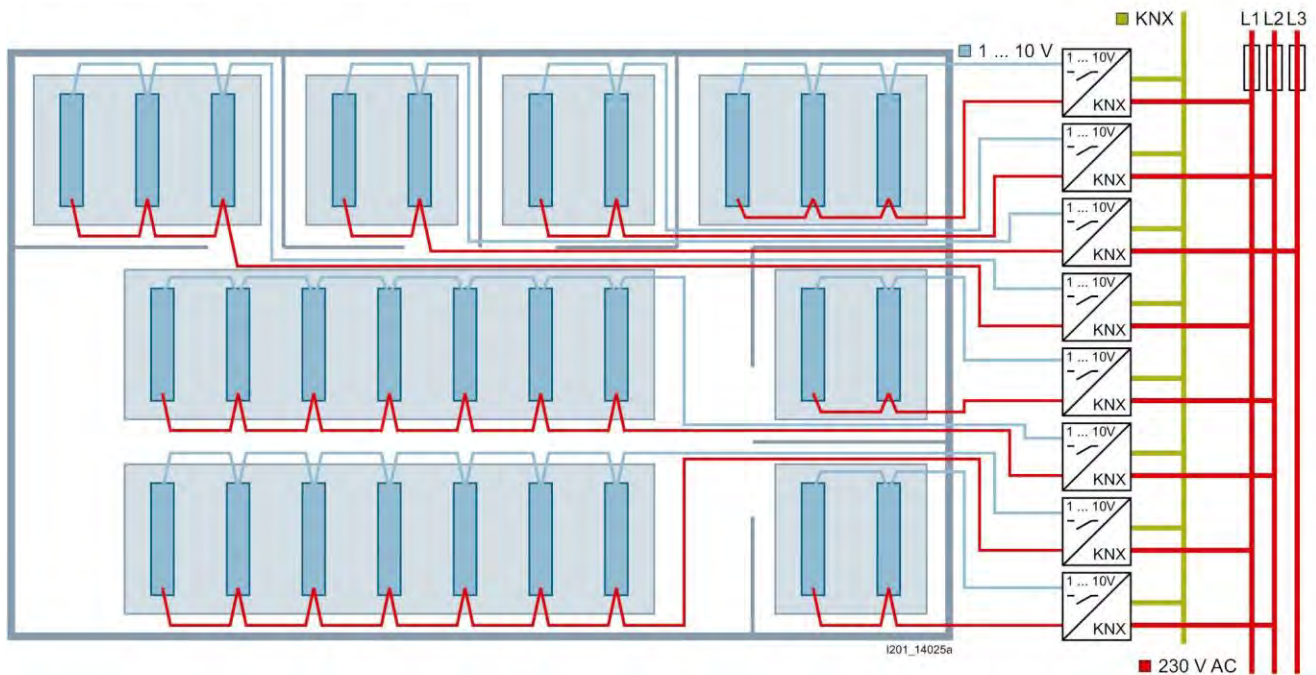

Wiring of lighting groups with DALI with KNX

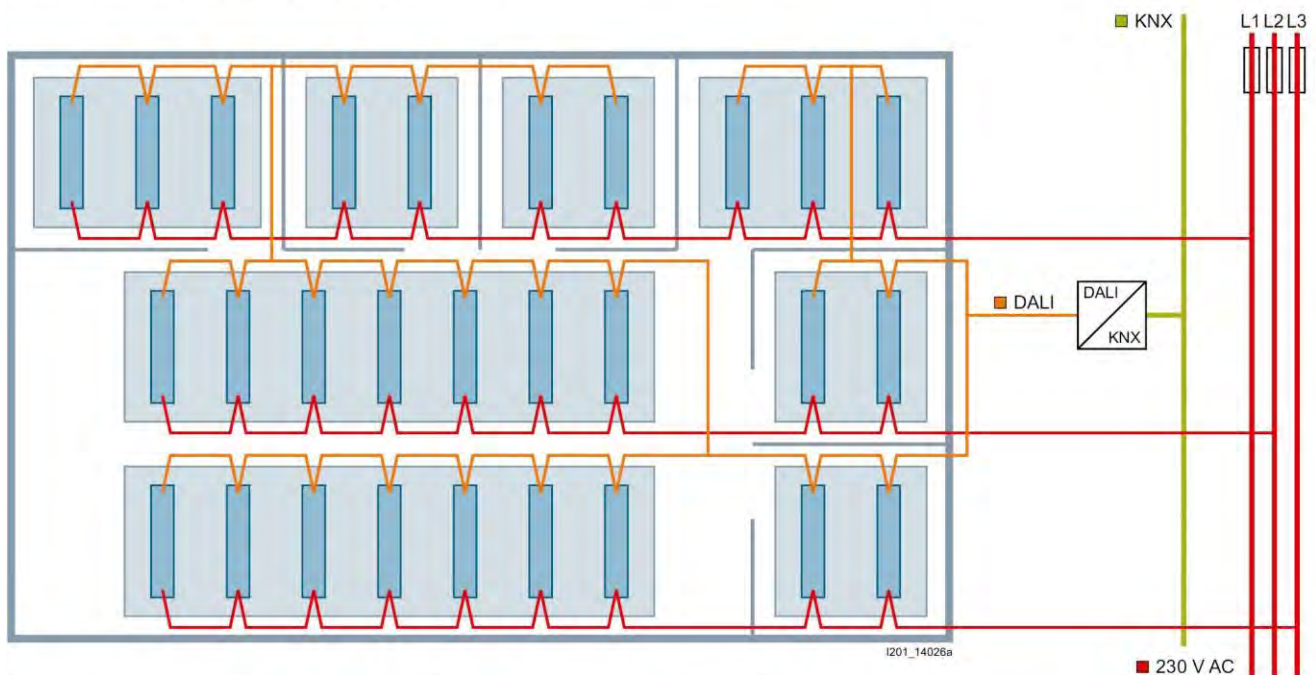

Modern lighting systems can be controlled efficiently and conveniently with DALI. Their efficiency can be increased even more when combined with the advantages of KNX. That's why KNX/DALI gateways from Siemens offer both standards directly: for DALI digital lighting IEC 62386-101 and 103 and for KNX building control (ISO/IEC 14543-3 or DIN EN 50090). It's possible to integrate DALI lighting into KNX installations quickly and easily.

Benefits:

- Lighting groups are not hardwire-connected
- Possible to plan control lines and power supply separately
- Even, uniform load distribution throughout the power supply network
- Lower fire load thanks to fewer cables
- Planning is simpler and faster
- Integration of emergency lighting into the general lighting
- Support for selected sensors with DALI interface
- Switching off standby when lighting is turned off
- Replacement of defective single-channel ballasts without software

Lighting

Overview and selection tools

5

Emergency lighting with KNX and DALI

Simple solution with KNX/DALI gateway

The KNX/DALI Gateway supports both luminaires, which are used in common lighting as emergency lights, and self-contained emergency lighting. In normal mode the failure indication messages during test can be prevented.

Normal mode

- Lighting control with DALI
- Feedback of fault indications and failure of lighting and ECGs to building control

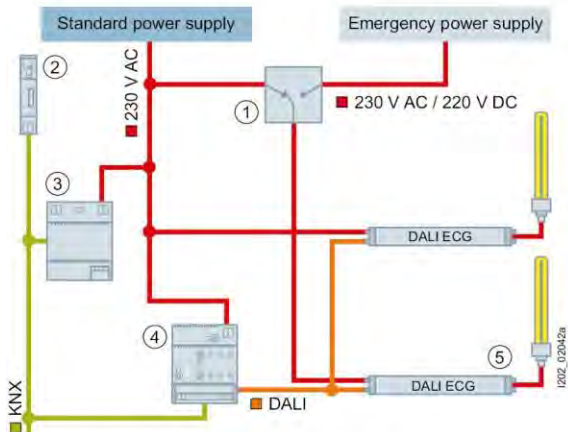

- ① Changeover Unit
- ② KNX Line Coupler
- ③ KNX Power Supply
- ④ KNX/DALI Gateway
- ⑤ Emergency luminaire

Emergency operation

- Automatic emergency lighting in the event of DALI voltage failure
- Parameterization of dimming value of DALI-ECG for emergency lighting via KNX/DALI gateway

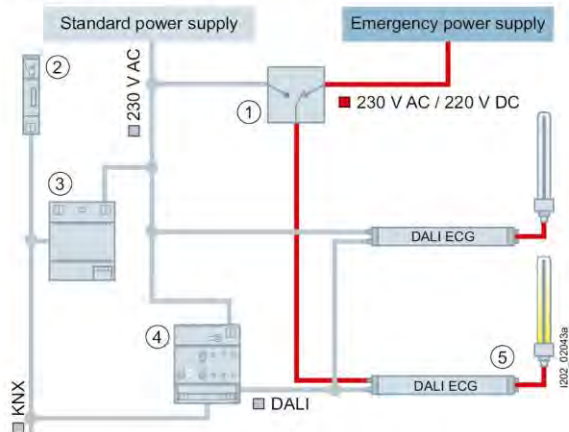

- ① Changeover Unit
- ② KNX Line Coupler
- ③ KNX Power Supply
- ④ KNX/DALI Gateway
- ⑤ Emergency luminaire

Intelligent solution via safety supply and KNX/DALI gateway with status indication in emergency mode

Normal mode

- Lighting control with DALI
- Feedback of fault indications and failure of lighting and ECGs to building control

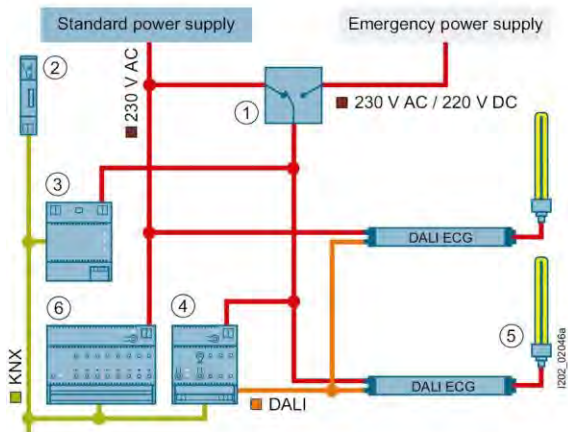

- ① Changeover Unit
- ② KNX Line Coupler
- ③ KNX Power Supply
- ④ KNX/DALI Gateway
- ⑤ Emergency luminaire
- ⑥ KNX binary input

Emergency operation

- Parameterization of dimming value of DALI-ECG in emergency operation via KNX/DALI gateway
- The continued transmission of status indications in emergency operation is possible because there is no interruption of supply to KNX and DALI.

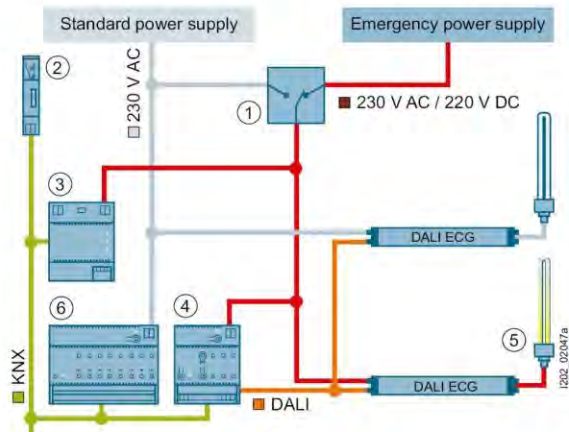

- ① Changeover Unit
- ② KNX Line Coupler
- ③ KNX Power Supply
- ④ KNX/DALI Gateway
- ⑤ Emergency luminaire
- ⑥ KNX binary input

Emergency lighting with single battery and KNX/DALI gateway

In case of self-contained emergency lighting according to IEC 62386-202 the mandatory self-tests are supported. The test results will be transmitted via KNX or stored in the KNX/DALI gateway. The test result memory can be read and saved using ETS.

Normal mode with two DALI devices

- Lighting control with DALI
- Initiate/record/save tests

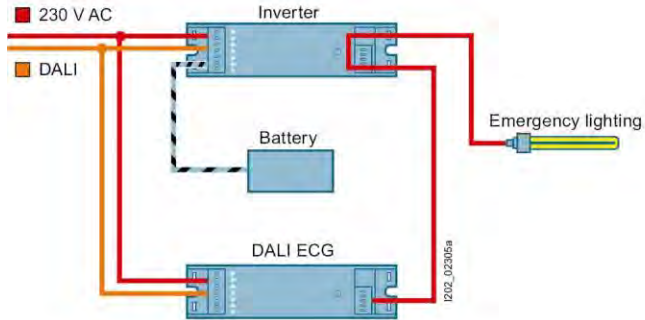

Emergency operation with two DALI devices

- Automatic emergency lighting acc. to parameterization via KNX/DALI gateway

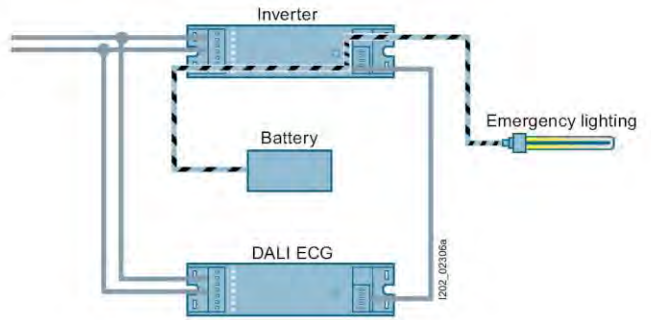

Normal mode with one DALI device

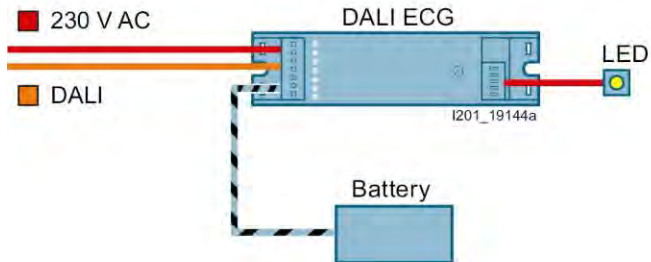

Emergency mode with one DALI device

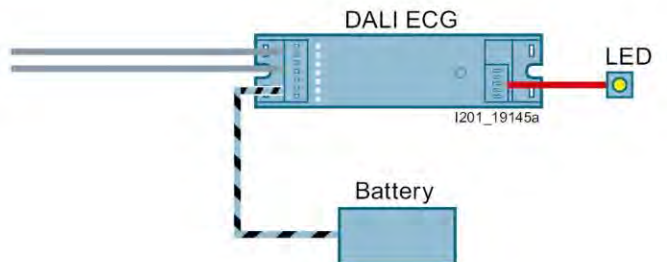

5

Lighting

Overview and selection tools

Tunable White and Human Centric Lighting Applications with DALI

Lighting control for perfect places

The KNX/DALI gateways N 141 and the Switch/dim actuator 2x DALI Broadcast N 525D11 support tunable white, a variable and seamless color temperature control from warm to cold white light. Dynamic color temperatures not only promote a good room atmosphere but contribute to human well-being. This follows the concept of Human Centric Lighting.

Human Centric Lighting

It is a way of light planning that responds to human needs. While cold white light promotes concentration, warm white lights has a calming effect. In this way, the light in a room can be positively adjusted to individual requirements and situations..

An adjusted color temperature can ensure perfect seeing and working conditions, which are crucial especially in educational institutions and offices.

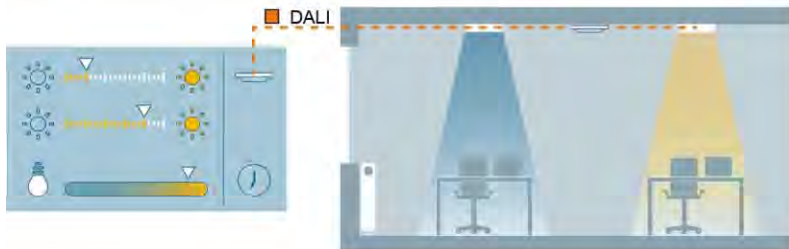

KNX/DALI Gateway N 141

An adjusted color temperature can ensure perfect seeing and working conditions, which are crucial especially in educational institutions and offices.

The KNX/DALI gateway plus also includes an embedded constant lighting control that can be used to control a main lighting group and up to four sub-lighting groups for which requirement-specific and energy-efficient lighting in rooms.

*plus versions!

Switch/dim actuator 2x DALI Broadcast N 525D11

With Tunable White and up to seven adjustable dimming curves, lighting can be adapted to any situation. Moreover, the devices offer the option of saving light scenarios, sending status and error notifications, and counting of switching cycles and operating hours.

Especially in combination with presence detectors, which control brightness fully automatically, the new switch/dim actuators offer the best foundation for optimal light conditions in the room.



1...10 V control output

High lighting convenience with dimmable ECG

Lighting types that cannot be dimmed directly are controlled by way of electronic ballasts (ECG). For example, fluorescent lamps are dimmed via ECG featuring a 1...10 V control input. The switching/dimming actuators N 536D offer the corresponding control output.

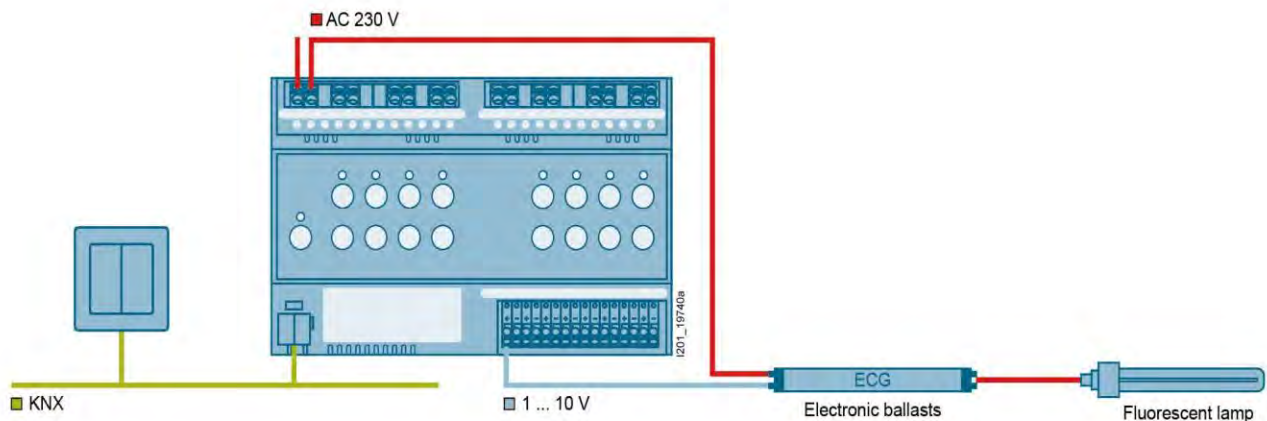

Switching and dimming LEDs via LED drivers



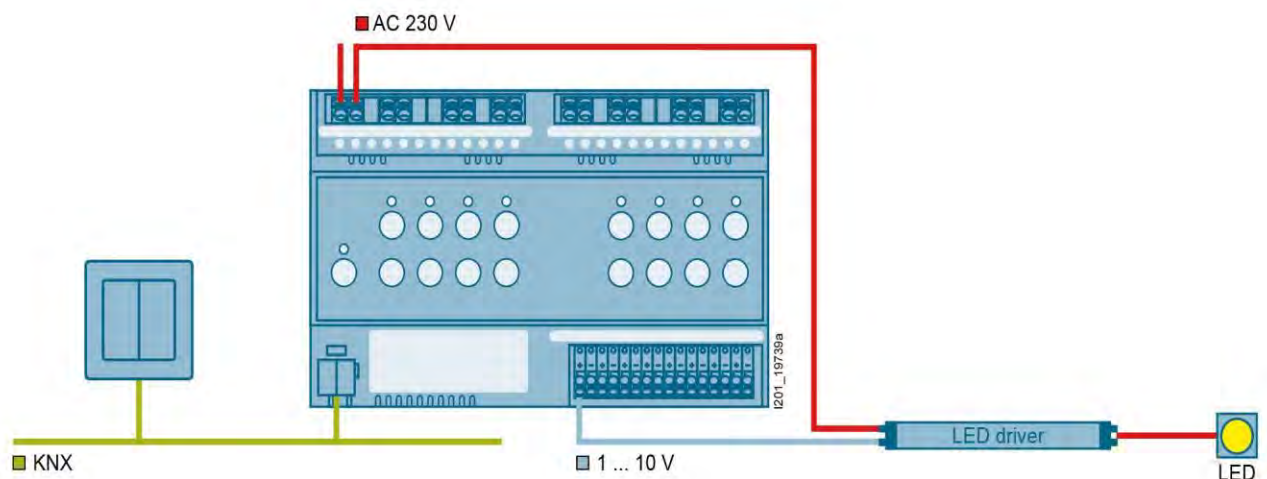





The use of switching/dimming actuators N 536D together with the suitable LED driver offers the possibility of creating pleasant lighting moods with LEDs. The control of fluorescent lamps and LEDs via the corresponding ballasts enables optimal workplace lighting in offices and conference rooms.



Lighting

Overview and selection tools

Switching/dimming actuators



Type	DALI control outputs					Control outputs 1...10 V		
								
Name	Twin plus	plus	Twin					
Enclosure data								
Design	N	N	N	N	N	N	N	RL
Modular installation devices for mounting on TH35 EN 60715 mounting rail	■	■	■	■	■	■	■	
Modular installation device for mounting in AP 118 automation module box or AP 641 room control box ³⁾								■
Dimensions								
Width [mm] (1 MW = 18 mm)	4 MW	4 MW	4 MW	4 MW	4 MW	6 MW	8 MW	47,8
Height [mm]								86,5
Depth [mm]								36,2
Display/control elements								
LED for status indication per output	■	■	■	■	■	■	■	
LEDs for fault indication (lighting failure) per output				■	■			
Pushbuttons for local operation on the device	■	■	■	■	■	■	■	
Direct operation (local operation)	■	■	■	■	■	■	■	
Power supply								
Bus-powered electronics						■	■	■
Electronics powered via an integrated power supply unit	■	■	■	■	■			
DALI outputs powered via an integrated power supply unit	■	■	■	■	■			
Power loss								
Maximum power loss [W]	11	6	11	11	6	7	12	2,4
Bus connection								
Integrated bus coupling units	■	■	■	■	■	■	■	■
Bus connection via contact system to data rail					■			
Bus connection via bus terminal	■	■	■	■	■	■	■	■
Outputs								
Control output								
1...10 V DC						4	8	2
DALI outputs (lines)	2	1	2	2	8			
DALI-2 Certification	■	■	■	■				
Max. ECG per output (units)	64	64	64	20	8	53 ¹⁾	47 ¹⁾	23 ¹⁾
Load output								
Floating relay contacts						4	8	2
Contact rated voltage, AC [V]						230	230	230
Contact rated current [A]						16 ²⁾	16 ²⁾	6

¹⁾ 2 mA per ECG

²⁾ 16 A ohmic, in switch actuator operation, dimming current = 0 mA, independent of installation position and temperature

³⁾ The AP 641 room control box and AP 118 automation module box must be ordered separately, see Chapter Quick-assembly system - Room control box - Module boxes

Switching/dimming actuators ...



Type	DALI control outputs				
					
Application program ¹⁾	N 141/21 9834xx ¹⁾	N 141/03 9837xx ¹⁾	N 141/31 983Dxx ¹⁾	N 525D11 9A1701	N 525E01 980801
Name	Twin plus	plus	Twin		
Functions					
Max. number of group addresses	3000	3000	3000	3000	108
Max. number of assignments	3000	3000	3000	3000	107
Integrated constant light level control	16	16			
Configurable behavior in the event of a bus voltage failure	■	■	■	■	■
Configurable behavior in the event of a bus voltage recovery	■	■	■	■	■
Configurable behavior in the event of a system voltage failure	■	■	■	■	■
Configurable behavior in the event of a system voltage recovery	■	■	■	■	■
Control functions					
Broadcast	■	■	■	■	■
Groups	32	16	32		
Individual ECG	128	64	128		
Switching					
Switching ON/OFF	■	■	■	■	■
Configurable starting value	■	■	■	■	■
Switching ON/OFF possible via BRIGHTER/DARKER dimming	■	■	■	■	■
Dimming					
BRIGHTER/DARKER dimming	■	■	■	■	■
Adjustable dimming time	■	■	■	■	■
Brightness limitation, adjustable min. dimming value/max. dimming value	■	■	■	■	■
Value transmission					
Set 8-bit value	■	■	■	■	■
Scene control					
Integrated 8-bit scene control	■	■	■	■	■
Scenes to be integrated per DALI output	16	16	16	16	16
Effect control					
Integrated effect control (one-off or cyclic chaselight operation, color control)	4	4			
Emergency lighting					
Support for prescribed test sequences for emergency lights	■	■	■		
Controlling single battery lights	■	■	■		
Saves test results of emergency lighting	■	■			
Status					
DALI short circuit	■ ²⁾	■	■ ²⁾	■ ²⁾	■ ²⁾
DALI power supply	■	■	■	■	■
Status output (ON/OFF, value, lamp fault, ECG fault)				■	■
Status group (ON/OFF, value, lamp fault, ECG fault)	■	■	■		
Status ECG (ON/OFF, value, lamp fault, ECG fault)	■	■	■		
Time functions					
ON/OFF delay	■	■	■	■	■
Timer mode, 1-step (stairwell circuits)	■	■	■	■	■
Timer mode, 2-step	■	■	■	■	■
Night mode (lighting for cleaning)	■	■	■	■	■
Warning of impending OFF	■	■	■	■	■
Further functions					
DALI sensors ³⁾ /2-point-control/constant light level control	■	■			
Stand-by shut down (areas)	12	6	12		
Function burn-in	■	■	■		
Color temperature control (Tunable White)	■	■	■	■	
Renew defective ECG without software	■	■	■	■	■
Stand-alone mode	■	■	■		
Pre-loaded applications	■	■		■	

¹⁾ For current application programs, see www.siemens.com/gamma-td²⁾ Per channel³⁾ Only selected DALI sensors are supported, see APB www.siemens.com/gamma-td

Lighting

Overview and selection tools

Continuation of the table ...

Type	Control outputs 1...10 V		
	 N 536D31	 N 536D51	 RL 526D23
Functions			
Max. number of group addresses	2000	2000	2000
Max. number of assignments	2000	2000	2000
Configurable behavior in the event of a bus voltage failure	■	■	■
Configurable behavior in the event of a bus voltage recovery	■	■	■
Switching			
Switching ON/OFF	■	■	■
Configurable starting value	■	■	■
Switching ON/OFF possible via BRIGHTER/DARKER dimming	■	■	■
Dimming			
BRIGHTER/DARKER dimming	■	■	■
Adjustable dimming time	■	■	■
Brightness limitation, adjustable min. dimming value/max. dimming value	■	■	■
Value transmission			
Set 8-bit value	■	■	■
Scene control			
Integrated 8-bit scene control	■	■	■
Scenes to be integrated per channel	8	8	8
Status			
Status output (ON/OFF, value, lamp fault, ECG fault)	■ ²⁾	■ ²⁾	■ ²⁾
Time functions			
ON/OFF delay	■	■	■
Timer mode, 1-step (stairwell circuits)	■	■	■
Timer mode, 2-step	■	■	■
Night mode (lighting for cleaning)	■	■	■
Warning of impending OFF	■	■	■

¹⁾ For current application programs, see www.siemens.com/gamma-td

²⁾ Status ON/OFF, value

Light level controls

Presence- and daylightdependent control



The presence detector with integrated brightness control regulates up to three independent output channels for various functions in the room, such as lighting, sun protection and HVAC systems. The automation serves to optimally adjust the room temperature and brightness to the room's actual use on a presence-dependent basis. That means optimum comfort and always a pleasant room climate, yet with low energy consumption.

At the start and end of every movement, each output channel individually actuates the respective functions. The follow-up times and brightness thresholds can be set independently of each other.

Motion and presence detectors

Mounting guidelines for motion and presence detectors in a room

- Do not expose motion detectors to direct sunlight
- Do not mount any lamps within the detection zone
- Avoid placing any sources of rapid temperature changes within the detection zone, e.g. air vents, fan heaters or incandescent and halogen lamps
- Ensure that the direction of air flows moves laterally to the detection zone
- Detection depends on the temperature difference between the surrounding ambient zone and the object to be detected
- The detection zone of a presence detector should not be impeded or blocked by shelves, plants or glass walls
- Minimum distance of 50 cm from cables and radiators

Mounting guidelines for motion detectors on a building

- Do not mount motion detectors on moving supports, such as poles
- In outdoor applications, mount presence detectors on stable walls
- The detection range of a presence detector should be free of interferences

Brightness sensors



Mounting guidelines for brightness sensors



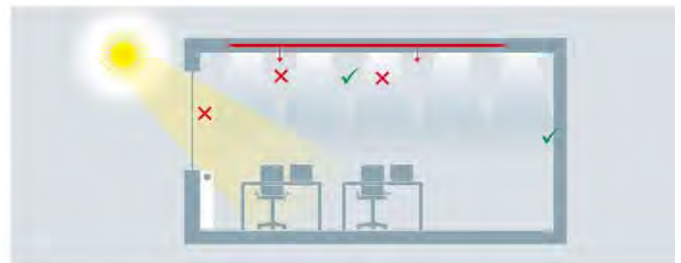





- Make sure that the brightness sensor measures only indirect, reflected light; direct sunlight distorts the measurement results
- Avoid shiny surfaces that are highly reflective, as this interferes with measurement
- Avoid surfaces that are too dark with low light reflection properties, as this impedes measurement of the current brightness level
- Keep in mind that thermal protection glass can influence the daylight measurement; the tripping value will be lower



Lighting

Overview and selection tools

Physical Sensors with KNX connection

								
Type	UP 258D31	UP 258D41	UP 258D51	UP 258D61	UP 258E22	UP 258D12	UP 255D21	AP 254/02
Enclosure data								
Mounting ¹⁾	UP/AP	UP/AP	UP/AP	UP/AP	UP/AP	UP/AP	UP	AP
Degree of protection	IP54	IP20	IP20	IP20	IP20	IP20	IP20	IP54
Dimensions								
• Width/Ø [mm] (1 MW = 18 mm)	120	120	120	120	88	88	88	72
• Height [mm]	41	41	41	41	63 ²⁾	63 ²⁾	63 ²⁾	110
• Depth [mm]	120	120	120	120				54
Power supply								
Bus-powered electronics	KNX	KNX	KNX	KNX	KNX	KNX	KNX	KNX
Bus connection								
Integrated bus coupling units	■	■	■	■	■	■	■	■
Bus connection via bus terminal	■	■	■	■	■	■	■	■
Transmission of sensor values via bus	■	■	■	■	■	■	■	■
Motion/presence								
Detection capability	PIR	PIR	PIR	Ultrasound/ PIR	PIR	PIR		
Motion	■	■	■	■	■	■		
Presence	■	■	■	■	■	■		
HVCA message output	■	■	■	■	■	■		
Horizontal sensing angle	360°	360°	360°	360°	360°	360°		
Vertical sensing angle	150°	150°	150°	150°	105°	105°		
Range on each side, up to [m]	42 ³⁾	42 ³⁾	42 ³⁾	8,9 ³⁾	7 ³⁾	7 ³⁾		
Adjustable range	■	■	■					
Adjustable sensitivity	■	■	■	■	■	■		
Adjustable sectorization	■	■	■					
Brightness								
Measuring range [Lux]	1...1000	1...1000	1...1000	1...1000	20...1000	20...1000	20...1000	1...100000
For measuring outdoor brightness								■
For measuring indoor brightness (mixed light)	■	■	■	■	■	■	■	
HVAC sensors								
Temperature measuring range [°C]	0...50	0...50	0...50	0...50				-25...+55
Humidity [% r.F.]		0...100	0...100					
CO2 [ppm]			400...10000					
Controller								
2-point brightness controller	■	■	■	■	■	■	■	
Constant light level controller	■	■	■	■	■		■	
Temperature controller	■			■				
Relative humidity controller		■	■					
Air quality controller			■					
Functions								
Comparator	■	■	■	■				
Calculator	■	■	■	■				
Threshold monitoring	■	■	■	■				
Dew point calculation		■	■	■				
Infrared (IR) receiver	■	■	■	■	■	■	■	

¹⁾ AP surface mounted, UP flush mounted

²⁾ For flush mounting, mounting height approx. 31 mm, for surface mounting with AP 258E surface-mounting enclosure, approx. 73 mm.

³⁾ For complete technical data visit www.siemens.de/gamma-td

Constant light control for up to five light groups

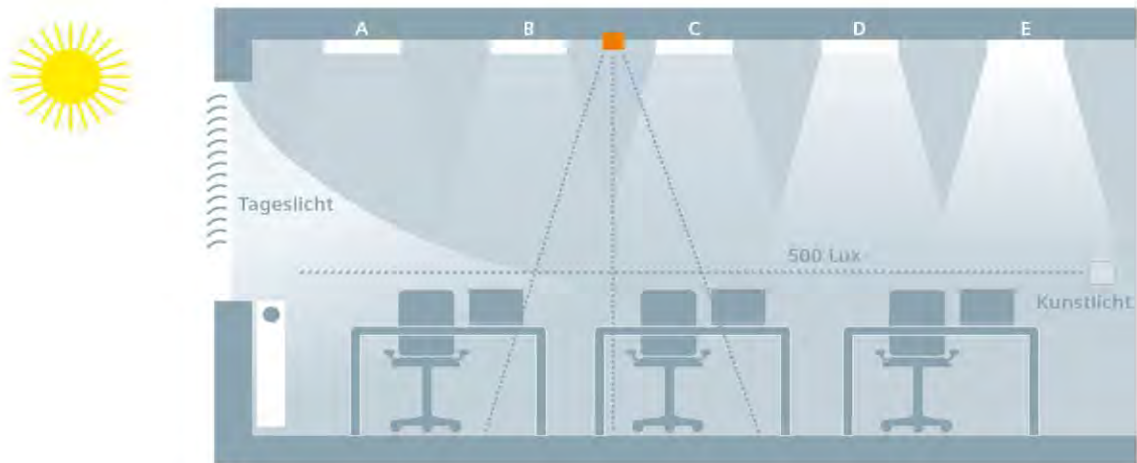

- Integrated constant light level controller with main lighting group and up to four lighting subgroups with one brightness sensor
- Automatic assignment of the artificial light distribution in the room to enable constant light level control of the up to five lighting groups via control characteristics

- Entry of five brightness values, measured under the lights during pure daylight, as a parameter in ETS
- Automatic measurement of artificial lighting in the room when it is dark (without daylight) through targeted on/off switching of the lighting groups and simultaneous measurement at the brightness sensor of the detector

Detection area UP 258D31, UP 258D41, UP 258D51

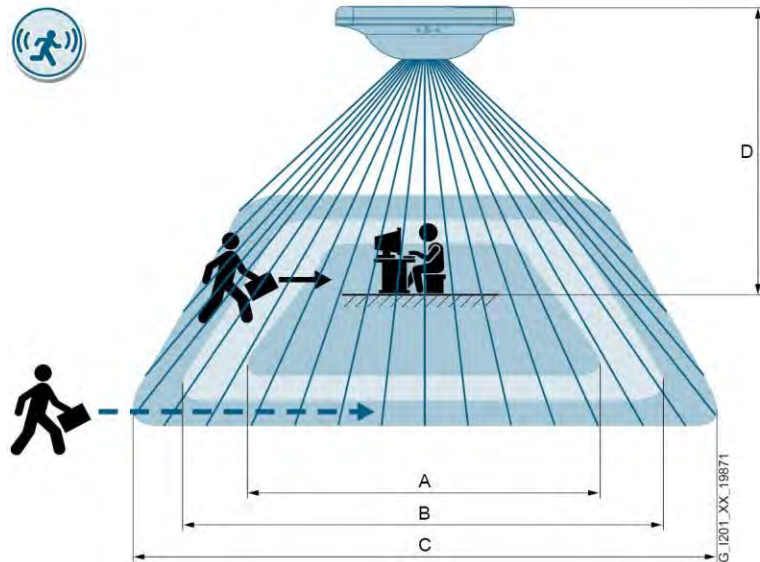

- The detection area has the following zones:
- A) Seated person
 - B) Walking person: step radial in detection of the presence detector on the floor
 - C) Walking person: step tangential in relations to the presence detector on the floor
 - D) Installation height from floor

The table shows the maximum possible diameter of the individual zones in meters at different installation heights (D) and with adjustable range.

D	A			B			C		
	1	4	7	1	4	7	1	4	7
25 m	3.6 m x 3.6 m	5.2 m x 5.2 m	7.8 m x 7.8 m	3.6 m x 3.6 m	5.2 m x 5.2 m	7.8 m x 7.8 m	4 m x 4 m	6 m x 6 m	18 m x 18 m
3 m	4 m x 4 m	5.8 m x 5.8 m	8 m x 8 m	4 m x 4 m	5.8 m x 5.8 m	5 m x 5 m	4 m x 4 m	7 m x 7 m	22 m x 22 m
5 m	--			6 m x 6 m	7 m x 7 m	8.1 m x 8.1 m	8 m x 8 m	17 m x 17 m	27 m x 27 m
10 m	--			7.4 m x 7.4 m	7.5 m x 7.5 m	8 m x 8 m	13 m x 13 m	27 m x 27 m	42 m x 42 m

Lighting

Overview and selection tools

5

Detection area UP 258D61

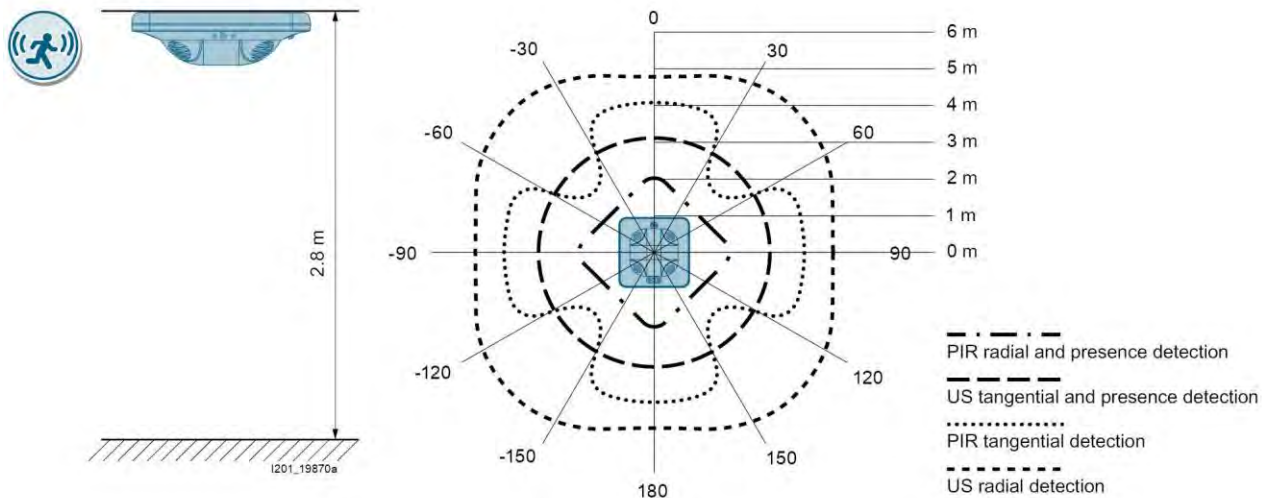

Detection area UP 258E22, UP 258D12

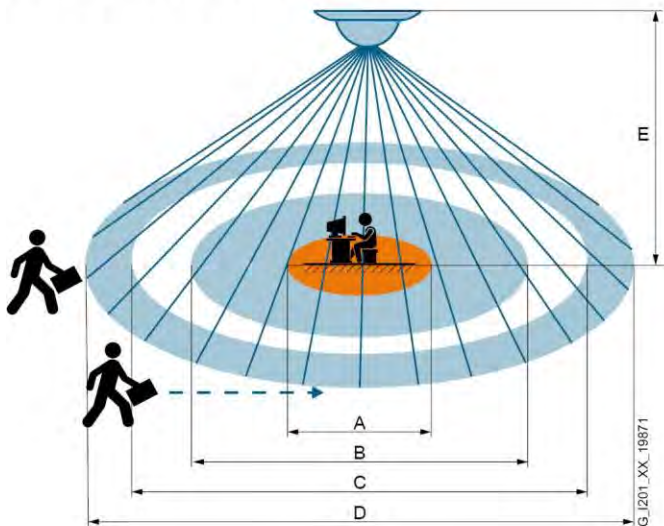

The maximum detection ranges to be achieved are as follows divided:

- A) Sitting person
- B) Walking person straight
- C) Walking person crosswise (tangential)
- D) Brightness measurement
- E) Mounting height from floor level

**Maximum achievable detection ranges
for UP 258E22 / UP 258D12 (in meters)**

E	A	B	C	D
5.0	—	Ø 8.5	Ø 14	Ø 3.0
4.0	—	Ø 7.5	Ø 12	Ø 2.3
3.5	Ø 5.5	Ø 6.5	Ø 10	Ø 2.0
3.0	Ø 5.0	Ø 6.0	Ø 8	Ø 1.6
2.5	Ø 4.5	Ø 5.0	Ø 7	Ø 1.2

Universal dimmer 2 x 300 VA, AC 230 V**N 528D01****5**

- Two outputs for switching and dimming resistive, inductive or capacitive loads
 - Automatic adjustment to leading edge or trailing edge control, depending on the type of load
 - Rated operational voltage AC 230 V
 - Rated frequency 50 / 60 Hz
 - Rated power at +35°C ambient temperature: 300 VA per output or 500 VA for single output usage, without any minimal load per output
 - Electronic protection of each output against overload, short circuit and temperature rise
 - Screw terminals for connection and through-wiring of untreated single-core, stranded or multi-core conductors, 0.5 ... 2.5 mm²
 - Bicolor LED for indicating the switch status (red = on, green = off) or an error (orange, blinking) per output
 - Bus-powered electronics
 - Integrated bus coupling unit, bus connection via bus terminal block
 - Device for DIN-rail mounting on a TH35 mounting rail according to DIN EN 60715
- Per output with selectable mode (normal mode, one- or two-level timer mode, blinking)
 - Adjustable ON- and OFF-delay
 - Separately adjustable dimming time from 0% to 100% for switching on/off and dimming brighter/darker
 - The ability to switch an output on or off by dimming brighter/darker
 - Adjustable dimming value when switching on
 - Immediate activation (jumping) or dimming to a new dimming value
 - Selectable additional status object switching and/or status object dimming value for each output
 - Additional object for each output for blocking/releasing the output
 - Sending of status objects on request and/or automatically after a change
 - Adjustable blocking time for sending status objects after restart and bus voltage recovery
 - Adjustable dimming value for each output in the event of bus voltage failure and recovery
 - Additional night mode object for time-limited switching on the output (and hence illumination) at night
 - Adjustable ON period at night or with timer mode
 - Selectable warning of imminent switching off the illumination by dimming to 50% of the previous dimming value during night mode or timer mode
 - Integrated 8-bit scene control and integration of each output in up to 8 scenes
 - Separately adjustable dimming time for scene control
 - Selectable counting of operating hours and with threshold monitoring of the operating hours
 - Selectable counting of load cycles and with threshold monitoring of the load cycles
 - Optional disabling of the ripple control compensation in an electrical grid with frequency fluctuations
 - Building site function for switching the building site lighting on and off even if the bus devices have not yet been commissioned with ETS

Data sheet	A6V10892651
Dimensions (W x H x D)	90 x 72 x 55 mm
Dimension width (1 MW = 18 mm)	4 MW

Stock no.	Product no.
5WG1528-1DB01	N 528D01

N 528C01



Universal dimmer 2 x 150 VA, AC 120 V

- Two outputs for switching and dimming resistive, inductive or capacitive loads
 - Automatic adjustment to leading edge or trailing edge control, depending on the type of load
 - Rated operational voltage AC 120 V
 - Rated frequency 50 / 60 Hz
 - Rated power at +35°C ambient temperature: 150 VA per output or 250 VA for single output usage, without any minimal load per output
 - Electronic protection of each output against overload, short circuit and temperature rise
 - Screw terminals for connection and through-wiring of untreated single-core, stranded or multi-core conductors, 0.5 ... 2.5 mm², AWG 20-13
 - Bicolor LED for indicating the switch status (red = on, green = off) or an error (orange, blinking) per output
 - Bus-powered electronics
 - Integrated bus coupling unit
 - Bus connection via bus terminal block
 - As a device for DIN-rail mounting on a TH35 mounting rail according to DIN EN 60715
-
- Per output with selectable mode (normal mode, one- or two-level timer mode, blinking)
 - Adjustable ON- and OFF-delay
 - Separately adjustable dimming time from 0% to 100% for switching on / off and dimming brighter / darker
 - The ability to switch an output on or off by dimming brighter / darker
 - Adjustable dimming value when switching on
 - Immediate activation (jumping) or dimming to a new dimming value
 - Selectable additional status object switching and / or status object dimming value for each output
 - Additional object for each output for blocking / releasing the output
 - Sending of status objects on request and / or automatically after a change
 - Adjustable blocking time for sending status objects after restart and bus voltage recovery
 - Adjustable dimming value for each output in the event of bus voltage failure and recovery
 - Additional night mode object for time-limited switching on the output (and hence illumination) at night
 - Adjustable ON period at night or with timer mode
 - Selectable warning of imminent switching off the illumination by dimming to 50% of the previous dimming value during night mode or timer mode
 - Integrated 8-bit scene control and integration of each output in up to 8 scenes
 - Separately adjustable dimming time for scene control
 - Selectable counting of operating hours and with threshold monitoring of the operating hours
 - Selectable counting of load cycles and with threshold monitoring of the load cycles
 - Optional disabling of the ripple control compensation in an electrical grid with frequency fluctuations
 - Building site function for switching the building site lighting on and off even if the bus devices have not yet been commissioned with ETS

Data sheet

A6V11642308

Dimension width (1 MW = 18 mm)

4 MW

Stock no.

Product no.

5WG1528-1CB01

N 528C01

Universal dimmer 4 x 300 VA / 1 x 1000 VA, AC 230 V**N 554D31****5**

- Four outputs for switching and dimming of resistive, inductive and capacitive loads
- Automatic adjustment to leading edge or trailing edge control, depending on the type of load
- Rated operational voltage AC 230 V
- Rated frequency 50 and 60 Hz
- Rated power at +45°C ambient temperature: up to 300 VA per output, up to 1000 VA with bundling of adjacent outputs, without minimum load per output
- Electronic protection per output against overload, short circuit and temperature rise
- Maintenance-free terminals for connection and through-wiring of untreated single-core, stranded or multi-core conductors, 0.5...2.5 mm²
- Manual operation buttons on the device for switching, dimming and activation of direct mode operation
- Bus-powered electronics
- DIN-rail mounted device for mounting on rail TH35 according to DIN EN 60715
- Building site function for bundling the outputs and switching the building site lighting without prior configuration of the device via ETS
- Object for surveillance of device function
- Object for retrieval of status values
- Per output with selectable operation mode (normal mode, one- or two-level timer mode, blinking)
- Adjustable ON-/OFF-delay
- Object Central Switching with separately configurable on/off delay selectable
- Separately adjustable dimming time from 0% to 100% for switching on/off and dimming brighter/darker
- Switch an output on or off by dimming brighter/darker
- Configurable dimming curves for optimization of the dimming operation of lights
- Additional status object switching and/or status object dimming value
- Additional object for dimming with individually adjustable dimming time
- Configurable maximum and minimum dimming value via parameter and object
- Selectable object for limiting the maximum dimming value
- Selectable object for reporting of overload, short circuit and temperature rise
- Adjustable blocking time for sending status objects after restart and bus voltage recovery
- Integrated 8-bit scene control, linking of the output in up to 8 scenes
- Additional night mode object for time-limited switching on the output at night
- Post-triggering of the On period (On period extension) in time switch mode up to a selectable maximum On period extension via repeated (2x, 3x, 4x, 5x) post-triggering
- Selectable warning signal prior to imminent switching-off by brief off and on switching (flashing) or by cutting the current dimming value in half at night or in time switch mode
- Selectable counting with threshold monitoring: operating hours, load cycles

Data sheet	A6V11418996
Rated voltage	AC 230 V
Rated current	1.3 A
Number of channels	4
Dimensions (W x H x D)	144 x 90 x 61 mm
Dimension width (1 MW = 18 mm)	8 MW

Stock no.	Product no.
5WG1554-1DB31	N 554D31

RS 525/23



Universal dimmer 1 x AC 230 V, 10...250 VA, (R,L,C load)

- Output for switching and dimming resistive, inductive or capacitive loads
- Automatic adjustment to leading edge or trailing edge control, depending on the type of load
- Rated frequency 50...60 Hz
- Electronic protection of the output against overload, short circuit and temperature rise
- Bus-powered electronics
- Integrated bus coupling unit, Bus connection via bus terminal block
- Type of protection: IP 20
- Rated operational voltage AC 230 V
- Rated power at +35°C ambient temperature: 10...250 VA
- Screw-less terminals for connection and through-wiring of untreated single-core, stranded or multi-core conductors, 0.5 ... 2.5 mm²
- With bus connection module
- Modular installation device for mounting in AP 118 automation module box or AP 641 room control box
- Selectable mode for each output (normal mode, one- or two-level timer mode, blinking)
- Adjustable on- and off-delay
- Separately adjustable dimming time from 0...100 % for switching on / off and dimming brighter / darker
- Two dimming value objects, each with individually adjustable dimming time from 0...100 %
- The ability to switch an output on or off by dimming brighter/darker
- Adjustable dimming value when switching on
- Immediate activation (jumping) or dimming to a new dimming value
- Selectable additional status object switching and / or status object dimming value for each output
- Additional object for each output for blocking / releasing the output
- Sending of status objects on request and / or automatically after a change
- Adjustable blocking time for sending status objects after restart and bus voltage recovery
- Adjustable dimming value for each output in the event of bus voltage failure and recovery, as well as for mains voltage recovery
- Additional night mode object for time-limited switching on the output (and hence illumination) at night
- Adjustable on period at night or with timer mode
- Selectable warning of imminent switching off the illumination by dimming to 50 % of the previous dimming value during night mode or timer mode
- Integrated 8-bit scene control and integration of each output in up to 8 scenes
- Separately adjustable dimming time for scene control
- Selectable counting of operating hours and with threshold monitoring of the operating hours
- Selectable counting of load cycles and with threshold monitoring of the load cycles

The AP 641 room control box and AP 118 automation module box must be ordered separately. See chapter Modular Installation System - Room control box - Module boxes.

Data sheet	A6V10416181
Rated voltage	AC 230 V
Rated current	1 A
Number of channels	1
Dimensions (W x H x D)	50.2 x 48.8 x 35.5 mm

Stock no.	Product no.
5WG1525-2AB23	RS 525/23

Universal dimmer 1 x AC 230 V, 10 ... 250 VA

UP 525/..3



5

- One output for switching and dimming resistive, inductive or capacitive loads
 - Automatic adjustment to leading edge or trailing edge control, depending on the type of load
 - Rated operational voltage AC 230 V
 - Rated frequency 50...60 Hz
 - Rated power at +35°C ambient temperature: 10...250 VA
 - Electronic protection of the output against overload, short circuit and temperature rise
 - Screwless terminals for connection and through-wiring of untreated single-core, stranded or multi-core conductors, 0.5...2.5 mm²
 - Bus-powered electronics
 - Integrated bus coupling units, bus connection via bus terminal
 - For insertion in flush-mounting switch and socket boxes 60 mm in diameter and 60 mm deep
- Reporting of overload, short circuit and temperature rise via the bus
 - Selectable mode for each output (normal mode, one- or two-level timer mode, blinking)
 - Adjustable on- and off-delay
 - Separately adjustable dimming time from 0% to 100% for switching on / off and dimming brighter / darker
 - Two dimming value objects, each with individually adjustable dimming time from 0...100%
 - The ability to switch an output on or off by dimming brighter / darker
 - Adjustable dimming value when switching on
 - Immediate activation (jumping) or dimming to a new dimming value
 - Selectable additional status object switching and / or status object dimming value for each output
 - Additional object for each output for blocking / releasing the output
 - Sending of status objects on request and / or automatically after a change
 - Adjustable blocking time for sending status objects after restart and bus voltage recovery
 - Adjustable dimming value for each output in the event of bus voltage failure and recovery, as well as for mains voltage recovery
 - Additional night mode object for time-limited switching on the output (and hence illumination) at night
 - Adjustable on period at night or with timer mode
 - Selectable warning of imminent switching off the illumination by dimming to 50% of the previous dimming value during night mode or timer mode
 - Integrated 8-bit scene control and integration of each output in up to 8 scenes
 - Separately adjustable dimming time for scene control
 - Selectable counting of operating hours and with threshold monitoring of the operating hours
 - Selectable counting of load cycles and with threshold monitoring of the load cycles

Range overview UP 525/..3

Product Title	Dimensions (WxHxD) [mm]	Stock no.	Product no.
Universal dimmer 1 x AC 230 V, 10 ... 250 VA, with mounting frame and BTI interface	71 x 71 x 42	5WG1525-2AB03	UP 525/03
Universal dimmer 1 x AC 230 V, 10...250 VA	50 x 50.9 x 41.3	5WG1525-2AB13	UP 525/13

Lighting Dimmers

UP 525S32



Universal dimmer, 1-fold

- One output for switching and dimming resistive, inductive and capacitive loads
 - Automatic or manual adjustment to leading edge or trailing edge control, depending on the type of load
 - Electronic protection against open-circuit, short circuit and temperature rise
 - Rated contact operating voltage: AC 230 V
 - Rated contact frequency: 50/60 Hz
 - Power rating: 1...200 W LEDs, 20...230 W conventional lamps
 - Screw terminals for connection of untreated single-core conductors, stranded without conductor sleeve 0.5 to 4 mm², stranded with conductor sleeve 0.5 to 2.5 mm²
 - 3 binary inputs for potential-free contacts, determination of switching status via voltage generated in the device
 - Poll voltage of the inputs: approx. 5 V
 - Max. 10 m length of connecting cables, preferably J-Y(St)Y, pre-assembled YY6x0.6
 - Bus-powered electronics
 - Integrated bus coupling unit
 - Mounting in appliance boxes according to DIN 49073 or in mounting case M 592/01 (accessories)
-
- KNX Data Secure compatible
 - Updateable with Siemens Firmware Download Tool
 - Dimming output optionally directly operable via input 1 or input 1 and 2
 - Adjustable functions of dimming output: status feedback, adjustable brightness limit values, adjustable dimming curves for optimising the dimming behaviour of lamps, adjustable switch-on and dimming behaviour, adjustable switch-on and switch-off delay, staircase function, scene control, logic operations, operating hours counting, disabling function or forced control, central function
 - Message in case of short-circuit, overload/mains voltage failure and type of load
 - Adjustable preferred behaviour after download, in case of bus voltage failure and recovery
 - Adjustable functions of each input: switching, dimming, colour temperature control, solar protection control, sending values, scene control, pair of inputs operation, controller extension (operating mode switchover, presence function, setpoint shift)
 - Adjustable debounce time per input
 - Adjustable locking of each input via locking object
 - 8 logic functions (logic gate, value converter, disabling element, comparator, limit value switch)

Data sheet

A6V12632898

Dimensions (W x H x D)

48 x 50 x 28 mm

Stock no.

Product no.

5WG1525-2SB32

UP 525S32

Accessories for UP 5..S32

M 592/01



Mounting case

- One mounting location for a flush-mounted actuator type UP 511S32, UP 562S32 or UP 525S32
- Separate wiring space and strain relief for function wiring
- Housing for mounting on DIN rail TH35 DIN EN 60715
- Housing with screw fastening for installation in cable ducts, under raised floors or for surface mounting under a ceiling
- Housing: plastic
- Type of protection: IP 20

Dimensions (W x H x D)

97 x 53 x 36 mm

Stock no.

Product no.

5WG1592-8AB01

M 592/01

Lighting

Switching/dimming actuators

DALI control output

KNX/DALI Gateway plus/Twin plus

N 141/03, N 141/21



5

- With emergency lighting, with sensors
- For communication via KNX with electronic ballasts (ECG) with a DALI interface
- DALI outputs with DALI-2 certification acc. to IEC 62386-101 -103, each for communication with up to 64 DALI ECG Ed.1 and DALI-2 and at least 10 sensors
- Integrated power supply with input voltage AC 110-240 V, 50-60 Hz or DC 120-240 V for powering the gateway electronics and DALI output
- Maximum DALI output voltage of 19 V, short circuit resistant
- Incorrect voltage detection during commissioning if incorrect power line is connected to a DALI output
- LED display for displaying operation mode and error messages
- Pushbutton for switching between bus and direct operating mode
- One pair of pushbuttons for switching On/Off of all connected DALI ECG
- One LED per DALI output for status signal of all connected luminaries in direct mode
- Configurable assignment of max. 64 DALI ECG per channel to max. 16 DALI groups per channel, exclusive controlled in groups or single (switching, dimming, set dimming value and color temperature) and feedback for group status and lamp failure
- Support of DALI DT8 ECG for colour temperature control (Tunable White). Individual, group, scene, effect and schedule control for Human Centric Lighting
- Configurable behaviour for bus failure (stand-alone mode)
- Configurable pre-loaded applications without ETS
- Configurable function burn-in for all ECG via pushbutton or single via object
- Scheduler for day, week, date with astro function
- Control of all connected luminaries together in broadcast mode
- Status signal and display of lamp and ECG failure per group and per DALI device
- Transformation of dimming commands into a temporary setpoint adjustment for ECG with integrated constant light level control and directly connected light level sensor
- One or two level timer
- Up to 4 integrated one time or cyclical control of repeatable sequences or color effects
- Distinction between self-contained emergency luminaries with one or two DALI devices
- Starting the self-conducted testing of each individual inverter and reporting the test result via bus or save in a persistent memory with memory space monitoring over object
- Distinction between function test, short duration test, and long duration test
- Optional configuration of any DALI ECG to dim to a preset dimming value in emergency mode
- Locking of switching and dimming commands as well as configuration while emergency mode is activated
- Activation of emergency mode based on a configurable number of failed DALI ECG
- Lock object to elimination of failure messages interruption of ECG during emergency lighting testing
- Inhibit mode for disabling battery mode of self-contained emergency luminaries over pushbutton
- Per channel up to 6 stand-by-area analysis for activation of switch actuators
- Scene control for up to 16 scenes per channel
- 16 integrated 2-level-controller for brightness control and 16 constant light level controller for main luminaries group and up to four additional luminaries groups
- Assignment of a CIN to a DALI ECG
- Reintegration defective DALI ECG without ETS
- Assignment of DALI ECG to groups and test option for ECG, groups, scenes and effects via ETS
- Assignment of DALI sensors and test option of sensors via ETS
- Integrated bus coupling unit with only half a standard bus load, bus connection via bus terminal
- Mounting on DIN rail EN 60715-TH35-7.5

Data sheet

A6V10466086

Range overview N 141/03, N 141/21

Product Title	Dimensions (WxHxD) [mm]	Dimension width (1 MW = 18 mm)	Stock no.	Product no.
KNX/DALI Gateway Twin plus, 2 channels	60 x 72 x 90	4 MW	5WG1141-1AB21	N 141/21
KNX/DALI Gateway plus, 1 channel	90 x 72 x 55	4 MW	5WG1141-1AB03	N 141/03

Lighting

Switching/dimming actuators

DALI control output

N 141/31



KNX/DALI Gateway Twin

- Communication via KNX EIB with electronic ballasts (ECG) with a DALI interface
- Two DALI outputs with DALI-2 certification acc. to IEC 62386-101 and 103, each for communication with up to 64 DALI ballasts
- Integrated power supply with input voltage AC 110...240 V, 50...60 Hz or DC 120...240 V for powering the gateway electronics and DALI output
- Support of ECGs Type 0, 1, 2, 3, 4, 5, 6, 7 and 8 according to EN 62386 edition 1 as well as edition 2 (DALI-2)
- Maximum DALI output voltage of 19 V, short circuit resistant
- Incorrect voltage detection during commissioning, whether incorrect power line is connected to a DALI output
- LED display for displaying operation mode and error messages
- Pushbutton for switching between bus and direct operating mode
- One pair of pushbuttons for switching On/Off of all connected DALI ballasts
- One LED per DALI output for status signal of all connected luminaries in direct mode
- Configurable behaviour for bus failure (stand-alone mode)
- Control (switching, dimming, set dimming value) of all connected luminaries together in broad-cast mode
- Status signal and display of lamp and ECG failure per group and per DALI device
- One or two level timer
- Integrated scene control for up to 32 scenes
- Assignment of DALI ECG to groups and test option for ECG, groups and scenes via ETS during commissioning
- Possibility to reintegrate defective DALI ECG without software
- Integrated bus coupling unit with only half a standard bus load
- Bus connection via bus terminal
- Mounting on DIN rail EN 60715-TH35-7.5

The following options are selectable, depending on the application program:

- Configurable assignment of max. 128 DALI ECG to max. 32 DALI groups, exclusive controlled in groups or single (switching, dimming, set dimming value and color temperature) and feedback for group status and lamp failure
- Support of DALI DT8 ECGs for colour temperature control Tc, Tunable White according to EN 62386 part 209. individual, group, scene, effect and schedule control for Human Centric Lighting (HCL)
- Configurable function burn-in for all ECG via pushbutton or single via object
- Up to twelve stand-by-area analysis for activation of switch actuators
- Distinction between self-contained emergency luminaries with one or two DALI devices
- Optional configuration of any DALI ECG to dim to a preset dimming value in case of emergency mode
- Locking of switching and dimming commands as well as configuration while emergency mode is activated
- Activation of emergency mode based on a configurable number of failed DALI ECG
- Lock object to elimination of failure messages interruption of ECG during emergency lighting testing
- Inhibit mode for disabling battery mode of self-contained emergency luminaries over pushbutton

Data sheet	A6V10466084
Dimensions (W x H x D)	60 x 72 x 90 mm
Dimension width (1 MW = 18 mm)	4 MW

Stock no.	Product no.
5WG1141-1AB31	N 141/31

Switch/dim actuator, 2x DALI Broadcast

N 525D11



5

- 2 DALI outputs with DALI-2 certification
- Control capacity for up to 20 DALI-ECGs per DALI output
- DALI output voltage of 19 V, short circuit resistant
- Integrated power supply with input voltage AC 110-240 V, 50-60 Hz or DC 120-240 V for powering the gateway electronics and DALI output
- LED display for displaying operation mode and the following failure messages: Illuminant defective, DALI incorrect voltage, DALI short circuit, no ECG found
- One pair of push buttons for switching On/Off and dimming of all connected DALI ECG
- Button on the device front for deactivation of the direct mode operation and LED to indicate activation direct mode operation
- Building site function that provides ex-factory enables switching the building site lighting on and off via bus wall switches and actuators, even if these devices have not yet been commissioned with the Engineering Tool Software (ETS)
- Housing: plastic, N-system
- DIN rail mounted device for mounting on rail TH35 according to DIN EN 60715
- Type of protection: IP 20
- Max. width 4 TE (1 TE = 18 mm)
- Control of color temperature (Tunable White)
- One switching, dimming and color temperature value and status object per output
- Selectable operation mode (normal mode, time switch mode, blinking)
- Adjustable ON- and OFF-delay, control value input object, central switching
- Two logic operation (AND/OR/NAND/NOR/EXOR/FILTER/TRIGGER)
- Adjustable dimming time for switching, dimming and color temperature
- Switch an output on or off by dimming
- Seven configurable dimming curves
- Maximum and minimum dimming and color temperature value
- Configurable sending of status objects on request, cyclically, and / or automatically after a change
- Configurable state on voltage failure and on voltage recovery
- Night mode for time-limited switching the output, i.e. the lighting, at night
- Variable On period at night or time switch mode, time limit in timer switch mode, warning signal prior to imminent switching-off
- Manual override, permanent OFF switching, forced control, locking mode
- Counting of operating hours and counting of load cycles with threshold monitoring
- Integrated 8-bit scene control and linking of each output into up to 8 scenes
- Failure status objects

Data sheet	A6V11914230
Number of channels	2
Dimensions (W x H x D)	72 x 90 x 61 mm
Dimension width (1 MW = 18 mm)	4 MW

Stock no.	Product no.
5WG1525-1DB11	N 525D11

Lighting

Switching/dimming actuators

DALI control output

N 525E01



Switch/dim actuator, 8 x DALI, 8 ECGs per DALI output

- 8 DALI outputs
- Control capacity for up to 8 DALI-ECGs per DALI output
- Power supplied to the electronics and the DALI outputs through an integrated power supply unit for AC 230 V
- Green LED for status display
- Pushbutton for selecting and switching over 4 DALI outputs respectively between bus and direct mode
- Yellow LED for indicating which 4 DALI outputs the direct mode is activated for
- 1 red LED per DALI output for indicating the circuit state or fault (e.g. lighting medium failure) of the connected group
- Four pushbutton pairs for switching and dimming of 4 DALI outputs in direct mode, functional when AC 230 V is applied (also when no bus voltage is connected and also when bus communication has not yet been started or is interrupted)
- Selection of identical or individual configuration of all DALI outputs
- Selectable operating mode per DALI output (normal mode, 1-level or 2-level time-switch mode)
- Per DALI output with command objects for switching on/off, dimming brighter/darker and setting dimming value
- Per DALI output optionally with up to 4 add-on status objects (circuit state and lighting medium failure, dimming value status and DALI status)
- Sending of status objects on request and/or automatically after change
- Per DALI output with add-on object for time-limited switching on of lighting in night mode (cleaning light)
- Warning approx. 1 minute before imminent switching off, by dimming to 50% of former dimming value in night or timer mode
- Adjustable switching on and/or off of a channel through dimming brighter/darker, dimming value when switching on, actuating or dimming a new dimming value, dimming time from 0% to 100%
- Adjustable behavior on bus voltage or mains voltage failure and bus voltage or mains voltage recovery
- Add-on object and integrated 8bit scene control for saving and restoring up to 16 scenes per DALI output
- Integrated bus coupling unit as only half standard bus load, bus connection through bus terminal
- Device for mounting on rail TH35 DIN EN 60715

Data sheet	A6V10416176
Rated voltage	AC 230 V
Number of channels	8
Dimensions (W x H x D)	90 x 72 x 60 mm
Dimension width (1 MW = 18 mm)	4 MW

Stock no.	Product no.
5WG1525-1EB01	N 525E01

Accessories for KNX/DALI Gateway

DALI Push button interface 4fold

- Binary input device
- 4 inputs to connect installation buttons
- Supported actions per input
 - Short button press
 - Long button press
- Integrated DALI bus coupling unit for communicating with a central DALI controller/gateway
- Power supply through DALI line with 6 mA DALI bus load
- For flush-mounting wall or ceiling outlet installations with a 60 mm diameter and depth of 60 mm
- Plug-in terminals for connecting the DALI line
- Cable set for connecting pushbuttons

Data sheet

A6V11786002

UP 141/71



5

Stock no.

Product no.

5WG1141-2AB71

UP 141/71

Lighting

Switching/dimming actuators

Control output 1...10 V DC

N 536D..1

Switch/dim actuator

- One relay contact per output as switching element
 - Rated contact operating voltage AC 230 V
 - Rated contact frequency: 50/60 Hz
 - Rated contact current: 16 A
 - Control voltage output DC 1-10 V per channel for controlling dimmable electronic ballasts
 - Per output direct operation function on the device for switching and dimming and indication of the switching status via LED
 - Button on the device front for deactivation of the direct mode operation and LED to indicate activation direct mode operation
 - Maintenance-free terminals for connection and through-wiring of untreated single-core, stranded or multi-core conductors, 0.5 ... 2.5 mm²
 - With one phase terminal per output
 - Bus-powered electronics
 - Housing: plastic, color RAL 7035 (light grey), N-system
 - DIN rail mounted device for mounting on rail TH35 according to DIN EN 60715
 - Type of protection: IP 20
-
- One switching and status object per output
 - One dimming and status object per output
 - Selectable operation mode (normal mode, time switch mode, blinking)
 - Adjustable ON- and OFF-delay, control value input object, central switching
 - Two logic operation (AND/OR/NAND/NOR/EXOR/FILTER/TRIGGER)
 - Adjustable dimming time for switching and dimming
 - Switch an output on or off by dimming
 - Configurable dimming curves
 - Maximum and minimum dimming value
 - Configurable sending of status objects on request, cyclically, and / or automatically after a change
 - Configurable state on bus voltage failure and dimming value on bus voltage recovery
 - Night mode for time-limited switching the output, i.e. the lighting, at night
 - Night mode for time-limited switching the output, i.e. the lighting, at night
 - Variable On period at night or time switch mode, time limit in timer switch mode, warning signal prior to imminent switching-off
 - Manual override, permanent OFF switching, forced control, locking mode
 - Counting of operating hours and counting of load cycles with threshold monitoring
 - Integrated 8-bit scene control and linking of each output into up to 8 scenes
 - Surveillance of device function

Rated current 10 A

N 536D31

**Switch/dim actuator, 4 x AC 230 V, 10 AX, 1...10 V**

- DIN rail mounted device for mounting on rail TH35 according to DIN EN 60715
- all functions as N 536D..1

Data sheet A6V11632775
 Dimensions (W x H x D) 72 x 90 x 61 mm
 Dimension width (1 MW = 18 mm) 6 MW



Stock no.	Product no.
5WG1536-1DB31	N 536D31

Lighting

Switching/dimming actuators

Control output 1...10 V DC

Switch/dim actuator, 8 x AC 230 V, 10 AX, 1...10 V

- DIN rail mounted device for mounting on rail TH35 according to DIN EN 60715
- all functions as N 536D..1

Data sheet	A6V11632775
Dimensions (W x H x D)	144 x 90 x 61 mm
Dimension width (1 MW = 18 mm)	8 MW

N 536D51



Stock no.	Product no.
5WG1536-1DB51	N 536D51

5

Switch/dim actuator, 2 x AC 230 V, 6 A, 1...10 V

- One relay contact per output as switching element
 - Rated contact operating voltage AC 230 V
 - Rated contact frequency: 50/60 Hz
 - Rated contact current: 6 A
 - Control voltage output DC 1-10 V (passive) per channel for controlling dimmable electronic ballasts
 - Maintenance-free terminals for connection and through-wiring of untreated single-core, stranded or multi-core conductors, 0.5 ... 2.5 mm²
 - Bus-powered electronics
 - Housing: plastic
 - Dimensions (L x W x H): 86,5 x 47,8 x 36,2 mm
 - As built-in device for mounting in a separately to be ordered Control Module Box AP 118 or Room Control Box AP 641
 - Type of protection: IP 20
-
- One switching, one dimming and status object per output
 - Selectable operation mode (normal mode, time switch mode, blinking)
 - Adjustable ON- and OFF-delay, control value input object, central switching
 - Two logic operation (AND/OR/NAND/NOR/EXOR/FILTER/TRIGGER)
 - Adjustable dimming time for switching and dimming
 - Switch an output on or off by dimming
 - Configurable dimming curves
 - Maximum and minimum dimming value
 - Configurable sending of status objects on request, cyclically, and / or automatically after a change
 - Configurable state on bus voltage failure and dimming value on bus voltage recovery
 - Night mode for time-limited switching the output, i.e. the lighting, at night,
 - Variable On period at night or time switch mode, time limit in timer switch mode, warning signal prior to imminent switching-off
 - Manual override, permanent OFF switching, forced control, locking mode
 - Counting of operating hours and counting of load cycles with threshold monitoring
 - Integrated 8-bit scene control and linking of each output into up to 8 scenes
 - Surveillance of device function

Data sheet	A6V12021343
Rated current	6 A
Number of channels	2
Dimensions (W x H x D)	86.5 x 47.8 x 36.2 mm

RL 526D23



Stock no.	Product no.
5WG1526-4DB23	RL 526D23

Lighting

Switching/dimming actuators

Control output 1...10 V DC

JB 526C23



Switch/dim actuator, 2 x AC 277 V, 20 A, 1...10 V

- Protruding wires stranded AWG 12
 - A phase connection for an output that is equipped with a relay contact per output as a switching element
 - Contact rated operational voltage AC 120 V, AC 230 V, AC 277 V, AC 347 V
 - Contact rated operational voltage AC/DC 24 V
 - Contact rated current according to DIN EN 60669-1: 16 A / 20 A (resistive load)
 - Fluorescent lamp load according to DIN EN 60669-1: 16 AX / 20 AX (200 µF) at AC 230 V
 - Bus-powered electronics
 - Integrated bus coupling unit
 - Bus connection via bus terminal
 - Red LED for display of the activation of the addressing mode as well as the operational readiness
 - Housing: plastics
 - For installation in 4" x 4" Junction box (UL/NEMA)
 - Degree of protection IP 20
- For switching and dimming of fluorescent lamps with dimmable electronic ballasts
 - Independent control voltage DC 0/1...10 V per output

Per output

- command objects for switching on/off, dimming brighter/darker and setting dimming value
- adjustable ON- and OFF-delay
- switching status object and/or dimming value status object as an optional addition
- adjustable sending of status objects on demand, cyclically and/or automatically after modification
- adjustable ON period during night and/or time switch operation
- selectable counting of operating hours and threshold monitoring of the operating hours
- selectable counting of load cycles and threshold monitoring of the load cycles
- selectable function blocking of the output
- selectable mode (normal mode, night mode, one- or two-level timer mode, flashing)
- separately adjustable dimming time from minimum to 100% for switching on/off, brighter/darker dimming and dimming value setting
- selectable sending of status objects on request, cyclically and / or automatically after a change or bus voltage recovery
- selectable warning of impending OFF by dimming to 50% of the previous dimming value during night mode or timer mode
- separately adjustable dimming time for scene control
- adjustable dimming curve correction
- construction site function for switching the construction site lighting on and off even if the bus devices have not yet been commissioned with ETS
- Integrated 8-bit scene control and integration of each output in up to 8 scenes
- Optional disabling of the ripple control compensation in an electrical grid with frequency fluctuations

Data sheet

A6V11786012

Dimensions (W x H x D)

70 x 90 x 44.6 mm

Stock no.

Product no.

5WG1526-4CB23

JB 526C23

Lighting

Switching/dimming actuators

Control output 1...10 V DC

Switch/dim actuator, 1 x AC 277 V, 20 A, 1...10 V

JB 527C23



- Protruding wires stranded AWG 12
 - A phase connection for an output that is equipped with a relay contact per output as a switching element
 - Contact rated operational voltage AC120 V, AC 230 V, AC 277 V, AC 347 V
 - Contact rated operational voltage AC / DC 24 V
 - Contact rated current according to DIN EN 60669-1: 16 A / 20 A (resistive load)
 - Fluorescent lamp load according to DIN EN 60669-1: 16 AX / 20 AX (200 µF) at AC 230 V
 - Bus-powered electronics
 - Integrated bus coupling unit
 - Bus connection via bus terminal
 - Red LED for display of the activation of the addressing mode as well as the operational readiness
 - Housing: plastics
 - For installation in 4" x 4" Junction box (UL/NEMA)
 - Degree of protection IP 20
-
- For switching and dimming of fluorescent lamps with dimmable electronic ballasts
 - Independent control voltage DC 0/1...10 V per output

Per output

- command objects for switching on/off, dimming brighter/darker and setting dimming value
- adjustable ON- and OFF-delay
- switching status object and/or dimming value status object as an optional addition
- adjustable sending of status objects on demand, cyclically and/or automatically after modification
- adjustable ON period during night and/or time switch operation
- selectable counting of operating hours and threshold monitoring of the operating hours
- selectable counting of load cycles and threshold monitoring of the load cycles
- selectable function blocking of the output
- selectable mode (normal mode, night mode, one- or two-level timer mode, flashing)
- separately adjustable dimming time from minimum to 100% for switching on/off, brighter/darker dimming and dimming value setting
- selectable sending of status objects on request, cyclically and / or automatically after a change or bus voltage recovery
- selectable warning of impending OFF by dimming to 50% of the previous dimming value during night mode or timer mode
- separately adjustable dimming time for scene control
- adjustable dimming curve correction
- construction site function for switching the construction site lighting on and off even if the bus devices have not yet been commissioned with ETS
- integrated 8-bit scene control and integration of each output in up to 8 scenes
- optional disabling of the ripple control compensation in an electrical grid with frequency fluctuations

Data sheet

A6V11786013

Dimensions (W x H x D)

70 x 90 x 44.6 mm

Stock no.

Product no.

5WG1527-4CB23

JB 527C23

5

Lighting Light level controls

UP 258D..1



Presence Detector WIDE

- Passive infrared detector for ceiling installation
 - Horizontal 360° motion detection area
 - Presence/motion detection up to 64 m² / 400 m² (depending on mounting or room height)
 - A 7-level setting to adjust the presence detection range
 - Brightness and temperature measurement
 - Integrated IR receiver and IR decoder for IR remote control with six pairs of buttons
 - LED for display of detected motions in the delivery state for easy commissioning
 - Programming button operable from the front
 - Integrated bus coupler, bus connection via bus terminal, operation of electronics with bus voltage
 - Mounting on the ceiling on a flush-mounting box with diameter of 60 mm, in a separately ordered housing for surface mounting or mounting plate for 4 x 4 boxes
 - Color white (similar to RAL 9016)
- Presence detection for three function blocks (presence, HVAC, slave)
 - Two selectable functions per function block at the start and two further functions at expiration of presence detection
 - Parallel operation of more presence detectors (master-slave, master-master) possible
 - Locking and output object for each function block
 - Extension inputs for semi-automatic mode
 - Adjustable sensitivity of detection
 - Deactivation of the individual 4 PIR sensors
 - Calibration of brightness measurement with correction factor/offset, via object mixed light-artificial light and two objects artificial light-daylight
 - Constant light control for one main row of lamps and up to four additional rows of lamps
 - 2-point light control
 - Adjustable temperature control as 2-point and/or steady control, heating/cooling operation
 - Sequence control for PI temperature control
 - Adjustable ventilator speed level
 - Object for dew point alarm
 - Comparator for analog values
 - Min., max. and composite calculator for brightness, temperature, humidity and CO₂
 - Threshold monitoring for brightness, temperature, humidity and CO₂

UP 258D31



Presence Detector WIDE with temperature measurement

- Passive infrared detector for ceiling installation
 - Horizontal 360° motion detection area
 - Presence/motion detection up to 64 m² / 400 m² (depending on mounting or room height)
 - A 7-level setting to adjust the presence detection range
 - Brightness and temperature measurement
 - Integrated IR receiver and IR decoder for IR remote control with six pairs of buttons
 - LED for display of detected motions in the delivery state for easy commissioning
 - Programming button operable from the front
 - Integrated bus coupler, bus connection via bus terminal, operation of electronics with bus voltage
 - Mounting on the ceiling on a flush-mounting box with diameter of 60 mm, in a separately ordered housing for surface mounting or mounting plate for 4 x 4 boxes
 - Color white (similar to RAL 9016)
- all functions as UP 258DB..1

Data sheet

A6V11895382

Dimensions (W x H x D)

120 x 41 x 120 mm

Stock no.

Product no.

5WG1258-2DB31

UP 258D31

Presence Detector WIDE pro with temperature and relative humidity measurement

UP 258D41



- Passive infrared detector for ceiling installation
 - Horizontal 360° motion detection area
 - Presence/motion detection up to 64 m² / 400 m² (depending on mounting or room height)
 - A 7-level setting to adjust the presence detection range
 - Brightness and temperature measurement
 - Integrated IR receiver and IR decoder for IR remote control with six pairs of buttons
 - LED for display of detected motions in the delivery state for easy commissioning
 - Programming button operable from the front
 - Integrated bus coupler, bus connection via bus terminal, operation of electronics with bus voltage
 - Mounting on the ceiling on a flush-mounting box with diameter of 60 mm, in a separately ordered housing for surface mounting or mounting plate for 4 x 4 boxes
 - Color white (similar to RAL 9016)
- all functions as UP 258DB..1
 - Integrated humidity controller via 3 switching thresholds
 - Dew point calculation

Data sheet A6V11895382
Dimensions (W x H x D) 120 x 41 x 120 mm

Stock no. 5WG1258-2DB41
Product no. UP 258D41

Presence Detector WIDE multi with temperature, humidity and CO2 measurement

UP 258D51



- Passive infrared detector for ceiling installation
 - Horizontal 360° motion detection area
 - Presence/motion detection up to 64 m² / 400 m² (depending on mounting or room height)
 - A 7-level setting to adjust the presence detection range
 - Brightness and temperature measurement
 - Integrated IR receiver and IR decoder for IR remote control with six pairs of buttons
 - LED for display of detected motions in the delivery state for easy commissioning
 - Programming button operable from the front
 - Integrated bus coupler, bus connection via bus terminal, operation of electronics with bus voltage
 - Mounting on the ceiling on a flush-mounting box with diameter of 60 mm, in a separately ordered housing for surface mounting or mounting plate for 4 x 4 boxes
 - Color white (similar to RAL 9016)
- all functions as UP 258DB..1
 - Integrated humidity and CO2 controller via 3 switching thresholds
 - Dew point calculation

Data sheet A6V11895382
Dimensions (W x H x D) 120 x 41 x 120 mm

Stock no. 5WG1258-2DB51
Product no. UP 258D51

Lighting

Light level controls

UP 258D61



Presence Detector WIDE DualTech with temperature measurement

- Ultrasound for reliable detection for ceiling installation indoors even behind objects
 - Additional detection options through PIR technology
 - Horizontal 360° motion detection area
 - Presence/motion detection up to 28 m² / 79 m² (depending on mounting or room height)
 - Brightness and temperature measurement
 - Integrated IR receiver and IR decoder for IR remote control with six pairs of buttons
 - LED for display of detected motions in the delivery state for easy commissioning
 - Programming button operable from the front
 - Integrated bus coupler, bus connection via bus terminal, operation of electronics with bus voltage
 - Mounting on the ceiling on a flush-mounting box with diameter of 60 mm, in a separately ordered housing for surface mounting or mounting plate for 4 x 4 boxes
 - Color white (similar to RAL 9016)
- Presence detection for three function blocks (presence, HVAC, slave)
 - Two selectable functions per function block at the start and two further functions at expiration of presence detection
 - Parallel operation of more presence detectors (master-slave, master-master) possible
 - Locking and output object for each function block
 - Extension inputs for semi-automatic mode
 - Adjustable sensitivity of detection
 - Calibration of brightness measurement with correction factor/offset, via object mixed light-artificial light and two objects artificial light-daylight
 - Constant light control for one main row of lamps and up to four additional rows of lamps
 - 2-point light control
 - Adjustable temperature control as 2-point and/or steady control, heating/cooling operation
 - Sequence control for PI temperature control
 - Adjustable ventilator speed level
 - Object for dew point alarm
 - Comparator for analog values
 - Min., max. and composite calculator for brightness, temperature, humidity and CO₂
 - Threshold monitoring for brightness, temperature, humidity and CO₂

Data sheet

A6V11895378

Dimensions (W x H x D)

120 x 41 x 120 mm

Stock no.

Product no.

5WG1258-2DB61

UP 258D61

Presence Detector / Motion detector with constant light level control

UP 258E22



- Passive infrared detector for ceiling mounting indoors
- Optional blinding of parts of the detection area
- Adjustable sensitivity of detection
- Mixed light measurement
- Cyclical sending or sending on change of value of the measured brightness value (Lux)
- Integrated two-position controller
- Constant light level control for a main group of luminaries and up to four additional groups of luminaries
- Lighting control configurable as fully automatic or semi-automatic
- Motion detection for three function blocks (presence detector, motion detector, and HVAC detector)
- 2 per function block selectable functions (A, B) on start of the presence detection and two per function block selectable functions (C, D) on expiration of the presence detection
- Configurable delay of 0...255 seconds between sending of function A and B respectively C and D
- Selection per function (A, B, C, D) switching On/Off, 8-bit value, selectable 8-bit value, 16-bit value, temperature value, brightness value, 8-bit scene control
- Blocking object per function block
- Per function block configurable overshoot time, in each case configurable as a fixed time, as switchable between two times via the bus, or settable to a value via the bus
- Parallel operation of several presence detectors (master-slave, master-master) without additional logic module
- Integrated IR receiver and IR decoder for IR remote controls with six pairs of pushbuttons
- Functions of the IR remote control selectable per pair of pushbuttons or per each single pushbutton of a button pair
- Per pushbutton selectable function toggle, switching on, switching off, 8-bit scene recall, 8-bit value, 16-bit value, temperature value, brightness value
- For each pair of pushbuttons selectable function switching On/Off, 2-button dimming with stop telegram, 2-button solar protection control, variable 8-bit value, 8-bit scene control
- Blocking object for IR decoder
- Test mode for easy start-up
- LED for display of detected movements in test mode, to be configured using ETS
- Integrated bus coupling unit, bus connection via bus terminal, Power supply over the bus line
- Ceiling mounting on a flush-mounting box with 60 mm diameter and min. 40 mm depth or in a housing for surface-mounting AP 258E01 (to be ordered separately)
- Monitoring motion range horizontal 360°, vertical approx. 105°
- Monitoring motion of an area of diameter 8 m (depending on mounting/room height)
- Programming button reachable from front

Data sheet A6V10489482
 Dimensions (W x H x D) 88 x 63 x 88 mm

Stock no.	Product no.
5WG1258-2EB22	UP 258E22

Lighting

Light level controls

UP 258D12



Presence Detector with brightness sensor

- Passive infrared detector for ceiling mounting indoors
- Adjustable sensitivity of detection
- Mixed light measurement
- Ceiling mounting on a flush-mounting box with 60 mm diameter and min. 40 mm depth or in a housing for surface-mounting AP 258E01 (to be ordered separately)
- Integrated IR decoder for S 255/11
- Programming button reachable from front
- Monitoring range horizontal 360°, vertical approx. 105°
- Monitoring motion of an area of diameter 8 m (depending on mounting/room height)
- Optional blinding of parts of the detection area
- Power supply via KNX bus
- Integrated bus coupling unit, bus connection via bus terminal

Data sheet

A6V10489482

Dimensions (W x H x D)

88 x 63 x 88 mm

Stock no.

Product no.

5WG1258-2DB12

UP 258D12

UP 255D21



Brightness Sensor with constant light level controller

- Mixed light measurement
- Ceiling mounting on a flush-mounting box with 60 mm diameter and min. 40 mm depth or in a housing for surface-mounting (to be ordered separately)
- Programming button reachable from front
- Integrated IR decoder for S 255/11
- Integrated 2-point control (switching)
- Constant light level control for main group of luminaries and up to 4 additional groups of luminaries incl. automatic calibrating

Data sheet

A6V10489482

Dimensions (W x H x D)

88 x 63 x 88 mm

Stock no.

Product no.

5WG1255-2DB21

UP 255D21

Accessories for UP 258..

AP 258E01



Surface Mounting Enclosure

- For fixing the presence detectors UP 258D12 and UP 258E22 and the brightness sensor UP 255D21 as a surface mounting device

Data sheet

A6V10416111

Stock no.

Product no.

5WG1258-7EB01

AP 258E01

Surface Mounting Box Type B

- Mounting presence detector UP 258Dx1 as a surface-mounted device
- Color white (similar to RAL 9016)

Dimensions (W x H x D) 109 x 109 x 30 mm

AP 258E11

Stock no.	Product no.
5WG1258-7EB11	AP 258E11

IR remote control

- 6 pushbutton pairs for the remote control of lighting, shutter/blinds and scenes
- Parameterization via ETS in the presence detectors UP 258E and UP 258D and in the brightness sensor UP 255D21
- Range: up to 10 m
- Power supply: CR2025 lithium button cell
- Degree of protection (acc. to EN 60529): IP40

Data sheet A6V11786011
Dimensions (W x H x D) 40 x 87 x 6 mm

S 255/11

Stock no.	Product no.
5WG1255-7AB11	S 255/11

Mounting plate

- Mounting presence detector UP 258Dx1 with 4x4 boxes
- Color white (similar to RAL 9016)

S 258/12

Stock no.	Product no.
5WG1258-8AB12	S 258/12

Lighting Light level controls

AP 254/02



Dual sensor for brightness measurement, temperature measurement, sun protection control, lighting control

- Brightness measurement, temperature measurement, sun protection control, lighting control
- For the detection and transmission of brightness and temperature
 - Temperature measuring range -25 °C...+55 °C
 - Brightness measuring range 1 Lux...100 kLux
 - Horizontal sensing angle -60°...+60°, vertical -35°...+66.5°
- For the control of switch, dimming and shutter/blind actuators, depending on the ambient luminosity and/or ambient temperature
- One sun protection channel for the automatic control of sun protection equipment, with
 - Starting and stopping of automation by means of an object or a dusk threshold
 - Up to three brightness thresholds for determining the height and position of the shutters/blinds or roller shutters
 - Optional teach-in of dusk thresholds and brightness thresholds by means of a teach-in facility
 - Blocking object for the temporary deactivation of the sun protection channel function
- Up to four universal channels for the control of switch, dimming and shutter/blind actuators, depending on ambient luminosity and/or temperature. Optionally available with:
 - Threshold switches for brightness
 - Threshold switches for temperature
 - Threshold switches with logical combination of brightness and temperature
 - Optional teach-in of brightness threshold for each universal channel by means of an associated teach-in facility
 - Deactivation option for each universal channel by means of an associated blocking object (1 bit)
 - Optional second object for transmission of a second telegram on fulfillment of threshold conditions
- Bus-powered electronics
- Integrated bus coupling units
- Bus connection via bus terminal
- Surface mounting
- Degree of protection: IP54

Data sheet

A6V10416100

Dimensions (W x H x D)

72 x 110 x 54 mm

Stock no.

Product no.

5WG1254-3EY02

AP 254/02

Solar protection, anti-glare protection, utilization of daylight



6

Overview and selection tools		184
Anti-glare/solar protection actuators		189
	Accessories for UP 5..S32	194
Central weather/solar protection systems		199
	Accessories for AP 257/..2	199

Solar protection, anti-glare protection, utilization of daylight

Overview and selection tools

Sunlight tracking control

With sunlight tracking control, the position of the sun is tracked so that the blind slats are not completely closed, but rather automatically adjusted to prevent the sun from shining directly into the room. The spacing between the blind slats still allows diffuse daylight to enter the room and contribute to ensuring glare-free room lighting while lowering electricity costs.



6

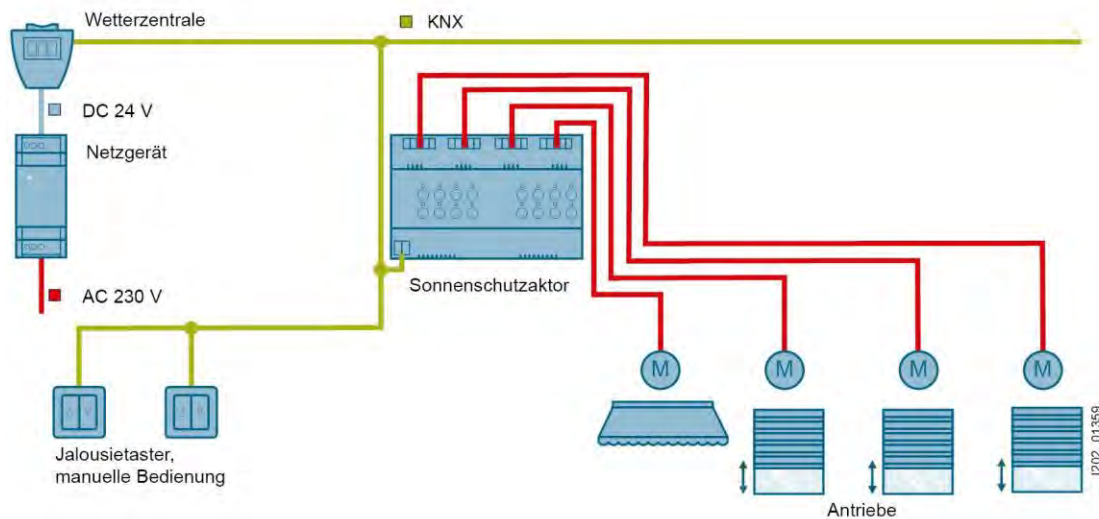

Benefits

- Reduced energy consumption and costs for room lighting
- Optimum room climate
- Glare-free workplaces

You will need

- Weather station AP 257/61 or AP 257/22
- Electronic power supply unit
- Sunblind actuator N 543
- Pushbutton, double UP 222/3
- Drives
- Bus coupling unit UP 117/12 (for pushbuttons)

Solar protection, anti-glare protection, utilization of daylight Overview and selection tools

Shadow tracking control

With shadow tracking control, sun protection is not lowered completely but only so far that the sun can still shine into the room for a certain distance (e.g. 50 cm), which can be set by adjustable parameters.

Benefits

This enables room occupants to look outside through the lower part of the window, and plants arranged on the windowsill can still be exposed to direct sunlight, while the room occupants are protected. This creates an optimum room climate, ensures glare-free workplaces and lowers energy demand and costs for room lighting.



Sunlight tracking control with shadow tracking control

The functions of sunlight tracking control and shadow tracking control can be performed with the same devices individually or in combination.



You will need

- Weather station AP 257/22
- Electronic power supply unit
- Solar protection actuator N 543
- Pushbutton, double UP 222/3
- Drive
- Bus coupling unit UP 117/12 (for pushbuttons)

Solar protection, anti-glare protection, utilization of daylight

Overview and selection tools

Anti-glare/sun protection actuators

	N 543D31	N 543D51	N 523/03	N 501/01	UP 520/03	UP 520/13	RS 520/23	RL 521/23	UP 562S32
Type									
Enclosure data									
Design	N	N	N	N	UP	UP	RS	RL	UP
Modular installation devices for mounting on TH35 EN 60715 mounting rail	■	■	■	■					
For installation in flush-mounting switch and socket boxes with Ø = 60 mm					■	■			■
Modular installation device for mounting in AP 118 automation module box or AP 641 room control box ¹⁾							■	■	
Built-in device in mounting housing M 592/01 ²⁾									■
10-pole BTI socket (BTI - Bus Transceiver Interface) for plugging of bus terminal devices with BTI connector					■				
Dimensions									
• Width/Ø [mm] (1 MW = 18 mm)	4 MW	8 MW	4 MW	8 MW	71	50	50.2	47.8	48
• Height [mm]					71	50.9	35.5	86.5	50
• Depth [mm]					42	41.3	48.8	36.2	28
Mounting type									
Screw fixing					■				
Display/control elements									
LED for status indication per output	■	■	■	■					
Direct operation (local operation)	■	■	■	■					
Power supply									
Bus-powered electronics	■	■			■	■	■	■	■
Electronics powered via an integrated power supply unit. Supply voltage AC 230 V			■	■					
Bus connection									
Integrated bus coupling units	■	■	■	■	■	■	■	■	■
Bus connection via bus terminal	■	■	■	■	■	■	■	■	■
Bus connection via contact system to data rail			■	■					
Outputs									
Load output									
Number of channels (one UP and one DOWN each)	4	8	4 ³⁾	4 ³⁾	1	1	1	2	1
Electrically interlocked relays (for reversing direction of rotation)	■	■	■	■	■	■	■	■	
Contact rated voltage									
• AC 230 V/50 Hz	■	■	■	■	■	■	■	■	■
• AC 120 V									
Contact rated current [A]	6	6	6	6	6	6	6	6	∑ 16 ⁴⁾
Inputs									
Max. cable length, unshielded, twisted [m]				100					10

¹⁾ The AP 641 room control box and AP 118 automation module box must be ordered separately, see Chapter Quick-assembly system - Room control box - enclosure

²⁾ The M 592/01 mounting device must be ordered separately, see Chapter Combination devices

³⁾ 2 floating

⁴⁾ The sum applies to both load outputs

Solar protection, anti-glare protection, utilization of daylight

Overview and selection tools

... Continuation of the table

Type	N 543D31	N 543D51	N 523/03	N 501/01	UP 520/03	UP 520/13	RS 520/23	RL 521/23	UP 562532
Application program ¹⁾	9A0B01	9A0C01	980183	981701	982A01	982A01	982A01	982B01	20DE22
Output functions									
Max. number of group addresses	2000	2000	100	220	120	120	120	120	1600
Max. number of assignments	2000	2000	100	220	120	120	120	120	1600
Configurable behavior in the event of a bus voltage failure	■	■		■	■	■	■	■	■
Configurable behavior in the event of a bus voltage recovery	■	■		■	■	■	■	■	■
Configurable behavior in the event of a system voltage recovery				■					
Operating mode									
Automatic mode for sunlight tracking control	■	■		■	■	■	■	■	■
Manual mode	■	■		■	■	■	■	■	■
Standard mode	■	■	■	■	■	■	■	■	■
Status									
Transmitting status per channel	■	■	■	■	■	■	■	■	■
Indication of direct operation with status object	■	■		■				■	■
Status position of sun protection, 8-bit	■	■	■	■	■	■	■	■	■
Status position of slats, 8-bit	■	■		■	■	■	■	■	■
Scene control									
Integrated 1-bit scene control	■	■	■	■	■	■	■	■	
Integrated 8-bit scene control	■	■		■	■	■	■	■	■
Scenes to be integrated per channel	8	8	2	8	8	8	8	8	64
Shutter/blind control									
Travel lock (e. g. for cleaning the outer shutter/blinds)	■	■	■	■	■	■	■	■	■
Separate raising/lowering protection	■	■	■	■				■	■
Alarm									
• Move to safety position	■	■	■	■	■	■	■	■	■
• Locking in this position for as long as alarm is active	■	■	■	■	■	■	■	■	■
• Alarm check, wire break, alarm delayed	■	■	■	■	■	■	■	■	■
• Channels single lockable during alarm	■	■	■	■	■	■	■	■	■
Individual configuration of actuator channels	■	■	■	■	■	■	■	■	■
Shared configuration of actuator channels			■	■				■	■
Adaptation of objects and functions to drive type	■	■	■	■	■	■	■	■	■
Delay time adjustable	■	■							
Suitable for integration in a sunlight tracking control system	■	■		■	■	■	■	■	■
End position detection	■	■			■	■	■	■	■
Sun protection control (UP/DOWN)									
Using position data (8-bit value)	■	■		■	■	■	■	■	■
Travel to end position, stopping, stepwise adjustment	■	■	■	■	■	■	■	■	■
Slat control (OPEN/CLOSE)									
Using position data (8-bit value)	■	■		■	■	■	■	■	■
Travel to end position, stopping, stepwise adjustment	■	■		■	■	■	■	■	■
Step adjustable ²⁾	n	n		n	n	n	n	n	

¹⁾ For current application programs, see www.siemens.com/gamma-td

²⁾ n = number, % = %-value

Solar protection, anti-glare protection, utilization of daylight

Overview and selection tools

Load data for shutter/blind actuators per channel						
Type	N 543D31 N 543D51	N 501/01	N 523/03	RL 521/23	UP 520/03 UP520/13 RS 520/23	UP 562S32
Contact current						
Rated current [A]	6 (AC)	6 (AC)	6 (AC)	6 (AC)	6 (AC)	∑ 16 (AC) ¹⁾
AC3 operation (p.f. = 0.45)[VA]		200	200	500	500	∑ 1380 (AC) ¹⁾
Contact voltage						
Rated voltage [V]	AC 230	AC 230	AC 230	AC 230	AC 230	AC 230
Service life						
Mechanical service life Switching operations in millions	50	20	20	10	10	3
Electrical service life Switching operations in millions	0,1	0.1	0.1	0.1	0.1	
Power loss						
Maximum power loss per device at rated power [W]	7	7	3	5	3	
Switching capacities/load types, loads						
Resistive load [W]	1380	1380	1380	1380	1380	∑ 2500 ¹⁾
Minimum switching capacity [V/mA]	5/10	6/10	6/10	24/10	24/10	
DC switching capacity [V/A]	30/6	24/6	24/6	30/10	30/10	

¹⁾ The sum applies to both load outputs

For complete technical specifications, see: www.siemens.com/gamma-td

Solar protection, anti-glare protection, utilization of daylight

Anti-glare/solar protection actuators

Shutter/blind actuators

N 523/..

- Rated contact current 6 A
- LED for status indication per output
- Direct operation (local operation)
- Electrically interlocked relays (for reversing direction of rotation)
- Transmitting status per channel
- Status Position Sonnenschutz 8 Bit
- Travel lock (e. g. for cleaning the outer shutter/blinds)
- Alarm: Move to safety position, locking in this position for as long as alarm is active
- Individual or shared configuration of actuator channels
- Adaptation of objects and functions to drive type
- Sun protection control (up/down): travel to end position, stopping, stepwise adjustment
- Integrated bus coupling units
- Bus connection via bus terminal or contact system to data rail
- Modular installation devices for mounting on TH35 EN 60715 mounting rail



Roller shutter actuator, 4 x AC 230 V, 6 A

N 523/03

- 4 channels (one up and one down each)
- Rated contact voltage AC 230 V, 50 Hz
- Integrated 1-bit scene control, 2 Scenes to be integrated per channel
- Integrated power supply unit for the electronics, connected to AC 230 V
- Separate raising/lowering protection

Data sheet	A6V10416172
Dimensions (W x H x D)	90 x 72 x 60 mm
Dimension width (1 MW = 18 mm)	4 MW



6



Stock no.	Product no.
5WG1523-1AB03	N 523/03

Solar protection, anti-glare protection, utilization of daylight

Anti-glare/solar protection actuators

N 543D..1

Solar protection actuator



- For control of drives with a motor for AC 230 V
 - Electrically interlocked relays to reverse the direction of rotation
 - Rated contact operating voltage AC 230 V
 - Rated contact frequency: 50/60 Hz
 - Rated contact current: 6 A
 - Electronics for detection of the actuation of an electromechanical and electronic limit switches
 - Automatic travel time determination via current measurement
 - Per actuator channel direct operation function on the device for driving solar protection up/down, stop command and slat adjustment
 - Two status LEDs per actuator channel to indicate the direction of travel and an override
 - Button on the device front for deactivation of the direct mode operation and LED to indicate activation direct mode operation
 - Maintenance-free terminals for connection and through-wiring of untreated single-core, stranded or multi-core conductors, 0.5 ... 2.5 mm²
 - Two terminals per actuator channel for motor connection (up, down)
 - At least one phase connection terminal for two actuator channel each
 - Bus-powered electronics
 - Housing: plastic, color RAL 7035 (light grey), N-system
 - DIN rail mounted device for mounting on rail TH35 according to DIN EN 60715
 - Type of protection: IP 20
-
- Selectable operation mode blinds, shutter/awning, ventilation flap
 - Per actuator channel motion commands for moving and stopping the solar protection or for adjustment of blind slats
 - Per actuator channel direct movement to a position of the sunblind and the blind slats
 - Per actuator channel central movement of the solar protection in manual mode and automatic mode and delay time for Up / Down
 - Distinction between automatic and manual mode (position of the sunblind and blind slats) and adjustable behaviour in sunshine
 - Programming and recalling preset positions 1-4 and 8-bit scene control
 - Adjustable behaviour in case of override (wind, rain, frost, lock, forced position, forced control, range limitation)
 - Adjustable reverse pause time and delay times of the drives
 - Per actuator channel configurable state on bus voltage failure and start value on bus voltage recovery
 - Adjustable transmission of status objects (direct operation, automatic operation, curtain and slat position, travel, calibration travel time to end positions, overriding) on request, cyclically and/or upon change
 - Adjustable transmission time of the status objects after bus voltage recovery and transmission delay between the status objects
 - Surveillance of device function

Rated current

6 A

Solar protection, anti-glare protection, utilization of daylight

Anti-glare/solar protection actuators

Solar protection actuator, 4 x AC 230 V, 6 A, with end position detection

N 543D31

- DIN rail mounted device for mounting on rail TH35 according to DIN EN 60715
- all functions as N 543D..1

Data sheet A6V11986596
 Dimensions (W x H x D) 72 x 90 x 61 mm
 Dimension width (1 MW = 18 mm) 4 MW



Stock no.	Product no.
5WG1543-1DB31	N 543D31

6

Solar protection actuator, 8 x AC 230 V, 6 A, with end position detection

N 543D51

- DIN rail mounted device for mounting on rail TH35 according to DIN EN 60715
- all functions as N 543D..1

Data sheet A6V11986596
 Dimensions (W x H x D) 144 x 90 x 61 mm
 Dimension width (1 MW = 18 mm) 8 MW



Stock no.	Product no.
5WG1543-1DB51	N 543D51

Solar protection, anti-glare protection, utilization of daylight

Anti-glare/solar protection actuators

N 501/01



Combination blind actuator, 4 x AC 230 V, 6 A, 8 x binary inputs

- 8 inputs for DC or AC in the range from 12 to 230 V
- 8 relay contact outputs locked in pairs against each other for controlling 4 x AC 230 V sunblind drives
- Contact rated voltage AC 230 V
- Contact rated current 6 A, p.f. = 1
- Electronics powered by a AC 230 V integrated power supply
- Device functional even without bus connection or if the bus communication fails
- Preset on delivery for direct output control for each blind button function via momentary contact switches connected to the inputs
- Key for switching between bus and direct mode
- Button for each relay contact output, for switching the output in direct mode
- Selectable function for each input when using the ETS:
 - Switching status, send binary value
 - Switching on leading edge, switching Short/Long
 - 1-pushbutton dimming, sunblind control, group control
 - 1-bit/8-bit scene control
 - 8-bit/16-bit value leading edge, Short/Long
 - 16-bit floating point value leading edge, Short/Long
- Or for each pair of inputs:
 - Acting directly on the corresponding outputs as blind button
 - 2-button dimming with stop telegram or with cyclical sending
 - 2-pushbutton sunblind control
- Selectable blocking of each input via a corresponding blocking object
- Sending of input objects after change
- Selectable cyclical input object sending
- Individual or shared configuration of actuator channels
- Communication objects for each blind channel for driving the sun protection into the end positions or for stopping the procedure and adjusting the blind slats in steps
- Communication objects for setting position of slats and blinds in percentage information
- Automatic opening of the blind slats to a preconfigured nominal setting after uninterrupted driving down of the blind from the top to the bottom end position, with integrated 1-bit scene control for storing and calling up (reproduction) of 2 interim blind and slat settings
- Integrated 1-bit/8-bit scene control, 8 scenes can be integrated per channel
- Optional "Sun" object for integration in a sunlight tracking control system
- Differentiation between automatic and manual mode and with automatic switchover from automatic to manual mode for the channel in question by pressing a bus button for manual control of the corresponding sun protection
- Manual mode taking precedence over automatic position commands
- Optional central command for each device or each channel for switching the relevant channels to automatic mode and driving the sun protection into the up or down end position
- Alarm: move to safety position, Locking in this position for as long as alarm is active
- Travel lock (e. g. for cleaning the outer shutter/blinds)
- Status objects for each channel for querying or for automatic sending of sun protection and slat settings as a percentage value
- Optional status objects for reporting that the up or down position has been reached
- Integrated bus coupling unit, Bus connection via bus terminal or contact system to data rail
- Modular installation devices for mounting on TH35 EN 60715 mounting rail

Data sheet	A6V10416147
Rated voltage	AC 230 V
Rated current	6 A
Number of channels	4
Number of inputs potentialfree	8
Dimensions (W x H x D)	90 x 144 x 60 mm
Dimension width (1 MW = 18 mm)	8 MW

Stock no.	Product no.
5WG1501-1AB01	N 501/01

Solar protection, anti-glare protection, utilization of daylight

Anti-glare/solar protection actuators

Shutter Blind Actuator, 1 x AC 120 V, 6 A

JB 520C23



- 1 channel
 - Electrically interlocked relays to reverse the direction of rotation
 - Integrated electronics for detection of the actuation of an electromechanical limit switch and with auto-calibration of the travel time from one limit switch to the other
 - Bus-powered electronics
 - Integrated bus coupling unit, Bus connection via bus terminal block
 - Type of protection: IP 20
 - For control of sun protection, door or window drive with a motor for AC 120 V and electromechanical or electronic limit switches per actuator channel
 - Relay contacts rated for nominal voltage AC 120 V, 6 A (resistive load)
 - As built-in device with 1/2 inch thread connection for mounting to or in a UL/NEMA Junction Box with feedthrough of the function wires through the 1/2 inch threaded connector
-
- Configurable behavior in the event of a bus voltage failure/recovery
 - Automatic mode for sunlight tracking control
 - Manual and standard mode
 - Status: Transmitting status per channel, status position of sun protection, 8-bit, status position of slats, 8-bit
 - Integrated 1-bit/8-bit scene control
 - 8 scenes to be integrated per channel
 - Travel lock (e. g. for cleaning the outer shutter/blinds)
 - Separate raising/lowering protection
 - Alarm (Wind, Rain, Frost): Move to safety position, locking in this position for as long as alarm is active
 - Individual configuration of actuator channels
 - Adaptation of objects and functions to drive type
 - Suitable for integration in a sunlight tracking control system
 - End position detection
 - Using position data (8-bit value) for sun protection control (up/down) and slat control (open/closed)

Data sheet A6V11786009
 Dimensions (W x H x D) 70 x 90 x 44.6 mm

Stock no.	Product no.
5WG1520-4CB23	JB 520C23

Solar protection, anti-glare protection, utilization of daylight

Anti-glare/solar protection actuators

UP 562S32



Switch/solar protection actuator 2 x AC 230 V, Σ 16 A

- One relay contact per output
- Rated contact operating voltage: AC 230 V
- Rated contact frequency: 50/60 Hz
- Rated contact current: Σ 16 A
- Screw terminals for connection of untreated single-core conductors, stranded without conductor sleeve 0.5 to 4 mm², stranded with conductor sleeve 0.5 to 2.5 mm²
- 3 binary inputs for potential-free contacts, determination of switching status via voltage generated in the device
- Poll voltage of the inputs: approx. 5 V
- Max. 10 m length of connecting cables, preferably J-Y(St)Y, pre-assembled YY6x0.6
- Bus-powered electronics
- Integrated bus coupling unit
- Mounting in appliance boxes according to DIN 49073 or in mounting case M 592/01 (accessories)
- KNX Data Secure compatible
- Updateable with Siemens Firmware Download Tool
- Adjustable functions per switching output: status feedback, adjustable as NO or NC contact, cyclical monitoring, adjustable switch-on and switch-off delay, staircase function, scene control, logic operations, operating hours counting, disabling function or forced control, central switching function
- Adjustable functions of solar protection channel: adjustable operating modes: venetian blind with slats, shutter/awning, venting louver/roof window, direct movement to a position of the sunblind and the slats, status feedback, adjustable behaviour in case of alarm (wind, rain, frost), adjustable solar protection or heating/cooling automatic, scene control, disabling function, forced control
- Adjustable preferred position after download, in case of bus voltage failure and recovery
- Adjustable functions of each input: switching, dimming, colour temperature control, solar protection control, sending values, scene control, pair of inputs operation, controller extension (operating mode switchover, presence function, setpoint shift), adjustable debounce time, locking of each input
- 8 logic functions

Data sheet

A6V12632892

Dimensions (W x H x D)

48 x 50 x 28 mm

Stock no.

Product no.

5WG1562-2SB32

UP 562S32

Accessories for UP 5..S32

M 592/01



Mounting case

- One mounting location for a flush-mounted actuator type UP 511S32, UP 562S32 or UP 525S32
- Separate wiring space and strain relief for function wiring
- Housing for mounting on DIN rail TH35 DIN EN 60715
- Housing with screw fastening for installation in cable ducts, under raised floors or for surface mounting under a ceiling
- Housing: plastic
- Type of protection: IP 20

Dimensions (W x H x D)

97 x 53 x 36 mm

Stock no.

Product no.

5WG1592-8AB01

M 592/01

Solar protection, anti-glare protection, utilization of daylight

Anti-glare/solar protection actuators

Shutter Blind Actuator, 2 x AC 230 V, 6 A

RL 521/23



- 2 channels
 - Electrically interlocked relays to reverse the direction of rotation
 - Integrated electronics for detection of the actuation of an electromechanical limit switch and with auto-calibration of the travel time from one limit switch to the other
 - Bus-powered electronics
 - Integrated bus coupling units, bus connection via bus terminal
 - Type of protection: IP 20
 - For the separate control per actuator channel of a sun protection, damper, door or window drive with a motor for AC 230 V and electromechanical limit switches
 - Screw-less terminals for connection and through-wiring of untreated single-core, stranded or multi-core conductors, 0.5 ... 2.5 mm²
 - For mounting in AP 118 automation module box or AP 641 room control box
-
- Communication objects per actuator channel for moving the sun protection to limit positions or to stop travel and for step-by-step adjustment of blind slats
 - Communication objects for moving the sun protection and adjusting blind slats directly to a new position by positioning commands as percentage values
 - Automatic opening of blind slats up to a set position after the blinds have been lowered without any stop from upper to lower limit position
 - Integrated 1-bit scene control for programming/recalling of 2 favored positions of blind and slats
 - Integrated 8-bit scene control and assignment of up to 8 scenes per channel
 - An optional object "Sunshine" for activation/deactivation of sunlight tracking of the slats for shading with greatest possible daylight component
 - Differentiation between automatic and manual mode and with automatic switch-over from automatic to manual mode of the respective actuator channel on activation of a bus pushbutton for manual control of the sun blind
 - Priority of manual mode over automatic positioning commands
 - Optional central command object for switching-over of all actuator channels to automatic mode and for moving the sun blinds to the upper or lower limit position
 - Alarm object wind/rain/frost per channel for moving the sun protection to the configured safety position in the event of an alarm and with blocking of travel to another position as long as alarm pending
 - Travel blocking object per device or per channel for blocking the sun protection in its current position (e.g. during cleaning of an outdoor Venetian blind)
 - Status objects per actuator channel for query or automatic transmission of sun blind and slat position as percentage values
 - Optional status objects for signalling that the lower or upper limit position has been reached

The AP 641 room control box and AP 118 automation module box must be ordered separately. See chapter Modular Installation System - Room control box - Module boxes.

Data sheet	A6V10416169
Rated voltage	AC 230 V
Rated current	6 A
Number of channels	2
Dimensions (W x H x D)	47.8 x 86.5 x 36.2 mm

Stock no.	Product no.
5WG1521-4AB23	RL 521/23

Solar protection, anti-glare protection, utilization of daylight

Anti-glare/solar protection actuators

JB 521C23



Shutter Blind Actuator, 2 x AC 120 V, 6 A

- 2 channels
- Electrically interlocked relays to reverse the direction of rotation
- Integrated electronics for detection of the actuation of an electromechanical limit switch and with auto-calibration of the travel time from one limit switch to the other
- Bus-powered electronics
- Integrated bus coupling units, bus connection via bus terminal
- Type of protection: IP 20
- For separate control of a sun protection, door or window drive with a motor for AC 120 V and electromechanical or electronic limit switches per actuator channel
- Relay contacts rated for AC 120 V, 6 A (resistive load)
- As built-in device with 1/2 inch thread connection for mounting to or in a UL/NEMA Junction Box with feedthrough of the function wires through the 1/2 inch threaded connector
- Communication objects per actuator channel for moving the sun protection to limit positions or to stop travel and for step-by-step adjustment of blind slats
- Communication objects for moving the sun protection and adjusting blind slats directly to a new position by positioning commands as percentage values
- Automatic opening of blind slats up to a set position after the blinds have been lowered without any stop from upper to lower limit position
- Integrated 1-bit scene control for programming/recalling of 2 favored positions of blind and slats
- Integrated 8-bit scene control and assignment of up to 8 scenes per channel
- An optional object "Sunshine" for activation/deactivation of sunlight tracking of the slats for shading with greatest possible daylight component
- Differentiation between automatic and manual mode and with automatic switch-over from automatic to manual mode of the respective actuator channel on activation of a bus pushbutton for manual control of the sun blind
- Priority of manual mode over automatic positioning commands
- Optional central command object for switching-over of all actuator channels to automatic mode and for moving the sun blinds to the upper or lower limit position
- Alarm object wind/rain/frost per channel for moving the sun protection to the configured safety position in the event of an alarm and with blocking of travel to another position as long as alarm pending
- Travel blocking object per device or per channel for blocking the sun protection in its current position (e.g. during cleaning of an outdoor Venetian blind)
- Status objects per actuator channel for query or automatic transmission of sun blind and slat position as percentage values
- Optional status objects for signalling that the lower or upper limit position has been reached

Data sheet

A6V11786010

Dimensions (W x H x D)

70 x 90 x 44.6 mm

Stock no.

Product no.

5WG1521-4CB23

JB 521C23

Solar protection, anti-glare protection, utilization of daylight

Anti-glare/solar protection actuators

Shutter Blind Actuator RS, 1 x AC 230 V, 6 A

RS 520/23



- 1 channel
 - Electrically interlocked relays to reverse the direction of rotation
 - Integrated electronics for detection of the actuation of an electromechanical limit switch and with auto-calibration of the travel time from one limit switch to the other
 - Bus-powered electronics
 - Integrated bus coupling unit, Bus connection via bus terminal block
 - Type of protection: IP 20
 - For the separate control per actuator channel of a sun protection, damper, door or window drive with a motor for AC 230 V and electromechanical limit switches
 - Screw-less terminals for connection and through-wiring of untreated single-core, stranded or multi-core conductors, 0.5 ... 2.5 mm²
 - With bus connection module
 - Modular installation device for mounting in AP 118 automation module box or AP 641 room control box
- Configurable behavior in the event of a bus voltage failure/recovery
 - Automatic mode for sunlight tracking control
 - Manual and standard mode
 - Status: Transmitting status per channel, status position of sun protection, 8-bit, status position of slats, 8-bit
 - Integrated 1-bit/8-bit scene control
 - 8 scenes to be integrated per channel
 - Travel lock (e. g. for cleaning the outer shutter/blinds)
 - Separate raising/lowering protection
 - Alarm (Wind, Rain, Frost): Move to safety position, locking in this position for as long as alarm is active
 - Individual configuration of actuator channels
 - Adaptation of objects and functions to drive type
 - Suitable for integration in a sunlight tracking control system
 - End position detection
 - Using position data (8-bit value) for sun protection control (up/down) and slat control (open/closed)

The AP 641 room control box and AP 118 automation module box must be ordered separately.
See chapter Modular Installation System - Room control box - Module boxes.

Data sheet	A6V10416164
Rated voltage	AC 230 V
Rated current	6 A
Number of channels	1
Dimensions (W x H x D)	50.2 x 48.8 x 35.5 mm

Stock no.	Product no.
5WG1520-2AB23	RS 520/23

Solar protection, anti-glare protection, utilization of daylight

Anti-glare/solar protection actuators

UP 520/..3



Shutter Blind Actuator, 1 x AC 230 V, 6 A

- Electrically interlocked relays (drive protection)
- End position detection
- Screwless terminals for connection and through-wiring of untreated single-core, stranded or multi-core conductors, 0.5...2.5mm²
- Bus-powered electronics
- Integrated bus coupling units, bus connection via bus terminal
- For insertion in flush-mounting switch and socket boxes 60 mm in diameter and 60 mm deep
- Configurable behavior in the event of a bus voltage failure and recovery
- Automatic mode for sunlight tracking control
- Manual or standard mode
- Status: transmitting status per channel, status position of sun protection 8-bit, status position of slats 8-bit
- Integrated 1-/8-bit scene control
- 8 scenes to be integrated per channel
- Travel lock (e. g. for cleaning the outer shutter/blinds)
- Separate raising/lowering protection
- Alarm (Wind, Rain, Frost): Move to safety position, locking in this position for as long as alarm is active
- Individual or shared configuration of actuator channels
- Adaptation of objects and functions to drive type
- Suitable for integration in a sunlight tracking control system
- Using position data (8-bit value) travel to end position, stopping, stepwise adjustment sun protection control (up/down) and Slat control (open/closed)

Range overview UP 520/..3

Product Title	Dimensions (WxHxD) [mm]	Stock no.	Product no.
Shutter Blind Actuator, 1 x AC 230 V, 6 A, with mounting frame and BTI interface	71 x 71 x 42	5WG1520-2AB03	UP 520/03
Shutter Blind Actuator UP, 1 x AC 230 V, 6 A	50 x 50.9 x 41.3	5WG1520-2AB13	UP 520/13

RS 520/23, RL 521/23: The AP 641 room control box and AP 118 automation module box must be ordered separately. See Chapter Quick-Assembly System, Room Control Box.

Solar protection, anti-glare protection, utilization of daylight Central weather/solar protection systems

Weather-/sun station

AP 257/..2



- Receiver for GPS time signal
- Input the assembly location by selecting country and city or by stating the GPS longitude/latitude coordinates
- Transmission and receipt of date and time over bus
- Transmission of all measured values via bus
- Functions:
 - Monitoring of all measured values up to 3 limit values each
 - Sensor monitoring
 - Sunlight tracking control
 - Shadow outline tracking
 - Central command for activation/deactivation of sun protection at the start and end of sunshine
 - 4 AND operations
 - 4 OR operations
 - 8 OR operations for alarm/fault indications
 - Blocking function for window cleaning tasks
 - Safety/alarm objects
- LED for the display of GPS reception
- Heated sensor for measuring wind speed without mechanically moved parts, measuring range at least 0...35 m/s
- Brightness sensor, measuring range min. 0...150 klx
- Dusk detection, measuring range min. 0...1000 lx
- Outdoor temperature sensor, measuring range min. -35...+80 °C
- Integrated bus coupling units
- Bus connection via bus terminal

Data sheet

A6V10416520

Range overview AP 257/..2

Product Title	Dimensions (WxHxD) [mm]	Stock no.	Product no.
Weather center (GPS), 8 facade sectors, sun tracking	96 x 77 x 118	5WG1257-3AB22	AP 257/22

Accessories for AP 257/..2

Product Title	Stock no.	Product no.
Electronic power supply unit, 350 mA	4AC2402	4AC2402

6

Solar protection, anti-glare protection, utilization of daylight

Central weather/solar protection systems

AP 257/51



Weather station

- Sensor for measuring wind speed, measuring range 2-30 m/s
- Three independent brightness sensors, measuring range 1-100 kLux
- Consideration of up to two external brightness sensors
- Outdoor temperature sensor, measuring range -30 ... +60°C
- Transmission of all measurement readings via the bus
- Monitoring of all measurement readings
- Consideration of the alignment of up to 3 facades and automatic activation / deactivation of the solar protection of a facade during the time in which the sun shines on the respective facade
- Safety alarm for deactivating the solar protection, initiated by an external safety object or by logical AND/ OR operations of the measured weather data
- 4 threshold switches, independant of the weather data, each with 2 output objects
- 6 logical AND, OR or XOR operations, independant of the whether data, of respectively up to 4 input objects and each with 2 output objects
- Integrated bus coupling unit, bus connection via a bus terminal block
- As a compact unit for mast or wall mounting, including mast fixture for diameter 48-60 mm

Data sheet

A6V11418967

Dimensions (W x H x D)

121 x 108 x 227 mm

Stock no.

Product no.

5WG1257-3AB51

AP 257/51

AP 257/61



Weather station

- Sensor for measuring wind speed, measuring range 2-30 m/s
- Three independent brightness sensors, measuring range 1-100000 Lux
- Consideration of up to two external brightness sensors
- Outdoor temperature sensor, measuring range -30 ... +60°C
- Heated precipitation sensor
- Transmission of date and time via the bus
- Transmission of GPS position via the bus
- Transmission of all measurement readings via the bus
- Monitoring of all measurement readings
- Input of the geographical location of the installation site via the entry of longitude and latitude or automatic detection via GPS
- Calculation and transmission of the angle data (azimuth and elevation) for current position of the sun
- Consideration of the alignment of up to 8 facades and automatic activation / deactivation of the solar protection of a facade during the time in which the sun shines on the respective facade
- Sun tracking control of the slats position for solar protection, so that no direct sunshine, but as much diffuse daylight as possible reaches the room
- Safety alarm for deactivating the solar protection, initiated by an external safety object or by logical AND/ OR operations of the measured weather data
- 4 threshold switches, independant of the weather data, each with 2 output objects
- 6 logical AND, OR or XOR operations, independant of the weather data, of respectively up to 4 input objects and each with 2 output objects
- External power supply of the heating for the precipitation sensor via 24 V DC, 210 mA
- Feed of the additional auxiliary power supply via the white / yellow twisted pair of the bus cable
- Integrated bus coupling unit, bus connection via a bus terminal block
- Compact unit for mast or wall mounting, including mast fixture for diameter 48-60 mm

Data sheet

A6V11418967

Dimensions (W x H x D)

121 x 108 x 227 mm

Stock no.

Product no.

5WG1257-3AB61

AP 257/61

Heating, ventilation and air conditioning - room temperature control



Overview and selection tools		202
Room thermostats	Flush-mounted	213
	Wall-mounted	216
Room temperature controllers with integrated sensing and operation	Flush-mounted	224
	Wall-mounted	228
Room temperature controllers with integrated sensing	i-system	238
	Wall-mounted	242
Room temperature controllers with detached operation	RXB	248
	Accessories for RXB..	250
Room sensors with KNX	i-system	252
	DELTA style	253
	GAMMA arina	254
Room sensors without KNX	i-system	255
	Wall-mounted	256
Actuators with KNX	Electromotive valve actuators	258
	Damper and rotary actuators	259
Actuators without KNX	Electrothermal valve actuators	263
	Electromotoric valve actuators	265
Other products	Central control unit RMB795B-1	267
	Window contacts	268
	Outside temperature sensors	269
	Condensation monitors	271

Heating, ventilation and air conditioning - room temperature control

Overview and selection tools

KNX room temperature controllers, sensors and actuators

The following table describes the different device categories for room temperature control with the corresponding device families. For each category it shows the covered functions (sensing, operation, display, control, actuating) and the interfaces to other categories. It is shown which device combinations are necessary or possible to implement a full room temperature control solution and serves as first step of device selection. More detailed differences between and within the device categories are described in the technical overviews and product descriptions on the following pages.

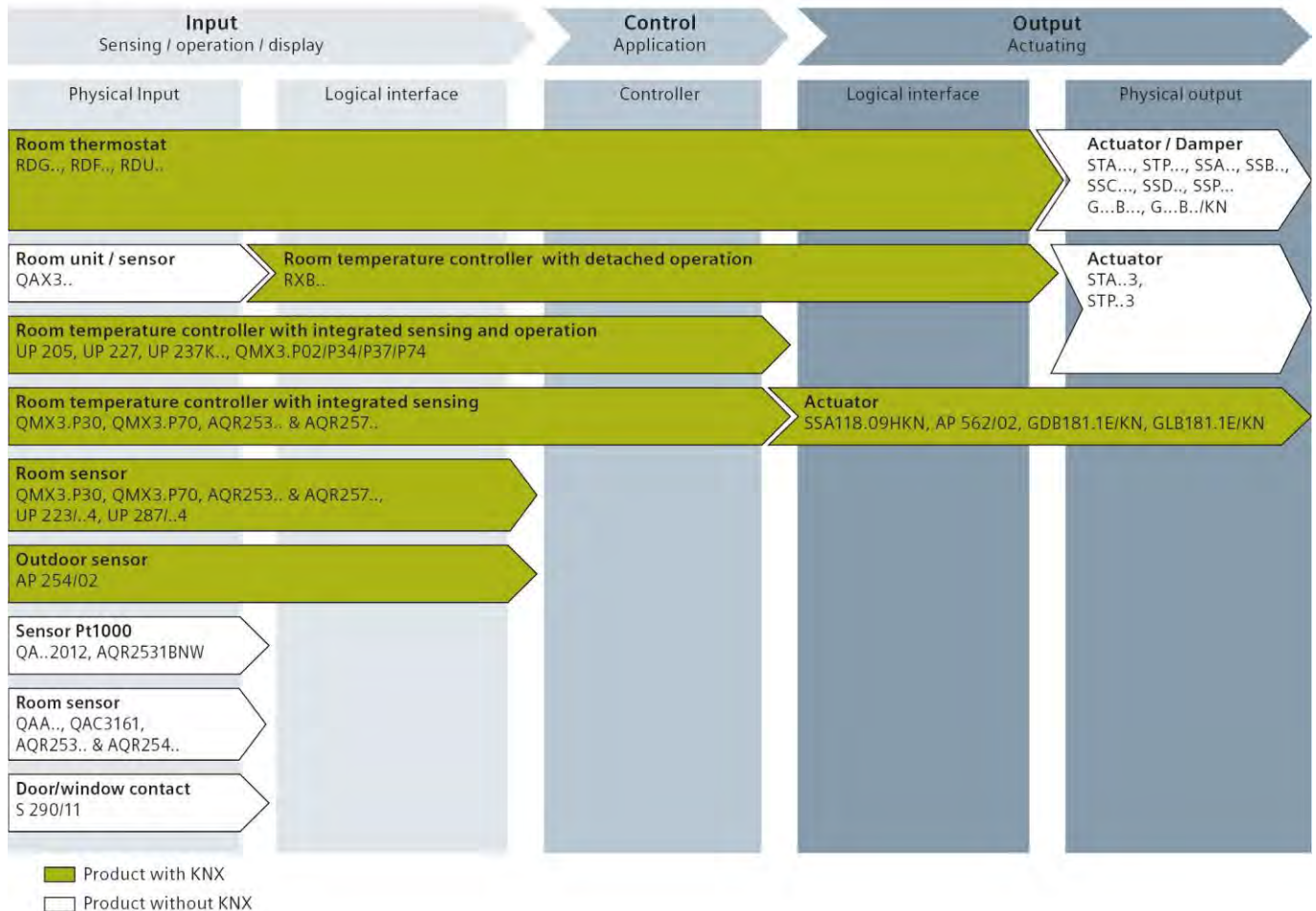

7

Heating, ventilation and air conditioning - room temperature control

Overview and selection tools

Overview room temperature controllers

Room thermostats	RDG200KN..., RDG260KN..., RDG204KN, RDG264KN, RDG405KN, RDF600KN..., RDF600KN/S, RDF800KN..., RDF870KN
Room temperature controllers with integrated sensing and operation	UP 205/21, UP 227, UP 237K, QMX3.P34, QMX3.P44, QMX3.P74, QMX3.P02, QMX3.P37
Room temperature controllers with integrated sensing	QMX3.P30, QMX3.P40, QMX3.P70, AQR253.. & AQR257..
Room temperature controllers w/ detached operation	RXB21..., RXB22..., RXB24..., RXB39..

Room temperature controllers

	Room thermostats	Room temperature controllers with integrated sensing and operation	Room temperature controllers with integrated sensing	Room temperature controllers with detached operation
Application				
Fancoil	RDF.., RDG2..	UP 205/21, UP 227	-	RXB21..., RXB22..., RXB39..
Radiator	RDG2..	All	All	RXB24..
Chilled / heated ceiling	RDG2..., RDF800KN...	UP 205/21, UP 227, UP 237K	-	RXB24..
Floor heating	RDG2..	All	All	RXB24..
Heat pump	RDF.., RDG2..	UP 205/21, UP 227, UP 237K	-	-
VAV	RDG405KN	-	-	-
Fresh air / Ventilation	RDF870KN	UP 205/21		
Sensing				
Temperature	All	All	All	-
Air Quality (PM2.5, CO ₂ , VOC)	RDG405KN ¹⁾ , RDF870KN ²⁾ , RDG2..4KN	QMX3.P74	QMX3.P70, AQR253.. & AQR257..	-
Relative humidity	RDG200KN..., RDG260KN..., RDF870KN ²⁾	QMX3.P44, QMX3.P74	QMX3.P40, QMX3.P70, AQR253.. & AQR257..	-
Display & Operation				
Display	All	All	-	-
Touch operation	RDF800KN	UP 205/21	-	-
Rotary wheel for setpoint setting	RDG..	UP 237K		
Push buttons	RDF..	QMX3.P02, QMX3.P37, UP 227, UP 237K	-	-
Installation				
Flush mounted	RDF..	UP 205/21, UP 227, UP 237K	AQR253.. & AQR257..	-
Fit to Delta line / miro	-	UP 227, UP 237K	AQR253.. & AQR257..	-
Wall mounted	RDG..	QMX3..	QMX3..	-
DIN-rail	-	-	-	All

¹⁾ IAQ control with RDG405KN needs an external CO₂/VOC sensor

²⁾ PM_{2.5} and CO₂ control with RDF870KN needs either external PM_{2.5} and CO₂ sensors or values via bus

Heating, ventilation and air conditioning - room temperature control

Overview and selection tools

Central collection of heating and cooling demands from rooms

The central control unit RMB795B-1 collects the heating and cooling demands from different devices/room controllers and forwards the calculated demands to the primary controller (producer).

The RMB795B-1 further supplies the room controllers with the following information:

- Time controlled operating mode for room groups
- Room group set points
- Adjustment of the room groups set point
- Emergency and application operating modes
- Device monitoring

Note:

The KNX room controllers must be able to send every 15 minutes a 1-Byte control or request signal on the bus.

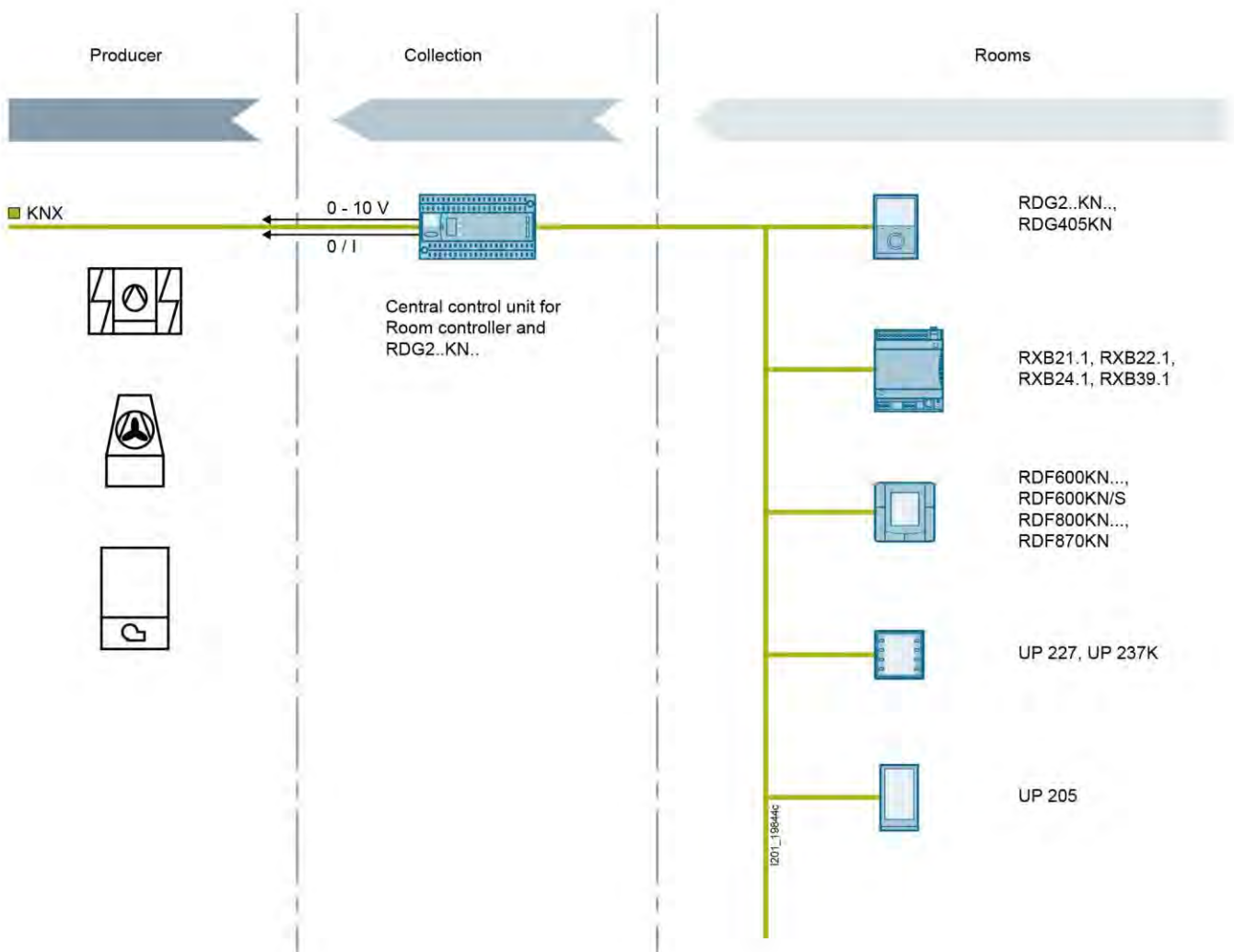









7

Heating, ventilation and air conditioning - room temperature control

Overview and selection tools

Room thermostats

									
Type	RDF600KN...	RDF600KN/S	RDF800KN...	RDF870KN	RDG200KN	RDG204KN	RDG260KN	RDG264KN	RDG405KN
Design									
Wall mounted					■	■	■	■	■
Flush Mounted	■	■	■	■					
For VDE box	■	■	■	■					
For British Standard box	■	■	■	■					
Housing									
Digital display	■	■	■	■	■	■	■	■	■
Touch Screen Display			★	■					
Setpoint knob					■	■	■	■	■
Operating mode button	■	■			■	■	■	■	■
Fan speed button	■	■			■	■	■	■	■
Green Leaf					■	■	■	■	
Buttons for light and blind control		★							
Bus connection									
Integrated bus coupling units	■	■	■	■	■	■	■	■	■
Power supply									
Terminal voltage AC 230 V	■	■	■	■	■	■			
Terminal voltage AC 24 V					■	■	■	■	■
Integrated sensor									
Room temperature sensor	■	■	■	■	■	■	■	■	■
Humidity sensor					■	■	■	■	
CO2 sensor						★		★	
Inputs									
Multifunctional inputs digital/analog	2	2	2	2	3	3	3	3	2
Input DC 0...10 V				■					1
Outputs									
ON/OFF (PWM) Triac (H/K)					★	★			■
ON/OFF Relay (H/C)	★	★	■				■	■	
Analog outputs DC 0...10 V (H/K)							★	★	■
3-stage Relay (fan)	■	■	■	■ ¹⁾	■	■	■	■	■
Analog DC 0...10 V (fan)				■	■	■	■	■	
Applications									
Fancoil 2-/4-pipe with/without electrical heater	■	■	■		■	■	■	■	
Fancoil with Radiator					■	■	■	■	
Heating / Cooling 2-/4-pipe			■		■	■	■	■	
Heating / Cooling with 6-port ball valve							★	★	
Humidity control					■	■	■	■	
Indoor Air Quality				★ ²⁾		★		★	■
Heat Pump System	■	■	■				■	■	
VAV with electrical heater and radiator / Heat-Cool coil									■
Functionalities									
2-position control	■	■	■	■ ⁵⁾	■	■	■	■	■
Modulating control	■ ³⁾	■ ³⁾	■ ³⁾	■ ⁵⁾	■	■	■	■	■
2-stage control sequence for heating or cooling	■ ⁴⁾	■ ⁴⁾	■ ⁴⁾		■	■	■	■	
Operating mode									
Comfort, Economy, Protection	■	■	■	■ ⁵⁾	■	■	■	■	■
Manual / Auto operating mode	■	■	■	■ ⁵⁾	■	■	■	■	■

¹⁾ available for 1-/3-/4-stage Relay (fan) ²⁾ PM2.5 or CO₂ or both controls plus display VOC ³⁾ modulating output only for 2-pipe applications ⁴⁾ only for 2-stage heating ⁵⁾ only fan control functions

■ valid for all variants ★ main feature

Heating, ventilation and air conditioning - room temperature control

Overview and selection tools

Room temperature controllers with integrated sensing and operation								
Type	 UP 237K	 UP 227	 UP 205/21	 QMX3.P34	 QMX3.P44	 QMX3.P74	 QMX3.P02	 QMX3.P37
Mounting								
Wall mounted				■	■	■	■	■
Flush mounted	■ ¹⁾	■ ¹⁾	■					
Display-/operating elements								
Display		■	■	■	■	■		■
Capacitive buttons		■					■	■
Rotary/push-button, Setpoint rotary wheel	■							
LED indicators per button							■	■
LED indicators central	■ ²⁾	■	■					
Proximity sensor			■					
Sensors								
Temperature	■	■	■	■	■	■	■	■
Humidity					■	■		
Air quality CO ₂						■		
Bus interface								
- Integrated bus coupling unit		■	■	■	■	■	■	■
- Separate bus coupling unit	■							
Power supply								
- KNX bus voltage	■	■	■	■	■	■	■	■
- Additional power supply DC 24 V			■					
Functionalities								
Switching ON/OFF/OVER		■	■				■	■
Pushbutton function (bell function)		■						
Dimming		■	■				■	■
Send Values								
- 8 bit/value			■					
- 8 bit/percent		■	■				■	■
- 16 bit		■						
- Brightness value		■						
- Temperature value		■	■					
- Wind speed value		■						
Display value								
- 1 bit		■						
- 8 bit/percent/16 bit		■						
- Brightness value		■	■					
- Temperature value		■	■	■	■	■		■
- Humidity value			■					
- Air Quality (PM2.5, PM10, VOC, CO2, AQI)			■					
- Wind speed value		■	■					
- Metering values			■					
- Text messages		■						
Alarmhandling		■	■					
Forced control		■	■					
Shutter-/blind control		■	■				■	■
Call and save scene, 1 bit		■						
Call and save scene, 8 bit		■	■				■	■
Button deactivation		■		■	■	■		■
Deactivation of the display via password protection			■					
Time switch schedules		■	■					

¹⁾ Design line i-system²⁾ Display operating modes, manual mode, heating/cooling, alarms

Heating, ventilation and air conditioning - room temperature control

Overview and selection tools

Room temperature controllers with integrated sensing and operation









Type	 UP 237K	 UP 227	 UP 205/21	 QMX3.P34	 QMX3.P44	 QMX3.P74	 QMX3.P02	 QMX3.P37
Room temperature controller functionality								
Setpoint value setting, absolute	■	■	■	■	■	■		■
Setpoint value shifting	■	■	■	■	■	■		■
Setting operating modes	■	■	■	■	■	■		■
Setting comfort prolongation	■	■	■	■	■	■		■
Heating/Cooling	■	■	■	■	■	■		■
Two-point control	■	■	■	■	■	■		■
Continuous control	■	■	■	■	■	■		■
Two-level heating and cooling (sequenz)	■	■		■	■	■		■
Applications								
Radiator	■	■	■	■	■	■	■	■
Underfloor heating	■	■	■	■	■	■	■	■
Fancoil		■	■					
Threshold control for humidity				■	■	■	■	■
Threshold control for air quality			■	■	■	■	■	■

¹⁾ Design line i-system

²⁾ Display operating modes, manual mode, heating/cooling, alarms

Heating, ventilation and air conditioning - room temperature control

Overview and selection tools

Room temperature controllers with integrated sensing										
Basic module + Front module Type										
Design										
Wall mounted	■	■	■							
Flush mounted				■	■	■	■	■	■	■
Display / operating										
Air quality indication on LED			■							■
Sensor										
Temperature	■	■	■	■	■		■	■	■	■
Humidity		■	■		■			■	■	■
Air quality CO ₂			■			■	■	■	■	■
Bus interface										
Integrated bus coupling unit	■	■	■	■	■	■	■	■	■	■
Controlling										
Controller enable /disable	■	■	■	■	■	■	■	■	■	■
PID controller for heating and/or cooling	■	■	■	■	■		■	■	■	■
Threshold controller for humidity	■	■	■		■			■	■	■
Threshold controller for air quality	■	■	■			■	■	■	■	■
Input										
Passive Temperature NTC 10k				■	■	■	■	■	■	■
Two potential-free contacts				■	■	■	■	■	■	■

7

Heating, ventilation and air conditioning - room temperature control

Overview and selection tools





Fields of application

The scope of RXB is defined by the preprogrammed application software. The following pages provide an overview of the options and the corresponding devices, divided into different areas of application. The devices are supplied preprogrammed with the applications. The required application can be selected by means of the ETS, Synco™ tool or the Handy tool QAX34.3.

Due to the fact that the applications are predefined, engineering simply involves the definition of a small number of parameters, e. g.:







- PWM or 3-position control of the valves and actuators
- Temperature setpoints
- Manual or automatic fan control
- Room operating units QAX3.. or UP2... / QMX3.P34 via KNX

Room temperature controllers with detached operation

	 RXB21.1/ FC-10	 RXB21.1/ FC-11	 RXB22.1/ FC-12	 RXB24.1/ CC-02	 RXB39.1/ FC-13
Type					
Applications					
FNC02: Two-pipe system with change-over	■				■
FNC03: Two-pipe system with change-over and electric heater			■		■
FNC04: Four-pipe system	■				■
FNC05: Four-pipe system with electric heater			■		
FNC08: Four-pipe system with room supply air cascade control	■				■
FNC10: Two-pipe system with change-over outside air damper		■			
FNC12: 4-pipe system with outside air damper		■			
FNC18: Two-pipe system with change-over and radiator		■			
FNC20: Four-pipe system with control of a single damper	■				
CLC01: Chilled ceiling				■	
CLC02: Chilled ceiling and radiator, dew point monitoring, Radiator with downdraft compensation				■	
RAD01: Radiator with downdraft compensation				■	
Functionality					
Temperature setpoints, 4 operating modes Comfort, Pre-Comfort, Economy, Protection	■	■	■	■	■
Digital inputs for window contact, presence detector, dew point sensor	2	2	2	2	
Analog Input for optional LG-Ni 1000 temperature sensor	1	1	1	1	1
3-speed fan control	■	■	■		
Continuous fan control 0-10 V (EC fan motor)					■
PWM valve actuator control	■	■	■	■	
3-Position valve actuator control	■	■	■	■	
KNX valve actuator control	■	■	■	■	■
Motoric 0-10 V valve actuator control					■
Electric reheater control		■			■
Room unit range QAX.. over PPS2 Interface with temperature sensor, set-point adjustment, Standby/Auto/Fan switch, display	■	■	■	■	■
Room units via KNX (UP2.../QMX3.P34)	■	■	■	■	■
Parameterization of applications over handy tool QAX34.3	■	■	■	■	■
Power supply	AC 230 V	AC 230 V	AC 230 V	AC 230 V	AC 230 V

Heating, ventilation and air conditioning - room temperature control

Overview and selection tools

Damper and rotary actuators						
						
	Actuators for air volume controllers 300 Pa operating range		Rotary actuators for ball valves		Rotary actuators for air dampers	
Type	GDB181.1E/KN	GLB181.1E/KN	GDB111.9E/KN	GLB111.9E/KN	GDB111.1E/KN	GLB111.1E/KN
	GDB 300 Pa VAV compact controller 5 Nm for approx. 0.8 m ² damper area 150 s running time	GLB 300 Pa VAV compact controller 10 Nm for approx. 1.5 m ² damper area 150 s running time	GDB Rotary actuator for 2-port, 3-port and 6-port control ball valves up to DN 25 5 Nm 150 s running time	GLB Rotary actuator for 2-port, 3-port and 6-port control ball valves up to DN 50 10 Nm 150 s running time	GDB Damper actuator 5 Nm (non-spring return) for approx. 0.8 m ² damper area, 150 s running time	GLB Damper actuator 10 Nm (non-spring return) for approx. 1.5 m ² damper area, 150 s running time
Control signal	KNX S-Mode KNX LTE-Mode KNX PL-Link	KNX S-Mode KNX LTE-Mode KNX PL-Link	KNX S-Mode KNX PL-Link	KNX S-Mode KNX PL-Link	KNX S-Mode KNX PL-Link	KNX S-Mode KNX PL-Link
Operating voltage	AC 24 V	AC 24 V	AC 24 V	AC 24 V	AC 24 V	AC 24 V
Standard model	GDB181.1E/KN	GLB181.1E/KN	GDB111.9E/KN	GLB111.9E/KN	GDB111.1E/KN	GLB111.1E/KN
Dimensions, round damper shaft (mm)	8...16	8...16	-	-	8...16	8...16
Dimensions, square damper shaft (mm)	6...12.8	6...12.8	-	-	6...12.8	6...12.8

7

Heating, ventilation and air conditioning - room temperature control

Overview and selection tools

Electrothermal valve actuators without KNX



Type	STA121	STA121.L20	STA121.L20H	STA121.L50	STA321	STA321.L20	STA321.L20H	STA321.L50
Enclosure data								
Dimensions								
• Width [mm]	39	39	39	39	39	39	39	39
• Height [mm]	40.5	40.5	40.5	40.5	40.5	40.5	40.5	40.5
• Depth [mm]	68	68	68	68	68	68	68	68
Output								
• AC 230 V					■	■	■	■
• AC/DC 24 V	■	■	■	■				
Positioning signal ¹⁾	NC	NC	NC	NC	NC	NC	NC	NC
Stroke [mm]	4.5	4.5	4.5	4.5	4.5	4.5	4.5	4.5
Positioning force [N]	110	110	110	110	110	110	110	110
Positioning time [s]	270	270	270	270	210	210	210	210
Cable length [m]	1	2		5	1	2		5
Halogen-free cable [m]			2				2	
Operation temperature [°C]	0 ... +50	0 ... +50	0 ... +50	0 ... +50	0 ... +50	0 ... +50	0 ... +50	0 ... +50
Power consumption [W]	1.6 W	1.6 W	1.6 W	1.6 W	1.7 W	1.7 W	1.7 W	1.7 W
Mounting 360°								
Degree of protection	IP54	IP54	IP54	IP54	IP54	IP54	IP54	IP54

¹⁾ Closed (NC), open (NO).

For further information regarding accessories (adapter, connector cable, ...) use the HIT-portal: www.siemens.com/hit

7

Electrothermal valve actuators without KNX



Type	STP121	STP121.L20	STP121.L20H	STP121.L50	STP321	STP321.L20	STP321.L20H	STP321.L50
Enclosure data								
Dimensions								
• Width [mm]	39	39	39	39	39	39	39	39
• Height [mm]	40.5	40.5	40.5	40.5	40.5	40.5	40.5	40.5
• Depth [mm]	72	72	72	72	72	72	72	72
Output								
• AC 230 V					■	■	■	■
• AC/DC 24 V	■	■	■	■				
Positioning signal ¹⁾	NO	NO	NO	NO	NO	NO	NO	NO
Stroke [mm]	4.5	4.5	4.5	4.5	4.5	4.5	4.5	4.5
Positioning force [N]	110	110	110	110	110	110	110	110
Positioning time [s]	270	270	270	270	210	210	210	210
Cable length [m]	1	2		5	1	2		5
Halogen-free cable [m]			2				2	
Operation temperature [°C]	0 ... +50	0 ... +50	0 ... +50	0 ... +50	0 ... +50	0 ... +50	0 ... +50	0 ... +50
Power consumption [W]	1.6 W	1.6 W	1.6 W	1.6 W	1.7 W	1.7 W	1.7 W	1.7 W
Mounting 360°								
Degree of protection	IP54	IP54	IP54	IP54	IP54	IP54	IP54	IP54

¹⁾ Closed (NC), open (NO).

For further information regarding accessories (adapter, connector cable, ...) use the HIT-portal: www.siemens.com/hit

Heating, ventilation and air conditioning - room temperature control

Overview and selection tools

Electromotoric valve actuators without KNX

Type	SSA151.05HF	SSA161.05HF	SSA161E.05HF	SSA131.00	SSA331.00	SSA161.05
Dimensions						
• Width [mm]	88.6	88.6	88.6	88.6	88.6	88.6
• Height [mm]	83.4	83.4	83.4	81	81	81
• Depth [mm]	51.4	51.4	51.4	51.4	51.4	51.4
Output						
• AC 230 V					(+/-) 15%	
• AC 24 V	(+/-) 15%	(+/-) 15%	(+/-) 15%	(+/-) 20%		(+/-) 15%
• DC 24 V	(+/-) 20%	(+/-) 20%	(+/-) 20%			(+/-) 20%
Control signal	4...20 mA	0...10 V	0...10 V	3 Point	3 Point	0...10 V
Max. lift [mm]	1.2...6.5	1.2...6.5	1.2...6.5	1.2...6.5	1.2...6.5	1.2...6.5
Max. positioning force [N]	100	100	100	100	100	100
Max. open/close time [s]	25	25	25	67.5	67.5	25
Length of connecting lead [m]	1.5	1.5	1.5	1.5	1.5	1.5
Ambient temperature for operation [°C]	1 ... 110	1 ... 110	1 ... 110	1 ... 110	1 ... 110	1 ... 110
Power Consumption [VA]	2.5	2.5	2.5	2.5	2.5	2.5
Mounting	360 °	360 °	360 °	360 °	360 °	360 °
Degree of protection	IP 54	IP 54	IP 54	IP 54	IP 54	IP 54

7

Heating, ventilation and air conditioning - room temperature control

Room thermostats Flush-mounted

Flush mount touch screen KNX room thermostat for 2-/4-pipe FCU with on/off outputs, 2x universal input and electrical heater application, fit for both round and square conduit boxes

RDF8..KNX Flush Mount

- Operating modes: Comfort, Economy and Protection
- For heating and/or cooling applications
- 2 or 3-position control outputs
- Output for 1-speed or 3-speed fan
- 2 multifunctional inputs for keycard contact, external room / return air temperature (QAH11.1, QAA32), heat / cool changeover, window contact on/off, dewpoint monitor, electrical heater enabled, fault contact, presence detector
- Automatic or manual heating/cooling changeover
- Adjustable commissioning and control parameters
- Minimum and maximum setpoint limitation
- Color of housing: Ivory white or black
- Backlit display



Application selectable:

- 2-pipe system
- 2-pipe system with electrical heater
- 4-pipe system

Data sheet	N3174
Power consumption	6 VA
Setpoint setting range	5...40 °C
Switching differential	0.5...6 K
Communication	Bus: KNX (S-mode and LTE mode with Synco 700)
Analog inputs, number	2
Relay outputs	Fan: N.O. contacts, non-floating Valve: N.O. contacts, non-floating
Relay outputs, number	5
Relay output, switching voltage	AC 230 V
Relay output, switching current	5 (2) A
Degree of protection	IP30
Dimensions (W x H x D)	86 x 86 x 47 mm

Range overview RDF8..KNX Flush Mount

Product Title	Operating voltage [V]	Stock no.	Product no.
Flush mount touch KNX room thermostat for 2-/4-pipe FCU with on/off output and 2x universal input, fit for both round and square conduit boxes, black	AC 230	S55770-T429	RDF800KN/VB
Flush mount touch KNX room thermostat for 2-/4-pipe FCU with on/off output and 2x universal input, fit for both round and square conduit boxes	AC 230	S55770-T350	RDF800KN

Heating, ventilation and air conditioning - room temperature control

Room thermostats

Flush-mounted

RDF6..KNX Flush Mount

Flush mount KNX room thermostat for 2-/4-pipe FCU with on/off outputs, 2x universal input and electrical heater application, fit for both round and square conduit boxes



Flush-mount room thermostat with LCD for fan coil units and compressors in DX-type equipment

- KNX communications
- For heating and/or cooling applications
- 2 or 3-position control outputs
- Output for 1-speed or 3-speed fan
- 2 multifunctional inputs for keycard contact, external room / return air temperature (QAH11.1, QAA32), heat / cool changeover, operation mode changeover, window contact on/off, dewpoint monitor, electrical heater enabled, fault contact, presence detector
- Operating modes: Comfort, Economy and Protection
- Automatic or manual heating/cooling changeover
- Adjustable commissioning and control parameters
- Minimum and maximum setpoint limitation
- Backlit display
- Color of housing: signal white (RAL 9003) or black
- Independent function for window contact, presence detector (standard presence and hotel presence)

Application selectable:

- 2-pipe system
- 2-pipe system with electrical heater
- 4-pipe system

Data sheet	N3076
Power consumption	2 VA
Switching differential	0.5...6 K
Communication	KNX
Analog inputs, number	2
Relay outputs	Fan: N.O. contacts, non-floating Valve: N.O. contacts, non-floating
Relay outputs, number	5
Relay output, switching voltage	AC 230 V
Relay output, switching current	5 (2) A
Type of fixing	With screws on recessed round conduit box diameter min. 60 mm
Dimensions (W x H x D)	86 x 86 x 46 mm

Range overview RDF6..KNX Flush Mount

Product Title	Operating voltage [V]	Stock no.	Product no.
Flush mount KNX room thermostat for 2-/4-pipe FCU with on/off output and 2x universal input, fit for both round and square conduit boxes	AC 230	S55770-T293	RDF600KN
Flush mount KNX room thermostat for 2-/4-pipe FCU with on/off output, KNX switching group, four buttons for switching lights and blinds and 2x universal input, fit for both round and square conduit boxes	AC 230	S55770-T400	RDF600KN/S
Flush mount KNX room thermostat for 2-/4-pipe FCU with on/off output and 2x universal input, fit for both round and square conduit boxes, black	AC 230	S55770-T430	RDF600KN/VB

Heating, ventilation and air conditioning - room temperature control

Room thermostats

Flush-mounted

Flush mount touch KNX PM2.5 & CO2 & Ventilation Controls with on/off or ECM fans selectable and 2x DC 0-10 V input, fit for both round and square conduit boxes

RDF870KN



- AC 230 V operating voltage, large, backlit display
- Display and setpoint adjustment for PM2.5 and CO2 control
- Display of room temperature, outside temperature, VOC (volatile organic compound) and RH (relative humidity)
- Support 1-/3-/4-speed On/Off fan or DC fan output
- Two multifunctional inputs for external passive and DC 0... 10 V sensors
- Operating modes: Comfort, Economy and Protection
- KNX S-Mode
- KNX commissioning via ETS or local control parameters
- KNX integration into Desigo via group (ETS) or individual addressing
- KNX integration into third-party system via group addressing (ETS)
- Mounting on recessed square 86 mm box or round 60 mm with 60 mm fixing centers and minimum 40 mm depth
- Color of housing: Ivory white (RAL 9001)

Application selectable:

- PM2.5 control only
- CO2 control only
- PM2.5 & CO2 controls (CO2 higher priority in control)
- Ventilation control

2x sensor inputs are selectable:

- 0: No function
- 1: Temperature (AI) (NTC 10k)
- 2: Temperature (AI) (0... 10 V)
- 3: PM2.5 (AI) $\mu\text{g}/\text{m}^3$ (0... 10 V)
- 4: CO2 (AI) ppm (0... 10 V)
- 5: VOC (AI) % (0... 10 V)
- 6: VOC (AI) mg/m^3 (0... 10 V)
- 7: RH (AI) % (0... 10 V)
- 8: Alarm input (DI)
- 9: Dummy AI (0... 10 V) (RU only)

Data sheet	A6V11439454
Operating voltage	AC 230 V 230 V
Power consumption	7 VA 2.5 W
Communication	KNX S-Mode
Analog outputs	DC 0... 10 V for ECM fan output
Relay outputs	Fan: N.O. contacts, non-floating Valve: N.O. contacts, non-floating
Degree of protection	IP30
Dimensions (W x H x D)	86 x 86 x 46.8 mm
Color	White
Warranty	24 WarrantyMonths

Stock no.	Product no.
S55770-T407	RDF870KN

Heating, ventilation and air conditioning - room temperature control

Room thermostats

Wall-mounted

RDG2..KN

Room thermostats RDG2.. with KNX communications

- KNX communications
- 3 multifunctional inputs for keycard contact, external room / return air temperature (NTC3K; QAH11.1, QAA32 or LG-Ni1000 sensors), heat / cool changeover, operation mode changeover, window contact on/off, dewpoint monitor, electrical heater enabled, fault contact, presence detector
- Operating modes: Comfort, Economy and Protection
- Automatic or manual DC fan or 1-/3-speed
- Automatic or manual heating / cooling changeover
- Adjustable commissioning and control parameters
- Minimum and maximum setpoint limitation
- Backlit display
- Green leaf function
- Local weekly time program (with 3 Comfort periods per day)
- Manager /Subordinate (M/S) function
- Delta temperature control for district heating and cooling
- Commissioning via Smartphone APP "PCT Go", local HMI or KNX tools.

Data sheet	A6V11545853
Setpoint setting range	5...40 °C
Switching differential	Heating: 0.5...6 K; Cooling: 0.5...6 K
Communication	Bus: KNX (S-mode and LTE with Synco)
Analog output, signal	DC 0...10 V
Relay output, switching current	5 (4) A
Type of fixing	Wall mounting with screws
Degree of protection	IP30
Dimensions (W x H x D)	92 x 134 x 25 mm

7

Heating, ventilation and air conditioning - room temperature control

Room thermostats Wall-mounted

KNX communicating room thermostat. Outputs modulating (PWM / 3-pos.) or on/off. Fan coil (3-speed / DC fan), universal applications

RDG200KN



- Built-in temperature and humidity sensors
- For applications with 2-position (on/off or PWM) or 3-position control outputs
- For applications with 3-speed or DC 0...10 V fan
- AC 230 V or AC 24 V power supply.

Application selectable:

- 2-pipe system
- 2-pipe system with electrical heater
- 2-pipe system and radiator / floor heating
- 2-pipe / 2-stage heating or cooling systems
- 4-pipe system
- 4-pipe system with electrical heater
- 4-pipe / 2-stage heating and cooling system (selectable also for 2-stage cooling / 1-stage heating or 2-stage heating / 1-stage cooling)

Data sheet	A6V11545853
Operating voltage	AC 24 V AC 230 V
Analog inputs, number	3
Analog outputs	Fan: 1 (DC 0...10 V)
Analog outputs, number	1
Digital inputs, number	3
Relay outputs	Fan: 1- or 3-speed
Relay output, switching voltage	AC 24 V or 230 V
Triac outputs	Valve, el. heater 2-position, PWM, 3-position
Triac outputs, number	4
Triac output, switching voltage	AC 24...230 V
Triac output, switching current	1 A

Stock no.

Product no.

S55770-T409

RDG200KN

Heating, ventilation and air conditioning - room temperature control

Room thermostats

Wall-mounted

RDG200KN/BK

**KNX communicating room thermostat in black. Outputs modulating (PWM / 3-pos.) or on/off. Fan coil (3-speed / DC fan), universal applications**

- Built-in temperature and humidity sensors
- Black color device RAL9011
- For applications with 2-position (on/off or PWM) or 3-position control outputs
- For applications with 3-speed or DC0...10 V fan
- AC 230 V or AC 24 V power supply.

Application selectable:

- 2-pipe system
- 2-pipe system with electrical heater
- 2-pipe system and radiator / floor heating
- 2-pipe / 2-stage heating or cooling systems
- 4-pipe system
- 4-pipe system with electrical heater
- 4-pipe / 2-stage heating and cooling system (selectable also for 2-stage cooling / 1-stage heating or 2-stage heating / 1-stage cooling)

Data sheet	A6V11545853
Operating voltage	AC 24 V AC 230 V
Analog inputs, number	3
Analog outputs	Fan. 1 (DC0...10 V)
Analog outputs, number	1
Digital inputs, number	3
Relay outputs	Fan: 1- or 3-speed
Relay output, switching voltage	AC 24 V or 230 V
Triac outputs	Valve, el. heater 2-position, PWM, 3-position
Triac outputs, number	4
Triac output, switching voltage	AC 24...230 V
Triac output, switching current	1 A

Stock no.

Product no.

S55770-T452

RDG200KN/BK

KNX communicating room thermostat with CO2 sensor. Outputs modulating (PWM / 3-pos.) or on/off. Fan coil (3-speed / DC fan), universal applications

RDG204KN



- Built-in temperature, humidity and CO2 sensors
- Indoor air quality monitoring and controlling (CO2) via fresh air damper
- Display of CO2 value in ppm (parts per million) or with text
- For applications with 2-position (on/off or PWM) or 3-position control outputs
- For applications with 3-speed or DC 0...10 V fan
- AC 230 V or AC 24 V power supply.

Application selectable:

- 2-pipe system
- 2-pipe system with electrical heater
- 2-pipe system and radiator / floor heating
- 2-pipe / 2-stage heating or cooling
- 4-pipe system
- 4-pipe system with electrical heater
- 4-pipe / 2-stage heating and cooling system (selectable also for 2-stage cooling / 1-stage heating or 2-stage heating / 1-stage cooling)

Data sheet	A6V11545853
Operating voltage	AC 24 V AC 230 V
Analog inputs, number	3
Analog outputs	Fan, fresh air damper: 2 (DC 0...10 V)
Analog outputs, number	2
Digital inputs, number	3
Relay outputs	Fan: 1- or 3-speed
Relay output, switching voltage	AC 24 V or 230 V
Triac outputs	Valve, el. heater, fresh air damper 2-position, PWM, 3-position
Triac outputs, number	4
Triac output, switching voltage	AC 24...230 V
Triac output, switching current	1 A

Stock no.

Product no.

S55770-T410

RDG204KN

Heating, ventilation and air conditioning - room temperature control

Room thermostats

Wall-mounted

RDG260KN



KNX communicating room thermostat. Outputs modulating (DC) or on/off. Fan coil (3-speed / DC fan) or universal applications

- Built-in temperature and humidity sensors
- For applications with DC control outputs and DC or 3-speed fan output
- For applications with 2-position control output with DC fan output
- AC or DC 24 V operating voltage

Application selectable:

- 2-pipe system
- 2-pipe system with electrical heater
- 2-pipe system and radiator / floor heating
- 2-pipe / 2-stage heating or cooling system
- 4-pipe system
- 4-pipe system with electrical heater
- 4-pipe / 2-stage heating and cooling system (selectable also for 2-stage cooling / 1-stage heating or 2-stage heating / 1-stage cooling)
- 4-pipe system with 6-port ball valves and PICV
- Heating / cooling with 6-port ball valves

Data sheet

A6V11545853

Operating voltage

AC/DC 24 V

Analog inputs, number

3

Analog outputs

Valve, el. heater: 4
Fan: 1 (DC 0...10 V)

Analog outputs, number

5

Digital inputs, number

3

Relay outputs

Valve, compressor or el. heater: 2 outputs, 2-position

Fan: 1- or 3-speed

Relay output, switching voltage

AC 24...230 V

Stock no.

Product no.

S55770-T412

RDG260KN

Heating, ventilation and air conditioning - room temperature control

Room thermostats Wall-mounted

KNX communicating room thermostat in black. Outputs modulating (DC) or on/off. Fan coil (3-speed / DC fan) or universal applications

- Built-in temperature and humidity sensors
- Black color device RAL9011
- For applications with DC control outputs and DC or 3-speed fan output
- For applications with 2-position control output with DC fan output
- AC or DC 24 V operating voltage

Application selectable:

- 2-pipe system
- 2-pipe system with electrical heater
- 2-pipe system and radiator / floor heating
- 2-pipe / 2-stage heating or cooling system
- 4-pipe system
- 4-pipe system with electrical heater
- 4-pipe / 2-stage heating and cooling system (selectable also for 2-stage cooling / 1-stage heating or 2-stage heating / 1-stage cooling)
- Heating / cooling with 6-port ball valves

Data sheet	A6V11545853
Operating voltage	AC/DC 24 V
Analog inputs, number	3
Analog outputs	Valve, el. heater: 4 Fan: 1 (DC0...10 V)
Analog outputs, number	5
Digital inputs, number	3
Relay outputs	Valve, compressor or el. heater: 2 outputs, 2-position Fan: 1- or 3-speed
Relay output, switching voltage	AC 24...230 V

RDG260KN/BK



7

Stock no.

Product no.

S55770-T453

RDG260KN/BK

Heating, ventilation and air conditioning - room temperature control

Room thermostats

Wall-mounted

RDG264KN



KNX communicating room thermostat with CO2 sensor. Outputs modulating (DC) or on/off. Fan coil (3-speed / DC fan) or universal applications

- Built-in temperature, humidity and CO2 sensors
- Indoor air quality monitoring and controlling (CO2) via fresh air damper
- Display of CO2 value in ppm (parts per million) or with text
- For applications with DC control outputs and DC or 3-speed fan output
- For applications with 2-position control output with DC fan output
- AC or DC 24 V operating voltage

Application selectable:

- 2-pipe system
- 2-pipe system with electrical heater
- 2-pipe system and radiator / floor heating
- 2-pipe / 2-stage heating or cooling system
- 4-pipe system
- 4-pipe system with electrical heater
- 4-pipe / 2-stage heating and cooling system (selectable also for 2-stage cooling / 1-stage heating or 2-stage heating / 1-stage cooling)
- Heating / cooling with 6-port ball valves

Data sheet	A6V11545853
Operating voltage	AC/DC 24 V
Analog inputs, number	3
Analog outputs	Valve, el. heater: 4 Fan, fresh air damper: 1 (DC 0...10 V)
Analog outputs, number	6
Digital inputs, number	3
Relay outputs	Valve, compressor or el. heater: 2 outputs, 2-position Fan: 1- or 3-speed
Relay output, switching voltage	AC 24...230 V

Stock no.	Product no.
S55770-T413	RDG264KN

Room thermostat for temperature and air quality control with KNX communications, AC 24 V, VAV heating and cooling systems

RDG405KN



- KNX communications
- Output DC 0...10 V for VAV actuator and auxiliary output ON/OFF, PWM or 3-position or 3-position for VAV actuator and auxiliary output DC 0...10 V
- 2 multifunctional inputs for keycard contact, external room / return air temperature (1x, QAH11.1, QAA32), heat / cool changeover, operation mode changeover, window contact on/off, dewpoint monitor, electrical heater enabled, fault contact, presence detector
- 1 input DC 0...10 V for damper position feedback, for CO2 sensor
- Operating modes: Comfort, Economy and Protection
- Modulating PI control
- Control depending on the room or the return air temperature and air quality
- Automatic or manual heating / cooling changeover
- Adjustable commissioning and control parameters
- Minimum and maximum setpoint limitation
- Minimum and maximum limitation of air flow signal
- Output signal inversion (DC 0...10 V) as an option
- Backlit display

Application selectable:

- Single-duct system
- Single-duct system with electrical heater
- Single-duct system and radiator / floor heating
- Single-duct system with heating / cooling coil

Data sheet	N3192
Operating voltage	AC 24 V
Power consumption	2 VA
Setpoint setting range	5...40 °C
Switching differential	Heating: 0.5...6 K; Cooling: 0.5...6 K
Communication	Bus: KNX (S-mode and LTE mode with Synco 700)
Analog inputs, number	2
Analog outputs	VAV actuator, electric heater, valve
Analog outputs, number	1
Analog output, signal	DC 0...10 V
Analog output, current	1 mA
Digital inputs, number	1
Triac outputs	VAV actuator, valve, el. heater
Triac outputs, number	2-position, PWM, 3-position
Triac output, switching voltage	24 V
Triac output, switching current	1 A
Type of fixing	Wall mounting with screws
Degree of protection	IP30
Dimensions (W x H x D)	93 x 128 x 30.8 mm
Warranty	24 WarrantyMonths

Stock no.	Product no.
S55770-T348	RDG405KN

Heating, ventilation and air conditioning - room temperature control

Room temperature controllers with integrated sensing and operation

Flush-mounted

UP 237K..



Temperature controller, i-system

- Integrated room temperature sensors
- Control can be set as a two-point control and/or continuous-action control (P or PI algorithm), for heating only, for cooling only, or for heating and cooling mode
- Operating modes that can be switched via KNX: comfort mode, pre-comfort mode, energy-saving mode and frost or heat protection mode
- Presence pushbutton to locally switch between comfort and pre-comfort mode or comfort and energy-saving mode and to extend comfort mode after operating energy-saving or protection mode
- Pushbutton for switching over between manual and automatic mode
- The room temperature setpoint value for comfort mode can be set via an interchangeable rotary button (+/-) on the controller and via the KNX
- Basic setpoint of the room temperature for comfort mode which can be set via the KNX
- Setpoint value for comfort mode in °C which can be set via an interchangeable rotary button on the controller
- Adjustable dead zone between the heating setpoint and the cooling setpoint for comfort mode
- Two-level heating or cooling
- Output of the control variable(s) either as an on/off switch command or as a positioning command in the range of 0...100 %
- 5 LEDs to display manual mode and the current operating modes
- 4 LEDs to display heating/cooling valve open, dew point alarm and open window
- For plugging onto a bus transceiver module (BTM) or a flush-mounting actuator with bus transceiver module (BTM)

Data sheet

A6V10416651

Ranger overview UP 237K..

Product Title	Dimensions (WxHxD) [mm]	Stock no.	Product no.
Temperature controller, titanium white	55 x 55 x 16	5WG1237-2KB11	UP 237K11

The bus transceiver module (BTM) (see Chapter System Products and Accessories) or flush-mounting actuator with bus transceiver module (BTM) must be ordered separately. The matching design frame must be ordered separately. See Chapter Display and Operation Units - Pushbutton accessories.

Heating, ventilation and air conditioning - room temperature control

Room temperature controllers with integrated sensing and operation

Flush-mounted

Room Control Unit, i-system

UP 227



- Multifunctional display-/control panel for KNX with Dot-Matrix LCD display 96 x 128 pixels
- 8 capacitive touch buttons for horizontal operation
- For the display and control of at least 10 adjustable room control functions: Switching toggle/On/Off, Dimming, Door bell function On/Off, Solar protection control; send 1 Byte/2 Byte value; display 1 Bit/1 Byte/2 Byte value; Forced control; display text messages; warning and alarm messaging; recall and save scenes; warning and alarm messaging
- Room control functions lockable via KNX-bus
- Green/red LED as orientation light, as status indication, as a response to pressing a button respectively to the signalling of alarm reports
- A signaler for acoustical alarm reports respectively as a status of the touch operation
- Integrated room temperature sensor
- Evaluation and weighting of an external inside temperature sensor
- Room temperature control configurable as two-step control and/or continuous control, for exclusive heating operation, exclusive cooling operation or heating and cooling operation
- Selectable operating modes over the KNX: Comfort, Pre-comfort, Energy-savings and protection
- Local indication
 - Of the active operating modes or automatic- respectively manual mode
 - Inside temperature or outside temperature
 - Heating or cooling mode
 - Dew point alarm
 - Open window
- Local switching between
 - Manual- and automatic mode
 - Comfort, pre-comfort, energy-saving- and protection mode
- Adjustable time-limited extension of the comfort mode
- Adjustable room temperature setpoint shifting for comfort mode
- Via KNX set basic setpoint value of the room temperature for comfort mode
- An outside temperature based temperature setpoint value tracing in the cooling operation
- Adjustable dead zone between the heating setpoint value and the cooling setpoint value for comfort mode
- Transmission of controller output(s) either as On/Off switching commands or as control commands in the range 0...100 %
- Local display of the manually selected fan rotational speed respectively of the automatic adjustment of the fan rotational speed
- Adjustable fan rotational speed respectively automatic adjustment of the fan rotational speed on the controller
- Weekly schedule programme for controller- operating modes, automatic mode and at the least 8 room control functions
- At the least 40 schedule tasks and Display and set of the date and time
- User control of LCD background lighting and Background color
- Display system settings and room temperature controller in the languages: German, English, French, Italian and Spanish
- User setting of at least 3 operating languages also Integrated bus coupling unit, bus connection via bus terminal possible
- Flush mounted device for the mounting in an flush wall box Ø 60 mm, for fixing on the mounting plate AQR2500NF via lateral springs (separately specified)

The matching design frame must be ordered separately. See chapter Display and Operation Units - Pushbuttons accessories.

The mounting plate AQR2500.. must be ordered separately.

Data sheet	A6V10416250
Dimensions (W x H x D)	55 x 55 x 37.2 mm

Stock no.	Product no.
5WG1227-2AB11	UP 227

Heating, ventilation and air conditioning - room temperature control

Room temperature controllers with integrated sensing and operation

Flush-mounted

Accessories for UP 227

AQR2500NF



Mounting plate EU (CEE/VDE)

- Mounting plates to plug onto the front module

Data sheet	N1408
Mechanical design	EU (CEE/VDE)
Dimensions (W x H x D)	71 x 71 x 45 mm
Warranty	60 WarrantyMonths

Stock no.	Product no.
S55720-S161	AQR2500NF

AQR2500NG



Mounting plate IT (3 modular)

- Mounting plates to plug onto the front module

Data sheet	N1408
Mechanical design	IT (3 modular)
Dimensions (W x H x D)	71 x 71 x 45 mm
Warranty	60 WarrantyMonths

Stock no.	Product no.
S55720-S163	AQR2500NG

Heating, ventilation and air conditioning - room temperature control

Room temperature controllers with integrated sensing and operation

Flush-mounted

Touch Control TC5, 5 inch touch panel, black

UP 205/21

- Aluminium and glass housing
 - Capacitive touch colour display 5", 480 x 854 pixels
 - LED colour light strip as orientation light, respectively to signal alarms
 - Integrated room temperature sensor
 - Micro SD card reader for on-site customization of wallpaper, screen saver and icons
 - Connection to external power supply DC 24 V
 - Flush mounted device for mounting in a flush wall box 60 mm Ø, for screw fixing
 - Mounting plate included in gift box
-
- Up to 15 configurable function pages
 - 2 configurable home pages for navigation
 - Room control functions switching, dimming, tunable white, RGB, solar protection, HVAC
 - Up to 120 channels for each individual function
 - Switching functions toggle, switching on/off
 - Dimming control page for colour lights: 3-color RGB light, 4-color RGBW light, optional with brightness and colour temperature adjustment
 - Solar protection functions for curtains, roller shutters and venetian blinds
 - Room temperature control configurable as two-step control and/or continuous control, for heating and/or cooling operation
 - Manual or automatic ventilation control
 - VRF interface
 - Up to 8 configurable sets of event functions with 3 different data type options for each output
 - Up to 8 inputs for logical operations: AND, OR, XOR, gate forwarding, threshold and format conversion
 - Up to 16 daily or weekly schedules
 - Display of date, time and temperature
 - Up to 10 display pages for external sensor readings: temperature, relative humidity, PM2.5, PM10, CO2, VOC, AQI, brightness and wind speed
 - Up to 10 display pages for energy metering values

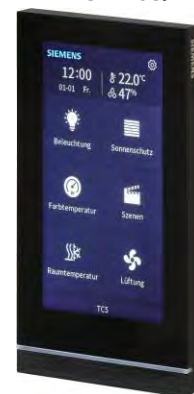

7

Data sheet	A6V12259028
Dimensions (W x H x D)	86 x 148.8 x 11.5 mm

Stock no.	Product no.
5WG1205-2AB21	UP 205/21

Heating, ventilation and air conditioning - room temperature control

Room temperature controllers with integrated sensing and operation

Wall-mounted

QMX3.P02



Room operator unit KNX with temperature sensor, configurable touchkeys, LED display, white

Functions:

- Temperature sensor
- Configurable touchkeys with LED display
- Switching and control of lighting, blinds, scenes
- Window for labels
- Temperature control, adjustable as PWM control and/or modulating control (PID algorithm), for pure heating mode, pure cooling mode, heating and cooling mode
- Operating modes switchable via KNX and/or display: Comfort mode, Pre-Comfort, energy savings and protection mode
- Adjustable commissioning and control parameters for radiated heating, slow and fast, floor heating slow and fast
- Integrated bus coupling unit
- 3 independently adjustable switching values for CO2 concentration and relative air humidity for air quality control
- Actuating variable for 1, 2, or 3-stage fans (humidity and CO2)
- Actuating variable for 1, 2, or 3-point positioning signal (humidity and CO2)
- Setpoint for room temperature and relative humidity and CO2 concentration adjustable via KNX

Data sheet	N1602
Voltage supply	KNX bus
Measuring range, temperature	0...50 °C
Sensing element, temperature	NTC
Display	LED
Communication	KNX PL-Link KNX S-Mode
Color	White
Degree of protection	IP30
Dimensions (W x H x D)	88.4 x 133.4 x 18 mm
Weight (net)	0.19 kg
Warranty	24 WarrantyMonths

Stock no.	Product no.
S55624-H107	QMX3.P02

Heating, ventilation and air conditioning - room temperature control

Room temperature controllers with integrated sensing and operation

Wall-mounted

Room operator unit KNX with temperature sensor, configurable touchkeys, LED display, black

QMX3.P02-1BSC



Functions:

- Temperature sensor
- Configurable touchkeys with LED display
- Switching and control of lighting, blinds, scenes
- Window for labels

- Temperature control, adjustable as PWM control and/or modulating control (PID algorithm), for pure heating mode, pure cooling mode, heating and cooling mode
- Operating modes switchable via KNX and/or display: Comfort mode, Pre-Comfort, energy savings and protection mode
- Adjustable commissioning and control parameters for radiated heating, slow and fast, floor heating slow and fast
- Integrated bus coupling unit
- 3 independently adjustable switching values for CO2 concentration and relative air humidity for air quality control
- Actuating variable for 1, 2, or 3-stage fans (humidity and CO2)
- Actuating variable for 1, 2, or 3-point positioning signal (humidity and CO2)
- Setpoint for room temperature and relative humidity and CO2 concentration adjustable via KNX

Data sheet	N1602
Voltage supply	KNX bus
Measuring range, temperature	0...50°C
Sensing element, temperature	NTC
Communication	KNX PL-Link KNX S-Mode
Color	Black
Degree of protection	IP30
Dimensions (W x H x D)	88.4 x 133.4 x 18 mm
Warranty	24 WarrantyMonths

Stock no. Product no.

S55624-H128 QMX3.P02-1BSC

7

Heating, ventilation and air conditioning - room temperature control

Room temperature controllers with integrated sensing and operation

Wall-mounted

QMX3.P34



Room operator unit KNX with temperature sensor, segmented backlit display, touchkeys, white

Functions:

- Temperature sensor
- Segmented backlit display and touchkeys
- Temperature control, adjustable as PWM control and/or modulating control (PID algorithm), for pure heating mode, pure cooling mode, heating and cooling mode
- Operating modes switchable via KNX and/or display: Comfort mode, Pre-Comfort, energy savings and protection mode
- Adjustable commissioning and control parameters for radiated heating, slow and fast, floor heating slow and fast
- Integrated bus coupling unit
- 3 independently adjustable switching values for CO₂ concentration and relative air humidity for air quality control
- Actuating variable for 1, 2, or 3-stage fans (humidity and CO₂)
- Actuating variable for 1, 2, or 3-point positioning signal (humidity and CO₂)
- Setpoint for room temperature and relative humidity and CO₂ concentration adjustable via KNX

Data sheet	N1602
Voltage supply	KNX bus
Measuring range, temperature	0...50 °C
Sensing element, temperature	NTC
Communication	KNX PL-Link KNX S-Mode
Color	White
Degree of protection	IP30
Dimensions (W x H x D)	88.4 x 133.4 x 18 mm
Weight (net)	0.21 kg
Warranty	24 WarrantyMonths

Stock no.	Product no.
S55624-H105	QMX3.P34

Heating, ventilation and air conditioning - room temperature control

Room temperature controllers with integrated sensing and operation

Wall-mounted

Room operator unit KNX with temperature sensor, segmented backlit display, touchkeys, black

QMX3.P34-1BSC



Functions:

- Temperature sensor
- Segmented backlit display and touchkeys
- Temperature control, adjustable as PWM control and/or modulating control (PID algorithm), for pure heating mode, pure cooling mode, heating and cooling mode
- Operating modes switchable via KNX and/or display: Comfort mode, Pre-Comfort, energy savings and protection mode
- Adjustable commissioning and control parameters for radiated heating, slow and fast, floor heating slow and fast
- Integrated bus coupling unit
- 3 independently adjustable switching values for CO2 concentration and relative air humidity for air quality control
- Actuating variable for 1, 2, or 3-stage fans (humidity and CO2)
- Actuating variable for 1, 2, or 3-point positioning signal (humidity and CO2)
- Setpoint for room temperature and relative humidity and CO2 concentration adjustable via KNX

Data sheet	N1602
Voltage supply	KNX bus
Measuring range, temperature	0...50°C
Sensing element, temperature	NTC
Communication	KNX PL-Link KNX S-Mode
Color	Black
Degree of protection	IP30
Dimensions (W x H x D)	88.4 x 133.4 x 18 mm
Warranty	24 WarrantyMonths

Stock no.

Product no.

S55624-H126

QMX3.P34-1BSC

7

Heating, ventilation and air conditioning - room temperature control

Room temperature controllers with integrated sensing and operation

Wall-mounted

QMX3.P37



Room operator unit KNX with temperature sensor, segmented backlit display, configurable touchkeys, LED display, white

Functions:

- Temperature sensor
- Segmented backlit display and touchkeys
- Configurable touchkeys with LED display
- Switching and control of lighting, blinds, scenes
- Window for labels
- Temperature control, adjustable as PWM control and/or modulating control (PID algorithm), for pure heating mode, pure cooling mode, heating and cooling mode
- Operating modes switchable via KNX and/or display: Comfort mode, Pre-Comfort, energy savings and protection mode
- Adjustable commissioning and control parameters for radiated heating, slow and fast, floor heating slow and fast
- Integrated bus coupling unit
- 3 independently adjustable switching values for CO2 concentration and relative air humidity for air quality control
- Actuating variable for 1, 2, or 3-stage fans (humidity and CO2)
- Actuating variable for 1, 2, or 3-point positioning signal (humidity and CO2)
- Setpoint for room temperature and relative humidity and CO2 concentration adjustable via KNX

Data sheet	N1602
Operating voltage	DC 21 V
Voltage supply	KNX bus
Measuring range, temperature	0...50 °C
Sensing element, temperature	NTC
Display	LED
Communication	KNX PL-Link KNX S-Mode
Color	White
Degree of protection	IP30
Dimensions (W x H x D)	88.4 x 133.4 x 18 mm
Weight (net)	0.216 kg
Warranty	24 WarrantyMonths

Stock no.	Product no.
S55624-H108	QMX3.P37

Heating, ventilation and air conditioning - room temperature control

Room temperature controllers with integrated sensing and operation

Wall-mounted

Room operator unit KNX with temperature sensor, segmented backlit display, configurable touchkeys, LED display, black

QMX3.P37-1BSC



Functions:

- Temperature sensor
- Segmented backlit display and touchkeys
- Configurable touchkeys with LED display
- Switching and control of lighting, blinds, scenes
- Window for labels

- Temperature control, adjustable as PWM control and/or modulating control (PID algorithm), for pure heating mode, pure cooling mode, heating and cooling mode
- Operating modes switchable via KNX and/or display: Comfort mode, Pre-Comfort, energy savings and protection mode
- Adjustable commissioning and control parameters for radiated heating, slow and fast, floor heating slow and fast
- Integrated bus coupling unit
- 3 independently adjustable switching values for CO₂ concentration and relative air humidity for air quality control
- Actuating variable for 1, 2, or 3-stage fans (humidity and CO₂)
- Actuating variable for 1, 2, or 3-point positioning signal (humidity and CO₂)
- Setpoint for room temperature and relative humidity and CO₂ concentration adjustable via KNX

Data sheet	N1602
Voltage supply	KNX bus
Measuring range, temperature	0...50 °C
Sensing element, temperature	NTC
Communication	KNX PL-Link KNX S-Mode
Color	Black
Degree of protection	IP30
Dimensions (W x H x D)	88.4 x 133.4 x 18 mm
Warranty	24 WarrantyMonths

Stock no.

Product no.

S55624-H129

QMX3.P37-1BSC

Heating, ventilation and air conditioning - room temperature control

Room temperature controllers with integrated sensing and operation

Wall-mounted

QMX3.P44



Room operator unit KNX with sensors for temperature, humidity, segmented backlit display, touchkeys, white

Functions:

- multisensor for temperature and humidity
- Segmented backlit display and touchkeys
- Temperature control, adjustable as PWM control and/or modulating control (PID algorithm), for pure heating mode, pure cooling mode, heating and cooling mode
- Operating modes switchable via KNX and/or display: Comfort mode, Pre-Comfort, energy savings and protection mode
- Adjustable commissioning and control parameters for radiated heating, slow and fast, floor heating slow and fast
- Integrated bus coupling unit
- 3 independently adjustable switching values for CO₂ concentration and relative air humidity for air quality control
- Actuating variable for 1, 2, or 3-stage fans (humidity and CO₂)
- Actuating variable for 1, 2, or 3-point positioning signal (humidity and CO₂)
- Setpoint for room temperature and relative humidity and CO₂ concentration adjustable via KNX

Data sheet	N1602
Voltage supply	KNX bus
Measuring range	NTC: 0...50 °C Humidity: 10%...95 % r.F.
Measuring range, temperature	0...50 °C
Sensing element, temperature	NTC
Communication	KNX PL-Link KNX S-Mode
Color	White
Degree of protection	IP30
Dimensions (W x H x D)	88.4 x 133.4 x 18 mm
Weight (net)	0.21 kg
Warranty	24 WarrantyMonths

Stock no.	Product no.
S55624-H143	QMX3.P44

Heating, ventilation and air conditioning - room temperature control

Room temperature controllers with integrated sensing and operation

Wall-mounted

Room operator unit KNX with sensors for temperature, humidity, segmented backlit display, touchkeys, black

QMX3.P44-1BSC



Functions:

- Multisensor for temperature and humidity
- Segmented backlit display and touchkeys
- Temperature control, adjustable as PWM control and/or modulating control (PID algorithm), for pure heating mode, pure cooling mode, heating and cooling mode
- Operating modes switchable via KNX and/or display: Comfort mode, Pre-Comfort, energy savings and protection mode
- Adjustable commissioning and control parameters for radiated heating, slow and fast, floor heating slow and fast
- Integrated bus coupling unit
- 3 independently adjustable switching values for CO2 concentration and relative air humidity for air quality control
- Actuating variable for 1, 2, or 3-stage fans (humidity and CO2)
- Actuating variable for 1, 2, or 3-point positioning signal (humidity and CO2)
- Setpoint for room temperature and relative humidity and CO2 concentration adjustable via KNX

Data sheet	N1602
Voltage supply	KNX bus
Measuring range	NTC: 0...50 °C Humidity: 10%...95 % r.F.
Measuring range, temperature	0...50 °C
Sensing element, temperature	NTC
Communication	KNX PL-Link KNX S-Mode
Color	Black
Degree of protection	IP30
Dimensions (W x H x D)	88.4 x 133.4 x 18 mm
Weight (net)	0.21 kg
Warranty	24 WarrantyMonths

Stock no.

Product no.

S55624-H144

QMX3.P44-1BSC

7

Heating, ventilation and air conditioning - room temperature control

Room temperature controllers with integrated sensing and operation

Wall-mounted

QMX3.P74



Room operator unit KNX with sensors for temperature, humidity, CO₂, segmented backlit display, touchkeys, white

Functions:

- multisensor for temperature, humidity and CO₂
- Segmented backlit display and touchkeys
- Temperature control, adjustable as PWM control and/or modulating control (PID algorithm), for pure heating mode, pure cooling mode, heating and cooling mode
- Operating modes switchable via KNX and/or display: Comfort mode, Pre-Comfort, energy savings and protection mode
- Adjustable commissioning and control parameters for radiated heating, slow and fast, floor heating slow and fast
- Integrated bus coupling unit
- 3 independently adjustable switching values for CO₂ concentration and relative air humidity for air quality control
- Actuating variable for 1, 2, or 3-stage fans (humidity and CO₂)
- Actuating variable for 1, 2, or 3-point positioning signal (humidity and CO₂)
- Setpoint for room temperature and relative humidity and CO₂ concentration adjustable via KNX

Data sheet	N1602
Voltage supply	KNX bus
Measuring range	400... 10000 ppm CO ₂
Sensing element	Temperature sensor, CO ₂ sensor, relative humidity sensor
Measuring range, temperature	0...50 °C
Sensing element, temperature	NTC
Communication	KNX PL-Link KNX S-Mode
Color	White
Degree of protection	IP30
Dimensions (W x H x D)	88.4 x 133.4 x 18 mm
Weight (net)	0.22 kg
Warranty	24 WarrantyMonths

Stock no.	Product no.
S55624-H106	QMX3.P74

Heating, ventilation and air conditioning - room temperature control

Room temperature controllers with integrated sensing and operation

Wall-mounted

Room operator unit KNX with sensors for temperature, humidity, CO₂, segmented backlit display, touchkeys, black

QMX3.P74-1BSC

Functions:

- Multisensor for temperature, humidity and CO₂
- Segmented backlit display and touchkeys
- Temperature control, adjustable as PWM control and/or modulating control (PID algorithm), for pure heating mode, pure cooling mode, heating and cooling mode
- Operating modes switchable via KNX and/or display: Comfort mode, Pre-Comfort, energy savings and protection mode
- Adjustable commissioning and control parameters for radiated heating, slow and fast, floor heating slow and fast
- Integrated bus coupling unit
- 3 independently adjustable switching values for CO₂ concentration and relative air humidity for air quality control
- Actuating variable for 1, 2, or 3-stage fans (humidity and CO₂)
- Actuating variable for 1, 2, or 3-point positioning signal (humidity and CO₂)
- Setpoint for room temperature and relative humidity and CO₂ concentration adjustable via KNX



Data sheet	N1602
Voltage supply	KNX bus
Measuring range	400...10000 ppm CO ₂
Sensing element	Temperature sensor, CO ₂ sensor, relative humidity sensor
Measuring range, temperature	0...50°C
Sensing element, temperature	NTC
Communication	KNX PL-Link KNX S-Mode
Color	Black
Degree of protection	IP30
Dimensions (W x H x D)	88.4 x 133.4 x 18 mm
Warranty	24 WarrantyMonths

Stock no.	Product no.
S55624-H127	QMX3.P74-1BSC

Accessories for QMX3..

Basic plate for conduit and cavity wall box

QMX3.MP1

Basic plate for conduit box / cavity wall box with 68 mm diameter hole

20 pcs. per package

Data sheet	N1602
Dimensions (W x H x D)	80.5 x 115 mm
Warranty	60 WarrantyMonths



Stock no.	Product no.
S55624-H110	QMX3.MP1

Heating, ventilation and air conditioning - room temperature control

Room temperature controllers with integrated sensing i-system

AQR2530NNW



Front module for base module, without sensor

- Front module without sensor for plugging onto the Base module
- Matching the DELTA line and DELTA miro frame program

Data sheet	N1411
Color	Titanium white
Degree of protection	IP30
Dimensions (W x H x D)	55 x 55 x 12 mm
Warranty	60 WarrantyMonths

Stock no.

Product no.

S55720-S137

AQR2530NNW

Matching the DELTA line and DELTA miro frame program. See chapter Display and Operation Units.
The relevant base modules must be ordered separately. See chapter Physical sensors.

AQR2532NNW



Front module for base modules, temperature (active)

- Front module with sensor for plugging onto the Base module
- Matching the DELTA line and DELTA miro frame program

Data sheet	N1411
Signal output temperature	Active
Measuring range, temperature	0...50 °C
Color	Titanium white
Degree of protection	IP30
Dimensions (W x H x D)	55 x 55 x 12 mm
Warranty	60 WarrantyMonths

Stock no.

Product no.

S55720-S136

AQR2532NNW

Matching the DELTA line and DELTA miro frame program. See chapter Display and Operation Units.
The relevant base modules must be ordered separately. See chapter Physical sensors.

7

Heating, ventilation and air conditioning - room temperature control

Room temperature controllers with integrated sensing i-system

Front module for base modules, humidity and temperature (active)

AQR2535NNW

- Front module with humidity and temperature sensor for plugging onto the Base module
- Matching the DELTA line and DELTA miro frame program

Data sheet	N1411
Signal output temperature	Active
Measurement range humidity	0... 100 % r.h.
Sensing element, temperature	Active
Measuring range, temperature	0...50 °C
Color	Titanium white
Degree of protection	IP30
Dimensions (W x H x D)	55 x 55 x 12 mm
Warranty	60 WarrantyMonths



Stock no.	Product no.
-----------	-------------

S55720-S141	AQR2535NNW
-------------	------------

Matching the DELTA line and DELTA miro frame program. See chapter Display and Operation Units.
The relevant base modules must be ordered separately. See chapter Physical sensors.

Front module for base module, humidity and temperature, with LED

AQR2535NNWQ

- Front module with humidity and temperature sensor and CO₂ indicator for plugging onto the Base module
- Matching the DELTA line and DELTA miro frame program

Data sheet	N1411
Signal output temperature	Active
Measurement range humidity	0... 100 % r.h.
Sensing element, temperature	Active
Measuring range, temperature	0...50 °C
Display	CO ₂ indicator by LED
Color	Titanium white
Degree of protection	IP30
Dimensions (W x H x D)	55 x 55 x 38 mm
Warranty	60 WarrantyMonths



Stock no.	Product no.
-----------	-------------

S55720-S219	AQR2535NNWQ
-------------	-------------

Matching the DELTA line and DELTA miro frame program. See chapter Display and Operation Units.
The relevant base modules must be ordered separately. See chapter Physical sensors - Without KNX connection.

Remote sensor for AQR257..

Product Title	Data sheet	Stock no.	Product no.
Front module with passiv temperature measurement, LG-Ni1000	N1408	S55720-S133	AQR2531ANW
Mounting plate EU (CEE/VDE)	N1408	S55720-S161	AQR2500NF
Cable temperature sensor PVC 2 m, NTC 10k	N1831	BPZ:QAP1030.200	QAP1030.200

Heating, ventilation and air conditioning - room temperature control

Room temperature controllers with integrated sensing i-system

AQR2570..



Base module with KNX for temperature and humidity measurement

- Base module without sensor for plugging onto a front module
- 1 analog input to connect temperature sensors with NTC 10k sensing element to measure room, floor, or ceiling temperature
- 2 multifunctional binary inputs to connect window contacts or buttons
- Power supply via KNX bus, bus load < 5 mA
- Communication: KNX S-Mode, KNX PL-Link
- Temperature control as continuous control (PID algorithm) for pure heating operation, heating and cooling operation, and adjustable positioning variable as continuous positioning signal 0...100%, or as pulse-width modulated (PWM) switching signal On/Off,
- Ventilation control across 3 settable switching steps for relative humidity, and 3 switching signal objects On/Off, or one positioning signal object 0...100% to control a ventilation actor
- Via setpoints for room temperature and relative humidity adjustable via KNX bus
- Adjustable commissioning and control parameters
- Integrated bus coupler with programming button and LED

Data sheet	N1411
Voltage supply	KNX bus
Analog inputs, number	1
Analog inputs	Passive temperature sensor NTC 10k
Digital inputs, number	2
Digital inputs	Potential-free contacts
Warranty	5 Years

Range overview AQR2570..

Mechanical design	Stock no.	Product no.
EU (CEE/VDE)	S55720-S203	AQR2570NF
IT (3 Modular)	S55720-S205	AQR2570NG
UK (British Standard)	S55720-S204	AQR2570NH
US (UL)	S55720-S206	AQR2570NJ

Heating, ventilation and air conditioning - room temperature control

Room temperature controllers with integrated sensing i-system

Base modules with KNX for CO₂ measurement

AQR2576..

- Base module with maintenance and recalibration-free CO₂ sensor to plug onto a front module
- 1 analog input to connect temperature sensors with NTC 10k sensing element to measure room, floor, or ceiling temperature
- 2 multifunctional binary inputs to connect window contacts or buttons
- Power supply via KNX bus, bus load < 5 mA
- Communication: KNX S-Mode, KNX PL-Link
- Ventilation control across 3 settable switching steps for relative humidity & CO₂ concentration, and 3 switching signal objects On/Off, or one positioning signal object 0...100% to control a ventilation actor
- Temperature control as continuous control (PID algorithm) for pure heating operation, heating and cooling operation, and adjustable positioning variable as continuous positioning signal 0...100%, or as pulse-width modulated (PWM) switching signal On/Off
- Via setpoints for room temperature and relative humidity, and CO₂ concentration, adjustable via KNX bus
- Adjustable commissioning and control parameters
- Integrated bus coupler with programming button and LED



Data sheet	N1411
Voltage supply	KNX bus
Measuring range	CO ₂ : 0...5000 ppm
Analog inputs, number	1
Analog inputs	Passive temperature sensor NTC 10k
Digital inputs, number	2
Digital inputs	Potential-free contacts
Warranty	5 Years

Range overview AQR2576..

Mechanical design	Dimensions (WxHxD) [mm]	Stock no.	Product no.
EU (CEE/VDE)	71 x 71 x 45	S55720-S207	AQR2576NF
IT (3 Modular)	71 x 71 x 45	S55720-S209	AQR2576NG
UK (British Standard)	71 x 71 x 45	S55720-S208	AQR2576NH
US (UL)	64 x 110 x 45	S55720-S210	AQR2576NJ

Heating, ventilation and air conditioning - room temperature control

Room temperature controllers with integrated sensing

Wall-mounted

QMX3.P30

Room sensor KNX for temperature, white



Functions:

- Temperature sensor
- Temperature control, adjustable as PWM control and/or modulating control (PID algorithm), for pure heating mode, pure cooling mode, heating and cooling mode
- Operating modes switchable via KNX and/or display: Comfort mode, Pre-Comfort, energy savings and protection mode
- Adjustable commissioning and control parameters for radiated heating, slow and fast, floor heating slow and fast
- Integrated bus coupling unit
- 3 independently adjustable switching values for CO₂ concentration and relative air humidity for air quality control
- Actuating variable for 1, 2, or 3-stage fans (humidity and CO₂)
- Actuating variable for 1, 2, or 3-point positioning signal (humidity and CO₂)
- Setpoint for room temperature and relative humidity and CO₂ concentration adjustable via KNX

Data sheet	N1602
Voltage supply	KNX bus
Measuring range, temperature	0...50 °C
Sensing element, temperature	NTC
Communication	KNX PL-Link KNX S-Mode KNX LTE-Mode
Color	White
Degree of protection	IP30
Dimensions (W x H x D)	88.4 x 133.4 x 18 mm
Weight (net)	0.19 kg
Warranty	24 WarrantyMonths

Stock no.	Product no.
S55624-H103	QMX3.P30

7

Heating, ventilation and air conditioning - room temperature control

Room temperature controllers with integrated sensing

Wall-mounted

Room sensor KNX for temperature, black

QMX3.P30-1BSC

Functions:

- Temperature sensor
- Temperature control, adjustable as PWM control and/or modulating control (PID algorithm), for pure heating mode, pure cooling mode, heating and cooling mode
- Operating modes switchable via KNX and/or display: Comfort mode, Pre-Comfort, energy savings and protection mode
- Adjustable commissioning and control parameters for radiated heating, slow and fast, floor heating slow and fast
- Integrated bus coupling unit
- 3 independently adjustable switching values for CO₂ concentration and relative air humidity for air quality control
- Actuating variable for 1, 2, or 3-stage fans (humidity and CO₂)
- Actuating variable for 1, 2, or 3-point positioning signal (humidity and CO₂)
- Setpoint for room temperature and relative humidity and CO₂ concentration adjustable via KNX



Data sheet	N1602
Voltage supply	KNX bus
Measuring range, temperature	0...50 °C
Sensing element, temperature	NTC
Communication	KNX PL-Link KNX S-Mode KNX LTE-Mode
Color	Black
Degree of protection	IP30
Dimensions (W x H x D)	88.4 x 133.4 x 18 mm
Warranty	24 WarrantyMonths

Stock no.

Product no.

S55624-H123

QMX3.P30-1BSC

7

Heating, ventilation and air conditioning - room temperature control

Room temperature controllers with integrated sensing

Wall-mounted

QMX3.P40



Room sensor KNX for temperature and humidity, white

Functions:

- Multisensor for temperature and humidity
- Temperature control, adjustable as PWM control and/or modulating control (PID algorithm), for pure heating mode, pure cooling mode, heating and cooling mode
- Operating modes switchable via KNX and/or display: Comfort mode, Pre-Comfort, energy savings and protection mode
- Adjustable commissioning and control parameters for radiated heating, slow and fast, floor heating slow and fast
- Integrated bus coupling unit
- 3 independently adjustable switching values for CO₂ concentration and relative air humidity for air quality control
- Actuating variable for 1, 2, or 3-stage fans (humidity and CO₂)
- Actuating variable for 1, 2, or 3-point positioning signal (humidity and CO₂)
- Setpoint for room temperature and relative humidity and CO₂ concentration adjustable via KNX

Data sheet	N1602
Voltage supply	KNX bus
Measuring range	NTC: 0...50 °C Humidity: 10%...95 % r.F.
Sensing element	Temperature sensor, relative humidity sensor
Measuring range, temperature	0...50 °C
Sensing element, temperature	NTC
Communication	KNX PL-Link KNX S-Mode
Color	White
Degree of protection	IP30
Dimensions (W x H x D)	88.4 x 133.4 x 18 mm
Weight (net)	0.71 kg
Warranty	24 WarrantyMonths

Stock no.	Product no.
S55624-H116	QMX3.P40

7

Heating, ventilation and air conditioning - room temperature control

Room temperature controllers with integrated sensing

Wall-mounted

Room sensor KNX for temperature and humidity, black

QMX3.P40-1BSC

Functions:

- Multisensor for temperature and humidity
- Temperature control, adjustable as PWM control and/or modulating control (PID algorithm), for pure heating mode, pure cooling mode, heating and cooling mode
- Operating modes switchable via KNX and/or display: Comfort mode, Pre-Comfort, energy savings and protection mode
- Adjustable commissioning and control parameters for radiated heating, slow and fast, floor heating slow and fast
- Integrated bus coupling unit
- 3 independently adjustable switching values for CO₂ concentration and relative air humidity for air quality control
- Actuating variable for 1, 2, or 3-stage fans (humidity and CO₂)
- Actuating variable for 1, 2, or 3-point positioning signal (humidity and CO₂)
- Setpoint for room temperature and relative humidity and CO₂ concentration adjustable via KNX



Data sheet	N1602
Voltage supply	KNX bus
Measuring range	NTC: 0...50 °C Humidity: 10%...95 % r.F.
Sensing element	Temperature sensor, relative humidity sensor
Measuring range, temperature	0...50 °C
Sensing element, temperature	NTC
Communication	KNX PL-Link KNX S-Mode
Color	Black
Degree of protection	IP30
Dimensions (W x H x D)	88.4 x 133.4 x 18 mm
Warranty	24 WarrantyMonths

Stock no.

Product no.

S55624-H124

QMX3.P40-1BSC

7

Heating, ventilation and air conditioning - room temperature control

Room temperature controllers with integrated sensing

Wall-mounted

QMX3.P70



Room sensor KNX for temperature, humidity, CO2, white

Functions:

- Multisensor for temperature, humidity and CO2
- Air quality indicator with LED
- Temperature control, adjustable as PWM control and/or modulating control (PID algorithm), for pure heating mode, pure cooling mode, heating and cooling mode
- Operating modes switchable via KNX and/or display: Comfort mode, Pre-Comfort, energy savings and protection mode
- Adjustable commissioning and control parameters for radiated heating, slow and fast, floor heating slow and fast
- Integrated bus coupling unit
- 3 independently adjustable switching values for CO2 concentration and relative air humidity for air quality control
- Actuating variable for 1, 2, or 3-stage fans (humidity and CO2)
- Actuating variable for 1, 2, or 3-point positioning signal (humidity and CO2)
- Setpoint for room temperature and relative humidity and CO2 concentration adjustable via KNX

Data sheet	N1602
Voltage supply	KNX bus
Measuring range	400...10000 ppm CO ₂
Sensing element	Temperature sensor, CO2 sensor, relative humidity sensor
Measuring range, temperature	0...50 °C
Sensing element, temperature	NTC
Communication	KNX PL-Link KNX S-Mode KNX LTE-Mode
Color	White
Degree of protection	IP30
Dimensions (W x H x D)	88.4 x 133.4 x 18 mm
Weight (net)	0.19 kg
Warranty	24 WarrantyMonths

Stock no.	Product no.
S55624-H104	QMX3.P70

Heating, ventilation and air conditioning - room temperature control

Room temperature controllers with integrated sensing

Wall-mounted

Room sensor KNX for temperature, humidity, CO₂, black

QMX3.P70-1BSC

Functions:

- multisensor for temperature, humidity and CO₂
- Air quality indicator with LED
- Temperature control, adjustable as PWM control and/or modulating control (PID algorithm), for pure heating mode, pure cooling mode, heating and cooling mode
- Operating modes switchable via KNX and/or display: Comfort mode, Pre-Comfort, energy savings and protection mode
- Adjustable commissioning and control parameters for radiated heating, slow and fast, floor heating slow and fast
- Integrated bus coupling unit
- 3 independently adjustable switching values for CO₂ concentration and relative air humidity for air quality control
- Actuating variable for 1, 2, or 3-stage fans (humidity and CO₂)
- Actuating variable for 1, 2, or 3-point positioning signal (humidity and CO₂)
- Setpoint for room temperature and relative humidity and CO₂ concentration adjustable via KNX



Data sheet	N1602
Voltage supply	KNX bus
Measuring range	400... 10000 ppm CO ₂
Sensing element	Temperature sensor, CO ₂ sensor, relative humidity sensor
Measuring range, temperature	0...50 °C
Sensing element, temperature	NTC
Communication	KNX PL-Link KNX S-Mode KNX LTE-Mode
Color	Black
Degree of protection	IP30
Dimensions (W x H x D)	88.4 x 133.4 x 18 mm
Warranty	24 WarrantyMonths

Stock no.

Product no.

S55624-H125

QMX3.P70-1BSC

Accessories for QMX3..

Product Title	Packaging unit	Data sheet	Stock no.	Product no.
Basic plate for conduit and cavity wall box		N1602	S55624-H110	QMX3.MP1

7

Heating, ventilation and air conditioning - room temperature control

Room temperature controllers with detached operation

RXB

RXB2..



Room controller with KNX communication

The controllers are used for temperature control in individual rooms.

- For 2-pipe with changeover or 4-pipe fan coil systems
- For radiator and chilled ceiling (RXB24.1 only)
- Control of thermal valve actuators AC 24 V, PWM, valve actuators AC 24 V (3-position) as well as KNX bus actuators
- Potential-free relay contacts for fan speed control
- Connecting relay for electric heating (RXB22.1 und RXB39.1)
- KNX bus communication
- Connection to Desigo building automation and control system via PXKNX
- Commissioning with "Handy Tool" QAX34.3 or Synco ACS

Application description fan coil: CM110672

Application description RAD/CLC: CM110671

Operating voltage	AC 230 V
Frequency	50/60 Hz
Power consumption	Max. 12 VA
Control Algorithm	PI
Communication	Bus: KNX (S-mode and LTE mode) Room unit: PPS2
Digital inputs, number	2
Relay output, switching voltage	AC 250 V
Relay output, switching current	5 (4) A
Triac outputs	PWM 3-position
Triac output, switching voltage	AC 24 V
Triac output, switching current	0.5 A
Interface type	KNX-bus
Mounting	DIN rail
Mounting location	Ceiling voids with cover Fan coil Panel
Degree of protection	IP30
Dimensions (W x H x D)	113 x 167 x 62 mm

Range overview RXB2..

Product Title	Triac outputs, number	Relay outputs, number	Data sheet	Stock no.	Product no.
Room controller for 3-speed fan	4	3	N3873	BPZ:RXB21.1/FC-10	RXB21.1/FC-10
Room controller for 3-speed fan	4	3	N3873	BPZ:RXB21.1/FC-11	RXB21.1/FC-11
Room controller with 3-speed fan and electric heating coil	2	4	N3873	BPZ:RXB22.1/FC-12	RXB22.1/FC-12
Room controller for chilled ceilings and radiators	4	0	N3874	BPZ:RXB24.1/CC-02	RXB24.1/CC-02

The application determines the usable actuator (PWM/3-position) with the triac output

Heating, ventilation and air conditioning - room temperature control

Room temperature controllers with detached operation

RXB

Room controller for fan-coil applications with KNX communication

RXB39.1/FC-13

The RXB39.1 room controller is used for temperature control in individual rooms.

- For 2-pipe and 4-pipe fan coil systems with or without changeover
- PI control
- KNX bus communication
- Connection to Desigo building automation and control system via PXMKNX
- DC 0...10 V control of valve and actuators, fan (ECM), and electric heater
- 2 Potential-free relay contacts to release fan and electric heating
- Commissioning with ETS Professional, "Handy Tool" QAX34.3 or Synco ACS
- Operating voltage AC 230 V
- Plug-in screw terminals

Data sheet	N3875
Operating voltage	AC 230 V
Frequency	50/60 Hz
Power consumption	12 VA
Control Algorithm	PI
Communication	Bus: KNX Room unit: PPS2
Analog inputs, number	2
Analog outputs, number	3
Analog output, signal	DC 0...10 V
Digital inputs, number	4
Relay outputs, number	1
Electric reheater relay	1
Relay outputs	Change-over contact
Relay output, switching voltage	250 V
Relay output, switching current	5 (4)A
Dimension width (1 MW = 18 mm)	9.5 MW
Mounting	DIN rail For screw fixing
Mounting location	Ceiling voids with cover Fan coil Panel
Degree of protection	IP20
Dimensions (W x H x D)	152 x 120 x 62 mm
Product conformity	CE RCM
Warranty	24 WarrantyMonths

Stock no.

Product no.

S55373-C121

RXB39.1/FC-13

Heating, ventilation and air conditioning - room temperature control

Room temperature controllers with detached operation

Accessories for RXB..

RXZ20.1**Terminal cover for RXB2..**

Data sheet
Warranty

N3834
24 WarrantyMonths

Stock no.	Product no.
BPZ:RXZ20.1	RXZ20.1

RXZ30.1**Terminal cover for RXB3..**

Data sheet
Warranty

N3840
24 WarrantyMonths

Stock no.	Product no.
BPZ:RXZ30.1	RXZ30.1

QAX3..**Room unit with PPS2 interface**

Room units for acquiring the room temperature and operation of individual room control.

Voltage supply	PPS2
Power consumption	0.10 VA
Time constant	≤8 min
Measuring range, temperature	0...40 °C
Sensing element, temperature	NTC
Measurement accuracy	±0.25 K at 25 °C ±0.5 K at 5...30 °C
Setpoint readjustment range	±12 K
Mounting location	Indoors
Degree of protection	IP30

QAX30.1**Room unit with sensor and PPS2 interface**

- Acquisition of room temperature

Data sheet	N1741
Dimensions (W x H x D)	90 x 100 x 32 mm

Stock no.	Product no.
BPZ:QAX30.1	QAX30.1

QAX31.1**Room unit with sensor, setpoint adjuster and PPS2 interface**

- Acquisition of room temperature
- Setpoint adjuster for room temperature

Data sheet	N1741
Dimensions (W x H x D)	90 x 100 x 36 mm

Stock no.	Product no.
BPZ:QAX31.1	QAX31.1

Heating, ventilation and air conditioning - room temperature control

Room temperature controllers with detached operation

Accessories for RXB..

Room unit with sensor, setpoint and operating mode selector and PPS2 interface

- Acquisition of room temperature
- Setpoint adjuster for room temperature
- Rocker switch for mode selection (Off / Auto)

Data sheet N1641
Dimensions (W x H x D) 90 x 100 x 36 mm

QAX32.1



Stock no.	Product no.
BPZ:QAX32.1	QAX32.1

Room unit with sensor, setpoint and operating mode selector, fan speed selection, and PPS2 interface

- Acquisition of room temperature
- Setpoint adjuster for room temperature
- Rocker switch for mode selection (Off/Auto) and for manual fan control with fan coil systems (up to 3 speeds)

Data sheet N1642
Dimensions (W x H x D) 90 x 100 x 36 mm

QAX33.1



Stock no.	Product no.
BPZ:QAX33.1	QAX33.1

Room unit with sensor, setpoint and operating mode selector, display and PPS2 interface

- Acquisition of room temperature
- Rocker switch for adjustment of room temperature setpoint
- Rocker switch for mode selection (Off/Auto) and for manual fan control with fan coil systems (up to 3 speeds)
- LCD with display of room temperature and control mode
- Together with the RXB controllers for parameter setting

Data sheet N1640
Dimensions (W x H x D) 96 x 119 x 24 mm

QAX34.3



Stock no.	Product no.
BPZ:QAX34.3	QAX34.3

7

Heating, ventilation and air conditioning - room temperature control

Room sensors with KNX i-system

UP 223/..4



Pushbutton with scene controller and room temperature sensor, i-system

- Pushbutton in 3 pairs
- Horizontal operation
- Per pushbutton selectable function, scene controller
- LED for orientation light
- Labeling field
- Temperature sensor
- Connectable bus coupling unit (BTM) or flush-mounted actuators via BTI

Data sheet

A6V10416510

Range overview UP 223/..4

Product Title	Dimensions (WxHxD) [mm]	Stock no.	Product no.
Pushbutton, triple, with status LED, with scene controller, with room temperature sensor, titanium white, i-system	55 x 55 x 11	5WG1223-2AB14	UP 223/14
Pushbutton, triple, with status LED, with scene controller, with room temperature sensor, aluminum metallic, i-system	55 x 55 x 11	5WG1223-2AB34	UP 223/34

The bus transceiver module (BTM) (see Chapter System Products and Accessories) or flush-mounting actuator with bus transceiver module (BTM) must be ordered separately. The matching design frame must be ordered separately. See Chapter Display and Operation Units - Pushbutton accessories.

7

Heating, ventilation and air conditioning - room temperature control

Room sensors with KNX DELTA style

Pushbutton with scene controller and room temperature sensor, DELTA style

UP 287/..4

- Pushbutton in 4 pairs
- Vertical operation
- Per pushbutton selectable function, scene controller
- LED for orientation light
- Labeling field
- Temperature sensor
- Connectable bus coupling unit (BTM) or flush-mounted actuators via BTI

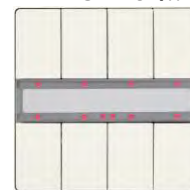

Data sheet

A6V10416538



Range overview UP 287/..4

Product Title	Dimensions (WxHxD) [mm]	Stock no.	Product no.
Pushbutton, quadruple, with status LED, titanium white, DELTA style	68 x 68 x 14	5WG1287-2AB14	UP 287/14
Pushbutton, quadruple, with status LED, platinum metallic, DELTA style	68 x 68 x 14	5WG1287-2AB44	UP 287/44

The bus transceiver module (BTM) (see Chapter System Products and Accessories) or flush-mounting actuator with bus transceiver module (BTM) must be ordered separately. The matching design frame must be ordered separately. See Chapter Display and Operation Units - Pushbutton accessories.

7

Heating, ventilation and air conditioning - room temperature control

Room sensors with KNX

GAMMA arina

UP 203/14



Touch sensor with status LED, scene controller and room temperature sensor, GAMMA arina, white

- Pair of touch areas for vertical operation
- Per touch area selectable function
- LED for orientation light
- Labeling field
- Room temperature sensor
- Integrated bus coupling unit

Data sheet
Dimensions (W x H x D)

A6V10438647
86 x 86 x 14 mm

Stock no.	Product no.
-----------	-------------

5WG1203-2DB14	UP 203/14
---------------	------------------

The suitable mounting frame is already included in the package.

Heating, ventilation and air conditioning - room temperature control

Room sensors without KNX i-system

Front modules for base module

AQR253..

- Front module with sensors
- Matching the DELTA line and DELTA miro frame program

Data sheet	N1411
Color	Titanium white
Degree of protection	IP30
Warranty	5 Years



Range overview AQR253..

Measuring range, temperature [°C]	Signal output temperature	Measurement range humidity [% r.h.]	Display	Dimensions (WxHxD) [mm]	Stock no.	Product no.
0...50	Active			55 x 55 x 12	S55720-S137	AQR2530NNW
0...50	Active	0... 100		55 x 55 x 12	S55720-S136	AQR2532NNW
0...50	Active	0... 100		55 x 55 x 12	S55720-S141	AQR2535NNW
0...50	Active	0... 100	CO ₂ indicator by LED	55 x 55 x 38	S55720-S219	AQR2535NNWQ

Matching the DELTA line and DELTA miro frame program. See chapter Display and Operation Units.
The relevant base modules must be ordered separately. See chapter Physical sensors.

Heating, ventilation and air conditioning - room temperature control

Room sensors without KNX

Wall-mounted

QAA2061



Room temperature sensor DC 0...10 V

Data sheet	N1749
Operating voltage	AC 24 V DC 13.5...35 V
Power consumption	1 VA
Sensing element	Pt1000
Measuring range, temperature	0...50 °C
Time constant	420 s
Measurement accuracy	At -50...50 °C: ±0.9 K
Connection, electrical	Screw terminals
Analog output, signal	DC 0...10 V
Degree of protection	IP30
Dimensions (W x H x D)	90 x 100 x 36 mm
Warranty	60 WarrantyMonths

Stock no.	Product no.
BPZ:QAA2061	QAA2061

QAA2061D



Room temperature sensor DC 0...10 V, with display

* Digital display	
Data sheet	N1749
Operating voltage	AC 24 V DC 13.5...35 V
Power consumption	1 VA
Sensing element	LG-Ni1000
Measuring range, temperature	0...50 °C
Time constant	420 s
Measurement accuracy	At -50...50 °C: ±0.9 K
Display	LCD
Connection, electrical	Screw terminals
Analog output, signal	DC 0...10 V
Degree of protection	IP30
Dimensions (W x H x D)	90 x 100 x 36 mm
Warranty	60 WarrantyMonths

Stock no.	Product no.
BPZ:QAA2061D	QAA2061D

QAD2012



Strap-on temperature sensor Pt1000

• Supplied complete with strap for pipe diameters from 15...140 mm.	
Data sheet	N1801
Measuring range, temperature	-30...130 °C
Sensing element, temperature	Pt1000
Time constant	3 s
Dimensions (W x H x D)	60 x 67 x 43 mm
Warranty	60 WarrantyMonths

Stock no.	Product no.
BPZ:QAD2012	QAD2012

Heating, ventilation and air conditioning - room temperature control

Room sensors without KNX Wall-mounted

Room temperature sensor Pt1000

QAA2012

- Passive sensors for acquiring the temperature in rooms.

Data sheet	N1745
Sensing element	Pt1000
Sensing element, temperature	Pt1000
Time constant	420 s
Measuring range, temperature	0...50 °C
Measurement accuracy	At 0...50 °C: ±0.6 K
Connection, electrical	Screw terminals
Degree of protection	IP30
Dimensions (W x H x D)	90 x 100 x 32 mm
Warranty	60 WarrantyMonths



Stock no.

Product no.

BPZ:QAA2012

QAA2012

Outside/room temperature sensor DC 0...10 V

QAC3161

Active sensor for acquiring the outside temperature. For use in heating, ventilation and air conditioning plants.

The QAC31.. may be used as an high-quality room sensor.

Data sheet	N1814
Operating voltage	AC 24 V DC 13.5...35 V
Power consumption	1 VA
Sensing element	Pt1000
Sensing element, temperature	Pt1000
Measuring range, temperature	-50...50 °C
Measurement accuracy	At -50...50 °C: ±0.9 K
Time constant	1200 s
Connection, electrical	Screw terminals
Analog output, signal	DC 0...10 V
Degree of protection	IP65
Dimensions (W x H x D)	80 x 88 x 39 mm
Warranty	60 WarrantyMonths



7

Stock no.

Product no.

BPZ:QAC3161

QAC3161

Heating, ventilation and air conditioning - room temperature control

Actuators with KNX

Electromotive valve actuators

AP 562/02



Electromotive valve actuator with LED valve position indication

Electromotive, proportional (constant) valve actuator with LED valve position indication and with integrated bus coupling unit for direct connection to KNX:

- For latching to valve adapter
- Delivery with valve adapterring VA80 for mounting on all regular valves with a connection thread of M30x1.5 mm and a ram stroke of up to 5.5 mm (e.g. Siemens series VPI46... and VPP46...)
- Max. positioning force: 120 N
- Cable (0.80 m) permanently connected to the enclosure for bus connection and two additional signaling contacts (e. g. window contacts), which can be connected as binary inputs
- For operation solely with the bus voltage, i. e. without external auxiliary power
- Maintenance-free, silent drive
- Automatic valve stroke detection, through which the actuator travel is adjusted to the valve used

Data sheet	A6V10416192
Number of channels	1
Relay outputs, number	2
Triac outputs, number	0
Dimensions (W x H x D)	50 x 82 x 65 mm

Stock no. Product no.

5WG1562-7AB02 **AP 562/02**

7

SSA..KN



Electromotoric actuators 100 N for valves with 1.2..6.5 mm stroke

For pressure independent combi valves (PICV), radiator valves, MiniCombi valves (MCV) and small globe valves.

Electromotoric actuators with KNX S-Mode and PL-Link communication for radiator, chilled ceiling, VAV and fan coil unit applications. With automatic stroke adaption, force-dependent switching off in the end position, LED position indication, and manual operation. Suited for use with Siemens PICV VPP46../VPI46..., Siemens radiator valves VDN../VEN../VUN..., Siemens MiniCombi valves VPD../VPE..., Siemens small valves VD1..CLC and on radiator valves with M30 x 1.5 connection without adapter (Heimeier, Cazzaniga, Oventrop M30x1.5, Honeywell-Braukmann, MNG, Junkers, Beulco new). Further valves of other manufacturers on request.

For fitting to the valve: Cap nut M30 x 1.5

Data sheet	A6V11858280
Positioning force	100 N
Stroke	1.2 mm 6.5 mm
Positioning time	50/100 s
Communication	KNX-TP
Degree of protection	IP54
Medium temperature	1...110 °C
Ambient humidity, operation	5...85 % r.h.
Dimensions (W x H x D)	88.6 x 83.4 x 51.4 mm
Mounting position	360°
Warranty	5 Years

Range overview SSA..KN

Operating voltage [V]	Auxiliary switch	Cable length [m]	Stock no.	Product no.
DC 21...30 24	0	1.5	S55180-A111	SSA118.09HKN

Heating, ventilation and air conditioning - room temperature control

Actuators with KNX

Damper and rotary actuators

VAV compact controller KNX

G..B181.1E/KN

- Compact controller with KNX communication for plants with variable or constant air volume flow
- Integrated, highly precise differential pressure sensor, damper actuator and digitally configurable air volume controller
- Nominal torque 5 or 10 Nm
- Air damper rotation angle mechanically adjustable between 0 and 90°
- Configurable as single device per room or for cascade control with pressure ratio 1:1, positive pressure, or negative pressure
- Prewired with a 0.9 m cable and a 0.9 m cable



Can be configured as damper actuator (without air volume control) with ETS.

Data sheet	N3547
Positioning time	150 s
Communication	KNX S-Mode KNX LTE-Mode KNX PL-Link
Cable length	0.9 m
Degree of protection	IP54
Dimensions (W x H x D)	71 x 158 x 61 mm
Warranty	5 Years

Range overview G..B181.1E/KN

Torque [Nm]	Operating voltage [V]	Air damper area [m ²]	Power consumption	Stock no.	Product no.
5	AC 24	0.8	3 VA 2.5 W	S55499-D134	GDB181.1E/KN
5	AC 24	0.8	3 VA 2.5 W	S55499-D505	GDB181.1EMKN
10	AC 24	1.5	3 VA 2.5 W	S55499-D135	GLB181.1E/KN
10	AC 24	1.5	3 VA 2.5 W	S55499-D263	GLB181.1EMKN

GDB181.EMKN packaging unit 18 pieces.
Basic Documentation No.: P3547

Heating, ventilation and air conditioning - room temperature control

Actuators with KNX

Damper and rotary actuators

GDB111.1E/KN



Rotary air damper actuators 5 Nm, without spring return

- KNX S-Mode or KNX PL-Link communication
- For shaft dia. 8...16 mm, square 6...12.8 mm, min. shaft length 30 mm
- With position indication and adjustable mechanical limit stop
- Button for disengaging the gear train to enable manual override
- With base made of steel, plastic housing and two 0.9 m connecting cables

Data sheet	A6V11566316
Torque	5 Nm
Air damper area	0.8 m ²
Angular rotation	90°
Power consumption	3 VA
	2.5 W
Positioning time	150 s
Communication	KNX TP
Cable length	0.9 m
Positioning signal	KNX TP
Spring return function	No
Degree of protection	IP54
Ambient humidity, operation	95 % r.h.
Dimensions (W x H x D)	68 x 137 x 59.5 mm
Operating voltage	AC 24 V
Auxiliary switch	0
Warranty	60 WarrantyMonths

Stock no.	Product no.
S55499-D190	GDB111.1E/KN

GLB111.1E/KN



Rotary air damper actuators 10 Nm, without spring return

- KNX S-Mode or KNX PL-Link communication
- For shaft dia. 8...16 mm, square 6...12.8 mm, min. shaft length 30 mm
- With position indication and adjustable mechanical limit stop
- Button for disengaging the gear train to enable manual override
- With base made of steel, plastic housing and two 0.9 m connecting cables

Data sheet	A6V11566316
Torque	10 Nm
Air damper area	1.5 m ²
Angular rotation	90°
Power consumption	3 VA
	2.5 W
Positioning time	150 s
Cable length	0.9 m
Positioning signal	KNX TP
Spring return function	No
Degree of protection	IP54
Ambient humidity, operation	95 % r.h.
Dimensions (W x H x D)	68 x 137 x 59.5 mm
Operating voltage	AC 24 V
Auxiliary switch	0
Warranty	60 WarrantyMonths

Stock no.	Product no.
S55499-D198	GLB111.1E/KN

Heating, ventilation and air conditioning - room temperature control

Actuators with KNX Damper and rotary actuators

Electromotoric rotary actuator KNX for control ball valves up to DN25

GDB111.9E/KN

Electromotoric rotary actuator

- for KNX S-Mode or KNX PL-Link communication
- for 2-/3-port control ball valves up to DN25
- for 6-port control ball valves up to DN25
- without spring-return
- pre-wired with two 0.9 m connection cables

Operating Mode 1:

- Use of two separate setpoints 0..100% for heating and cooling

Operating Mode 2:

- Use of one setpoint 0..100% for actuator position



Data sheet	A6V10725318
Torque	5 Nm
Angular rotation	90°
Power consumption	3 VA
	2.5 W
Positioning time	150 s
Cable length	0.9 m
Communication	KNX S-Mode or KNX PL-Link
Positioning signal	KNX S-Mode or KNX PL-Link
Spring return function	No
Degree of protection	IP54
Medium temperature	5...90 °C
Ambient humidity, operation	95 % r.h.
Dimensions (W x H x D)	88 x 112 x 143 mm
Mounting position	Horizontal or vertical
Operating voltage	AC 24 V
Position feedback	None
Auxiliary switch	0
Warranty	60 WarrantyMonths

Stock no.

Product no.

S55499-D203

GDB111.9E/KN

Heating, ventilation and air conditioning - room temperature control

Actuators with KNX

Damper and rotary actuators

GLB111.9E/KN

Electromotoric rotary actuator KNX for control ball valves up to DN50



- Electromotoric rotary actuator
- for KNX S-Mode or KNX PL-Link communication
 - for 2-/3-port control ball valves up to DN50
 - without spring-return
 - pre-wired with two connection cables

Data sheet	A6V10725318
Torque	10 Nm
Angular rotation	90°
Power consumption	3 VA
	2.5 W
Positioning time	150 s
Cable length	0.9 m
Communication	KNX S-Mode or KNX PL-Link
Positioning signal	KNX S-Mode or KNX PL-Link
Spring return function	No
Degree of protection	IP54
Dimensions (W x H x D)	88 x 112 x 143 mm
Mounting position	Upright to horizontal
Operating voltage	AC 24 V
Position feedback	KNX S-Mode or KNX PL-Link
Auxiliary switch	0
Warranty	60 WarrantyMonths

Stock no.

Product no.

S55499-D207

GLB111.9E/KN

Heating, ventilation and air conditioning - room temperature control

Actuators without KNX

Electrothermal valve actuators

Electrothermal actuators with connecting cable for radiator, small, and zone valves

STA..

Electrothermal actuators, NC in a deenergized state, with connection cable for:

- Radiator valves VUN..
- Radiator valves VPD.., VPE.., VPU..
- Small valves VD1..CLC..
- Zone valves V..I46..
- Combi valves VPP46.., VPI46.., VQP46..
- VVP47.., VXP47..
- Valves of other manufacturers



Actuators are equipped with connection cables

- 1m / 2m / 2m Halogenfree / 5m

The given positioning time refers to the maximum stroke of 4.5 mm.

Data sheet	A6V12968650
Force	110 N
Stroke	4.5 mm
Degree of protection	IP54
Dimensions (W x H x D)	41 x 68 x 39 mm
Warranty	5 Years

Range overview STA..21..

Operating voltage [V]	Positioning time [s]	Cable length [m]	Stock no.	Product no.
AC/DC 24	270	1	S55174-A177	STA121
AC/DC 24	270	2	S55174-A181	STA121.L20
AC/DC 24	270	2	S55174-A195	STA121.L20H
AC/DC 24	270	5	S55174-A185	STA121.L50
AC 230	210	1	S55174-A178	STA321
AC 230	210	2	S55174-A182	STA321.L20
AC 230	210	2	S55174-A196	STA321.L20H
AC 230	210	5	S55174-A186	STA321.L50

7

Heating, ventilation and air conditioning - room temperature control

Actuators without KNX

Electrothermal valve actuators

STP..



Electrothermal actuators with connecting cable for radiator, small, and zone valves

Electrothermal actuators, NO in a deenergized state, with connection cable for:

- Radiator valves VUN..
- Radiator valves VPD.., VPE.., VPU..
- Small valves VD1..CLC..
- Zone valves V..I46..
- Combi valves VPP46.., VPI46.., VQP46..
- VVP47..., VXP47..
- Valves of other manufacturers

Actuators are equipped with connection cables

- 1m / 2m / 2m Halogenfree / 5m

The given positioning time refers to the maximum stroke of 4.5 mm.

Data sheet	A6V12968650
Force	110 N
Stroke	4.5 mm
Degree of protection	IP54
Dimensions (W x H x D)	41 x 72 x 39 mm
Warranty	5 Years

7

Range overview STP..21..

Operating voltage [V]	Positioning time [s]	Cable length [m]	Stock no.	Product no.
AC/DC 24	270	1	S55174-A179	STP121
AC/DC 24	270	2	S55174-A183	STP121.L20
AC/DC 24	270	5	S55174-A187	STP121.L50
AC 230	210	1	S55174-A180	STP321
AC 230	210	2	S55174-A184	STP321.L20
AC 230	210	5	S55174-A188	STP321.L50

Heating, ventilation and air conditioning - room temperature control

Actuators without KNX

Electromotoric valve actuators

Electromotoric actuators 100 N for valves with 1.2...6.5 mm stroke

SSA..

For pressure independent combi valves (PICV), radiator valves, MiniCombi valves (MCV) and small globe valves.

Electromotoric actuators for modulating control in radiator, chilled ceiling, VAV and fan coil unit applications. With automatic stroke adaption, force-dependent switching off in the end position, LED position indication, feedback signal, and manual operation. Suited for use with Siemens PICV VPP46../VPI46.., Siemens radiator valves VDN../VEN../VUN.., Siemens MiniCombi valves VPD../VPE.., Siemens small valves VD1..CLC and on radiator valves with M30 x 1.5 connection without adapter (Heimeier, Cazzaniga, Oventrop M30x1.5, Honeywell-Braukmann, MNG, Junkers, Beulco new). Further valves of other manufacturers on request.



For fitting to the valve: Cap nut M30 x 1.5
1.2 mm minimal stroke required for self calibration

Data sheet	CE1N4893, A6V11858278, A6V11858276
Stroke	1.2 mm 6.5 mm
Positioning force	100 N
Degree of protection	IP54
Medium temperature	1... 110 °C
Mounting position	360°
Warranty	5 Years

Range overview SSA..

Operating voltage [V]	Positioning signal	Power consumption [VA]	Auxiliary switch	Cable length [m]	Stock no.	Product no.
AC 24	3-position	0.8	0	1.5	S55180-A106	SSA131.00
AC 24	4...20 mA	2.5	0	1.5	S55180-A110	SSA151.05HF
DC 24						
AC 24	DC 0...10 V	2.5	0	1.5	S55180-A107	SSA161.05
DC 24						
AC 24	DC 0...10 V	2.5	0	1.5	S55180-A108	SSA161.05HF
DC 24						
AC 24	DC 0...10 V	2.5	0	1.5	S55180-A109	SSA161E.05HF
DC 24						
AC 230	3-position	7	0	1.5	S55180-A105	SSA331.00

Positioning time for 2.5 mm stroke.

7

Heating, ventilation and air conditioning - room temperature control

Actuators without KNX

Electromotoric valve actuators

SSA911.01ZB

Radiator valve actuator ZigBee



Battery-powered radiator valve actuator

- Communication with Siemens Connected Home
- ZigBee wireless protocol
- Display with user interface
- Integrated temperature sensor
- Local temperature control algorithm
- 2x AA alkaline batteries
- M30 x 1.5 valve connection

Data sheet	A6V12789814
Positioning force	90 N
Stroke	5 mm
Communication	Zigbee
Degree of protection	IP20
Medium temperature	20...70 °C
Ambient humidity, operation	65 % r.h.
Dimensions (W x H x D)	55 x 68 x 86 mm
Operating voltage	3.0 V
Warranty	24 WarrantyMonths

Stock no.

Product no.

S55181-A103

SSA911.01ZB

7

Heating, ventilation and air conditioning - room temperature control

Other products

Central control unit RMB795B-1

Central control unit for room controllers and room thermostats

RMB795B-1



- Central control unit with integrated control and supervisory functions for individual room control with RXB room controllers and room thermostats RDG/RDF
- Central collection of heating and cooling demands from any KNX room controllers
- Control of any HVAC primary controllers in dependence on the received and calculated heating/cooling demands
- Individual time programs for room groups
- Preselected operating modes and setpoints, minimum / maximum temperature supervision and supervision of RXB room controllers and room thermostats RDG/RDF
- Trend and fault reporting functions for the input variables temperature, relative / absolute humidity, pressure / differential pressure, volumetric air flow, indoor air quality, etc.
- Heating / cooling changeover function for operation with 2-pipe systems
- Flexible configuration
- Clear-text operation with separate operator unit (plug-in type or detached)
- Integrated KNX bus communication
- No commissioning tool required

The RMB795B-1 supports the languages: English, German, French, Italian, Spanish, Portuguese, Dutch, Danish, Finnish, Norwegian, Swedish, Polish, Czech, Hungarian, Russian, Slovak, Bulgarian, Greek, Romanian, Slovenian, Serbian, Croatian, Turkish, Chinese.

Extension modules complement the central control unit and offer extra functions. They are attached to the controller via plug-in connectors. The extension modules do not operate autonomously. The operation of the device from commissioning to enduser operation can be done via the operator unit.

Available extension modules:

- 1 universal module RMZ785
- 2 universal modules RMZ787

A total of 3 extension modules can simultaneously be used with the central control unit.

Available operator units:

- Plug-in type operator unit RMZ790
- Detached operator unit RMZ791
- Bus operator unit RMZ792

Data sheet	N3122
Operating voltage	AC 24 V
Frequency	50/60 Hz
Power consumption	12 VA
Communication	KNX (KNX TP1)
Analog outputs, number	2
Analog output, signal	DC 0...10 V
Analog output, current	Max. 1 mA
Digital outputs, number	4
Universal inputs, number	6
Universal input, signal	2 x LG-Ni1000 DC 0...10 V Potential-free digital status contact LG-Ni1000 Pt1000 T1 (PTC)
Relay outputs, number	4
Relay output, switching voltage	AC 19...250 V
Relay output, switching current	4 (3) A
Mounting	DIN rail
Degree of protection	IP20
Dimensions (W x H x D)	173 x 90 x 80 mm
Warranty	24 WarrantyMonths

Stock no.

Product no.

S55370-C162

RMB795B-1

7

Heating, ventilation and air conditioning - room temperature control

Other products

Window contacts

S 290/11



Door/window contact, white

- Opening alarm for the monitoring of windows and doors, comprising:
 - 1 magnet (Ø 8 x 30 mm)
 - 1 magnetically operated contact in a fully cast plastic enclosure (Ø 8 x 30 mm)
 - Switching voltage: max. DC 110 V
 - Switching current: 10...100 mA
 - Contact current carrying capacity: max. 5 W
 - Contact resistance: max. 150 mW
 - VdS-class B
 - 5 m long connection cable LiYY 4 x 0,14 mm²
- Suitable for flush and surface mounting
- 2 surface-mounting enclosure tops (43 x 12 x 12 mm)
- 2 surface-mounting enclosure bottoms
- 4 spacer plates (thickness: 2 x 4 mm or 2 x 2 mm)
- 2 flush-mounting flanges
- 4 antimagnetic countersunk self-tapping screws DIN 7982-ST2, 9 x 16-A2

Data sheet

A6V11793756

Dimensions (W x H x D)

43 x 12 x 12 mm

Stock no.

Product no.

5WG1290-7AB11

S 290/11

Dual sensor for brightness measurement, temperature measurement, sun protection control, lighting control

AP 254/02



- Brightness measurement, temperature measurement, sun protection control, lighting control
- For the detection and transmission of brightness and temperature
 - Temperature measuring range -25 °C...+55 °C
 - Brightness measuring range 1 Lux...100 kLux
 - Horizontal sensing angle -60°...+60°, vertical -35°...+66.5°
- For the control of switch, dimming and shutter/blind actuators, depending on the ambient luminosity and/or ambient temperature
- One sun protection channel for the automatic control of sun protection equipment, with
 - Starting and stopping of automation by means of an object or a dusk threshold
 - Up to three brightness thresholds for determining the height and position of the shutters/blinds or roller shutters
 - Optional teach-in of dusk thresholds and brightness thresholds by means of a teach-in facility
 - Blocking object for the temporary deactivation of the sun protection channel function
- Up to four universal channels for the control of switch, dimming and shutter/blind actuators, depending on ambient luminosity and/or temperature. Optionally available with:
 - Threshold switches for brightness
 - Threshold switches for temperature
 - Threshold switches with logical combination of brightness and temperature
 - Optional teach-in of brightness threshold for each universal channel by means of an associated teach-in facility
 - Deactivation option for each universal channel by means of an associated blocking object (1 bit)
 - Optional second object for transmission of a second telegram on fulfillment of threshold conditions
- Bus-powered electronics
- Integrated bus coupling units
- Bus connection via bus terminal
- Surface mounting
- Degree of protection: IP54

Data sheet A6V10416100
 Dimensions (W x H x D) 72 x 110 x 54 mm

Stock no. Product no.
 5WG1254-3EY02 AP 254/02

Outside sensor Pt1000

QAC2012



- For acquiring the outside temperature and – to a lesser degree – solar radiation, the effect of wind and the temperature of the wall.

Data sheet N1811
 Measuring range, temperature -50...70 °C
 Sensing element Pt1000
 Sensing element, temperature Pt1000
 Time constant 840 s
 Measurement accuracy 0 °C: ±0.3 K
 Dimensions (W x H x D) 80 x 92 x 50 mm
 Warranty 60 WarrantyMonths

Stock no. Product no.
 BPZ:QAC2012 QAC2012

Heating, ventilation and air conditioning - room temperature control

Other products

Outside temperature sensors

QAC3161



Outside/room temperature sensor DC 0...10 V

Active sensor for acquiring the outside temperature. For use in heating, ventilation and air conditioning plants.

The QAC31.. may be used as an high-quality room sensor.

Data sheet	N1814
Operating voltage	AC 24 V DC 13.5...35 V
Power consumption	1 VA
Sensing element	Pt1000
Sensing element, temperature	Pt1000
Measuring range, temperature	-50...50 °C
Measurement accuracy	At -50...50 °C: ±0.9 K
Time constant	1200 s
Connection, electrical	Screw terminals
Analog output, signal	DC 0...10 V
Degree of protection	IP65
Dimensions (W x H x D)	80 x 88 x 39 mm
Warranty	60 WarrantyMonths

Stock no.

Product no.

BPZ:QAC3161

QAC3161

Heating, ventilation and air conditioning - room temperature control

Other products

Condensation monitors

Condensation monitor

QXA21..

For preventing condensation in buildings with chilled ceilings or in cooling plants.

Data sheet	A6V10741072
Operating voltage	AC 24 V DC 24 V
Power consumption	1 VA
Digital outputs	1-pin Potential-free Changeover contact
Switching point	95 ± 4 % r.h.
Connection, electrical	Screw terminals
Degree of protection	IP40
Dimensions (W x H x D)	60 x 83 x 37 mm
Warranty	5 Years



Range overview QXA21..

Product Title	Stock no.	Product no.
Condensation monitor	S55770-T375	QXA2100
Condensation monitor with remote sensor head (cable length 1 m)	S55770-T376	QXA2101

Heating, ventilation and air conditioning - primary control



Overview and selection tools		274
Communicating controllers - Synco™ 700	Central control unit RMB795B..	276
	Heating controller RMH760B..	277
	Boiler sequence controller RMK770..	278
	Universal controllers RMU7..0B..	279
	Switching and monitoring device RMS705B..	280
	Extension modules and operator units for RMB, RMH, RMK, RMU and RMS	281
	Software, web and remote access	285

Heating, ventilation and air conditioning - primary control

Overview and selection tools

KNX - One system for all types of applications

Synco tool – support functions for quick commissioning

To facilitate commissioning, the Synco tool offers you a host of help functions and choices: Diagnostics including trending, for example, straightforward fault tracing thanks to access to all data points of all controllers, saving all settings on the PC, or printing commissioning reports.

Synco operating – efficient operation of plant with straightforward remote control

Thanks to the Synco web server, plant operation and monitoring can be effected from a PC or smartphone at any time and from any location. An alarm system delivers fault status or maintenance messages in due time, also via SMS or e-mail, if required. The app allows your customers operation from underway or from the sofa.

Simple concept for opening communication

With Synco, defining and commissioning of communication is child's play: Simply inter-connect the units, activate the bus power supply on the controller and set the device address. All relevant settings can be made directly via local operation.

GAMMA Building Control - simply add more functionality with KNX

With KNX, the functionalities of the system can be significantly enlarged, for example with lighting or shading control. The GAMMA portfolio offers corresponding actuators, sensors and interfaces, for example DALI and BACnet. Commissioning of those extensions is done with ETS (Engineering Tool Software). For example, simultaneous control of the ventilation system and of lighting via the same presence detectors, is possible.

Synco IC - easy and secure remote access

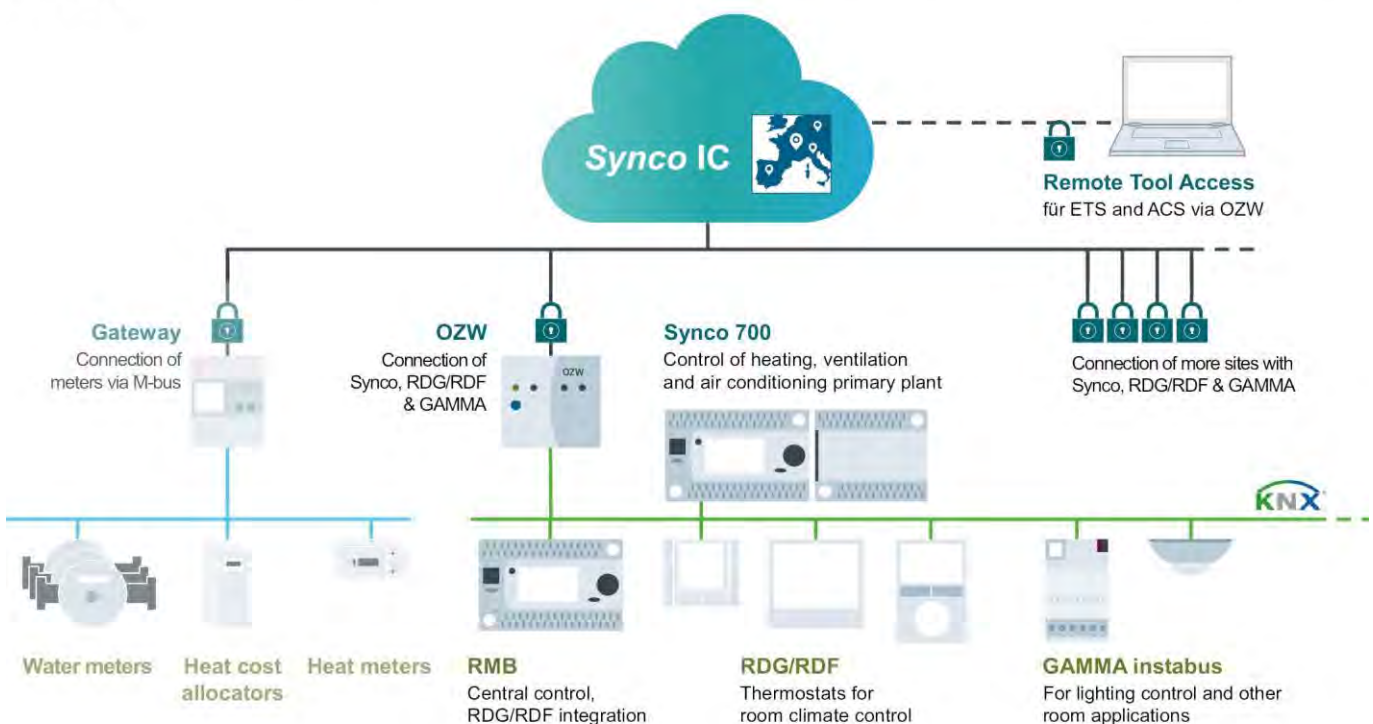

Synco IC is a web-based remote access system. Just connect your web server with the internet, create your account on the www.siemens-syncoic.com and enter the key for your web server. Setting up a secure internet access to your plant is therefore child's play.



Heating, ventilation and air conditioning - primary control

Overview and selection tools

Product details communicating controllers Synco™

Type													
	RMB795B-1	RMH760B-1	RMK770-1	RMU..			RMS705B-1	RMZ..					
				710B-1	720B-1	730B-1		782B	783B	785	787	788	789
	Central control unit RMB795B for room controllers and room thermostats	Modular heating controller max. 3 heating circuit	Boiler sequence controller	Modular universal controller, 1 control loop	Modular universal controller, 2 control loops	Modular universal controller, 3 control loops	Switching and Monitoring Device	Heating circuit module 3UI, 3DO, 1AO	DHW module 4UI, 5DO, 1AO	Universal module, 8UI	Universal module, 4UI, 4DO	Universal module, 4UI, 2DO, 2AO	Universal module, 6UI, 2AO, 4DO
Operation	■ ¹⁾	■ ¹⁾	■ ¹⁾	■ ¹⁾	■ ¹⁾	■ ¹⁾	■ ¹⁾						
KNX communication	■	■	■	■	■	■	■						
7-day time switch and holiday/special day programm	■	■	■	■	■	■	■						
Supervision	■	■	■	■	■	■	■						
Logic functions	■	■	■	■	■	■	■						
Outputs													
Step switch		■	■	■	■	■	■						
Relay	4	5	7	2	4	6	6	3	5		4	2	4
3-position		1	3					1	1				
DC 0...10 V	2	2	2	2	3	4	4	1	1			2	2
Universal inputs													
T1	■	■	■	■	■	■	■			■	■	■	■
Pt1000	■	■	■	■	■	■	■	■	■	■	■	■	■
DC 0...10 V	■	■	■	■	■	■	■	■	■	■	■	■	■
Digital	■	■	■	■	■	■	■	■	■	■	■	■	■
LG-Ni 1000	■	■	■	■	■	■	■	■	■	■	■	■	■
Number of universal inputs	6	6	8	6	8	8	8	3	4	8	4	4	6
Controlled variable													
Universal	■			■	■	■	■						
Temperatur °C	■	■	■	■	■	■	■						
Control mode													
PID		■	■	■	■	■	■						
P/PI		■	■	■	■	■	■						
Control loops													
Cascade		■	■	■	■	■	■						
Number		6	7	1	2	3	3						

■¹⁾ Optional operation:
 RMZ790: Plug-in operator unit
 RMZ791: Detached operator unit
 RMZ792: Bus operator unit

AO Analog output
 DO Digital output
 UI Universal inputs

Heating, ventilation and air conditioning - primary control

Communicating controllers - Synco™ 700

Central control unit RMB795B..

RMB795B-1



Central control unit for room controllers and room thermostats

- Central control unit with integrated control and supervisory functions for individual room control with RXB room controllers and room thermostats RDG/RDF
- Central collection of heating and cooling demands from any KNX room controllers
- Control of any HVAC primary controllers in dependence on the received and calculated heating/cooling demands
- Individual time programs for room groups
- Preselected operating modes and setpoints, minimum / maximum temperature supervision and supervision of RXB room controllers and room thermostats RDG/RDF
- Trend and fault reporting functions for the input variables temperature, relative / absolute humidity, pressure / differential pressure, volumetric air flow, indoor air quality, etc.
- Heating / cooling changeover function for operation with 2-pipe systems
- Flexible configuration
- Clear-text operation with separate operator unit (plug-in type or detached)
- Integrated KNX bus communication
- No commissioning tool required

The RMB795B-1 supports the languages: English, German, French, Italian, Spanish, Portuguese, Dutch, Danish, Finnish, Norwegian, Swedish, Polish, Czech, Hungarian, Russian, Slovak, Bulgarian, Greek, Romanian, Slovenian, Serbian, Croatian, Turkish, Chinese.

Extension modules complement the central control unit and offer extra functions. They are attached to the controller via plug-in connectors. The extension modules do not operate autonomously. The operation of the device from commissioning to enduser operation can be done via the operator unit.

Available extension modules:

- 1 universal module RMZ785
- 2 universal modules RMZ787

A total of 3 extension modules can simultaneously be used with the central control unit.

Available operator units:

- Plug-in type operator unit RMZ790
- Detached operator unit RMZ791
- Bus operator unit RMZ792

Data sheet	N3122
Operating voltage	AC 24 V
Frequency	50/60 Hz
Power consumption	12 VA
Communication	KNX (KNX TP1)
Analog outputs, number	2
Analog output, signal	DC 0...10 V
Analog output, current	Max. 1 mA
Digital outputs, number	4
Universal inputs, number	6
Universal input, signal	2 x LG-Ni1000 DC 0...10 V Potential-free digital status contact LG-Ni1000 Pt1000 T1 (PTC)
Relay outputs, number	4
Relay output, switching voltage	AC 19...250 V
Relay output, switching current	4 (3) A
Mounting	DIN rail
Degree of protection	IP20
Dimensions (W x H x D)	173 x 90 x 80 mm
Warranty	24 WarrantyMonths

Stock no.	Product no.
S55370-C162	RMB795B-1

Heating, ventilation and air conditioning - primary control

Communicating controllers - Synco™ 700

Heating controller RMH760B..

Heating controller

RMH760B-1

- Heating controller as primary controller or main controller (district heat) or heating circuit controller
- Boiler temperature control
- Control of max. 3 heating circuits and DHW heating (7 variants available) with optional extension modules
- Tested, predefined applications (refer to Application Catalog)
- Flexible configuration
- Clear-text operation with separate operator unit (plug-in type or detached)
- Integrated KNX bus communication
- No commissioning tool required



The RMH760B-1 supports the languages: English, German, French, Italian, Spanish, Portuguese, Dutch, Danish, Finnish, Norwegian, Swedish, Polish, Czech, Hungarian, Russian, Slovak, Bulgarian, Greek, Romanian, Slovenian, Serbian, Croatian, Turkish.

Extension modules complement the heating controller and offer extra functions. They are attached to the controller via plug-in connectors. The extension modules do not operate autonomously. The operation of the device from commissioning to enduser operation can be done via the operator unit.

Available extension modules:

- 2 heating circuit modules RMZ782B
- 1 DHW module RMZ783B
- 1 universal module RMZ787
- 2 universal modules RMZ789

A total of 4 extension modules can simultaneously be used with the heating controller.

Available operator units:

- Plug-in type operator unit RMZ790
- Detached operator unit RMZ791
- Bus operator unit RMZ792

Data sheet	N3133
Operating voltage	AC 24 V
Frequency	50/60 Hz
Power consumption	12 VA
Communication	KNX (KNX TP1)
Analog outputs, number	2
Analog output, signal	DC 0...10 V
Analog output, current	Max. 1 mA
Digital outputs, number	5
Universal inputs, number	6
Universal input, signal	T1 (PTC) Pt1000 Potential-free digital status contact NTC 575 LG-Ni1000 Digital pulse contact DC 0...10 V 2 x LG-Ni1000 1000...1175 Ohm 0...1000 Ohm
Relay outputs, number	5
Relay output, switching voltage	AC 19...250 V
Relay output, switching current	4 (3) A
Mounting	DIN rail
Degree of protection	IP20
Dimensions (W x H x D)	173 x 90 x 80 mm
Warranty	24 WarrantyMonths

Stock no.

Product no.

BPZ:RMH760B-1

RMH760B-1

Heating, ventilation and air conditioning - primary control

Communicating controllers - Synco™ 700

Boiler sequence controller RMK770..

RMK770-1



Boiler sequence controller

Modular heating controller with integrated control and supervisory functions for:

- Up to 6 boilers, multistage or modulating burners
- Precontrol, heating circuit
- Tested, predefined applications (refer to Application Catalog)
- Flexible configuration
- Clear-text operation with separate operator unit (plug-in type or detached)
- Integrated KNX bus communication
- No commissioning tool required

The RMK770-1 supports the languages: English, German, French, Italian, Spanish, Portuguese, Dutch, Danish, Finnish, Norwegian, Swedish, Polish, Czech, Hungarian, Russian, Slovak, Bulgarian, Greek, Romanian, Slovenian, Serbian, Croatian, Turkish.

Extension modules complement the boiler sequence controller and offer extra functions. They are attached to the controller via plug-in connectors. The extension modules do not operate autonomously. The operation of the device from commissioning to enduser operation can be done via the operator unit.

Available extension modules:

- 3 universal modules RMZ785
- 3 universal modules RMZ787
- 3 universal modules RMZ788
- 3 universal modules RMZ789

A total of 3 extension modules can simultaneously be used with the boiler sequence controller.

Available operator units:

- Plug-in type operator unit RMZ790
- Detached operator unit RMZ791
- Bus operator unit RMZ792

Data sheet	N3132
Operating voltage	AC 24 V
Frequency	50/60 Hz
Power consumption	12 VA
Communication	KNX (KNX TP1)
Analog outputs, number	2
Analog output, signal	DC 0...10 V
Analog output, current	Max. 1 mA
Digital inputs, number	2
Digital inputs	Potential-free input signal
Digital input, contact query	5 mA
	DC 15 V
Digital outputs, number	7
Universal inputs, number	8
Universal input, signal	T1 (PTC)
	Pt1000
	Potential-free digital status contact
	LG-Ni1000
	DC 0...10 V
	2 x LG-Ni1000
	1000...1175 Ohm
	0...1000 Ohm
Relay outputs, number	7
Relay output, switching voltage	AC 19...250 V
Relay output, switching current	4 (3) A
Mounting	DIN rail
Degree of protection	IP20
Dimensions (W x H x D)	173 x 90 x 80 mm
Warranty	24 WarrantyMonths

Stock no. Product no.

BPZ:RMK770-1

RMK770-1

Heating, ventilation and air conditioning - primary control

Communicating controllers - Synco™ 700

Universal controllers RMU7..0B..

Universal controller

RMU7..0B-1

- Universal controllers with integrated control and supervisory functions
- Suited for the controlled variables temperature, relative / absolute humidity, pressure / differential, air flow rate, indoor air quality, etc.
- Autonomous sequence controllers with P, PI or PID mode
- Tested, predefined applications (refer to Application Catalog)
- Flexible configuration
- Clear-text operation with separate operator unit (plug-in type or detached)
- Integrated KNX bus communication
- No commissioning tool required

The RMU7..0B-1 supports the languages: English, German, French, Italian, Spanish, Portuguese, Dutch, Danish, Finnish, Norwegian, Swedish, Polish, Czech, Hungarian, Russian, Slovak, Bulgarian, Greek, Romanian, Slovenian, Serbian, Croatian, Turkish, Chinese.

Extension modules complement the universal controller and offer extra functions. They are attached to the controller via plug-in connectors. The extension modules do not operate autonomously. The operation of the device from commissioning to enduser operation can be done via the operator unit.

Available extension modules:

- 1 universal module RMZ785
- 2 universal modules RMZ787
- 2 universal modules RMZ788

A total of 4 extension modules can simultaneously be used with the universal controller.

Available operator units:

- Plug-in type operator unit RMZ790
- Detached operator unit RMZ791
- Bus operating unit RMZ792

Data sheet	N3150
Operating voltage	AC 24 V
Frequency	50/60 Hz
Power consumption	12 VA
Communication	KNX (KNX TP1)
Analog output, signal	DC 0...10 V
Analog output, current	Max. 1 mA
Universal input, signal	LG-Ni1000 T1 (PTC) Pt1000 0...1000 Ohm 1000...1175 Ohm
	DC 0...10 V
	Digital pulse contact Potential-free digital status contact
Relay output, switching voltage	2 x LG-Ni1000 AC 19...250 V
Relay output, switching current	4 (3) A
Degree of protection	IP20
Dimensions (W x H x D)	173 x 90 x 80 mm

Range overview RMU7..0B..

Analog outputs, number	Universal- inputs, number	Relay outputs, number	Control loops, number	Stock no.	Product no.
2	6	2	1	BPZ:RMU710B-1	RMU710B-1
3	8	4	2	BPZ:RMU720B-1	RMU720B-1
4	8	6	3	BPZ:RMU730B-1	RMU730B-1

Heating, ventilation and air conditioning - primary control

Communicating controllers - Synco™ 700

Switching and monitoring device RMS705B..

RMS705B-1



Switching and monitoring device

The RMS705B-1 complements the range of Synco700 products as a freely configurable unit for

- control and supervisory functions in heating, ventilation and refrigeration plant
 - non-standard applications
- and, for this reason, offers no predefined standard applications.

The RMS705B-1 is especially suited for the following functions:

- Connection of additional universal alarm inputs
- Adding free inputs for display and supervision
- Event logging (e.g. legionella function)
- Additional time programs (ON / OFF) for basic functions
- Calculation of enthalpy, enthalpy differential, absolute humidity, dewpoint and wet bulb temperature
- Logic function blocks for switching on / off depending on different conditions
- Lead / lag control of pumps, fans, motors, etc., with automatic changeover
- Step switch with linear, binary or flexible functionality

The RMS705B-1 supports the languages: English, German, French, Italian, Spanish, Portuguese, Dutch, Danish, Finnish, Norwegian, Swedish, Polish, Czech, Hungarian, Russian, Slovak, Bulgarian, Greek, Romanian, Slovenian, Serbian, Croatian, Turkish, Chinese.

Extension modules complement the switching and monitoring device and offer extra functions. They are attached to the controller via plug-in connectors. The extension modules do not operate autonomously. The operation of the device from commissioning to enduser operation can be done via the operator unit.

Available extension modules:

- 1 universal module RMZ785
- 2 universal modules RMZ787
- 2 universal modules RMZ788

A total of 4 extension modules can simultaneously be used with the switching and monitoring device.

Available operator units:

- Plug-in operator unit RMZ790
- Detached operator unit RMZ791
- Bus operating unit RMZ792

Data sheet	N3124
Operating voltage	AC 24 V
Frequency	50/60 Hz
Power consumption	12 VA
Communication	KNX (KNX TP1)
Analog outputs, number	4
Analog output, signal	DC 0...10 V
Analog output, current	1 mA
Digital outputs, number	6
Universal inputs, number	8
Universal input, signal	T1 (PTC) Pt1000 Potential-free digital status contact LG-Ni1000 Digital pulse contact DC 0...10 V 2 x LG-Ni1000 0...1000 Ohm
Relay outputs, number	6
Relay output, switching voltage	AC 19...250 V
Relay output, switching current	4 (3)A
Mounting	DIN rail
Degree of protection	IP20
Dimensions (W x H x D)	173 x 90 x 80 mm
Warranty	24 WarrantyMonths

Stock no.	Product no.
S55370-C100	RMS705B-1

Heating, ventilation and air conditioning - primary control

Communicating controllers - Synco™ 700

Extension modules and operator units for RMB, RMH, RMK, RMU and RMS

Plug-in type operator unit

RMZ790

- Operator unit plugs into the Synco™ 700 controllers
- For displaying and changing plant data for service staff and enduser
- Clear-text operation
- Can be plugged in and removed during operation
- Power supply via the controller



Data sheet	N3111
Mounting	DIN rail
Warranty	24 WarrantyMonths

Stock no.	Product no.
-----------	-------------

BPZ:RMZ790	RMZ790
------------	--------

Detached operator unit with 3 m cable

RMZ791

Like plug-in type operator unit, but:

- Other mounting choices (typically for control panel door or wall mounting)
- Larger display
- Connection via a prefabricated 3 m cable, supplied as standard



Data sheet	N3112
Mounting	Surface mounted (plaster)
Warranty	24 WarrantyMonths



Stock no.	Product no.
-----------	-------------

BPZ:RMZ791	RMZ791
------------	--------

8

Bus operator unit

RMZ792

Communicating operator unit for operating up to 150 controllers, room units and central units from the Synco™ 700 range via KNX bus.

Favorite pages can be freely defined. Designed for fixed installation or mobile use.



Data sheet	N3113
Operating voltage	AC 24 V
Voltage supply	KNX bus
Power consumption	2.5 VA
Degree of protection	IP20
Dimensions (W x H x D)	145 x 96 x 34 mm
Warranty	24 WarrantyMonths

Stock no.	Product no.
-----------	-------------

BPZ:RMZ792	RMZ792
------------	--------

Heating, ventilation and air conditioning - primary control

Communicating controllers - Synco™ 700

Extension modules and operator units for RMB, RMH, RMK, RMU and RMS

QAW740



Room unit with KNX bus

Configurable unit with display of operating mode, timer, temperatures and fault.

With 3 operating elements:

- Knob for setpoint readjustments
- Operating mode button
- Timer button

Data sheet	N1633
Operating voltage	DC 24 V
Voltage supply	KNX bus
Measuring range, temperature	0...45 °C
Setpoint readjustment range	-3...3 K
Communication	KNX (KNX TP1)
Connection cable	2-wire
Degree of protection	IP20
Dimensions (W x H x D)	96 x 96 x 47 mm
Weight (net)	0.22 kg
Warranty	24 WarrantyMonths

Stock no.	Product no.
BPZ:QAW740	QAW740

RMZ78..

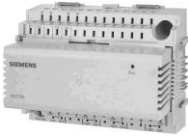

Universal modules

Additional inputs and outputs required by the Synco™ 700 controllers can be provided by these modules. A description of the functions is given with the relevant controller module.

Data sheet	N3146
Voltage supply	Supply from controller module
Power consumption	3 VA
Analog output, signal	DC 0...10 V
Analog output, current	Max. 1 mA
Universal input, signal	0...1000 Ohm
	1000...1175 Ohm
	DC 0...10 V
	Potential-free digital status contact
	LG-Ni1000
	Pt1000
	T1 (PTC)
	2 x LG-Ni1000
Relay outputs	switching contact, potential-free
Relay output, switching voltage	AC 19...265 V
Relay output, switching current	4 (3) A
Degree of protection	IP20
Dimensions (W x H x D)	117 x 90 x 75 mm

Range overview RMZ78..

Universal- inputs, number	Analog outputs, number	Relay outputs, number	Weight (net) [kg]	Stock no.	Product no.
4	2	2	0.322	BPZ:RMZ788	RMZ788
6	2	4	0.359	BPZ:RMZ789	RMZ789
8	0	0	0.3	BPZ:RMZ785	RMZ785
4	0	4	0.334	BPZ:RMZ787	RMZ787

Heating, ventilation and air conditioning - primary control

Communicating controllers - Synco™ 700

Extension modules and operator units for RMB, RMH, RMK, RMU and RMS

Heating circuit module

- Weather-compensated flow temperature control via heating circuit's mixing valve
 - Control of heating circuit pump
- The available heating circuit control and supervisory functions are the same as those of the RMH760B-1

RMZ782B

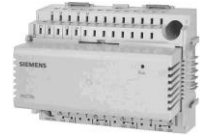

Data sheet	N3136
Operating voltage	AC 24 V
Voltage supply	Supply from controller module
Power consumption	3 VA
Analog outputs, number	1
Analog output, signal	DC 0...10 V
Analog output, current	1 mA
Universal inputs, number	3
Universal input, signal	LG-Ni1000 0...1000 Ohm 1000...1175 Ohm DC 0...10 V Pt1000 NTC 575 2 x LG-Ni1000
Relay outputs, number	3
Relay outputs	Normally open contact Potential-free
Relay output, switching voltage	AC 19...265 V
Relay output, switching current	4 (3)A
Degree of protection	IP20
Weight (net)	0.334 kg
Dimensions (W x H x D)	117 x 90 x 75 mm
Warranty	24 WarrantyMonths

Stock no.

Product no.

BPZ:RMZ782B

RMZ782B

Heating, ventilation and air conditioning - primary control

Communicating controllers - Synco™ 700

Extension modules and operator units for RMB, RMH, RMK, RMU and RMS

RMZ783B

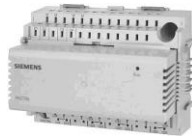

DHW module

- Control of the storage tank temperature
- Storage tank charging with integrated coil, with pump or mixing valve
- Storage tank charging with detached heat exchanger, with pump and mixing valve
- Storage tank charging according to a time program
- Control of the circulating pump according to a time program

Data sheet	N3136
Operating voltage	AC 24 V
Voltage supply	Supply from controller module
Power consumption	3 VA
Analog outputs, number	1
Analog output, signal	DC 0...10 V
Analog output, current	1 mA/1 A
Universal inputs, number	4
Universal input, signal	LG-Ni1000 0...1000 Ohm 1000...1175 Ohm DC 0...10 V Pt1000 NTC 575 2 x LG-Ni1000
Relay outputs, number	5
Relay outputs	Normally open contact Potential-free
Relay output, switching voltage	AC 19...265 V
Relay output, switching current	4 (3)A
Degree of protection	IP20
Weight (net)	0.36 kg
Dimensions (W x H x D)	117 x 90 x 75 mm
Warranty	24 WarrantyMonths

Stock no.	Product no.
-----------	-------------

BPZ:RMZ783B	RMZ783B
-------------	---------

RMZ780



Module connector

Module connector for detached mounting of extension modules within the control panel.

Data sheet	N3138
Max. cable length	10 m
Dimensions (W x H x D)	18.5 x 87.5 x 22.5 mm
Warranty	24 WarrantyMonths

Stock no.	Product no.
-----------	-------------

BPZ:RMZ780	RMZ780
------------	--------

Heating, ventilation and air conditioning - primary control Communicating controllers - Synco™ 700 Software, web and remote access

Commissioning and plant operating software

ACS790

PC software for commissioning, operating and supervision of HVAC plants.
Consists of 3 programs: ACS Tool, ACS Alarm and Remote Tool Access.

ACS Tool:

for plant commissioning, operating and service

- Popcard (standard and customized)
- Plant diagram (standard and customized)
- Plant view (standard and customized)
- Trend functions (online and offline)
- File transfer
- Parameter settings
- Commissioning protocol

ACS Alarm:

- For receiving and managing alarms

Remote Tool Access:

On web servers as of V7.0, you can establish a secure connection to the web server with the ACS790 and the "Remote Tool Access" software via Synco IC portal.

Commissioning and service via OCI7.. service interface

Compatible devices OCI700.1 and OCI702.

Plant operation and supervision for

KNX systems

- Web server: OZW772
- Synco™ living: QAX9...
- Controllers: Synco™700, Synco RXB
- Thermostats: RDF..., RDG...
- Sensors: QMX3.P30, QMX3.P70, AQR253.. and AQR257..

The software can be downloaded for free via <http://www.siemens.com/acs790>.

Data sheet

N5649

Stock no.

Product no.

S55800-Y100

ACS790

Heating, ventilation and air conditioning - primary control

Communicating controllers - Synco™ 700

Software, web and remote access

OCI702



USB - KNX Service interface

The service interface consists of:

- OCI702 service interface
- USB 2.0 cable (Type A / B)
- KNX service cable for Synco™ controllers (RJ45 / RJ45)
- KNX service cable for Desigo™ TRA (RJ45 / jack plug 2.5 mm)
- KNX service cable (RJ45 / KNX bus terminal)

With the respective PC software, the interfaces allows to commission and service devices with KNX communication, e.g. from the following ranges:

- Synco™ 700 controllers and room devices
- KNX room thermostats RDF..., RDG..
- Individual room controllers RXB..
- Synco™ living central apartment units QAX9...
- Desigo TRA
- GAMMA devices

Data sheet

A6V10438951

Degree of protection

IP20

Warranty

24 WarrantyMonths

Stock no.

Product no.

S55800-Y101

OCI702

Heating, ventilation and air conditioning - primary control

Communicating controllers - Synco™ 700

Software, web and remote access

Web server for Synco devices

OZW772..



Web server OZW772 allows for remote plant control and monitoring via the web.

- Operate web browser via PC/laptop and Smartphone
- Operate ACS (PC/laptop with ACS plant operating software)
- Connections: USB and Ethernet
- Display fault messages in the web browser
- Send fault messages to a maximum of 4 e-mail recipients
- Periodically send system reports to e-mail recipients
- Visualize the plants in the web browser based on standard plant diagrams and customized plant web pages
- Acquire and display consumption data
- Send consumption data file to 2 email recipients
- Function "Energy indicator" to monitor data points for energy-related limit values, or "Green limits"
- Web services for external applications via Web API (Web Application Programming Interface)
- Encrypted with https and TLS for e-mails
- Record of trends, display and dispatch to 2 e-mail recipients
- Integration up to 237 S-Mode data points of KNX devices (not OZW772.01)
- Direct commissioning with webbrowser or ACS service tool
- Easy and secure remote access and plant overview with Synco IC Remote Access - a web-based service for secure remote access (www.siemens-syncoic.com)

Internet portal Synco IC offers simple and secure access to your plants

- Simple and fast set up of access via the Internet (fixed net- or mobile router)
- The portal provides additional functions:
 - Manage one or multiple plants
 - Central user management
 - Display of plant overview, state of Energy indicators and alarms
 - Send alarm notifications per e-mail
 - Secured communications through encryption (https)

Web servers OZW772.01, OZW772.04, OZW772.16, OZW772.250 can connect 1, 4, 16, or 250 KNX devices from the product ranges Synco 700, Synco RXB, and RDG/RDF room thermostats, and the QAX Synco living central apartment units.

Data sheet	N5701
Operating voltage	Power pack: AC 230 V Web server: DC 24 V
Communication	KNX TP (twisted pair) Ethernet, RJ45 plug socket (shielded) USB V2.0
Mounting	On DIN rails With Screws
Degree of protection	IP30
Dimensions (W x H x D)	87.5 x 90 x 40 mm

Range overview OZW772..

Product Title	Stock no.	Product no.
Web server for 1 Synco device	BPZ:OZW772.01	OZW772.01
Web server for 4 Synco devices	BPZ:OZW772.04	OZW772.04
Web server for 16 Synco devices	BPZ:OZW772.16	OZW772.16
Web server for 250 Synco devices	BPZ:OZW772.250	OZW772.250

Modular installation system, room control box



Overview and selection tools		290
Room control box	Module boxes	295
	Modules	296
Junction box (UL/NEMA) devices		305

Modular installation system, room control box

Overview and selection tools

Decentralized and yet modular room automation with its own KNX components for flexible use in the room, based on one platform – regardless of installation location and type.

The different mounting forms allow a flexible installation in different locations in the room: in installation ducts, under a raised floor, above a suspended ceiling, and in wall boxes. The system presented here offers a great functional variety for installation in-wall, on-wall, in parapet ducts, in suspended ceilings, and under raised floors.

The Room Control Box AP 641, the Control Module Box AP 118, and the in-wall mounted UP devices enable distributed room control with a few devices, high flexibility, great adaptability and modularity. Both control boxes are assembled with RS or RL sensor/actuator modules in a special quick-mount design. The available modules are full KNX bus participants functioning as binary inputs and outputs, as well as blind actuators, universal dimmer, switch actuators, switch/dim actuators and as thermal drive actuators. The RS and RL modules have the same functionality as the flush-mounting UP actuators. Therefore identical functionality is available for different installation types or locations featuring the same configuration possibilities. As a result, the devices use a common application program regardless of mounting variant – i.e. devices for installation in the Room Control Box and automation control box as well as flush-mount with or without mounting frame.

Advantages of the modular installation systems

- with maintenance-free terminals for connection and through-wiring of untreated single-core, stranded or multi-core conductors,
- the actuator can be placed close to where the function is executed, i.e. the user operation interface and the actuator can be installed in the same location,
- Reduced wiring and less wall boxes must be installed. The actuator is accessible under the user operation interface for maintenance.

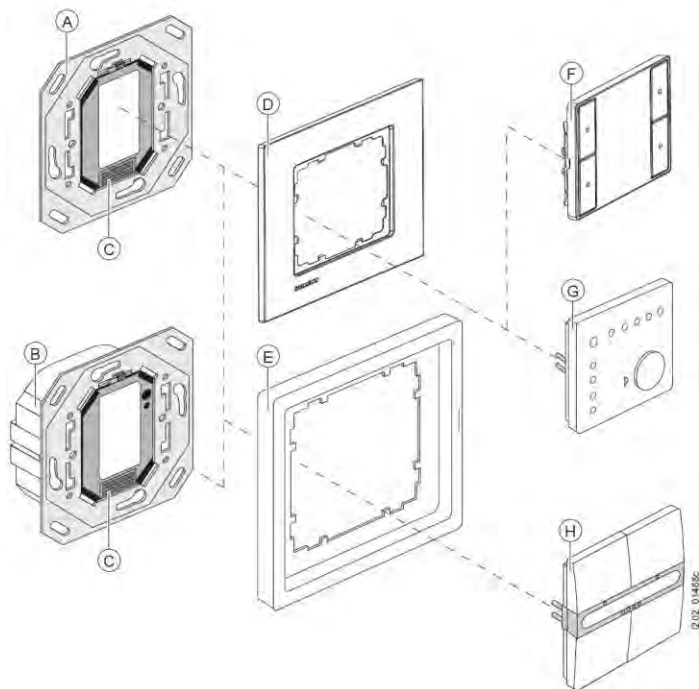
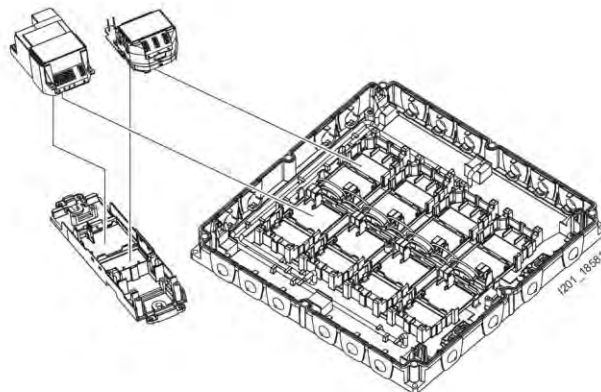

- (A) Bus transceiver module (BTM)
- (B) Flush-mounting actuator with bus transceiver module (BTM)
- (C) BTI interface
- (D) DELTA frames i-system
- (E) DELTA frames style
- (F) Pushbutton i-system
- (G) Temperature controller i-system
- (H) Pushbutton style

Modular installation system, room control box

Overview and selection tools

Modular bus transceiver module and flush-mounting actuator

A key feature of the GAMMA instabus is its uniform bus transceiver-module. The bus transceiver module (BTM) can be used as a stand-alone unit, as well as a combined version in various devices of the flush-mounting actuator range.

Implementation of the BTI interface (Bus Transceiver Interface) with the bus transceiver module (BTM) ensures maximum flexibility and an impressive range of functions. Bus coupling units (BTM) and flush-mounting actuators with integrated bus transceiver modules (BTM) enable the use of GAMMA display/operator interfaces. Thus, all GAMMA instabus operator interfaces with BTI interface in the design lines i-system and DELTA style can be combined with either a bus trans-

ceiver module (BTM) or a flushmounting actuator with bus transceiver module (BTM).

This reduces planning work and facilitates installation and commissioning. The application programs of the flush-mounting actuators are identical to those of the functionally equivalent devices from the modular room control range. This means that all devices have the same application program - regardless of mounting type - whether flush-mounting, with or without mounting frame - or whether designed for installation in the Room Control Box and Control Module Box.

Modular system for function-oriented installation of room automation

Siemens is the only company marketing a complete range of products for room automation and offering the highest flexibility when it comes to selecting the type and place of installation.

Solution 1: Room Control Box (AP 641) – compact and easy to install



Place of installation:

- In corridors above the false ceiling
- Power and bus lines are run to the Room Control Box AP 641.
- Load lines are run to the lights and the blind motors from the Room Control Box AP 641.

Benefits:

- Space-saving installation in a false ceiling and a raised floor
- Multifunctional, can be combined in a room-oriented way
- Can be flexibly equipped with actuator and sensor modules
- Low wiring costs
- Low fire load

Solution 2: Control Module Box (AP 118) – flexible and function-oriented

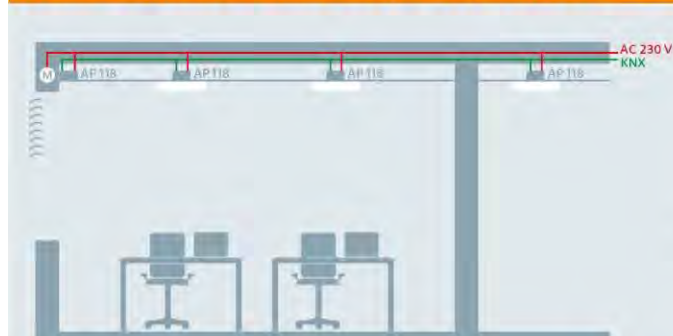

Place of installation:

- In a parapet duct and above the false ceiling (alternatively: in the lamps)
- Power and bus lines are run directly to the Control Module Boxes AP 118.
- The load lines are run to the lamps or the blind motors from the respective Control Module Box AP 118.

Benefits:

- Decentralized installation in false ceiling, cable duct and lamp housing
- Function-oriented installation
- Free choice of room-related functions
- Low fire load

Solution 3: Flush mounting (UP) – conventional and smart

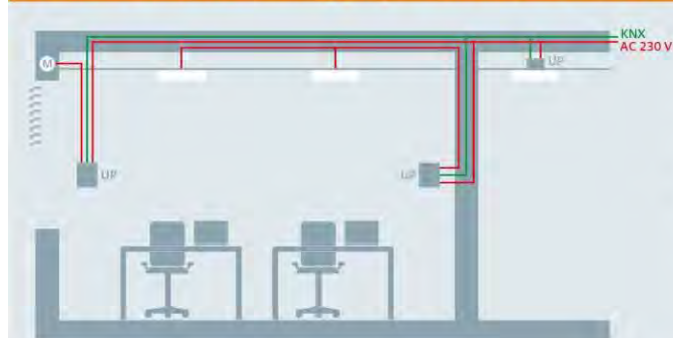

Place of installation:

- In flush-mounting boxes or parapet ducts
- Power and bus lines are run to the flush-mounting boxes.
- The load lines are run to the lamps or the blind motors from the respective flush-mounting actuator.

Benefits:

- Flexible combination of user interfaces and actuators
- Function-oriented installation
- Straightforward upgrading from conventional to KNX installations (e.g. for modernization)

Modular installation system, room control box

Overview and selection tools

Decentrally installed Room Control Box in office

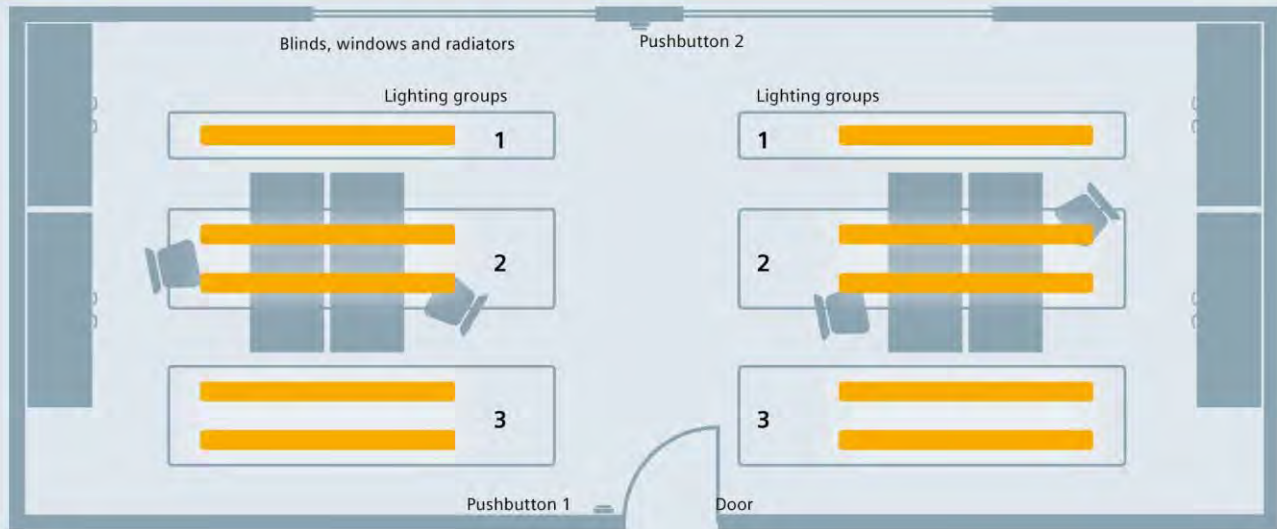

A decenterally installed Room Control Box for room functions

In an office with four workplaces, a window facade with two windows, three lighting groups, two blinds, two switched outlets, two radiators and two pushbuttons, the room function controls are to be installed simply, flexibly and decentralized. This is done by equipping a Room Control Box with two switching actuators RL 513/23 for the two groups of three lights, a shutter blind actuator RL 521/23 for the two blinds, two switching actuators RL 512 for two outlets, a thermo drive actuator RL 510K23 for the two radiators and a decentralized power supply RL 125 for additional island solutions. Seven of the eight slots in the Room Control Box are thus occupied, controlling the room with all of the required functions.

Modular installation system, room control box Overview and selection tools

Decentralized solution for a presence- and time-dependent temperature control

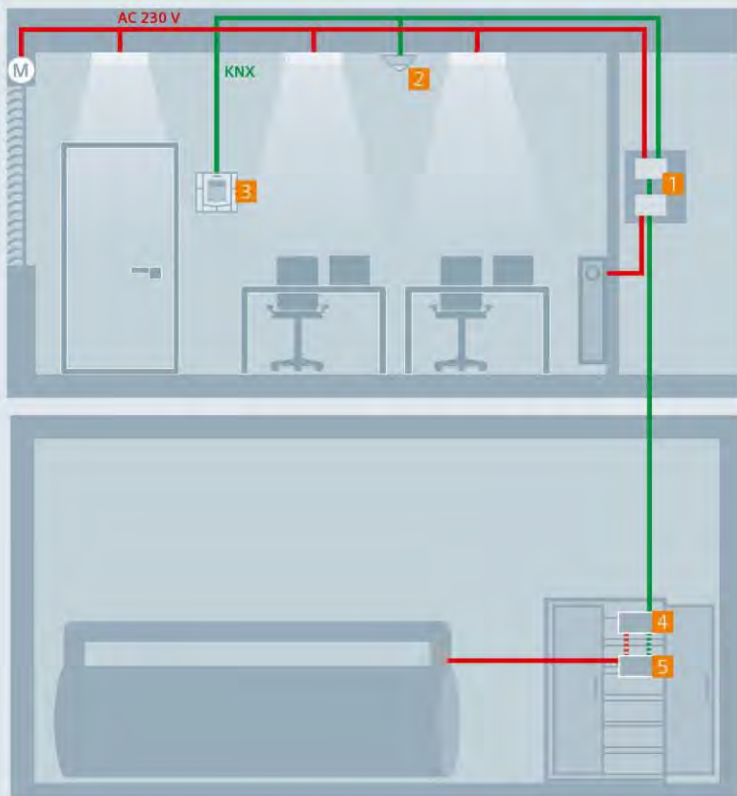

Legend:

- 1 Room Control Box AP 641 with actuators and sensors for room automation
- 2 Presence detector
- 3 Room temperature controller
- 4 Central control unit RMB795B
- 5 Heating controller with 0...10 V heating demand input or KNX interface

Optimal use of the thermo drive actuator

A room temperature controller installed in a room controls the thermo drive actuator installed in a Room Control Box to minimize the energy demand in the room. The energy demand is simultaneously transmitted via KNX to the central control unit RMB795, which determines the exact quantity of energy required for heating or cooling in all rooms, compares this demand with the time-controlled demands and transmits it to the heating or cooling controllers. This ensures the highest possible energy efficiency.

Modular installation system, room control box

Overview and selection tools

Modular room control for UL/NEMA markets

The modular installation system is also available for installation in standard 4" x 4" UL/NEMA junction boxes.

The full range of control devices comprises of a decentralized power supply, binary input, binary outputs (single, dual, triple), switching/dimming actuators, solar protection actuators, and universal dimmer.

These devices can either be mounted inside a standard 4" x 4" junction box or attached to a standard 4" x 4" junction box.

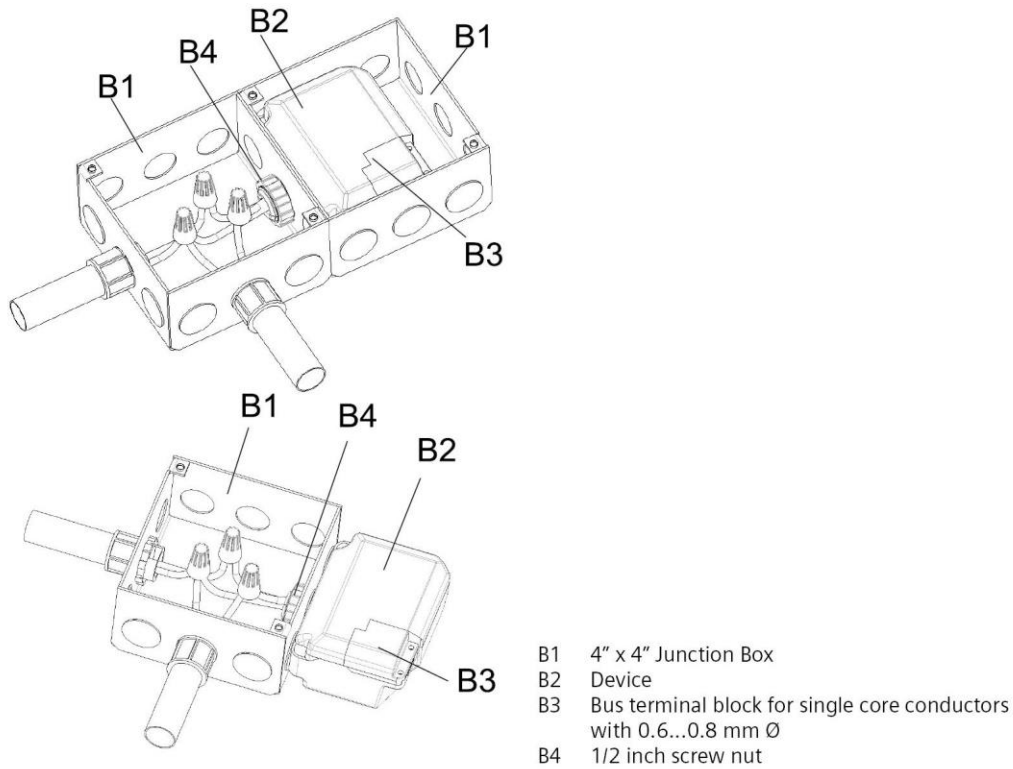

9

The decentralized power supply unit JB 125/23 provides the system power necessary for the instabus KNX.

For each bus line, at least one decentralized power supply unit JB 125/23 is needed. The decentralized power supply provides 80 mA bus current. Up to eight decentralized power supply units JB 125/23 may be attached in parallel to a single bus line providing a total bus current of 640 mA.

With the decentralized power supply independently operating control zones can be designed.

Placing the control devices close to the point of control allows for minimized wiring and thus significant installation cost reduction.

Modular installation system, room control box

Room control box

Module boxes

Control Module Box

- 1 slot for a sensor/actuator module, type RS or RL
- Separate connection compartment and strain relief for bus cable and functional lines
- Modular installation device with screw fixing for installation in linking ducts, under raised floors or for surface mounting on the ceiling
- Enclosure: Plastic
- Degree of protection: IP20

Data sheet A6V11438329
 Dimensions (W x H x D) 180 x 50 x 41.1 mm

AP 118/01



Stock no. Product no.
 5WG1118-4AB01 AP 118/01

Room Control Box

- 8 slots for a sensor/actuator module, type RS or RL
- Internal bus cable for connection of the sensor/actuator module to the bus
- Separate connection compartment and strain relief for functional lines
- Two PE/N bars for accommodation of the PE and neutral conductor of the functional lines
- Bus connection via bus terminal
- Modular installation device with screw fixing for installation under raised floors, on the wall or ceiling or in wet rooms
- Enclosure: Plastic
- Degree of protection: IP54

Data sheet A6V10416220
 Dimensions (W x H x D) 300 x 300 x 50 mm

AP 641/01



Stock no. Product no.
 5WG1641-3AB01 AP 641/01

Modular installation system, room control box

Room control box

Modules

RL 125/23



Decentralized power supply, 80 mA, AC 230 V

- Integrated choke
- Output voltage DC 29 V
- Output current 80 mA
- Connection of choke-protected output voltage via a plug-in extra-low voltage terminal or bus terminal
- Type of protection: IP 20 (installed)
- Rated operational voltage AC 120...230 V, 50...60 Hz, DC 220 V
- For mounting in AP 118 automation module box or AP 641 room control box

The AP 641 room control box and AP 118 automation module box must be ordered separately. See Chapter Modular Installation System - Room control box - Module boxes.

Data sheet A6V11535388
Dimensions (W x H x D) 86.5 x 47.8 x 36.2 mm

Stock no.	Product no.
5WG1125-4AB23	RL 125/23

RL 260/23



Binary Input 4 x AC/DC 12...230 V

- 4 Inputs for AC/DC 12...230 V
 - Max. cable length, unshielded, twisted 100 m
 - Bus-powered electronics
 - Integrated bus coupling unit, with bus connection via bus terminal block
 - Type of protection: IP 20
 - Screw-less terminals for connection and through-wiring of untreated single-core, stranded or multi-core conductors, 0.5...2.5 mm²
 - For mounting in AP 118 automation module box or AP 641 room control box
- The following functions can be selected per input:
 - Switching state/send binary value/Transmission of the input objects after change
 - Switch edge, short/long switch, 8-bit value edge, 8-bit value short/long
 - Dimming, shading control, single button group control
 - 1/8-bit scene control
 - 16-bit floating-point value edge and 16-bit floating-point short/long
 - Pulse counting with/without limit value monitoring (8/16/32 Bit)
 - The following functions can be selected per input pair:
 - 2-pushbutton dimming with stop telegram and 2-pushbutton shading control
 - Optional blocking of each input by means of the respective blocking object
 - Optional cyclic transmission of input objects

The AP 641 room control box and AP 118 automation module box must be ordered separately. See Chapter Modular Installation System - Room control box - Module boxes.

Data sheet A6V10416114

Stock no.	Product no.
5WG1260-4AB23	RL 260/23

Modular installation system, room control box

Room control box

Modules

Binary Output 3 x 6 A, AC 230 V

RL 513D23



- 3 floating relay contact
 - One relay contact per output as switching element
 - Contact rated current according to DIN EN 60669-1: 6 A (resistive load)
 - Bus-powered electronics
 - Integrated bus coupling unit, bus connection via bus terminal block
 - Type of protection: IP 20
 - Rated contact operating voltage AC 230 V
 - Rated contact frequency: 50/60 Hz
 - Screw-less terminals for connection and through-wiring of untreated single-core, stranded or multi-core conductors, 0.5...2.5 mm²
 - For mounting in AP 118 automation module box or AP 641 room control box
-
- For each output:
 - Selectable operating mode (normal mode, time switch mode)
 - Selectable relay mode (NO contact / NC contact)
 - Status object as an optional addition
 - Variable On and Off delay times
 - Selectable logic operation (AND/OR) of two communication objects
 - Selectable switching state at bus voltage failure and recovery
 - Optional addition of a night mode object for time-limited switching On of the output (and hence the illumination) at night
 - Variable On period at night or time switch mode
 - Selectable post-triggering of the On period (On period extension) in time switch mode
 - Selectable warning signal prior to imminent switching-off by means of three-times short off and on switching (flashing) at night or in time switch mode
 - Selectable function:
 - Including additional communication object for manual override of an output
 - Selectable forced control, including additional communication object for switching an output on or off in forced mode
 - Selectable counting of operating hours and with threshold monitoring of the operating hours
 - Selectable counting of load cycles and with threshold monitoring of the load cycles
 - Integrated 8-bit scene control and linking of each output into up to 8 scenes

The AP 641 room control box and AP 118 automation module box must be ordered separately.
See chapter Modular Installation System - Room control box - Module boxes.

Data sheet	A6V11375522
Rated voltage	AC 230 V
Rated current	6 A
Number of channels	3
Dimensions (W x H x D)	86.5 x 47.8 x 36.2 mm

Stock no.	Product no.
5WG1513-4DB23	RL 513D23

9

Modular installation system, room control box

Room control box

Modules

RS 510/23



Binary Output, 2 x AC 230 V, 10 A (resistive load)

- Rated contact frequency: 50/60 Hz
 - 2 floating relay contacts
 - Contact rated current according to DIN EN 60669-1: 10 A (resistive load)
 - Bus-powered electronics
 - Integrated bus coupling unit, bus connection via bus terminal
 - Type of protection: IP 20
 - Rated contact voltage AC 230 V
 - Screw-less terminals for connection and through-wiring of untreated single-core, stranded or multi-core conductors, 0.5 ... 2.5 mm²
 - With bus connection module
 - Modular installation device for mounting in AP 118 automation module box or AP 641 room control box
-
- For each output:
 - Selectable operating mode (normal mode/time switch mode)
 - Selectable relay mode (NO contact/NC contact)
 - Status object as optional addition
 - Variable On and Off delay times
 - Selectable logic operation (AND/OR) of two communication objects
 - Selectable switching state at bus voltage failure and recovery
 - Optional addition of night mode object for time-limited switching On of the output (and hence the illumination) at night
 - Variable On period at night or time switch mode
 - Selectable post-triggering of the On period (On period extension) in time switch mode
 - Selectable warning signal prior to imminent switching-off by means of three-times short off and on switching (flashing) at night or in time switch mode
 - Selectable function:
 - Including additional communication object for manual override of an output
 - Forced control, including additional communication object for switching an output on or off in forced mode
 - Counting of operating hours and with threshold monitoring of the operating hours
 - Counting of load cycles and with threshold monitoring of the load cycles
 - Integrated 8-bit scene control and linking of each output into up to 8 scenes

The AP 641 room control box and AP 118 automation module box must be ordered separately. See chapter Modular Installation System - Room control box - Module boxes.

Data sheet	A6V10416153
Rated voltage	AC 230 V
Rated current	10 A
Number of channels	2
Dimensions (W x H x D)	50.2 x 48.8 x 35.5 mm

Stock no.	Product no.
5WG1510-2AB23	RS 510/23

Switching actuator 1 x AC 230 V, 16 AX, C load

RL 512/23



- One relay contact as switching element
 - Bus-powered electronics
 - Integrated bus coupling unit, Bus connection via bus terminal block
 - Type of protection: IP 20
 - Rated contact voltage AC 230 V
 - Rated contact frequency: 50/60 Hz
 - Rated contact current 16 AX / 20 A
 - Screw-less terminals for connection and through-wiring of untreated single-core, stranded or multi-core conductors, 0.5...2.5 mm²
 - For mounting in AP 118 automation module box or AP 641 room control box
-
- Selectable operating mode (normal mode, time switch mode)
 - Selectable relay mode (NO contact / NC contact)
 - Status object as an optional addition
 - Variable On and Off delay times
 - Selectable logic operation (AND/OR) of two communication objects
 - Selectable switching state at bus voltage failure and recovery
 - Optional addition of a night mode object for time-limited switching On of the output (and hence the illumination) at night
 - Variable On period at night or time switch mode
 - Selectable post-triggering of the On period (On period extension) in time switch mode
 - Selectable warning signal prior to imminent switching-off by means of three-times short off and on switching (flashing) at night or in time switch mode
 - Selectable function:
 - Including additional communication object for manual override of an output
 - Selectable forced control, including additional communication object for switching an output on or off in forced mode
 - Selectable counting of operating hours with threshold monitoring of the operating hours
 - Selectable counting of load cycles with threshold monitoring of the load cycles
 - Integrated 8-bit scene control and linking of each output into up to 8 scenes

The AP 641 room control box and AP 118 automation module box must be ordered separately.
 See chapter Modular Installation System - Room control box - Module boxes.

Data sheet	A6V10416159
Rated voltage	AC 230 V
Rated current	16 A
Number of channels	1
Dimensions (W x H x D)	86.5 x 47.8 x 36.2 mm

Stock no.	Product no.
5WG1512-4AB23	RL 512/23

Modular installation system, room control box

Room control box

Modules

RL 526D23



Switch/dim actuator, 2 x AC 230 V, 6 A, 1...10 V

- One relay contact per output as switching element
 - Rated contact operating voltage AC 230 V
 - Rated contact frequency: 50/60 Hz
 - Rated contact current: 6 A
 - Control voltage output DC 1-10 V (passive) per channel for controlling dimmable electronic ballasts
 - Maintenance-free terminals for connection and through-wiring of untreated single-core, stranded or multi-core conductors, 0.5 ... 2.5 mm²
 - Bus-powered electronics
 - Housing: plastic
 - Dimensions (L x W x H): 86,5 x 47,8 x 36,2 mm
 - As built-in device for mounting in a separately to be ordered Control Module Box AP 118 or Room Control Box AP 641
 - Type of protection: IP 20
- One switching, one dimming and status object per output
 - Selectable operation mode (normal mode, time switch mode, blinking)
 - Adjustable ON- and OFF-delay, control value input object, central switching
 - Two logic operation (AND/OR/NAND/NOR/EXOR/FILTER/TRIGGER)
 - Adjustable dimming time for switching and dimming
 - Switch an output on or off by dimming
 - Configurable dimming curves
 - Maximum and minimum dimming value
 - Configurable sending of status objects on request, cyclically, and / or automatically after a change
 - Configurable state on bus voltage failure and dimming value on bus voltage recovery
 - Night mode for time-limited switching the output, i.e. the lighting, at night,
 - Variable On period at night or time switch mode, time limit in timer switch mode, warning signal prior to imminent switching-off
 - Manual override, permanent OFF switching, forced control, locking mode
 - Counting of operating hours and counting of load cycles with threshold monitoring
 - Integrated 8-bit scene control and linking of each output into up to 8 scenes
 - Surveillance of device function

Data sheet	A6V12021343
Rated current	6 A
Number of channels	2
Dimensions (W x H x D)	86.5 x 47.8 x 36.2 mm

Stock no.	Product no.
5WG1526-4DB23	RL 526D23

Universal dimmer 1 x AC 230 V, 10...250 VA, (R,L,C load)

RS 525/23



- Output for switching and dimming resistive, inductive or capacitive loads
 - Automatic adjustment to leading edge or trailing edge control, depending on the type of load
 - Rated frequency 50...60 Hz
 - Electronic protection of the output against overload, short circuit and temperature rise
 - Bus-powered electronics
 - Integrated bus coupling unit, Bus connection via bus terminal block
 - Type of protection: IP 20
 - Rated operational voltage AC 230 V
 - Rated power at +35°C ambient temperature: 10...250 VA
 - Screw-less terminals for connection and through-wiring of untreated single-core, stranded or multi-core conductors, 0.5 ... 2.5 mm²
 - With bus connection module
 - Modular installation device for mounting in AP 118 automation module box or AP 641 room control box
-
- Selectable mode for each output (normal mode, one- or two-level timer mode, blinking)
 - Adjustable on- and off-delay
 - Separately adjustable dimming time from 0...100 % for switching on / off and dimming brighter / darker
 - Two dimming value objects, each with individually adjustable dimming time from 0...100 %
 - The ability to switch an output on or off by dimming brighter/darker
 - Adjustable dimming value when switching on
 - Immediate activation (jumping) or dimming to a new dimming value
 - Selectable additional status object switching and / or status object dimming value for each output
 - Additional object for each output for blocking / releasing the output
 - Sending of status objects on request and / or automatically after a change
 - Adjustable blocking time for sending status objects after restart and bus voltage recovery
 - Adjustable dimming value for each output in the event of bus voltage failure and recovery, as well as for mains voltage recovery
 - Additional night mode object for time-limited switching on the output (and hence illumination) at night
 - Adjustable on period at night or with timer mode
 - Selectable warning of imminent switching off the illumination by dimming to 50 % of the previous dimming value during night mode or timer mode
 - Integrated 8-bit scene control and integration of each output in up to 8 scenes
 - Separately adjustable dimming time for scene control
 - Selectable counting of operating hours and with threshold monitoring of the operating hours
 - Selectable counting of load cycles and with threshold monitoring of the load cycles

The AP 641 room control box and AP 118 automation module box must be ordered separately.
See chapter Modular Installation System - Room control box - Module boxes.

Data sheet	A6V10416181
Rated voltage	AC 230 V
Rated current	1 A
Number of channels	1
Dimensions (W x H x D)	50.2 x 48.8 x 35.5 mm

Stock no.	Product no.
5WG1525-2AB23	RS 525/23

Modular installation system, room control box

Room control box

Modules

RL 521/23



Shutter Blind Actuator, 2 x AC 230 V, 6 A

- 2 channels
- Electrically interlocked relays to reverse the direction of rotation
- Integrated electronics for detection of the actuation of an electromechanical limit switch and with auto-calibration of the travel time from one limit switch to the other
- Bus-powered electronics
- Integrated bus coupling units, bus connection via bus terminal
- Type of protection: IP 20
- For the separate control per actuator channel of a sun protection, damper, door or window drive with a motor for AC 230 V and electromechanical limit switches
- Screw-less terminals for connection and through-wiring of untreated single-core, stranded or multi-core conductors, 0.5 ... 2.5 mm²
- For mounting in AP 118 automation module box or AP 641 room control box
- Communication objects per actuator channel for moving the sun protection to limit positions or to stop travel and for step-by-step adjustment of blind slats
- Communication objects for moving the sun protection and adjusting blind slats directly to a new position by positioning commands as percentage values
- Automatic opening of blind slats up to a set position after the blinds have been lowered without any stop from upper to lower limit position
- Integrated 1-bit scene control for programming/recalling of 2 favored positions of blind and slats
- Integrated 8-bit scene control and assignment of up to 8 scenes per channel
- An optional object "Sunshine" for activation/deactivation of sunlight tracking of the slats for shading with greatest possible daylight component
- Differentiation between automatic and manual mode and with automatic switch-over from automatic to manual mode of the respective actuator channel on activation of a bus pushbutton for manual control of the sun blind
- Priority of manual mode over automatic positioning commands
- Optional central command object for switching-over of all actuator channels to automatic mode and for moving the sun blinds to the upper or lower limit position
- Alarm object wind/rain/frost per channel for moving the sun protection to the configured safety position in the event of an alarm and with blocking of travel to another position as long as alarm pending
- Travel blocking object per device or per channel for blocking the sun protection in its current position (e.g. during cleaning of an outdoor Venetian blind)
- Status objects per actuator channel for query or automatic transmission of sun blind and slat position as percentage values
- Optional status objects for signalling that the lower or upper limit position has been reached

The AP 641 room control box and AP 118 automation module box must be ordered separately. See chapter Modular Installation System - Room control box - Module boxes.

Data sheet	A6V10416169
Rated voltage	AC 230 V
Rated current	6 A
Number of channels	2
Dimensions (W x H x D)	47.8 x 86.5 x 36.2 mm

Stock no.	Product no.
5WG1521-4AB23	RL 521/23

Shutter Blind Actuator RS, 1 x AC 230 V, 6 A

RS 520/23



- 1 channel
 - Electrically interlocked relays to reverse the direction of rotation
 - Integrated electronics for detection of the actuation of an electromechanical limit switch and with auto-calibration of the travel time from one limit switch to the other
 - Bus-powered electronics
 - Integrated bus coupling unit, Bus connection via bus terminal block
 - Type of protection: IP 20
 - For the separate control per actuator channel of a sun protection, damper, door or window drive with a motor for AC 230 V and electromechanical limit switches
 - Screw-less terminals for connection and through-wiring of untreated single-core, stranded or multi-core conductors, 0.5 ... 2.5 mm²
 - With bus connection module
 - Modular installation device for mounting in AP 118 automation module box or AP 641 room control box
-
- Configurable behavior in the event of a bus voltage failure/recovery
 - Automatic mode for sunlight tracking control
 - Manual and standard mode
 - Status: Transmitting status per channel, status position of sun protection, 8-bit, status position of slats, 8-bit
 - Integrated 1-bit/8-bit scene control
 - 8 scenes to be integrated per channel
 - Travel lock (e. g. for cleaning the outer shutter/blinds)
 - Separate raising/lowering protection
 - Alarm (Wind, Rain, Frost): Move to safety position, locking in this position for as long as alarm is active
 - Individual configuration of actuator channels
 - Adaptation of objects and functions to drive type
 - Suitable for integration in a sunlight tracking control system
 - End position detection
 - Using position data (8-bit value) for sun protection control (up/down) and slat control (open/closed)

The AP 641 room control box and AP 118 automation module box must be ordered separately.
 See chapter Modular Installation System - Room control box - Module boxes.

Data sheet	A6V10416164
Rated voltage	AC 230 V
Rated current	6 A
Number of channels	1
Dimensions (W x H x D)	50.2 x 48.8 x 35.5 mm

Stock no.	Product no.
5WG1520-2AB23	RS 520/23

Modular installation system, room control box

Room control box

Modules

RS 510K23



Thermo Drive Actuator, 2 x 1.5 A, AC 24...230 V / DC 24 V

- 2 switching outputs for control of electro-thermal drives for heating radiator and cooling ceiling valves
- Per output up to 4 connected electro-thermal drives with in total up to 1.5 A in the on-state and up to 58 W power consumption when switched on
- One relay contact per output as switching element
- Rated contact operating voltage AC 24...230 V or DC 24 V
- Rated contact frequency: 50/60 Hz
- Contact rated current according to DIN EN 60669-1: 1.5 A (resistive load)
- Screw-less terminals for connection and through-wiring of untreated single-core, stranded or multi-core conductors, 0.5...2.5 mm²
- With bus connection module
- Bus-powered electronics
- Integrated bus coupling unit, bus connection via bus terminal
- Modular installation device for mounting in AP 118 automation module box or AP 641 room control box
- Selectable control via switching commands (on-off control) or via control commands in percent (continuous control)
- Conversion of control commands in percent into pulse width modulated (PWM) switching commands
- Additional functions for avoiding calcification of a valve and forced position as well as a status object per output
- Status object as an optional addition for each output
- Selectable switching state for each output on bus voltage failure and recovery

The AP 641 room control box and AP 118 automation module box must be ordered separately. See chapter Modular Installation System - Room control box - Module boxes.

Data sheet	A6V10532363
Rated voltage	AC 24 V
Rated current	1.5 A
Number of channels	2
Relay outputs, number	2
Triac outputs, number	0
Dimensions (W x H x D)	50.2 x 48.8 x 35.5 mm

Stock no.	Product no.
5WG1510-2KB23	RS 510K23

Modular installation system, room control box Junction box (UL/NEMA) devices

Decentralized Power Supply, 80 mA, AC 120 V

JB 125C23

- Integrated choke
- Output voltage DC 29 V
- Output current 80 mA
- Connection of choke-protected output voltage via a plug-in extra-low voltage terminal or bus terminal
- Type of protection: IP 20 (installed)
- Rated operational voltage AC 120 V, 50...60 Hz
- Built-in device with 1/2 inch thread connection for mounting to or in a UL/NEMA Junction Box with feedthrough of the function wires through the 1/2 inch threaded connector



Data sheet A6V11808808
Dimensions (W x H x D) 70 x 90 x 44.6 mm

Stock no. Product no.
5WG1125-4CB23 JB 125C23

Binary Input 4 x AC/DC 12...230 V

JB 260C23

- 4 Inputs for AC/DC 12...230 V
- Max. cable length, unshielded, twisted 100 m
- Bus-powered electronics
- Integrated bus coupling unit, with bus connection via bus terminal block
- Type of protection: IP 20
- As built-in device with 1/2 inch thread connection for mounting to or in a UL/NEMA Junction Box with feedthrough of the function wires through the 1/2 inch threaded connector
- The following functions can be selected per input:
 - Switching state/send binary value/Transmission of the input objects after change
 - Switch edge, short/long switch, 8-bit value edge, 8-bit value short/long
 - Dimming, shading control, single button group control
 - 1/8-bit scene control
 - 16-bit floating-point value edge and 16-bit floating-point short/long
 - Pulse counting with/without limit value monitoring (8/16/32 Bit)
- The following functions can be selected per input pair:
 - 2-pushbutton dimming with stop telegram and 2-pushbutton shading control
- Optional blocking of each input by means of the respective blocking object
- Optional cyclic transmission of input objects



Data sheet A6V11786003

Stock no. Product no.
5WG1260-4CB23 JB 260C23

Modular installation system, room control box

Junction box (UL/NEMA) devices

JB 510C23



Binary Output, 2 x AC 120...277 V, 10 A (resistive load)

- 2 floating relay contacts
 - Rated contact frequency: 50/60 Hz
 - Contact rated current according to DIN EN 60669-1: 10 A (resistive load)
 - Bus-powered electronics
 - Integrated bus coupling unit, bus connection via bus terminal
 - Type of protection: IP 20
 - Rated contact operating voltage AC 120...277 V
 - As built-in device with 1/2 inch thread connection for mounting to or in a UL/NEMA Junction Box with feedthrough of the function wires through the 1/2 inch threaded connector
-
- For each output:
 - Selectable operating mode (normal mode/time switch mode)
 - Selectable relay mode (NO contact/NC contact)
 - Status object as optional addition
 - Variable On and Off delay times
 - Selectable logic operation (AND/OR) of two communication objects
 - Selectable switching state at bus voltage failure and recovery
 - Optional addition of night mode object for time-limited switching On of the output (and hence the illumination) at night
 - Variable On period at night or time switch mode
 - Selectable post-triggering of the On period (On period extension) in time switch mode
 - Selectable warning signal prior to imminent switching-off by means of three-times short off and on switching (flashing) at night or in time switch mode
 - Selectable function:
 - Including additional communication object for manual override of an output
 - Forced control, including additional communication object for switching an output on or off in forced mode
 - Counting of operating hours and with threshold monitoring of the operating hours
 - Counting of load cycles and with threshold monitoring of the load cycles
 - Integrated 8-bit scene control and linking of each output into up to 8 scenes

Data sheet

A6V11786004

Dimensions (W x H x D)

70 x 90 x 44.6 mm

Stock no.

Product no.

5WG1510-4CB23

JB 510C23

Modular installation system, room control box Junction box (UL/NEMA) devices

Switching actuator 1 x AC 120...277 V, 20 A or 1 x AC 347 V, 15 AX, C load

JB 512C23



- One relay contact as switching element
 - Bus-powered electronics
 - Integrated bus coupling unit, Bus connection via bus terminal block
 - Type of protection: IP 20
 - Rated contact operating voltage AC 120...277 V, AC 347 V
 - Rated contact frequency: 50/60 Hz
 - Fluorescent lamp load acc. to DIN EN 60669-1: 20 AX (200 µF) at AC 120/277 V, 15 AX (200 µF) at AC 347 V
 - As built-in device with 1/2 inch thread connection for mounting to or in a UL/NEMA Junction Box with feedthrough of the function wires through the 1/2 inch threaded connector
-
- Selectable operating mode (normal mode, time switch mode)
 - Selectable relay mode (NO contact / NC contact)
 - Status object as an optional addition
 - Variable On and Off delay times
 - Selectable logic operation (AND/OR) of two communication objects
 - Selectable switching state at bus voltage failure and recovery
 - Optional addition of a night mode object for time-limited switching On of the output (and hence the illumination) at night
 - Variable On period at night or time switch mode
 - Selectable post-triggering of the On period (On period extension) in time switch mode
 - Selectable warning signal prior to imminent switching-off by means of three-times short off and on switching (flashing) at night or in time switch mode
 - Selectable function:
 - Including additional communication object for manual override of an output
 - Selectable forced control, including additional communication object for switching an output on or off in forced mode
 - Selectable counting of operating hours with threshold monitoring of the operating hours
 - Selectable counting of load cycles with threshold monitoring of the load cycles
 - Integrated 8-bit scene control and linking of each output into up to 8 scenes

Data sheet

A6V11786007

Dimensions (W x H x D)

70 x 90 x 44.6 mm

Stock no.

Product no.

5WG1512-4CB23

JB 512C23

9

Modular installation system, room control box

Junction box (UL/NEMA) devices

JB 513C23



Binary Output 3 x 6 A, AC 120...277 V

- 3 floating relay contact
 - One relay contact per output as switching element
 - Contact rated current according to DIN EN 60669-1: 6 A (resistive load)
 - Bus-powered electronics
 - Integrated bus coupling unit, bus connection via bus terminal block
 - Type of protection: IP 20
 - One relay contact per output as switching element
 - Rated contact operating voltage AC 120...277 V
 - Rated contact frequency: 50/60 Hz
 - As built-in device with 1/2 inch thread connection for mounting to or in a UL/NEMA Junction Box with feedthrough of the function wires through the 1/2 inch threaded connector
-
- For each output:
 - Selectable operating mode (normal mode, time switch mode)
 - Selectable relay mode (NO contact / NC contact)
 - Status object as an optional addition
 - Variable On and Off delay times
 - Selectable logic operation (AND/OR) of two communication objects
 - Selectable switching state at bus voltage failure and recovery
 - Optional addition of a night mode object for time-limited switching On of the output (and hence the illumination) at night
 - Variable On period at night or time switch mode
 - Selectable post-triggering of the On period (On period extension) in time switch mode
 - Selectable warning signal prior to imminent switching-off by means of three-times short off and on switching (flashing) at night or in time switch mode
 - Selectable function:
 - Including additional communication object for manual override of an output
 - Selectable forced control, including additional communication object for switching an output on or off in forced mode
 - Selectable counting of operating hours and with threshold monitoring of the operating hours
 - Selectable counting of load cycles and with threshold monitoring of the load cycles
 - Integrated 8-bit scene control and linking of each output into up to 8 scenes

Data sheet

A6V11786008

Dimensions (W x H x D)

70 x 90 x 44.6 mm

Stock no.

Product no.

5WG1513-4CB23

JB 513C23

Modular installation system, room control box Junction box (UL/NEMA) devices

Switch/dim actuator, 2 x AC 277 V, 20 A, 1...10 V

JB 526C23



- Protruding wires stranded AWG 12
 - A phase connection for an output that is equipped with a relay contact per output as a switching element
 - Contact rated operational voltage AC 120 V, AC 230 V, AC 277 V, AC 347 V
 - Contact rated operational voltage AC/DC 24 V
 - Contact rated current according to DIN EN 60669-1: 16 A / 20 A (resistive load)
 - Fluorescent lamp load according to DIN EN 60669-1: 16 AX / 20 AX (200 µF) at AC 230 V
 - Bus-powered electronics
 - Integrated bus coupling unit
 - Bus connection via bus terminal
 - Red LED for display of the activation of the addressing mode as well as the operational readiness
 - Housing: plastics
 - For installation in 4" x 4" Junction box (UL/NEMA)
 - Degree of protection IP 20
- For switching and dimming of fluorescent lamps with dimmable electronic ballasts
 - Independent control voltage DC 0/1...10 V per output

Per output

- command objects for switching on/off, dimming brighter/darker and setting dimming value
- adjustable ON- and OFF-delay
- switching status object and/or dimming value status object as an optional addition
- adjustable sending of status objects on demand, cyclically and/or automatically after modification
- adjustable ON period during night and/or time switch operation
- selectable counting of operating hours and threshold monitoring of the operating hours
- selectable counting of load cycles and threshold monitoring of the load cycles
- selectable function blocking of the output
- selectable mode (normal mode, night mode, one- or two-level timer mode, flashing)
- separately adjustable dimming time from minimum to 100% for switching on/off, brighter/darker dimming and dimming value setting
- selectable sending of status objects on request, cyclically and / or automatically after a change or bus voltage recovery
- selectable warning of impending OFF by dimming to 50% of the previous dimming value during night mode or timer mode
- separately adjustable dimming time for scene control
- adjustable dimming curve correction
- construction site function for switching the construction site lighting on and off even if the bus devices have not yet been commissioned with ETS
- Integrated 8-bit scene control and integration of each output in up to 8 scenes
- Optional disabling of the ripple control compensation in an electrical grid with frequency fluctuations

Data sheet

A6V11786012

Dimensions (W x H x D)

70 x 90 x 44.6 mm

Stock no.

Product no.

5WG1526-4CB23

JB 526C23

Modular installation system, room control box

Junction box (UL/NEMA) devices

JB 527C23



Switch/dim actuator, 1 x AC 277 V, 20 A, 1...10 V

- Protruding wires stranded AWG 12
 - A phase connection for an output that is equipped with a relay contact per output as a switching element
 - Contact rated operational voltage AC120 V, AC 230 V, AC 277 V, AC 347 V
 - Contact rated operational voltage AC/ DC 24 V
 - Contact rated current according to DIN EN 60669-1: 16 A / 20 A (resistive load)
 - Fluorescent lamp load according to DIN EN 60669-1: 16 AX / 20 AX (200 µF) at AC 230 V
 - Bus-powered electronics
 - Integrated bus coupling unit
 - Bus connection via bus terminal
 - Red LED for display of the activation of the addressing mode as well as the operational readiness
 - Housing: plastics
 - For installation in 4" x 4" Junction box (UL/NEMA)
 - Degree of protection IP 20
- For switching and dimming of fluorescent lamps with dimmable electronic ballasts
 - Independent control voltage DC 0/1...10 V per output

Per output

- command objects for switching on/off, dimming brighter/darker and setting dimming value
- adjustable ON- and OFF-delay
- switching status object and/or dimming value status object as an optional addition
- adjustable sending of status objects on demand, cyclically and/or automatically after modification
- adjustable ON period during night and/or time switch operation
- selectable counting of operating hours and threshold monitoring of the operating hours
- selectable counting of load cycles and threshold monitoring of the load cycles
- selectable function blocking of the output
- selectable mode (normal mode, night mode, one- or two-level timer mode, flashing)
- separately adjustable dimming time from minimum to 100% for switching on/off, brighter/darker dimming and dimming value setting
- selectable sending of status objects on request, cyclically and / or automatically after a change or bus voltage recovery
- selectable warning of impending OFF by dimming to 50% of the previous dimming value during night mode or timer mode
- separately adjustable dimming time for scene control
- adjustable dimming curve correction
- construction site function for switching the construction site lighting on and off even if the bus devices have not yet been commissioned with ETS
- integrated 8-bit scene control and integration of each output in up to 8 scenes
- optional disabling of the ripple control compensation in an electrical grid with frequency fluctuations

Data sheet

A6V11786013

Dimensions (W x H x D)

70 x 90 x 44.6 mm

Stock no.

Product no.

5WG1527-4CB23

JB 527C23

Modular installation system, room control box

Junction box (UL/NEMA) devices

Shutter Blind Actuator, 1 x AC 120 V, 6 A

JB 520C23



- 1 channel
 - Electrically interlocked relays to reverse the direction of rotation
 - Integrated electronics for detection of the actuation of an electromechanical limit switch and with auto-calibration of the travel time from one limit switch to the other
 - Bus-powered electronics
 - Integrated bus coupling unit, Bus connection via bus terminal block
 - Type of protection: IP 20
 - For control of sun protection, door or window drive with a motor for AC 120 V and electromechanical or electronic limit switches per actuator channel
 - Relay contacts rated for nominal voltage AC 120 V, 6 A (resistive load)
 - As built-in device with 1/2 inch thread connection for mounting to or in a UL/NEMA Junction Box with feedthrough of the function wires through the 1/2 inch threaded connector
-
- Configurable behavior in the event of a bus voltage failure/recovery
 - Automatic mode for sunlight tracking control
 - Manual and standard mode
 - Status: Transmitting status per channel, status position of sun protection, 8-bit, status position of slats, 8-bit
 - Integrated 1-bit/8-bit scene control
 - 8 scenes to be integrated per channel
 - Travel lock (e. g. for cleaning the outer shutter/blinds)
 - Separate raising/lowering protection
 - Alarm (Wind, Rain, Frost): Move to safety position, locking in this position for as long as alarm is active
 - Individual configuration of actuator channels
 - Adaptation of objects and functions to drive type
 - Suitable for integration in a sunlight tracking control system
 - End position detection
 - Using position data (8-bit value) for sun protection control (up/down) and slat control (open/closed)

Data sheet A6V11786009
 Dimensions (W x H x D) 70 x 90 x 44.6 mm

Stock no. Product no.
 5WG1520-4CB23 JB 520C23

9

Modular installation system, room control box

Junction box (UL/NEMA) devices

JB 521C23



Shutter Blind Actuator, 2 x AC 120 V, 6 A

- 2 channels
- Electrically interlocked relays to reverse the direction of rotation
- Integrated electronics for detection of the actuation of an electromechanical limit switch and with auto-calibration of the travel time from one limit switch to the other
- Bus-powered electronics
- Integrated bus coupling units, bus connection via bus terminal
- Type of protection: IP 20
- For separate control of a sun protection, door or window drive with a motor for AC 120 V and electromechanical or electronic limit switches per actuator channel
- Relay contacts rated for AC 120 V, 6 A (resistive load)
- As built-in device with 1/2 inch thread connection for mounting to or in a UL/NEMA Junction Box with feedthrough of the function wires through the 1/2 inch threaded connector
- Communication objects per actuator channel for moving the sun protection to limit positions or to stop travel and for step-by-step adjustment of blind slats
- Communication objects for moving the sun protection and adjusting blind slats directly to a new position by positioning commands as percentage values
- Automatic opening of blind slats up to a set position after the blinds have been lowered without any stop from upper to lower limit position
- Integrated 1-bit scene control for programming/recalling of 2 favored positions of blind and slats
- Integrated 8-bit scene control and assignment of up to 8 scenes per channel
- An optional object "Sunshine" for activation/deactivation of sunlight tracking of the slats for shading with greatest possible daylight component
- Differentiation between automatic and manual mode and with automatic switch-over from automatic to manual mode of the respective actuator channel on activation of a bus pushbutton for manual control of the sun blind
- Priority of manual mode over automatic positioning commands
- Optional central command object for switching-over of all actuator channels to automatic mode and for moving the sun blinds to the upper or lower limit position
- Alarm object wind/rain/frost per channel for moving the sun protection to the configured safety position in the event of an alarm and with blocking of travel to another position as long as alarm pending
- Travel blocking object per device or per channel for blocking the sun protection in its current position (e.g. during cleaning of an outdoor Venetian blind)
- Status objects per actuator channel for query or automatic transmission of sun blind and slat position as percentage values
- Optional status objects for signalling that the lower or upper limit position has been reached

Data sheet

A6V11786010

Dimensions (W x H x D)

70 x 90 x 44.6 mm

Stock no.

Product no.

5WG1521-4CB23

JB 521C23

Modular installation system, room control box Junction box (UL/NEMA) devices

Universal Dimmer, 1 x AC 120 V, 10...125 VA (R,L,C load)

JB 525C23



- Output for switching and dimming resistive, inductive or capacitive loads
 - Automatic adjustment to leading edge or trailing edge control, depending on the type of load
 - Rated frequency 50...60 Hz
 - Electronic protection of the output against overload, short circuit and temperature rise
 - Bus-powered electronics
 - Integrated bus coupling unit, Bus connection via bus terminal block
 - Type of protection: IP 20
 - Rated operational voltage AC 120 V
 - Rated power at +35°C ambient temperature: 10... 125 VA
 - Selectable mode for each output (normal mode, one- or two-level timer mode, blinking)
 - As built-in device with 1/2 inch thread connection for mounting to or in a UL/NEMA Junction Box with feedthrough of the function wires through the 1/2 inch threaded connector
-
- Selectable mode for each output (normal mode, one- or two-level timer mode, blinking)
 - Adjustable on- and off-delay
 - Separately adjustable dimming time from 0...100 % for switching on / off and dimming brighter / darker
 - Two dimming value objects, each with individually adjustable dimming time from 0...100 %
 - The ability to switch an output on or off by dimming brighter/darker
 - Adjustable dimming value when switching on
 - Immediate activation (jumping) or dimming to a new dimming value
 - Selectable additional status object switching and / or status object dimming value for each output
 - Additional object for each output for blocking / releasing the output
 - Sending of status objects on request and / or automatically after a change
 - Adjustable blocking time for sending status objects after restart and bus voltage recovery
 - Adjustable dimming value for each output in the event of bus voltage failure and recovery, as well as for mains voltage recovery
 - Additional night mode object for time-limited switching on the output (and hence illumination) at night
 - Adjustable on period at night or with timer mode
 - Selectable warning of imminent switching off the illumination by dimming to 50 % of the previous dimming value during night mode or timer mode
 - Integrated 8-bit scene control and integration of each output in up to 8 scenes
 - Separately adjustable dimming time for scene control
 - Selectable counting of operating hours and with threshold monitoring of the operating hours
 - Selectable counting of load cycles and with threshold monitoring of the load cycles

Data sheet A6V11808810
Dimensions (W x H x D) 70 x 90 x 44.6 mm

Stock no.	Product no.
5WG1525-4CB23	JB 525C23

Gateways, interface converters



Overview and selection tools	316
KNX/Ethernet	321
	Accessories for N 148/23
	Accessories for N 146/03
	Accessories for N 152/01
KNX/DALI	324
	Accessories for KNX / DALI Gateway
KNX/BACnet	329
	Accessories for N 143/01
KNX/USB	330
KNX/LOGO!	331

Gateways, interface converters

Overview and selection tools

The KNX network

GAMMA instabus offers interfaces to many other technologies, such as Ethernet (LAN) and lighting controls with DALI and BACnet network, making it easy to exchange information and data via the KNX network.

Interfaces to KNX

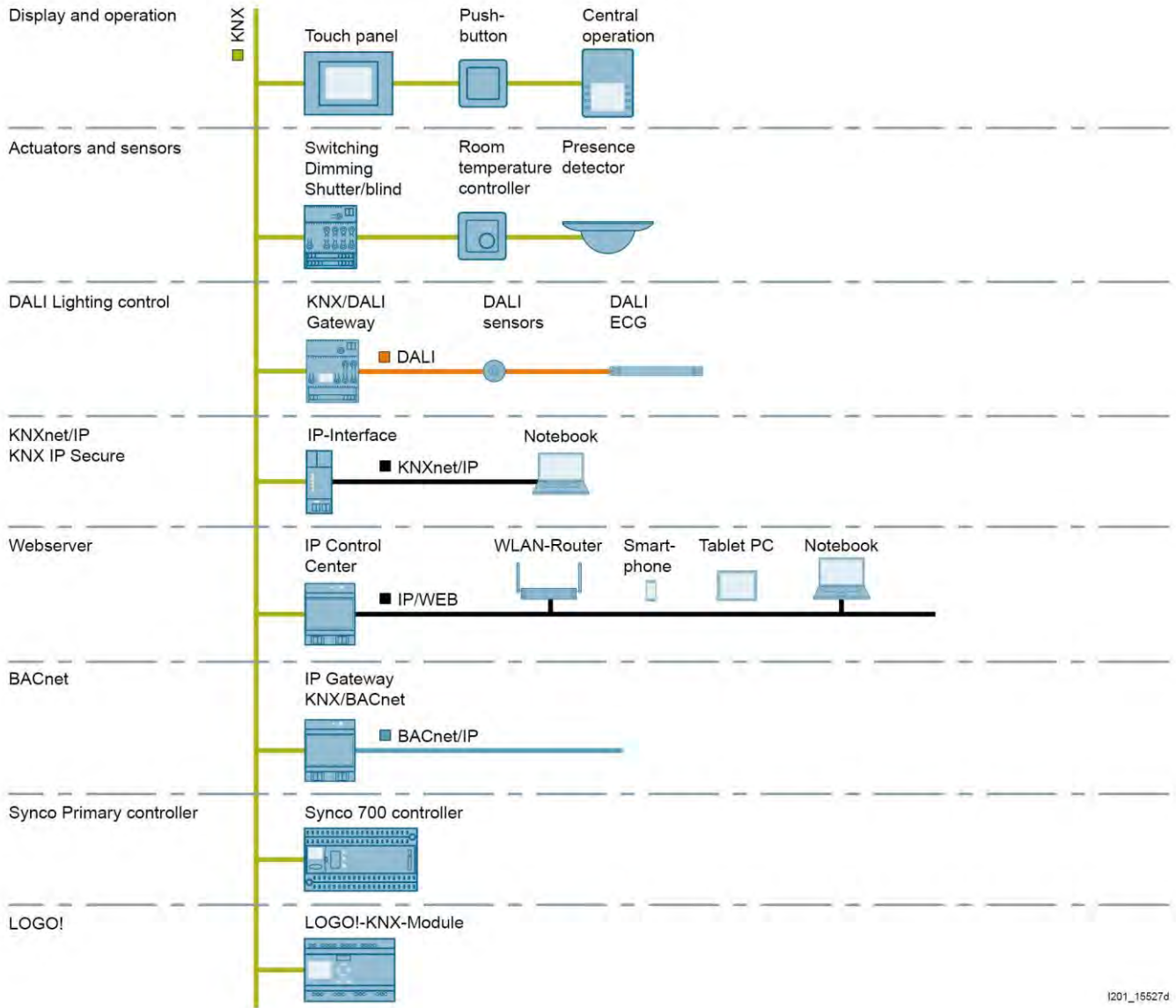

I201_15527d

10

KNX IP Secure**Faster and secure downloads save time**

With the KNX IP Secure standard, KNX telegrams can be secure transmitted via Ethernet (LAN). This enables applications and solutions. Existing network infrastructures and technologies are used to transmit KNX data over greater distances. Links between buildings and/or building levels can be clearly and easily implemented using KNXnet/IP.

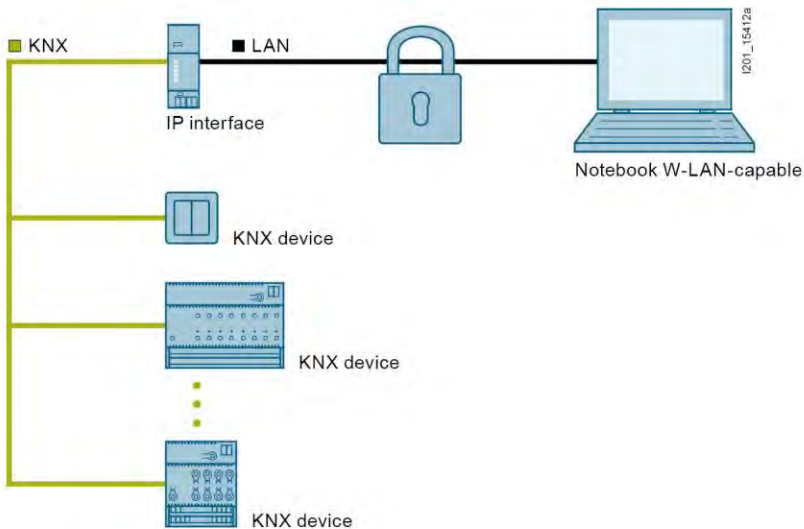

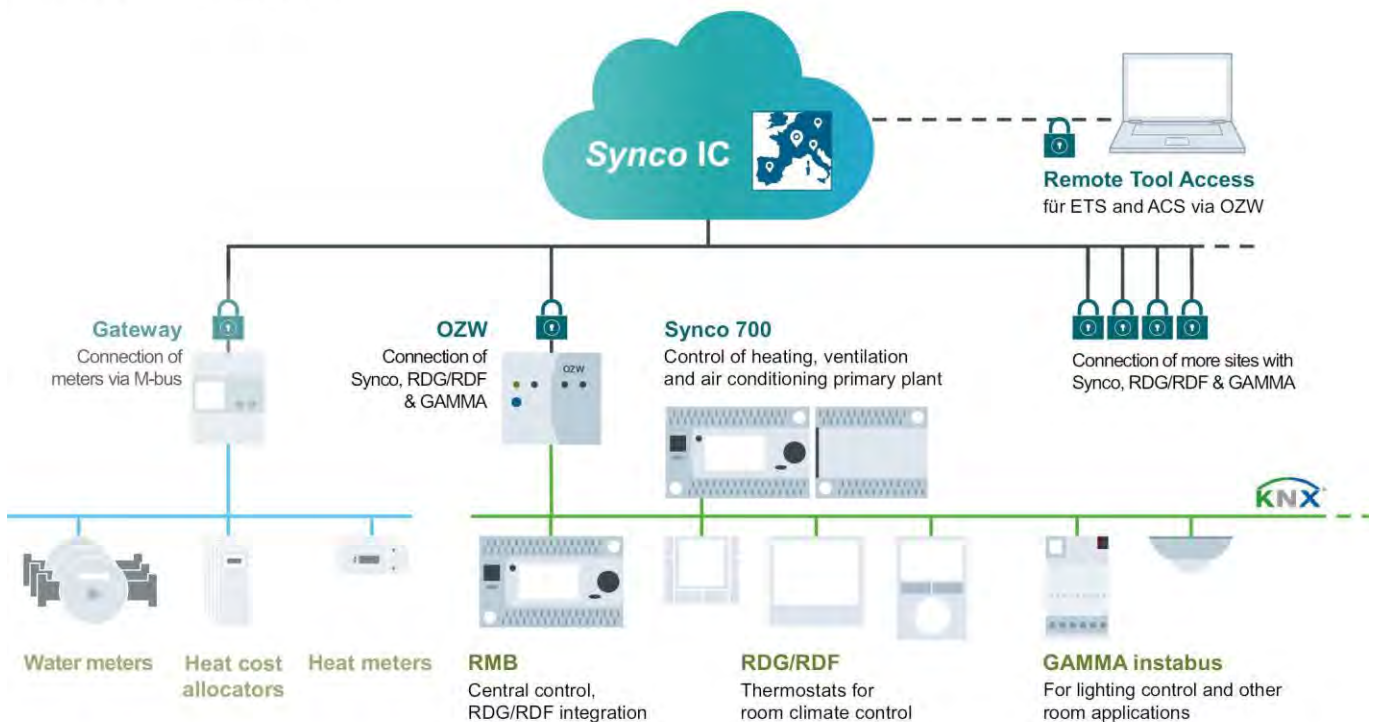

**Synco IC**

Synco is a web based remote access system for easy and secure monitoring and operation of your plant. More info at siemens.com/syncoic.







Gateways, interface converters

Overview and selection tools

KNX/Ethernet					
					
Type	N 148/23	N 146/03	N 143/01	N 152/01	OZW772..
Enclosure data					
Design	N	N	N	N	REG
Modular installation devices for mounting on TH35 EN 60715 mounting rail	■	■	■	■	■
Width (1 MW = 18 mm)	2 MW	2 MW	4 MW	4 MW	88 x 90 x 40
Display/control elements					
LEDs for indicating that the device is ready-to-run, KNX communication, IP communication	■	■	■	■	■
Power supply					
Electronics powered via an external nominal AC/DC power supply unit for	AC/DC 24 V	AC/DC 24 V	AC/DC 24 V	DC 24 V	AC 230 V
Power consumption at DC 24 V [mA]	60	60	40	50	
Power supply for the electronics via "Power over Ethernet" according to IEEE 802.3af	■	■			
Bus connection					
Integrated bus coupling units	■	■	■	■	■
Bus connection via bus terminal	■	■	■	■	
Main connection					
Ethernet connection via RJ45 socket	■	■	■	■	■
Plug-in terminal block for the connection of an external power supply unit	■	■	■	■	
Gateway					
Supports KNX IP Secure	■	■			
Supports KNXnet/IP	■	■	■	■	■
Line coupler function (Routing)		■			
Interface functions (Tunneling)	5	5	1	1	1
Weekly scheduling program				■	
Astro function				■	
Yearly time switching functions				■	
Event entries				■	
Logic gates				■	
Web servers			■	■	■





Switching/dimming actuators

Type	DALI control outputs				
	 N 141/21 Twin plus	 N 141/03 plus	 N 141/31 Twin	 N 525D11	 N 525E01
Name					
Enclosure data					
Design	N	N	N	N	N
Modular installation devices for mounting on TH35 EN 60715 mounting rail	■	■	■	■	■
Dimensions					
Width [mm] (1 MW = 18 mm)	4 MW	4 MW	4 MW	4 MW	4 MW
Display/control elements					
LED for status indication per output	■	■	■	■	■
LEDs for fault indication (lighting failure) per output				■	■
Pushbuttons for local operation on the device	■	■	■	■	■
Direct operation (local operation)	■	■	■	■	■
Power supply					
Electronics powered via an integrated power supply unit	■	■	■	■	■
DALI outputs powered via an integrated power supply unit	■	■	■	■	■
Power loss					
Maximum power loss [W]	11	6	11	11	6
Bus connection					
Integrated bus coupling units	■	■	■	■	■
Bus connection via contact system to data rail					■
Bus connection via bus terminal	■	■	■	■	■
Outputs					
DALI outputs (lines)	2	1	2	2	8
DALI-2 Certification	■	■	■	■	
Max. ECG per output (units)	64	64	64	20	8

Gateways, interface converters

Overview and selection tools

Switching/dimming actuators ...

Type	DALI control outputs				
					
Application program ¹⁾	9834xx ¹⁾	9837xx ¹⁾	983Dxx ¹⁾	9A1701	980801
Name	Twin plus	plus	Twin		
Functions					
Max. number of group addresses	3000	3000	3000	3000	108
Max. number of assignments	3000	3000	3000	3000	107
Integrated constant light level control	16	16			
Configurable behavior in the event of a bus voltage failure	■	■	■	■	■
Configurable behavior in the event of a bus voltage recovery	■	■	■	■	■
Configurable behavior in the event of a system voltage failure	■	■	■	■	■
Configurable behavior in the event of a system voltage recovery	■	■	■	■	■
Control functions					
Broadcast	■	■	■	■	■
Groups	32	16	32		
Individual ECG	128	64	128		
Switching					
Switching ON/OFF	■	■	■	■	■
Configurable starting value	■	■	■	■	■
Switching ON/OFF possible via BRIGHTER/DARKER dimming	■	■	■	■	■
Dimming					
BRIGHTER/DARKER dimming	■	■	■	■	■
Adjustable dimming time	■	■	■	■	■
Brightness limitation, adjustable min. dimming value/max. dimming value	■	■	■	■	■
Value transmission					
Set 8-bit value	■	■	■	■	■
Scene control					
Integrated 8-bit scene control	■	■	■	■	■
Scenes to be integrated per DALI output	16	16	16	16	16
Effect control					
Integrated effect control (one-off or cyclic chaselight operation, color control)	4	4			
Emergency lighting					
Support for prescribed test sequences for emergency lights	■	■	■		
Controlling single battery lights	■	■	■		
Saves test results of emergency lighting	■	■			
Status					
DALI short circuit	■	■	■	■ ²⁾	■ ²⁾
DALI power supply	■	■	■	■	■
Status output (ON/OFF, value, lamp fault, ECG fault)				■	■
Status group (ON/OFF, value, lamp fault, ECG fault)	■	■	■		
Status ECG (ON/OFF, value, lamp fault, ECG fault)	■	■	■		
Time functions					
ON/OFF delay	■	■	■	■	■
Timer mode, 1-step (stairwell circuits)	■	■	■	■	■
Timer mode, 2-step	■	■	■	■	■
Night mode (lighting for cleaning)	■	■	■	■	■
Warning of impending OFF	■	■	■	■	■
Further functions					
DALI sensors ³⁾ /2-point-control/constant light level control	■	■			
Stand-by shut down (areas)	12	6	12		
Function burn-in	■	■	■		
Color temperature control (Tunable White)	■	■	■	■	
Renew defective ECG without software	■	■	■	■	■
Stand-alone mode	■	■	■		
Pre-loaded applications	■	■		■	

¹⁾ For current application programs, see www.siemens.com/gamma-td

²⁾ Per channel

³⁾ Only selected DALI sensors are supported, see APB www.siemens.com/gamma-td

IP Interface Secure**N 148/23**

- For communication between KNX devices and PCs or other devices with Ethernet (10BaseT or 100BaseT) interface, for remote access to an KNX installation
- Uses the KNXnet/IP protocol or secured access and data transmission via KNXnet/IP Secure
- Up to five KNXnet/IP Tunneling connections for parallel bus access by ETS and further PC software
- Assignment of the network parameters by the installer using ETS, automatically by a DHCP server in the network
- 5 LEDs for display of availability, KNX communication and IP communication
- Electronics powered via "Power over Ethernet" according to IEEE 802.3af or alternatively by an external safety extra low voltage power supply for AC/DC 24V
- Pluggable terminal block for connection of external power supply unit (not included)
- Ethernet connection via RJ45 socket
- Housing: plastic, color RAL 7035 (light grey), N-system
- DIN rail mounted device for mounting on rail TH35 according to DIN EN 60715
- Type of protection: IP 20



Data sheet	A6V11689764
Dimensions (W x H x D)	36 x 90 x 61 mm
Dimension width (1 MW = 18 mm)	2 MW

Stock no.	Product no.
5WG1148-1AB23	N 148/23

Accessories for N 148/23

Product Title	Stock no.	Product no.
Electronic power supply unit, 350 mA	4AC2402	4AC2402
LOGO! Power 24 V/1.3 A	6EP3331-6SB00-0AY0	LOGO!POWER 24 V/1,3 A

IP Router Secure**N 146/03**

- For interconnection of bus lines or bus areas via a fast data network (Ethernet 10BaseT or 100BaseT) with Internet Protocol (IP)
- To be used as line, area and system coupler
- Uses the KNXnet/IP protocol or secured access and data transmission via KNXnet/IP Secure
- Up to five KNXnet/IP Tunneling connections for parallel bus access by ETS and further PC software
- Assignment of the network parameters by the installer using ETS, automatically by a DHCP server in the network
- 5 LEDs for display of availability, KNX communication and IP communication
- Electronics powered via "Power over Ethernet" according to IEEE 802.3af or alternatively by an external safety extra low voltage power supply for AC/DC 24 V
- Pluggable terminal block for connection of external power supply unit (not included)
- Ethernet connection via RJ45 socket
- Housing: plastic, color RAL 7035 (light grey), N-system
- DIN rail mounted device for mounting on rail TH35 according to DIN EN 60715
- Type of protection: IP 20



Data sheet	A6V11656735
Dimensions (W x H x D)	36 x 90 x 61 mm
Dimension width (1 MW = 18 mm)	2 MW

Stock no.	Product no.
5WG1146-1AB03	N 146/03

Accessories for N 146/03

Product Title	Stock no.	Product no.
Electronic power supply unit, 350 mA	4AC2402	4AC2402
LOGO! Power 24 V/1.3 A	6EP3331-6SB00-0AY0	LOGO!POWER 24 V/1,3 A

10

Gateways, interface converters

KNX/Ethernet

N 152/01



IP Control Center

Visualisation controller for full-graphic visualizations on web-compatible end devices such as PCs, tablets and smart phones with a standard web browser.

For communication between KNX devices and PCs and, in connection with a LAN-/WLAN modem or DSL router, for remote access to a KNX installation, for usage as an interface for the ETS 3/4/5 and as an interface for a visualization, with usage of the KNXnet/IP protocol, with the following simultaneously usable functions:

- Web server for operating and monitoring up to 1250 statuses and values transmitted by the KNX network, which can be displayed using a standard browser on PCs, tablets, or smartphones connected to the IP network
- Special web-configuration page for a firmware update, to set the IP configuration, SMTP server, security settings, password protection, certificates, Sonos module, API connection and restart
- Graphical web editor for a creation of fully graphical visualization with control and display elements, configurable in various styles
- Smart editor for the creation of a visualisation, tuned for mobile browsers, smartphones, tablets with control and display elements, configurable in various styles and layouts
- Annual timer, with astronomical calendar, for 300 time switch schedules with up to 30 time switch commands per time switch schedule
- Scene module with up to 5000 scenes or events
- Chart module for recording and reporting of up to 10 data points
- Monitoring module for monitoring and storage of up to 1000 events into a ring buffer
- IP interface for control of up to 20 IP-devices via up to 20 TCP/UDP commands per IP-device
- Fully graphical logic module with up to 1000 logic functions
- Alarm function for up to 250 different alarms
- E-mail function, with up to 20 contacts, for transmission of chart data from chart module, logged data from monitoring module or alarm data
- Data point management for viewing, managing, editing and categorizing all available data points
- Module for controlling SONOS loudspeakers
- Module for controlling the Philips HUE LED lighting system
- Ethernet interface 10/100 Mbits/s with RJ45 socket for connection to the IP network using the Internet Protocol
- 2 LED displays for IP connection/communication and for error messages
- Integrated bus connector and bus terminal for connection to a KNX network
- Power supply of the electronics by an external voltage source for AC/DC 24 V, 50 mA
- Series installation device for mounting on support rails TH35 DIN EN 60715

Data sheet	A6V10417875
Dimensions (W x H x D)	90 x 72 x 55 mm
Dimension width (1 MW = 18 mm)	4 MW

Stock no.	Product no.
5WG1152-1AB01	N 152/01

Accessories for N 152/01

Product Title	Stock no.	Product no.
Electronic power supply unit, 350 mA	4AC2402	4AC2402
LOGO! Power 24 V/1.3 A	6EP3331-6SB00-0AY0	LOGO!POWER 24 V/1,3 A

Web server for Synco devices

Web server OZW772 allows for remote plant control and monitoring via the web.

- Operate web browser via PC/laptop and Smartphone
- Operate ACS (PC/laptop with ACS plant operating software)
- Connections: USB and Ethernet
- Display fault messages in the web browser
- Send fault messages to a maximum of 4 e-mail recipients
- Periodically send system reports to e-mail recipients
- Visualize the plants in the web browser based on standard plant diagrams and customized plant web pages
- Acquire and display consumption data
- Send consumption data file to 2 email recipients
- Function "Energy indicator" to monitor data points for energy-related limit values, or "Green limits"
- Web services for external applications via Web API (Web Application Programming Interface)
- Encrypted with https and TLS for e-mails
- Record of trends, display and dispatch to 2 e-mail recipients
- Integration up to 237 S-Mode data points of KNX devices (not OZW772.01)
- Direct commissioning with webbrowser or ACS service tool
- Easy and secure remote access and plant overview with Synco IC Remote Access - a web-based service for secure remote access (www.siemens-syncoic.com)

OZW772..



Internet portal Synco IC offers simple and secure access to your plants

- Simple and fast set up of access via the Internet (fixed net- or mobile router)
- The portal provides additional functions:
 - Manage one or multiple plants
 - Central user management
 - Display of plant overview, state of Energy indicators and alarms
 - Send alarm notifications per e-mail
 - Secured communications through encryption (https)

Web servers OZW772.01, OZW772.04, OZW772.16, OZW772.250 can connect 1, 4, 16, or 250 KNX devices from the product ranges Synco 700, Synco RXB, and RDG/RDF room thermostats, and the QAX Synco living central apartment units.

Data sheet	N5701
Operating voltage	Power pack: AC 230 V Web server: DC 24 V
Communication	KNX TP (twisted pair) Ethernet, RJ45 plug socket (shielded) USB V2.0
Mounting	On DIN rails With Screws
Degree of protection	IP30
Dimensions (W x H x D)	87.5 x 90 x 40 mm

Range overview OZW772..

Product Title	Stock no.	Product no.
Web server for 1 Synco device	BPZ:OZW772.01	OZW772.01
Web server for 4 Synco devices	BPZ:OZW772.04	OZW772.04
Web server for 16 Synco devices	BPZ:OZW772.16	OZW772.16
Web server for 250 Synco devices	BPZ:OZW772.250	OZW772.250

Gateways, interface converters

KNX/DALI

N 141/03, N 141/21



KNX/DALI Gateway plus/Twin plus

- With emergency lighting, with sensors
- For communication via KNX with electronic ballasts (ECG) with a DALI interface
- DALI outputs with DALI-2 certification acc. to IEC 62386-101 -103, each for communication with up to 64 DALI ECG Ed.1 and DALI-2 and at least 10 sensors
- Integrated power supply with input voltage AC 110-240 V, 50-60 Hz or DC 120-240 V for powering the gateway electronics and DALI output
- Maximum DALI output voltage of 19 V, short circuit resistant
- Incorrect voltage detection during commissioning if incorrect power line is connected to a DALI output
- LED display for displaying operation mode and error messages
- Pushbutton for switching between bus and direct operating mode
- One pair of pushbuttons for switching On/Off of all connected DALI ECG
- One LED per DALI output for status signal of all connected luminaries in direct mode
- Configurable assignment of max. 64 DALI ECG per channel to max. 16 DALI groups per channel, exclusive controlled in groups or single (switching, dimming, set dimming value and color temperature) and feedback for group status and lamp failure
- Support of DALI DT8 ECG for colour temperature control (Tunable White). Individual, group, scene, effect and schedule control for Human Centric Lighting
- Configurable behaviour for bus failure (stand-alone mode)
- Configurable pre-loaded applications without ETS
- Configurable function burn-in for all ECG via pushbutton or single via object
- Scheduler for day, week, date with astro function
- Control of all connected luminaries together in broadcast mode
- Status signal and display of lamp and ECG failure per group and per DALI device
- Transformation of dimming commands into a temporary setpoint adjustment for ECG with integrated constant light level control and directly connected light level sensor
- One or two level timer
- Up to 4 integrated one time or cyclical control of repeatable sequences or color effects
- Distinction between self-contained emergency luminaries with one or two DALI devices
- Starting the self-conducted testing of each individual inverter and reporting the test result via bus or save in a persistent memory with memory space monitoring over object
- Distinction between function test, short duration test, and long duration test
- Optional configuration of any DALI ECG to dim to a preset dimming value in emergency mode
- Locking of switching and dimming commands as well as configuration while emergency mode is activated
- Activation of emergency mode based on a configurable number of failed DALI ECG
- Lock object to elimination of failure messages interruption of ECG during emergency lighting testing
- Inhibit mode for disabling battery mode of self-contained emergency luminaries over pushbutton
- Per channel up to 6 stand-by-area analysis for activation of switch actuators
- Scene control for up to 16 scenes per channel
- 16 integrated 2-level-controller for brightness control and 16 constant light level controller for main luminaries group and up to four additional luminaries groups
- Assignment of a CIN to a DALI ECG
- Reintegration defective DALI ECG without ETS
- Assignment of DALI ECG to groups and test option for ECG, groups, scenes and effects via ETS
- Assignment of DALI sensors and test option of sensors via ETS
- Integrated bus coupling unit with only half a standard bus load, bus connection via bus terminal
- Mounting on DIN rail EN 60715-TH35-7.5

Data sheet

A6V10466086

Range overview N 141/03, N 141/21

Product Title	Dimensions (WxHxD) [mm]	Dimension width (1 MW = 18 mm)	Stock no.	Product no.
KNX/DALI Gateway Twin plus, 2 channels	60 x 72 x 90	4 MW	5WG1141-1AB21	N 141/21
KNX/DALI Gateway plus, 1 channel	90 x 72 x 55	4 MW	5WG1141-1AB03	N 141/03

KNX/DALI Gateway Twin**N 141/31**

- Communication via KNX EIB with electronic ballasts (ECG) with a DALI interface
- Two DALI outputs with DALI-2 certification acc. to IEC 62386-101 and 103, each for communication with up to 64 DALI ballasts
- Integrated power supply with input voltage AC 110...240 V, 50...60 Hz or DC 120...240 V for powering the gateway electronics and DALI output
- Support of ECGs Type 0, 1, 2, 3, 4, 5, 6, 7 and 8 according to EN 62386 edition 1 as well as edition 2 (DALI-2)
- Maximum DALI output voltage of 19 V, short circuit resistant
- Incorrect voltage detection during commissioning, whether incorrect power line is connected to a DALI output
- LED display for displaying operation mode and error messages
- Pushbutton for switching between bus and direct operating mode
- One pair of pushbuttons for switching On/Off of all connected DALI ballasts
- One LED per DALI output for status signal of all connected luminaries in direct mode
- Configurable behaviour for bus failure (stand-alone mode)
- Control (switching, dimming, set dimming value) of all connected luminaries together in broad-cast mode
- Status signal and display of lamp and ECG failure per group and per DALI device
- One or two level timer
- Integrated scene control for up to 32 scenes
- Assignment of DALI ECG to groups and test option for ECG, groups and scenes via ETS during commissioning
- Possibility to reintegrate defective DALI ECG without software
- Integrated bus coupling unit with only half a standard bus load
- Bus connection via bus terminal
- Mounting on DIN rail EN 60715-TH35-7.5

The following options are selectable, depending on the application program:

- Configurable assignment of max. 128 DALI ECG to max. 32 DALI groups, exclusive controlled in groups or single (switching, dimming, set dimming value and color temperature) and feedback for group status and lamp failure
- Support of DALI DT8 ECGs for colour temperature control Tc, Tunable White according to EN 62386 part 209. individual, group, scene, effect and schedule control for Human Centric Lighting (HCL)
- Configurable function burn-in for all ECG via pushbutton or single via object
- Up to twelve stand-by-area analysis for activation of switch actuators
- Distinction between self-contained emergency luminaries with one or two DALI devices
- Optional configuration of any DALI ECG to dim to a preset dimming value in case of emergency mode
- Locking of switching and dimming commands as well as configuration while emergency mode is activated
- Activation of emergency mode based on a configurable number of failed DALI ECG
- Lock object to elimination of failure messages interruption of ECG during emergency lighting testing
- Inhibit mode for disabling battery mode of self-contained emergency luminaries over pushbutton

Data sheet	A6V10466084
Dimensions (W x H x D)	60 x 72 x 90 mm
Dimension width (1 MW = 18 mm)	4 MW

Stock no.	Product no.
5WG1141-1AB31	N 141/31

10

Gateways, interface converters

KNX/DALI

N 525D11



Switch/dim actuator, 2x DALI Broadcast

- 2 DALI outputs with DALI-2 certification
- Control capacity for up to 20 DALI-ECGs per DALI output
- DALI output voltage of 19 V, short circuit resistant
- Integrated power supply with input voltage AC 110-240 V, 50-60 Hz or DC 120-240 V for powering the gateway electronics and DALI output
- LED display for displaying operation mode and the following failure messages: Illuminant defective, DALI incorrect voltage, DALI short circuit, no ECG found
- One pair of push buttons for switching On/Off and dimming of all connected DALI ECG
- Button on the device front for deactivation of the direct mode operation and LED to indicate activation direct mode operation
- Building site function that provides ex-factory enables switching the building site lighting on and off via bus wall switches and actuators, even if these devices have not yet been commissioned with the Engineering Tool Software (ETS)
- Housing: plastic, N-system
- DIN rail mounted device for mounting on rail TH35 according to DIN EN 60715
- Type of protection: IP 20
- Max. width 4 TE (1 TE = 18 mm)
- Control of color temperature (Tunable White)
- One switching, dimming and color temperature value and status object per output
- Selectable operation mode (normal mode, time switch mode, blinking)
- Adjustable ON- and OFF-delay, control value input object, central switching
- Two logic operation (AND/OR/NAND/NOR/EXOR/FILTER/TRIGGER)
- Adjustable dimming time for switching, dimming and color temperature
- Switch an output on or off by dimming
- Seven configurable dimming curves
- Maximum and minimum dimming and color temperature value
- Configurable sending of status objects on request, cyclically, and / or automatically after a change
- Configurable state on voltage failure and on voltage recovery
- Night mode for time-limited switching the output, i.e. the lighting, at night
- Variable On period at night or time switch mode, time limit in timer switch mode, warning signal prior to imminent switching-off
- Manual override, permanent OFF switching, forced control, locking mode
- Counting of operating hours and counting of load cycles with threshold monitoring
- Integrated 8-bit scene control and linking of each output into up to 8 scenes
- Failure status objects

Data sheet	A6V11914230
Number of channels	2
Dimensions (W x H x D)	72 x 90 x 61 mm
Dimension width (1 MW = 18 mm)	4 MW

Stock no.	Product no.
5WG1525-1DB11	N 525D11

Switch/dim actuator, 8 x DALI, 8 ECGs per DALI output**N 525E01**

- 8 DALI outputs
- Control capacity for up to 8 DALI-ECGs per DALI output
- Power supplied to the electronics and the DALI outputs through an integrated power supply unit for AC 230 V
- Green LED for status display
- Pushbutton for selecting and switching over 4 DALI outputs respectively between bus and direct mode
- Yellow LED for indicating which 4 DALI outputs the direct mode is activated for
- 1 red LED per DALI output for indicating the circuit state or fault (e.g. lighting medium failure) of the connected group
- Four pushbutton pairs for switching and dimming of 4 DALI outputs in direct mode, functional when AC 230 V is applied (also when no bus voltage is connected and also when bus communication has not yet been started or is interrupted)
- Selection of identical or individual configuration of all DALI outputs
- Selectable operating mode per DALI output (normal mode, 1-level or 2-level time-switch mode)
- Per DALI output with command objects for switching on/off, dimming brighter/darker and setting dimming value
- Per DALI output optionally with up to 4 add-on status objects (circuit state and lighting medium failure, dimming value status and DALI status)
- Sending of status objects on request and/or automatically after change
- Per DALI output with add-on object for time-limited switching on of lighting in night mode (cleaning light)
- Warning approx. 1 minute before imminent switching off, by dimming to 50% of former dimming value in night or timer mode
- Adjustable switching on and/or off of a channel through dimming brighter/darker, dimming value when switching on, actuating or dimming a new dimming value, dimming time from 0% to 100%
- Adjustable behavior on bus voltage or mains voltage failure and bus voltage or mains voltage recovery
- Add-on object and integrated 8bit scene control for saving and restoring up to 16 scenes per DALI output
- Integrated bus coupling unit as only half standard bus load, bus connection through bus terminal
- Device for mounting on rail TH35 DIN EN 60715

Data sheet	A6V10416176
Rated voltage	AC 230 V
Number of channels	8
Dimensions (W x H x D)	90 x 72 x 60 mm
Dimension width (1 MW = 18 mm)	4 MW

Stock no.	Product no.
5WG1525-1EB01	N 525E01

10

Gateways, interface converters KNX/DALI

Accessories for KNX / DALI Gateway

UP 141/71



DALI Push button interface 4fold

- Binary input device
- 4 inputs to connect installation buttons
- Supported actions per input
 - Short button press
 - Long button press
- Integrated DALI bus coupling unit for communicating with a central DALI controller/gateway
- Power supply through DALI line with 6 mA DALI bus load
- For flush-mounting wall or ceiling outlet installations with a 60 mm diameter and depth of 60 mm
- Plug-in terminals for connecting the DALI line
- Cable set for connecting pushbuttons

Data sheet

A6V11786002

Stock no. Product no.

5WG1141-2AB71 **UP 141/71**

IP Gateway KNX/BACnet**N 143/01**

- BACnet Application Specific Controller (B-ASC) as Gateway between KNX TP and BACnet IP
- BTL certified
- Up to 250 BACnet objects
- Up to 455 BACnet COV subscriptions
- Automatic translation of KNX communication objects into BACnet objects according to the configuration with ETS
- For communication between KNX EIB devices and PCs or other devices with Ethernet (10BaseT) interface, as well as in conjunction with a LAN modem or DSL router for remote access to an KNX EIB installation
- For use as an interface e.g. for ETS or for visualization software
- Use the KNXnet/IP protocol
- KNXnet/IP Tunneling connection for parallel bus access by ETS and further PC software
- ObjectServer connection for visualization via network connections with long signal transmission duration
- Assignment of the network parameters by the installer using ETS, or automatically by a DHCP server in the network
- 2 LEDs for display of operational availability and IP communication
- Additional power supply by an external safety extra low voltage power supply for AC/DC 24 V, 40 mA
- Pluggable terminal block for connection of external power supply unit (not included)
- Integrated bus coupling unit with bus connection via bus terminal
- Ethernet connection via RJ45 socket
- Mounting on DIN rail EN 60715-TH35-7.5

Data sheet	A6V10466141
Dimensions (W x H x D)	90 x 72 x 55 mm
Dimension width (1 MW = 18 mm)	4 MW

Stock no.	Product no.
5WG1143-1AB01	N 143/01

Accessories for N 143/01

Product Title	Stock no.	Product no.
Electronic power supply unit, 350 mA	4AC2402	4AC2402
LOGO! Power 24 V/1.3 A	6EP3331-6SB00-0AY0	LOGO!POWER 24 V/1,3 A

Gateways, interface converters

KNX/USB

N 148/12



USB Interface

- Compatible with USB 2.0 and USB 3.0
- For isolated access to the bus line over the built-in USB socket (type B)
- For connection of a PC for addressing, parameterization, visualization, logging and diagnosis of bus devices
- Access to all bus devices in the whole bus system
- Support of bus telegrams with up to 64 bytes length
- Power supply over the bus line and over USB through the connected PC
- Integrated bus coupling unit, bus connection over bus terminal
- Transmission at USB 2.0 speed (max. 12 Mbit/s) between PC and USB interface
- Modular installation device for mounting on TH35 DIN EN 60715 mounting rail

Data sheet

A6V11535346

Dimensions (W x H x D)

55 x 18 x 90 mm

Dimension width (1 MW = 18 mm)

1 MW

Stock no.

Product no.

5WG1148-1AB12

N 148/12

OCI702



USB - KNX Service interface

The service interface consists of:

- OCI702 service interface
- USB 2.0 cable (Type A / B)
- KNX service cable for Synco™ controllers (RJ45 / RJ45)
- KNX service cable for Desigo™ TRA (RJ45 / jack plug 2.5 mm)
- KNX service cable (RJ45 / KNX bus terminal)

With the respective PC software, the interfaces allows to commission and service devices with KNX communication, e.g. from the following ranges:

- Synco™ 700 controllers and room devices
- KNX room thermostats RDF..., RDG..
- Individual room controllers RXB..
- Synco™ living central apartment units QAX9...
- Desigo TRA
- GAMMA devices

Data sheet

A6V10438951

Degree of protection

IP20

Warranty

24 WarrantyMonths

Stock no.

Product no.

S55800-Y101

OCI702

Communication Module LOGO! CMK2000

- For communication between LOGO! 8 and KNX devices via the KNX bus
- Transformation of typical PLC signals into KNX telegrams and vice versa
- Linking transmitted KNX data points and LOGO! inputs and outputs via logic and control functions through LOGO!
- The following channels are available at the maximum configuration level of the LOGO!:
 - 24 binary inputs
 - 20 binary outputs
 - 8 analog inputs
 - 8 analog outputs
- Date and time can be synchronized via KNX
- 50 configurable communication objects
- Communication via Ethernet with LOGO! 8

Data sheet A6V11642346
 Dimension width (1 MW = 18 mm) 4 MW

LOGO! CMK2000

Stock no.	Product no.
6BK1700-0BA20-0AA0	LOGO! CMK2000

Physical sensors



Overview and selection tools		334
with KNX connection	Multisensors	338
	Motion/presence	342
	Brightness	345
	Temperature, humidity	346
	Temperature, humidity, air quality	353
without KNX connection	Motion	357
	Temperature	358
	Humidity	361
	Air quality	365
	Sunlight intensity	371

Physical sensors

Overview and selection tools

Room sensors for flush mounting

The Symaro sensor front module is equipped with spring clips. The spring clips ensure easy and error-free mounting of the front module to the basic module. In addition, an anti-theft device prevent unauthorized removal of the front module.

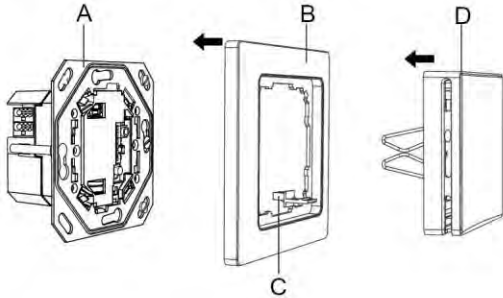

- A: Basic module AQR257../AQR254...
- B: DELTA frame see chapter Display and operation units - Pushbutton accessories
- C: Anti-theft device
- D: Front module AQR253..

Overview of module combinations – Room sensors

Communicating sensors		Mounting ¹⁾	Measuring Variables			Display	Input	
Basic module	Front module		CO2	Relative humidity	Temperature	CO2-indicator	passive Temperature NTC 10k	Two potential-free contacts
AQR2570Nx	+ AQR2532NNW	UP			■		■	■
AQR2570Nx	+ AQR2535NNW	UP		■	■		■	■
AQR2576Nx	+ AQR2530NNW	UP	■				■	■
AQR2576Nx	+ AQR2532NNW	UP	■		■		■	■
AQR2576Nx	+ AQR2535NNW	UP	■	■	■		■	■
AQR2576Nx	+ AQR2535NNWQ	UP	■	■	■ (radial)	■	■	■
QMX3.P30		AP			■			
QMX3.P40		AP		■	■			
QMX3.P70		AP	■	■	■	■		

- Replace x with:
- F for VDE/CEE (70 x 70 mm)
 - H for British Standard (83 x 83 mm)
 - G for Italian Standard 3 modular (110 x 64 mm)
 - J for UL Standard 2" x 4" (64 x 110 mm)
- ¹⁾ AP surface mounted, UP flush mounted

Detection area

Detection area UP 258D61

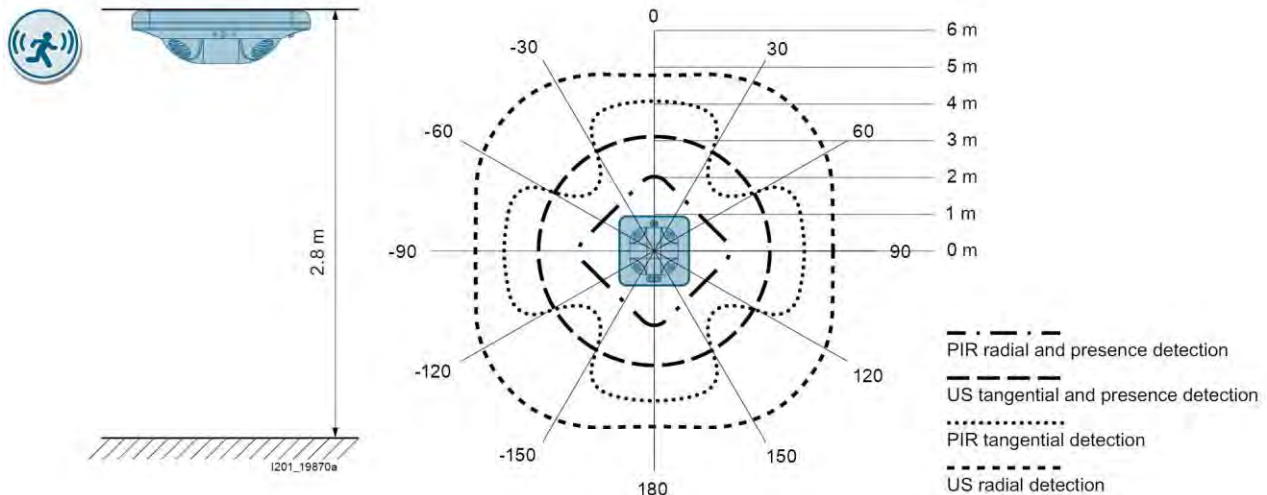

11

Detection area UP 258D31, UP 258D41, UP 258D51

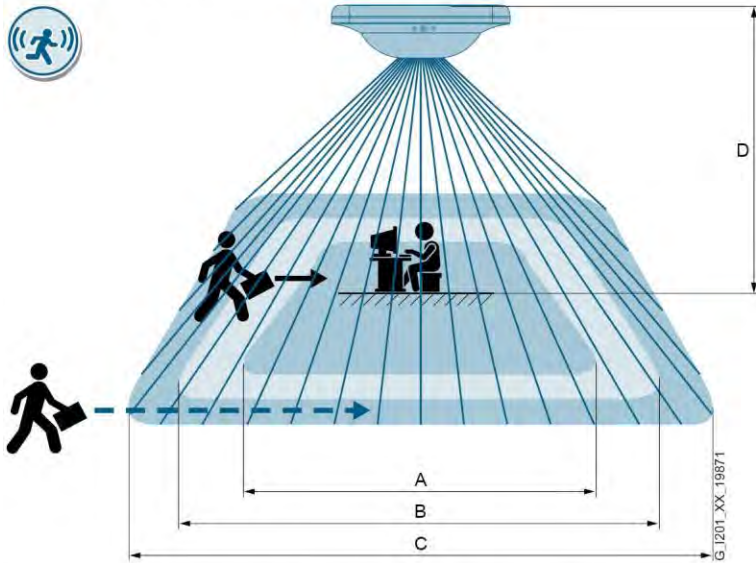

- The detection area has the following zones:
- A) Seated person
 - B) Walking person: step radial in detection of the presence detector on the floor
 - C) Walking person: step tangential in relations to the presence detector on the floor
 - D) Installation height from floor

The table shows the maximum possible diameter of the individual zones in meters at different installation heights (D) and with adjustable range.

		A			B			C		
		1	4	7	1	4	7	1	4	7
D	25 m	3.6 m x 3.6 m	5.2 m x 5.2 m	7.8 m x 7.8 m	3.6 m x 3.6 m	5.2 m x 5.2 m	7.8 m x 7.8 m	4 m x 4 m	6 m x 6 m	18 m x 18 m
	3 m	4 m x 4 m	5.8 m x 5.8 m	8 m x 8 m	4 m x 4 m	5.8 m x 5.8 m	5 m x 5 m	4 m x 4 m	7 m x 7 m	22 m x 22 m
	5 m	--			6 m x 6 m	7 m x 7 m	8.1 m x 8.1 m	8 m x 8 m	17 m x 17 m	27 m x 27 m
	10 m	--			7.4 m x 7.4 m	7.5 m x 7.5 m	8 m x 8 m	13 m x 13 m	27 m x 27 m	42 m x 42 m

Detection area UP 258E22, UP 258D12

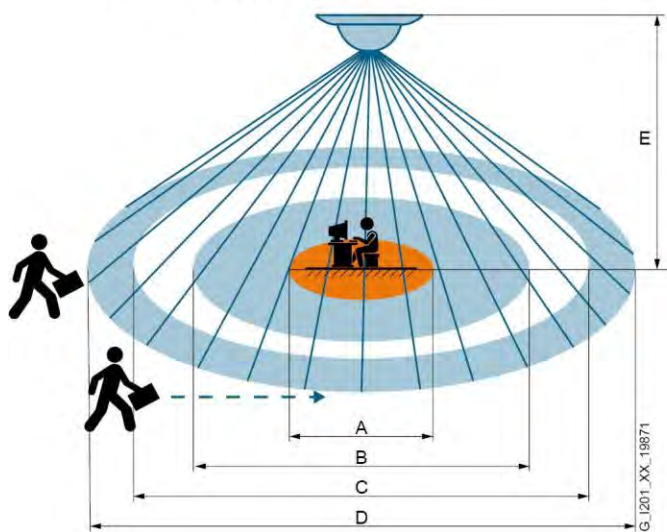

The maximum detection ranges to be achieved are as follows divided:

- A) Sitting person
- B) Walking person straight
- C) Walking person crosswise (tangential)
- D) Brightness measurement
- E) Mounting height from floor level

Maximum achievable detection ranges for UP 258E22 / UP 258D12 (in meters)

E	A	B	C	D
5.0	–	Ø 8.5	Ø 14	Ø 3.0
4.0	–	Ø 7.5	Ø 12	Ø 2.3
3.5	Ø 5.5	Ø 6.5	Ø 10	Ø 2.0
3.0	Ø 5.0	Ø 6.0	Ø 8	Ø 1.6
2.5	Ø 4.5	Ø 5.0	Ø 7	Ø 1.2

Physical sensors

Overview and selection tools

Physical Sensors with KNX connection

										
Type	UP 258D31	UP 258D41	UP 258D51	UP 258D61	UP 258E22	UP 258D12	UP 255D21	AP 254/02	AQR257..	QMX3..
Enclosure data										
Mounting ¹⁾	UP/AP	UP/AP	UP/AP	UP/AP	UP/AP	UP/AP	UP	AP	UP	AP
Degree of protection	IP54	IP20	IP20	IP20	IP20	IP20	IP20	IP54	IP20	IP30
Dimensions										
• Width/Ø [mm] (1 MW = 18 mm)	120	120	120	120	88	88	88	72	71	89
• Height [mm]	41	41	41	41	63 ²⁾	63 ²⁾	63 ²⁾	110	71	134
• Depth [mm]	120	120	120	120				54	39	18
Power supply										
Bus-powered electronics	KNX	KNX	KNX	KNX	KNX	KNX	KNX	KNX	KNX	KNX
Bus connection										
Integrated bus coupling units	■	■	■	■	■	■	■	■	■	■
Bus connection via bus terminal	■	■	■	■	■	■	■	■	■	■
Transmission of sensor values via bus	■	■	■	■	■	■	■	■	■	■
Motion/presence										
Detection capability	PIR	PIR	PIR	Ultra-sound/PIR	PIR	PIR				
Motion	■	■	■	■	■	■				
Presence	■	■	■	■	■	■				
HVCA message output	■	■	■	■	■	■				
Horizontal sensing angle	360°	360°	360°	360°	360°	360°				
Vertical sensing angle	150°	150°	150°	150°	105°	105°				
Range on each side, up to [m]	42 ³⁾	42 ³⁾	42 ³⁾	8,9 ³⁾	7 ³⁾	7 ³⁾				
Adjustable range	■	■	■	■	■	■				
Adjustable sensitivity	■	■	■	■	■	■				
Adjustable sectorization	■	■	■							
Brightness										
Measuring range [Lux]	1...1000	1...1000	1...1000	1...1000	20...1000	20...1000	20...1000	1...100000		
For measuring outdoor brightness								■		
For measuring indoor brightness (mixed light)	■	■	■	■	■	■	■			
HVAC sensors										
Temperature measuring range [°C]	0...50	0...50	0...50	0...50				-25...+55	0...50 ⁴⁾	0...50 ⁴⁾
Temperature sensor inputs									NTC 10k ⁴⁾	
Temperature max. cable length, unshielded, twisted [m]									10 ⁴⁾	
Humidity [% r.F.]		0...100	0...100						0...100 ⁴⁾	0...100 ⁴⁾
CO ₂ [ppm]			400...10000						0...5000 ⁴⁾	0...5000 ⁴⁾
Controller										
2-point brightness controller	■	■	■	■	■	■	■			
Constant light level controller	■	■	■	■	■	■	■			
Temperature controller	■		■	■					■	■
Relative humidity controller		■	■						■	■ ⁵⁾
Air quality controller			■						■	■ ⁵⁾
Functions										
Comparator	■	■	■	■						
Calculator	■	■	■	■						
Threshold monitoring	■	■	■	■						
Dew point calculation		■	■							
Infrared (IR) receiver	■	■	■	■	■	■	■			

¹⁾ AP surface mounted, UP flush mounted

²⁾ For flush mounting, mounting height approx. 31 mm, for surface mounting with AP 258E surface-mounting enclosure, approx. 73 mm.

³⁾ For complete technical data visit www.siemens.de/gamma-td

⁴⁾ Only available with appropriate module combination or variant.

⁵⁾ Depending on the model.

Physical Sensors without KNX connection											
Active sensors			Mounting ⁴⁾	Measuring Variables						Display	Relay contact
Basic module	+	Front module		PM2.5/10	CO ₂	VOC	Relative humidity	Active temp.	Passive temp.	CO ₂ -indicator	
AQR2540Nx	+	AQR2532NNW	UP					■			
AQR2540Nx	+	AQR2535NNW	UP				■	■			
AQR2540Nx	+	AQR2534ANW	UP				■	■	LG-Ni1000		
AQR2546Nx	+	AQR2530NNW	UP		■						
AQR2546Nx	+	AQR2532NNW	UP		■			■			
AQR2546Nx	+	AQR2535NNW	UP		■		■	■ ²⁾			
AQR2546Nx	+	AQR2535NNWQ	UP		■		■	■ ²⁾	■		
AQR2546Nx	+	AQR2534ANW	UP		■		■	■ ²⁾	LG-Ni1000		
AQR2547Nx	+	AQR2530NNW	UP			■					
AQR2547Nx	+	AQR2532NNW	UP			■		■			
AQR2547Nx	+	AQR2535NNW	UP			■	■	■ ²⁾			
AQR2547Nx	+	AQR2534ANW	UP			■	■	■ ²⁾	LG-Ni1000		
AQR2548Nx	+	AQR2530NNW	UP		■	■ ¹⁾					
AQR2548Nx	+	AQR2532NNW	UP		■	■ ¹⁾		■			
AQR2548Nx	+	AQR2535NNW	UP		■	■ ¹⁾	■	■ ²⁾			
AQR2548Nx	+	AQR2535NNWQ	UP		■	■ ¹⁾	■	■ ²⁾	■		
AQR2548Nx	+	AQR2534ANW	UP		■	■ ¹⁾	■	■ ²⁾	LG-Ni1000		
AQR2500Nx	+	AQR2531ANW	UP						LG-Ni1000		
Room sensor - Temperature											
QAA2012			AP								
QAA2061			AP					■ ³⁾			
QAA2061D			AP					■ ³⁾			
QAA2071			AP					■ ³⁾			
Contact sensor											
QAD2012			AP								
External sensor - Temperature											
QAC2012			AP								
QAC3161			AP					■ ³⁾			
Room sensor - Humidity											
QFA2000			AP				■				
QFA2060			AP				■	■ ³⁾			
QFA2060D			AP				■	■ ³⁾	■		
Hygrostats											
QFA1000			AP				■ ³⁾			■	
QFA1001			AP				■ ³⁾			■	
Room sensor - Air quality											
QPA2000			AP		■						
QPA2002			AP		■	■					
QPA2060			AP		■			■ ³⁾			
QPA2062			AP		■		■	■ ³⁾			
QPA2062D			AP		■		■	■ ³⁾	■		
QPA1000			AP			■					
QPA1004			AP		■						
QPA1064			AP		■			■ ³⁾			
Room sensor - Fine dust											
QSA2700			AP	■							
QSA2700D			AP	■					■		

¹⁾ Here, the in-door air quality is calculated from the CO₂ and VOC measuring variables. VOC is not available as direct measuring variable

²⁾ The measuring variable is solely available as switch output

³⁾ Measuring range adjustable

⁴⁾ AP surface mounted, UP flush mounted

Physical sensors with KNX connection Multisensors

UP 258D..1



Presence Detector WIDE

- Passive infrared detector for ceiling installation
 - Horizontal 360° motion detection area
 - Presence/motion detection up to 64 m² / 400 m² (depending on mounting or room height)
 - A 7-level setting to adjust the presence detection range
 - Brightness and temperature measurement
 - Integrated IR receiver and IR decoder for IR remote control with six pairs of buttons
 - LED for display of detected motions in the delivery state for easy commissioning
 - Programming button operable from the front
 - Integrated bus coupler, bus connection via bus terminal, operation of electronics with bus voltage
 - Mounting on the ceiling on a flush-mounting box with diameter of 60 mm, in a separately ordered housing for surface mounting or mounting plate for 4 x 4 boxes
 - Color white (similar to RAL 9016)
- Presence detection for three function blocks (presence, HVAC, slave)
 - Two selectable functions per function block at the start and two further functions at expiration of presence detection
 - Parallel operation of more presence detectors (master-slave, master-master) possible
 - Locking and output object for each function block
 - Extension inputs for semi-automatic mode
 - Adjustable sensitivity of detection
 - Deactivation of the individual 4 PIR sensors
 - Calibration of brightness measurement with correction factor/offset, via object mixed light-artificial light and two objects artificial light-daylight
 - Constant light control for one main row of lamps and up to four additional rows of lamps
 - 2-point light control
 - Adjustable temperature control as 2-point and/or steady control, heating/cooling operation
 - Sequence control for PI temperature control
 - Adjustable ventilator speed level
 - Object for dew point alarm
 - Comparator for analog values
 - Min., max. and composite calculator for brightness, temperature, humidity and CO₂
 - Threshold monitoring for brightness, temperature, humidity and CO₂

UP 258D31



Presence Detector WIDE with temperature measurement

- Passive infrared detector for ceiling installation
 - Horizontal 360° motion detection area
 - Presence/motion detection up to 64 m² / 400 m² (depending on mounting or room height)
 - A 7-level setting to adjust the presence detection range
 - Brightness and temperature measurement
 - Integrated IR receiver and IR decoder for IR remote control with six pairs of buttons
 - LED for display of detected motions in the delivery state for easy commissioning
 - Programming button operable from the front
 - Integrated bus coupler, bus connection via bus terminal, operation of electronics with bus voltage
 - Mounting on the ceiling on a flush-mounting box with diameter of 60 mm, in a separately ordered housing for surface mounting or mounting plate for 4 x 4 boxes
 - Color white (similar to RAL 9016)
- all functions as UP 258DB..1

Data sheet

A6V11895382

Dimensions (W x H x D)

120 x 41 x 120 mm

Stock no.

Product no.

5WG1258-2DB31

UP 258D31

Presence Detector WIDE pro with temperature and relative humidity measurement

UP 258D41



- Passive infrared detector for ceiling installation
 - Horizontal 360° motion detection area
 - Presence/motion detection up to 64 m² / 400 m² (depending on mounting or room height)
 - A 7-level setting to adjust the presence detection range
 - Brightness and temperature measurement
 - Integrated IR receiver and IR decoder for IR remote control with six pairs of buttons
 - LED for display of detected motions in the delivery state for easy commissioning
 - Programming button operable from the front
 - Integrated bus coupler, bus connection via bus terminal, operation of electronics with bus voltage
 - Mounting on the ceiling on a flush-mounting box with diameter of 60 mm, in a separately ordered housing for surface mounting or mounting plate for 4 x 4 boxes
 - Color white (similar to RAL 9016)
- all functions as UP 258DB..1
 - Integrated humidity controller via 3 switching thresholds
 - Dew point calculation

Data sheet A6V11895382
Dimensions (W x H x D) 120 x 41 x 120 mm

Stock no. Product no.
5WG1258-2DB41 UP 258D41

Presence Detector WIDE multi with temperature, humidity and CO2 measurement

UP 258D51



- Passive infrared detector for ceiling installation
 - Horizontal 360° motion detection area
 - Presence/motion detection up to 64 m² / 400 m² (depending on mounting or room height)
 - A 7-level setting to adjust the presence detection range
 - Brightness and temperature measurement
 - Integrated IR receiver and IR decoder for IR remote control with six pairs of buttons
 - LED for display of detected motions in the delivery state for easy commissioning
 - Programming button operable from the front
 - Integrated bus coupler, bus connection via bus terminal, operation of electronics with bus voltage
 - Mounting on the ceiling on a flush-mounting box with diameter of 60 mm, in a separately ordered housing for surface mounting or mounting plate for 4 x 4 boxes
 - Color white (similar to RAL 9016)
- all functions as UP 258DB..1
 - Integrated humidity and CO2 controller via 3 switching thresholds
 - Dew point calculation

Data sheet A6V11895382
Dimensions (W x H x D) 120 x 41 x 120 mm

Stock no. Product no.
5WG1258-2DB51 UP 258D51

Physical sensors with KNX connection Multisensors

UP 258D61



Presence Detector WIDE DualTech with temperature measurement

- Ultrasound for reliable detection for ceiling installation indoors even behind objects
 - Additional detection options through PIR technology
 - Horizontal 360° motion detection area
 - Presence/motion detection up to 28 m² / 79 m² (depending on mounting or room height)
 - Brightness and temperature measurement
 - Integrated IR receiver and IR decoder for IR remote control with six pairs of buttons
 - LED for display of detected motions in the delivery state for easy commissioning
 - Programming button operable from the front
 - Integrated bus coupler, bus connection via bus terminal, operation of electronics with bus voltage
 - Mounting on the ceiling on a flush-mounting box with diameter of 60 mm, in a separately ordered housing for surface mounting or mounting plate for 4 x 4 boxes
 - Color white (similar to RAL 9016)
- Presence detection for three function blocks (presence, HVAC, slave)
 - Two selectable functions per function block at the start and two further functions at expiration of presence detection
 - Parallel operation of more presence detectors (master-slave, master-master) possible
 - Locking and output object for each function block
 - Extension inputs for semi-automatic mode
 - Adjustable sensitivity of detection
 - Calibration of brightness measurement with correction factor/offset, via object mixed light-artificial light and two objects artificial light-daylight
 - Constant light control for one main row of lamps and up to four additional rows of lamps
 - 2-point light control
 - Adjustable temperature control as 2-point and/or steady control, heating/cooling operation
 - Sequence control for PI temperature control
 - Adjustable ventilator speed level
 - Object for dew point alarm
 - Comparator for analog values
 - Min., max. and composite calculator for brightness, temperature, humidity and CO₂
 - Threshold monitoring for brightness, temperature, humidity and CO₂

Data sheet

A6V11895378

Dimensions (W x H x D)

120 x 41 x 120 mm

Stock no.

Product no.

5WG1258-2DB61

UP 258D61

Accessories for multisensors

AP 258E11



Surface Mounting Box Type B

- Mounting presence detector UP 258Dx1 as a surface-mounted device
- Color white (similar to RAL 9016)

Dimensions (W x H x D)

109 x 109 x 30 mm

Stock no.

Product no.

5WG1258-7EB11

AP 258E11

Physical sensors with KNX connection Multisensors

IR remote control

- 6 pushbutton pairs for the remote control of lighting, shutter/blinds and scenes
- Parameterization via ETS in the presence detectors UP 258E and UP 258D and in the brightness sensor UP 255D21
- Range: up to 10 m
- Power supply: CR2025 lithium button cell
- Degree of protection (acc. to EN 60529): IP40

Data sheet A6V11786011
 Dimensions (W x H x D) 40 x 87 x 6 mm

S 255/11



Stock no.	Product no.
5WG1255-7AB11	S 255/11

Mounting plate

- Mounting presence detector UP 258Dx1 with 4x4 boxes
- Color white (similar to RAL 9016)

S 258/12



Stock no.	Product no.
5WG1258-8AB12	S 258/12

Physical sensors with KNX connection Motion/presence

UP 258E22



Presence Detector / Motion detector with constant light level control

- Passive infrared detector for ceiling mounting indoors
- Optional blinding of parts of the detection area
- Adjustable sensitivity of detection
- Mixed light measurement
- Cyclical sending or sending on change of value of the measured brightness value (Lux)
- Integrated two-position controller
- Constant light level control for a main group of luminaries and up to four additional groups of luminaries
- Lighting control configurable as fully automatic or semi-automatic
- Motion detection for three function blocks (presence detector, motion detector, and HVAC detector)
- 2 per function block selectable functions (A, B) on start of the presence detection and two per function block selectable functions (C, D) on expiration of the presence detection
- Configurable delay of 0...255 seconds between sending of function A and B respectively C and D
- Selection per function (A, B, C, D) switching On/Off, 8-bit value, selectable 8-bit value, 16-bit value, temperature value, brightness value, 8-bit scene control
- Blocking object per function block
- Per function block configurable overshoot time, in each case configurable as a fixed time, as switchable between two times via the bus, or settable to a value via the bus
- Parallel operation of several presence detectors (master-slave, master-master) without additional logic module
- Integrated IR receiver and IR decoder for IR remote controls with six pairs of pushbuttons
- Functions of the IR remote control selectable per pair of pushbuttons or per each single pushbutton of a button pair
- Per pushbutton selectable function toggle, switching on, switching off, 8-bit scene recall, 8-bit value, 16-bit value, temperature value, brightness value
- For each pair of pushbuttons selectable function switching On/Off, 2-button dimming with stop telegram, 2-button solar protection control, variable 8-bit value, 8-bit scene control
- Blocking object for IR decoder
- Test mode for easy start-up
- LED for display of detected movements in test mode, to be configured using ETS
- Integrated bus coupling unit, bus connection via bus terminal, Power supply over the bus line
- Ceiling mounting on a flush-mounting box with 60 mm diameter and min. 40 mm depth or in a housing for surface-mounting AP 258E01 (to be ordered separately)
- Monitoring motion range horizontal 360°, vertical approx. 105°
- Monitoring motion of an area of diameter 8 m (depending on mounting/room height)
- Programming button reachable from front

Data sheet

A6V10489482

Dimensions (W x H x D)

88 x 63 x 88 mm

Stock no.

Product no.

5WG1258-2EB22

UP 258E22

Physical sensors with KNX connection Motion/presence

Presence Detector with brightness sensor

- Passive infrared detector for ceiling mounting indoors
- Adjustable sensitivity of detection
- Mixed light measurement
- Ceiling mounting on a flush-mounting box with 60 mm diameter and min. 40 mm depth or in a housing for surface-mounting AP 258E01 (to be ordered separately)
- Integrated IR decoder for S 255/11
- Programming button reachable from front
- Monitoring range horizontal 360°, vertical approx. 105°
- Monitoring motion of an area of diameter 8 m (depending on mounting/room height)
- Optional blinding of parts of the detection area
- Power supply via KNX bus
- Integrated bus coupling unit, bus connection via bus terminal

Data sheet A6V10489482
 Dimensions (W x H x D) 88 x 63 x 88 mm

UP 258D12



Stock no. Product no.

5WG1258-2DB12 UP 258D12

Accessories for UP 258D12, UP 258E22 and UP 255D21

Surface Mounting Enclosure

- For fixing the presence detectors UP 258D12 and UP 258E22 and the brightness sensor UP 255D21 as a surface mounting device

Data sheet A6V10416111

AP 258E01



Stock no. Product no.

5WG1258-7EB01 AP 258E01

Physical sensors with KNX connection Motion/presence

S 255/11



IR remote control

- 6 pushbutton pairs for the remote control of lighting, shutter/blinds and scenes
- Parameterization via ETS in the presence detectors UP 258E and UP 258D and in the brightness sensor UP 255D21
- Range: up to 10 m
- Power supply: CR2025 lithium button cell
- Degree of protection (acc. to EN 60529): IP40

Data sheet

A6V11786011

Dimensions (W x H x D)

40 x 87 x 6 mm



Stock no.

Product no.

5WG1255-7AB11

S 255/11

Physical sensors with KNX connection Brightness

Brightness Sensor with constant light level controller

- Mixed light measurement
- Ceiling mounting on a flush-mounting box with 60 mm diameter and min. 40 mm depth or in a housing for surface-mounting (to be ordered separately)
- Programming button reachable from front
- Integrated IR decoder for S 255/11
- Integrated 2-point control (switching)
- Constant light level control for main group of luminaires and up to 4 additional groups of luminaires incl. automatic calibrating

Data sheet A6V10489482
Dimensions (W x H x D) 88 x 63 x 88 mm

UP 255D21



Stock no.

Product no.

5WG1255-2DB21

UP 255D21

Dual sensor for brightness measurement, temperature measurement, sun protection control, lighting control

- Brightness measurement, temperature measurement, sun protection control, lighting control
- For the detection and transmission of brightness and temperature
 - Temperature measuring range -25 °C...+55 °C
 - Brightness measuring range 1 Lux...100 kLux
 - Horizontal sensing angle -60°...+60°, vertical -35°...+66.5°
- For the control of switch, dimming and shutter/blind actuators, depending on the ambient luminosity and/or ambient temperature
- One sun protection channel for the automatic control of sun protection equipment, with
 - Starting and stopping of automation by means of an object or a dusk threshold
 - Up to three brightness thresholds for determining the height and position of the shutters/blinds or roller shutters
 - Optional teach-in of dusk thresholds and brightness thresholds by means of a teach-in facility
 - Blocking object for the temporary deactivation of the sun protection channel function
- Up to four universal channels for the control of switch, dimming and shutter/blind actuators, depending on ambient luminosity and/or temperature. Optionally available with:
 - Threshold switches for brightness
 - Threshold switches for temperature
 - Threshold switches with logical combination of brightness and temperature
 - Optional teach-in of brightness threshold for each universal channel by means of an associated teach-in facility
 - Deactivation option for each universal channel by means of an associated blocking object (1 bit)
 - Optional second object for transmission of a second telegram on fulfillment of threshold conditions
- Bus-powered electronics
- Integrated bus coupling units
- Bus connection via bus terminal
- Surface mounting
- Degree of protection: IP54

Data sheet A6V10416100
Dimensions (W x H x D) 72 x 110 x 54 mm

AP 254/02



Stock no.

Product no.

5WG1254-3EY02

AP 254/02

Physical sensors with KNX connection Temperature, humidity

AQR2530NNW



Front module for base module, without sensor

- Front module without sensor for plugging onto the Base module
- Matching the DELTA line and DELTA miro frame program

Data sheet	N1411
Color	Titanium white
Degree of protection	IP30
Dimensions (W x H x D)	55 x 55 x 12 mm
Warranty	60 WarrantyMonths

Stock no.	Product no.
S55720-S137	AQR2530NNW

Matching the DELTA line and DELTA miro frame program. See chapter Display and Operation Units.
The relevant base modules must be ordered separately. See chapter Physical sensors.

AQR2532NNW



Front module for base modules, temperature (active)

- Front module with sensor for plugging onto the Base module
- Matching the DELTA line and DELTA miro frame program

Data sheet	N1411
Signal output temperature	Active
Measuring range, temperature	0...50 °C
Color	Titanium white
Degree of protection	IP30
Dimensions (W x H x D)	55 x 55 x 12 mm
Warranty	60 WarrantyMonths

Stock no.	Product no.
S55720-S136	AQR2532NNW

Matching the DELTA line and DELTA miro frame program. See chapter Display and Operation Units.
The relevant base modules must be ordered separately. See chapter Physical sensors.

Physical sensors with KNX connection Temperature, humidity

Front module for base modules, humidity and temperature (active)

AQR2535NNW

- Front module with humidity and temperature sensor for plugging onto the Base module
- Matching the DELTA line and DELTA miro frame program

Data sheet	N1411
Signal output temperature	Active
Measurement range humidity	0... 100 % r.h.
Sensing element, temperature	Active
Measuring range, temperature	0... 50 °C
Color	Titanium white
Degree of protection	IP30
Dimensions (W x H x D)	55 x 55 x 12 mm
Warranty	60 WarrantyMonths



Stock no.	Product no.
-----------	-------------

S55720-S141	AQR2535NNW
-------------	------------

Matching the DELTA line and DELTA miro frame program. See chapter Display and Operation Units.
The relevant base modules must be ordered separately. See chapter Physical sensors.

Dual sensor for brightness measurement, temperature measurement, sun protection control, lighting control

AP 254/02

- Brightness measurement, temperature measurement, sun protection control, lighting control
- For the detection and transmission of brightness and temperature
 - Temperature measuring range -25 °C...+55 °C
 - Brightness measuring range 1 Lux... 100 kLux
 - Horizontal sensing angle -60° ...+60°, vertical -35° ...+66.5°
- For the control of switch, dimming and shutter/blind actuators, depending on the ambient luminosity and/or ambient temperature
- One sun protection channel for the automatic control of sun protection equipment, with
 - Starting and stopping of automation by means of an object or a dusk threshold
 - Up to three brightness thresholds for determining the height and position of the shutters/blinds or roller shutters
 - Optional teach-in of dusk thresholds and brightness thresholds by means of a teach-in facility
 - Blocking object for the temporary deactivation of the sun protection channel function
- Up to four universal channels for the control of switch, dimming and shutter/blind actuators, depending on ambient luminosity and/or temperature. Optionally available with:
 - Threshold switches for brightness
 - Threshold switches for temperature
 - Threshold switches with logical combination of brightness and temperature
 - Optional teach-in of brightness threshold for each universal channel by means of an associated teach-in facility
 - Deactivation option for each universal channel by means of an associated blocking object (1 bit)
 - Optional second object for transmission of a second telegram on fulfillment of threshold conditions
- Bus-powered electronics
- Integrated bus coupling units
- Bus connection via bus terminal
- Surface mounting
- Degree of protection: IP54

Data sheet	A6V10416100
Dimensions (W x H x D)	72 x 110 x 54 mm



Stock no.	Product no.
-----------	-------------

5WG1254-3EY02	AP 254/02
---------------	-----------

Physical sensors with KNX connection Temperature, humidity

QMX3.P30



Room sensor KNX for temperature, white

Functions:

- Temperature sensor
- Temperature control, adjustable as PWM control and/or modulating control (PID algorithm), for pure heating mode, pure cooling mode, heating and cooling mode
- Operating modes switchable via KNX and/or display: Comfort mode, Pre-Comfort, energy savings and protection mode
- Adjustable commissioning and control parameters for radiated heating, slow and fast, floor heating slow and fast
- Integrated bus coupling unit
- 3 independently adjustable switching values for CO₂ concentration and relative air humidity for air quality control
- Actuating variable for 1, 2, or 3-stage fans (humidity and CO₂)
- Actuating variable for 1, 2, or 3-point positioning signal (humidity and CO₂)
- Setpoint for room temperature and relative humidity and CO₂ concentration adjustable via KNX

Data sheet	N1602
Voltage supply	KNX bus
Measuring range, temperature	0...50 °C
Sensing element, temperature	NTC
Communication	KNX PL-Link KNX S-Mode KNX LTE-Mode
Color	White
Degree of protection	IP30
Dimensions (W x H x D)	88.4 x 133.4 x 18 mm
Weight (net)	0.19 kg
Warranty	24 WarrantyMonths

Stock no.	Product no.
S55624-H103	QMX3.P30

Physical sensors with KNX connection Temperature, humidity

Room sensor KNX for temperature, black

QMX3.P30-1BSC

Functions:

- Temperature sensor
- Temperature control, adjustable as PWM control and/or modulating control (PID algorithm), for pure heating mode, pure cooling mode, heating and cooling mode
- Operating modes switchable via KNX and/or display: Comfort mode, Pre-Comfort, energy savings and protection mode
- Adjustable commissioning and control parameters for radiated heating, slow and fast, floor heating slow and fast
- Integrated bus coupling unit
- 3 independently adjustable switching values for CO₂ concentration and relative air humidity for air quality control
- Actuating variable for 1, 2, or 3-stage fans (humidity and CO₂)
- Actuating variable for 1, 2, or 3-point positioning signal (humidity and CO₂)
- Setpoint for room temperature and relative humidity and CO₂ concentration adjustable via KNX



Data sheet	N1602
Voltage supply	KNX bus
Measuring range, temperature	0...50 °C
Sensing element, temperature	NTC
Communication	KNX PL-Link KNX S-Mode KNX LTE-Mode
Color	Black
Degree of protection	IP30
Dimensions (W x H x D)	88.4 x 133.4 x 18 mm
Warranty	24 WarrantyMonths

Stock no.

Product no.

S55624-H123

QMX3.P30-1BSC

Physical sensors with KNX connection Temperature, humidity

QMX3.P40



Room sensor KNX for temperature and humidity, white

Functions:

- Multisensor for temperature and humidity
- Temperature control, adjustable as PWM control and/or modulating control (PID algorithm), for pure heating mode, pure cooling mode, heating and cooling mode
- Operating modes switchable via KNX and/or display: Comfort mode, Pre-Comfort, energy savings and protection mode
- Adjustable commissioning and control parameters for radiated heating, slow and fast, floor heating slow and fast
- Integrated bus coupling unit
- 3 independently adjustable switching values for CO₂ concentration and relative air humidity for air quality control
- Actuating variable for 1, 2, or 3-stage fans (humidity and CO₂)
- Actuating variable for 1, 2, or 3-point positioning signal (humidity and CO₂)
- Setpoint for room temperature and relative humidity and CO₂ concentration adjustable via KNX

Data sheet	N1602
Voltage supply	KNX bus
Measuring range	NTC: 0...50 °C Humidity: 10%...95 % r.F.
Sensing element	Temperature sensor, relative humidity sensor
Measuring range, temperature	0...50 °C
Sensing element, temperature	NTC
Communication	KNX PL-Link KNX S-Mode
Color	White
Degree of protection	IP30
Dimensions (W x H x D)	88.4 x 133.4 x 18 mm
Weight (net)	0.71 kg
Warranty	24 WarrantyMonths

Stock no.	Product no.
S55624-H116	QMX3.P40

Physical sensors with KNX connection Temperature, humidity

Room sensor KNX for temperature and humidity, black

QMX3.P40-1BSC
Functions:

- Multisensor for temperature and humidity
- Temperature control, adjustable as PWM control and/or modulating control (PID algorithm), for pure heating mode, pure cooling mode, heating and cooling mode
- Operating modes switchable via KNX and/or display: Comfort mode, Pre-Comfort, energy savings and protection mode
- Adjustable commissioning and control parameters for radiated heating, slow and fast, floor heating slow and fast
- Integrated bus coupling unit
- 3 independently adjustable switching values for CO₂ concentration and relative air humidity for air quality control
- Actuating variable for 1, 2, or 3-stage fans (humidity and CO₂)
- Actuating variable for 1, 2, or 3-point positioning signal (humidity and CO₂)
- Setpoint for room temperature and relative humidity and CO₂ concentration adjustable via KNX



Data sheet	N1602
Voltage supply	KNX bus
Measuring range	NTC: 0...50 °C Humidity: 10%...95 % r.F.
Sensing element	Temperature sensor, relative humidity sensor
Measuring range, temperature	0...50 °C
Sensing element, temperature	NTC
Communication	KNX PL-Link KNX S-Mode
Color	Black
Degree of protection	IP30
Dimensions (W x H x D)	88.4 x 133.4 x 18 mm
Warranty	24 WarrantyMonths

Stock no.	Product no.
S55624-H124	QMX3.P40-1BSC

Accessories for QMX3..

Product Title	Dimensions (W x H)	Stock no.	Product no.
Basic plate for conduit and cavity wall box	80.5 x 115 mm	S55624-H110	QMX3.MP1

Physical sensors with KNX connection Temperature, humidity

AQR2570..



Base module with KNX for temperature and humidity measurement

- Base module without sensor for plugging onto a front module
- 1 analog input to connect temperature sensors with NTC 10k sensing element to measure room, floor, or ceiling temperature
- 2 multifunctional binary inputs to connect window contacts or buttons
- Power supply via KNX bus, bus load < 5 mA
- Communication: KNX S-Mode, KNX PL-Link
- Temperature control as continuous control (PID algorithm) for pure heating operation, heating and cooling operation, and adjustable positioning variable as continuous positioning signal 0...100%, or as pulse-width modulated (PWM) switching signal On/Off,
- Ventilation control across 3 settable switching steps for relative humidity, and 3 switching signal objects On/Off, or one positioning signal object 0...100% to control a ventilation actor
- Via setpoints for room temperature and relative humidity adjustable via KNX bus
- Adjustable commissioning and control parameters
- Integrated bus coupler with programming button and LED

Data sheet	N1411
Voltage supply	KNX bus
Analog inputs, number	1
Analog inputs	Passive temperature sensor NTC 10k
Digital inputs, number	2
Digital inputs	Potential-free contacts
Warranty	5 Years

Range overview AQR2570..

Mechanical design	Stock no.	Product no.
EU (CEE/VDE)	S55720-S203	AQR2570NF
IT (3 Modular)	S55720-S205	AQR2570NG
UK (British Standard)	S55720-S204	AQR2570NH
US (UL)	S55720-S206	AQR2570NJ

QAP1030.200



Cable temperature sensor PVC 2 m, NTC 10k

Data sheet	N1831
Measuring range, temperature	-25...95 °C
Sensing element, temperature	NTC 10k
Sensing element	NTC 10k
Measurement accuracy	At -25...95 °C: ±1.4 K
Time constant	Without protection pocket: 20 s
Protection pocket	40.5 mm; 6 mm
Material, protection pocket	Stainless steel
Connection cable	PVC
Cable length	2 m
Type of fixing	Cable tie or with accessories
Degree of protection	IP65
Warranty	60 WarrantyMonths

Stock no.	Product no.
BPZ:QAP1030.200	QAP1030.200

Physical sensors with KNX connection Temperature, humidity, air quality

Room sensor KNX for temperature, humidity, CO₂, white

QMX3.P70
Functions:

- Multisensor for temperature, humidity and CO₂
- Air quality indicator with LED
- Temperature control, adjustable as PWM control and/or modulating control (PID algorithm), for pure heating mode, pure cooling mode, heating and cooling mode
- Operating modes switchable via KNX and/or display: Comfort mode, Pre-Comfort, energy savings and protection mode
- Adjustable commissioning and control parameters for radiated heating, slow and fast, floor heating slow and fast
- Integrated bus coupling unit
- 3 independently adjustable switching values for CO₂ concentration and relative air humidity for air quality control
- Actuating variable for 1, 2, or 3-stage fans (humidity and CO₂)
- Actuating variable for 1, 2, or 3-point positioning signal (humidity and CO₂)
- Setpoint for room temperature and relative humidity and CO₂ concentration adjustable via KNX



Data sheet	N 1602
Voltage supply	KNX bus
Measuring range	400... 10000 ppm CO ₂
Sensing element	Temperature sensor, CO ₂ sensor, relative humidity sensor
Measuring range, temperature	0...50 °C
Sensing element, temperature	NTC
Communication	KNX PL-Link KNX S-Mode KNX LTE-Mode
Color	White
Degree of protection	IP30
Dimensions (W x H x D)	88.4 x 133.4 x 18 mm
Weight (net)	0.19 kg
Warranty	24 WarrantyMonths

Stock no.

Product no.

S55624-H104

QMX3.P70

Physical sensors with KNX connection Temperature, humidity, air quality

QMX3.P70-1BSC



Room sensor KNX for temperature, humidity, CO2, black

Functions:

- multisensor for temperature, humidity and CO2
- Air quality indicator with LED
- Temperature control, adjustable as PWM control and/or modulating control (PID algorithm), for pure heating mode, pure cooling mode, heating and cooling mode
- Operating modes switchable via KNX and/or display: Comfort mode, Pre-Comfort, energy savings and protection mode
- Adjustable commissioning and control parameters for radiated heating, slow and fast, floor heating slow and fast
- Integrated bus coupling unit
- 3 independently adjustable switching values for CO2 concentration and relative air humidity for air quality control
- Actuating variable for 1, 2, or 3-stage fans (humidity and CO2)
- Actuating variable for 1, 2, or 3-point positioning signal (humidity and CO2)
- Setpoint for room temperature and relative humidity and CO2 concentration adjustable via KNX

Data sheet	N1602
Voltage supply	KNX bus
Measuring range	400...10000 ppm CO ₂
Sensing element	Temperature sensor, CO2 sensor, relative humidity sensor
Measuring range, temperature	0...50 °C
Sensing element, temperature	NTC
Communication	KNX PL-Link KNX S-Mode KNX LTE-Mode
Color	Black
Degree of protection	IP30
Dimensions (W x H x D)	88.4 x 133.4 x 18 mm
Warranty	24 WarrantyMonths

Stock no.	Product no.
S55624-H125	QMX3.P70-1BSC

Accessories for QMX3..

Product Title	Dimensions (W x H)	Stock no.	Product no.
Basic plate for conduit and cavity wall box	80.5 x 115 mm	S55624-H110	QMX3.MP1

Physical sensors with KNX connection Temperature, humidity, air quality

Front modules for base module

AQR253..

- Front module with sensors
- Matching the DELTA line and DELTA miro frame program

Data sheet	N1411
Color	Titanium white
Degree of protection	IP30
Warranty	5 Years



Range overview AQR253..

Measuring range, temperature [°C]	Signal output temperature	Measurement range humidity [% r.h.]	Display	Dimensions (WxHxD) [mm]	Stock no.	Product no.
0...50	Active			55 x 55 x 12	S55720-S137	AQR2530NNW
0...50	Active	0...100		55 x 55 x 12	S55720-S136	AQR2532NNW
0...50	Active	0...100		55 x 55 x 12	S55720-S141	AQR2535NNW
0...50	Active	0...100	CO ₂ indicator by LED	55 x 55 x 38	S55720-S219	AQR2535NNWQ

Matching the DELTA line and DELTA miro frame program. See chapter Display and Operation Units.
The relevant base modules must be ordered separately. See chapter Physical sensors.

Cable temperature sensor PVC 2 m, NTC 10k

QAP1030.200

Data sheet	N1831
Measuring range, temperature	-25...95 °C
Sensing element, temperature	NTC 10k
Sensing element	NTC 10k
Measurement accuracy	At -25...95 °C: ±1.4 K
Time constant	Without protection pocket: 20 s
Protection pocket	40.5 mm; 6 mm
Material, protection pocket	Stainless steel
Connection cable	PVC
Cable length	2 m
Type of fixing	Cable tie or with accessories
Degree of protection	IP65
Warranty	60 WarrantyMonths



Stock no.	Product no.
-----------	-------------

BPZ:QAP1030.200	QAP1030.200
-----------------	-------------

Physical sensors with KNX connection Temperature, humidity, air quality

AQR2576..



Base modules with KNX for CO₂ measurement

- Base module with maintenance and recalibration-free CO₂ sensor to plug onto a front module
- 1 analog input to connect temperature sensors with NTC 10k sensing element to measure room, floor, or ceiling temperature
- 2 multifunctional binary inputs to connect window contacts or buttons
- Power supply via KNX bus, bus load < 5 mA
- Communication: KNX S-Mode, KNX PL-Link
- Ventilation control across 3 settable switching steps for relative humidity & CO₂ concentration, and 3 switching signal objects On/Off, or one positioning signal object 0...100% to control a ventilation actor
- Temperature control as continuous control (PID algorithm) for pure heating operation, heating and cooling operation, and adjustable positioning variable as continuous positioning signal 0...100%, or as pulse-width modulated (PWM) switching signal On/Off
- Via setpoints for room temperature and relative humidity, and CO₂ concentration, adjustable via KNX bus
- Adjustable commissioning and control parameters
- Integrated bus coupler with programming button and LED

Data sheet	N1411
Voltage supply	KNX bus
Measuring range	CO ₂ : 0...5000 ppm
Analog inputs, number	1
Analog inputs	Passive temperature sensor NTC 10k
Digital inputs, number	2
Digital inputs	Potential-free contacts
Warranty	5 Years

Range overview AQR2576..

Mechanical design	Dimensions (WxHxD) [mm]	Stock no.	Product no.
EU (CEE/DE)	71 x 71 x 45	S55720-S207	AQR2576NF
IT (3 Modular)	71 x 71 x 45	S55720-S209	AQR2576NG
UK (British Standard)	71 x 71 x 45	S55720-S208	AQR2576NH
US (UL)	64 x 110 x 45	S55720-S210	AQR2576NJ

Surface-mounting motion detector, AC 230 V 50 Hz

5TC72200

- Surface-mounting motion detector for ceilings
- AC 230 V 50 Hz
- Power consumption < 1 W
- Contact Capacity: 16 A cos $\phi = 1$
- Switching capacity:
 - Incandescent lamps or halogen lamps 230 V: 3000 W
 - Halogen lamps with electronic transformer: 3000 W
 - Halogen lamps with ferromagnetic transformer: 2400 W
 - Fluorescent lamps: 1300 W (130 μ F)
 - Compact lamps: 18 x 7 W, 12 x 11 W, 10 x 15 W, 10 x 20 W, 10 x 23 W
 - LED lamps
- Capture area: 360° circle
- Capture area: \emptyset m at 2,5 m installation height and a temperature of 18°C
- Configuration via potentiometer
- Luminance: 5 - 1200 Lux
- Adjustable time period: from 6 seconds up to 12 minutes
- Dimensions (mounted): 118,5 mm x 45 mm. Protection class: IP40 / class II. Allowed operating temperature: -10°C to +45°C.



Dimensions (W x H) 118.5 x 45 mm

Stock no.	Product no.
5TC7220-0	5TC72200

Flush-mounting motion detector, AC 230 V 50 Hz

5TC72201

- Flush-mounting motion detector for ceilings
- AC 230 V 50 Hz
- Power consumption < 1 W
- Contact Capacity: 16 A cos $\phi = 1$
- Switching capacity:
 - Incandescent lamps or halogen lamps 230 V: 3000 W
 - Halogen lamps with electronic transformer: 3000 W
 - Halogen lamps with ferromagnetic transformer: 2400 W
 - Fluorescent lamps: 1300 W (130 μ F)
 - Compact lamps: 18 x 7 W, 12 x 11 W, 10 x 15 W, 10 x 20 W, 10 x 23 W
 - LED lamps
- Capture area: 360° circle
- Capture area: \emptyset m at 2,5 m installation height and a temperature of 18°C
- Configuration via potentiometer
- Luminance: 5 - 1200 Lux
- Adjustable time period: from 6 seconds up to 12 minutes
- Dimensions (mounted): 118,5 mm x 45 mm. Protection class: IP40 / class II. Allowed operating temperature: -10°C to +45°C.



Dimensions (W x H) 118.5 x 45 mm

Stock no.	Product no.
5TC7220-1	5TC72201

Physical sensors without KNX connection Temperature

AQR2532NNW



Front module for base modules, temperature (active)

- Front module with sensor for plugging onto the Base module
- Matching the DELTA line and DELTA miro frame program

Data sheet	N1411
Signal output temperature	Active
Measuring range, temperature	0...50 °C
Color	Titanium white
Degree of protection	IP30
Dimensions (W x H x D)	55 x 55 x 12 mm
Warranty	60 WarrantyMonths

Stock no.	Product no.
S55720-S136	AQR2532NNW

Matching the DELTA line and DELTA miro frame program. See chapter Display and Operation Units.
The relevant base modules must be ordered separately. See chapter Physical sensors.

QAD2012



Strap-on temperature sensor Pt1000

- Supplied complete with strap for pipe diameters from 15...140 mm.

Data sheet	N1801
Measuring range, temperature	-30...130 °C
Sensing element, temperature	Pt1000
Time constant	3 s
Dimensions (W x H x D)	60 x 67 x 43 mm
Warranty	60 WarrantyMonths

Stock no.	Product no.
BPZ:QAD2012	QAD2012

QAA20..1



Room temperature sensors, active

Data sheet	N1749
Measuring range, temperature	0...50 °C
Time constant	7 min
Measurement accuracy	at AC 24 V in the range of -25 °C...+25 °C ±0.75 K -50 °C...+50 °C ±0.9 K
Connection, electrical	Screw terminals
Degree of protection	IP30
Dimensions (W x H x D)	90 x 100 x 36 mm
Warranty	5 Years

Range overview QAA20..1

Analog output, signal	Operating voltage [V]	Display	Stock no.	Product no.
DC 0...10 V	AC 24 DC 13.5...35		BPZ:QAA2061	QAA2061
DC 0...10 V	AC 24 DC 13.5...35	LCD	BPZ:QAA2061D	QAA2061D
DC 4...20 mA	DC 13.5...35		BPZ:QAA2071	QAA2071

Physical sensors without KNX connection Temperature

Room temperature sensor Pt1000

QAA2012

- Passive sensors for acquiring the temperature in rooms.

Data sheet	N1745
Sensing element	Pt1000
Sensing element, temperature	Pt1000
Time constant	420 s
Measuring range, temperature	0...50 °C
Measurement accuracy	At 0...50 °C: ±0.6 K
Connection, electrical	Screw terminals
Degree of protection	IP30
Dimensions (W x H x D)	90 x 100 x 32 mm
Warranty	60 WarrantyMonths



Stock no.	Product no.
BPZ:QAA2012	QAA2012

Outside sensor Pt1000

QAC2012

- For acquiring the outside temperature and – to a lesser degree – solar radiation, the effect of wind and the temperature of the wall.

Data sheet	N1811
Measuring range, temperature	-50...70 °C
Sensing element	Pt1000
Sensing element, temperature	Pt1000
Time constant	840 s
Measurement accuracy	0 °C: ±0.3 K
Dimensions (W x H x D)	80 x 92 x 50 mm
Warranty	60 WarrantyMonths



Stock no.	Product no.
BPZ:QAC2012	QAC2012

Outside/room temperature sensor DC 0...10 V

QAC3161

Active sensor for acquiring the outside temperature. For use in heating, ventilation and air conditioning plants.

The QAC31.. may be used as an high-quality room sensor.

Data sheet	N1814
Operating voltage	AC 24 V DC 13.5...35 V
Power consumption	1 VA
Sensing element	Pt1000
Sensing element, temperature	Pt1000
Measuring range, temperature	-50...50 °C
Measurement accuracy	At -50...50 °C: ±0.9 K
Time constant	1200 s
Connection, electrical	Screw terminals
Analog output, signal	DC 0...10 V
Degree of protection	IP65
Dimensions (W x H x D)	80 x 88 x 39 mm
Warranty	60 WarrantyMonths



Stock no.	Product no.
BPZ:QAC3161	QAC3161

11

Physical sensors without KNX connection Temperature

AQR2540..



Base modules for temperature and humidity measurement

- Base module without sensor for plugging onto a front module

Data sheet	N1410
Operating voltage	AC 24 V DC 15...36 V
Connection, electrical	Screw terminals
Analogue output, signal	DC 0...10 V DC 2...10 V DC 0...5 V DC 0...20 mA DC 4...20 mA DC 0...10 mA
Digital outputs	CO: 1 Potential-free
Warranty	5 Years

Range overview AQR2540..

Mechanical design	Dimensions (WxHxD) [mm]	Stock no.	Product no.
EU (CEE/VDE)	71 x 71 x 45	S55720-S142	AQR2540NF

Physical sensors without KNX connection Humidity

Front module for base modules, humidity and temperature (active)

AQR2535NNW

- Front module with humidity and temperature sensor for plugging onto the Base module
- Matching the DELTA line and DELTA miro frame program

Data sheet	N1411
Signal output temperature	Active
Measurement range humidity	0... 100 % r.h.
Sensing element, temperature	Active
Measuring range, temperature	0... 50 °C
Color	Titanium white
Degree of protection	IP30
Dimensions (W x H x D)	55 x 55 x 12 mm
Warranty	60 WarrantyMonths



Stock no.

Product no.

S55720-S141

AQR2535NNW

Matching the DELTA line and DELTA miro frame program. See chapter Display and Operation Units.
The relevant base modules must be ordered separately. See chapter Physical sensors.

Room sensor for humidity (DC 0...10 V)

QFA2000

- For relative humidity.

Data sheet	N1857
Signal output humidity	DC 0...10 V
Operating voltage	AC 24 V DC 13.5...35 V
Measurement range humidity	0...95 % r.h.
Measurement accuracy	23 °C: 23 % r.h., 0...95 % r.h.: ±5 % r.h.
Time constant	Humidity: 20 s Temperature: 510 s
Dimensions (W x H x D)	90 x 100 x 36 mm
Warranty	60 WarrantyMonths



Stock no.

Product no.

BPZ:QFA2000

QFA2000

Physical sensors without KNX connection Humidity

QFA2060



Room sensor for humidity (DC 0...10 V) and temperature (DC 0...10 V)

- For relative humidity and temperature.

Data sheet	N1857
Signal output humidity	DC 0...10 V
Signal output temperature	DC 0...10 V
Operating voltage	AC 24 V DC 13.5...35 V
Sensing element, temperature	DC 0...10 V
Measuring range, temperature	0...50 °C -35...35 °C -40...70 °C
Measurement range humidity	0...95 % r.h.
Measurement accuracy	23 °C: 23 % r.h., 0...95 % r.h.: ±5 % r.h.
Time constant	Humidity: 20 s Temperature: 510 s
Dimensions (W x H x D)	90 x 100 x 36 mm
Warranty	60 WarrantyMonths

Stock no. Product no.

BPZ:QFA2060 QFA2060

QFA2060D



Room sensor for humidity (DC 0...10 V) and temperature (DC 0...10 V), with digital Display

- For relative humidity and temperature.

Data sheet	N1857
Signal output humidity	DC 0...10 V
Signal output temperature	DC 0...10 V
Operating voltage	AC 24 V DC 13.5...35 V
Sensing element, temperature	DC 0...10 V
Measuring range, temperature	0...50 °C -35...35 °C -40...70 °C
Measurement range humidity	0...95 % r.h.
Measurement accuracy	23 °C: 23 % r.h., 0...95 % r.h.: ±5 % r.h.
Time constant	Humidity: 20 s Temperature: 510 s
Display	LCD
Dimensions (W x H x D)	90 x 100 x 36 mm
Warranty	60 WarrantyMonths

Stock no. Product no.

BPZ:QFA2060D QFA2060D

Physical sensors without KNX connection Humidity

Room hygrostat, setpoint setting range 30...90 % r.h., setpoint adjuster inside device

QFA1000



- 2-position controller with humidity sensor
- Setpoint adjuster inside device

Data sheet	N1518
Setpoint setting range	30...90 % r.h.
Switching differential	6 % r.h.
Time constant	At v = 0.2 m/s: 5 min
Digital outputs	CO: 1 Potential-free
Connection, electrical	Screw terminals
Degree of protection	IP20
Dimensions (W x H x D)	76 x 76 x 34 mm
Warranty	60 WarrantyMonths

Stock no.

Product no.

BPZ:QFA1000

QFA1000

Room hygrostat, setpoint setting range 30...90 % r.h., external setpoint adjustment

QFA1001



- 2-position controller with humidity sensor
- External setpoint adjustment

Data sheet	N1518
Setpoint setting range	30...90 % r.h.
Switching differential	6 % r.h.
Digital outputs	CO: 1 Potential-free
Connection, electrical	Screw terminals
Degree of protection	IP20
Dimensions (W x H x D)	76 x 76 x 34 mm
Warranty	60 WarrantyMonths

Stock no.

Product no.

BPZ:QFA1001

QFA1001

Physical sensors without KNX connection Humidity

AQR2540..



Base modules for temperature and humidity measurement

- Base module without sensor for plugging onto a front module

Data sheet	N1410
Operating voltage	AC 24 V DC 15...36 V
Connection, electrical	Screw terminals
Analogue output, signal	DC 0...10 V DC 2...10 V DC 0...5 V DC 0...20 mA DC 4...20 mA DC 0...10 mA
Digital outputs	CO: 1 Potential-free
Warranty	5 Years

Range overview AQR2540..

Mechanical design	Dimensions (WxHxD) [mm]	Stock no.	Product no.
EU (CEE/DE)	71 x 71 x 45	S55720-S142	AQR2540NF

Physical sensors without KNX connection Air quality

Room air quality sensor VOC

QPA1000

Note: Not suited for safety-related applications!

Data sheet	N1961
Operating voltage	AC 24 V DC 15...35 V
Analog output, signal	DC 0...5 V DC 0...10 V DC 4...20 mA
Ambient temperature, operation	0...50 °C
Connection, electrical	Screw terminals
Degree of protection	IP30
Dimensions (W x H x D)	90 x 100 x 36 mm
Warranty	60 WarrantyMonths



Stock no.	Product no.
S55720-S119	QPA1000

Room air quality sensor CO₂

QPA1004

Note: Not suited for safety-related applications!

Data sheet	A6V101099173
Operating voltage	AC 24 V DC 15...35 V
Analog output, signal	DC 0...10 V
Measuring range	0...2000 ppm CO ₂
Ambient temperature, operation	0...50 °C
Degree of protection	IP30
Dimensions (W x H x D)	90 x 100 x 36 mm
Warranty	60 WarrantyMonths



Stock no.	Product no.
S55720-S453	QPA1004

Room air quality sensor CO₂ / temperature

QPA1064

Note: Not suited for safety-related applications!

Data sheet	A6V101099173
Operating voltage	AC 24 V DC 15...35 V
Analog output, signal	DC 0...10 V DC 4...20 mA
Measuring range, temperature	0...50 °C
Measuring range	0...2000 ppm CO ₂
Ambient temperature, operation	0...50 °C
Degree of protection	IP30
Dimensions (W x H x D)	90 x 100 x 36 mm
Warranty	60 WarrantyMonths



Stock no.	Product no.
S55720-S454	QPA1064

11

Physical sensors without KNX connection Air quality

QPA2000

Room air quality sensor CO₂



Note: Not suited for safety-related applications!

Data sheet	N1961
Operating voltage	AC 24 V DC 15...35 V
Analog output, signal	DC 0...5 V DC 0...10 V DC 4...20 mA
Ambient temperature, operation	0...50 °C
Connection, electrical	Screw terminals
Degree of protection	IP30
Dimensions (W x H x D)	90 x 100 x 36 mm
Warranty	60 WarrantyMonths

Stock no.	Product no.
BPZ:QPA2000	QPA2000

QPA2002

Room air quality sensor CO₂+VOC



Note: Not suited for safety-related applications!

Data sheet	N1961
Operating voltage	AC 24 V DC 15...35 V
Analog output, signal	DC 0...5 V DC 0...10 V DC 4...20 mA
Ambient temperature, operation	0...50 °C
Connection, electrical	Screw terminals
Degree of protection	IP30
Dimensions (W x H x D)	90 x 100 x 36 mm
Warranty	60 WarrantyMonths

Stock no.	Product no.
BPZ:QPA2002	QPA2002

QPA2060

Room air quality sensor CO₂+temperature



Note: Not suited for safety-related applications!

Data sheet	N1961
Operating voltage	AC 24 V DC 15...35 V
Analog output, signal	DC 0...5 V DC 0...10 V DC 4...20 mA
Measuring range, temperature	0...50 °C -35...35 °C
Ambient temperature, operation	0...50 °C
Connection, electrical	Screw terminals
Degree of protection	IP30
Dimensions (W x H x D)	90 x 100 x 36 mm
Warranty	60 WarrantyMonths

Stock no.	Product no.
BPZ:QPA2060	QPA2060

Physical sensors without KNX connection Air quality

Room air quality sensor CO₂+temperature+rel. air humidity

QPA2062

Note: Not suited for safety-related applications!

Data sheet	N1961
Operating voltage	AC 24 V DC 15...35 V
Analog output, signal	DC 0...5 V DC 0...10 V DC 4...20 mA
Measuring range, temperature	0...50 °C -35...35 °C
Measurement range humidity	0...95 % r.h.
Ambient temperature, operation	0...50 °C
Connection, electrical	Screw terminals
Degree of protection	IP30
Dimensions (W x H x D)	90 x 100 x 36 mm
Warranty	60 WarrantyMonths



Stock no.

Product no.

BPZ:QPA2062

QPA2062

Room air quality sensor CO₂+temperature+rel. air humidity with display

QPA2062D

Note: Not suited for safety-related applications!

Data sheet	N1961
Operating voltage	AC 24 V DC 15...35 V
Analog output, signal	DC 0...5 V DC 0...10 V DC 4...20 mA
Measuring range, temperature	0...50 °C -35...35 °C
Measurement range humidity	0...95 % r.h.
Ambient temperature, operation	0...50 °C
Connection, electrical	Screw terminals
Degree of protection	IP30
Dimensions (W x H x D)	90 x 100 x 36 mm
Warranty	60 WarrantyMonths



Stock no.

Product no.

BPZ:QPA2062D

QPA2062D

Physical sensors without KNX connection Air quality

QSA2700



Fine dust sensor, 0-10V & Modbus

Room sensor for detection of PM2.5 and PM10

Data sheet	A6V11160938
Operating voltage	AC/DC 24 V DC 24 V
Connection cable	Micro USB
Analog outputs	DC 0...10 V
Display	3-color LED service indication
Communication	Modbus RTU (RS-485)
Degree of protection	IP30
Dimensions (W x H x D)	86 x 86 x 30 mm
Warranty	60 WarrantyMonths

Stock no.	Product no.
S55720-S457	QSA2700

QSA2700D



Fine dust sensor +display, 0-10V, Modbus

Room sensor with LCD display for detection of PM2.5 and PM10

Data sheet	A6V11160938
Operating voltage	AC 24 V DC 24 V
Connection cable	Micro USB
Analog outputs	DC 0...10 V
Display	LCD; 2.4 "
Communication	Modbus RTU (RS-485)
Degree of protection	IP30
Dimensions (W x H x D)	86 x 86 x 30 mm
Warranty	60 WarrantyMonths

Stock no.	Product no.
S55720-S458	QSA2700D

AQR253..



Front modules for base module

- Front module with sensors
- Matching the DELTA line and DELTA miro frame program

Data sheet	N1411
Color	Titanium white
Degree of protection	IP30
Warranty	5 Years

Range overview AQR253..

Measuring range, temperature [°C]	Signal output temperature	Measurement range humidity [% r.h.]	Display	Dimensions (WxHxD) [mm]	Stock no.	Product no.
0...50	Active			55 x 55 x 12	S55720-S137	AQR2530NNW
0...50	Active			55 x 55 x 12	S55720-S136	AQR2532NNW
0...50	Active	0...100		55 x 55 x 12	S55720-S141	AQR2535NNW
0...50	Active	0...100	CO ₂ indicator by LED	55 x 55 x 38	S55720-S219	AQR2535NNWQ

Matching the DELTA line and DELTA miro frame program. See chapter Display and Operation Units.
The relevant base modules must be ordered separately. See chapter Physical sensors.

Physical sensors without KNX connection Air quality

Base modules with integrated CO₂ measurement

AQR2546..

- Base module with maintenance-free CO₂ sensing element to plug onto a front module

Data sheet	N1410
Operating voltage	AC 24 V DC 15...36 V
Analog output, signal	DC 0...10 V DC 2...10 V DC 0...5 V DC 0...20 mA DC 4...20 mA DC 0...10 mA
Connection, electrical	Screw terminals
Digital outputs	1-pin Potential-free Changeover contact
Warranty	5 Years



Range overview AQR2546..

Measuring range [ppm CO ₂]	Mechanical design	Dimensions (WxHxD) [mm]	Stock no.	Product no.
0...2000	EU (CEE/VDE)	71 x 71 x 45	S55720-S147	AQR2546NF

Base modules with integrated VOC measurement

AQR2547..

- Base module with VOC sensing element to plug onto a front module

Data sheet	N1410
Operating voltage	AC 24 V DC 15...36 V
Analog output, signal	DC 0...10 V DC 2...10 V DC 0...5 V DC 0...20 mA DC 4...20 mA DC 0...10 mA
Connection, electrical	Screw terminals
Digital outputs	1-pin Potential-free Changeover contact
Warranty	5 Years



Range overview AQR2547..

Measuring range	Mechanical design	Dimensions (WxHxD) [mm]	Stock no.	Product no.
0...100% VOC	EU (CEE/VDE)	71 x 71 x 45	S55720-S146	AQR2547NF

11

Physical sensors without KNX connection Air quality

AQR2548..



Base modules with integrated CO₂ and VOC measurement

- Base module with maintenance-free CO₂/VOC sensing element to plug onto a front module

Data sheet	N1410
Operating voltage	AC 24 V DC 15...36 V
Analog output, signal	DC 0...10 V DC 2...10 V DC 0...5 V DC 0...20 mA DC 4...20 mA DC 0...10 mA
Connection, electrical	Screw terminals
Digital outputs	CO: 1 Potential-free
Warranty	5 Years

Range overview AQR2548..

Measuring range	Mechanical design	Dimensions (WxHxD) [mm]	Stock no.	Product no.
0...2000 ppm CO ₂ 0...100 % VOC	EU (CEE/VDE)	71 x 71 x 45	S55720-S148	AQR2548NF

Physical sensors without KNX connection Sunlight intensity

Solar sensor

QLS60

- For measuring the solar radiation intensity.

Data sheet	N1943
Operating voltage	AC 24 V DC 18...30 V
Power consumption	2.5 VA
Measuring range	0...1000 W/m ²
Time constant	2 s
Connection, electrical	Screw terminals
Analog output, signal	DC 0...10 V DC 4...20 mA
Degree of protection	IP65
Dimensions (W x H x D)	51 x 92 x 46 mm
Warranty	60 WarrantyMonths



Stock no.	Product no.
BPZ:QLS60	QLS60

Control and automation devices



Overview and selection tools		374
Logic and control functions	IP control devices	376
	Scene/event controller	377
Programmable logic controllers	LOGO! Communication module	378
	LOGO! 8 Basic modules	379
	LOGO! 8 Expansion modules	380
	LOGO! Power	383

Control and automation devices

Overview and selection tools

Programmable logic controllers

Type	LOGO! 8 Basic modules						LOGO! 8 Expansion modules						
	LOGO! CIM	LOGO! CMK2000	LOGO! 12/24 RCE	LOGO! 230 RCE	LOGO! 12/24 RCEo	LOGO! 230 RCEo	LOGO! DM8 12/24 R	LOGO! DM8 230 R	LOGO! DM16 24 R	LOGO! DM16 230 R	LOGO! AM2	LOGO! AM2 RTD	LOGO! AM2 AQ
Enclosure data													
Dimensions													
• Width [mm] (1 MW = 18 mm)	4 MW	4 MW	4 MW	4 MW	4 MW	4 MW	2 MW	2 MW	4 MW	4 MW	2 MW	2 MW	2 MW
• Height [mm]	90	90	90	90	90	90	90	90	90	90	90	90	90
• Depth [mm]	58.5	58.5	60	60	60	60	58	58	60	60	58	58	58
Power supply													
Power supply AC/DC 115...230 V				■		■		■		■			
Power supply DC 12...24 V			■		■		■				■	■	
Power supply DC 24 V	■	■							■				■
Inputs													
Control inputs													
• Digital input			8 (4) ¹⁾	8	8 (4) ¹⁾	8	4	4	8	8			
• Analog input (0...10 V)			up to 4		up to 4								
• Analog input (0...10 V or 0/4...20 mA)											2 ²⁾		
Sensor inputs													
Temperature sensor input PT100 and/or PT1000 automatic detection													2
Measuring range [°C]													-50... +200 ³⁾
Outputs													
Digital output, relays			4	4	4	4	4	4	8	8			
Analog output (0...10 V or 0/4...20 mA)													2 ²⁾
Rated current [A] resistive load/ inductive load			10/ 3	10/ 3	10/ 3	10/ 3	5/ 3	5/ 3	5/ 3	5/ 3			
LCD display, 6 lines			■	■									
Cursor keys			■	■									
Ethernet interface	■	■	■	■	■	■							
Modbus TCP/IP (client/ server) ⁴⁾	■		■	■	■	■							
Time synchronisation via NTP (client and server) ⁴⁾	■		■	■	■	■							
Integrated web server	■		■	■	■	■							
Cloud connection (AWS)	■		■	■	■	■							
Modbus RTU	■												
GPS/GNSS	■												



¹⁾ 8 digital inputs, of which 4 can be used as analog inputs 0...10 V

²⁾ resolution 10 bit

³⁾ resolution 0,25°C

⁴⁾ function is available in basic modules issue status FS:04 and higher

Logic and control functions

	IP control device	Scene / event controller
		
Type	N 152/01	N 305/01
Application program	983501	750006
Enclosure data		
Modular installation devices for mounting on TH35 EN 60715 mounting rail	4 MW	1 MW
Width (1 MW = 18 mm)		
Ethernet connection via RJ45 socket	■	
Power supply		
Bus-powered electronics		■
Electronics powered via an external power supply unit [V]	DC 12...30	
Bus connection		
Integrated bus coupling units	■	■
Bus connection via bus terminal	■	■
Bus connection via contact system to data rail		■
Functions		
Logic gate	1.000	
Scheduled entries	300 ¹⁾	
Master clock (time source)	■ ²⁾	
Event entries	5.000 ³⁾	80 ⁴⁾
Scenes	5.000 ³⁾	8
Effect control	5.000 ³⁾	
Alarms	250	
Email contacts	20	

¹⁾ Per week²⁾ Via time server³⁾ The sum of event entries, scenes and effects can be 5.000 maximum⁴⁾ 10 entries per trip unit (8)

Control and automation devices

Logic and control functions

IP control devices

N 152/01



IP Control Center

Visualisation controller for full-graphic visualizations on web-compatible end devices such as PCs, tablets and smart phones with a standard web browser.

For communication between KNX devices and PCs and, in connection with a LAN-/WLAN modem or DSL router, for remote access to a KNX installation, for usage as an interface for the ETS 3/4/5 and as an interface for a visualization, with usage of the KNXnet/IP protocol, with the following simultaneously usable functions:

- Web server for operating and monitoring up to 1250 statuses and values transmitted by the KNX network, which can be displayed using a standard browser on PCs, tablets, or smartphones connected to the IP network
- Special web-configuration page for a firmware update, to set the IP configuration, SMTP server, security settings, password protection, certificates, Sonos module, API connection and restart
- Graphical web editor for a creation of fully graphical visualization with control and display elements, configurable in various styles
- Smart editor for the creation of a visualisation, tuned for mobile browsers, smartphones, tablets with control and display elements, configurable in various styles and layouts
- Annual timer, with astronomical calendar, for 300 time switch schedules with up to 30 time switch commands per time switch schedule
- Scene module with up to 5000 scenes or events
- Chart module for recording and reporting of up to 10 data points
- Monitoring module for monitoring and storage of up to 1000 events into a ring buffer
- IP interface for control of up to 20 IP-devices via up to 20 TCP/UDP commands per IP-device
- Fully graphical logic module with up to 1000 logic functions
- Alarm function for up to 250 different alarms
- E-mail function, with up to 20 contacts, for transmission of chart data from chart module, logged data from monitoring module or alarm data
- Data point management for viewing, managing, editing and categorizing all available data points
- Module for controlling SONOS loudspeakers
- Module for controlling the Philips HUE LED lighting system
- Ethernet interface 10/100 Mbits/s with RJ45 socket for connection to the IP network using the Internet Protocol
- 2 LED displays for IP connection/communication and for error messages
- Integrated bus connector and bus terminal for connection to a KNX network
- Power supply of the electronics by an external voltage source for AC/DC 24 V, 50 mA
- Series installation device for mounting on support rails TH35 DIN EN 60715

Data sheet	A6V10417875
Dimensions (W x H x D)	90 x 72 x 55 mm
Dimension width (1 MW = 18 mm)	4 MW

Stock no.	Product no.
5WG1152-1AB01	N 152/01

Accessories for N 152/01

Product Title	Stock no.	Product no.
Electronic power supply unit, 350 mA	4AC2402	4AC2402
LOGO! Power 24 V/1.3 A	6EP3331-6SB00-0AY0	LOGO!POWER 24 V/1,3 A

Control and automation devices

Logic and control functions

Scene/event controller

Scene-/Event Controller

- 80 Event entries, 8 Event trigger, Sequence control
- 1-bit-/8-bit integrated scene control, 8 scenes to be integrated
- Bus-powered electronics
- Integrated bus coupling units, bus connection via bus terminal or contact system to data rail
- Modular installation devices for mounting on TH35 EN 60715 mounting rail

Data sheet	A6V10416128
Dimensions (W x H x D)	90 x 18 x 55 mm
Dimension width (1 MW = 18 mm)	1 MW

N 305/01



Stock no.	Product no.
5WG1305-1AB01	N 305/01

Control and automation devices

Programmable logic controllers

LOGO! Communication module

LOGO! CMK2000



Communication Module LOGO! CMK2000

- For communication between LOGO! 8 and KNX devices via the KNX bus
- Transformation of typical PLC signals into KNX telegrams and vice versa
- Linking transmitted KNX data points and LOGO! inputs and outputs via logic and control functions through LOGO!
- The following channels are available at the maximum configuration level of the LOGO!:
 - 24 binary inputs
 - 20 binary outputs
 - 8 analog inputs
 - 8 analog outputs
- Date and time can be synchronized via KNX
- 50 configurable communication objects
- Communication via Ethernet with LOGO! 8

Data sheet

A6V11642346

Dimension width (1 MW = 18 mm)

4 MW

Stock no.

Product no.

6BK1700-0BA20-0AA0

LOGO! CMK2000

LOGO! CSM 12/24



Communication Module LOGO! CSM 12/24

- Connect LOGO! and up to three additional devices to an Ethernet network with 10/100 Mbps in line, tree, or star topology
- Unmanaged 4-port switch, one port at the front for easy diagnostic access
- Easy connection via four RJ45 connectors
- Cost-efficient solution to realize small, local Ethernet networks, also stand-alone
- Power supply DC 12/24 V

Dimension width (1 MW = 18 mm)

4 MW

Stock no.

Product no.

6GK7177-1MA20-0AA0

LOGO! CSM 12/24

Control and automation devices

Programmable logic controllers

LOGO! 8 Basic modules

Basic Modules

LOGO! 8 12/24 RCE, RCEo

- Power supply DC 12...24 V
- 8 digital inputs DC 12/24 V, of which 4 can be used as analog inputs (0...10 V)
- 4 floating relay contacts 10 A
- Integrated time switch
- Ethernet interface
- Integrated customer specific web server
- Modbus TCP/IP (client/ server)
- Time synchronisation via NTP (client and server)
- 400 function blocks linkable
- Expandable with extra modules
- Integrated Cloud connection (AWS)

Basic Module LOGO! 8 12/24 RCE

- 6-line LCD display and cursor keys

Dimension width (1 MW = 18 mm)

4 MW

LOGO! 8 12/24 RCE



Stock no.

Product no.

6ED1052-1MD08-0BA1

LOGO! 8 12/24 RCE

Basic Modules

LOGO! 8 230 RCE, RCEo

- Power supply AC/DC 115...230 V
- 8 digital inputs AC/DC 115...230 V
- 4 floating relay contacts 10 A
- Integrated time switch
- Ethernet interface
- Integrated customer specific web server
- Modbus TCP/IP (client/ server)
- Time synchronisation via NTP (client and server)
- 400 function blocks linkable
- Expandable with extra modules
- Integrated Cloud connection (AWS)

Basic Module LOGO! 8 230 RCE

- 6-line LCD display and cursor keys

Dimension width (1 MW = 18 mm)

4 MW

LOGO! 8 230 RCE



Stock no.

Product no.

6ED1052-1FB08-0BA1

LOGO! 8 230 RCE

12

Control and automation devices

Programmable logic controllers

LOGO! 8 Expansion modules

LOGO! DM8 12/24 R



Expansion Module LOGO! DM8 12/24 R

- Power supply DC 12...24 V
- 4 digital inputs DC 12...24 V
- 4 floating relay contacts 5 A

Dimension width (1 MW = 18 mm)

2 MW

Stock no.

Product no.

6ED1055-1MB00-0BA2

LOGO! DM8 12/24 R

LOGO! DM16 24 R



Expansion Module LOGO! DM16 24 R

- Power supply DC 24 V
- 8 digital inputs DC 24 V
- 8 floating relay contacts 5 A

Dimension width (1 MW = 18 mm)

4 MW

Stock no.

Product no.

6ED1055-1NB10-0BA2

LOGO! DM16 24 R

LOGO! DM..230 R

Expansion Modules

Power supply AC/DC 115...230 V

LOGO! DM 8 230 R



Expansion Modules LOGO! DM 8 230 R

- Power supply AC/DC 115...230 V
- 4 digital inputs AC/DC 115...230 V
- 4 floating relay contacts 5 A

Dimension width (1 MW = 18 mm)

2 MW

Stock no.

Product no.

6ED1055-1FB00-0BA2

LOGO! DM 8 230 R

Control and automation devices

Programmable logic controllers

LOGO! 8 Expansion modules

Expansion Module LOGO! DM 16 230 R

- Power supply AC/DC 115...230 V
- 8 digital inputs AC/DC 115...230 V
- 8 floating relay contacts 5 A

Dimension width (1 MW = 18 mm) 4 MW

LOGO! DM 16 230 R



Stock no.

Product no.

6ED1055-1FB10-0BA2

LOGO! DM 16 230 R

Expansion Module LOGO! AM2

- Power supply DC 12...24 V
- 2 analog inputs 0...10 V or 0/4...20 mA, resolution 10 bit

Dimension width (1 MW = 18 mm) 2 MW

LOGO! AM2



Stock no.

Product no.

6ED1055-1MA00-0BA2

LOGO! AM2

Expansion Module LOGO! AM2 RTD

- Power supply DC 12...24 V
- 2 analog inputs PT 100/1000, temperature range -50°C...200°C

Dimension width (1 MW = 18 mm) 2 MW

LOGO! AM2 RTD



Stock no.

Product no.

6ED1055-1MD00-0BA2

LOGO! AM2 RTD

LOGO! Power 12 V/0.9 A**LOGO!POWER 12 V/0,9 A**

- Controlled power supply 12 V/ DC 0.9 A
- For connection to a 1-phase AC system
- Rated input voltage AC 100...240 V wide-range input
- Range input voltage AC 85...264 V/DC 110...300 V
- Nominal output voltage DC 12 V
- Nominal output current 0.9 A
- Efficiency during operation at rated value typ. 78 %
- Power loss < 0.3 Watt
- Ambient temperature -25...70 °C
- Protection class II, Degree of protection: IP20
- Potential separation SELV acc. to EN 60950 and EN 50178
- Emitted interference class B acc. to EN 55022
- Approval acc. to CE, cULus, cURus, NEC Class 2, FM, ATEX
- Marine approval DNV GL, ABS



Dimension width (1 MW = 18 mm) 1 MW

Stock no.

Product no.

6EP3320-6SB00-0AY0

LOGO!POWER 12 V/0,9 A

LOGO! Power 12 V/1.9 A**LOGO!POWER 12 V/1,9 A**

- Controlled power supply DC 12 V/1.9 A
- For connection to a 1-phase AC system
- Rated input voltage AC 100...240 V wide-range input
- Range input voltage AC 85...264 V/DC 110...300 V
- Nominal output voltage DC 12 V, setting range 10.5...16.1 V
- Nominal output current 1.9 A
- Measuring point for output voltage
- Efficiency during operation at rated value typ. 81 %
- Power loss < 0.3 Watt
- Ambient temperature -25...70 °C
- Protection class II, Degree of protection: IP20
- Potential separation SELV acc. to EN 60950 and EN 50178
- Emitted interference class B acc. to EN 55022
- Approval acc. to CE, cULus, cURus, NEC Class 2, FM, ATEX
- Marine approval DNV GL, ABS



Dimension width (1 MW = 18 mm) 2 MW

Stock no.

Product no.

6EP3321-6SB00-0AY0

LOGO!POWER 12 V/1,9 A

Control and automation devices

Programmable logic controllers

LOGO! Power

LOGO!POWER 12 V/4,5 A LOGO! Power 12 V/4.5 A



- Controlled power supply DC 12 V/4.5 A
- For connection to a 1-phase AC system
- Rated input voltage AC 100...240 V wide-range input
- Range input voltage AC 85...264 V/DC 110...300 V
- Nominal output voltage DC 12 V, setting range 10.5...16.1 V
- Nominal output current 4.5 A
- Measuring point for output voltage
- Efficiency during operation at rated value typ. 87 %
- Power loss < 0.3 Watt
- Ambient temperature -25...70 °C
- Protection class II, Degree of protection: IP20
- Potential separation SELV acc. to EN 60950 and EN 50178
- Emitted interference class B acc. to EN 55022
- Approval acc. to CE, cULus, cURus, NEC Class 2, FM, ATEX
- Marine approval DNV GL, ABS

Dimension width (1 MW = 18 mm) 3 MW

Stock no.

Product no.

6EP3322-6SB00-0AY0

LOGO!POWER 12 V/4,5 A

LOGO!POWER 24 V/0,6 A LOGO! Power 24 V/0.6 A



- Controlled power supply DC 24 V/0.6 A
- For connection to a 1-phase AC system
- Rated input voltage AC 100...240 V wide-range input
- Range input voltage AC 85...264 V/DC 110...300 V
- Nominal output voltage DC 24 V
- Nominal output current 0.6 A
- Efficiency during operation at rated value typ. 81 %
- Power loss < 0.3 Watt
- Ambient temperature -25...70 °C
- Protection class II, Degree of protection: IP20
- Potential separation SELV acc. to EN 60950 and EN 50178
- Emitted interference class B acc. to EN 55022
- Approval acc. to CE, cULus, cURus, NEC Class 2, FM, ATEX
- Marine approval DNV GL, BV, LRS, ABS

Dimension width (1 MW = 18 mm) 1 MW

Stock no.

Product no.

6EP3330-6SB00-0AY0

LOGO!POWER 24 V/0,6 A

LOGO! Power 24 V/1.3 A**LOGO!POWER 24 V/1,3 A**

- Controlled power supply DC 24 V/1.3 A
- For connection to a 1-phase AC system
- Rated input voltage AC 100...240 V wide-range input
- Range input voltage AC 85...264 V/DC 110...300 V
- Nominal output voltage DC 24 V, setting range DC 22.2...26.4 V
- Nominal output current 1.3 A
- Measuring point for output voltage
- Efficiency typ. 86 %
- Power loss - less than 0.3 Watt
- Ambient temperature -25...70 °C
- Protection class II, Degree of protection: IP20
- Potential separation SELV acc. to EN 60950 and EN 50178
- Emitted interference class B acc. to EN 55022
- Approval acc. to CE, cULus, cURus, NEC Class 2, FM, ATEX
- Marine approval DNV GL, BV, LRS, ABS



Dimension width (1 MW = 18 mm) 2 MW

Stock no.

Product no.

6EP3331-6SB00-0AY0

LOGO!POWER 24 V/1,3 A

LOGO! Power 24 V/2.5 A**LOGO!POWER 24 V/2,5 A**

- Controlled power supply DC 24 V/2.5 A
- For connection to a 1-phase AC system
- Rated input voltage AC 100...240 V wide-range input
- Range input voltage AC 85...264 V/DC 110...300 V
- Nominal output voltage DC 24 V, setting range DC 22.2...26.4 V
- Nominal output current 2.5 A
- Measuring point for output voltage
- Efficiency typ. 90 %
- Power loss < 0.3 Watt
- Ambient temperature -25...70 °C
- Protection class II, Degree of protection: IP20
- Potential separation SELV acc. to EN 60950 and EN 50178
- Emitted interference class B acc. to EN 55022
- Approval acc. to CE, cULus, cURus, NEC Class 2, FM, ATEX
- Marine approval DNV GL, BV, LRS, ABS



Dimension width (1 MW = 18 mm) 3 MW

Stock no.

Product no.

6EP3332-6SB00-0AY0

LOGO!POWER 24 V/2,5 A

Control and automation devices

Programmable logic controllers

LOGO! Power

LOGO!POWER 24 V/4 A



LOGO! Power 24 V/4 A

- Controlled power supply DC 24 V/4 A
- For connection to a 1-phase AC system
- Rated input voltage AC 100...240 V wide-range input
- Range input voltage AC 85...264 V/DC 110...300 V
- Nominal output voltage DC 24 V, setting range DC 22.2...26.4 V
- Nominal output current 4 A
- Measuring point for output voltage
- Efficiency typ. 89 %
- Power loss < 0.3 Watt
- Ambient temperature -25...70 °C
- Protection class II, Degree of protection: IP20
- Potential separation SELV acc. to EN 60950 and EN 50178
- Emitted interference class B acc. to EN 55022
- Approval acc. to CE, cULus, cURus, FM, ATEX
- Marine approval DNV GL, BV, LRS, ABS

Dimension width (1 MW = 18 mm)

4 MW

Stock no.

Product no.

6EP3333-6SB00-0AY0

LOGO!POWER 24 V/4 A

Accessories for programmable logic controllers LOGO!

Product Title	Product Description	Stock no.	Product no.
LOGO! 8 12/24 V Starter Kit	LOGO! 12/24 RCE, LOGO! Power 24 V, 1,3 A	6ED1057-3BA01-0AA8	LOGO! 8 12/24 V Starter Kit
LOGO! 8 230 V Starter Kit	LOGO! 230 RCE	6ED1057-3BA03-0AA8	LOGO! 8 230 V Starter Kit
LOGO! 8 TDE Starter Kit	LOGO! 12/24 RCE _o , LOGO! Power 24 V, 1,3 A, LOGO! TDE	6ED1057-3BA11-0AA8	LOGO! 8 TDE Starter Kit
LOGO! 8 12/24 V + KP300 Basic Starter Kit	LOGO! 12/24 RCE, LOGO! Power 24 V, 1,3 A, SIMATIC HMI KP300 Basic mono PN	6AV2132-0HA00-0AA1	LOGO! 8 12/24 V + KP300
LOGO! 8 12/24 V + KTP400 Basic Starter Kit	LOGO! 12/24 RCE, LOGO! Power 24 V, 1,3 A, SIMATIC HMI KTP400 Basic	6AV2132-0KA00-0AA1	LOGO! 8 12/24 V + KTP400
LOGO! 8 12/24 V + KTP700 Basic Starter Kit	LOGO! 12/24 RCE, LOGO! Power 24 V, 1,3 A, SIMATIC HMI KTP700 Basic	6AV2132-3GB00-0AA1	LOGO! 8 12/24 V + KTP700
LOGO! Soft Comfort V8	for Windows 8, 7, XP, Linux and Mac OSX, on DVD, downwards compatible	6ED1058-0BA08-0YA1	LOGO! Soft Comfort V8

System products and accessories



Overview and selection tools		388
System products	Bus coupling units	392
	Power supply units	393
	Line couplers	396
	Network gateways	397

System products and accessories

Overview and selection tools

Fitting power supplies for every KNX system

Each bus line needs its own power supply unit. The power supply unit provides the system power necessary for the instabus KNX. The KNX system provides for decentralized and central power supply units. Central power supply units are installed as DIN rail mounted devices in distribution boards and control cabinets, while decentralized power supply units are designed for installation in junction boxes, in parapet channels or in room control boxes.

Central power supply units provide 160 mA, 320 mA or 640 mA bus current. Maximum up to two central power supply units may be attached to a single bus line. A second unit is not required unless the supply voltage at a bus device is less than 21 V. When more than 30 bus devices are installed in short bus cable distance (e.g. 10 m), e.g. in distribution boards, the power supply unit should be arranged near these bus devices. The distance between power supply unit and any of its bus devices must not exceed 350 m.

A decentralized power supply provides 80 mA bus current. This allows for decentralized solutions for self-sufficient control of a single room or, by integration of several room control islands, of a floor or even a complete building. Up to eight decentralized power supply units may be operated in parallel, such that a complete KNX bus line can be setup with e.g. eight room control boxes.

When several bus devices are installed in short bus cable distance (e.g. 10 m), e.g. in distribution boards, or in a room control box AP 641, the power supply units shall be arranged near these bus devices. The distance along the bus wire between any bus device and the closest power supply unit must not exceed 350 m. If only the decentralized power supply RL 125/23 is used, then the maximum KNX cable length in a bus line is 350 m for one, 700 m for two, and 1000 m for 3 or more decentralized power supplies RL 125/23.

In principle, central and decentralized power supply units can be operated in parallel with each other. Consideration must be taken regarding the sum of the short circuit currents of the power supply units, which must be lower than 3 amperes.

The following table shows the respective short circuit current:

Material number	Type	Short circuit current	Bus current
5WG1 125-4AB23	RL 125/23	< 0.2 A	80 mA
5WG1 125-1AB02	N 125/02	< 1.0 A	160 mA
5WG1 125-1AB12	N 125/12	< 1.0 A	320 mA
5WG1 125-1AB22	N 125/22	< 1.5 A	640 mA

With eight decentralized power supply units RL 125/23 operated in parallel the maximum short circuit current is 1.6 A.

Additionally, it is possible to operate a power supply unit N 125/02 or N 125/12 in parallel to eight RL 125/23. Only with the power supply unit N 125/22 observe that it has a short circuit current of 1.5 A, which is why only seven decentralized power supply units can be operated in parallel.

To ensure an uninterrupted power supply a separate circuit with safety separation should be used for the power supply unit N 125/x2 power supply line.

The power supply units N 125/x2 can supply DC 24 V power from an additional pair of terminals (yellow-white). This DC 24 V output voltage can be used to power e.g. an additional line via a separate choke N 120.

All power supply units N 125/x2, RL 125/23 can be powered by AC 120...230 V or by DC 220 V.

A minimum cable length is not required between these power supply units from Siemens.

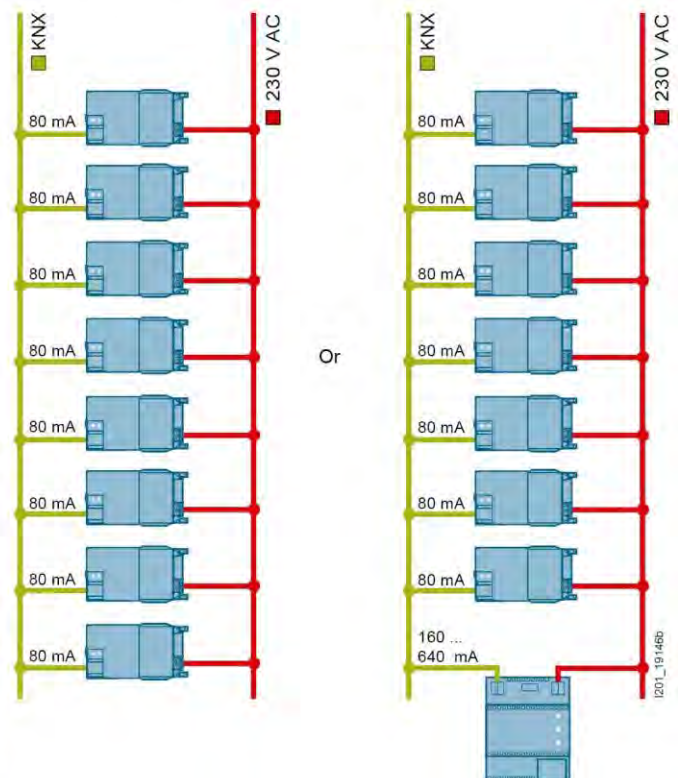

For example

Classic topology

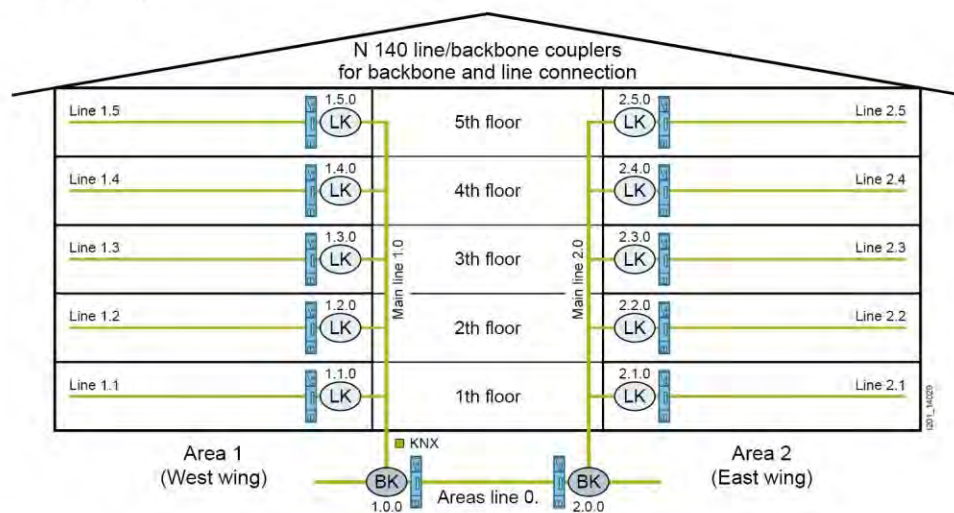

In conventional topologies, all line and backbone couplers have usually been designed as KNX couplers.

This topology is proven and widely used. For the most part, the bus line lengths are limited to one building.

Modern and safe topology

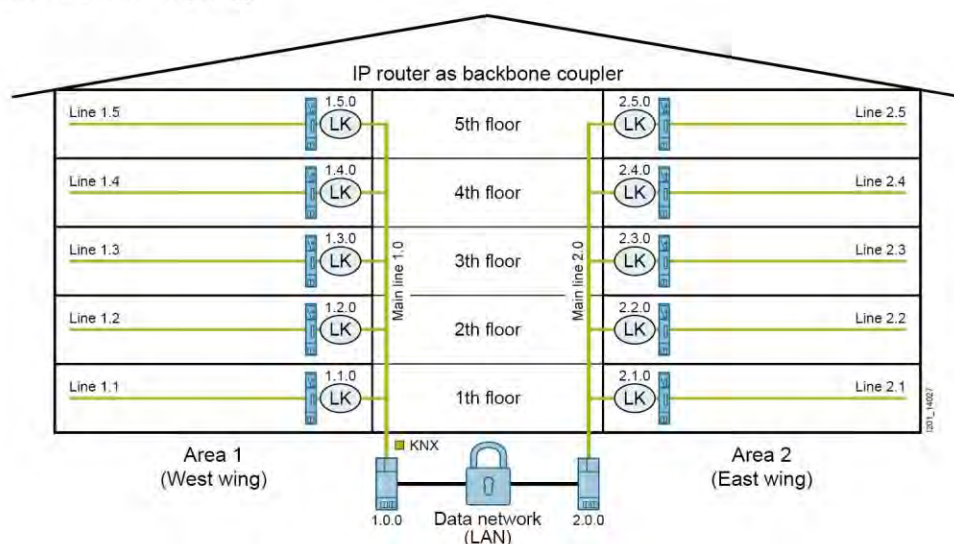

In this modern and save topology, the backbone couplers are replaced with IP routers Secure.

Thanks to the use of standard network components, the connection for example of two building sections is no longer limited to bus line lengths.

Use of other media such as fiberoptic cabling or WLAN is also possible for the purpose of coupling distant buildings and exchanging group address telegrams.

Innovative and save topology

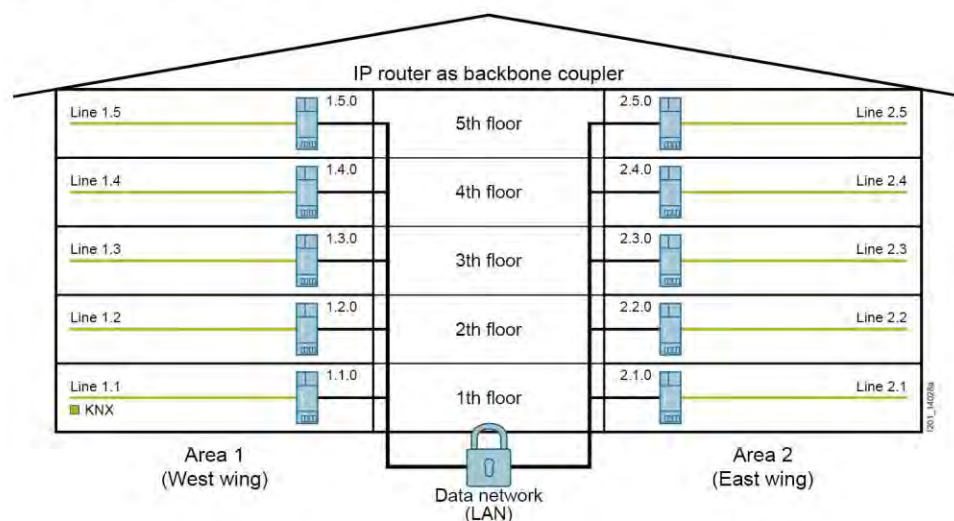

In this innovative and save topology, all line couplers are replaced with IP routers Secure.





Backbone couplers are no longer needed. This configuration allows to connect every building floor by Ethernet (LAN) and utilize existing LAN networks safe.

Moreover, correct configuration of the IP router enables major projects to be commissioned as smaller, individual subprojects in a simpler, clearer manner.





It's possible to exchange group address telegrams despite the separation into individual projects.

System products and accessories

Overview and selection tools

Power supply units					
					
Type	N 125/02	N 125/12	N 125/22	RL 125/23	JB 125C33
Enclosure data					
Modular installation devices for mounting on TH35 EN 60715 mounting rail	■	■	■		
Device for installation in Control Module Box AP 118 or Room Control Box AP 641				■	
Device for installation in Junction Box 4" x 4"					■
Dimensions					
• Width (1 MW = 18 mm)	4 MW	4 MW	4 MW	47.8 mm	70 mm
• Height [mm]				86.5 mm	90 mm
• Depth [mm]				36.2 mm	44.6 mm
Bus connection					
Integrated chokes	■	■	■	■	■
Bus connection via bus terminal	■	■	■	■	■
Outputs					
Rated operational voltage					
• AC V	120...230	120...230	120...230	120...230	120...277
• DC V	220	220	220	220	
50...60 Hz	■	■	■	■	■
Output voltage, DC [V]	29	29	29	29	29
Output current [mA]	160	320	640	80	160
Additional unchoked output for DC 29 V, for powering a second bus line via an external choke (e. g. N 120/02)	■	■	■		

Network gateways

				
Type	N 148/23	N 146/03	N 152/01	N 143/01
Enclosure data				
Design	N	N	N	N
Modular installation devices for mounting on TH35 EN 60715 mounting rail	■	■	■	■
Dimensions				
Width (1 MW = 18 mm)	2 MW	2 MW	4 MW	4 MW
Display/control elements				
LEDs for indicating that the device is ready-to-run, KNX communication, IP communication	■	■	■	■
Power supply				
Electronics powered via an external nominal AC/DC power supply unit for	AC/DC 24 V	AC/DC 24 V	DC 24 V	AC/DC 24 V
Power consumption at DC 24 V [mA]	60	60	50	60
Power supply for the electronics via "Power over Ethernet" according to IEEE 802.3af	■	■		
Bus connection				
Integrated bus coupling units	■	■	■	■
Bus connection via bus terminal	■	■	■	■
Mains connection				
Ethernet connection via RJ45 socket	■	■	■	■
Plug-in terminal block for the connection of an external power supply unit	■	■	■	■
Gateway				
Supports KNXnet/IP	■	■	■	■
Supports KNX IP Secure	Yes	Yes	No	No
Line coupler function (Routing)		■		
Interface functions (Tunneling)	5	5	1	1
Weekly scheduling program			■	
Astro function			■	
Yearly time switching functions			■	
Event entries			■	
Logic gates			■	
Web servers			■	■

System products and accessories

System products
Bus coupling units

UP 117/12



Bus transceiver modules, mounting depth 18 mm

- For connection of a modular bus device to the bus line
- 10-pole BTI socket (BTI - Bus Transceiver Interface) for plugging of bus terminal devices with BTI connector
- For installation in flush-mounting switch and socket boxes with Ø 60 mm in diameter 40 mm deep
- Screw fixing
- Bus connection via bus terminal

Data sheet

A6V10416065

Dimensions (W x H x D)

71 x 71 x 18 mm

Stock no.

Product no.

5WG1117-2AB12

UP 117/12

UP 117C12



Bus Coupling Unit (BTM), NEMA

- For connection of a modular bus device to the bus line
- 10-pole Bus Transceiver Interface (BTI) socket for clipping on an application module with BTI plug connector, with DC converter with output voltage / current of DC 5 V / 30 mA and DC 20 V / 25 mA for supply of the clipped on bus device via the bus line
- Mounting bracket for installation in a NEMA wall box with minimum inside dimensions 50 x 89 x 40 mm (W x H x D), with screw connection
- Mounting depth 19mm
- Bus connection via bus terminal
- Type of protection: IP 20

The matching design frame must be ordered separately. See Chapter Display and Operation Units - Pushbutton accessories.

Data sheet

A6V11808813

Dimensions (W x H x D)

111 x 65 x 19 mm

Stock no.

Product no.

5WG1117-2CB12

UP 117C12

Decentralized power supply, 80 mA, AC 230 V

- Integrated choke
- Output voltage DC 29 V
- Output current 80 mA
- Connection of choke-protected output voltage via a plug-in extra-low voltage terminal or bus terminal
- Type of protection: IP 20 (installed)
- Rated operational voltage AC 120...230 V, 50...60 Hz, DC 220 V
- For mounting in AP 118 automation module box or AP 641 room control box

The AP 641 room control box and AP 118 automation module box must be ordered separately.
 See Chapter Modular Installation System - Room control box - Module boxes.

Data sheet A6V11535388
 Dimensions (W x H x D) 86.5 x 47.8 x 36.2 mm

RL 125/23



Stock no.	Product no.
5WG1125-4AB23	RL 125/23

System products and accessories

System products

Power supply units

N 125/..2



Power supply unit

- Integrated chokes
- Bus connection via bus terminal
- Parallel operating mode power supplies
- Rated operational voltage AC 120...230 V, 50...60 Hz, DC 220 V
- Output voltage DC 29 V
- Additional unchoked output for DC 29 V, for powering a second bus line via an external choke N 120/2
- Modular installation devices for mounting on TH35 EN 60715 mounting rail

Data sheet

A6V10416488

Range overview N 125/..2

Product Title	Dimensions (WxHxD) [mm]	Dimension width (1 MW = 18 mm)	Stock no.	Product no.
Power supply unit DC 29 V, 160 mA with additional unchoked output, N 125/02	90 x 72 x 55	4 MW	5WG1125-1AB02	N 125/02
Power supply unit DC 29 V, 320 mA with additional unchoked output, N 125/12	60 x 72 x 90	4 MW	5WG1125-1AB12	N 125/12
Power supply unit DC 29 V, 640 mA with additional unchoked output, N 125/22	60 x 72 x 90	4 MW	5WG1125-1AB22	N 125/22

JB 125C23



Decentralized Power Supply, 80 mA, AC 120 V

- Integrated choke
- Output voltage DC 29 V
- Output current 80 mA
- Connection of choke-protected output voltage via a plug-in extra-low voltage terminal or bus terminal
- Type of protection: IP 20 (installed)
- Rated operational voltage AC 120 V, 50...60 Hz
- Built-in device with 1/2 inch thread connection for mounting to or in a UL/NEMA Junction Box with feedthrough of the function wires through the 1/2 inch threaded connector

Data sheet

A6V11808808

Dimensions (W x H x D)

70 x 90 x 44.6 mm

Stock no.

Product no.

5WG1125-4CB23

JB 125C23

System products and accessories

System products

Power supply units

Choke, 640 mA

- For operation with a KNX power supply without integrated choke or for connection to the unchoked output of the KNX N 125/x2 power supplies
- Low-voltage terminal for unchoked voltage and bus
- Modular installation devices for mounting on TH35 EN 60715 mounting rail

Data sheet	A6V10416067
Dimensions (W x H x D)	90 x 36 x 60 mm
Dimension width (1 MW = 18 mm)	2 MW

N 120/02



Stock no.	Product no.
5WG1120-1AB02	N 120/02

Electronic power supply unit, 350 mA

- Max. cable length between power supply unit and weather system: 100 m
- Rated operational voltage 85...265 V AC (50/60 Hz), 85...300 V DC
- Rated secondary voltage 24 V DC, +5 %
- Residual ripple < 100 mV
- Rated secondary current 0.35 A
- Electronic overload protection
- Permissible ambient operating temperature: - 20...+60 °C
- Degree of protection: IP20
- For mounting on EN 60715-TH35-7.5 mounting rail

Dimension width (1 MW = 18 mm)	2 MW
--------------------------------	------

4AC2402



Stock no.	Product no.
4AC2402	4AC2402

System products and accessories

System products

Line couplers

N 146/03



IP Router Secure

- For interconnection of bus lines or bus areas via a fast data network (Ethernet 10BaseT or 100BaseT) with Internet Protocol (IP)
- To be used as line, area and system coupler
- Uses the KNXnet/IP protocol or secured access and data transmission via KNXnet/IP Secure
- Up to five KNXnet/IP Tunneling connections for parallel bus access by ETS and further PC software
- Assignment of the network parameters by the installer using ETS, automatically by a DHCP server in the network
- 5 LEDs for display of availability, KNX communication and IP communication
- Electronics powered via "Power over Ethernet" according to IEEE 802.3af or alternatively by an external safety extra low voltage power supply for AC/DC 24 V
- Pluggable terminal block for connection of external power supply unit (not included)
- Ethernet connection via RJ45 socket
- Housing: plastic, color RAL 7035 (light grey), N-system
- DIN rail mounted device for mounting on rail TH35 according to DIN EN 60715
- Type of protection: IP 20

Data sheet	A6V11656735
Dimensions (W x H x D)	36 x 90 x 61 mm
Dimension width (1 MW = 18 mm)	2 MW

Stock no.	Product no.
5WG1146-1AB03	N 146/03

Accessories for N 146/03

Product Title	Stock no.	Product no.
Electronic power supply unit, 350 mA	4AC2402	4AC2402
LOGO! Power 24 V/1.3 A	6EP3331-6SB00-0AY0	LOGO!POWER 24 V/1,3 A

N 140/13



Line/backbone coupler

- For data exchange between two KNX bus lines with telegrams of up to 64 byte
- For use as line coupler for connecting a line to the main line or as backbone coupler for connecting a main line to the backbone line or as repeater for connecting two segments of the same line, with electrical isolation of the two bus lines
- Loadable filter table for control of the data exchange between the two bus lines
- Additional loadable filter table for telegrams with LTE addressing
- Detection of a communication fault on the lower-level line and signaling to the higher-level line
- 3 LEDs for display of availability and receipt of a telegram per line
- Power supply from the main line
- Modular installation devices for mounting on TH35 EN 60715 mounting rail
- With bus connection to the line and to the main line via bus terminal.

Data sheet	A6V10416071
Dimensions (W x H x D)	60 x 36 x 90 mm
Dimension width (1 MW = 18 mm)	2 MW

Stock no.	Product no.
5WG1140-1AB13	N 140/13

IP Interface Secure

N 148/23

- For communication between KNX devices and PCs or other devices with Ethernet (10BaseT or 100BaseT) interface, for remote access to an KNX installation
- Uses the KNXnet/IP protocol or secured access and data transmission via KNXnet/IP Secure
- Up to five KNXnet/IP Tunneling connections for parallel bus access by ETS and further PC software
- Assignment of the network parameters by the installer using ETS, automatically by a DHCP server in the network
- 5 LEDs for display of availability, KNX communication and IP communication
- Electronics powered via "Power over Ethernet" according to IEEE 802.3af or alternatively by an external safety extra low voltage power supply for AC/DC 24V
- Pluggable terminal block for connection of external power supply unit (not included)
- Ethernet connection via RJ45 socket
- Housing: plastic, color RAL 7035 (light grey), N-system
- DIN rail mounted device for mounting on rail TH35 according to DIN EN 60715
- Type of protection: IP 20



Data sheet	A6V11689764
Dimensions (W x H x D)	36 x 90 x 61 mm
Dimension width (1 MW = 18 mm)	2 MW

Stock no.	Product no.
5WG1148-1AB23	N 148/23

Accessories for N 148/23

Product Title	Stock no.	Product no.
Electronic power supply unit, 350 mA	4AC2402	4AC2402
LOGO! Power 24 V/1.3 A	6EP3331-6SB00-0AY0	LOGO!POWER 24 V/1,3 A

IP Router Secure

N 146/03

- For interconnection of bus lines or bus areas via a fast data network (Ethernet 10BaseT or 100BaseT) with Internet Protocol (IP)
- To be used as line, area and system coupler
- Uses the KNXnet/IP protocol or secured access and data transmission via KNXnet/IP Secure
- Up to five KNXnet/IP Tunneling connections for parallel bus access by ETS and further PC software
- Assignment of the network parameters by the installer using ETS, automatically by a DHCP server in the network
- 5 LEDs for display of availability, KNX communication and IP communication
- Electronics powered via "Power over Ethernet" according to IEEE 802.3af or alternatively by an external safety extra low voltage power supply for AC/DC 24 V
- Pluggable terminal block for connection of external power supply unit (not included)
- Ethernet connection via RJ45 socket
- Housing: plastic, color RAL 7035 (light grey), N-system
- DIN rail mounted device for mounting on rail TH35 according to DIN EN 60715
- Type of protection: IP 20



Data sheet	A6V11656735
Dimensions (W x H x D)	36 x 90 x 61 mm
Dimension width (1 MW = 18 mm)	2 MW

Stock no.	Product no.
5WG1146-1AB03	N 146/03

Accessories for N 146/03

Product Title	Stock no.	Product no.
Electronic power supply unit, 350 mA	4AC2402	4AC2402
LOGO! Power 24 V/1.3 A	6EP3331-6SB00-0AY0	LOGO!POWER 24 V/1,3 A

System products and accessories

System products

Network gateways

N 152/01



IP Control Center

Visualisation controller for full-graphic visualizations on web-compatible end devices such as PCs, tablets and smart phones with a standard web browser.

For communication between KNX devices and PCs and, in connection with a LAN-/WLAN modem or DSL router, for remote access to a KNX installation, for usage as an interface for the ETS 3/4/5 and as a n interface for a visualization, with usage of the KNXnet/IP protocol, with the following simultaneously usable functions:

- Web server for operating and monitoring up to 1250 statuses and values transmitted by the KNX network, which can be displayed using a standard browser on PCs, tablets, or smartphones connected to the IP network
- Special web-configuration page for a firmware update, to set the IP configuration, SMTP server, security settings, password protection, certificates, Sonos module, API connection and restart
- Graphical web editor for a creation of fully graphical visualization with control and display elements, configurable in various styles
- Smart editor for the creation of a visualisation, tuned for mobile browsers, smartphones, tablets with control and display elements, configurable in various styles and layouts
- Annual timer, with astronomical calendar, for 300 time switch schedules with up to 30 time switch commands per time switch schedule
- Scene module with up to 5000 scenes or events
- Chart module for recording and reporting of up to 10 data points
- Monitoring module for monitoring and storage of up to 1000 events into a ring buffer
- IP interface for control of up to 20 IP-devices via up to 20 TCP/UDP commands per IP-device
- Fully graphical logic module with up to 1000 logic functions
- Alarm function for up to 250 different alarms
- E-mail function, with up to 20 contacts, for transmission of chart data from chart module, logged data from monitoring module or alarm data
- Data point management for viewing, managing, editing and categorizing all available data points
- Module for controlling SONOS loudspeakers
- Module for controlling the Philips HUE LED lighting system
- Ethernet interface 10/100 Mbits/s with RJ45 socket for connection to the IP network using the Internet Protocol
- 2 LED displays for IP connection/communication and for error messages
- Integrated bus connector and bus terminal for connection to a KNX network
- Power supply of the electronics by an external voltage source for AC/DC 24 V, 50 mA
- Series installation device for mounting on support rails TH35 DIN EN 60715

Data sheet	A6V10417875
Dimensions (W x H x D)	90 x 72 x 55 mm
Dimension width (1 MW = 18 mm)	4 MW

Stock no.	Product no.
5WG1152-1AB01	N 152/01

Accessories for N 152/01

Product Title	Stock no.	Product no.
Electronic power supply unit, 350 mA	4AC2402	4AC2402
LOGO! Power 24 V/1.3 A	6EP3331-6SB00-0AY0	LOGO!POWER 24 V/1,3 A

IP Gateway KNX/BACnet

N 143/01

- BACnet Application Specific Controller (B-ASC) as Gateway between KNX TP and BACnet IP
- BTL certified
- Up to 250 BACnet objects
- Up to 455 BACnet COV subscriptions
- Automatic translation of KNX communication objects into BACnet objects according to the configuration with ETS
- For communication between KNX EIB devices and PCs or other devices with Ethernet (10BaseT) interface, as well as in conjunction with a LAN modem or DSL router for remote access to an KNX EIB installation
- For use as an interface e.g. for ETS or for visualization software
- Use the KNXnet/IP protocol
- KNXnet/IP Tunneling connection for parallel bus access by ETS and further PC software
- ObjectServer connection for visualization via network connections with long signal transmission duration
- Assignment of the network parameters by the installer using ETS, or automatically by a DHCP server in the network
- 2 LEDs for display of operational availability and IP communication
- Additional power supply by an external safety extra low voltage power supply for AC/DC 24 V, 40 mA
- Pluggable terminal block for connection of external power supply unit (not included)
- Integrated bus coupling unit with bus connection via bus terminal
- Ethernet connection via RJ45 socket
- Mounting on DIN rail EN 60715-TH35-7.5



Data sheet	A6V10466141
Dimensions (W x H x D)	90 x 72 x 55 mm
Dimension width (1 MW = 18 mm)	4 MW

Stock no.	Product no.
5WG1143-1AB01	N 143/01

Accessories for N 143/01

Product Title	Stock no.	Product no.
Electronic power supply unit, 350 mA	4AC2402	4AC2402
LOGO! Power 24 V/1.3 A	6EP3331-6SB00-0AY0	LOGO!POWER 24 V/1,3 A

Bus terminal, 2-pole, 4 plug-in connectors, red/dark gray

S 193/01

- For connection of bus devices to the bus cable
- For connection of up to 4 bus cables
- Comprising two engaged clamp parts + (red) and - (dark gray), each with 4 screwless plug-in terminals per clamp part for solid conductors, \varnothing 0.6 mm...0.8 mm



Dimensions (W x H x D)	10 x 12.4 x 10 mm
------------------------	-------------------

Stock no.	Product no.
5WG1193-8AB01	S 193/01

System products and accessories

System products

Network gateways

S 190/01



Overvoltage protection, as fine protection for bus devices

- For the overvoltage fine protection of bus devices
- For inserting in a bus device instead of a 193 bus terminal or for direct connection to a bus terminal
- For surge protection through connection of the yellow/green ground conductor to the next grounding point
- 2 socket contacts (1 mm Ø) for insertion in bus devices
- 2 solid wires (0.8 mm Ø) for connection to the bus terminal
- A solid wire (0.75 mm Ø) for surge protection
- Rated voltage DC 24 V
- Rated current 6 A
- Rated discharge surge current 5 kA
- Protection level 350 V

Data sheet

A6V10416502

Dimensions (W x H x D)

11.6 x 10.5 x 11.1 mm

Stock no.

Product no.

5WG1190-8AD01

S 190/01

Technical Information and Application Examples

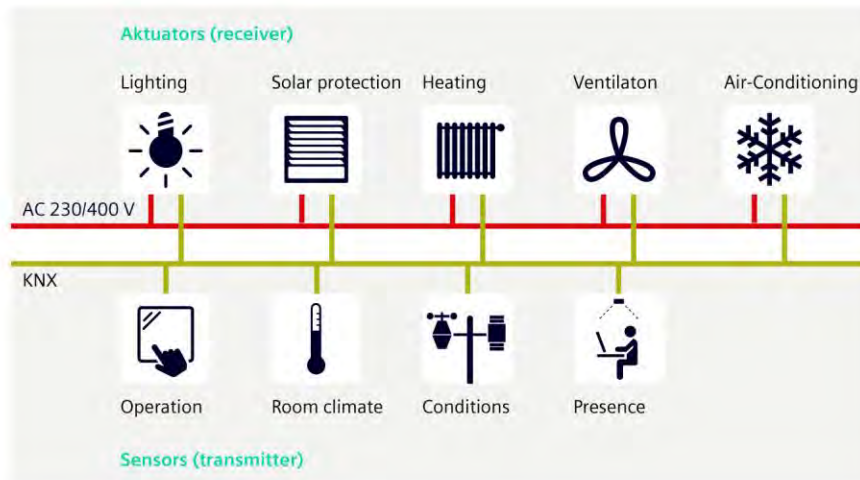

Technical Information	System overview	402
	Fast Download using ETS5 with KNX "Long Frames"	407
	UL standard	409
Application Examples	Commissioning a KNX system via Ethernet (LAN)	413
	Commissioning a KNX system via Ethernet (WLAN)	414
	Coupling KNX lines via Ethernet (LAN)	415
	Remote access a KNX system via the Internet	416
	KNX visualization via Ethernet (LAN)	417
	Remote access to several locations	418
	Monitoring properties with KNX via Ethernet (LAN)	419
	Fault indication via Ethernet (LAN)	420
	Using DALI luminaires with easy KNX commissioning	421
	Integrating KNX into BACnet	422
	Web-based visualization	423
	Notes	424

Technical Information and Application Examples

Technical Information

System overview

Building Control GAMMA instabus – future proof installation system based on KNX

GAMMA instabus is an event-oriented, distributed control installation system based on KNX, the worldwide standard for home and building control. KNX is approved as an International Standard (ISO/IEC 14543-3), as a European Standard (CENELEC EN 50090 and CEN EN 13321-1) and as a Chinese Standard (GB/T 20965). Hence, KNX is future-proof. KNX products of different vendors can be combined - the KNX logo guarantees networking and interworking. KNX is the only world-wide open standard for control of residential and non-residential including industrial buildings. With the consistent bus system KNX control information (from command senders) is sent to all building control components. The actuators (command recipients) receive these commands via the KNX bus line and act accordingly.

Installation system with KNX

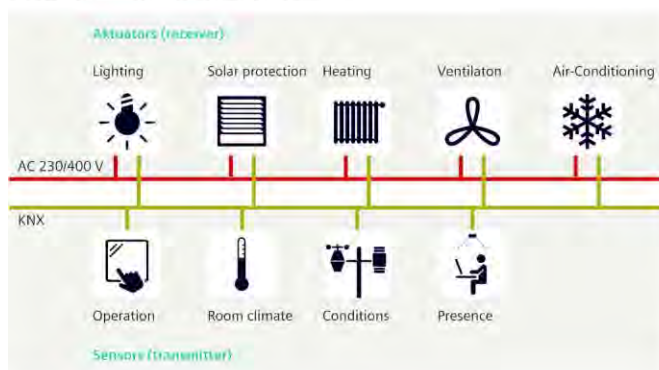

Examples of application with KNX:

- Lighting
- Solar protection
- Heating, including demand driven control of primary system
- Ventilation
- Air conditioning
- Display and operation
- Room climate to measure CO₂, air quality and air humidity
- Evaluation of weather data such as wind force, solar radiation, day and night time
- Presence in a room

In residential and non-residential buildings, KNX integrates many building functions which used to be realized with separated systems until now. The demand for comfort in rooms increases and can be realized with daytime and presence dependent air conditioning and lighting. Furthermore, the efficient use of energy is getting more and more important. An intelligent monitoring and control of all products implies the wiring of all sensors and actuators with the central supervisory monitoring and control system. The conventional wiring leads to cable loads and to higher planning and installation efforts, fire risk and rapidly increasing costs. Using the intelligent networking of all bus devices via KNX bus wiring, the wiring and thus the fire load is reduced. The mains power is directly wired to the loads and with the decentralized actuators being close to the load the power wiring can be run from one load to another load. The sensors are connected via the bus line. The KNX system is designed for integrating several disciplines i.e., using a multi pushbutton user control the lighting can be controlled, the solar protection moved and the ventilation can be turned on and off.

An installation on basis KNX offers the following advantages:

- Installation of a future-proof system technology
- Reduction of wiring
- Fast and easy retrofitting of additional functions
- Cross-discipline usage of products from several different vendors is possible
- Reduction of power demand and operating costs
- Reduced costs for later changes in room usage and changes of the original room setup (change of configuration versus change of installation)
- Remote maintenance and surveillance via IP network connection for distributed facilities

System design

KNX is an upwards-compatible, flexible, and innovative system for various residential and non-residential building applications. The bus wiring KNX TP (Twisted Pair), but also Ethernet KNXnet/IP, Radio System KNX RF (Radio frequency) and Infrared can be used as transmission medium. Thus KNX helps to implement specific customer requests and perform a fast and easy change in use of rooms and buildings.

KNX TP (Twisted Pair)

The signal transmission of KNX TP (Twisted Pair) happens via the certified bus wire. Using this wiring as the transfer medium assures a high resistance to interference.

KNXnet/IP and KNX IP Secure (Ethernet)

Information transmission with KNXnet/IP is done using the Internet Protocol (IP). It allows using the existing network infrastructure (LAN). Coupling between KNX and the local area network (LAN) is done via KNXnet/IP interfaces. This allows for coupling of complete KNX installations between buildings and the remote access via Internet/Intranet. KNX IP Secure is available for the secure transfer of data and protection against unauthorized access. This standard allows KNX IP devices to be connected directly to the Internet.

KNX RF (radio frequency)

KNX device supporting this communication medium uses radio frequency (RF) to transmit KNX telegrams. These are transmitted on the 868 MHz frequency band.

Technical Information and Application Examples

Technical Information

System overview

Topology

KNX is hierarchically structured and can be adjusted individually to the size of the installation. The smallest part in a KNX installation is a line. Each line, also the main line, includes up to 64 bus devices. Via the line coupler (LC) a maximum of 15 lines can be combined to a functional zone.

Installation system with KNX - one functional zone with 15 lines



Via the backbone coupler (BbC) the 15 functional zones can be combined once again. Thus, more than 14.400 KNX devices can be controlled and such a KNX installation can be further expanded via repeaters.

Installation system with KNX - 15 functional zones combined

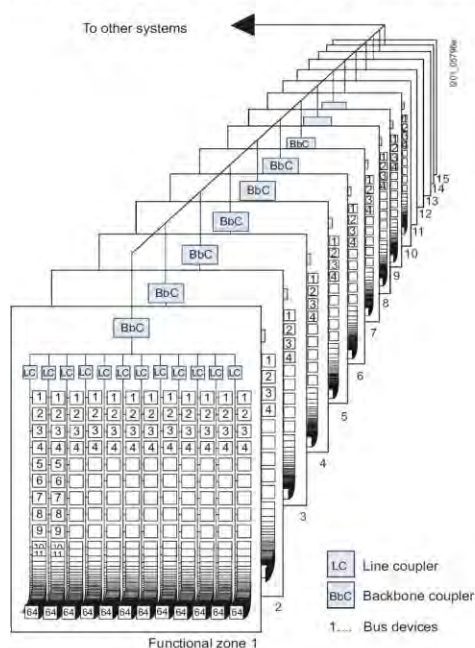

If more than 64 devices are necessary in one line, up to 4 line segments can be combined via a line amplifier. This line amplifier can also be used to extend the line length beyond the maximum line length. One line segment needs one KNX power supply.

For each line segment there are the same rules about the maximum amount of devices to connect and the distances to each other as well as the length of the lines. In one line a maximum amount of further 3 line couplers is allowed, leading to a maximum amount of 4 times 64, i.e. 256, bus devices allowed to be installed in one line. At the main line and the functional zone there are no line amplifiers allowed. With each line having its own power supply, each line needs to galvanically isolated using line/backbone couplers. This guarantees that a failure of a line does not impact the remainder of the system.

Another advantage of separating a system in lines and functional zones is to limit the transmission of such data to the functions within one line. The line and backbone couplers transfer only those telegrams which are relevant for these lines or zones. This also enables a parallel communication in several lines and functional zones at the same time. Due to the hierarchical organization of a KNX system, a clear commissioning, diagnose and maintenance is possible any time. In case the disciplines shall be structured independently, the topology or the system design with lines and functional zones provides suitable solutions. The system can be structured like this: line structure, star structure, tree structure and a mixed structure out of these three designs. Within a line there are the following wire installation rules to note:

- Maximum length of wire in one line: 1000 m
- Maximum distance between two participants: 700 m
- Maximum distance between participant and power supply: 350 m

Transmission Technology

The individual bus participants exchange information via telegrams. The telegram contains for example switching commands or status messages. As the bus wire is symmetrically structured and the wiring is installed floating potential free to Earth ground, a potential difference between the two wire cores does not cause disturbances with reference to the earth potential. Regarding transmission speed, pulse generation and pulse reception the transmission technology is designed that no termination resistor is necessary and any wiring topology is possible. The transmission rate of KNX TP is 9600 bit/s, which are about 40 to 50 telegrams per second.

The bus access of each KNX product secures a well ordered information exchange. This is guaranteed by a serial and asynchronous transmission on the bus line. For increasing the reliability and targeting highest transmission rate, KNX applies the CSMA/CA- bus access procedures (Carrier Sense Multiple Access with Collision Avoidance). With the help of this procedure no telegram gets lost when several KNX users are sending telegrams and the higher prioritized telegram gets through the line first.

All KNX participants are always listening to the bus. The participant decides on its own when the telegram is sent to the bus as long as the bus is not busy with transmitting information. The transmission of KNX is event-driven, that means, the telegrams are only sent to the bus when the event actually happens and the transmission of information is necessary.

Technical Information and Application Examples

Technical Information System overview

Telegram structure

A telegram consists of a sequence of characters. Each character has 11 Bit, which contains a Start Bit, followed by eight data bits, a parity Bit and a stop Bit. The telegram is a sequence of information, the bus specific information and the user specific information. To begin transmission of the information, the KNX needs to be free for a certain time in order to start the sending procedure.

First, a control field is sent, which contains information about the system e.g. the priority of the transmission or whether it is the first or a repeated telegram. The control field is followed by the address field. This consists of the source address and the target address of the telegram. The source address is the physical address of the sender and the target address of the receiving participant. The target address can be a physical or group address. After the address field is sent out, the data field with the user data information follows. The security field serves to check and secure the telegram (vertical parity). After the security field, the bus is silent for a certain time (break). After that all the addressed participants confirm the error-free receipt of the telegram. If the telegram is not understood right, the participant who received that signal sends out in the confirm field NAK (Not Acknowledge) and repeats the whole telegram. If no participant confirms the telegram, the sender repeats the telegram.

A KNX participant sends out up to three repetitions. A telegram signed NAK is higher prioritized than an understood telegram (ACK = Acknowledge) which leads to a repetition of the telegram.

Addressing

Communication among KNX participants can be distinguished between two kinds of addressing:

Physical address

The address of the product is also called „physical address“. It serves for a unique naming for the sending KNX participant (name). Due to this rule, the sender can be tracked. When a certain participant is addressed, i.e. the telegram is sent to a specific device, then, the target address is the unique physical address. This is the case when an application program of the ETS (Engineering Tool Software) is loaded to a KNX participant via the KNX interface. Normally, the target address is a group address.

Group address

A group address is associated with a specific function e.g. switching, dimming or heating. In this case, information is sent from a sensor to an actuator function using a group address. As all KNX participants are informed via the KNX bus they check each telegram whether the telegram contains a group address determined for them. If the target address is identical with a group address registered in the participant, the telegram initiates the pre-defined function. If different push-buttons control the same actuators, the same function can be triggered by several sensors.

A participant sends a telegram with a group address and any number of participant listen to this (multicast). Thus, one pushbutton can control different actuators and cause an execution of a function. Central functions e.g. turn off the window-side luminaries on the South-facing façade can be implemented in a building.

Sensors are for example pushbuttons, motion detectors, room temperature controllers, brightness sensors, and combined meters for wind speed and wind direction, binary input (e.g. window contact for window surveillance/switching status)

Actuators are for example load switches, dimmers, binary outputs, solar protection actuators, valve actuator for heating

Engineering Tool Software (ETS)

The ETS (Engineering Tool Software) is a vendor-neutral software, which supports planning, project configuration, commissioning up to failure diagnosis of KNX systems. It is easy and clearly structured and thus optimally suitable for all user groups.

With the ETS, consultant engineers, planners and electrical installers can plan the whole plant, set the device configuration as well as establish the function assignment of the sensors and actuators. After project planning it is possible to export the single work steps and to give them to the installer.

In principle, members of the KNX Association provide their KNX product data base to the ETS users. The current KNX product data base can be downloaded from the Internet, in order for the user to quickly receive the latest data of the KNX products.

In addition to the ETS, several manufacturers offer ETSApps, which are additional software providing specific or advanced functions for project planning, commissioning or data transfer.

Link: www.knx.org



Technical Information and Application Examples

Technical Information

System overview

System data		
Bus cable		
• Cable type	mm ²	YCYM 2 x 2 x 0.8 One core pair (red, black) for signal transmission and power supply, one core pair (yellow, white) for additional applications (SELV or voice)
Cable length		
• Cable lengths of one line in total (core diameter: 0.8 mm)	m	Max. 1000 (including all junctions)
• Length between two bus devices	m	Max. 700
• Length between bus device and power supply unit (320 mA)/choke	m	Max. 350
• Length between power supply unit (320 mA) and choke		Side-by-side mounting necessary
Bus devices		
• Number of areas		Max. 15
• Number of lines per area		Max. 15
• Number of bus devices per line		Max. 64
Topology		
• Topology structure		Line, star or tree structure
Power supply		
• Power supply	V DC	24 (SELV safety extra-low voltage)
• Power supply units per line		Minimum one power supply unit (160, 320 or 640 mA or 2 x 640 mA)
Transmission		
• Transmission technology		Distributed, event-controlled, serial, symmetric
• Baud rate	bit/s	9600

Device characteristics (unless otherwise specified)		
Device properties		
Degree of protection according to EN 60529		IP20
Protective measure		Bus: safety extra-low voltage SELV 24 V DC
Overvoltage category		III
Rated insulation voltage Ui	V	250
Degree of pollution		2
EMC requirements		complies with EN 50428
Resistance to climate		EN50491-2
Operating conditions		
Application		For fixed installation indoors, for dry rooms and installation in heavy-current distribution boards
Ambient operating temperature	°C	-5 to +45
Humidity in operation	%	Max. 93
Storage temperature	°C	-25 to +70
Humidity in storage	%	Max. 93
Certification		KNX certified
CE marking		Compliant with EMC Directive (residential and non-residential buildings), Low Voltage Directive

Technical Information and Application Examples

Technical Information System overview

Fitting power supplies for every KNX system

Each bus line needs its own power supply unit. The power supply unit provides the system power necessary for the instabus KNX. The KNX system provides for decentralized and central power supply units. Central power supply units are installed as DIN rail mounted devices in distribution boards and control cabinets, while decentralized power supply units are designed for installation in junction boxes, in parapet channels or in room control boxes.

Central power supply units provide 160 mA, 320 mA or 640 mA bus current. Maximum up to two central power supply units may be attached to a single bus line. A second unit is not required unless the supply voltage at a bus device is less than 21 V. When more than 30 bus devices are installed in short bus cable distance (e.g. 10 m), e.g. in distribution boards, the power supply unit should be arranged near these bus devices. The distance between power supply unit and any of its bus devices must not exceed 350 m.

A decentralized power supply provides 80 mA bus current. This allows for decentralized solutions for self-sufficient control of a single room or, by integration of several room control islands, of a floor or even a complete building. Up to eight decentralized power supply units may be operated in parallel, such that a complete KNX bus line can be setup with e.g. eight room control boxes.

When several bus devices are installed in short bus cable distance (e.g. 10 m), e.g. in distribution boards, or in a room control box AP 641, the power supply units shall be arranged near these bus devices. The distance along the bus wire between any bus device and the closest power supply unit must not exceed 350 m. If only the decentralized power supply RL 125/23 is used, then the maximum KNX cable length in a bus line is 350 m for one, 700 m for two, and 1000 m for 3 or more decentralized power supplies RL 125/23.

In principle, central and decentralized power supply units can be operated in parallel with each other. Consideration must be taken regarding the sum of the short circuit currents of the power supply units, which must be lower than 3 amperes.

The following table shows the respective short circuit current:

Material number	Type	Short circuit current	Bus current
5WG1125-4AB23	RL 125/23	< 0.2 A	80 mA
5WG1125-1AB02	N 125/02	< 1.0 A	160 mA
5WG1125-1AB12	N 125/12	< 1.0 A	320 mA
5WG1125-1AB22	N 125/22	< 1.5 A	640 mA

With eight decentralized power supply units RL 125/23 operated in parallel the maximum short circuit current is 1.6 A.

Additionally, it is possible to operate a power supply unit N 125/02 or N 125/12 in parallel to eight RL 125/23. Only with the power supply unit N 125/22 observe that it has a short circuit current of 1.5 A, which is why only seven decentralized power supply units can be operated in parallel.

To ensure an uninterrupted power supply a separate circuit with safety separation should be used for the power supply unit N 125/x2 power supply line.

The power supply units N 125/x2 can supply DC 24 V power from an additional pair of terminals (yellow-white). This DC 24 V output voltage can be used to power e.g. an additional line via a separate choke N 120.

All power supply units N 125/x2, RL 125/23 and JB 125C23 can be powered by AC 120...230 V or by DC 220 V.

A minimum cable length is not required between these power supply units from Siemens.

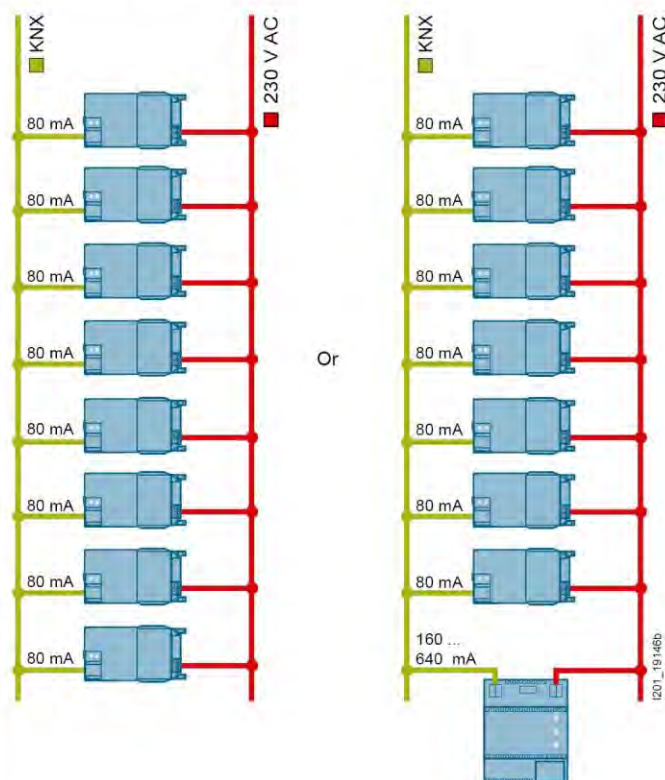

Technical Information and Application Examples

Technical Information

Fast Download using ETS5 with KNX "Long Frames"

GAMMA instabus devices and fast download with ETS

Starting with ETS5, in addition to KNX Standard Telegrams ETS supports Telegrams with „Long Frames“, which allow sending longer telegrams on the KNX bus.

For devices supporting the reception of these „Long Frames“ more user data can be packed into a telegram. This leads to shorter download times of downloads with ETS5.

Following GAMMA KNX products support the „Long Frame“ Download with ETS5

Product Title	Stock No.
Line/backbone coupler N 140/13	5WG1140-1AB13
IP Router 146/03	5WG1146-1AB03
Interface N 148/12 USB	5WG1148-1AB12
IP Interface N 148/23	5WG1148-1AB23
Push button interface 4x potential-free contact UP 220/31	5WG1220-2DB31
Push button single i-system UP 221/2	5WG1221-2DB12
Push button single i-system UP 221/3	5WG1221-2DB13
Push button single i-system UP 221/2	5WG1221-2DB32
Push button single i-system UP 221/3	5WG1221-2DB33
Push button double i-system UP 222/2	5WG1222-2DB12
Push button double i-system UP 222/3	5WG1222-2DB13
Push button double i-system UP 222/2	5WG1222-2DB32
Push button double i-system UP 222/3	5WG1222-2DB33
Push button triple i-system UP 223/2	5WG1223-2DB12
Push button triple i-system UP 223/3	5WG1223-2DB13
Push button triple i-system, temperature sensor UP 223/4	5WG1223-2AB14
Push button triple i-system UP 223/2	5WG1223-2DB32
Push button triple i-system UP 223/3	5WG1223-2DB33
Push button triple i-system, temperature sensor UP 223/4	5WG1223-2AB34
UP 255D21 Brightness sensor with constant light level control	5WG1255-2DB21
UP 258D12 Presence detector DESK	5WG1258-2DB12
Binary input RL 260/23	5WG1260-4AB23
Binary input JB 260C23	5WG1260-4CB23
Push button single style UP 285/2	5WG1285-2DB12
Push button single style UP 285/3	5WG1285-2DB13
Push button single style UP 285/2	5WG1285-2DB42
Push button single style UP 285/3	5WG1285-2DB43
Push button double style UP 286/2	5WG1286-2DB12
Push button double style UP 286/3	5WG1286-2DB13
Push button double style UP 286/2	5WG1286-2DB42
Push button double style UP 286/3	5WG1286-2DB43

Technical Information and Application Examples

Technical Information

Fast Download using ETS5 with KNX "Long Frames"

Following GAMMA KNX products support the „Long Frame“ Download with ETS5

Product Title	Stock No.
Push button quadruple style UP 287/2	5WG1287-2DB12
Push button quadruple style UP 287/3	5WG1287-2DB13
Push button quadruple style, temperature sensor UP 287/4	5WG1287-2AB14
Push button quadruple style UP 287/2	5WG1287-2DB42
Push button quadruple style UP 287/3	5WG1287-2DB43
Push button quadruple style, temperature sensor UP 287/4	5WG1287-2AB44
Binary output device UP 510/03	5WG1510-2AB03
Binary output device UP 510/13	5WG1510-2AB13
Binary output device RS 510/23	5WG1510-2AB23
Binary output device JB 510C23	5WG1510-4CB23
Thermo drive actuator RS 510K23	5WG1510-2KB23
Switching actuator RL 512/23	5WG1512-4AB23
Switching actuator JB 512C23	5WG1512-4CB23
Binary output 3x6A RL 513D23	5WG1513-4DB23
Binary output JB 513C23	5WG1513-4CB23
Solar protection actuator UP 520/03	5WG1520-2AB03
Solar protection actuator UP 520/13	5WG1520-2AB13
Solar protection actuator RS 520/23	5WG1520-2AB23
Solar protection actuator JB 520C23	5WG1520-4CB23
Solar protection actuator RL 521/23	5WG1521-4AB23
Solar protection actuator JB 521C23	5WG1521-4CB23
Universal dimmer UP 525/03	5WG1525-2AB03
Universal dimmer UP 525/13	5WG1525-2AB13
Universal dimmer RS 525/23	5WG1525-2AB23
Universal dimmer JB 525C23	5WG1525-4CB23
Switch-/Dimming actuator JB 526C23	5WG1526-4CB23
Switch-/Dimming actuator JB 527C23	5WG1527-4CB23
Universal dimmer N 528D01, 2 x 300 VA, AC 230 V	5WG1528-1DB01
Switching actuator N 530D31 4x AC 230 V 6 AX	5WG1530-1DB31
Switching actuator N 530D51 8x AC 230 V 6 AX	5WG1530-1DB51
Switching actuator N 530D61 12x AC 230 V 6 AX	5WG1530-1DB61
Switching actuator N 532D31 4x AC 230 V 10 AX	5WG1532-1DB31
Switching actuator N 532D51 8x AC 230 V 10 AX	5WG1532-1DB51
Switching actuator N 532D61 12x AC 230 V 10 AX	5WG1532-1DB61
Switching actuator N 534D31 4x AC 230 V 16/20 AX	5WG1534-1DB31
Switching actuator N 534D51 8x AC 230 V 16/20 AX	5WG1534-1DB51
Switching actuator N 534D61 12x AC 230 V 16/20 AX	5WG1534-1DB61
Switching actuator N 535D51 8x AC 230 V 16/20 AX, with Load-Check	5WG1535-1DB51
Switch-/Dimming actuator N 536D51	5WG1536-1DB51
Solar protection actuator N 543D51	5WG1543-1DB51

GAMMA instabus Devices comply with UL standard

Broad spectrum

UL standards are used in North America, but also in several other countries. The mark UL (Underwriters Laboratories) is allowed to print on the product when the security check was successfully done according to the UL guidelines. This is of particular importance to European exporters of electrical switchgear equipment for machines who export to the USA, as their products will only be accepted if they meet the relevant UL standards. UL 508A describes the design of control cabinets and implementation of integral components with reference to other pertinent UL standards where applicable. It therefore represents the basic standard for all electrical systems used in North America. A wide range of GAMMA instabus devices comply with UL standards and are therefore suitable for implementation worldwide in both IEC/EN and UL applications within the framework of their specified use.

Further links:

For general information about the UL standard: www.ul.com

Online database for UL products: www.ul.com/database

For information about ul certification: www.ul-certification.com

For information about GAMMA products: www.siemens.com/gamma

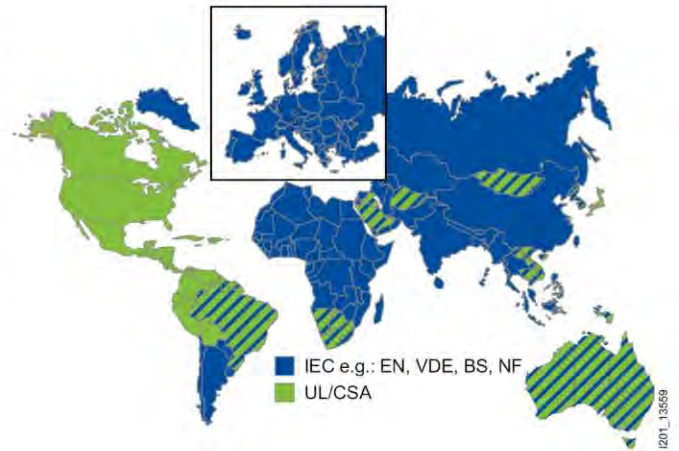

Worldwide application of EN/IEC or UL standards

Low-voltage systems in the USA

While a variety of different systems are used in the USA, three-phase systems with 240 V as well 480 V and 3- and 4-wire systems are the most common, with 208 V and 600 V playing a considerably smaller role. Residential buildings are primarily fitted with 120 V to 240 V single-phase systems. A frequency of 60 Hz is standard in North America.

Industry and commercial		Residential
Three-phase, 4 wires	Three-phase, 3 wires	Single-phase, 3 wires
Three-phase wye, 4 wires	Three-phase delta, 3 wires, grounded corner	Single phase, 120 V/240 V, grounded midpoint
Caution: The PE must not be used for electricity. There is no PEN conductor => N = „Grounded Conductor“ (white or gray), separate wires must be used for PE and N.		
480 V Y/277 V ¹⁾	240 V	240 V, phase conductor
600 V Y/347 V ¹⁾	480 V	120 V to ground
240 V Y/131 V ¹⁾	600 V	
208 V Y/120 V ¹⁾		







¹⁾ "Y" describes the „Solidly grounded circuit“. The „Y“ value specifies the voltage between the phases (e. g. 480 V), the value after the slash specifies the voltage between the phase and the grounding (e.g. 277 V at 480 V voltage between the phases).

Technical Information and Application Examples

Technical Information

UL standard

Explanation of UL symbols

Symbol	Application
	UL symbol This is the most used UL symbol. This UL mark lines out that the products fullfill the security check. The security check follows guidelines published by UL (UL standard).
	c-UL symbol This mark applies to products for the Canadian market. Products with this mark have been examined by UL in accordance with Canadian safety directives, which differ in some points from the US directives.
	c-UL US symbol This symbol was introduced at the beginning of 1998. It means that the device bearing this mark complies with both UL and Canadian regulations.
	UR, c-UR and c-UR us symbol These symbols are seldom seen by consumers as they are affixed to special components that are part of a larger system or product. These components may have technical or design restrictions.
	The Component Recognition symbol can be on a large number of products, such as switches, power supplies, printed boards, switching devices and many other products. Products for Canada have an additional „c“.
	The c UR us symbol was introduced in 1998 and means that the marked components meet both the UL and CSA regulations.

The „UL listed“ symbol ® is applied to devices that can be installed universally and without further instructions or any restriction of their respective applicability, e. g. contactors to UL 508, miniature circuit breakers to UL 489, energy management devices according to UL 916 ...
The „UL Recognized“ symbol  is intended for devices that may only be installed by experts as components, e. g. miniature circuit breakers to UL 1077, time switches to UL 917, SITOR fuses and so on.

KNX installation system in a UL standard installation system

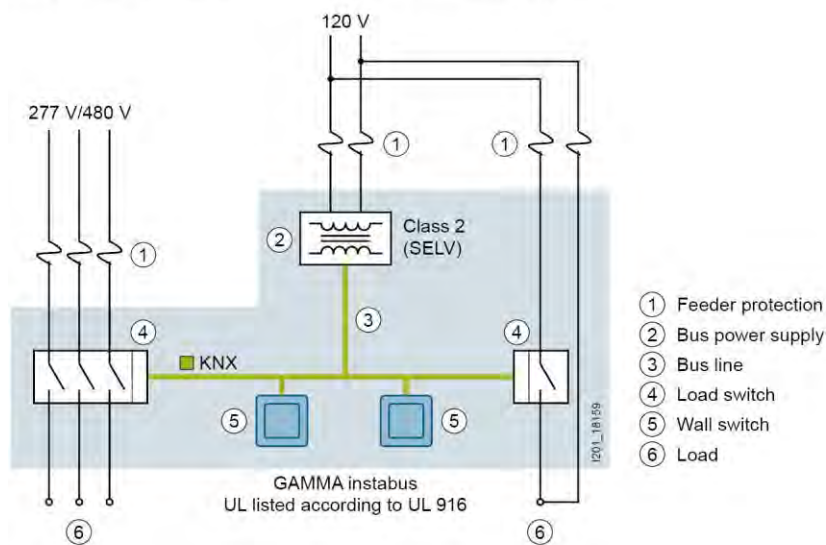

5WG1 energy management devices ... according to UL 916

The UL 916 requirements cover energy management equipment rated 600 V or less intended for installation in accordance with the National Electrical Code NFPA 70. This primarily applies to devices for the control of electrical loads to achieve the desired use of electrical power. Such equipment controls electrical loads by responding to sensors and actuators.

All devices that are powered by the bus voltage or by an external fewer DC 30 V and fewer 1.5 A power supply, and that are not connected to voltages greater than AC/DC 30 V, meet the conditions the UL standard. These devices can be used as energy management equipment according to UL 916 (energy management equipment accessories).

Technical Information and Application Examples

Technical Information

UL standard

The following KNX products of the GAMMA portfolio have a UL mark

	Product title	Stock no.	Type
	Power supply unit [®] Integrated choke, 640 mA additional unchoked output, DC 29 V	5WG1125-1AB22	N 125/22
	Power supply units [®] Integrated choke, 340 mA additional unchoked output, DC 29 V	5WG1125-1AB12	N 125/12
	Power supply unit [®] Integrated choke, 160 mA additional unchoked output, DC 29 V	5WG1125-1AB02	N 125/02
	KNX/DALI Gateway plus, 1 channel [®]	5WG1141-1AB03	N 141/03
	KNX/DALI Gateway Twin plus, 2 channels [®]	5WG1141-1AB21	N 141/21
	KNX/DALI Gateway Twin [®]	5WG1141-1AB31	N 141/31
	Load switch [®] 8 x AC 120 V/277 V, 20 A; AC 347 V, 15 A	5WG1512-1CB01	N 512
	Universal Dimmer [®] 2 x 150 VA, AC 120 V	5WG1528-1CB01	N 528C01
	Switching actuator [®] 3 x AC 230/400 V, 20 AX	5WG1513-1AB11	N 513/11
	Switching actuator submodule [®] 3 x AC 230/400 V, 20 AX	5WG1513-1AB21	N 513/21

Technical Information and Application Examples

Technical Information

UL standard

The following KNX products of the GAMMA portfolio have a UL mark

	Product title	Article No.	Type
	Power Supply ^{UL} 160 mA, AC 120-277 V	5WG1125-4CB33	JB 125C33
	Binary Input ^{UL} 4 x AC/DC 12-230 V	5WG1260-4CB23	JB 260C23
	Binary Output ^{UL} 2 x AC 120-277 V, 10 A (resistive load)	5WG1510-4CB23	JB 510C23
	Switching Actuator ^{UL} 1 x AC 120-277 V, 20 A or 1 x AC 347 V, 15 AX (resistive load)	5WG1512-4CB23	JB 512C23
	Binary Output ^{UL} 3 x AC 120-277 V, 6 A	5WG1513-4CB23	JB 513C23
	Solar Protection Actuator ^{UL} 1 x AC 120 V, 6 A	5WG1520-4CB23	JB 520C23
	Solar Protection Actuator ^{UL} 2 x AC 120 V, 6 A	5WG1521-4CB23	JB 521C23
	Universal Dimmer ^{UL} 1 x AC 120 V, 10...125 VA	5WG1525-4CB23	JB 525C23
	Switching/dimming actuators ^{UL} 2 x 20 A, AC 277 V / AC 347 V, 0/1...10 V	5WG1526-4CB23	JB 526C23
	Switching/dimming actuators ^{UL} 1x 20 A, AC 277 V / AC 347 V, 0/1...10 V	5WG1527-4CB23	JB 527C23

Technical Information and Application Examples

Application Examples

Commissioning a KNX system via Ethernet (LAN)

Fast and secure download saves time

In every GAMMA instabus project, the devices are commissioned after their installation. Once the physical addresses have been assigned, application programs, parameters and addresses are loaded to the devices. This can take some time in large-scope projects with many devices.

The LAN connection from Siemens makes it all go much faster, saving you time and money. Simply connect your notebook to the GAMMA instabus via an IP interface and start the download. With a LAN connection, the download takes only half as long as it does with USB.

The solution

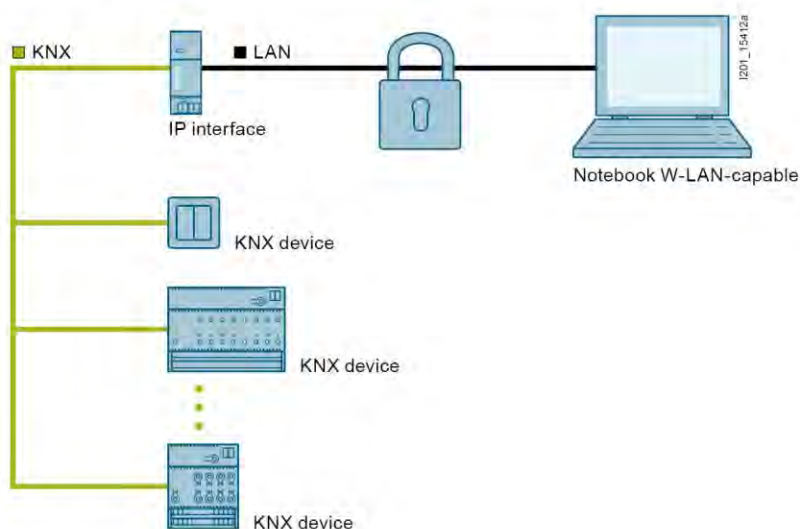

Benefits

- Plan, configure, commission and diagnose with ETS, the KNX commissioning software
- Simply connect your notebook and start the download
- Downloading takes only half as long, thereby halving commissioning times and significantly reducing time at the project site

Follow these steps

- Connect the IP interface to the KNX bus line
- Connect the notebook to the IP interface using the Ethernet cable – and start the download.

You will need

- An IP interface, for example
- 24-V power supply for IP interface, e.g. Power over Ethernet, unchoked bus voltage
- LAN-enabled notebook
- ETS; see knx.org for the latest version

Note:

LAN stands for Local Area Network. In LANs, data transport is organized using the IP (Internet Protocol) – the standard network protocol on the Internet.

Technical Information and Application Examples

Application Examples

Commissioning a KNX system via Ethernet (WLAN)

Commissioning – Easy and safe access via WLAN

In every GAMMA instabus project, the devices are commissioned after their installation. First, the physical addresses must be assigned. To do this, select the device in ETS on the notebook and press the programming key on the device. If you have various devices at different places such as flush-mounted bus coupling units, this can result in intensive walkways. That's the reason why two people usually perform the commissioning.

You can save yourself this considerable extra work by connecting your notebook wirelessly to the KNX via WLAN. This lets you move about freely during commissioning – just take your notebook with you to each room. Any errors such as mixup of devices due to misunderstandings are ruled out.

The solution

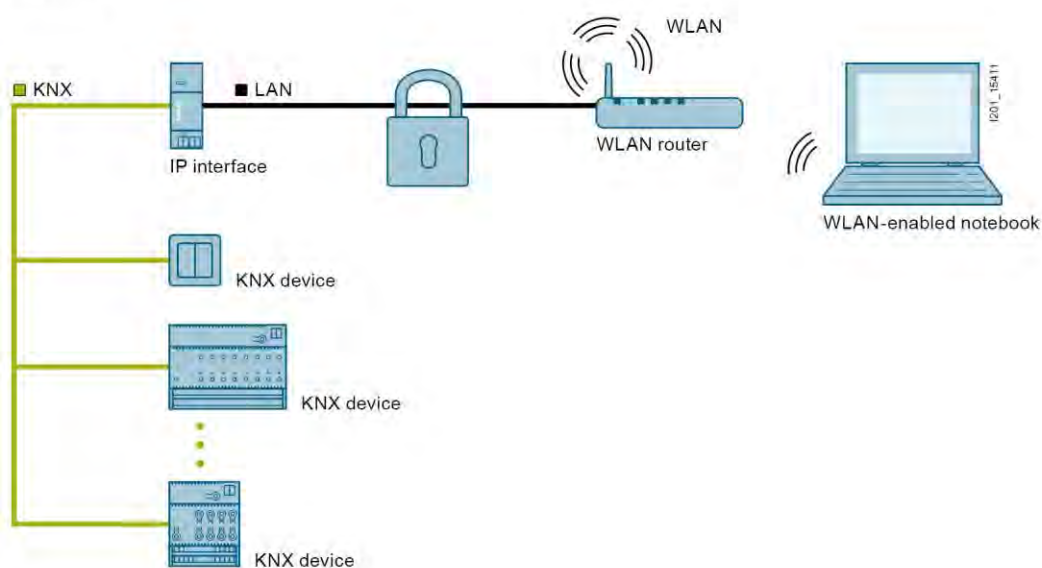

Benefits

- Wireless GAMMA instabus commissioning via WLAN
- Possible to move freely throughout the building
- Only one person needed for commissioning

Follow these steps

- Connect the IP interface with the KNX, and connect the WLAN router to the IP interface using the Ethernet cable – and you can go to each individual room with your notebook and the ETS
- The related safety and security requirements governing the LAN and WLAN have to be observed

You will need

- An IP interface, for example
- 24-V power supply for IP interface, e.g. Power over Ethernet, unchoked bus voltage
- Ethernet
- WLAN router
- WLAN-enabled notebook
- ETS; see knx.org for the latest version

Note:

WLAN stands for Wireless Local Area Network and describes a „wireless“ local radio network for data transmission.

WLANs are quick and easy to install, cover large areas and operate cost-effectively.

Technical Information and Application Examples

Application Examples

Coupling KNX lines via Ethernet (LAN)

Connect main and backbone lines via KNXnet/IP and KNX IP Secure

The new KNXnet/IP standard enables KNX telegrams to be transmitted via Ethernet (LAN), which leads to new applications and solutions.

Existing network infrastructure and technologies are used to securely transmit KNX data over longer distances. Connections between buildings or floors can be clearly and easily implemented with KNXnet/IP.

The solution

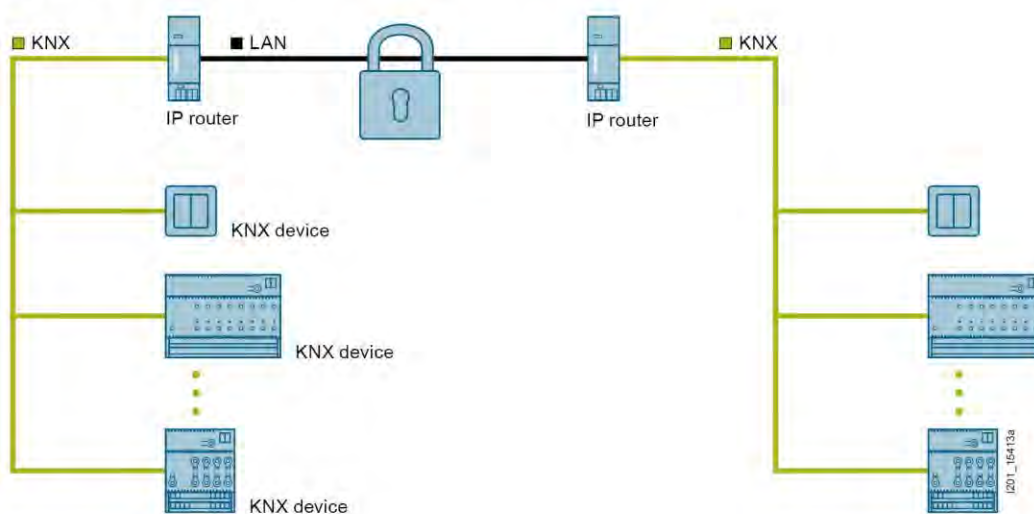

Benefits

- LAN as the main and backbone line
- Data can be transmitted over longer distances
- Existing data network and components (LAN) can be used

Follow these steps

- Connect an IP router to every KNX line (instead of a line coupler N 140)
- Connect the IP router via a multicaster-enabled LAN
- Commission each IP router just like a "conventional" line/backbone coupler using ETS
- Observe the related safety and security requirements governing the LAN

You will need

- One IP router per line
- 24-V power supply for IP router, e.g. Power over Ethernet, unchoked bus voltage
- Ethernet patch cable or LAN, depending on the size
- ETS; see knx.org for the latest version

Note:

LAN stands for Local Area Network. In LANs, data transport is organized using the IP (Internet Protocol) – the standard network protocol on the Internet.

Multicast-capable: multicast telegrams can simultaneously operate several IP devices in the LAN. In the case of network components (network switches, routers) this requires the appropriate configuration.

Technical Information and Application Examples

Application Examples

Remote access a KNX system via the Internet

Easy remote access

In almost every project, changes are often requested during building completion or after the building goes into operation, for example if the set lighting times are too long. Up to now this meant making an appointment with the customer, driving to the property, changing the parameter settings, driving back again.

Now you can cut time and costs by making these changes remotely from your office via Internet, LAN or a wired broadband connection (fiber optics or DSL). Most buildings already have an Internet and LAN connection – thus providing global connectivity. This is why data security must be ensured using a VPN DSL router or dial-up router respectively.

The solution

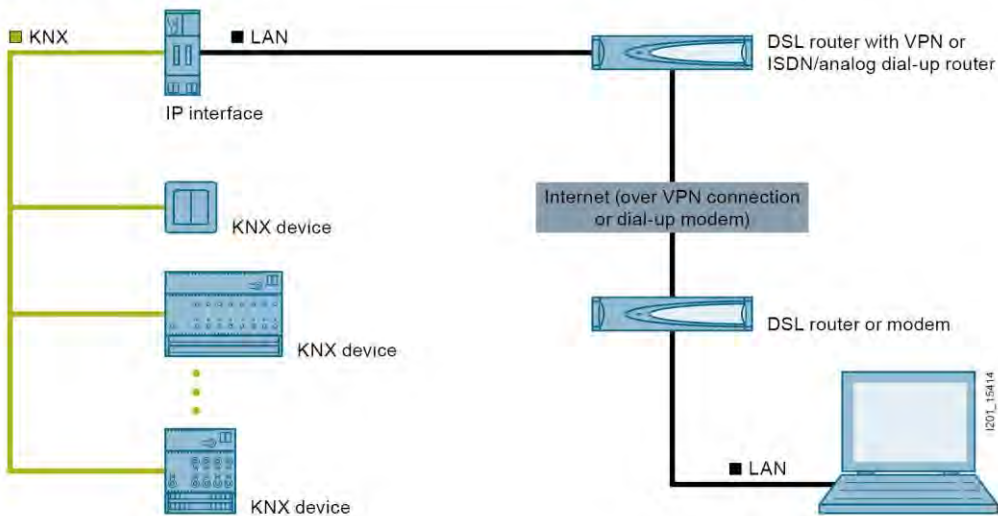

Benefits

- Parameters can be quickly changed by remote access
- Remote access saves driving time and costs
- Data security is ensured

Follow these steps

- Connect IP interface to the KNX and LAN
- Configure the VPN DSL router or dial-up router

You will need

- An IP interface, for example
- 24-V power supply for IP interface, e.g. Power over Ethernet, unchoked bus voltage
- VPN DSL router or ISDN/analog dial-up router
- ETS; see knx.org for the latest version

Note:

LAN stands for Local Area Network. In LANs, data transport is organized using the IP (Internet Protocol) – the standard network protocol on the Internet.

VPN (Virtual Private Network) lets you set up a secure subnetwork via an open, unsecured network (Internet, wireless network) by protecting all communication against access or being tapped into by unauthorized third parties. This is achieved by means of „tunneling“ the data traffic via a VPN server, which means that any connections must be authenticated and that all data is also encoded.

Technical Information and Application Examples

Application Examples

KNX visualization via Ethernet (LAN)

Visualization – up to 200 times faster with KNXnet/IP

When retrieving large numbers of data points cyclically for visualization in large projects, waiting periods can sometimes occur while data is being updated.

Use your LAN as the main and backbone line and connect your PC for visualization to the LAN. This makes visualization up to 200 times faster: you can monitor larger numbers of data points and the data volume is no longer important.

The solution

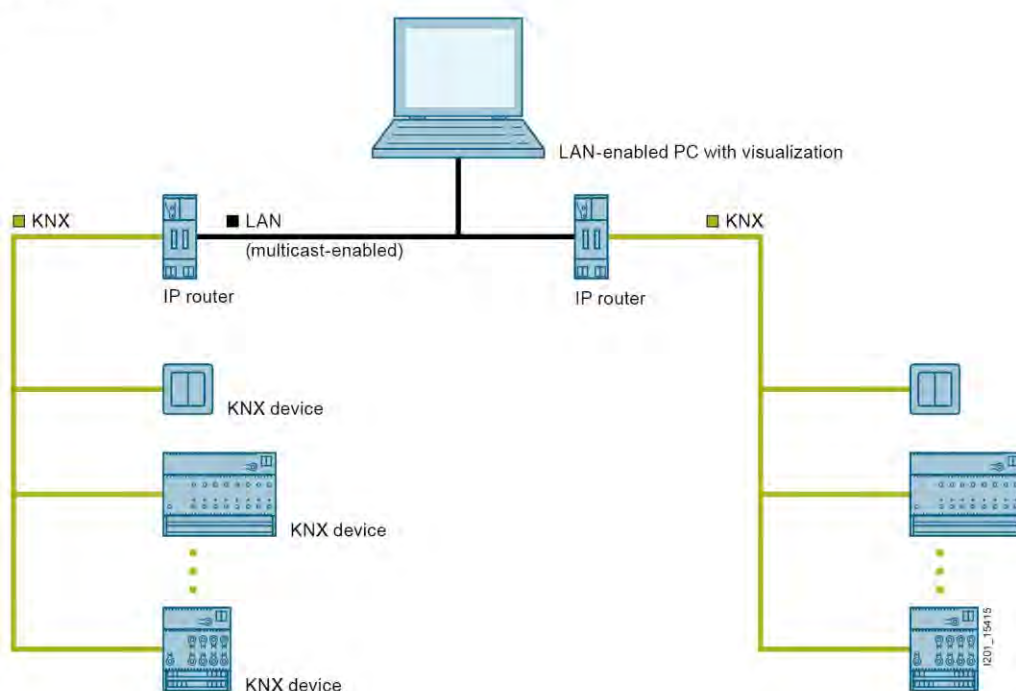

Benefits

- LAN as the main and backbone line
- Visualization up to 200 times faster than previously
- High data volume possible
- No data concentrators needed

Follow these steps

- Commission the KNX devices, including the IP router
- Install the visualization software
- Find and connect the IP router as the visualization interface
- Configure the visualization
- Observe the related safety and security requirements governing the LAN

You will need

- One IP router per line
- IP Control Center N 152
- 24-V power supply for IP interface, e.g. Power over Ethernet, unchoked bus voltage
- Ethernet network (LAN)
- ETS; see knx.org for the latest version

Note:

LAN stands for Local Area Network. In LANs, data transport is organized using the IP (Internet Protocol) – the standard network protocol on the Internet.

Multicast-capable: multicast telegrams can simultaneously operate several IP devices in the LAN. In the case of network components (network switches, routers) this requires the appropriate configuration.

Technical Information and Application Examples

Application Examples

Remote access to several locations

Remote operation and remote visualization

In many cases, several locations need to be managed simultaneously. There are many such examples:

- Monitoring of cooling temperatures in several supermarkets or warehouses
- Monitoring of fans for failure
- Monitoring of temperature and humidity in several greenhouses

It is now possible to carry out these monitoring tasks centrally via the Internet/Intranet from absolutely anywhere. This saves you human resources, time and money. And the Internet/Intranet is available everywhere. Commissioning is further facilitated by the fact that distributed locations can be configured identically.

The solution

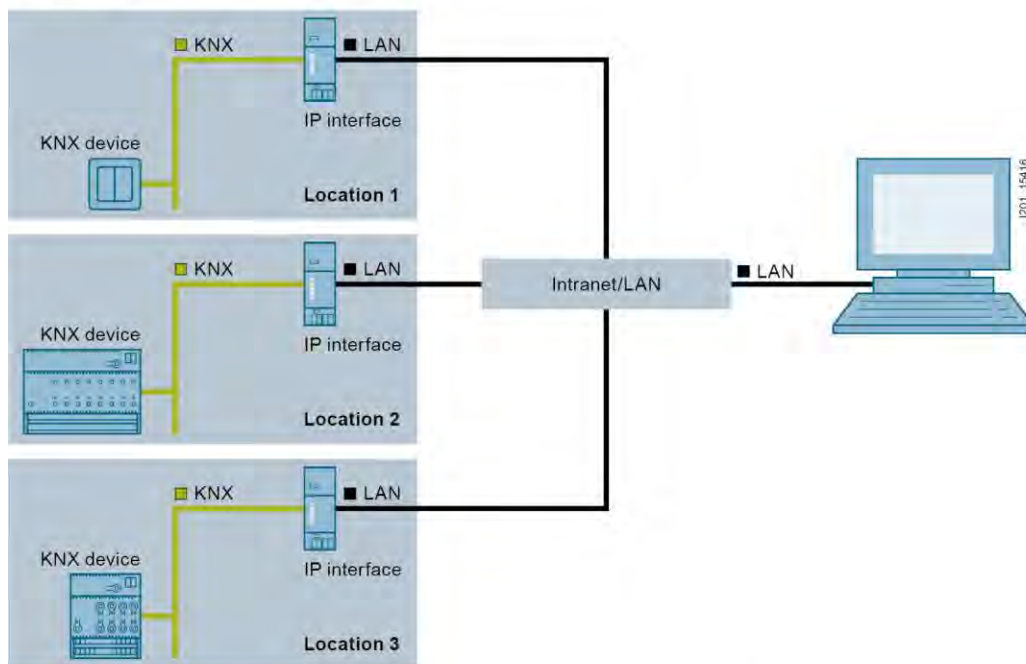

Benefits

- Plants and locations can be remotely visualized, controlled and monitored via existing networks
- Simple commissioning thanks to options for identical configuration of different locations

Follow these steps

- Connect one IP interface per location to the KNX
- Connect the IP interface to the LAN
- Configure the IP interface via the Intranet/Internet
- Define the IP interface

You will need

- One IP interface for each property, for example
- 24-V power supply for IP interface, e.g. Power over Ethernet, unchoked bus voltage
- Visualization software
- ETS; see knx.org for the latest version

Note:

LAN stands for Local Area Network. In LANs, data transport is organized using the IP (Internet Protocol) – the standard network protocol on the Internet.

Technical Information and Application Examples

Application Examples

Monitoring properties with KNX via Ethernet (LAN)

Demand-oriented maintenance through remote signaling

Some distributed properties need to be checked regularly for certain conditions and maintained accordingly, for example the fill levels of oil tanks in distributed apartment buildings or the operating hours of consumers.

These states can now be reported centrally to any location. This can eliminate the need for cyclical inspection walkthroughs and appropriate maintenance can be carried out when needed, such as refilling the oil tanks in distributed properties. You can even select the best time to do this, such as when oil prices are lowest.

The solution

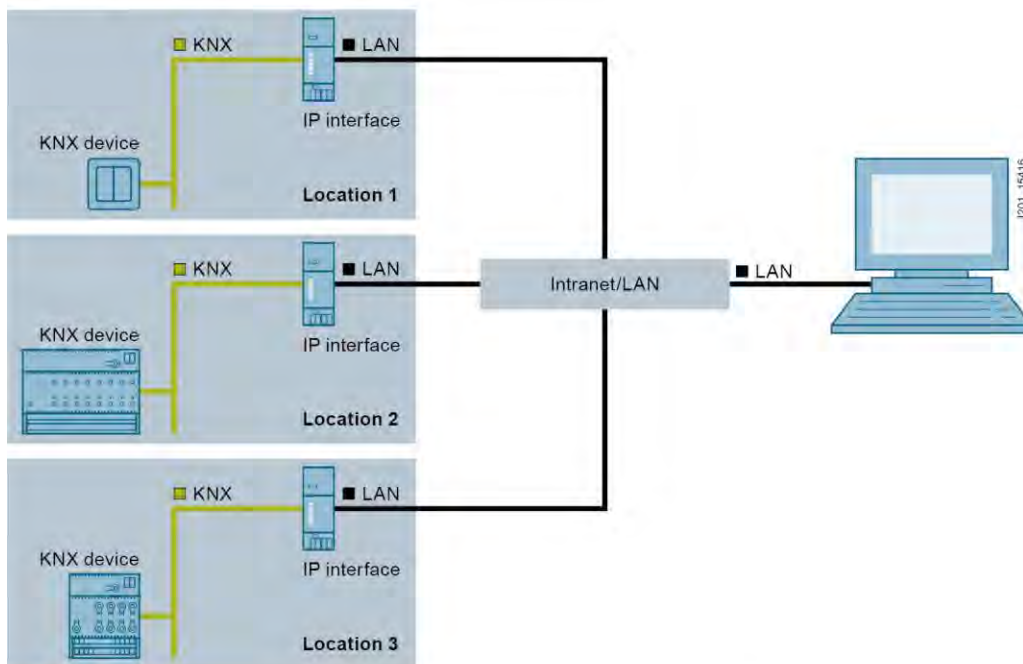

Benefits

- Central status messages for distributed properties
- Less maintenance required
- Optimization of maintenance costs

Follow these steps

- Connect one IP interface to the KNX for each property
- Connect the IP interface to the LAN
- Configure the IP interface via the Internet/intranet for accessibility
- Define the IP interface in the visualization software or ETS respectively
- Observe the related safety and security requirements governing the LAN

You will need

- One IP interface for each property, for example
- 24-V power supply for IP interface, e.g. Power over Ethernet, unchoked bus voltage
- Visualization software
- ETS; see knx.org for the latest version

Note:

LAN stands for Local Area Network. In LANs, data transport is organized using the IP (Internet Protocol) – the standard network protocol on the Internet.

Technical Information and Application Examples

Application Examples

Fault indication via Ethernet (LAN)

Enhanced plant availability due to early fault detection

Whether dealing with a lamp failure in depots or offices, a drop in pressure in filters, or pump failure - automated plants in distributed locations are constantly subject to possible faults/malfunctions. The earlier such faults are detected, the less costly they are to remedy.

If such plants are being controlled with GAMMA instabus and are connected over LAN/IP, these types of fault indications can be forwarded over the Internet. A fast response means that the functionality of the plant is quickly restored and costs are kept to a minimum.

The solution

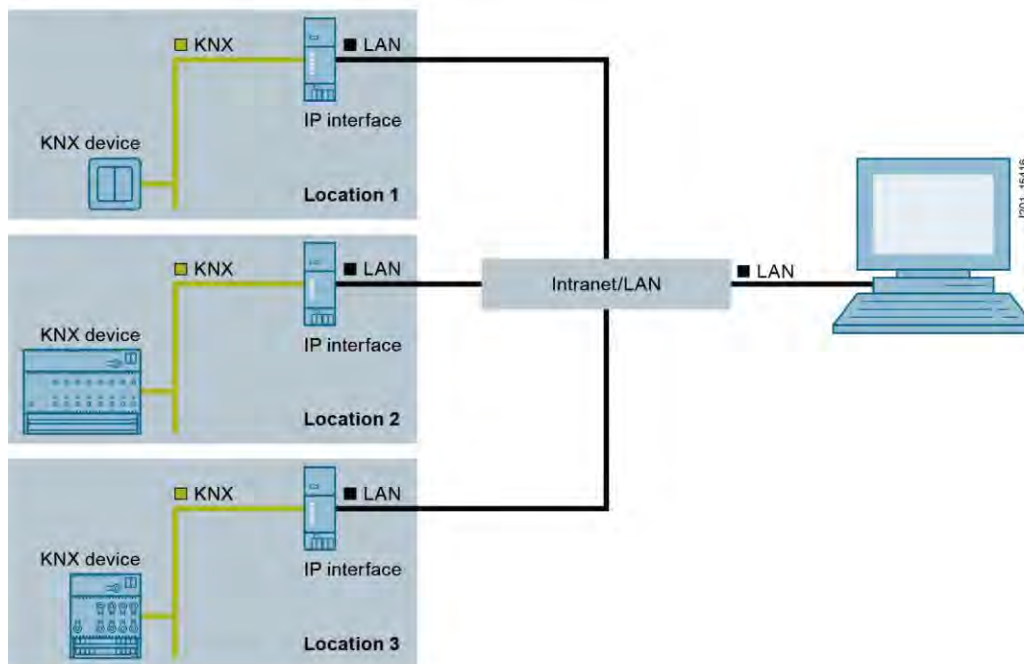

Benefits

- Central solution for distributed locations
- Fast forwarding of fault indications
- Fast responses mean less damage

Follow these steps

- Connect one IP interface per location to the KNX
- Connect the IP interface to the LAN
- Configure the IP interface over the Intranet/Internet
- Define the IP interface in your visualization program/ETS

You will need

- One IP interface for each property, for example
- 24-V power supply for IP interface, e.g. Power over Ethernet, unchoked bus voltage
- Visualization software
- ETS; see knx.org for the latest version

Note:

LAN stands for Local Area Network. In LANs, data transport is organized using the IP (Internet Protocol) – the standard network protocol on the Internet.

VPN (Virtual Private Network) lets you set up a secure subnetwork via an open, unsecured network (Internet, wireless network) by protecting all communication against access or being tapped into by unauthorized third parties. This is achieved by means of „tunneling“ the data traffic via a VPN server, which means that any connections must be authenticated and that all data is also encoded.

Technical Information and Application Examples

Application Examples

Using DALI luminaires with easy KNX commissioning

The smart way to control your room

The integrated KNX controller of the TC5 contains comprehensive lighting control for switching, dimming, tunable white as well as solar protection control. The room temperature controller supports many HVAC applications and the device can not only monitor several ambient measurements, but also evaluate them and indicate visually their quality level.

Scene editor and timer functions complete the features of the TC5, allowing you to meet all room requirements.

The solution

The smart way to a productive and healthy working environment

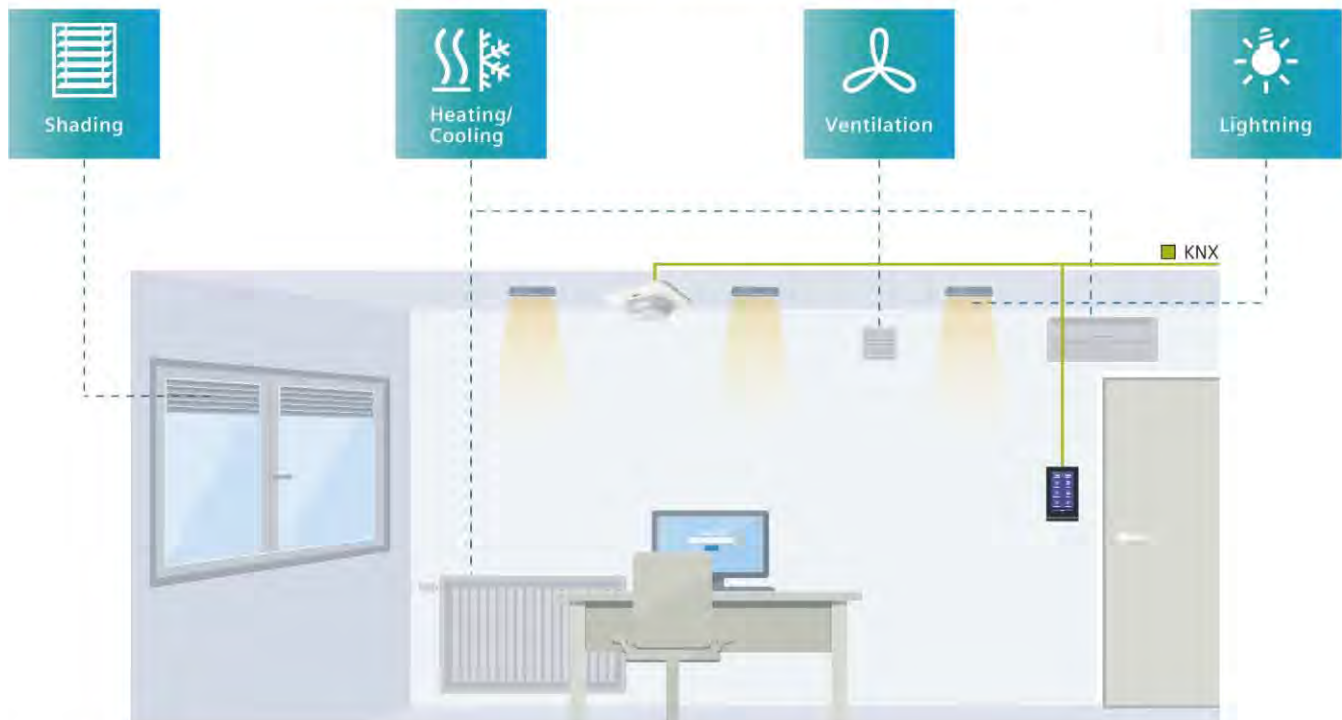

Benefits

- Automatic and manual control of lighting and solar protection
- Human Centric Lighting application with use of Tunable White
- Display of indoor measurements, such as temperature, humidity and CO₂
- Control of HVAC and/or ventilation system. Floor heating or radiators in this case.
- Visual alarm in case of low quality level

You will need

- Touch control TC5 UP 205/21
- KNX / DALI Gateway plus N 141/03
- Presence detector WIDE multi UP 258D51
- Solar protection actuator N 543D31
- KNX valve actuators AP 562/02

Follow these steps

- Configure buttons for the desired functions on the TC5 together with the respective KNX actuators
- Use the schedules of the TC5 to create a HCL profile that simulates the sun during the day and link them to the KNX/DALI Gateway
- Create a page in the TC5 to display all the indoor values sent by the multisensor
- Set the HVAC controller to have the right temperature with KNX valve actuators
- Utilize the color strip of the TC5 as a visual alarm in case of low quality level

Technical Information and Application Examples

Application Examples

Integrating KNX into BACnet

Easy combination of a KNX installation into a BACnet installation system

The IP gateway KNX/BACnet enables KNX installations to be integrated into BACnet-based networks and building automation systems quickly, simply and efficiently. No separate commissioning interface is needed owing to the KNXnet/IP interface integrated into the gateway. This facilitates for example the integration of new KNX installations into already existing building management systems that use BACnet as their system protocol.

It enables building automation systems to be expanded simply and costefficiently. Thanks to its KNXnet/IP interface, the KNX installation technician can commission the gateway using the ETS. The system integrator that recognizes the IP gateway KNX/BACnet as controller (B-ASC) is responsible for the integration into the BACnet system.

The solution

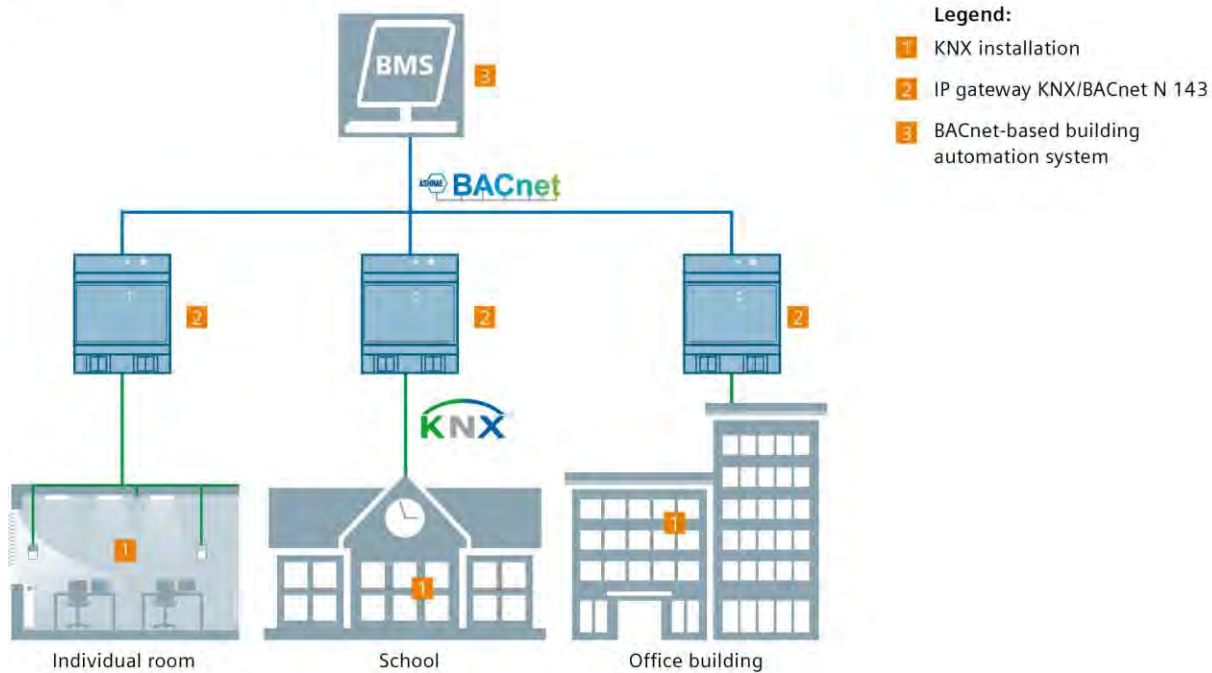

Benefits

- Commissioning of the IP gateway KNX/BACnet N 143 by the KNX installation technician only using the ETS
- Integration of a KNX installation into a BACnet system without KNX knowledge by the BACnet system integrator
- Clear separation of responsibility for KNX installation and BACnet system integration/building management
- Simple, flexible integration of a KNX installation
- Integrated Web server for documentation of the configuration and export of an EDE file
- Configuration of a KNX installation via IP gateway KNX/BACnet N 143

Follow these steps

- Connect the IP gateway KNX/BACnet N 143 to the KNX, configure and program it in ETS
- 250 BACnet objects can be created, for which up to 455 BACnet entries for automatic forwarding of BACnet object values can be stored

You will need

- IP gateway KNX/BACnet N 143
- ETS; see knx.org for the latest version

WEB Visualization of a KNX installation with an IP Control Center

The Control Center N 152 is a compact visualization controller. It enables the entire room and building automation to be conveniently operated and visualized via Web-enabled PCs, tablets and smartphones – also in a wireless configuration via WLAN. Up to 1250 KNX objects and group addresses are available for this purpose.

In the event of a fault, an alarm message is sent via e-mail. The integrated KNX interface allows commissioning of the KNX installation. With an additional router, the KNX installation can be serviced via remote maintenance.

The solution

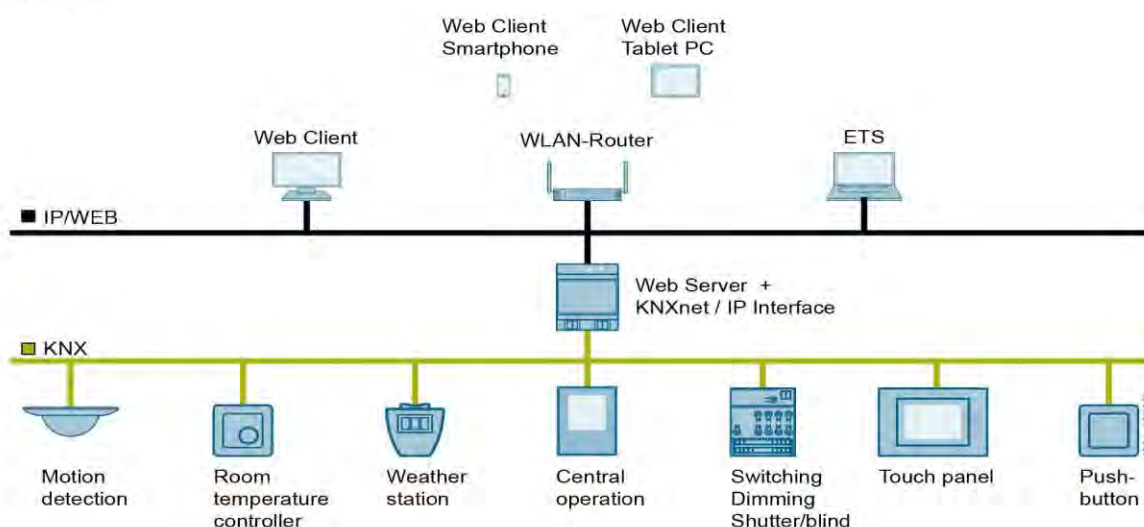

Benefits

- IP Control Center N 152
- An integrated Web editor
- For all Web-enabled operating devices such as PCs, notebooks, tablets and smartphones
- Create customized visualization of operating and display interfaces

Follow these steps

- Connect the IP Control Center N 152 to the KNX, configure and program it in ETS
- Create the visualization of the operating and display interfaces via the Web editor
- The related safety and security requirements governing the WLAN shall be observed

You will need

- IP Control Center N 152
- ETS; see knx.org for the latest version

Note:

To handle comprehensive building and room functions, up to 1250 KNX objects are available with the IP Control Center. In addition, there are powerful application modules for scene control, scheduler programs, chart modules, data logging, alarm reporting and logic functions for use in connection with central control. A clear model project is available via download for the IP Control Center.

Technical Information and Application Examples
Application Examples
Notes

Appendix



Catalog notes	426
Ordering information	427

Appendix

Catalog notes

Trademarks

All product designations may be registered trademarks or product names of Siemens AG or supplier companies whose use by third parties for their own purposes may violate the rights of the owner.

Amendments

All technical data, dimensions and weights are subject to change without notice unless otherwise specified on the pages of this catalog.

Dimensions

All dimensions are in millimeter (mm).

Images

The illustrations are not binding.

Technical data

The technical data are for general information purposes only. Always read the operating instructions and notices on individual products during assembly, operation and maintenance.

Further technical information is available at:

www.siemens.com/GAMMA-TD

and

www.siemens.com/sios

under „Product-Support“ -> „Entry type“:

- Application examples
- Certificates
- Characteristics
- Downloads
- FAQs
- Manual
- Product notes
- Software archive
- Technical Data

Assembly, operation and maintenance

The instruction manuals and the operating instructions on the products must be observed during assembly, operation and maintenance.

General ordering information

Unless stated otherwise in the „Selection and ordering data“ of this catalog, our products are supplied individually packed. It is essential that whole number multiples of these quantities be ordered to ensure satisfactory quality of the products and problem-free order processing. The products are delivered in a neutral carton. The label includes warning notices, the CE marking, and device descriptions in English and German. In addition to the Article No. (MLFB) and the number of items in the packaging, the operating instructions order number (Instr.-Order-No.) is also specified. Most device Article No.'s can be obtained by means of the EAN barcode to simplify ordering and storage logistics. The associated master data is available from your local Siemens representative, too.

Ordering very small quantities

When very small quantities are ordered, the cost of order processing often exceeds the order value. We therefore recommend that you combine several small orders. Where this is not possible, we regret that we are obliged to make a small processing charge: for orders with a net goods value of less than € 200 we charge a € 25 supplement to cover our order processing and invoicing costs.

Explanations on the selection and ordering data**Delivery time class (DT=LK)**

The delivery time class (DT) lines out the delivery time starting from the shipping point from Siemens AG (products ready for dispatch). If ordered in normal quantities, the products are usually delivered within the specified delivery times, calculated from the date we receive your order. In exceptional cases, delivery times may vary from those specified. The delivery times are valid ex works from Siemens AG (products ready for dispatch). The goods shipping time depends on the destination and the method of shipping.

In this catalog, the following delivery time classes are mentioned:

- A = 1 – 2 days
- B = 3 – 7 days
- C = 8 – 21 days
- D = 22 – 30 days
- X = more than 30 days

Price

The price refers to the price unit (PU).

Price unit (PU)

The price unit defines the number of units, sets or meters to which the specified price and weight apply.

Price group (PG)

Each product is allocated to a price group.

Weight

The defined weight is the net weight in kg and refers to the price unit (PU).

Example

DT	Article-No.	Price per PU	PU	PG
A	5WG1125-1AB02		1 ST	A21

DT: Delivery time class A = two workdays

Price: Price per Price Unit (PU)

PU: One unit (on which price is based)

PG: Price group A21

**Published by
Siemens Switzerland Ltd**

Smart Infrastructure
Global Headquarters
Theilerstrasse 1a
6300 Zug
Switzerland
Tel +41 58 724 24 24

**For the U.S. published by
Siemens Industry Inc.**

800 North Point Parkway
Suite 450
Alpharetta, GA 30005
United States

Smart Infrastructure combines the real and digital worlds across energy systems, buildings and industries, enhancing the way people live and work and significantly improving efficiency and sustainability.

We work together with customers and partners to create an ecosystem that both intuitively responds to the needs of people and helps customers achieve their business goals.

It helps our customers to thrive, communities to progress and supports sustainable development to protect our planet for the next generation.

[siemens.com/smart-infrastructure](https://www.siemens.com/smart-infrastructure)

Subject to changes and errors. The information given in this document only contains general descriptions and/or performance features which may not always specifically reflect those described, or which may undergo modification in the course of further development of the products. The requested performance features are binding only when they are expressly agreed upon in the concluded contract.

© Siemens 2022