

IBC-Structural



2022 GROUP B PROPOSED CHANGES TO THE I-CODES ROCHESTER COMMITTEE ACTION HEARINGS

March 27 - April 6, 2022

Rochester Riverside Convention Center, Rochester, NY

2021-2022 Code Development Cycle, Group B (2022) Proposed Changes to the 2021 *International Codes*

First Printing

Publication Date: February 2022

Copyright © 2022

by

International Code Council, Inc.

ALL RIGHTS RESERVED. This 2021-2022 Code Development Cycle, Group B (2022) Proposed Changes to the 2021 *International Codes* is a copyrighted work owned by the International Code Council, Inc. (“ICC”). Without advance written permission from the ICC, no part of this book may be reproduced, distributed, or transmitted in any form or by any means, including, without limitations, electronic, optical or mechanical means (by way of example and not limitation, photocopying, or recording by or in an information storage retrieval system). For information on use rights and permissions, please contact: ICC Publications, 4051 Flossmoor Road, Country Club Hills IL, 60478. Phone 1-888-ICC-SAFE (422-7233).

Trademarks: “International Code Council,” the “International Code Council” logo, “ICC,” the “ICC” logo and other names and trademarks appearing in this book are registered trademarks of the International Code Council, Inc., and/or its licensors (as applicable), and may not be used without permission.

PRINTED IN THE U.S.A.

TENTATIVE ORDER OF DISCUSSION 2022 PROPOSED CHANGES TO THE INTERNATIONAL BUILDING CODE - STRUCTURAL

The following is the tentative order in which the proposed changes to the code will be discussed at the public hearings. Proposed changes which impact the same subject have been grouped to permit consideration in consecutive changes.

Proposed change numbers that are indented are those which are being heard out of numerical order. Indentation does not necessarily indicate that one change is related to another. Proposed changes may be grouped for purposes of discussion at the hearing at the discretion of the chair. Note that some S code change proposals may not be included on this list, as they are being heard by another committee.

Numbers Not Used

S54-22
S61-22
S93-22
S104-22
S120-22
S156-22
S221-22
S237-22
S238-22

EB2-22	EB59-22	FS7-22
EB3-22	EB60-22	FS8-22
EB4-22	EB61-22	FS9-22
EB6-22	EB62-22	FS10-22
EB9-22	EB63-22	FS11-22
EB10-22	EB64-22	FS12-22
EB13-22	EB65-22	PC1-22
EB14-22	EB66-22	PC2-22
EB15-22	EB67-22	PC3-22
EB16-22	EB68-22	PC4-22
EB17-22	EB69-22	PC5-22
EB18-22	EB70-22	PC6-22
EB19-22	EB75-22	G1-22 Part I
EB38-22	EB76-22	G2-22
EB39-22	EB77-22	G3-22
EB40-22	EB103-22 Part II	G4-22 Part I
EB41-22	EB104-22	G5-22 Part I
EB47-22	EB105-22	G6-22
EB49-22	EB112-22	G7-22
EB50-22	EB113-22	G8-22
EB51-22	EB114-22	G9-22
EB52-22	FS1-22	G10-22
EB53-22	FS2-22	G11-22
EB54-22	FS3-22	G12-22
EB55-22	FS4-22	G13-22
EB57-22	FS5-22	G14-22
EB58-22	FS6-22	G15-22

SP1-22	S56-22	S115-22
SP2-22	S57-22	S116-22
S1-22	S58-22 Part I	S117-22
S2-22	S59-22 Part I	S118-22
S3-22	S60-22	S119-22 Part I
S4-22	S62-22	S121-22
S5-22	S63-22	S122-22
S6-22	S64-22	S123-22
S7-22	S65-22	S124-22
S8-22	S66-22	S125-22 Part I
S9-22	S67-22	S126-22
S10-22	S68-22	S127-22
S11-22	S69-22	S128-22
S12-22	S70-22	S129-22
S13-22	S71-22	S130-22
S14-22	S72-22	S131-22
S15-22	S73-22	S132-22
S16-22	S74-22	S133-22
S17-22	S75-22	S134-22
S18-22	S76-22	S135-22
S19-22	S77-22	S136-22
S20-22	S78-22	S137-22
S21-22	S79-22	S138-22
S22-22 Part I	S80-22	S139-22
S23-22	S81-22	S140-22
S24-22 Part I	S82-22	S141-22
S25-22	S83-22	S142-22
S26-22	S84-22	S143-22
S27-22	S85-22	S144-22
S28-22	S86-22	S145-22
S29-22	S87-22	S146-22
S30-22	S88-22	S147-22
S31-22	S89-22	S148-22
S32-22	S90-22	S149-22
S33-22	S91-22	S150-22
S34-22	S92-22	S151-22
S35-22 Part I	S94-22	S152-22
S36-22	S95-22	S153-22
S37-22	S96-22	S154-22 Part I
S38-22	S97-22	S155-22
S39-22	S98-22	S157-22
S40-22	S99-22	S158-22
S41-22	S100-22	S159-22
S42-22	S101-22	S160-22
S43-22	S102-22	S161-22
S44-22	S103-22	S162-22
S45-22	S105-22	S163-22
S46-22	S106-22	S164-22
S47-22	S107-22	S165-22
S48-22 Part I	S108-22	S166-22
S49-22 Part I	S109-22	S167-22
S50-22	S110-22	S168-22
S51-22	S111-22	S169-22
S52-22	S112-22	S170-22
S53-22	S113-22	S171-22
S55-22	S114-22	S172-22

S173-22
S174-22
S175-22
S176-22
S177-22
S178-22
S179-22
S180-22
S181-22
S182-22
S183-22
S184-22
S185-22
S186-22
S187-22
S188-22
S189-22
S190-22
S191-22
S192-22
S193-22
S194-22
S195-22
S196-22
S197-22
S198-22
S199-22
S200-22
S201-22
S202-22
S203-22
S204-22
S205-22
S206-22
S207-22
S208-22
S209-22
S210-22
S211-22
S212-22
S213-22
S214-22
S215-22
S216-22
S217-22
S218-22
S219-22
S220-22
S222-22
S223-22
S224-22
S225-22
S227-22
S228-22
S229-22
S230-22
S231-22
S232-22
S233-22
S234-22
S235-22
S236-22
S239-22
S240-22 Part I
S241-22 Part I
S242-22
S243-22 Part I
S244-22

S1-22

IBC: 1502.3

Proponents: Mark Graham, representing National Roofing Contractors Assoc. (mgraham@nrca.net)

2021 International Building Code

Delete without substitution:

~~**1502.3 Scuppers.** Where *scuppers* are used for secondary (emergency overflow) roof drainage, the quantity, size, location and inlet elevation of the *scuppers* shall be sized to prevent the depth of ponding water from exceeding that for which the roof was designed as determined by Section 1611.1. *Scuppers* shall not have an opening dimension of less than 4 inches (102 mm). The flow through the primary system shall not be considered when locating and sizing *scuppers*.~~

Reason Statement: IBC's Section 1502.3-Scuppers provides requirements for scuppers used as secondary (emergency overflow) roof drainage that are identical to those in IPC's Section 1106.5-Parapet Wall Scuppers and Section 1108-Secondary (Emergency) Roof Drains. IBC's Section 1502.1-General and Section 1502.2-Secondary (Emergency Overflow) Drains or Scuppers already provide pointers to the IPC. This proposal deletes the redundant requirement in IBC Section 1502.3-Scuppers.

Cost Impact: The code change proposal will not increase or decrease the cost of construction. This proposal eliminates redundant language. There is no change in technical requirements.

S1-22

S2-22

IBC: 1502.4

Proponents: Mark Graham, representing National Roofing Contractors Assoc. (mgraham@nrca.net)

2021 International Building Code

Revise as follows:

1502.4 Gutters. Gutters and leaders placed on the outside of buildings, other than Group R-3, *private garages* and buildings of Type V construction, shall be of corrosion resistant metal with a thickness not less than 0.019 inch (0.483 mm) (No. 26 galvanized sheet), noncombustible material or not less than Schedule 40 plastic pipe.

Reason Statement: This code change proposal provides additional guidance to the code regarding specific materials commonly used to fabricate and install sheet metal gutters and downspouts/leaders. The reference to 0.019 inch (0.483 mm) (No. 26 galvanized sheet) is consistent with other areas of the chapter for describing light-gauge metal sheet.

Cost Impact: The code change proposal will not increase or decrease the cost of construction
The code change proposal will not increase or decrease construction cost as it only adds an additional option and clarity.

S2-22

S3-22

IBC: 1502.5 (New)

Proponents: Emily Lorenz, representing International Institute of Building Enclosure Consultants (emilyblorenz@gmail.com)

2021 International Building Code

Add new text as follows:

1502.5 Waterproofing weather-exposed areas. Balconies, decks, landings, exterior stairways, occupied roofs, and similar surfaces exposed to the weather and sealed underneath shall be waterproofed and sloped a minimum of 1/4 unit vertical in 12 units horizontal (2-percent slope) for drainage.

Reason Statement:

To ensure life-safety of users of balconies in cold climates, and to promote bulk water flow away from exterior walls or assemblies that adjoin balconies, so that ponding does not occur. Proper drainage on balconies, decks, etc., is an important performance requirement to aid in draining liquid water away from the building. In cold climates, any ponding that may occur could potentially freeze, causing a safety issue. Add the original code reference from 1997 UBC Chapter 14 under the roof drainage sections of IBC Chapter 15 (1502) and IRC Chapter 9 (R903.4). Section 1402.3 of the 1997 Uniform Building Code (UBC) stated:

1402.3 Waterproofing Weather-exposed Areas.

Balconies, landings, exterior stairways, occupied roofs, and similar surfaces exposed to the weather and sealed underneath shall be waterproofed and sloped a minimum of 1/4 unit vertical in 12 units horizontal (2% slope) for drainage.

Section 1402.3 of the 1997 Uniform Building Code (UBC) is what most waterproofing consultants considered the gold standard for ensuring that architects and builders constructed balcony and stairways with a minimum of 2% slope. The 2% slope requirement referenced in the Section 1402.3 of the 1997 UBC does not exist at any location within any version of IBC from 2000 through 2018. Decks were also listed as an area that should be waterproofed and sloped.

During the transition from the UBC to the IBC, this valuable and useful reference to require a minimum 2% surface slope for balconies, landings, and exterior stairways was omitted from the IBC and IRC. There are no referenced statements or definitions anywhere in the current codes on this issue.

Cost Impact: The code change proposal will not increase or decrease the cost of construction. This should be standard practice, thus will not impact the cost of construction.

S4-22

IBC: 1503.2

Proponents: Mark Graham, representing National Roofing Contractors Assoc. (mgraham@nrca.net)

2021 International Building Code

Revise as follows:

1503.2 Flashing. Flashing shall be installed according to the roof covering manufacturer's installation instructions in such a manner so as to prevent water from entering the wall and roof through joints in copings, through moisture-permeable materials and at intersections with *parapet walls* and other penetrations through the roof plane.

Reason Statement: The code change proposal is intended to add clarity to the code by specifically indicating flashings are to be installed by the roof covering manufacturer's installation instructions.

Cost Impact: The code change proposal will not increase or decrease the cost of construction
This code change proposal is a clarification of existing requirements; there are no changes to the code's technical requirements.

S4-22

S5-22

IBC: 1503.4

Proponents: Mark Graham, representing National Roofing Contractors Assoc. (mgraham@nrca.net)

2021 International Building Code

Revise as follows:

1503.4 Attic and rafter ventilation. Ventilation of attic and enclosed rafter assemblies ~~Intake and exhaust vents~~ shall be provided in accordance with Section 1202.2 and the vent product manufacturer's installation instructions.

Exception: Unvented attic and unvented enclosed rafter assemblies shall be permitted in accordance with Section 1202.3.

Reason Statement: This code change proposal is intended to clarify the code's existing requirements regarding attic and enclosed rafter ventilation. The words "... attic and enclosed rafter assemblies..." are added to clarify the scoping of the requirement. An exception is added to direct users to Section 1202.3 to the code's provisions unvented attics and unvented enclosed rafters.

Cost Impact: The code change proposal will not increase or decrease the cost of construction
The code change proposal has no cost impact. It simply clarifies the code's existing requirements.

S5-22

S6-22

IBC: 1504.1

Proponents: Mark Graham, representing National Roofing Contractors Assoc. (mgraham@nrca.net)

2021 International Building Code

Revise as follows:

1504.1 Wind resistance of roofs. *Roof decks and roof coverings shall be designed for wind loads in accordance with Chapter 16 and this Sections 1504.2, 1504.3, 1504.4 and 1504.5.*

Reason Statement: This code change proposal is intended to clarify this section's intent. This code change proposal is not intended to change the code's technical requirements or stringency.

Currently, Section 1504.1 indicates roof decks and roof coverings "...shall be designed for *wind loads*..." While this is true for some of the roof covering types in this section, some other roof covering types are designed by classifications based on the maximum basic wind speed maps. For example, asphalt shingle roof coverings are designed for wind resistance based on classifications in Table 1504.2.

Also, the change striking "...Sections 1504.2, 1504.3, 1504. and 1504.5..." and replacing it with "...this Section." is intended to appropriately reference the requirements entire section. Over the years and code development cycles, this section has been added to without updating the subsection pointers in Section 1504.1. Changing this pointer to "...this Section." addresses this and also will address any future additions.

Cost Impact: The code change proposal will not increase or decrease the cost of construction

This code change proposal is a clarification of the code's existing requirements; it does not change the code's technical requirements or stringency.

S6-22

S7-22

IBC: 1504.4.4 (New)

Proponents: Mark Graham, representing National Roofing Contractors Assoc. (mgraham@nrca.net)

2021 International Building Code

Add new text as follows:

1504.4.4 Slate shingles. Slate shingles shall be tested in accordance with ASTM D3161. Slate packaging shall bear a label indicating compliance with ASTM D3161 and the required classification in Table 1504.2.

Reason Statement: This code change proposal is intended to provide building officials and users of the code guidance regarding the wind resistance of slate roof coverings. Wind resistance of slate roof coverings is not currently addressed in the IBC. This code change adds wind resistance testing in accordance with ASTM D3161 and its classification designations similar to what is already provided for in the IBC for asphalt shingles and metal roof shingles. Existing Table 1504.2 is referenced providing the required wind resistance classification based on the maximum basic wind speed, V , or maximum allowable stress design wind speed, V_{asd} . Slate package labeling is required to facilitate classification identification and enforcement. Such package labeling would be slate supplier specific, but most likely would be in the form of a pallet tag.

Cost Impact: The code change proposal will not increase or decrease the cost of construction. While this code change proposal adds a requirement for wind resistance testing, it will not result in an increase in the cost of construction. Slate suppliers have indicated they already have ASTM D3161 testing in-place and classifications available.

S7-22

S8-22

IBC: SECTION 202 (New), SECTION 202, 1504.5, 1504.6, 1504.6.1, 1504.7, 1504.8, 1507.12.3

Proponents: Jonathan Roberts, representing UL (jonathan.roberts@ul.com)

2021 International Building Code

Add new definition as follows:

LOW-SLOPE. A roof slope two units vertical in 12 units horizontal (17-percent slope) or less.

Revise as follows:

[BF] STEEP-SLOPE. A roof slope greater than 2 units vertical in 12 units horizontal (17-percent slope) ~~or greater~~.

1504.5 Ballasted low-slope single-ply roof systems. Ballasted low-slope (~~roof slope < 2:12~~) single-ply roof system coverings installed in accordance with Section 1507.12 shall be designed in accordance with ANSI/SPRI RP-4.

1504.6 Edge systems for low-slope roofs. Metal edge systems, except gutters and counterflashing, installed on built-up, modified bitumen and single-ply roof systems ~~having a slope less than 2 units vertical in 12 units horizontal (2:12)~~ on a low slope roof shall be designed and installed for wind loads in accordance with Chapter 16 and tested for resistance in accordance with Test Methods RE-1, RE-2 and RE-3 of ANSI/SPRI ES-1, except basic design *wind speed*, *V*, shall be determined from Figures 1609.3(1) through 1609.3(12) as applicable.

1504.6.1 Gutter securement for low-slope roofs. Gutters that are used to secure the perimeter edge of the roof membrane on low-slope (~~less than 2:12 slope~~) built-up, modified bitumen, and single-ply roofs, shall be designed, constructed and installed to resist wind loads in accordance with Section 1609 and shall be tested in accordance with Test Methods G-1 and G-2 of SPRI GT-1.

1504.7 Physical properties. *Roof coverings* installed on low-slope roofs (~~roof slope < 2:12~~) in accordance with Section 1507 shall demonstrate physical integrity over the working life of the roof based on 2,000 hours of exposure to accelerated weathering tests conducted in accordance with ASTM G152, ASTM G154 or ASTM G155. Those *roof coverings* that are subject to cyclical flexural response due to wind loads shall not demonstrate any significant loss of tensile strength for unreinforced membranes or breaking strength for reinforced membranes when tested as herein required.

1504.8 Impact resistance. *Roof coverings* installed on low-slope roofs (~~roof slope < 2:12~~) in accordance with Section 1507 shall resist impact damage based on the results of tests conducted in accordance with ASTM D3746, ASTM D4272 or the "Resistance to Foot Traffic Test" in FM 4470.

1507.12.3 Ballasted low-slope roofs. Ballasted low-slope roofs (~~roof slope < 2:12~~) shall be installed in accordance with this section and Section 1504.5. Stone used as *ballast* shall comply with ASTM D448 or ASTM D7655.

Reason Statement: This proposal addresses an inconsistency in the code. Per referenced standard ANSI/SPRI/FM 4435-ES-1—17 a low slope roof is one with a slope of 2:12 or less (e.g. $\leq 2:12$), but the references in section 1504 to low-slope are less than 2:12 (e.g. $< 2:12$). This proposal corrects these discrepancies and adds a definition of Low-Slope. The definition of steep slope has subsequently been revised to reference roof slopes greater than 2:12.

Cost Impact: The code change proposal will not increase or decrease the cost of construction. This code change proposal is just an editorial correction therefore no cost is associated with it.

S8-22

S9-22

IBC: SECTION 202, [BS] 1404.16, [BS] 1404.18, 1504.6, 1504.9; IBC: TABLE 1504.9; IBC: 1507.1.1, TABLE 1507.1.1(1), TABLE 1507.1.1(2), TABLE 1507.1.1(3), 1507.16.8, 1602.1, 1603.1, 1603.1.4, TABLE 1604.3, 1609.1.1, TABLE 1609.2, 1609.2.2, 1609.3, 1609.3.1, TABLE 1609.3.1, 1705.12, 2304.6.1, TABLE 2304.10.2, TABLE 2308.7.5, 2404.1, 2404.2, 2404.3.1, 2404.3.3, 2404.3.5, 2405.5.2

Proponents: Emily Guglielmo, representing NCSEA Wind Committee (eguglielmo@martinmartin.com); Don Scott, representing ASCE 7 Wind Load Subcommittee (dscott@pcs-structural.com); Jennifer Goupil, representing Structural Engineering Institute of ASCE (jgoupil@asce.org)

2021 International Building Code

Revise as follows:

[BS] BASIC WIND SPEED, V.

~~Basic design wind speeds—The wind speed used for design, as determined in Chapter 16.~~

[BS] HURRICANE-PRONE REGIONS. Areas vulnerable to hurricanes defined as:

1. The US Atlantic Ocean and Gulf of Mexico coasts where the basic ~~design~~ wind speed, V, for Risk Category II buildings is greater than 115 mph (51.4 m/s);
2. Hawaii, Puerto Rico, Guam, Virgin Islands and American Samoa.

[BS] WINDBORNE DEBRIS REGION. Areas within *hurricane-prone regions* located:

1. Within 1 mile (1.61 km) of the mean high-water line where an Exposure D condition exists upwind at the waterline and the basic ~~design~~ wind speed, V, is 130 mph (58 m/s) or greater; or
2. In areas where the basic ~~design~~ wind speed, V, is 140 mph (63 m/s) or greater.

For *Risk Category* II buildings and structures and *Risk Category* III buildings and structures, except health care facilities, the windborne debris region shall be based on Figure 1609.3.(1). For *Risk Category* IV buildings and structures and *Risk Category* III health care facilities, the windborne debris region shall be based on Figure 1609.3(2).

[BS] 1404.16 Fiber-cement siding. *Fiber-cement siding* complying with Section 1403.10 shall be permitted on *exterior walls* of Type I, II, III, IV and V construction for wind pressure resistance or basic wind speed exposures as indicated by the manufacturer's listing and *label* and *approved* installation instructions. Where specified, the siding shall be installed over sheathing or materials listed in Section 2304.6 and shall be installed to conform to the *water-resistive barrier* requirements in Section 1402. Siding and accessories shall be installed in accordance with *approved* manufacturer's instructions. Unless otherwise specified in the *approved* manufacturer's instructions, nails used to fasten the siding to wood studs shall be corrosion-resistant round head smooth shank and shall be long enough to penetrate the studs not less than 1 inch (25 mm). For cold-formed steel *light-frame construction*, corrosion-resistant fasteners shall be used. Screw fasteners shall penetrate the cold-formed steel framing not fewer than three exposed full threads. Other fasteners shall be installed in accordance with the approved construction documents and manufacturer's instructions.

[BS] 1404.18 Polypropylene siding. *Polypropylene siding* conforming to the requirements of this section and complying with Section 1403.12 shall be limited to *exterior walls* located in areas where the basic wind speed, V, specified in Chapter 16 does not exceed 100 miles per hour (45 m/s) and the building height is less than or equal to 40 feet (12 192 mm) in Exposure C. Where construction is located in areas where the basic wind speed, V, exceeds 100 miles per hour (45 m/s), or building heights are in excess of 40 feet (12 192 mm), tests or calculations indicating compliance with Chapter 16 shall be submitted. *Polypropylene siding* shall be installed in accordance with the manufacturer's instructions. *Polypropylene siding* shall be secured to the building so as to provide weather protection for the *exterior walls* of the building.

1504.6 Edge systems for low-slope roofs. Metal edge systems, except gutters and counterflashing, installed on built-up, modified bitumen and single-ply roof systems having a slope less than 2 units vertical in 12 units horizontal (2:12) shall be designed and installed for wind *loads* in accordance with Chapter 16 and tested for resistance in accordance with Test Methods RE-1, RE-2 and RE-3 of ANSI/SPRI ES-1, except basic ~~design~~ wind speed, V, shall be determined from Figures 1609.3(1) through 1609.3(12) as applicable.

1504.9 Wind resistance of aggregate-surfaced roofs. Parapets shall be provided for aggregate surfaced roofs and shall comply with Table 1504.9.

2021 International Building Code - Second Printing

Revise as follows:

TABLE 1504.9 MINIMUM REQUIRED PARAPET HEIGHT (INCHES) FOR AGGREGATE SURFACED ROOFS^{a, b, c}

AGGREGATE SIZE	MEAN ROOF HEIGHT (ft)	WIND EXPOSURE AND BASIC DESIGN WIND SPEED, V (MPH)																	
		Exposure B									Exposure C ^d								
		≤ 95	100	105	110	115	120	130	140	150	≤ 95	100	105	110	115	120	130	140	150
ASTM D1863 (No. 7 or No. 67)	15	2	2	2	2	12	12	16	20	24	2	13	15	18	20	23	27	32	37
	20	2	2	2	2	12	14	18	22	26	12	15	17	19	22	24	29	34	39
	30	2	2	2	13	15	17	21	25	30	14	17	19	22	24	27	32	37	42
	50	12	12	14	16	18	21	25	30	35	17	19	22	25	28	30	36	41	47
	100	14	16	19	21	24	27	32	37	42	21	24	26	29	32	35	41	47	53
	150	17	19	22	25	27	30	36	41	46	23	26	29	32	35	38	44	50	56
ASTM D1863 (No. 6)	15	2	2	2	2	12	12	12	15	18	2	2	2	13	15	17	22	26	30
	20	2	2	2	2	12	12	13	17	21	2	2	12	15	17	19	23	28	32
	30	2	2	2	2	12	12	16	20	24	2	12	14	17	19	21	26	31	35
	50	12	12	12	12	14	16	20	24	28	12	15	17	19	22	24	29	34	39
	100	12	12	14	16	19	21	26	30	35	16	18	21	24	26	29	34	39	45
	150	12	14	17	19	22	24	29	34	39	18	21	23	26	29	32	37	43	48

For SI: 1 inch = 25.4 mm; 1 foot = 304.8 mm; 1 mile per hour = 0.447 m/s.

- a. Interpolation shall be permitted for mean roof height and parapet height.
- b. Basic design wind speed, V, and wind exposure shall be determined in accordance with Section 1609.
- c. Where the minimum required parapet height is indicated to be 2 inches (51 mm), a gravel stop shall be permitted and shall extend not less than 2 inches (51 mm) from the roof surface and not less than the height of the aggregate.
- d. For Exposure D, add 8 inches (203 mm) to the parapet height required for Exposure C and the parapet height shall not be less than 12 inches (305 mm).

2021 International Building Code

Revise as follows:

1507.1.1 Underlayment. Underlayment for asphalt shingles, clay and concrete tile, metal roof shingles, mineral-surfaced roll roofing, slate and slate-type shingles, wood shingles, wood shakes, metal roof panels and *photovoltaic shingles* shall conform to the applicable standards listed in this chapter. Underlayment materials required to comply with ASTM D226, D1970, D4869 and D6757 shall bear a label indicating compliance with the standard designation and, if applicable, type classification indicated in Table 1507.1.1(1). Underlayment shall be applied in accordance with Table 1507.1.1(2). Underlayment shall be attached in accordance with Table 1507.1.1(3).

Exceptions:

1. As an alternative, a minimum 4-inch-wide (102 mm) strip of self-adhering polymer modified bitumen membrane complying with ASTM D1970 and installed in accordance with the manufacturer's installation instructions for the deck material shall be applied over all joints in the roof decking. An approved underlayment for the applicable roof covering for design basic wind speeds, V, less than 120 mph (54 m/s) shall be applied over the 4-inch-wide (102 mm) membrane strips.
2. As an alternative, two layers of underlayment complying with ASTM D226 Type II or ASTM D4869 Type IV shall be permitted to be installed as follows: Apply a 19-inch (483 mm) strip of underlayment parallel with the eave. Starting at the eave, apply 36-inch-wide (914 mm) strips of underlayment felt, overlapping successive sheets 19 inches (483 mm). The underlayment shall be attached with corrosion-resistant fasteners in a grid pattern of 12 inches (305 mm) between side laps with a 6-inch (152 mm) spacing at side and end laps. End laps shall be 4 inches (102 mm) and shall be offset by 6 feet (1829 mm). Underlayment shall be attached using metal or plastic cap nails with a nominal cap diameter of not less than 1 inch (25.4 mm). Metal caps shall have a thickness of not less than 32-gage sheet metal. Power-driven metal caps shall have a thickness of not less than 0.010 inch (0.254 mm). Thickness of the outside edge of plastic caps shall be not less than 0.035 inch (0.89 mm). The cap nail shank shall be not less than 0.083 inch (2.1 mm) for ring shank cap nails and 0.091 inch (2.3 mm) for smooth shank cap nails. The cap nail shank shall have a length sufficient to penetrate through the roof sheathing or not less than 3/4 inch (19.1 mm) into the roof sheathing.
3. Structural metal panels that do not require a substrate or underlayment.

TABLE 1507.1.1(1) UNDERLAYMENT TYPES

ROOF COVERING	SECTION	MAXIMUM BASIC DESIGN WIND SPEED, V < 140 MPH	MAXIMUM BASIC DESIGN WIND SPEED, V ≥ 140 MPH
Asphalt shingles	1507.2	ASTM D226 Type I or II ASTM D4869 Type I, II, III or IV ASTM D6757	ASTM D226 Type II ASTM D4869 Type IV ASTM D6757
Clay and concrete tiles	1507.3	ASTM D226 Type II ASTM D2626 Type I ASTM D6380 Class M mineral surfaced roll roofing	ASTM D226 Type II ASTM D2626 Type I ASTM D6380 Class M mineral surfaced roll roofing
Metal roof panels	1507.4	Manufacturer's instructions	ASTM D226 Type II ASTM D4869 Type IV
Metal roof shingles	1507.5	ASTM D226 Type I or II ASTM D4869 Type I, II, III or IV	ASTM D226 Type II ASTM D4869 Type IV
Mineral-surfaced roll roofing	1507.6	ASTM D226 Type I or II ASTM D4869 Type I, II, III or IV	ASTM D226 Type II ASTM D4869 Type IV
Slate shingles	1507.7	ASTM D226 Type II ASTM D4869 Type III or IV	ASTM D226 Type II ASTM D4869 Type IV
Wood shingles	1507.8	ASTM D226 Type I or II ASTM D4869 Type I, II, III or IV	ASTM D226 Type II ASTM D4869 Type IV
Wood shakes	1507.9	ASTM D226 Type I or II ASTM D4869 Type I, II, III or IV	ASTM D226 Type II ASTM D4869 Type IV
Photovoltaic shingles	1507.16	ASTM D226 Type I or II ASTM D4869 Type I, II, III or IV ASTM D6757	ASTM D226 Type II ASTM D4869 Type IV ASTM D6757

TABLE 1507.1.1(2) UNDERLAYMENT APPLICATION

ROOF COVERING	SECTION	MAXIMUM BASIC DESIGN WIND SPEED, $V < 140$ MPH	MAXIMUM BASIC DESIGN WIND SPEED, $V \geq 140$ MPH
Asphalt shingles	1507.2	For roof slopes from 2 units vertical in 12 units horizontal (2:12), up to 4 units vertical in 12 units horizontal (4:12), underlayment shall be two layers applied as follows: Apply a 19-inch strip of underlayment felt parallel to and starting at the eaves. Starting at the eave, apply 36-inch-wide sheets of underlayment, overlapping successive sheets 19 inches. End laps shall be 4 inches and shall be offset by 6 feet. Distortions in the underlayment shall not interfere with the ability of the shingles to seal. For roof slopes of 4 units vertical in 12 units horizontal (4:12) or greater, underlayment shall be one layer applied as follows: Underlayment shall be applied shingle fashion, parallel to and starting from the eave and lapped 2 inches, Distortions in the underlayment shall not interfere with the ability of the shingles to seal. End laps shall be 4 inches and shall be offset by 6 feet.	Same as Maximum Basic Design-Wind Speed, $V < 140$ mph except all laps shall be not less than 4 inches
Clay and concrete tile	1507.3	For roof slopes from 2 ¹ / ₂ units vertical in 12 units horizontal (2 ¹ / ₂ :12), up to 4 units vertical in 12 units horizontal (4:12), underlayment shall be not fewer than two layers applied as follows: Starting at the eave, a 19-inch strip of underlayment shall be applied parallel with the eave. Starting at the eave, a 36-inch-wide strip of underlayment felt shall be applied, overlapping successive sheets 19 inches. End laps shall be 4 inches and shall be offset by 6 feet. For roof slopes of 4 units vertical in 12 units horizontal (4:12) or greater, underlayment shall be one layer applied as follows: Underlayment shall be applied shingle fashion, parallel to and starting from the eave and lapped 2 inches. End laps shall be 4 inches and shall be offset by 6 feet.	Same as Maximum Basic Design-Wind Speed, $V < 140$ mph except all laps shall be not less than 4 inches
Metal roof panels	1507.4	Apply in accordance with the manufacturer's installation instructions	For roof slopes from 2 units vertical in 12 units horizontal (2:12), up to 4 units vertical in 12 units horizontal (4:12), underlayment shall be two layers applied as follows: Apply a 19-inch strip of underlayment felt parallel to and starting at the eaves. Starting at the eave, apply 36-inch-wide sheets of underlayment, overlapping successive sheets 19 inches. End laps shall be 4 inches and shall be offset by 6 feet. For roof slopes of 4 units vertical in 12 units horizontal (4:12) or greater, underlayment shall be one layer applied as follows: Underlayment shall be applied shingle fashion, parallel to and starting from the eave and lapped 4 inches. End laps shall be 4 inches and shall be offset by 6 feet.
Metal roof shingles	1507.5		
Mineral-surfaced roll roofing	1507.6		
Slate shingles	1507.7		
Wood shingles	1507.8		
Wood shakes	1507.9		
Photovoltaic shingles	1507.16	For roof slopes from 3 units vertical in 12 units horizontal (3:12), up to 4 units vertical in 12 units horizontal (4:12), underlayment shall be two layers applied as follows: Apply a 19-inch strip of underlayment felt parallel to and starting at the eaves. Starting at the eave, apply 36-inch-wide sheets of underlayment, overlapping successive sheets 19 inches. End laps shall be 4 inches and shall be offset by 6 feet. Distortions in the underlayment shall not interfere with the ability of the shingles to seal. For roof slopes of 4 units vertical in 12 units horizontal (4:12) or greater, underlayment shall be one layer applied as follows: Underlayment shall be applied shingle fashion, parallel to and starting from the eave and lapped 2 inches. Distortions in the underlayment shall not interfere with the ability of the shingles to seal. End laps shall be 4 inches and shall be offset by 6 feet.	Same as Maximum Basic Design-Wind Speed, $V < 140$ mph except all laps shall be not less than 4 inches

For SI: 1 inch = 25.4 mm, 1 foot = 304.8 mm; 1 mile per hour = 0.447 m/s.

TABLE 1507.1.1(3) UNDERLAYMENT ATTACHMENT

ROOF COVERING	SECTION	MAXIMUM BASIC DESIGN WIND SPEED, $V < 140$ MPH	MAXIMUM BASIC DESIGN WIND SPEED, $V \geq 140$ MPH
Asphalt shingles	1507.2	Fastened sufficiently to hold in place	The underlayment shall be attached with corrosion-resistant fasteners in a grid pattern of 12 inches between side laps with a 6-inch spacing at side and end laps. Underlayment shall be attached using metal or plastic cap nails or cap staples with a nominal cap diameter of not less than 1 inch. Metal caps shall have a thickness of not less than 32-gage (0.0134 inch) sheet metal. Power-driven metal caps shall have a minimum thickness of 0.010 inch. Minimum thickness of the outside edge of plastic caps shall be 0.035 inch. The cap nail shank shall be not less than 0.083 inch for ring shank cap nails and 0.091 inch for smooth shank cap nails. Staples shall be not less than 21 gage (0.032 inch). The cap nail shank and cap staple legs shall have a length sufficient to penetrate through the roof sheathing or not less than $\frac{3}{4}$ inch into the roof sheathing.
Clay and concrete tile	1507.3		
Photovoltaic shingles	1507.16		
Metal roof panels	1507.4	Manufacturer's installation instructions	The underlayment shall be attached with corrosion-resistant fasteners in a grid pattern of 12 inches between side laps with a 6-inch spacing at side and end laps. Underlayment shall be attached using metal or plastic cap nails or cap staples with a nominal cap diameter of not less than 1 inch. Metal caps shall have a thickness of not less than 32-gage sheet metal. Power-driven metal caps shall have a minimum thickness of 0.010 inch. Minimum thickness of the outside edge of plastic caps shall be 0.035 inch. The cap nail shank shall be not less than 0.083 inch for ring shank cap nails and 0.091 inch for smooth shank cap nails. Staples shall be not less than 21 gage. The cap nail shank and cap staple legs shall have a length sufficient to penetrate through the roof sheathing or not less than $\frac{3}{4}$ inch into the roof sheathing.
Metal roof shingles	1507.5		
Mineral-surfaced roll roofing	1507.6		
Slate shingles	1507.7		
Wood shingles	1507.8		
Wood shakes	1507.9		

For SI: 1 inch = 25.4 mm; 1 mile per hour = 0.447 m/s.

1507.16.8 Wind resistance. Photovoltaic shingles shall comply with the classification requirements of Table 1504.2 for the appropriate maximum nominal design basic wind speed, V .

1602.1 Notations. The following notations are used in this chapter:

D	=	Dead load.
D_i	=	Weight of ice in accordance with Chapter 10 of ASCE 7.
E	=	Combined effect of horizontal and vertical earthquake induced forces as defined in Section 12.4 of ASCE 7.
F	=	Load due to fluids with well-defined pressures and maximum heights.
F_a	=	Flood load in accordance with Chapter 5 of ASCE 7.
H	=	Load due to lateral earth pressures, ground water pressure or pressure of bulk materials.
L	=	Live load.
L_r	=	Roof live load.
R	=	Rain load.
S	=	Snow load.
T	=	Cumulative effects of self-straining load forces and effects.
V_{asd}	=	Allowable stress design wind speed, miles per hour (mph) (km/hr) (m/s) where applicable.
V	=	Basic design wind speed, V , miles per hour (mph) (km/hr) (m/s) determined from Figures 1609.3(1) through 1609.3(12) or ASCE 7.
W	=	Load due to wind pressure.
W_i	=	Wind-on-ice in accordance with Chapter 10 of ASCE 7.

1603.1 General. Construction documents shall show the size, section and relative locations of structural members with floor levels, column centers and offsets dimensioned. The design loads and other information pertinent to the structural design required by Sections 1603.1.1 through 1603.1.9 shall be indicated on the construction documents.

Exception: Construction documents for buildings constructed in accordance with the conventional light-frame construction provisions of Section

Exception. Construction documents for buildings constructed in accordance with the conventional light-frame construction provisions of Section 2308 shall indicate the following structural design information:

1. Floor and roof dead and live loads.
2. Ground snow load, p_g .
3. Basic ~~design~~ wind speed, V , miles per hour (mph) (~~km/hr~~)-(m/s) and allowable stress design wind speed, V_{asd} , as determined in accordance with Section 1609.3.1 and wind exposure.
4. *Seismic design category* and *site class*.
5. Flood design data, if located in *flood hazard areas* established in Section 1612.3.
6. Design load-bearing values of soils.
7. Rain load data.

1603.1.4 Wind design data. The following information related to wind *loads* shall be shown, regardless of whether wind *loads* govern the design of the lateral force-resisting system of the structure:

1. Basic ~~design~~ wind speed, V , miles per hour and *allowable stress design wind speed*, V_{asd} , as determined in accordance with Section 1609.3.1.
2. *Risk category*.
3. Wind exposure. Applicable wind direction if more than one wind exposure is utilized.
4. Applicable internal pressure coefficient.
5. Design wind pressures and their applicable zones with dimensions to be used for exterior component and cladding materials not specifically designed by the *registered design professional* responsible for the design of the structure, pounds per square foot (kN/m²).

TABLE 1604.3 DEFLECTION LIMITS^{a, b, c, h, i}

CONSTRUCTION	L or L_r	S or W^f	$D + L^{d, g}$
Roof members: ^e			
Supporting plaster or stucco ceiling	$l/360$	$l/360$	$l/240$
Supporting nonplaster ceiling	$l/240$	$l/240$	$l/180$
Not supporting ceiling	$l/180$	$l/180$	$l/120$
Floor members	$l/360$	—	$l/240$
Exterior walls:			
With plaster or stucco finishes	—	$l/360$	—
With other brittle finishes	—	$l/240$	—
With flexible finishes	—	$l/120$	—
Interior partitions: ^b			
With plaster or stucco finishes	$l/360$	—	—
With other brittle finishes	$l/240$	—	—
With flexible finishes	$l/120$	—	—
Farm buildings	—	—	$l/180$
Greenhouses	—	—	$l/120$

For SI: 1 foot = 304.8 mm.

- a. For structural roofing and siding made of formed metal sheets, the total load deflection shall not exceed $l/60$. For secondary roof structural members supporting formed metal roofing, the live load deflection shall not exceed $l/150$. For secondary wall members supporting formed metal siding, the design wind load deflection shall not exceed $l/90$. For roofs, this exception only applies when the metal sheets have no roof covering.
- b. Flexible, folding and portable partitions are not governed by the provisions of this section. The deflection criterion for interior partitions is based on the horizontal load defined in Section 1607.16 .
- c. See Section 2403 for glass supports.
- d. The deflection limit for the $D+(L+L_r)$ load combination only applies to the deflection due to the creep component of long-term dead load deflection plus the short-term live load deflection. For lumber, structural glued laminated timber, prefabricated wood I-joists and structural composite lumber members that are dry at time of installation and used under dry conditions in accordance with the ANSI/AWC NDS, the creep component of the long-term deflection shall be permitted to be estimated as the immediate dead load deflection resulting from $0.5D$. For lumber and glued laminated timber members installed or used at all other moisture conditions or cross laminated timber and wood structural panels that are dry at time of installation and used under dry conditions in accordance with the ANSI/AWC NDS, the creep component of the long-term deflection is permitted to be estimated as the immediate dead load deflection resulting from D . The value of $0.5D$ shall not be used in combination with ANSI/AWC NDS provisions for long-term loading.
- e. The preceding deflections do not ensure against ponding. Roofs that do not have sufficient slope or camber to ensure adequate drainage shall be investigated for ponding. See Chapter 8 of ASCE 7.
- f. The wind load shall be permitted to be taken as 0.42 times the “component and cladding” loads or directly calculated using the 10-year mean return interval basic wind speed, V , for the purpose of determining deflection limits in Table 1604.3. Where framing members support glass, the deflection limit therein shall not exceed that specified in Section 1604.3.7
- g. For steel structural members, the deflection due to creep component of long-term dead load shall be permitted to be taken as zero.
- h. For aluminum structural members or aluminum panels used in skylights and sloped glazing framing, roofs or walls of sunroom additions or patio covers not supporting edge of glass or aluminum sandwich panels, the total load deflection shall not exceed $l/60$. For continuous aluminum structural members supporting edge of glass, the total load deflection shall not exceed $l/175$ for each glass lite or $l/60$ for the entire length of the member, whichever is more stringent. For aluminum sandwich panels used in roofs or walls of sunroom additions or patio covers, the total load deflection shall not exceed $l/120$.
- i. l = Length of the member between supports. For cantilever members, l shall be taken as twice the length of the cantilever.

1609.1.1 Determination of wind loads. Wind loads on every building or structure shall be determined in accordance with Chapters 26 to 30 of ASCE 7. The type of opening protection required, the basic ~~design~~ wind speed, V , and the exposure category for a site is permitted to be determined in accordance with Section 1609 or ASCE 7. Wind shall be assumed to come from any horizontal direction and wind pressures shall be assumed to act normal to the surface considered.

Exceptions:

1. Subject to the limitations of Section 1609.1.1.1, the provisions of ICC 600 shall be permitted for applicable Group R-2 and R-3 buildings.
2. Subject to the limitations of Section 1609.1.1.1, residential structures using the provisions of AWC WFCM.
3. Subject to the limitations of Section 1609.1.1.1, residential structures using the provisions of AISI S230.
4. Designs using NAAMM FP 1001.
5. Designs using TIA-222 for antenna-supporting structures and antennas, provided that the horizontal extent of Topographic Category 2 escarpments in Section 2.6.6.2 of TIA-222 shall be 16 times the height of the escarpment.
6. Wind tunnel tests in accordance with ASCE 49 and Sections 31.4 and 31.5 of ASCE 7.

The wind speeds in Figures 1609.3(1) through 1609.3(12) are basic ~~design~~ wind speeds, V , and shall be converted in accordance with Section 1609.3.1 to allowable stress design wind speeds, V_{asd} , when the provisions of the standards referenced in Exceptions 4 and 5 are used.

TABLE 1609.2 WINDBORNE DEBRIS PROTECTION FASTENING SCHEDULE FOR WOOD STRUCTURAL PANELS^{a, b, c, d}

FASTENER TYPE	FASTENER SPACING (inches)		
	Panel Span ≤ 4 feet	4 feet < Panel Span ≤ 6 feet	6 feet < Panel ≤ Span 8 feet
No. 8 wood-screw-based anchor with 2-inch embedment length	16	10	8
No. 10 wood-screw-based anchor with 2-inch embedment length	16	12	9
1/4-inch diameter lag-screw-based anchor with 2-inch embedment length	16	16	16

For SI: 1 inch = 25.4 mm, 1 foot = 304.8 mm, 1 pound = 4.448 N, 1 mile per hour = 0.447 m/s.

- a. This table is based on a 140 mph basic wind speed, V , and a 45-foot mean roof height.
- b. Fasteners shall be installed at opposing ends of the wood structural panel. Fasteners shall be located not less than 1 inch from the edge of the panel.
- c. Anchors shall penetrate through the exterior wall covering with an embedment length of 2 inches minimum into the building frame. Fasteners shall be located not less than 2 1/2 inches from the edge of concrete block or concrete.
- d. Where panels are attached to masonry or masonry/stucco, they shall be attached using vibration-resistant anchors having a minimum ultimate withdrawal capacity of 1,500 pounds.

1609.2.2 Application of ASTM E1996. The text of Section 6.2.2 of ASTM E1996 shall be substituted as follows:

6.2.2 Unless otherwise specified, select the wind zone based on the basic design wind speed, V , as follows:

6.2.2.1 *Wind Zone 1*—130 mph ≤ basic design wind speed, V < 140 mph.

6.2.2.2 *Wind Zone 2*—140 mph ≤ basic design wind speed, V < 150 mph at greater than one mile (1.6 km) from the coastline. The coastline shall be measured from the mean high water mark.

6.2.2.3 *Wind Zone 3*—150 mph (67 m/s) ≤ basic design wind speed, V ≤ 160 mph (72 m/s), or 140 mph (63 m/s) ≤ basic design wind speed, V ≤ 160 mph (72 m/s) and within one mile (1.6 km) of the coastline. The coastline shall be measured from the mean high water mark.

6.2.2.4 *Wind Zone 4*—basic design wind speed, V > 160 mph (72 m/s).

1609.3 Basic design wind speed. The basic design wind speed, V , in mph, for the determination of the wind loads shall be determined by Figures 1609.3(1) through 1609.3(12). The basic design wind speed, V , for use in the design of *Risk Category II* buildings and structures shall be obtained from Figures 1609.3(1), 1609.3(5) and 1609.3(6). The basic design wind speed, V , for use in the design of *Risk Category III* buildings and structures shall be obtained from Figures 1609.3(2), 1609.3(7) and 1609.3(8). The basic design wind speed, V , for use in the design of *Risk Category IV* buildings and structures shall be obtained from Figures 1609.3(3), 1609.3(9) and 1609.3(10). The basic design wind speed, V , for use in the design of *Risk Category I* buildings and structures shall be obtained from Figures 1609.3(4), 1609.3(11) and 1609.3(12). The basic design wind speed, V , for the special wind regions indicated near mountainous terrain and near gorges shall be in accordance with local jurisdiction requirements. The basic design wind speeds, V , determined by the local jurisdiction shall be in accordance with Chapter 26 of ASCE 7.

In nonhurricane-prone regions, when the basic design wind speed, V , is estimated from regional climatic data, the basic design wind speed, V , shall be determined in accordance with Chapter 26 of ASCE 7.

1609.3.1 Wind speed conversion. Where required, the basic design wind speed, V , of Figures 1609.3(1) through 1609.3(12) shall be converted to allowable stress design wind speeds, V_{asd} , using Table 1609.3.1 or Equation 16-17.

$$V_{asd} = V\sqrt{0.6} \tag{Equation 16-17}$$

where:

V_{asd} = Allowable stress design wind speed applicable to methods specified in Exceptions 4 and 5 of Section 1609.1.1.

V = Basic design wind speeds determined from Figures 1609.3(1) through 1609.3(12).

TABLE 1609.3.1 WIND SPEED CONVERSIONS^{a, b, c}

V	100	110	120	130	140	150	160	170	180	190	200
V _{asd}	78	85	93	101	108	116	124	132	139	147	155

For SI: 1 mile per hour = 0.44 m/s.

- a. Linear interpolation is permitted.
- b. V_{asd} = allowable stress design wind speed applicable to methods specified in Exceptions 1 through 5 of Section 1609.1.1.
- c. V = basic design wind speeds determined from Figures 1609.3(1) through 1609.3(12).

1705.12 Special inspections for wind resistance. *Special inspections* for wind resistance specified in Sections 1705.12.1 through 1705.12.3, unless exempted by the exceptions to Section 1704.2, are required for buildings and structures constructed in the following areas:

- 1. In wind Exposure Category B, where basic wind speed, V is 150 miles per hour (67 m/sec) or greater.
- 2. In wind Exposure Category C or D, where basic wind speed, V is 140 mph (62.6 m/sec) or greater.

2304.6.1 Wood structural panel sheathing. Where *wood structural panel* sheathing is used as the exposed finish on the outside of *exterior walls*, it shall have an exterior exposure durability classification. Where *wood structural panel* sheathing is used elsewhere, but not as the exposed finish, it shall be of a type manufactured with exterior glue (Exposure 1 or Exterior). *Wood structural panel* sheathing, connections and framing spacing shall be in accordance with Table 2304.6.1 for the applicable allowable stress design wind speed and exposure category where used in enclosed buildings with a mean roof height not greater than 30 feet (9144 mm) and a topographic factor (K_z) of 1.0.

TABLE 2304.10.2 FASTENING SCHEDULE

DESCRIPTION OF BUILDING ELEMENTS	NUMBER AND TYPE OF FASTENER ⁹	SPACING AND LOCATION
Roof		
1. Blocking between ceiling joists, rafters or trusses to top plate or other framing below	4-8d box (2 ¹ / ₂ " x 0.113"); or 3-8d common (2 ¹ / ₂ " x 0.131"); or 3-10d box (3" x 0.128"); or 3-3" x 0.131" nails; or 3-3" 14 gage staples, 7/16" crown	Each end, toenail
Blocking between rafters or truss not at the wall top plate, to rafter or truss	2-8d common (2 ¹ / ₂ " x 0.131") 2-3" x 0.131" nails 2-3" 14 gage staples	Each end, toenail
	2-16 d common (3 ¹ / ₂ " x 0.162") 3-3" x 0.131" nails 3-3" 14 gage staples	End nail
Flat blocking to truss and web filler	16d common (3 ¹ / ₂ " x 0.162") @ 6" o.c. 3" x 0.131" nails @ 6" o.c. 3" x 14 gage staples @ 6" o.c	Face nail
2. Ceiling joists to top plate	4-8d box (2 ¹ / ₂ " x 0.113"); or 3-8d common (2 ¹ / ₂ " x 0.131"); or 3-10d box (3" x 0.128"); or 3-3" x 0.131" nails; or 3-3" 14 gage staples, 7/16" crown	Each joist, toenail
3. Ceiling joist not attached to parallel rafter, laps over partitions (no thrust) (see Section 2308.7.3.1, Table 2308.7.3.1)	3-16d common (3 ¹ / ₂ " x 0.162"); or 4-10d box (3" x 0.128"); or 4-3" x 0.131" nails; or 4-3" 14 gage staples, 7/16" crown	Face nail
4. Ceiling joist attached to parallel rafter (heel joint) (see Section 2308.7.3.1, Table 2308.7.3.1)	Per Table 2308.7.3.1	Face nail
5. Collar tie to rafter	3-10d common (3" x 0.148"); or 4-10d box (3" x 0.128"); or 4-3" x 0.131" nails; or 4-3" 14 gage staples, 7/16" crown	Face nail
6. Rafter or roof truss to top plate (See Section 2308.7.5, Table 2308.7.5)	3-10 common (3" x 0.148"); or 3-16d box (3 ¹ / ₂ " x 0.135"); or 4-10d box (3" x 0.128"); or 4-3" x 0.131 nails; or 4-3" 14 gage staples, 7/16" crown	2 toenails on one side and 1 toenail on opposite side of rafter or truss ^c
7. Roof rafters to ridge valley or hip rafters; or roof rafter to 2-inch ridge beam	2-16d common (3 ¹ / ₂ " x 0.162"); or 3-16d box (3 ¹ / ₂ " x 0.135"); or 3-10d box (3" x 0.128"); or 3-3" x 0.131" nails; or 3-3" 14 gage staples, 7/16" crown	End nail
	3-10d common (3 ¹ / ₂ " x 0.148"); or 4-16d box (3 ¹ / ₂ " x 0.135"); or 4-10d box (3" x 0.128"); or 4-3" x 0.131" nails; or 4-3" 14 gage staples, 7/16" crown	Toenail
Wall		
8. Stud to stud (not at braced wall panels)	16d common (3 ¹ / ₂ " x 0.162");	24" o.c. face nail
	10d box (3" x 0.128"); or 3" x 0.131" nails; or 3-3" 14 gage staples, 7/16" crown	16" o.c. face nail
9. Stud to stud and abutting studs at intersecting wall	16d common (3 ¹ / ₂ " x 0.162")	16" o.c. face nail
	16d box (3 ¹ / ₂ " x 0.135"); or 3" x 0.131" nails; or 3-3" 14 gage staples, 7/16" crown	12" o.c. face nail

DESCRIPTION OF BUILDING ELEMENTS	NUMBER AND TYPE OF FASTENER	SPACING AND LOCATION
10. Built-up header (2" to 2" header)	16d common (3 1/2" x 0.162")	16" o.c. each edge, face nail
	16d box (3 1/2" x 0.135")	12" o.c. each edge, face nail
11. Continuous header to stud	4-8d common (2 1/2" x 0.131"); or 4-10d box (3" x 0.128"); or 5-8d box (2 1/2" x 0.113")	Toenail
12. Top plate to top plate	16d common (3 1/2" x 0.162")	16" o.c. face nail
12. Top plate to top plate	10d box (3" x 0.128"); or 3" x 0.131" nails; or 3" 14 gage staples, 7/16" crown	12" o.c. face nail
13. Top plate to top plate, at end joints	8-16d common (3 1/2" x 0.162"); or 12-16d box (3 1/2" x 0.135"); or 12-10d box (3" x 0.128"); or 12-3" x 0.131" nails; or 12-3" 14 gage staples, 7/16" crown	Each side of end joint, face nail (minimum 24" lap splice length each side of end joint)
14. Bottom plate to joist, rim joist, band joist or blocking (not at braced wall panels)	16d common (3 1/2" x 0.162")	16" o.c. face nail
	16d box (3 1/2" x 0.135"); or 3" x 0.131" nails; or 3" 14 gage staples, 7/16" crown	12" o.c. face nail
15. Bottom plate to joist, rim joist, band joist or blocking at braced wall panels	2-16d common (3 1/2" x 0.162"); or 3-16d box (3 1/2" x 0.135"); or 4-3" x 0.131" nails; or 4-3" 14 gage staples, 7/16" crown	16" o.c. face nail
16. Stud to top or bottom plate	3-16d box (3 1/2" x 0.135"); or 4-8d common (2 1/2" x 0.131"); or 4-10d box (3" x 0.128"); or 4-3" x 0.131" nails; or 4-8d box (2 1/2" x 0.113"); or 4-3" 14 gage staples, 7/16" crown	Toenail
16. Stud to top or bottom plate	2-16d common (3 1/2" x 0.162"); or 3-16d box (3 1/2" x 0.135"); or 3-10d box (3" x 0.128"); or 3-3" x 0.131" nails; or 3-3" 14 gage staples, 7/16" crown	End nail
17. Top plates, laps at corners and intersections	2-16d common (3 1/2" x 0.162"); or 3-10d box (3" x 0.128"); or 3-3" x 0.131" nails; or 3-3" 14 gage staples, 7/16" crown	Face nail
18. 1" brace to each stud and plate	3-8d box (2 1/2" x 0.113"); or 2-8d common (2 1/2" x 0.131"); or 2-10d box (3" x 0.128"); or 2-3" x 0.131" nails; or 2-3" 14 gage staples, 7/16" crown	Face nail
19. 1" x 6" sheathing to each bearing	3-8d box (2 1/2" x 0.113"); or 2-8d common (2 1/2" x 0.131"); or 2-10d box (3" x 0.128"); or 2-1 3/4" 16 gage staples, 1" crown	Face nail
	3-8d common (2 1/2" x 0.131"); or 3-8d box (2 1/2" x 0.113"); or 3-10d box (3" x 0.128"); or 3-1 3/4" 16 gage staples, 1" crown	

20. 1" x 8" and wider sheathing to roof joists	DESCRIPTION OF BUILDING ELEMENTS	NUMBER AND TYPE OF FASTENER	Face Nail SPACING AND LOCATION	
		Wider than 1" x 8" 3-8d common (2 1/2" x 0.131"); or 4-8d box (2 1/2" x 0.113"); or 3-10d box (3" x 0.128"); or 4-1 3/4" 16 gage staples, 1" crown		
Floor				
21. Joist to sill, top plate, or girder		4-8d box (2 1/2" x 0.113"); or 3-8d common (2 1/2" x 0.131"); or floor 3-10d box (3" x 0.128"); or 3-3" x 0.131" nails; or 3-3" 14 gage staples, 7/16" crown	Toenail	
22. Rim joist, band joist, or blocking to top plate, sill or other framing below		8d box (2 1/2" x 0.113")	4" o.c., toenail	
		8d common (2 1/2" x 0.131"); or 10d box (3" x 0.128"); or 3" x 0.131" nails; or 3" 14 gage staples, 7/16" crown	6" o.c., toenail	
23. 1" x 6" subfloor or less to each joist		3-8d box (2 1/2" x 0.113"); or 2-8d common (2 1/2" x 0.131"); or 3-10d box (3" x 0.128"); or 2-1 3/4" 16 gage staples, 1" crown	Face nail	
24. 2 subfloor to joist or girder		3-16d box (3 1/2" x 0.135"); or 2-16d common (3 1/2" x 0.162")	Blind and face nail	
25. 2" planks (plank & beam – floor & roof)		3-16d box (3 1/2" x 0.135"); or 2-16d common (3 1/2" x 0.162")	Each bearing, face nail	
26. Built-up girders and beams, 2" lumber layers		20d common (4" x 0.192")	32" o.c., face nail at top and bottom staggered on opposite sides	
		10d box (3" x 0.128"); or 3" x 0.131" nails; or 3" 14 gage staples, 7/16" crown	24" o.c. face nail at top and bottom staggered on opposite sides	
		And: 2-20d common (4" x 0.192"); or 3-10d box (3" x 0.128"); or 3-3" x 0.131" nails; or 3-3" 14 gage staples, 7/16" crown	Ends and at each splice, face nail	
27. Ledger strip supporting joists or rafters		3-16d common (3 1/2" x 0.162"); or 4-16d box (3 1/2" x 0.135"); or 4-10d box (3" x 0.128"); or 4-3" x 0.131" nails; or 4-3" 14 gage staples, 7/16" crown	Each joist or rafter, face nail	
28. Joist to band joist or rim joist		3-16d common (3 1/2" x 0.162"); or 4-10d box (3" x 0.128"); or 4-3" x 0.131" nails; or 4-3" 14 gage staples, 7/16" crown	End nail	
29. Bridging or blocking to joist, rafter or truss		2-8d common (2 1/2" x 0.131"); or 2-10d box (3" x 0.128"); or 2-3" x 0.131" nails; or 2-3" 14 gage staples, 7/16" crown	Each end, toenail	
Wood structural panels (WSP), subfloor, roof and interior wall sheathing to framing and particleboard wall sheathing to framing^a				
			Edges (inches)	Intermediate supports (inches)
		6d common or deformed (2" x 0.113"); or 2 3/8" x 0.113" nail (subfloor and wall)	6	12
		8d common or deformed (2 1/2" x 0.131" x 0.281" head) (roof) or RSRS-01 (2 3/8" x 0.113") nail (roof) ^d	6 ^e	6 ^e

30. $\frac{3}{8}$ " - $\frac{1}{4}$ "	DESCRIPTION OF BUILDING ELEMENTS	NUMBER AND TYPE OF FASTENER	SPACING AND LOCATION	
		$1\frac{3}{4}$ " 16 gage staple, $\frac{7}{16}$ " crown (subfloor and wall)	4	8
		$2\frac{3}{8}$ " x 0.113" x 0.266" head nail (roof)	3 ^f	3 ^f
	$1\frac{3}{4}$ " 16 gage staple, $\frac{7}{16}$ " crown (roof)	3 ^f	3 ^f	
31. $\frac{19}{32}$ " - $\frac{3}{4}$ "		8d common ($2\frac{1}{2}$ " x 0.131"); or deformed (2 " x 0.113") (subfloor and wall)	6	12
		8d common or deformed ($2\frac{1}{2}$ " x 0.131" x 0.281" head) (roof) or RSRS-01 ($2\frac{3}{8}$ " x 0.113") nail (roof) ^d	6 ^e	6 ^e
		$2\frac{3}{8}$ " x 0.113" x 0.266" head nail; or 2" 16 gage staple, $\frac{7}{16}$ " crown	4	8
	32. $\frac{7}{8}$ " - $1\frac{1}{4}$ "	10d common (3 " x 0.148"); or deformed ($2\frac{1}{2}$ " x 0.131" x 0.281" head)	6	12
Other exterior wall sheathing				
	33. $\frac{1}{2}$ " fiberboard sheathing ^b	$1\frac{1}{2}$ " x 0.120", galvanized roofing nail ($\frac{7}{16}$ " head diameter); or $1\frac{1}{4}$ " 16 gage staple with $\frac{7}{16}$ " or 1" crown	3	6
	34. $\frac{25}{32}$ " fiberboard sheathing ^b	$1\frac{3}{4}$ " x 0.120" galvanized roofing nail ($\frac{7}{16}$ " diameter head); or $1\frac{1}{2}$ " 16 gage staple with $\frac{7}{16}$ " or 1" crown	3	6
Wood structural panels, combination subfloor underlayment to framing				
	35. $\frac{3}{4}$ " and less	8d common ($2\frac{1}{2}$ " x 0.131"); or deformed (2 " x 0.113"); or deformed (2 " x 0.120")	6	12
	36. $\frac{7}{8}$ " - 1"	8d common ($2\frac{1}{2}$ " x 0.131"); or deformed ($2\frac{1}{2}$ " x 0.131"); or deformed ($2\frac{1}{2}$ " x 0.120")	6	12
	37. $1\frac{1}{8}$ " - $1\frac{1}{4}$ "	10d common (3 " x 0.148"); or deformed ($2\frac{1}{2}$ " x 0.131"); or deformed ($2\frac{1}{2}$ " x 0.120")	6	12
Panel siding to framing				
	38. $\frac{1}{2}$ " or less	6d corrosion-resistant siding ($1\frac{7}{8}$ " x 0.106"); or 6d corrosion-resistant casing (2 " x 0.099")	6	12
	39. $\frac{5}{8}$ "	8d corrosion-resistant siding ($2\frac{3}{8}$ " x 0.128"); or 8d corrosion-resistant casing ($2\frac{1}{2}$ " x 0.113")	6	12
Wood structural panels (WSP), subfloor, roof and interior wall sheathing to framing and particleboard wall sheathing to framing^a				
			Edges (inches)	Intermediate supports (inches)
Interior paneling				
	40. $\frac{1}{4}$ "	4d casing ($1\frac{1}{2}$ " x 0.080"); or 4d finish ($1\frac{1}{2}$ " x 0.072")	6	12
	41. $\frac{3}{8}$ "	6d casing (2 " x 0.099"); or 6d finish (2 " x 0.092") (Panel supports at 24 inches)	6	12

For SI: 1 inch = 25.4 mm.

- a. Nails spaced at 6 inches at intermediate supports where spans are 48 inches or more. For nailing of wood structural panel and particleboard diaphragms and shear walls, refer to Section 2305. Nails for wall sheathing are permitted to be common, box or casing.
- b. Spacing shall be 6 inches on center on the edges and 12 inches on center at intermediate supports for nonstructural applications. Panel supports at 16 inches (20 inches if strength axis in the long direction of the panel, unless otherwise marked).

- c. Where a rafter is fastened to an adjacent parallel ceiling joist in accordance with this schedule and the ceiling joist is fastened to the top plate in accordance with this schedule, the number of toenails in the rafter shall be permitted to be reduced by one nail.
- d. RSRS-01 is a Roof Sheathing Ring Shank nail meeting the specifications in ASTM F1667.
- e. Tabulated fastener requirements apply where the ~~ultimate design~~ basic wind speed, V, is less than 140 mph. For wood structural panel roof sheathing attached to gable-end roof framing and to intermediate supports within 48 inches of roof edges and ridges, nails shall be spaced at 4 inches on center where the ~~ultimate design~~ basic wind speed, V, is greater than 130 mph in Exposure B or greater than 110 mph in Exposure C. Spacing exceeding 6 inches on center at intermediate supports shall be permitted where the fastening is designed per the AWC NDS.
- f. Fastening is only permitted where the ~~ultimate design~~ basic wind speed, V, is less than or equal to 110 mph.
- g. Nails and staples are carbon steel meeting the specifications of ASTM F1667. Connections using nails and staples of other materials, such as stainless steel, shall be designed by acceptable engineering practice or approved under Section 104.11.

TABLE 2308.7.5 REQUIRED RATING OF APPROVED UPLIFT CONNECTORS (pounds)^{a, b, c, e, f, g, h}

NOMINAL-ALLOWABLE STRESS DESIGN WIND SPEED, V_{asd} ⁱ	ROOF SPAN (feet)							OVERHANGS (pounds/feet) ^d
	12	20	24	28	32	36	40	
85	-72	-120	-145	-169	-193	-217	-241	-38.55
90	-91	-151	-181	-212	-242	-272	-302	-43.22
100	-131	-281	-262	-305	-349	-393	-436	-53.36
110	-175	-292	-351	-409	-467	-526	-584	-64.56

For SI: 1 inch = 25.4 mm, 1 foot = 304.8 mm, 1 mile per hour = 1.61 km/hr

0.447 meters per second, 1 pound = 0.454 Kg, 1 pound/foot = 14.5939 N/m.

- a. The uplift connection requirements are based on a 30-foot mean roof height located in Exposure B. For Exposure C or D and for other mean roof heights, multiply the loads by the following adjustment coefficients:

EXPOSURE	Mean Roof Height (feet)									
	15	20	25	30	35	40	45	50	55	60
B	1.001	.001	.001	.001	.051	.091	.121	.161	.19	1.22
C	1.211	.291	.351	.401	.451	.491	.531	.561	.59	1.62
D	1.471	.551	.611	.661	.701	.741	.781	.811	.84	1.87

- b. The uplift connection requirements are based on the framing being spaced 24 inches on center. Multiply by 0.67 for framing spaced 16 inches on center and multiply by 0.5 for framing spaced 12 inches on center.
- c. The uplift connection requirements include an allowance for 10 pounds of dead load.
- d. The uplift connection requirements do not account for the effects of overhangs. The magnitude of the loads shall be increased by adding the overhang loads found in the table. The overhang loads are based on framing spaced 24 inches on center. The overhang loads given shall be multiplied by the overhang projection and added to the roof uplift value in the table.
- e. The uplift connection requirements are based on wind loading on end zones as defined in Figure 28.5-1 of ASCE 7. Connection loads for connections located a distance of 20 percent of the least horizontal dimension of the building from the corner of the building are permitted to be reduced by multiplying the table connection value by 0.7 and multiplying the overhang load by 0.8.
- f. For wall-to-wall and wall-to-foundation connections, the capacity of the uplift connector is permitted to be reduced by 100 pounds for each full wall above. (For example, if a 500-pound rated connector is used on the roof framing, a 400-pound rated connector is permitted at the next floor level down).
- g. Interpolation is permitted for intermediate values of V_{asd} and roof spans.
- h. The rated capacity of approved tie-down devices is permitted to include up to a 60-percent increase for wind effects where allowed by material specifications.
- i. V_{asd} shall be determined in accordance with Section 1609.3.1.

2404.1 Vertical glass. Glass sloped 15 degrees (0.26 rad) or less from vertical in windows, curtain and window walls, doors and other exterior applications shall be designed to resist the wind loads due to basic design wind speed, V , in Section 1609 for components and cladding. Glass in glazed curtain walls, glazed storefronts and glazed partitions shall meet the seismic requirements of ASCE 7, Section 13.5.9. The load resistance of glass under uniform load shall be determined in accordance with ASTM E1300.

The design of vertical glazing shall be based on Equation 24-1.

$$0.6F_{gw} \leq F_{ga} \tag{Equation 24-1}$$

where:

F_{gw} = Wind load on the glass due to basic design wind speed, V , computed in accordance with Section 1609.

F_{ga} = Short duration load on the glass as determined in accordance with ASTM E1300.

2404.2 Sloped glass. Glass sloped more than 15 degrees (0.26 rad) from vertical in skylights, sunrooms, sloped roofs and other exterior applications shall be designed to resist the most critical combinations of loads determined by Equations 24-2, 24-3 and 24-4.

$$F_g = 0.6W_o - D \tag{Equation 24-2}$$

$$F_g = 0.6W_f + D + 0.5 S \tag{Equation 24-3}$$

$$F_g = 0.3 W_i + D + S$$

(Equation 24-4)

where:

D = Glass *dead load* psf (kN/m²).

For glass sloped 30 degrees (0.52 rad) or less from horizontal,

= 13 t_g (For SI: 0.0245 t_g).

For glass sloped more than 30 degrees (0.52 rad) from horizontal,

= 13 $t_g \cos \theta$ (For SI: 0.0245 $t_g \cos \theta$).

F_g = Total *load*, psf (kN/m²) on glass.

S = Snow *load*, psf (kN/m²) as determined in Section 1608.

t_g = Total glass thickness, inches (mm) of glass panes and plies.

W_i = Inward wind force, psf (kN/m²) due to basic ~~design~~ *wind speed*, V, as calculated in Section 1609.

W_o = Outward wind force, psf (kN/m²) due to basic ~~design~~ *wind speed*, V, as calculated in Section 1609.

θ = Angle of slope from horizontal.

Exception: The performance grade rating of *unit skylights* and *tubular daylighting devices* shall be determined in accordance with Section 2405.5.

The design of sloped glazing shall be based on Equation 24-5.

$$F_g \leq F_{ga}$$

(Equation 24-5)

where:

F_g = Total *load* on the glass as determined by Equations 24-2, 24-3 and 24-4.

F_{ga} = Short duration *load* resistance of the glass as determined in accordance with ASTM E1300 for Equations 24-2 and 24-3; or the long duration *load* resistance of the glass as determined in accordance with ASTM E1300 for Equation 24-4.

2404.3.1 Vertical wired glass. Wired glass sloped 15 degrees (0.26 rad) or less from vertical in windows, curtain and window walls, doors and other exterior applications shall be designed to resist the wind *loads* in Section 1609 for components and cladding according to the following equation:

$$0.6F_{gw} < 0.5 F_{ge}$$

(Equation 24-6)

where:

F_{gw} = Wind *load* on the glass due to basic ~~design~~ *wind speed*, V, computed in accordance with Section 1609.

F_{ge} = Nonfactored *load* from ASTM E1300 using a thickness designation for monolithic glass that is not greater than the thickness of wired glass.

2404.3.3 Vertical patterned glass. Patterned glass sloped 15 degrees (0.26 rad) or less from vertical in windows, curtain and window walls, doors and other exterior applications shall be designed to resist the wind *loads* in Section 1609 for components and cladding according to Equation 24-9.

$$F_{gw} < 1.0 F_{ge}$$

(Equation 24-9)

where:

F_{gw} = Wind *load* on the glass due to basic ~~design~~ *wind speed*, V, computed in accordance with Section 1609.

F_{ge} = Nonfactored *load* in accordance with ASTM E1300. The value for patterned glass shall be based on the thinnest part of the glass. Interpolation between nonfactored *load* charts in ASTM E1300 shall be permitted.

2404.3.5 Vertical sandblasted glass. Sandblasted glass sloped 15 degrees (0.26 rad) or less from vertical in windows, curtain and window walls, doors, and other exterior applications shall be designed to resist the wind *loads* in Section 1609 for components and cladding according to Equation 24-12.

$$0.6F_{gw} < 0.5 F_{ge}$$

(Equation 24-12)

where:

F_g = Wind load on the glass due to basic ~~design~~ wind speed, V , computed in accordance with Section 1609.

F_{ge} = Nonfactored load in accordance with ASTM E1300. The value for sandblasted glass is for moderate levels of sandblasting.

2405.5.2 Skylights rated for separate performance grades for positive and negative design pressure. The design of skylights rated for performance grade for both positive and negative design pressures shall be based on Equations 24-14 and 24-15.

$$F_{gi} \leq PG_{Pos} \quad \text{(Equation 24-14)}$$

$$F_{go} \leq PG_{Neg} \quad \text{(Equation 24-15)}$$

where:

PG_{Pos} = Performance grade rating of the skylight under positive design pressure;

PG_{Neg} = Performance grade rating of the skylight under negative design pressure; and

F_{gi} and F_{go} are determined in accordance with the following:

For

where:

W_o = Outward wind force, psf (kN/m²) due to basic ~~design~~ wind speed, V , as calculated in Section 1609.

D = The dead weight of the glazing, psf (kN/m²) as determined in Section 2404.2 for glass, or by the weight of the plastic, psf (kN/m²) for plastic glazing.

F_{gi} = Maximum load on the skylight determined from Equations 24-3 and 24-4 in Section 2404.2.

F_{go} = Maximum load on the skylight determined from Equation 24-2.

For $0.6 W_o < D$,

where:

W_o = The outward wind force, psf (kN/m²) due to basic ~~design~~ wind speed, V , as calculated in Section 1609.

D = The dead weight of the glazing, psf (kN/m²) as determined in Section 2404.2 for glass, or by the weight of the plastic for plastic glazing.

F_{gi} = Maximum load on the skylight determined from Equations 24-2 through 24-4 in Section 2404.2.

$F_{go} = 0$.

Staff Analysis: CC# S9-22 and CC# S62-22 addresses requirements in a different or contradicting manner. The committee is urged to make their intentions clear with their actions on these proposals.

Reason Statement: This is a clarifying proposal to clean up the wording in regard to the basic wind speed referenced in the many sections of the code. This proposal makes the wording consistent with ASCE 7 and other loading standards.

Also, modified the metric conversions used for wind speeds in that the maps are based on miles per hour and the conversion is to meters per second not kilometers per hour.

Cost Impact: The code change proposal will not increase or decrease the cost of construction

The proposed code change will not affect the cost of construction. It's just a cleanup with the language to make consistent with other documents.

S10-22

IBC: 1504.7 (New), 1504.6, MCA (New), (New)

Proponents: Bob Zabcik, representing Metal Construction Association (bob@ztech-consulting.com); Andy Williams, representing National Frame Building Association (panelcladsolutions@gmail.com)

2021 International Building Code

Add new text as follows:

1504.7 Metal edge systems for metal roofs. Metal edge systems, excluding gutters, installed on metal roofs shall be designed and installed for wind loads in accordance with Chapter 16 and tested for resistance in accordance with ANSI/MCA FTS-1.

Exception: Direct-fastened edge systems without cleats as defined in ANSI/MCA FTS-1 which are connected to cold-formed steel or aluminum cladding or framing are permitted to be designed for resistance to wind loads in accordance with the applicable referenced structural design standard in Section 2210.1 and 2002.1 as applicable.

Revise as follows:

1504.6 Edge systems for built-up, modified bitumen and single-ply low-slope roofs. Metal edge systems, except gutters and counterflashing, installed on built-up, modified bitumen and single-ply roof systems having a slope less than 2 units vertical in 12 units horizontal (2:12) shall be designed and installed for wind loads in accordance with Chapter 16 and tested for resistance in accordance with Test Methods RE-1, RE-2 and RE-3 of ANSI/SPRI ES-1, except basic design wind speed, V, shall be determined from Figures 1609.3(1) through 1609.3(12) as applicable.

Add new text as follows:

MCA

Metal Construction Association
8735 W. Higgins Rd., Suite 300
Chicago, IL 60631

ANSI/MCA FTS-1-2019. Test Method for Wind Load Resistance of Flashings Used with Metal Roof System

Reason Statement: This proposal adds requirements for testing of edge metal systems on metal roofs, similar to those currently in place for low-slope built-up, modified bitumen and single-ply roof systems in Section 1504.6. It is being put forth by the Metal Construction Association (MCA) to address issues observed by the Roofing Industry Committee on Weather Issues (RICOWI) through their Windstorm Investigation Program (WIP). The test standard cited, ANSI/MCA FTS-1-2019, was developed by MCA through the Single Ply Roofing Institute's (SPRI) ANSI-accredited canvassing process. MCA is a sponsoring organization of RICOWI and began development of ANSI/MCA FTS-1 in 2016 to address this issue and the method was finalized and released in 2019. The standard may be found at <<https://tinyurl.com/ytemy7u4>> and a video of a test may be viewed at <<https://tinyurl.com/y36heu49>>.

The RICOWI WIP post-event field studies revealed instances where the edge metal system was torn from the perimeter of a building with a metal roof, exposing a longer leading edge of the incorporated roof panel and initiating a partial failure of the roof system, particularly near the corners and gable edges of the roof. Although the damage was very localized, it did allow water to enter the building and in some cases, the edge metal became a wind-borne debris threat. Most commonly, this occurred in two cases:

- 1) Where a multi-piece edge trim assembly incorporating cleats deformed enough to disengage the cleat.
- 2) Where the metal edge trim assembly was fastened to a non-metal substrate such as wood or masonry, leaving to question the appropriateness of the fastener used since it would often not be provided by the edge system manufacturer for non-metal substrates.

The exception in Section 1504.7 recognizes that neither of the two conditions listed applies to non-cleated, single-piece edge systems attached to structural metal roof or wall panels and framing, provided the fastening is appropriately designed in accordance with the relevant design standards. (i.e., the fastener and substrate material requirements and fastener spacing criteria of these standards are met.) These standards are AISI S100 for cold-formed steel and AA ADM for aluminum. See Figures 1 through 4 in the attachment or at <<https://tinyurl.com/2p8msj2t>>, which visually differentiate these conditions.

Additional text is also being added to the title of Section 1504.6 to provide delineation between the sections. However, this does not alter the requirements for built-up, modified bitumen and single-ply roof systems in any way.

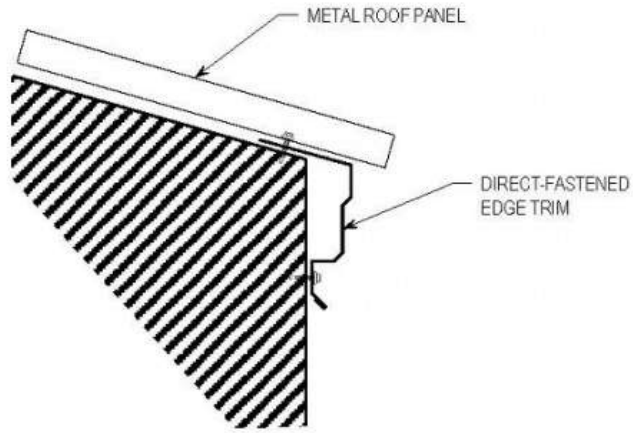

Figure 1: Direct-Fastened, Non-Cleated Eave Edge System

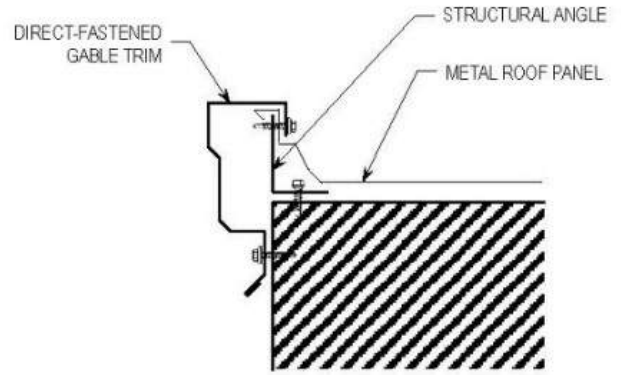

Figure 3: Direct-Fastened, Non-Cleated Gable Edge System

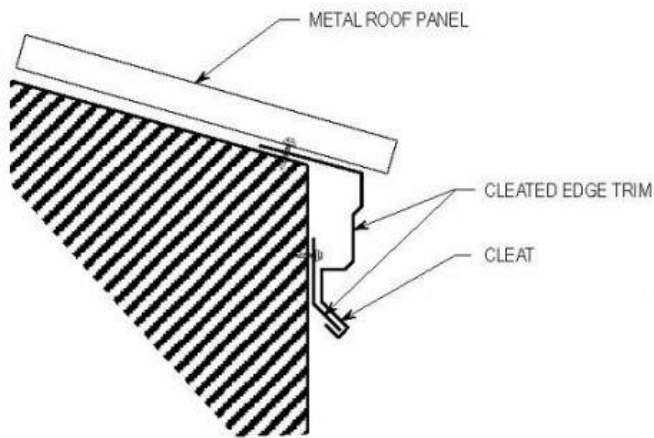

Figure 2: Cleated Eave Edge System

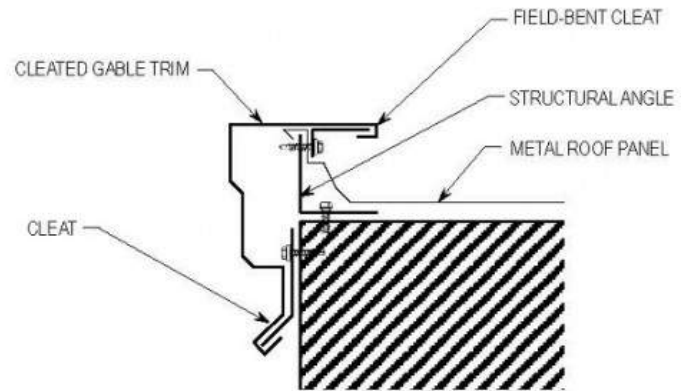

Figure 4: Cleated Gable Edge System

Cost Impact: The code change proposal will increase the cost of construction

This change would indirectly increase the cost of construction as the cost of the testing would presumably be passed to the consumer. However, the impact is tiny. The test cost is estimated to be \$1,500/test and most manufacturers carry 2-5 styles of edge metal systems different enough to test separately. Thus, total cost is estimated to be \$3,000 to \$7,500. If this cost is accrued over the life of the product line, assumed to be 500 to 10,000 buildings, it results in a nominal increase of at most \$15 per building. If a typical building includes 400 feet of trim valued at \$5/lineal foot, this represents a nominal increase of 0.8% for the trim system. The cost of the edge metal is at most 1% of the total building cost, making the increase at most 0.008% over the entire building.

S11-22

IBC: 1504.7

Proponents: Mark Graham, representing National Roofing Contractors Assoc. (mgraham@nrca.net)

2021 International Building Code

Delete without substitution:

~~**1504.7 Physical properties.** *Roof coverings* installed on low-slope roofs (roof slope < 2:12) in accordance with Section 1507 shall demonstrate physical integrity over the working life of the roof based on 2,000 hours of exposure to accelerated weathering tests conducted in accordance with ASTM G152, ASTM G154 or ASTM G155. Those *roof coverings* that are subject to cyclical flexural response due to wind *loads* shall not demonstrate any significant loss of tensile strength for unreinforced membranes or breaking strength for reinforced membranes when tested as herein required.~~

Reason Statement: This code change proposal is intended to clarify the code's intent by removing Section 1504.7-Physical Properties, which requires accelerated weathering for roof coverings used on low-slope roofs (roof slope < 2:12) to demonstrate no significant loss of tensile strength or breaking strength. The code's requirement does not specifically define "significant loss" levels. As a result, this requirement is difficult to interpret and enforce.

Section 1506.2 already requires roofing products to conform to the applicable product standards prescribed in the code. Section 1507-Requirements for Roof Coverings defines the specific standards the products and materials. Such product standards include accelerated aging and weathering testing, and specific pass/fail criteria deemed appropriate by the standard developer for the products. For example, the product standard for TPO single-ply roof membranes, ASTM D6878, "Standard Specification for Thermoplastic Polyolefin-based Sheet Roofing," includes not only accelerated weathering resistance testing with no resulting cracks or crazing, but also ozone resistance testing (no cracks) and retention of physical properties after heat aging (max. 1.5% weight loss and no cracking when bent over a mandrel). Such testing is more severe than that currently in Section 1504.7.

Removing Section 1504.7 and relying on the testing included in the product standards already included in Section 1507 will not decrease the performance levels of roof coverings.

Cost Impact: The code change proposal will not increase or decrease the cost of construction

This code change proposal has no cost impact. It does not lower or raise performance levels already incorporated in the code.

S11-22

S12-22

IBC: TABLE 1504.9

Proponents: Aaron Phillips, representing Asphalt Roofing Manufacturers Association (ARMA) (aphillips@asphaltroofing.org); Jay Crandell, P.E., ABTG/ARES Consulting, representing ABTG / ARES Consulting (jcrandell@aresconsulting.biz)

2021 International Building Code

Revise as follows:

TABLE 1504.9 MINIMUM REQUIRED PARAPET HEIGHT (INCHES) FOR AGGREGATE SURFACED ROOFS^{a, b, c, d}

AGGREGATE SIZE	MEAN ROOF HEIGHT (ft)	WIND EXPOSURE AND BASIC DESIGN WIND SPEED (MPH)																	
		Exposure B									Exposure C ^{e,d}								
		≤ 95	100	105	110	115	120	130	140	150	≤ 95	100	105	110	115	120	130	140	150
ASTM D1863 (No. 7 or No. 67)	15	2	2	2	2	12	12	16	20	24	2	13	15	18	20	23	27	32	37
	20	2	2	2	2	12	14	18	22	26	12	15	17	19	22	24	29	34	39
	30	2	2	2	13	15	17	21	25	30	14	17	19	22	24	27	32	37	42
	50	12	12	14	16	18	21	25	30	35	17	19	22	25	28	30	36	41	47
	100	14	16	19	21	24	27	32	37	42	21	24	26	29	32	35	41	47	53
	150	17	19	22	25	27	30	36	41	46	23	26	29	32	35	38	44	50	56
ASTM D1863 (No. 6)	15	2	2	2	2	12	12	12	15	18	2	2	2	13	15	17	22	26	30
	20	2	2	2	2	12	12	13	17	21	2	2	12	15	17	19	23	28	32
	30	2	2	2	2	12	12	16	20	24	2	12	14	17	19	21	26	31	35
	50	12	12	12	12	14	16	20	24	28	12	15	17	19	22	24	29	34	39
	100	12	12	14	16	19	21	26	30	35	16	18	21	24	26	29	34	39	45
	150	12	14	17	19	22	24	29	34	39	18	21	23	26	29	32	37	43	48

For SI: 1 inch = 25.4 mm; 1 foot = 304.8 mm; 1 mile per hour = 0.447 m/s.

- a. Interpolation shall be permitted for mean roof height and parapet height.
- b. Basic design wind speed, V , and wind exposure shall be determined in accordance with Section 1609.
- c. Where the minimum required parapet height is indicated to be 2 inches (51 mm), a gravel stop shall be permitted and shall extend not less than 2 inches (51 mm) from the roof surface and not less than the height of the aggregate.
- d. The tabulated values apply only to conditions where the topographic factor (K_{zt}) determined in accordance with Chapter 26 of ASCE 7 is 1.0 or where K_{zt} is incorporated in the mapped basic design wind speed in section 1609.
- ~~e.~~ For Exposure D, add 8 inches (203 mm) to the parapet height required for Exposure C and the parapet height shall not be less than 12 inches (305 mm).

Reason Statement: This proposal is needed because Table 1504.9 does not indicate that the tabulated values are based on the absence of topographic effects at the building site. Consequently, the tabulated values could be inappropriately interpreted as applying to sites where topographic effects exist (e.g., $K_{zt} > 1.0$). This could result in increased wind speed at roof height and result in a more severe condition for aggregate blow-off than considered in developing the table based on the assumption of $K_{zt} = 1.0$. This concern does not apply where topographic wind speed-up effects are incorporated into the wind map for Hawaii [2021 IBC Figures 1609.3(5) through 1609.3(12)].

Cost Impact: The code change proposal will not increase or decrease the cost of construction. This proposal does not change technical content. It adds documentation about an existing limitation associated with Table 1504.9. There should be no change in cost of construction if this proposal is approved.

S13-22

IBC: 1504.9

Proponents: Aaron Phillips, representing Asphalt Roofing Manufacturers Association (ARMA) (aphillips@asphaltroofing.org); Jay Crandell, P.E., ABTG/ARES Consulting, representing ABTG / ARES Consulting (jcrandell@aresconsulting.biz)

2021 International Building Code

Revise as follows:

1504.9 Wind resistance of aggregate-surfaced roofs. Parapets shall be provided for aggregate surfaced roofs and shall comply with Table 1504.9. Such parapets shall be provided on the perimeter of the roof at all exterior sides except where an adjacent wall extends above the roof to a height at least equivalent to that required for the parapet.

Reason Statement: The additional sentence clarifies treatment of the Table 1504.9 requirements for the special circumstance in which a building roof has at least one side bounded by a wall.

Cost Impact: The code change proposal will not increase or decrease the cost of construction. Existing language implies a parapet is required on all roof sides. This change makes that implied requirement explicit and addresses potential confusion in interpretation of Section 1504.9. Because it improves understanding of existing provisions without creating new requirements, no change in cost of construction is associated with this proposal.

S13-22

S14-22

IBC: 1504.9

Proponents: Aaron Phillips, representing Asphalt Roofing Manufacturers Association (ARMA) (aphillips@asphaltroofing.org); Jay Crandell, P.E., ABTG/ARES Consulting, representing ABTG / ARES Consulting (jcrandell@aresconsulting.biz)

2021 International Building Code

Revise as follows:

1504.9 Wind resistance of aggregate-surfaced roofs. Parapets shall be provided for aggregate surfaced roofs and shall comply with Table 1504.9. For roofs with differing surface elevations due to slope or sections at different elevations, the minimum parapet height shall be provided for each roof surface elevation and at no point shall the parapet height be less than that required by Table 1504.9.

Reason Statement: The additional sentence clarifies treatment of the Table 1504.9 requirements with respect to both roof slope and the special circumstance in which a building has roof sections at different elevations.

Cost Impact: The code change proposal will not increase or decrease the cost of construction. The additional sentence in this proposal makes explicit what is already implied in Section 1504.9 without creating a new requirement. The improved understanding of existing provisions should not alter cost of construction if this proposal is approved.

S14-22

S15-22

IBC: TABLE 1504.9

Proponents: Aaron Phillips, representing Asphalt Roofing Manufacturers Association (ARMA) (aphillips@asphaltroofing.org); Jay Crandell, P.E., ABTG/ARES Consulting, representing ABTG / ARES Consulting (jcrandell@aresconsulting.biz)

2021 International Building Code

Revise as follows:

TABLE 1504.9 MINIMUM REQUIRED PARAPET HEIGHT (INCHES) FOR AGGREGATE SURFACED ROOFS^{a, b, c}

AGGREGATE SIZE	MEAN ROOF HEIGHT (ft)	WIND EXPOSURE AND BASIC DESIGN WIND SPEED (MPH)																	
		Exposure B									Exposure C ^d								
		≤ 95	100	105	110	115	120	130	140	150	≤ 95	100	105	110	115	120	130	140	150
ASTM D1863 (No. 7 or No. 67)	15	2	2	2	2	12	12	16	20	24	2	13	15	18	20	23	27	32	37
	20	2	2	2	2	12	14	18	22	26	12	15	17	19	22	24	29	34	39
	30	2	2	2	13	15	17	21	25	30	14	17	19	22	24	27	32	37	42
	50	12	12	14	16	18	21	25	30	35	17	19	22	25	28	30	36	41	47
	100	14	16	19	21	24	27	32	37	42	21	24	26	29	32	35	41	47	53
	150	17	19	22	25	27	30	36	41	46	23	26	29	32	35	38	44	50	56
ASTM D1863 (No. 6)	15	2	2	2	2	12	12	12	15	18	2	2	2	13	15	17	22	26	30
	20	2	2	2	2	12	12	13	17	21	2	2	12	15	17	19	23	28	32
	30	2	2	2	2	12	12	16	20	24	2	12	14	17	19	21	26	31	35
	50	12	12	12	12	14	16	20	24	28	12	15	17	19	22	24	29	34	39
	100	12	12	14	16	19	21	26	30	35	16	18	21	24	26	29	34	39	45
	150	12	14	17	19	22	24	29	34	39	18	21	23	26	29	32	37	43	48

For SI: 1 inch = 25.4 mm; 1 foot = 304.8 mm; 1 mile per hour = 0.447 m/s.

- a. Interpolation shall be permitted for wind speed, mean roof height and parapet height. Extrapolation is not permitted.
- b. Basic design wind speed, V, and wind exposure shall be determined in accordance with Section 1609.
- c. Where the minimum required parapet height is indicated to be 2 inches (51 mm), a gravel stop shall be permitted and shall extend not less than 2 inches (51 mm) from the roof surface and not less than the height of the aggregate.
- d. For Exposure D, add 8 inches (203 mm) to the parapet height required for Exposure C and the parapet height shall not be less than 12 inches (305 mm).

Reason Statement: This proposal clarifies that interpolation is permissible for wind speed in addition to mean roof height and parapet height. It further clarifies that extrapolation beyond the limits of the table is not permitted.

Cost Impact: The code change proposal will not increase or decrease the cost of construction. The modifications to the footnote provide additional explanatory information without making any technical change. No change in cost of construction is expected if this proposal is approved.

S16-22

IBC: TABLE 1504.9

Proponents: Aaron Phillips, representing Asphalt Roofing Manufacturers Association (ARMA) (aphillips@asphaltroofing.org); Jay Crandell, P.E., ABTG/ARES Consulting, representing ABTG / ARES Consulting (jcrandell@aresconsulting.biz)

2021 International Building Code

Revise as follows:

TABLE 1504.9 MINIMUM REQUIRED PARAPET HEIGHT (INCHES) FOR AGGREGATE SURFACED ROOFS^{a, b, c, d}

AGGREGATE SIZE	MEAN ROOF HEIGHT (ft)	WIND EXPOSURE AND BASIC DESIGN WIND SPEED (MPH)																	
		Exposure B									Exposure C ^{e,d}								
		≤ 95	100	105	110	115	120	130	140	150	≤ 95	100	105	110	115	120	130	140	150
ASTM D1863 (No. 7 or No. 67)	15	2	2	2	2	12	12	16	20	24	2	13	15	18	20	23	27	32	37
	20	2	2	2	2	12	14	18	22	26	12	15	17	19	22	24	29	34	39
	30	2	2	2	13	15	17	21	25	30	14	17	19	22	24	27	32	37	42
	50	12	12	14	16	18	21	25	30	35	17	19	22	25	28	30	36	41	47
	100	14	16	19	21	24	27	32	37	42	21	24	26	29	32	35	41	47	53
	150	17	19	22	25	27	30	36	41	46	23	26	29	32	35	38	44	50	56
ASTM D1863 (No. 6)	15	2	2	2	2	12	12	12	15	18	2	2	2	13	15	17	22	26	30
	20	2	2	2	2	12	12	13	17	21	2	2	12	15	17	19	23	28	32
	30	2	2	2	2	12	12	16	20	24	2	12	14	17	19	21	26	31	35
	50	12	12	12	12	14	16	20	24	28	12	15	17	19	22	24	29	34	39
	100	12	12	14	16	19	21	26	30	35	16	18	21	24	26	29	34	39	45
	150	12	14	17	19	22	24	29	34	39	18	21	23	26	29	32	37	43	48

For SI: 1 inch = 25.4 mm; 1 foot = 304.8 mm; 1 mile per hour = 0.447 m/s.

- a. Parapet height is measured vertically from the top surface of the coping down to the surface of the roof covering in the field of the roof adjacent to the parapet and outboard of any cant strip.
- b.a- Interpolation shall be permitted for mean roof height and parapet height.
- c.b- Basic design wind speed, V, and wind exposure shall be determined in accordance with Section 1609.
- d.e- Where the minimum required parapet height is indicated to be 2 inches (51 mm), a gravel stop shall be permitted and shall extend not less than 2 inches (51 mm) from the roof surface and not less than the height of the aggregate.
- e.d- For Exposure D, add 8 inches (203 mm) to the parapet height required for Exposure C and the parapet height shall not be less than 12 inches (305 mm).

Reason Statement: The proposal provides necessary direction for measurement of the parapet height.

Cost Impact: The code change proposal will not increase or decrease the cost of construction. The new footnote provides guidance for measurement of the parapet height. A few users may obtain lower parapet heights and a few may obtain higher heights if their measurement technique differs substantially from this provision, causing some to experience decreases in cost of construction and some to experience increases. The number of cases where a different height is obtained is likely to be very small, and there is no basis to believe a systematic bias exists between existing measurement techniques and the guidance provided in this proposal. Therefore, no general increase in cost of construction is anticipated.

S17-22

IBC: 1504.9

Proponents: Mark Graham, representing National Roofing Contractors Assoc. (mgraham@nrca.net)

2021 International Building Code

Revise as follows:

1504.9 Wind resistance of aggregate-surfaced roofs. Parapets shall be provided for aggregate surfaced roofs and shall comply with Table 1504.9.

Exception: Aggregate ballasted single-ply roof coverings shall be designed and installed accordance with Section 1504.5.

Reason Statement: This code change proposal is intended to add clarity to the code by adding an exception to Section 1504.9 indicating aggregate ballasted single-ply membrane roofs are already addressed by the requirements in Section 1504.5. No changes are intended to the code's requirements.

Cost Impact: The code change proposal will not increase or decrease the cost of construction
This proposal is simply a clarification of the code's existing requirements.

S17-22

S18-22

IBC: [BF] 1505.8, SECTION 202

Proponents: Larry Sherwood, representing Sustainable Energy Action Committee (Larry@irecusa.org); Kevin Reinertson, representing California Fire Chiefs Association FPO (kevin.reinertson@fire.ca.gov); Benjamin Davis, representing California Solar & Storage Association (ben@calssa.org); Philip Oakes, representing National Association of State Fire Marshals; Joseph Cain, representing Solar Energy Industries Association (SEIA) (joecainpe@gmail.com)

2021 International Building Code

Revise as follows:

[BF] 1505.8 Building-integrated photovoltaic (BIPV) ~~products~~ systems. ~~BIPV products~~ systems installed as the roof covering shall be tested, listed and labeled for fire classification in accordance with Section 1505.1.

[BS] BUILDING-INTEGRATED PHOTOVOLTAIC (BIPV) ~~PRODUCT~~ SYSTEM. A building ~~product~~ system that incorporates *photovoltaic modules* and functions as ~~a~~ an integral part component of the building envelope, such as roof assemblies and roof coverings, exterior wall envelopes and exterior wall coverings, and fenestration.

Reason Statement: The term “BIPV product” is used twice in the I-codes, both requiring fire classification for roofing applications (IBC Section 1505.8 and IRC Section R902.3). The term “BIPV system” is used eight times in the I-codes, addressing roof access, rapid shutdown systems, and fire classification for roofing applications (IFC Sections 1205.2 and 1205.2.3; IBC Sections 3111.3.2 and 3113.3; and IRC Sections R324.5, R324.5.2, R324.6 and R324.6.3). IBC Section 3111.3.2 directs BIPV systems to have a fire classification in accordance with Section 1505.8. The word “system” is defined by the dictionary as “a combination of things or parts forming a complex or unitary whole”, whereas the word “product” is defined as “the totality of goods or services that a company makes available; something produced”. “Product” infers a discrete piece, whereas “system” better describes a number of components that when installed function together for a specific purpose. This proposal also clarifies that these systems, when installed per the manufacturer’s installation instructions, become an integral part of the building envelope to provide a physical separator between internal and external environments. The types of BIPV systems that include “*exterior wall envelopes and exterior wall coverings, and fenestration*” are added because FS150-21 in Group A added these types of BIPV systems to Chapter 14 of the IBC.

This proposal was prepared by the Sustainable Energy Action Committee (SEAC), a forum for all stakeholders (including, but not limited to, AHJs, designers, engineers, contractors, first responders, manufacturers, suppliers, utilities, and testing labs) to collaboratively identify and find solutions for issues that affect the installation and use of solar energy systems, energy storage systems, demand response, and energy efficiency. The purpose is to facilitate the deployment and use of affordable, clean and renewable energy in a safe, efficient, and sustainable manner.

All recommendations from SEAC are approved by diverse stakeholders through a consensus process.

Cost Impact: The code change proposal will not increase or decrease the cost of construction. This proposal clarifies the term as it is used throughout the family of ICC codes.

S18-22

S19-22

IBC: 1507.1.1

Proponents: Aaron Phillips, representing Asphalt Roofing Manufacturers Association (ARMA) (aphillips@asphaltroofing.org)

2021 International Building Code

Revise as follows:

1507.1.1 Underlayment. Underlayment for asphalt shingles, clay and concrete tile, metal roof shingles, mineral-surfaced roll roofing, slate and slate-type shingles, wood shingles, wood shakes, metal roof panels and *photovoltaic shingles* shall conform to the applicable standards listed in this chapter. Underlayment materials required to comply with ASTM D226, D1970, D4869 and D6757 shall bear a label indicating compliance with the standard designation and, if applicable, type classification indicated in Table 1507.1.1(1). Underlayment shall be applied in accordance with Table 1507.1.1(2). Underlayment shall be attached in accordance with Table 1507.1.1(3).

Exceptions:

1. As an alternative, self-adhering polymer modified bitumen underlayment complying with ASTM D1970 and installed in accordance with the manufacturer's installation instructions for the deck material, roof ventilation configuration and climate exposure for the roof covering to be installed shall be permitted.
- ~~2.1-~~ As an alternative, a minimum 4-inch-wide (102 mm) strip of self-adhering polymer modified bitumen membrane complying with ASTM D1970 and installed in accordance with the manufacturer's installation instructions for the deck material shall be applied over all joints in the roof decking. An approved underlayment for the applicable roof covering for design wind speeds less than 120 mph (54 m/s) shall be applied over the 4-inch-wide (102 mm) membrane strips.
- ~~3.2-~~ As an alternative, two layers of underlayment complying with ASTM D226 Type II or ASTM D4869 Type IV shall be permitted to be installed as follows: Apply a 19-inch (483 mm) strip of underlayment parallel with the eave. Starting at the eave, apply 36-inch-wide (914 mm) strips of underlayment felt, overlapping successive sheets 19 inches (483 mm). The underlayment shall be attached with corrosion-resistant fasteners in a grid pattern of 12 inches (305 mm) between side laps with a 6-inch (152 mm) spacing at side and end laps. End laps shall be 4 inches (102 mm) and shall be offset by 6 feet (1829 mm). Underlayment shall be attached using metal or plastic cap nails with a nominal cap diameter of not less than 1 inch (25.4 mm). Metal caps shall have a thickness of not less than 32-gage sheet metal. Power-driven metal caps shall have a thickness of not less than 0.010 inch (0.254 mm). Thickness of the outside edge of plastic caps shall be not less than 0.035 inch (0.89 mm). The cap nail shank shall be not less than 0.083 inch (2.1 mm) for ring shank cap nails and 0.091 inch (2.3 mm) for smooth shank cap nails. The cap nail shank shall have a length sufficient to penetrate through the roof sheathing or not less than $\frac{3}{4}$ inch (19.1 mm) into the roof sheathing.
- ~~4.3-~~ Structural metal panels that do not require a substrate or underlayment.

Reason Statement: This proposal adds back into the IBC an exception permitting underlayment complying with ASTM D1970 that was removed during the previous code development cycle. Proposal S24-19 struck the existing exception and cited the mention of D1970 in 1507.1.1 as justification. Section 1507.1.1 states that D1970 underlayment must bear a label and refers to Tables 1507.1.1(1), 1507.1.1(2), and 1507.1.1(3). However, D1970 is not included in those tables, which is the reason this exception is necessary. In addition, the exception is needed to maintain some of the specific criteria for the use of this underlayment such as roof ventilation and climate exposure.

Cost Impact: The code change proposal will not increase or decrease the cost of construction

This proposal corrects an error by reinserting a section that should not have been removed. By doing so, it expands available underlayment options for all roof covering types that use underlayment. The cost of construction impact will be project specific and might lead to decrease or increase. When considered across many projects, cost impact of approving this proposal is expected to be neutral.

S19-22

S20-22

IBC: 1507.1.1, TABLE 1507.1.1(1), TABLE 1507.1.1(2), TABLE 1507.1.1(3)

Proponents: T. Eric Stafford, representing Insurance Institute for Business and Home Safety (testafford@charter.net)

2021 International Building Code

Revise as follows:

1507.1.1 Underlayment. Underlayment for asphalt shingles, clay and concrete tile, metal roof shingles, mineral-surfaced roll roofing, slate and slate-type shingles, wood shingles, wood shakes, metal roof panels and *photovoltaic shingles* shall conform to the applicable standards listed in this chapter. Underlayment materials required to comply with ASTM D226, D1970, D4869 and D6757 shall bear a label indicating compliance with the standard designation and, if applicable, type classification indicated in Table 1507.1.1(1). Underlayment shall be applied in accordance with Table 1507.1.1(2). Underlayment shall be attached in accordance with Table 1507.1.1(3).

Exceptions:

1. As an alternative, self-adhering polymer-modified bitumen underlayment bearing a label indicating compliance with ASTM D1970 and installed in accordance with both the underlayment manufacturer's and roof covering manufacturer's instructions for the deck material, roof ventilation configuration and climate exposure for the roof covering to be installed, shall be permitted.
- ~~1.~~ 2. As an alternative, a minimum 4-inch-wide (102 mm) strip of self-adhering polymer modified bitumen membrane bearing a label indicating compliance to complying with ASTM D1970 and installed in accordance with the manufacturer's installation instructions for the deck material shall be applied over all joints in the roof decking. An approved underlayment complying with Table 1507.1.1(1) for the applicable roof covering and design wind speed for design wind speeds less than 120 mph (54 m/s) shall be applied over the entire roof over the 4-inch-wide (102 mm) membrane strips. Underlayment shall be applied in accordance with Table 1507.1.1(2) using the application requirements for where the maximum basic design wind speed is less than 130 mph. Underlayment shall be attached in accordance with Table 1507.1.1(3) for the applicable roof covering and design wind speed.
- ~~2.~~ As an alternative, two layers of underlayment complying with ASTM D226 Type II or ASTM D4869 Type IV shall be permitted to be installed as follows: Apply a 19-inch (483 mm) strip of underlayment parallel with the eave. Starting at the eave, apply 36-inch-wide (914 mm) strips of underlayment felt, overlapping successive sheets 19 inches (483 mm). The underlayment shall be attached with corrosion resistant fasteners in a grid pattern of 12 inches (305 mm) between side laps with a 6-inch (152 mm) spacing at side and end laps. End laps shall be 4 inches (102 mm) and shall be offset by 6 feet (1829 mm). Underlayment shall be attached using metal or plastic cap nails with a nominal cap diameter of not less than 1 inch (25.4 mm). Metal caps shall have a thickness of not less than 32-gage sheet metal. Power driven metal caps shall have a thickness of not less than 0.010 inch (0.254 mm). Thickness of the outside edge of plastic caps shall be not less than 0.035 inch (0.89 mm). The cap nail shank shall be not less than 0.083 inch (2.1 mm) for ring shank cap nails and 0.091 inch (2.3 mm) for smooth shank cap nails. The cap nail shank shall have a length sufficient to penetrate through the roof sheathing or not less than ³/₄ inch (19.1 mm) into the roof sheathing.
3. Structural metal panels that do not require a substrate or underlayment.

TABLE 1507.1.1(1) UNDERLAYMENT TYPES

ROOF COVERING	SECTION	MAXIMUM BASIC DESIGN WIND SPEED, $V < 130$ 140 MPH <u>IN HURRICANE-PRONE REGIONS OR $V < 140$ MPH OUTSIDE HURRICANE-PRONE REGIONS</u>	MAXIMUM BASIC DESIGN WIND SPEED, $V \geq 130$ 140 MPH <u>IN HURRICANE-PRONE REGIONS OR $V \geq 140$ MPH OUTSIDE HURRICANE-PRONE REGIONS</u>
Asphalt shingles	1507.2	ASTM D226 Type I or II ASTM D4869 Type I, II, III or IV ASTM D6757	ASTM D226 Type II ASTM D4869 Type <u>III or IV</u> ASTM D6757
Clay and concrete tiles	1507.3	ASTM D226 Type II ASTM D2626 Type I ASTM D6380 Class M mineral surfaced roll roofing	ASTM D226 Type II ASTM D2626 Type I ASTM D6380 Class M mineral surfaced roll roofing
Metal roof panels	1507.4	Manufacturer's instructions	ASTM D226 Type II ASTM D4869 Type <u>III or IV</u>
Metal roof shingles	1507.5	ASTM D226 Type I or II ASTM D4869 Type I, II, III or IV	ASTM D226 Type II ASTM D4869 Type <u>III or IV</u>
Mineral-surfaced roll roofing	1507.6	ASTM D226 Type I or II ASTM D4869 Type I, II, III or IV	ASTM D226 Type II ASTM D4869 Type <u>III or IV</u>
Slate shingles	1507.7	ASTM D226 Type II ASTM D4869 Type III or IV	ASTM D226 Type II ASTM D4869 Type <u>III or IV</u>
Wood shingles	1507.8	ASTM D226 Type I or II ASTM D4869 Type I, II, III or IV	ASTM D226 Type II ASTM D4869 Type <u>III or IV</u>
Wood shakes	1507.9	ASTM D226 Type I or II ASTM D4869 Type I, II, III or IV	ASTM D226 Type II ASTM D4869 Type <u>III or IV</u>
Photovoltaic shingles	1507.16	ASTM D226 Type I or II ASTM D4869 Type I, II, III or IV ASTM D6757	ASTM D226 Type II ASTM D4869 Type <u>III or IV</u> ASTM D6757

TABLE 1507.1.1(2) UNDERLAYMENT APPLICATION

ROOF COVERING	SECTION	MAXIMUM BASIC DESIGN WIND SPEED, $V < 130$ 140 MPH IN HURRICANE-PRONE REGIONS OR $V < 140$ MPH OUTSIDE HURRICANE-PRONE REGIONS	MAXIMUM BASIC DESIGN WIND SPEED, $V \geq 130$ 140 MPH IN HURRICANE-PRONE REGIONS OR $V \geq 140$ MPH OUTSIDE HURRICANE-PRONE REGIONS
Asphalt shingles	1507.2	For roof slopes from 2 units vertical in 12 units horizontal (2:12), up to 4 units vertical in 12 units horizontal (4:12), underlayment shall be two layers applied as follows: Apply a 19-inch strip of underlayment felt parallel to and starting at the eaves. Starting at the eave, apply 36-inch-wide sheets of underlayment, overlapping successive sheets 19 inches. End laps shall be 4 inches and shall be offset by 6 feet. Distortions in the underlayment shall not interfere with the ability of the shingles to seal. For roof slopes of 4 units vertical in 12 units horizontal (4:12) or greater, underlayment shall be one layer applied as follows: Underlayment shall be applied shingle fashion, parallel to and starting from the eave and lapped 2 inches, Distortions in the underlayment shall not interfere with the ability of the shingles to seal. End laps shall be 4 inches and shall be offset by 6 feet.	Same as Maximum Basic Design Wind Speed, $V < 140$ mph except all laps shall be not less than 4 inches. Underlayment shall be two layers applied as follows: Apply a 19-inch strip of underlayment felt parallel to and starting at the eaves. Starting at the eave, apply 36-inch-wide sheets of underlayment, overlapping successive sheets 19 inches. End laps shall be 4 inches and shall be offset by 6 feet. Distortions in the underlayment shall not interfere with the ability of the shingles to seal.
Clay and concrete tile	1507.3	For roof slopes from 2 ¹ / ₂ units vertical in 12 units horizontal (2 ¹ / ₂ :12), up to 4 units vertical in 12 units horizontal (4:12), underlayment shall be not fewer than two layers applied as follows: Starting at the eave, a 19-inch strip of underlayment shall be applied parallel with the eave. Starting at the eave, a 36-inch-wide strip of underlayment felt shall be applied, overlapping successive sheets 19 inches. End laps shall be 4 inches and shall be offset by 6 feet. For roof slopes of 4 units vertical in 12 units horizontal (4:12) or greater, underlayment shall be one layer applied as follows: Underlayment shall be applied shingle fashion, parallel to and starting from the eave and lapped 2 inches. End laps shall be 4 inches and shall be offset by 6 feet.	Same as Maximum Basic Design Wind Speed, $V < 140$ mph except all laps shall be not less than 4 inches. Underlayment shall be two layers applied as follows: Apply a 19-inch strip of underlayment felt parallel to and starting at the eaves. Starting at the eave, apply 36-inch-wide sheets of underlayment, overlapping successive sheets 19 inches. End laps shall be 4 inches and shall be offset by 6 feet.
Metal roof panels	1507.4	Apply in accordance with the manufacturer's installation instructions	For roof slopes from 2 units vertical in 12 units horizontal (2:12), up to 4 units vertical in 12 units horizontal (4:12), underlayment shall be two layers applied as follows: Apply a 19-inch strip of underlayment felt parallel to and starting at the eaves. Starting at the eave, apply 36-inch-wide sheets of underlayment, overlapping successive sheets 19 inches. End laps shall be 4 inches and shall be offset by 6 feet. For roof slopes of 4 units vertical in 12 units horizontal (4:12) or greater, underlayment shall be one layer applied as follows: Underlayment shall be applied shingle fashion, parallel to and starting from the eave and lapped 4 inches. End laps shall be 4 inches and shall be offset by 6 feet.
Metal roof shingles	1507.5		
Mineral-surfaced roll roofing	1507.6		
Slate shingles	1507.7		
Wood shingles	1507.8		
Wood shakes	1507.9		
Photovoltaic shingles	1507.16	For roof slopes from 3 units vertical in 12 units horizontal (3:12), up to 4 units vertical in 12 units horizontal (4:12), underlayment shall be two layers applied as follows: Apply a 19-inch strip of underlayment felt parallel to and starting at the eaves. Starting at the eave, apply 36-inch-wide sheets of underlayment, overlapping successive sheets 19 inches. End laps shall be 4 inches and shall be offset by 6 feet. Distortions in the underlayment shall not interfere with the ability of the shingles to seal. For roof slopes of 4 units vertical in 12 units horizontal (4:12) or greater, underlayment shall be one layer applied as follows: Underlayment shall be applied shingle fashion, parallel to and starting from the eave and lapped 2 inches. Distortions in the underlayment shall not interfere with the ability of the shingles to seal. End laps shall be 4 inches and shall be offset by 6 feet.	Same as Maximum Basic Design Wind Speed, $V < 140$ mph except all laps shall be not less than 4 inches. Underlayment shall be two layers applied as follows: Apply a 19-inch strip of underlayment felt parallel to and starting at the eaves. Starting at the eave, apply 36-inch-wide sheets of underlayment, overlapping successive sheets 19 inches. End laps shall be 4 inches and shall be offset by 6 feet. Distortions in the underlayment shall not interfere with the ability of the shingles to seal.

For SI: 1 inch = 25.4 mm, 1 foot = 304.8 mm; 1 mile per hour = 0.447 m/s.

TABLE 1507.1.1(3) UNDERLAYMENT ATTACHMENT

ROOF COVERING	SECTION	MAXIMUM BASIC DESIGN WIND SPEED, V < 130 140 MPH IN HURRICANE-PRONE REGIONS OR V < 140 MPH OUTSIDE HURRICANE-PRONE REGIONS	MAXIMUM BASIC DESIGN WIND SPEED, V ≥ 130 140 MPH IN HURRICANE-PRONE REGIONS OR V ≥ 140 MPH OUTSIDE HURRICANE-PRONE REGIONS
Asphalt shingles	1507.2	Fastened sufficiently to hold in place	The underlayment shall be attached with corrosion-resistant fasteners in a grid pattern of 12 inches between side laps with a 6-inch spacing at side and end laps. Underlayment shall be attached using <u>annular ring or deformed shank nails with 1 inch diameter</u> metal or plastic cap s nails or cap staples with a nominal cap diameter of not less than 1 inch . Metal caps shall have a thickness of not less than 32-gage (0.0134 inch) sheet metal. Power-driven metal caps shall have a minimum thickness of 0.010 inch. Minimum thickness of the outside edge of plastic caps shall be 0.035 inch. The cap nail shank shall be not less than 0.083 inch for ring shank cap nails and 0.091 inch for smooth shank cap nails . Staples shall be not less than 21 gage (0.032 inch) . The cap nail shank and cap staple legs shall have a length sufficient to penetrate through the roof sheathing or not less than 3/4 inch into the roof sheathing.
Clay and concrete tile	1507.3		
Photovoltaic shingles	1507.16		
Metal roof panels	1507.4	Manufacturer's installation instructions	The underlayment shall be attached with corrosion-resistant fasteners in a grid pattern of 12 inches between side laps with a 6-inch spacing at side and end laps. Underlayment shall be attached using <u>annular ring or deformed shank nails with 1 inch diameter</u> metal or plastic cap s nails or cap staples with a nominal cap diameter of not less than 1 inch . Metal caps shall have a thickness of not less than 32-gage sheet metal. Power-driven metal caps shall have a minimum thickness of 0.010 inch. Minimum thickness of the outside edge of plastic caps shall be 0.035 inch. The cap nail shank shall be not less than 0.083 inch for ring shank cap nails and 0.091 inch for smooth shank cap nails . Staples shall be not less than 21 gage . The cap nail shank and cap staple legs shall have a length sufficient to penetrate through the roof sheathing or not less than 3/4 inch into the roof sheathing.
Metal roof shingles	1507.5		
Mineral-surfaced roll roofing	1507.6		
Slate shingles	1507.7		
Wood shingles	1507.8		
Wood shakes	1507.9		

For SI: 1 inch = 25.4 mm; 1 mile per hour = 0.447 m/s.

Reason Statement: This code change will align the IBC roof underlayment requirements in high wind regions with the 2021 IRC. For practical purposes, this code change simply requires an extra layer of 30# roofing felt (ASTM D 226 Type II, or ASTM D 4869 Types III or IV) for areas vulnerable to roof covering loss and subsequent water intrusion in the hurricane-prone regions. The fastening of the underlayment remains the same as required in the 2021 IBC except the use of staples as a fastening method has been removed. The effectiveness of staples in keeping the underlayment in place when subjected to hurricane-level wind loads has not been tested. Additionally, the trigger for the enhanced underlayment has been changed to where the design wind speed is 130 mph and greater for consistency with the 2021 IRC. This wind speed would capture areas impacted by Hurricane Michael where design wind speeds currently range from 130 mph to 140 mph. However, for special wind regions and Alaska, the trigger remains the same consistent with the IRC.

Water infiltration due to wind driven rain has been well documented from post-hurricane damage assessments where hurricane winds were strong enough to blow off the primary roof covering, but not strong enough to blow off roof sheathing. In such instances, significant property damage and extended occupant displacement routinely occur due to water intrusion. In many cases, the building will appear relatively undamaged from the exterior except for roof covering loss. However, a closer inspection would reveal significant interior and contents damage.

Water entry can occur where it is able to infiltrate through the roof, walls, vents, windows, and/or doors, or at interfaces between these items. Water intrusion can cause extensive damage to interior finishes, furnishings, and other contents, and can lead to ceiling collapse when attic insulation is saturated. When power is lost and/or a building cannot otherwise be dried out within 24–48 hours, additional issues such as mold can develop, potentially extending the period during which the property may not be available for use. Recent hurricanes have not been an exception.

Tests performed by IBHS at the Research Center have consistently shown that the secondary roof underlayment strategies recommended by the IBHS Fortified Commercial - Hurricane program consistently show significantly reduced water intrusion rates when one of these strategies was employed. Two of these strategies are already recognized by the code in Exceptions 1 and 2 to Section 1507.1.1. A 2011 hurricane demonstration clearly showed the benefit of sealing the

seams of the roof deck sheathing which is one of the strategies recognized in Exception 1 to Section 1507.1.1.

A summary of the results of the demonstration can be viewed at the following link:

<http://ibhstest.wpengine.com/ibhsnews-releases/ibhs-hurricane-demonstration-illustrates-importance-of-sealed-roof-deck-3/>.

The wind driven rain demonstration can be viewed at the following

<https://disastersafety.org/thunderstorms/winddriven-rain-demo/>.

A more recent study included an assessment of a new approach where the roof is covered with two layers of high-quality underlayment attached with cap nails. Based on the performance achieved with this system, it has now been added to the FORTIFIED program as a fifth option for achieving a sealed roof deck. This report is identified in the bibliography and has been included as an attachment to this code change. All of the underlayment strategies, including the two layers of felt underlayment reduced water entry into the attic space by 70% or more.

This proposal also adds one the most effective methods for preventing water intrusion back into the code. The use of fully adhered underlayment complying with ASTM D1970 has been recognized in the IBC going back to the mid-2000's. S24-19 deleted this exception permitting the use of ASTM D1970 underlayment on basis of it being redundant as it was listed in Section 1507.1.1. However, Section 1507.1.1 doesn't specifically permit this type of underlayment other than it is required to comply with the listed standard. A similar proposal for the IRC was proposed but a public comment added the exception for fully adhered underlayment back in. This proposal adds the exception for fully adhered underlayment complying with ASTM D 1970 back in the code consistent with the 2021 IRC.

Bibliography: Brown, T.M., Quarles, S.L., Giammanco, I.M., Brown, R., Insurance Institute for Business and Home Safety, "Building Vulnerability to Wind-Driven Rain Entry and Effectiveness of Mitigation Techniques." 14th International Conference on Wind Engineering (ICWE).

Cost Impact: The code change proposal will increase the cost of construction
If one of the methods in Exceptions 1 or 2 of Section 1507.1.1 are used, this proposal will not increase the cost of construction.

If the double layer of underlayment option is used, for areas where design wind speeds are greater than or equal to 130 mph in the Hurricane-Prone Region (140 mph elsewhere), the cost of the additional layer of underlayment will vary by region. However, for a 2000 square foot roof, the cost increase for the additional layer of underlayment will be between \$100 to \$200. For areas where the design wind speed is less than 140 mph but equal to or greater than 130 mph in the Hurricane-Prone region, additional fasteners will be required in addition to the additional layer of underlayment.

S20-22

S21-22

IBC: SECTION 202, SECTION 202 (New), 1507.1.1, TABLE 1507.1.1(1), TABLE 1507.1.1(2), TABLE 1507.1.1(3), 1507.16, 1507.16.1, 1507.16.2, 1507.16.3, 1507.16.4, 1507.16.5, 1507.16.6, 1507.16.7, 1507.16.8

Proponents: Larry Sherwood, representing Sustainable Energy Action Committee (Larry@irecusa.org); Kevin Reinertson, representing California Fire Chiefs Association FPO (kevin.reinertson@fire.ca.gov); Benjamin Davis, representing California Solar & Storage Association (ben@calssa.org); Philip Oakes, representing National Association of State Fire Marshals; Joseph Cain, representing Solar Energy Industries Association (SEIA) (joecainpe@gmail.com)

2021 International Building Code

Revise as follows:

~~[BS] PHOTOVOLTAIC SHINGLES. A roof covering resembling shingles that incorporates photovoltaic modules.~~

Add new definition as follows:

BUILDING-INTEGRATED PHOTOVOLTAIC (BIPV) ROOF COVERING. A BIPV system that also functions as a roof covering. Coverings include, but not limited to, shingles, tiles, and roof panels.

Revise as follows:

1507.1.1 Underlayment. Underlayment for asphalt shingles, clay and concrete tile, metal roof shingles, mineral-surfaced roll roofing, slate and slate-type shingles, wood shingles, wood shakes, metal roof panels and ~~photovoltaic shingles~~ BIPV roof coverings shall conform to the applicable standards listed in this chapter. Underlayment materials required to comply with ASTM D226, D1970, D4869 and D6757 shall bear a label indicating compliance with the standard designation and, if applicable, type classification indicated in Table 1507.1.1(1). Underlayment shall be applied in accordance with Table 1507.1.1(2). Underlayment shall be attached in accordance with Table 1507.1.1(3).

Exceptions:

1. As an alternative, a minimum 4-inch-wide (102 mm) strip of self-adhering polymer modified bitumen membrane complying with ASTM D1970 and installed in accordance with the manufacturer's installation instructions for the deck material shall be applied over all joints in the roof decking. An approved underlayment for the applicable roof covering for design wind speeds less than 120 mph (54 m/s) shall be applied over the 4-inch-wide (102 mm) membrane strips.
2. As an alternative, two layers of underlayment complying with ASTM D226 Type II or ASTM D4869 Type IV shall be permitted to be installed as follows: Apply a 19-inch (483 mm) strip of underlayment parallel with the eave. Starting at the eave, apply 36-inch-wide (914 mm) strips of underlayment felt, overlapping successive sheets 19 inches (483 mm). The underlayment shall be attached with corrosion-resistant fasteners in a grid pattern of 12 inches (305 mm) between side laps with a 6-inch (152 mm) spacing at side and end laps. End laps shall be 4 inches (102 mm) and shall be offset by 6 feet (1829 mm). Underlayment shall be attached using metal or plastic cap nails with a nominal cap diameter of not less than 1 inch (25.4 mm). Metal caps shall have a thickness of not less than 32-gage sheet metal. Power-driven metal caps shall have a thickness of not less than 0.010 inch (0.254 mm). Thickness of the outside edge of plastic caps shall be not less than 0.035 inch (0.89 mm). The cap nail shank shall be not less than 0.083 inch (2.1 mm) for ring shank cap nails and 0.091 inch (2.3 mm) for smooth shank cap nails. The cap nail shank shall have a length sufficient to penetrate through the roof sheathing or not less than $\frac{3}{4}$ inch (19.1 mm) into the roof sheathing.
3. Structural metal panels that do not require a substrate or underlayment.

TABLE 1507.1.1(1) UNDERLAYMENT TYPES

ROOF COVERING	SECTION	MAXIMUM BASIC DESIGN WIND SPEED, V < 140 MPH	MAXIMUM BASIC DESIGN WIND SPEED, V ≥ 140 MPH
Asphalt shingles	1507.2	ASTM D226 Type I or II ASTM D4869 Type I, II, III or IV ASTM D6757	ASTM D226 Type II ASTM D4869 Type IV ASTM D6757
Clay and concrete tiles	1507.3	ASTM D226 Type II ASTM D2626 Type I ASTM D6380 Class M mineral surfaced roll roofing	ASTM D226 Type II ASTM D2626 Type I ASTM D6380 Class M mineral surfaced roll roofing
Metal roof panels	1507.4	Manufacturer's instructions	ASTM D226 Type II ASTM D4869 Type IV
Metal roof shingles	1507.5	ASTM D226 Type I or II ASTM D4869 Type I, II, III or IV	ASTM D226 Type II ASTM D4869 Type IV
Mineral-surfaced roll roofing	1507.6	ASTM D226 Type I or II ASTM D4869 Type I, II, III or IV	ASTM D226 Type II ASTM D4869 Type IV
Slate shingles	1507.7	ASTM D226 Type II ASTM D4869 Type III or IV	ASTM D226 Type II ASTM D4869 Type IV
Wood shingles	1507.8	ASTM D226 Type I or II ASTM D4869 Type I, II, III or IV	ASTM D226 Type II ASTM D4869 Type IV
Wood shakes	1507.9	ASTM D226 Type I or II ASTM D4869 Type I, II, III or IV	ASTM D226 Type II ASTM D4869 Type IV
Photovoltaic shingles <u>BIPV roof coverings</u>	1507.16	ASTM D226 Type I or II ASTM D4869 Type I, II, III or IV ASTM D6757	ASTM D226 Type II ASTM D4869 Type IV ASTM D6757

TABLE 1507.1.1(2) UNDERLAYMENT APPLICATION

ROOF COVERING	SECTION	MAXIMUM BASIC DESIGN WIND SPEED, $V < 140$ MPH	MAXIMUM BASIC DESIGN WIND SPEED, $V \geq 140$ MPH
Asphalt shingles	1507.2	For roof slopes from 2 units vertical in 12 units horizontal (2:12), up to 4 units vertical in 12 units horizontal (4:12), underlayment shall be two layers applied as follows: Apply a 19-inch strip of underlayment felt parallel to and starting at the eaves. Starting at the eave, apply 36-inch-wide sheets of underlayment, overlapping successive sheets 19 inches. End laps shall be 4 inches and shall be offset by 6 feet. Distortions in the underlayment shall not interfere with the ability of the shingles to seal. For roof slopes of 4 units vertical in 12 units horizontal (4:12) or greater, underlayment shall be one layer applied as follows: Underlayment shall be applied shingle fashion, parallel to and starting from the eave and lapped 2 inches, Distortions in the underlayment shall not interfere with the ability of the shingles to seal. End laps shall be 4 inches and shall be offset by 6 feet.	Same as Maximum Basic Design Wind Speed, $V < 140$ mph except all laps shall be not less than 4 inches
Clay and concrete tile	1507.3	For roof slopes from 2 ¹ / ₂ units vertical in 12 units horizontal (2 ¹ / ₂ :12), up to 4 units vertical in 12 units horizontal (4:12), underlayment shall be not fewer than two layers applied as follows: Starting at the eave, a 19-inch strip of underlayment shall be applied parallel with the eave. Starting at the eave, a 36-inch-wide strip of underlayment felt shall be applied, overlapping successive sheets 19 inches. End laps shall be 4 inches and shall be offset by 6 feet. For roof slopes of 4 units vertical in 12 units horizontal (4:12) or greater, underlayment shall be one layer applied as follows: Underlayment shall be applied shingle fashion, parallel to and starting from the eave and lapped 2 inches. End laps shall be 4 inches and shall be offset by 6 feet.	Same as Maximum Basic Design Wind Speed, $V < 140$ mph except all laps shall be not less than 4 inches
Metal roof panels	1507.4	Apply in accordance with the manufacturer's installation instructions	For roof slopes from 2 units vertical in 12 units horizontal (2:12), up to 4 units vertical in 12 units horizontal (4:12), underlayment shall be two layers applied as follows: Apply a 19-inch strip of underlayment felt parallel to and starting at the eaves. Starting at the eave, apply 36-inch-wide sheets of underlayment, overlapping successive sheets 19 inches. End laps shall be 4 inches and shall be offset by 6 feet. For roof slopes of 4 units vertical in 12 units horizontal (4:12) or greater, underlayment shall be one layer applied as follows: Underlayment shall be applied shingle fashion, parallel to and starting from the eave and lapped 4 inches. End laps shall be 4 inches and shall be offset by 6 feet.
Metal roof shingles	1507.5		
Mineral-surfaced roll roofing	1507.6		
Slate shingles	1507.7		
Wood shingles	1507.8		
Wood shakes	1507.9		
Photovoltaic shingles BIPV roof coverings	1507.16	For roof slopes from 3 units vertical in 12 units horizontal (3:12), up to 4 units vertical in 12 units horizontal (4:12), underlayment shall be two layers applied as follows: Apply a 19-inch strip of underlayment felt parallel to and starting at the eaves. Starting at the eave, apply 36-inch-wide sheets of underlayment, overlapping successive sheets 19 inches. End laps shall be 4 inches and shall be offset by 6 feet. Distortions in the underlayment shall not interfere with the ability of the shingles to seal. For roof slopes of 4 units vertical in 12 units horizontal (4:12) or greater, underlayment shall be one layer applied as follows: Underlayment shall be applied shingle fashion, parallel to and starting from the eave and lapped 2 inches. Distortions in the underlayment shall not interfere with the ability of the shingles to seal. End laps shall be 4 inches and shall be offset by 6 feet.	Same as Maximum Basic Design Wind Speed, $V < 140$ mph except all laps shall be not less than 4 inches

For SI: 1 inch = 25.4 mm, 1 foot = 304.8 mm; 1 mile per hour = 0.447 m/s.

TABLE 1507.1.1(3) UNDERLAYMENT ATTACHMENT

ROOF COVERING	SECTION	MAXIMUM BASIC DESIGN WIND SPEED, $V < 140$ MPH	MAXIMUM BASIC DESIGN WIND SPEED, $V \geq 140$ MPH
Asphalt shingles	1507.2	Fastened sufficiently to hold in place	The underlayment shall be attached with corrosion-resistant fasteners in a grid pattern of 12 inches between side laps with a 6-inch spacing at side and end laps. Underlayment shall be attached using metal or plastic cap nails or cap staples with a nominal cap diameter of not less than 1 inch. Metal caps shall have a thickness of not less than 32-gage (0.0134 inch) sheet metal. Power-driven metal caps shall have a minimum thickness of 0.010 inch. Minimum thickness of the outside edge of plastic caps shall be 0.035 inch. The cap nail shank shall be not less than 0.083 inch for ring shank cap nails and 0.091 inch for smooth shank cap nails. Staples shall be not less than 21 gage (0.032 inch). The cap nail shank and cap staple legs shall have a length sufficient to penetrate through the roof sheathing or not less than $\frac{3}{4}$ inch into the roof sheathing.
Clay and concrete tile	1507.3		
Photovoltaic shingles BIPV roof coverings	1507.16		
Metal roof panels	1507.4	Manufacturer's installation instructions	The underlayment shall be attached with corrosion-resistant fasteners in a grid pattern of 12 inches between side laps with a 6-inch spacing at side and end laps. Underlayment shall be attached using metal or plastic cap nails or cap staples with a nominal cap diameter of not less than 1 inch. Metal caps shall have a thickness of not less than 32-gage sheet metal. Power-driven metal caps shall have a minimum thickness of 0.010 inch. Minimum thickness of the outside edge of plastic caps shall be 0.035 inch. The cap nail shank shall be not less than 0.083 inch for ring shank cap nails and 0.091 inch for smooth shank cap nails. Staples shall be not less than 21 gage. The cap nail shank and cap staple legs shall have a length sufficient to penetrate through the roof sheathing or not less than $\frac{3}{4}$ inch into the roof sheathing.
Metal roof shingles	1507.5		
Mineral-surfaced roll roofing	1507.6		
Slate shingles	1507.7		
Wood shingles	1507.8		
Wood shakes	1507.9		

For SI: 1 inch = 25.4 mm; 1 mile per hour = 0.447 m/s.

1507.16 Photovoltaic BIPV shingles. The installation of ~~photovoltaic BIPV shingles~~ shall comply with the provisions of this section.

1507.16.1 Deck requirements. ~~Photovoltaic BIPV shingles~~ shall be applied to a solid or closely fitted deck, except where the shingles are specifically designed to be applied over spaced sheathing.

1507.16.2 Deck slope. ~~Photovoltaic BIPV shingles~~ shall be installed on roof slopes of not less than 2 units vertical in 12 units horizontal (2:12).

1507.16.3 Underlayment. ~~Underlayment~~ shall comply with Section 1507.1.1.

1507.16.4 Ice barrier. Where required, ice barriers shall comply with Section 1507.1.2.

Revise as follows:

1507.16.5 Fasteners. Fasteners for ~~photovoltaic BIPV shingles~~ shall be galvanized, stainless steel, aluminum or copper roofing nails, minimum 12-gage [0.105 inch (2.67 mm)] shank with a minimum $\frac{3}{8}$ -inch-diameter (9.5 mm) head, of a length to penetrate through the roofing materials and not less than $\frac{3}{4}$ inch (19.1 mm) into the roof sheathing. Where the roof sheathing is less than $\frac{3}{4}$ inch (19.1 mm) thick, the nails shall penetrate through the sheathing. Fasteners shall comply with ASTM F1667.

1507.16.6 Material standards. ~~Photovoltaic BIPV shingles~~ shall be listed and labeled in accordance with UL 7103 or with both UL 61730-1 and UL 61730-2.

1507.16.7 Attachment. ~~Photovoltaic BIPV shingles~~ shall be attached in accordance with the manufacturer's installation instructions.

1507.16.8 Wind resistance. ~~Photovoltaic BIPV shingles~~ shall comply with the classification requirements of Table 1504.2 for the appropriate maximum nominal design wind speed.

Reason Statement: For the definitions, there are different forms of BIPV roof coverings, just as there are different forms of traditional roof coverings. The code defines roof coverings in general, and the different forms are described in Chapter 15 for their specific application. This change aligns with the change to the definition of BIPV Systems, which clarifies this type of photovoltaic solar energy system.

This proposal was prepared by the Sustainable Energy Action Committee (SEAC), a forum for all stakeholders (including, but not limited to, AHJs, designers, engineers, contractors, first responders, manufacturers, suppliers, utilities, and testing labs) to collaboratively identify and find solutions for issues that affect the installation and use of solar energy systems, energy storage systems, demand response, and energy efficiency. The

purpose is to facilitate the deployment and use of affordable, clean and renewable energy in a safe, efficient, and sustainable manner.

All recommendations from SEAC are approved by diverse stakeholders through a consensus process.

Cost Impact: The code change proposal will not increase or decrease the cost of construction
This provides clarity and consistency in terminology related to BIPV used as roof assemblies and roof coverings.

S21-22

S22-22 Part I

IBC: TABLE 1507.1.1(1), 1507.1.1, ASTM Chapter 35 (New)

Proponents: Mark Graham, representing National Roofing Contractors Assoc. (mgraham@nrca.net)

THIS IS A 2 PART CODE CHANGE. PART I WILL BE HEARD BY THE IBC STRUCTURAL CODE COMMITTEE. PART II WILL BE HEARD BY THE IRC-B CODE COMMITTEE. SEE THE TENTATIVE HEARING ORDER FOR THESE COMMITTEES.

2021 International Building Code

Revise as follows:

TABLE 1507.1.1(1) UNDERLAYMENT TYPES

ROOF COVERING	SECTION	MAXIMUM BASIC DESIGN WIND SPEED, V < 140 MPH	MAXIMUM BASIC DESIGN WIND SPEED, V ≥ 140 MPH
Asphalt shingles	1507.2	ASTM D226 Type I or II ASTM D4869 Type I, II, III or IV ASTM D6757 <u>ASTM D8257</u>	ASTM D226 Type II ASTM D4869 Type IV ASTM D6757 <u>ASTM D8257</u>
Clay and concrete tiles	1507.3	ASTM D226 Type II ASTM D2626 Type I ASTM D6380 Class M mineral surfaced roll roofing <u>ASTM D8257</u>	ASTM D226 Type II ASTM D2626 Type I ASTM D6380 Class M mineral surfaced roll roofing <u>ASTM D8257</u>
Metal roof panels	1507.4	Manufacturer's instructions <u>ASTM D8257</u>	ASTM D226 Type II ASTM D4869 Type IV <u>ASTM D8257</u>
Metal roof shingles	1507.5	ASTM D226 Type I or II ASTM D4869 Type I, II, III or IV <u>ASTM D8257</u>	ASTM D226 Type II ASTM D4869 Type IV <u>ASTM D8257</u>
Mineral-surfaced roll roofing	1507.6	ASTM D226 Type I or II ASTM D4869 Type I, II, III or IV <u>ASTM D8257</u>	ASTM D226 Type II ASTM D4869 Type IV <u>ASTM D8257</u>
Slate shingles	1507.7	ASTM D226 Type II ASTM D4869 Type III or IV <u>ASTM D8257</u>	ASTM D226 Type II ASTM D4869 Type IV <u>ASTM D8257</u>
Wood shingles	1507.8	ASTM D226 Type I or II ASTM D4869 Type I, II, III or IV <u>ASTM D8257</u>	ASTM D226 Type II ASTM D4869 Type IV <u>ASTM D8257</u>
Wood shakes	1507.9	ASTM D226 Type I or II ASTM D4869 Type I, II, III or IV <u>ASTM D8257</u>	ASTM D226 Type II ASTM D4869 Type IV <u>ASTM D8257</u>
Photovoltaic shingles	1507.16	ASTM D226 Type I or II ASTM D4869 Type I, II, III or IV ASTM D6757 <u>ASTM D8257</u>	ASTM D226 Type II ASTM D4869 Type IV ASTM D6757 <u>ASTM D8257</u>

1507.1.1 Underlayment. Underlayment for asphalt shingles, clay and concrete tile, metal roof shingles, mineral-surfaced roll roofing, slate and slate-type shingles, wood shingles, wood shakes, metal roof panels and *photovoltaic shingles* shall conform to the applicable standards listed in this chapter. Underlayment materials required to comply with ASTM D226, D1970, D4869, ~~and D6757~~ or ASTM D8257 shall bear a label indicating compliance with the standard designation and, if applicable, type classification indicated in Table 1507.1.1(1). Underlayment shall be applied in accordance with Table 1507.1.1(2). Underlayment shall be attached in accordance with Table 1507.1.1(3).

Exceptions:

1. As an alternative, a minimum 4-inch-wide (102 mm) strip of self-adhering polymer modified bitumen membrane complying with ASTM D1970 and installed in accordance with the manufacturer's installation instructions for the deck material shall be applied over all joints in the roof decking. An approved underlayment for the applicable roof covering for design wind speeds less than 120 mph (54 m/s) shall be applied over the 4-inch-wide (102 mm) membrane strips.

2. As an alternative, two layers of underlayment complying with ASTM D226 Type II or ASTM D4869 Type IV shall be permitted to be installed as follows: Apply a 19-inch (483 mm) strip of underlayment parallel with the eave. Starting at the eave, apply 36-inch-wide (914 mm) strips of underlayment felt, overlapping successive sheets 19 inches (483 mm). The underlayment shall be attached with corrosion-resistant fasteners in a grid pattern of 12 inches (305 mm) between side laps with a 6-inch (152 mm) spacing at side and end laps. End laps shall be 4 inches (102 mm) and shall be offset by 6 feet (1829 mm). Underlayment shall be attached using metal or plastic cap nails with a nominal cap diameter of not less than 1 inch (25.4 mm). Metal caps shall have a thickness of not less than 32-gage sheet metal. Power-driven metal caps shall have a thickness of not less than 0.010 inch (0.254 mm). Thickness of the outside edge of plastic caps shall be not less than 0.035 inch (0.89 mm). The cap nail shank shall be not less than 0.083 inch (2.1 mm) for ring shank cap nails and 0.091 inch (2.3 mm) for smooth shank cap nails. The cap nail shank shall have a length sufficient to penetrate through the roof sheathing or not less than $\frac{3}{4}$ inch (19.1 mm) into the roof sheathing.
3. Structural metal panels that do not require a substrate or underlayment.

Add new standard(s) as follows:

ASTM

ASTM International
100 Barr Harbor Drive, P.O. Box C700
West Conshohocken, PA 19428

D8257/D8257M-20

Standard Specification for Mechanically Attached Polymeric Roof Underlayment Used in Steep Slope Roofing

Staff Analysis: A review of the standard proposed for inclusion in the code, ASTM D8257/D8257M-20 Standard Specification for Mechanically Attached Polymeric Roof Underlayment Used in Steep Slope Roofing, with regard to some of the key ICC criteria for referenced standards (Section 3.6 of CP#28) will be posted on the ICC website on or before March 16, 2022.

Reason Statement: This code change proposal adds a new product standard for synthetic roof underlayment, ASTM D8257, "Standard Specification for Mechanically Attached Polymeric Roof Underlayment Used in Steep Slope Roofing," to Section 1507.1.1-Underlayment and Table 1507.1.1(1)-Underlayment Types.

Cost Impact: The code change proposal will not increase or decrease the cost of construction. This proposal adds an additional option for roof underlayment. Synthetic underlayment products are priced competitively to the underlayment products already included in the Code.

S22-22 Part I

S22-22 Part II

IRC: R905.1.1, TABLE R905.1.1(1), ASTM Chapter 44 (New)

Proponents: Mark Graham, representing National Roofing Contractors Assoc. (mgraham@nrca.net)

2021 International Residential Code

Revise as follows:

R905.1.1 Underlayment. *Underlayment* for asphalt shingles, clay and concrete tile, *metal roof shingles*, mineral-surfaced roll roofing, slate and slate-type shingles, wood shingles, wood shakes, *metal roof panels* and *photovoltaic shingles* shall conform to the applicable standards listed in this chapter. *Underlayment* materials required to comply with ASTM D226, D1970, D4869, ~~and D6757~~ and D8257 shall bear a *label* indicating compliance to the standard designation and, if applicable, type classification indicated in Table R905.1.1(1). *Underlayment* shall be applied in accordance with Table R905.1.1(2). *Underlayment* shall be attached in accordance with Table R905.1.1(3).

Exceptions:

1. As an alternative, self-adhering polymer-modified bitumen underlayment bearing a label indicating compliance with ASTM D1970 and installed in accordance with both the *underlayment* manufacturer's and roof covering manufacturer's instructions for the deck material, roof ventilation configuration and climate exposure for the roof covering to be installed, shall be permitted.
2. As an alternative, a minimum 4-inch-wide (102 mm) strip of self-adhering polymer-modified bitumen membrane bearing a *label* indicating compliance with ASTM D1970, installed in accordance with the *manufacturer's installation instructions* for the deck material, shall be applied over all joints in the roof decking. An *approved underlayment* complying with Table R905.1.1(1) for the applicable roof covering

TABLE R905.1.1(1) UNDERLAYMENT TYPES

ROOF COVERING	SECTION	AREAS WHERE WIND DESIGN IS NOT REQUIRED IN ACCORDANCE WITH FIGURE R301.2.1.1	AREAS WHERE WIND DESIGN IS REQUIRED IN ACCORDANCE WITH FIGURE R301.2.1.1
Asphalt shingles	R905.2	ASTM D226 Type I or II ASTM D4869 Type I, II, III or IV ASTM D6757 <u>ASTM D8257</u>	ASTM D226 Type II ASTM D4869 Type III or Type IV <u>ASTM D8257</u>
Clay and concrete tile	R905.3	ASTM D226 Type II ASTM D2626 Type I ASTM D6380 Class M mineral-surfaced roll roofing <u>ASTM D8257</u>	ASTM D226 Type II <u>ASTM D8257</u>
Metal roof shingles	R905.4	ASTM D226 Type I or II ASTM D4869 Type I, II, III or IV <u>ASTM D8257</u>	ASTM D226 Type II ASTM D4869 Type III or Type IV <u>ASTM D8257</u>
Mineral-surfaced roll roofing	R905.5	ASTM D226 Type I or II ASTM D4869 Type I, II, III or IV <u>ASTM D8257</u>	ASTM D226 Type II ASTM D4869 Type III or Type IV <u>ASTM D8257</u>
Slate and slate-type shingles	R905.6	ASTM D226 Type I ASTM D4869 Type I, II, III or IV <u>ASTM D8257</u>	ASTM D226 Type II ASTM D4869 Type III or Type IV <u>ASTM D8257</u>
Wood shingles	R905.7	ASTM D226 Type I or II ASTM D4869 Type I, II, III or IV <u>ASTM D8257</u>	ASTM D226 Type II ASTM D4869 Type III or Type IV <u>ASTM D8257</u>
Wood shakes	R905.8	ASTM D226 Type I or II ASTM D4869 Type I, II, III or IV <u>ASTM D8257</u>	ASTM D226 Type II ASTM D4869 Type III or Type IV <u>ASTM D8257</u>
Metal panels	R905.10	Manufacturer's instructions <u>ASTM D8257</u>	ASTM D226 Type II ASTM D4869 Type III or Type IV <u>ASTM D8257</u>
Photovoltaic shingles	R905.16	ASTM D4869 Type I, II, III or IV ASTM D6757 <u>ASTM D8257</u>	ASTM D4869 Type III or Type IV <u>ASTM D8257</u>

For SI: 1 mile per hour = 0.447 m/s.

Add new standard(s) as follows:

ASTM

ASTM International
100 Barr Harbor Drive, P.O. Box C700
West Conshohocken, PA 19428

D8257/D8257M-20

Standard Specification for Mechanically Attached Polymeric Roof Underlayment Used in Steep Slope Roofing

Staff Analysis: A review of the standard proposed for inclusion in the code, ASTM D8257/D8257M-20 Standard Specification for Mechanically Attached Polymeric Roof Underlayment Used in Steep Slope Roofing, with regard to some of the key ICC criteria for referenced standards (Section 3.6 of CP#28) will be posted on the ICC website on or before March 16, 2022.

Reason Statement: This code change proposal adds a new product standard for synthetic roof underlayment, ASTM D8257, "Standard Specification for Mechanically Attached Polymeric Roof Underlayment Used in Steep Slope Roofing," to Section R905.1.1-Underlayment and Table R905.1.1(1)-Underlayment Types.

Cost Impact: The code change proposal will not increase or decrease the cost of construction
This proposal adds an additional option for roof underlayment. Synthetic underlayment products are priced competitively to the underlayment products already included in the Code

S23-22

IBC: TABLE 1507.1.1(1), 1507.1.1

Proponents: Mark Graham, representing National Roofing Contractors Assoc. (mgraham@nrca.net)

2021 International Building Code

Revise as follows:

TABLE 1507.1.1(1) UNDERLAYMENT TYPES

ROOF COVERING	SECTION	MAXIMUM BASIC DESIGN WIND SPEED, V < 140 MPH	MAXIMUM BASIC DESIGN WIND SPEED, V ≥ 140 MPH
Clay and concrete tiles	1507.3	ASTM D226 Type II ASTM D2626 Type I ASTM D6380 Class M mineral-surfaced roll roofing	ASTM D226 Type II ASTM D2626 Type I ASTM D6380 Class M mineral-surfaced roll roofing
Metal roof panels <u>applied to a solid or closely fitted deck</u>	1507.4	Manufacturer's instructions ASTM D226 Type I or II ASTM D4869, Type I, II, III or IV	ASTM D226 Type II ASTM D4869 Type IV
Wood shakes <u>applied to a solid sheathing roof deck</u>	1507.9	ASTM D226 Type I or II ASTM D4869 Type I, II, III or IV	ASTM D226 Type II ASTM D4869 Type IV

1507.1.1 Underlayment. Underlayment for asphalt shingles, clay and concrete tile, metal roof shingles, mineral-surfaced roll roofing, slate and slate-type shingles, wood shingles, wood shakes, metal roof panels and *photovoltaic shingles* shall conform to the applicable standards listed in this chapter. Underlayment materials required to comply with ASTM D226, D1970, D4869, ~~and D6757, D2626 Type I or D6380 Class M~~ shall bear a label indicating compliance with the standard designation and, if applicable, type classification indicated in Table 1507.1.1(1). Underlayment shall be applied in accordance with Table 1507.1.1(2). Underlayment shall be attached in accordance with Table 1507.1.1(3).

Exceptions:

1. As an alternative, a minimum 4-inch-wide (102 mm) strip of self-adhering polymer modified bitumen membrane complying with ASTM D1970 and installed in accordance with the manufacturer's installation instructions for the deck material shall be applied over all joints in the roof decking. An approved underlayment for the applicable roof covering for design wind speeds less than 120 mph (54 m/s) shall be applied over the 4-inch-wide (102 mm) membrane strips.
2. As an alternative, two layers of underlayment complying with ASTM D226 Type II, ~~or~~ ASTM D4869 Type IV or ASTM D6757 shall be permitted to be installed as follows: Apply a 19-inch (483 mm) strip of underlayment parallel with the eave. Starting at the eave, apply 36-inch-wide (914 mm) strips of underlayment felt, overlapping successive sheets 19 inches (483 mm). The underlayment shall be attached with corrosion-resistant fasteners in a grid pattern of 12 inches (305 mm) between side laps with a 6-inch (152 mm) spacing at side and end laps. End laps shall be 4 inches (102 mm) and shall be offset by 6 feet (1829 mm). Underlayment shall be attached using metal or plastic cap nails with a nominal cap diameter of not less than 1 inch (25.4 mm). Metal caps shall have a thickness of not less than 32-gage sheet metal. Power-driven metal caps shall have a thickness of not less than 0.010 inch (0.254 mm). Thickness of the outside edge of plastic caps shall be not less than 0.035 inch (0.89 mm). The cap nail shank shall be not less than 0.083 inch (2.1 mm) for ring shank cap nails and 0.091 inch (2.3 mm) for smooth shank cap nails. The cap nail shank shall have a length sufficient to penetrate through the roof sheathing or not less than 3/4 inch (19.1 mm) into the roof sheathing.
3. Structural metal panels that do not require a substrate or underlayment.

Reason Statement: This code change proposal is a clarification and clean-up of Table 1507.1.1(1). Specifically:

- In Section 1507.1.1, ASTM D2626, Type I and ASTM D6380, Class M are added since these already occur in the table.
- In Section 1507.1.1, Exception 2, ASTM D6757 is added since it already appears in the table and is appropriate for a two layer application.
- In the table in the row for clay and concrete tile roof coverings, "mineral surface roof roofing" is deleted from the description of ASTM D6380, Class M as it is unnecessary. The Class M designation already identifies the product as being mineral granule-surfacing.
- In the table in the row for metal roof panel coverings, underlayment is only used over solid or closely fitted decks. Where a structural metal panel roof covering is applied over open framing without a roof deck, an underlayment is not applied. Also, "Manufacturer's instructions" is struck from the cell for maximum basic wind design wind speed, V < 140 mph. This is replaced with ASTM designation underlayment standards similar to what is already appearing in the rows for Clay and Concrete Roof Tiles through Wood Shakes.
- In the table for the row for wood shake roof coverings, underlayment is only used over solid roof deck sheathing. Where a wood shake roof covering is applied over spaced sheathing, an underlayment is not applied to allow for downward venting/drying of the wood shakes. An interlayment is unused between courses of wood shakes per Section 1507.9.6

Cost Impact: The code change proposal will not increase or decrease the cost of construction. This is simply a clarification and clean-up of the table.

S24-22 Part I

IBC: 1507.1.1, TABLE 1507.1.1(1), TABLE 1507.1.1(2), TABLE 1507.1.1(3), ASTM Chapter 35 (New)

Proponents: Gregory Keeler, representing Owens Corning (greg.keeler@owenscorning.com)

THIS IS A 2 PART CODE CHANGE. PART I WILL BE HEARD BY THE IBC STRUCTURAL CODE COMMITTEE. PART II WILL BE HEARD BY THE IRC-B CODE COMMITTEE. SEE THE TENTATIVE HEARING ORDER FOR THESE COMMITTEES.

2021 International Building Code

Revise as follows:

1507.1.1 Underlayment. Underlayment in accordance with this section is required for asphalt shingles, clay and concrete tile, metal roof shingles, mineral-surfaced roll roofing, slate and slate-type shingles, wood shingles, wood shakes, metal roof panels and *photovoltaic shingles* and shall conform to the applicable standards listed in this chapter. Underlayment materials required to comply with ASTM D226, D1970, D4869, and D6757, and D8257 shall bear a label indicating compliance with the standard designation and, if applicable, type classification indicated in Table 1507.1.1(1). Underlayment shall be applied in accordance with Table 1507.1.1(2). Underlayment shall be ~~attached~~ fastened in accordance with Table 1507.1.1(3).

Exceptions:

- 1- ~~As an alternative, a minimum 4-inch wide (102 mm) strip of self-adhering polymer-modified bitumen membrane complying with ASTM D1970 and installed in accordance with the manufacturer's installation instructions for the deck material shall be applied over all joints in the roof decking. An approved underlayment for the applicable roof covering for design wind speeds less than 120 mph (54 m/s) shall be applied over the 4-inch wide (102 mm) membrane strips.~~
- 2- ~~As an alternative, two layers of underlayment complying with ASTM D226 Type II or ASTM D4869 Type IV shall be permitted to be installed as follows: Apply a 19-inch (483 mm) strip of underlayment parallel with the eave. Starting at the eave, apply 36-inch wide (914 mm) strips of underlayment felt, overlapping successive sheets 19 inches (483 mm). The underlayment shall be attached with corrosion-resistant fasteners in a grid pattern of 12 inches (305 mm) between side laps with a 6-inch (152 mm) spacing at side and end laps. End laps shall be 4 inches (102 mm) and shall be offset by 6 feet (1829 mm). Underlayment shall be attached using metal or plastic cap nails with a nominal cap diameter of not less than 1 inch (25.4 mm). Metal caps shall have a thickness of not less than 32-gage sheet metal. Power-driven metal caps shall have a thickness of not less than 0.010 inch (0.254 mm). Thickness of the outside edge of plastic caps shall be not less than 0.035 inch (0.89 mm). The cap nail shank shall be not less than 0.083 inch (2.1 mm) for ring shank cap nails and 0.091 inch (2.3 mm) for smooth shank cap nails. The cap nail shank shall have a length sufficient to penetrate through the roof sheathing or not less than $\frac{3}{4}$ inch (19.1 mm) into the roof sheathing.~~
- 3- Structural metal panels that do not require a substrate or underlayment.

TABLE 1507.1.1(1) UNDERLAYMENT TYPES

ROOF COVERING	SECTION	MAXIMUM BASIC DESIGN WIND SPEED, V < 140 MPH	MAXIMUM BASIC DESIGN WIND SPEED, V ≥ 140 MPH
Asphalt shingles	1507.2	ASTM D226 Type I or II ASTM D4869 Type I, II, III or IV ASTM D6757 <u>ASTM D8257</u> <u>ASTM D1970</u>	ASTM D226 Type II ASTM D4869 Type IV ASTM D6757 <u>ASTM D8257</u> <u>ASTM D1970</u>
Clay and concrete tiles	1507.3	ASTM D226 Type II ASTM D2626 Type I ASTM D6380 Class M mineral surfaced roll roofing <u>ASTM D8257</u> <u>ASTM D1970</u>	ASTM D226 Type II ASTM D2626 Type I ASTM D6380 Class M mineral surfaced roll roofing <u>ASTM D8257</u> <u>ASTM D1970</u>
Metal roof panels	1507.4	Manufacturer's instructions	ASTM D226 Type II ASTM D4869 Type IV <u>ASTM D8257</u> <u>ASTM D1970</u>
Metal roof shingles	1507.5	ASTM D226 Type I or II ASTM D4869 Type I, II, III or IV <u>ASTM D8257</u> <u>ASTM D1970</u>	ASTM D226 Type II ASTM D4869 Type IV <u>ASTM D8257</u> <u>ASTM D1970</u>
Mineral-surfaced roll roofing	1507.6	ASTM D226 Type I or II ASTM D4869 Type I, II, III or IV <u>ASTM D8257</u> <u>ASTM D1970</u>	ASTM D226 Type II ASTM D4869 Type IV <u>ASTM D8257</u> <u>ASTM D1970</u>
Slate shingles	1507.7	ASTM D226 Type II ASTM D4869 Type III or IV <u>ASTM D8257</u> <u>ASTM D1970</u>	ASTM D226 Type II ASTM D4869 Type IV <u>ASTM D8257</u> <u>ASTM D1970</u>
Wood shingles	1507.8	ASTM D226 Type I or II ASTM D4869 Type I, II, III or IV <u>ASTM D8257</u>	ASTM D226 Type II ASTM D4869 Type IV <u>ASTM D8257</u>
Wood shakes	1507.9	ASTM D226 Type I or II ASTM D4869 Type I, II, III or IV <u>ASTM D8257</u>	ASTM D226 Type II ASTM D4869 Type IV <u>ASTM D8257</u>
Photovoltaic shingles	1507.16	ASTM D226 Type I or II ASTM D4869 Type I, II, III or IV ASTM D6757 <u>ASTM D8257</u> <u>ASTM D1970</u>	ASTM D226 Type II ASTM D4869 Type IV ASTM D6757 <u>ASTM D8257</u> <u>ASTM D1970</u>

TABLE 1507.1.1(2) UNDERLAYMENT APPLICATION

ROOF COVERING	SECTION	MAXIMUM BASIC DESIGN WIND SPEED, $V < 140$ MPH	MAXIMUM BASIC DESIGN WIND SPEED, $V \geq 140$ MPH
Asphalt shingles	1507.2	<p>For roof slopes from 2 units vertical in 12 units horizontal (2:12), up to 4 units vertical in 12 units horizontal (4:12), underlayment shall be two layers applied as follows in the following manner: Apply a 19-inch strip of underlayment felt that is half the width of a full sheet parallel to and starting at the eaves. Starting at the eave, apply 36-inch wide full width sheets of underlayment, overlapping successive sheets 19 inches half the width of a full sheet plus 2 inches. End laps shall be 4 inches and shall be offset by 6 feet. Distortions in the underlayment shall not interfere with the ability of the shingles to seal.</p> <p>For roof slopes of 4 units vertical in 12 units horizontal (4:12) or greater, underlayment shall be one layer applied as follows: Underlayment shall be applied shingle fashion, parallel to and starting from the eave and lapped 2 inches, Distortions in the underlayment shall not interfere with the ability of the shingles to seal. End laps shall be 4 inches and shall be offset by 6 feet. <u>Additionally, a single layer of self-adhering polymer modified bitumen underlayment complying with ASTM D1970, installed in accordance with the underlayment and roof covering manufacturer's installation instructions for the deck material, roof ventilation configuration, and climate exposure of the roof covering.</u></p>	<p>Same as Maximum Basic Design Wind Speed, $V < 140$ mph except all laps shall be not less than 4 inches</p> <p>Underlayment shall be one of the following:</p> <ol style="list-style-type: none"> 1. <u>Two layers of mechanically fastened underlayment applied in the following manner: Apply a strip of underlayment felt that is half the width of a full sheet parallel to and starting at the eaves, fastened sufficiently to hold in place. Starting at the eave, apply full width sheets of underlayment, overlapping successive sheets half the width of a full sheet plus 2 inches. Distortions in the underlayment shall not interfere with the ability of the shingles to seal. End laps shall be 4 inches and shall be offset by 6 feet.</u> 2. <u>A minimum 4 inch wide strip of self-adhering polymer modified bitumen underlayment complying with ASTM D1970, installed in accordance with the manufacturer's installation instructions for the deck material, shall be applied over all joints in the roof decking. An approved underlayment complying with Table R905.1.1(1) for the applicable roof covering shall be applied over the entire roof over the 4 inch (95.25mm) wide membrane strips.</u> 3. <u>A single layer of self-adhering polymer modified bitumen underlayment complying with ASTM D1970, installed in accordance with the underlayment and roof covering manufacturer's installation instructions for the deck material, roof ventilation configuration, and climate exposure of the roof covering.</u>

ROOF COVERING	SECTION	MAXIMUM BASIC DESIGN WIND SPEED, $V < 140$ MPH	MAXIMUM BASIC DESIGN WIND SPEED, $V \geq 140$ MPH
Clay and concrete tile	1507.3	<p>For roof slopes from $2\frac{1}{2}$ units vertical in 12 units horizontal ($2\frac{1}{2}$:12), up to 4 units vertical in 12 units horizontal (4:12), underlayment shall be two layers applied as follows in the following manner: Apply a 19-inch strip of underlayment felt that is half the width of a full sheet parallel to and starting at the eaves. Starting at the eave, apply 36-inch-wide full width sheets of underlayment, overlapping successive sheets 19-inches half the width of a full sheet plus 2 inches. End laps shall be 4 inches and shall be offset by 6 feet. For roof slopes of 4 units vertical in 12 units horizontal (4:12) or greater, underlayment shall be one layer applied as follows: Underlayment shall be applied shingle fashion, parallel to and starting from the eave and lapped 2 inches. End laps shall be 4 inches and shall be offset by 6 feet. <u>Additionally, a single layer of self-adhering polymer modified bitumen underlayment complying with ASTM D1970, installed in accordance with the underlayment and roof covering manufacturer's installation instructions for the deck material, roof ventilation configuration, and climate exposure of the roof covering.</u></p>	<p>Same as Maximum Basic Design Wind Speed, $V < 140$ mph except all laps shall be not less than 4 inches.</p> <p><u>Underlayment shall be one of the following:</u></p> <p>1. <u>Two layers of mechanically fastened underlayment applied in the following manner: Apply a strip of underlayment that is half the width of a full sheet parallel to and starting at the eaves, fastened sufficiently to hold in place. Starting at the eave, apply full width sheets of underlayment, overlapping successive sheets half the width of a full sheet plus 2 inches. Distortions in the underlayment shall not interfere with the ability of the shingles to seal. End laps shall be 4 inches and shall be offset by 6 feet.</u></p> <p>2. <u>A minimum 4 inch wide strip of self-adhering polymer modified bitumen underlayment complying with ASTM D1970, installed in accordance with the manufacturer's installation instructions for the deck material, shall be applied over all joints in the roof decking. An approved underlayment complying with Table R905.1.1(1) for the applicable roof covering shall be applied over the entire roof over the 4 inch wide membrane strips.</u></p> <p>3. <u>A single layer of self-adhering polymer modified bitumen underlayment complying with ASTM D1970, installed in accordance with the underlayment and roof covering manufacturer's installation instructions for the deck material, roof ventilation configuration, and climate exposure of the roof covering.</u></p>
Metal roof panels	1507.4		
Metal roof shingles	1507.5		
Mineral-surfaced roll roofing	1507.6		

ROOF COVERING	SECTION	MAXIMUM BASIC DESIGN WIND SPEED, $V < 140$ MPH	MAXIMUM BASIC DESIGN WIND SPEED, $V \geq 140$ MPH
Slate shingles	1507.7	Apply in accordance with the manufacturer's installation instructions	<p data-bbox="1183 254 1503 310"><u>Underlayment shall be one of the following:</u></p> <p data-bbox="1183 344 1511 814">1. <u>Two layers of mechanically fastened underlayment applied in the following manner: Apply a strip of underlayment that is half the width of a full sheet parallel to and starting at the eaves, fastened sufficiently to hold in place. Starting at the eave, apply full width sheets of underlayment, overlapping successive sheets half the width of a full sheet plus 2 inches. Distortions in the underlayment shall not interfere with the ability of the shingles to seal. End laps shall be 4 inches and shall be offset by 6 feet.</u></p> <p data-bbox="1183 848 1503 1262">2. <u>A minimum 4 inch wide strip of self-adhering polymer modified bitumen underlayment complying with ASTM D1970, installed in accordance with the manufacturer's installation instructions for the deck material, shall be applied over all joints in the roof decking. An approved underlayment complying with Table R905.1.1(1) for the applicable roof covering shall be applied over the entire roof over the 4 inch wide membrane strips.</u></p> <p data-bbox="1183 1295 1520 1591">3. <u>A single layer of self-adhering polymer modified bitumen underlayment complying with ASTM D1970, installed in accordance with the underlayment and roof covering manufacturer's installation instructions for the deck material, roof ventilation configuration, and climate exposure of the roof covering.</u></p>
Wood shingles	1507.8		
Wood shakes	1507.9		

ROOF COVERING	SECTION	MAXIMUM BASIC DESIGN WIND SPEED, $V < 140$ MPH	MAXIMUM BASIC DESIGN WIND SPEED, $V \geq 140$ MPH
Photovoltaic shingles	1507.16	<p>For roof slopes from 3 units vertical in 12 units horizontal (3:12), up to 4 units vertical in 12 units horizontal (4:12), underlayment shall be two layers applied as follows <u>in the following manner</u>: Apply a 19-inch strip of underlayment felt <u>that is half the width of a full sheet</u> parallel to and starting at the eaves. Starting at the eave, apply 36-inch-wide <u>full width</u> sheets of underlayment, overlapping successive sheets 19 inches <u>half the width of a full sheet plus 2 inches</u>. End laps shall be 4 inches and shall be offset by 6 feet. Distortions in the underlayment shall not interfere with the ability of the shingles to seal. For roof slopes of 4 units vertical in 12 units horizontal (4:12) or greater, underlayment shall be one layer applied as follows: Underlayment shall be applied shingle fashion, parallel to and starting from the eave and lapped 2 inches, Distortions in the underlayment shall not interfere with the ability of the shingles to seal. End laps shall be 4 inches and shall be offset by 6 feet. <u>Additionally, a single layer of self-adhering polymer modified bitumen underlayment complying with ASTM D1970, installed in accordance with the underlayment and roof covering manufacturer's installation instructions for the deck material, roof ventilation configuration, and climate exposure of the roof covering.</u></p>	<p>Same as Maximum Basic Design Wind Speed, $V < 140$ mph except <u>all laps shall be not less than 4 inches</u>.</p> <p><u>Underlayment shall be one of the following:</u></p> <ol style="list-style-type: none"> 1. <u>Two layers of mechanically fastened underlayment applied in the following manner: Apply a strip of underlayment felt that is half the width of a full sheet parallel to and starting at the eaves, fastened sufficiently to hold in place. Starting at the eave, apply 36-inch-wide full width sheets of underlayment, overlapping successive sheets half the width of a full sheet plus 2 inches. Distortions in the underlayment shall not interfere with the ability of the shingles to seal. End laps shall be 4 inches and shall be offset by 6 feet.</u> 2. <u>A minimum 4 inch wide strip of self-adhering polymer modified bitumen underlayment complying with ASTM D1970, installed in accordance with the manufacturer's installation instructions for the deck material, shall be applied over all joints in the roof decking. An approved underlayment complying with Table 1507.1.1(1) for the applicable roof covering shall be applied over the entire roof over the 4 inch wide membrane strips.</u> 3. <u>A single layer of self-adhering polymer modified bitumen underlayment complying with ASTM D1970, installed in accordance with the underlayment and roof covering manufacturer's installation instructions for the deck material, roof ventilation configuration, and climate exposure of the roof covering.</u>

For SI: 1 inch = 25.4 mm, 1 foot = 304.8 mm; 1 mile per hour = 0.447 m/s.

TABLE 1507.1.1(3) UNDERLAYMENT ATTACHMENT FASTENING

ROOF COVERING	SECTION	MAXIMUM BASIC DESIGN WIND SPEED, V < 140 MPH	MAXIMUM BASIC DESIGN WIND SPEED, V ≥ 140 MPH
Asphalt shingles	1507.2	Fastened sufficiently to hold in place	The <u>Mechanically fastened</u> underlayment shall be attached fastened with corrosion-resistant fasteners in a grid pattern of <u>maximum 12 inches horizontally and vertically</u> between side laps with a 6-inch spacing at side and end laps. <u>Mechanically fastened</u> U underlayment shall be <u>fastened</u> attached using metal or plastic cap nails or cap staples with a nominal cap diameter of not less than 1 inch. Metal caps shall have a thickness of not less than 32-gage (0.0134 inch) sheet metal. Power-driven metal caps shall have a minimum thickness of 0.010 inch. Minimum thickness of the outside edge of plastic caps shall be 0.035 inch. The cap nail shank shall be not less than 0.083 inch for ring shank cap nails and 0.091 inch for smooth shank cap nails. Staples shall be not less than 21 gage (0.032 inch). The cap nail shank and cap staple legs shall have a length sufficient to penetrate through the roof sheathing or not less than 3/4 inch into the roof sheathing. <u>Self-adhering polymer modified bitumen underlayment shall be installed in accordance with the underlayment and roof covering manufacturer's installation instructions for the deck material, roof ventilation configuration, and climate exposure of the roof covering.</u>
Clay and concrete tile	1507.3		
Photovoltaic shingles	1507.16		
Metal roof panels	1507.4	Manufacturer's installation instructions	The <u>Mechanically fastened</u> underlayment shall be attached fastened with corrosion-resistant fasteners in a grid pattern of <u>maximum 12 inches horizontally and vertically</u> between side laps with a 6-inch spacing at side and end laps. <u>Mechanically fastened</u> U underlayment shall be <u>fastened</u> attached using metal or plastic cap nails or cap staples with a nominal cap diameter of not less than 1 inch. Metal caps shall have a thickness of not less than 32-gage (0.0134 inch) sheet metal. Power-driven metal caps shall have a minimum thickness of 0.010 inch. Minimum thickness of the outside edge of plastic caps shall be 0.035 inch. The cap nail shank shall be not less than 0.083 inch for ring shank cap nails and 0.091 inch for smooth shank cap nails. Staples shall be not less than 21 gage (0.032 inch). The cap nail shank and cap staple legs shall have a length sufficient to penetrate through the roof sheathing or not less than 3/4 inch into the roof sheathing. <u>Self-adhering polymer modified bitumen underlayment shall be installed in accordance with the underlayment and roof covering manufacturer's installation instructions for the deck material, roof ventilation configuration, and climate exposure of the roof covering.</u>
Metal roof shingles	1507.5		
Mineral-surfaced roll roofing	1507.6		
Slate shingles	1507.7		
Wood shingles	1507.8		
Wood shakes	1507.9		

For SI: 1 inch = 25.4 mm; 1 mile per hour = 0.447 m/s.

Add new standard(s) as follows:

ASTM

ASTM International
100 Barr Harbor Drive, P.O. Box C700
West Conshohocken, PA 19428

D8257/D8257M-20 Standard Specification for Mechanically Attached Polymeric Roof Underlayment Used in Steep Slope Roofing

Staff Analysis: A review of the standard proposed for inclusion in the code, ASTM D8257/D8257M-20 Standard Specification for Mechanically Attached Polymeric Roof Underlayment Used in Steep Slope Roofing, with regard to some of the key ICC criteria for referenced standards (Section 3.6 of CP#28) will be posted on the ICC website on or before March 16, 2022.

Reason Statement: The first language modification in this proposal is to stipulate that underlayment is required. I receive feedback regularly from contractors that while the existing language implies that underlayment is required, that requirement is not clearly stated. Additionally, this proposal adds the first ever consensus-based Standard that is applicable to synthetic/polymeric underlayments. The roofing industry has been in need of such a Standard for many years so that this category of products can be adequately evaluated for performance. This proposal also modifies the language that is applicable to installation of a 2-layer underlayment system in such a way that it reduces waste (the current language results in a strip of underlayment that is too narrow to be used in most cases), and so that the lapping and fastening requirements are applicable to any width of underlayment. Finally, this proposal also re-configures the expression of the options for enhanced underlayment systems in high wind areas.

Cost Impact: The code change proposal will not increase or decrease the cost of construction. This proposal adds a new ASTM Standard for qualifying synthetic underlayments which have been in use for many years and clarifies and reorganizes existing requirements.

S24-22 Part II

IRC: R905.1.1, TABLE R905.1.1(1), TABLE R905.1.1(2), TABLE R905.1.1(3), ASTM Chapter 44 (New)

Proponents: Gregory Keeler, representing Owens Corning (greg.keeler@owenscorning.com)

2021 International Residential Code

Revise as follows:

R905.1.1 Underlayment. *Underlayment in accordance with this section is required* for asphalt shingles, clay and concrete tile, *metal roof shingles*, mineral-surfaced roll roofing, slate and slate-type shingles, wood shingles, wood shakes, *metal roof panels* and *photovoltaic shingles* shall conform to the applicable standards listed in this chapter. *Underlayment* materials required to comply with ASTM D226, D1970, D4869, ~~and~~ D6757, and D8257 shall bear a *label* indicating compliance to the standard designation and, if applicable, type classification indicated in Table R905.1.1(1). *Underlayment* shall be applied in accordance with Table R905.1.1(2). *Underlayment* shall be ~~attached~~ fastened in accordance with Table R905.1.1(3).

Exceptions:

1. ~~As an alternative, self-adhering polymer-modified bitumen underlayment bearing a label indicating compliance with ASTM D1970 and installed in accordance with both the *underlayment* manufacturer's and roof covering manufacturer's instructions for the deck material, roof ventilation configuration and climate exposure for the roof covering to be installed, shall be permitted.~~
2. ~~As an alternative, a minimum 4-inch-wide (102-mm) strip of self-adhering polymer-modified bitumen membrane bearing a *label* indicating compliance with ASTM D1970, installed in accordance with the *manufacturer's installation instructions* for the deck material, shall be applied over all joints in the roof decking. An *approved underlayment* complying with Table R905.1.1(1) for the applicable roof covering~~

Exception: Structural metal panels that do not require a substrate or underlayment.

TABLE R905.1.1(1) UNDERLAYMENT TYPES

ROOF COVERING	SECTION	AREAS WHERE WIND DESIGN IS NOT REQUIRED IN ACCORDANCE WITH FIGURE R301.2.1.1	AREAS WHERE WIND DESIGN IS REQUIRED IN ACCORDANCE WITH FIGURE R301.2.1.1
Asphalt shingles	R905.2	ASTM D226 Type I or II ASTM D4869 Type I, II, III or IV ASTM D6757 <u>ASTM D8257</u> <u>ASTM D1970</u>	ASTM D226 Type II ASTM D4869 Type III or Type IV <u>ASTM D8257</u> <u>ASTM D1970</u>
Clay and concrete tile	R905.3	ASTM D226 Type II ASTM D2626 Type I ASTM D6380 Class M mineral-surfaced roll roofing	ASTM D226 Type II
Metal roof shingles	R905.4	ASTM D226 Type I or II ASTM D4869 Type I, II, III or IV <u>ASTM D8257</u> <u>ASTM D1970</u>	ASTM D226 Type II ASTM D4869 Type III or Type IV <u>ASTM D8257</u> <u>ASTM D1970</u>
Mineral-surfaced roll roofing	R905.5	ASTM D226 Type I or II ASTM D4869 Type I, II, III or IV <u>ASTM D8257</u> <u>ASTM D1970</u>	ASTM D226 Type II ASTM D4869 Type III or Type IV <u>ASTM D8257</u> <u>ASTM D1970</u>
Slate and slate-type shingles	R905.6	ASTM D226 Type I ASTM D4869 Type I, II, III or IV <u>ASTM D8257</u> <u>ASTM D1970</u>	ASTM D226 Type II ASTM D4869 Type III or Type IV <u>ASTM D8257</u> <u>ASTM D1970</u>
Wood shingles	R905.7	ASTM D226 Type I or II ASTM D4869 Type I, II, III or IV <u>ASTM D8257</u> <u>ASTM D1970</u>	ASTM D226 Type II ASTM D4869 Type III or Type IV <u>ASTM D8257</u> <u>ASTM D1970</u>
Wood shakes	R905.8	ASTM D226 Type I or II ASTM D4869 Type I, II, III or IV <u>ASTM D8257</u> <u>ASTM D1970</u>	ASTM D226 Type II ASTM D4869 Type III or Type IV <u>ASTM D8257</u> <u>ASTM D1970</u>
Metal panels	R905.10	Manufacturer's instructions	ASTM D226 Type II ASTM D4869 Type III or Type IV <u>ASTM D8257</u> <u>ASTM D1970</u>
Photovoltaic shingles	R905.16	ASTM D4869 Type I, II, III or IV ASTM D6757 <u>ASTM D8257</u> <u>ASTM D1970</u>	ASTM D4869 Type III or Type IV <u>ASTM D8257</u> <u>ASTM D1970</u>

For SI: 1 mile per hour = 0.447 m/s.

TABLE R905.1.1(2) UNDERLAYMENT APPLICATION

ROOF COVERING	SECTION	AREAS WHERE WIND DESIGN IS NOT REQUIRED IN ACCORDANCE WITH FIGURE R301.2.1.1	AREAS WHERE WIND DESIGN IS REQUIRED IN ACCORDANCE WITH FIGURE R301.2.1.1
Asphalt shingles	R905.2	<p>For roof slopes from 2 units vertical in 12 units horizontal (2:12), up to 4 units vertical in 12 units horizontal (4:12), underlayment shall be two layers applied in the following manner: apply a 19-inch strip of underlayment felt that is half the width of a full sheet parallel to and starting at the eaves, <u>fastened sufficiently to hold in place</u>. Starting at the eave, apply 36-inch-wide full width sheets of underlayment, overlapping successive sheets <u>half the width of a full sheet plus 2 inches</u> 19-inches. Distortions in the underlayment shall not interfere with the ability of the shingles to seal. End laps shall be 4 inches and shall be offset by 6 feet. For roof slopes of 4 units vertical in 12 units horizontal (4:12) or greater, underlayment shall be one layer applied in the following manner: underlayment shall be applied shingle fashion, parallel to and starting from the eave and lapped 2 inches. Distortions in the underlayment shall not interfere with the ability of the shingles to seal. End laps shall be 4 inches and shall be offset by 6 feet. <u>Additionally, a single layer of self-adhering polymer modified bitumen underlayment complying with ASTM D1970, installed in accordance with the underlayment and roof covering manufacturer's installation instructions for the deck material, roof ventilation configuration, and climate exposure of the roof covering.</u></p>	<p>Underlayment shall be one of the following:</p> <ol style="list-style-type: none"> <u>1. Two two layers of mechanically fastened underlayment</u> applied in the following manner: a Apply a 19-inch strip of underlayment felt that is half the width of a full sheet parallel to and starting at the eaves, <u>fastened sufficiently to hold in place</u>. Starting at the eave, apply 36-inch-wide full width sheets of underlayment, overlapping successive sheets <u>half the width of a full sheet plus 2 inches</u> 19-inches. Distortions in the underlayment shall not interfere with the ability of the shingles to seal. End laps shall be 4 inches and shall be offset by 6 feet. <u>2. A minimum 4 inch wide strip of self-adhering polymer modified bitumen underlayment complying with ASTM D1970, installed in accordance with the manufacturer's installation instructions for the deck material, shall be applied over all joints in the roof decking. An approved underlayment complying with Table R905.1.1(1) for the applicable roof covering shall be applied over the entire roof over the 4 inch wide membrane strips.</u> <u>3. A single layer of self-adhering polymer modified bitumen underlayment complying with ASTM D1970, installed in accordance with the underlayment and roof covering manufacturer's installation instructions for the deck material, roof ventilation configuration, and climate exposure of the roof covering.</u>

ROOF COVERING	SECTION	AREAS WHERE WIND DESIGN IS NOT REQUIRED IN ACCORDANCE WITH FIGURE R301.2.1.1	AREAS WHERE WIND DESIGN IS REQUIRED IN ACCORDANCE WITH FIGURE R301.2.1.1

ROOF COVERING	SECTION	AREAS WHERE WIND DESIGN IS NOT REQUIRED IN ACCORDANCE WITH FIGURE R301.2.1.1	AREAS WHERE WIND DESIGN IS REQUIRED IN ACCORDANCE WITH FIGURE R301.2.1.1
Clay and concrete tile	R905.3	<p>For roof slopes from 2¹/₂ units vertical in 12 units horizontal (2¹/₂:12), up to 4 units vertical in 12 units horizontal (4:12), underlayment shall be two layers applied in the following manner: apply a 19-inch strip of underlayment felt that is half the width of a full sheet parallel to and starting at the eaves, fastened sufficiently to hold in place. Starting at the eave, apply 36-inch-wide full width sheets of underlayment, overlapping successive sheets half the width of a full sheet plus 2 inches 19-inches. End laps shall be 4 inches and shall be offset by 6 feet. For roof slopes of 4 units vertical in 12 units horizontal (4:12) or greater, underlayment shall be one layer applied in the following manner: underlayment shall be applied shingle fashion, parallel to and starting from the eave and lapped 2 inches. End laps shall be 4 inches and shall be offset by 6 feet. <u>Additionally, a single layer of self-adhering polymer modified bitumen underlayment complying with ASTM D1970, installed in accordance with the underlayment and roof covering manufacturer's installation instructions for the deck material, roof ventilation configuration, and climate exposure of the roof covering.</u></p>	<p>Underlayment shall be one of the following:</p> <ol style="list-style-type: none"> Two two-layers of mechanically fastened underlayment applied in the following manner: apply Apply a 19-inch strip of underlayment felt that is half the width of a full sheet parallel to and starting at the eaves, fastened sufficiently to hold in place. Starting at the eave, apply 36-inch-wide full width sheets of underlayment, overlapping successive sheets half the width of a full sheet plus 2 inches 19-inches. End laps shall be 4 inches and shall be offset by 6 feet. A minimum 4 inch wide strip of self-adhering polymer modified bitumen underlayment complying with ASTM D1970, installed in accordance with the manufacturer's installation instructions for the deck material, shall be applied over all joints in the roof decking. An approved underlayment complying with Table R905.1.1(1) for the applicable roof covering shall be applied over the entire roof over the 4 inch wide membrane strips. A single layer of self-adhering polymer modified bitumen underlayment complying with ASTM D1970, installed in accordance with the underlayment and roof covering manufacturer's installation instructions for the deck material, roof ventilation configuration, and climate exposure of the roof covering.
Metal roof shingles	R905.4		
Mineral-surfaced roll roofing	R905.5		
Slate and slate-type shingles	R905.6		
Wood shingles	R905.7		
Wood shakes	R905.8		

ROOF COVERING	SECTION	AREAS WHERE WIND DESIGN IS NOT REQUIRED IN ACCORDANCE WITH FIGURE R301.2.1.1	AREAS WHERE WIND DESIGN IS REQUIRED IN ACCORDANCE WITH FIGURE R301.2.1.1
Metal panels	R905.10	Apply in accordance with the manufacturer's installation instructions.	<p>Underlayment shall be one of the following:</p> <p>1. Two two layers of <u>mechanically fastened underlayment</u> applied in the following manner: apply <u>Apply</u> a 19-inch strip of <u>underlayment-felt that is half the width of a full sheet</u> parallel to and starting at the eaves, <u>fastened sufficiently to hold in place</u>. Starting at the eave, apply 36-inch-wide full <u>width sheets of underlayment, overlapping successive sheets half the width of a full sheet plus 2 inches 19-inches</u>. End laps shall be 4 inches and shall be offset by 6 feet.</p> <p>2. A minimum 4 inch wide strip of <u>self-adhering polymer modified bitumen underlayment complying with ASTM D1970, installed in accordance with the manufacturer's installation instructions for the deck material, shall be applied over all joints in the roof decking. An approved underlayment complying with Table R905.1.1(1) for the applicable roof covering shall be applied over the entire roof over the 4 inch wide membrane strips.</u></p> <p>3. A single layer of <u>self-adhering polymer modified bitumen underlayment complying with ASTM D1970, installed in accordance with the underlayment and roof covering manufacturer's installation instructions for the deck material, roof ventilation configuration, and climate exposure of the roof covering.</u></p>

ROOF COVERING	SECTION	AREAS WHERE WIND DESIGN IS NOT REQUIRED IN ACCORDANCE WITH FIGURE R301.2.1.1	AREAS WHERE WIND DESIGN IS REQUIRED IN ACCORDANCE WITH FIGURE R301.2.1.1
Photovoltaic shingles	R905.16	<p>For roof slopes from 2 units vertical in 12 units horizontal (2:12), up to 4 units vertical in 12 units horizontal (4:12), underlayment shall be two layers applied in the following manner: apply a 19-inch strip of underlayment felt <u>that is half the width of a full sheet</u> parallel to and starting at the eaves, fastened sufficiently to hold in place. Starting at the eave, apply 36-inch-wide <u>full width</u> sheets of underlayment, overlapping successive sheets <u>half the width of a full sheet plus 2 inches</u> 19-inches. Distortions in the underlayment shall not interfere with the ability of the shingles to seal. End laps shall be 4 inches and shall be offset by 6 feet. For roof slopes of 4 units vertical in 12 units horizontal (4:12) or greater, underlayment shall be one layer applied in the following manner: underlayment shall be applied shingle fashion, parallel to and starting from the eave and lapped 2 inches. Distortions in the underlayment shall not interfere with the ability of the shingles to seal. End laps shall be 4 inches and shall be offset by 6 feet. <u>Additionally, a single layer of self-adhering polymer modified bitumen underlayment complying with ASTM D1970, installed in accordance with the underlayment and roof covering manufacturer's installation instructions for the deck material, roof ventilation configuration, and climate exposure of the roof covering.</u></p>	<p>Underlayment shall be one of the following:</p> <ol style="list-style-type: none"> 1. Two two-layers of mechanically fastened underlayment applied in the following manner: apply <u>Apply a 19-inch strip of underlayment-felt that is half the width of a full sheet parallel to and starting at the eaves, fastened sufficiently to hold in place</u>. Starting at the eave, apply 36-inch-wide <u>full width</u> sheets of underlayment, overlapping successive sheets <u>half the width of a full sheet plus 2 inches</u> 19-inches. Distortions in the underlayment shall not interfere with the ability of the shingles to seal. End laps shall be 4 inches and shall be offset by 6 feet. 2. <u>A minimum 4 inch wide strip of self-adhering polymer modified bitumen underlayment complying with ASTM D1970, installed in accordance with the manufacturer's installation instructions for the deck material, shall be applied over all joints in the roof decking. An approved underlayment complying with Table R905.1.1(1) for the applicable roof covering shall be applied over the entire roof over the 4 inch wide membrane strips.</u> 3. <u>A single layer of self-adhering polymer modified bitumen underlayment complying with ASTM D1970, installed in accordance with the underlayment and roof covering manufacturer's installation instructions for the deck material, roof ventilation configuration, and climate exposure of the roof covering.</u>

For SI: 1 inch = 25.4 mm, 1 foot = 304.8 mm, 1 mile per hour = 0.447 m/s.

TABLE R905.1.1(3) UNDERLAYMENT APPLICATION ATTACHMENT

ROOF COVERING	SECTION	AREAS WHERE WIND DESIGN IS NOT REQUIRED IN ACCORDANCE WITH FIGURE R301.2.1.1	AREAS WHERE WIND DESIGN IS REQUIRED IN ACCORDANCE WITH FIGURE R301.2.1.1
Asphalt shingles	R905.2	Fastened sufficiently to hold in place	<p>The <u>Mechanically fastened</u> underlayment shall be attached <u>fastened</u> with corrosion-resistant fasteners in a grid pattern of 12 inches between side laps with a 6-inch spacing at side and end laps. Underlayment shall be attached using annular ring or deformed shank nails with 1-inch-diameter metal or plastic caps. Metal caps shall have a thickness of not less than 32-gage sheet metal. Power-driven metal caps shall have a minimum thickness of 0.010 inch. Minimum thickness of the outside edge of plastic caps shall be 0.035 inch. The cap nail shank shall be not less than 0.083 inch. The cap nail shank shall have a length sufficient to penetrate through the roof sheathing or not less than 3/4 inch into the roof sheathing. <u>Self-adhering polymer modified bitumen underlayment shall be installed in accordance with the underlayment and roof covering manufacturer's installation instructions for the deck material, roof ventilation configuration, and climate exposure of the roof covering.</u></p>
Clay and concrete tile	R905.3		
Photovoltaic shingles	R905.16		
Metal roof shingles	R905.4	Manufacturer's installation instructions.	<p>The <u>Mechanically fastened</u> underlayment shall be attached <u>fastened</u> with corrosion-resistant fasteners in a grid pattern of 12 inches between side laps with a 6-inch spacing at side and end laps. Underlayment shall be attached using annular ring or deformed shank nails with 1-inch-diameter metal or plastic caps. Metal caps shall have a thickness of not less than 32-gage sheet metal. Power-driven metal caps shall have a minimum thickness of 0.010 inch. Minimum thickness of the outside edge of plastic caps shall be 0.035 inch. The cap nail shank shall be not less than 0.083 inch. The cap nail shank shall have a length sufficient to penetrate through the roof sheathing or not less than 3/4 inch into the roof sheathing. <u>Self-adhering polymer modified bitumen underlayment shall be installed in accordance with the underlayment and roof covering manufacturer's installation instructions for the deck material, roof ventilation configuration, and climate exposure of the roof covering.</u></p> <p>Exception:</p> <p>Self-adhering polymer modified bitumen underlayment shall not be installed under wood shakes or wood shingles.</p>
Mineral-surfaced roll roofing	R905.5		
Slate and slate-type shingles	R905.6		
Wood shingles	R905.7		
Wood shakes	R905.8		
Wood shakes	R905.8		
Metal panels	R905.10		

For SI: 1 inch = 25.4 mm, 1 mile per hour = 0.447 m/s.

Add new standard(s) as follows:

ASTM

ASTM International
 100 Barr Harbor Drive, P.O. Box C700
 West Conshohocken, PA 19428

D8257/D8257M-20 Standard Specification for Mechanically Attached Polymeric Roof Underlayment Used in Steep Slope Roofing

Staff Analysis: A review of the standard proposed for inclusion in the code, ASTM D8257/D8257M-20 Standard Specification for Mechanically Attached Polymeric Roof Underlayment Used in Steep Slope Roofing, with regard to some of the key ICC criteria for referenced standards (Section 3.6 of CP#28) will be posted on the ICC website on or before March 16, 2022.

Reason Statement: The first language modification in this proposal is to stipulate that underlayment is required. I receive feedback regularly from contractors that while the existing language implies that underlayment is required, that requirement is not clearly stated. Additionally, this proposal adds the first ever consensus-based Standard that is applicable to synthetic/polymeric underlayments. The roofing industry has been in need of such a Standard for many years so that this category of products can be adequately evaluated for performance. This proposal also modifies the language that is applicable to installation of a 2-layer underlayment system (See below Fig. clarifying the Underlayment Lapping and Fastening) in such a way that it reduces waste (the current language results in a strip of underlayment that is too narrow to be used in most cases), and so that the lapping and fastening requirements are applicable to any width of underlayment. Finally, this proposal also adds an exception in the charging paragraph for consistency with current IBC language, and also includes some cleanup items for clarity and consistency.

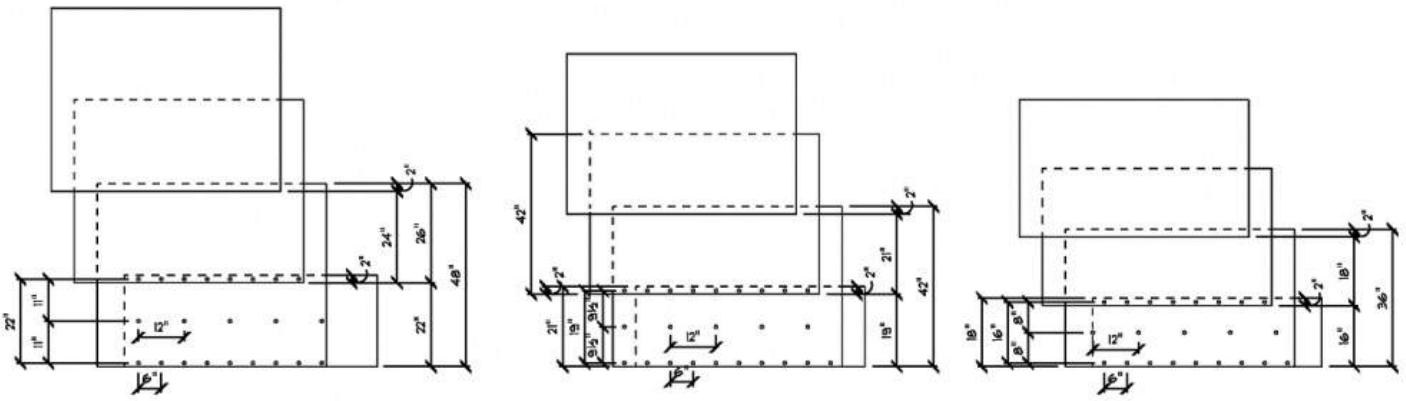

Cost Impact: The code change proposal will not increase or decrease the cost of construction. This proposal adds a new ASTM Standard for qualifying synthetic underlayments which have been in use for many years and clarifies and reorganizes existing requirements.

S25-22

IBC: 1507.1.3 (New); IEBC: [BS] 705.1

Proponents: Bill McHugh, representing Chicago Roofing Contractors Association (bill@mc-hugh.us)

2021 International Building Code

Add new text as follows:

1507.1.3 Flashing Heights for Low Sloped Roofs. For roofs with slope less than or equal to 2:12, vertical roof membrane flashings shall not be terminated less than 8" (203mm) above the top of the roof membrane surface.

2021 International Existing Building Code

Revise as follows:

[BS] 705.1 General. Materials and methods of application used for recovering or replacing an existing roof covering shall comply with the requirements of Chapter 15 of the International Building Code. For roofs with slope less than or equal to 2:12, vertical roof membrane flashings shall not be terminated less than 8" (203mm) above the top of the roof membrane surface.

Exceptions:

1. *Roof replacement* or roof recover of existing low-slope roof coverings shall not be required to meet the minimum design slope requirement of $\frac{1}{4}$ unit vertical in 12 units horizontal (2-percent slope) in Section 1507 of the International Building Code for roofs that provide positive roof drainage.
2. Recovering or replacing an existing roof covering shall not be required to meet the requirement for secondary (emergency overflow) drains or scuppers in Section 1502 of the International Building Code for roofs that provide for positive roof drainage. For the purposes of this exception, existing secondary drainage or scupper systems required in accordance with this code shall not be removed unless they are replaced by secondary drains or scuppers designed and installed in accordance with Section 1502 of the International Building Code.

Reason Statement: The purpose of this proposal is to put a minimum requirement in this section of the building and existing building code specifying a low sloped roof, less than or equal to 2:12 slope, (flat) for vertical roof membrane flashing heights. The IBC has been silent on this issue, causing all kinds of field interpretations from "do the best you can" to "isn't there an industry norm for 8" vertical height of flashings?". The most important point of this proposal is that the 8" vertical roof membrane flashing height provides protection from wind driven rain and snow that can be forced up under low flashings, entering the building through vented or open flashing tops. The minimum roof membrane flashing height requirement results in a better built building for the owner and manager.

Many industry blogs and manufacturers, in addition to the National Roofing Contractors Association's Roofing Manuals, mention the 8" minimum roof membrane vertical flashing height termination. However, we still have "do the best you can" as a reply to the question, "How high should flashings be on flat roofs", by many in the industry.

The minimum 8" vertical roof membrane flashing termination heights allow for a variety of roofing systems to be installed now and in the future. The NRCA's Roofing and Waterproofing Manuals recommend 8" vertical flashing heights as well. However, many standard details do not show a height from the top of the roof surface to the top of the vertical roof membrane flashing.

Cost Impact: The code change proposal will not increase or decrease the cost of construction

While it can be said this proposal might increase or decrease the cost of construction, it can also be said that this will decrease the cost of construction. From research, it was found that the major roofing manufacturers specify a 8" flashing height in their installation instructions and flashing details. However, because this is not a building code minimum requirement, the flashing heights can be altered in the field. Codifying a minimum requirement serves the building owner for the building life cycle, by providing a minimum benchmark that is crystal clear in the code.

S25-22

S26-22

IBC: 1507.2.8

Proponents: Aaron Phillips, representing Asphalt Roofing Manufacturers Association (ARMA) (aphillips@asphaltroofing.org)

2021 International Building Code

Revise as follows:

1507.2.8 Flashings. Flashing for asphalt shingles shall comply with this section. Flashing shall be applied in accordance with this section and the asphalt shingle manufacturer's ~~printed~~ instructions.

Reason Statement: Manufacturer's instructions are increasingly made available in media other than printed versions. This proposal removes the word "printed" from the only instance in IBC Chapter 15 where it is used in conjunction with "instructions." Removal of the word "printed" will permit alternative methods for providing instructions, including digital formats that support greater sustainability. The proposed change is important in light of events such as the COVID-19 pandemic, which brought attention to the need to deliver information using alternative methods.

Cost Impact: The code change proposal will not increase or decrease the cost of construction

The proposal expands available options for delivering manufacturer's instructions, which allows manufacturers to select the option that best serves their customers. There is no basis to expect either a general increase or decrease in cost of construction if this proposal is approved.

S26-22

S27-22

IBC: 1507.2.8.2

Proponents: Aaron Phillips, representing Asphalt Roofing Manufacturers Association (ARMA) (aphillips@asphaltroofing.org)

2021 International Building Code

Revise as follows:

1507.2.8.2 Valleys. Valley linings shall be installed in accordance with the manufacturer's instructions before applying shingles. Valley linings of the following types shall be permitted:

1. For open valleys (valley lining exposed) lined with metal, the valley lining shall be not less than 24 inches (610 mm) wide and of any of the corrosion-resistant metals in Table 1507.2.8.2.
2. For open valleys, valley lining of two plies of mineral-surfaced roll roofing complying with ASTM D3909 or ASTM D6380 shall be permitted. The bottom layer shall be 18 inches (457 mm) and the top layer not less than 36 inches (914 mm) wide.
3. For closed valleys (valleys covered with shingles), valley lining of one ply of smooth roll roofing complying with ASTM D6380, and not less than 36 inches (914 mm) wide or types as described in Item 1 or 2 above shall be permitted. Self-adhering polymer modified bitumen *underlayment* bearing a label indicating compliance with ASTM D1970 and not less than 36 inches (914 mm) wide shall be permitted in lieu of the lining material.

Reason Statement: Although implied, the minimum width of ASTM D1970 valley lining is not provided in the existing language of the IBC. This proposal establishes that ASTM D1970 underlayment used as closed valley lining must be at least 36" wide.

Cost Impact: The code change proposal will not increase or decrease the cost of construction. This proposal defines an implied requirement to remove ambiguity. No change in cost of construction is expected if this proposal is approved.

S27-22

S28-22

IBC: 1507.4.3, TABLE 1507.4.3(1), TABLE 1507.4.3(2), 1507.5.5

Proponents: Mark Graham, representing National Roofing Contractors Assoc. (mgraham@nrca.net)

2021 International Building Code

Revise as follows:

1507.4.3 Material standards. Metal-sheet *roof covering* systems that incorporate supporting structural members shall be designed in accordance with Chapter 22. Metal-sheet *roof coverings* installed over structural decking shall comply with Table 1507.4.3(1). ~~The materials used for metal-sheet *roof coverings* shall be naturally corrosion resistant or provided with *corrosion resistance* in accordance with the standards and minimum thicknesses shown in Table 1507.4.3(2).~~

TABLE 1507.4.3(1) METAL ROOF COVERINGS

ROOF COVERING TYPE	STANDARD APPLICATION RATE/THICKNESS
<u>5% Aluminum alloy-coated steel</u>	<u>ASTM A875, GF60</u>
Aluminum	ASTM B209, 0.024 inch minimum thickness for roll-formed panels and 0.019 inch minimum thickness for press-formed shingles.
<u>Aluminum-coated steel</u>	<u>ASTM A463, T2 65</u>
Aluminum-zinc alloy coated steel	ASTM A792 AZ 50
Cold-rolled copper	ASTM B370 minimum 16 oz./sq. ft. and 12 oz./sq. ft. high yield copper for metal-sheet roof covering systems; 12 oz./sq. ft. for preformed metal shingle systems.
Copper	16 oz./sq. ft. for metal-sheet roof-covering systems; 12 oz./sq. ft. for preformed metal shingle systems.
Galvanized steel	ASTM A653 G-90 zinc-coated ^a .
Hard lead	2 lbs./sq. ft.
Lead-coated copper	ASTM B101
Prepainted steel	ASTM A755
Soft lead	3 lbs./sq. ft.
Stainless steel	ASTM A240, 300 Series Alloys
Steel	ASTM A924
Terne and terne-coated stainless	Terne coating of 40 lbs. per double base box, field painted where applicable in accordance with manufacturer's installation instructions.
Zinc	0.027 inch minimum thickness; 99.995% electrolytic high grade zinc with alloy additives of copper (0.08% - 0.20%), titanium (0.07% - 0.12%) and aluminum (0.015%).

For SI: 1 ounce per square foot = 0.305 kg/m², 1 pound per square foot = 4.882 kg/m², 1 inch = 25.4 mm, 1 pound = 0.454 kg.

a. For Group U buildings, the minimum coating thickness for ASTM A653 galvanized steel roofing shall be G-60.

TABLE 1507.4.3(2) MINIMUM CORROSION RESISTANCE

55% Aluminum-zinc alloy coated steel	ASTM A792 AZ 50
5% Aluminum alloy coated steel	ASTM A875 GF60
Aluminum coated steel	ASTM A463 T2 65
Galvanized steel	ASTM A653 G-90
Prepainted steel	ASTM A755 ^a

- a. ~~Paint systems in accordance with ASTM A755 shall be applied over steel products with corrosion-resistant coatings complying with ASTM A463, ASTM A653, ASTM A792 or ASTM A875.~~

1507.5.5 Material standards. ~~Metal roof shingle roof coverings shall comply with Table 1507.4.3(1). The materials used for metal roof shingle roof coverings shall be naturally corrosion resistant or provided with corrosion resistance in accordance with the standards and minimum thicknesses specified in the standards listed in Table 1507.4.3(2).~~

Reason Statement: This code change is intended to clarify code's requirements regarding metal sheet stock used in fabricating metal roof panels and metal roof shingles.

This proposal combines existing Table 1507.4.3(1) and Table 1507.4.3(2) into a single new table, Table 1507.4.3. ASTM A792 AZ 50; ASTM G653 G90 and ASTM A755 currently occur in both tables. From existing Table 1507.4.3(2), ASTM A857 GF 60 and A463 T2 65 do not occur in Table 1507.4.3(1), so they these standards are being added to the new consolidated table.

From existing Table 1507.4.3(2), Footnote "a" is deleted. ASTM A463, ASTM A653, ASTM A792 and ASTM A875 are already incorporated into ASTM A755 and, therefore, these standards and this footnote are not necessary in the code.

There are no changes in code's technical requirements.

Cost Impact: The code change proposal will not increase or decrease the cost of construction. This is simply a clarification of existing provisions. There are no changes in code's technical requirements.

S29-22

IBC: SECTION 202, 1507.4.3, TABLE 1507.4.3(1), [BS] 3301.2.1

Proponents: Mark Graham, representing National Roofing Contractors Assoc. (mgraham@nrca.net)

2021 International Building Code

Revise as follows:

[BS] ROOF COATING. A fluid-applied, adhered coating used for roof maintenance or *roof repair*, or as a component of a ~~roof covering system or roof assembly~~.

ROOF COVERING SYSTEM. See "*Roof assembly*."

1507.4.3 Material standards. Metal-sheet ~~roof coverings systems~~ that incorporate supporting structural members shall be designed in accordance with Chapter 22. Metal-sheet *roof coverings* installed over structural decking shall comply with Table 1507.4.3(1). The materials used for metal-sheet *roof coverings* shall be naturally corrosion resistant or provided with *corrosion resistance* in accordance with the standards and minimum thicknesses shown in Table 1507.4.3(2).

TABLE 1507.4.3(1) METAL ROOF COVERINGS

ROOF COVERING TYPE	STANDARD APPLICATION RATE/THICKNESS
Cold-rolled copper	ASTM B370 minimum 16 oz./sq. ft. and 12 oz./sq. ft. high yield copper for metal-sheet roof coverings systems ; 12 oz./sq. ft. for preformed metal shingle systems.
Copper	16 oz./sq. ft. for metal-sheet roof coverings covering systems ; 12 oz./sq. ft. for preformed metal shingle systems.

For SI: 1 ounce per square foot = 0.305 kg/m², 1 pound per square foot = 4.882 kg/m², 1 inch = 25.4 mm, 1 pound = 0.454 kg.

- a. For Group U buildings, the minimum coating thickness for ASTM A653 galvanized steel roofing shall be G-60.

[BS] 3301.2.1 Structural and construction loads. Structural roof components shall be capable of supporting the ~~roof covering system~~, roof assembly, and the material and equipment *loads* that will be encountered during installation of the system.

Reason Statement: This code change proposal is intended to clarify the code's intent by eliminating the term "roof covering system" in its four uses in the code and using the already defined term "roof assembly" instead. While the term "roof covering system" is defined in Chapter 2-Definitions, its definition provides a see-reference to the term and definition for roof assembly as follows:

ROOF COVERING SYSTEM: See "*Roof assembly*."

This change eliminates the need for the see-reference and is not intended to change the technical requirements of the code. The existing four uses of the current term are revised with this proposal.

Cost Impact: The code change proposal will not increase or decrease the cost of construction. This is a clarification of an existing definition. There is no change in the code's technical requirements.

S30-22

IBC: 1507.8.1

Proponents: Chadwick Collins, representing Cedar Shake & Shingle Bureau (ccollins@kellencompany.com)

2021 International Building Code

Revise as follows:

1507.8.1 Deck requirements. Wood shingles shall be installed on solid or spaced sheathing. Where spaced sheathing is used, sheathing boards shall be not less than 1-inch by 4-inch (25 mm by 102 mm) nominal dimensions and shall be spaced on centers equal to the weather exposure to coincide with the placement of fasteners. Where 1-inch by 4-inch (25 mm by 102 mm) spaced sheathing is installed at 10 inches (254 mm) on center or greater, additional 1-inch by 4-inch (25 mm by 102 mm) boards shall be installed between the sheathing boards. When wood shingles are installed over spaced sheathing and the underside of the shingles are exposed to the attic space, the attic shall be ventilated in accordance with Section 1202.2. The shingles shall not be backed with materials that prevent the free movement of air on the interior side of the spaced sheathing.

Reason Statement: When shingles are installed over spaced sheathing, the underlayment is interwoven as the installation progresses. Due to this configuration, moisture can reach the underlayment. While much of the drying of the underlayment occurs in the direction of the exterior, some of the drying process occurs toward the interior. The exposure of this surface (the backside of the shingles and underlayment) to the ventilation space is necessary to facilitate this process. This language is proposed to ensure this configuration is maintained and not compromised with the installation of other building components, such as spray foam insulation, that would otherwise occupy this air space and eliminate this process. Further, installation of components such as spray foam insulation also eliminates one surface for shingles to release heat gained through exposure. This slows the release of heat energy, requiring the shingle to hold on to heat load for longer durations, which leads to shorter service life cycles

Cost Impact: The code change proposal will not increase or decrease the cost of construction
This proposal does not add any requirements to current construction practices, but clarifies the configuration of the installation.

S30-22

S31-22

IBC: 1507.8.6, 1507.9.7

Proponents: Chadwick Collins, representing Cedar Shake & Shingle Bureau (ccollins@kellencompany.com)

2021 International Building Code

Revise as follows:

1507.8.6 Attachment. ~~Fasteners for wood shingles shall be corrosion resistant with a minimum penetration of $\frac{3}{4}$ inch (19.1 mm) into the sheathing. For sheathing less than $\frac{1}{2}$ inch (12.7 mm) in thickness, the fasteners shall extend through the sheathing. Each shingle shall be attached with not fewer than two fasteners.~~ Fasteners for untreated (naturally durable) wood shingles shall be box nails in accordance with Table 1507.8. Nails shall be stainless steel Type 304 or 316 or hot-dipped galvanized with a coating weight of ASTM A153 Class D (1.0 oz/ft²). Alternatively, two 16-gage stainless steel Type 304 or 316 staples with crown widths 7/16 inch (11.1 mm) minimum, 3/4-inch (19.1 mm) maximum, shall be used. Fasteners installed within 15 miles (24 km) of saltwater coastal areas shall be stainless steel Type 316. Fasteners for fire-retardant-treated shingles or pressure-impregnated-preservative treated shingles of naturally durable wood in accordance with AWPA U1 shall be stainless steel Type 316. Fasteners shall have a minimum penetration into the sheathing of 3/4 inch (19.1 mm). For sheathing less than 3/4 inch (19.1 mm) in thickness, each fastener shall penetrate through the sheathing. Wood shingles shall be attached to the roof with two fasteners per shingle, positioned in accordance with the manufacturer's installation instructions. Fastener packaging shall bear a label indicating the appropriate grade material or coating weight.

1507.9.7 Attachment. ~~Fasteners for wood shakes shall be corrosion resistant with a minimum penetration of $\frac{3}{4}$ inch (19.1 mm) into the sheathing. For sheathing less than $\frac{1}{2}$ inch (12.7 mm) in thickness, the fasteners shall extend through the sheathing. Each shake shall be attached with not fewer than two fasteners.~~ Fasteners for untreated (naturally durable) wood shingles shall be box nails in accordance with Table 1507.8. Nails shall be stainless steel Type 304 or 316 or hot-dipped galvanized with a coating weight of ASTM A153 Class D (1.0 oz/ft²). Alternatively, two 16-gage stainless steel Type 304 or 316 staples with crown widths 7/16 inch (11.1 mm) minimum, 3/4-inch (19.1 mm) maximum, shall be used. Fasteners installed within 15 miles (24 km) of saltwater coastal areas shall be stainless steel Type 316. Fasteners for fire-retardant-treated shingles or pressure-impregnated-preservative treated shingles of naturally durable wood in accordance with AWPA U1 shall be stainless steel Type 316. Fasteners shall have a minimum penetration into the sheathing of 3/4 inch (19.1 mm). For sheathing less than 3/4 inch (19.1 mm) in thickness, each fastener shall penetrate through the sheathing. Wood shingles shall be attached to the roof with two fasteners per shingle, positioned in accordance with the manufacturer's installation instructions. Fastener packaging shall bear a label indicating the appropriate grade material or coating weight.

Reason Statement: This proposal is an effort to harmonize language in this section with the information in Table 1507.8 and match language in the International Residential Code for this material in Chapter 9.

Cost Impact: The code change proposal will not increase or decrease the cost of construction

This proposal will not increase the cost of construction as this update aligns this section with the requirements of currently found in Table 1507.8 and matches practices for this material as required in Chapter 9 of the International Residential Code since the 2015 edition and has been manufacturer's installation instructions requirements since 2010 (Cedar Shake & Shingle Bureau - New Construction Manual).

S31-22

S32-22

IBC: 1507.9.1

Proponents: Chadwick Collins, representing Cedar Shake & Shingle Bureau (ccollins@kellencompany.com)

2021 International Building Code

Revise as follows:

1507.9.1 Deck requirements. Wood shakes shall only be used on solid or spaced sheathing. Where spaced sheathing is used, sheathing boards shall be not less than 1-inch by 4-inch (25 mm by 102 mm) nominal dimensions and shall be spaced on centers equal to the weather exposure to coincide with the placement of fasteners. Where 1-inch by 4-inch (25 mm by 102 mm) spaced sheathing is installed at 10 inches (254 mm) on center, additional 1-inch by 4-inch (25 mm by 102 mm) boards shall be installed between the sheathing boards. Where wood shakes are installed over spaced sheathing and the underside of the shakes are exposed to the attic space, the attic shall be ventilated in accordance with Section 1202.2. The shakes shall not be backed with materials that prevent the free movement of air on the interior side of the spaced sheathing.

Reason Statement: When shakes are installed over spaced sheathing, the underlayment is interwoven as the installation progresses. Due to this configuration, moisture can reach the underlayment. While much of the drying of the underlayment occurs in the direction of the exterior, some of the drying process occurs toward the interior. The exposure of this surface (the backside of the shakes and underlayment) to the ventilation space is necessary to facilitate this process. This language is proposed to ensure this configuration is maintained and not compromised with the installation of other building components, such as spray foam insulation, that would otherwise occupy this air space and eliminate this process. Further, installation of components such as spray foam insulation also eliminates one surface for shakes to release heat gained through exposure. This slows the release of heat energy, requiring the shakes to hold on to heat load for longer durations, which leads to shorter service life cycles

Cost Impact: The code change proposal will not increase or decrease the cost of construction
This proposal does not add any requirements to current construction practices, but clarifies the configuration of the installation.

S32-22

S33-22

IBC: 1507.14.2

Proponents: Chadwick Collins, representing Roof Coating Manufacturers Association (RCMA) (ccollins@kellencompany.com)

2021 International Building Code

Revise as follows:

1507.14.2 Material standards. Liquid-applied roofing shall comply with ASTM C836, ASTM C957 ~~or~~ ASTM D3468, ASTM D6694, or ASTM D6947.

Reason Statement: In 2019, the successful proposal S32-19 removed these two reference standards as part of a larger edit with the reasoning statement that these products are specific intended for use in SPF roof system and their inclusion in 1507.13 (Sprayed Polyurethane Foam Roofing) as justification of that edit. Further, the new section 1509 included these two standards as acknowledgement that these products as roof coatings. Since, many Roof Coating Manufacturers Association (RCMA) members have indicated that these products are also installed as liquid-applied roofing systems, with the different installation instructions and in some cases, additional components such as reinforcements, to distinguish between their use as a roof coating and as a liquid-applied roofing system. This proposal is to reinstate those two material standards to eliminate any confusion if the referenced configurations are recognized and accepted by the building code.

Cost Impact: The code change proposal will not increase or decrease the cost of construction
This proposal is adding two reference standards for products that can be configured for installation as a liquid-applied roofing system.

S33-22

S34-22

IBC: 1507.14, 1507.14.1, 1507.14.2, 1507.14.3 (New), 1507.14.4 (New)

Proponents: Chadwick Collins, representing Roof Coating Manufacturers Association (RCMA) (ccollins@kellencompany.com)

2021 International Building Code

1507.14 Liquid-applied roofing. The installation of liquid-applied roofing shall comply with the provisions of this section.

1507.14.1 Slope. Liquid-applied roofing shall have a design slope of not less than $\frac{1}{4}$ unit vertical in 12 units horizontal (2-percent slope).

1507.14.2 Material standards. Liquid-applied roofing shall comply with ASTM C836, ASTM C957 or ASTM D3468.

Add new text as follows:

1507.14.3 Application. Liquid-applied roofing shall be installed in accordance with the manufacturer's installation instructions.

1507.14.4 Flashings. Flashings shall be applied in accordance section 1507.14 and the liquid-applied roofing manufacturer's installation instructions.

Reason Statement: This proposal provides clarity and direction that is missing from section 1507.14 regarding application and flashings that other sections within 1507 currently have for those respective materials. The manufacturer's installation instructions have the specifics for each specific product and should be the source material to consult for proper application and flashing guidance.

Cost Impact: The code change proposal will not increase or decrease the cost of construction
This proposal updates 1507.14 to mimic the format and content of sister subsections of 1507 to be consistent.

S34-22

S35-22 Part I

IBC: 1507.16.6, 1507.17.5

Proponents: Larry Sherwood, representing Sustainable Energy Action Committee (Larry@irecusa.org); Kevin Reinertson, representing California Fire Chiefs Association FPO (kevin.reinertson@fire.ca.gov); Benjamin Davis, representing California Solar & Storage Association (ben@calssa.org); Philip Oakes, representing National Association of State Fire Marshals; Joseph Cain, representing Solar Energy Industries Association (SEIA) (joecainpe@gmail.com)

THIS IS A 2 PART CODE CHANGE. PART I WILL BE HEARD BY THE IBC STRUCTURAL CODE COMMITTEE. PART II WILL BE HEARD BY THE IRC-B CODE COMMITTEE. SEE THE TENTATIVE HEARING ORDER FOR THESE COMMITTEES.

2021 International Building Code

Revise as follows:

1507.16.6 Material standards. *Photovoltaic shingles* shall be *listed* and labeled in accordance with UL 7103 ~~or with both UL 61730-1 and UL 61730-2.~~

1507.17.5 Material standards. BIPV roof panels shall be listed and labeled in accordance with UL 7103 ~~or with both UL 61730-1 and UL 61730-2.~~

S35-22 Part I

S35-22 Part II

IRC: R905.16.4, R905.17.5

Proponents: Larry Sherwood, representing Sustainable Energy Action Committee (larry@irecusa.org); Kevin Reinertson, representing California Fire Chiefs Association FPO (kevin.reinertson@fire.ca.gov); Benjamin Davis, representing California Solar & Storage Association (ben@calssa.org); Philip Oakes, representing National Association of State Fire Marshals; Joseph Cain, representing Solar Energy Industries Association (SEIA) (joecainpe@gmail.com)

2021 International Residential Code

Revise as follows:

R905.16.4 Material standards. *Photovoltaic shingles* shall be *listed* and *labeled* in accordance with UL 7103 ~~or with both UL 61730-1 and UL 61730-2.~~

R905.17.5 Material standards. *BIPV roof panels* shall be *listed* and *labeled* in accordance with UL 7103 ~~or with both UL 61730-1 and UL 61730-2.~~

Reason Statement: The standard for all forms of BIPV roof coverings and roof assemblies is UL 7103, which covers all aspects of these products – fire classification, material performance, and wind resistance. UL 61730-1 and UL 61730-2, which primarily cover the related electrical requirements, are part of the requirements within UL 7103.

This proposal was prepared by the Sustainable Energy Action Committee (SEAC), a forum for all stakeholders (including, but not limited to, AHJs, designers, engineers, contractors, first responders, manufacturers, suppliers, utilities, and testing labs) to collaboratively identify and find solutions for issues that affect the installation and use of solar energy systems, energy storage systems, demand response, and energy efficiency. The purpose is to facilitate the deployment and use of affordable, clean and renewable energy in a safe, efficient, and sustainable manner.

All recommendations from SEAC are approved by diverse stakeholders through a consensus process.

Cost Impact: The code change proposal will not increase or decrease the cost of construction. This proposal properly references the standard for BIPV roofing systems.

S35-22 Part II

S36-22

IBC: 1507.16.9 (New), 1507.17.9 (New)

Proponents: Mark Graham, representing National Roofing Contractors Assoc. (mgraham@nrca.net)

2021 International Building Code

Add new text as follows:

1507.16.9 Flashing. Flashing for *photovoltaic shingles* shall be installed in accordance with the *roof covering* manufacturer's installation instructions to prevent water from entering the wall and roof through joints in copings, through moisture-permeable materials and at intersections with *parapet walls* and other penetrations through the roof plane.

1507.17.9 Flashing. Flashing for BIPV roof panels shall be installed in accordance with the *roof covering* manufacturer's installation instructions to prevent water from entering the wall and roof through joints in copings, through moisture-permeable materials and at intersections with *parapet walls* and other penetrations through the roof plane.

Reason Statement: This code change proposal is intended to add guidance to building officials and users of the code by specifically indicating flashings for PV shingles and BIPV roof panels be installed according to the roof covering manufacturer's installation instructions.

Cost Impact: The code change proposal will not increase or decrease the cost of construction
This code change proposal adds clarity to the code; it does not change the codes existing technical requirements.

S36-22

S37-22

IBC: TABLE 1508.2, ASTM Chapter 35 (New)

Proponents: Greg Keeler, Owens Corning, representing Owens Corning (greg.keeler@owenscorning.com)

2021 International Building Code

Revise as follows:

TABLE 1508.2 MATERIAL STANDARDS FOR ROOF INSULATION

Cellular glass board	ASTM C552 or <u>ASTM C1902</u>
Composite boards	ASTM C1289, Type III, IV, V or VII
Expanded polystyrene	ASTM C578
Extruded polystyrene	ASTM C578
Fiber-reinforced gypsum board	ASTM C1278
Glass-faced gypsum board	ASTM C1177
High-density polyisocyanurate board	ASTM C1289, Type II, Class 4
Mineral fiber insulation board	ASTM C726
Perlite board	ASTM C728
Polyisocyanurate board	ASTM C1289, Type I or II
Wood fiberboard	ASTM C208, Type II

Add new standard(s) as follows:

ASTM

ASTM International
 100 Barr Harbor Drive, P.O. Box C700
 West Conshohocken, PA 19428

C1902-20 Standard Specification for Cellular Glass Insulation Used in Building and Roof Applications

Staff Analysis: A review of the standard proposed for inclusion in the code, ASTM C1902-20 Standard Specification for Cellular Glass Insulation Used in Building and Roof Applications, with regard to some of the key ICC criteria for referenced standards (Section 3.6 of CP#28) will be posted on the ICC website on or before March 16, 2022.

Reason Statement: Today, the scope of ASTM C552, “Standard Specification for Cellular Glass Thermal Insulation”, encompasses applications where the cellular glass is intended to be used on surfaces that operate between -450 F and 800 F. While useful in industrial and pipe applications, this temperature range is much broader than needed for typical building material applications and limits the flexibility in the manufacturing operation to modify the formulation or process to tailor the properties to the needs of the building materials market. Therefore, the new material specification of ASTM C1902, “Standard Specification for Cellular Glass Insulation Used in Building and Roof Applications”, is being proposed that is better aligned to service the building materials market. This specification would be differentiated from the existing ASTM C552 specification in the following ways:

1. Narrow the scope of the service temperature range to that of typical building applications
 - a. From the industrial temperature of -450 F to 800 F to the building temperature range of -50 F to 200 F
2. Remove properties that are not pertinent to the building materials market
 - a. Hot-surface performance warpage – This test refers primarily to high-temperature insulations that are applicable to hot-side temperatures as high as 800° F to determine material warpage or cracking and is not relevant to buildings.
 - b. Stress corrosion – This test is for insulation in contact with austenitic stainless-steel piping to assess corrosion of a stressed component and is not relevant to buildings.
3. Add properties that are pertinent to the building materials market
 - a. Dimensional stability – This is a measurement of a material's change in dimensions in response to various environmental exposure conditions, which can be important to building systems.

Cost Impact: The code change proposal will decrease the cost of construction. The current code language requires products to be over-engineered for the building application and does not address dimensional stability, a key characteristic for building insulation. This proposed change addresses dimensional stability, over-engineering, and enables the product density to be reduced to enable lower cost and improved thermal resistance of the cellular glass. The improved thermal resistance further enables reduced energy usage for the occupied building.

S38-22

IBC: 1509.1, 1509.2, 1509.3 (New), 1509.4 (New)

Proponents: Chadwick Collins, representing Roof Coating Manufacturers Association (RCMA) (ccollins@kellencompany.com)

2021 International Building Code

1509.1 General. The installation of a *roof coating* on a *roof covering* shall comply with the requirements of Section 1505 and this section.

1509.2 Material standards. Roof coating materials shall comply with the standards in Table 1509.2.

Add new text as follows:

1509.3 Application. Roof coatings shall be installed in accordance with the manufacturer's installation instructions.

1509.4 Flashings. Roof coatings shall be applied to flashings in accordance with section 1509 and the roof coating manufacturer's installation instructions.

Reason Statement: This proposal provides clarity and direction that is missing from 1509 regarding application that is found with other materials in chapter 15. The manufacturer's installation instructions have the specifics for each coating type and to the various substrates that the product may be installed over which is the reason directing stakeholders to the source material for consultation is being proposed.

Cost Impact: The code change proposal will not increase or decrease the cost of construction
This proposal updates 1509 to mimic the format and content of other material sections in chapter 15.

S38-22

S39-22

IBC: SECTION 1510 (New), SECTION 202 (New), 1510.1 (New), 1510.2 (New), 1510.3 (New), 1510.4 (New), 1510.4.1 (New)

Proponents: Chadwick Collins, representing Protected Membrane Roofing Institute (ccollins@kellencompany.com)

2021 International Building Code

Add new text as follows:

SECTION 1510 PROTECTED MEMBRANE ROOF ASSEMBLIES

Add new definition as follows:

PROTECTED MEMBRANE ROOF ASSEMBLY. A roof assembly of interacting components designed to waterproof a building's top surface where insulation is installed above the roof membrane and outside of the air barrier.

Add new text as follows:

1510.1 General. A protected membrane roof assembly shall comply with the applicable requirements of this Chapter.

1510.2 Landscaped roofs and vegetative roofs. Landscaped roofs and vegetative roofs that include protected membrane roof assemblies shall comply with Sections 1505.10 and 1507.15.

1510.3 Foam plastics. Foam plastic insulation in protected membrane roof assemblies shall comply with the applicable requirements of Chapter 26.

1510.4 Installation. Protected membrane roof assemblies shall be installed in accordance with the manufacturer's installation instructions.

1510.4.1 Flashing. Flashing for protected membrane roof assemblies shall be installed in accordance with this Section and the manufacturers installation instructions.

Reason Statement: The current IBC presumes that foam plastic insulation in roofing assemblies is installed within the assembly and below the membrane. That installation is common with many roof covering types, including single-ply, EPDM, and other roofing materials. For example, section 1508.1 includes a reference to above-deck foam plastic insulation being installed below an approved roof covering.

There are many applications of low-slope systems where some or all of the above-deck insulation is installed above the roof covering membrane. These systems are known as Protected Membrane Roofs and are commonly used for vegetative and landscaped roofs.

The proposal adds a new Section to address this growing segment of the roofing market by establishing the minimum standards specific to this use. It also adds a definition for the assembly to clarify when this proposed section would apply. The new section includes basic provisions for installation, flashing, and foam plastic installation requirements. Additionally, it provides pointers to the appropriate provisions for vegetative and landscaped roofs. It should be noted that proposal F15-21 modified definitions for vegetative roofing and landscaped roofs by making careful distinctions between a vegetative roof system, and a landscaped roof- meaning a roof that has landscaping elements above but not part of the roof assembly. This proposal completes the work done last year by including protected membrane roofs in the IBC.

Cost Impact: The code change proposal will not increase or decrease the cost of construction

The proposal would provide additional roofing options in the code, and help streamline product approval. The use of protected membrane roofing is not mandatory thus adds no new requirements.

S39-22

S40-22

IBC: [BF] 1510.2

Proponents: Phillip Smith, representing fm approvals (phillip.smith@fmglobal.com)

2021 International Building Code

Revise as follows:

[BF] 1510.2 Fire testing. *Radiant barriers* shall be permitted for use above decks where the *radiant barrier* is covered with an *approved roof covering* and the system consisting of the *radiant barrier* and the *roof covering* complies with the requirements of either FM ~~4450~~ 4470 or UL 1256.

Staff Analysis: The proposed referenced standard, FM 4470, is currently referenced in the International Building Code.

Reason Statement: all requirements of 4450 are included in 4470.

Cost Impact: The code change proposal will not increase or decrease the cost of construction
All requirements of 4450 are included in 4470

S40-22

S41-22

IBC: SECTION 1511 (New), 1511.1 (New), 1511.2 (New), 3111.3.6 (New), ASTM Chapter 35 (New)

Proponents: Mark Graham, representing National Roofing Contractors Assoc. (mgraham@nrca.net)

2021 International Building Code

Add new text as follows:

SECTION 1511 **ROOFTOP-MOUNTED PHOTVOLTAIC PANEL SYSTEMS**

1511.1 General. Rooftop-mounted photovoltaic panel systems shall be designed and installed in accordance with Section 3111.

1511.2 Roof penetration flashing. Flashing for rooftop-mounted photovoltaic panel systems shall be installed in accordance with the roof covering manufacturer's installation instructions to prevent moisture from entering through roof penetrations.

Exception: The application of flashing in accordance with ASTM E2766 is permitted.

3111.3.6 Roof penetrations. Roof penetrations shall be flashed in accordance with Chapter 15.

Add new standard(s) as follows:

ASTM

ASTM International
100 Barr Harbor Drive, P.O. Box C700
West Conshohocken, PA 19428

E2766-13(2019)

Standard Practice for Installation of Roof Mounted Photovoltaic Arrays on Steep-Slope Roofs

Staff Analysis: A review of the standard proposed for inclusion in the code, ASTM E2766-13(2019) Standard Practice for Installation of Roof Mounted Photovoltaic Arrays on Steep-Slope Roofs, with regard to some of the key ICC criteria for referenced standards (Section 3.6 of CP#28) will be posted on the ICC website on or before March 16, 2022.

Reason Statement: This code change proposal proposal is intended to provide guidance to building officials and user of the code regarding flashing penetrations in rooftop-mounted PV panel systems. This proposal adds a new section to Chapter 15, Section 1511, specifically addressing rooftop-mounted PV panel systems. This new section first provides a pointer to IBC's existing requirements for PV systems, then adds specific direction regarding flashing roof penetrations. Flashing penetrations are required to be in accordance with the roof covering manufacturer's installation instructions or compliance with ASTM E2766 is permitted. ASTM E2766, "Standard Practice for Installation of Roof Mounted Photovoltaic Arrays on Steep-Slope Roofs," includes specific guidance on roof penetration flashings.

Cost Impact: The code change proposal will not increase or decrease the cost of construction. This proposal adds additional direction and guidance. It does not add additional requirements that will add to the cost of construction.

S41-22

S42-22

IBC: SECTION 1511 (New), 1511.1 (New), 1511.1.1 (New), 1511.1.2 (New), 1511.1.3 (New), 1511.1.4 (New)

Proponents: Bill McHugh, representing Chicago Roofing Contractors Association (bill@mc-hugh.us)

2021 International Building Code

Add new text as follows:

SECTION 1511 **AIR BARRIERS**

1511.1 General. A continuous air barrier shall be provided throughout the building thermal envelope. The continuous air barriers shall be located on the inside or outside of the building thermal envelope, located within the assemblies composing the building thermal envelope, or any combination thereof. Air Barrier construction shall comply with the *International Building Code*, *International Energy Conservation Code*, and shall comply with Sections 1511.1.1 through 1511.1.4.

Exception: Air barriers are not required in buildings located in *Climate Zone 2B* as referenced in the *International Energy Conservation Code*.

1511.1.1 Construction. The continuous air barrier shall be constructed to comply with the following:

1. The air barrier shall be continuous for all assemblies that are the thermal envelope of the building and across the joints and assemblies.
2. Air barrier joints and seams shall be sealed, including sealing transitions in places and changes in materials. The joints and seals shall be securely installed in or on the joint for its entire length so as not to dislodge, loosen or otherwise impair its ability to resist positive and negative pressure from wind, stack effect and mechanical ventilation.
3. Penetrations of the air barrier shall be caulked, gasketed or otherwise sealed in a manner compatible with the construction materials and location. Sealing shall allow for expansion, contraction and mechanical vibration. Joints and seams associated with penetrations shall be sealed in the same manner or taped. Sealing materials shall be securely installed around the penetration so as not to dislodge, loosen or otherwise impair the penetrations' ability to resist positive and negative pressure from wind, stack effect and mechanical ventilation. Sealing of concealed fire sprinklers, where required, shall be in a manner that is recommended by the manufacturer. Caulking or other adhesive sealants shall not be used to fill voids between fire sprinkler cover plates and walls or ceilings.
4. Recessed lighting fixtures shall comply with Section C402.5.10. Where similar objects are installed that penetrate the air barrier, provisions shall be made to maintain the integrity of the air barrier.

1511.1.2 Continuous air barrier. A continuous air barrier for the opaque building envelope shall comply with the following:

1. Buildings or portions of buildings, including Group R and I occupancies, shall meet the provisions of Section C402.5.2.

Exception: Buildings in *Climate Zones 2B, 3C and 5C*.

2. Buildings or portions of buildings other than Group R and I occupancies shall meet the provisions of Section C402.5.3.

Exceptions:

1. Buildings in *Climate Zones 2B, 3B, 3C and 5C*.
 2. Buildings larger than 5,000 square feet (464.5 m²) floor area in *Climate Zones 0B, 1, 2A, 4B and 4C*.
 3. Buildings between 5,000 square feet (464.5 m²) and 50,000 square feet (4645 m²) floor area in *Climate Zones 0A, 3A and 5B*.
3. Buildings or portions of buildings that do not complete air barrier testing shall meet the provisions of Section C402.5.1.3 or C402.5.1.4 in addition to Section C402.5.1.5.

1511.1.3 Materials. Materials with an air permeability not greater than 0.004 cfm/ft² (0.02 L/s × m²) under a pressure differential of 0.3 inch water gauge (75 Pa) when tested in accordance with ASTM E2178 shall comply with this section. Materials in Items 1 through 16 shall be deemed to comply with this section, provided that joints are sealed and materials are installed as air barriers in accordance with the manufacturer's instructions.

1. Plywood with a thickness of not less than $\frac{3}{8}$ inch (10 mm).
2. Oriented strand board having a thickness of not less than $\frac{3}{8}$ inch (10 mm).

3. Extruded polystyrene insulation board having a thickness of not less than $\frac{1}{2}$ inch (12.7 mm).
4. Foil-back polyisocyanurate insulation board having a thickness of not less than $\frac{1}{2}$ inch (12.7 mm).
5. Closed-cell spray foam having a minimum density of 1.5 pcf (2.4 kg/m³) and having a thickness of not less than $1\frac{1}{2}$ inches (38 mm).
6. Open-cell spray foam with a density between 0.4 and 1.5 pcf (0.6 and 2.4 kg/m³) and having a thickness of not less than $4\frac{1}{2}$ inches (113 mm).
7. Exterior or interior gypsum board having a thickness of not less than $\frac{1}{2}$ inch (12.7 mm).
8. Cement board having a thickness of not less than $\frac{1}{2}$ inch (12.7 mm).
9. Built-up roofing membrane.
10. Modified bituminous roof membrane.
11. Single-ply roof membrane.
12. A Portland cement/sand parge, or gypsum plaster having a thickness of not less than $\frac{5}{8}$ inch (15.9 mm).
13. Cast-in-place and precast concrete.
14. Fully grouted concrete block masonry.
15. Sheet steel or aluminum.
16. Solid or hollow masonry constructed of clay or shale masonry units.

1511.1.4 Assemblies. Assemblies of materials and components with an average air leakage not greater than 0.04 cfm/ft² (0.2 L/s × m²) under a pressure differential of 0.3 inch of water gauge (w.g.) (75 Pa) when tested in accordance with ASTM E2357, ASTM E1677, ASTM D8052 or ASTM E283 shall comply with this section. Assemblies listed in Items 1 through 3 shall be deemed to comply, provided that joints are sealed and the requirements of Section C402.5.1.1 of the International Energy Conservation Code are met.

1. Concrete masonry walls coated with either one application of block filler or two applications of a paint or sealer coating.
2. Masonry walls constructed of clay or shale masonry units with a nominal width of 4 inches (102 mm) or more.
3. A Portland cement/sand parge, stucco or plaster not less than $\frac{1}{2}$ inch (12.7 mm) in thickness

Staff Analysis: These provisions are duplicated from the 2021 International Energy Conservation Code.

Reason Statement: Air Barrier requirements appeared in The 2012 International Energy Conservation Code. While air barriers are required in great detail in the IECC, there is nowhere in the International Building Code that covers details for building these assemblies. In the IBC, there are chapters for plastics, where insulation is regulated. Roofing materials are regulated in Chapter 15. After a search of the 2021 IBC, it was found that air barrier is mentioned once, in Chapter 12, and not in the context of an air barrier found in the IECC.

The building envelope covers the whole building, and all that's encompassed in the assemblies. There are thermal, moisture and fire requirements, penetrations and breaches made for joints, all that have to be accounted for in air barrier design. Having air barriers in the same code as the rest of the building requirements means consistency and better built buildings.

In order to build air barriers to protect the building elements - and their interaction with other requirements, the air barrier sections belong duplicated in the International Building Code.

Cost Impact: The code change proposal will not increase or decrease the cost of construction

Since air barriers are already required by the International Energy Conservation Code, this proposal will not increase the cost of construction, nor will it decrease. It is the hope that the air barrier will be built with all the other complexities of buildings referenced in the same code, the IBC.

S43-22

IBC: [BG] 1511.7, 1511.7.6 (New), 1511.7.6.1 (New)

Proponents: Amanda Hickman, representing Single-Ply Roofing Industry (SPRI) (amanda@thehickmangroup.com)

2021 International Building Code

Revise as follows:

[BG] 1511.7 Other rooftop structures. *Rooftop structures* not regulated by Sections 1511.2 through 1511.6 shall comply with Sections 1511.7.1 through 1511.7.5.6, as applicable.

Add new text as follows:

1511.7.6 Lightning Protection Systems. Lightning protection system components shall be installed in accordance with Section 1511.7.6.1. Lightning protection systems shall not be attached directly to metal edge systems, including gutters, where these roof assembly components are required to be tested to ANSI/SPRI/FM 4435-ES-1 or ANSI/SPRI GT-1 in accordance with Sections 1504.6 or 1504.6.1.

Exception: Where permitted by the manufacturer's installation instructions for the metal edge systems or gutters.

1511.7.6.1 Installation. Lightning protection system components directly attached to or through the roof covering shall be installed in accordance with this chapter and the roof covering manufacturer's installation instructions. Flashing shall be installed in accordance with the roof assembly manufacturer's installation instructions and Sections 1503.2 and 1507 where the lightning protection system installation results in a penetration through the roof plane.

Reason Statement: Progress was made during the Group A cycle to include Lightning Protection Systems (LPS) and their appropriate installation standards in the IBC (G176-21). However, these standards (NFPA 780 and UL 96A) are currently silent on the impact the attachment of LPS have on the roof.

In order to preserve the building envelope in a wind or weather event, it is critical to maintain the integrity of the roof components which are required by code to be tested and to ensure weatherproofing continuity.

Even in moderate wind events, there have been documented failures of code compliant and tested roof assembly components where LPS were attached.

Roof assembly components such as coping and gutters are required by code to be tested to specific wind loads. LPS attachments to these roof component systems not only alter the wind load on of these tested components, but also alter their performance by restricting thermal movement causing galvanic reaction, leak point, etc.

This proposal clarifies that attachment of LPS to any part of the roof needs to be done in accordance with the installation instructions for the roof assembly, roof covering, metal edge systems, or gutter. Where LPS components attach to or penetrate the roof, they must be properly flashed. Reasonable and readily available methods and details exist to attach LPS systems independent of coping, fascia, gutter and roof assembly components and for flashing of existing LPS attachment methods where penetrations are required. This proposal clarifies that regardless of sequencing challenges which may exist in new or retrofit applications of LPS, the integrity of tested components and the envelope shall be maintained.





Due to the installation of the Lightning Protection System components there may be certain details which require additional hot air welded patches installed under cable splices, frayed cable, and specific connections that could abrade the membrane. Hot air welded patches will provide sufficient protection to the field membrane from abrasion. Pictures below show examples of areas where additional hot air welded patches would be required.

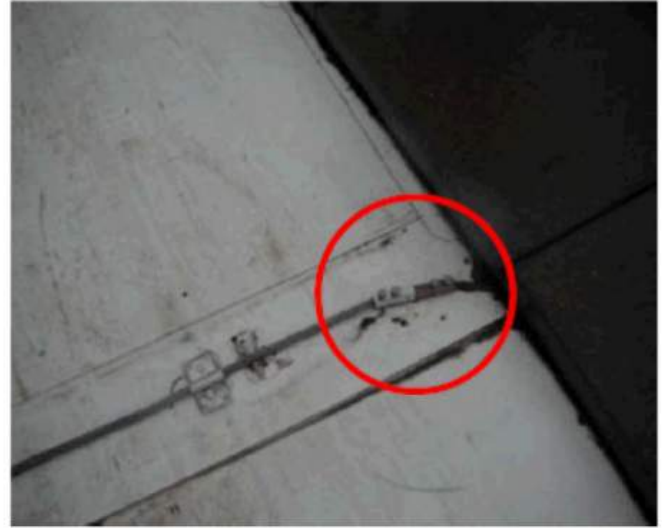





Cost Impact: The code change proposal will not increase or decrease the cost of construction

This proposal just clarifies that LPS must be installed in accordance with the roofing component manufacturer's installation instructions. Flashing is already required for penetrations. There will, however, be a reduction in failure costs.

S43-22

S44-22

IBC: 1512.1

Proponents: Emily Lorenz, representing International Institute of Building Enclosure Consultants (emilyblorenz@gmail.com)

2021 International Building Code

Revise as follows:

1512.1 General. Materials and methods of application used for recovering or replacing an existing *roof covering* shall comply with the requirements of Chapter 15.

Exceptions:

1. *Roof replacement* or *roof recover* of existing low-slope *roof coverings* shall not be required to meet the minimum design slope requirement of $\frac{1}{4}$ unit vertical in 12 units horizontal (2-percent slope) in Section 1507 for roofs that provide *positive roof drainage* and meet the requirements of Section 1608.3 and Section 1611.2.
2. Recovering or replacing an existing *roof covering* shall not be required to meet the requirement for secondary (emergency overflow) drains or *scuppers* in Section 1502.2 for roofs that provide for *positive roof drainage*. For the purposes of this exception, existing secondary drainage or *scupper* systems required in accordance with this code shall not be removed unless they are replaced by secondary drains or *scuppers* designed and installed in accordance with Section 1502.2.

Reason Statement: This additional language is necessary to ensure public life-safety. It emphasizes the IBC requirement that susceptible bays be analyzed for ponding instability during structural design/loads analyses that are required incidental to the recovering or replacement of existing *roof coverings*, which adds new live loads to existing roof structures. As the IBC has evolved through periodic updates, there have been fundamental changes in its requirements related to roof drainage, structural requirements for ponding instability, and, with climate change, significant increases in design rain loads (both rainfall intensity and duration). Annually, re-roofing projects comprise about three-quarters of U.S. low-sloped roofing projects. This additional language is needed to reduce the likelihood of catastrophic roof collapses that occur from uncontrolled ponding and/or inadequate drainage that is directly related to new live loads imposed onto existing roof structures from re-roofing.

The following recent studies and case studies further support, in much greater detail, justification for the proposed additional language to Exception 1.

Fundamental Changes Related to Drainage

A 2012 study published by the American Society of Plumbing Engineers (ASPE) and the International Association of Plumbing and Mechanical Officials (IAPMO) concluded: "The research produced stunning results that verified that the sizing method for storm drainage systems, as required in the plumbing codes, is inaccurate." (Ballanco 2012) In summary, the roof drains design criteria the engineering/construction industry has been using for more than 70 years is flawed. Drainage assemblies' flow rates are based on the head of water over the drains and their geometry.

This research led to significant changes to the *IPC*. As of 2015, the *IPC* no longer publishes flow rates through drains. The *IPC* requires the designer to use "the published roof drain flow rate" for drainage design. The problem is that, at the time of this writing, there is only one drain manufacturer that publishes flow rates for their roof drains. The only published data on flow through drains is *FM Global Property Loss Prevention Data Sheets 1-54: Roof Loads for New Construction*, which essentially addresses only one type of drain. As a result of these code changes, the IIBEC-RCI Foundation recently published the second edition of *Roof Drainage* (IIBEC-RCI Foundation 2021), which provides an in-depth explanation of the new drainage design criteria and a guide for roof drainage designers. Accordingly, roof drainage systems that were designed per plumbing code requirement prior to *IPC* 2015 should be re-evaluated as part of roof recovering or replacement over an existing *roof covering*.

Structural Requirements for Ponding Instability

The second major change to codes involves structural requirements for ponding instability. Currently Section 1512.1 Exception 1 allows slopes less than $\frac{1}{4}$ inch per foot for re-roofing projects. By definition (2021 IBC Section 202), a *susceptible bay* is "a roof or portion thereof with a slope less than $\frac{1}{4}$ inch per foot." Sections 1608.3 and 1611.2 require that *susceptible bays* be evaluated for ponding instability in accordance with Chapters 7 and 8 of ASCE 7. This proposed change allows a slope of less than $\frac{1}{4}$ inch per foot only if the roof is not susceptible to ponding instability.

ASCE 7-16 significantly revised its "Chapter 8: Rain Loads" (ASCE 2016). Historically, ASCE and the model codes required ponding instability to be investigated when the roof slope was less than $\frac{1}{4}$ inch per foot. Ponding instability is a serious life-safety and structural issue for roofs. We have also learned that *ponding instability* is not just an issue on roofs with slopes less than $\frac{1}{4}$ -inch per foot, but can also an issue on many more roof configurations. In other words, the potential for roof collapse resulting from ponding instability is more widespread than originally thought, and there are a number of roofs constructed before the 2016 design standards were enacted that have never been analyzed for ponding instability.

The most significant change in the evaluation of ponding instability addressed in ASCE 7-16 is structural orientation. The load on the joists is much greater if the joists are oriented parallel to the wall to which the water drains than if the joists are perpendicular to the wall. Below is example of a

collapse in Dallas where ponding instability and structural orientation was an issue. The build-up of water on the 1st and 2nd joists running parallel to the wall was much greater than if the joists had been perpendicular to the wall. This condition resulted in excessive rainwater load on the joists.

Figure 1 (left) shows the roof collapse, and **Figure 1** (right) shows the structural orientation.



Figure 2 is an excerpt from “Roof Drainage Design, Roof Collapses, and the Code” (Patterson and Mehta 2018) illustrating the distribution on a roof with joists running parallel to the drainage wall (Patterson and Mehta 2018). In most cases these joists were designed using a live load of 16 psf, so the rainwater live load is double the design live load.

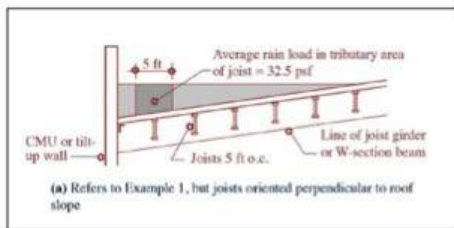

In a paper by Coffman and Williamson (2019), they discuss ponding that can occur due to differences between “design slope” found in IBC Chapter 15 and “roof slope” used in ASCE 7. Their recommendation is “When design constraints necessitate a 1/4 in 12 design slope be used, the framing members should be cambered or investigated for ponding.”

Increases in Design Rain Loads

ASCE 7-16 also recognized another important roof drainage design issue in “Section 8.2 Roof Drainage.” There have been two rainfall rates used for the design of secondary drainage systems. Currently, the IPC requires a 1-hour, 100-year rainfall rate for designing the secondary drainage system, while the *National Standard Plumbing Code* requires a 15-minute, 100-year rainfall rate for designing the secondary drainage system. The original *IPC* also included the requirement to use a 15-minute, 100-year rainfall rate for designing the secondary drainage system, which was also in the *Standard Plumbing Code* before the *IPC* replaced it. ASCE 7-16 added the requirement that the secondary drainage system be designed based on the 15-minute, 100-year rainfall rate, which is contrary to the current *IPC* requirements. The *IPC* requirements are also in conflict in the current IBC, which is the reason why this change is important. The 15-minute, 100-year rainfall rate is double (two times) the 1-hour, 100-year rainfall rate. In other words, to comply with ASCE 7 and Section 1608.3 and Section 1611.2 of the IBC, the secondary drainage system must be designed using double the design rainfall rate required in the *IPC*.

As a result, the secondary drainage system design can be based on the *IPC* and not meet the requirements of ASCE and the IBC. Chapter 3, Sections 3.4 and 3.5 of *Roof Drainage* (IIBEC-RCI Foundation 2021) provides an in-depth discussion of the use and importance of the 15-minute, 100-year design standard for secondary drainage systems. Essentially, ASCE 7 has doubled the “Rainwater Loads” on roofs.

In addition, Levine (2021) conducted a review of US rainfall intensity data reports and various plumbing codes from 1935 to the present. He found that “plumbing codes have remained relatively static, rarely contain current rainfall intensity data, and truly represent a minimum standard with regard to the design of roof drainage systems.”

Catastrophic Failures Due to Ponding

Ponding water on roofs, the accumulation of water on roofs, or *ponding instability* has the potential to cause serious structural/life safety issues, including roof collapses. There is a precedent for the ICC recognizing the significance of changes in design standards based upon new inputs, especially when related to life-safety issues. “Section 403.5 Bracing for unreinforced masonry parapets upon reroofing” and “Section 403.8 Roof diaphragms resisting wind loads in high-wind regions” in the IEBEC require the correction of potentially hazardous conditions from seismic and wind forces. When reroofing a building in a high-wind region, an analysis of the structural diaphragms and correction of the deficiencies are required. IEBEC Section 302.1, Dangerous Conditions, gives the building official “the authority to require the eliminate of conditions deemed *dangerous*.” IEBEC Section 706.2, Addition or replacement of roofing or replacement of equipment, requires replacement or alteration to structural elements when the structural element’s design dead, live or snow load, including snow drift effects, is increased by 5 percent. In roof re-cover situations, the additional load from the re-cover roof is not the only increase in gravity loads, because the changes in the IBC and ASCE 7, as discussed previously, have doubled the gravity load from rainwater. These “Rain Loads” changes in ASCE 7 were made to address significant life-

safety structural issues related to water accumulation on roofs. Michael O'Rourke, PhD, PE and Aaron Lewis, PE have published an excellent monograph regarding rain loads (O'Rourke and Lewis 2020).

Case Studies of Failures

Case Study 1: Roof Failure in Walhalla, South Carolina, on October 8, 2017 (Figures 3-4)

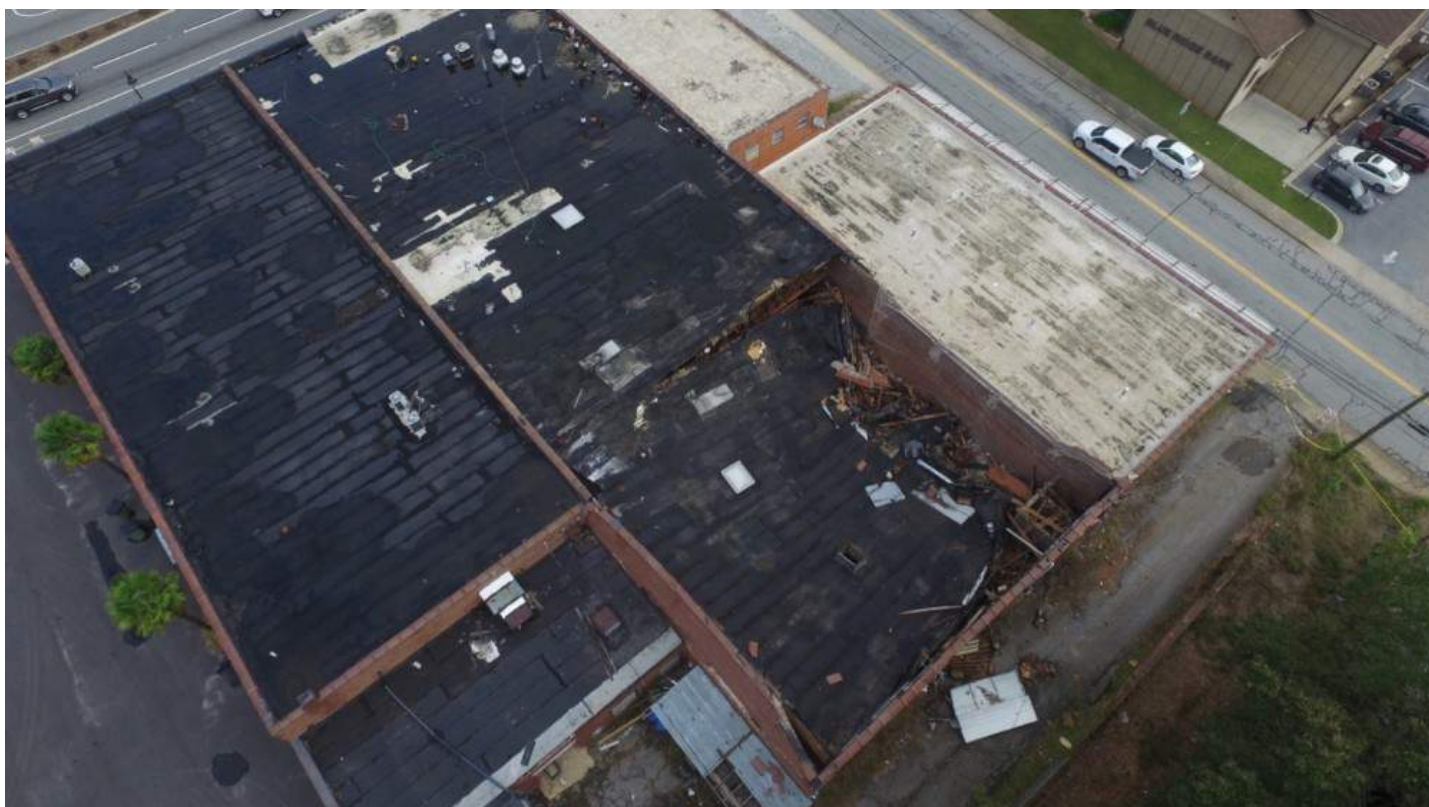

Background:

Construction Science and Engineering, Inc. of Westminster, SC, performed an investigation following the collapse of a roof structure in Walhalla, SC, in October of 2017. Research was limited due to the number of weather recording stations proximate to the subject building; however, a private weather station within 3 miles of the building reported 4.3 in. of rain on the day of the event.

Findings:

In the opinion of Construction Science and Engineering, Inc., the primary cause of the roof collapse was due to excessive and rapid water accumulation on the roof during the significant weather event on October 8, 2017. The reported 5 in. of rainwater reported by the adjacent resident was similar to the 4.3 in. of rainwater measured from the closest private weather station. Additionally, the measured 3.5 in. water depth at the rear of an adjacent building 3 days after the rain event corroborated the reported rain amounts.

A 20 psf unreduced roof design load is specified as the standard in the applicable building code. An accumulation of 5 in. of rainwater equates to approximately 26 psf load on a roof structure. This roof load represents approximately 30% higher load than the current code prescribed design load. Due to the installation of the granular cap sheet below the tile parapet cap, the weight of the water is believed to have initiated the steel truss collapse by pulling a portion of the masonry brick parapet wall onto the roof. This impact force would result in the damage observed at the subject property.

Per Figure 1106.1(3), 100-Year, 1-Hour Rainfall (Inches) Eastern United States provides the 100-year hourly rainfall rate is 4.0 inches for Walhalla, South Carolina.

Case Study 2:

Roof Failure in Kinston, North Carolina, on August 1, 2020 (**Figures 5-7**)







Background:

REI Engineers, Inc. of Greenville, NC, performed an investigation following the collapse of a roof structure in Kinston, NC, in August of 2020.

Findings:

In the opinion of REI Engineers, Inc., the primary cause of the roof collapse was due to excessive loading of the roof framing system. Examination of the roof storm drainage system showed the primary drainage scuppers to be obstructed by debris. Additionally, no secondary (emergency) drainage was observed. The combined factors of failure of the primary drainage system and lack of an overflow drainage system most likely caused the excess amount of water to accumulate on the roof, as it was contained by the structure's parapet. This additional load exceeded the structural framing's ability and a failure of the framing occurred by collapse.

Bibliography: American Society of Civil Engineers (ASCE). 2016. *ASCE 7 -16: Minimum Design Loads Minimum Design Loads and Associated Criteria for Buildings and Other Structures*. Reston, VA: ASCE.

Ballanco, Julius. 2012. *Storm Drainage System Research Project: Flow Rate Through Roof Drains*. Rosemont, IL: American Society of Plumbing Engineers (ASPE) Research Foundation.

Coffman, Scott D., and Thomas Williamson. 2019. "Low-Slope Roofs: Design Solutions for Building Code-Permitted Low-Slope Applications that Cause Ponding Water."

Civil + Structural Engineering. Fayetteville, AR: Zweig Group.

Levine, Jeffrey. 2021. "Rainfall Intensity Changes Over Time: Have the Codes Kept Pace?," *Interface*, 39 (10): International Institute of Building Enclosure Consultants.

O'Rourke, Michael, and Aaron R. Lewis. 2020. *Rain Loads: Guide to the Rain Load Provisions of ASCE 7-16*. Reston, VA: ASCE.

Patterson, Stephen, and Medan Mehta. 2021. *Roof Drainage*. Second Edition, Raleigh, NC: IIBEC-RCI Foundation.

Patterson, Stephen L., and Madan Mehta. 2018. "Roof Drainage Design, Roof Collapses, and the Code" in *Proceedings of the 33^d RCI International Convention and Trade Show*, March 22-27, 2018: RCI.

Cost Impact: The code change proposal will increase the cost of construction

Most buildings that will be reroofed already meet IBC requirements, and there will be no increased costs resulting from the proposed additional language. Most residential and multi-family buildings' roofs (typically steep-slope) and commercial buildings' roofs that drain over the edge and buildings with rigid structures will not be affected.

There will be increased costs to buildings with flexible structural elements that are susceptible to *ponding instability*, which leads to roof structure overloading and catastrophic roof collapse. These buildings would fall into the "Dangerous Condition" category, as defined in IEBC Section 401.3 (however, it should be noted that the IEBC is typically a voluntary code in most jurisdictions, and accordingly, this issue needs to be fully discussed in the IBC).

For these "Dangerous Condition" buildings, additional cost would involve a structural engineering evaluation to determine that the building structure with new live loading is safe. In a majority of cases, it is presumed that structural engineering evaluation would be the extent of the additional costs, since building structures are typically designed with sufficient additional safety factors. In cases where a structural engineering evaluation indicates a building/roof structure is unsafe, there would be additional costs to strengthen, supplement, replace or otherwise alter the structure, as required to carry the additional loads. These costs would vary from building-to-building depending upon the extent of the discovered issues. In most cases, overflow drains or scuppers could be added or resized to limit the amount of water that would accumulate on the new roof. Overflow scuppers costs vary from \$500 to \$1,500 depending on their complexity.

Regardless, the costs to evaluate and/or modify a structure that has been found to be unsafe from additional loading caused by re-roofing, is necessary to protect public life-safety.

S45-22

IBC: 1512.1

Proponents: Emily Lorenz, representing International Institute of Building Enclosure Consultants (emilyblorenz@gmail.com)

2021 International Building Code

Revise as follows:

1512.1 General. Materials and methods of application used for recovering or replacing an existing *roof covering* shall comply with the requirements of Chapter 15.

Exceptions:

1. *Roof replacement* or *roof recover* of existing low-slope *roof coverings* shall not be required to meet the minimum design slope requirement of $\frac{1}{4}$ unit vertical in 12 units horizontal (2-percent slope) in Section 1507 for roofs that provide *positive roof drainage*.
2. Recovering or replacing an existing *roof covering* shall not be required to meet the requirement for secondary (emergency overflow) drains or *scuppers* in Section 1502.2 for roofs that provide for *positive roof drainage* and have been determined to resist all design loads. For the purposes of this exception, existing secondary drainage or *scupper* systems required in accordance with this code shall not be removed unless they are replaced by secondary drains or *scuppers* designed and installed in accordance with Section 1502.2.

Reason Statement: This amended language is necessary to ensure public life-safety. It clarifies specifically when the Exception 2 is applicable so as to prevent roof collapses/structural overload failures from uncontrolled ponding, incidental to new dead-loads imposed onto existing roof structures, inadequate/missing secondary drainage assemblies at existing roofs, or alteration of drainage assemblies during re-roofing projects. This amended language is also needed to ensure preservation of physical assets or operations covered by existing roofs that are subject to re-roofing. The IBC and its predecessor building codes have long called for scuppers (or other secondary drainage measures) within all roofs that incorporate parapet walls and within other low-slope roofs, to prevent roof-structure overload and collapse. If during a low-slope re-roofing project, an owner discovers that their as-constructed roof has defective or missing code-required emergency overflow or secondary-drainage assemblies, the existing roof was most likely not code-compliant at the time of its installation and was and remains a danger to public life-safety from catastrophic collapse.

The following recent studies further support, in much greater detail, justification for the proposed additional language to Exception 2.

Secondary Drainage Should Have Been Provided During Original Construction

Chapter 15, Section 1502.2 Secondary (emergency overflow) drains or scuppers requires that, “secondary (emergency overflow) drains or scuppers shall be provided where the roof perimeter construction extends above the roof in such a manner that water will be entrapped if the primary drains allow buildup for any reason.” Generally, this provision only applies to low-sloped roofs with parapet walls. As the title suggests, the *secondary drainage system* is an *emergency system* that is required to prevent the roof structures from collapsing in the event of an unsafe buildup of water. The *secondary (emergency overflow) drains or scuppers* are the safety valves for the roof structure.

Building codes have required that buildings have an *emergency overflow drainage system* since modern codes were introduced. Below is an excerpt from Chapter 32 Roof Construction and Covering from the first *Uniform Building Code* (1927) requiring that, “Overflows ... (be) installed at each low point to which the water drains.” (**Figure 1**)

Roof Drainage **Sec. 3206.** Roofs of all buildings shall be sloped so that they will drain to gutters and downspouts which shall be connected with conductors to carry the water down from the roof underneath the sidewalk to and through the curb. Overflows shall be installed at each low point of the roof to which the water drains.

Doesn't Apply to Roofs Designed to Drain Over Edge

The provision for an *emergency overflow drainage system* does not apply to roofs that drain over the edge, which are the vast majority of buildings. These include most residential buildings, multi-family buildings, pre-engineered metal buildings, and buildings with low-slope roofs that drain over the edge into the gutters. The provision only applies to roofs where water can accumulate when the primary drains are blocked, i.e., buildings with parapet walls. A building with parapet walls and no *emergency overflow drainage system* did not meet building codes when they were built and do not meet the building codes today.

Exception: Buildings where the structure is sufficient to support the buildup of water do not require overflow. One example of this would be a concrete structure designed to be a future floor. In many cases, these roofs will support water that would build up to the top of the parapet wall. A typical parapet 2-foot wall would result in 2-feet of water buildup at the perimeter or 125 psf of Rain Load (**Figure 2**).

Exception: Buildings where the structure is sufficient to support the buildup of water do not require overflow. One example of this would be a concrete structure designed to be a future floor. In many cases, these roofs will support water that would build up to the top of the parapet wall. A typical parapet 2-foot wall would result in 2-feet of water buildup at the perimeter or 125 psf of Rain Load.

Secondary Drainage Essential to Structural Integrity

An *emergency overflow drainage system* is essential to the structural integrity of a building. It is the safety valve to prevent an unsafe water buildup on a roof in the case that the primary drainage system is blocked or if the rainfall rate exceeds the design rainfall rate for the primary drainage system. The head of water over an overflow drain or scupper is a critical component in the design calculus for roof structures. Both the IBC and ASCE-7 require that the roof structure be designed to support the weight (head) of water that accumulates over the *emergency overflow drainage system* assuming the primary drainage are blocked. **Figure 3** is an excerpt from Chapter 16, Section 1611.1 from the 2021 IBC describing the design requirements for "Rain Loads."

SECTION 1611 RAIN LOADS

1611.1 Design rain loads. Each portion of a roof shall be designed to sustain the *load* of rainwater as per the requirements of Chapter 8 of ASCE 7. The design rainfall shall be based on the 100-year 15-minute duration event, or on other rainfall rates determined from approved local weather data. Alternatively, a design rainfall of twice the 100-year hourly rainfall rate indicated in Figures 1611.1(1) through 1611.1(5) shall be permitted.

Increases in Design Rain Loads

It is important to note that in the 2021 edition there was a significant change. Previously, the IBC and IPC required using the 1-hour, 100-year rainfall rate for the design of both the primary and secondary drainage systems. Section 1611.1 has changed the design rainfall rate to the 15-minute, 100-year rainfall rate. The requirement to use the 15-minute rainfall rate was made in ASCE 7-16 (ASCE 2016), so both ASCE and IBC require the 15-minute rainfall rate for designing overflow systems. The 15-minute rainfall rate is approximately double the 1-hour rainfall rate. **In other words, to comply with ASCE 7 and Section 1611.1 of the IBC, the secondary drainage system must be designed using double the design rainfall rate.** The result is that the new code requirement significantly increases the Rain Load on a building.

The change from the 1-hour to the 15-minute duration rainfall rate is well supported in the technical literature. Chapter 3, Section 3.4 and 3.5 of *Roof Drainage* (IIBEC-RCI Foundation 2021) provides an in-depth discussion of the use and importance of the 15-minute, 100-year design standard for secondary drainage systems. There is also strong precedence in the codes for using the 15-minute rainfall rate for secondary drains. Prior to the consolidation of codes, the *Standard Plumbing Code* required using the 15-minute rainfall rates. The National Standard Plumbing Code requires using the 15-minute rainfall rate. Also, the first IPC required using the 15-minute duration rainfall rate for secondary drain systems. This requirement was changed in the 2000 IPC.

From a structural design perspective, rainfall rates commonly exceed the 1-hour, 100-year rainfall rate for short durations. **Figure 4** is an excerpt from *Roof Drainage* (IIBEC-RCI Foundation 2021) showing a typical distribution of rainfall rates occurring over 1-hour. The area above the 3.0 in/h line illustrate the time when the Rain Load would exceed the design Rain Load using the 1-hour rainfall rate. The illustration also shows (in blue) the 15-minute rainfall rate, which is about double the 1-hour rainfall rate. The Rain Load from 15-minute duration rainfall rate is now recognized as the appropriate standard. These structural design changes were made because of the serious recurring problem of roof collapses.

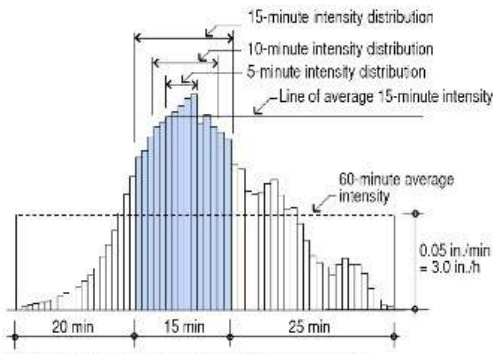

(a) Rainfall intensity distribution over 60 minutes. Width of each rectangle is one minute.

Climate change is causing more frequent and more intense rain events to occur. A good example was Hurricane Harvey. The flooding in Houston resulting from Hurricane Harvey contributed to the collapse of several roofs. A common scenario was that the flood water filled the storm drainage systems preventing the primary drains from functioning properly. This flooding severely tested the *secondary emergency overflow drainage system*. Most passed the test, but several roofs did not.

Another major change in the IPC significantly affects the design of a *secondary emergency overflow drainage system*. A 2012 study (Ballanco 2012) published by the American Society of Plumbing Engineers and the International Association of Plumbing and Mechanical Officials in found that, **“The research produced stunning results that verified that the sizing method for storm drainage systems, as required in the plumbing codes, is inaccurate.”** In other words, **the drainage design criteria we have been using for more than 70 years is wrong ... stunning indeed.** The study showed that flow rates are based on the head of water over the drains and the drain geometry, which is the very data a structural engineer must use in determining “Rain Loads.” So not only have we changed the rainfall rate for designing secondary emergency drainage systems, we have an entirely different standard for determining the head (weight) of water over the drains.

As stated previously, the requirement that the re-roof system includes an appropriate *emergency overflow drainage system* has been in the National Codes since these codes addressed reroofing. Chapter 32 Re-Roofing was added to the Appendix of the *Uniform Building Code* in 1979. Chapter 32 Re-Roof required that the new roof conform the applicable provisions of Chapter 32 of this code. Section 3207 (c) required Overflow Drains and Scuppers. Below is an excerpt from the 1979 UBC addressing the applicable provision related to the requirement for Overflow Drains and Scuppers. There was a reason that for almost 40 years the codes required the reroofing system to have an appropriate *secondary emergency overflow drainage system* (Figure 5).

(c) **Overflow Drains and Scuppers.** Where roof drains are required, overflow drains having the same size as the roof drains shall be installed with the inlet flow line located 2 inches above the low point of the roof, or overflow scuppers having three times the size of the roof drains may be installed in adjacent parapet walls with the inlet flow line located 2 inches above the low point of the adjacent roof and having a minimum opening height of 4 inches.
Overflow drains shall be connected to drain lines independent from the roof drains.

Buildings are typically reroofed every 20 years or so. The IBC requires building permits for recovering the existing roof or for reroofing. This is typically the only time during the life of a building that the Building Official and the Code are involved with the roof. This is the appropriate time to make sure the building structure is safe and that the roof drainage system was constructed properly in accordance with the code. The omission of an appropriate *emergency overflow drainage system* is a design and/or construction defect that should be corrected. A building constructed without an appropriate *emergency overflow drainage system* does not meet the code now or in the past. It is critical that this provision be reinstated to ensure our buildings are safe.

Bibliography:

American Society of Civil Engineers (ASCE). 2016. *ASCE 7 -16: Minimum Design Loads Minimum Design Loads and Associated Criteria for Buildings and Other Structures*. Reston, VA: ASCE.

Ballanco, Julius. 2012. *Storm Drainage System Research Project: Flow Rate Through Roof Drains*. Rosemont, IL: American Society of Plumbing Engineers (ASPE) Research Foundation.

Coffman, Scott D., and Thomas Williamson. 2019. “Low-Slope Roofs: Design Solutions for Building Code-Permitted Low-Slope Applications that

Cause Ponding Water." *Civil + Structural Engineering*. Fayetteville, AR: Zweig Group.

Levine, Jeffrey. 2021. "Rainfall Intensity Changes Over Time: Have the Codes Kept Pace?," *Interface*, 39 (10): International Institute of Building Enclosure Consultants.

O'Rourke, Michael, and Aaron R. Lewis. 2020. *Rain Loads: Guide to the Rain Load Provisions of ASCE 7-16*. Reston, VA: ASCE.

Patterson, Stephen, and Medan Mehta. 2021. *Roof Drainage*. Second Edition, Raleigh, NC: IIBEC-RCI Foundation.

Patterson, Stephen L., and Madan Mehta. 2018. "Roof Drainage Design, Roof Collapses, and the Code" in *Proceedings of the 33rd RCI International Convention and Trade Show*, March 22-27, 2018: RCI.

Cost Impact: The code change proposal will increase the cost of construction

Most buildings that will be re-roofed already meet IBC requirements, and there will be no increased costs resulting from the proposed additional language. Most residential and multi-family buildings' roofs (typically steep-slope) and commercial buildings with roofs that drain over the edge and buildings with rigid structures will not be affected. The cost of adding parapet wall emergency through-wall scuppers or other secondary drainage measures at low-slope roofs that require such assemblies, should have been borne at the time of the existing low-slope roof's original construction, based on requirements of earlier adopted building codes.

If found to missing, parapet wall through-wall scuppers or other secondary drainage measures are typically of nominal cost to retrofit into existing buildings/roofs. The costs to add or modify an emergency overflow drainage system varies. In many cases, all that is required is to add overflow drains or scuppers to control the volume of water that would accumulate on the roof. Overflow scupper costs vary from \$500 to \$1500 depending on their complexity and overflow drains vary from \$1500 to \$3000.

There will be increased costs to buildings with flexible structural elements that are susceptible to ponding instability, which leads to roof structure overloading and catastrophic roof collapse. These buildings would fall into the "Dangerous Condition" category, as defined in IEBC Section 302.1. For these "Dangerous Condition" buildings, additional cost would involve a structural engineering evaluation to determine that the building structure with new, added dead-loading is safe and additionally, that the new dead-loading will not alter the function of in-place secondary drainage systems. In most cases, it is presumed that structural engineering evaluation would be the extent of the additional costs, since building structures are typically designed with sufficient margin-of-safety factors.

In cases where a structural engineering evaluation indicates a building/roof structure is unsafe, there would be additional costs to strengthen, supplement, replace or otherwise alter the structure, as required to carry the additional loads. These costs would vary from building-to-building depending upon the extent of the discovered issues.

Regardless, the costs to evaluate and/or modify a structure that has been found to be unsafe from additional loading caused by re-roofing or from inadequate or missing secondary drainage systems, is necessary to protect public life-safety and property/operations below existing roofs.

S45-22

S46-22

IBC: SECTION 1512, 1512.1; IEBC: SECTION 705, [BS] 705.1

Proponents: Mark Graham, representing National Roofing Contractors Assoc. (mgraham@nrca.net)

2021 International Building Code

SECTION 1512 REROOFING

Revise as follows:

1512.1 General. Materials and methods of application used for recovering or replacing an existing *roof covering* shall comply with the requirements of Chapter 15.

Exceptions:

1. *Roof replacement* or *roof recover* of existing low-slope *roof coverings* shall not be required to meet the minimum design slope requirement of $\frac{1}{4}$ unit vertical in 12 units horizontal (2-percent slope) in Section 1507 for roofs that provide *positive roof drainage*.
2. Recovering or replacing an existing *roof covering* shall not be required to meet the requirement for secondary (emergency overflow) drains or *scuppers* in Section 1502.2 for roofs that provide for *positive roof drainage*. For the purposes of this exception, existing secondary drainage or *scupper* systems required in accordance with this code shall not be removed unless they are replaced by secondary drains or *scuppers* designed and installed in accordance with Section 1502.2.
3. For *roof replacement* with insulation above the *roof deck* where the required *R-value* cannot be provided because the additional thickness would restrict accessibility, reduce of the height of existing *guards* or result in thickness limitations that occur with the existing rooftop conditions, including low roof drains or secondary (emergency overflow) drains, low rooftop mechanical equipment, low door or glazing heights, low parapet heights, or proper roof flashing heights, the maximum thickness of insulation compatible with the available space and existing rooftop conditions shall be installed, as approved by the *building official*. In no case shall the *R-value* of the roof insulation be reduced or the *U-factor* of the *roof assembly* be increased as part of the *roof replacement*.

2021 International Existing Building Code

SECTION 705 REROOFING

Revise as follows:

[BS] 705.1 General. Materials and methods of application used for recovering or replacing an existing roof covering shall comply with the requirements of Chapter 15 of the International Building Code.

Exceptions:

1. *Roof replacement* or *roof recover* of existing low-slope roof coverings shall not be required to meet the minimum design slope requirement of $\frac{1}{4}$ unit vertical in 12 units horizontal (2-percent slope) in Section 1507 of the International Building Code for roofs that provide positive roof drainage.
2. Recovering or replacing an existing roof covering shall not be required to meet the requirement for secondary (emergency overflow) drains or scuppers in Section 1502 of the International Building Code for roofs that provide for positive roof drainage. For the purposes of this exception, existing secondary drainage or scupper systems required in accordance with this code shall not be removed unless they are replaced by secondary drains or scuppers designed and installed in accordance with Section 1502 of the International Building Code.
3. For *roof replacement* with insulation above the *roof deck* where the required *R-value* cannot be provided because the additional thickness would restrict accessibility, reduce of the height of existing *guards* or result in thickness limitations that occur with the existing rooftop conditions, including low roof drains or secondary (emergency overflow) drains, low rooftop mechanical equipment, low door or glazing heights, low parapet heights, or proper roof flashing heights, the maximum thickness of insulation compatible with the available space and existing rooftop conditions shall be installed, as approved by the *building official*. In no case shall the *R-value* of the roof insulation be reduced or the *U-factor* of the *roof assembly* be increased as part of the *roof replacement*.

Reason Statement: This proposed code change is intended to provide guidance to code officials and users in situations where a roof replacement's additional roof covering thickness can restrict accessibility, reduce guard heights or result in less than necessary clearances for existing rooftop conditions. In reroofing, problematic existing rooftop conditions include HVAC equipment, low door or glazing heights, parapet heights, and proper roof flashing heights. This provision requires the maximum thickness of insulation compatible with the available space and existing rooftop conditions to be installed. Also, the provision stipulates in no case shall the *R*-value of the roof insulation for the new roof covering be reduced or the *U*-factor of the *roof assembly* be increased from that of the existing building as part of the roof replacement. Implementation of this provision requires approval by the building official.

Cost Impact: The code change proposal will decrease the cost of construction

This code change proposal could provide cost savings compared to requiring strict, literal compliance with the code without code official approved alternatives. Since rooftop conditions vary on a building-to-building basis, the amount of the saving varies from minimal to significant -- exceeding the cost of roof replacement alone in some cases, such as those requiring accessibility changes, reworking guard heights and addressing specific rooftop conditions.

S47-22

IBC: 1512.1, SPRI Chapter 35 (New); IEBC: [BS] 705.1, SPRI (New), (New)

Proponents: Amanda Hickman, representing Single-Ply Roofing Industry (SPRI) (amanda@thehickmangroup.com)

2021 International Building Code

Revise as follows:

1512.1 General. Materials and methods of application used for recovering or replacing an existing *roof covering* shall comply with the requirements of Chapter 15. The existing decking material shall be tested in accordance with ANSI/SPRI FX-1 or ANSI/SPRI IA-1

Exceptions:

1. *Roof replacement* or *roof recover* of existing low-slope *roof coverings* shall not be required to meet the minimum design slope requirement of $\frac{1}{4}$ unit vertical in 12 units horizontal (2-percent slope) in Section 1507 for roofs that provide *positive roof drainage*.
2. Recovering or replacing an existing *roof covering* shall not be required to meet the requirement for secondary (emergency overflow) drains or *scuppers* in Section 1502.2 for roofs that provide for *positive roof drainage*. For the purposes of this exception, existing secondary drainage or *scupper* systems required in accordance with this code shall not be removed unless they are replaced by secondary drains or *scuppers* designed and installed in accordance with Section 1502.2.

Add new standard(s) as follows:

SPRI

Single-Ply Roofing Institute
465 Waverly Oaks Road, Suite 421
Waltham, MA 02452

ANSI/SPRI FX-1 2021

Standard Field Test Procedure for Determining the Withdrawal Resistance of Roofing Fasteners

ANSI/SPRI IA-1 2021

Standard Field Test Procedure for Verifying the Suitability of Roof Substrates and Adhesives

2021 International Existing Building Code

Revise as follows:

[BS] 705.1 General. Materials and methods of application used for recovering or replacing an existing roof covering shall comply with the requirements of Chapter 15 of the International Building Code. The existing decking material shall be tested in accordance with ANSI/SPRI FX-1 or ANSI/SPRI IA-1.

Exceptions:

1. *Roof replacement* or *roof recover* of existing low-slope roof coverings shall not be required to meet the minimum design slope requirement of $\frac{1}{4}$ unit vertical in 12 units horizontal (2-percent slope) in Section 1507 of the International Building Code for roofs that provide positive roof drainage.
2. Recovering or replacing an existing roof covering shall not be required to meet the requirement for secondary (emergency overflow) drains or scuppers in Section 1502 of the International Building Code for roofs that provide for positive roof drainage. For the purposes of this exception, existing secondary drainage or scupper systems required in accordance with this code shall not be removed unless they are replaced by secondary drains or scuppers designed and installed in accordance with Section 1502 of the International Building Code.

Add new text as follows:

SPRI

Single-Ply Roofing Institute
465 Waverly Oaks Road
Waltham, MA 02452
USA

ANSI/SPRI FX-1 2021. Standard Field Test Procedure for Determining the Withdrawal Resistance of Roofing Fasteners

ANSI/SPRI IA-1 2021. Standard Field Test Procedure for Verifying the Suitability of Roof Substrates and Adhesives

Staff Analysis: A review of the standard proposed for inclusion in the code, SPRI ANSI/SPRI FX-1 2021 Standard Field Test Procedure for Determining the Withdrawal Resistance of Roofing Fasteners, with regard to some of the key ICC criteria for referenced standards (Section 3.6 of CP#28) will be posted on the ICC website on or before March 16, 2022.

A review of the standard proposed for inclusion in the code, SPRI ANSI/SPRI IA-1 2021 Standard Field Test Procedure for Verifying the Suitability of Roof Substrates and Adhesives, with regard to some of the key ICC criteria for referenced standards (Section 3.6 of CP#28) will be posted on the

ICC website on or before March 16, 2022.

Reason Statement: It is critical that a roof system performs properly in a wind event. Currently the provisions on reroofing and roof replacement are silent on the need to determine and verify that the existing roof assembly, substrate and adhesive combination are suitable for a reroof or roof replacement. The addition of these two standards will ensure that existing roof decks are properly tested to meet the required minimum uplift loads in Chapter 16 of the IBC.

ANSI/SPRI FX-1 provides procedures used out at the jobsite to test the pullout resistance of roofing fasteners from substrate (decking materials).

ANSI/SPRI IA-1 specifies a field test procedure to verify the suitability of an existing roof substrate or roof assembly, and adhesive combination. This testing procedure encompasses various types of insulation adhesives and substrates.

Cost Impact: The code change proposal will not increase or decrease the cost of construction

Prior to a reroof or roof replacement, installers already perform some version of a field test to determine the suitability of the existing decking materials and verify the suitability of an existing roof substrate or roof assembly, and adhesive combination. The proposed test procedures provide a standardized method for appropriately administering these tests.

S47-22

S48-22 Part I

IBC: 1512.2; IEBC: [BS] 705.2

Proponents: Marcin Pazera, representing Polyisocyanurate Insulation Manufacturers Association (mpazera@pima.org); Richard Justin Koscher, representing Polyisocyanurate Insulation Manufacturers Association (jkoscher@pima.org)

THIS IS A 2 PART CODE CHANGE. PART I WILL BE HEARD BY THE IBC STRUCTURAL CODE COMMITTEE. PART II WILL BE HEARD BY THE IRC-B CODE COMMITTEE. SEE THE TENTATIVE HEARING ORDER FOR THESE COMMITTEES.

2021 International Building Code

Revise as follows:

1512.2 Roof replacement. *Roof replacement* shall include the removal of all existing layers of *roof assembly* materials down to the *roof deck*.

Exception: Where the existing *roof assembly* includes an ice barrier membrane that is adhered to the *roof deck*, the existing ice barrier membrane shall be permitted to remain in place and covered with an additional layer of ice barrier membrane in accordance with Section 1507.

Where the existing *roof assembly* contains insulation entirely above the roof deck, installation of roof insulation materials shall comply with Section C503.2.1 of the *International Energy Conservation Code*.

2021 International Existing Building Code

Revise as follows:

[BS] 705.2 Roof replacement. *Roof replacement* shall include the removal of all existing layers of roof coverings down to the roof deck.

Exception: Where the existing roof assembly includes an ice barrier membrane that is adhered to the roof deck, the existing ice barrier membrane shall be permitted to remain in place and covered with an additional layer of ice barrier membrane in accordance with Section 1507 of the International Building Code.

Where the existing *roof assembly* contains insulation entirely above the roof deck, installation of roof insulation materials shall comply with Section C503.2.1 of the *International Energy Conservation Code*.

Staff Analysis: CC# S48-22 and CC# S49-22 addresses requirements in a different or contradicting manner. The committee is urged to make their intentions clear with their actions on these proposals.

S48-22 Part I

S48-22 Part II

IRC: R908.3

Proponents: Marcin Pazera, representing Polyisocyanurate Insulation Manufacturers Association (mpazera@pima.org); Richard Justin Koscher, representing Polyisocyanurate Insulation Manufacturers Association (jkoscher@pima.org)

2021 International Residential Code

Revise as follows:

R908.3 Roof replacement. *Roof replacement* shall include the removal of existing layers of roof coverings down to the *roof deck*.

Exception: Where the existing *roof assembly* includes an ice barrier membrane that is adhered to the *roof deck*, the existing ice barrier membrane shall be permitted to remain in place and covered with an additional layer of ice barrier membrane in accordance with Section R905.

Where the existing *roof assembly* is part of the building thermal envelope, the *alteration* shall comply with Section R503.1.1 of the *International Energy Conservation Code--Residential Provisions*.

Staff Analysis: CC# S48-22 and CC# S49-22 addresses requirements in a different or contradicting manner. The committee is urged to make their intentions clear with their actions on these proposals.

Reason Statement: This proposal adds a reference within the IBC, IEBC and IRC provisions relating to roof replacements that points code users to the applicable IECC requirements for roof replacement projects or alterations to the roof assembly where the assembly is part of the building thermal envelope. This proposal adds an important connection between the building code and the energy code, and will improve compliance with the energy code requirements. The new language is intended to appear under the existing exception. Roof replacements are required to comply with the IECC requirements regardless of the reuse of existing materials such as an ice barrier membrane.

Cost Impact: The code change proposal will not increase or decrease the cost of construction
This proposal provide clarification of requirements related to roof replacements and creates no new requirements.

S48-22 Part II

S49-22 Part I

IBC: 1512.2; IEBC: [BS] 705.2

Proponents: Richard Justin Koscher, representing Polyisocyanurate Insulation Manufacturers Association (jkoscher@pima.org); Marcin Pazera, representing Polyisocyanurate Insulation Manufacturers Association (mpazera@pima.org)

THIS IS A 2 PART CODE CHANGE. PART I WILL BE HEARD BY THE IBC STRUCTURAL CODE COMMITTEE. PART II WILL BE HEARD BY THE IRC-B CODE COMMITTEE. SEE THE TENTATIVE HEARING ORDER FOR THESE COMMITTEES.

2021 International Building Code

Revise as follows:

1512.2 Roof replacement. *Roof replacement* shall include the removal of all existing layers of *roof assembly* materials down to the *roof deck*.

~~**Exception** **Exceptions:** Where the existing *roof assembly* includes an ice barrier membrane that is adhered to the *roof deck*, the existing ice barrier membrane shall be permitted to remain in place and covered with an additional layer of ice barrier membrane in accordance with Section 1507.~~

1. Where the existing *roof assembly* includes an ice barrier membrane that is adhered to the *roof deck*, the existing ice barrier membrane shall be permitted to remain in place and covered with an additional layer of ice barrier membrane in accordance with Section 1507.
2. Where the existing *roof assembly* includes roof insulation above the *roof deck*, the existing roof insulation shall be permitted to be reused in accordance with Section 1508. Existing roof insulation that is damaged, deteriorated or water soaked shall not be reused.

2021 International Existing Building Code

Revise as follows:

[BS] 705.2 Roof replacement. *Roof replacement* shall include the removal of all existing layers of roof coverings down to the roof deck.

~~**Exceptions** **Exceptions:** Where the existing *roof assembly* includes an ice barrier membrane that is adhered to the *roof deck*, the existing ice barrier membrane shall be permitted to remain in place and covered with an additional layer of ice barrier membrane in accordance with Section 1507 of the International Building Code.~~

1. Where the existing *roof assembly* includes an ice barrier membrane that is adhered to the *roof deck*, the existing ice barrier membrane shall be permitted to remain in place and covered with an additional layer of ice barrier membrane in accordance with Section 1507 of the *International Building Code*.
2. Where the existing *roof assembly* includes roof insulation above the *roof deck*, the existing roof insulation shall be permitted to be reused in accordance with Section 1508 of the *International Building Code*. Existing roof insulation that is damaged, deteriorated or water soaked shall not be reused.

Staff Analysis: CC# S48-22 and CC# S49-22 addresses requirements in a different or contradicting manner. The committee is urged to make their intentions clear with their actions on these proposals.

S49-22 Part I

S49-22 Part II

IRC: R908.3

Proponents: Richard Justin Koscher, representing Polyisocyanurate Insulation Manufacturers Association (jkoscher@pima.org); Marcin Pazera, representing Polyisocyanurate Insulation Manufacturers Association (mpazera@pima.org)

2021 International Residential Code

Revise as follows:

R908.3 Roof replacement. *Roof replacement* shall include the removal of existing layers of roof coverings down to the *roof deck*.

~~**Exceptions** **Exceptions:** Where the existing *roof assembly* includes an ice barrier membrane that is adhered to the *roof deck*, the existing ice barrier membrane shall be permitted to remain in place and covered with an additional layer of ice barrier membrane in accordance with Section R905.~~

1. Where the existing *roof assembly* includes an ice barrier membrane that is adhered to the roof deck, the existing ice barrier membrane shall be permitted to remain in place and covered with an additional layer of ice barrier membrane in accordance with Section R905.
2. Where the existing *roof assembly* includes roof insulation above the roof deck, the existing roof insulation shall be permitted to be reused in accordance with Section R906. Existing roof insulation that is damaged, deteriorated or water soaked shall not be reused.

Staff Analysis: CC# S48-22 and CC# S49-22 addresses requirements in a different or contradicting manner. The committee is urged to make their intentions clear with their actions on these proposals.

Reason Statement: This code change proposal recognizes that roof insulation boards that are in good repair may be appropriately reused as part of a roof replacement project. This code change proposal will reduce the amount of construction materials that are landfilled during a roof replacement project by clarifying the appropriate circumstances under which roof insulation boards may be reused. Additional layers of new insulation may be installed over existing layers of roof insulation in order to meet the requirements of the International Energy Conservation Code as well as to prepare an appropriate substrate for the installation of a new roof membrane.

Cost Impact: The code change proposal will not increase or decrease the cost of construction. This code change proposal does not create any new requirements for roof replacement projects. Where existing roof insulation is reused, this code change proposal may reduce the cost of construction.

S49-22 Part II

S50-22

IBC: 1512.2

Proponents: Mark Graham, representing National Roofing Contractors Assoc. (mgraham@nrca.net)

2021 International Building Code

Revise as follows:

1512.2 Roof replacement. *Roof replacement* shall include the removal of all existing layers of *roof assembly covering* materials down to the *roof deck*.

Exception: Where the existing *roof assembly* includes an ice barrier membrane that is adhered to the *roof deck*, the existing ice barrier membrane shall be permitted to remain in place and covered with an additional layer of ice barrier membrane in accordance with Section 1507.

Reason Statement: This code change proposal is intended to clarify the code. Use of the term "roof assembly" here, as is defined in Chapter 2-Definitions, is confusing because it includes the roof deck. The requirement indicates the roof deck is intended to remain in-place. Substituting the term "roof covering," which is also defined in Chapter 2-Definitions, clarifies the requirement's intent. A "roof covering" is those materials applied over the roof deck for weather resistance, fire classification or appearance.

Cost Impact: The code change proposal will not increase or decrease the cost of construction. This is simply a clarification of existing requirements. There is no change in technical requirements.

S50-22

S51-22

IBC: 1512.2

Proponents: T. Eric Stafford, representing Insurance Institute for Business and Home Safety (testafford@charter.net)

2021 International Building Code

Revise as follows:

1512.2 Roof replacement. *Roof replacement* shall include the removal of all existing layers of *roof assembly* materials down to the *roof deck*.

Exception-Exceptions:

1. Where the existing *roof assembly* includes an ice barrier membrane that is adhered to the *roof deck* and the existing sheathing is not water soaked or deteriorated to the point that it is not adequate as a base for additional roofing, the existing ice barrier membrane shall be permitted to remain in place and covered with an additional layer of ice barrier membrane in accordance with Section 1507 where permitted by the roof covering manufacturer and self-adhered underlayment manufacturer.
2. Where the existing roof includes a self-adhered underlayment and the existing sheathing is not water soaked or deteriorated to the point that it is not adequate as a base for additional roofing, the existing self-adhered underlayment shall be permitted to remain in place and covered with an underlayment complying with Table 1507.1.1(1), Table 1507.1.1(2), and Table 1507.1.1(3).
3. Where the existing roof includes one layer of self-adhered underlayment and the existing layer cannot be removed without damaging the roof deck, a second layer of self-adhered underlayment is permitted to be installed over the existing self-adhered underlayment provided the following conditions are met:
 - 3.1. It is permitted by the roof covering manufacturer and self-adhered underlayment manufacturer.
 - 3.2. The existing sheathing is not water soaked or deteriorated to the point that it is not adequate as a base for additional roofing, and
 - 3.3. The second layer of self-adhered underlayment is installed such that buildup of material at walls, valleys, roof edges, end laps, and side laps does not exceed two layers.

Reason Statement: The use of a self-adhered polymer modified bitumen membrane complying with ASTM D1970 is one of several underlayment options permitted for roof coverings in the IBC. ASTM D1970 self-adhered membranes were first recognized in the 2000 IBC and IRC as an underlayment and as an option for an ice barrier. After 20 years of code implementation, it remains approved by shingle manufacturers, underlayment manufacturers and building codes, and has been consistently observed to perform very well as a method for preventing water intrusion in the event the roof covering is lost or damaged.

While the code requires materials and methods for roof replacement to comply with Chapter 15, it doesn't provide any specific requirements for what to do where a roof is being replaced and there is an existing self-adhered underlayment other than ice barrier membranes. Section 1512.2 requires roof replacement to include the removal of all roof covering layers down to the roof deck. An exception permits one additional layer of an ice barrier membrane where the existing roof has an ice barrier membrane.

As currently written, the code would imply that a self-adhered membrane would have to be removed during a roof replacement. However, depending on the decking material, many self-adhered membranes can be difficult to remove. Some may not be able to be removed without damaging or removing the roof deck. Damaging the deck and/or removing the roof decking can be expensive and unnecessary.

This proposal is a collaboration between the Insurance Institute for Business and Home Safety (IBHS), the Asphalt Roofing Manufacturers Association (ARMA), and the National Roofing Contractors Association (NRCA). It provides specific requirements on acceptable methods for dealing with existing self-adhered membranes during a roof replacement. The underlayment methods in the 2021 IBC include specific methods for preventing water intrusion in the event the roof covering is damaged or lost in high wind regions. The changes proposed herein seek to maintain that level of protection during roof replacement.

ARMA provides guidance on the removal of self-adhered membrane in their Technical Bulletin, Self-Adhering Underlayment Removal Prior to Steep Slope Re-Roofing: *"Removal of self-adhering underlayment is always recommended in situations in which it can be removed without damaging the deck....If one layer of self-adhering underlayment is in place, and it is not possible to remove it without damaging the deck, installation of a second layer of underlayment over the existing membrane may be permissible. Check with the underlayment manufacturer's installation instructions and local building codes for details. Offset end and side laps in the new and existing underlayment to minimize thickness build-up and "feather in" the new underlayment by extending the new material a minimum of 8" up the slope onto the bare deck. This will reduce the likelihood of problems with drainage and aesthetics. If two or more layers of self-adhering underlayment are in place, all layers should be removed."*

In lieu of an additional layer of self-adhered underlayment, this proposal also permits felt underlayment to be installed in accordance with Tables 1507.1.1(1), 1507.1.1(2), and 1507.1.1(3).

This proposal also provides industry recommended clarifications regarding the installation of an additional layer of an ice barrier membrane.

Cost Impact: The code change proposal will decrease the cost of construction

For existing roofs with one layer of self-adhered membrane underlayment, this proposal would reduce the cost of construction by permitting the existing layer to remain in place.

S52-22

IBC: 1512.2

Proponents: Gregory Keeler, representing Owens Corning (greg.keeler@owenscorning.com)

2021 International Building Code

Revise as follows:

1512.2 Roof replacement. *Roof replacement* shall include the removal of all existing layers of *roof assembly* materials down to the *roof deck*.

~~Exception~~ Exceptions:

1. Where the existing *roof assembly* includes an ice barrier membrane that is adhered to the *roof deck*, the existing ice barrier membrane shall be permitted to remain in place and covered with an additional layer of ~~ice barrier~~ self-adhering modified bitumen membrane complying with ASTM D1970 in accordance with the new ice barrier membrane manufacturer's installation instructions and Section 1507.2.
2. Where the existing *roof assembly* includes a self-adhered underlayment that cannot be removed from the *roof deck*, the existing membrane shall be permitted to remain in place and covered with an additional layer of underlayment in accordance with Section 1507.1.1.

Reason Statement: It is increasingly common to encounter an existing self-adhered membrane on a roof deck on which the roofing is being replaced. In many cases, especially in high wind regions, the self-adhering underlayment is covering the entire deck. This modification adds additional language to deal with both ice dam and whole-roof self-adhered underlayment situations.

Cost Impact: The code change proposal will not increase or decrease the cost of construction. Roofing contractors have been searching for guidance on how to handle these situations for years. This proposal simply codifies requirements that are consistent with how these situations have been handled historically.

S52-22

S53-22

IBC: 1512.2; IEBC: [BS] 705.2

Proponents: Bill McHugh, representing Chicago Roofing Contractors Association (bill@mc-hugh.us)

2021 International Building Code

Revise as follows:

1512.2 Roof replacement. *Roof replacement* shall include the removal of all existing layers of *roof assembly* materials down to the *roof deck*.

~~Exception~~ Exceptions:

1. Where the existing *roof assembly* includes an ice barrier membrane that is adhered to the *roof deck*, the existing ice barrier membrane shall be permitted to remain in place and covered with an additional layer of ice barrier membrane in accordance with Section 1507.
2. *Roof replacement of existing low sloped roofs shall comply with the roof insulation requirements for new construction unless the installation of additional insulation above the structural roof deck is infeasible due to the height of existing parapets, equipment curbs, skylight curbs, window sills, door thresholds, and similar elements with flashing into the roof system. In no case shall a roof replacement reduce the insulating value of the roof.*

2021 International Existing Building Code

Revise as follows:

[BS] 705.2 Roof replacement. *Roof replacement* shall include the removal of all existing layers of roof coverings down to the roof deck.

~~Exception~~ Exceptions:

1. Where the existing roof assembly includes an ice barrier membrane that is adhered to the roof deck, the existing ice barrier membrane shall be permitted to remain in place and covered with an additional layer of ice barrier membrane in accordance with Section 1507 of the International Building Code.
2. *Roof replacement of existing low sloped roofs shall comply with the roof insulation requirements for new construction unless the installation of additional insulation above the structural roof deck is infeasible due to the height of existing parapets, equipment curbs, skylight curbs, window sills, door thresholds, and similar elements with flashing into the roof system. In no case shall a roof replacement reduce the insulating value of the roof.*

Reason Statement: A major jurisdiction, the City of Chicago, in its adoption of the I-Codes, put this in Chapter 3 of the 2019 Chicago Building Rehabilitation Code, their version of the International Existing Building Code. The City of Chicago has this in its 2016 Chicago Roofing Memorandum. The State of Illinois and Minnesota both have similar language in their adoptions of the I-codes as well. To be consistent with the IBC and IEBC format, a slight edit was made to the Chicago Rehabilitation Code to remove *roof recover'* from the proposal. That would be covered in a separate proposal.

This proposal provides the building official clear guidance for roof replacements on existing buildings where there are limitations to what can be done on the rooftop, with the structure itself, when a new roof is needed on an existing building.

The structure's characteristics, set during design, do not always provide vertical flashing heights above the roof membrane surface that can allow thicker materials below the membrane, additional deck materials, or insulation, when a new roof is needed, without rebuilding some number of elements on the rooftop.

Cost Impact: The code change proposal will decrease the cost of construction
By not rebuilding the rooftop, the building owner and manager does reduce costs to what the limitations of the building present.

S53-22

S55-22

IBC: 1512.2.1.1, ASTM Chapter 35 (New), SPRI Chapter 35 (New)

Proponents: Emily Lorenz, representing International Institute of Building Enclosure Consultants (emilyblorenz@gmail.com)

2021 International Building Code

Revise as follows:

1512.2.1.1 **Exceptions.** A *roof recover* shall not be permitted where any of the following conditions occur:

1. Where the existing roof or *roof covering* is ~~water soaked~~ found to have moisture present by infrared testing in accordance with ASTM C1153, electrical impedance testing in accordance with ASTM D7954/D7954M, or nuclear testing in accordance with ANSI/SPRI/RCI NT-1 2012 and the existing roof or *roof covering* cannot be removed and restored on a spot basis. ~~or~~
2. Where the existing roof or *roof covering* has deteriorated to the point that the existing roof or *roof covering* is not adequate as a base for additional roofing.
- ~~2-3.~~ Where the existing *roof covering* is slate, clay, cement or asbestos-cement tile.
- ~~3-4.~~ Where the existing roof has two or more applications of any type of *roof covering*.

Add new standard(s) as follows:

ASTM

ASTM International
100 Barr Harbor Drive, P.O. Box C700
West Conshohocken, PA 19428

C1153-10 (2015)

Standard Practice for Location of Wet Insulation in Roofing Systems Using Infrared Imaging

D7954/D7954M-15a

Standard Practice for Moisture Surveying of Roofing and Waterproofing Systems Using Non-Destructive Electrical Impedance Scanners

SPRI

Single-Ply Roofing Institute
465 Waverly Oaks Road, Suite 421
Waltham, MA 02452

ANSI/SPRI/RCI NT-1 2017

Detection And Location Of Latent Moisture in Building Roofing Systems by Nuclear Radioisotopic Thermalization

Staff Analysis: A review of the standard proposed for inclusion in the code, ASTM C1153-10 (2015) Standard Practice for Location of Wet Insulation in Roofing Systems Using Infrared Imaging, with regard to some of the key ICC criteria for referenced standards (Section 3.6 of CP#28) will be posted on the ICC website on or before March 16, 2022.

A review of the standard proposed for inclusion in the code, ASTM D7954/D7954M-15a Standard Practice for Moisture Surveying of Roofing and Waterproofing Systems Using Non-Destructive Electrical Impedance Scanner, with regard to some of the key ICC criteria for referenced standards (Section 3.6 of CP#28) will be posted on the ICC website on or before March 16, 2022.

A review of the standard proposed for inclusion in the code, SPRI ANSI/SPRI/RCI NT-1 2017 Detection And Location Of Latent Moisture in Building Roofing Systems by Nuclear Radioisotopic Thermalization, with regard to some of the key ICC criteria for referenced standards (Section 3.6 of CP#28) will be posted on the ICC website on or before March 16, 2022.

Reason Statement:

The term "water soaked" is not clearly defined. If a roof is recovered and the underlying, existing roof still contains moisture, the new system is in a compromised state from the start; specifically, accelerated roof deck and fastener decay, and loss of R-value and wind-uplift resistance. The referenced standards added to the exception provide protocols to test for the presence of moisture in existing systems. These methods are more accurate than a few small core cuts taken at random areas, where moisture/water damaged or laden material can be missed. These three-consensus based standard test methods are well established, easy to perform, and allow cost-effective testing of the entire roof surface area in a short amount of time. Performing these tests reduces the chance for missing areas of moisture- or water-damaged material in the existing roof or roof covering and related substrate materials. These standards provide a better definition of "water soaked" while allowing moisture- or water-damaged or laden materials, where discovered, to be removed and infilled with like material, thereby allowing a roof recover without unintended consequences.

Bibliography: ASTM International. 2015. *Standard Practice for Location of Wet Insulation in Roofing Systems Using Infrared Imaging*. ASTM C1153-10(2015), West Conshohocken, PA: ASTM International.

ASTM International. 2015. *Standard Practice for Moisture Surveying of Roofing and Waterproofing Systems Using Non-Destructive Electrical Impedance Scanners*. ASTM D7954/D7954M-15a, West Conshohocken, PA: ASTM International.

Single Ply Roofing Industry (SPRI). 2017. *Detection And Location Of Latent Moisture in Building Roofing Systems by Nuclear Radioisotopic Thermalization*. ANSI/SPRI/RCI NT-1, Waltham, MA: SPRI.

Cost Impact: The code change proposal will increase the cost of construction

The cost to apply the consensus-based testing standards is minimal. Generally, less than \$0.04 per square foot. Furthermore, they can be performed quickly not adding delay to re-roofing projects. The cost of the equipment and training necessary to be proficient with these testing procedures is nominal, generally, less than \$5000.

S55-22

S56-22

IBC: 1512.2.2.2 (New)

Proponents: Mark Graham, representing National Roofing Contractors Assoc. (mgraham@nrca.net)

2021 International Building Code

Add new text as follows:

1512.2.2.2 Roof recover membrane layer removal. In a roof recover, the membrane or water-shedding layer shall be permitted to be removed and any existing thermal barrier, insulation or vapor retarder remain in-place and be reused in the new roof covering in accordance with the applicable portions of this section, the roof covering manufacturer's installation instructions and as approved by the building official.

Exception: Membrane or water-shedding layer removal and reuse of any existing thermal barrier, insulation or vapor retarder remain in-place shall not be permitted in roof recovering where the existing roof has two or more applications of any type of roof covering.

Reason Statement: This code change proposal is intended to add clarity to the code's current requirements regarding roof recovering. The code currently permits roof recovering in certain specific circumstances described in Section 1512.2.1 and Section 1512.3. This provision adds specific guidance to building officials and users of the code by addressing those situations where the topmost surface of the roof membrane or water shedding layer is deteriorated, irregular or otherwise unsuitable to receive a new roof covering layer as a roof recover. Removal of the roof membrane or water shedding layer removes some of the roof covering's dead load, allows for inspection of the underlying roof covering components and can allow for a smooth surface to apply the new roof re-cover roof covering.

The provision requires compliance with the requirements of other provisions of Section 1512-Reroofing and the roof covering manufacturer's installation instructions and requires approval of the building code official.

Cost Impact: The code change proposal will decrease the cost of construction

While this code change proposal is intended to add clarity to the already existing requirements for roof recovering, for those situations where it is interpreted membrane or water-shedding removal requires complete removal of the roof covering, this proposal would result in a cost savings. The savings would be the cost of roof tear-off and disposal labor, dumpster and disposal costs, and any associated overhead and profit. Roof tear-off labor output and costs vary on a project-to-project basis based on a number of factors, including the complexity of the roof area and building height.

S56-22

S57-22

IBC: 1512.2.2 (New); IEBC: 705.4 (New)

Proponents: Bill McHugh, representing The Chicago Roofing Contractors Association (bill@mc-hugh.us)

2021 International Building Code

Add new text as follows:

1512.2.2 Roof Membrane Peel and Replacement. Roof membrane peel and replacement shall be allowed where only an existing roof membrane is removed, exposing insulation or sheathing, and only a new weather resisting roof membrane is installed. Roof membrane peel and replacement shall be approved by the *building official*.

2021 International Existing Building Code

Add new text as follows:

705.4 Roof Membrane Peel and Replacement. Roof membrane peel and replacement shall be allowed where only an existing roof membrane is removed, exposing insulation or sheathing, and only a new weather resisting roof membrane is installed. Roof membrane peel and replacement shall be approved by the *building official*.

Reason Statement: The purpose of this proposal is to add a section on roof membrane replacement into the International Building Code and International Existing Building Code. This proposal mirrors what has been used in a major jurisdiction for over 6 years - in the Building Codes. The Chicago Roofing Memorandum to the Chicago Municipal Code has had roof membrane peel and replacement allowed since 2016 as amendment. The I-Code based Chicago Building Rehabilitation Code has allowed roof membrane peel and replacement since 2019's adoption of the code.

In addition, the Illinois Adoption of the International Energy Conservation Code has had roof membrane peel and replacement since the 2018 adoption. At this writing, the Illinois Commercial Energy Conservation Advisory Council has approved using this definition in the 2021 Illinois Adoption.

The reason for the International Building Code is to reflect what a major jurisdiction has declared. In its adoption of the International Family of Codes, the City of Chicago put this requirement into the Chicago Rehabilitation Code, similar to the Existing Building Code and the reroofing section of the IBC's Chapter 15.

In addition, this proposal is more restrictive than the current Chicago Building Rehabilitation Code and 2016 Chicago Roofing Memorandum. The proposal adds that the building code official must approve the activity.

This is even more restrictive than currently exists in the International Building Code for the code defined, *Roof Recover* activity. *Roof recover* does NOT require building code official approval.

This activity, where an existing roof is removed, the substrate prepared, and a new roof membrane installed in accordance with the manufacturers installation instructions and the listing, (if required), is sometimes the preferred choice.

Cost Impact: The code change proposal will decrease the cost of construction

This roof membrane peel and replacement option will provide the building owner and manager another way to keep water out of the building if the rooftop conditions fit the definition. It would be the optimal cost, rather than a decreased cost, if it fits. If it is determined a roof replacement is needed, then the activity moves to that category instead of the roof membrane peel and replacement. Roof replacement is a more expensive option. However, roof recover vs. roof membrane peel and replacement can either be more or less expensive, depending on the configuration.

S57-22

S58-22 Part I

IBC: [A] 110.3.6, 1512.3; IEBC: [A] 109.3.5, [BS] 705.3

Proponents: Tim Earl, representing the Gypsum Association (tearl@gbhint.com)

THIS IS A 2 PART CODE CHANGE. PART I WILL BE HEARD BY THE IBC STRUCTURAL CODE COMMITTEE. PART II WILL BE HEARD BY THE IRC-B CODE COMMITTEE. SEE THE TENTATIVE HEARING ORDER FOR THESE COMMITTEES.

2021 International Building Code

Revise as follows:

[A] 110.3.6 Lath, ~~gypsum board~~ and gypsum panel product inspection. Lath, ~~gypsum board~~ and *gypsum panel product* inspections shall be made after lathing, ~~gypsum board~~ and *gypsum panel products*, interior and exterior, are in place, but before any plastering is applied or ~~gypsum board~~ and *gypsum panel product* joints and fasteners are taped and finished.

Exception: ~~Gypsum board~~ and ~~gypsum panel products~~ that are not part of a fire-resistance-rated assembly or a shear assembly.

1512.3 Roof recovering. Where the application of a new *roof covering* over wood shingle or shake roofs creates a combustible concealed space, the entire existing surface shall be covered with ~~gypsum board~~ *gypsum panel products*, mineral fiber, glass fiber or other *approved* materials securely fastened in place.

2021 International Existing Building Code

Revise as follows:

[A] 109.3.5 Lath or gypsum ~~board~~ panel product inspection. Lath and gypsum ~~board~~ panel inspections shall be made after lathing and gypsum ~~board~~ panel products, interior and exterior, is in place but before any plastering is applied or before gypsum ~~board~~ panel product joints and fasteners are taped and finished.

Exception: Gypsum ~~board~~ panels that ~~is~~ are not part of a fire-resistance-rated assembly or a shear assembly.

[BS] 705.3 Roof recovering. Where the application of a new roof covering over wood shingle or shake roofs creates a combustible concealed space, the entire existing surface shall be covered with gypsum ~~board~~ panel products, mineral fiber, glass fiber or other *approved* materials securely fastened in place.

S58-22 Part I

S58-22 Part II

IRC: R109.1.5.1

Proponents: Tim Earl, representing the Gypsum Association (tearl@gbhint.com)

2021 International Residential Code

Revise as follows:

R109.1.5.1 Fire-resistance-rated construction inspection. Where fire-resistance-rated construction is required between *dwelling units* or due to location on property, the *building official* shall require an inspection of such construction after lathing or gypsum board or gypsum panel products are in place, but before any plaster is applied, or before ~~board~~ or panel joints and fasteners are taped and finished.

Reason Statement: Gypsum board is a type of gypsum panel product. These two sections erroneously use the term board instead of panel. Exterior products are often glass mat, which are panels but not boards, so panel is the appropriate term here.

Cost Impact: The code change proposal will not increase or decrease the cost of construction
Simple editorial cleanup with no impact on cost.

S58-22 Part II

S59-22 Part I

IBC: 1512.4; IEBC: [BS] 705.4

Proponents: Richard Justin Koscher, representing Polyisocyanurate Insulation Manufacturers Association (jkoscher@pima.org); Marcin Pazera, representing Polyisocyanurate Insulation Manufacturers Association (mpazera@pima.org)

THIS IS A 2 PART CODE CHANGE. PART I WILL BE HEARD BY THE IBC STRUCTURAL CODE COMMITTEE. PART II WILL BE HEARD BY THE IRC-B CODE COMMITTEE. SEE THE TENTATIVE HEARING ORDER FOR THESE COMMITTEES.

2021 International Building Code

Revise as follows:

1512.4 Reinstallation of materials. Existing slate, clay or cement tile shall be permitted for reinstallation, except that damaged, cracked or broken slate or tile shall not be reinstalled. Existing vent flashing, metal edgings, drain outlets, collars and metal counterflashings shall not be reinstalled where rusted, damaged or deteriorated. Existing *ballast* that is damaged, cracked or broken shall not be reinstalled. Existing aggregate surfacing materials from built-up roofs shall not be reinstalled. Existing roof insulation boards that are damaged, deteriorated or water soaked shall not be reused or reinstalled.

2021 International Existing Building Code

Revise as follows:

[BS] 705.4 Reinstallation of materials. Existing slate, clay or cement tile shall be permitted for reinstallation, except that damaged, cracked or broken slate or tile shall not be reinstalled. Existing vent flashing, metal edgings, drain outlets, collars and metal counterflashings shall not be reinstalled where rusted, damaged or deteriorated. Existing ballast that is damaged, cracked or broken shall not be reinstalled. Existing aggregate surfacing materials from built-up roofs shall not be reinstalled. Existing roof insulation boards that are damaged, deteriorated or water soaked shall not be reused or reinstalled.

S59-22 Part I

S59-22 Part II

IRC: R908.5

Proponents: Richard Justin Koscher, representing Polyisocyanurate Insulation Manufacturers Association (jkoscher@pima.org); Marcin Pazera, representing Polyisocyanurate Insulation Manufacturers Association (mpazera@pima.org)

2021 International Residential Code

Revise as follows:

R908.5 Reinstallation of materials. Existing slate, clay or cement tile shall be permitted for reinstallation, except that damaged, cracked or broken slate or tile shall not be reinstalled. Any existing flashings, edgings, outlets, vents or similar devices that are a part of the assembly shall be replaced where rusted, damaged or deteriorated. Aggregate surfacing materials shall not be reinstalled. Existing roof insulation boards that are damaged, deteriorated or water soaked shall not be reused or reinstalled.

Reason Statement: This code change proposal recognizes that roof insulation boards that are in good repair may be appropriately reused as part of a reroofing project. The new language is written in the negative (i.e., when reuse is not permissible) to match the existing provisions for the reinstallation of roofing materials. This code change proposal will reduce the amount of construction materials that are landfilled during a reroofing project by clarifying the appropriate circumstances under which roof insulation boards may be reused.

Cost Impact: The code change proposal will not increase or decrease the cost of construction. This code change proposal does not impose any new requirements for reroofing projects. Therefore, the proposal will not increase or decrease the cost of construction. Where roof insulation is reused as part of a reroofing project, the provision may reduce the cost of construction by reducing the quantity of new roofing materials purchased to complete the project.

S59-22 Part II

S60-22

IBC: 1512.4, 1512.5 (New), 1512.5.1 (New), 1512.5; IEBC: [BS] 705.4, 705.5 (New), 705.5.1 (New), [BS] 705.5

Proponents: Joseph Cain, representing Solar Energy Industries Association (SEIA) (JoeCainPE@gmail.com)

2021 International Building Code

1512.4 Reinstallation of materials. Existing slate, clay or cement tile shall be permitted for reinstallation, except that damaged, cracked or broken slate or tile shall not be reinstalled. Existing vent flashing, metal edgings, drain outlets, collars and metal counterflashings shall not be reinstalled where rusted, damaged or deteriorated. Existing *ballast* that is damaged, cracked or broken shall not be reinstalled. Existing aggregate surfacing materials from built-up roofs shall not be reinstalled.

Add new text as follows:

1512.5 Reinstallation of equipment. Existing installations of rooftop-mounted photovoltaic (PV) panel systems approved under previous code requirements are permitted to remain in use, in accordance with NFPA 70 and this code.

1512.5.1 Permit for reinstalled equipment. Existing rooftop-mounted photovoltaic (PV) panel systems shall be permitted for reinstallation after roof repair or replacement, provided all of the following are provided:

1. The installation of the original equipment was permitted and approved.
2. The permit is obtained by a qualified person for the removal and reinstallation of the equipment.
3. At the time of application for permit, the applicant shall provide at least one of the following:
 - 3.1 A copy of the original approved plans that includes the equipment.
 - 3.2 Where plans are unavailable, photographs of the existing rooftop-mounted PV panel system prior to removal.

Revise as follows:

~~1512.5~~ **1512.6 Flashings.** Flashings shall be reconstructed in accordance with *approved* manufacturer's installation instructions. Metal flashing to which bituminous materials are to be adhered shall be primed prior to installation.

2021 International Existing Building Code

[BS] 705.4 Reinstallation of materials. Existing slate, clay or cement tile shall be permitted for reinstallation, except that damaged, cracked or broken slate or tile shall not be reinstalled. Existing vent flashing, metal edgings, drain outlets, collars and metal counterflashings shall not be reinstalled where rusted, damaged or deteriorated. Existing ballast that is damaged, cracked or broken shall not be reinstalled. Existing aggregate surfacing materials from built-up roofs shall not be reinstalled.

Add new text as follows:

705.5 Reinstallation of equipment. Existing installations of rooftop-mounted *photovoltaic (PV) panel systems* approved under previous code requirements are permitted to remain in use, in accordance with NFPA 70 and the *International Building Code*.

705.5.1 Permit for reinstalled equipment. Existing rooftop-mounted *photovoltaic (PV) panel systems* shall be permitted for reinstallation after roof repair or replacement, provided all of the following are provided:

1. The installation of the original equipment was permitted and approved.
2. The permit is obtained by a qualified person for the removal and reinstallation of the equipment.
3. At the time of application for permit, the applicant shall provide at least one of the following:
 - 3.1. A copy of the original approved plans that includes the equipment.
 - 3.2 Where plans are unavailable, photographs of the existing rooftop-mounted *PV panel system* prior to removal.

Revise as follows:

[BS] ~~705.5~~ 705.6 Flashings. Flashings shall be reconstructed in accordance with *approved* manufacturer's installation instructions. Metal flashing to which bituminous materials are to be adhered shall be primed prior to installation.

Reason Statement: The Sustainable Energy Action Committee (SEAC) has recognized that PV systems often continue to have useful life after the time that a roof covering or roof assembly is in need of repair or replacement. A guidance document has been prepared by SEAC to address this concern. Following is a link to the document, and an excerpt that is include on the SEAC web site.

<https://sustainableenergyaction.org/resources/reinstallation-of-pv-system/>

The growing number of re-roofing projects on buildings that have photovoltaic panel systems installed is prompting AHJs to search for sensible guidelines to ensure safety codes are followed. SEAC has developed the following permitting and inspection guidelines in an effort to support the inspection community and the growing number of re-roofing projects that involve an existing photovoltaic panel system. These guidelines pertain to the following activities:

1. Removing a previously installed, inspected, and approved photovoltaic panel system. Followed by...
2. Repairing or replacing the roof surface below the photovoltaic panel system. Followed by...
3. Reinstallation of the previously installed, inspected, and approved photovoltaic panel system.

Cost Impact: The code change proposal will not increase or decrease the cost of construction

The code change proposal simply clarifies the ongoing use of approved equipment after roof repair or replacement, so does not impact the cost of construction.

S60-22

S62-22

IBC: CHAPTER 2, SECTION 202, SECTION 202 (New), CHAPTER 15, SECTION 1504, TABLE 1504.2, 1504.6, CHAPTER 16, SECTION 1602, 1602.1, SECTION 1609, 1609.1.1, 1609.3, FIGURE 1609.3(1), FIGURE 1609.3(2), FIGURE 1609.3(3), FIGURE 1609.3(4), FIGURE 1609.3(5), FIGURE 1609.3(6), FIGURE 1609.3(7), FIGURE 1609.3(8), FIGURE 1609.3(9), FIGURE 1609.3(10), FIGURE 1609.3(11), FIGURE 1609.3(12), 1609.3.1, TABLE 1609.3.1

Proponents: Jennifer Goupil, representing Structural Engineering Institute of ASCE (jgoupil@asce.org)

2021 International Building Code

CHAPTER 2 DEFINITIONS

SECTION 202 DEFINITIONS

Revise as follows:

[BS] WINDBORNE DEBRIS REGION. Areas within *hurricane-prone regions* located:

1. Within 1 mile (1.61 km) of the mean high-water line where an Exposure D condition exists upwind at the waterline and the basic ~~design~~ wind speed, V , is 130 mph (58 m/s) or greater; or
2. In areas where the basic ~~design~~ wind speed, V , is 140 mph (63 m/s) or greater.

For *Risk Category II* buildings and structures and *Risk Category III* buildings and structures, except health care facilities, the windborne debris region shall be based on Figure ~~1609.3(1)~~ 1609.3(2). For *Risk Category III* health care facilities, and *Risk Category IV* buildings and structures and *Risk Category III* health care facilities, the windborne debris region shall be based on Figure ~~1609.3(2)~~ 1609.3(3) and Figure 1609.3(4), respectively .

Add new definition as follows:

[BS] WIND DESIGN GEODATABASE. The ASCE database (version 2022-1.0) of geocoded wind speed design data. The ASCE Wind Design Geodatabase of geocoded wind speed design data is available at <https://asce7hazardtool.online/>.

CHAPTER 15 ROOF ASSEMBLIES AND ROOFTOP STRUCTURES

SECTION 1504 PERFORMANCE REQUIREMENTS

Revise as follows:

TABLE 1504.2 CLASSIFICATION OF STEEP SLOPE ROOF SHINGLES TESTED IN ACCORDANCE WITH ASTM D3161 OR D7158

MAXIMUM BASIC WIND SPEED, V , FROM FIGURES 1609.3(1)–(8) (4) OR ASCE 7(mph)	MAXIMUM ALLOWABLE STRESS DESIGN WIND SPEED, V_{asd} , FROM Table 1609.3.1 (mph)	ASTM D7158 ^a CLASSIFICATION	ASTM D3161 or UL 7103 CLASSIFICATION
110	85	D, G or H	A, D or F
116	90	D, G or H	A, D or F
129	100	G or H	A, D or F
142	110	G or H	F
155	120	G or H	F
168	130	H	F
181	140	H	F
194	150	H	F

For SI: 1 foot = 304.8 mm; 1 mph = 0.447 m/s.

- a. The standard calculations contained in ASTM D7158 assume Exposure Category B or C and building height of 60 feet or less. Additional calculations are required for conditions outside of these assumptions.

1504.6 Edge systems for low-slope roofs. Metal edge systems, except gutters and counterflashing, installed on built-up, modified bitumen and single-ply roof systems having a slope less than 2 units vertical in 12 units horizontal (2:12) shall be designed and installed for wind loads in accordance with Chapter 16 and tested for resistance in accordance with Test Methods RE-1, RE-2 and RE-3 of ANSI/SPRI ES-1, except basic design wind speed, V , shall be determined from Figures 1609.3(1) through ~~1609.3(12)~~ 1609.3(4) as applicable.

**CHAPTER 16
STRUCTURAL DESIGN
SECTION 1602
NOTATIONS**

Revise as follows:

1602.1 Notations. The following notations are used in this chapter:

D	=	Dead load.
D_i	=	Weight of ice in accordance with Chapter 10 of ASCE 7.
E	=	Combined effect of horizontal and vertical earthquake induced forces as defined in Section 12.4 of ASCE 7.
F	=	Load due to fluids with well-defined pressures and maximum heights.
F_a	=	Flood load in accordance with Chapter 5 of ASCE 7.
H	=	Load due to lateral earth pressures, ground water pressure or pressure of bulk materials.
L	=	Live load.
L_r	=	Roof live load.
R	=	Rain load.
S	=	Snow load.
T	=	Cumulative effects of self-straining load forces and effects.
V_{asd}	=	Allowable stress design wind speed, miles per hour (mph) (km/hr m/s) where applicable.
V	=	Basic design wind speeds, miles per hour (mph) (km/hr m/s) determined from Figures 1609.3(1) through 1609.3(12) (4) or ASCE 7.
W	=	Load due to wind pressure.
W_i	=	Wind-on-ice in accordance with Chapter 10 of ASCE 7.

**SECTION 1609
WIND LOADS**

Revise as follows:

1609.1.1 Determination of wind loads. Wind loads on every building or structure shall be determined in accordance with Chapters 26 to 30 of ASCE 7. The type of opening protection required, the basic ~~design-wind speed~~, V , and the exposure category for a site is permitted to be determined in accordance with Section 1609 or ASCE 7. Wind shall be assumed to come from any horizontal direction and wind pressures shall be assumed to act normal to the surface considered.

Exceptions:

1. Subject to the limitations of Section 1609.1.1.1, the provisions of ICC 600 shall be permitted for applicable Group R-2 and R-3 buildings.
2. Subject to the limitations of Section 1609.1.1.1, residential structures using the provisions of AWC WFCM.
3. Subject to the limitations of Section 1609.1.1.1, residential structures using the provisions of AISI S230.
4. Designs using NAAMM FP 1001.
5. Designs using TIA-222 for antenna-supporting structures and antennas, provided that the horizontal extent of Topographic Category 2 escarpments in Section 2.6.6.2 of TIA-222 shall be 16 times the height of the escarpment.
6. Wind tunnel tests in accordance with ASCE 49 and Sections 31.4 and 31.5 of ASCE 7.

The wind speeds in Figures 1609.3(1) through ~~1609.3(12)~~ 1609.3(4) are basic ~~design-wind speeds~~, V , and shall be converted in accordance with Section 1609.3.1 to allowable stress design wind speeds, V_{asd} , when the provisions of the standards referenced in Exceptions 4 and 5 are used.

1609.3 Basic design wind speed. The basic ~~design-wind speed~~, V , in mph, for the determination of the wind loads shall be determined by Figures 1609.3(1) through ~~1609.3(12)~~ 1609.3(4). The basic ~~design-wind speed~~, V , for use in the design of *Risk Category I* buildings and structures shall be obtained from Figures ~~1609.3(1), 1609.3(5) and 1609.3(6)~~. The basic ~~design-wind speed~~, V , for use in the design of *Risk Category II* buildings and structures shall be obtained from Figures ~~1609.3(2), 1609.3(7) and 1609.3(8)~~. The basic ~~design-wind speed~~, V , for use in the design of *Risk Category III* buildings and structures shall be obtained from Figures ~~1609.3(3), 1609.3(9) and 1609.3(10)~~. The basic ~~design-wind speed~~, V , for use in the design of *Risk Category IV* buildings and structures shall be obtained from Figures ~~1609.3(4), 1609.3(11) and 1609.3(12)~~. Basic wind speeds for Hawaii, US Virgin Islands, and Puerto Rico shall be determined by using the ASCE Wind Design Geodatabase. The ASCE Wind Design Geodatabase is available at <https://asce7hazardtool.online>, or an approved equivalent.

The basic ~~design-wind speed~~, V , for the special wind regions indicated near mountainous terrain and near gorges shall be in accordance with local jurisdiction requirements. The basic ~~design-wind speeds~~, V , determined by the local jurisdiction shall be in accordance with Chapter 26 of ASCE 7. In nonhurricane-prone regions, when the basic ~~design-wind speed~~, V , is estimated from regional climatic data, the basic design wind speed, V , shall be determined in accordance with Chapter 26 of ASCE 7.

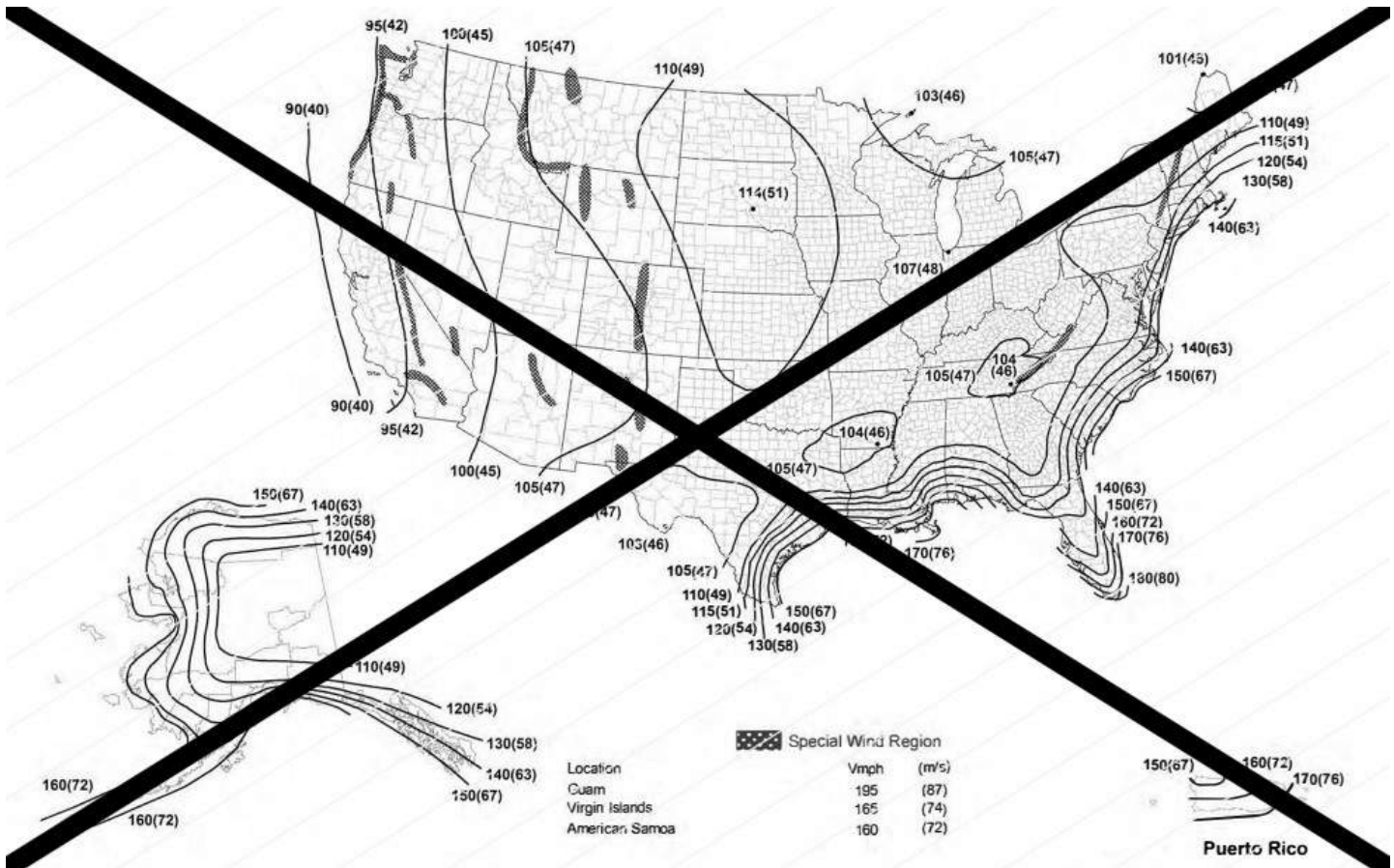

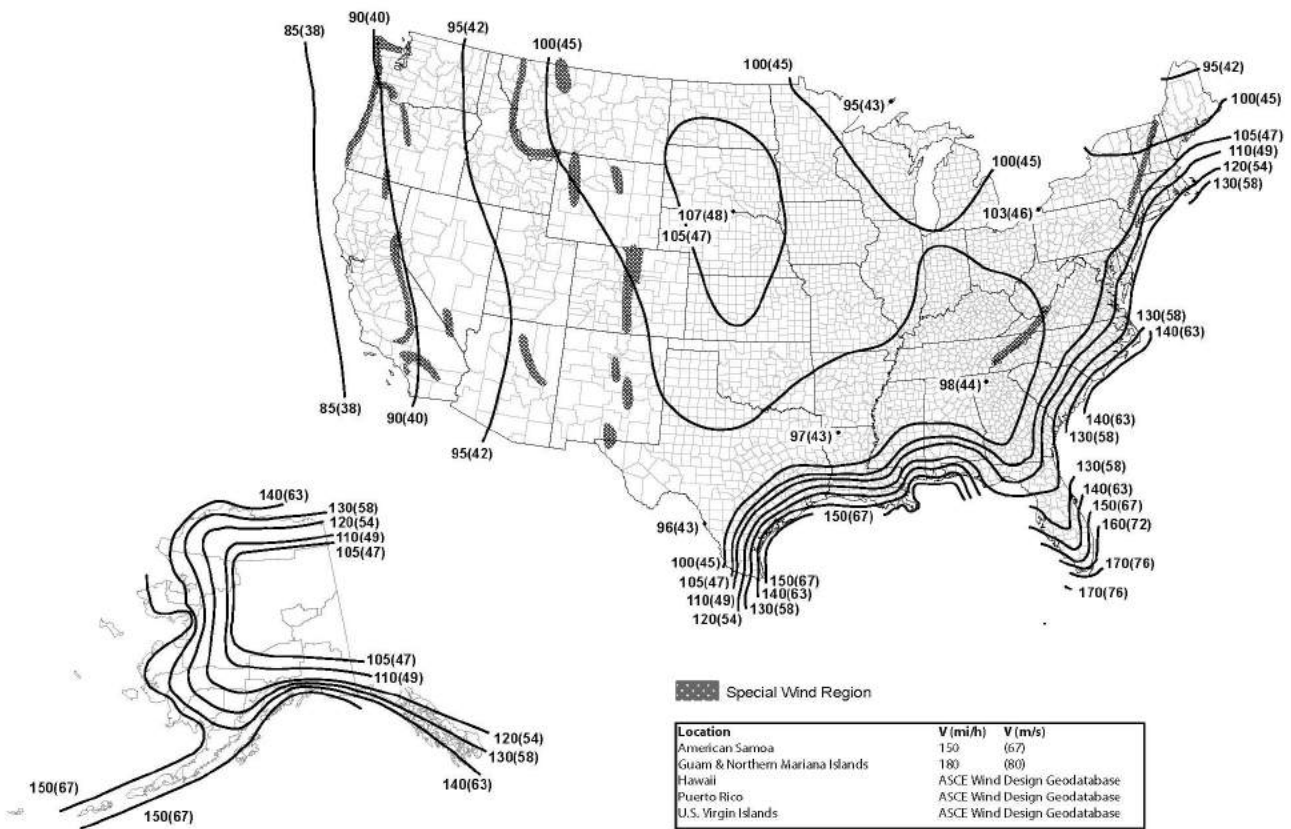

Notes:

1. Values are nominal design 3-second gust wind speeds in miles per hour (m/s) at 33 feet (10 m) above ground for Exposure C Category.
2. Linear interpolation between contours. Point values are provided to aid with interpolation.
3. Islands, coastal areas, and land boundaries outside the last contour shall use the last wind speed contour.
4. Mountainous terrain, gorges, ocean promontories, and special wind regions shall be examined for unusual wind conditions.
5. Wind speeds correspond to approximately a 7% probability of exceedance in 50 years (Annual Exceedance Probability = 0.00143, MRI = 700 Years).
6. Location-specific basic wind speeds shall be permitted to be determined using www.atccouncil.org/windspeed

Notes:

1. Values are 3 s gust wind speeds in mi/h (m/s) at 33 ft (10 m) above ground for Exposure Category C.
2. Linear interpolation is permitted between contours. Point values are provided to aid with interpolation.
3. Islands, coastal areas, and land boundaries outside the last contour shall use the last wind speed contour.
4. Location-specific basic wind speeds shall be permitted to be determined using the ASCE Wind Design Geodatabase.
5. Wind speeds for Hawaii, US Virgin Islands, and Puerto Rico shall be determined from the ASCE Wind Design Geodatabase.
6. Mountainous terrain, gorges, ocean promontories, and special wind regions shall be examined for unusual wind conditions. Site specific values for selected special wind regions shall be permitted to be determined using the ASCE Wind Design Geodatabase.
7. Wind speeds correspond to approximately a 15% probability of exceedance in 50 years (Annual Exceedance Probability = 0.00033, MRI = 300 years).

8. The ASCE Wind Design Geodatabase can be accessed at the ASCE 7 Hazard Tool (<https://asce7hazardtool.online>) or approved equivalent.

FIGURE 1609.3(1) BASIC DESIGN-WIND SPEEDS, V , FOR RISK CATEGORY I-BUILDINGS AND OTHER STRUCTURES

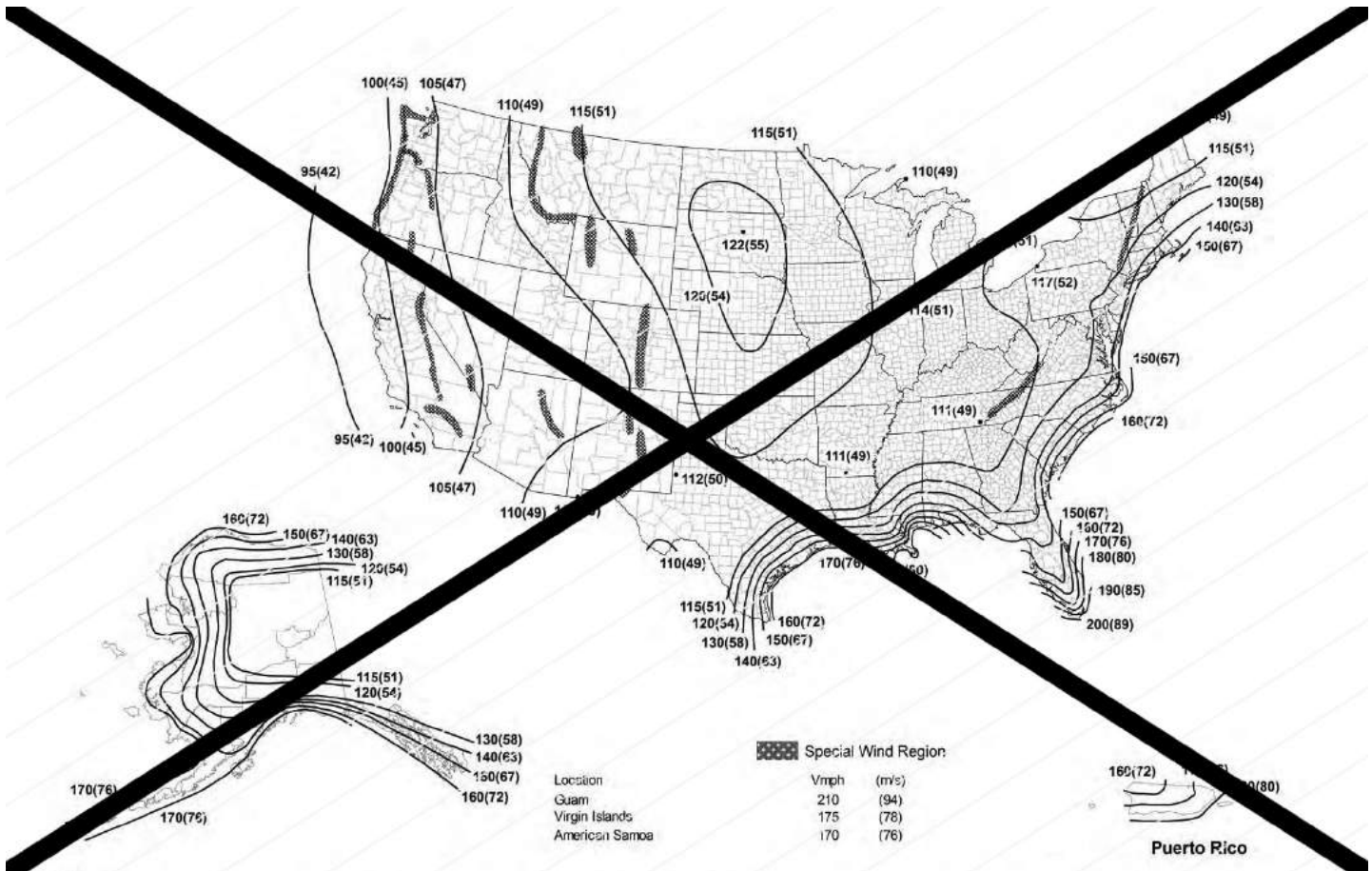

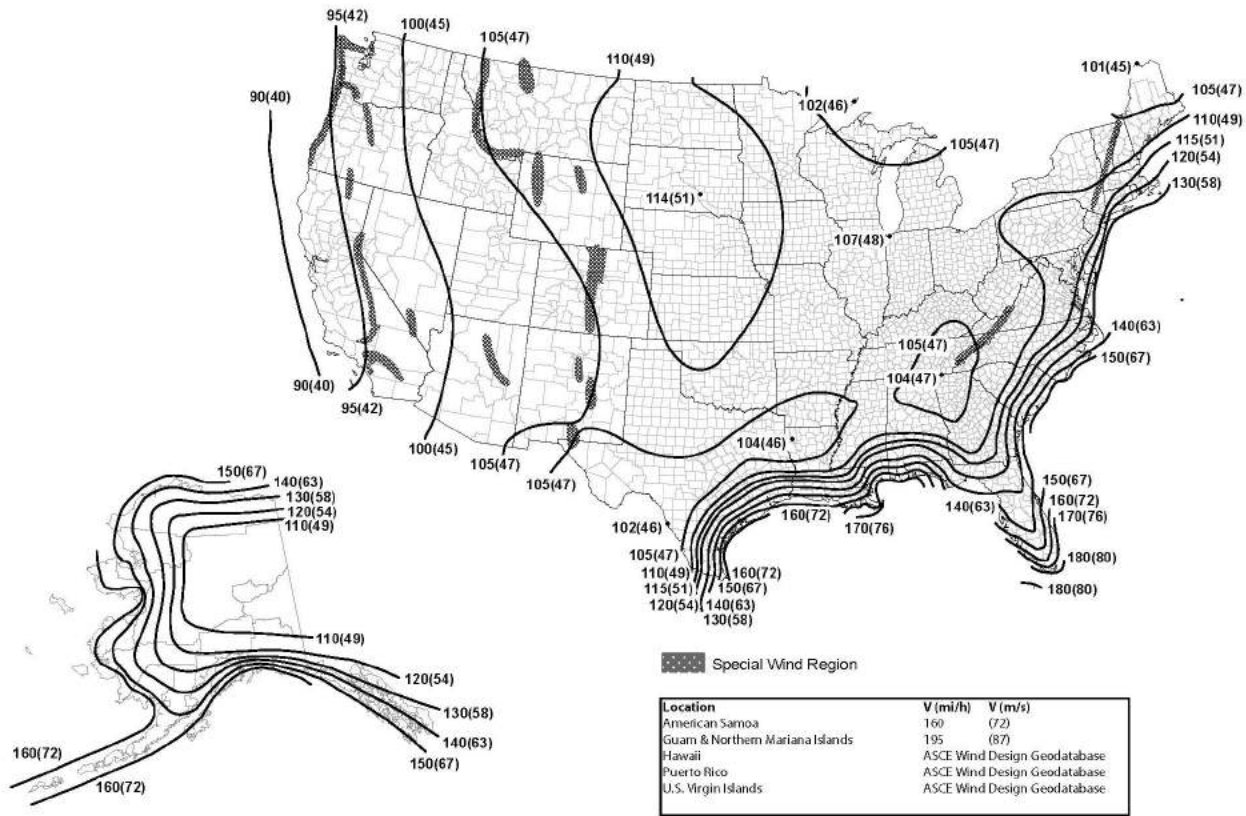

Notes:

1. Values are nominal design 3-second gust wind speeds in miles per hour (m/s) at 33 feet (10 m) above ground for Exposure C Category.
2. Linear interpolation between contours. Point values are provided to aid with interpolation.
3. Islands, coastal areas, and land boundaries outside the last contour shall use the last wind speed contour.
4. Mountainous terrain, gorges, ocean promontories, and special wind regions shall be examined for unusual wind conditions.
5. Wind speeds correspond to approximately a 3% probability of exceedance in 50 years (Annual Exceedance Probability = 0.00143, MRI = 700 Years).
6. Location-specific basic wind speeds shall be permitted to be determined using www.atcouncil.org/windspeed

Notes:

1. Values are 3 s gust wind speeds in mi/h (m/s) at 33 ft (10 m) above ground for Exposure Category C.
2. Linear interpolation is permitted between contours. Point values are provided to aid with interpolation.
3. Islands, coastal areas, and land boundaries outside the last contour shall use the last wind speed contour.
4. Location-specific basic wind speeds shall be permitted to be determined using the ASCE Wind Design Geodatabase.
5. Wind speeds for Hawaii, US Virgin Islands, and Puerto Rico shall be determined from the ASCE Wind Design Geodatabase.
6. Mountainous terrain, gorges, ocean promontories, and special wind regions shall be examined for unusual wind conditions. Site specific values for selected special wind regions shall be permitted to be determined using the ASCE Wind Design Geodatabase.
7. Wind speeds correspond to approximately a 15% probability of exceedance in 50 years (Annual Exceedance Probability = 0.00033, MRI = 700 years).

8. The ASCE Wind Design Geodatabase can be accessed at the ASCE 7 Hazard Tool (<https://asce7hazardtool.online>) or approved equivalent.

FIGURE 1609.3(2) BASIC DESIGN-WIND SPEEDS, V, FOR RISK CATEGORY II BUILDINGS AND OTHER STRUCTURES

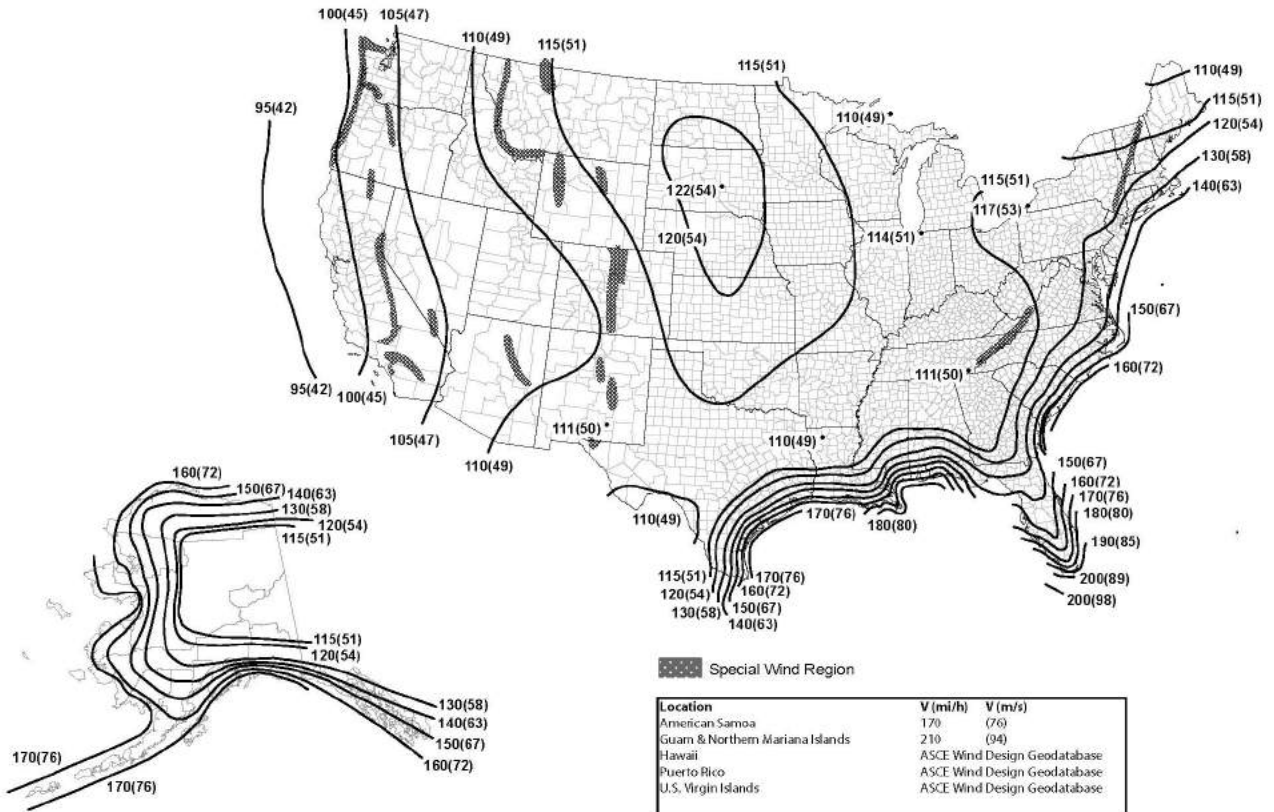
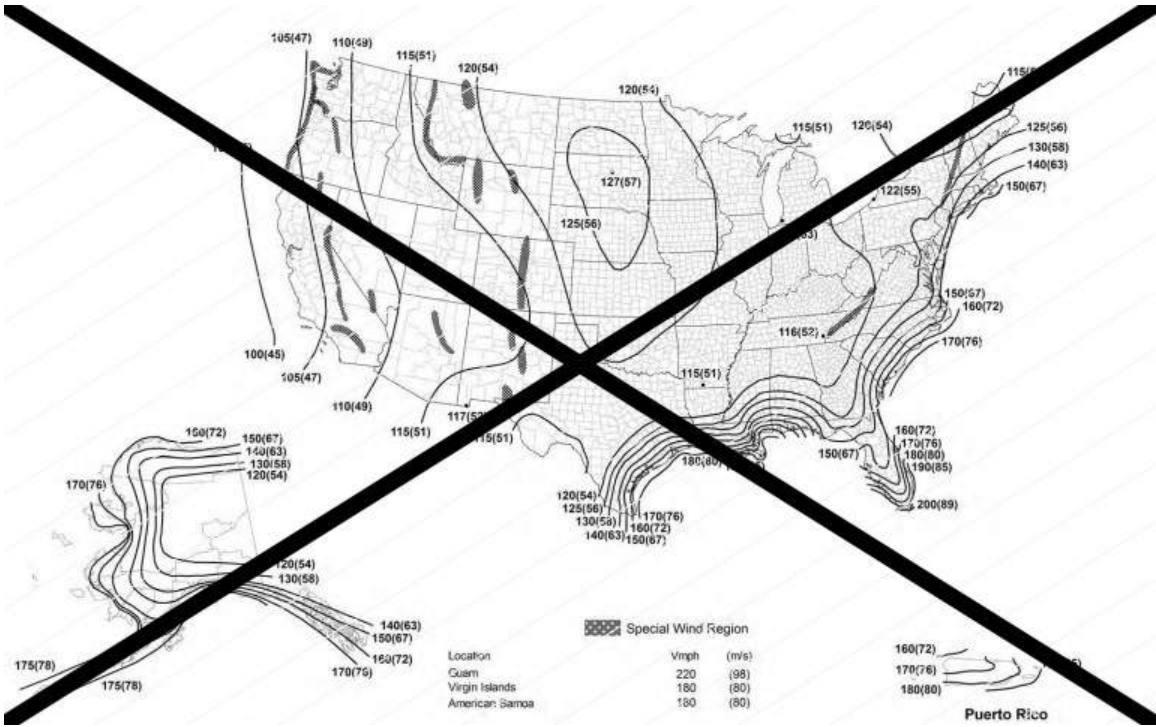

Notes:

1. Values are nominal design 3-second gust wind speeds in miles per hour (m/s) at 33 feet (10 m) above ground for Exposure C Category.
2. Linear interpolation between contours. Point values are provided to aid with interpolation.
3. Islands, coastal areas, and land boundaries outside the last contour shall use the last wind speed contour.
4. Mountainous terrain, gorges, ocean promontories, and special wind regions shall be examined for unusual wind conditions.
5. Wind speeds correspond to approximately a 1.6% probability of exceedance in 50 years (Annual Exceedance Probability = 0.00033, MRI = 3000 Years).
6. Location-specific basic wind speeds shall be permitted to be determined using www.atcouncil.org/windspeed

Notes:

1. Values are 3 s gust wind speeds in mi/h (m/s) at 33 ft (10 m) above ground for Exposure Category C.
2. Linear interpolation is permitted between contours. Point values are provided to aid with interpolation.
3. Islands, coastal areas, and land boundaries outside the last contour shall use the last wind speed contour.
4. Location-specific basic windspeeds shall be permitted to be determined using the ASCE Wind Design Geodatabase.
5. Wind speeds for Hawaii, US Virgin Islands, and Puerto Rico shall be determined from the ASCE Wind Design Geodatabase.
6. Mountainous terrain, gorges, ocean promontories, and special wind regions shall be examined for unusual wind conditions. Site specific values for selected special wind regions shall be permitted to be determined using the ASCE Wind Design Geodatabase.
7. Wind speeds correspond to approximately a 15% probability of exceedance in 50 years (Annual Exceedance Probability = 0.00033, MRI = 1,700 years).
8. The ASCE Wind Design Geodatabase can be accessed at the ASCE 7 Hazard Tool (<https://asce7hazardtool.online>) or approved equivalent.

FIGURE 1609.3(3) BASIC DESIGN-WIND SPEEDS, V, FOR RISK CATEGORY III BUILDINGS AND OTHER STRUCTURES

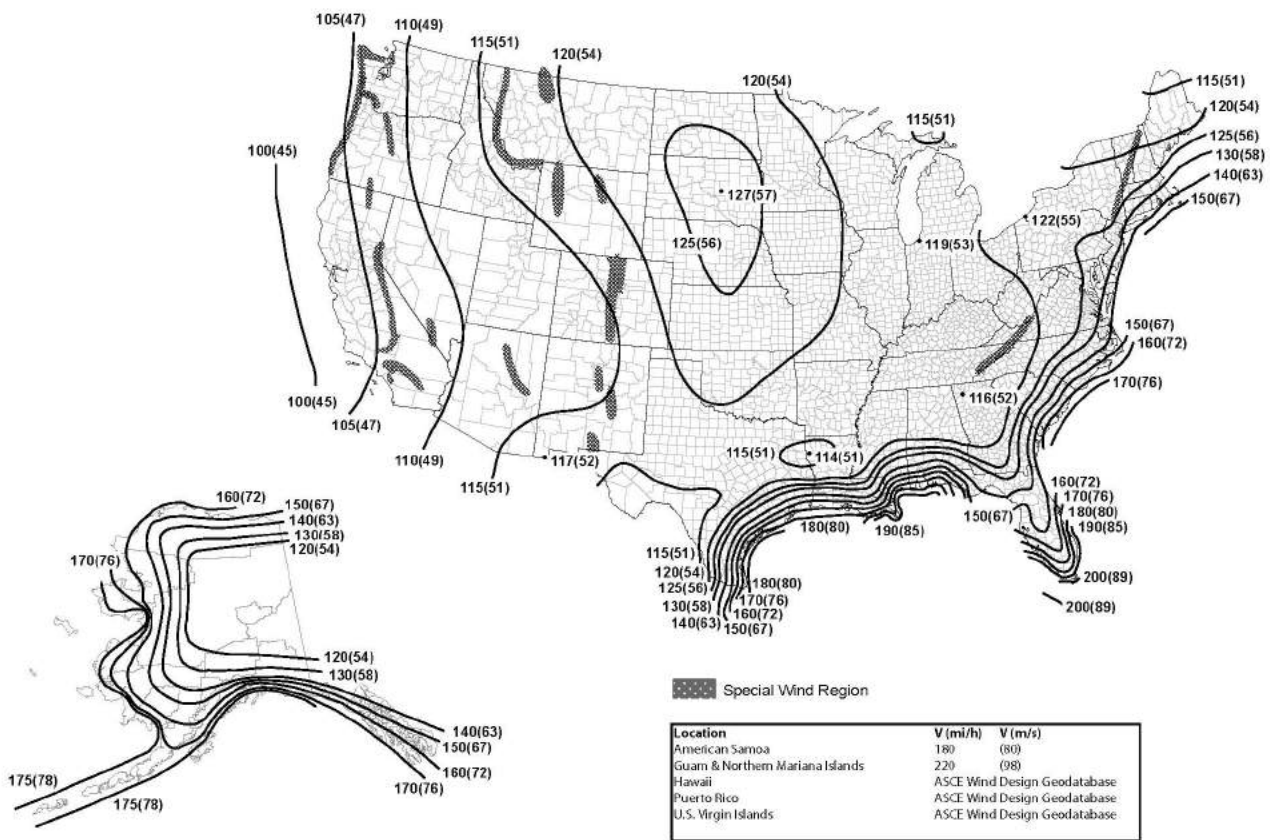
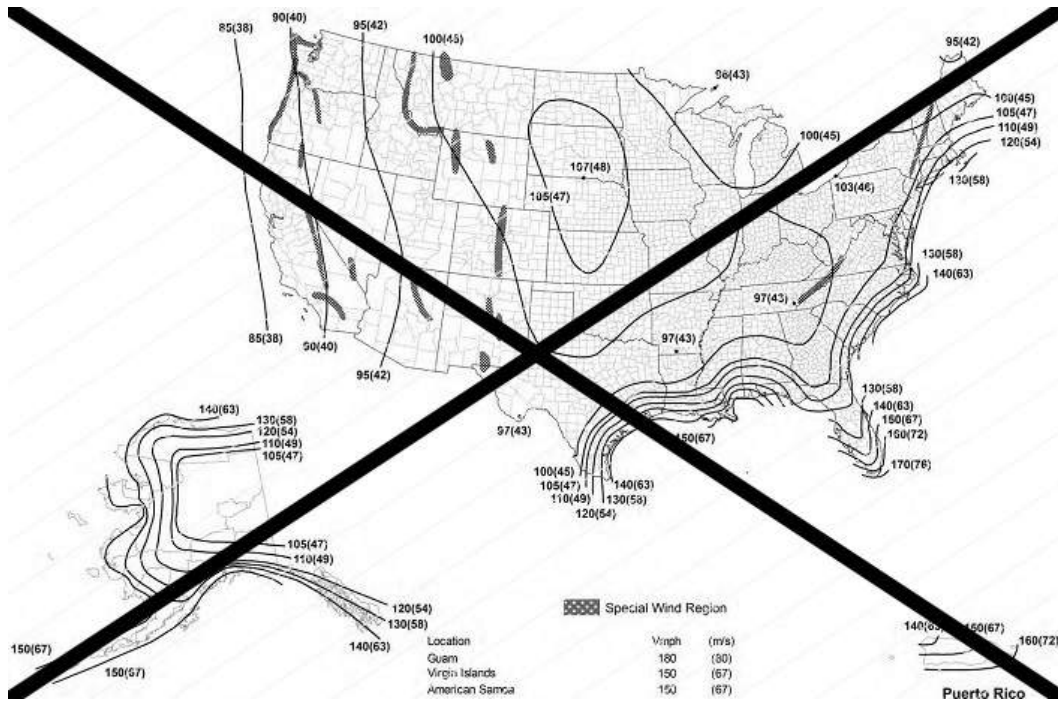

Notes:

1. Values are nominal design 3-second gust wind speeds in miles per hour (m/s) at 33 feet (10 m) above ground for Exposure C Category.
2. Linear interpolation between contours. Point values are provided to aid with interpolation.
3. Islands, coastal areas, and land boundaries outside the last contour shall use the last wind speed contour.
4. Mountainous terrain, gorges, ocean promontories, and special wind regions shall be examined for unusual wind conditions.
5. Wind speeds correspond to approximately a 15% probability of exceedance in 50 years (Annual Exceedance Probability = 0.00333, MRI = 300 Years).
6. Location-specific basic wind speeds shall be permitted to be determined using www.atcouncil.org/wind-speed.

Notes:

1. Values are 3 s gust wind speeds in mi/h (m/s) at 33 ft (10 m) above ground for Exposure Category C.
2. Linear interpolation is permitted between contours. Point values are provided to aid with interpolation.
3. Islands, coastal areas, and land boundaries outside the last contour shall use the last wind speed contour.
4. Location-specific basic wind speeds shall be permitted to be determined using the ASCE Wind Design Geodatabase.
5. Wind speeds for Hawaii, US Virgin Islands, and Puerto Rico shall be determined from the ASCE Wind Design Geodatabase.
6. Mountainous terrain, gorges, ocean promontories, and special wind regions shall be examined for unusual wind conditions. Site specific values for selected special wind regions shall be permitted to be determined using the ASCE Wind Design Geodatabase.
7. Wind speeds correspond to approximately a 15% probability of exceedance in 50 years (Annual Exceedance Probability = 0.00333, MRI = 3,000 years).
8. The ASCE Wind Design Geodatabase can be accessed at the ASCE 7 Hazard Tool (<https://asce7hazardtool.online>) or approved equivalent.

FIGURE 1609.3(4) BASIC DESIGN WIND SPEEDS, V, FOR RISK CATEGORY IV BUILDINGS AND OTHER STRUCTURES

Delete without substitution:

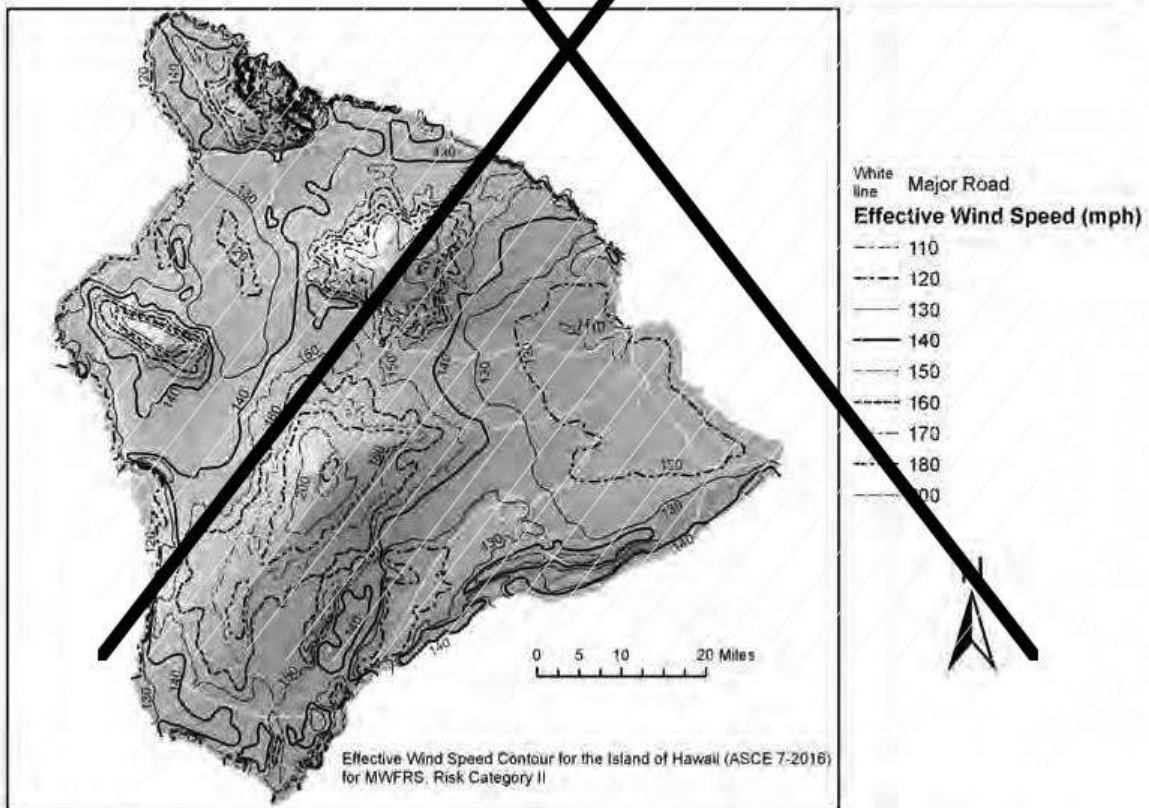
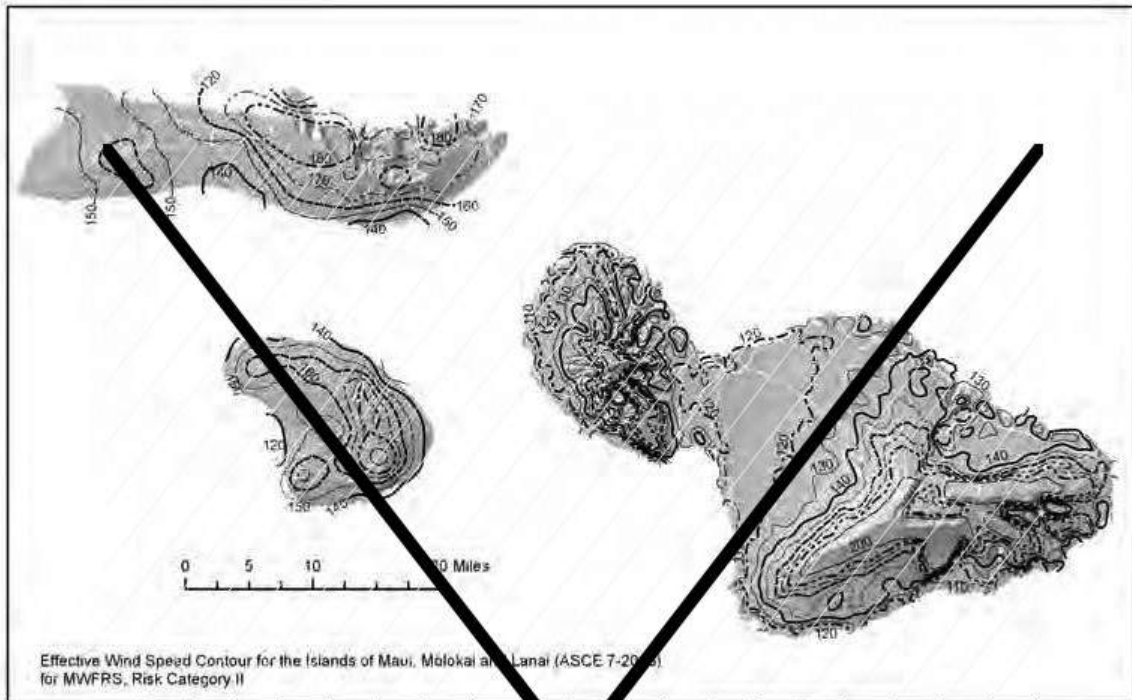

Notes:

1. Values are nominal design 3-second gust wind speeds in miles per hour at 33 feet (10 m) above ground for Exposure C Category.
2. Linear interpolation between contours is permitted.
3. Islands and coastal areas outside the last contour shall use the last wind speed contour of the coastal area.
4. It is permitted to use the standard values of K_{zt} of 1.0 and K_d as given in Table 26.6-1 of ASCE 7.
5. Ocean promontories and local escarpments shall be examined for unusual wind conditions.

6. Wind speeds correspond to approximately a 7% probability of exceedance in 50 years (Annual Exceedance Probability = 0.00143, MRI = 700 Years).

FIGURE 1609.3(5) BASIC DESIGN WIND SPEEDS, V, FOR RISK CATEGORY II BUILDINGS AND OTHER STRUCTURES IN HAWAII

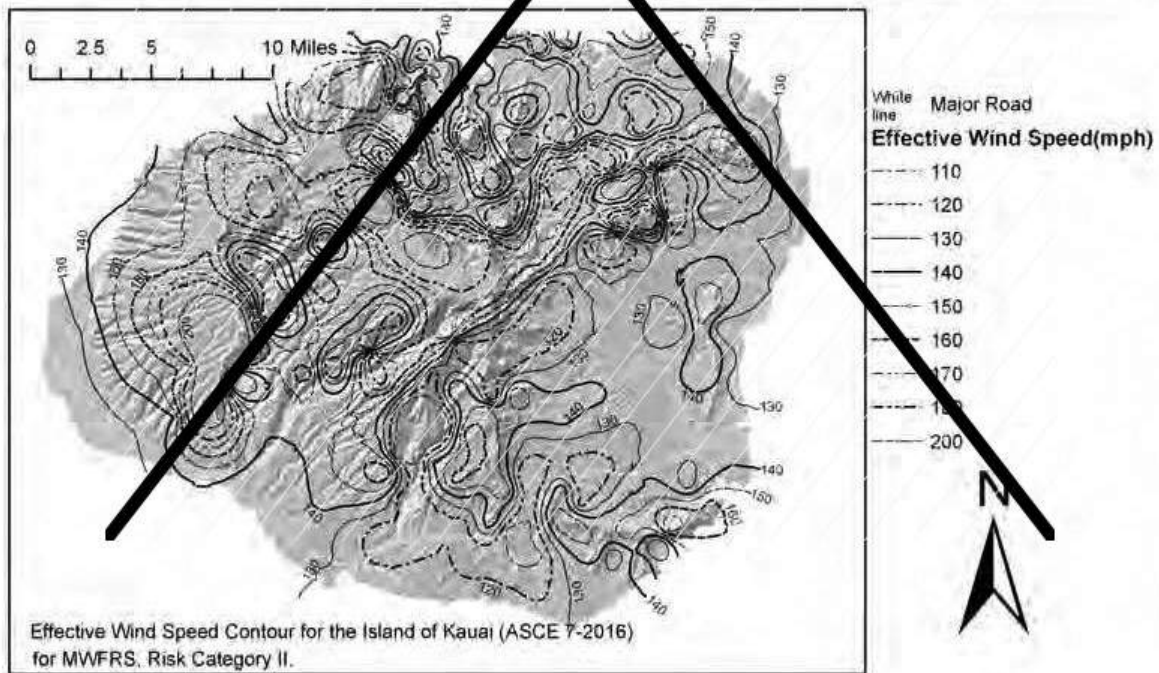
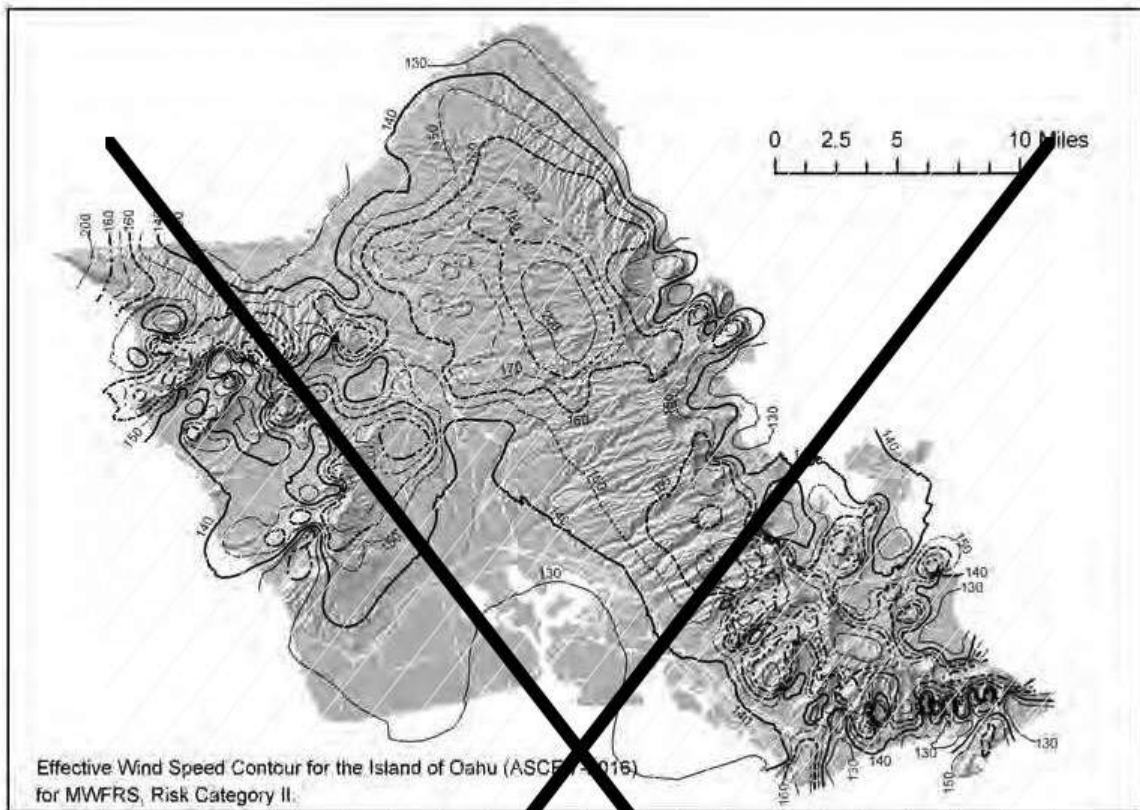

Notes:

1. Values are nominal design 3-second gust wind speeds in miles per hour at 33 feet (10 m) above ground for Exposure C Category.
2. Linear interpolation between contours is permitted.
3. Islands and coastal areas outside the last contour shall use the last wind speed contour of the coastal area.
4. It is permitted to use the standard values of K_{zt} of 1.0 and K_d as given in Table 26.6-1 of ASCE 7.
5. Ocean promontories and local escarpments shall be examined for unusual wind conditions.

6. Wind speeds correspond to approximately a 7% probability of exceedance in 50 years (Annual Exceedance Probability = 0.00143, MRI = 700 Years).

FIGURE 1609.3(6) BASIC DESIGN WIND SPEEDS, V, FOR RISK CATEGORY II BUILDINGS AND OTHER STRUCTURES IN HAWAII (OAHU, KAUAI)

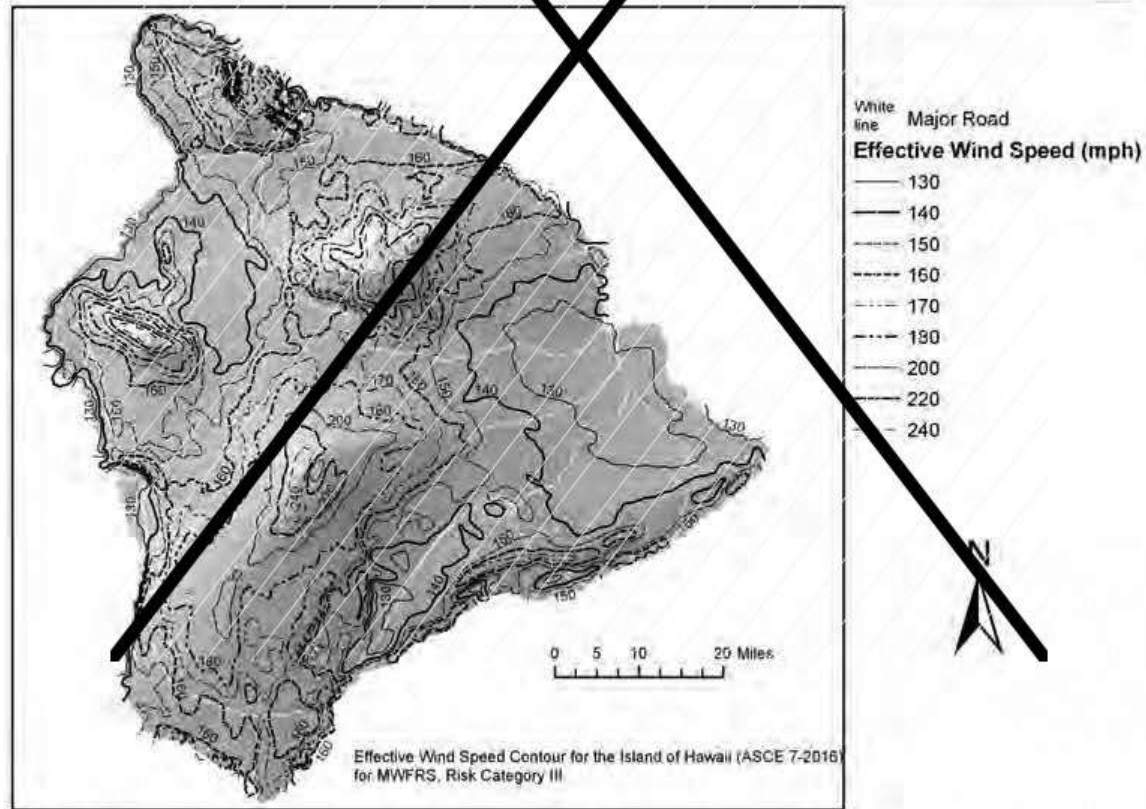
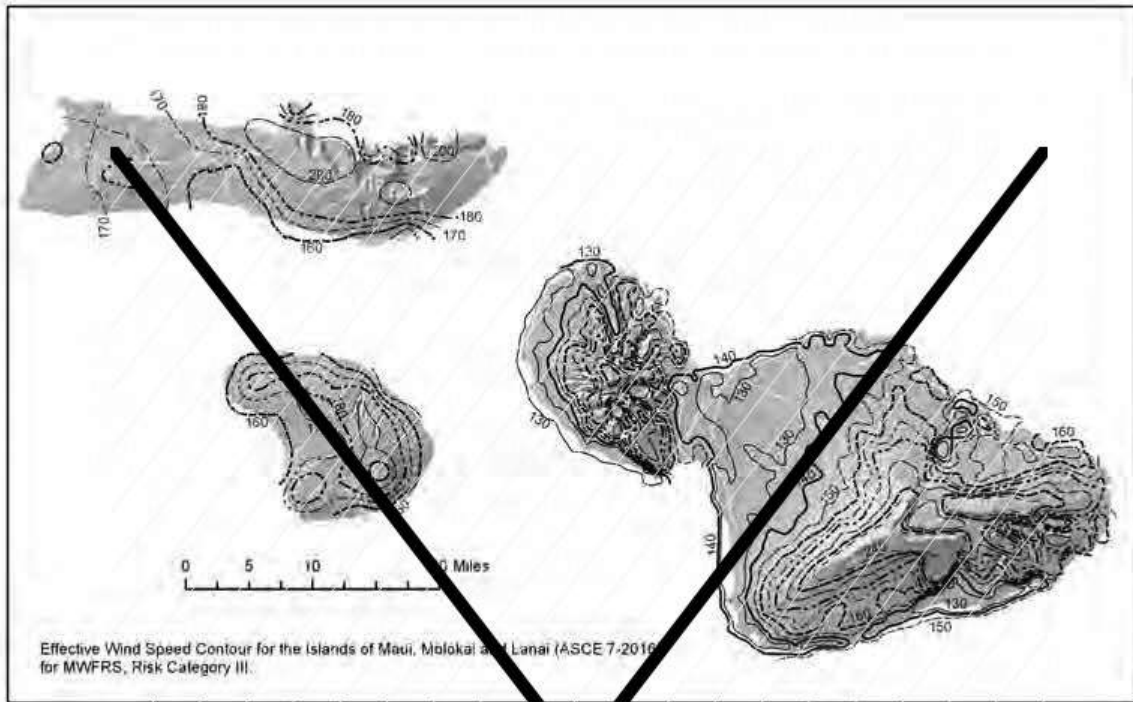

Notes:

1. Values are nominal design 3-second gust wind speeds in miles per hour at 33 feet (10 m) above ground for Exposure C Category.
2. Linear interpolation between contours is permitted.
3. Islands and coastal areas outside the last contour shall use the last wind speed contour of the coastal area.
4. It is permitted to use the standard values of K_{zr} of 1.0 and K_d as given in Table 26.6-1 of ASCE 7.
5. Ocean promontories and local escarpments shall be examined for unusual wind conditions.

6. Wind speeds correspond to approximately a 3% probability of exceedance in 50 years (Annual Exceedance Probability = 0.00143, MRI = 700 Years).

FIGURE 1609.3(7) BASIC DESIGN WIND SPEEDS, V, FOR RISK CATEGORY III BUILDINGS AND OTHER STRUCTURES IN HAWAII

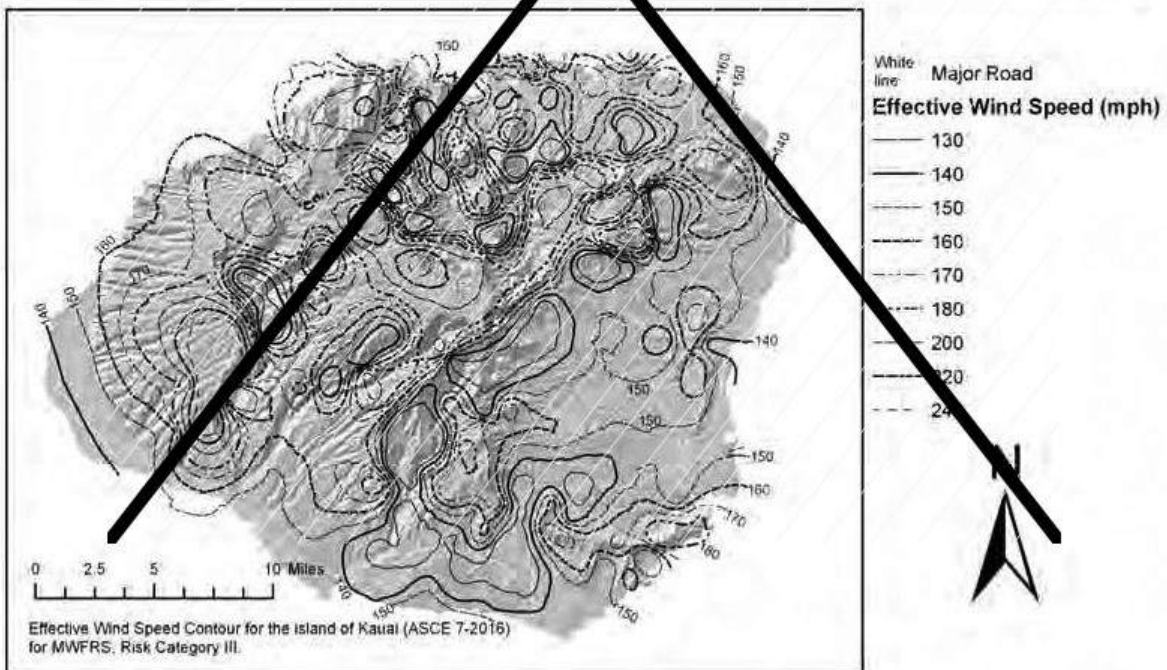
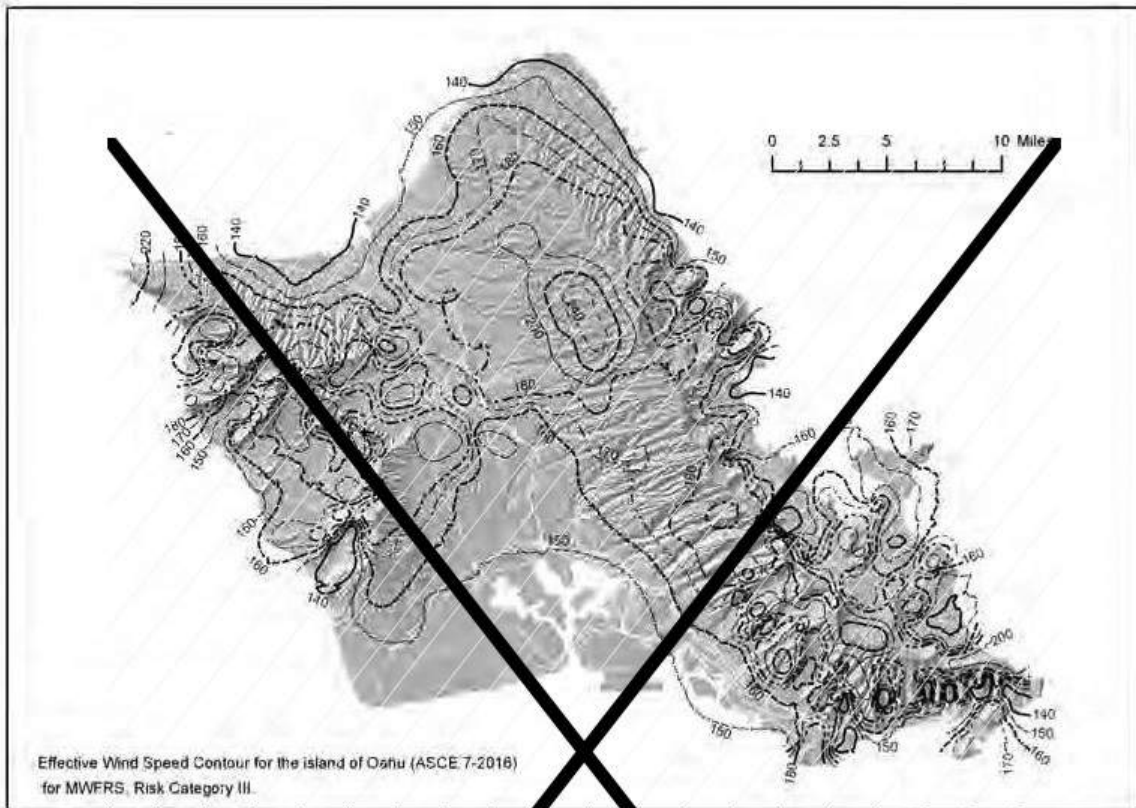

Notes:

1. Values are nominal design 3-second gust wind speeds in miles per hour at 33 feet (10 m) above ground for Exposure C Category.
2. Linear interpolation between contours is permitted.
3. Islands and coastal areas outside the last contour shall use the last wind speed contour of the coastal area.
4. It is permitted to use the standard values of K_{zt} of 1.0 and K_d as given in Table 26.6-1 of ASCE 7.
5. Ocean promontories and local escarpments shall be examined for unusual wind conditions.

6. Wind speeds correspond to approximately a 3% probability of exceedance in 50 years (Annual Exceedance Probability = 0.00143, MRI = 700 Years).

-
FIGURE 1609.3(8) BASIC DESIGN WIND SPEEDS, V, FOR RISK CATEGORY III BUILDINGS AND OTHER STRUCTURES IN HAWAII (OAHU, KAUAI)

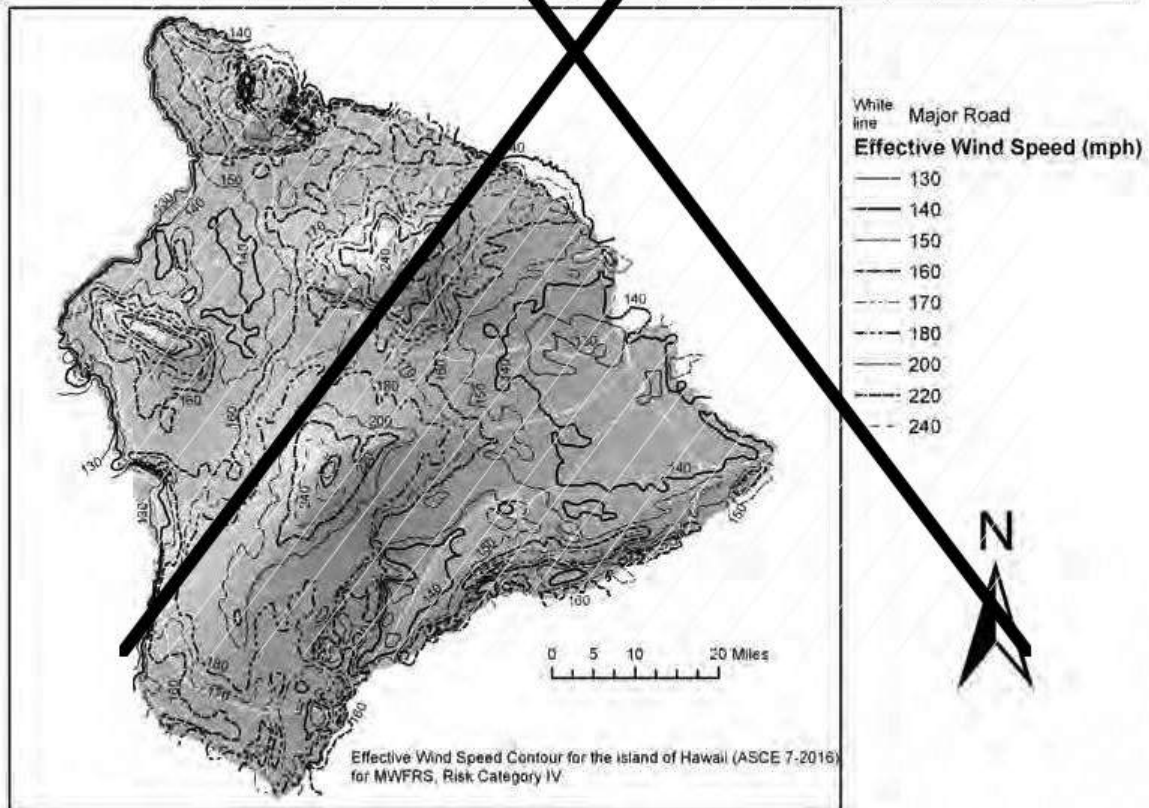
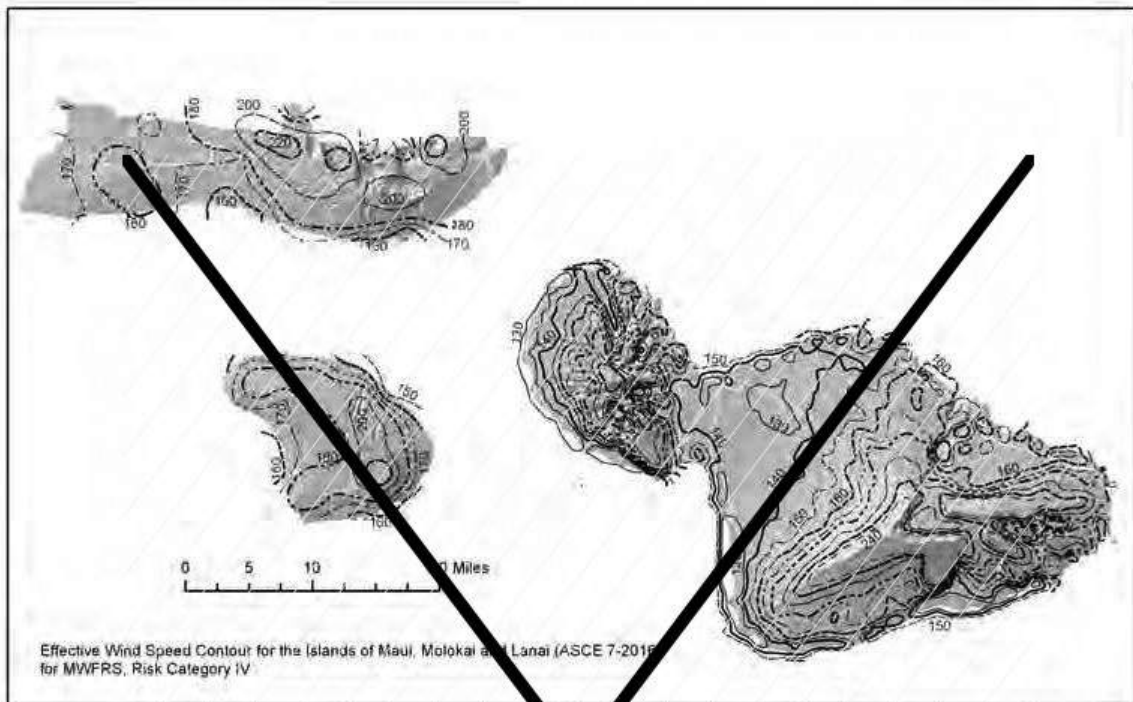

Notes:

1. Values are nominal design 3-second gust wind speeds in miles per hour at 33 feet (10-m) above ground for Exposure C category.
2. Linear interpolation between contours is permitted.
3. Islands and coastal areas outside the last contour shall use the last wind speed contour of the coastal area.
4. It is permitted to use the standard values of K_{zt} of 1.0 and K_g as given in Table 26.6-1 of ASCE 7.
5. Ocean promontories and local escarpments shall be examined for unusual wind conditions.

6. Wind speeds correspond to approximately a 1.7% probability of exceedance in 50 years (Annual Exceedance Probability = 0.00143, MRI = 700 Years).

FIGURE 1609.3(9) BASIC DESIGN WIND SPEEDS, V, FOR RISK CATEGORY IV BUILDINGS AND OTHER STRUCTURES IN HAWAII

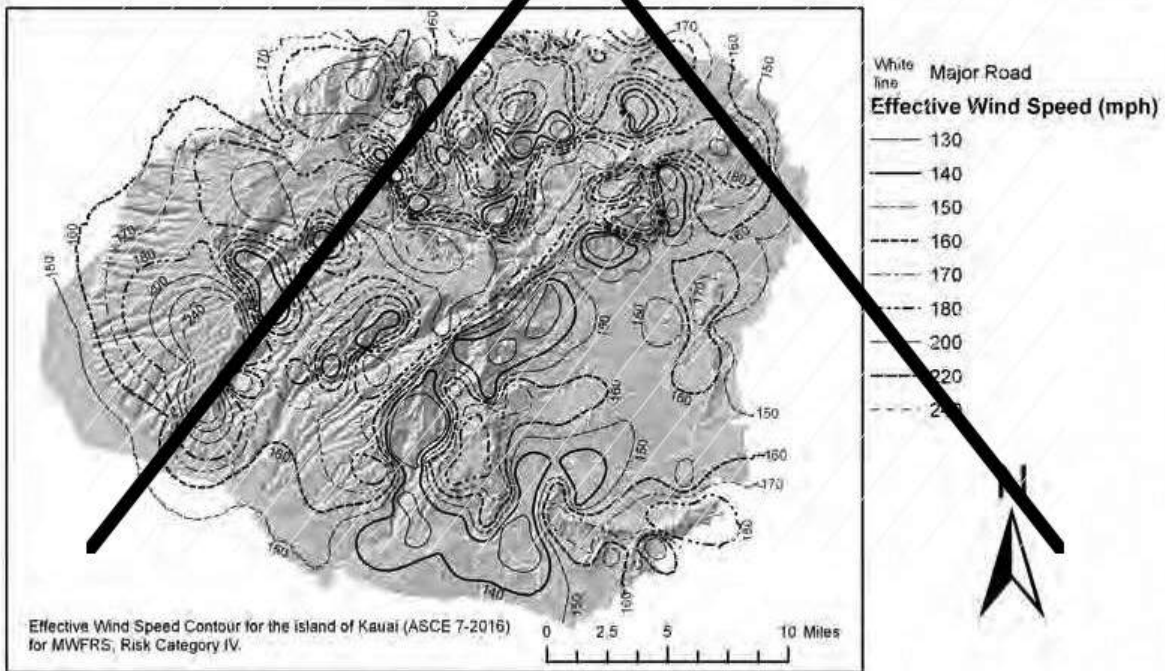
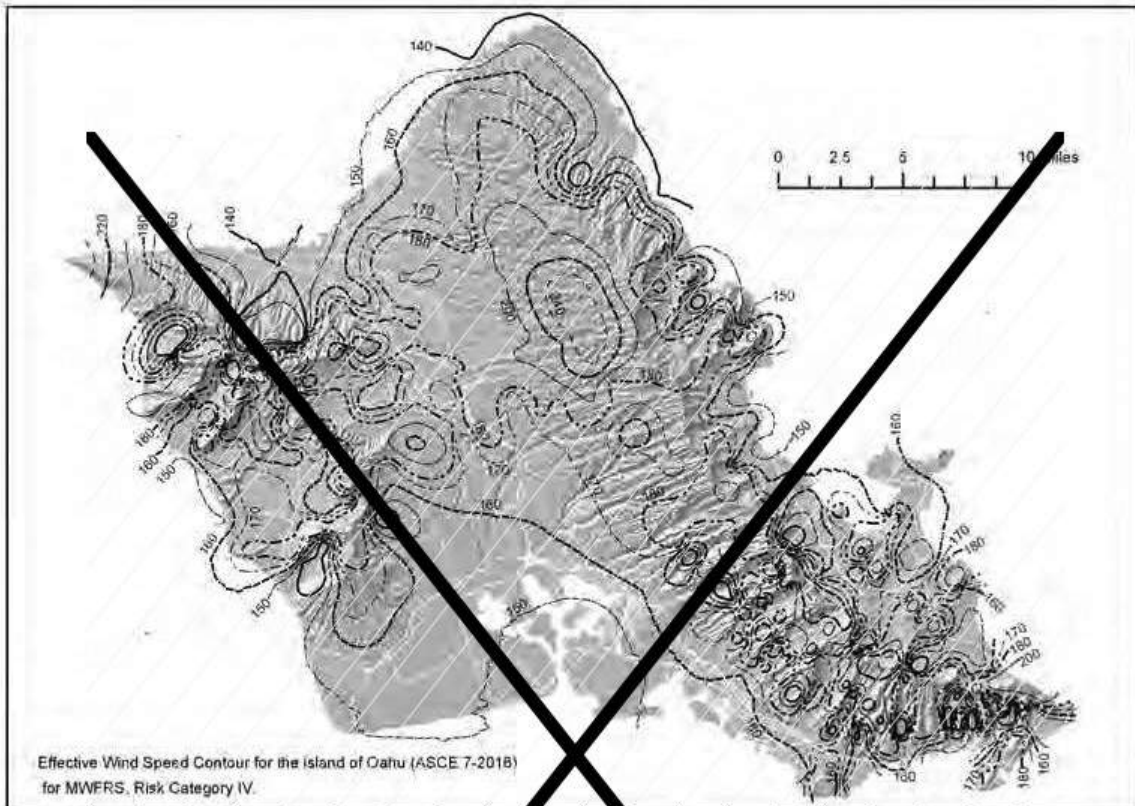

Notes:

1. Values are nominal design 3-second gust wind speeds in miles per hour at 33 feet (10-m) above ground for Exposure C category.
2. Linear interpolation between contours is permitted.
3. Islands and coastal areas outside the last contour shall use the last wind speed contour of the coastal area.
4. It is permitted to use the standard values of K_{zt} of 1.0 and K_d as given in Table 26.6-1 of ASCE 7.
5. Ocean promontories and local escarpments shall be examined for unusual wind conditions.

6. Wind speeds correspond to approximately a 1.7% probability of exceedance in 50 years (Annual Exceedance Probability = 0.00143, MRI = 700 Years).

FIGURE 1609.3(10) BASIC DESIGN WIND SPEEDS, V, FOR RISK CATEGORY IV BUILDINGS AND OTHER STRUCTURES IN HAWAII (OAHU, KAUAI)

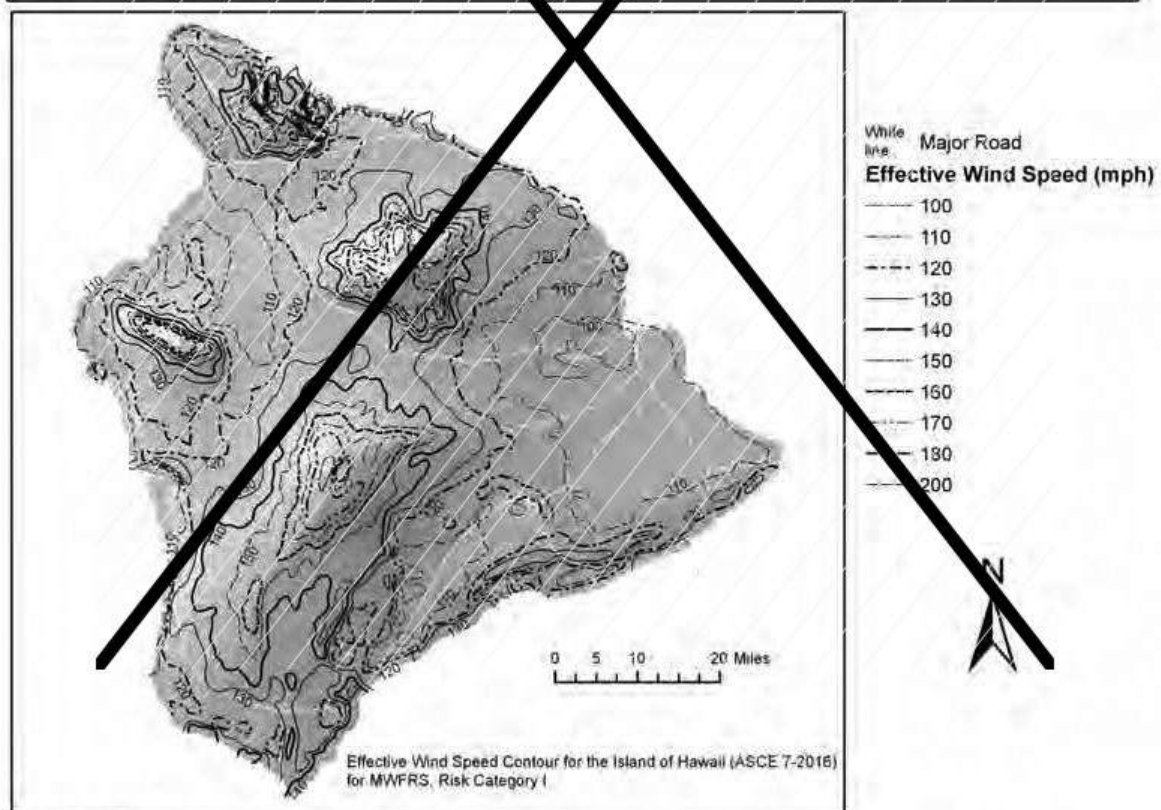
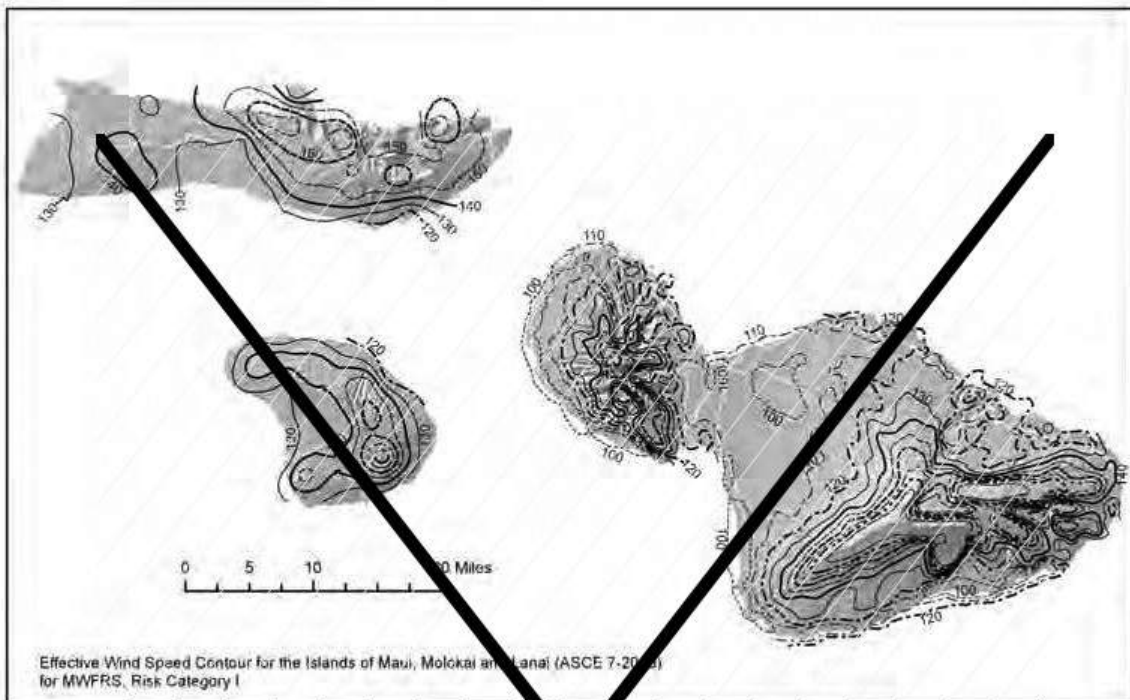

Notes:

1. Values are nominal design 3-second gust wind speeds in miles per hour at 33 feet (10-m) above ground for Exposure C category.
2. Linear interpolation between contours is permitted.
3. Islands and coastal areas outside the last contour shall use the last wind speed contour of the coastal area.
4. It is permitted to use the standard values of K_{zt} of 1.0 and K_g as given in Table 26.6-1 of ASCE 7.
5. Ocean promontories and local escarpments shall be examined for unusual wind conditions.

6. Wind speeds correspond to approximately a 15% probability of exceedance in 50 years (Annual Exceedance Probability = 0.00143, MRI = 700 Years).

FIGURE 1609.3(11) BASIC DESIGN WIND SPEEDS, V, FOR RISK CATEGORY I BUILDINGS AND OTHER STRUCTURES IN HAWAII

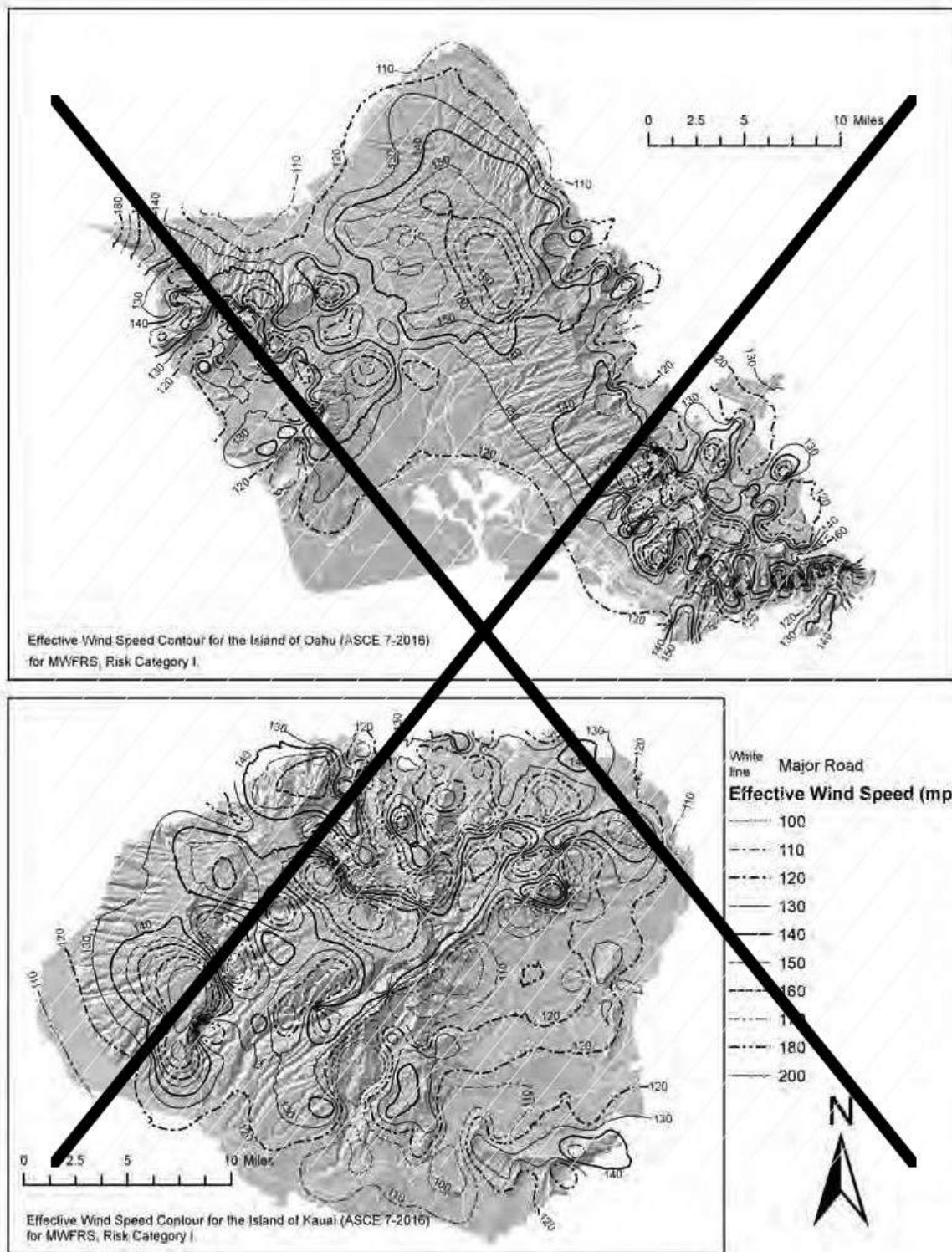

Notes:

1. Values are nominal design 3-second gust wind speeds in miles per hour at 33 feet (10-m) above ground for Exposure C category.
2. Linear interpolation between contours is permitted.
3. Islands and coastal areas outside the last contour shall use the last wind speed contour of the coastal area.
4. It is permitted to use the standard values of K_{zt} of 1.0 and K_d as given in Table 26.6-1 of ASCE 7.
5. Ocean promontories and local escarpments shall be examined for unusual wind conditions.

6. Wind speeds correspond to approximately a 15% probability of exceedance in 50 years (Annual Exceedance Probability = 0.00143, MRI = 700 Years).

FIGURE 1609.3(12) BASIC DESIGN WIND SPEEDS, V, FOR RISK CATEGORY I BUILDINGS AND OTHER STRUCTURES IN HAWAII (OAHU, KAUAI)

Revise as follows:

1609.3.1 Wind speed conversion. Where required, the basic design wind speeds of Figures 1609.3(1) through 1609.3(12) (4) shall be converted to *allowable stress design* wind speeds, V_{asd} , using Table 1609.3.1 or Equation 16-17.

$$V_{asd} = V\sqrt{0.6} \quad \text{(Equation 16-17)}$$

where:

V_{asd} = *Allowable stress design* wind speed applicable to methods specified in Exceptions 4 and 5 of Section 1609.1.1.

V = Basic design wind speeds determined from Figures 1609.3(1) through 1609.3(12) (4).

TABLE 1609.3.1 WIND SPEED CONVERSIONS^{a, b, c}

V	100	110	120	130	140	150	160	170	180	190	200
V _{asd}	78	85	93	101	108	116	124	132	139	147	155

For SI: 1 mile per hour = 0.44 m/s.

- a. Linear interpolation is permitted.
- b. V_{asd} = allowable stress design wind speed applicable to methods specified in Exceptions 1 through 5 of Section 1609.1.1.
- c. V = basic ~~design~~ wind speeds determined from Figures 1609.3(1) through 1609.3(12) (4).

Staff Analysis: CC# S9-22 and CC# S62-22 addresses requirements in a different or contradicting manner. The committee is urged to make their intentions clear with their actions on these proposals.

Reason Statement: This proposal is a coordination proposal to bring the 2024 IBC up to date with the provisions of the 2022 edition of *ASCE/SEI 7 Minimum Design Loads and Associated Criteria for Buildings and Other Structures* (ASCE/SEI 7-22). ASCE 7 will be updated to the 2022 edition from the 2016 edition as an Administrative update in the 2024 I-Codes.

This proposal includes technical updates as well as editorial corrections or re-organizations. Technical updates to the wind speed maps within ASCE/SEI 7-22 include new hurricane coastline wind speed contours from the Carolina’s through Texas, as well as, new Special Wind Region definitions in Southern California and Northern Colorado. All of these updates are based upon recent wind studies conducted in these areas. These wind speeds for the contiguous United States and Alaska are available from the maps in ASCE 7-22, which are updated in Section 1609 of this proposal.

Along with the continental United States, the wind speeds for US Virgin Island and Puerto Rico were also updated based upon recent wind studies of these islands. The resulting wind speeds accounting for the steep terrain of these island created a very dense contour map that is not easily read by a map that is sized practically for inclusion into a printed standard. Therefore the the wind speeds for US Virgin Islands and Puerto Rico - along with wind speeds for Hawaii - are only included in the ASCE Wind Design Geodatabase and therefore are no longer represented with maps in ASCE/SEI 7-22. Consequently, Hawaii and Puerto Rico maps - as well as values for US Virgin Islands - are being removed from the IBC and replaced with a pointer to the ASCE Wind Design Geodatabase. The wind speeds within the updated Special Wind Regions also are available for the designer ASCE Wind Design Geodatabase. This database of geocoded wind speed design data is freely available and accessed at the ASCE 7 Hazard Tool at <https://asce7hazardtool.online/>, or from an approved equivalent.

A summary of the coordination changes is provided below.

Section 202 DEFINITIONS:

Windborne Debris Region: Corrections to this definition for correct term of “basic *wind speed*” deleting the outdated inclusion of “design” in the term. Also reorganized Risk Category order and correct pointers to the updated maps. No technical changes.

Wind Design Geodatabase: Adding a new definition for the database that contains the windspeeds from ASCE 7-22. The database is the 2022-1.0 version and is freely available at <https://asce7hazardtool.online/>.

Table 1504.2: Updates the pointer to the maps in 1609.3(1)-(4).

1504.6 Edge systems for low-slope roofs. Updates the pointer to the maps in 1609.3(1)-(4). Removes “design” from basic wind speed.

1602.1 Notations: Updates the pointer to the maps in 1609.3(1)-(4). Removes “design” from basic wind speed.

1609.1.1Determination of wind loads: Updates the pointer to the maps in 1609.3(1)-(4). Removes “design” from basic wind speed.

1609.3 Basic design wind speed: This section updates all of the basic wind speed maps for the contiguous United States and Alaska, as well as the Notes, to match what is in ASCE/SEI 7-22. It also includes the updates to the pointers for the maps. Additionally, the order of the maps has been revised. The maps now begin with Risk Category I and progress to Risk Category IV. The pointer to the ASCE Wind Design Geodatabase is added for Hawaii, US Virgin Islands, and Puerto Rico, and because maps for these three areas are no longer produced in ASCE/SEI 7-22, the maps have been removed from the IBC and are not replaced.

1609.3.1 Wind speed conversion and Table 1609.3.1: Updates the pointer to the maps in 1609.3(1)-(4). Removes “design” from basic wind speed.

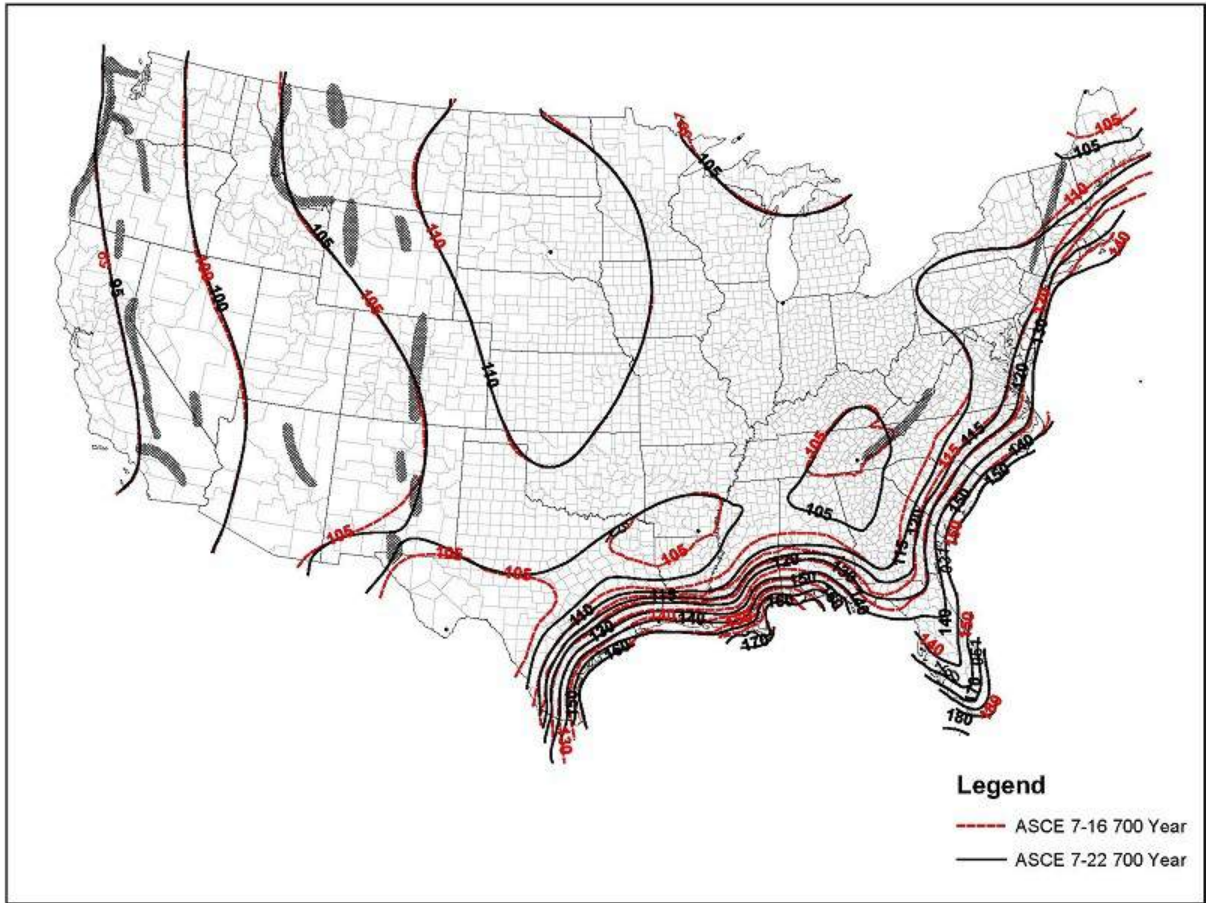

Cost Impact: The code change proposal will increase the cost of construction

ASCE 7 is a national minimum design load standard. Therefore as the study of each hazard advances from one edition to the next, updates to the national maps will impact the nation differently. In this case, the wind speeds for ASCE 7-22 largely remain unchanged, therefore there is no impact to the cost of construction from the updated maps. However, in some areas the wind speeds decrease and in other areas the wind speeds increase. The proposed code change will modestly increase the cost of construction along in some areas along the hurricane coastline between the Carolinas and Texas where the windspeeds have increased.

Although the wind speeds do increase in some locations along the hurricane coastline, the higher wind speeds influence less than 3% of the United States. The wind speeds decrease in most areas along the hurricane coastline (as shown by the wind speed contours moving closer to the coastline), while in the Gulf Coast area of the Florida Panhandle the contours extend further inland, which indicates higher wind speeds for this area. And most of the rest of the continental United States the speeds do not change and therefore the cost of construction will be unchanged; see the Risk Category II map below that compared ASCE 7-22 to ASCE 7-16. ASCE 7 Wind speeds are available at the ASCE 7 Hazard Tool (<https://asce7hazardtool.online/>), which is free to all users, to view and compare various locations.

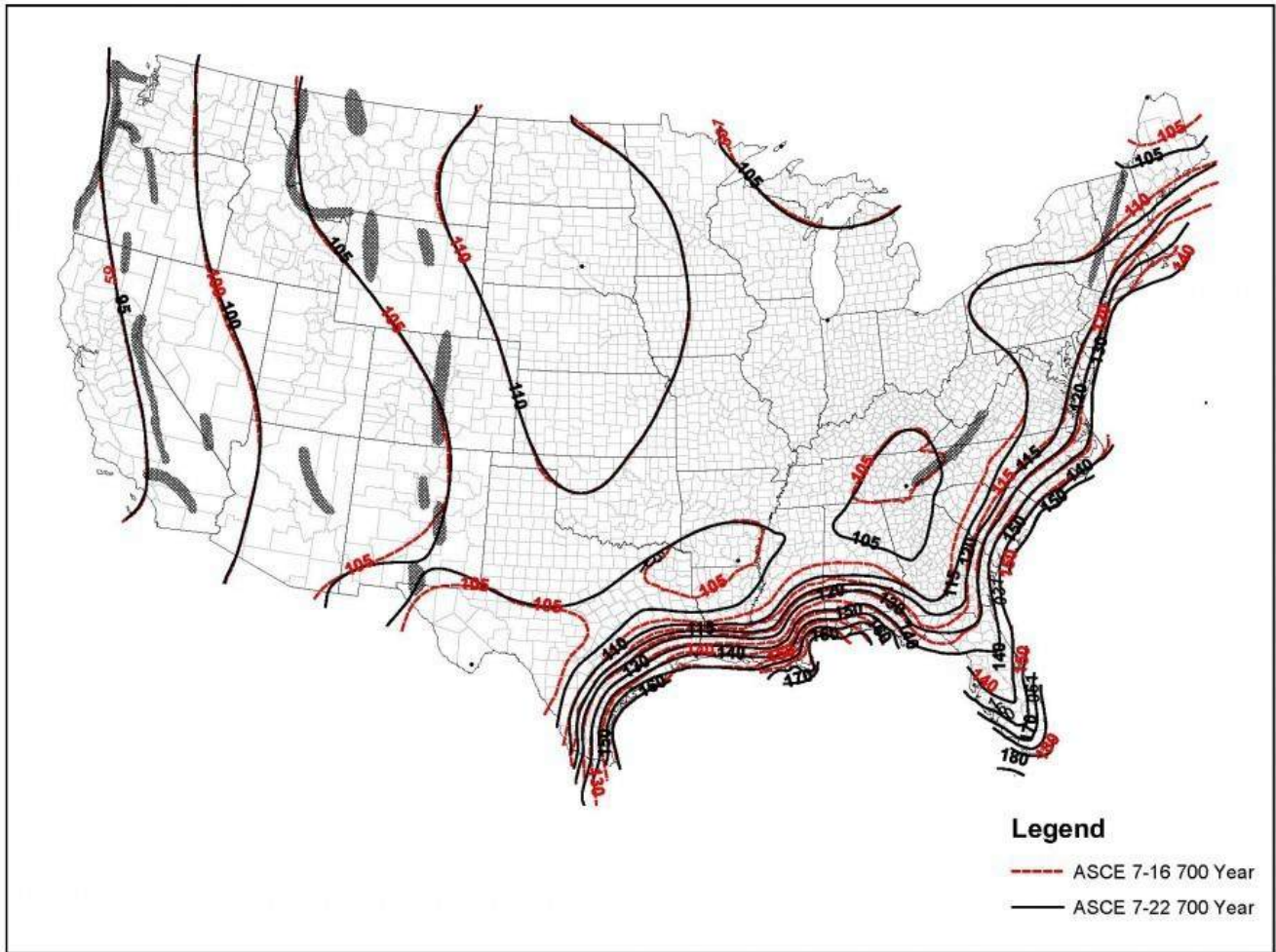

FIGURE: Comparison of ASCE/SEI 7-22 basic wind speeds for Risk Category II (700 Year MRI) to ASCE/SEI 7-16. (Courtesy ARA)

All of the other proposed changes are editorial and will not impact the cost of construction.

S63-22

IBC: CHAPTER 2, SECTION 202, CHAPTER 16, SECTION 1602, 1602.1, SECTION 1603, 1603.1.4, SECTION 1605, 1605.1, SECTION 1607, 1607.14, 1607.14.3, SECTION 1609, 1609.5 (New), 1609.5, 1609.5.1, 1609.5.2, 1609.6.3 (New), 1609.5.3, 1609.6.3.2 (New), CHAPTER 23, SECTION 2308, 2308.2.3

Proponents: Jennifer Goupil, representing Structural Engineering Institute of ASCE (jgoupil@asce.org); Marc Levitan, National Institute of Standards and Technology, representing NIST (marc.levitan@nist.gov); Pataya Scott, representing Federal Emergency Management Agency (pataya.scott@fema.dhs.gov)

2021 International Building Code

CHAPTER 2 DEFINITIONS

SECTION 202 DEFINITIONS

Revise as follows:

[BS] NOMINAL LOADS. The magnitudes of the *loads* specified in Chapter 16 (dead, live, soil, wind, tornado, snow, rain, *flood* and earthquake).

[BS] ESSENTIAL FACILITIES. Buildings and other structures that are intended to remain operational in the event of extreme environmental loading from *flood*, wind, tornadoes, snow or earthquakes.

[BS] RISK CATEGORY. A categorization of buildings and *other structures* for determination of *flood*, wind, tornado, snow, ice and earthquake *loads* based on the risk associated with unacceptable performance.

CHAPTER 16 STRUCTURAL DESIGN

SECTION 1602 NOTATIONS

Revise as follows:

1602.1 Notations. The following notations are used in this chapter:

D	=	Dead load.
D_i	=	Weight of ice in accordance with Chapter 10 of ASCE 7.
E	=	Combined effect of horizontal and vertical earthquake induced forces as defined in Section 12.4 of ASCE 7.
F	=	Load due to fluids with well-defined pressures and maximum heights.
F_a	=	Flood load in accordance with Chapter 5 of ASCE 7.
H	=	Load due to lateral earth pressures, ground water pressure or pressure of bulk materials.
L	=	Live load.
L_r	=	Roof live load.
R	=	Rain load.
S	=	Snow load.
T	=	Cumulative effects of self-straining load forces and effects.
V_{asd}	=	Allowable stress design wind speed, miles per hour (mph) (km/hr) where applicable.
V	=	Basic design wind speeds, miles per hour (mph) (km/hr) determined from Figures 1609.3(1) through 1609.3(12) or ASCE 7.
\underline{V}_T	=	<u>Tornado speed, miles per hour (mph) (m/s) determined from Chapter 32 of ASCE 7.</u>
W	=	Load due to wind pressure.
W_i	=	Wind-on-ice in accordance with Chapter 10 of ASCE 7.

SECTION 1603 CONSTRUCTION DOCUMENTS

Revise as follows:

1603.1.4 Wind and tornado design data. The following information related to wind and tornado loads shall be shown, regardless of whether wind or tornado loads govern the design of the lateral force-resisting system of the structure:

1. Basic ~~design wind speed, V (mph),~~ tornado speed, V_T (mph), miles per hour and *allowable stress design wind speed, V_{asd} (mph)*, as determined in accordance with Section 1609.3.1.
2. *Risk category.*
3. Effective plan area, A_e , for tornado design in accordance with Chapter 32 of ASCE 7.
- ~~3-4.~~ Wind exposure. Applicable wind direction if more than one wind exposure is utilized.
- ~~4-5.~~ Applicable internal pressure coefficients, and applicable tornado internal pressure coefficients.
- ~~5-6.~~ Design wind pressures and their applicable zones with dimensions to be used for exterior component and cladding materials not specifically designed by the *registered design professional* responsible for the design of the structure, pounds per square foot (kN/m²). Where design for tornado loads is required, the design pressures shown shall be the maximum of wind or tornado pressures.

SECTION 1605 LOAD COMBINATIONS

Revise as follows:

1605.1 General. Buildings and *other structures* and portions thereof shall be designed to resist the strength load combinations specified in ASCE 7, Section 2.3, the *allowable stress design* load combinations specified in ASCE 7, Section 2.4, or the alternative *allowable stress design* load combinations of Section 1605.2.

Exceptions:

1. The modifications to load combinations of ASCE 7 Section 2.3, ASCE 7 Section 2.4, and Section 1605.2 specified in ASCE 7 Chapters 18 and 19 shall apply.
2. Where the allowable stress design load combinations of ASCE 7 Section 2.4 are used, flat roof snow *loads* of 30 pounds per square foot (1.44 kN/m²) and *roof live loads* of 30 pounds per square foot (1.44 kN/m²) or less need not be combined with seismic load. Where flat roof snow *loads* exceed 30 pounds per square foot (1.44 kN/m²), 20 percent shall be combined with seismic loads.
3. Where the allowable stress design load combinations of ASCE 7 Section 2.4 are used, crane hook loads need not be combined with *roof live loads* or with more than three-fourths of the snow load or one-half of the wind loads.
4. Where tornado loads are required, the alternative *allowable stress design* load combinations of Section 1605.2 shall not apply when *tornado loads* govern the design.

SECTION 1607 LIVE LOADS

Revise as follows:

1607.14 Roof loads. The structural supports of roofs and *marquees* shall be designed to resist wind and, where applicable, tornado and snow and earthquake *loads*, in addition to the *dead load* of construction and the appropriate *live loads* as prescribed in this section, or as set forth in Table 1607.1. The *live loads* acting on a sloping surface shall be assumed to act vertically on the horizontal projection of that surface.

1607.14.3 Awnings and canopies. *Awnings* and canopies shall be designed for uniform *live loads* as required in Table 1607.1 as well as for snow *loads* and wind and tornado loads as specified in Sections 1608 and 1609.

SECTION 1609 WIND LOADS

Add new text as follows:

1609.5 Tornado Loads. The design and construction of *Risk Category* III and IV buildings and *other structures* located in the tornado-prone region as shown in Figure 1609.5 shall be in accordance with Chapter 32 of ASCE 7, except as modified by this code.



FIGURE 1609.5 TORNADO-PRONE REGION

Revise as follows:

~~1609.5~~ **1609.6 Roof systems.** Roof systems shall be designed and constructed in accordance with Sections ~~1609.5.1~~ 1609.6.1 through ~~1609.5.3,~~ 1609.6.3 as applicable.

~~1609.5.1~~ **1609.6.1 Roof deck.** The *roof deck* shall be designed to withstand the greater of wind pressures or tornado pressures determined in accordance with ASCE 7.

~~1609.5.2~~ **1609.6.2 Roof coverings.** *Roof coverings* shall comply with Section ~~1609.5.1~~ 1609.6.1.

Exception: Rigid tile *roof coverings* that are air permeable and installed over a *roof deck* complying with Section ~~1609.5.1~~ 1609.6.1 are permitted to be designed in accordance with Section 1609.5.6.3.

Asphalt shingles installed over a *roof deck* complying with Section ~~1609.5.1~~ 1609.6.1 shall comply with the wind-resistance requirements of Section 1504.2 .

Add new text as follows:

1609.6.3 Rigid Tile . Wind and tornado loads on rigid tiles shall comply with Sections 1609.6.3.1 or 1609.6.3.2, as applicable.

Revise as follows:

~~1609.5.3~~ **1609.6.3.1 Rigid tile-Wind loads.** Wind loads on rigid tile *roof coverings* shall be determined in accordance with the following equation:

$$M_a = q_h C_L b L L_a [1.0 - GC_p] \tag{Equation 16-18}$$

For SI:

$$M_a = \frac{q_h C_L b L L_a [1.0 - GC_p]}{1,000}$$

where:

b = Exposed width, feet (mm) of the roof tile.

C_L = Lift coefficient. The lift coefficient for concrete and clay tile shall be 0.2 or shall be determined by test in accordance with Section 1504.3.1.

GC_p = Roof pressure coefficient for each applicable roof zone determined from Chapter 30 of ASCE 7. Roof coefficients shall not be adjusted for internal pressure.

L = Length, feet (mm) of the roof tile.

L_a = Moment arm, feet (mm) from the axis of rotation to the point of uplift on the roof tile. The point of uplift shall be taken at 0.76L from the head of the tile and the middle of the exposed width. For roof tiles with nails or screws (with or without a tail clip), the axis of rotation shall be taken as the head of the tile for direct deck application or as the top edge of the batten for battened applications. For roof tiles fastened only by a nail or screw along the side of the tile, the axis of rotation shall be determined by testing. For roof tiles installed with battens and fastened only by a clip near the tail of the tile, the moment arm shall be determined about the top edge of the batten with consideration given for the point of rotation of the tiles based on straight bond or broken bond and the tile profile.

M_a = Aerodynamic uplift moment, feet-pounds (N-mm) acting to raise the tail of the tile.

q_h = Wind velocity pressure, psf (kN/m²) determined from Section 26.10.2 of ASCE 7.

Concrete and clay roof tiles complying with the following limitations shall be designed to withstand the aerodynamic uplift moment as determined by this section.

1. The roof tiles shall be either loose laid on battens, mechanically fastened, *mortar* set or adhesive set.
2. The roof tiles shall be installed on solid sheathing that has been designed as components and cladding.
3. An *underlayment* shall be installed in accordance with Chapter 15.
4. The tile shall be single lapped interlocking with a minimum head lap of not less than 2 inches (51 mm).
5. The length of the tile shall be between 1.0 and 1.75 feet (305 mm and 533 mm).
6. The exposed width of the tile shall be between 0.67 and 1.25 feet (204 mm and 381 mm).
7. The maximum thickness of the tail of the tile shall not exceed 1.3 inches (33 mm).
8. Roof tiles using *mortar* set or adhesive set systems shall have not less than two-thirds of the tile's area free of *mortar* or adhesive contact.

Add new text as follows:

1609.6.3.2 Tornado Loads. Tornado loads on rigid tile roof coverings shall be determined in accordance with Section 1609.6.3.1, replacing q_h with q_{hT} and (GC_p) with $K_{VT}(GC_p)$ in Equation 16-18, where:
 q_{hT} = tornado velocity pressure, psf (kN/m²) determined in accordance with Section 32.10 of ASCE 7.

K_{VT} = tornado pressure coefficient adjustment factor for vertical winds, determined in accordance with Section 32.14 of ASCE 7.

CHAPTER 23 WOOD

SECTION 2308 CONVENTIONAL LIGHT-FRAME CONSTRUCTION

Revise as follows:

2308.2.3 Allowable loads. *Loads* shall be in accordance with Chapter 16 and shall not exceed the following:

1. Average *dead loads* shall not exceed 15 psf (718 N/m²) for combined roof and ceiling, *exterior walls*, floors and partitions.

Exceptions:

1. Subject to the limitations of Section 2308.6.10, stone or masonry *veneer* up to the less of 5 inches (127 mm) thick or 50 pounds per square foot (2395 N/m²) and installed in accordance with Chapter 14 is permitted to a height of 30 feet (9144 mm) above a noncombustible foundation, with an additional 8 feet (2439) permitted for *gable* ends.
2. Concrete or masonry fireplaces, heaters and chimneys shall be permitted in accordance with the provisions of this code.

2. *Live loads* shall not exceed 40 psf (1916 N/m²) for floors.

Exception: *Live loads* for concrete slab-on-ground floors in *Risk Categories* I and II shall be not more than 125 psf.

3. Ground snow *loads* shall not exceed 50 psf (2395 N/m²).
4. Tornado loads on the main wind force resisting system and all components and cladding shall not exceed the corresponding wind loads on these same elements

Reason Statement: This proposal is a coordination proposal to bring the 2024 IBC up to date with the provisions of the 2022 edition of ASCE/SEI 7 Minimum Design Loads and Associated Criteria for Buildings and Other Structures (ASCE/SEI 7-22). ASCE 7 will be updated to the 2022 edition from the 2016 edition as an Administrative update in the 2024 I-Codes.

This proposal includes technical updates as well as editorial coordination. The specific changes to each section included in this proposal is outlined below, and a detailed summary of the technical updates are explained below that:

Section 202 Definitions: Updates to **Nominal Loads**, **Essential Facilities**, and **Risk Category** to include tornadoes.

Section 1602.1 Notations: Add new term V_T for tornado speeds.

Section 1603.1.4 Wind design data: Modifies section to include tornado speed and applicable internal pressures to be included on the construction drawings.

Section 1605.1 General: Adds new Exception 4 to exclude the use of the Alternative allowable stress design load combinations in Section 1605.2 when tornado loads govern the design.

Section 1607.14 Roof loads; Section 1607.14.3 Awnings and canopies: Modifies section to include tornado.

Section 1609.5 Tornado Loads: Added new section for charging language for tornado loads as well as a new **Figure 1609.5 Tornado Prone Region** to determine where tornado loads must be considered, per ASCE 7-22 Chapter 32.

Section 1609.5 Roof systems: This is to update the section number to 1609.6 after adding the new section 1609.5 for Tornado loads.

Section 1609.5.1 Roof deck: This updates to the new section number of 1609.6.1 and clarifies the requirement to be the greater of wind or tornado pressures for roof deck design.

Section 1609.5.2 Roof coverings: This updates the new section number 1609.6.2 as well as updates the pointers to the new section numbers.

Section 1609.5.3 Rigid Tile: This updates to the new section number of 1609.6.3 as well as adds new section **1609.6.3.1 Wind loads** and **1609.6.3.2 Tornado loads** to differentiate the requirements for wind and tornado. Also the new section 1609.6.3.2 for tornado loads clarifies the terms to be used in Equation 16-18 as well as adds pointers to ASCE 7 Chapter 32. [NOTE TO EVERYONE: cdpAccess would not permit me to strikeout the redundant "Section 1609.5.3 Rigid Tile" following the new section "Section 1609.6.3.1 Wind Loads" shown in the PDF of this proposal. My intention is to strike out "~~Section 1609.5.3 Rigid Tile~~" but cannot in cdpAccess at the time of this submittal.]

Section 2308.2.3 Allowable loads: This adds a requirement that allowable loads for conventional light-frame construction shall not be used on any portion of the design where tornado loads govern. This is written to specifically address only the portions of the design - specific to each element - where the loads are governed by tornado loads and does not intend to exclude the rest of the project that is not governed by tornado loads.

TECHNCIAL REASON STATEMENT:

Overview

Tornado hazards have not previously been considered in the design of conventional buildings, despite the fact that tornadoes and tornadic storms cause more fatalities than hurricanes and earthquakes combined (NIST 2014) and more catastrophe insured losses than hurricanes and tropical storms combined (Insurance Information Institute 2021). This gap is addressed for the first time in ASCE 7-22, which now includes requirements for tornado loads. The tornado hazard maps and load methodology are based on a decade of research and development led by the National Institute of Standards and Technology (NIST), in collaboration with ASCE, following the record 2011 tornado season (1,691 tornadoes causing 553 fatalities). ASCE 7-22 requirements for tornado loads apply to Risk Category III and IV buildings and other structures sited in the tornado-prone region, which is approximately equal to the area of the U.S. east of the Continental Divide.

The tornado loads specified in the new Chapter 32 provide reasonable consistency with the reliability delivered by the existing criteria in ASCE 7 Chapters 26 and 27 for the Main Wind Force Resisting System (MWFRS), using the same return periods as the basic wind speed maps in Chapter 26 for Risk Category III and IV facilities (1,700 and 3,000 years, respectively). At return periods of 300 and 700 years (used for wind speeds with Risk Category I and II structures), tornado speeds are generally so low that tornado loads will not control over Chapter 26 wind loads. Therefore, design for tornadoes is not required for Risk Category I and II buildings and other structures.

ASCE 7-22 tornado design speeds for Risk Category III and IV structures range from 60 to 138 mph, depending on geographic location, Risk Category, and effective plan area (which is a function of the building footprint size and shape). This approximately corresponds to the speeds for Enhanced Fujita Scale EF0- EF2 tornadoes, which are not the most intense tornadoes but they are the most common. During the period from 1995 to 2016, over 89% of all reported tornadoes were EF0-EF1, and 97% were in the range of EF0-EF2. Furthermore, most of the area impacted by a tornado does not experience the maximum winds speeds on which the tornado is rated. For example, in the 2011 EF-5 tornado that damaged or destroyed approximately 8,000 buildings in Joplin, Missouri, an estimated 72% of the area swept by the tornado experienced EF0-EF2 winds, while just 28% experienced EF3 and greater winds (NIST 2014). It should also be noted that while property losses per individual tornado increase dramatically with increasing EF number, the aggregate losses caused by all EF1 tornadoes are very similar in magnitude to aggregate losses for all EF2s, for all EF3s, for all EF4s, and for all EF5s (NIST 2014). This is due to the fact that there are so many more lower-intensity tornadoes; e.g., only 59 of the nearly 66,000 recorded tornadoes since 1950 have been rated as EF-5.

To make it very clear that the ASCE 7 tornado provisions are not intended to provide protection from the most violent tornadoes, a large User Note on the first page of the Tornado Load chapter advises readers as follows:

Options for protection of life and property from more intense tornadoes include construction of a storm shelter and/or design for longer-return-period

tornado speeds as provided in Appendix G, including performance-based design. A building or other structure designed for tornado loads determined exclusively in accordance with Chapter 32 cannot be designated as a storm shelter without meeting additional critical requirements provided in the applicable building code and ICC 500, the ICC/NSSA Standard for the Design and Construction of Storm Shelters. See Commentary Section C32.1.1 for an in-depth discussion on storm shelters. (ASCE 7-22 Section 32.1.1)

The referenced commentary section explains that life safety protection against the most violent tornadoes requires a tornado shelter that meets the ICC 500 Standard for Design and Construction of Storm Shelters (ICC 2020), or a tornado safe room meeting FEMA P-361 guidelines (FEMA 2021; note that Safe Rooms must meet all ICC 500 requirements plus additional FEMA Funding Criteria). Tornado hazard criteria for ICC 500 and FEMA P-361 are much more stringent than ASCE 7, reflecting the purpose to provide 'near-absolute life safety protection' as described by FEMA (2021). For example, the tornado shelter design speed in the central US is 250 mph. This compares to ASCE 7 speeds of 78-124 mph for Risk Category III and 95-138 mph for Risk Category IV, where the lower and upper values in the ranges correspond to 1 ft² and 4 million ft² effective plan areas, respectively.

Tornado Hazards

Among the many reasons that building codes and standards have not previously required design for tornado hazards is the misperception that tornadoes are too rare. As seen in Figure 1, in recent decades there have been an average of 1,251 reported tornadoes per year. The apparent smaller numbers of tornadoes from the 1950s through the early 1990s is primarily due to reporting issues, before there were doppler radar networks, cell phones, and trained spotter networks. Even today, many tornadoes in areas of low population density go unreported, in a well-known effect called *population bias*. There are less tornadoes per square mile per year recorded in very rural areas compared to suburban and urban areas in the same region of the country. The average annual frequency of tornadoes per state is shown in Figure 2, with the majority of tornadoes occurring in the Central and Southeast states.

Although the peak months for tornado activity in the US are in the spring, tornadoes can and do occur year-round. The end of 2021 yielded a record-setting December. The "Quad-State Tornado Outbreak" on December 10-11 spawned 68 tornadoes across 10 states, including two that tracked for more than 100 miles. This outbreak caused 90 confirmed fatalities. "The total damages and economic losses resulting from the historic tornado outbreak that impacted multiple states from the South to the Midwest could amount to \$18 billion, which would make it the costliest tornado outbreak in U.S. history," (AccuWeather 2021). The day after AccuWeather published that loss estimate, a derecho over the upper Midwest on December 15-16 caused another outbreak of 94 tornadoes. December yielded a total of 193 tornadoes across the Midwest and Southeast, including 42 EF-0, 96 EF-1, 42 EF-2, 6 EF-3, and 2 EF-4 tornadoes, with 5 more rated as unknown intensity (Figure 3).

While tornadoes have been recorded in all 50 states, the overwhelming majority occur east of the Continental Divide as seen in Figure 4. Even from this raw data, it is apparent why the tornado prone-region is east of the Rocky Mountains. The most intense tornadoes, shown in the darker colors, generally occur in the Central US, except near the Gulf Coast. Similarly, there are fewer intense tornadoes along the Atlantic Coast states. The coastal states have a large number of lower intensity tornadoes, many of them generated by hurricanes. In comparison, the Mountain and Western States experience relatively few tornadoes, and almost no strong (EF2-EF3) or violent (EF4-EF5) tornadoes.

Tornadoes can vary significantly in size. Path lengths range from as short as tens of yards to over a hundred miles. December's Quad-State Tornado tracked 166 miles across Arkansas, Missouri, Tennessee and Kentucky over the span of 4 hours. It was the 9th longest tornado on record (the longest being 219 miles). Path widths vary from around 10 yards to over a mile. The widest tornado on record occurred in El Reno, Oklahoma in 2013, with a maximum path width of 2.6 miles. The average path length for the December 2021 tornadoes was 8.8 miles, while the average maximum path width was 184 yards (Figure 3).

It is clear from the climatology that tornadoes are not rare events. For example, Oklahoma City has been struck by at least 141 tornadoes since 1940, for an average of nearly 2 per year (NWS 2022a). Another way to understand how frequent tornadoes actually are is to consider them from a building impacts perspective. Mining of event and episode narratives from NOAA's National Centers for Environmental Information (NCEI) Storm Events Database from 1993-2020 indicated at least 647 reports of schools being struck by tornadoes. Figure 5 shows the number of preK-12 schools per state that were struck by tornadoes. This average of more than 23 schools per year is a lower bound. The purpose of the Storm Events Database narratives is not to document school impacts per se, but rather summarize key features of storm and its overall impacts. Schools are often mentioned, but this is by no means a complete data source for school strikes. Review of other databases, post-storm reports, news searches, and other sources of information revealed many additional schools that were struck by tornadoes during this time period.

One recent example school impact: in a terrible way to ring in the new year, Veterans Memorial Middle School in Covington, Georgia was struck by an EF-1 tornado on December 31, 2021 (Figure 6). According to the National Weather Service, which conducted its assessment on New Year's Day, structural damage was observed at the school (NWS 2022b). "The tornado reached peak intensity of 90 mph as it hit Veterans Middle School removing significant amounts of siding and roofing from the gymnasium and sections of roof."

Tornado Load Provisions

The commentary chapter C32 of ASCE 7-22 provides descriptions and references supporting the development and application of the tornado load

provisions. A brief summary is provided below.

Introduction. The tornado hazard maps and load methodology were developed over the course of a decade of R&D by the National Institute of Standards and Technology, working closely with Applied Research Associates, Inc. and ASCE. The ASCE 7 tornado load provisions were developed by the ASCE 7 Tornado Task Committee in cooperation with the ASCE 7 Wind Load and Load Combinations Subcommittees. Three workshops were held (two at ASCE headquarters, in September 2015 and May 2019) in support of the tornado hazard map development. A broad range of stakeholders were informed about the detailed plans for map development at the first two workshops and advised on the details of the final methodology and draft maps at the last workshop. Stakeholder feedback from all workshops was incorporated into the final tornado hazard maps and load methodology.

Incorporation of Tornado Loads in ASCE 7. Tornado loads are treated completely separately from wind loads, hence their inclusion in a new chapter. While tornadoes are a type of windstorm, there are significantly different characteristics between tornadoes and other windstorms. For instance, tornadic winds have significant updrafts near the core; rapid atmospheric pressure changes can induce loads; and load combinations including tornado loads are not always the same as those including other wind loads (e.g., tornadoes are warm weather phenomena, so snow loads would not be included in combination with tornado loads). As a result of these considerations, tornado loads are treated separately from wind loads, not as a subset of wind loads. This is analogous to the separate treatment of flood loads and tsunami loads; both are hydrodynamic loads on buildings, but the nature of the hazard and the hazard-structure interaction is different enough that they are considered as completely separate loads.

Tornado Load Procedures. The tornado load procedures are based on the overall framework of the ASCE 7 wind load procedures. Tornado velocity pressure and design pressure/design load equations are similar to those found in Chapters 26-31 (exclusive of Chapter 28 Envelope Procedure, where the underlying methodology is incompatible with the tornado load approach). However, most of the terms used in the tornado load equations have some differences compared to their wind load counterparts, reflecting the unique characteristics of tornadic winds and wind-structure interaction in contrast to straight-line winds. Several wind load parameters are not used in the tornado load chapter, while Chapter 32 also introduces a few new and significantly revised parameters.

Tornado Hazard Maps. Critical to development of the entire tornado load methodology was creation of a new generation of tornado hazard maps. The R&D needed to create these maps broke new ground in a number of areas. For example, novel approaches to quantify the well-known problems of population bias (where more tornadoes are reported in areas having greater population) and to capture regional variation in tornado climate were developed and applied. Tornado wind speeds associated with the Enhanced Fujita (EF) Scale intensity ratings were derived through engineering analysis instead of relying on the original EF Scale methodology, which was based on expert elicitation. The tornado hazard maps take spatial effects into account (since larger buildings are more likely to be struck by a tornado, tornado wind speeds increase with increasing plan (i.e., footprint) area of the building). These efforts resulted in a set of state-of-the-art probabilistic tornado hazard maps prescribing tornado design wind speeds for a wide range of return periods and target building plan area sizes, enabling tornado-resistant design of conventional buildings and infrastructure, including essential facilities.

The mapped tornado speeds represent the maximum 3-s gust produced by the translating tornado at a height of 33 ft anywhere within the plan area of the target building. The design tornado speeds for Risk Category III and IV buildings (for 1,700- and 3,000-year return periods, respectively) typically range from EF0-EF2 intensity, depending on geographic location, Risk Category, and plan size and shape. For protection from more violent tornadoes, performance-based design is explicitly allowed, and commentary on additional design requirements for storm shelters is provided. An appendix is included with tornado speeds for longer return periods. At return periods of 300 and 700 years, tornado speeds are generally so low that tornado loads will not control over Ch. 26 wind loads, hence design for tornadoes is not required for Risk Category I and II buildings and other structures.

Tornado Velocity Pressure. While the effects of terrain and topography on tornado wind speed profiles are not yet well understood, a review of near-surface tornadic wind measurements from mobile research radar platforms plus numerical and experimental simulations consistently showed wind speed profiles with greater horizontal wind speeds closer to the ground than aloft. The tornado velocity pressure profile ($K_{zTornado}$) used has a uniform value of 1.0 from the ground up to a height of 200 ft, with a slightly smaller value at greater heights. In comparison, wind loads are based on an assumed boundary layer profile, where wind speeds are slower near the ground due to the effects of surface roughness.

Tornado Design Pressures. Atmospheric pressure change (APC) was found to have significant contributions to the tornado loads, particularly for large buildings with low permeability. The internal pressure coefficient was modified to also include the effects of APC. Since APC-related loads are not directionally dependent, the directionality factor was removed from the velocity pressure equation and added to the external pressure term (only) in the design pressure/load equations. The directionality factor K_d was modified through analysis of tornado load simulations on building MWFRS and components and cladding (C&C) systems. The resulting tornado directionality factor K_{dT} has values slightly less than the corresponding wind K_d values, with the exception of roof zone 1' (in the field of the roof), which increased. External pressure and force coefficients for both the MWFRS and C&C remain unchanged, but a modifier (K_{VT}) was added to account for experimentally determined increases to uplift loads on roofs caused by updrafts in the core of the tornado.

Reliability. A reliability analysis was conducted to evaluate the tornado load provisions for the purpose of identifying appropriate return periods for the tornado hazard maps. This effort was conducted by a working group composed of members from both the ASCE 7-22 Load Combinations and Wind Load Subcommittees. Monte Carlo analyses (adapted from the ASCE 7-16 wind speed map return period analysis) were used, in which significant uncertainties for system demands and capacity were identified and quantified in the form of random variables with defined probability

distributions. The results of this series of risk-informed analyses showed that the tornadic load criteria of Chapter 32 provided reasonable consistency with the reliability delivered by the existing criteria in Chapters 26 and 27 for MWFRS; therefore confirming that the 1,700- and 3,000-year return periods used for Risk Category III and IV wind hazard maps (respectively) in Chapter 26 were also suitable return periods to use for the tornado hazard maps.

Load Combinations. In both the Strength and Allowable Stress Design (ASD) load combinations that maximize wind load effects, the wind load term W is replaced by the term $(W \text{ or } W_T)$, where W_T is the tornado load. Tornado loads do not appear in combinations that maximize other loads where wind is an arbitrary point-in-time load.

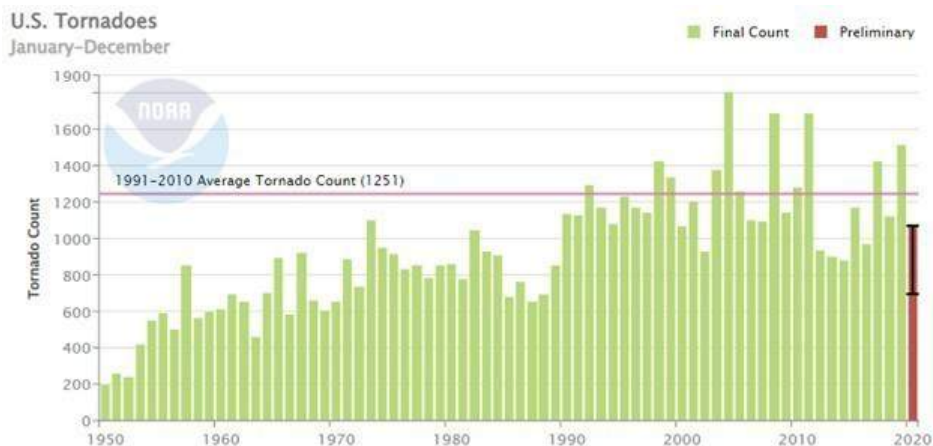

Figure 1. Number of reported tornadoes per year from 1950-2020 (NCEI 2022).

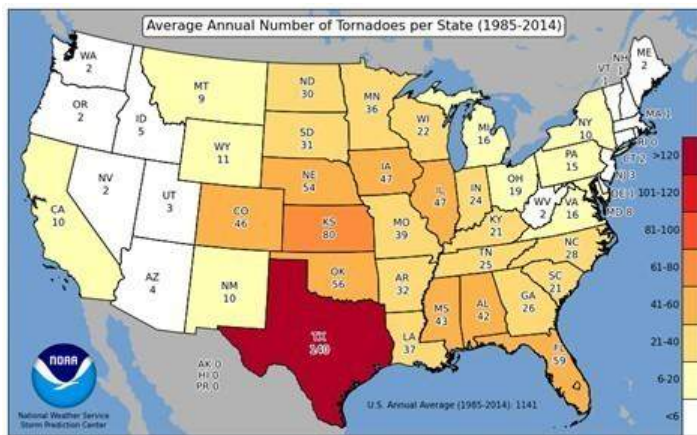

Figure 2. Average annual number of tornadoes per state (SPC 2022).

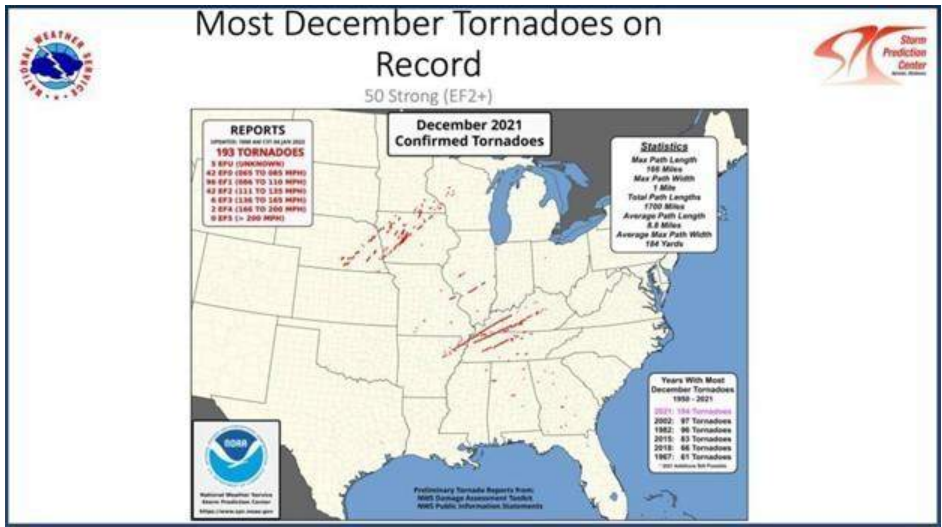

Figure 3. December 2021 produced a record 193 tornadoes across 17 states. (source: NOAA/NWS/Storm Prediction Center)

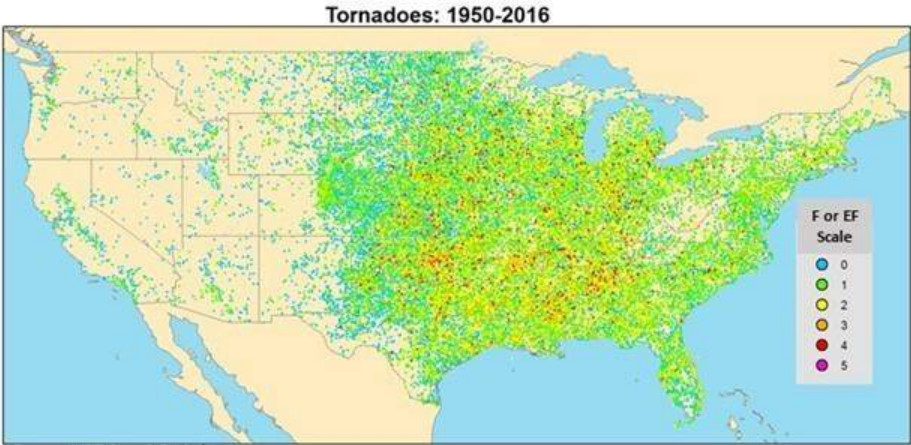

Figure 4. Map of tornado locations from 1950-2016 (source: NIST, using NOAA data).

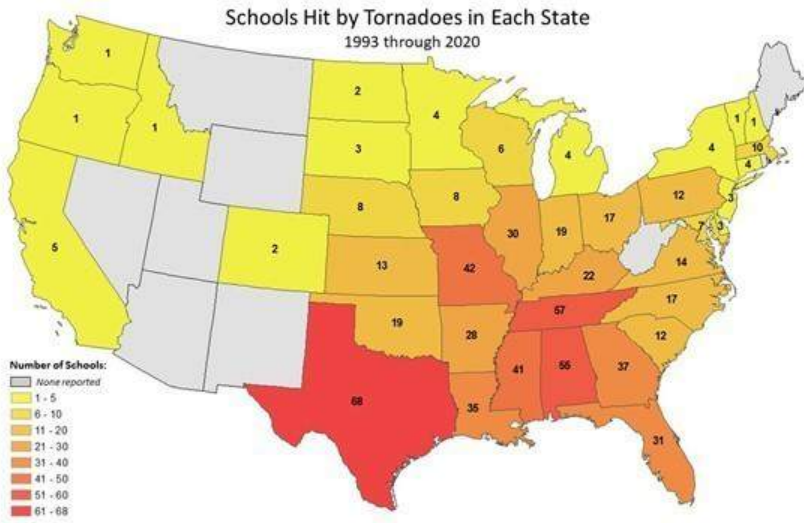

Figure 5. Lower bound for the number of schools struck by tornadoes, per state, for the 28-year period of 1993-2020 (source: NIST, using NOAA data).



Figure 6. EF-1 tornado in Covington, Georgia on New Year's Eve, 2021 (left); resulting damage to Veterans Memorial Middle School (right). (source: NWS)

References:

AccuWeather. 2021. Total economic impacts of historic tornado outbreak about \$18 billion. December 14. <https://www.accuweather.com/en/severe-weather/total-economic-impacts-of-historic-tornado-outbreak-about-18-billion/1062259>

Federal Emergency Management Agency (FEMA). 2021. Safe rooms for tornadoes and hurricanes: Guidance for community and residential safe rooms. P-361, 4th ed. Washington, DC: FEMA. <https://www.fema.gov/emergency-managers/risk-management/safe-rooms>

Insurance Information Institute. 2021. "Spotlight on: Catastrophes: Insurance issues." December 13. <https://www.iii.org/article/spotlight-on-catastrophes-insurance-issues>

International Code Council (ICC). 2020. ICC/NSSA Standard for the design and construction of storm shelters. ICC 500-2020. Washington, DC: ICC and National Storm Shelter Association. <https://codes.iccsafe.org/content/ICC5002020P1>

National Centers for Environmental Information (NCEI). 2022. U.S. Tornadoes. National Oceanic and Atmospheric Administration. <https://www.ncdc.noaa.gov/societal-impacts/tornadoes/>

National Institute of Standards and Technology (NIST). 2014. Final report: NIST technical investigation of the May 22, 2011, tornado in Joplin Missouri. NCSTAR 3, March. <https://doi.org/10.6028/NIST.NCSTAR.3>

National Weather Service (NWS). 2022a. Tornadoes in the Oklahoma City, Oklahoma Area Since 1890. <https://www.weather.gov/oun/tornadodata-okc>

NWS. 2022b. NWsChat - PUBLIC INFORMATION STATEMENT, NATIONAL WEATHER SERVICE PEACHTREE CITY GA, 258 PM EST SAT JAN 1. <https://nwschat.weather.gov/p.php?pid=202201011958-KFFC-NOUS42-PNSFFC>

Storm Prediction Center (SPC). 2022. Annual Averages: Tornadoes by State. National weather Service/ National Oceanic and Atmospheric Administration. <https://www.spc.noaa.gov/wcm/>

Cost Impact: The code change proposal will increase the cost of construction

This proposal may increase the cost of construction for Risk Category III and IV buildings and other structures located in the tornado-prone region where tornado loads govern the design.

The ASCE 7-22 tornado load provisions in Section 32.5.2 include provisions to help identify many of the situations where tornado loads will not control any aspects of the wind load design. If the tornado speed $V_T < 60$ mph, tornado loads will not control over wind loads, so design for tornado loads is not required. Additionally, if the tornado speed is less than a certain percentage of the basic (non-tornado) wind speed, V , tornado loads will not control. For structures located in wind Exposure Category B or C, design for tornado loads is not required where $V_T < 0.5V$ or $V_T < 0.6V$, respectively (in this context, Exposure B means that the structure is surrounded on all sides by urban, suburban or wooded terrain, otherwise it would be considered Exposure C). The exposure category does not change the tornado loads, while wind loads in Exposure B are less than in Exposure C. Therefore, a building located in Exposure B is more likely to have tornado loads control over wind loads compared to the same building in Exposure C.

Whether or not tornado loads will ultimately control any aspects of the wind load design for a particular structure is dependent on a large number of factors, including but not limited to:

1. tornado speed, which is a function of
 - o geographic location
 - o Risk Category
 - o effective plan area, which depends on footprint size and shape
2. basic wind speed, which is a function of
 - o geographic location
 - o Risk Category
3. wind exposure category
4. building shape
5. roof geometry
6. roof height
7. enclosure classification
8. designation as an essential facility or not

Maps were created to show where design for tornado loads is not required, based on the tornado speed criteria in the previous paragraph. Examples for a medium size Risk Category III facility and a very large Risk Category IV facility are shown in Figures 7 and 8, for both Exposures B and C. At locations where the tornado speed is greater than the specified percentage of the basic wind speed, design for tornado loads is required but may still not control. This is because the net pressure loading patterns on a building are different for tornadic versus non-tornadic winds, due to the differences in wind and wind-structure interaction characteristics which are reflected by factors 4 through 8 above.

For a medium-sized Risk Category III building, the tornado speeds are less than 60 mph across much of the tornado prone region (Figure 7). Tornado loads are required only in the areas shaded with the warm colors, which spans roughly between north Texas, central Minnesota, and the central Carolinas. In contrast, tornado loads are required across most of the tornado-prone region for very large Risk Category IV facilities, except New England and small areas of south Florida and south Louisiana for Exposure C (Figure 8). In both figures, the darker reds indicate areas that tornado loads are more likely to exceed wind loads. In general, tornado loads are more likely to control at least some element(s) of the wind load design for buildings and other structures that have one or more of the following characteristics:

- are located in the central or southeast US, except near the coast (where hurricanes can dominate the extreme wind climate),
- are Risk Category IV,
- have large effective plan areas,
- are designated as Essential Facilities,
- are located in Exposure B,
- have low mean roof heights, and
- are classified as enclosed buildings for purposes of determining internal pressures.

A case study was conducted to compare MWFRS and C&C pressures between ASCE 7-16 (non-tornado) and ASCE 7-22 tornado provisions in the Dallas / Fort Worth area of Texas, and also consider the cost impacts. The case study considered four building types, an elementary school, a high school, a fire station, and a large hospital facility. The schools were Risk Category III, while the fire station and hospital were Risk Category IV essential facilities. All were new construction (no additions or renovations).

The elementary school was assumed to have an effective plan area of 100,000 ft² while the high school was 500,000 ft². For the two-story schools, the basic wind speed $V = 112$ mph, while the tornado speeds for the elementary and high school were $V_T = 90$ and 102 mph, respectively. Even though the tornado speeds were less than the basic wind speeds, tornado loads exceeded wind loads for many elements of the design. The high school experienced greater increases in design pressures compared to the elementary school, given its greater tornado speed. The tornado loads were generally larger than the corresponding wind loads, with the most significant impacts occurring where the magnitude of MWFRS and C&C pressure coefficients are relatively small. Tornado suction pressures on the leeward wall and uplift pressures in the field of the roof were more than double the corresponding wind loads in some instances. This was primarily due to the increased tornado internal pressure coefficient and the new pressure coefficient adjustment factor for vertical winds, which increases the uplift on the roof. These surfaces have the smallest magnitude pressures to begin with, so increases of internal pressure and other coefficients have more relative effect. MWFRS loads on the windward walls of all schools also increased (again, due to internal pressures), but less than on the leeward walls. The net lateral loads on the buildings were not significantly impacted (internal pressure cancels out). MWFRS and C&C tornado pressures on roof edges and corners generally increased for the Exposure B cases, but were similar to or smaller than the corresponding wind design pressures when the schools were in Exposure C.

Although specific percentage changes to design pressures are dependent on many factors as discussed previously, the trend for the greatest relative impacts to occur on parts of the building or structure that have the smallest absolute values of wind loads holds true, as was the case for the fire station and hospital examples. The fire station and hospital were designed with effective plan areas of 15,000 ft² and 4 million ft² and heights of 20 ft and 80 ft (5-stories), respectively. The basic wind speed for Risk Category IV facilities in the DFW area is $V = 115$ mph. Tornado speeds for the fire station and hospital were $V_T = 97$ and 123 mph, respectively. The relative impacts on the fire station were generally somewhere between those for the elementary and high schools. The hospital, with its much greater tornado speed due to the large effective plan area, experienced greater relative pressure differences. For example, C&C tornado pressures (for effective wind area of 200 ft²) exceeded corresponding wind pressures across the four different flat roof pressure zones by 81 to 126% for Exposure B, and 39 to 73% for Exposure C. The tornado design pressures for the hospital were similar in magnitude to wind pressures for a comparable facility located in the hurricane-prone region along the Texas coast.

A study of the cost impacts for the schools showed that the structural cost increases were very modest. On the elementary school with a building cost of \$20M, the estimated cost increases were 0.24% and 0.14% for wind Exposure B and C, respectively. For the \$200M high school, the cost increases were 0.13% and 0.08% for Exposures B and C. The study did not include cladding and appurtenance costs. It should be noted that Dallas-Ft. Worth location of this case study is part of the most highly impacted area of the country (as seen in Figures 7 and 8 below), having a combination of comparatively high tornado speeds and low basic wind speeds. The increases in design pressures and costs diminish rapidly outside of the parts of the central and southeast US that experience the most frequent and intense tornadoes and have the greatest tornado speeds, roughly approximated as the area between north Texas, west Iowa, and north Alabama.

Therefore, while tornado load design could increase loads and pressures for Risk Category III and IV structures in the tornado prone area, the impacts on cost of construction resulting in increases will most likely be small when compared to the overall project costs.

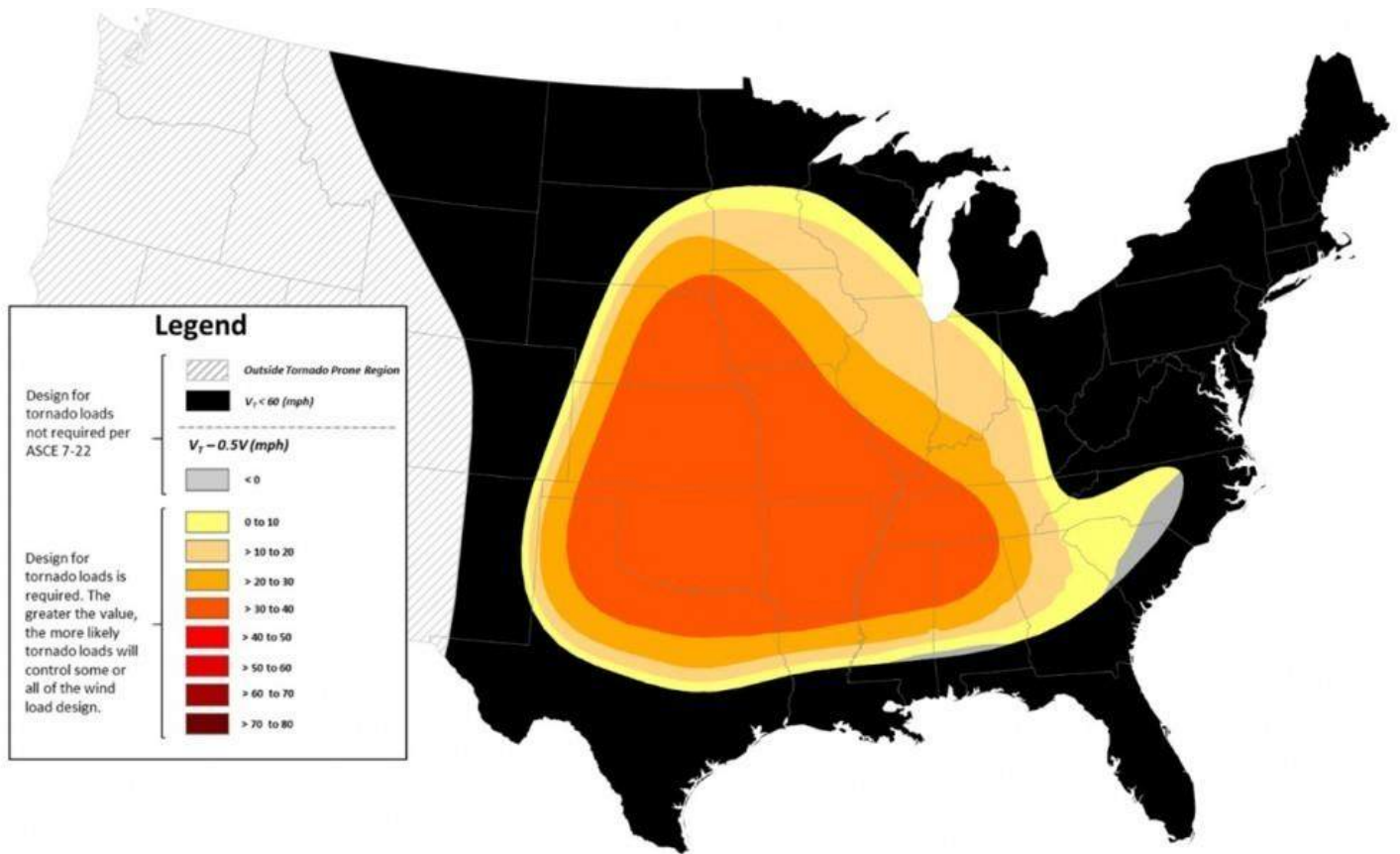

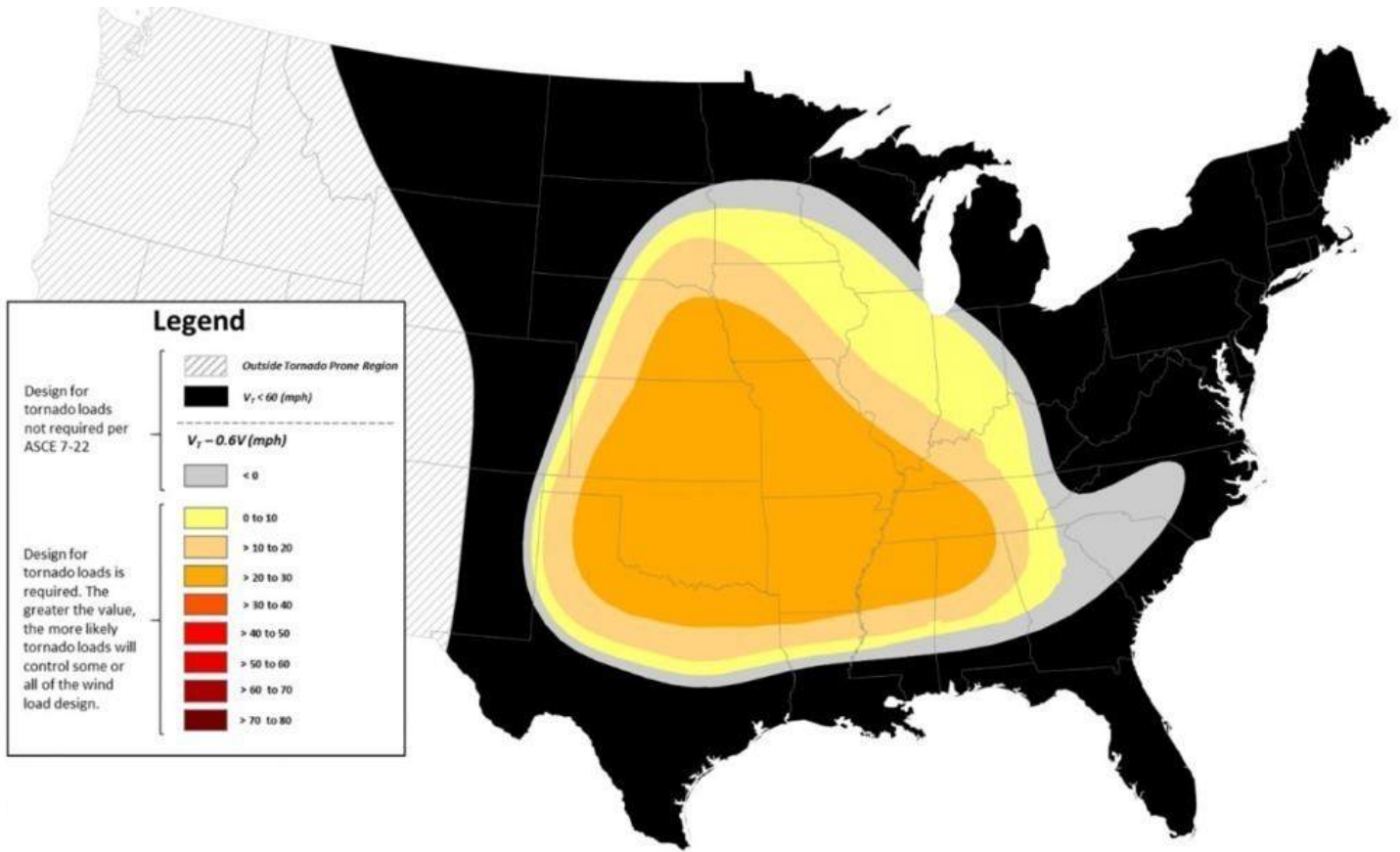
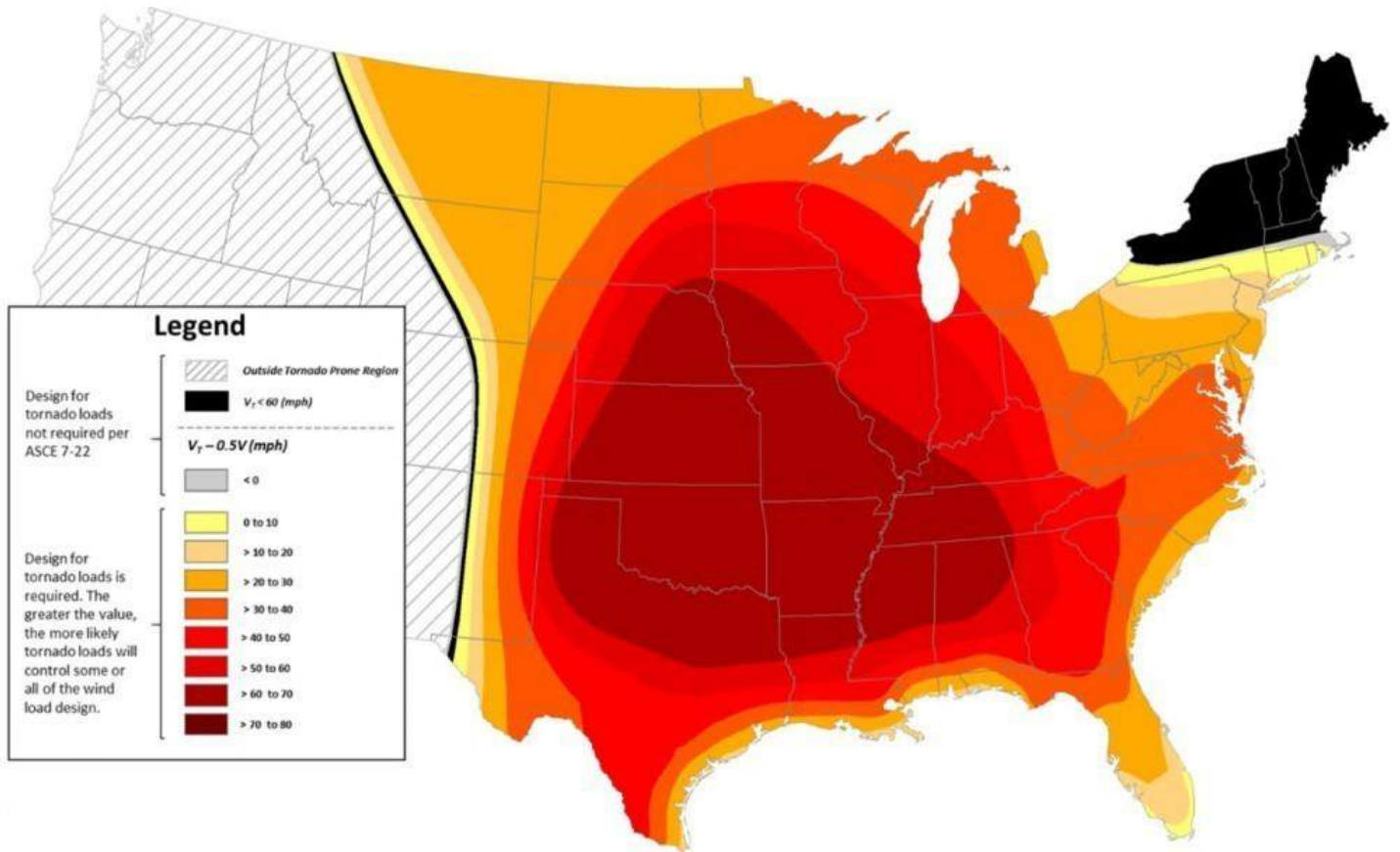

Figure 7. Locations where design for tornado loads is not required for a Risk Category III building or other structure having an effective plan area $A_e = 100,000 \text{ ft}^2$, located in Exposure B (top) and Exposure C (bottom).



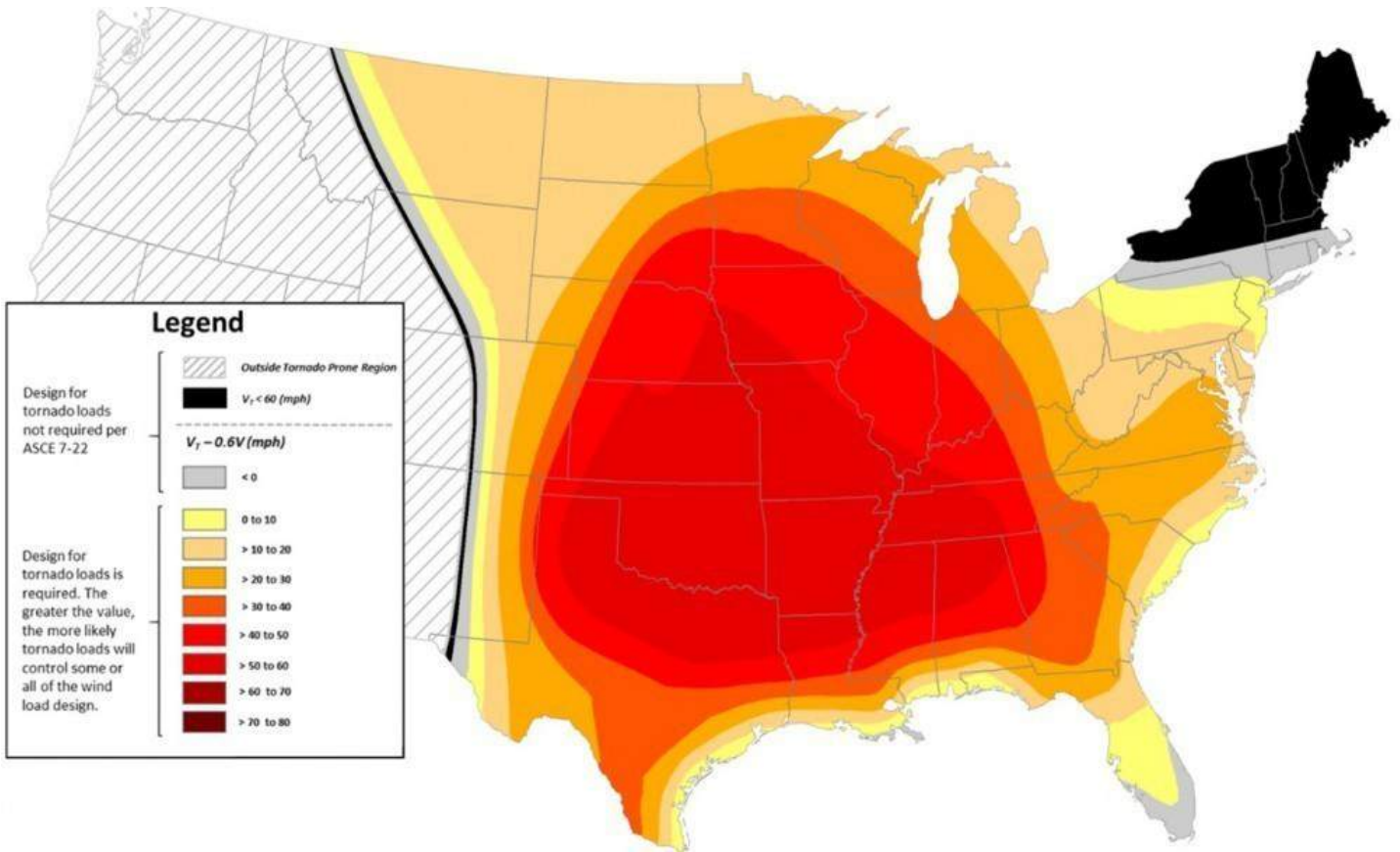

Figure 8. Locations where design for tornado loads is not required for a Risk Category IV building or other structure having an effective plan area $A_e = 1,000,000 \text{ ft}^2$, located in Exposure B (top) and Exposure C (bottom).

S64-22

IBC: CHAPTER 2, SECTION 202, SECTION 202 (New), CHAPTER 16, SECTION 1602, 1602.1, SECTION 1603, 1603.1.3, SECTION 1605, 1605.1, 1605.2, SECTION 1608, 1608.1, 1608.2, 1608.2.1 (New), TABLE 1608.2, FIGURE 1608.2(1), FIGURE 1608.2(2), (New)

Proponents: Jennifer Goupil, representing Structural Engineering Institute of ASCE (jgoupil@asce.org)

2021 International Building Code

CHAPTER 2 DEFINITIONS

SECTION 202 DEFINITIONS

Add new definition as follows:

GROUND SNOW LOAD GEODATABASE. The ASCE database (version 2022-1.0) of geocoded values of risk-targeted design ground snow load values.

GROUND SNOW LOAD, p_g . design ground snow loads

GROUND SNOW LOAD, $p_{g(asd)}$. Allowable stress design ground snow loads

CHAPTER 16 STRUCTURAL DESIGN

SECTION 1602 NOTATIONS

Revise as follows:

1602.1 Notations. The following notations are used in this chapter:

D	=	Dead load.
D_i	=	Weight of ice in accordance with Chapter 10 of ASCE 7.
E	=	Combined effect of horizontal and vertical earthquake induced forces as defined in Section 12.4 of ASCE 7.
F	=	Load due to fluids with well-defined pressures and maximum heights.
F_a	=	Flood load in accordance with Chapter 5 of ASCE 7.
H	=	Load due to lateral earth pressures, ground water pressure or pressure of bulk materials.
L	=	Live load.
L_r	=	Roof live load.
$p_{g(asd)}$	=	<u>Allowable stress design ground snow load</u>
p_g	=	<u>Ground snow load determined from reliability-targeted (strength-based) maps in Figures 1608.2(1) through 1608.2(4)</u>
R	=	Rain load.
S	=	Snow load.
T	=	Cumulative effects of self-straining load forces and effects.
V_{asd}	=	Allowable stress design wind speed, miles per hour (mph) (km/hr) where applicable.
V	=	Basic design wind speeds, miles per hour (mph) (km/hr) determined from Figures 1609.3(1) through 1609.3(12) or ASCE 7.
W	=	Load due to wind pressure.
W_i	=	Wind-on-ice in accordance with Chapter 10 of ASCE 7.

SECTION 1603 CONSTRUCTION DOCUMENTS

Revise as follows:

1603.1.3 Roof snow load data. The ground snow *load*, p_g , shall be indicated. In areas where the ground snow *load*, p_g , exceeds 10 pounds per

square foot (psf) (0.479 kN/m²), the following additional information shall also be provided, regardless of whether snow *loads* govern the design of the roof:

1. Flat-roof snow *load*, p_f .
2. Snow exposure factor, C_e .
3. ~~Snow load importance factor, I_s .~~ Risk category.
4. Thermal factor, C_t .
5. Slope factor(s), C_s .
6. Drift surcharge load(s), p_d , where the sum of p_d and p_f exceeds 20 psf (0.96 kN/m²).
7. Width of snow drift(s), w .

SECTION 1605 LOAD COMBINATIONS

Revise as follows:

1605.1 General. Buildings and *other structures* and portions thereof shall be designed to resist the strength load combinations specified in ASCE 7, Section 2.3, the *allowable stress design* load combinations specified in ASCE 7, Section 2.4, or the alternative *allowable stress design* load combinations of Section 1605.2.

Exceptions:

1. The modifications to load combinations of ASCE 7 Section 2.3, ASCE 7 Section 2.4, and Section 1605.2 specified in ASCE 7 Chapters 18 and 19 shall apply.
2. Where the allowable stress design load combinations of ASCE 7 Section 2.4 are used, flat roof snow *loads* of ~~30~~ 45 pounds per square foot (~~1.44~~ 2.15 kN/m²) and *roof live loads* of 30 pounds per square foot (1.44 kN/m²) or less need not be combined with seismic load. Where flat roof snow *loads* exceed ~~30~~ 45 pounds per square foot (~~1.44~~ 2.15 kN/m²), ~~20-15~~ percent shall be combined with seismic loads.
3. Where the allowable stress design load combinations of ASCE 7 Section 2.4 are used, crane hook loads need not be combined with *roof live loads* or with more than three-fourths of the snow load or one-half of the wind loads.

1605.2 Alternative allowable stress design load combinations. In lieu of the load combinations in ASCE 7, Section 2.4, structures and portions thereof shall be permitted to be designed for the most critical effects resulting from the following combinations. Where using these alternative allowable stress load combinations that include wind or seismic *loads*, allowable stresses are permitted to be increased or load combinations reduced where permitted by the material chapter of this code or the referenced standards. For load combinations that include the counteracting effects of dead and wind *loads*, only two-thirds of the minimum *dead load* likely to be in place during a design wind event shall be used. Where using these alternative load combinations to evaluate sliding, overturning and soil bearing at the soil-structure interface, the reduction of foundation overturning from Section 12.13.4 in ASCE 7 shall not be used. Where using these alternative basic *load* combinations for proportioning foundations for loadings, which include seismic *loads*, the vertical seismic *load effect*, E_v , in Equation 12.4-4 of ASCE 7 is permitted to be taken equal to zero. Where required by ASCE 7, Chapters 12, 13 and 15, the load combinations including overstrength of ASCE 7, Section 2.3.6 shall be used.

$$D + L + (L_r \text{ or } \underline{0.7} S \text{ or } R) \quad \text{(Equation 16-1)}$$

$$D + L + 0.6W \quad \text{(Equation 16-2)}$$

$$D + L + 0.6W + \underline{0.7} S/2 \quad \text{(Equation 16-3)}$$

$$D + L + \underline{0.7} S + 0.6(W/2) \quad \text{(Equation 16-4)}$$

$$D + L + \underline{0.1} S + E/1.4 \quad \text{(Equation 16-5)}$$

$$0.9D + E/1.4 \quad \text{(Equation 16-6)}$$

Exceptions:

1. Crane hook *loads* need not be combined with *roof live loads* or with more than three-fourths of the snow load or one-half of the wind load.
2. Flat roof snow *loads* of ~~30~~ 45 pounds per square foot (~~1.44~~ 2.15 kN/m²) or less and *roof live loads* of 30 pounds per square foot (1.44 kN/m²) or less need not be combined with seismic loads. Where flat roof snow *loads* exceed ~~30~~ 45 pounds per square foot (~~1.44~~ 2.15 kN/m²), ~~20~~ 15 percent shall be combined with seismic loads.

SECTION 1608 SNOW LOADS

1608.1 General. Design snow loads shall be determined in accordance with Chapter 7 of ASCE 7, but the design roof load shall be not less than that determined by Section 1607.

Revise as follows:

1608.2 Ground snow loads. The ground snow loads to be used in determining the design snow loads for roofs shall be determined in accordance with the reliability-targeted (strength based) ground snow load values in Chapter 7 of ASCE 7 or Figures 1608.2(1) and through 1608.2(4) for the contiguous United States and Table 1608.2 for Alaska. Site-specific case studies shall be determined in accordance with Chapter 7 of ASCE 7 and shall be approved by the *building official*, made in areas designated "CS" in Figures 1608.2(1) and 1608.2(2). Ground snow loads for sites at elevations above the limits indicated in Figures 1608.2(1) and 1608.2(2) and for all sites within the CS areas shall be approved. Ground snow load determination for such sites shall be based on an extreme value statistical analysis of data available in the vicinity of the site using a value with a 2-percent annual probability of being exceeded (50-year mean recurrence interval). Snow loads are zero for Hawaii, except in mountainous regions as approved by the *building official*.

Add new text as follows:

1608.2.1 Ground snow conversion . Where required, the ground snow loads, p_g , of Figures 1608.2(1) through 1608.2(4) shall be converted to allowable stress design ground snow loads, $p_{g(ASD)}$, using Equation 16-17 .

$p_{g(ASD)} = 0.7 p_g$
where:

(Equation 16-17)

$p_{g(ASD)}$ = Allowable stress design ground snow load

p_g = Ground snow load determined from Figures 1608.2(1) through 1608.2(4)

Revise as follows:

TABLE 1608.2 GROUND SNOW LOADS, P_g , FOR ALASKAN LOCATIONS

City/Town LOCATION	Pounds per square foot	Elevation (ft)	Ground Snow Load, $P_g^{1,2,4}$ (lb/ft ²)			
			Risk Category			
	-		I	II	III	IV
Adak	30	100	32	40	46	50
Anchorage/Eagle River ²	50	500	64	80	92	100
Arctic Village		2,100	38	48	55	60
Angoon	70					
Barrow	25					
Barter Island	35					
Bethel	40	100	51	64	74	80
Bettles		700	102	128	147	160
Big Delta	50					
Cantwell		2,100	109	136	156	170
Cold Bay	25	100	45	56	64	70
Cordova	100	100	128	160	184	200
Deadhorse		100	32	40	46	50
Delta Junction		400	51	64	74	80
Dillingham		100	141	176	202	220
Emmonak		100	128	160	184	200
Fairbanks	60	1,200	77	96	110	120
Fort Yukon	60	400	64	80	92	100
Galena	60	200	77	96	110	120
Girdwood		200	179	224	258	280
Glennallen		1,400	58	72	83	90
Gulkana	70					
Haines		100	237	296	340	370
Holy Cross		100	154	192	221	240
Homer ²	40	500	58	72	83	90
Iliamna		200	102	128	147	160
Juneau	60	100	90	112	129	140
Kaktovik		100	58	72	83	90
Kenai/Soldotna	70	200	83	104	120	130
Ketchikan		100	38	48	55	60
Kobuk		200	115	144	166	180
Kodiak	30	100	45	56	64	70
Kotzebue	60	100	77	96	110	120
McGrath	70	400	83	104	120	130
Nenana	80	400	96	120	138	150
Nikiski		200	102	128	147	160
Nome	70	100	90	112	129	140
Palmer/Wasilla	50	500	64	80	92	100
Petersburg	150	100	122	152	175	190
Point Hope		100	58	72	83	90
Saint Lawrence Island		100	122	152	175	190
Saint Paul Islands	40	100	51	64	74	80

City/Town LOCATION	Pounds per square foot	Elevation (ft)	Ground Snow Load, P (lb/ft)			
			Risk Category			
	-		I	II	III	IV
Seward	50	100	77	96	110	120
Shemya	25					
Sitka	50	100	64	80	92	100
Talkeetna	120	400	154	192	221	240
Tok		1,700	45	56	64	70
Umiat		300	38	48	55	60
Unalakleet	50	100	45	56	64	70
Unalaska		100	96	120	138	150
Utqiagvik (Barrow)		100	32	40	46	50
Valdez	160	100	205	256	294	320
Wainwright		100	32	40	46	50
Whittier	300	100	346	432	497	540
Willow		300	102	128	147	160
Wrangell	60					
Yakutat	150	100	179	224	258	280

For SI: 1 pound per square foot = 0.0479 kN/m², 1 foot = 0.3048 m

- a. Statutory requirements of the building official are not included in this state ground snow load table
- b. For locations where there is substantial change in altitude over the city/town, the load applies at and below the cited elevation within the jurisdiction and up to 100 feet above the cited elevation unless otherwise noted.
- c. For locations in Anchorage/Eagle River and Homer above the cited elevation, the ground snow load shall be increased by 15% for every 100 feet above the cited elevation

Delete and substitute as follows:

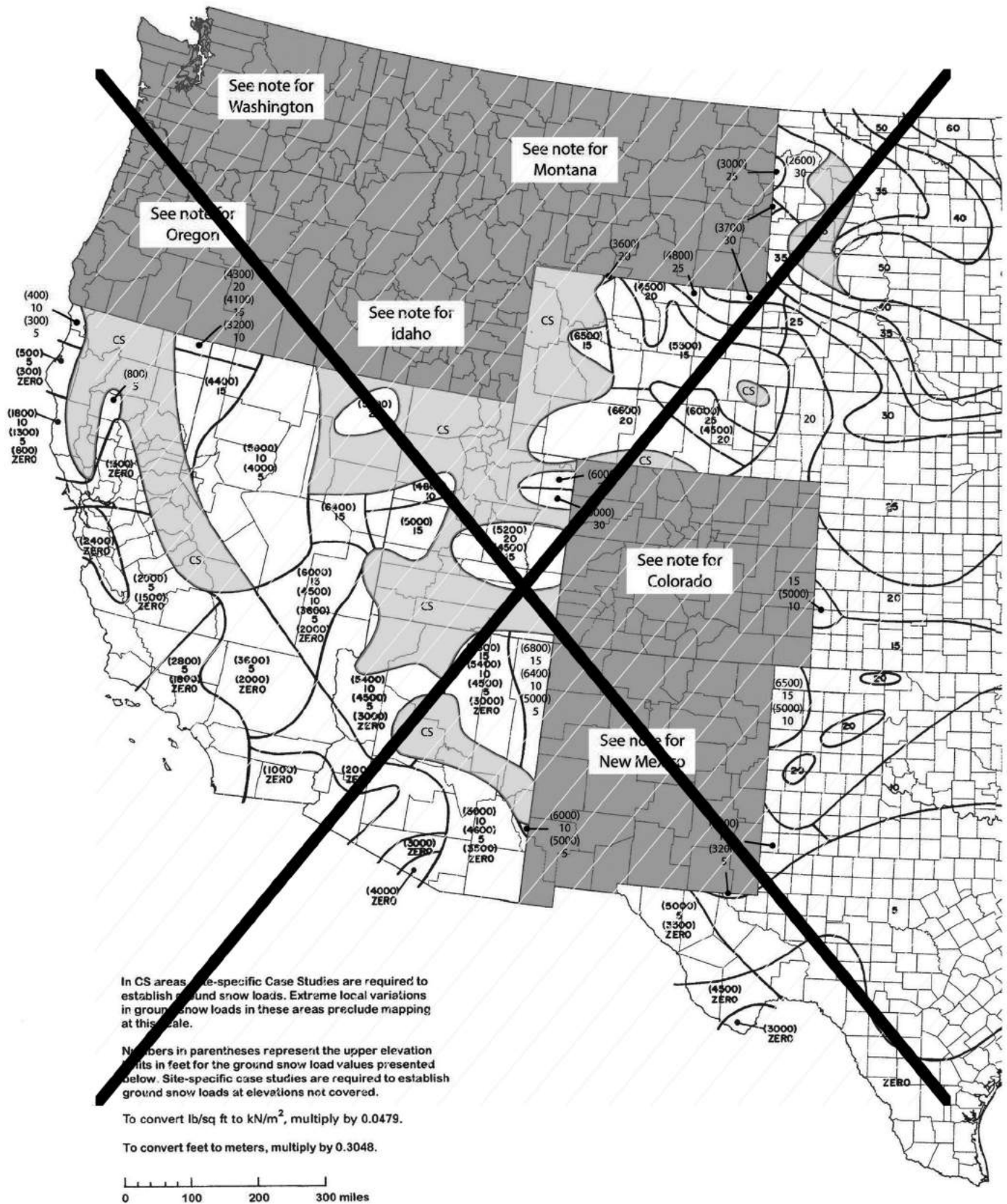

NOTE: See ASCE 7 Table 7.2-2 for Colorado, Table 7.2-3 for Idaho, Table 7.2-4 for Montana, Table 7.2-5 for Washington, Table 7.2-6 for New Mexico and Table 7.2-7 for Oregon.

FIGURE 1608.2(1) GROUND SNOW LOADS, p_g, FOR THE UNITED STATES (psf)

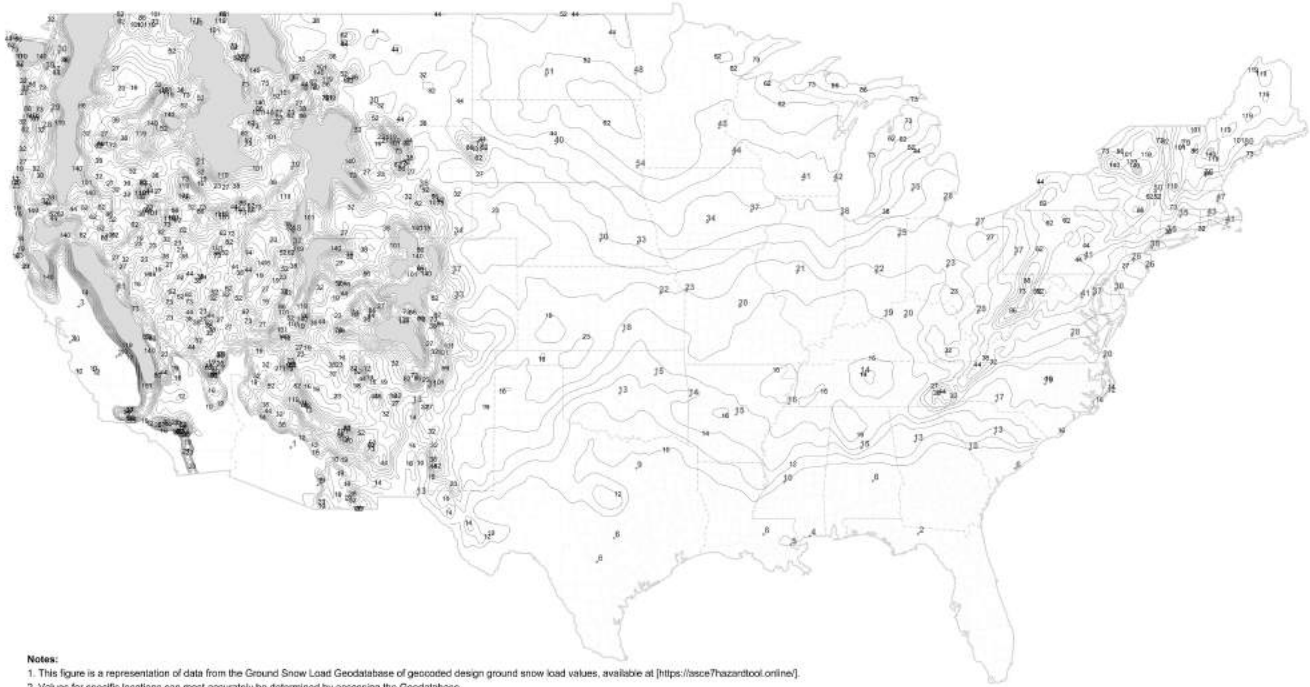

Notes:
 1. This figure is a representation of data from the Ground Snow Load Geodatabase of geocoded design ground snow load values, available at [https://asce7hazardtool.online/].
 2. Values for specific locations can most accurately be determined by accessing the Geodatabase.
 3. Lines shown on the figure are contours separated by a constant ratio of 1.18 with values of 10, 12, 14, 16, 19, 23, 27, 32, 38, 44, 52, 62, 73, 86, 101, 119 and 140 psf.
 4. Values denoted with a "+" symbol indicate design ground snow loads at state capitals or other cities with large populations.
 5. Areas shown in gray represent areas with ground snow loads exceeding 140 psf. Ground snow load values for these locations must be determined from the Geodatabase.

NOTES:

- a. Location-specific ground snow load values are provided in the *Ground Snow Load Geodatabase* of geocoded design ground snow load values, which can be accessed at the ASCE 7 Hazard Tool at <https://asce7hazardtool.online/> or an approved equivalent.
- b. Lines shown on the figure are contours separated by a constant ratio 1.18 with values of 10, 12, 14, 16, 19, 23, 27, 32, 38, 44, 52, 62, 73, 86, 101, 119, and 140 psf.
- c. Values denoted with a "+" symbol indicate design ground snow loads at state capitals or other high-population locations.
- d. Areas shown in gray represent areas with ground snow loads exceeding 140 psf. Ground snow load values for these locations can be determined from the Geodatabase.

FIGURE 1608.2(1) Ground snow loads, p_g , for Risk Category I for the conterminous United States (lb/ft²).

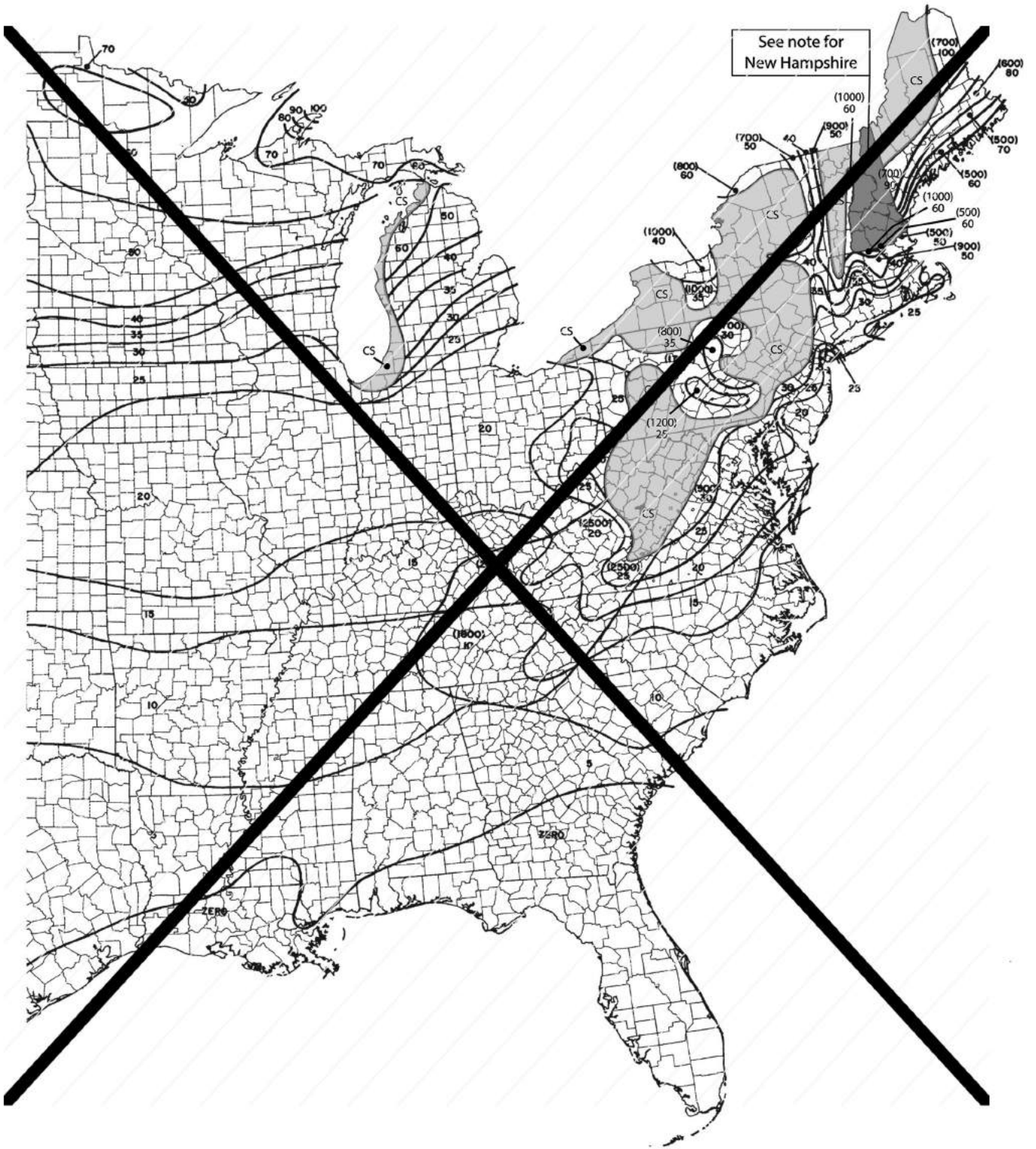

Note: See ASCE 7 Table 7.2-8 for New Hampshire.

FIGURE 1608.2(2) GROUND SNOW LOADS, P_g , FOR THE UNITED STATES (psf)

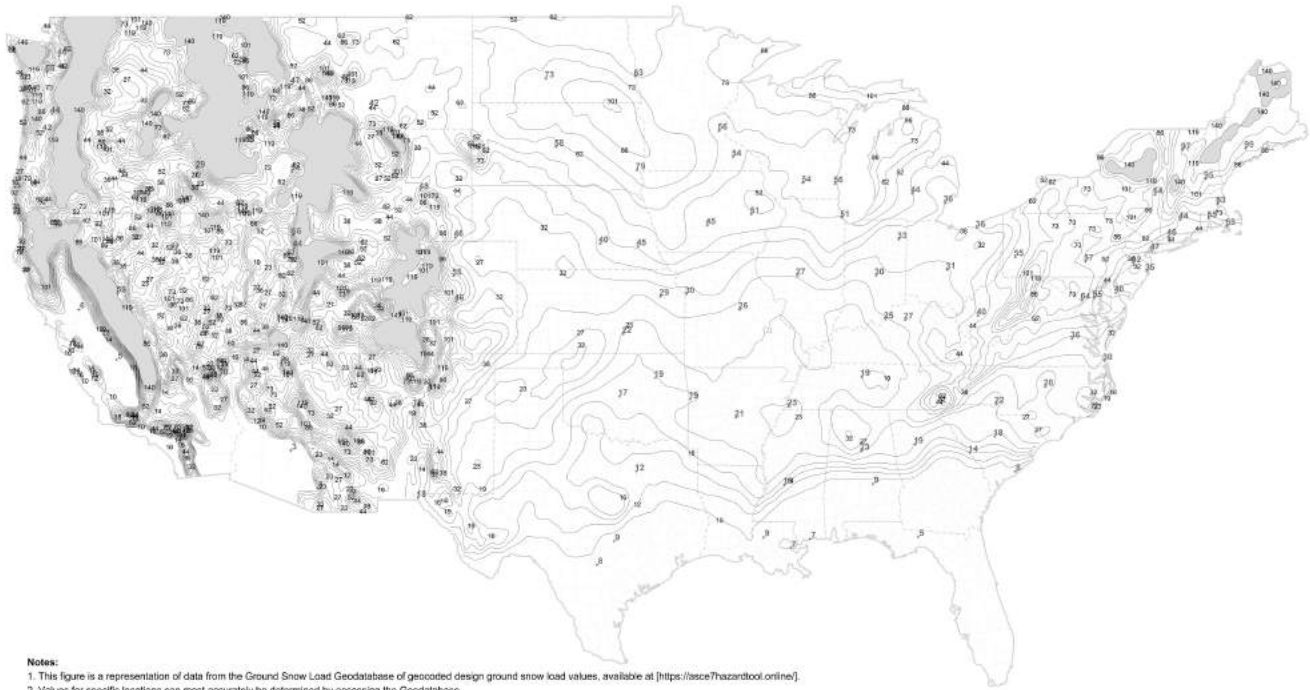

- Notes:**
1. This figure is a representation of data from the Ground Snow Load Geodatabase of geocoded design ground snow load values, available at [<https://asce7hazardtool.online/>].
 2. Values for specific locations can most accurately be determined by accessing the Geodatabase.
 3. Lines shown on the figure are contours separated by a constant ratio of 1.18 with values of 10, 12, 14, 16, 19, 23, 27, 32, 38, 44, 52, 62, 73, 86, 101, 119 and 140 psf.
 4. Values denoted with a "+" symbol indicate design ground snow loads at state capitals or other cities with large populations.
 5. Areas shown in gray represent areas with ground snow loads exceeding 140 psf. Ground snow load values for these locations must be determined from the Geodatabase.

NOTES:

- a. Location-specific ground snow load values are provided in the *Ground Snow Load Geodatabase* of geocoded design ground snow load values, which can be accessed at the ASCE 7 Hazard Tool at <https://asce7hazardtool.online/> or an approved equivalent.
- b. Lines shown on the figure are contours separated by a constant ratio 1.18 with values of 10, 12, 14, 16, 19, 23, 27, 32, 38, 44, 52, 62, 73, 86, 101, 119, and 140 psf.
- c. Values denoted with a "+" symbol indicate design ground snow loads at state capitals or other high-population locations.
- d. Areas shown in gray represent areas with ground snow loads exceeding 140 psf. Ground snow load values for these locations can be determined from the Geodatabase.

FIGURE 1608.2(2) Ground snow loads, p_g , for Risk Category II for the conterminous United States (lb/ft²).

Add new text as follows:

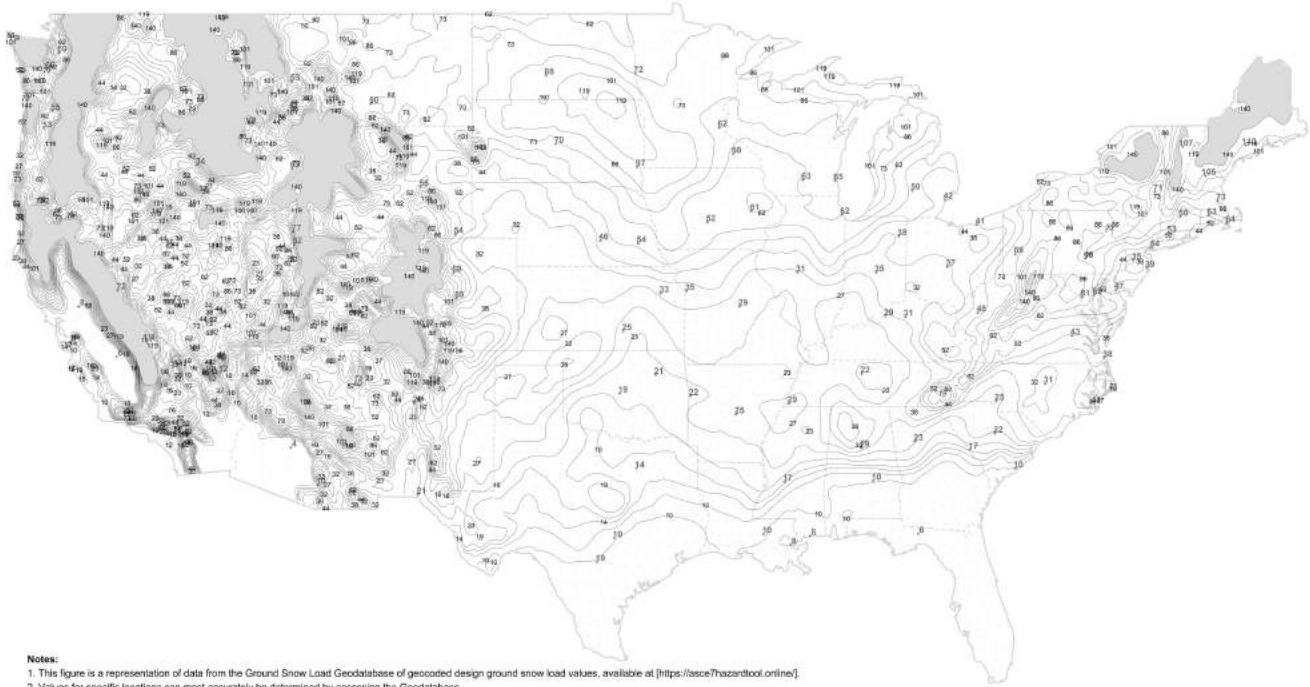

- Notes:**
1. This figure is a representation of data from the Ground Snow Load Geodatabase of geocoded design ground snow load values, available at (<https://asce7hazardtool.online/>).
 2. Values for specific locations can most accurately be determined by accessing the Geodatabase.
 3. Lines shown on the figure are contours separated by a constant ratio of 1.18 with values of 10, 12, 14, 16, 19, 23, 27, 32, 38, 44, 52, 62, 73, 86, 101, 119 and 140 psf.
 4. Values denoted with a "+" symbol indicate design ground snow loads at state capitals or other cities with large populations.
 5. Areas shown in gray represent areas with ground snow loads exceeding 140 psf. Ground snow load values for these locations must be determined from the Geodatabase.

NOTES:

- a. Location-specific ground snow load values are provided in the *Ground Snow Load Geodatabase* of geocoded design ground snow load values, which can be accessed at the ASCE 7 Hazard Tool at <https://asce7hazardtool.online/> or an approved equivalent.
- b. Lines shown on the figure are contours separated by a constant ratio 1.18 with values of 10, 12, 14, 16, 19, 23, 27, 32, 38, 44, 52, 62, 73, 86, 101, 119, and 140 psf.
- c. Values denoted with a "+" symbol indicate design ground snow loads at state capitals or other high-population locations.
- d. Areas shown in gray represent areas with ground snow loads exceeding 140 psf. Ground snow load values for these locations can be determined from the Geodatabase.

FIGURE 1608.2(3) Ground snow loads, p_g , for Risk Category III for the conterminous United States (lb/ft²)

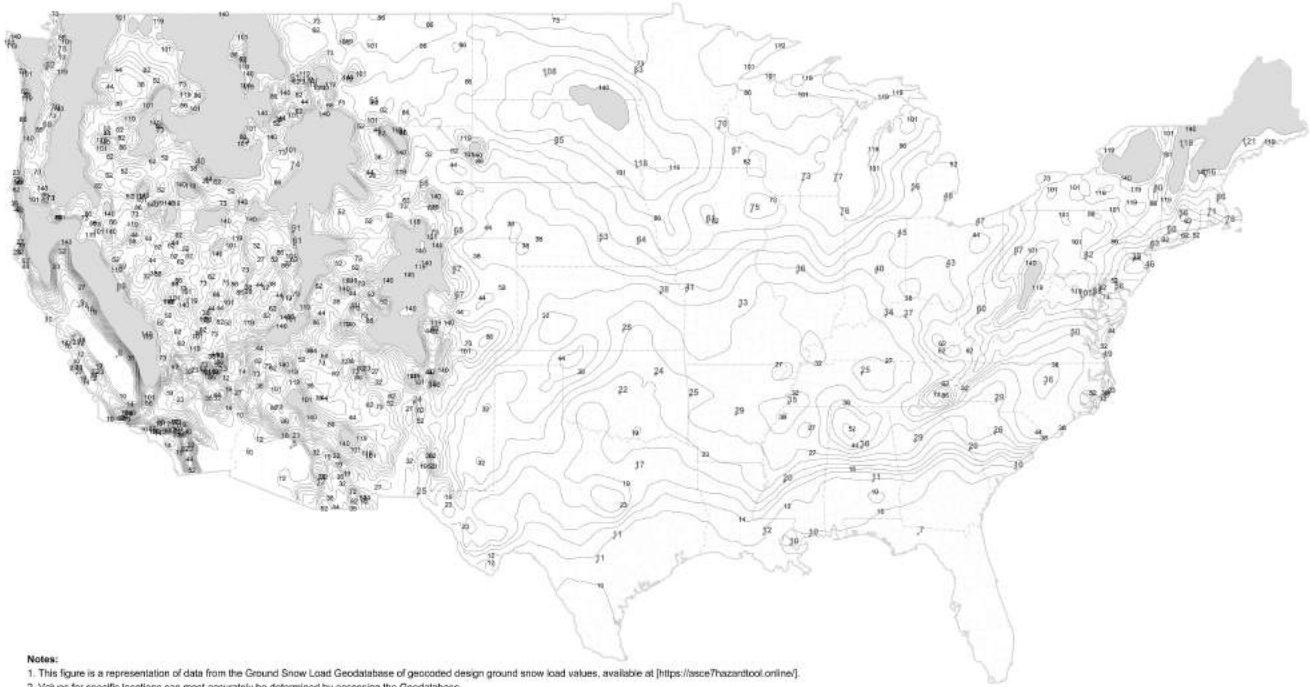

Notes:
 1. This figure is a representation of data from the Ground Snow Load Geodatabase of geocoded design ground snow load values, available at [https://asce7hazardtool.online/].
 2. Values for specific locations can most accurately be determined by accessing the Geodatabase.
 3. Lines shown on the figure are contours separated by a constant ratio of 1.18 with values of 10, 12, 14, 16, 19, 23, 27, 32, 38, 44, 52, 62, 73, 86, 101, 119 and 140 psf.
 4. Values denoted with a "+" symbol indicate design ground snow loads at state capitals or other cities with large populations.
 5. Areas shown in gray represent areas with ground snow loads exceeding 140 psf. Ground snow load values for these locations must be determined from the Geodatabase.

NOTES:

- a. Location-specific ground snow load values are provided in the *Ground Snow Load Geodatabase* of geocoded design ground snow load values, which can be accessed at the ASCE 7 Hazard Tool at <https://asce7hazardtool.online/> or an approved equivalent.
- b. Lines shown on the figure are contours separated by a constant ratio 1.18 with values of 10, 12, 14, 16, 19, 23, 27, 32, 38, 44, 52, 62, 73, 86, 101, 119, and 140 psf.
- c. Values denoted with a "+" symbol indicate design ground snow loads at state capitals or other high-population locations.
- d. Areas shown in gray represent areas with ground snow loads exceeding 140 psf. Ground snow load values for these locations can be determined from the Geodatabase.

FIGURE 1608.2(4) Ground snow loads, p_g , for Risk Category IV for the conterminous United States (lb/ft²)

Reason Statement: This proposal is a coordination proposal to bring the 2024 IBC up to date with the provisions of the 2022 edition of ASCE/SEI 7 Minimum Design Loads and Associated Criteria for Buildings and Other Structures (ASCE/SEI 7-22). ASCE 7 will be updated to the 2022 edition from the 2016 edition as an Administrative update in the 2024 I-Codes.

This proposal includes technical updates as well as editorial corrections or re-organizations. Technical updates are explained further below, along with a rationale for developing the new ground snow load data.

A summary of the specific coordination changes is provided below.

Section 202 Definitions.

Add new definition of *Ground Snow Loads Geodatabase* as the location for the geocoded values of risk-targeted design ground snow load values. The database is uniquely identified by the version (2022-1.0).

Section 1603.1 General. Added a new term $p_{g(asd)}$ to provide a value of ground snow that can be correctly used with existing provisions in the IBC and IRC. **Section 1603.1.3 Roof snow load data.** This change removes the Snow load importance factor, I_s , which is no longer needed because

the ground snow loads included are now risk-targeted maps.

Section 1605.1 General. This changes the current allowable stress design limits to the appropriate strength load ($30\text{psf}/0.7 =$ approximately 45 psf) that will be calculated from the strength-based ground snow loads from the new maps. The use of 45 psf as a bound for when snow loads are considered in seismic weight is slightly conservative based on the calculated value. Because the reliability targeted loads are greater than the unfactored 50 year MRI loads in the current standard, 15% of the snow load is used (approximately equal to $20\%/1.6$).

Section 1605.2 Alternative allowable stress design load combinations.

This section was updated to match the revisions in the ASD load combinations in ASCE 7-22. The factor on snow load as the principal variable load for strength design changes from 1.6 to 1.0. Changes to the ASD combinations were chosen by first dividing the current factor by 1.5 and then rounding up to the nearest 0.05. We chose not to round down because that would assume that ASD standards have a reliability as uniform as a strength design standard, which has not been demonstrated. Also the allowable stress design load limit of 30 psf is changed to a strength-based design of 45 psf as described above.

Section 1608.2 Ground snow loads. This section is updated to point to the four new risk-targeted maps in **Figures 1608.2(1) through 1608.2(4)**. It also updates the **Table 1608.2** for risk-targeted ground snow loads for Alaskan cities.

Section 1608.2.1 Ground snow conversion. This is a new section (modeled after the approach used for wind loads) that introduces a new term for allowable stress design ground snow loads, $p_g(\text{asd})$, in order to provide a value that can be used correctly with the existing provisions in the IBC and IRC that have developed tables or charts based on the allowable stress design ground snow loads.

Technical rationale

The previous editions of ASCE 7 included mapped values for ground snow load, p_g , (GSL) based on a statistical analysis using National Weather Service snowfall data from 1952 to 1992. This map was first included in the 1992 edition of ASCE 7 and was updated with additional information for the 1995 edition. It has remained essentially as it was in 1995 for each subsequent edition through 2016. Additionally, at the time that map was generated, the authors (researchers at the Cold Regions Research and Engineering Laboratory [CRREL] of the US Army Corps of Engineers) marked as Case Study or 'CS' several significant regions, encompassing large parts of eighteen states, where the statistical analysis had not been completed or the data were insufficient to perform the analysis. The CS regions place significant burden on structural engineers to do snow load hazard analysis, and very little guidance has been provided as to how to conduct such studies.

The new GSL in ASCE 7-22 are included in four updated national GSL datasets in electronic and map form. The electronic datasets are defined in the Ground Snow Loads Geodatabase (version 2022-1.0) in ASCE 7-22, and the maps in Chapter 7 are a representation of that data. The new snow loads are also based on nearly 30 years of additional snow load data since the previous study and updated procedures for estimating snow loads from depth-only measurements. The loads account for site-specific variability throughout the United States in both the magnitude and variation of the annual ground snow loads. Additionally, this approach incorporates advanced spatial mapping that has reduced the number and size of case study regions in mountainous areas significantly and eliminates discontinuities in design values across state boundaries (Bean et al. 2021).

A very small fraction of the locations defined in the Ground Snow Loads Geodatabase indicate that a case study must be completed to determine the ground snow load. These case-study regions are now limited and apply only to locations higher than any locally available snow measurement locations. Database ground snow load values are still provided to the user, with a warning that the estimated value lies outside the range of elevations of surrounding measurement locations. Information from local experts, from the Bean et al. (2021) report, or from Buska et al. (2020) can be used to determine values at these locations.

ASCE 7-22 also includes GSL maps for each Risk Category. Each of these maps (and associated datasets) is based on reliability calculations that target the reliability objectives of Chapter 1 of ASCE 7-22. The adoption of reliability-targeted design ground snow loads represents a significant change from ASCE/SEI 7-16 and prior editions, which previously used ground snow loads with a 50-year mean recurrence interval (MRI). Reliability-targeted loads are adopted to address the nonuniform reliability of roofs designed according to the 50-year snow load in different parts of the country, due to climatic differences. In some parts of the country, designing for the 1.6 load factor times the 50-year value does not meet the reliability targets of the standard (and, in some of these places, failures due to an underestimated ground snow load have been observed); in other places, designing for the 1.6 load factor times the 50-year value is unnecessarily conservative.

Given that the values of GSL have been provided as allowable stress loads up until this point, there are many provisions within the IBC and the IRC that rely on ASD values. Therefore a new section is proposed to provide a conversion from the strength-based values provided in the reliability-targeted ground snow loads maps to an ASD value. An additional, separate code change proposal will be submitted for clarifying where existing tables are for ASD values.

References

Bean, B., Maguire, M., Sun, Y, Wagstaff, J., Al-Rubaye, S., Wheeler, J., Jarman, S., and Rogers, M. (2021). "The 2020 National Snow Load Study." Mathematics and Statistics Faculty Publications. Paper 276.

Buska, J., Grestorex, A., and Tobiasson, W. (2020). "Site-specific Case Studies for Determining Ground Snow Loads in the United States". U.S. Army Corps of Engineers Engineer Research and Development Center. ERDC/CRREL SR-20-1.

Cost Impact: The code change proposal will increase the cost of construction

ASCE 7 is a national minimum design load standard. Therefore, as the study of each hazard advances from one edition to the next, updates to the national maps will impact the nation differently. In this case, the ground snow loads developed for ASCE 7-22 will result in some decreases in loads, but on average results in an increase in loads. The proposed code change will modestly increase the cost of construction in the areas where the snow loads have increased.

In order to estimate this impact, roof total loads that would be used in specifying roof secondary structural members, such as open-web roof joists, were calculated for approximately 80 locations throughout the portion of the conterminous US affected by snow loading. The box plot to the right shows the ratio of these Total Load results.

The average change in Total Load is a 5% increase. At most locations, the change is between a 5% reduction to a 15% increase. Regarding the effect of this average 5% increase, the increase in Total Load would generally equate to an increase in weight of these secondary members of +5% and a structural cost impact of about +2-3%. Extending this to the effects on the total in-place cost of the structure, we expect an estimated impact of +0.5-0.7%.

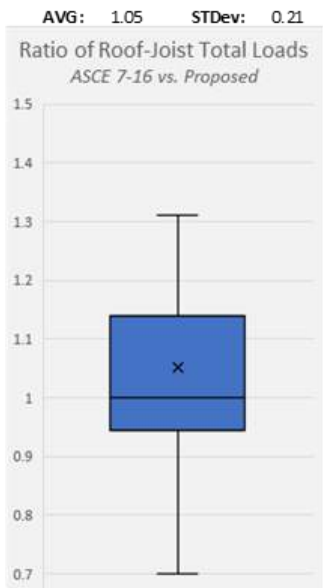

Figure 1. Box plot of ratio of roof-joist total loads of ASCE 7-16 vs. ASCE 7-22.

S65-22

IBC: 1602.1, 1605.2

Proponents: John Grenier, representing National Council of Structural Engineers Associations (NCSEA) (jgrenier@greniereng.com); Stephen Kerr, representing Self (skerr@jwa-se.com)

2021 International Building Code

Revise as follows:

1602.1 Notations. The following notations are used in this chapter:

D	=	Dead load.
D_i	=	Weight of ice in accordance with Chapter 10 of ASCE 7.
E	=	Combined effect of horizontal and vertical earthquake induced forces as defined in Section 12.4 of ASCE 7.
F	=	Load due to fluids with well-defined pressures and maximum heights.
F_a	=	Flood load in accordance with Chapter 5 of ASCE 7.
H	=	Load due to lateral earth pressures, ground water pressure or pressure of bulk materials.
L	=	Live load.
L_r	=	Roof live load.
R	=	Rain load.
S	=	Snow load.
T	=	Cumulative effects of self-straining load forces and effects.
V_{asd}	=	Allowable stress design wind speed, miles per hour (mph) (km/hr) where applicable.
V	=	Basic design wind speeds, miles per hour (mph) (km/hr) determined from Figures 1609.3(1) through 1609.3(12) or ASCE 7.
W	=	Load due to wind pressure.
W_i	=	Wind-on-ice in accordance with Chapter 10 of ASCE 7.
W_T	=	Load due to tornado wind pressure in accordance with Chapter 32 of ASCE 7.

1605.2 Alternative allowable stress design load combinations. In lieu of the load combinations in ASCE 7, Section 2.4, structures and portions thereof shall be permitted to be designed for the most critical effects resulting from the following combinations. Where using these alternative allowable stress load combinations that include wind or seismic loads, allowable stresses are permitted to be increased or load combinations reduced where permitted by the material chapter of this code or the referenced standards. For load combinations that include the counteracting effects of dead and wind loads, only two-thirds of the minimum dead load likely to be in place during a design wind event shall be used. Where using these alternative load combinations to evaluate sliding, overturning and soil bearing at the soil-structure interface, the reduction of foundation overturning from Section 12.13.4 in ASCE 7 shall not be used. Where using these alternative basic load combinations for proportioning foundations for loadings, which include seismic loads, the vertical seismic load effect, E_v , in Equation 12.4-4 of ASCE 7 is permitted to be taken equal to zero. Where required by ASCE 7, Chapters 12, 13 and 15, the load combinations including overstrength of ASCE 7, Section 2.3.6 shall be used.

$$D + L + (L_r \text{ or } S \text{ or } R) \quad \text{(Equation 16-1)}$$

$$D + L + (L_r \text{ or } 0.7S \text{ or } R) \quad \text{(Equation 16-1)}$$

$$D + L + 0.6W \quad \text{(Equation 16-2)}$$

$$D + L + 0.6W \text{ or } 0.6W_T \quad \text{(Equation 16-2)}$$

$$D + L + 0.6W + S/2 \quad \text{(Equation 16-3)}$$

$$D + L + 0.6W \text{ or } 0.6W_T + 0.7(S/2) \quad \text{(Equation 16-3)}$$

$$D + L + S + 0.6(W/2) \quad \text{(Equation 16-4)}$$

$$D + L + 0.7S + 0.6(W/2) \text{ or } 0.6(W_T/2) \quad \text{(Equation 16-4)}$$

$$D + L + S + E/1.4 \quad \text{(Equation 16-5)}$$

$$D + L + 0.7S + 0.7E/1.4 \quad \text{(Equation 16-5)}$$

$$0.9D + E/1.4 \quad \text{(Equation 16-6)}$$

$$0.9D + 0.7S/1.4 \quad \text{(Equation 16-6)}$$

Exceptions:

1. Crane hook loads need not be combined with roof live loads or with more than three-fourths of the snow load or one-half of the wind load.

2. Flat roof snow *loads* of 30 pounds per square foot (1.44 kN/m²) or less and *roof live loads* of 30 pounds per square foot (1.44 kN/m²) or less need not be combined with seismic loads. Where flat roof snow loads exceed 30 pounds per square foot (1.44 kN/m²), 20 percent shall be combined with seismic loads.

Reason Statement: The Alternate allowable stress load combinations must change because the underlying basis for these loads in ASCE 7-22 has changed.

Snow loads have changed from being presented as ASD loads to LRFD loads. Thus, in ASD load combinations, S is replaced with 0.7S in ASD load combinations.

ASCE 7-22 has added Chapter 32 for design for Tornado Loads. These are presented at the LRFD level. In ASD Load Combinations these forces are presented as $0.6W_T$.

ASCE 7 presents seismic loads as 0.7 E in ASD load combinations. The IBC presents seismic loads as E/1.4 (0.71E) in ASD load combinations. The change for seismic loading to 0.7E in Equations 16-5 and 16-6 is for consistency between the two documents.

Cost Impact: The code change proposal will increase the cost of construction

The cost of structures designed for snow loading or seismic loading will neither increase or decrease. The cost of building structures for tornado loading may increase. The cost of structures designed for snow loading or seismic loading will neither increase or decrease. The cost of building structures for tornado loading may increase.

S66-22

IBC: 1603.1

Proponents: John-Jozef Proczka, representing Self (John-jozef.proczka@phoenix.gov)

2021 International Building Code

Revise as follows:

1603.1 General. *Construction documents* shall show the material, size, section and relative locations of structural members with floor levels, column centers and offsets dimensioned. The design loads and other information pertinent to the structural design required by Sections 1603.1.1 through 1603.1.9 shall be indicated on the *construction documents*.

Exception: *Construction documents* for buildings constructed in accordance with the *conventional light-frame construction* provisions of Section 2308 shall indicate the following structural design information:

1. Floor and roof dead and live loads.
2. Ground snow load, p_g .
3. Basic design wind speed, V , miles per hour (mph) (km/hr) and allowable stress design wind speed, V_{asd} , as determined in accordance with Section 1609.3.1 and wind exposure.
4. *Seismic design category* and *site class*.
5. Flood design data, if located in *flood hazard areas* established in Section 1612.3.
6. Design load-bearing values of soils.
7. Rain load data.

Reason Statement: The code provisions of structural designs are very reliant on the type of material being used for structural members, but there is no global requirement to identify this material, even though a code compliant design would be impossible without such identification. This change would add a global requirement to identify the material of construction for the structural members. Construction documents are defined to include specifications, so this change would not place a requirement to identify the material of construction directly on the drawings.

Cost Impact: The code change proposal will not increase or decrease the cost of construction. This is essentially an editorial reorganization to place the requirements that are already inherent in the code in an obvious location.

S66-22

S67-22

IBC: 1603.1, 1603.1.1 (New)

Proponents: John Grenier, representing National Council of Structural Engineers Associations (NCSEA) (jgrenier@greniereng.com)

2021 International Building Code

Revise as follows:

1603.1 General. *Construction documents* shall show the size, section and relative locations of structural members with floor levels, column centers and offsets dimensioned. The design loads and other information pertinent to the structural design required by Sections 1603.1.1 through ~~1603.1.9~~ 1603.1.10 shall be indicated on the *construction documents*.

Exception: *Construction documents* for buildings constructed in accordance with the *conventional light-frame construction* provisions of Section 2308 shall indicate the following structural design information:

1. Floor and roof dead and live loads.
2. Ground snow load, p_g .
3. Basic design wind speed, V , miles per hour (mph) (km/hr) and allowable stress design wind speed, V_{asdt} as determined in accordance with Section 1609.3.1 and wind exposure.
4. *Seismic design category* and *site class*.
5. Flood design data, if located in *flood hazard areas* established in Section 1612.3.
6. Design load-bearing values of soils.
7. Rain load data.

Add new text as follows:

1603.1.1 Design Dead Loads. The *dead load* as defined in section 1606 used in the design shall be indicated for all areas of the structure.

- Reason Statement:**
1. By requiring the design dead loads to be listed on the construction documents provides a building official a quick review of the project and can also act as a check list item for the Registered Design Professional in Responsible Charge, especially if there are different areas that have different dead loads.
 2. Understanding what the original design dead loads were used for a structure is useful information whenever there are revisions, alterations or additions proposed to a structure in the future.
 3. The current requirement of indicating the loads listed in sections 1603.1.1 thru 1603.1.9 and not requiring the Design Dead Load makes the list incomplete.
 4. The Design Dead loads are currently required to be listed on the drawings for conventional light frame construction, which establishes a precedence.

Cost Impact: The code change proposal will not increase or decrease the cost of construction
This will be documentation information only and has no cost impact.

S67-22

S68-22

IBC: 1603.1.10 (New)

Proponents: John-Jozef Proczka, representing Self (John-jozef.proczka@phoenix.gov)

2021 International Building Code

Add new text as follows:

1603.1.10 Material Specification. Specifications for the materials to be used in the construction of the structural members shall be shown on the *construction documents* in accordance with the applicable material chapters and referenced standards.

Reason Statement: This change would add a global more readily seen requirement to identify the material properties of construction for the structural members, as already required by the structural referenced standards or material chapters of the IBC.

The code provisions of structural designs are very reliant on the type of material being used for structural members. The absence of material specification can cause insufficiently strong structures, especially when similar materials are or can be used, such as: differing steel grades, steel versus aluminum hollow sections, and differing wood species/grades. Material specification absence causes issues with correct communication between the designer, the contractor, and the inspector.

Construction documents are defined to include specifications, so this change would not place a requirement to identify the material of construction directly on the drawings.

Cost Impact: The code change proposal will not increase or decrease the cost of construction

This is an editorial reorganization to place the requirements that are already in the code in an obvious and globally applicable location.

S68-22

S69-22

IBC: 1604.4

Proponents: Ronald LaPlante, Division of State Architect, representing Federal Emergency Management Agency/Applied Technology Council - Seismic Code Support Committee (ron.laplante@dgs.ca.gov); Kelly Cobeen, representing Federal Emergency Management Agency/Applied Technology Council - Seismic Code Support Committee (kcobeen@wje.com); Michael Mahoney, representing FEMA (mike.mahoney@fema.dhs.gov)

2021 International Building Code

Revise as follows:

1604.4 Analysis. *Load effects* on structural members and their connections shall be determined by methods of structural analysis that take into account equilibrium, general stability, geometric compatibility and both short- and long-term material properties.

Members that tend to accumulate residual deformations under repeated service *loads* shall have included in their analysis the effects of added deformations expected to occur during their service life.

Any system or method of construction to be used shall be based on a rational analysis in accordance with well-established principles of mechanics. Such analysis shall result in a system that provides a complete *load* path capable of transferring *loads* from their point of origin to the load-resisting elements. The total lateral force shall be distributed to the various vertical elements of the lateral force-resisting system in proportion to their rigidities, considering the rigidity of the horizontal bracing system or *diaphragm*. Rigid elements assumed not to be a part of the lateral force-resisting system are permitted to be incorporated into buildings provided that their effect on the action of the system is considered and provided for in the design. Where a diaphragm is not permitted to be idealized as either flexible or rigid in accordance with ASCE 7 or for wood diaphragms in accordance with AWC SDPWS, it is permitted to perform an envelope analysis of the structure using a flexible and rigid diaphragm analysis separately and designing each component for the more severe load condition in lieu of a semirigid diaphragm analysis. A diaphragm is rigid for the purpose of distribution of story shear and torsional moment when the lateral deformation of the diaphragm is less than or equal to two times the average story drift. Where required by ASCE 7, provisions shall be made for the increased forces induced on resisting elements of the structural system resulting from torsion due to eccentricity between the center of application of the lateral forces and the center of rigidity of the lateral force-resisting system. Every structure shall be designed to resist the effects caused by the forces specified in this chapter, including overturning, uplift and sliding. Where sliding is used to isolate the elements, the effects of friction between sliding elements shall be included as a force.

Reason Statement: ASCE 7 Section 12.3.1 requires that the structural analysis consider the relative stiffness of the diaphragms and the vertical elements of the seismic force-resisting system. This section also requires the structural analysis to explicitly consider the stiffness of the diaphragm with a semirigid diaphragm analysis unless the diaphragms meet certain conditions where they may be idealized as flexible or rigid. The current IBC language is in direct conflict with ASCE 7 as it permits a simple comparison of the diaphragm deflection relative to the vertical seismic force-resisting system average drift as whether a diaphragm is either rigid or flexible and this would never result in a semirigid diaphragm analysis. There are many conditions that occur in buildings where a semirigid diaphragm analysis is necessary to develop a more accurate distribution of forces in the structure. The proposed change will align the IBC with ASCE 7 while also permitting an envelope solution for buildings where a 3D analysis may not have been performed.

Furthermore, this change is necessary as the current IBC language provides no guidance on which loads are to be used to evaluate the lateral deformation of the diaphragm to compare it to the story drift to determine the rigid diaphragm condition. For example, for seismic design, diaphragms have different design loads than the vertical seismic force-resisting system when computing drift. ASCE 7 provides clarity on which design loads are to be used to compute these displacements, which the IBC is lacking.

The SDPWS provides specific requirements for when a diaphragm may be idealized as flexible or rigid and that direct reference has been added to clarify that for wood diaphragms, that standard may be used.

Cost Impact: The code change proposal will not increase or decrease the cost of construction

The code change proposal will not, in general, increase or decrease the overall cost of construction, rather provide an alternate diaphragm analysis approach, that in some cases may cause less design effort and in other case more design effort. The exception can be used to limit the design effort and avoid a computer analysis.

S69-22

S70-21

IBC: TABLE 1604.5

Proponents: Homer Maiel, PE,CBO, representing ICC Tri-Chapter (Peninsula, East Bay, Monterey Bay) (hmaiel@gmail.com)

2021 International Building Code

Revise as follows:

TABLE 1604.5 RISK CATEGORY OF BUILDINGS AND OTHER STRUCTURES

Portions of table not shown remain unchanged.

RISK CATEGORY	NATURE OF OCCUPANCY
I	<p>Buildings and other structures that represent a low hazard to human life in the event of failure, including but not limited to: Agricultural facilities.</p> <p>Certain temporary facilities.</p> <p>Minor storage facilities.</p>
II	<p>Buildings and other structures except those listed in Risk Categories I, III and IV.</p>
III	<p>Buildings and other structures that represent a substantial hazard to human life in the event of failure, including but not limited to: Buildings and other structures whose primary occupancy is public assembly with an occupant load greater than 300.</p> <p>Buildings and other structures containing one or more public assembly spaces, each having an occupant load greater than 300 and a cumulative occupant load of the public assembly spaces of greater than 2,500.</p> <p>Buildings and other structures containing Group E or Group I-4 occupancies or combination thereof, with an occupant load greater than 250.</p> <p>Buildings and other structures containing educational occupancies for students above the 12th grade with an occupant load greater than 500.</p> <p>Group I-2, Condition 1 occupancies with 50 or more care recipients.</p> <p>Group I-2, Condition 2 occupancies not having emergency surgery or emergency treatment facilities.</p> <p>Group I-3 occupancies.</p> <p>Any other occupancy with an occupant load greater than 5,000.^a</p> <p>Power-generating stations, water treatment facilities for potable water, wastewater treatment facilities and other public utility facilities not included in Risk Category IV.</p> <p>Buildings and other structures not included in Risk Category IV containing quantities of toxic or explosive materials that: Exceed maximum allowable quantities per control area as given in Table 307.1(1) or 307.1(2) or per outdoor control area in accordance with the <i>International Fire Code</i>; and Are sufficient to pose a threat to the public if released.^b</p>

RISK CATEGORY	NATURE OF OCCUPANCY
IV	<p>Buildings and other structures designated as essential facilities, including but not limited to: Group I-2, Condition 2 occupancies having emergency surgery or emergency treatment facilities.</p> <p>Ambulatory care facilities having emergency surgery or emergency treatment facilities.</p> <p>Fire, rescue, ambulance and police stations and emergency vehicle garages</p> <p>Designated earthquake, hurricane or other emergency shelters.</p> <p>Designated emergency preparedness, communications and operations centers and other facilities required for emergency response.</p> <p>Power-generating stations and other public utility facilities required as emergency backup facilities for <i>Risk Category IV</i> structures.</p> <p>Buildings and other structures containing quantities of highly toxic materials that:</p> <p>Exceed maximum allowable quantities per control area as given in Table 307.1(2) or per outdoor control area in accordance with the <i>International Fire Code</i>; and</p> <p>Are sufficient to pose a threat to the public if released.^b</p> <p>Aviation control towers, air traffic control centers and emergency aircraft hangars.</p> <p>Buildings and other structures having critical national defense functions.</p> <p>Water storage facilities and pump structures required to maintain water pressure for fire suppression.</p> <p><u>Storm shelters in accordance with Section 423.1</u></p>

- a. For purposes of occupant load calculation, occupancies required by Table 1004.5 to use gross floor area calculations shall be permitted to use net floor areas to determine the total occupant load.
- b. Where approved by the building official, the classification of buildings and other structures as Risk Category III or IV based on their quantities of toxic, highly toxic or explosive materials is permitted to be reduced to Risk Category II, provided that it can be demonstrated by a hazard assessment in accordance with Section 1.5.3 of ASCE 7 that a release of the toxic, highly toxic or explosive materials is not sufficient to pose a threat to the public.

Reason Statement: This is simply cross referring a table to a section and a section to a table. In Section 423.1 there is mention of storm shelters to comply with Table 1604.5 as a Risk Cat. IV. However, table does not mention Section 423.1.

Cost Impact: The code change proposal will not increase or decrease the cost of construction
This is simply an editorial clarification; make a section and a table to reference each other.

S71-22

IBC: 1604.5

Proponents: Ali Fattah, representing City of San Diego Development Services Department (AFATTAH@SANDIEGO.GOV)

2021 International Building Code

Revise as follows:

1604.5 Risk category. Each building and structure shall be assigned a *risk category* in accordance with Table 1604.5. Where a referenced standard specifies an occupancy category, the *risk category* shall not be taken as lower than the occupancy category specified therein. Where a referenced standard specifies that the assignment of a *risk category* be in accordance with ASCE 7, Table 1.5-1, Table 1604.5 shall be used in lieu of ASCE 7, Table 1.5-1.

Exception-Exceptions:

1. The assignment of buildings and structures to Tsunami *Risk Categories* III and IV is permitted to be in accordance with Section 6.4 of ASCE 7.
2. Free standing parking garages shall be assigned to *Risk Category II*.

Reason Statement: The proposed code change is necessary to address an anomaly in the IBC whereby large parking structures that serve airports, shopping centers and other large buildings trigger a risk Category III designation when they have a floor area that exceeds 1,000,00 sq ft. The code change addresses the intent of the IBC as well as ASCE 7 whereby the codes are interested in providing more protection for buildings with a high concentration of occupants and certain large buildings that in total have 5,000 or more occupants. ASCE 7 intends to improve protection for "Buildings and other structures, the failure of which could pose a substantial risk to human life"

The occupant load for parking garages is determined based on an occupant load factor of 200 sq ft per occupant gross. There are circumstances where even when deducting drive aisles and the other items permitted to establish an occupant load based on net area the total occupant load can still exceed 5,000. The occupancy for parking garages is classified as a Group S-2 light hazard storage area and the occupant load density tends to be low due to the intermittent nature of the storage occupancy.

- It is hard to imagine that a large parking garage will have 5,000 occupants simultaneously entering or exiting a garage concurrent with the occurrence of a major earthquake.
- From experience large structures may experience partial damage or collapse but the entire structure should not collapse.

The Commentary to ASCE 7 states "Classification continues to reflect a progression of the anticipated seriousness of the consequence of failure from lowest risk to human life (Risk Category I) to the highest (Risk Category IV)." It is therefore reasonable to assign free standing parking structures to Risk Category II.

My jurisdiction recently review a 5 level 2.5 million sq ft parking plaza, a free standing open parking garage, that had to be structurally divided into two or more structures with independent means of egress and life safety systems. The garage will serve an enlarged replacement terminal at San Diego International Airport. Proponent has also heard from other jurisdictions that had similar projects.

The proposed code change shall be considered on it's own and is not reliant on the approval of other related code changes.

Cost Impact: The code change proposal will decrease the cost of construction

The proposed code change will have the effect of reducing earthquake loads on parking garages the are large and have a low concentration of occupant load.

The code change will also reduce the need to create separate structures and will allow more efficient designs where the distribution and sizing of exists is only dependent on the requirements in IBC Chapter 10. Additionally, the code change will permit the use of common life safety systems such as emergency power from a common generator or UPS system.

S71-22

S72-22

IBC: TABLE 1604.5

Proponents: Ali Fattah, representing City of San Diego Development Services Department (AFATTAH@SANDIEGO.GOV)

2021 International Building Code

Revise as follows:

TABLE 1604.5 RISK CATEGORY OF BUILDINGS AND OTHER STRUCTURES

RISK CATEGORY	NATURE OF OCCUPANCY
I	<p>Buildings and other structures that represent a low hazard to human life in the event of failure, including but not limited to: Agricultural facilities.</p> <p>Certain temporary facilities.</p> <p>Minor storage facilities.</p>
II	<p>Buildings and other structures except those listed in Risk Categories I, III and IV.</p>
III	<p>Buildings and other structures that represent a substantial hazard to human life in the event of failure, including but not limited to: Buildings and other structures whose primary occupancy is public assembly with an occupant load greater than 300.</p> <p>Buildings and other structures containing one or more public assembly spaces, each having an occupant load greater than 300 and a cumulative occupant load of these public assembly spaces of greater than 2,500.</p> <p>Buildings and other structures containing Group E or Group I-4 occupancies or combination thereof, with an occupant load greater than 250.</p> <p>Buildings and other structures containing educational occupancies for students above the 12th grade with an occupant load greater than 500.</p> <p>Group I-2, Condition 1 occupancies with 50 or more care recipients.</p> <p>Group I-2, Condition 2 occupancies not having emergency surgery or emergency treatment facilities.</p> <p>Group I-3 occupancies.</p> <p>Any other occupancy with an occupant load greater than 5,000.^a</p> <p>Power-generating stations, water treatment facilities for potable water, wastewater treatment facilities and other public utility facilities not included in Risk Category IV.</p> <p>Buildings and other structures not included in Risk Category IV containing quantities of toxic or explosive materials that:</p> <p>Exceed maximum allowable quantities per control area as given in Table 307.1(1) or 307.1(2) or per outdoor control area in accordance with the <i>International Fire Code</i> ; and</p> <p>Are sufficient to pose a threat to the public if released.^b</p>

RISK CATEGORY	NATURE OF OCCUPANCY
IV	<p>Buildings and other structures designated as essential facilities, including but not limited to: Group I-2, Condition 2 occupancies having emergency surgery or emergency treatment facilities.</p> <p>Ambulatory care facilities having emergency surgery or emergency treatment facilities.</p> <p>Fire, rescue, ambulance and police stations and emergency vehicle garages</p> <p>Designated earthquake, hurricane or other emergency shelters.</p> <p>Designated emergency preparedness, communications and operations centers and other facilities required for emergency response.</p> <p>Power-generating stations and other public utility facilities required as emergency backup facilities for <i>Risk Category IV</i> structures.</p> <p>Buildings and other structures containing quantities of highly toxic materials that:</p> <p>Exceed maximum allowable quantities per control area as given in Table 307.1(2) or per outdoor control area in accordance with the <i>International Fire Code</i> ; and</p> <p>Are sufficient to pose a threat to the public if released.^b</p> <p>Aviation control towers, air traffic control centers and emergency aircraft hangars.</p> <p>Buildings and other structures having critical national defense functions.</p> <p>Water storage facilities and pump structures required to maintain water pressure for fire suppression.</p>

- a. For purposes of occupant load calculation, occupancies required by Table 1004.5 to use gross floor area calculations shall be permitted to use net floor areas to determine the total occupant load. The floor area for vehicular drive aisles shall be permitted to be excluded in the determination of net floor area in parking garages.
- b. Where approved by the building official, the classification of buildings and other structures as Risk Category III or IV based on their quantities of toxic, highly toxic or explosive materials is permitted to be reduced to Risk Category II, provided that it can be demonstrated by a hazard assessment in accordance with Section 1.5.3 of ASCE 7 that a release of the toxic, highly toxic or explosive materials is not sufficient to pose a threat to the public.

Reason Statement: The proposed code change is necessary to clarify the determination of occupant load in parking garages when establishing the total occupant load in a building for purposes of assigning the Risk Category. Table 1604.5 assigns risk categories based on the occupant load in an occupancy or the building. Parking garages are classified as occupancy Group S-2 and footnote (a) to the table permits the use of floor area net to determine the total occupant load used in assigning the Risk Category.

- The IBC defines floor area net as "[BE] FLOOR AREA, NET. The actual occupied area not including unoccupied accessory areas such as corridors , stairways , ramps , toilet rooms, mechanical rooms and closets."
- Aisle is also defined as "[BE] AISLE. An unenclosed exit access component that defines and provides a path of egress travel"

While occupants use drive aisles to access parked motor vehicles they are not commonly identified as AISLE based on the definition. The proposed code change modifies footnote (a) to clarify that floor area for drive aisles can be deducted when determining net floor area for the assignment of Risk Category. Unlike mechanical access parking garages, vehicular aisles are an integral part for the functioning the of the garage and occupants in the motor vehicle would not be located concurrently within the drive aisle. Additionally, drive aisles are not commonly associated with exit access aisles.

There can be situations where a public assembly such as a multiplex cinema or an amenity space for a residential community may be located above a parking structure serving that amenity space and other surrounding buildings. The occupant load in the parking garage itself which is accessory to the public assembly or other buildings may requiring the structure to be assigned to Risk Category III merely due to the size of the parking garage. The proposed code change should be considered to be editorial in nature.

The occupant load for parking garages is determined based on an occupant load factor of 200 sq ft per occupant gross. there are circumstances when even deducting drive aisles and the other items permitted to establish an occupant load based on net area the total occupant load can still exceed 5,000. The occupancy for parking garages is classified as a Group S-2 light hazard storage area and the occupant load density tends to be low due to the intermittent nature of the storage occupancy.

- It is hard to imagine that a large parking garage will have 5,000 occupants simultaneously entering or exiting a garage concurrent with

the occurrence of a major earthquake.

- From experience large structures may experience partial damage or collapse but the entire structure should not collapse.

The Commentary to ASCE 7 states "Classification continues to reflect a progression of the anticipated seriousness of the consequence of failure from lowest risk to human life (Risk Category I) to the highest (Risk Category IV)." It is therefore reasonable to assign free standing parking structures to Risk Category II.

Cost Impact: The code change proposal will not increase or decrease the cost of construction

The proposed code change is editorial and can be considered to reduce the cost of construction in jurisdiction that do not permit the deduction of the floor area in drive aisle. Proponent feels the code change will neither increase nor decrease the cost of construction and merely adds a clarification to footnote (a).

S72-22

S73-22

IBC: TABLE 1604.5

Proponents: John-Jozef Proczka, representing Self (john-jozef.proczka@phoenix.gov)

2021 International Building Code

Revise as follows:

TABLE 1604.5 RISK CATEGORY OF BUILDINGS AND OTHER STRUCTURES

RISK CATEGORY	NATURE OF OCCUPANCY
I	<p>Buildings and other structures that represent a low hazard to human life in the event of failure, including but not limited to: Agricultural facilities.</p> <p>Certain temporary facilities.</p> <p>Minor storage facilities.</p>
II	<p>Buildings and other structures except those listed in Risk Categories I, III and IV.</p>
III	<p>Buildings and other structures that represent a substantial hazard to human life in the event of failure, including but not limited to: Buildings and other structures whose primary occupancy is public assembly with an occupant load greater than 300.</p> <p>Buildings and other structures containing one or more public assembly spaces, each having an occupant load greater than 300 and a cumulative occupant load of these public assembly spaces of greater than 2,500.</p> <p>Buildings and other structures containing Group E or Group I-4 occupancies or combination thereof, with an occupant load greater than 250.</p> <p>Buildings and other structures containing educational occupancies for students above the 12th grade with an occupant load greater than 500.</p> <p>Group I-2, Condition 1 occupancies with 50 or more care recipients.</p> <p>Group I-2, Condition 2 occupancies not having emergency surgery or emergency treatment facilities.</p> <p>Group I-3 occupancies.</p> <p>Any other occupancy with an occupant load greater than 5,000.^a</p> <p>Power-generating stations, water treatment facilities for potable water, wastewater treatment facilities and other public utility facilities not included in Risk Category IV.</p> <p>Buildings and other structures not included in Risk Category IV containing quantities of toxic or explosive materials that: Exceed maximum allowable quantities per control area as given in Table 307.1(1) or 307.1(2) or per outdoor control area in accordance with the <i>International Fire Code</i> ; and Are sufficient to pose a threat to the public if released.^b</p>

RISK CATEGORY	NATURE OF OCCUPANCY
IV	<p>Buildings and other structures designated as essential facilities, including but not limited to: Group I-2, Condition 2 occupancies having emergency surgery or emergency treatment facilities.</p> <p>Ambulatory care facilities having emergency surgery or emergency treatment facilities.</p> <p>Fire, rescue, ambulance and police stations and emergency vehicle garages</p> <p>Designated earthquake, hurricane or other emergency shelters.</p> <p>Designated emergency preparedness, communications and operations centers and other facilities required for emergency response.</p> <p>Power-generating stations and other public utility facilities required as emergency backup facilities for <i>Risk Category IV</i> structures.</p> <p>Buildings and other structures containing quantities of highly toxic materials that:</p> <p>Exceed maximum allowable quantities per control area as given in Table 307.1(2) or per outdoor control area in accordance with the <i>International Fire Code</i> ; and</p> <p>Are sufficient to pose a threat to the public if released.^b</p> <p>Aviation control towers, air traffic control centers and emergency aircraft hangars.</p> <p>Buildings and other structures having critical national defense functions.</p> <p>Water storage facilities and pump structures required to maintain water pressure for fire suppression <u>of a community</u>.</p>

- a. For purposes of occupant load calculation, occupancies required by Table 1004.5 to use gross floor area calculations shall be permitted to use net floor areas to determine the total occupant load.
- b. Where approved by the building official, the classification of buildings and other structures as Risk Category III or IV based on their quantities of toxic, highly toxic or explosive materials is permitted to be reduced to Risk Category II, provided that it can be demonstrated by a hazard assessment in accordance with Section 1.5.3 of ASCE 7 that a release of the toxic, highly toxic or explosive materials is not sufficient to pose a threat to the public.

Reason Statement: Fire pumps for a single building's automatic sprinkler system or standpipes in structures outside of the primary structure they are serving are relatively common. This proposal clarifies that the intent of having risk category IV water pump structures does not extend to these ancillary structures serving only lower risk category structures. The intent is for maintaining water pressure for fire suppression for an entire community - not a single structure.

Cost Impact: The code change proposal will not increase or decrease the cost of construction
This proposal is a clarification of what is a risk category IV structure. This proposal may decrease cost if the existing provisions have been misinterpreted.

S74-22

IBC: TABLE 1604.5

Proponents: David Bonowitz, representing FEMA-ATC Seismic Code Support Committee (dbonowitz@att.net); Kelly Cobeen, representing Federal Emergency Management Agency/Applied Technology Council - Seismic Code Support Committee (kcobeen@wje.com); Michael Mahoney, representing FEMA (mike.mahoney@fema.dhs.gov)

2021 International Building Code

Revise as follows:

TABLE 1604.5 RISK CATEGORY OF BUILDINGS AND OTHER STRUCTURES

RISK CATEGORY	NATURE OF OCCUPANCY
I	<p>Buildings and other structures that represent a low hazard to human life in the event of failure, including but not limited to: Agricultural facilities.</p> <p>Certain temporary facilities.</p> <p>Minor storage facilities.</p>
II	<p>Buildings and other structures except those listed in Risk Categories I, III and IV.</p>
III	<p>Buildings and other structures that represent a substantial hazard to human life in the event of failure, including but not limited to: Buildings and other structures whose primary occupancy is public assembly with an occupant load greater than 300.</p> <p>Buildings and other structures containing one or more public assembly spaces, each having an occupant load greater than 300 and a cumulative occupant load of these public assembly spaces of greater than 2,500.</p> <p>Buildings and other structures containing Group E or Group I-4 occupancies or combination thereof, with an occupant load greater than 250.</p> <p>Buildings and other structures containing educational occupancies for students above the 12th grade with an occupant load greater than 500.</p> <p>Group I-2, Condition 1 occupancies with 50 or more care recipients.</p> <p>Group I-2, Condition 2 occupancies not having emergency surgery or emergency treatment facilities.</p> <p>Group I-3 occupancies.</p> <p>Any other occupancy with an occupant load greater than 5,000.^a</p> <p>Power-generating stations, water treatment facilities for potable water, wastewater treatment facilities and other public utility facilities not included in Risk Category IV.</p> <p>Buildings and other structures not included in Risk Category IV containing quantities of toxic or explosive materials that:</p> <p>Exceed maximum allowable quantities per control area as given in Table 307.1(1) or 307.1(2) or per outdoor control area in accordance with the <i>International Fire Code</i> ; and</p> <p>Are sufficient to pose a threat to the public if released.^b</p>

RISK CATEGORY	NATURE OF OCCUPANCY
IV	<p>Buildings and other structures designated as essential facilities <u>and buildings where loss of function represents a substantial hazard to occupants</u>, including but not limited to:</p> <p>Group I-2 occupancies, Condition 2 occupancies having emergency surgery or emergency treatment facilities.</p> <p>Ambulatory care facilities having emergency surgery or emergency treatment facilities.</p> <p>Fire, rescue, ambulance and police stations and emergency vehicle garages</p> <p>Designated earthquake, hurricane or other emergency shelters.</p> <p>Designated emergency preparedness, communications and operations centers and other facilities required for emergency response.</p> <p>Power-generating stations and other public utility facilities required as emergency backup facilities for <i>Risk Category IV</i> structures.</p> <p>Buildings and other structures containing quantities of highly toxic materials that:</p> <p>Exceed maximum allowable quantities per control area as given in Table 307.1(2) or per outdoor control area in accordance with the <i>International Fire Code</i> ; and</p> <p>Are sufficient to pose a threat to the public if released.^b</p> <p>Aviation control towers, air traffic control centers and emergency aircraft hangars.</p> <p>Buildings and other structures having critical national defense functions.</p> <p>Water storage facilities and pump structures required to maintain water pressure for fire suppression.</p>

- a. For purposes of occupant load calculation, occupancies required by Table 1004.5 to use gross floor area calculations shall be permitted to use net floor areas to determine the total occupant load.
- b. Where approved by the building official, the classification of buildings and other structures as Risk Category III or IV based on their quantities of toxic, highly toxic or explosive materials is permitted to be reduced to Risk Category II, provided that it can be demonstrated by a hazard assessment in accordance with Section 1.5.3 of ASCE 7 that a release of the toxic, highly toxic or explosive materials is not sufficient to pose a threat to the public.

Reason Statement: This proposal improves consistency in the assignment of risk categories. It applies current thinking from IBC Chapters 3 and 4 to the risk category assignments in Table 1604.5. The logic of the proposal is as follows:

1. **Risk Category IV is the IBC’s main tool to provide functional facilities** soon after a natural hazard event (earthquake, flood, snow, or wind). In terms of post-event functionality, there is a wide gap between RC II-III facilities (which have identical requirements for nonstructural systems) and RC IV facilities. The difference in expected recovery time can be on the order of weeks or months.
2. The performance gap between RC II-III and RC IV is most acute for occupancies that depend on functional nonstructural systems and special design provisions to serve vulnerable users.
3. Because these facilities are rare and specially designed, their services and occupants cannot be quickly relocated to other buildings.
4. Therefore, facilities with special design features and vulnerable users should be strong candidates for Risk Category IV.

Following this logic, this proposal expands the scope of RC IV from just “essential facilities” to include “buildings where loss of function represents a substantial hazard.” **This “substantial hazard” can even be life threatening** where, for example, a 24-hour medical facility, residential care facility, public water or power utility, detention center with impeded egress, or critical supply chain facility is out of service for weeks. The code defines *essential facilities* as those that need to “remain operational” through and after an “extreme” earthquake, flood, wind, or snow event. The additional facilities described by the logic above and considered in this proposal might not require continuous operation, but **prolonged downtime – which can be expected from RC II design criteria – can give rise to a similar risk for vulnerable users**, if not on Day 1 after the event, then possibly by Day 3, 10, or 30.

This proposal addresses medical care facilities assigned to Group I-2. Many design professionals assume all hospitals, typically assigned to Group I-2, are already assigned to RC IV, but that is only true for facilities that provide emergency surgery or emergency treatment. (Even “in-patient stabilization,” which is part of what defines Group I-2 Condition 2, does not currently qualify for RC IV.) Many Group I-2 facilities, which include hospitals, nursing homes, and detoxification facilities, are assigned to RC II or RC III, even though they provide **24-hour medical care** for patients who are **incapable of self-preservation**, and even though they are already required to meet special design requirements for corridors, egress plans, etc. in Section 407. Under the current code, Group I-2 facilities with fewer than 50 patients are not even assigned to RC III.

Because of the specialized nature of the care provided, the vulnerability of the patients, and the special design features, none of which would be available in typical RC II buildings, no Group I-2 facility designed under the current code could reasonably be expected to provide or relocate its normal services in a timely fashion after a design-level storm or earthquake. Therefore, this proposal reassigns all Group I-2 facilities to RC IV.

Despite this reassignment, this proposal is measured in its scope. **It does NOT affect:**

- Medical care facilities for 5 or fewer residents. Per Section 308.3, Group I-2 applies only to larger facilities.
- Any *medical care* facility eligible for design under the IRC.
- Outpatient or *ambulatory care facilities* (even those subject to Section 422), including “urgent care” businesses, dialysis centers, dentists, optometrists, or similar clinics; these are typically Group B. (Ambulatory care facilities with emergency surgery or emergency treatment facilities are already assigned to RC IV.)
- Pharmacies or drug stores, typically Group M.
- Medical office buildings, typically Group B. Medical supply or equipment manufacturers, warehouses, or stores. **This proposal is consistent with current IBC principles.** This proposal extends the current scope of Risk Category IV, but it does so consistent with the purpose, philosophy, and normative goals the IBC already represents.

Even if you think of the IBC as strictly a “life safety” code, safety is more than mere survival, and safety can be at risk even after the rain, snow, or ground shaking has stopped. If building damage affects the safety of vulnerable users in the following days or weeks, it is consistent with even a safety-based code to manage those risks through design.

But the IBC’s purpose is broader than just “life safety.” Section 101.3 states that the purpose of the IBC is to provide a “reasonable level of safety, **health and general welfare.**” So a focus on the health and welfare of vulnerable building users, even where their building provides immediate safety, is both “reasonable” and completely consistent with the purpose of the code.

With its definition of *essential facilities* and its use of Risk Category IV to ensure they “remain operational,” the IBC is already more than a safety code. It is, in fact, already a basic “functional recovery” code; the only question is which building uses, and users, we decide should qualify for a designed recovery. Where RC II or RC III is not reliable enough, it is consistent with the purpose and scope of the IBC to assign more building uses to RC IV.

Not all of the IBC’s tools are perfectly nuanced. Some involve bright lines and broad categories, and it is sometimes necessary to err on the conservative side. So even if a certain use is not quite as “essential” as a fire station, RC IV might still be a more appropriate choice than RC II or RC III, and in these cases, it is consistent with the code to assign buildings to the higher category. In time, design criteria should evolve to address more specific recovery objectives (FEMA, 2020; FEMA-NIST, 2021). But those nuanced provisions are *at least* a decade away. For now, however, RC IV is the most appropriate tool we have, and we ought to use it. Adapting existing practices to new objectives is entirely consistent with the history of code development.

IBC Chapters 3 and 4 define and provide special requirements to manage fire and egress risks for particular groups of users. Table 1604.5 is meant to do the same for rare natural hazard events. But while Chapters 3 and 4 consider dozens of specific building uses and conditions, Table 1604.5 has only four categories. Changing the scope of Risk Category IV to account for specific building uses that are not adequately served by RC II or RC III criteria is consistent with the detailed, use-specific approach of Chapters 3 and 4.

Table 1604.5 represents public policy about what we desire from our buildings. As such, it has changed over time, along with public expectations. As we consider new or increasing risks related to more frequent natural hazard events, urbanization, the pandemic, or aging populations, it is both appropriate and consistent with past practice for Table 1604.5 to evolve as well.

Bibliography: Almufti, I. et al. (2016). “The resilience-based design of 181 Fremont Tower,” *Structure*, June.

Bade, M. (2014). “Mission Bay Block 25 Building – An Exercise in Lean Target Value Design,” Presentation to the Lean Construction Institute, Finland, April 12.

Berkowitz, R. (2021). “UCSF Center for Vision Neuroscience,” 2021 EERI Annual Meeting, Session 3B, March 24.

CISA, 2020. “Guidance on the Essential Critical Infrastructure Workforce: Ensuring Community and National Resilience in COVID-19 Response (Version 2.0).” U.S. Department of Homeland Security, Cybersecurity & Infrastructure Security Agency, March 28.

FEMA (2020b). *NEHRP Recommended Seismic Provisions for New Buildings and Other Structures, Volume II: Part 3 Resource Papers*, 2020 Edition, FEMA P-2082-2, prepared by the Building Seismic Safety Council of the National Institute of Buildings Sciences for Federal Emergency Management Agency, September.

FEMA-NIST (2021). *Recommended Options for Improving the Built Environment for Post-Earthquake Reoccupancy and Functional Recovery Time*, FEMA P-2090 / NIST SP-1254, Federal Emergency Management Agency and National Institute of Standards and Technology, January.

Mar, D. (2021). “Making Resilience Affordable,” 2021 EERI Annual Meeting, Session 3B, March 24.

SEFT Consulting Group (2015). "Beaverton School District Resilience Planning for High School at South Cooper Mountain and Middle School at Timberland," SEFT Consulting Group, July 10.

SFDPH, 2020. "Order of the Health Officer No. C19-07b." City and County of San Francisco, Department of Public Health, March 31, et seq.

Cost Impact: The code change proposal will increase the cost of construction

This proposal will increase the cost of construction for the buildings newly assigned to RC IV. The largest increases will likely be in high seismic areas where assignment to RC IV makes the largest changes to structural and nonstructural design criteria. This does not mean, however, that every RC IV facility will have the same unit cost as a new state-of-the-art hospital. On the contrary, case studies of voluntary RC IV-like seismic design have found a **construction cost premium ranging typically from 0% to 2%** relative to normal RC II designs. (See proposal references by Almufti, Bade, Berkowitz, Mar, and SEFT.) This estimate stands to reason: Wind, snow, and earthquake loads can already vary significantly within a jurisdiction, but the building designs and unit costs don't change wildly from one side of the county to the other. For example, the seismic design force in Berkeley is about 1.5 times that in downtown San Francisco; so with respect to the structure, any nursing home or grocery store you can build as RC II in Berkeley you can also build as RC IV in San Francisco with no change to the design. The same is likely true for snow design, for example, in Vail v. Boulder and for wind design in Galveston v. the west side of Houston. On the nonstructural side, a facility's nonstructural systems might need more bracing or support when assigned to RC IV, but the number and size of the components themselves don't suddenly look like a hospital just because the risk category has changed.

S74-22

S75-22

IBC: TABLE 1604.5

Proponents: David Bonowitz, representing FEMA-ATC Seismic Code Support Committee (dbonowitz@att.net); Kelly Cobeen, representing Federal Emergency Management Agency/Applied Technology Council - Seismic Code Support Committee (kcobeen@wje.com); Michael Mahoney, representing FEMA (mike.mahoney@fema.dhs.gov)

2021 International Building Code

Revise as follows:

TABLE 1604.5 RISK CATEGORY OF BUILDINGS AND OTHER STRUCTURES

RISK CATEGORY	NATURE OF OCCUPANCY
I	<p>Buildings and other structures that represent a low hazard to human life in the event of failure, including but not limited to: Agricultural facilities.</p> <p>Certain temporary facilities.</p> <p>Minor storage facilities.</p>
II	<p>Buildings and other structures except those listed in Risk Categories I, III and IV.</p>
III	<p>Buildings and other structures that represent a substantial hazard to human life in the event of failure, including but not limited to: Buildings and other structures whose primary occupancy is public assembly with an occupant load greater than 300.</p> <p>Buildings and other structures containing one or more public assembly spaces, each having an occupant load greater than 300 and a cumulative occupant load of these public assembly spaces of greater than 2,500.</p> <p>Buildings and other structures containing Group E or Group I-4 occupancies or combination thereof, with an occupant load greater than 250.</p> <p>Buildings and other structures containing educational occupancies for students above the 12th grade with an occupant load greater than 500.</p> <p>Group I-2, Condition 1 occupancies with 50 or more care recipients.</p> <p>Group I-2, Condition 2 occupancies not having emergency surgery or emergency treatment facilities.</p> <p>Group I-3, <u>Condition 1</u> occupancies.</p> <p>Any other occupancy with an occupant load greater than 5,000.^a</p> <p>Power-generating stations, water treatment facilities for potable water, wastewater treatment facilities and other public utility facilities not included in Risk Category IV.</p> <p>Buildings and other structures not included in Risk Category IV containing quantities of toxic or explosive materials that:</p> <p>Exceed maximum allowable quantities per control area as given in Table 307.1(1) or 307.1(2) or per outdoor control area in accordance with the <i>International Fire Code</i> ; and</p> <p>Are sufficient to pose a threat to the public if released.^b</p>

RISK CATEGORY	NATURE OF OCCUPANCY
IV	<p>Buildings and other structures designated as essential facilities <u>and buildings where loss of function represents a substantial hazard to occupants</u>, including but not limited to:</p> <p>Group I-2, Condition 2 occupancies having emergency surgery or emergency treatment facilities.</p> <p>Ambulatory care facilities having emergency surgery or emergency treatment facilities.</p> <p><u>Group I-3 occupancies other than Condition 1.</u></p> <p>Fire, rescue, ambulance and police stations and emergency vehicle garages</p> <p>Designated earthquake, hurricane or other emergency shelters.</p> <p>Designated emergency preparedness, communications and operations centers and other facilities required for emergency response.</p> <p>Power-generating stations and other public utility facilities required as emergency backup facilities for <i>Risk Category IV</i> structures.</p> <p>Buildings and other structures containing quantities of highly toxic materials that:</p> <p>Exceed maximum allowable quantities per control area as given in Table 307.1(2) or per outdoor control area in accordance with the <i>International Fire Code</i> ; and</p> <p>Are sufficient to pose a threat to the public if released.^b</p> <p>Aviation control towers, air traffic control centers and emergency aircraft hangars.</p> <p>Buildings and other structures having critical national defense functions.</p> <p>Water storage facilities and pump structures required to maintain water pressure for fire suppression.</p>

- a. For purposes of occupant load calculation, occupancies required by Table 1004.5 to use gross floor area calculations shall be permitted to use net floor areas to determine the total occupant load.
- b. Where approved by the building official, the classification of buildings and other structures as Risk Category III or IV based on their quantities of toxic, highly toxic or explosive materials is permitted to be reduced to Risk Category II, provided that it can be demonstrated by a hazard assessment in accordance with Section 1.5.3 of ASCE 7 that a release of the toxic, highly toxic or explosive materials is not sufficient to pose a threat to the public.

Reason Statement: This proposal improves consistency in the assignment of risk categories. It applies current thinking from IBC Chapters 3 and 4 to the risk category assignments in Table 1604.5. The logic of the proposal is as follows:

1. **Risk Category IV is the IBC's main tool to provide functional facilities** soon after a natural hazard event (earthquake, flood, snow, or wind). In terms of post-event functionality, there is a wide gap between RC II-III facilities (which have identical requirements for nonstructural systems) and RC IV facilities. The difference in expected recovery time can be on the order of weeks or months.
2. The performance gap between RC II-III and RC IV is most acute for occupancies that depend on functional nonstructural systems and special design provisions to serve vulnerable users.
3. Because these facilities are rare and specially designed, their services and occupants cannot be quickly relocated to other buildings.
4. Therefore, facilities with special design features and vulnerable users should be strong candidates for Risk Category IV.

Following this logic, this proposal expands the scope of RC IV from just “essential facilities” to include “buildings where loss of function represents a substantial hazard.” **This “substantial hazard” can even be life threatening** where, for example, a 24-hour medical facility, residential care facility, public water or power utility, detention center with impeded egress, or critical supply chain facility is out of service for weeks. The code defines *essential facilities* as those that need to “remain operational” through and after an “extreme” earthquake, flood, wind, or snow event. The additional facilities described by the logic above and considered in this proposal might not require continuous operation, but **prolonged downtime – which can be expected from RC II design criteria – can give rise to a similar risk for vulnerable users**, if not on Day 1 after the event, then possibly by Day 3, 10, or 30.

This proposal addresses detention facilities with special security needs, where occupants depend on facility staff for safety and habitability. Group I-3 buildings, currently assigned to RC III, include jails, prisons, and similar facilities in which six or more people are held “**under restraint [and] generally incapable of self-preservation.**” Group I-3 facilities are also subject to special design requirements in Section 408 for means of egress, fire safety, guard stations, glazing, door mechanisms, etc., making them **essentially unique within a community**. This proposal

represents the best way to use current code tools to ensure that a new detention facility will actually be available to serve the community in the days and weeks after a major storm or earthquake.

Existing jails and prisons have a record of life-threatening failures after recent hurricanes (Omorogieva, 2018). So do other old buildings, but the risk to restrained occupants is obviously higher – so much so that it can violate constitutional rights and impose liability on local governments (Jones v. San Francisco, 1997; Omorogieva, 2018). Even if the structure remains safe from collapse – the objective of both RC II and RC III – the loss of power and damage to MEP, communications, and security systems can leave the facility non-functional and, for restrained occupants, uninhabitable to the point of violation (Jones v. San Francisco, 1997). The concern has prompted a current bill in the U.S. Senate seeking information on the preparedness and damage costs in federal correctional facilities after major disasters (S.4748, 2020). The IBC should ensure that new jails and prisons are not adding to the problem.

RC III design provisions for nonstructural systems are the same as for RC II. Most jails and prisons do have emergency plans, and IBC Section 408.4.2 does require emergency power for certain doors and locks. But those strategies are focused on short-term outages or emergency response; they typically do not consider the effects of a long-term outage due to inevitable storm or earthquake damage. Many emergency plans assume feasible evacuation. But pre-event evacuation is only possible for trackable storms, not for earthquakes. Evacuation also comes with high costs and security concerns, requires a facility to evacuate to, and makes no provision for return to a damaged building. Better design can, and should, help solve this problem.

This proposal reassigns four of the five Conditions under Group I-3 to RC IV. Except for Condition 1, which this proposal leaves in RC III, all Group I-3 facilities have **egress and free movement impeded by locks**, rendering the occupants incapable of self-preservation. Because of this restraint, the uniqueness of Group I-3 facilities, and the implications of long repair times, Risk Category IV is appropriate.

Despite this reassignment, this proposal is measured in its scope. **It does NOT affect:**

- Group I-3, Condition 1. These facilities do allow free movement for occupants and are even eligible for design as residential occupancies. (One might argue that these do not even need to be assigned to RC III, but a change to RC II is outside the scope of this proposal.)
- Facilities with fewer than 6 people under restraint. Per Section 308.4, Group I-3 applies only to larger facilities. This would exempt typical holding cells in small court facilities.
- Halfway houses assigned to Group I-1 or R-4. (The difference between “halfway houses,” listed in Sections 308.2 and 310.5, and “prerelease centers,” listed in Section 308.4, is unclear.)

This proposal is consistent with current IBC principles. This proposal extends the current scope of Risk Category IV, but it does so consistent with the purpose, philosophy, and normative goals the IBC already represents.

Even if you think of the IBC as strictly a “life safety” code, safety is more than mere survival, and safety can be at risk even after the rain, snow, or ground shaking has stopped. If building damage affects the safety of vulnerable users in the following days or weeks, it is consistent with even a safety-based code to manage those risks through design.

But the IBC’s purpose is broader than just “life safety.” Section 101.3 states that the purpose of the IBC is to provide a “reasonable level of safety, **health and general welfare.**” So a focus on the health and welfare of vulnerable building users, even where their building provides immediate safety, is both “reasonable” and completely consistent with the purpose of the code.

With its definition of *essential facilities* and its use of Risk Category IV to ensure they “remain operational,” the IBC is already more than a safety code. It is, in fact, already a basic “functional recovery” code; the only question is which building uses, and users, we decide should qualify for a designed recovery. Where RC II or RC III is not reliable enough, it is consistent with the purpose and scope of the IBC to assign more building uses to RC IV.

Not all of the IBC’s tools are perfectly nuanced. Some involve bright lines and broad categories, and it is sometimes necessary to err on the conservative side. So even if a certain use is not quite as “essential” as a fire station, RC IV might still be a more appropriate choice than RC II or RC III, and in these cases, it is consistent with the code to assign buildings to the higher category. In time, design criteria should evolve to address more specific recovery objectives (FEMA, 2020; FEMA-NIST, 2021). But those nuanced provisions are *at least* a decade away. For now, however, RC IV is the most appropriate tool we have, and we ought to use it. Adapting existing practices to new objectives is entirely consistent with the history of code development.

IBC Chapters 3 and 4 define and provide special requirements to manage fire and egress risks for particular groups of users. Table 1604.5 is meant to do the same for rare natural hazard events. But while Chapters 3 and 4 consider dozens of specific building uses and conditions, Table 1604.5 has only four categories. Changing the scope of Risk Category IV to account for specific building uses that are not adequately served by RC II or RC III criteria is consistent with the detailed, use-specific approach of Chapters 3 and 4.

Table 1604.5 represents public policy about what we desire from our buildings. As such, it has changed over time, along with public expectations. As we consider new or increasing risks related to more frequent natural hazard events, urbanization, the pandemic, or aging populations, it is both appropriate and consistent with past practice for Table 1604.5 to evolve as well.

Bibliography: Almufti, I. et al. (2016). "The resilience-based design of 181 Fremont Tower," *Structure*, June.

Bade, M. (2014). "Mission Bay Block 25 Building – An Exercise in Lean Target Value Design," Presentation to the Lean Construction Institute, Finland, April 12.

Berkowitz, R. (2021). "UCSF Center for Vision Neuroscience," 2021 EERI Annual Meeting, Session 3B, March 24.

CISA, 2020. "Guidance on the Essential Critical Infrastructure Workforce: Ensuring Community and National Resilience in COVID-19 Response (Version 2.0)." U.S. Department of Homeland Security, Cybersecurity & Infrastructure Security Agency, March 28.

FEMA (2020b). *NEHRP Recommended Seismic Provisions for New Buildings and Other Structures, Volume II: Part 3 Resource Papers, 2020 Edition*, FEMA P-2082-2, prepared by the Building Seismic Safety Council of the National Institute of Buildings Sciences for Federal Emergency Management Agency, September.

FEMA-NIST (2021). *Recommended Options for Improving the Built Environment for Post-Earthquake Reoccupancy and Functional Recovery Time*, FEMA P-2090 / NIST SP-1254, Federal Emergency Management Agency and National Institute of Standards and Technology, January.

Jones v. San Francisco, 1997. Arnold Jones et al. v. City and County of San Francisco, et al., 976 F.Supp. 896, July 18.

Mar, D. (2021). "Making Resilience Affordable," 2021 EERI Annual Meeting, Session 3B, March 24.

Omorgieva, W., 2018. "Prison Preparedness and Legal Obligations to Protect Prisoners During Natural Disasters." Sabin Center for Climate Change Law, Columbia Law School, May.

S.4748, 2020. "Correctional Facility Disaster Preparedness Act of 2020" [S.4748].

SEFT Consulting Group (2015). "Beaverton School District Resilience Planning for High School at South Cooper Mountain and Middle School at Timberland," SEFT Consulting Group, July 10.

SFDPH, 2020. "Order of the Health Officer No. C19-07b." City and County of San Francisco, Department of Public Health, March 31, et seq.

Cost Impact: The code change proposal will increase the cost of construction

This proposal will increase the cost of construction for the buildings newly assigned to RC IV. The largest increases will likely be in high seismic areas where assignment to RC IV makes the largest changes to structural and nonstructural design criteria. This does not mean, however, that every RC IV facility will have the same unit cost as a new state-of-the-art hospital. On the contrary, case studies of voluntary RC IV-like seismic design have found a **construction cost premium ranging typically from 0% to 2%** relative to normal RC II designs. (See proposal references by Almufti, Bade, Berkowitz, Mar, and SEFT.) This estimate stands to reason: Wind, snow, and earthquake loads can already vary significantly within a jurisdiction, but the building designs and unit costs don't change wildly from one side of the county to the other. For example, the seismic design force in Berkeley is about 1.5 times that in downtown San Francisco; so with respect to the structure, any nursing home or grocery store you can build as RC II in Berkeley you can also build as RC IV in San Francisco with no change to the design. The same is likely true for snow design, for example, in Vail v. Boulder and for wind design in Galveston v. the west side of Houston. On the nonstructural side, a facility's nonstructural systems might need more bracing or support when assigned to RC IV, but the number and size of the components themselves don't suddenly look like a hospital just because the risk category has changed.

S76-22

IBC: TABLE 1604.5

Proponents: David Bonowitz, representing FEMA-ATC Seismic Code Support Committee (dbonowitz@att.net); Kelly Cobeen, representing Federal Emergency Management Agency/Applied Technology Council - Seismic Code Support Committee (kcobeen@wje.com); Michael Mahoney, representing FEMA (mike.mahoney@fema.dhs.gov)

2021 International Building Code

Revise as follows:

TABLE 1604.5 RISK CATEGORY OF BUILDINGS AND OTHER STRUCTURES

RISK CATEGORY	NATURE OF OCCUPANCY
I	<p>Buildings and other structures that represent a low hazard to human life in the event of failure, including but not limited to: Agricultural facilities.</p> <p>Certain temporary facilities.</p> <p>Minor storage facilities.</p>
II	<p>Buildings and other structures except those listed in Risk Categories I, III and IV.</p>
III	<p>Buildings and other structures that represent a substantial hazard to human life in the event of failure, including but not limited to: Buildings and other structures whose primary occupancy is public assembly with an occupant load greater than 300.</p> <p>Buildings and other structures containing one or more public assembly spaces, each having an occupant load greater than 300 and a cumulative occupant load of these public assembly spaces of greater than 2,500.</p> <p>Buildings and other structures containing Group E or Group I-4 occupancies or combination thereof, with an occupant load greater than 250.</p> <p>Buildings and other structures containing educational occupancies for students above the 12th grade with an occupant load greater than 500.</p> <p>Group I-2, Condition 1 occupancies with 50 or more care recipients.</p> <p>Group I-2, Condition 2 occupancies not having emergency surgery or emergency treatment facilities.</p> <p>Group I-3 occupancies.</p> <p>Any other occupancy with an occupant load greater than 5,000.^a</p> <p>Power-generating stations, water treatment facilities for potable water, wastewater treatment facilities and other public <u>Public utility</u> facilities not included in Risk Category IV.</p> <p>Buildings and other structures not included in Risk Category IV containing quantities of toxic or explosive materials that:</p> <p>Exceed maximum allowable quantities per control area as given in Table 307.1(1) or 307.1(2) or per outdoor control area in accordance with the <i>International Fire Code</i> ; and</p> <p>Are sufficient to pose a threat to the public if released.^b</p>

RISK CATEGORY	NATURE OF OCCUPANCY
IV	<p>Buildings and other structures designated as essential facilities <u>and buildings where loss of function represents a substantial hazard to occupants or users</u>, including but not limited to:</p> <p>Group I-2, Condition 2 occupancies having emergency surgery or emergency treatment facilities.</p> <p>Ambulatory care facilities having emergency surgery or emergency treatment facilities.</p> <p>Fire, rescue, ambulance and police stations and emergency vehicle garages</p> <p>Designated earthquake, hurricane or other emergency shelters.</p> <p>Designated emergency preparedness, communications and operations centers and other facilities required for emergency response.</p> <p><u>Public utility facilities providing power generation, potable water treatment, or wastewater treatment.</u></p> <p>Power-generating stations and other public utility facilities required as emergency backup facilities for <i>Risk Category IV</i> structures.</p> <p>Buildings and other structures containing quantities of highly toxic materials that:</p> <p>Exceed maximum allowable quantities per control area as given in Table 307.1(2) or per outdoor control area in accordance with the <i>International Fire Code</i> ; and</p> <p>Are sufficient to pose a threat to the public if released.^b</p> <p>Aviation control towers, air traffic control centers and emergency aircraft hangars.</p> <p>Buildings and other structures having critical national defense functions.</p> <p>Water storage facilities and pump structures required to maintain water pressure for fire suppression.</p>

- a. For purposes of occupant load calculation, occupancies required by Table 1004.5 to use gross floor area calculations shall be permitted to use net floor areas to determine the total occupant load.
- b. Where approved by the building official, the classification of buildings and other structures as Risk Category III or IV based on their quantities of toxic, highly toxic or explosive materials is permitted to be reduced to Risk Category II, provided that it can be demonstrated by a hazard assessment in accordance with Section 1.5.3 of ASCE 7 that a release of the toxic, highly toxic or explosive materials is not sufficient to pose a threat to the public.

Reason Statement: This proposal improves consistency in the assignment of risk categories. It applies current thinking from IBC Chapters 3 and 4 to the risk category assignments in Table 1604.5. The logic of the proposal is as follows:

1. **Risk Category IV is the IBC's main tool to provide functional facilities** soon after a natural hazard event (earthquake, flood, snow, or wind). In terms of post-event functionality, there is a wide gap between RC II-III facilities (which have identical requirements for nonstructural systems) and RC IV facilities. The difference in expected recovery time can be on the order of weeks or months.
2. The performance gap between RC II-III and RC IV is most acute for occupancies that depend on functional nonstructural systems and special design provisions to serve vulnerable users.
3. Because these facilities are rare and specially designed, their services and occupants cannot be quickly relocated to other buildings.
4. Therefore, facilities with special design features and vulnerable users should be strong candidates for Risk Category IV.

Following this logic, this proposal expands the scope of RC IV from just “essential facilities” to include “buildings where loss of function represents a substantial hazard.” **This “substantial hazard” can even be life threatening** where, for example, a 24-hour medical facility, residential care facility, public water or power utility, detention center with impeded egress, or critical supply chain facility is out of service for weeks. The code defines *essential facilities* as those that need to “remain operational” through and after an “extreme” earthquake, flood, wind, or snow event. The additional facilities described by the logic above and considered in this proposal might not require continuous operation, but **prolonged downtime – which can be expected from RC II design criteria – can give rise to a similar risk for vulnerable users**, if not on Day 1 after the event, then possibly by Day 3, 10, or 30.

This proposal addresses buildings that support the operations of public utilities. Under the current code, utility buildings that support power generation and water treatment are mostly assigned to RC III even though their value and function is closely linked to the performance of specialized nonstructural components. Only those that provide “emergency backup facilities” for other RC IV facilities are themselves assigned to RC IV.

Instead of drawing a line between normal operations and “emergency backup,” this proposal makes the distinction between public utilities (typically designated not by the code but by a state or local commission) and other utilities. If housing, schools, offices, shops, and all the other normal buildings assigned to RC II are to be unusable for prolonged periods after a major storm or earthquake, it should not be because of a failure at a public water or power utility. On the contrary, a policy that expects people to “shelter in place” for weeks or longer in damaged but occupiable buildings should, at the very least, supply those buildings with water and power within at most a few days.

Further, those who would argue that RC IV design for more buildings should be voluntary must acknowledge that no developer would do that voluntary work until reliable utility services are in place. Otherwise, the voluntary work would be wasted as long as a utility outage continues.

Therefore, this proposal makes the key distinction between public water and power utilities and other utilities as follows:

- It maintains the “emergency backup” utilities in RC IV, with no change to the current code.
- It moves public utility facilities for power generation, potable water, and wastewater from RC III to RC IV.
- It maintains the broad assignment of the remaining public utilities to RC III, essentially as in the current code. In some jurisdictions, these “other public utilities” (in the current code’s phrasing) might include communications or public transit facilities, but it is the fact that they are designated as public utilities that qualifies them for design consideration beyond RC II.

Despite this reassignment, this proposal is measured in its scope. **It does NOT affect** any non-public utility or any utility supply chain facility not already included in the current RC III provision.

(The current wording of Table 1604.5 regarding utilities is unclear in several ways, but clarifying or correcting it is outside the scope of this proposal. Examples of unclear wording include: Is it assumed that all power generation and water treatment facilities *are* public utilities? Is a solar installation that returns power to the grid considered “power generation”? Are power distribution facilities included with “power generating stations”? What “other” utility functions does the code expect to be assigned to RC III? Why would public utilities be considered *backup* for private facilities, rather than the primary service? And if there is no backup, shouldn’t the primary service be assigned to RC IV as well? How many public utilities serve only RC IV facilities, but not the broader community? Etc.)

This proposal is consistent with current IBC principles. This proposal extends the current scope of Risk Category IV, but it does so consistent with the purpose, philosophy, and normative goals the IBC already represents.

Even if you think of the IBC as strictly a “life safety” code, safety is more than mere survival, and safety can be at risk even after the rain, snow, or ground shaking has stopped. If building damage affects the safety of vulnerable users in the following days or weeks, it is consistent with even a safety-based code to manage those risks through design.

But the IBC’s purpose is broader than just “life safety.” Section 101.3 states that the purpose of the IBC is to provide a “reasonable level of safety, **health and general welfare.**” So a focus on the health and welfare of vulnerable building users, even where their building provides immediate safety, is both “reasonable” and completely consistent with the purpose of the code.

With its definition of *essential facilities* and its use of Risk Category IV to ensure they “remain operational,” the IBC is already more than a safety code. It is, in fact, already a basic “functional recovery” code; the only question is which building uses, and users, we decide should qualify for a designed recovery. Where RC II or RC III is not reliable enough, it is consistent with the purpose and scope of the IBC to assign more building uses to RC IV.

Not all of the IBC’s tools are perfectly nuanced. Some involve bright lines and broad categories, and it is sometimes necessary to err on the conservative side. So even if a certain use is not quite as “essential” as a fire station, RC IV might still be a more appropriate choice than RC II or RC III, and in these cases, it is consistent with the code to assign buildings to the higher category. In time, design criteria should evolve to address more specific recovery objectives (FEMA, 2020; FEMA-NIST, 2021). But those nuanced provisions are *at least* a decade away. For now, however, RC IV is the most appropriate tool we have, and we ought to use it. Adapting existing practices to new objectives is entirely consistent with the history of code development.

IBC Chapters 3 and 4 define and provide special requirements to manage fire and egress risks for particular groups of users. Table 1604.5 is meant to do the same for rare natural hazard events. But while Chapters 3 and 4 consider dozens of specific building uses and conditions, Table 1604.5 has only four categories. Changing the scope of Risk Category IV to account for specific building uses that are not adequately served by RC II or RC III criteria is consistent with the detailed, use-specific approach of Chapters 3 and 4.

Table 1604.5 represents public policy about what we desire from our buildings. As such, it has changed over time, along with public expectations. As we consider new or increasing risks related to more frequent natural hazard events, urbanization, the pandemic, or aging populations, it is both appropriate and consistent with past practice for Table 1604.5 to evolve as well.

Bibliography: Almufti, I. et al. (2016). “The resilience-based design of 181 Fremont Tower,” *Structure*, June.

Bade, M. (2014). “Mission Bay Block 25 Building – An Exercise in Lean Target Value Design,” Presentation to the Lean Construction Institute, Finland, April 12.

Berkowitz, R. (2021). "UCSF Center for Vision Neuroscience," 2021 EERI Annual Meeting, Session 3B, March 24.

CISA, 2020. "Guidance on the Essential Critical Infrastructure Workforce: Ensuring Community and National Resilience in COVID-19 Response (Version 2.0)." U.S. Department of Homeland Security, Cybersecurity & Infrastructure Security Agency, March 28.

FEMA (2020b). *NEHRP Recommended Seismic Provisions for New Buildings and Other Structures, Volume II: Part 3 Resource Papers*, 2020 Edition, FEMA P-2082-2, prepared by the Building Seismic Safety Council of the National Institute of Buildings Sciences for Federal Emergency Management Agency, September.

FEMA-NIST (2021). *Recommended Options for Improving the Built Environment for Post-Earthquake Reoccupancy and Functional Recovery Time*, FEMA P-2090 / NIST SP-1254, Federal Emergency Management Agency and National Institute of Standards and Technology, January.

Mar, D. (2021). "Making Resilience Affordable," 2021 EERI Annual Meeting, Session 3B, March 24.

SEFT Consulting Group (2015). "Beaverton School District Resilience Planning for High School at South Cooper Mountain and Middle School at Timberland," SEFT Consulting Group, July 10.

SFDPH, 2020. "Order of the Health Officer No. C19-07b." City and County of San Francisco, Department of Public Health, March 31, et seq.

Cost Impact: The code change proposal will increase the cost of construction

This proposal will increase the cost of construction for the buildings newly assigned to RC IV. The largest increases will likely be in high seismic areas where assignment to RC IV makes the largest changes to structural and nonstructural design criteria. This does not mean, however, that every RC IV facility will have the same unit cost as a new state-of-the-art hospital. On the contrary, case studies of voluntary RC IV-like seismic design have found a **construction cost premium ranging typically from 0% to 2%** relative to normal RC II designs. (See proposal references by Almufti, Bade, Berkowitz, Mar, and SEFT.) This estimate stands to reason: Wind, snow, and earthquake loads can already vary significantly within a jurisdiction, but the building designs and unit costs don't change wildly from one side of the county to the other. For example, the seismic design force in Berkeley is about 1.5 times that in downtown San Francisco; so with respect to the structure, any nursing home or grocery store you can build as RC II in Berkeley you can also build as RC IV in San Francisco with no change to the design. The same is likely true for snow design, for example, in Vail v. Boulder and for wind design in Galveston v. the west side of Houston. On the nonstructural side, a facility's nonstructural systems might need more bracing or support when assigned to RC IV, but the number and size of the components themselves don't suddenly look like a hospital just because the risk category has changed.

S77-22

IBC: TABLE 1604.5

Proponents: David Bonowitz, representing Self (dbonowitz@att.net)

2021 International Building Code

Revise as follows:

TABLE 1604.5 RISK CATEGORY OF BUILDINGS AND OTHER STRUCTURES

RISK CATEGORY	NATURE OF OCCUPANCY
I	<p>Buildings and other structures that represent a low hazard to human life in the event of failure, including but not limited to: Agricultural facilities.</p> <p>Certain temporary facilities.</p> <p>Minor storage facilities.</p>
II	<p>Buildings and other structures except those listed in Risk Categories I, III and IV.</p>
III	<p>Buildings and other structures that represent a substantial hazard to human life in the event of failure, including but not limited to: Buildings and other structures whose primary occupancy is public assembly with an occupant load greater than 300.</p> <p>Buildings and other structures containing one or more public assembly spaces, each having an occupant load greater than 300 and a cumulative occupant load of these public assembly spaces of greater than 2,500.</p> <p>Buildings and other structures containing Group E or Group I-4 occupancies or combination thereof, with an occupant load greater than 250.</p> <p>Buildings and other structures containing educational occupancies for students above the 12th grade with an occupant load greater than 500.</p> <p>Group I-2, Condition 1 occupancies with 50 or more care recipients.</p> <p>Group I-2, Condition 2 occupancies not having emergency surgery or emergency treatment facilities.</p> <p>Group I-3 occupancies.</p> <p>Any other occupancy with an occupant load greater than 5,000.^a</p> <p>Power-generating stations, water treatment facilities for potable water, wastewater treatment facilities and other public utility facilities not included in Risk Category IV.</p> <p>Buildings and other structures not included in Risk Category IV containing quantities of toxic or explosive materials that:</p> <p>Exceed maximum allowable quantities per control area as given in Table 307.1(1) or 307.1(2) or per outdoor control area in accordance with the <i>International Fire Code</i> ; and</p> <p>Are sufficient to pose a threat to the public if released.^b</p>

RISK CATEGORY	NATURE OF OCCUPANCY
IV	<p>Buildings and other structures designated as essential facilities <u>and buildings where loss of function represents a substantial hazard to occupants</u>, including but not limited to:</p> <p><u>Group I-1 occupancies in which at least half of the Group I-1 care recipients qualify as Group I-1, Condition 2</u></p> <p>Group I-2, Condition 2 occupancies having emergency surgery or emergency treatment facilities.</p> <p>Ambulatory care facilities having emergency surgery or emergency treatment facilities.</p> <p>Fire, rescue, ambulance and police stations and emergency vehicle garages</p> <p>Designated earthquake, hurricane or other emergency shelters.</p> <p>Designated emergency preparedness, communications and operations centers and other facilities required for emergency response.</p> <p>Power-generating stations and other public utility facilities required as emergency backup facilities for <i>Risk Category IV</i> structures.</p> <p>Buildings and other structures containing quantities of highly toxic materials that:</p> <p>Exceed maximum allowable quantities per control area as given in Table 307.1(2) or per outdoor control area in accordance with the <i>International Fire Code</i> ; and</p> <p>Are sufficient to pose a threat to the public if released.^b</p> <p>Aviation control towers, air traffic control centers and emergency aircraft hangars.</p> <p>Buildings and other structures having critical national defense functions.</p> <p>Water storage facilities and pump structures required to maintain water pressure for fire suppression.</p>

- a. For purposes of occupant load calculation, occupancies required by Table 1004.5 to use gross floor area calculations shall be permitted to use net floor areas to determine the total occupant load.
- b. Where approved by the building official, the classification of buildings and other structures as Risk Category III or IV based on their quantities of toxic, highly toxic or explosive materials is permitted to be reduced to Risk Category II, provided that it can be demonstrated by a hazard assessment in accordance with Section 1.5.3 of ASCE 7 that a release of the toxic, highly toxic or explosive materials is not sufficient to pose a threat to the public.

Reason Statement: This proposal improves consistency in the assignment of risk categories. It applies current thinking from IBC Chapters 3 and 4 to the risk category assignments in Table 1604.5. The logic of the proposal is as follows:

1. **Risk Category IV is the IBC's main tool to provide functional facilities** soon after a natural hazard event (earthquake, flood, snow, or wind). In terms of post-event functionality, there is a wide gap between RC II-III facilities (which have identical requirements for nonstructural systems) and RC IV facilities. The difference in expected recovery time can be on the order of weeks or months.
2. The performance gap between RC II-III and RC IV is most acute for occupancies that depend on functional nonstructural systems and special design provisions to serve vulnerable users.
3. Because these facilities are rare and specially designed, their services and occupants cannot be quickly relocated to other buildings.
4. Therefore, facilities with special design features and vulnerable users should be strong candidates for Risk Category IV.

Following this logic, this proposal expands the scope of RC IV from just “essential facilities” to include “buildings where loss of function represents a substantial hazard.” **This “substantial hazard” can even be life threatening** where, for example, a 24-hour medical facility, residential care facility, public water or power utility, detention center with impeded egress, or critical supply chain facility is out of service for weeks. The code defines *essential facilities* as those that need to “remain operational” through and after an “extreme” earthquake, flood, wind, or snow event. The additional facilities described by the logic above and considered in this proposal might not require continuous operation, but **prolonged downtime – which can be expected from RC II design criteria – can give rise to a similar risk for vulnerable users**, if not on Day 1 after the event, then possibly by Day 3, 10, or 30.

This proposal addresses custodial care facilities that provide housing for vulnerable residents. Group I-1 buildings, currently assigned to RC II, provide **24-hour supervised housing** for residents receiving *custodial care*, a defined term meaning assistance with day-to-day tasks, including bathing, cooking, and taking medication. This proposal reassigns certain Group I-1, Condition 2 facilities to RC IV.

Condition 2 occupancies include assisted living facilities (this is the term used in Sections 308.2 and 420.7) and similar care facilities. Residents in these facilities require assistance with daily tasks as well as **assistance with emergency egress** in or after natural hazard events. These facilities are already required to meet special design requirements in IBC Section 420, and specifically Section 420.7, regarding sprinklers, alarms, refuge areas, and cooking facilities. These requirements are not met by normal market housing. Further, the staffs that provide supervision and assist residents with their daily tasks have facility-specific training and resources. Therefore, residents of these facilities cannot be simply relocated to market housing.

Because Group I-1 facilities can sometimes combine Condition 1 and Condition 2, the proposal assigns to RC IV only those that are majority Condition 2. Since Group I-1 includes only facilities with at least 17 residents, only facilities with at least 9 residents qualified as Condition 2 are covered by this proposal.

Despite this reassignment, this proposal is measured in its scope. **It does NOT affect:**

- Custodial care facilities for 16 or fewer residents. Per Section 308.2, Group I-1 applies only to larger facilities.
- Group I-1, Condition 1 facilities, whose residents are more capable of self-preservation than those in Condition 2. For example, alcohol and drug centers, halfway houses, and other care facilities are included in Group I-1 but are likely Condition 1.
- Group I-1 facilities that are majority Condition 1.
- Other small residential facilities assigned to Group R, even if subject to Section 420.
- Any residential or care facility eligible for design under the IRC.
- Daycare facilities (child or adult), typically in Group I-4.

This proposal is consistent with current IBC principles. This proposal extends the current scope of Risk Category IV, but it does so consistent with the purpose, philosophy, and normative goals the IBC already represents.

Even if you think of the IBC as strictly a “life safety” code, safety is more than mere survival, and safety can be at risk even after the rain, snow, or ground shaking has stopped. If building damage affects the safety of vulnerable users in the following days or weeks, it is consistent with even a safety-based code to manage those risks through design.

But the IBC’s purpose is broader than just “life safety.” Section 101.3 states that the purpose of the IBC is to provide a “reasonable level of safety, **health and general welfare.**” So a focus on the health and welfare of vulnerable building users, even where their building provides immediate safety, is both “reasonable” and completely consistent with the purpose of the code.

With its definition of *essential facilities* and its use of Risk Category IV to ensure they “remain operational,” the IBC is already more than a safety code. It is, in fact, already a basic “functional recovery” code; the only question is which building uses, and users, we decide should qualify for a designed recovery. Where RC II or RC III is not reliable enough, it is consistent with the purpose and scope of the IBC to assign more building uses to RC IV.

Not all of the IBC’s tools are perfectly nuanced. Some involve bright lines and broad categories, and it is sometimes necessary to err on the conservative side. So even if a certain use is not quite as “essential” as a fire station, RC IV might still be a more appropriate choice than RC II or RC III, and in these cases, it is consistent with the code to assign buildings to the higher category. In time, design criteria should evolve to address more specific recovery objectives (FEMA, 2020; FEMA-NIST, 2021). But those nuanced provisions are *at least* a decade away. For now, however, RC IV is the most appropriate tool we have, and we ought to use it. Adapting existing practices to new objectives is entirely consistent with the history of code development.

IBC Chapters 3 and 4 define and provide special requirements to manage fire and egress risks for particular groups of users. Table 1604.5 is meant to do the same for rare natural hazard events. But while Chapters 3 and 4 consider dozens of specific building uses and conditions, Table 1604.5 has only four categories. Changing the scope of Risk Category IV to account for specific building uses that are not adequately served by RC II or RC III criteria is consistent with the detailed, use-specific approach of Chapters 3 and 4.

Table 1604.5 represents public policy about what we desire from our buildings. As such, it has changed over time, along with public expectations. As we consider new or increasing risks related to more frequent natural hazard events, urbanization, the pandemic, or aging populations, it is both appropriate and consistent with past practice for Table 1604.5 to evolve as well.

Bibliography: Almufti, I. et al. (2016). “The resilience-based design of 181 Fremont Tower,” *Structure*, June.

Bade, M. (2014). “Mission Bay Block 25 Building – An Exercise in Lean Target Value Design,” Presentation to the Lean Construction Institute, Finland, April 12.

Berkowitz, R. (2021). “UCSF Center for Vision Neuroscience,” 2021 EERI Annual Meeting, Session 3B, March 24.

CISA, 2020. “Guidance on the Essential Critical Infrastructure Workforce: Ensuring Community and National Resilience in COVID-19 Response (Version 2.0).” U.S. Department of Homeland Security, Cybersecurity & Infrastructure Security Agency, March 28.

FEMA (2020b). *NEHRP Recommended Seismic Provisions for New Buildings and Other Structures, Volume II: Part 3 Resource Papers*, 2020

Edition, FEMA P-2082-2, prepared by the Building Seismic Safety Council of the National Institute of Buildings Sciences for Federal Emergency Management Agency, September.

FEMA-NIST (2021). *Recommended Options for Improving the Built Environment for Post-Earthquake Reoccupancy and Functional Recovery Time*, FEMA P-2090 / NIST SP-1254, Federal Emergency Management Agency and National Institute of Standards and Technology, January.

Mar, D. (2021). "Making Resilience Affordable," 2021 EERI Annual Meeting, Session 3B, March 24.

SEFT Consulting Group (2015). "Beaverton School District Resilience Planning for High School at South Cooper Mountain and Middle School at Timberland," SEFT Consulting Group, July 10.

SFDPH, 2020. "Order of the Health Officer No. C19-07b." City and County of San Francisco, Department of Public Health, March 31, et seq.

Cost Impact: The code change proposal will increase the cost of construction

This proposal will increase the cost of construction for the buildings newly assigned to RC IV. The largest increases will likely be in high seismic areas where assignment to RC IV makes the largest changes to structural and nonstructural design criteria. This does not mean, however, that every RC IV facility will have the same unit cost as a new state-of-the-art hospital. On the contrary, case studies of voluntary RC IV-like seismic design have found a **construction cost premium ranging typically from 0% to 2%** relative to normal RC II designs. (See proposal references by Almufti, Bade, Berkowitz, Mar, and SEFT.) This estimate stands to reason: Wind, snow, and earthquake loads can already vary significantly within a jurisdiction, but the building designs and unit costs don't change wildly from one side of the county to the other. For example, the seismic design force in Berkeley is about 1.5 times that in downtown San Francisco; so with respect to the structure, any nursing home or grocery store you can build as RC II in Berkeley you can also build as RC IV in San Francisco with no change to the design. The same is likely true for snow design, for example, in Vail v. Boulder and for wind design in Galveston v. the west side of Houston. On the nonstructural side, a facility's nonstructural systems might need more bracing or support when assigned to RC IV, but the number and size of the components themselves don't suddenly look like a hospital just because the risk category has changed.

S77-22

S78-22

IBC: TABLE 1604.5

Proponents: David Bonowitz, representing Self (dbonowitz@att.net)

2021 International Building Code

Revise as follows:

TABLE 1604.5 RISK CATEGORY OF BUILDINGS AND OTHER STRUCTURES

RISK CATEGORY	NATURE OF OCCUPANCY
I	<p>Buildings and other structures that represent a low hazard to human life in the event of failure, including but not limited to: Agricultural facilities.</p> <p>Certain temporary facilities.</p> <p>Minor storage facilities.</p>
II	<p>Buildings and other structures except those listed in Risk Categories I, III and IV.</p>
III	<p>Buildings and other structures that represent a substantial hazard to human life in the event of failure, including but not limited to: Buildings and other structures whose primary occupancy is public assembly with an occupant load greater than 300.</p> <p>Buildings and other structures containing one or more public assembly spaces, each having an occupant load greater than 300 and a cumulative occupant load of these public assembly spaces of greater than 2,500.</p> <p>Buildings and other structures containing Group E or Group I-4 occupancies or combination thereof, with an occupant load greater than 250.</p> <p>Buildings and other structures containing educational occupancies for students above the 12th grade with an occupant load greater than 500.</p> <p>Group I-2, Condition 1 occupancies with 50 or more care recipients.</p> <p>Group I-2, Condition 2 occupancies not having emergency surgery or emergency treatment facilities.</p> <p>Group I-3 occupancies.</p> <p>Any other occupancy with an occupant load greater than 5,000.^a</p> <p>Power-generating stations, water treatment facilities for potable water, wastewater treatment facilities and other public utility facilities not included in Risk Category IV.</p> <p>Buildings and other structures not included in Risk Category IV containing quantities of toxic or explosive materials that: Exceed maximum allowable quantities per control area as given in Table 307.1(1) or 307.1(2) or per outdoor control area in accordance with the <i>International Fire Code</i> ; and Are sufficient to pose a threat to the public if released.^b</p>

RISK CATEGORY	NATURE OF OCCUPANCY
IV	<p>Buildings and other structures designated as essential facilities <u>and buildings where loss of function represents a substantial hazard to occupants or users</u>, including but not limited to:</p> <p>Group I-2, Condition 2 occupancies having emergency surgery or emergency treatment facilities.</p> <p>Ambulatory care facilities having emergency surgery or emergency treatment facilities.</p> <p><u>Group F-1 food processing establishments or commercial kitchens, not primarily associated with dining facilities, with gross floor area exceeding 30,000 square feet.</u></p> <p><u>Group M retail or wholesale stores with gross floor area exceeding 30,000 square feet in which at least half of the usable floor area is used for the sale of food or beverages.</u></p> <p>Fire, rescue, ambulance and police stations and emergency vehicle garages</p> <p>Designated earthquake, hurricane or other emergency shelters.</p> <p>Designated emergency preparedness, communications and operations centers and other facilities required for emergency response.</p> <p>Power-generating stations and other public utility facilities required as emergency backup facilities for Risk Category IV structures.</p> <p>Buildings and other structures containing quantities of highly toxic materials that:</p> <p>Exceed maximum allowable quantities per control area as given in Table 307.1(2) or per outdoor control area in accordance with the <i>International Fire Code</i> ; and</p> <p>Are sufficient to pose a threat to the public if released.^b</p> <p>Aviation control towers, air traffic control centers and emergency aircraft hangars.</p> <p>Buildings and other structures having critical national defense functions.</p> <p>Water storage facilities and pump structures required to maintain water pressure for fire suppression.</p>

- a. For purposes of occupant load calculation, occupancies required by Table 1004.5 to use gross floor area calculations shall be permitted to use net floor areas to determine the total occupant load.
- b. Where approved by the building official, the classification of buildings and other structures as Risk Category III or IV based on their quantities of toxic, highly toxic or explosive materials is permitted to be reduced to Risk Category II, provided that it can be demonstrated by a hazard assessment in accordance with Section 1.5.3 of ASCE 7 that a release of the toxic, highly toxic or explosive materials is not sufficient to pose a threat to the public.

Reason Statement: This proposal improves consistency in the assignment of risk categories. It applies current thinking from IBC Chapters 3 and 4 to the risk category assignments in Table 1604.5. The logic of the proposal is as follows:

1. **Risk Category IV is the IBC's main tool to provide functional facilities** soon after a natural hazard event (earthquake, flood, snow, or wind). In terms of post-event functionality, there is a wide gap between RC II-III facilities (which have identical requirements for nonstructural systems) and RC IV facilities. The difference in expected recovery time can be on the order of weeks or months.
2. The performance gap between RC II-III and RC IV is most acute for occupancies that depend on functional nonstructural systems and special design provisions to serve vulnerable users.
3. Because these facilities are rare and specially designed, their services and occupants cannot be quickly relocated to other buildings.
4. Therefore, facilities with special design features and vulnerable users should be strong candidates for Risk Category IV.

Following this logic, this proposal expands the scope of RC IV from just "essential facilities" to include "buildings where loss of function represents a substantial hazard." **This "substantial hazard" can even be life threatening** where, for example, a 24-hour medical facility, residential care facility, public water or power utility, detention center with impeded egress, or critical supply chain facility is out of service for weeks. The code defines *essential facilities* as those that need to "remain operational" through and after an "extreme" earthquake, flood, wind, or snow event. The additional facilities described by the logic above and considered in this proposal might not require continuous operation, but **prolonged downtime – which can be expected from RC II design criteria – can give rise to a similar risk for vulnerable users**, if not on Day 1 after the event, then possibly by Day 3, 10, or 30.

This proposal addresses large facilities that are essential to a stable food supply chain. “Food and Agriculture” has been designated a “critical infrastructure sector” by the federal government since 2003 and as such, is addressed in the National Infrastructure Protection Plan (NIPP). The mission of the sector is “to protect against a disruption anywhere in the food system that would pose a serious threat to public health, safety, welfare, or to the national economy,” and to achieve that mission, the NIPP relies explicitly on “the support and action of the private sector.” (FDA et al., 2015)

No doubt that reliance includes the government’s general adoption of ICC’s model codes. Indeed, while the NIPP lays out an extensive sector taxonomy including categories for “Processing, Packaging, and Production” and “Agricultural and Food Product Distribution,” it says almost nothing about the design of these critical facilities as buildings. For that, **the NIPP is relying on the IBC**, which labels these facilities as “food processing establishments,” “commercial kitchens,” and “retail or wholesale stores” – and currently assigns them all to Risk Category II, just like any other factory or shop.

More recently, as cities and states took actions against the COVID pandemic, nearly all immediately recognized grocery stores, food banks, and other establishments on the food supply chain as “**essential businesses**” (For example, SFDPH, 2020), and the federal government issued an advisory identifying grocery and food manufacturing employees as “**essential critical infrastructure workers**” (CISA, 2020). This recognition not only reflected an obvious need – one that arises after every natural hazard event as well – but was also consistent with the NIPP’s emphasis on public health and the economy, not just building-specific safety.

Food processing facilities, commercial kitchens, and large grocery stores have mechanical, electrical, and plumbing systems unlike those in other RC II commercial buildings. Only Risk Category IV design provisions address the post-event functionality of these nonstructural systems.

For these reasons, this proposal considers certain Group F-1 and Group M uses currently assigned to RC II. The proposal reassigns the largest of these, with gross floor areas exceeding 30,000 square feet, to RC IV. The 30,000 square foot criterion is meant to **exempt minor processing facilities and small stores that are less likely to disrupt the local food supply chain if damaged**. In the larger facilities, the per-building costs of a Risk Category IV design (such as the seismic certification of designated equipment, discussed below) are also less significant. The 30,000 square foot criterion is based on an in-progress inventory of existing grocery stores in San Francisco, where buildings of this size are all standalone supermarkets serving large customer bases, as opposed to specialty stores within larger buildings. The proposed cutoff size is somewhat arbitrary, but no more so than that other arbitrary measures of size or occupant load used by the current code to assign occupancy or risk category. The exercise of assigning occupancies and risk categories has always involved drawing lines based on judgment, so this is no departure from past code development practices.

The two uses proposed for RC IV are:

- Large Group F-1 food processing establishments or commercial kitchens. Consistent with Section 306.2, this proposal includes only those facilities not associated with specific dining facilities. Also, Section 306.2 applies to these uses in buildings larger than just 2500 square feet, so the proposed 30,000 square foot criterion is far more selective.
- Large Group M supermarkets. As described above, the 30,000 square foot criterion is meant to capture only the type of store that serves a large area and could represent a large portion of the local food distribution system. Because many of these larger facilities sell a variety of items, the proposal includes only those where at least half the floor space is dedicated to food supply.

Despite this reassignment, this proposal is measured in its scope. **It does NOT affect:**

- Processing facilities or markets smaller than 30,000 square feet.
- Multi-purpose stores selling non-food items where less than half the area is for food.
- Facilities primarily associated with specific restaurants or dining establishments.
- Food warehouses, trucking facilities, or other distribution facilities along the food supply chain, even if associated with the RC IV processing facility or supermarket.

This proposal is consistent with current IBC principles. This proposal extends the current scope of Risk Category IV, but it does so consistent with the purpose, philosophy, and normative goals the IBC already represents.

Even if you think of the IBC as strictly a “life safety” code, safety is more than mere survival, and safety can be at risk even after the rain, snow, or ground shaking has stopped. If building damage affects the safety of vulnerable users in the following days or weeks, it is consistent with even a safety-based code to manage those risks through design.

But the IBC’s purpose is broader than just “life safety.” Section 101.3 states that the purpose of the IBC is to provide a “reasonable level of safety, **health and general welfare**.” So a focus on the health and welfare of vulnerable building users, even where their building provides immediate safety, is both “reasonable” and completely consistent with the purpose of the code.

With its definition of *essential facilities* and its use of Risk Category IV to ensure they “remain operational,” the IBC is already more than a safety code. It is, in fact, already a basic “functional recovery” code; the only question is which building uses, and users, we decide should qualify for a designed recovery. Where RC II or RC III is not reliable enough, it is consistent with the purpose and scope of the IBC to assign more building uses

to RC IV.

Not all of the IBC's tools are perfectly nuanced. Some involve bright lines and broad categories, and it is sometimes necessary to err on the conservative side. So even if a certain use is not quite as "essential" as a fire station, RC IV might still be a more appropriate choice than RC II or RC III, and in these cases, it is consistent with the code to assign buildings to the higher category. In time, design criteria should evolve to address more specific recovery objectives (FEMA, 2020; FEMA-NIST, 2021). But those nuanced provisions are *at least* a decade away. For now, however, RC IV is the most appropriate tool we have, and we ought to use it. Adapting existing practices to new objectives is entirely consistent with the history of code development.

IBC Chapters 3 and 4 define and provide special requirements to manage fire and egress risks for particular groups of users. Table 1604.5 is meant to do the same for rare natural hazard events. But while Chapters 3 and 4 consider dozens of specific building uses and conditions, Table 1604.5 has only four categories. Changing the scope of Risk Category IV to account for specific building uses that are not adequately served by RC II or RC III criteria is consistent with the detailed, use-specific approach of Chapters 3 and 4.

Table 1604.5 represents public policy about what we desire from our buildings. As such, it has changed over time, along with public expectations. As we consider new or increasing risks related to more frequent natural hazard events, urbanization, the pandemic, or aging populations, it is both appropriate and consistent with past practice for Table 1604.5 to evolve as well.

Bibliography: Almufti, I. et al. (2016). "The resilience-based design of 181 Fremont Tower," *Structure*, June.

Bade, M. (2014). "Mission Bay Block 25 Building – An Exercise in Lean Target Value Design," Presentation to the Lean Construction Institute, Finland, April 12.

Berkowitz, R. (2021). "UCSF Center for Vision Neuroscience," 2021 EERI Annual Meeting, Session 3B, March 24.

CISA, 2020. "Guidance on the Essential Critical Infrastructure Workforce: Ensuring Community and National Resilience in COVID-19 Response (Version 2.0)." U.S. Department of Homeland Security, Cybersecurity & Infrastructure Security Agency, March 28.

FDA et al., 2015. *Food and Agriculture Sector-Specific Plan*. Jointly authored and published by the Food and Drug Administration, the U.S. Department of Agriculture, and the U.S. Department of Homeland Security. Available at <https://www.cisa.gov/sites/default/files/publications/nipp-ssp-food-ag-2015-508.pdf>

FEMA (2020b). *NEHRP Recommended Seismic Provisions for New Buildings and Other Structures, Volume II: Part 3 Resource Papers*, 2020 Edition, FEMA P-2082-2, prepared by the Building Seismic Safety Council of the National Institute of Buildings Sciences for Federal Emergency Management Agency, September.

FEMA-NIST (2021). *Recommended Options for Improving the Built Environment for Post-Earthquake Reoccupancy and Functional Recovery Time*, FEMA P-2090 / NIST SP-1254, Federal Emergency Management Agency and National Institute of Standards and Technology, January.

Mar, D. (2021). "Making Resilience Affordable," 2021 EERI Annual Meeting, Session 3B, March 24.

SEFT Consulting Group (2015). "Beaverton School District Resilience Planning for High School at South Cooper Mountain and Middle School at Timberland," SEFT Consulting Group, July 10.

SFDPH, 2020. "Order of the Health Officer No. C19-07b." City and County of San Francisco, Department of Public Health, March 31, et seq.

Cost Impact: The code change proposal will increase the cost of construction

This proposal will increase the cost of construction for the buildings newly assigned to RC IV. The largest increases will likely be in high seismic areas where assignment to RC IV makes the largest changes to structural and nonstructural design criteria. This does not mean, however, that every RC IV facility will have the same unit cost as a new state-of-the-art hospital. On the contrary, case studies of voluntary RC IV-like seismic design have found a **construction cost premium ranging typically from 0% to 2%** relative to normal RC II designs. (See proposal references by Almufti, Bade, Berkowitz, Mar, and SEFT.) This estimate stands to reason: Wind, snow, and earthquake loads can already vary significantly within a jurisdiction, but the building designs and unit costs don't change wildly from one side of the county to the other. For example, the seismic design force in Berkeley is about 1.5 times that in downtown San Francisco; so with respect to the structure, any nursing home or grocery store you can build as RC II in Berkeley you can also build as RC IV in San Francisco with no change to the design. The same is likely true for snow design, for example, in Vail v. Boulder and for wind design in Galveston v. the west side of Houston. On the nonstructural side, a facility's nonstructural systems might need more bracing or support when assigned to RC IV, but the number and size of the components themselves don't suddenly look like a hospital just because the risk category has changed.

S79-22

IBC: 1604.5, TABLE 1604.5

Proponents: Joseph Cain, representing Solar Energy Industries Association (SEIA) (JoeCainPE@gmail.com)

2021 International Building Code

1604.5 Risk category. Each building and structure shall be assigned a *risk category* in accordance with Table 1604.5. Where a referenced standard specifies an occupancy category, the *risk category* shall not be taken as lower than the occupancy category specified therein. Where a referenced standard specifies that the assignment of a *risk category* be in accordance with ASCE 7, Table 1.5-1, Table 1604.5 shall be used in lieu of ASCE 7, Table 1.5-1.

Exception: The assignment of buildings and structures to Tsunami *Risk Categories* III and IV is permitted to be in accordance with Section 6.4 of ASCE 7.

Revise as follows:

TABLE 1604.5 RISK CATEGORY OF BUILDINGS AND OTHER STRUCTURES

RISK CATEGORY	NATURE OF OCCUPANCY
I	<p>Buildings and other structures that represent a low hazard to human life in the event of failure, including but not limited to: Agricultural facilities.</p> <p>Certain temporary facilities.</p> <p>Minor storage facilities.</p> <p><u>Ground-mounted photovoltaic (PV) panel systems.</u></p>
II	<p>Buildings and other structures except those listed in Risk Categories I, III and IV.</p>
III	<p>Buildings and other structures that represent a substantial hazard to human life in the event of failure, including but not limited to: Buildings and other structures whose primary occupancy is public assembly with an occupant load greater than 300.</p> <p>Buildings and other structures containing one or more public assembly spaces, each having an occupant load greater than 300 and a cumulative occupant load of these public assembly spaces of greater than 2,500.</p> <p>Buildings and other structures containing Group E or Group I-4 occupancies or combination thereof, with an occupant load greater than 250.</p> <p>Buildings and other structures containing educational occupancies for students above the 12th grade with an occupant load greater than 500.</p> <p>Group I-2, Condition 1 occupancies with 50 or more care recipients.</p> <p>Group I-2, Condition 2 occupancies not having emergency surgery or emergency treatment facilities.</p> <p>Group I-3 occupancies.</p> <p>Any other occupancy with an occupant load greater than 5,000.^a</p> <p>Power-generating stations <u>with individual power units not smaller than 100 MW</u>, water treatment facilities for potable water, wastewater treatment facilities and other public utility facilities not included in Risk Category IV.</p> <p>Buildings and other structures not included in Risk Category IV containing quantities of toxic or explosive materials that:</p> <p>Exceed maximum allowable quantities per control area as given in Table 307.1(1) or 307.1(2) or per outdoor control area in accordance with the <i>International Fire Code</i> ; and</p> <p>Are sufficient to pose a threat to the public if released.^b</p>

RISK CATEGORY	NATURE OF OCCUPANCY
IV	<p>Buildings and other structures designated as essential facilities, including but not limited to: Group I-2, Condition 2 occupancies having emergency surgery or emergency treatment facilities.</p> <p>Ambulatory care facilities having emergency surgery or emergency treatment facilities.</p> <p>Fire, rescue, ambulance and police stations and emergency vehicle garages</p> <p>Designated earthquake, hurricane or other emergency shelters.</p> <p>Designated emergency preparedness, communications and operations centers and other facilities required for emergency response.</p> <p>Power-generating stations and other public utility facilities <u>required for compliance</u> as emergency backup facilities for <i>Risk Category IV</i> structures.</p> <p>Buildings and other structures containing quantities of highly toxic materials that:</p> <p>Exceed maximum allowable quantities per control area as given in Table 307.1(2) or per outdoor control area in accordance with the <i>International Fire Code</i> ; and</p> <p>Are sufficient to pose a threat to the public if released.^b</p> <p>Aviation control towers, air traffic control centers and emergency aircraft hangars.</p> <p>Buildings and other structures having critical national defense functions.</p>

Water storage facilities and pump structures required to maintain water pressure for fire suppression.

- a. For purposes of occupant load calculation, occupancies required by Table 1004.5 to use gross floor area calculations shall be permitted to use net floor areas to determine the total occupant load.
- b. Where approved by the building official, the classification of buildings and other structures as Risk Category III or IV based on their quantities of toxic, highly toxic or explosive materials is permitted to be reduced to Risk Category II, provided that it can be demonstrated by a hazard assessment in accordance with Section 1.5.3 of ASCE 7 that a release of the toxic, highly toxic or explosive materials is not sufficient to pose a threat to the public.

Reason Statement: IBC Section 1604.5 and IBC Table 1604.5 are presently silent for assignment of risk category for all types of photovoltaic (PV) installations. This is a serious gap that still exists in the IBC, even as many other PV provisions in the I-codes have matured over several cycles. The problem this proposal seeks to resolve is confusion and gross inconsistencies regarding the assignment of risk categories for PV projects. With zero guidance in the IBC, AHJs and other code-enforcing authorities are left to make up their own rules and their own policies, based on their own personal opinions and interpretations. While there is broad agreement on several of these topics, there are outlier cases where the most stringent AHJs create interpretations that increase the cost of construction arbitrarily. With a code that is silent, industry stakeholders and permit applicants have no recourse other than to attempt a negotiation at the building department counter with each AHJ or sometimes with each project.

As there are several primary types of structures used to support PV panels, it is a serious gap in the IBC to be entirely silent on assignment of risk category for these primary applications. Justification is provided here for each of the six categories in this proposal. Note these line items are based on the following definitions. The first definition has appeared in several cycles of the IBC.

PHOTOVOLTAIC (PV) PANEL SYSTEM. A system that incorporates discrete photovoltaic panels, that converts solar radiation into electricity, including rack support systems.

During Group A proceedings in 2021, Proposal G193-21 was approved As Submitted, creating two new definitions that are foundational to the assignment of risk category.

PHOTOVOLTAIC (PV) PANEL SYSTEM, GROUND-MOUNTED. An independent photovoltaic (PV) panel system without useable space underneath, installed directly on the ground.

PHOTOVOLTAIC (PV) SUPPORT STRUCTURE, ELEVATED. An independent photovoltaic (PV) panel support structure designed with useable space underneath with minimum clear height of 7 feet 6 inches (2286 mm), intended for secondary use such as providing shade or parking of motor vehicles.

Justification by proposal line item is provided as follows:

1. Ground-mounted PV panel systems serving Group R-3 buildings shall be assigned as Risk Category I (one).

We hope all stakeholders can agree that a ground-mounted PV panel system installed in the back yard behind someone's home does not need to be anything other than Risk Category I (one), as it represents "a low hazard to human life in the event of failure."

2. Ground-mounted PV panel systems shall be assigned as Risk Category I (one).

Fundamentally, ground-mounted PV panel systems meet the description of Risk Category I, as they "represent a low hazard to human life in the event of failure."

Unfortunately, the Solar Energy Industries Association (SEIA) is aware of a broad range of interpretation by local authorities regarding proper assignment of Risk Category for ground-mounted PV panel systems. This is especially true -- and especially impactful -- for large-scale (often referred to as "utility scale") ground-mounted PV facilities. Given the same set of construction drawings, different building department staff can reach different conclusions, based on different rationale. Different building departments have reviewed projects that are fundamentally the same design, and determined it was Risk Category I, or Risk Category II, or Risk Category III. A few reviewers have even claimed the same design should be assigned as Risk Category IV. Owing to this broad range of opinions and beliefs, the solar industry cannot design a large-scale solar facility without first asking the building code official to make this determination, and the design features and associated cost of construction of a solar facility are therefore dependent on individual opinions and beliefs of reviewers. This is far too subjective.

This inconsistency in the assignment of risk category for ground-mounted PV systems is sometimes based on the Risk Category III description that reads: "Power-generating stations, water treatment facilities for potable water, wastewater treatment facilities and other public utility facilities not included in Risk Category IV." Unfortunately, there is no definition in the IBC for "power generating stations," so it has no distinct meaning and no consistent interpretation. Is a ground-mounted PV system in the back yard of a residential property a "power generating station"?

With no definition found in the IBC, we can search ASCE 7-16 and find Section 15.5.4.1, which states: "Electrical power-generating facilities are power plants that generate electricity by steam turbines, combustion turbines, diesel generators, or similar turbo machinery." While ASCE 7-16 Table 1.5-1 does not use the term "power generating station" or "electrical power generating station," the description of Risk Category III includes "Buildings and other structures ... with potential to cause a substantial economic impact and/or mass disruption of day-to-day civilian life in the event of failure." It is clear that the original intent of "power-generating stations" as Risk Category III structures was based on large power-generating units such as turbines and was never intended to apply to individual PV panel systems that had not yet scaled at the time this language was created.

ASCE 7-16 Commentary C1.5 states in part: "Risk Category III ... has also included structures associated with utilities required to protect the health and safety of a community, including power generating stations and water treatment and sewage treatment plants. ... Failures of power plants that supply electricity on the national grid can cause substantial economic losses and disruption to civilian life when their failures can trigger other plants to go offline in succession. The result can be massive and potentially extended power outage, shortage, or both that lead to huge economic losses because of idled industries and a serious disruption of civilian life because of inoperable subways, road traffic signals, and so forth."

IMPORTANT: It is extremely important to note there is a fundamental difference between the physical behavior of conventional turbine power plants and PV facilities. For example, if one reactor shuts down at a nuclear power plant, over 1 gigaWatt of power production can be lost at once. The physical behavior of ground-mounted PV facilities is not the same as turbine-based power generating stations. Where failures in PV facilities have been observed -- except in the most extreme cases during hurricanes Irma and Maria -- they are typically localized failures that do not shut down the entire plant.

This behavior is described in future ASCE 7-22 Commentary Section C32.5.2.1, which states in part: "Large-scale photovoltaic facilities can cover hundreds of acres of land, yet they are composed of hundreds or thousands of small, structurally independent 'tables' of PV panels, each with their own independent foundation system. The PV panels on these independent nonbuilding structures are linked with electrical conductors to central inverters that convert DC power to AC power. Large-scale PV facilities can have dozens to hundreds of independent central inverters. If an electrical fault is detected, only the inverter associated with that fault is shut down, and the remainder of the facility remains operational. The entire PV facility will shut down only if the electrical substation is shut down, or if the system otherwise detects a loss of the AC signal from the grid. Substations and grids are outside the scope of ASCE 7.

While there is little data of tornado strikes on large-scale PV facilities, in two known cases the damage from a tornado strike was isolated to localized damage. These facilities typically remain operational with localized damage. For ground-mounted photovoltaic installations, the effective plan area A_e should be the size of the largest structurally independent nonbuilding structure supporting PV panels."

Further, PV panel systems are by their nature an intermittent power source. They convert sunlight to electricity, producing power during daylight hours only. Photovoltaic power systems do not cause substantial economic losses and disruption to civilian life when they stop producing power during night-time hours. We acknowledge that the addition of Energy Storage Systems (ESS) is changing this part of the conversation. However, the addition of ESS does not change the fact that where structural failures have occurred in ground-mounted PV panel systems (except as noted), those failures have been localized and did not trigger a complete shut-down of a power plant. Where electrical faults are detected, individual inverters can shut down portions of a power plant, without any disruption to civilian life. Therefore, they do not meet the IBC or ASCE 7 criteria for Risk Category III.

There are other considerations that have been brought up for discussion.

Some AHJs have expressed an opinion that ground-mounted PV systems can be assigned as Risk Category I only if they are enclosed by a fence. While most large-scale PV facilities are in fact enclosed within a fence, they are simply not facilities open to the public. They can be accessed only by authorized personnel, who are keenly aware of behavioral conditions during weather events. It is not rational to assign an increased risk category and associated increase in cost of construction to protect possible trespassers. In a different case, with small projects located at school sites, there could be provisions for keeping students and other unauthorized people away from PV systems, but this is independent of the assignment of risk category.

In another deviation from the norm, at least one AHJ requires an increase of risk category based on proximity to highways, schools, or residential developments, with an apparent rationale that a dislodged PV panel could become airborne and cause injury at some distance away from the PV facility after being carried by high winds. In this case, the concern of the AHJ is one failure mode only – panel dislodgement. It would be far more rational to refer to Failure Modes and Effects (FMEA) analysis to focus on the root cause of that one failure mode, and to then solve the problem directly. It is not rational to use a very indirect approach of arbitrarily increasing the risk category of the entire facility because of concern about one failure mode, thereby increasing the structural loads and increasing the cost of the PV facility – perhaps without even solving the problem.

It is true that dislodgement of PV panels has been observed in some cases. It is also true that dislodgement of PV panels has led to progressive failure, as observed in at least one catastrophic failure during a hurricane event. Focused work is underway today to address that identified risk. Attachment of PV panels to the superstructure is being considered by the recently formed ASCE Solar PV Structures Committee. Recommendations are expected to be published in the future Manual of Practice. This is a problem to be solved that is independent of assignment of risk category.

There are other factors that have been identified in forensic studies, which are usually conducted under Non-Disclosure Agreements (NDAs). Work is underway to gather data that can be anonymized and aggregated, in an effort of continual improvement. Some of this work is being funded under a grant by the U.S. Department of Energy. Members of the structural engineering community who are deeply involved in solar projects are engaged in these efforts.

There are other factors that can contribute to increased reliability and resilience of PV facilities. For example, better consideration of gust effect factor and topographic factors; and a growing knowledge base from boundary layer wind tunnel studies; as well as design, specification, installation, and maintenance of components. It is both more rational and more economical to focus directly on resolving specific issues. It is not rational to believe we can increase risk category and wind loads until problems are nonexistent.

For any situation where project owners or financiers desire enhanced performance beyond code-minimum provisions for safety, a performance factor could be developed to voluntarily increase structural loads, but this should be independent of code-prescribed assignment of risk categories or methods for determining minimum structural loads.

3. *Elevated PV support structures other than those described in Items 4 and 6 shall be assigned as Risk Category II (two).*

The newly defined term for elevated PV support structures will make it easier to clarify the assignment of risk category. Elevated PV support structures are often constructed on the ground surface over parking spaces. In this application, the elevated PV support structures are not using any space that is not already used as a parking lot, and they provide the added benefit of providing shade for vehicles. Elevated PV support structures can also be constructed on the ground surface to provide shade for other uses, such as picnic areas. In all of these cases other than described in Items 4 and 6, elevated PV support structures meet the criteria and intent for Risk Category II.

There are also some emerging agricultural uses, sometimes referred to as “agri-voltaics.” As one example, elevated PV support structures have been built over cranberry bogs. Although there could be an exception for agricultural use, for simplicity this proposal is not seeking to treat agricultural uses differently than the more-common installations assigned as Risk Category II.

4. *Roof-top-mounted PV panel systems and elevated PV support structures installed on top of buildings shall be assigned a risk category that is the same as the risk category of the building on which they are mounted.*

This concept is widely accepted by industry and AHJs and should not be controversial. Where PV panel systems are mounted on building roofs, whether attached or unattached, they shall be assigned as the same risk category as the building on which they are mounted. Elevated PV support structures have been installed on top of buildings along with vegetative roof features, and on top of parking garages over parking spaces. In any of these cases, PV structures must be designed to at least the same risk category as the building on which they are installed.

5. *PV panel systems and elevated PV support structures paired with energy storage systems (ESS) and serving as a dedicated, stand-alone source of backup power for Risk Category IV (four) buildings shall be assigned as Risk Category IV (four).*

The intermittent nature of power generation makes PV panel systems and elevated PV support structures an extremely unlikely choice as an on-site, sole source of required emergency backup power for a Risk Category IV structure. We believe most essential services facilities are still using fuel-powered (usually diesel) generators and a stock of fuel for backup power. However, with increasing adoption of Energy Storage Systems (ESS), it is conceivable that PV paired with ESS could be a sole source of required backup power.

Where PV plus ESS is the only direct source of backup power for an essential services facility – with a transfer switch or other equipment enabling it to operate independently from the grid during a time of grid power outage – it shall be assigned as Risk Category IV. If PV plus ESS is not designed to operate in the event of grid power outage, then it need not be Risk Category IV. This assignment of risk category can also apply when power switching enables the use of either the PV + ESS or a generator interchangeably.

6. *Elevated PV support structures dedicated to parking of emergency vehicles shall be assigned as Risk Category IV (four).*

There could be cases where elevated PV support structures are installed on the same site as a Risk Category IV building, over surface parking spaces that are designated for emergency services vehicles. Whether or not those elevated PV support structures are serving as part of a backup power source (as in Item 5), the elevated PV support structures must be assigned as Risk Category IV.

Cost Impact: The code change proposal will not increase or decrease the cost of construction

Where ground-mounted PV panel systems are already designed and constructed as Risk Category I (one), this proposal will neither increase nor decrease the cost of construction. Where additional clarity is provided by this proposal, there could be projects where the cost of construction is decreased.

S79-22

S80-22

IBC: 1604.5.1

Proponents: David Bonowitz, representing FEMA-ATC Seismic Code Support Committee (dbonowitz@att.net); Kelly Cobeen, representing Federal Emergency Management Agency/Applied Technology Council - Seismic Code Support Committee (kcobeen@wje.com)

2021 International Building Code

Revise as follows:

1604.5.1 Multiple occupancies. Where a building or structure is occupied by two or more occupancies not included in the same *risk category*, it shall be assigned the classification of the highest *risk category* corresponding to the various occupancies. Where buildings or structures have two or more portions that are structurally separated, each portion shall be separately classified. Where a separated portion of a building or structure provides required access to, required egress from or shares life safety components with another portion having a higher *risk category*, or provides required electrical, communications, mechanical, plumbing, or conveying support to another portion assigned to Risk Category IV, both portions shall be assigned to the higher *risk category*.

Exception: Where a *storm shelter* designed and constructed in accordance with ICC 500 is provided in a building, structure or portion thereof normally occupied for other purposes, the *risk category* for the normal occupancy of the building shall apply unless the *storm shelter* is a designated emergency shelter in accordance with Table 1604.5.

Reason Statement: This proposal ensures that a building assigned to Risk Category IV will have all the building systems and services it needs to actually perform like a RC IV building, without relying on another portion of the building designed only as RC II. It extends the application of a current provision (Section 1604.5.1) to buildings with RC IV uses.

Current IBC Section 1604.5.1 already says that a building with multiple uses can have multiple risk categories under certain conditions. The question is: If Portion A of a new building would be assigned to RC IV, when can Portion B be assigned to only RC II or III? The current provision says that can happen when all four of the following are true:

- Portion B is “structurally separated” from Portion A.
- Portion B does *not* provide required access to Portion A.
- Portion B does *not* provide required egress for Portion A.
- Portion B does not “share” any “life safety components” with Portion A. (“Share” is not defined. “Life safety components” is also not defined. It is probably broader than Life Safety Systems, a definition just added to the 2021 IBC.)

Those four conditions are meant to ensure that Portion A can perform adequately, independent of Portion B. But are they enough if Portion A is assigned to Risk Category IV? RC IV facilities need reliable power, HVAC, and functional recovery capacity that is not covered by the four conditions. Therefore, this proposal adds a fifth condition where Portion A is assigned to RC IV.

The phrase “electrical, communications, mechanical, plumbing, or conveying” refers to the requirements of IBC Chapters 27, 28, 29, and 30, respectively. The references are intended be generic, just like the current provision’s references to undefined “life safety components” and to egress, access, and structural separation. As with many IBC provisions, it’s appropriate to leave project specific details to the project team and the code official, in this case to determine which aspects of any of those systems is necessary for the RC IV function in question.

Cost Impact: The code change proposal will increase the cost of construction

The proposal could increase the cost of construction for mixed-use buildings that include RC IV uses, but only in cases that where interpretation of the current code would fail to give proper attention to RC IV performance.

S80-22

S81-22

IBC: 1604.5, 1604.5.1, 1604.5.2 (New)

Proponents: Joseph Cain, representing Solar Energy Industries Association (SEIA) (JoeCainPE@gmail.com)

2021 International Building Code

1604.5 Risk category. Each building and structure shall be assigned a *risk category* in accordance with Table 1604.5. Where a referenced standard specifies an occupancy category, the *risk category* shall not be taken as lower than the occupancy category specified therein. Where a referenced standard specifies that the assignment of a *risk category* be in accordance with ASCE 7, Table 1.5-1, Table 1604.5 shall be used in lieu of ASCE 7, Table 1.5-1.

Exception: The assignment of buildings and structures to Tsunami *Risk Categories* III and IV is permitted to be in accordance with Section 6.4 of ASCE 7.

1604.5.1 Multiple occupancies. Where a building or structure is occupied by two or more occupancies not included in the same *risk category*, it shall be assigned the classification of the highest *risk category* corresponding to the various occupancies. Where buildings or structures have two or more portions that are structurally separated, each portion shall be separately classified. Where a separated portion of a building or structure provides required access to, required egress from or shares life safety components with another portion having a higher *risk category*, both portions shall be assigned to the higher *risk category*.

Exception: Where a *storm shelter* designed and constructed in accordance with ICC 500 is provided in a building, structure or portion thereof normally occupied for other purposes, the *risk category* for the normal occupancy of the building shall apply unless the *storm shelter* is a designated emergency shelter in accordance with Table 1604.5.

Add new text as follows:

1604.5.2 Photovoltaic (PV) panel systems. *Photovoltaic (PV) panel systems and elevated PV support structures shall be assigned a risk category as follows:*

1. Ground-mounted PV panel systems serving Group R-3 buildings shall be assigned as Risk Category I.
2. Ground-mounted PV panel systems shall be assigned as Risk Category I.
3. Elevated PV support structures other than those described in Items 4 and 6 shall be assigned as Risk Category II.
4. Rooftop-mounted PV panel systems and elevated PV support structures installed on top of buildings shall be assigned a risk category that is the same as the risk category of the building on which they are mounted.
5. PV panel systems and elevated PV support structures paired with energy storage systems (ESS) and serving as a dedicated, stand-alone source of backup power for Risk Category IV buildings shall be assigned as Risk Category IV.
6. Elevated PV support structures dedicated to parking of emergency vehicles shall be assigned as Risk Category IV.

Reason Statement: IBC Section 1604.5 and IBC Table 1604.5 are presently silent for assignment of risk category for all types of photovoltaic (PV) installations. This is a serious gap that still exists in the IBC, even as many other PV provisions in the I-codes have matured over several cycles. The problem this proposal seeks to resolve is confusion and gross inconsistencies regarding the assignment of risk categories for PV projects. With zero guidance in the IBC, AHJs and other code-enforcing authorities are left to make up their own rules and their own policies, based on their own personal opinions and interpretations. While there is broad agreement on several of these topics, there are outlier cases where the most stringent AHJs create interpretations that increase the cost of construction arbitrarily. With a code that is silent, industry stakeholders and permit applicants have no recourse other than to attempt a negotiation at the building department counter with each AHJ or sometimes with each project.

As there are several primary types of structures used to support PV panels, it is a serious gap in the IBC to be entirely silent on assignment of risk category for these primary applications. Justification is provided here for each of the six categories in this proposal. Note these line items are based on the following definitions. The first definition has appeared in several cycles of the IBC.

PHOTOVOLTAIC (PV) PANEL SYSTEM. A system that incorporates discrete photovoltaic panels, that converts solar radiation into electricity, including rack support systems.

During Group A proceedings in 2021, Proposal G193-21 was approved As Submitted, creating two new definitions that are foundational to the assignment of risk category.

PHOTOVOLTAIC (PV) PANEL SYSTEM, GROUND-MOUNTED. An independent photovoltaic (PV) panel system without useable space underneath, installed directly on the ground.

PHOTOVOLTAIC (PV) SUPPORT STRUCTURE, ELEVATED. An independent photovoltaic (PV) panel support structure designed with useable space underneath with minimum clear height of 7 feet 6 inches (2286 mm), intended for secondary use such as providing shade or parking of

motor vehicles.

Justification by proposal line item is provided as follows:

1. Ground-mounted PV panel systems serving Group R-3 buildings shall be assigned as Risk Category I (one).

We hope all stakeholders can agree that a ground-mounted PV panel system installed in the back yard behind someone's home does not need to be anything other than Risk Category I (one), as it represents "a low hazard to human life in the event of failure."

2. Ground-mounted PV panel systems shall be assigned as Risk Category I (one).

Fundamentally, ground-mounted PV panel systems meet the description of Risk Category I, as they "represent a low hazard to human life in the event of failure."

Unfortunately, the Solar Energy Industries Association (SEIA) is aware of a broad range of interpretation by local authorities regarding proper assignment of Risk Category for ground-mounted PV panel systems. This is especially true -- and especially impactful -- for large-scale (often referred to as "utility scale") ground-mounted PV facilities. Given the same set of construction drawings, different building department staff can reach different conclusions, based on different rationale. Different building departments have reviewed projects that are fundamentally the same design, and determined it was Risk Category I, or Risk Category II, or Risk Category III. A few reviewers have even claimed the same design should be assigned as Risk Category IV. Owing to this broad range of opinions and beliefs, the solar industry cannot design a large-scale solar facility without first asking the building code official to make this determination, and the design features and associated cost of construction of a solar facility are therefore dependent on individual opinions and beliefs of reviewers. This is far too subjective.

This inconsistency in the assignment of risk category for ground-mounted PV systems is sometimes based on the Risk Category III description that reads: "Power-generating stations, water treatment facilities for potable water, wastewater treatment facilities and other public utility facilities not included in Risk Category IV." Unfortunately, there is no definition in the IBC for "power generating stations," so it has no distinct meaning and no consistent interpretation. Is a ground-mounted PV system in the back yard of a residential property a "power generating station"?

With no definition found in the IBC, we can search ASCE 7-16 and find Section 15.5.4.1, which states: "Electrical power-generating facilities are power plants that generate electricity by steam turbines, combustion turbines, diesel generators, or similar turbo machinery." While ASCE 7-16 Table 1.5-1 does not use the term "power generating station" or "electrical power generating station," the description of Risk Category III includes "Buildings and other structures ... with potential to cause a substantial economic impact and/or mass disruption of day-to-day civilian life in the event of failure." It is clear that the original intent of "power-generating stations" as Risk Category III structures was based on large power-generating units such as turbines and was never intended to apply to individual PV panel systems that had not yet scaled at the time this language was created.

ASCE 7-16 Commentary C1.5 states in part: "Risk Category III ... has also included structures associated with utilities required to protect the health and safety of a community, including power generating stations and water treatment and sewage treatment plants. ... Failures of power plants that supply electricity on the national grid can cause substantial economic losses and disruption to civilian life when their failures can trigger other plants to go offline in succession. The result can be massive and potentially extended power outage, shortage, or both that lead to huge economic losses because of idled industries and a serious disruption of civilian life because of inoperable subways, road traffic signals, and so forth."

IMPORTANT: It is extremely important to note there is a fundamental difference between the physical behavior of conventional turbine power plants and PV facilities. For example, if one reactor shuts down at a nuclear power plant, over 1 gigaWatt of power production can be lost at once. The physical behavior of ground-mounted PV facilities is not the same as turbine-based power generating stations. Where failures in PV facilities have been observed -- except in the most extreme cases during hurricanes Irma and Maria -- they are typically localized failures that do not shut down the entire plant.

This behavior is described in future ASCE 7-22 Commentary Section C32.5.2.1, which states in part: "Large-scale photovoltaic facilities can cover hundreds of acres of land, yet they are composed of hundreds or thousands of small, structurally independent 'tables' of PV panels, each with their own independent foundation system. The PV panels on these independent nonbuilding structures are linked with electrical conductors to central inverters that convert DC power to AC power. Large-scale PV facilities can have dozens to hundreds of independent central inverters. If an electrical fault is detected, only the inverter associated with that fault is shut down, and the remainder of the facility remains operational. The entire PV facility will shut down only if the electrical substation is shut down, or if the system otherwise detects a loss of the AC signal from the grid. Substations and grids are outside the scope of ASCE 7."

While there is little data of tornado strikes on large-scale PV facilities, in two known cases the damage from a tornado strike was isolated to localized damage. These facilities typically remain operational with localized damage. For ground-mounted photovoltaic installations, the effective plan area A_p should be the size of the largest structurally independent nonbuilding structure supporting PV panels."

Further, PV panel systems are by their nature an intermittent power source. They convert sunlight to electricity, producing power during daylight hours only. Photovoltaic power systems do not cause substantial economic losses and disruption to civilian life when they stop producing power during night-time hours. We acknowledge that the addition of Energy Storage Systems (ESS) is changing this part of the conversation. However, the

addition of ESS does not change the fact that where structural failures have occurred in ground-mounted PV panel systems (except as noted), those failures have been localized and did not trigger a complete shut-down of a power plant. Where electrical faults are detected, individual inverters can shut down portions of a power plant, without any disruption to civilian life. Therefore, they do not meet the IBC or ASCE 7 criteria for Risk Category III.

There are other considerations that have been brought up for discussion.

Some AHJs have expressed an opinion that ground-mounted PV systems can be assigned as Risk Category I only if they are enclosed by a fence. While most large-scale PV facilities are in fact enclosed within a fence, they are simply not facilities open to the public. They can be accessed only by authorized personnel, who are keenly aware of behavioral conditions during weather events. It is not rational to assign an increased risk category and associated increase in cost of construction to protect possible trespassers. In a different case, with small projects located at school sites, there could be provisions for keeping students and other unauthorized people away from PV systems, but this is independent of the assignment of risk category.

In another deviation from the norm, at least one AHJ requires an increase of risk category based on proximity to highways, schools, or residential developments, with an apparent rationale that a dislodged PV panel could become airborne and cause injury at some distance away from the PV facility after being carried by high winds. In this case, the concern of the AHJ is one failure mode only – panel dislodgement. It would be far more rational to refer to Failure Modes and Effects (FMEA) analysis to focus on the root cause of that one failure mode, and to then solve the problem directly. It is not rational to use a very indirect approach of arbitrarily increasing the risk category of the entire facility because of concern about one failure mode, thereby increasing the structural loads and increasing the cost of the PV facility – perhaps without even solving the problem.

It is true that dislodgement of PV panels has been observed in some cases. It is also true that dislodgement of PV panels has led to progressive failure, as observed in at least one catastrophic failure during a hurricane event. Focused work is underway today to address that identified risk. Attachment of PV panels to the superstructure is being considered by the recently formed ASCE Solar PV Structures Committee. Recommendations are expected to be published in the future Manual of Practice. This is a problem to be solved that is independent of assignment of risk category.

There are other factors that have been identified in forensic studies, which are usually conducted under Non-Disclosure Agreements (NDAs). Work is underway to gather data that can be anonymized and aggregated, in an effort of continual improvement. Some of this work is being funded under a grant by the U.S. Department of Energy. Members of the structural engineering community who are deeply involved in solar projects are engaged in these efforts.

There are other factors that can contribute to increased reliability and resilience of PV facilities. For example, better consideration of gust effect factor and topographic factors; and a growing knowledge base from boundary layer wind tunnel studies; as well as design, specification, installation, and maintenance of components. It is both more rational and more economical to focus directly on resolving specific issues. It is not rational to believe we can increase risk category and wind loads until problems are nonexistent.

For any situation where project owners or financiers desire enhanced performance beyond code-minimum provisions for safety, a performance factor could be developed to voluntarily increase structural loads, but this should be independent of code-prescribed assignment of risk categories or methods for determining minimum structural loads.

3. *Elevated PV support structures other than those described in Items 4 and 6 shall be assigned as Risk Category II (two).*

The newly defined term for elevated PV support structures will make it easier to clarify the assignment of risk category. Elevated PV support structures are often constructed on the ground surface over parking spaces. In this application, the elevated PV support structures are not using any space that is not already used as a parking lot, and they provide the added benefit of providing shade for vehicles. Elevated PV support structures can also be constructed on the ground surface to provide shade for other uses, such as picnic areas. In all of these cases other than described in Items 4 and 6, elevated PV support structures meet the criteria and intent for Risk Category II.

There are also some emerging agricultural uses, sometimes referred to as “agri-voltaics.” As one example, elevated PV support structures have been built over cranberry bogs. Although there could be an exception for agricultural use, for simplicity this proposal is not seeking to treat agricultural uses differently than the more-common installations assigned as Risk Category II.

4. *Rooftop-mounted PV panel systems and elevated PV support structures installed on top of buildings shall be assigned a risk category that is the same as the risk category of the building on which they are mounted.*

This concept is widely accepted by industry and AHJs and should not be controversial. Where PV panel systems are mounted on building roofs, whether attached or unattached, they shall be assigned as the same risk category as the building on which they are mounted. Elevated PV support structures have been installed on top of buildings along with vegetative roof features, and on top of parking garages over parking spaces. In any of these cases, PV structures must be designed to at least the same risk category as the building on which they are installed.

5. *PV panel systems and elevated PV support structures paired with energy storage systems (ESS) and serving as a dedicated, stand-alone source of backup power for Risk Category IV (four) buildings shall be assigned as Risk Category IV (four).*

The intermittent nature of power generation makes PV panel systems and elevated PV support structures an extremely unlikely choice as an on-site, sole source of required emergency backup power for a Risk Category IV structure. We believe most essential services facilities are still using fuel-powered (usually diesel) generators and a stock of fuel for backup power. However, with increasing adoption of Energy Storage Systems (ESS), it is conceivable that PV paired with ESS could be a sole source of required backup power.

Where PV plus ESS is the only direct source of backup power for an essential services facility – with a transfer switch or other equipment enabling it to operate independently from the grid during a time of grid power outage – it shall be assigned as Risk Category IV. If PV plus ESS is not designed to operate in the event of grid power outage, then it need not be Risk Category IV. This assignment of risk category can also apply when power switching enables the use of either the PV + ESS or a generator interchangeably.

6. *Elevated PV support structures dedicated to parking of emergency vehicles shall be assigned as Risk Category IV (four).*

There could be cases where elevated PV support structures are installed on the same site as a Risk Category IV building, over surface parking spaces that are designated for emergency services vehicles. Whether or not those elevated PV support structures are serving as part of a backup power source (as in Item 5), the elevated PV support structures must be assigned as Risk Category IV.

Cost Impact: The code change proposal will not increase or decrease the cost of construction

This proposal adds clarity for assignment of risk category. The proposal does not increase the cost of construction, and in some cases could decrease the cost of construction.

S82-22

IBC: 1604.8.2

Proponents: John-Jozef Proczka, representing Self (john-jozef.proczka@phoenix.gov)

2021 International Building Code

Revise as follows:

1604.8.2 Structural walls. Walls that provide vertical load-bearing resistance or lateral shear resistance for a portion of the structure shall be anchored to the roof and to all floors and members that provide lateral support for the wall or that are supported by the wall. The connections shall be capable of resisting the horizontal forces that result from the application of the prescribed loads. The required earthquake out-of-plane loads are specified in Section 1.4.4 of ASCE 7 for walls of structures assigned to *Seismic Design Category A* and to Section 12.11 of ASCE 7 for walls of structures assigned to all other *seismic design categories*. Required anchors in masonry walls of hollow units or *cavity walls* shall be embedded in a reinforced grouted structural element of the wall. See Sections 1609 for wind design requirements and 1613 for earthquake design requirements.

Reason Statement: This proposal clarifies that where wind, lateral earth pressures, or other loads are the dominant lateral in-plane or out-of-plane loads on structural walls that those walls must be anchored to resist those forces. The StEER Hurricane Michael P-VAT report Figure 17 showed Jinks Middle School's gymnasium walls on two sides completely separating and collapsing from the roof they could have been properly anchored to. https://www.weather.gov/media/tae/events/20181010_Michael/StEER_PVAT.pdf

Cost Impact: The code change proposal will increase the cost of construction
This proposal will increase the cost of wall anchorage where design currently may have incorrectly been ignoring non-earthquake loading.

S82-22

S83-22

IBC: SECTION 1606, 1606.1, 1606.2, 1606.3, 1606.4, 1606.5, 1607.1

Proponents: Jennifer Goupil, representing Structural Engineering Institute of ASCE (jgoupil@asce.org)

2021 International Building Code

SECTION 1606 DEAD LOADS

Revise as follows:

1606.1 General. ~~Dead loads are those loads defined in Chapter 2 of this code. Dead loads shall be considered to be permanent loads. Buildings, structures, and parts thereof shall be designed to resist the effects of dead loads in accordance with Chapter 3 of ASCE 7.~~

Delete without substitution:

1606.2 Weights of materials of construction. ~~For purposes of design, the actual weights of materials of construction shall be used. In the absence of definite information, values used shall be subject to the approval of the building official.~~

1606.3 Weight of fixed service equipment. ~~In determining dead loads for purposes of design, the weight of fixed service equipment, including the maximum weight of the contents of fixed service equipment, shall be included. The components of fixed service equipment that are variable, such as liquid contents and movable trays, shall not be used to counteract forces causing overturning, sliding, and uplift conditions in accordance with Section 1.3.6 of ASCE 7.~~

Exceptions:

- ~~1. Where force effects are the result of the presence of the variable components, the components are permitted to be used to counter those load effects. In such cases, the structure shall be designed for force effects with the variable components present and with them absent.~~
- ~~2. For the calculation of seismic force effects, the components of fixed service equipment that are variable, such as liquid contents and movable trays, need not exceed those expected during normal operation.~~

1606.4 Photovoltaic panel systems. ~~The weight of photovoltaic panel systems, their support system, and ballast shall be considered as dead load.~~

1606.5 Vegetative and landscaped roofs. ~~The weight of all landscaping and hardscaping materials for vegetative and landscaped roofs shall be considered as dead load. The weight shall be computed considering both fully saturated soil and drainage layer materials and fully dry soil and drainage layer materials to determine the most severe load effects on the structure.~~

Revise as follows:

1607.1 General. ~~Live loads are those loads defined in Chapter 2 of this code. Buildings, structures, and parts thereof shall be designed to resist the effects of live loads.~~

Reason Statement: This proposal is a coordination proposal to bring the 2024 IBC up to date with the provisions of the 2022 edition of ASCE/SEI 7 Minimum Design Loads and Associated Criteria for Buildings and Other Structures (ASCE/SEI 7-22). ASCE 7 will be updated to the 2022 edition from the 2016 edition as an Administrative update in the 2024 I-Codes.

These changes are proposed to improve the coordination between the IBC and ASCE 7 by removing text in the IBC that is contained in ASCE 7. Reducing overlap between the IBC and ASCE 7, where appropriate, makes it easier to keep the documents coordinated. This overlap reduction has been successfully done in the past with overlap between the IBC and material design standards such as ACI 381, AISC 360, and TMS 402. Section 1606 Dead Load is deleted entirely and replaced with reference to the applicable chapter in ASCE 7. The information currently contained within Section 1606 is structural design information used by the design professional. The technical requirements in ASCE 7 are the same as the IBC and the wording is very similar, therefore this proposal does not change technical requirements, just where they are located and maintained. This is similar to material design information that is contained in referenced design standards and not within the IBC itself, such as in ACI 318 for concrete and AISC 360 for steel.

It is also noted that dead loads are not commonly reviewed by building officials during their review of the design shown on the construction documents as the weight of the construction and the weight of items considered as dead loads are not required to be listed out on the construction documents by Section 1603 (floor and roof dead loads for construction in accordance with the conventional light-frame construction provisions of Section 2308 are an exception). Removal of this information from the IBC is not likely to impact reviews performed by building officials.

This proposal revises the General section for live loads to include charging text similar to the other load sections in the IBC. Currently the General sub-section doesn't actually require buildings and structures to be designed for these loads. The proposal corrects this. The proposed text is based

on current text for the other design loads, specifically wind, soil, rain, and earthquake.

This proposal also removes the text pointing to Chapter 2 for the definition of Live Load. This pointer is unnecessary as Chapter 2 adequately describes how definitions are applied, such pointers are not used elsewhere in the IBC, and defined terms are italicized throughout the IBC which by itself is a pointer to Chapter 2.

Cost Impact: The code change proposal will not increase or decrease the cost of construction

The proposal does not change what loads are considered dead loads, it simply changes where the design information for dead loads is located.

S83-22

S84-22

IBC: SECTION 1606, 1606.1, SECTION 1607, 1607.1

Proponents: Jennifer Goupil, representing Structural Engineering Institute of ASCE (jgoupil@asce.org)

2021 International Building Code

SECTION 1606 DEAD LOADS

Revise as follows:

1606.1 General. ~~Dead loads are those loads defined in Chapter 2 of this code. Dead loads shall be considered to be permanent loads. Buildings, structures, and parts thereof shall be designed to resist the effects of dead loads.~~

SECTION 1607 LIVE LOADS

Revise as follows:

1607.1 General. ~~Live loads are those loads defined in Chapter 2 of this code.~~ Buildings, structures, and parts thereof shall be designed to resist the effects of live loads.

Reason Statement: This proposal is a coordination proposal to bring the 2024 IBC up to date with the provisions of the 2022 edition of ASCE/SEI 7 Minimum Design Loads and Associated Criteria for Buildings and Other Structures (ASCE/SEI 7-22). ASCE 7 will be updated to the 2022 edition from the 2016 edition as an Administrative update in the 2024 I-Codes.

This proposal revises the General section for both dead loads and live loads to include charging text similar the other load sections in the IBC. Currently the "General" sub-section for both dead and live loads doesn't actually require buildings and structures to be designed for these loads. The proposal corrects this.

The proposed text is based on current text for the other design loads, specifically wind, soil, rain, and earthquake.

The proposal also removes the text pointing to Chapter 2 for the definitions of Dead Load and Live Load. This pointer is unnecessary as Chapter 2 adequately describes how definitions are applied, such pointers are not used elsewhere in the IBC, and defined terms are italicized throughout the IBC which by itself is pointer to Chapter 2.

The sentence indicating dead loads are to be considered permanent loads is also deleted as it is unnecessary. The load combination provisions in Section 1605 and the symbol notations in Section 1602.1 no longer refer to permanent or transient conditions. It is also noted that the dead load chapter of ASCE 7 does not refer to dead loads as permanent loads.

Cost Impact: The code change proposal will not increase or decrease the cost of construction. Improving coordination with ASCE 7 and adding charging text is not expected to effect the cost of construction.

S84-22

S85-22

IBC: 1607.6, 1607.6.1 (New), TABLE 1607.1

Proponents: Jennifer Goupil, representing Structural Engineering Institute of ASCE (jgoupil@asce.org)

2021 International Building Code

Revise as follows:

1607.6 Helipads. Landing areas designed for a design basis helicopter with maximum take-off weight of 3,000 pounds (13.35 kN) shall be identified with a 3,000-pound (13.34 kN) weight limitation. The landing area weight limitation shall be indicated by the numeral "3" (kips) located in the bottom right corner of the landing area as viewed from the primary approach path. The indication for the landing area weight limitation shall be a minimum 5 feet (1524 mm) in height. Helipads shall be designed for the following live loads:

1. ~~A uniform live load, L , as specified in Items 1.1 and 1.2. This load shall not be reduced.~~
 - 1.1. ~~40 psf (1.92 kN/m²) where the design basis helicopter has a maximum take-off weight of 3,000 pounds (13.35 kN) or less.~~
 - 1.2. ~~60 psf (2.87 kN/m²) where the design basis helicopter has a maximum take-off weight greater than 3,000 pounds (13.35 kN).~~
2. ~~A single concentrated live load, L , of 3,000 pounds (13.35 kN) applied over an area of 4.5 inches by 4.5 inches (114 mm by 114 mm) and located so as to produce the maximum load effects on the structural elements under consideration. The concentrated load is not required to act concurrently with other uniform or concentrated live loads.~~
3. ~~Two single concentrated live loads, L , 8 feet (2438 mm) apart applied on the landing pad (representing the helicopter's two main landing gear, whether skid type or wheeled type), each having a magnitude of 0.75 times the maximum take-off weight of the helicopter, and located so as to produce the maximum load effects on the structural elements under consideration. The concentrated loads shall be applied over an area of 8 inches by 8 inches (203 mm by 203 mm) and are not required to act concurrently with other uniform or concentrated live loads.~~

~~Landing areas designed for a design basis helicopter with maximum take-off weight of 3,000 pounds (13.35 kN) shall be identified with a 3,000-pound (13.34 kN) weight limitation. The landing area weight limitation shall be indicated by the numeral "3" (kips) located in the bottom right corner of the landing area as viewed from the primary approach path. The indication for the landing area weight limitation shall be a minimum 5 feet (1524 mm) in height.~~

Add new text as follows:

1607.6.1 Concentrated loads. Helipads shall be designed for the following concentrated live loads:

1. A single concentrated live load, L , of 3,000 pounds (13.35 kN) applied over an area of 4.5 inches by 4.5 inches (114 mm by 114 mm) and located so as to produce the maximum load effects on the structural elements under consideration. The concentrated load is not required to act concurrently with other uniform or concentrated live loads.
2. Two single concentrated live loads, L , 8 feet (2438 mm) apart applied on the landing pad (representing the helicopter's two main landing gear, whether skid type or wheeled type), each having a magnitude of 0.75 times the maximum take-off weight of the helicopter, and located so as to produce the maximum load effects on the structural elements under consideration. The concentrated loads shall be applied over an area of 8 inches by 8 inches (203 mm by 203 mm) and are not required to act concurrently with other uniform or concentrated live loads.

Revise as follows:

TABLE 1607.1 MINIMUM UNIFORMLY DISTRIBUTED LIVE LOADS, L_0 , AND MINIMUM CONCENTRATED LIVE LOADS
Portions of table not shown remain unchanged.

OCCUPANCY OR USE		UNIFORM (psf)	CONCENTRATED (pounds)	ALSO SEE SECTION
16.	Handrails, guards and grab bars	See Section 1607.9		—
17.	Helipads	<u>See Section 1607.6.40</u>	<u>See Section 1607.6.1</u>	<u>Section 1607.6</u>
		<u>60</u>	<u>See Section 1607.6.1</u>	<u>Section 1607.6</u>

For SI: 1 inch = 25.4 mm, 1 square inch = 645.16 mm²,

1 square foot = 0.0929 m²,

1 pound per square foot = 0.0479 kN/m², 1 pound = 0.004448 kN,

1 pound per cubic foot = 16 kg/m³.

- a. Live load reduction is not permitted.
- b. Live load reduction is only permitted in accordance with Section 1607.12.1.2 or Item 1 of Section 1607.12.2.
- c. Live load reduction is only permitted in accordance with Section 1607.12.1.3 or Item 2 of Section 1607.12.2.

Reason Statement: This proposal is a coordination proposal to bring the 2024 IBC up to date with the provisions of the 2022 edition of ASCE/SEI 7 Minimum Design Loads and Associated Criteria for Buildings and Other Structures (ASCE/SEI 7-22). ASCE 7 will be updated to the 2022 edition from the 2016 edition as an Administrative update in the 2024 I-Codes.

This proposal reorganizes both the section on helipads and the live load table entry for helipads to coordinate with the organization in ASCE 7. The reorganization also more closely follows the typical IBC format for live loads by placing the live load value in the live load table itself where ever possible.

This proposal does not change the technical requirements for helipads.

Currently the entry in the live load table for helipads is simply a pointer as it states to See Section 1607.6. This proposal moves the uniform live loads into the Live Load Table as they can be concisely listed in the table by using two rows. The helipad concentrated loads remain in Section 1607 as they have accompanying text that would not fit concisely in the table.

Section 1607.6 is also logically reorganized by adding a subsection. This way the base text addressing the requirements for identification on the helipad are placed first and the concentrated loads are placed in their own subsection.

Cost Impact: The code change proposal will not increase or decrease the cost of construction. Reorganizing text and improving coordination with ASCE 7 is not expected to effect the cost of construction.

S86-22

IBC: TABLE 1607.1

Proponents: Jennifer Goupil, representing Structural Engineering Institute of ASCE (jgoupil@asce.org)

2021 International Building Code

Revise as follows:

TABLE 1607.1 MINIMUM UNIFORMLY DISTRIBUTED LIVE LOADS, L₀, AND MINIMUM CONCENTRATED LIVE LOADS
 Portions of table not shown remain unchanged.

OCCUPANCY OR USE		UNIFORM (psf)	CONCENTRATED (pounds)	ALSO SEE SECTION	
3.	Armories and drill rooms	150 ^{ab}	—	—	
4.	Assembly areas	Fixed seats (fastened to floor)	60 ^a	—	—
		Follow spot, projections and control rooms	50		
		Lobbies	100 ^a		
		Movable seats	100 ^a		
		Stage floors	150 ^{ab}		
		Platforms (assembly)	100 ^a		
		Bleachers, folding and telescopic seating and grandstands	100 ^a (See Section 1607.19)		
		Stadiums and arenas with fixed seats (fastened to the floor)	60 ^a (See Section 1607.19)		
		Other assembly areas	100 ^a		
25.	Recreational uses	Bowling alleys, poolrooms and similar uses	75 ^a	—	—
		Dance halls and ballrooms	100 ^a		
		Gymnasiums	100 ^a		
		Theater projection, control, and follow spot rooms	50		
		Ice skating rinks	250 ^b		
		Roller skating rinks	100 ^a		

For SI: 1 inch = 25.4 mm, 1 square inch = 645.16 mm²,

1 square foot = 0.0929 m²,

1 pound per square foot = 0.0479 kN/m², 1 pound = 0.004448 kN,

1 pound per cubic foot = 16 kg/m³.

- a. Live load reduction is not permitted.
- b. Live load reduction is only permitted in accordance with Section 1607.12.1.2 or Item 1 of Section 1607.12.2.
- c. Live load reduction is only permitted in accordance with Section 1607.12.1.3 or Item 2 of Section 1607.12.2.

Reason Statement: This proposal is a coordination proposal to bring the 2024 IBC up to date with the provisions of the 2022 edition of ASCE/SEI 7 Minimum Design Loads and Associated Criteria for Buildings and Other Structures (ASCE/SEI 7-22). ASCE 7 will be updated to the 2022 edition from the 2016 edition as an Administrative update in the 2024 I-Codes.

This proposal makes changes to the Live Load table to coordinate with ASCE 7.1) The table entry for follow spot rooms, control rooms, and projection rooms in theaters is moved from Item 4 Assembly Areas to Item 25 Recreation Areas. This matches the location in the ASCE 7-22 Live Load table. These rooms are not areas that are typically open to the public or have large crowds gather. These are behind the scenes type areas and as such the entry is better located under Recreation Areas. The entry is also reworded in order to make it clear that the intent of these areas is within theaters. The rewording matches the ASCE 7-22 text.

2)The live load reduction footnote for two entries is changed to match the requirements in ASCE 7. For both "Armories and Drill Rooms" and "Stage Floors", the footnote is changed from Footnote B which allows live load reduction per certain sections, to Footnote A which does not allow live load reduction. Both of these changes coordinate with ASCE 7. The occupancy of these two areas is not similar to the occupancies upon which the live load reduction provisions are based and as such the live load reduction provisions should not apply.

Cost Impact: The code change proposal will increase the cost of construction

For designers that were using live load reduction per the IBC and not ASCE 7, this change could increase the size of structural members and as such the cost of construction. It is noted that in these types of areas floor deflection or vibration can control the design and in those cases the size of members and the cost of construction would be unchanged.

S87-22

IBC: TABLE 1607.1

Proponents: Jennifer Goupil, representing Structural Engineering Institute of ASCE (jgoupil@asce.org)

2021 International Building Code

Revise as follows:

TABLE 1607.1 MINIMUM UNIFORMLY DISTRIBUTED LIVE LOADS, L_0 , AND MINIMUM CONCENTRATED LIVE LOADS
 Portions of table not shown remain unchanged.

OCCUPANCY OR USE		UNIFORM (psf)	CONCENTRATED (pounds)	ALSO SEE SECTION
15.	<u>Garages and vehicle floors</u>	40 ^c	Passenger vehicles only garages	—
			Trucks and buses	
		Fire trucks and emergency vehicles		
		Forklifts and movable equipment		

For SI: 1 inch = 25.4 mm, 1 square inch = 645.16 mm²,

1 square foot = 0.0929 m²,

1 pound per square foot = 0.0479 kN/m², 1 pound = 0.004448 kN,

1 pound per cubic foot = 16 kg/m³.

- a. Live load reduction is not permitted.
- b. Live load reduction is only permitted in accordance with Section 1607.12.1.2 or Item 1 of Section 1607.12.2.
- c. Live load reduction is only permitted in accordance with Section 1607.12.1.3 or Item 2 of Section 1607.12.2.

Reason Statement: This proposal is a coordination proposal to bring the 2024 IBC up to date with the provisions of the 2022 edition of ASCE/SEI 7 Minimum Design Loads and Associated Criteria for Buildings and Other Structures (ASCE/SEI 7-22). ASCE 7 will be updated to the 2022 edition from the 2016 edition as an Administrative update in the 2024 I-Codes.

This proposal makes changes to the live load table to include uses already contained elsewhere in Chapter 16. These changes also coordinate with the ASCE 7 live load table. The IBC already contains provisions for vehicles and moveable equipment in Section 1607.8. These uses should be included in the live load table along with the passenger vehicle and heavy vehicle loads. There is no basis for only including some aspects of Section 1607.8 in the Live Load table.

Cost Impact: The code change proposal will not increase or decrease the cost of construction
 This code change proposal does not change requirements and as such will not affect the cost of construction.

S88-22

IBC: TABLE 1607.1

Proponents: Jennifer Goupil, representing Structural Engineering Institute of ASCE (jgoupil@asce.org)

2021 International Building Code

Revise as follows:

TABLE 1607.1 MINIMUM UNIFORMLY DISTRIBUTED LIVE LOADS, L₀, AND MINIMUM CONCENTRATED LIVE LOADS

OCCUPANCY OR USE		UNIFORM (psf)	CONCENTRATED (pounds)	ALSO SEE SECTION	
26.	Residential	One- and two-family dwellings:		—	Section 1607.22
		Uninhabitable attics without storage	10		
		Uninhabitable attics with storage	20		
		Habitable attics and sleeping areas	30		
		Canopies, including marquees	20		
		All other areas	40		
		Hotels and multifamily dwellings:			
		Private rooms and corridors serving them	40		
		Public rooms ^a and corridors serving them	100 ^a		
		Corridors serving public rooms	100		
27.	Roofs	Ordinary flat, pitched, and curved roofs (that are not occupiable)	20	—	Section 1607.15.2
		Roof areas used for assembly purposes	100 ^a	—	
		Roof areas used for occupancies other than assembly	Same as occupancy served	—	
		Vegetative and landscaped roofs:		—	
		Roof areas not intended for occupancy	20	—	
		Roof areas used for assembly purposes	100 ^a	—	
		Roof areas used for other occupancies <u>other than assembly</u>	Same as occupancy served	—	
		Awnings and canopies:		—	
		Fabric construction supported by a skeleton structure	5 ^a	—	
		All other construction, except one- and two-family dwellings	20	—	
		Primary roof members exposed to a work floor:			
		Single panel point of lower chord of roof trusses or any point along primary structural members supporting roofs over manufacturing, storage warehouses, and repair garages	—	2,000	
		All other primary roof members	—	300	
		All roof surfaces subject to maintenance workers	—	300	

For SI: 1 inch = 25.4 mm, 1 square inch = 645.16 mm²,

1 square foot = 0.0929 m²,

1 pound per square foot = 0.0479 kN/m², 1 pound = 0.004448 kN,

1 pound per cubic foot = 16 kg/m³.

- a. Live load reduction is not permitted.
- b. Live load reduction is only permitted in accordance with Section 1607.12.1.2 or Item 1 of Section 1607.12.2.
- c. Live load reduction is only permitted in accordance with Section 1607.12.1.3 or Item 2 of Section 1607.12.2.

Reason Statement: This proposal is a coordination proposal to bring the 2024 IBC up to date with the provisions of the 2022 edition of ASCE/SEI 7 Minimum Design Loads and Associated Criteria for Buildings and Other Structures (ASCE/SEI 7-22). ASCE 7 will be updated to the 2022 edition from the 2016 edition as an Administrative update in the 2024 I-Codes.

This proposal makes changes to two items in the live load table. In Item 26 for "Hotels and multifamily dwellings", the sub-item "public rooms and corridors serving them" is separated into two sub-items, "public rooms" and "corridors serving public rooms". This is done so that Footnote A,

which indicates that live load reduction is not permitted, is only applied to the public room sub-item. The public room is the assembly area, where live load reduction is not to be applied. Corridors, including corridors serving the public, are not assembly areas themselves and live load reduction is intended to be permitted as it is for corridors per Item 8 of the live load table. This change also aligns the IBC with the corresponding portion of the live load table in ASCE 7.

In Item 27, editorial changes are made so that consistent terminology is used. The revised text under "Vegetative and landscaped roofs" matches the phrasing used immediately above. These editorial changes are also consistent with ASCE 7.

Cost Impact: The code change proposal will not increase or decrease the cost of construction. The intent has always been not to allow live load reduction for the public room, however some designers may have been excluding live load reduction for the corridors serving them as well. For those designers the size of structural members could decrease and as such the cost of construction could decrease. Most likely the change has no effect on the cost of construction.

The change to the Roof item of the Live Load table is for clarification and will not affect the cost of construction.

S89-22

IBC: TABLE 1607.1

Proponents: Jennifer Goupil, representing Structural Engineering Institute of ASCE (jgoupil@asce.org)

2021 International Building Code

Revise as follows:

TABLE 1607.1 MINIMUM UNIFORMLY DISTRIBUTED LIVE LOADS, L₀, AND MINIMUM CONCENTRATED LIVE LOADS
Portions of table not shown remain unchanged.

OCCUPANCY OR USE			UNIFORM (psf)	CONCENTRATED (pounds)	ALSO SEE SECTION
24.	Penal institutions	Cell blocks	40	—	—
		Corridors	100		
25.	Public Restrooms		Same as live load for area served but not required to exceed 60 psf	—	—

For SI: 1 inch = 25.4 mm, 1 square inch = 645.16 mm²,

1 square foot = 0.0929 m²,

1 pound per square foot = 0.0479 kN/m², 1 pound = 0.004448 kN,

1 pound per cubic foot = 16 kg/m³.

- a. Live load reduction is not permitted.
- b. Live load reduction is only permitted in accordance with Section 1607.12.1.2 or Item 1 of Section 1607.12.2.
- c. Live load reduction is only permitted in accordance with Section 1607.12.1.3 or Item 2 of Section 1607.12.2.

Reason Statement: This proposal is a coordination proposal to bring the 2024 IBC up to date with the provisions of the 2022 edition of ASCE/SEI 7 Minimum Design Loads and Associated Criteria for Buildings and Other Structures (ASCE/SEI 7-22). ASCE 7 will be updated to the 2022 edition from the 2016 edition as an Administrative update in the 2024 I-Codes.

A public restroom live load was added to the live load table in ASCE 7-22. This live load was contained in a table in the 7-16 commentary. This change coordinates the IBC live load table with ASCE 7-22.

The following text appears in the commentary to ASCE 7-22. "The public restroom uniform live load in Table 4.3-1 applies to restrooms for publicly accessible spaces. Public restrooms should be designed for the live load associated with the occupancy it serves, with an upper limit of 60 psf. The upper limit recognizes that the fixtures within restrooms limit the space available for a dense grouping of occupants."

Cost Impact: The code change proposal will increase the cost of construction

The impact of this change will vary depending on the live load that designers are currently using for these spaces. It is possible that designers are using a lower live load and therefore the size of structural members and the cost of construction could increase.

S90-22

IBC: TABLE 1607.1

Proponents: Jennifer Goupil, representing Structural Engineering Institute of ASCE (jgoupil@asce.org)

2021 International Building Code

Revise as follows:

TABLE 1607.1 MINIMUM UNIFORMLY DISTRIBUTED LIVE LOADS, L₀, AND MINIMUM CONCENTRATED LIVE LOADS
Portions of table not shown remain unchanged.

OCCUPANCY OR USE		UNIFORM (psf)	CONCENTRATED (pounds)	ALSO SEE SECTION
25.	Recreational uses	Bowling alleys, poolrooms and similar uses	75 ^a	—
		Dance halls and ballrooms	100 ^a	
		Gymnasiums	100 ^a	
		Ice skating rinks	250^b	
		Roller skating rinks	100 ^a	

For SI: 1 inch = 25.4 mm, 1 square inch = 645.16 mm²,

1 square foot = 0.0929 m²,

1 pound per square foot = 0.0479 kN/m², 1 pound = 0.004448 kN,

1 pound per cubic foot = 16 kg/m³.

- a. Live load reduction is not permitted.
- b. Live load reduction is only permitted in accordance with Section 1607.12.1.2 or Item 1 of Section 1607.12.2.
- c. Live load reduction is only permitted in accordance with Section 1607.12.1.3 or Item 2 of Section 1607.12.2.

Reason Statement: This proposal is a coordination proposal to bring the 2024 IBC up to date with the provisions of the 2022 edition of ASCE/SEI 7 Minimum Design Loads and Associated Criteria for Buildings and Other Structures (ASCE/SEI 7-22). ASCE 7 will be updated to the 2022 edition from the 2016 edition as an Administrative update in the 2024 I-Codes.

This proposal improves the coordination between the live load table in the IBC and the table in ASCE 7-22.

The ASCE 7-16 live load table does not contain either Ice Skating Rinks or Roller Skating Rinks. These items are contained in a table in the commentary. During the development cycle for the 2022 edition, moving these items from the commentary into the standard was considered. Roller Skating Rinks were moved into the standard, however Ice Skating Rinks were not. A consensus was not reached on the basis for and the appropriateness of the 250 psf value for Ice Skating Rinks. Therefore Ice Skating Rinks were left in the commentary for now. Further discussion and research is expected to occur in the next ASCE 7 development cycle.

Removing the live load for Ice Skating Rinks in the IBC coordinates the IBC with ASCE 7. Designers and code officials still have the ASCE 7 commentary for guidance.

Further Background Information: In the 2006 & 2009 editions of the IBC, the live load table listed "Skating Rinks" with a live load of 100 psf. This item was removed from the 2012 IBC live load table. Code change proposal S88-12 resulted in the 2015 IBC live load table containing both Roller Skating Rinks, with a live load of 100 psf, and Ice Skating Rinks, with a live load of 250 psf. Both the S88-12 proposal and the ROH are attached. The only technical justification provided for the live load values in S88-12 is that they appear in the ASCE 7 commentary.

The ASCE 7 consensus process has established that further work is needed to establish an appropriate the live load value for ice skating rinks. Items to be researched and discussed further include what the load value includes (flooring types, thickness of ice, occupants, vehicles, etc.). As such it is appropriate for now that the Ice Skating Rink live load simply appear in the ASCE 7 commentary, not in the IBC live load table.

S88-12
Table 1607.1

Proponent: Edwin Huston, National Council of Structural Engineers Associations (NCSEA), representing NCSEA Code Advisory Subcommittee – General Requirements Subcommittee (Huston@smithhustoninc.com)

Revise as follows:

TABLE 1607.1
MINIMUM UNIFORMLY DISTRIBUTED LIVE LOADS, L_o, AND
MINIMUM CONCENTRATED LIVE LOADS⁹

OCCUPANCY OR USE	UNIFORM (psf)	CONCENTRATED (lbs)
24.Recreational uses:		
Ice Skating Rink	250 ^m	See Section 1607.7.4
Roller Skating Rink	100 ^m	

m. Live load reduction is not permitted unless specific exceptions of Section 1607.10 apply.

(Portions of Table and footnotes not shown remain unchanged)

Reason: : Uniformly distributed live load for rinks were in previous editions of the IBC. They were removed from the IBC 2009, as part of a larger CCP. The intent of this code change proposal is to once again list the recommended minimum uniform live load for rinks back into IBC. The proposed loads are consistent with the recommendations in ASCE7 commentary for minimum uniformly distributed live load.

Cost Impact: The code change proposal will not increase the cost of construction.

S88-12

Public Hearing: Committee: AS AM D
 Assembly: ASF AMF DF

T1607.1-S-HUSTON.doc

S88-12

Committee Action: **Approved as Submitted**

Committee Reason: This code change puts the uniformly distributed live loads for ice rinks and roller rinks back into the IBC.

Assembly Action: **None**

S89-12

Committee Action: **Approved as Submitted**

Committee Reason: This is a relatively minor clarification of the partition loading requirement that brings consistency with the live load value of 80 psf for corridors that is commonly applied to an entire floor.

Assembly Action: **None**

S90-12

PART I – IBC STRUCTURAL

Committee Action: **Approved as Submitted**

Committee Reason: This proposal clarifies the owner's responsibilities and recognizes that the owner's authorized agent can also be responsible. The use of these terms throughout makes the provisions easier to apply.

Assembly Action: **None**

PART II – IBC GENERAL

Committee Action: **Approved as Submitted**

Committee Reason: See reason for S90-12, Part I.

Assembly Action: **None**

PART III – IBC FIRE SAFETY

Committee Action: **Approved as Submitted**

Committee Reason: See reason for S90-12, Part I.

Assembly Action: **None**

PART IV – IBC MEANS OF EGRESS

Committee Action: **Approved as Submitted**

Committee Reason: See reason for S90-12, Part I.

Assembly Action: **None**

S91-12

Committee Action: **Disapproved**

Committee Reason: The proposed increase in gross vehicle weight was not supported. The proponent may have a point that the current 10,000 pound is not necessarily the correct threshold for heavy vehicle loads, but the justification for the proposed 12,000 pound threshold was insufficient.

Assembly Action: **None**

Cost Impact: The code change proposal will not increase or decrease the cost of construction. The ice skating rink live load will still appear in the commentary of ASCE 7. While removing it from the IBC may require designers to spend more time considering the appropriate live load, it is not likely to affect the cost of construction.

S91-22

IBC: TABLE 1607.1

Proponents: John Grenier, representing National Council of Structural Engineers Associations (NCSEA) (jgrenier@greniereng.com)

2021 International Building Code

Revise as follows:

TABLE 1607.1 MINIMUM UNIFORMLY DISTRIBUTED LIVE LOADS, L_0 , AND MINIMUM CONCENTRATED LIVE LOADS
Portions of table not shown remain unchanged.

OCCUPANCY OR USE		UNIFORM (psf)	CONCENTRATED (pounds)	ALSO SEE SECTION
25.	Recreational uses	Bowling alleys, poolrooms and similar uses	75 ^a	—
		Dance halls and ballrooms	100 ^a	
		Gymnasiums	100 ^a	
		Ice skating rinks	250 ^b <u>100</u>	
		Roller skating rinks	100 ^a	

For SI: 1 inch = 25.4 mm, 1 square inch = 645.16 mm²,

1 square foot = 0.0929 m²,

1 pound per square foot = 0.0479 kN/m², 1 pound = 0.004448 kN,

1 pound per cubic foot = 16 kg/m³.

- a. Live load reduction is not permitted.
- b. Live load reduction is only permitted in accordance with Section 1607.12.1.2 or Item 1 of Section 1607.12.2.
- c. Live load reduction is only permitted in accordance with Section 1607.12.1.3 or Item 2 of Section 1607.12.2.

Reason Statement: 1. NCSEA submitted a code change proposal for the 2015 IBC that added Ice Skating Rinks into Table 1607.1. At that time, we pointed to the ASCE 7 commentary and submitted using the 250 psf load cited there. We did not at that time delve into the ASCE commentary to see the origin of the 250 psf load, and we now feel that the 250 psf is overly conservative and not realistic.

2. We have currently researched and there is typically only 1" to 2" of actual ice used in a new rink (a maximum of 10 psf). The critical load for a rink is the Zamboni; with them weighing 11,000 pounds maximum. With a footprint of 16' x 7', will generate a footprint load of 98 psf.

3. We feel that a 100 psf Uniform load is more realistic and will account for the ice and piping associated with the rink, as well as the Zamboni and the players on the ice.

4. Our review of the New York Building Code and the National Building Code of Canadian, both list Ice Rinks at 100 psf.

Cost Impact: The code change proposal will decrease the cost of construction
 Reducing the live load from 250 to 100 psf will decrease the size and the cost of the structural supports.

S92-22

IBC: 1507.15, 1603.1.2, SECTION 1607, 1607.1, 1607.2, 1607.3, 1607.13, 1607.14.1, 1607.12, 1607.14, 1607.14.2, 1607.14.2.1, 1607.14.2.2, 1607.14.3, 1607.14.4, 1607.14.4.1, 1607.14.4.2, 1607.14.4.3, 1607.14.4.4, 1607.14.4.5, 1808.3, 3111.1, 3111.1.1, 3111.1.2

Proponents: Jennifer Goupil, representing Structural Engineering Institute of ASCE (jgoupil@asce.org)

2021 International Building Code

Revise as follows:

1507.15 Vegetative roofs and landscaped roofs. *Vegetative roofs* and landscaped roofs shall comply with the requirements of this chapter, Section ~~1607.14.2.2~~ 1607.13.2 and the *International Fire Code*.

1603.1.2 Roof live load. The *roof live load* used in the design shall be indicated for roof areas (~~Section 1607.14~~).

SECTION 1607 LIVE LOADS

1607.1 General. *Live loads* are those loads defined in Chapter 2 of this code.

1607.2 Loads not specified. For occupancies or uses not designated in Section 1607, the *live load* shall be determined in accordance with a method *approved* by the *building official*.

Revise as follows:

1607.3 Uniform live loads. The *live loads* used in the design of buildings and *other structures* shall be the maximum loads expected by the intended use or occupancy but shall not be less than the minimum uniformly distributed *live loads* given in Table 1607.1. *Live loads acting on a sloping surface shall be assumed to act vertically on the horizontal projection of that surface.*

~~1607.13~~ **1607.3.1 Distribution of floor loads. Partial loading of floors.** Where uniform floor *live loads* are involved in the design of structural members arranged so as to create continuity, the minimum applied loads shall be the full *dead loads* on all spans in combination with the floor *live loads* on spans selected to produce the greatest *load effect* at each location under consideration. Floor *Uniform floor live loads applied to selected spans* are permitted to be reduced in accordance with Section 1607.12 .

~~1607.14.1~~ **1607.3.2 Distribution of roof loads. Partial loading of roofs.** Where uniform roof *live loads* are reduced to less than 20 psf (0.96 kN/m²) in accordance with Section ~~1607.14.2.1~~ 1607.13.1 and are applied to the design of structural members arranged so as to create continuity, the reduced roof *live load* shall be applied to adjacent spans or to alternate spans, whichever produces the most unfavorable *load effect*. See Section ~~1607.14.2~~ for reductions in minimum roof *live loads* and Section 7.5 of ASCE 7 for partial snow loading.

1607.12 Reduction in uniform live loads. Except for uniform *live loads* at roofs, all other minimum uniformly distributed *live loads*, L_o , in Table 1607.1 are permitted to be reduced in accordance with Section 1607.12.1 or 1607.12.2. Uniform *live loads* at roofs are permitted to be reduced in accordance with Section ~~1607.14.2~~ 1607.13.

~~1607.14~~ **Roof loads.** The structural supports of roofs and *marquees* shall be designed to resist wind and, where applicable, snow and earthquake loads, in addition to the *dead load* of construction and the appropriate *live loads* as prescribed in this section, or as set forth in Table 1607.1. The *live loads* acting on a sloping surface shall be assumed to act vertically on the horizontal projection of that surface.

~~1607.14.2~~ **1607.13 Reduction in uniform roof live loads.** The minimum uniformly distributed *live loads* of roofs and *marquees*, L_o , in Table 1607.1 are permitted to be reduced in accordance with Section ~~1607.14.2.1~~ 1607.13.1.

~~1607.14.2.1~~ **1607.13.1 Ordinary roofs, awnings and canopies.** Ordinary flat, pitched and curved roofs, and *awnings* and canopies other than of fabric construction supported by a skeleton structure, are permitted to be designed for a reduced uniformly distributed *roof live load*, L_r , as specified in the following equations or other controlling combinations of *loads* as specified in Section 1605, whichever produces the greater *load effect*.

In structures such as *greenhouses*, where special scaffolding is used as a work surface for workers and materials during maintenance and repair operations, a lower roof *load* than specified in the following equations shall not be used unless *approved* by the *building official*. Such structures shall be designed for a minimum roof *live load* of 12 psf (0.58 kN/m²).

$$L_r = L_o R_1 R_2 \tag{Equation 16-10}$$

where: $12 \leq L_r \leq 20$

$$\text{For SI: } L_r = L_o R_1 R_2$$

where: $0.58 \leq L_r \leq 0.96$

L_o = Unreduced *roof live load* per square foot (m²) of horizontal projection supported by the member (see Table 1607.1).

L_r = Reduced *roof live load* per square foot (m^2) of horizontal projection supported by the member.

The reduction factors R_1 and R_2 shall be determined as follows:

$$R_1 = 1 \text{ for } A_t \leq 200 \text{ square feet (18.58 m}^2\text{)} \quad \text{(Equation 16-11)}$$

$$R_1 = 1.2 - 0.001A_t \text{ for } 200 \text{ square feet} \\ < A_t < 600 \text{ square feet} \quad \text{(Equation 16-12)}$$

$$R_1 = 0.6 \text{ for } A_t \geq 600 \text{ square feet (55.74 m}^2\text{)} \quad \text{(Equation 16-13)}$$

where:

A_t = Tributary area (span length multiplied by effective width) in square feet (m^2) supported by the member, and

$$R_2 = 1 \text{ for } F \leq 4 \quad \text{(Equation 16-14)}$$

$$R_2 = 1.2 - 0.05 F \text{ for } 4 < F < 12 \quad \text{(Equation 16-15)}$$

$$R_2 = 0.6 \text{ for } F \geq 12 \quad \text{(Equation 16-16)}$$

where:

F = For a sloped roof, the number of inches of rise per foot (for SI: $F = 0.12 \times$ slope, with slope expressed as a percentage), or for an arch or dome, the rise-to-span ratio multiplied by 32.

Live Preview

1607.14.2.1 Ordinary roofs, awnings and canopies.

Ordinary flat, pitched and curved roofs, and *awnings* and canopies other than of fabric construction supported by a skeleton structure, are permitted to be designed for a reduced uniformly distributed *roof live load*, L_r , as specified in the following equations or other controlling combinations of *loads* as specified in Section 1605, whichever produces the greater *load effect*.

In structures such as *greenhouses*, where special scaffolding is used as a work surface for workers and materials during maintenance and repair operations, a lower *roof load* than specified in the following equations shall not be used unless *approved* by the *building official*. Such structures shall be designed for a minimum *roof live load* of 12 psf (0.58 kN/ m^2).

$$L_r = L_o R_1 R_2 \quad \text{(Equation 16-10)}$$

where: $12 \leq L_r \leq 20$

For SI: $L_r = L_o R_1 R_2$

where: $0.58 \leq L_r \leq 0.96$

L_o = Unreduced *roof live load* per square foot (m^2) of horizontal projection supported by the member (see Table 1607.1).

L_r = Reduced *roof live load* per square foot (m^2) of horizontal projection supported by the member.

The reduction factors R_1 and R_2 shall be determined as follows:

$$R_1 = 1 \text{ for } A_t \leq 200 \text{ square feet (18.58 m}^2\text{)} \quad \text{(Equation 16-11)}$$

$$R_1 = 1.2 - 0.001A_t \text{ for } 200 \text{ square feet} \\ < A_t < 600 \text{ square feet} \quad \text{(Equation 16-12)}$$

$$R_1 = 0.6 \text{ for } A_t \geq 600 \text{ square feet (55.74 m}^2\text{)} \quad \text{(Equation 16-13)}$$

where:

A_t = Tributary area (span length multiplied by effective width) in square feet (m^2) supported by the member, and

$$R_2 = 1 \text{ for } F \leq 4 \quad \text{(Equation 16-14)}$$

$$R_2 = 1.2 - 0.05 F \text{ for } 4 < F < 12 \quad \text{(Equation 16-15)}$$

$$R_2 = 0.6 \text{ for } F \geq 12 \quad \text{(Equation 16-16)}$$

where:

F = For a sloped roof, the number of inches of rise per foot (for SI: $F = 0.12 \times$ slope, with slope expressed as a percentage), or for an arch or dome,

the rise-to-span ratio multiplied by 32.

Original Codebook Text

1607.14.2.1 Ordinary roofs, awnings and canopies.

Ordinary flat, pitched and curved roofs, and *awnings* and canopies other than of fabric construction supported by a skeleton structure, are permitted to be designed for a reduced uniformly distributed *roof live load*, L_r , as specified in the following equations or other controlling combinations of *loads* as specified in Section 1605, whichever produces the greater *load effect*.

In structures such as *greenhouses*, where special scaffolding is used as a work surface for workers and materials during maintenance and repair operations, a lower roof *load* than specified in the following equations shall not be used unless *approved* by the *building official*. Such structures shall be designed for a minimum roof live *load* of 12 psf (0.58 kN/m²).

$$L_r = L_o R_1 R_2 \quad \text{(Equation 16-10)}$$

where: $12 \leq L_r \leq 20$

For SI: $L_r = L_o R_1 R_2$

where: $0.58 \leq L_r \leq 0.96$

L_o = Unreduced *roof live load* per square foot (m²) of horizontal projection supported by the member (see Table 1607.1).

L_r = Reduced *roof live load* per square foot (m²) of horizontal projection supported by the member.

The reduction factors R_1 and R_2 shall be determined as follows:

$$R_1 = 1 \text{ for } A_t \leq 200 \text{ square feet (18.58 m}^2\text{)} \quad \text{(Equation 16-11)}$$

$$R_1 = 1.2 - 0.001A_t \text{ for } 200 \text{ square feet} \\ < A_t < 600 \text{ square feet} \quad \text{(Equation 16-12)}$$

$$R_1 = 0.6 \text{ for } A_t \geq 600 \text{ square feet (55.74 m}^2\text{)} \quad \text{(Equation 16-13)}$$

where:

A_t = Tributary area (span length multiplied by effective width) in square feet (m²) supported by the member, and

$$R_2 = 1 \text{ for } F \leq 4 \quad \text{(Equation 16-14)}$$

$$R_2 = 1.2 - 0.05 F \text{ for } 4 < F < 12 \quad \text{(Equation 16-15)}$$

$$R_2 = 0.6 \text{ for } F \geq 12 \quad \text{(Equation 16-16)}$$

where:

F = For a sloped roof, the number of inches of rise per foot (for SI: $F = 0.12 \times$ slope, with slope expressed as a percentage), or for an arch or dome, the rise-to-span ratio multiplied by 32.

SaveCancel Remove

~~1607.14.2.2~~ 1607.13.2 Occupiable roofs. Areas of roofs that are occupiable, such as *vegetative roofs*, landscaped roofs or for assembly or other similar purposes, and *marquees* are permitted to have their uniformly distributed *live loads* reduced in accordance with Section 1607.12 .

~~1607.14.3~~ 1607.14 Awnings and canopies. *Awnings* and canopies shall be designed for uniform *live loads* as required in Table 1607.1 as well as for snow *loads* and wind *loads* as specified in Sections 1608 and 1609.

~~1607.14.4~~ 1607.15 Photovoltaic panel systems. Roof structures that provide support for *photovoltaic panel systems* shall be designed in accordance with Sections ~~1607.14.4.1~~ 1607.15.1 through ~~1607.14.4.5~~ 1607.15.5, as applicable.

~~1607.14.4.1~~ 1607.15.1 Roof live load. Roof structures that support *photovoltaic panel systems* shall be designed to resist each of the following conditions:

1. Applicable uniform and concentrated roof *loads* with the *photovoltaic panel system dead loads*.

Exception: *Roof live loads* need not be applied to the area covered by *photovoltaic panels* where the clear space between the panels and the roof surface is 24 inches (610 mm) or less.

2. Applicable uniform and concentrated roof *loads* without the *photovoltaic panel system* present.

~~1607.14.4.2~~ **1607.15.2 Photovoltaic panels or modules.** The structure of a roof that supports solar *photovoltaic panels* or modules shall be designed to accommodate the full solar *photovoltaic panels* or modules and ballast *dead load*, including concentrated *loads* from support frames in combination with the *loads* from Section ~~1607.14.4.1~~ 1607.15.1 and other applicable *loads*. Where applicable, snow drift *loads* created by the *photovoltaic panels* or modules shall be included.

~~1607.14.4.3~~ **1607.15.3 Photovoltaic panels installed on open grid roof structures.** Structures with open grid framing and without a *roof deck* or sheathing supporting *photovoltaic panel systems* shall be designed to support the uniform and concentrated *roof live loads* specified in Section ~~1607.14.4.1~~ 1607.15.1, except that the uniform *roof live load* shall be permitted to be reduced to 12 psf (0.57 kN/m²).

~~1607.14.4.4~~ **1607.15.4 Ground-mounted photovoltaic (PV) panel systems or modules installed as an independent structure.** Ground-mounted photovoltaic (PV) panel systems that are independent structures and do not have accessible/occupied space underneath are not required to accommodate a roof photovoltaic *live load*. Other *loads* and combinations in accordance with Section 1605 shall be accommodated.

~~1607.14.4.5~~ **1607.15.5 Ballasted photovoltaic panel systems.** Roof structures that provide support for ballasted *photovoltaic panel systems* shall be designed, or analyzed, in accordance with Section 1604.4; checked in accordance with Section 1604.3.6 for deflections; and checked in accordance with Section 1611 for ponding.

1808.3 Design loads. Foundations shall be designed for the most unfavorable effects due to the combinations of *loads* specified in Section 2.3 or 2.4 of ASCE 7 or the alternative allowable stress design load combinations of Section 1605.2. The *dead load* is permitted to include the weight of foundations and overlying fill. Reduced *live loads*, as specified in Sections 1607.12 and ~~1607.14~~ 1607.13, shall be permitted to be used in the design of foundations.

3111.1 General. Solar energy systems shall comply with the requirements of this section.

3111.1.1 Wind resistance. Rooftop-mounted photovoltaic (PV) panel systems and solar thermal collectors shall be designed in accordance with Section 1609.

Revise as follows:

3111.1.2 Roof live load. Roof structures that provide support for solar energy systems shall be designed in accordance with Section ~~1607.14.4~~ 1607.15.

Reason Statement: This proposal is a coordination proposal to bring the 2024 IBC up to date with the provisions of the 2022 edition of ASCE/SEI 7 Minimum Design Loads and Associated Criteria for Buildings and Other Structures (ASCE/SEI 7-22). ASCE 7 will be updated to the 2022 edition from the 2016 edition as an Administrative update in the 2024 I-Codes.

These changes are proposed to improve the coordination between the IBC and ASCE 7 by aligning the organization of 1) partial loading requirements and 2) roof live load provisions.

This proposal primarily relocates requirements in Section 1607 Live Loads so that they are provided in a more logical order and so that they align with ASCE 7. General requirements for the distribution of uniform floor live loads and uniform roof live loads, also known as partial loading or pattern loading, are moved forward in Section 1607 so that they appear immediately after the introduction of uniform live loads in Section 1607.3. These requirements are better suited to appear in the beginning of the Live Load section as they are general requirements. The placement as subsections under Section 1607.3 Uniform live loads is logical as they apply to uniform loads. This location also aligns with ASCE 7.

Minor changes to the text are also made in some locations for clarity and to coordinate with the ASCE 7 text.

In Section 1607.3, the sentence added at the end is moved from existing Section 1607.14 Roof Loads as that section is deleted in the proposal (see below for why). This sentence does not just apply to roofs, it also applies to sloped ramps, and therefore it is better suited in Section 1607.3 whose scope is not limited to roofs.

Section 1607.13 is relocated to 1607.3.1 as a sub-section to the Uniform Live Load section. It is also renamed to better describe the content. This section deals with selectively applying the uniform live load, or pattern loading, and therefore is more appropriately located directly after the uniform live load section.

Section 1607.14 Roof Loads is deleted except for one sentence that was moved to Section 1607.3 as described above. There is no need for a stand alone Roof Loads section as roof live loads are contained in Table 1607.1 just like all the other live loads. In addition, most of the text in 1607.14 references other loads, wind, snow, earthquake, and dead, which has no place in the Live Load section. These loads have their own sections in the IBC, and there is also a section (Load Combinations) that governs how to combine the different loads.

Section 1607.14.1 is also relocated as a sub-section to the Uniform Live Load section, as new Section 1607.3.2. This section deals with roof pattern live loading and is more appropriately located after the uniform live load section.

The remainder of the changes are section number changes that are the result of moving the two sections on load distribution, 1607.3 and 1607.14.1, and deleting the Roof Load section, 1607.14. The uniform roof live load reduction provision get their own section, Section 1607.13, awnings and

canopies get Section 1607.14, and the photovoltaic panel systems get Section 1607.14.

Due to an issue with cdpAccess not formatting existing Section 1607.14.2.1 correctly, a Word file is attached to this proposal that correctly shows the new section number for this section and shows it in its new location.

Cost Impact: The code change proposal will not increase or decrease the cost of construction
The proposal contains ASCE 7 alignment and coordination changes.

S92-22

S94-22

IBC: 1607.5

Proponents: Jennifer Goupil, representing Structural Engineering Institute of ASCE (jgoupil@asce.org)

2021 International Building Code

Revise as follows:

1607.5 Partition loads. In office buildings and in other buildings where partition locations are subject to change, provisions for partition weight shall be made, whether or not partitions are shown on the construction documents, ~~unless the specified live load is 80 psf (3.83 kN/m²) or greater.~~ The partition load shall be not less than a ~~uniformly distributed~~ live load of 15 psf (0.72 kN/m²) ~~and shall not be reduced per Section 1607.12.~~

Exception: A partition live load is not required where the minimum specified live load is 80 psf (3.83 kN/m²) or greater.

Reason Statement: This proposal is a coordination proposal to bring the 2024 IBC up to date with the provisions of the 2022 edition of ASCE/SEI 7 Minimum Design Loads and Associated Criteria for Buildings and Other Structures (ASCE/SEI 7-22). ASCE 7 will be updated to the 2022 edition from the 2016 edition as an Administrative update in the 2024 I-Codes.

These changes are proposed to improve the coordination between the IBC and ASCE 7.

This proposal moves the exception that is embedded within the text and places it at the end of the section in the typical format for exceptions in the IBC. It also removes the words "uniformly distributed" as they are unnecessary. The indicated 15 psf live load is by nature of the units, a uniform load.

This proposal does not change the technical requirements of the section. The proposed clarification regarding live load reduction was added in the 2022 edition of ASCE 7. The following text is part of the reason statement contained in the ASCE 7 proposal:

"On November 7th, 2018, Dr. Ross Corotis and James R Harris met with the Dead and Live Load Subcommittee and confirmed that when partition loads were added to ASCE 7 they were not considered to be reducible. The current ASCE 7 language leaves room for interpretation, therefore the subcommittee felt that further clarification was needed. Dr. Ross Corotis is a co-author for various articles in structural engineering journals that eventually become the live load reduction theory that is currently found in ASCE 7. These articles include "Probability Model for Design Live Loads" and "Area-Dependent Processes for Structural Live Loads" in the Journal of the Structural Division, in October 1980 and May 1981 respectively, which are references in the Live Load Commentary. Neither of those studies provide any basis for reduction of partition loads. In office buildings and in other buildings where partition locations are subject to change, partitions are often moved around without consulting a structural engineer. Since a new tenant might cluster partitions differently than the last tenant, preparing for the worst-case load for the life of the building is recommended. "

Cost Impact: The code change proposal will not increase or decrease the cost of construction. Improving coordination with ASCE 7 is not expected to effect the cost of construction.

S94-22

S95-22

IBC: 1607.6

Proponents: John Grenier, representing National Council of Structural Engineers Associations (NCSEA) (jgrenier@greniereng.com); Erik Madsen, representing NCSEA (erik@madsenengineering.com)

2021 International Building Code

Revise as follows:

1607.6 Helipads. Helipads shall be designed for the following *live loads*:

1. A uniform *live load*, *L*, as specified in Items 1.1 and 1.2. This *load* shall not be reduced.
 - 1.1. 40 psf (1.92 kN/m²) where the design basis helicopter has a maximum take-off weight of 3,000 pounds (13.35 kN) or less.
 - 1.2. 60 psf (2.87 kN/m²) where the design basis helicopter has a maximum take-off weight greater than 3,000 pounds (13.35 kN).
2. A single concentrated *live load*, *L*, of 3,000 pounds (13.35 kN) applied over an area of 4.5 inches by 4.5 inches (114 mm by 114 mm) and located so as to produce the maximum *load effects* on the structural elements under consideration. The concentrated *load* is not required to act concurrently with other uniform or concentrated *live loads*.
3. Two single concentrated *live loads*, *L*, 8 feet (2438 mm) apart applied on the landing pad (representing the helicopter's two main landing gear, whether skid type or wheeled type), each having a magnitude of 0.75 times the maximum take-off weight of the helicopter, and located so as to produce the maximum *load effects* on the structural elements under consideration. The concentrated loads shall be applied over an area of 8 inches by 8 inches (203 mm by 203 mm) and are not required to act concurrently with other uniform or concentrated *live loads*.

~~Landing areas designed for a design basis helicopter with Helipads shall be marked to indicate the maximum take-off weight of 3,000 pounds (13.35 kN) shall be identified with a 3,000-pound (13.34 kN) weight limitation. The take-off landing area weight limitation shall be indicated in units of thousands of pounds and placed in a box that is by the numeral "3" (kips) located in the bottom right corner of the landing area as viewed from the primary approach path. The indication for the landing area weight limitation box shall be a minimum 5 feet (1524 mm) in height.~~

Staff Analysis: CC# S95-22 and CC# S96-22 addresses requirements in a different or contradicting manner. The committee is urged to make their intentions clear with their actions on these proposals.

Reason Statement: To extend the marking requirements to all helipads and not just helipads with a maximum take-off weight of 3,000 pounds. In review of the current requirements and the commentary it is not clear as to why only helipads with a maximum take-off weight of 3,000 lbs are required to have markings identifying the weight limitations. Helipads for design weights greater than or less than 3,000 lbs should also have the weight limitations identified.

FAA Advisory Circular AC No. 150/5390-2C (2012) provides standards for the design of heliports serving helicopters with single rotors. Sections 215(b), 314(b), and 414(b) of the FAA Advisory Circular contain marking requirements for the touchdown and lift-off (TLOF) area for heliports. The proposed changes to the marking requirements are consistent with the FAA Advisory Circular.

For General Aviation identification symbols (Figure 2-23 AC No. 150/5390-2C) the symbol is a 5ft square "box". The term "box" is used within the Circular and applied to this proposal. Marking requirements within the box are not contained in current IBC language and based on current IBC commentary standard practice.

Bibliography: FAA Advisory Circular AC No. 150/5390-2C (2012) https://www.faa.gov/airports/resources/advisory_circulars/index.cfm/go/document.current/documentNumber/150_5390-2

Cost Impact: The code change proposal will increase the cost of construction. The cost of construction will be marginally increase by this change. The additional cost for paint making the weight limitation, while most often already in practice, will be required for all helipads.

S95-22

S96-22

IBC: 1607.6

Proponents: John Grenier, representing National Council of Structural Engineers Associations (NCSEA) (jgrenier@greniereng.com); Erik Madsen, representing NCSEA (erik@madsenengineering.com)

2021 International Building Code

Revise as follows:

1607.6 Helipads. Helipads shall be designed for the following *live loads*:

1. A uniform *live load*, *L*, as specified in Items 1.1 and 1.2. This *load* shall not be reduced.
 - 1.1. 40 psf (1.92 kN/m²) where the design basis helicopter has a maximum take-off weight of 3,000 pounds (13.35 kN) or less.
 - 1.2. 60 psf (2.87 kN/m²) where the design basis helicopter has a maximum take-off weight greater than 3,000 pounds (13.35 kN).
2. A single concentrated *live load*, *L*, of 3,000 pounds (13.35 kN) applied over an area of 4.5 inches by 4.5 inches (114 mm by 114 mm) and located so as to produce the maximum *load effects* on the structural elements under consideration. The concentrated *load* is not required to act concurrently with other uniform or concentrated *live loads*.
3. Two single concentrated *live loads*, *L*, 8 feet (2438 mm) apart applied on the landing pad (representing the helicopter's two main landing gear, whether skid type or wheeled type), each having a magnitude of 0.75 times the maximum take-off weight of the helicopter, and located so as to produce the maximum *load effects* on the structural elements under consideration. The concentrated loads shall be applied over an area of 8 inches by 8 inches (203 mm by 203 mm) and are not required to act concurrently with other uniform or concentrated *live loads*.

~~Landing areas designed for a design basis helicopter with maximum take-off weight of 3,000 pounds (13.35 kN) shall be identified with a 3,000-pound (13.34 kN) weight limitation. The landing area weight limitation shall be indicated by the numeral "3" (kips) located in the bottom right corner of the landing area as viewed from the primary approach path. The indication for the landing area weight limitation shall be a minimum 5 feet (1524 mm) in height. Helipads shall be marked to indicate the maximum take-off weight in accordance with the standards and specifications required by the jurisdiction having authority for the design and construction of helipads in the same location of the structure.~~

Staff Analysis: CC# S95-22 and CC# S96-22 addresses requirements in a different or contradicting manner. The committee is urged to make their intentions clear with their actions on these proposals.

Reason Statement: To provide uniform and consistent marking requirements for helipads.

FAA Advisory Circular AC No. 150/5390-2C (2012) provides standards for the design of heliports serving helicopters with single rotors. Section 215(b) of the circular states:“(b) TLOF weight limitations. If a TLOF has limited weight-carrying capability, mark it with the maximum takeoff weight of the design helicopter, in units of thousands of pounds, as shown in Figure 2–23. Do not use metric equivalents for this purpose. Center this marking in the upper section of a TLOF size/weight limitation box. If the TLOF does not have a weight limit, add a diagonal line, extending from the lower left hand corner to the upper right hand corner, to the upper section of the TLOF size/weight limitation box. See Figure 2–23.”

The marking requirements from the FAA are more than just simply providing the Take-off design limit currently shown in the IBC. While the IBC commentary does make reference that the marking is a standard practice, to avoid any misleading or incomplete language within the IBC the specifics for the marking requirements are removed from the code.

It is recommended that the commentary include reference to the FAA Circular, similar to what was done for heavy vehicle loads and the reference to AASHTO in the commentary in section 1607.8.1.

Cost Impact: The code change proposal will not increase or decrease the cost of construction. Marking is already a requirement for helipads.

S96-22

S97-22

IBC: 1607.7

Proponents: Jennifer Goupil, representing Structural Engineering Institute of ASCE (jgoupil@asce.org)

2021 International Building Code

Revise as follows:

1607.7 Passenger vehicle garages. Floors in garages ~~or~~ and portions of a building used for the storage of motor vehicles shall be designed for the uniformly distributed *live loads* indicated in Table 1607.1 or the following concentrated *load*:

1. For garages restricted to passenger vehicles accommodating not more than nine passengers, 3,000 pounds (13.35 kN) acting on an area of 4.5 inches by 4.5 inches (114 mm by 114 mm).
2. For mechanical parking structures without slab or deck that are used for storing passenger vehicles only, 2,250 pounds (10 kN) per wheel.

Reason Statement: This proposal is a coordination proposal to bring the 2024 IBC up to date with the provisions of the 2022 edition of ASCE/SEI 7 Minimum Design Loads and Associated Criteria for Buildings and Other Structures (ASCE/SEI 7-22). ASCE 7 will be updated to the 2022 edition from the 2016 edition as an Administrative update in the 2024 I-Codes.

This proposal makes a change to coordinate with the 2022 edition of ASCE 7. The proposal replaces "or" with "and" as the intent is to require **both** 1) garage floors and 2) portions of a building floor used for the storage of motor vehicles, to be designed for the indicated live loads.

Cost Impact: The code change proposal will not increase or decrease the cost of construction. Making the text more clear and improving coordination with ASCE 7 is not expected to effect the cost of construction.

S97-22

S98-22

IBC: 1607.8, 1607.8.1, 1607.8.2

Proponents: Jennifer Goupil, representing Structural Engineering Institute of ASCE (jgoupil@asce.org)

2021 International Building Code

1607.8 Heavy vehicle loads. Floors and other surfaces that are intended to support vehicle *loads* greater than a 10,000-pound (4536 kg) gross vehicle weight rating shall comply with Sections 1607.8.1 through 1607.8.5.

1607.8.1 Loads. Where any structure does not restrict access for vehicles that exceed a 10,000-pound (4536 kg) gross vehicle weight rating, those portions of the structure subject to such *loads* shall be designed using the vehicular *live loads*, including consideration of impact and fatigue, in accordance with the codes and specifications required by the jurisdiction having authority for the design and construction of the roadways and bridges in the same location of the structure.

Revise as follows:

1607.8.2 Fire truck and emergency vehicles. Where a structure or portions of a structure are accessed ~~and loaded~~ by fire department ~~access~~ vehicles and other similar emergency vehicles, those portions of the structure subject to such loads shall be designed for the greater of the following *loads*:

1. The actual operational *loads*, including outrigger reactions and contact areas of the vehicles as stipulated and *approved by the building official*.
2. The live loading specified in Section 1607.8.1.

Emergency vehicle loads need not be assumed to act concurrently with other uniform *live loads*.

Reason Statement: This proposal is a coordination proposal to bring the 2024 IBC up to date with the provisions of the 2022 edition of ASCE/SEI 7 Minimum Design Loads and Associated Criteria for Buildings and Other Structures (ASCE/SEI 7-22). ASCE 7 will be updated to the 2022 edition from the 2016 edition as an Administrative update in the 2024 I-Codes.

This proposal revises the text of Section 1607.8.2 to coordinate with ASCE 7. The 2022 edition of ASCE 7 has added live loads due to fire truck and emergency vehicles.

The proposed changes to the first paragraph also coordinate with the text of the preceding section, Section 1607.8.1 by using the phrases "those portions of" and "subject to such loads". The text, "and loaded", is deleted as it is unnecessary with the use of the "subject to such loads". It is noted that the "and loaded" text is also redundant as it is used, if a vehicle accesses a portion of the structure, it will also load that portion of the structure.

The additional text at the end of the section adds clarity for the application of the live loads. The operational loads of fire trucks and emergency vehicles are significant loads and do not need to be combined with other uniform live loads.

Cost Impact: The code change proposal will not increase or decrease the cost of construction. Reorganizing text and improving coordination with ASCE 7 is not expected to effect the cost of construction.

S98-22

S99-22

IBC: SECTION 106, [A] 106.1, [A] 106.2, [A] 106.3, 1607.8.5

Proponents: Mike Nugent, representing Building Code Action Committee (bcac@iccsafe.org)

2021 International Building Code

Delete without substitution:

SECTION 106 FLOOR AND ROOF DESIGN LOADS

~~[A] 106.1 Live loads posted.~~ In commercial or industrial buildings, for each floor or portion thereof designed for *live loads* exceeding 50 psf (2.40 kN/m²), such design *live loads* shall be conspicuously posted by the owner or the owner's authorized agent in that part of each story in which they apply, using durable signs. It shall be unlawful to remove or deface such notices.

~~[A] 106.2 Issuance of certificate of occupancy.~~ A certificate of occupancy required by Section 111 shall not be issued until the floor load signs, required by Section 106.1, have been installed.

~~[A] 106.3 Restrictions on loading.~~ It shall be unlawful to place, or cause or permit to be placed, on any floor or roof of a building, structure or portion thereof, a *load* greater than is permitted by this code.

Revise as follows:

1607.8.5 Posting. The maximum weight of vehicles allowed into or on a garage or other structure shall be posted on a durable sign in a readily visible location at the vehicle entrance of the building or other approved location by the owner or the owner's authorized agent in accordance with Section 106.1.

Reason Statement: This proposal addresses the concerns expressed during testimony on a similar change last cycle. S52-19 attempted to move this signage requirement back to Chapter 16. This section was moved to the administrative provisions from structural by S48-07/08. The structural committee felt that this sign did not belong with the loading provisions in Chapter 16. There was testimony stating that the signage for live loads exceeding 50 pounds was an erroneous requirement. Signage requirements do not belong in the administrative provisions and none are found in any of the Administrative requirements in any of the other codes. Therefore, this proposal to delete the sign that was considered ineffective out of Chapter 1, and add a clarification of the requirements for the vehicle loading in Section 107.7.5 where it currently exists. This proposal is submitted by the ICC Building Code Action Committee (BCAC).

BCAC was established by the ICC Board of Directors in July 2011 to pursue opportunities to improve and enhance assigned International Codes or portions thereof. In 2020 and 2021 the BCAC has held several virtual meetings open to any interested party. In addition, there were numerous virtual Working Group meetings for the current code development cycle, which included members of the committee as well as interested parties. Related documents and reports are posted on the BCAC website at <https://www.iccsafe.org/products-and-services/i-codes/code-development/cs/building-code-action-committee-bcac/>.

Cost Impact: The code change proposal will decrease the cost of construction
Eliminates signage in some areas.

S99-22

S100-22

IBC: 1607.9.1

Proponents: Jennifer Goupil, representing Structural Engineering Institute of ASCE (jgoupil@asce.org)

2021 International Building Code

Revise as follows:

1607.9.1 Handrails and guards. *Handrails* and *guards* shall be designed to resist a linear *load* of 50 pounds per linear foot (plf) (0.73 kN/m) in accordance with Section 4.5.1.1 of ASCE 7. Glass *handrail* assemblies and *guards* shall comply with Section 2407.

Exceptions:

1. For one- and two-family dwellings, only the single concentrated *load* required by Section 1607.9.1.1 shall be applied.
2. In Group I-3, F, H and S occupancies, for areas that are not accessible to the general public and that have an *occupant load* less than 50, the minimum *load* shall be 20 pounds per foot (0.29 kN/m).
3. For roofs not intended for occupancy, only the single concentrated *load* required by Section 1607.9.1.1 shall be applied.

Reason Statement: This proposal is a coordination proposal to bring the 2024 IBC up to date with the provisions of the 2022 edition of ASCE/SEI 7 Minimum Design Loads and Associated Criteria for Buildings and Other Structures (ASCE/SEI 7-22). ASCE 7 will be updated to the 2022 edition from the 2016 edition as an Administrative update in the 2024 I-Codes.

This proposal adds an exception to the requirement to design handrails and guards for the 50 plf load to coordinate with ASCE 7. The proposed exception was added to ASCE 7 for the 2022 edition.

Unoccupied rooftops are not factory, industrial, or storage occupancies and therefore do not currently qualify for what is in essence a reduced load; however, unoccupied roofs have, at most, a few maintenance workers on them at intermittent times and arguably pose less of a hazard than rails at one- and two-family dwellings and the other occupancies to which this exception currently applies. Unoccupied rooftop areas meet the two other requirements -- namely that they are areas not accessible to the public and serve an occupant load not greater than 50.

Note, the term "roofs not intended for occupancy" is proposed as it coordinates with the terminology used in the live load table.

Cost Impact: The code change proposal will not increase or decrease the cost of construction

This proposal has the possibility of reducing design and construction costs where the new exception applies.

S100-22

S101-22

IBC: 1607.9, 1607.9.1.1, 1607.9.1

Proponents: John Grenier, representing National Council of Structural Engineers Associations (NCSEA) (jgrenier@greniereng.com); Erik Madsen, representing NCSEA (erik@madsenengineering.com); Edwin Huston, representing NCSEA (huston@smithhustoninc.com)

2021 International Building Code

1607.9 Loads on handrails, guards, grab bars and seats. *Handrails* and *guards* shall be designed and constructed for the structural loading conditions set forth in Section 1607.9.1. Grab bars, shower seats and accessible benches shall be designed and constructed for the structural loading conditions set forth in Section 1607.9.2.

Revise as follows:

~~1607.9.1.1 Concentrated load~~ **Handrails and guards.** *Handrails* and *guards* shall be designed to resist a concentrated *load* of 200 pounds (0.89 kN) in accordance with Section 4.5.1 of ASCE 7. Glass handrail assemblies and guards shall comply with Section 2407.

~~1607.9.1.1 Handrails and guards~~ **Uniform Load.** *Handrails* and *guards* shall be designed to resist a linear *load* of 50 pounds per linear foot (plf) (0.73 kN/m) in accordance with Section 4.5.1.1 of ASCE 7. ~~Glass handrail assemblies and guards shall comply with Section 2407. This load need not be assumed to act concurrently with the concentrated load specified in Section 1607.9.1~~

Exceptions:

1. For one- and two-family dwellings, only the single concentrated *load* required by Section 1607.9.1.1 shall be applied.
2. In Group I-3, F, H and S occupancies, for areas that are not accessible to the general public and that have an *occupant load* less than 50, the minimum *load* shall be 20 pounds per foot (0.29 kN/m).

Reason Statement: The purpose for the proposed changes are two fold.

First, the intent is to clarify that the uniform load and concentrated load need not be applied concurrently. While it is contained within the ASCE 7 language that the concentrated and uniform guard loads are not concurrent, there was seen as a need to reinforce this requirement in the language within the IBC.

Second, the text was modified to be consistent with section 4.5.1 of ASCE 7. The order of the loading requirements in IBC is changed to match the order within ASCE 7. The concentrated load will be presented first, with the uniform load, and the limitations on the uniform load, will be moved to the subsection. The technical design requirements are not being changed. The editorial modifications are being proposed to make the two loads more clearly defined.

Cost Impact: The code change proposal will not increase or decrease the cost of construction
The proposed change is editorial and to provide consistency between the IBC and referenced standards.

S101-22

S102-22

IBC: 1607.9.1.2, 1607.9.1.2.1 (New)

Proponents: John Grenier, representing National Council of Structural Engineers Associations (NCSEA) (jgrenier@greniereng.com); Erik Madsen, representing NCSEA (erik@madsenengineering.com)

2021 International Building Code

Revise as follows:

1607.9.1.2 Guard component loads. Balusters, panel fillers and guard infill components, including all rails, wires and cables except the handrail and the top rail, shall be designed to resist a horizontally applied concentrated load of 50 pounds (0.22 kN), distributed in accordance with Section 4.5.1.2 of ASCE 7.

Add new text as follows:

1607.9.1.2.1 Barrier Cable Systems. For wire or cable used as guard infill components of a pedestrian barrier / protection system, the wires or cables shall be tightened or stressed sufficient to prevent a sphere with a diameter equivalent to the opening limitations of Section 1015.4 from passing through the barrier when the component force is applied to the sphere. The 50 pound (0.22 kN) component force applied to an individual opening sphere may be divided by the number of wires or cables within a 12 inch (305 mm) width.

Reason Statement: The use of barrier cable systems for guards is widely used. The criteria for how to apply the component force to design or test the cable stressing however is not currently in the code or referenced standards.

The purpose of the proposed change is to address the unique aspect of cable rail systems in order to provide guidance for the amount of tension required on the infill cables to prevent splaying of the cables beyond the code opening limitation. Currently the 50 pound infill load per ASCE 7 Section 4.5.1.2 is applied on an area not to exceed 12 in. by 12 in., including openings. If the force is applied to a flat plate applied to the cables then the effect of cables splaying will not be captured. The new text clarifies that that the load for design and testing of a cable system should be applied to the individual sphere or cone and would be reduced by the number of cables in the test area.

Cost Impact: The code change proposal will not increase or decrease the cost of construction

The intent of the code change is to capture the state of the practice for cable systems and properly designed systems already meet the proposed changes.

S102-22

S103-22

IBC: 1607.17, 1607.10, 1607.11

Proponents: Jennifer Goupil, representing Structural Engineering Institute of ASCE (jgoupil@asce.org)

2021 International Building Code

Revise as follows:

~~1607.17~~ **1607.10 Fixed ladders.** Fixed ladders with rungs shall be designed to resist a single concentrated *load* of 300 pounds (1.33 kN) in accordance with Section 4.5.4 of ASCE 7. Where rails of fixed ladders extend above a floor or platform at the top of the ladder, each side rail extension shall be designed to resist a single concentrated *load* of 100 pounds (0.445 kN) in accordance with Section 4.5.4 of ASCE 7. Ship's ladders shall be designed to resist the *stair loads* given in Table 1607.1.

~~1607.10~~ **1607.11 Vehicle barriers.** *Vehicle barriers* for passenger vehicles shall be designed to resist a concentrated *load* of 6,000 pounds (26.70 kN) in accordance with Section 4.5.3 of ASCE 7. Garages accommodating trucks and buses shall be designed in accordance with an *approved* method that contains provisions for traffic railings.

~~1607.11~~ **1607.12 Impact loads.** The *live loads* specified in Sections 1607.3 through ~~1607.10~~ 1607.11 shall be assumed to include adequate allowance for ordinary impact conditions. Provisions shall be made in the structural design for uses and loads that involve unusual vibration and impact forces.

Reason Statement: This proposal is a coordination proposal to bring the 2024 IBC up to date with the provisions of the 2022 edition of ASCE/SEI 7 Minimum Design Loads and Associated Criteria for Buildings and Other Structures (ASCE/SEI 7-22). ASCE 7 will be updated to the 2022 edition from the 2016 edition as an Administrative update in the 2024 I-Codes.

This proposal moves the Fixed Ladders live load section in order to place it under the umbrella of the live loads considered to include allowance for ordinary impact conditions by the Impact Loads section. This change coordinates with how ASCE 7 treats fixed ladder live loads.

No technical changes are made to the live load values. Subsequent sections will need to be renumbered.

Cost Impact: The code change proposal will not increase or decrease the cost of construction

It is not likely that designers are increasing fixed ladder loads to account for impact, but if they are, this would decrease the cost of construction.

S103-22

S105-22

IBC: 1607.12.1.2, 1607.12.1.3

Proponents: Jennifer Goupil, representing Structural Engineering Institute of ASCE (jgoupil@asce.org)

2021 International Building Code

Revise as follows:

1607.12.1.2 Heavy live loads. *Live loads* that exceed 100 psf (4.79 kN/m²) shall not be reduced.

Exceptions:

1. The *live loads* for members supporting two or more floors are permitted to be reduced by not greater than 20 percent, but the reduced live load shall be not less than *L* as calculated in Section 1607.12.1.
2. For uses other than storage, where *approved*, additional *live load* reductions shall be permitted where shown by the *registered design professional* that a rational approach has been used and that such reductions are warranted.

1607.12.1.3 Passenger vehicle garages. The *live loads* shall not be reduced in passenger vehicle garages.

Exception: The *live loads* for members supporting two or more floors are permitted to be reduced by not greater than 20 percent, but the reduced live load ~~be~~ shall be not less than *L* as calculated in Section 1607.12.1.

Reason Statement: This proposal is a coordination proposal to bring the 2024 IBC up to date with the provisions of the 2022 edition of ASCE/SEI 7 Minimum Design Loads and Associated Criteria for Buildings and Other Structures (ASCE/SEI 7-22). ASCE 7 will be updated to the 2022 edition from the 2016 edition as an Administrative update in the 2024 I-Codes.

The proposal adds the word "reduced" in front of live load in two places to coordinate the IBC text with the ASCE 7 text. The text should indicate the "reduced live load" as it is the reduced value from these two sections (limited to a maximum 20% reduction) that is required to be compared to "L" in Section 1607.12.1. The proposal also deletes an extraneous "be" in the exception.

Cost Impact: The code change proposal will not increase or decrease the cost of construction
Editorial changes for clarity.

S105-22

S106-22

IBC: 1607.12.2

Proponents: Jennifer Goupil, representing Structural Engineering Institute of ASCE (jgoupil@asce.org)

2021 International Building Code

Revise as follows:

1607.12.2 Alternative uniform live load reduction. As an alternative to Section 1607.12.1 and subject to the limitations of Table 1607.1, uniformly distributed *live loads* are permitted to be reduced in accordance with the following provisions. Such reductions shall apply to slab systems, beams, girders, columns, piers, walls and foundations.

1. For *live loads* not exceeding 100 psf (4.79 kN/m²), the design *live load* for structural members supporting 150 square feet (13.94 m²) or more is permitted to be reduced in accordance with Equation 16-8.

$$R = 0.08(A - 150) \quad \text{(Equation 16-8)}$$

For SI: $R = 0.861(A - 13.94)$

where:

A = Area of floor supported by the member, square feet (m²).

R = Reduction in percent.

Such reduction shall not exceed the smallest of:

- 1.1 40 percent for members supporting one floor.
- 1.2 60 percent for members supporting two or more floors.
- 1.3 R as determined by the following equation:

$$R = 23.1(1 + D/L_a) \quad \text{(Equation 16-9)}$$

where:

D = Dead load per square foot (m²) of area supported.

L_a = Unreduced *live load* per square foot (m²) of area supported.

2. A reduction shall not be permitted where the *live load* exceeds 100 psf (4.79 kN/m²) except that the design *live load* for members supporting two or more floors is permitted to be reduced by not greater than 20 percent.

Exception: For uses other than storage, where *approved*, additional *live load* reductions shall be permitted where shown by the registered design professional that a rational approach has been used and that such reductions are warranted.

3. A reduction shall not be permitted in passenger vehicle parking garages except that the *live loads* for members supporting two or more floors are permitted to be reduced by not greater than 20 percent.
4. For one-way slabs, the area, A , for use in Equation 16-8 shall not exceed the product of the slab span and a width normal to the span of 0.5 times the slab span.

- ~~1. A reduction shall not be permitted where the *live load* exceeds 100 psf (4.79 kN/m²) except that the design *live load* for members supporting two or more floors is permitted to be reduced by not greater than 20 percent.~~

~~**Exception:** For uses other than storage, where *approved*, additional *live load* reductions shall be permitted where shown by the registered design professional that a rational approach has been used and that such reductions are warranted.~~

- ~~2. A reduction shall not be permitted in passenger vehicle parking garages except that the *live loads* for members supporting two or more floors are permitted to be reduced by not greater than 20 percent.~~
- ~~3. For *live loads* not exceeding 100 psf (4.79 kN/m²), the design *live load* for any structural member supporting 150 square feet (13.94 m²) or more is permitted to be reduced in accordance with Equation 16-8~~

4. For one-way slabs, the area, A , for use in Equation 16-8 shall not exceed the product of the slab span and a width normal to the span of 0.5 times the slab span.

$$R = 0.09(A - 150)$$

(Equation 16-8)

$$\text{For SI: } R = 0.861(A - 13.94)$$

Such reduction shall not exceed the smallest of:

1. 40 percent for members supporting one floor.
2. 60 percent for members supporting two or more floors.
3. R as determined by the following equation:

$$R = 23.1(1 + D/L_o)$$

(Equation 16-9)

where:

A = Area of floor supported by the member, square feet (m^2).

D = Dead load per square foot (m^2) of area supported.

L_o = Unreduced live load per square foot (m^2) of area supported.

R = Reduction in percent.

Reason Statement: This proposal reorganizes the alternative live load reduction provisions (Section 1607.12.2) into a more logical order that aligns with both the historical format of these provisions and the format of the basic live load reduction provisions (Section 1607.12.1). The current order places the actual live load reduction equation at the end of the section, after the qualifications and limitations. This places the proverbial cart before the horse.

Currently Section 1607.12.2 lists four numbered items, then presents the reduction equation, the equation limitations, and the symbol definitions. This organization has caused confusion as it appears the equation and related information is a part of Item 4.

The reorganization moves Item 3 to Item 1 as Item 1 is the general requirement and it directly references the reduction equation. The reduction equation, its limitations, and the symbol definitions are then incorporated into Item 1. Placing the equation into the first item is more logical and mirrors the layout of the basic live load reduction requirement in Section 1607.12.1. It also aligns with the historical format from ANSI A58.1, *Building Code Requirements for Minimum Design Loads in Buildings and Other Structures*, which listed the rate of live load reduction first, before any limitations.

The other existing items are then simply renumbered and reference back to the previously provided equation as necessary.

This proposal does not change the technical requirements of the section. There is a minor change as the word "any", in front of "structural member", was removed from Item 3 (now Item 1). The word "any" in this case is unnecessary, it also does appear in the corresponding location in Section 1607.12.

Cost Impact: The code change proposal will not increase or decrease the cost of construction
No technical changes are included in this proposal.

S106-22

S107-22

IBC: 1607.12.1, 1607.12.1.1, 1607.12.1.2, 1607.12.1.3, 1607.12.2

Proponents: Jennifer Goupil, representing Structural Engineering Institute of ASCE (jgoupil@asce.org)

2021 International Building Code

1607.12.1 Basic uniform live load reduction. Subject to the limitations of Sections 1607.12.1.1 through 1607.12.1.3 and Table 1607.1, members for which a value of $K_{LL}A_T$ is 400 square feet (37.16 m²) or more are permitted to be designed for a reduced uniformly distributed *live load*, L , in accordance with the following equation:

$$L = L_o \left(0.25 + \frac{15}{\sqrt{K_{LL}A_T}} \right) \quad \text{(Equation 16-7)}$$

For SI:

$$L = L_o \left(0.25 + \frac{4.57}{\sqrt{K_{LL}A_T}} \right)$$

where:

L = Reduced design *live load* per square foot (m²) of area supported by the member.

L_o = Unreduced design *live load* per square foot (m²) of area supported by the member (see Table 1607.1).

K_{LL} = *Live load* element factor (see Table 1607.12.1).

A_T = Tributary area, in square feet (m²).

L shall be not less than $0.50L_o$ for members supporting one floor and L shall be not less than $0.40L_o$ for members supporting two or more floors.

1607.12.1.1 One-way slabs. The tributary area, A_T , for use in Equation 16-7 for one-way slabs shall not exceed an area defined by the slab span times a width normal to the span of 1.5 times the slab span.

Revise as follows:

1607.12.1.2 Heavy live loads. *Live loads* that exceed 100 psf (4.79 kN/m²) shall not be reduced.

Exceptions:

1. The *live loads* for members supporting two or more floors are permitted to be reduced by not greater than 20 percent, but the *live load* shall be not less than L as calculated in Section 1607.12.1.
2. For uses other than storage, where *approved*, additional *live load* reductions shall be permitted where shown by the *registered design professional* that a rational approach has been used and that such reductions are warranted.

1607.12.1.3 Passenger vehicle garages. The *live loads* shall not be reduced in passenger vehicle garages.

Exception: The *live loads* for members supporting two or more floors are permitted to be reduced by not greater than 20 percent, but the *live load* shall be not less than L as calculated in Section 1607.12.1.

Revise as follows:

1607.12.2 Alternative uniform live load reduction. As an alternative to Section 1607.12.1 and subject to the limitations of Table 1607.1, uniformly distributed *live loads* are permitted to be reduced in accordance with the following provisions. Such reductions shall apply to slab systems, beams, girders, columns, piers, walls and foundations.

1. A reduction shall not be permitted where the *live load* exceeds 100 psf (4.79 kN/m²) except that the design *live load* for members supporting two or more floors is permitted to be reduced by not greater than 20 percent.

Exception: For uses other than storage, where *approved*, additional *live load* reductions shall be permitted where shown by the *registered design professional* that a rational approach has been used and that such reductions are warranted.

2. A reduction shall not be permitted in passenger vehicle parking garages except that the *live loads* for members supporting two or more floors are permitted to be reduced by not greater than 20 percent.
3. For *live loads* not exceeding 100 psf (4.79 kN/m²), the design *live load* for any structural member supporting 150 square feet (13.94 m²) or more is permitted to be reduced in accordance with Equation 16-8

4. For one-way slabs, the area, A , for use in Equation 16-8 shall not exceed the product of the slab span and a width normal to the span of 0.5 times the slab span.

$$R = 0.08(A - 150) \quad \text{(Equation 16-8)}$$

For SI: $R = 0.861(A - 13.94)$

Such reduction shall not exceed the smallest of:

1. 40 percent for members supporting one floor.
2. 60 percent for members supporting two or more floors.
3. R as determined by the following equation:

$$R = 23.1(1 + D/L_o) \quad \text{(Equation 16-9)}$$

where:

A = Area of floor supported by the member, square feet (m^2).

D = Dead load per square foot (m^2) of area supported.

L_o = Unreduced live load per square foot (m^2) of area supported.

R = Reduction in percent.

Reason Statement: This proposal is a coordination proposal to bring the 2024 IBC up to date with the provisions of the 2022 edition of ASCE/SEI 7 Minimum Design Loads and Associated Criteria for Buildings and Other Structures (ASCE/SEI 7-22). ASCE 7 will be updated to the 2022 edition from the 2016 edition as an Administrative update in the 2024 I-Codes.

These changes are proposed to 1) improve the coordination between the IBC and ASCE 7 and 2) remove a vague and unnecessary exception to the live load reduction provisions that applies to live loads that exceed 100 psf. The exception appears in two places and is proposed to be deleted in both places.

The exception is unnecessary as it is essentially a repeat of the alternative materials, design, and methods provision in Section 104.11. Section 104.11 already allows the building official to approve an alternative design and therefore this exception in Chapter 16 is redundant. If this exception contained additional requirements or further detail above what is contained in Section 104.11, such as specific information required be submitted to the building official, then the exception would have value. However the exception is nonspecific, simply requiring a registered design professional to use a "rational approach" and to show that the reductions are "warranted". This offers little guidance to the building official in their review of the registered design professionals submittal.

This exception is not contained in ASCE 7 and it does not appear that it was reviewed by ASCE 7 technical committees even though live loads and live load reduction provisions are contained and maintained in ASCE 7. Removing this exception will coordinate with ASCE 7.

This exception first appeared in the 2006 edition of the IBC for the basic live load reduction provisions and in the 2009 edition for the alternative live load provisions.

The reason statement in the ICC proposal that resulted in the inclusion of this exception, S24-04/05, essentially states that there are non-storage areas with live loads that exceed 100 psf, such as mechanical rooms, where there is not a good chance of the entire tributary area being loaded to the full design load. The merits of this position should be reviewed by the technical committees of ASCE 7. If there are uses with heavy live loads where a reduction should be permitted, those uses, and any appropriate limitations on the amount of live load reduction, should be specifically stated. This applies to both ASCE 7 and the IBC.

Cost Impact: The code change proposal will not increase or decrease the cost of construction. The alternative method is still available to the designer and as such no change in the cost of construction is expected.

S107-22

S108-22

IBC: 1607.12, 1607.12.2

Proponents: Jennifer Goupil, representing Structural Engineering Institute of ASCE (jgoupil@asce.org)

2021 International Building Code

Revise as follows:

1607.12 Reduction in uniform live loads. Except for uniform *live loads* at roofs, all other minimum uniformly distributed *live loads*, L_o , in Table 1607.1 are permitted to be reduced in accordance with Section 1607.12.1 ~~or 1607.12.2~~. Uniform *live loads* at roofs are permitted to be reduced in accordance with Section 1607.14.2.

1607.12.2 Alternative uniform live load reduction. As an alternative to Section 1607.12.1 and subject to the limitations of Table 1607.1, uniformly distributed *live loads* are permitted to be reduced in accordance with the following provisions. Such reductions shall apply to slab systems, beams, girders, columns, piers, walls and foundations:

1. A reduction shall not be permitted where the *live load* exceeds 100 psf (4.79 kN/m²) except that the design *live load* for members supporting two or more floors is permitted to be reduced by not greater than 20 percent.

Exception: For uses other than storage, where *approved*, additional *live load* reductions shall be permitted where shown by the *registered design professional* that a rational approach has been used and that such reductions are warranted.

2. A reduction shall not be permitted in passenger vehicle parking garages except that the *live loads* for members supporting two or more floors are permitted to be reduced by not greater than 20 percent.
3. For *live loads* not exceeding 100 psf (4.79 kN/m²), the design *live load* for any structural member supporting 150 square feet (13.94 m²) or more is permitted to be reduced in accordance with Equation 16-8
4. For one-way slabs, the area, A , for use in Equation 16-8 shall not exceed the product of the slab span and a width normal to the span of 0.5 times the slab span.

$$R = 0.08(A - 150)$$

(Equation 16-8)

$$\text{For SI: } R = 0.861(A - 13.94)$$

Such reduction shall not exceed the smallest of:

1. 40 percent for members supporting one floor.
2. 60 percent for members supporting two or more floors.
3. R as determined by the following equation:

$$R = 23.1(1 + D/L_o)$$

(Equation 16-9)

where:

A = Area of floor supported by the member, square feet (m²).

D = Dead load per square foot (m²) of area supported.

L_o = Unreduced *live load* per square foot (m²) of area supported.

R = Reduction in percent.

Reason Statement: This proposal is a coordination proposal to bring the 2024 IBC up to date with the provisions of the 2022 edition of ASCE/SEI 7 Minimum Design Loads and Associated Criteria for Buildings and Other Structures (ASCE/SEI 7-22). ASCE 7 will be updated to the 2022 edition from the 2016 edition as an Administrative update in the 2024 I-Codes.

These changes are proposed to 1) improve the coordination between the IBC and ASCE 7 and 2) remove an outdated provision that has been superceded by a more rigorously supported provision.

The IBC contains two methods of live load reduction, referred to as the Basic Uniform Live Load Reduction (Basic) and the Alternative Live Load Reduction (Alternate). The Basic method corresponds to the method contained in ASCE 7, which dates back to the 1982 edition, when the standard was known as ANSI A58.1. The Alternate method corresponds to the method contained in ANSI A58.1 prior to the 1982 edition. It last appeared in the 1972 edition. The Alternate method is based on building survey data published in 1947, and analysis published in 1968 per the ANSI A58.1-72 commentary. The Basic method is the result of work published in the early 1980's by Chalk and Corotis, as well as Harris, Corotis, and Bova per the ASCE 7 commentary.

Prior to the first edition of the IBC in 2000, the legacy codes had started to transition from the older Alternate method to the newer Basic method. The BOCA National Building Code only contained the Basic method, the UBC contained both methods, and SBCCI's Standard Building Code still contained the Alternate method. The melding of the three legacy codes resulted in the 2000 IBC including both methods. Both methods have continued to appear in the IBC despite the newer Basic method being based on on more current and more extensive information.

This proposal removes the alternative live load reduction provisions from the IBC. There has been a long enough transition period provided by both the legacy model codes and the IBC. The Alternative method has been replaced by the more rigorously supported Basic method, and it is time for the IBC to reflect this, as was done long ago in ASCE 7/ANSI A58.1. The Basic method is based on more recent and more extensive data as well as statistical analysis of theoretical models.

Cost Impact: The code change proposal will increase the cost of construction

For designers that are still using the alternative live load reduction method, some designs can result in slightly lower live load reductions with the basic method. For these designs the slightly higher live load could result in an increased cost of construction.

S108-22

S109-22

IBC: 1607.14.2

Proponents: John-Jozef Proczka, representing Self (john-jozef.proczka@phoenix.gov)

2021 International Building Code

Revise as follows:

1607.14.2 Reduction in uniform roof live loads. The minimum uniformly distributed *live loads* of roofs and canopies ~~marquees~~, L_o , in Table 1607.1 are permitted to be reduced in accordance with Section 1607.14.2.1.

Reason Statement: *Marquees* are defined to be a specific kind of *canopy*, yet the subsections of this section include all *canopies*. This is simply a clean up of incorrect wording.

Cost Impact: The code change proposal will not increase or decrease the cost of construction
Just clarifying wording of a section to line-up with its subsections

S109-22

S110-22

IBC: 1607.14.3

Proponents: Jennifer Goupil, representing Structural Engineering Institute of ASCE (jgoupil@asce.org)

2021 International Building Code

Delete without substitution:

~~**1607.14.3 Awnings and canopies.** Awnings and canopies shall be designed for uniform *live loads* as required in Table 1607.1 as well as for snow loads and wind loads as specified in Sections 1608 and 1609.~~

Staff Analysis: CC# S110-22 and CC# S111-22 addresses requirements in a different or contradicting manner. The committee is urged to make their intentions clear with their actions on these proposals.

Reason Statement: This proposal is a coordination proposal to bring the 2024 IBC up to date with the provisions of the 2022 edition of ASCE/SEI 7 Minimum Design Loads and Associated Criteria for Buildings and Other Structures (ASCE/SEI 7-22). ASCE 7 will be updated to the 2022 edition from the 2016 edition as an Administrative update in the 2024 I-Codes.

These changes are proposed to improve the coordination between the IBC and ASCE 7 by removing unnecessary pointers that do not appear in ASCE 7.

Awning and canopy live loads are listed in the live load table. Section 1607.14.3 is simply a pointer to the live load table and as such is unnecessary. Typically separate section are only provided when additional information regarding the live load is provided. This section does not further clarify the application or applicability of the live load for these items.

The reference to snow and wind loads in the live load section is also unnecessary. These loads are addressed in their own IBC sections. There is nothing in the wind and snow load sections that suggest that awnings and canopies are exempt from these loads.

Cost Impact: The code change proposal will not increase or decrease the cost of construction

This proposal does not change loads in the IBC.

S110-22

S111-22

IBC: 1607.14.3

Proponents: Jennifer Goupil, representing Structural Engineering Institute of ASCE (jgoupil@asce.org)

2021 International Building Code

Revise as follows:

1607.14.3 Awnings and canopies. *Awnings* and canopies shall be designed for uniform *live loads* as required in Table 1607.1 ~~as well as for snow loads and wind loads as specified in Sections 1608 and 1609.~~

Staff Analysis: CC# S110-22 and CC# S111-22 addresses requirements in a different or contradicting manner. The committee is urged to make their intentions clear with their actions on these proposals.

Reason Statement: This proposal is a coordination proposal to bring the 2024 IBC up to date with the provisions of the 2022 edition of ASCE/SEI 7 Minimum Design Loads and Associated Criteria for Buildings and Other Structures (ASCE/SEI 7-22). ASCE 7 will be updated to the 2022 edition from the 2016 edition as an Administrative update in the 2024 I-Codes.

The reference to snow and wind loads in the live load section is unnecessary. These loads are addressed in their own IBC sections. There is nothing in the wind and snow load sections that suggest that awnings and canopies are exempt from those loads.

Referencing environmental loads in the live load section for only some building components can also be confusing. What does it mean when environmental loads are not called out in the live load section for other building components?

Cost Impact: The code change proposal will not increase or decrease the cost of construction. This proposal does not change design requirements and will have no affect on the cost of construction.

S111-22

S112-22

IBC: 1607.14.4.3

Proponents: Larry Sherwood, representing Sustainable Energy Action Committee (Larry@irecusa.org); Benjamin Davis, representing California Solar & Storage Association (ben@calssa.org); Joseph Cain, representing Solar Energy Industries Association (SEIA) (joecainpe@gmail.com); Philip Oakes, representing National Association of State Fire Marshals

2021 International Building Code

Revise as follows:

~~1607.14.4.3 Photovoltaic panels installed on~~ **Elevated PV support structures with open grid roof structures framing.** ~~Structures~~ Elevated PV support structures with open grid framing and without a *roof deck* or sheathing ~~supporting photovoltaic panel systems~~ shall be designed to support the uniform and concentrated *roof live loads* specified in Section 1607.14.4.1, except that the uniform *roof live load* shall be permitted to be reduced to 12 psf (0.57 kN/m²).

Reason Statement: This provides alignment with a new definition for these types of structures, which was included in the Group A cycle in accordance with Proposal G193-21. Language that occurs in the newly defined term becomes redundant and can be struck from Section 1607.14.4.3 for clarity.

PHOTOVOLTAIC (PV) SUPPORT STRUCTURE, ELEVATED. An independent photovoltaic (PV) panel support structure designed with useable space underneath with minimum clear height of 7 feet 6 inches (2286 mm), intended for secondary use such as providing shade or parking of motor vehicles.

This proposal was prepared by the Sustainable Energy Action Committee (SEAC), a forum for all stakeholders (including, but not limited to, AHJs, designers, engineers, contractors, first responders, manufacturers, suppliers, utilities, and testing labs) to collaboratively identify and find solutions for issues that affect the installation and use of solar energy systems, energy storage systems, demand response, and energy efficiency. The purpose is to facilitate the deployment and use of affordable, clean and renewable energy in a safe, efficient, and sustainable manner.

All recommendations from SEAC are approved by diverse stakeholders through a consensus process.

Cost Impact: The code change proposal will not increase or decrease the cost of construction. This proposal provides clarity, and alignment with the new definition for these types of structures.

S112-22

S113-22

IBC: 1607.14.4.4

Proponents: Larry Sherwood, representing Sustainable Energy Action Committee (Larry@irecusa.org); Kevin Reinertson, representing California Fire Chiefs Association FPO (kevin.reinertson@fire.ca.gov); Benjamin Davis, representing California Solar & Storage Association (ben@calssa.org); Philip Oakes, representing National Association of State Fire Marshals; Joseph Cain, representing Solar Energy Industries Association (SEIA) (joecainpe@gmail.com)

2021 International Building Code

Revise as follows:

1607.14.4.4 Ground-mounted photovoltaic (PV) panel systems or modules installed as an independent structure. Ground-mounted photovoltaic (PV) panel systems that ~~are independent structures and do not have accessible/occupied space underneath~~ are not required to accommodate a roof ~~photovoltaic~~ *live load*. Other *loads* and combinations in accordance with Section 1605 shall be accommodated.

Reason Statement:

This is a further improvement on what was revised in Group A through the action on G1-21, Part I. The proposal G1-21, Part I was to address the need to revise “accessible” to “access”.

Note the following definition was created by Proposal G193-21 in Group A. “**PHOTOVOLTAIC (PV) PANEL SYSTEM, GROUND-MOUNTED.** An independent photovoltaic (PV) panel system without useable space underneath, installed directly on the ground.”

This provides alignment with a new definition for these types of structures, which was included in the Group A cycle in accordance with Proposal G193-21.

This proposal was prepared by the Sustainable Energy Action Committee (SEAC), a forum for all stakeholders (including, but not limited to, AHJs, designers, engineers, contractors, first responders, manufacturers, suppliers, utilities, and testing labs) to collaboratively identify and find solutions for issues that affect the installation and use of solar energy systems, energy storage systems, demand response, and energy efficiency. The purpose is to facilitate the deployment and use of affordable, clean and renewable energy in a safe, efficient, and sustainable manner.

All recommendations from SEAC are approved by diverse stakeholders through a consensus process.

Bibliography: G1-21 Part I
Section 1607.14.4.4

Cost Impact: The code change proposal will not increase or decrease the cost of construction
This proposal provides clarity, and alignment with the definition of ground mounted PV panel systems and accessible.

S113-22

S114-22

IBC: 1607.15, 1607.15.1, 1607.15.2, 1607.15.3, 1607.15.4

Proponents: Jennifer Goupil, representing Structural Engineering Institute of ASCE (jgoupil@asce.org)

2021 International Building Code

Revise as follows:

1607.15 Crane loads. The crane *live load* shall be the rated capacity of the crane. Design *loads* for the runway beams, including connections and support brackets, of moving bridge cranes and monorail cranes shall ~~be in accordance with Section 4.9 of ASCE 7, include the maximum wheel loads of the crane and the vertical impact, lateral and longitudinal forces induced by the moving crane.~~

Delete without substitution:

1607.15.1 Maximum wheel load. The maximum wheel *loads* shall be the wheel *loads* produced by the weight of the bridge, as applicable, plus the sum of the rated capacity and the weight of the trolley with the trolley positioned on its runway at the location where the resulting *load effect* is maximum.

1607.15.2 Vertical impact force. The maximum wheel *loads* of the crane shall be increased by the following percentages to account for the effects of vertical impact or vibration:

Monorail cranes (powered)	25 percent
Gab-operated or remotely operated bridge cranes (powered)	25 percent
Pendant-operated bridge cranes (powered)	10 percent
Bridge cranes or monorail cranes with hand-gear bridge, trolley and hoist	0 percent

1607.15.3 Lateral force. The lateral force on crane runway beams with electrically powered trolleys shall be calculated as 20 percent of the sum of the rated capacity of the crane and the weight of the hoist and trolley. The lateral force shall be assumed to act horizontally at the traction surface of a runway beam, in either direction perpendicular to the beam, and shall be distributed with due regard to the lateral stiffness of the runway beam and supporting structure.

1607.15.4 Longitudinal force. The longitudinal force on crane runway beams, except for bridge cranes with hand-gear bridges, shall be calculated as 10 percent of the maximum wheel *loads* of the crane. The longitudinal force shall be assumed to act horizontally at the traction surface of a runway beam, in either direction parallel to the beam.

Reason Statement: This proposal is a coordination proposal to bring the 2024 IBC up to date with the provisions of the 2022 edition of ASCE/SEI 7 Minimum Design Loads and Associated Criteria for Buildings and Other Structures (ASCE/SEI 7-22). ASCE 7 will be updated to the 2022 edition from the 2016 edition as an Administrative update in the 2024 I-Codes.

This proposal is the first of two proposals from ASCE 7 regarding crane live loads. Both proposals are intended to keep the IBC coordinated with ASCE 7, but each proposal accomplishes that coordination in different ways. The 2022 edition of ASCE 7 includes revisions to the Vertical Impact Force provisions for the crane wheel loads. These changes were made to align the vertical impact factor with crane service class for consistency with crane industry practice and with the CMAA (Crane Manufacturers Association of America) document referenced by the ASCE 7 commentary. The revisions consist of changes to the Vertical Impact Factor table and the inclusion of crane service class descriptions adapted from the CMAA document.

In order to keep the IBC coordinated with ASCE 7-22, as well as crane industry practice, changes are also needed to the IBC. However, the changes to ASCE 7 included the addition of a significant amount of text. As an alternative to also placing this text in the IBC, this proposal accomplishes the IBC-ASCE 7 coordination by having the IBC simply reference ASCE 7 for the majority of the crane load information. The base requirement that the crane live load is to be the rated capacity of the crane remains stated in the IBC. The information detailing the design loads for the runway beams is removed and replaced with the reference to ASCE 7.

The information removed from the IBC is structural design information used by the design professional. The information applies to a very limited use, that for runway beams supporting moving bridge cranes and monorail cranes. The reference to ASCE 7 for this design information is similar to material design information that is contained in referenced design standards and not within the IBC itself, such as in ACI 318 for concrete and AISC 360 for steel.

Cost Impact: The code change proposal will not increase or decrease the cost of construction

Relocating the crane load information from the IBC to ASCE 7 is not expected to affect the cost of construction. The revisions in ASCE 7 to categorize the crane wheel load impact factor based on the crane service class is also not expect to affect the cost of construction as the use of the crane service class is recognized in the crane industry.

S115-22

IBC: 1607.15, 1607.15.1, 1607.15.2, 1607.15.2.1 (New), 1607.15.3, 1607.15.4

Proponents: Jennifer Goupil, representing Structural Engineering Institute of ASCE (jgoupil@asce.org)

2021 International Building Code

1607.15 Crane loads. The crane *live load* shall be the rated capacity of the crane. Design *loads* for the runway beams, including connections and support brackets, of moving bridge cranes and monorail cranes shall include the maximum wheel *loads* of the crane and the vertical impact, lateral and longitudinal forces induced by the moving crane.

1607.15.1 Maximum wheel load. The maximum wheel *loads* shall be the wheel *loads* produced by the weight of the bridge, as applicable, plus the sum of the rated capacity and the weight of the trolley with the trolley positioned on its runway at the location where the resulting *load effect* is maximum.

Revise as follows:

1607.15.2 Vertical impact force. The maximum wheel *loads* of the crane shall be increased by the following percentages to account for the effects of vertical impact or vibration:

Monorail cranes (powered)	25 percent
Cab-operated or remotely operated bridge cranes (powered) Bridge crane service class D, E, or F	25 percent
Pendant-operated bridge cranes (powered) Bridge crane service class, A, B, or C	10 percent
Bridge cranes or monorail cranes <u>Cranes</u> with hand-gearred bridge, trolley and hoist	0 percent

Add new text as follows:

1607.15.2.1 Bridge crane service class. For the purpose of determining the vertical impact force, one of the following bridge crane service class shall be assigned based on the actual service conditions including the frequency of use, variability in load lifted, and the operation speed.

1. Bridge Crane Service Class A (Standby or infrequent service). This service class shall include cranes used in installations such as powerhouses, public utilities, turbine rooms, motor rooms and transformer stations where precise handling of equipment at slow speeds is required and cranes are infrequently used or are idled for long periods. Full rated loads shall be handled for initial installation of equipment and for infrequent maintenance.
2. Bridge Crane Service Class B (Light service). This service class shall include cranes used in repair shops, light assembly operations, service buildings, light warehousing, etc. where service requirements are light and the speed is slow. Loads are permitted to vary, but full rated loads shall occur only occasionally, with two to five lifts per hour, averaging 10 feet per lift.
3. Bridge Crane Service Class C (Moderate service). This service class shall include cranes used in machine shops or paper mill machine rooms, etc. where service requirements are moderate. In this type of service, the crane shall handle loads which average 50 percent of the rated capacity with five to ten lifts per hour, averaging 15 feet, not over 50 percent of the lifts at rated capacity.
4. Bridge Crane Service Class D (Heavy service). This service class shall include cranes used in heavy machine shops, foundries, fabricating plants, steel warehouses, container yards, lumber mills, etc., and the standard duty bucket and magnet operations where heavy duty production is required. In this type of service, the crane shall handle loads approaching 50 percent of the rated capacity constantly during the working period. High speeds are used for this type of service with 10 to 20 lifts per hour averaging 15 feet, not over 65 percent of the lifts at rated capacity.
5. Bridge Crane Service Class E (Severe service). This service class shall include cranes capable of handling loads approaching rated capacity throughout its life. Applications include magnet, bucket, magnet/bucket combination cranes for scrap yards, cement mills, lumber mills, fertilizer plants, container handling, etc., with twenty or more lifts per hour at or near the rated capacity.
6. Bridge Crane Service Class F (Continuous severe service). This service class shall include cranes capable of handling loads approaching rated capacity continuously under severe service conditions throughout its life. Applications include custom designed specialty cranes essential to performing the critical work tasks affecting the total production facility. These cranes shall provide the highest reliability with special attention to ease of maintenance features.

1607.15.3 Lateral force. The lateral force on crane runway beams with electrically powered trolleys shall be calculated as 20 percent of the sum of the rated capacity of the crane and the weight of the hoist and trolley. The lateral force shall be assumed to act horizontally at the traction surface of a runway beam, in either direction perpendicular to the beam, and shall be distributed with due regard to the lateral stiffness of the runway beam and supporting structure.

1607.15.4 Longitudinal force. The longitudinal force on crane runway beams, except for bridge cranes with hand-gearred bridges, shall be calculated as 10 percent of the maximum wheel *loads* of the crane. The longitudinal force shall be assumed to act horizontally at the traction surface of a runway beam, in either direction parallel to the beam.

Reason Statement: This proposal is a coordination proposal to bring the 2024 IBC up to date with the provisions of the 2022 edition of ASCE/SEI 7 Minimum Design Loads and Associated Criteria for Buildings and Other Structures (ASCE/SEI 7-22). ASCE 7 will be updated to the 2022 edition from the 2016 edition as an Administrative update in the 2024 I-Codes.

This proposal is the second of two proposals from ASCE 7 regarding crane live loads. Both proposals are intended to keep the IBC coordinated with ASCE 7, but each proposal accomplishes that coordination in different ways. The 2022 edition of ASCE 7 includes revisions to the Vertical Impact Force provisions for the crane wheel loads. These changes were made to align the vertical impact factor with crane service class for consistency with crane industry practice and with the CMAA (Crane Manufacturers Association of America) document referenced by the ASCE 7 commentary. The revisions consist of changes to the Vertical Impact Factor table and the inclusion of crane service class descriptions adapted from the CMAA document.

In order to keep the IBC coordinated with ASCE 7-22, as well as crane industry practice, changes are also needed to the IBC. This proposal accomplishes the IBC-ASCE 7 coordination by making the same revisions in the IBC as were made in ASCE 7. The following is part of the reason statement contained in the ASCE 7 proposal:

"The magnitude of potential impact forces is dependent on service class and hoisting and trolley travel speeds. The proposed changes align the vertical impact factor based on the crane service class that considers the overall use of the crane. MHI defines the crane service classes and uses it in the design of the various crane components (Note, MHI is correctly changed to CMAA in ASCE 7-22 proposal DL-CH04-28r01). Structural engineers currently use service class for fatigue loading and deflection criteria of members supporting the crane. An example is AISC Design Guide 7 / Industrial Buildings – Roofs to Anchor Rods, 2nd Edition, Part 2, Chapter 11, which describes the use of service class to address frequency of loading. Only two impact factors are used, 10% and 25%, to align with previous ASCE 7 editions, but all six crane service classes are listed and defined for consistency with the MHI/CMAA referenced document and crane industry practice.

As speeds are similar for remotely operated cranes and pendant-operated cranes, using different impact factors is illogical. The current higher factor for radio-controlled cranes of light to moderate service class imposes an un-necessary increase in costs for a crane system that has a higher level of operational safety. In recent years as improvements in remote controlled systems have become more available, existing pendant systems retrofitting to utilize remote control without any review or modifications to the structure has occurred without any known/reported problems with runway beam design/performance. New applications are utilizing both control systems with the pendant control acting as a back up to the remote control leading to confusion on which impact factor to use.

As crane service class is a requirement by crane manufacturers and used in other aspects of design, its use in setting the vertical impact factor is an improvement without any significant change in impact factor values."

The format of the service class information is modeled after the format used to describe wind load exposure categories and surface roughness categories in Section 1609.4.

Cost Impact: The code change proposal will not increase or decrease the cost of construction. Categorizing the crane wheel load impact factor based on the crane service class is not expected to affect the cost of construction as the use of the crane service class is recognized in the crane industry.

S115-22

S116-22

IBC: CHAPTER 1, SECTION 108, [A] 108.1, CHAPTER 2, SECTION 202, SECTION 202 (New), CHAPTER 16, SECTION 1608, 1608.1, SECTION 1609, 1609.1.1, SECTION 1612, 1612.2, SECTION 1613, 1613.1, SECTION 1614, 1614.1, SECTION 1615, 1615.1, CHAPTER 31, SECTION 3103, 3103.1, 3103.1.1 (New), 3103.1.1, 3103.1.2, 3103.5 (New), 3103.5.1 (New), TABLE 3103.5.1 (New), 3103.5.1.1 (New), 3103.5.1.2 (New), 3103.5.1.3 (New), 3103.5.1.4 (New), 3103.5.1.5 (New), 3103.5.1.6 (New), 3103.5.1.7 (New), 3103.5.1.8 (New), 3103.5.2 (New), TABLE 3103.5.2 (New), 3103.5.3 (New), 3103.5.4 (New), 3103.5.5 (New), 3103.6 (New), 3103.7 (New), 3103.7.1 (New), 3103.7.2 (New), 3103.7.3 (New), CHAPTER 35, ANSI Chapter 35 (New)

Proponents: Jennifer Goupil, representing Structural Engineering Institute of ASCE (jgoupil@asce.org); Don Scott, representing ASCE 7 Wind Load Subcommittee (dscott@pcs-structural.com); John Grenier, representing National Council of Structural Engineers Associations (NCSEA) (jgrenier@greniereng.com); Ali Fattah, representing City of San Diego Development Services Department (afattah@sandiego.gov)

2021 International Building Code

CHAPTER 1 SCOPE AND ADMINISTRATION

SECTION 108 TEMPORARY STRUCTURES AND USES

Revise as follows:

[A] 108.1 General. The *building official* is authorized to issue a *permit* for temporary structures and temporary uses. Such *permits* shall be limited as to time of service, but shall not be permitted for more than 180 days. The *building official* is authorized to grant extensions for demonstrated cause. Structures designed to comply with Section 3103.5 shall not be in service for a period of more than 1-year unless an extension of time is granted.

CHAPTER 2 DEFINITIONS

SECTION 202 DEFINITIONS

Add new definition as follows:

PUBLIC-OCCUPANCY TEMPORARY STRUCTURE. Any building or structure erected for a period of one year or less that support public or private assemblies, or that provide human shelter, protection, or safety. Public-occupancy temporary structures within the confines of another existing structure (such as convention booths) are exempted from Section 3103.5.

SERVICE LIFE. The period of time that a structure serves its intended purpose. For temporary structures, this shall be the cumulative time of service for sequential temporary events which may occur in multiple locations. For *public-occupancy temporary structures* this is assumed to be a minimum of 10 years.

TEMPORARY EVENT. A single use during the service life of a *public-occupancy temporary structure* at a given location which includes its installation, inspection, use and occupancy, and dismantling.

TEMPORARY STRUCTURE. Any building or structure erected for a period of 180 days or less to support *temporary events*. *Temporary structures* include a range of structure types (*public-occupancy temporary structures, temporary special event structures, tents, umbrella and other membrane structures, relocatable buildings, temporary bleachers, etc.*) for a range of purposes (storage, equipment protection, dining, workspace, assembly, etc.).

CHAPTER 16 STRUCTURAL DESIGN

SECTION 1608 SNOW LOADS

Revise as follows:

1608.1 General. Design snow *loads* shall be determined in accordance with Chapter 7 of ASCE 7, but the design roof *load* shall be not less than that determined by Section 1607.

Exception: Temporary structures complying with Section 3103.5.1.3.

SECTION 1609 WIND LOADS

Revise as follows:

1609.1.1 Determination of wind loads. Wind loads on every building or structure shall be determined in accordance with Chapters 26 to 30 of ASCE 7. The type of opening protection required, the basic design wind speed, V , and the exposure category for a site is permitted to be determined in accordance with Section 1609 or ASCE 7. Wind shall be assumed to come from any horizontal direction and wind pressures shall be assumed to act normal to the surface considered.

Exceptions:

1. Subject to the limitations of Section 1609.1.1.1, the provisions of ICC 600 shall be permitted for applicable Group R-2 and R-3 buildings.
2. Subject to the limitations of Section 1609.1.1.1, residential structures using the provisions of AWC WFCM.
3. Subject to the limitations of Section 1609.1.1.1, residential structures using the provisions of AISI S230.
4. Designs using NAAMM FP 1001.
5. Designs using TIA-222 for antenna-supporting structures and antennas, provided that the horizontal extent of Topographic Category 2 escarpments in Section 2.6.6.2 of TIA-222 shall be 16 times the height of the escarpment.
6. Wind tunnel tests in accordance with ASCE 49 and Sections 31.4 and 31.5 of ASCE 7.
7. Temporary structures complying with Section 3103.5.1.4.

The wind speeds in Figures 1609.3(1) through 1609.3(12) are basic design wind speeds, V , and shall be converted in accordance with Section 1609.3.1 to allowable stress design wind speeds, V_{asd} , when the provisions of the standards referenced in Exceptions 4 and 5 are used.

SECTION 1612 FLOOD LOADS

Revise as follows:

1612.2 Design and construction. The design and construction of buildings and structures located in *flood hazard areas*, including *coastal high hazard areas* and *coastal A zones*, shall be in accordance with Chapter 5 of ASCE 7 and ASCE 24.

Exception: Temporary structures complying with Section 3103.5.1.5.

SECTION 1613 EARTHQUAKE LOADS

Revise as follows:

1613.1 Scope. Every structure, and portion thereof, including nonstructural components that are permanently attached to structures and their supports and attachments, shall be designed and constructed to resist the effects of earthquake motions in accordance with Chapters 11, 12, 13, 15, 17 and 18 of ASCE 7, as applicable. The *seismic design category* for a structure is permitted to be determined in accordance with Section 1613 or ASCE 7.

Exceptions:

1. Detached one- and two-family dwellings, assigned to *Seismic Design Category A, B or C*, or located where the mapped short-period spectral response acceleration, S_S , is less than 0.4 g.
2. The *seismic force-resisting system* of wood-frame buildings that conform to the provisions of Section 2308 are not required to be analyzed as specified in this section.
3. Agricultural storage structures intended only for incidental human occupancy.
4. Structures that require special consideration of their response characteristics and environment that are not addressed by this code or ASCE 7 and for which other regulations provide seismic criteria, such as vehicular bridges, electrical transmission towers, hydraulic structures, buried utility lines and their appurtenances and nuclear reactors.
5. References within ASCE 7 to Chapter 14 shall not apply, except as specifically required herein.
6. Temporary structures complying with Section 3103.5.1.6.

SECTION 1614

ATMOSPHERIC ICE LOADS

Revise as follows:

1614.1 General. *Ice-sensitive structures* shall be designed for atmospheric ice loads in accordance with Chapter 10 of ASCE 7. *Public-occupancy temporary structures* shall comply with Section 3103.7.3.

Exception: *Temporary structures* complying with Section 3103.5.1.7.

SECTION 1615 TSUNAMI LOADS

Revise as follows:

1615.1 General. The design and construction of *Risk Category III* and *IV* buildings and structures located in the *Tsunami Design Zones* defined in the *Tsunami Design Geodatabase* shall be in accordance with Chapter 6 of ASCE 7, except as modified by this code.

Exception: *Temporary structures* complying with Section 3103.5.1.8.

CHAPTER 31 SPECIAL CONSTRUCTION

SECTION 3103 TEMPORARY STRUCTURES

Revise as follows:

3103.1 General. The provisions of Sections 3103.1 through ~~3103.4~~ 3103.7 shall apply to structures erected for a period of less than 180 days. *Temporary special event structures*, tents, umbrella structures and other membrane structures erected for a period of less than 180 days shall also comply with the *International Fire Code*. ~~These *Temporary structures*~~ erected for a longer period of time and *public-occupancy temporary structures* shall comply with applicable sections of this code.

Exception: *Public-occupancy temporary structures* complying with Section 3103.1.1 shall be permitted to remain in service for 180 days or more but not more than 1 year when approved by the *Building Official*.

Add new text as follows:

3103.1.1 Extended period of service time. *Public-occupancy temporary structures* shall be permitted to remain in service for 180 days or more without complying with requirements in this code for new buildings or structures when extensions for up to 1 year are granted by the *Building Official* in accordance with Section 108.1 and when the following conditions are satisfied:

1. Additional inspections as determined by the *Building Official* shall be performed to verify that site conditions and the approved installation comply with the conditions of approval at the time of final inspection.
2. The *Building Official* shall perform follow up inspections after initial occupancy at intervals not exceeding 180 days to verify the site conditions and the installation conform to the approved site conditions and installation requirements.
3. An examination shall be performed by a registered design professional to determine the adequacy of the *temporary structure* to resist the structural loads required in Section 3103.5.
4. Relocation of the *temporary structures* shall require a new approval by the *Building Official*.
5. The use or occupancy approved at the time of final inspection shall remain unchanged.

Revise as follows:

~~3103.1.1~~ **3103.1.2 Conformance.** Temporary structures and uses shall conform to the structural strength, fire safety, *means of egress*, accessibility, light, *ventilation* and sanitary requirements of this code as necessary to ensure public health, safety and general welfare.

~~3103.1.2~~ **3103.1.3 Permit required.** Temporary structures that cover an area greater than 120 square feet (11.16 m²), including connecting areas or spaces with a common *means of egress* or entrance that are used or intended to be used for the gathering together of 10 or more persons, shall not be erected, operated or maintained for any purpose without obtaining a *permit* from the *building official*.

Add new text as follows:

3103.5 Structural requirements. *Temporary structures* shall comply with Chapter 16 of this code. *Public-occupancy temporary structures* shall be designed and erected to comply with requirements of this Section.

3103.5.1 Structural loads. *Public-occupancy temporary structures* shall be classified, based on the risk to human life, health, and welfare

associated with damage or failure by nature of their occupancy or use, according to Table 1604.5 for the purposes of applying flood, wind, snow, earthquake, and ice provisions. Additionally, public assembly facilities that require more than 15 min to evacuate to a safe location and any structure whose failure or collapse would endanger the public assembled near the structure, such as speaker stands or other temporary structures for public gatherings shall be classified as Risk Category III.

TABLE 3103.5.1 REDUCTION FACTORS FOR GROUND SNOW LOADS FOR PUBLIC-OCCUPANCY TEMPORARY STRUCTURES

Risk Category	Service Life	
	≤ 10 yr	>10 yr
II	0.7	1.0
III	0.8	1.0
IV	1.0	1.0

3103.5.1.1 Dead. Dead loads on *public-occupancy temporary structures* shall be determined in accordance with Section 1606.

3103.5.1.2 Live. Live loads on *public-occupancy temporary structures* shall be determined in accordance with Section 1607.

Exception : Where *approved*, live loads less than those prescribed by Table 1607.1 *Minimum Uniformly Distributed Live Loads, L_0 , and Minimum Concentrated Live Loads* shall be permitted where shown by the *registered design professional* that a rational approach has been used and that such reductions are warranted.

3103.5.1.3 Snow. Snow loads on *public-occupancy temporary structures* shall be determined in accordance with Section 1608 and Chapter 7 of ASCE 7. The ground snow loads, p_g , in Section 1608 shall be modified according to Table 3103.5.1.

If the *public-occupancy temporary structure* is not subject to snow loads or not constructed and occupied during winter months when snow is to be expected, snow loads need not be considered, provided that the design is reviewed and modified, as appropriate, to account for snow loads if the period of time when the *public-occupancy temporary structure* is in service shifts to include winter months.

Exception: Risk Category II *public-occupancy temporary structures* that employ controlled occupancy measures per Section 3103.7.2 shall be permitted to use a ground snow load reduction factor of 0.65 instead of the ground snow load reduction factors in Table 3105.1.

3103.5.1.4 Wind. Wind loads on *public-occupancy temporary structures* shall be determined in accordance with Section 1609 and Chapters 26 to 30 of ASCE 7. The design wind load shall be modified according to Table 3103.5.2.

Exceptions

1. *Public-occupancy temporary structures* that employ controlled occupancy measures per Section 3103.7.1 shall be permitted to use a load reduction factor of 0.65 instead of the load reduction factors in Table 3103.5.2.
2. *Public-occupancy temporary structures* erected in a hurricane-prone region outside of hurricane season, the design wind speed shall be set at the following 3-second gust basic wind speeds depending on Risk Category:
 - 2.1. For Risk Category II use 115 mph.
 - 2.2. For Risk Category III use 120 mph, and
 - 2.3. For Risk Category IV use 125 mph.

3103.5.1.5 Flood. An Emergency Action Plan, in accordance with 3103.5.4, shall be submitted for *public-occupancy temporary structures* in a Flood Hazard Area when requested by the Building or Fire Official. *Public-occupancy temporary structures* need not be designed for flood loads specified in Section 1615 except when specifically designed as a dry floodproofed structure or designated to be occupied during a storm event per the approved Emergency Action Plan.

3103.5.1.6 Seismic. Seismic loads on *public-occupancy temporary structures* assigned to Seismic Design Categories C through F shall be determined in accordance with Section 1613. The resulting seismic loads are permitted to be taken as 75% of those determined by Section 1613. *Public-occupancy temporary structures* assigned to Seismic Design Categories A and B need not be designed for seismic loads.

3103.5.1.7 Ice. Ice loads on *public-occupancy temporary structures* shall be determined in accordance with Section 1614, Chapter 10 of ASCE 7, with the largest maximum nominal thickness being 0.5 in, for all Risk Categories. When ice is expected during the occupancy of *public-occupancy temporary structures*, ice loads shall be determined for surfaces on which ice could accumulate in accordance with ASCE 7. If the *public-occupancy temporary structure* is not subject to ice loads or not constructed and occupied during winter months when ice is to be expected, ice loads need not be considered, provided that the design is reviewed and modified, as appropriate, to account for ice loads if the period of time when the temporary structure is in service shifts to include winter months.

3103.5.1.8 Tsunami. An Emergency Action Plan, in accordance with 3103.5.4, shall be submitted for *public-occupancy temporary structures* in a Tsunami Design Zone when requested by the Building or Fire Official. The *public-occupancy temporary structure* need not be designed for tsunami loads specified in Section 1615.

3103.5.2 Foundations. *Public-occupancy temporary structures* may be supported on the ground with temporary foundations when approved by the Building Official. Consideration shall be given for the impacts of differential settlement when foundations do not extend below the ground or foundations supported on compressible materials. The presumptive load-bearing value for *public-occupancy temporary structures* supported on a

pavement, slab on grade or on other *Collapsible or Controlled Low Strength* substrates soils such as beach sand or grass shall be assumed not to exceed 1,000 psf unless determined through testing and evaluation by a registered design professional. The presumptive load-bearing values listed in Table 1806.2 shall be permitted to be used for other supporting soil conditions.

TABLE 3103.5.2 REDUCTION FACTORS FOR WIND LOADS FOR PUBLIC-OCCUPANCY TEMPORARY STRUCTURES

Risk Category	Service Life	
	≤ 10 yr	>10 yr
II	0.8	1.0
III	0.9	1.0
IV	1.0	1.0

3103.5.3 Installation and maintenance inspections. A qualified person shall inspect public-occupancy temporary structures that are assembled using transportable and reusable materials; components shall be inspected when purchased or acquired and at least once per year. The inspection shall evaluate individual components, and the fully assembled structure, to determine suitability for use based on the requirements in ESTA ANSI E1.21. Inspection records shall be kept and shall be made available for verification by the Building Official. Additionally, public-occupancy temporary structures shall be inspected at regular intervals when in service.

3103.5.4 Emergency Action plans. When required by the Building Official, Emergency Action Plans shall be submitted and approved. Emergency Action Plans shall include procedures to be implemented due to flood, wind, or snow hazards, or within the tsunami design zone. The action plans shall include provisions for evacuating, securing, or dismantling public-occupancy temporary structures, in whole or in part, and removal to prevent damage to surrounding buildings or structures.

3103.5.5 Durability and maintenance. Reusable components used in the erection and the installation of public-occupancy temporary structures shall be manufactured of durable materials necessary to withstand environmental conditions at the service location. Components damaged during transportation or installation and due to the effects of weathering shall be replaced or repaired. A qualified person shall inspect public-occupancy temporary structures, including components, when purchased or acquired and at least once per year, based on the requirements in ANSI E1.21. Inspection records shall be kept and shall be made available for verification by the building official. Additionally, public-occupancy temporary structures shall be inspected at regular intervals when in service to ensure that the structure continues to perform as designed and initially erected.

3103.6 Serviceability. The effects of structural loads or conditions shall not adversely affect the serviceability or performance of the public-occupancy temporary structure.

3103.7 Controlled occupancy. Public-occupancy temporary structures that comply with Section 3103.5 for structural requirements do not require monitoring for controlled occupancy. Public-occupancy temporary structures that employ exceptions for reduced environmental loads shall employ controlled occupancy procedures as specified in this section and in accordance with ANSI ES1.7. An operations management plan conforming to ANSI E1.21 with an occupant evacuation plan shall be submitted to the Building Official for approval as a part of the permit documents.

3103.7.1 Wind. Wind speeds associated with the design wind loads shall be monitored before and during occupancy of the public-occupancy temporary structure. The public-occupancy temporary structure shall be vacated in the event that the design wind speed is expected to be exceeded during its occupancy.

3103.7.2 Snow. Surfaces on which snow accumulates shall be monitored before and during occupancy of the public-occupancy temporary structure and any loads in excess of the design snow load shall be removed prior to its occupancy, or the public-occupancy temporary structure shall be vacated in the event that the design snow load is exceeded during its occupancy.

3103.7.3 Ice. Surfaces on which ice accumulates shall be monitored before and during occupancy of the public-occupancy temporary structure and any loads in excess of the design ice load shall be removed prior to its occupancy, or the public-occupancy temporary structure shall be vacated in the event that the design ice load is exceeded during its occupancy.

CHAPTER 35 REFERENCED STANDARDS

Add new standard(s) as follows:

ANSI

American National Standards Institute
25 West 43rd Street, Fourth Floor
New York, NY 10036

E1.21-2013 Entertainment Technology: Temporary Structures Used for Technical Production of Outdoor Entertainment Event

ES1.7-2021 Event Safety Requirements - Weather Preparednes

Staff Analysis: A review of the standard proposed for inclusion in the code, ANSI ES1.7-2021 Event Safety Requirements - Weather Preparedness, with regard to some of the key ICC criteria for referenced standards (Section 3.6 of CP#28) will be posted on the ICC website on or before March 16, 2022.

ANSI E1.21-2013 is already referenced in the IFC. This is simply a new occurrence of the reference in the I-Codes.

Reason Statement: There is a need for code provisions for minimum structural loads for temporary structures. In past code cycles, inappropriate references were attempted to be introduced to the International Building Code but failed due to lack of consensus within the industry. Following that failed attempt, committee members from the adopted structural loading standard ASCE/SEI 7 *Minimum Design Loads and Associated Criteria for Buildings and Other Structures* committed to work with building officials and industry stakeholders to develop provisions that align with the design basis for Chapter 16 and ASCE/SEI 7, as well as provide the appropriate level of risk and structural reliability to the public.

To meet the need for minimum loading provisions and deliver on their commitment, this code change proposal was developed by a diverse group of experts that have experience with the development of the ASCE/SEI 7 Standard, building officials from many jurisdictions from across the country that have experience with large events and temporary structures, and industry representatives from the US entertainment industry.

This proposal was developed by an ad hoc committee that met every month since mid-2020 and the included the following members:

- Don Scott; PCS Structural Solutions – ASCE 7 Wind Load Subcommittee
- Jennifer Goupil; ASCE/SEI Codes & Standards - ASCE 7 Main Committee
- Therese McAllister, PhD; NIST – ASCE 7 Load Combinations Subcommittee
- John Hooper; MKA – ASCE 7 Seismic Subcommittee
- John Duntemann; WJE – ASCE 7 Snow Subcommittee
- Andrew Stam; WJE – ASCE 7 Dead & Live Load Subcommittee
- Bryan Lanier; American Tower Corporation – ASCE 7 Ice Load Subcommittee
- Chris Cerino; STV – ASCE 7 Flood Load Subcommittee
- James (Greg) Soules, PhD; CBI – ASCE 7 Main Committee
- Ali Fattah; City of San Diego
- Constadino (Gus) Sirakis; City of New York

This proposal was developed in collaboration with industry stakeholders, many of whom reviewed the proposal and provided comments to the ad hoc committee; the following stakeholders were invited to collaborate, and many provided comments and input for this proposal:

- Richard Nix; Entertainment Services and Technology Assoc. (ESTA)
- Mike Nugent; ICC BCAC Chair
- Steve Kerr; National Council of Structural Engineers Associations (NCSEA)
- Kai Ki Mow; Seattle Department of Construction and Inspection
- Julius Carreon; City of Bellevue Washington
- Paul Armstrong; PCA Code Services
- Daniel Clark; Clark Reder Engineers
- William Gorlin; McLaren Engineers
- David Renn; City of Denver
- Jon Siu; Jon Siu Consulting
- Gary Ehrlich; National Association of Home Builders and ICC/PTF
- Edgar Surla; Southern Nevada Chapter of ICC

Due to the staggered nature of the ICC and ASCE 7 Standard code development processes, this IBC proposal is the first of two efforts to address the need for provisions for loads on temporary structures. The second effort includes development of a new Appendix to ASCE 7 to address temporary structures.

Following is the description and rationale for content of this code change proposal:

The International Codes regulate the construction of new buildings and temporary structures through the International Building Code (IBC) and regulate existing buildings through the International Existing Building Code (IEBC). A temporary structure is not an existing building because it is not permanent and is therefore regulated through Chapter 31 of the IBC.

Temporary Special Event Structures are regulated by the International Fire Code. However, they are a type of temporary structure and thus need to also meet the requirements of this proposed section.

Three new definitions are added for public-occupancy temporary structures, service life, and temporary event. Public-occupancy temporary structures are new buildings or structures that are used by the general public, or that support public events, where the public expects similar levels of reliability and safety as offered by permanent construction. Public-occupancy temporary structures are often assembled with re-useable components and designed for a particular purpose and defined period of time, which is defined as a temporary event when the period of time is less than one year. Public-occupancy temporary structures in service for a period that exceeds 1-year are required to comply with the IBC for new buildings. Temporary structures should not pose more risk to occupants than permanent structures, but because the code's design-level environmental loads are far less likely during a temporary event, this proposal makes adjustments to reduce the requirements for a consistent level of risk. The code change addresses the hazards in the built environment in IBC chapter 16 for public-occupancy temporary structures. The code change includes the ability to mitigate some hazards through Emergency Action Plans. Portions of temporary structures may be removed to reduce wind loads, for example.

The concept of controlled occupancy is also introduced to address cases where an environmental loading hazard cannot be reasonably mitigated and allows for actions based on a preapproved action plan that the Building Official may use to allow installations that cannot resist code prescribed loads. For example, hazard areas such as flood hazard areas and tsunami inundation zones are clearly mapped, and evacuation plans are adopted and include tsunami alert warning systems and temporary structures subject to high wind loads may be evacuated and have sections removed to reduce the wind load. The code change proposal recognizes that it may be desirable for a temporary structure to remain in service for more than 180 days, whether continuously occupied or not, and provides a process that the Building Official can follow to facilitate such an extended service period. However, after 1-year has passed, the structure is required to comply with requirements for new buildings or is removed from service by being disassembled.

DESIGN PHILOSOPHY:

Temporary structures that are occupied by the general public or that could cause injuries or loss of life by their failure require a design basis that is consistent with the risk and reliability criteria in ASCE 7. The basis of design for temporary structures needs to consider voluntary vs involuntary risk, service life, and reliability as well as the ability to reduce risk for the general public for severe weather events, as elaborated below. Therefore, temporary structures occupied by the general public are expected to have the same level of reliability (or failure rate) and performance as permanent structures.

While temporary structures are developed for use up to 180 days, many of these structures are used repeatedly at different locations. Thus, their actual service life may be on the order of 5 to 10 years. Such structures are consequently subjected to repeated assembly and dismantling with associated wear and tear. Therefore, service life for temporary structures is defined to provide a consistent basis of reliability relative to that of new buildings, and a service life of 10 years is assumed for determining structural load requirements in Section 3103.5.

Risk:

In a general sense, risk represents the potential consequences of exposure to a natural or man-made hazard in the presence of uncertainty. There are three components to risk – hazard, consequences and context – and risk-informed decisions should involve all three. The focus in structural engineering has been on the hazard (and its probability of exceedance) and structural performance in terms of failure given a hazard intensity over a structure's service life. Consequences and context are reflected indirectly through Risk Categories (or Importance Factors).

The concept of voluntary and involuntary risk assumed by the general public should be considered in the design of structures. Voluntary risk

assumption occurs when people choose to undertake an activity with a known level of hazard and consequences, such as driving or flying to a destination. Involuntary risks occur when people are exposed to a hazard without understanding the potential consequences. The willingness of people to incur risk depends on whether the risk is incurred voluntarily or involuntarily (Slovic, 2000). Because people require shelter, building occupancy is an involuntary risk. The general public assumes that all structures, permanent and temporary, have been designed and constructed to provide the same level of structural safety and reliability. If a structure is designed to a lower level of safety or reliability, the general public has no means to identify or assess the difference in risk. This includes temporary structures that may not be accessible to the general public but could cause injuries or loss of life in the event of failure (e.g., special event structures such as towers, platforms, and stages). Analogies can be made to various modes of transportation, and their inherent risks; the general public is aware of differences in assumed risk and can choose a mode of transportation accordingly. In contrast, ASCE 37 was developed for temporary structures used in construction. The risk associated with these structures is generally limited to construction workers, who voluntarily accept a higher-risk environment and have training and skills for operating in a construction environment. Therefore, temporary structures that are used by or in close proximity to the general public need to have a level of reliability consistent with the other structures designed for involuntary risk.

Reliability:

Structural reliability requires the combined analysis of the probability of occurrence of the hazard and the probability that the loads caused by the hazard equal or exceed the structural resistance. Temporary structures that are used, occupied, or placed in close proximity to the general public should meet reliability targets that are consistent with those for permanent structures in ASCE, allowing for differences in service lives and other conditions of use.

ASCE 7 Table 1.3-1 presents the target reliabilities by Risk Category (RC) and failure mode (e.g., ductile vs brittle failures) for hazards other than earthquake, tsunami, or extraordinary events. The target reliabilities are presented in two formats: the mean annual failure rate and the probability of failure for a 50-yr service life, expressed in terms of reliability index, β . For example, a RC II structure with ductile, local failure modes has a target mean annual failure rate $P_F = 3.0 \times 10^{-5}$ and a 50-yr target reliability index of $\beta = 3.0$ (or $P_F = 1.43 \times 10^{-3}$ over 50 years).

WIND:

ASCE 7-16 wind hazard maps were updated to confirm the risk-based mean recurrence interval (MRI) for RC I to III and to establish a risk-based MRI for RC IV (McAllister, Wang, and Ellingwood 2018). The updated wind maps are based on a fully coupled reliability analysis that considered the hazard and structural resistance. The results for the recommended MRI for the target reliabilities are shown in Figure 3105.5.2.

Two exceptions are allowed for wind:

- An exception is allowed where controlled occupancy actions in Section 3103.7 are adopted, given that on-site management and weather forecasting capabilities allow sufficient time to reduce the risk to occupants by canceling events or reducing the wind loads through removal of wind surface area or dismantling sections of the temporary structure.
- An exception is allowed when public-occupancy temporary structures are erected in a hurricane-prone region outside of hurricane season. The wind load reduction is based on hurricane and non-hurricane wind speeds. ASCE 7 publishes wind speed maps that include both hurricane and non-hurricane winds for permanent structures. Pintar et al (2015) published maps of non-hurricane non-tornadic wind speeds for the contiguous United States.

A study by Dasgupta and Ghosh (2019) evaluated a wind speed factor of 0.78 used by the Unified Facilities Criteria for temporary structures for 5-yr and 25-yr service lives. This study selected the 50-yr target reliabilities and associated 50-yr wind speed exceedance probabilities to evaluate the wind speed load factor for occupied temporary structures based on ASCE 7-16 wind speed maps. The ASCE 7-16 wind maps for RC I, II, III and IV structures were developed for 15%, 7%, 3% and 1.6% probabilities of wind speed exceedance. To evaluate the 0.78 wind speed factor, wind speeds at 342 locations across the country were identified for specified mean recurrence intervals (MRI). The specified MRI were determined by computing the MRI that would provide the same probability of wind speed exceedance in 5 years and 25 years as that specified for a 50-yr service life in ASCE 7, as shown in Table C3105.1.1. However, the mean recurrence rates of wind speeds, and therefore the structural reliability, are quite different from the ASCE 7 target reliabilities, as shown in Example 1. Assuming that the structural resistance is similar, a comparison of the RC II mean annual frequency for wind speeds for a 50-yr service life (1.43×10^{-3}) to that of a 5-yr service life (1.43×10^{-2}) and a 10-yr service life (7.14×10^{-2}) show service life reliability ratios of 10 and 5, respectively, which do not meet the ASCE 7 target reliability criteria.

Until further analyses can be conducted, a 10-yr service life and a wind speed factor of 0.9 is deemed to provide a reasonable level of reliability, given the ability to evacuate or modify temporary structures for strong wind events.

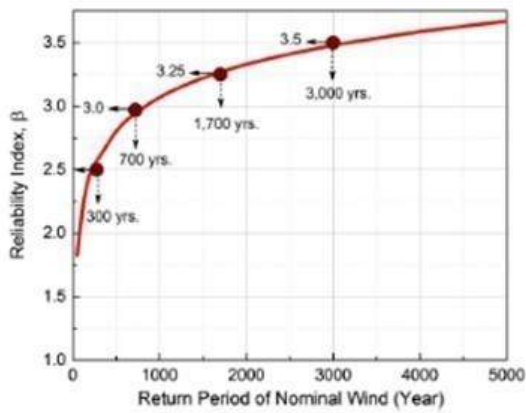

Fig. 3. Recommended mean return periods for wind maps in ASCE 7-16 ($K_{ds} = 0.85$; $\mu_{Kd} = 0.71$)

Figure C3105.5.1. ASCE 7 wind MRI versus reliability index (McAllister, Wang, and Ellingwood 2018).

Table C3105.5.1. Proposed wind speed factor for 5-yr and 25-yr service life for temporary structures by Dasgupta and Ghosh (2019) based on 50-yr service reliability criteria.

ASCE 7 MRI Wind speed factor 5 yr MRI 25 yr MRI 3000.7830150117000.7870350111,7000.781708501V3,0000.783001,500

Example 1: Probability of exceedance over T yr service life for W

This example provides a comparison of probability of wind speed exceedance for service lives (T) from 5 to 25 years and Risk Category. The probability of wind exceedance is set to remain constant for each risk category; however, the mean annual frequency (P_a) can vary significantly between different values of T.

$$P(W > w \text{ for } T) = 1 - (1 - P_a)^T = X\%$$

- W – random wind speed (3-sec gust)
- w – wind speed (3-sec gust) for Mean Recurrence Interval (MRI)
- T is the service life (yr)
- $P_a = 1/T$ is the mean annual frequency for this wind speed (1/yr)
- X is the probability of the wind speed exceedance for T

For a 50 yr service life (ASCE 7):

RC I $P(W > 300 \text{ MRI in 50 yrs}) = 1 - (1 - 0.0033)^{50} = 0.15 = 15\% \quad P_a = 3.3 \times 10^{-3}$

RC II $P(W > 700 \text{ MRI in 50 yrs}) = 1 - (1 - 0.00143)^{50} = 0.069 = 7\% \quad P_a = 1.4 \times 10^{-3}$

RC III $P(W > 1700 \text{ MRI in 50 yrs}) = 1 - (1 - 0.00059)^{50} = 0.029 = 3\% \quad P_a = 5.9 \times 10^{-4}$

RC IV $P(W > 3000 \text{ MRI in 50 yrs}) = 1 - (1 - 0.00033)^{50} = 0.017 = 1.7\% \quad P_a = 3.3 \times 10^{-4}$

For a 25 yr service life:

RC I $P(W > 150 \text{ MRI in 25 yrs}) = 1 - (1 - 0.0067)^{25} = 0.15 = 15\% \quad P_a = 6.7 \times 10^{-3}$

RC II $P(W > 350 \text{ MRI in 25 yrs}) = 1 - (1 - 0.0029)^{25} = 0.069 = 7\% \quad P_a = 2.9 \times 10^{-3}$

RC III $P(W > 850 \text{ MRI in 25 yrs}) = 1 - (1 - 0.0012)^{25} = 0.029 = 3\% \quad P_a = 1.2 \times 10^{-3}$

RC IV $P(W > 1500 \text{ MRI in 25 yrs}) = 1 - (1 - 0.0007)^{25} = 0.017 = 1.7\% \quad P_a = 6.7 \times 10^{-4}$

For a 10 yr service life:

RC I $P(W > 60 \text{ MRI in 10 yrs}) = 1 - (1 - 0.017)^{10} = 0.16 = 16\% \quad P_a = 1.7 \times 10^{-2}$

RC II $P(W > 140 \text{ MRI in 10 yrs}) = 1 - (1 - 0.0714)^{10} = 0.069 = 7\% \quad P_a = 7.1 \times 10^{-3}$

RC III $P(W > 340 \text{ MRI in 10 yrs}) = 1 - (1 - 0.00294)^{10} = 0.029 = 3\% \quad P_a = 2.9 \times 10^{-3}$

RC IV $P(W > 600 \text{ MRI in 10 yrs}) = 1 - (1 - 0.00167)^{10} = 0.017 = 1.7\% \quad P_a = 1.7 \times 10^{-3}$

For a 5 yr service life:

RC I $P(W > 30 \text{ MRI in 5 yrs}) = 1 - (1 - 0.0333)^5 = 0.16 = 16\% \quad P_a = 3.3 \times 10^{-2}$

RC II $P(W > 70 \text{ MRI in 5 yrs}) = 1 - (1 - 0.0143)^5 = 0.069 = 7\% \quad P_a = 1.4 \times 10^{-2}$

RC III $P(W > 170 \text{ MRI in 5 yrs}) = 1 - (1 - 0.0059)^5 = 0.029 = 3\% \quad P_a = 5.9 \times 10^{-3}$

RC IV $P(W > 300 \text{ MRI in 5 yrs}) = 1 - (1 - 0.0033)^5 = 0.017 = 1.7\% \quad P_a = 3.3 \times 10^{-3}$

References

Dasgupta, P. and S.K. Ghosh (2019) *An Evaluation of the Wind and Seismic Provisions of UFC 1-201-01 for Temporary Structures*, S.K. Ghosh Associates LLC, www.skghoshassociates.com

McAllister, T., N. Wang, and B. R. Ellingwood. 2018. *Risk-informed mean recurrence intervals for update wind maps in ASCE 7-16*, J. Struct. Eng. 144 (5). [https://doi.org/10.1061/\(ASCE\)ST.1943-541X.0002011](https://doi.org/10.1061/(ASCE)ST.1943-541X.0002011)

Pintar, A.L., Simiu, E., Lombardo, F.T., Levitan, M. 2015. *Maps of Non-hurricane Non-tornadic Wind Speeds With Specified Mean Recurrence Intervals for the Contiguous United States Using a Two-dimensional Poisson Process Extreme Value Model and Local Regression*, NIST Special Publication 500-301, National Institute of Standards and Technology, Gaithersburg, MD <https://nvlpubs.nist.gov/nistpubs/SpecialPublications/NIST.SP.500-301.pdf>

Slovic, P. (2000), *The perception of risk*. Earthscan Publications, Sterling, VA. <https://www.researchgate.net/publication/232546133> The perception of risk Risk society and policy series

SEISMIC:

The requirement that the seismic loads on temporary structures assigned to Seismic Design Categories C through F are permitted to be taken as 75% of those required by Section 1613, while resulting in reduced seismic performance relative to permanent structures, is consistent with the reduction generally accepted for the evaluation/upgrade of existing buildings and would result in a similar seismic risk to the occupants. Due to the unique lack of warning associated with earthquakes, taking further reductions, even for temporary structures, results in unacceptable, involuntary risk to the occupants. Even for short time frames, the risk to the occupants should be similar, whether it's a temporary or permanent structure. Given the low seismic risk associated with Seismic Design Categories A and B locations, which results in low seismic demands, temporary structures are exempted from designing for seismic loads.

TSUNAMI:

Given that most tsunami-affected areas will have time to respond to a possible inundation, designing temporary structures for tsunami loads was deemed unnecessary. Rather, temporary structures located in a Tsunami Design Zone will require an Emergency Action Plan that will provide details for evacuating the structure in the event of a tsunami warning.

SNOW:

When snowfall is expected during the service life of a temporary structure, snow loads are determined for surfaces on which snow can accumulate in accordance with Section 1608 and Chapter 7 of ASCE 7. In recognition of the relatively short service life of temporary structures, the ground snow load can be reduced to reflect the relatively low probability that the ASCE 7 ground snow loads will occur during the shorter service life of a temporary structure. The reduction factors of 0.7 and 0.8 in Table 3103.5.1 approximately correspond to 10-year and 20-year MRI for ground snow loads, respectively. If the service life of the temporary structure will not occur during winter months when snow is to be expected, snow loads need not be considered. Similar to wind, an exception is allowed where controlled occupancy actions in Section 3103.7 are adopted, given that on-site management and weather forecasting capabilities allow sufficient time to reduce the risk to occupants by canceling events or reducing the snow loads.

FLOOD:

Temporary structures within riverine and coastal flood zones should be evacuated at the time of loading, therefore the intent of this section is to have a defined plan to secure the structure and minimize the potential for the temporary structure to become floating debris for the surrounding environment. While local flash flooding can occur without advanced warning, the potential hazard area is much more wide-spread and not easily quantified for an enforceable Code provision as part of this cycle. For this reason, there are no requirements for temporary structures outside of a mapped flood zone.

ICE:

When ice can accumulate on a temporary structure during the service life of a temporary structure, ice loads are determined for surfaces on which ice can accumulate in accordance with Section 1614 and Chapter 10 of ASCE 7.

The 0.5-inch nominal ice thickness is based on consideration of the 10-yr and 25-yr mean recurrence interval values. Based on this, the use of a single nominal ice thickness for all locations with a Risk Category II nominal thickness greater than 0.5 inch is recommended. The gust wind speeds in Figure 10.5-1 are concurrent values, rather than extremes, so they should be used in determining wind-ice-loads for temporary ice-sensitive structures.

LOAD FACTORS/RELIABILITY:

The proposed code change is necessary to harmonize the IBC with the IFC since the latter addresses Temporary Special Event Structures and tents that are in service for up to 180 days. The recent pandemic has shown that temporary structures can be in service for more than 180 days and includes structures not regulated within the scope of the IFC.

Given the need to propose load and design criteria for publicly occupied temporary structures based on existing information and standards, the approach presented uses the load and Risk Category criteria in ASCE 7-22. Further analyses may be able to refine these criteria for the next edition of ASCE 7.

EMERGENCY ACTION PLANS:

The code change addresses all the natural hazards and associated environmental loads addressed in IBC chapter 16 and ASCE 7. However, some

hazards are more frequent with a likelihood of occurrence during the in-service period or occupancy while others have a remote possibility of occurrence. Emergency Action plans are currently accepted by authorities having jurisdiction for wind loads to reduce the risk to public safety, given the reduced level of reliability relative to new buildings. Flood hazards may be seasonal for example during hurricane seasons or flash flooding is forecast in advance to allow for removal or tying down of installations. They provide the Building Official with the ability to permit a more cost effective alternative than full compliance.

DURABILITY AND MAINTENCE:

Temporary structures are designed to be assembled and disassembled and transported to many locations as components or as modules. Additionally, they may be in service during varying weather conditions. The components may be damaged during transportation or installation. Components may have been manufactured more than a decade prior to the latest use. As a consequence, and unlike a new structure that is typically constructed with new building materials and components that were not previously used, components for temporary structures need to be inspected regularly and suitability for re-use needs to be assessed. This is typically done by the installation crews, and this is similar to bleachers regulated by ICC 300 (Section 501.2). The qualified person is identified by the owner and approved by the Building Official.

Temporary structures are typically assembled utilizing transportable and reusable components that can get damaged in use or during transportation and in use and need to be verified prior to reuse. The most qualified personnel to address whether superficial corrosion is acceptable or whether bent members can be used will be the specifying engineer or the rigging supervisors or owner's management team who tend to be most familiar with the components and the temporary structure's system.

Cost Impact: The code change proposal will decrease the cost of construction

The proposed code change will reduce the cost of construction since it proposes reduction to the adopted loads in IBC Ch 16 and ASCE 7. The codes and standards that are in effect under the 2021 edition of the I Codes, with the exception of the International Fire Code regulations for Temporary Special Event Structures, do not provide structural loading criteria adjusted to lower loads for temporary structures that typically have a service life of a few days or weeks not to exceed 1 year.

S117-22

IBC: SECTION 202, 1608.3, 1611.2

Proponents: Nathalie Boeholt, representing Washington Association of Building Officials Technical Code Development Committee; Micah Chappell, representing Washington Association of Building Officials Technical Code Development Committee (micah.chappell@seattle.gov)

2021 International Building Code

Delete without substitution:

[BS] SUSCEPTIBLE BAY. A roof or portion thereof with either of the following:

1. A slope less than $\frac{1}{4}$ inch per foot (0.0208 rad).
2. On which water is impounded, in whole or in part, and the secondary drainage system is functional but the primary drainage system is blocked.

A roof surface with a slope of $\frac{1}{4}$ inch per foot (0.0208 rad) or greater towards points of free drainage is not a susceptible bay.

Revise as follows:

1608.3 Ponding instability. ~~Susceptible bays of roofs shall be evaluated for ponding.~~ Ponding instability on roofs shall be evaluated in accordance with Chapters 7 and 8 of ASCE 7.

1611.2 Ponding instability. ~~Susceptible bays of roofs shall be evaluated for ponding.~~ Ponding instability on roofs shall be evaluated in accordance with Chapters 7 and 8 of ASCE 7.

Reason Statement: Section 1608.3 (Snow Loads-Ponding instability) and section 1611.2 (Rain Loads-Ponding instability) refer to the defined term "Susceptible Bay" for ponding instability evaluation. The referenced standard ASCE 7-22 has eliminated the defined term "Susceptible Bay" but still takes ponding into account for snow and rain loads. This proposal will help align the Building Code with the ASCE 7-22 standard by removing this term. This proposal also shortens the code language with a simple reference to ASCE 7.

Cost Impact: The code change proposal will not increase or decrease the cost of construction

This proposal is only an editorial change and does not change the technical requirements for ponding consideration. There will be no cost impact when approving this proposal.

S117-22

S118-22

IBC: 1609.2.1

Proponents: Amanda Hickman, representing Air Movement and Control Association International, Inc. (AMCA) (amanda@thehickmangroup.com)

2021 International Building Code

Revise as follows:

1609.2.1 Louvers. Louvers protecting ~~intake and exhaust ventilation ducts not assumed to be open~~ the exterior wall envelope that are located within 30 feet (9144 mm) of grade shall meet the requirements of AMCA 540.

Reason Statement:

The current language is clunky, confusing, and unclear. This proposal simplifies and clarifies the intent of the section.

There are many and differing interpretations of what the phrase “not assumed to be open” means.

Does it mean the louver is open?

That does not make sense as a louver is a device made up of many blades that are typically “open” to allow airflow into or out of a building for various reasons. Some louvers have adjustable blades that allow the blades to be “closed” to stop airflow. The phrase “not assumed to be open” is confusing as it is unknown if it pertains to if the louver blades are in the open or closed position.

Is that phrase referring to the ducts being open?

An open duct allows extra wind pressure into a room or system where a closed duct does not.

Another interpretation could be that “open” refers to if the face area of the louver that is or is not counted towards the total “open area” of a building’s envelope, which has great influence on if a building is classified as an “enclosed”, a “partially enclosed”, or an “open” building per ASCE 7 (which then has great influence on the ASCE 7 structural calculations of the building).

To better clarify the correct interpretation of this phrase is to replace it with a code defined term for what the louver is protecting: “the exterior wall envelope”.

Not all installations of louvers in the exterior wall envelope are ducted. However, the louver still needs to protect the building and maintain the continuity of the exterior wall envelope.

Cost Impact: The code change proposal will not increase or decrease the cost of construction

Non-ducted or non-intake/exhaust louvers meeting location requirements of IBC 1609.2 already need to be impact protected. Per IMC 401.5, intake louvers already need to be impact protected per IBC 1609. Per IMC 501.3.2, exhaust louvers already need to be impact protected per IBC 1609.

S118-22

S119-22 Part I

IBC: 1609.2.2, 1609.2.3

Proponents: Mike Nugent, representing Building Code Action Committee (bcac@iccsafe.org)

THIS IS A 2 PART CODE CHANGE. PART I WILL BE HEARD BY THE IBC STRUCTURAL CODE COMMITTEE. PART II WILL BE HEARD BY THE IRC-B CODE COMMITTEE. SEE THE TENTATIVE HEARING ORDER FOR THESE COMMITTEES.

2021 International Building Code

Delete without substitution:

~~1609.2.2 Application of ASTM E1996.~~ The text of Section 6.2.2 of ASTM E1996 shall be substituted as follows:

~~6.2.2 Unless otherwise specified, select the wind zone based on the basic design wind speed, V , as follows:~~

~~6.2.2.1 Wind Zone 1 — $130 \text{ mph} \leq \text{basic design wind speed, } V < 140 \text{ mph}$.~~

~~6.2.2.2 Wind Zone 2 — $140 \text{ mph} \leq \text{basic design wind speed, } V < 150 \text{ mph}$ at greater than one mile (1.6 km) from the coastline. The coastline shall be measured from the mean high water mark.~~

~~6.2.2.3 Wind Zone 3 — $150 \text{ mph} (67 \text{ m/s}) \leq \text{basic design wind speed, } V \leq 160 \text{ mph} (72 \text{ m/s})$, or $140 \text{ mph} (63 \text{ m/s}) \leq \text{basic design wind speed, } V \leq 160 \text{ mph} (72 \text{ m/s})$ and within one mile (1.6 km) of the coastline. The coastline shall be measured from the mean high water mark.~~

~~6.2.2.4 Wind Zone 4 — basic design wind speed, $V > 160 \text{ mph} (72 \text{ m/s})$.~~

Revise as follows:

~~1609.2.3~~ **1609.2.2 Garage doors.** Garage door glazed opening protection for windborne debris shall meet the requirements of an *approved* impact-resisting standard or ANSI/DASMA 115.

S119-22 Part I

S119-22 Part II

IRC: R301.2.1.2.1

Proponents: Mike Nugent, representing Building Code Action Committee (bcac@iccsafe.org)

2021 International Residential Code

Delete without substitution:

R301.2.1.2.1 Application of ASTM E1996. The text of Section 2.2 of ASTM E1996 shall be substituted as follows:
2.2 ASCE Standard:

~~ASCE 7-10 American Society of Civil Engineers *Minimum Design Loads for Buildings and Other Structures*~~

~~The text of Section 6.2.2 of ASTM E1996 shall be substituted as follows:~~

~~6.2.2 Unless otherwise specified, select the wind zone based on the ultimate design wind speed, V_{ult} , as follows:~~

~~6.2.2.1 Wind Zone 1—130 mph \leq ultimate design wind speed, $V_{ult} < 140$ mph.~~

~~6.2.2.2 Wind Zone 2—140 mph \leq ultimate design wind speed, $V_{ult} < 150$ mph at greater than 1 mile (1.6 km) from the coastline. The coastline shall be measured from the mean high water mark.~~

~~6.2.2.3 Wind Zone 3—150 mph (67 m/s) \leq ultimate design wind speed, $V_{ult} \leq 170$ mph (76 m/s), or 140 mph (54 m/s) \leq ultimate design wind speed, $V_{ult} \leq 170$ mph (76 m/s) and within 1 mile (1.6 km) of the coastline. The coastline shall be measured from the mean high water mark.~~

~~6.2.2.4 Wind Zone 4—ultimate design wind speed, $V_{ult} > 170$ mph (76 m/s).~~

Reason Statement: This proposal removes the technical criteria that is redundant with the current reference standards ASTM E1996-20 and ASCE 7-22. ASTM E1996 has changed to ultimate design from strength design and reduced the wind zones from 4 to 3. The 'correction' as specified in IBC Section 1609.2.2 and IRC Section R301.2.1.2.1 is no longer needed with the current ASTM E1996-20 and ASCE 7-22. ASCE 7-10 changed the basis of its wind speed maps from allowable stress-level wind speeds to strength design-level wind speeds. However, due to the timing of the ICC code development cycle leading to the 2012 IBC and IRC and of the ASTM cycle for updating E1996, there was not enough time to correlate and update the wind speeds associated with the E1996 wind zones. Section 1609.2.2 was introduced as a temporary measure to correlate the E1996 wind zones with ASCE 7-10.

In addition, Wind Zone 4 was modified to trigger at a higher wind speed as was specified in E1996 at the time. Wind Zone 4 was originally introduced to bring Miami-Dade County on board with accepting ASTM E1996 as equivalent to the TAS 102. The IBC and IRC raised the Wind Zone 4 trigger as the ASCE 7-10 wind maps would have otherwise resulted in Wind Zone 4 extending beyond Miami-Dade County.

This proposal is submitted by the ICC Building Code Action Committee (BCAC).

BCAC was established by the ICC Board of Directors in July 2011 to pursue opportunities to improve and enhance assigned International Codes or portions thereof. In 2020 and 2021 the BCAC has held several virtual meetings open to any interested party. In addition, there were numerous virtual Working Group meetings for the current code development cycle, which included members of the committee as well as interested parties. Related documents and reports are posted on the BCAC website at <https://www.iccsafe.org/products-and-services/i-codes/code-development/cs/building-code-action-committee-bcac/>.

Cost Impact: The code change proposal will not increase or decrease the cost of construction. Removing the IBC and IRC modification will not change any design or testing requirements as the wind zone definitions in E1996 largely match those in the modification. It may reduce confusion in southern Florida by removing reference to Wind Zone 4, which no longer exists in E1996.

S119-22 Part II

S121-22

IBC: SECTION 1609, 1609.5.3

Proponents: Jennifer Goupil, representing Structural Engineering Institute of ASCE (jgoupil@asce.org)

2021 International Building Code

SECTION 1609 WIND LOADS

Revise as follows:

1609.5.3 Rigid tile. Wind loads on rigid tile roof coverings shall be determined in accordance with the following equation:

$$M_a = q_h K_d C_L b L L_a [1.0 - (GC_p)]$$

(Equation 16-18)

For SI:

$$M_a = q_h K_d C_L b L L_a [1.0 - (GC_p)] / 1,000$$

where:

b = Exposed width, feet (mm) of the roof tile.

C_L = Lift coefficient. The lift coefficient for concrete and clay tile shall be 0.2 or shall be determined by test in accordance with Section 1504.3.1.

(GC_p) = Roof pressure coefficient for each applicable roof zone determined from Chapter 30 of ASCE 7. Roof coefficients shall not be adjusted for internal pressure.

K_d = Wind directionality factor determined from Chapter 26 of ASCE 7.

L = Length, feet (mm) of the roof tile.

L_a = Moment arm, feet (mm) from the axis of rotation to the point of uplift on the roof tile. The point of uplift shall be taken at 0.76L from the head of the tile and the middle of the exposed width. For roof tiles with nails or screws (with or without a tail clip), the axis of rotation shall be taken as the head of the tile for direct deck application or as the top edge of the batten for battened applications. For roof tiles fastened only by a nail or screw along the side of the tile, the axis of rotation shall be determined by testing. For roof tiles installed with battens and fastened only by a clip near the tail of the tile, the moment arm shall be determined about the top edge of the batten with consideration given for the point of rotation of the tiles based on straight bond or broken bond and the tile profile.

M_a = Aerodynamic uplift moment, feet-pounds (N-mm) acting to raise the tail of the tile.

q_h = Wind velocity pressure, psf (kN/m²) determined from Section 26.10.2 of ASCE 7.

Concrete and clay roof tiles complying with the following limitations shall be designed to withstand the aerodynamic uplift moment as determined by this section.

1. The roof tiles shall be either loose laid on battens, mechanically fastened, mortar set or adhesive set.
2. The roof tiles shall be installed on solid sheathing that has been designed as components and cladding.
3. An underlayment shall be installed in accordance with Chapter 15.
4. The tile shall be single lapped interlocking with a minimum head lap of not less than 2 inches (51 mm).
5. The length of the tile shall be between 1.0 and 1.75 feet (305 mm and 533 mm).
6. The exposed width of the tile shall be between 0.67 and 1.25 feet (204 mm and 381 mm).
7. The maximum thickness of the tail of the tile shall not exceed 1.3 inches (33 mm).
8. Roof tiles using mortar set or adhesive set systems shall have not less than two-thirds of the tile's area free of mortar or adhesive contact.

Reason Statement: This proposal is a coordination proposal to bring the 2024 IBC up to date with the provisions of the 2022 edition of ASCE/SEI 7 Minimum Design Loads and Associated Criteria for Buildings and Other Structures (ASCE/SEI 7-22). ASCE 7 will be updated to the 2022 edition from the 2016 edition as an Administrative update in the 2024 I-Codes.

A summary of the coordination changes is provided below.

1609.5.3 Rigid tile. This code change is needed because the Wind Directionality Factor (K_d) in ASCE 7 - 22 Standard *Minimum Design Loads and Associated Criteria for Buildings and Other Structures* was relocated from the Velocity Pressure Equation that determines q_h to the pressure equations that determine pressures on the components and cladding elements of the structure. Because K_d is no longer included in the calculation for q_h directly, it is added here. This is not a new addition for M_a equation, but only re-organization of the terms in the calculation. The parentheses are added around (GCp) to match with the formatting of the term in ASCE 7.

Cost Impact: The code change proposal will not increase or decrease the cost of construction

This proposal only coordinates the re-organization of the terms in the ASCE 7-22 equations for calculating the loads on rigid tiles. It does not change the values and therefore will have no effect on the cost of construction.

S121-22

S122-22

IBC: 1609.6 (New), 1612.2, 1613.4 (New), 3001.3, 3001.6 (New)

Proponents: Julie Furr, representing FEMA-ATC Seismic Code Support Committee (jfurr@rimkus.com); Kelly Cobeen, representing Federal Emergency Management Agency/Applied Technology Council - Seismic Code Support Committee (kcobeen@wje.com); Michael Mahoney, representing FEMA (mike.mahoney@fema.dhs.gov); Emily Guglielmo, representing NCSEA Wind Committee (eguglielmo@martinmartin.com); Kevin Brinkman, representing National Elevator Industry, Inc. (klbrinkman@neii.org); Robert Bachman, representing FEMA/ATC Seismic Code Support Committee (rebachmanse@aol.com)

2021 International Building Code

Add new text as follows:

1609.6 Elevators, Escalators, and other Conveying Systems. Elevators, escalators, and other conveying systems and their components exposed to outdoor environments shall satisfy the wind design requirements of ASCE 7.

Revise as follows:

1612.2 Design and construction. The design and construction of buildings and structures located in *flood hazard areas*, including *coastal high hazard areas* and *coastal A zones*, shall be in accordance with Chapter 5 of ASCE 7 and ASCE 24. Elevators, escalators, conveying systems and their components shall conform to ASCE 24 and ASME A17.1/CSA B44 as applicable.

Add new text as follows:

1613.4 Elevators, Escalators, and other Conveying Systems. Elevators, escalators, and other conveying systems and their components shall satisfy the seismic requirements of ASCE 7 and ASME A17.1/CSA B44 as applicable.

Revise as follows:

3001.3 Referenced standards. ~~Except as otherwise provided for in this code, the design, construction, installation, alteration, repair and maintenance of elevators and conveying systems and their components shall conform to the applicable standard specified in Table 3001.3 and Section 3001.6. ASCE 24 for construction in *flood hazard areas* established in Section 1612.3.~~ The design, construction, installation, alteration, repair and maintenance of elevators and conveying systems and their components shall conform to the applicable standard specified in Table 3001.3 and Section 3001.6.

Add new text as follows:

3001.6 Structural Design. All interior and exterior elevators, escalators, and other conveying systems and their components shall comply with all applicable design loading criteria in Chapter 16, including wind, flood, and seismic loads established in Sections 1609, 1612, and 1613.

Reason Statement: The proposed revisions to Chapter 30 are intended to clarify which design criteria and standards apply to elevators, escalators, conveying systems and their components and that the provisions are applicable to both interior and exterior systems. Additionally, since applicable standards are published by different organizations subject to different update cycles, this specifies that the provisions of all applicable standards shall apply to ensure the absence of a provision in one standard is not used to avoid the provision entirely. These revisions do not impose new technical requirements on the structural design of these systems.

Environmental provisions, both interior and exterior, are relevant to the design and construction of elevators, escalators, and conveying systems. However, Section 3001.3 currently points only to ASME, ALI, ANSI and ASCE 24 (flood provisions) standards, without reference to ASCE 7. The omission of ASCE 7 leaves Chapter 30 open to an interpretation that ASCE 7 does not apply or is overridden by the listed standards.

Wind

There have been many cases in south Florida where high wind loads were not considered in the design and installation of outdoors escalators and elevators. ASME A17.1 does not currently address wind provisions, leaving ASCE 7 as the next appropriate standard to reference. However, since ASCE 7 is not specified in Chapter 30, a common interpretation is that only ASME A17.1 should apply and ASCE 7 is not required. This leaves exterior structures vulnerable to damage and/or failure when exposed to high winds.

Seismic

ASME A17.1 and ASCE 7 both outline seismic requirements for elevators and conveying systems, but different update cycles mean these two standards are not always in sync. As such, seismic provisions in the current version of ASME A17.1 are based on ASCE 7-16 and still need to be updated to comply with changes in ASCE 7-22. There are significant differences in the requirements of ASCE 7-22 and ASCE 7-16 that the casual user may be unaware of. It is unknown if ASME A17.1 will be updated in time for incorporation into the 2024 IBC.

For individual structures, this proposal may reduce the nonstructural component seismic design forces constructed using lateral force-resisting system with higher ductility, which are commonly used in regions of high seismic risk while for structures using low or moderate ductility systems the seismic design forces may increase.

Flood

Reference to ASCE 24 specifically for elevators, escalators and conveying systems has been relocated to Section 1612. ASME A17.1 Section 8.12 specifically states that elevators must be in compliance with ASCE 24.

Other

Snow, ice, and other environmental loads are equally important to maintain structural stability and should be considered in design for exterior systems, where applicable. The general reference to Chapter 16 captures all other environmental loading conditions.

Cost Impact: The code change proposal will not increase or decrease the cost of construction

This is a clarification that more clearly defines when ASCE and ASME standards are required for different environmental loads and conditions. The added language in Chapter 16 further clarifies that a lack of reference to specific environmental loads in one standard does not mean the design is exempt from considering that environmental load.

S122-22

S123-22

IBC: SECTION 1610, 1610.1

Proponents: Jennifer Goupil, representing Structural Engineering Institute of ASCE (jgoupil@asce.org)

2021 International Building Code

SECTION 1610 SOIL LOADS AND HYDROSTATIC PRESSURE

Revise as follows:

1610.1 Lateral pressures. ~~Foundation walls and retaining walls.~~ Structures below grade shall be designed to resist lateral soil *loads* from adjacent soil. Soil *loads* specified in Table 1610.1 shall be used as the minimum design lateral soil *loads* unless determined otherwise by a geotechnical investigation in accordance with Section 1803. Foundation walls and other walls in which horizontal movement is restricted at the top shall be designed for at-rest pressure. ~~Retaining walls.~~ Walls that are free to move and rotate at the top, such as retaining walls, shall be permitted to be designed for active pressure.

~~Where applicable, lateral~~ Lateral pressure from fixed or moving surcharge *loads* shall be added to the lateral soil *load*. Lateral pressure shall be increased if expansive soils are present at the site. Foundation walls shall be designed to support the weight of the full hydrostatic pressure of undrained backfill unless a drainage system is installed in accordance with Sections 1805.4.2 and 1805.4.3.

Exception: Foundation walls extending not more than 8 feet (2438 mm) below grade and laterally supported at the top by flexible *diaphragms* shall be permitted to be designed for active pressure.

Reason Statement: This proposal is a coordination proposal to bring the 2024 IBC up to date with the provisions of the 2022 edition of ASCE/SEI 7 Minimum Design Loads and Associated Criteria for Buildings and Other Structures (ASCE/SEI 7-22). ASCE 7 will be updated to the 2022 edition from the 2016 edition as an Administrative update in the 2024 I-Codes.

This proposal makes minor changes to coordinate with the 2022 edition of ASCE 7. The revised text is more clear and does not limit the use of the lateral soil loads to just foundation walls and retaining walls. The loads can be applied to all below grade structures as limited within the section.

Cost Impact: The code change proposal will not increase or decrease the cost of construction
The lateral soil loads are unchanged.

S123-22

S124-22

IBC: SECTION 1603, 1603.1.9, SECTION 1611, 1611.1, FIGURE 1611.1(1), FIGURE 1611.1(2), FIGURE 1611.1(3), FIGURE 1611.1(4), FIGURE 1611.1(5), 1611.2, 1611.3

Proponents: Jennifer Goupil, representing Structural Engineering Institute of ASCE (jgoupil@asce.org)

2021 International Building Code

SECTION 1603 CONSTRUCTION DOCUMENTS

Revise as follows:

1603.1.9 Roof rain load data. Design rainfall Rain-intensity, i (in/hr) (cm/hr), shall be shown regardless of whether rain loads govern the design.

SECTION 1611 RAIN LOADS

Revise as follows:

1611.1 Design rain loads. Each portion of a roof shall be designed to sustain the *load* of rainwater as per the requirements of Chapter 8 of ASCE 7. Rain loads shall be based on the summation of the static head, d_s , hydraulic head, d_h , and ponding head, d_p , using Eqn. 16-19. The hydraulic head shall be based on hydraulic test data or hydraulic calculations assuming a flow rate corresponding to a rainfall intensity equal to or greater than the 15-min duration storm with return period given in Table 1611.1. Rainfall intensity shall be determined in inches per hour for 15 minute duration storms for Risk Category given in Table 1611.1. The design rainfall shall be based on the 100-year 15-minute duration event, or on other rainfall rates determined from approved local weather data. Alternatively, a design rainfall of twice the 100-year hourly rainfall rate indicated in Figures 1611.1(1) through 1611.1(5) shall be permitted. The ponding head shall be based on structural analysis as the depth of water due to deflections of the roof subjected to unfactored rain load and unfactored dead load.

$$R = 5.2 (d_s + d_h + d_p)$$

(Equation 16-19)

$$\text{For SI: } R = 0.0098(d_s + d_h + d_p)$$

where:

d_h = hydraulic head equal to the depth of water on the undeflected roof above the inlet of the secondary drainage system for structural loading (SDSL) required to achieve the design flow in in. (mm). Additional depth of water on the undeflected roof above the inlet of secondary drainage system at its design flow (in other words, the hydraulic head), in inches (mm).

d_s = static head equal to the depth of water on the undeflected roof up to the inlet of the secondary drainage system for structural loading (SDSL) in in. (mm). Depth of water on the undeflected roof up to the inlet of secondary drainage system when the primary drainage system is blocked (in other words, the static head), in inches (mm).

d_p = ponding head equal to the depth of water due to deflections of the roof subjected to unfactored rain load and unfactored dead load, in in. (mm).
 R = Rain load on the undeflected roof, in psf (kN/m²). Where the phrase "undeflected roof" is used, deflections from loads (including dead loads) shall not be considered when determining the amount of rain on the roof.

SDSL is the roof drainage system through which water is drained from the roof when the drainage systems listed in ASCE 7 Section 8.2 (a) through (d) are blocked or not working.

Table 1611.1 Design Storm Return Period by Risk Category

Risk Category	Design Storm Return Period
I & II	100 Years
III	200 Years
IV	500 Years

Delete without substitution:

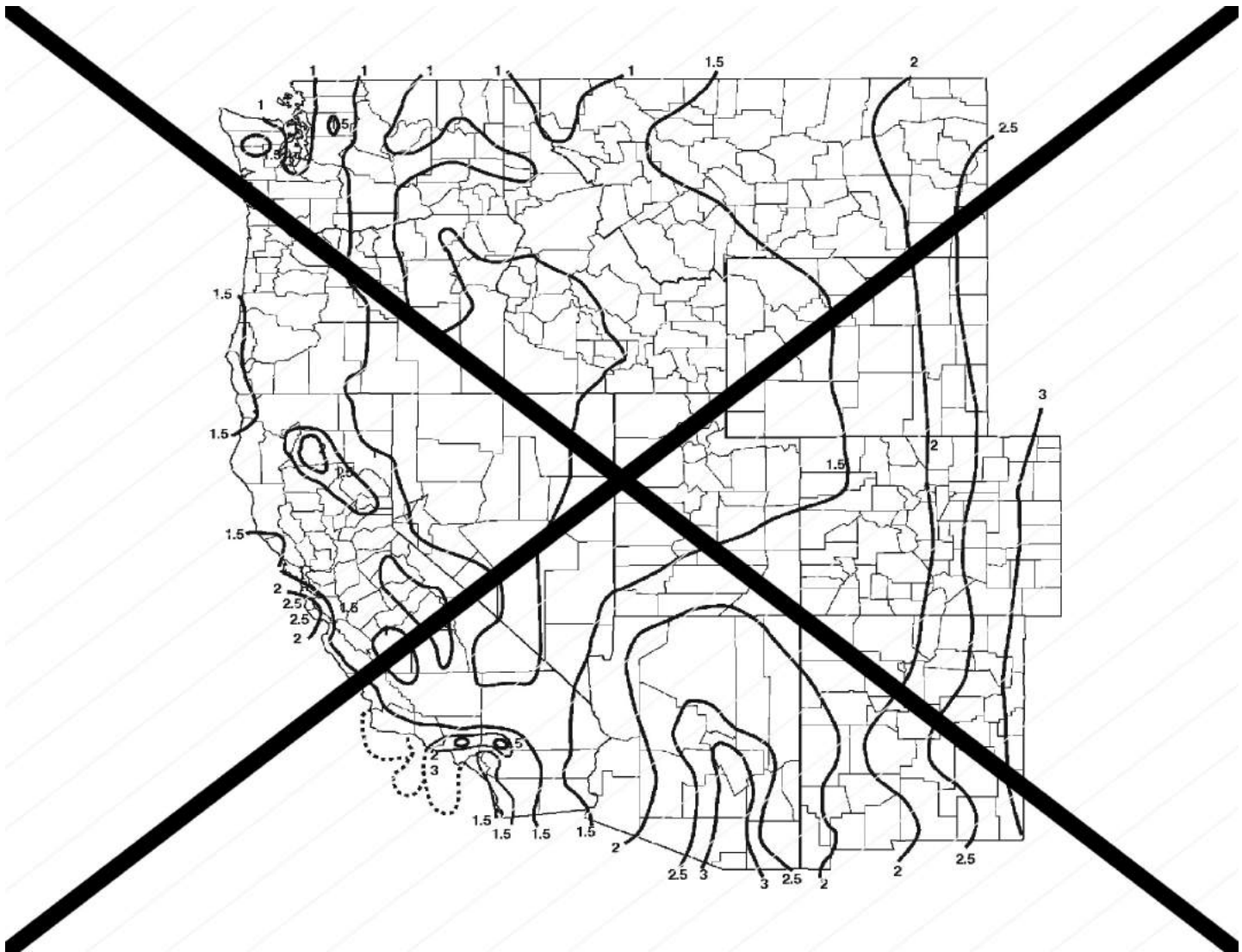

For SI: 1 inch = 25.4 mm.

Source: National Weather Service, National Oceanic and Atmospheric Administration, Washington, DC.

FIGURE 1611.1(1) 100-YEAR, 1-HOUR RAINFALL (INCHES) WESTERN UNITED STATES

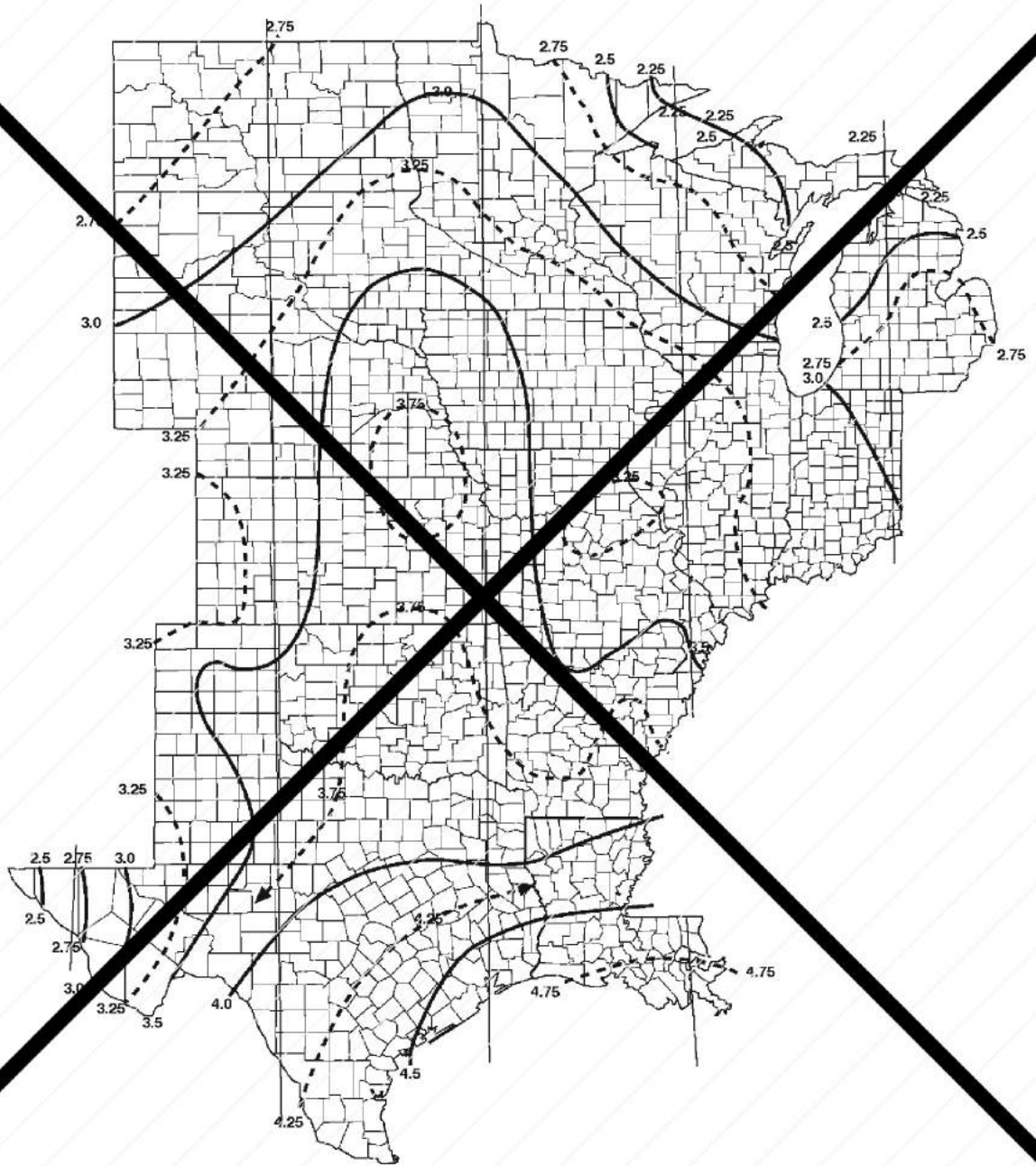

For SI: 1 inch = 25.4 mm.

Source: National Weather Service, National Oceanic and Atmospheric Administration, Washington, DC.

FIGURE 1611.1(2) 100-YEAR, 1-HOUR RAINFALL (INCHES) CENTRAL UNITED STATES

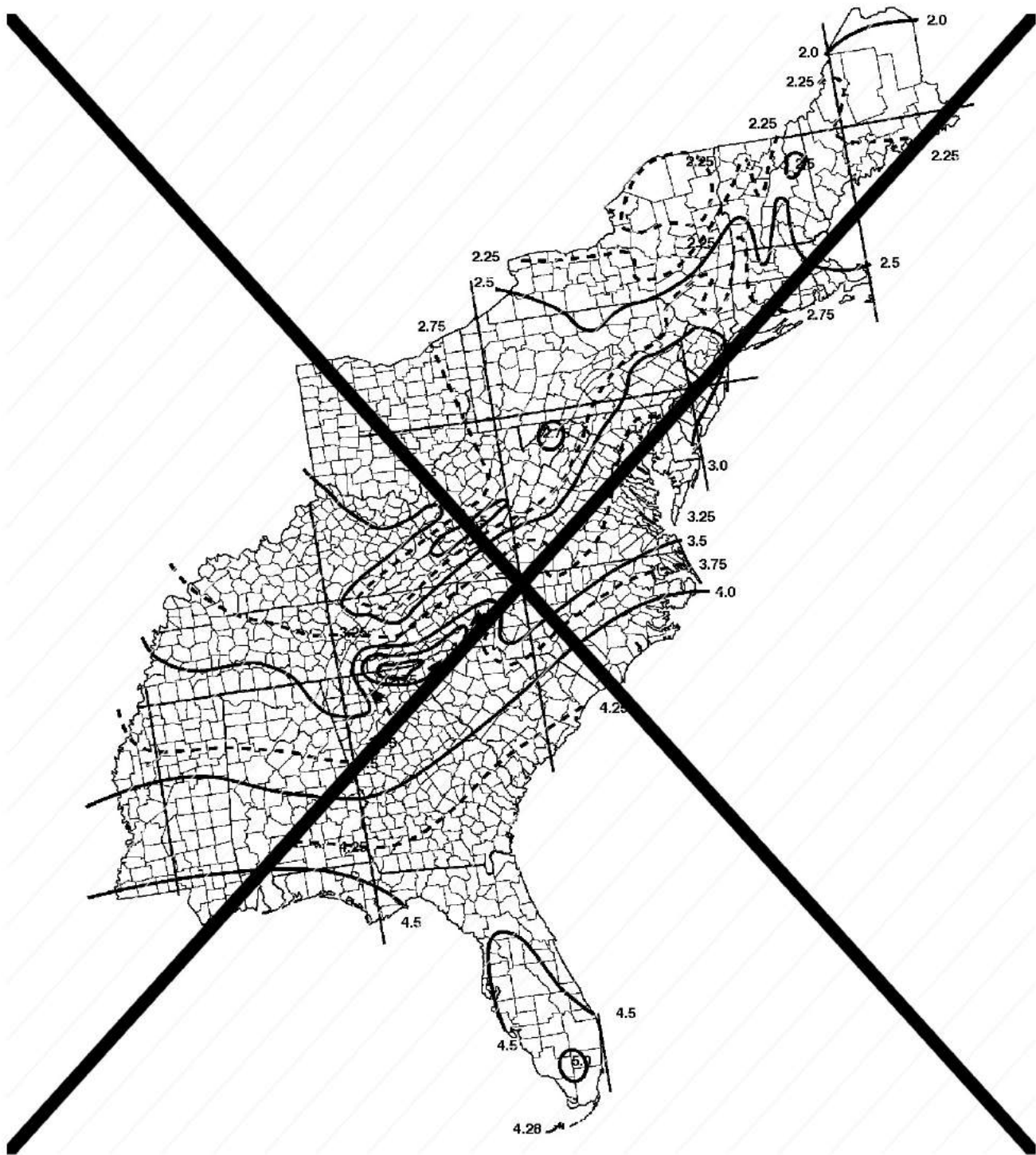

For SI: 1 inch = 25.4 mm.

Source: National Weather Service, National Oceanic and Atmospheric Administration, Washington, DC.

FIGURE 1611.1(3) 100-YEAR, 1-HOUR RAINFALL (INCHES) EASTERN UNITED STATES

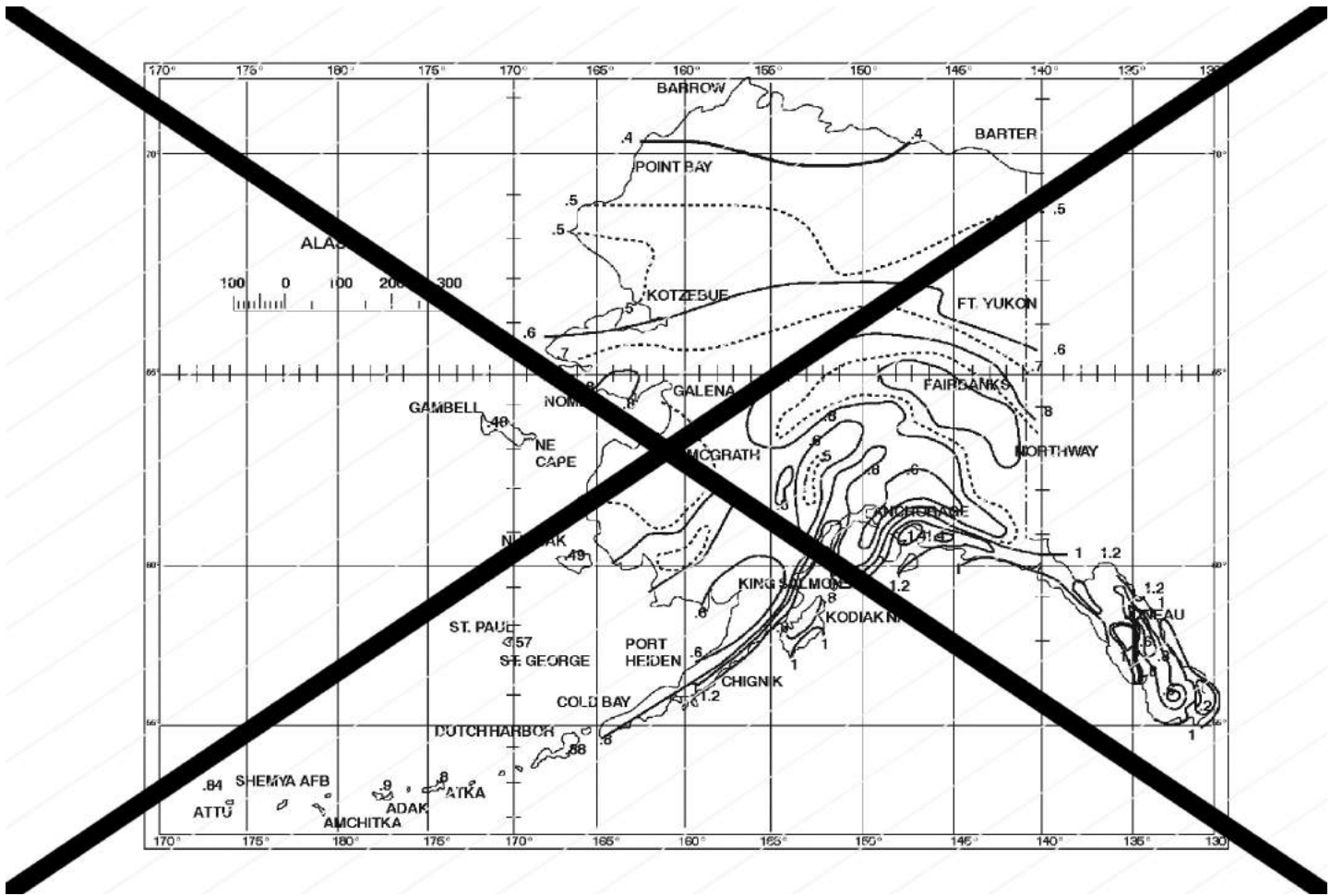

For SI: 1 inch = 25.4 mm.

Source: National Weather Service, National Oceanic and Atmospheric Administration, Washington, DC.

FIGURE 1611.1(4) 100-YEAR, 1-HOUR RAINFALL (INCHES) ALASKA

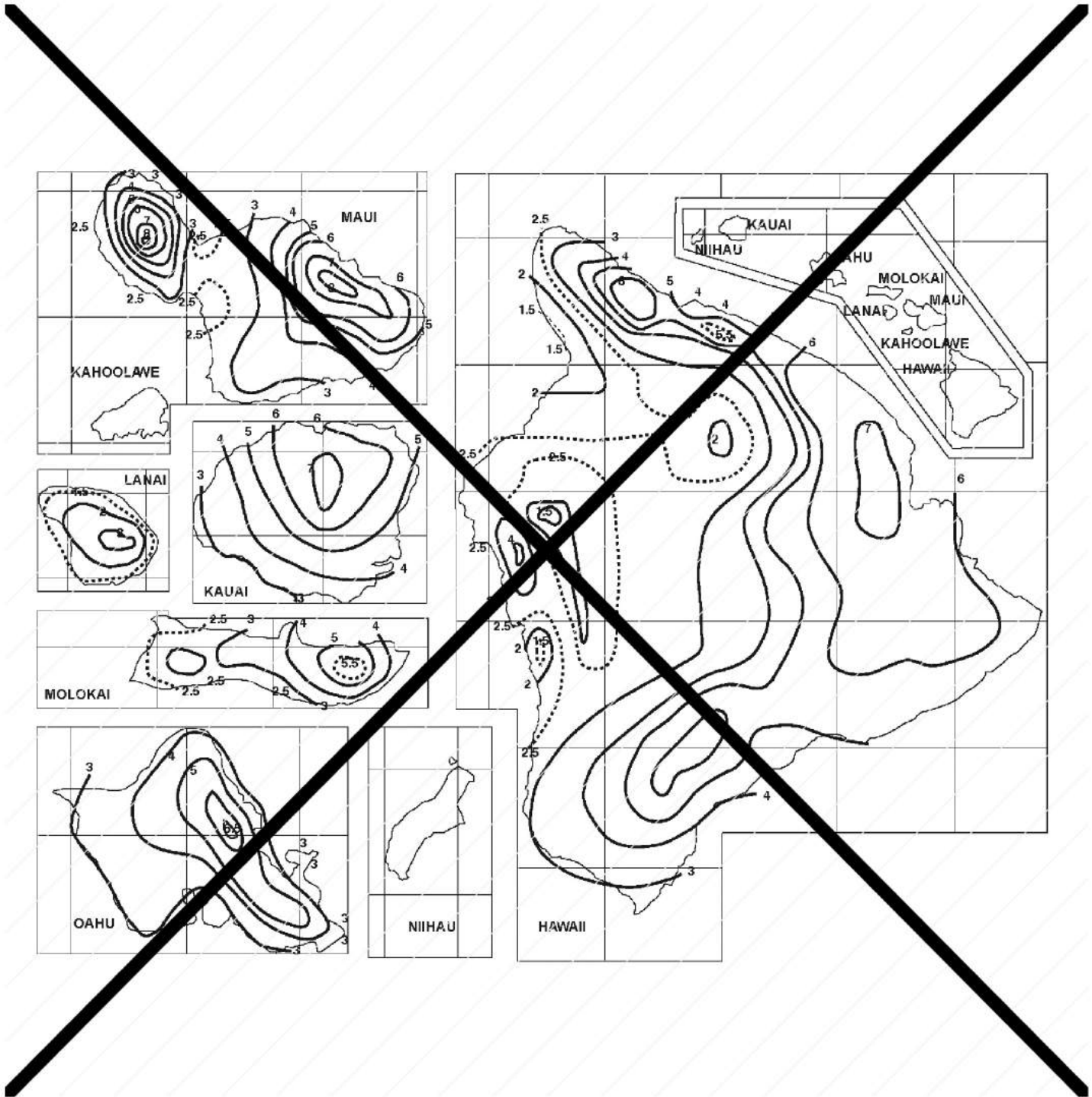

For SI: 1 inch = 25.4 mm.

Source: National Weather Service, National Oceanic and Atmospheric Administration, Washington, DC.

FIGURE 1611.1(5) 100-YEAR, 1-HOUR RAINFALL (INCHES) HAWAII

1611.2 Ponding instability. *Susceptible bays* of roofs shall be evaluated for ponding instability in accordance with Chapters 7 and 8 of ASCE 7.

1611.3 Controlled drainage. Roofs equipped with hardware to control the rate of drainage shall be equipped with a secondary drainage system at a higher elevation that limits accumulation of water on the roof above that elevation. Such roofs shall be designed to sustain the *load* of rainwater that will accumulate on them to the elevation of the secondary drainage system plus the uniform *load* caused by water that rises above the inlet of the secondary drainage system at its design flow determined from Section 1611.1. Such roofs shall be checked for ponding instability in accordance with Section 1611.2.

Reason Statement: This proposal is a coordination proposal to bring the 2024 IBC up to date with the provisions of the 2022 edition of ASCE/SEI 7 Minimum Design Loads and Associated Criteria for Buildings and Other Structures (ASCE/SEI 7-22). ASCE 7 will be updated to the 2022 edition from

the 2016 edition as an Administrative update in the 2024 I-Codes.

This proposal includes technical updates as well as editorial corrections or re-organizations.

A summary of the coordination changes made to each section is as follows.

Section 1611.1 Design rain loads. The primary change is the addition of the ponding head (d_p) directly into the rain load calculation. In ASCE 7-16 and previous editions, there was a requirement to perform a ponding analysis, yet limited guidance was provided on how to perform that analysis. The commentary references the methods in Appendix 2 of the AISC Specification (AISC 360), however these provisions are of limited scope and they are currently under ballot to be removed from the AISC Specification. The addition of the ponding head to rain load provides a more consistent approach to accommodate ponding. The addition SDSL pointer to ensure that the requirement that the inlet to the SDSL be vertically separated from the inlet to the primary drainage system by not less than 2 in. This requirement will allow activation of the SDSL to serve as a warning that the primary drainage system is blocked.

Table 1611.1 Design Storm Return Period by Risk Category – ASCE 7-22 incorporates risk category into the determination of rainfall intensity. Therefore, this change to design storm return period for determination of hydraulic head to be based on risk category. **Figures 1611.1(1) through 1611.1(5).** These figures were removed because they are outdated. These are 100-year hourly rainfall maps, which do not adequately provide the rainfall intensity required by a 15 minute storm. Furthermore, the rainfall is now required to be determined based upon risk category. ASCE 7 does not provide rainfall data or maps for determining the rainfall rate. The best source currently is the National Oceanic and Atmospheric Administration (NOAA's) National Weather Service Precipitation Frequency Data Server - Hydrometeorological Design Studies Center for precipitation intensity (inches per hour) based on the required mean recurrence interval (years).

Cost Impact: The code change proposal will not increase or decrease the cost of construction

This code change will not add load or increase costs. It is a change to how the load is calculated to align with ASCE 7-22. Past editions of ASCE 7 have included the requirement that ponding be considered in structural designs. This proposal formalizes aspects of the method in which the engineer must consider ponding, most notably by including the effects of ponding in the rain load. While rain load will increase because of this proposal, the effect on overall demands and construction cost is less clear since separate ponding investigation requirements have been removed. The impact on construction cost will largely be dependent on the methods previously used by individual engineers to perform their ponding investigation.

S124-22

S125-22 Part I

IBC: [A] 110.3.12.1, 1612.4

Proponents: Gregory Wilson, representing FEMA (gregory.wilson2@fema.dhs.gov); Rebecca Quinn, representing DHS Federal Emergency Management Agency (rcquinn@earthlink.net)

THIS IS A 2 PART CODE CHANGE. PART I WILL BE HEARD BY THE IBC STRUCTURAL CODE COMMITTEE. PART II WILL BE HEARD BY THE ADMIN CODE COMMITTEE. SEE THE TENTATIVE HEARING ORDER FOR THESE COMMITTEES.

2021 International Building Code

Revise as follows:

[A] 110.3.12.1 Flood hazard documentation. If located in a *flood hazard area*, documentation of the elevation of the *lowest floor* or the elevation of dry floodproofing, if applicable, as required in Section 1612.4 shall be submitted to the *building official* prior to the final inspection.

1612.4 Flood hazard documentation. The following documentation shall be prepared and sealed by a *registered design professional* and submitted to the *building official*:

1. For construction in *flood hazard areas* other than *coastal high hazard areas* or *coastal A zones*:
 - 1.1. The elevation of the *lowest floor*, including the basement, as required by the lowest floor elevation inspection in Section 110.3.3 and for the final inspection in Section 110.3.12.1.
 - 1.2. For fully enclosed areas below the *design flood elevation* where provisions to allow for the automatic entry and exit of floodwaters do not meet the minimum requirements in Section 2.7.2.1 of ASCE 24, *construction documents* shall include a statement that the design will provide for equalization of hydrostatic flood forces in accordance with Section 2.7.2.2 of ASCE 24.
 - 1.3. For *dry floodproofed* nonresidential buildings, *construction documents* shall include a statement that the *dry floodproofing* is designed in accordance with ASCE 24 and shall include the flood emergency plan specified in Chapter 6 of ASCE 24.
 - 1.4. For dry floodproofed nonresidential buildings, the elevation to which the building is dry floodproofed as required for the final inspection in Section 110.3.12.1.
2. For construction in *coastal high hazard areas* and *coastal A zones*:
 - 2.1. The elevation of the bottom of the lowest horizontal structural member as required by the *lowest floor* elevation inspection in Section 110.3.3 and for the final inspection in Section 110.3.12.1.
 - 2.2. *Construction documents* shall include a statement that the building is designed in accordance with ASCE 24, including that the pile or column foundation and building or structure to be attached thereto is designed to be anchored to resist flotation, collapse and lateral movement due to the effects of wind and *flood loads* acting simultaneously on all building components, and other *load* requirements of Chapter 16.
 - 2.3. For breakaway walls designed to have a resistance of more than 20 psf (0.96 kN/m²) determined using *allowable stress design*, *construction documents* shall include a statement that the breakaway wall is designed in accordance with ASCE 24.
 - 2.4. For breakaway walls where provisions to allow for the automatic entry and exit of floodwaters do not meet the minimum requirements in Section 2.7.2.1 of ASCE 24, *construction documents* shall include a statement that the design will provide for equalization of hydrostatic flood forces in accordance with Section 2.7.2.2 of ASCE 24.

S125-22 Part I

S125-22 Part II

IEBC: [A] 109.3.10

Proponents: Gregory Wilson, representing FEMA (gregory.wilson2@fema.dhs.gov); Rebecca Quinn, representing DHS Federal Emergency Management Agency (rcquinn@earthlink.net)

2021 International Existing Building Code

Revise as follows:

[A] 109.3.10 Flood hazard documentation. Where a building is located in a *flood hazard area*, documentation of the elevation of the lowest floor or the elevation of dry floodproofing, if applicable, as required in the International Building Code or the International Residential Code, as applicable, shall be submitted to the *code official* prior to the final inspection.

Reason Statement: When nonresidential buildings in flood hazard areas are proposed to be dry floodproofed, several aspects of design are critical, including the strength of walls and flood shields that are designed to be watertight (addressed in 1612.4 #1.3) and the required elevation of the dry floodproofing, which is specified in ASCE 24 Chapter 6.

The proposed change follows the pattern already established for documentation of lowest floor elevations prior to the final inspection. Because dry floodproofed buildings do not have elevated “lowest floors,” rather than survey floors, this change clarifies the elevation to which dry floodproofed buildings are protected is to be documented. Having this elevation determined and documented helps local officials confirm compliance with the design requirements. The NFIP regulations require communities to obtain the elevation to which structures are floodproofed [44 Code of Federal Regulations Sec. 60.3(b)(5)(ii)].

FEMA’s Mitigation Assessment Team reports prepared after some significant flood events document failures of dry floodproofing systems. Some failures are caused by floodwater rising higher than the protective measures, which indicates the value of documenting that construction of those measures does meet the requirements for compliance.

Many communities require permittees to use the FEMA Floodproofing Certificate for Non-Residential Structures (FEMA Form 086-0-34). That form is prepared for use to certify designs as part of documentation submitted with permit applications, as well as for use to certify the “floodproofed elevation.” The form also is used when certification of as-built conditions is required, including the elevation to which the building is dry floodproofed. The FEMA National Flood Insurance Program requires as-built certification as part of qualifying for NFIP flood insurance policy coverage for dry floodproofed nonresidential buildings.

Bibliography: FEMA Form 086-0-34, FEMA Floodproofing Certificate for Non-Residential Structures: <https://www.fema.gov/media-library/assets/documents/2748>

Cost Impact: The code change proposal will not increase or decrease the cost of construction

The code change proposal clarifies that the elevation to which dry floodproofed buildings are protected is to be documented, rather than documentation of the “lowest floors.” There is no change in cost because the cost to survey the elevation to which a building is dry floodproofed would be equal to the cost to survey a floor elevation relative to datum. Completion of the survey portion of the FEMA Nonresidential Floodproofing Certificate requires fewer inputs by the professional certifying the survey than are required to complete a FEMA Elevation Certificate.

S125-22 Part II

S126-22

IBC: 1612.4

Proponents: Gregory Wilson, representing FEMA (gregory.wilson2@fema.dhs.gov); Rebecca Quinn, representing DHS Federal Emergency Management Agency (rcquinn@earthlink.net)

2021 International Building Code

Revise as follows:

1612.4 Flood hazard documentation. The following documentation shall be prepared and sealed by a *registered design professional* and submitted to the *building official*:

1. For construction in *flood hazard areas* other than *coastal high hazard areas* or *coastal A zones*:
 - 1.1. The elevation of the *lowest floor*, including the basement, as required by the lowest floor elevation inspection in Section 110.3.3 and for the final inspection in Section 110.3.12.1.
 - 1.2. For fully enclosed areas below the *design flood elevation* where provisions to allow for the automatic entry and exit of floodwaters do not meet the minimum requirements in Section 2.7.2.1 of ASCE 24, *construction documents* shall include a statement that the design will provide for equalization of hydrostatic flood forces in accordance with Section 2.7.2.2 of ASCE 24.
 - 1.3. For *dry floodproofed* nonresidential buildings, *construction documents* shall include a statement that the *dry floodproofing* is designed in accordance with ASCE 24 and shall include the flood emergency plan specified in Chapter 6 of ASCE 24.
2. For construction in *coastal high hazard areas* and *coastal A zones*:
 - 2.1. The elevation of the bottom of the lowest horizontal structural member as required by the *lowest floor* elevation inspection in Section 110.3.3 and for the final inspection in Section 110.3.12.1.
 - 2.2. *Construction documents* shall include a statement that the building is designed in accordance with ASCE 24, including that the pile or column foundation and building or structure to be attached thereto is designed to be anchored to resist flotation, collapse and lateral movement due to the effects of wind and *flood loads* acting simultaneously on all building components, and other *load* requirements of Chapter 16.
 - 2.3. For breakaway walls designed to have a resistance of more than 20 psf (0.96 kN/m²) determined using *allowable stress design or a resistance to an ultimate load of more than 33 psf (1.58 kN/m²)*, *construction documents* shall include a statement that the breakaway wall is designed in accordance with ASCE 24.
 - 2.4. For breakaway walls where provisions to allow for the automatic entry and exit of floodwaters do not meet the minimum requirements in Section 2.7.2.1 of ASCE 24, *construction documents* shall include a statement that the design will provide for equalization of hydrostatic flood forces in accordance with Section 2.7.2.2 of ASCE 24.

Reason Statement: This code change does not change the loads used to design breakaway walls. It just shows how the loads expressed using allowable stress design are expressed as ultimate loads, which is used in ASCE 7 for seismic design and wind loads. One of the reasons for the lower load shown in the existing section is to avoid breakaway walls that might fail under wind loads. Showing the loads expressed as ultimate loads will make it easier to compare to calculated wind loads and seismic loads.

Cost Impact: The code change proposal will not increase or decrease the cost of construction

The code change proposal shows how the loads expressed using allowable stress design are expressed as ultimate loads to better align with ASCE 7. There is no change to the technical content of the provisions. By showing how existing load values are expressed as ultimate loads, there will be no cost impact when approving this proposal.

S126-22

S127-22

IBC: CHAPTER 16, SECTION 1613, 1613.1, 1613.2, 1613.2.1, FIGURE 1613.2.1(1), FIGURE 1613.2.1(2), FIGURE 1613.2.1(3), FIGURE 1613.2.1(4), FIGURE 1613.2.1(5), FIGURE 1613.2.1(6), FIGURE 1613.2.1(7), FIGURE 1613.2.1(8), FIGURE 1613.2.1(9), FIGURE 1613.2.1(10), 1613.2.2, 1613.2.3, TABLE 1613.2.3(1), TABLE 1613.2.3(2), 1613.2.4, 1613.2.5, TABLE 1613.2.5(1), TABLE 1613.2.5(2), 1613.2.5.1, 1613.2.5.2, 1613.3

Proponents: Jennifer Goupil, representing Structural Engineering Institute of ASCE (jgoupil@asce.org)

2021 International Building Code

CHAPTER 16 STRUCTURAL DESIGN

SECTION 1613 EARTHQUAKE LOADS

Revise as follows:

1613.1 Scope. Every structure, and portion thereof, including nonstructural components that are permanently attached to structures and their supports and attachments, shall be designed and constructed to resist the effects of earthquake motions in accordance with Chapters 11, 12, 13, 15, 17 and 18 of ASCE 7, as applicable. The *seismic design category* for a structure is permitted to be determined in accordance with Section 1613 or ASCE 7.

Exceptions:

1. Detached one- and two-family dwellings, assigned to *Seismic Design Category A, B or C*, or located where the mapped short-period spectral response acceleration, S_s , is less than 0.4g.
2. The *seismic force-resisting system* of wood-frame buildings that conform to the provisions of Section 2308 are not required to be analyzed as specified in this section.
3. Agricultural storage structures intended only for incidental human occupancy.
4. Structures that require special consideration of their response characteristics and environment that are not addressed by this code or ASCE 7 and for which other regulations provide seismic criteria, such as vehicular bridges, electrical transmission towers, hydraulic structures, buried utility lines and their appurtenances and nuclear reactors.
5. References within ASCE 7 to Chapter 14 shall not apply, except as specifically required herein.

1613.2 Seismic ground motion values. Seismic ground motion values shall be determined in accordance with this section.

Delete and substitute as follows:

~~**1613.2.1 Mapped acceleration parameters.** The parameters S_s and S_1 shall be determined from the 0.2 and 1-second spectral response accelerations shown on Figures 1613.2.1(1) through 1613.2.1(10). Where S_s is less than or equal to 0.04 and S_1 is less than or equal to 0.15, the structure is permitted to be assigned *Seismic Design Category A*.~~

1613.2.1 Risk-Targeted Maximum Considered Earthquake (MCE_R) Spectral Response Acceleration Parameters. Risk-Targeted Maximum Considered Earthquake (MCE_R) spectral response acceleration parameters S_1 , S_{MS} , and S_{M1} shall be determined based on one of the following methods unless the authority having jurisdiction or geotechnical data determine that Site Class DE, E, or F soils are present at the site. Where Site Class DE, E, or F soils are present, the spectral response acceleration parameters shall be determined in accordance with ASCE 7.

1. Using Figures 1613.2.1(1) through 1613.2.1(10).
2. Determined in accordance with ASCE 7.

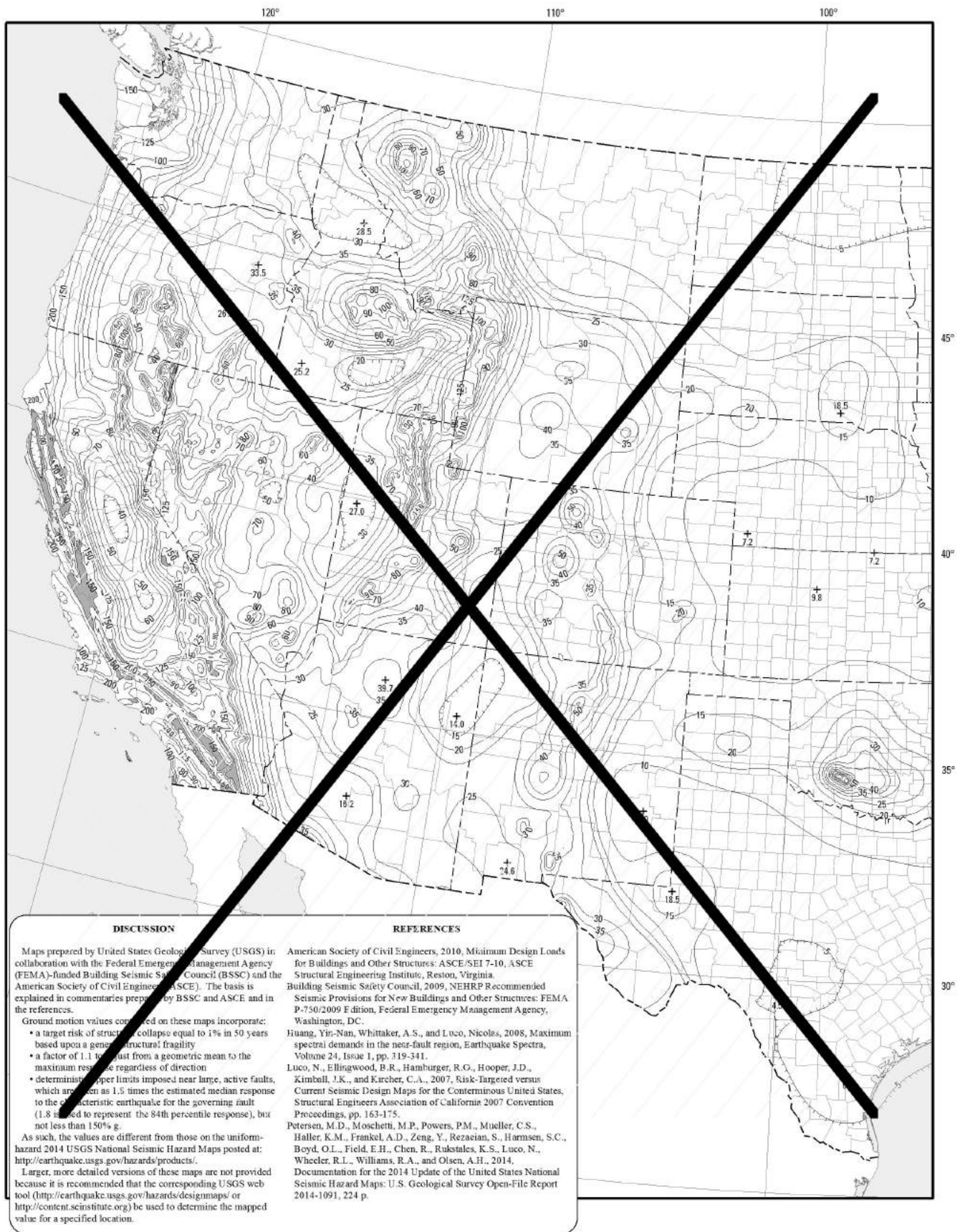
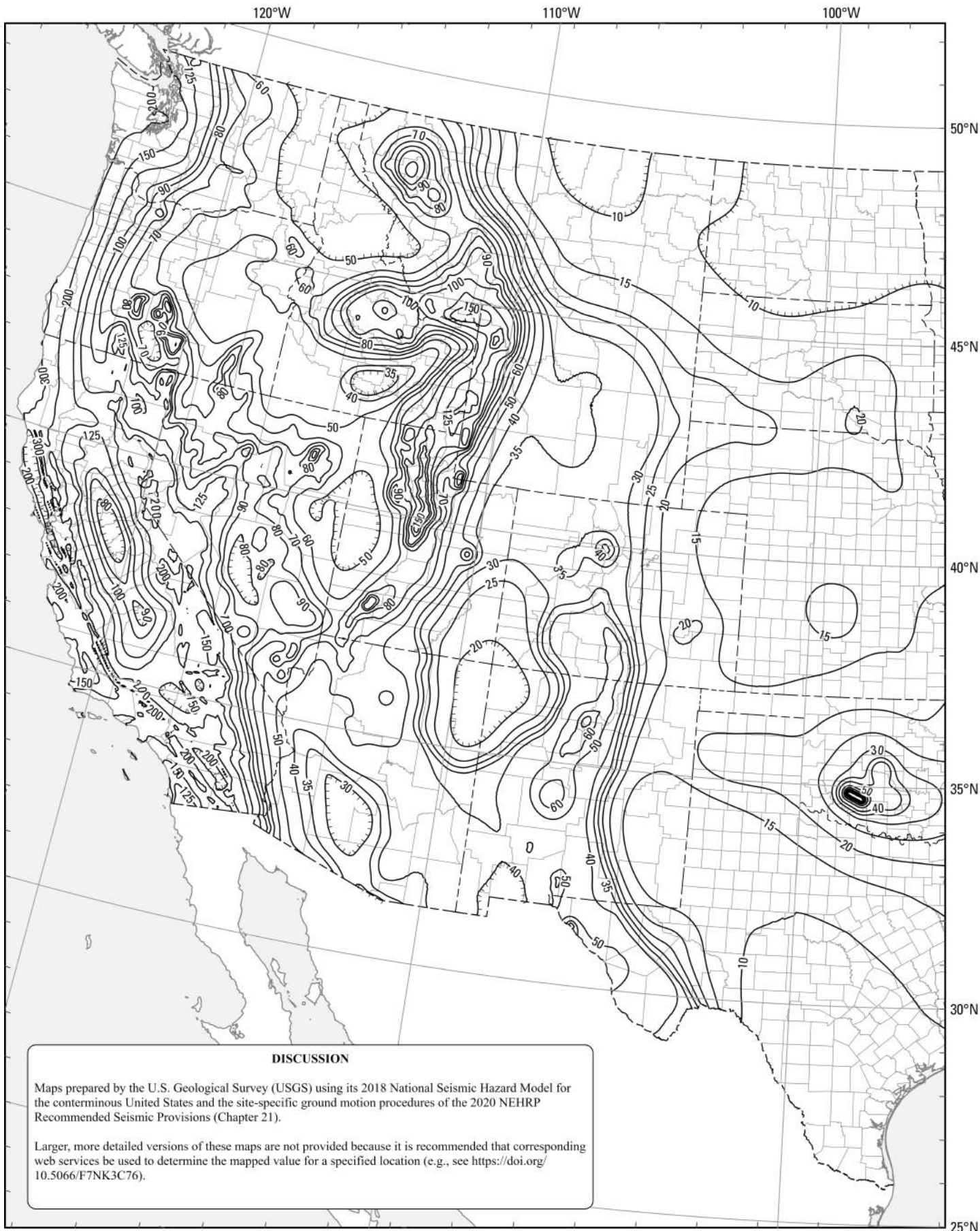

FIGURE 1613.2-1(1) RISK-TARGETED MAXIMUM CONSIDERED EARTHQUAKE (MCE_R) GROUND MOTION RESPONSE ACCELERATIONS FOR THE CONTERMINOUS UNITED STATES OF 02-SECOND SPECTRAL RESPONSE ACCELERATION (5% OF CRITICAL DAMPING)



Notes:

Maps prepared by USGS in collaboration with the FEMA-funded Building Seismic Safety Council (BSSC) and ASCE. The basis is explained in commentaries prepared by BSSC and ASCE and in the references.

Ground motion values contoured on these maps incorporate:

- a. A target risk of structural collapse equal to 1% in 50 years based upon a generic structural fragility.
- b. A factor of 1.1 to adjust from a geometric mean to the maximum response regardless of direction, and
- c. Deterministic upper limits imposed near large, active faults, which are taken as 1.8 times the estimated median response to the characteristic earthquake for the governing fault (1.8 is used to represent the 84th percentile response), but not less than 150% g.

As such, the values are different from those on the uniform-hazard 2014 USGS National Seismic Hazard Maps posted at <https://doi.org/10.5066/F7HT2MHG>.

Larger, more detailed versions of these maps are not provided because it is recommended that the corresponding USGS web tool (<https://doi.org/10.5066/F7NK3C76>) be used

to determine the mapped value for a specified location.

- User Note: The USGS Seismic Design Geodatabase is available at the ASCE 7 Hazard Tool <https://asce7hazardtool.online/> or an approved equivalent.

FIGURE 1613.2.1(1)
S_{MS} for the default site condition for the coterminous United States.

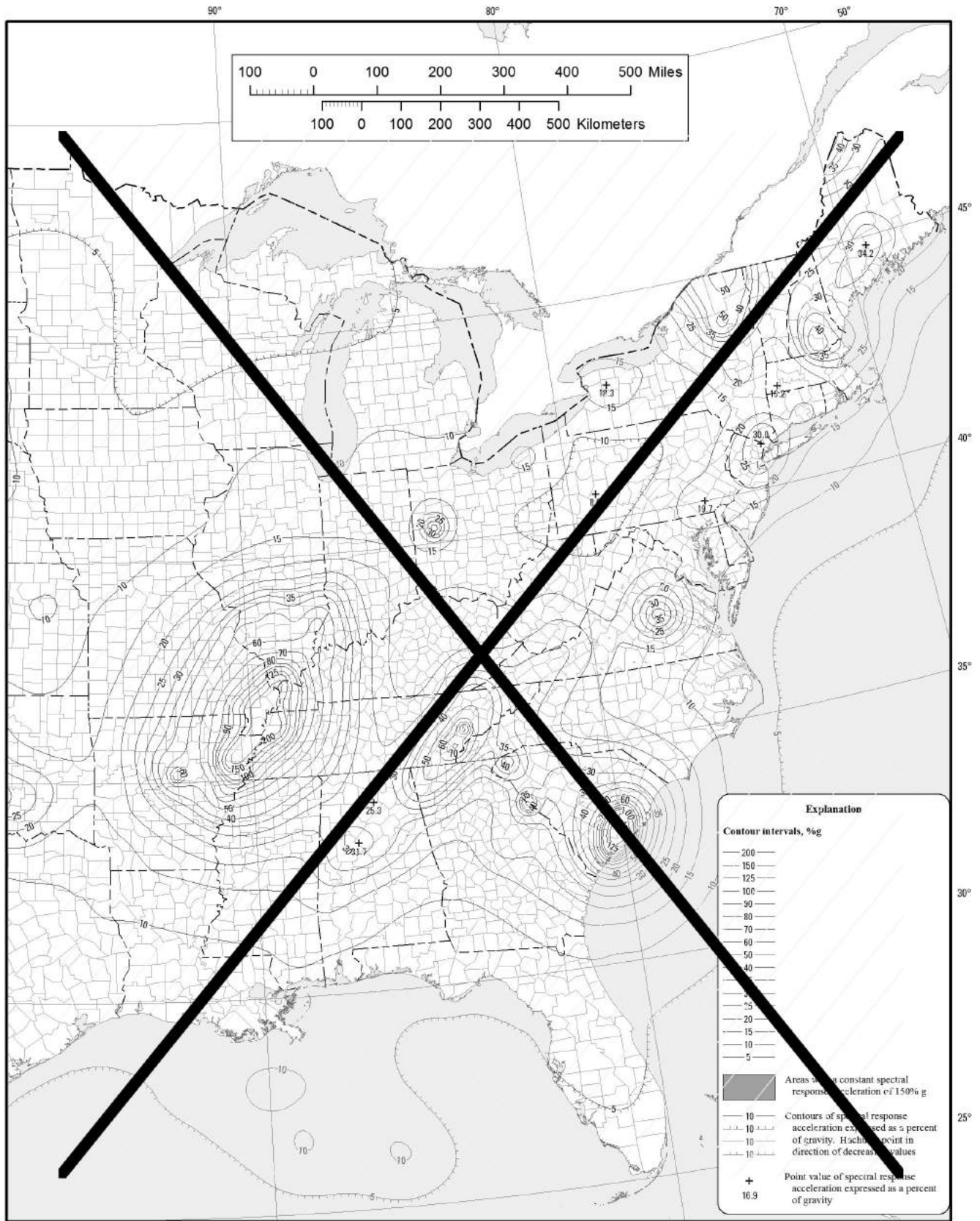

Figure 1613.3.1(1)-continued Risk-Targeted Maximum Considered Earthquake (MCE_R) Ground Motion for the Conterminous United States of 0.2-Second Spectral Response Acceleration (5% of Critical Damping)

FIGURE 1613.2.1(2) RISK-TARGETED MAXIMUM CONSIDERED EARTHQUAKE (MCE_R) GROUND MOTION RESPONSE ACCELERATIONS FOR THE CONTERMINOUS UNITED STATES OF 0.2-SECOND SPECTRAL RESPONSE ACCELERATION (5% OF CRITICAL DAMPING)

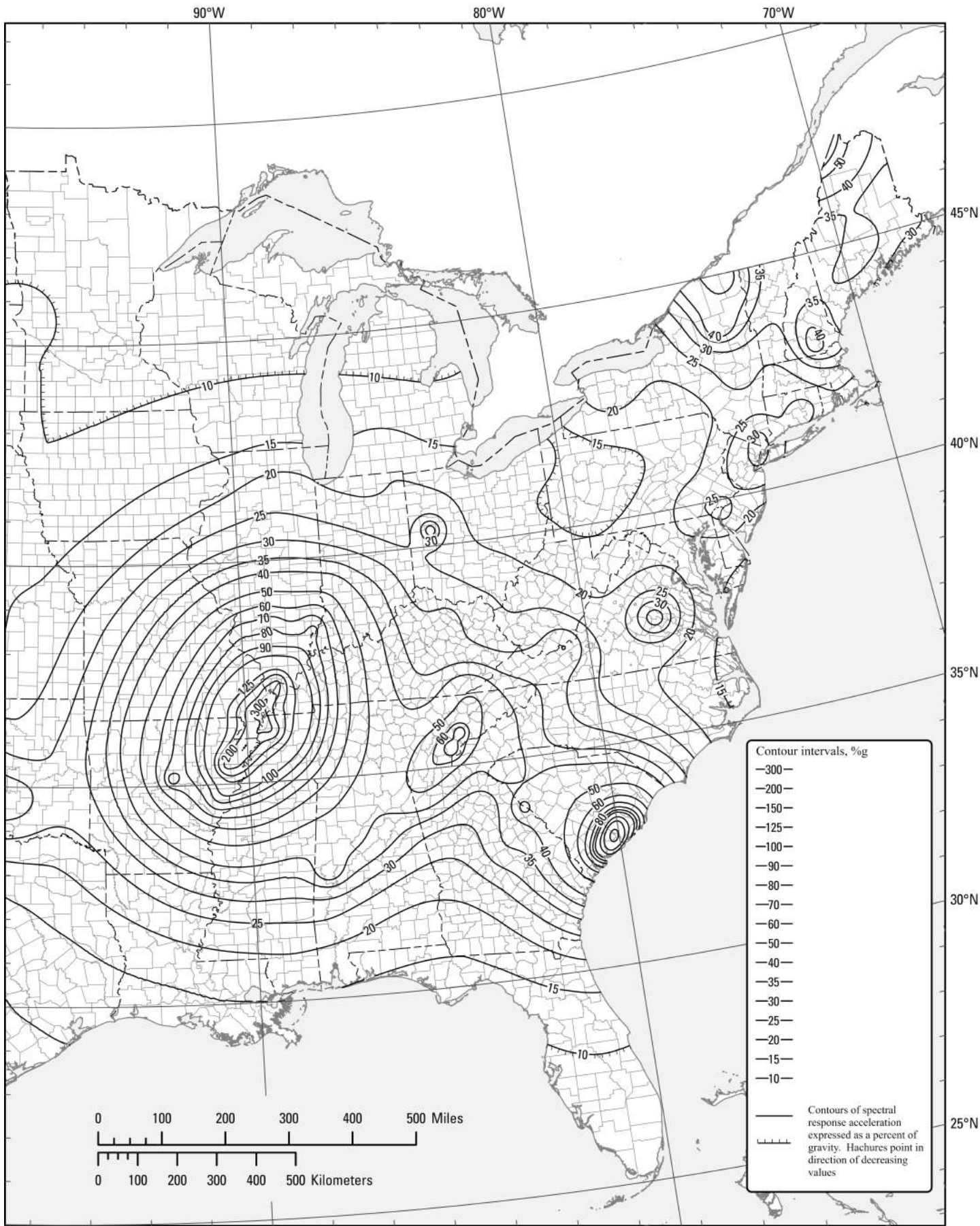

FIGURE 1613.2.1(2)
(Continued). S_{MS} for the default site conditions for the coterminous United States.

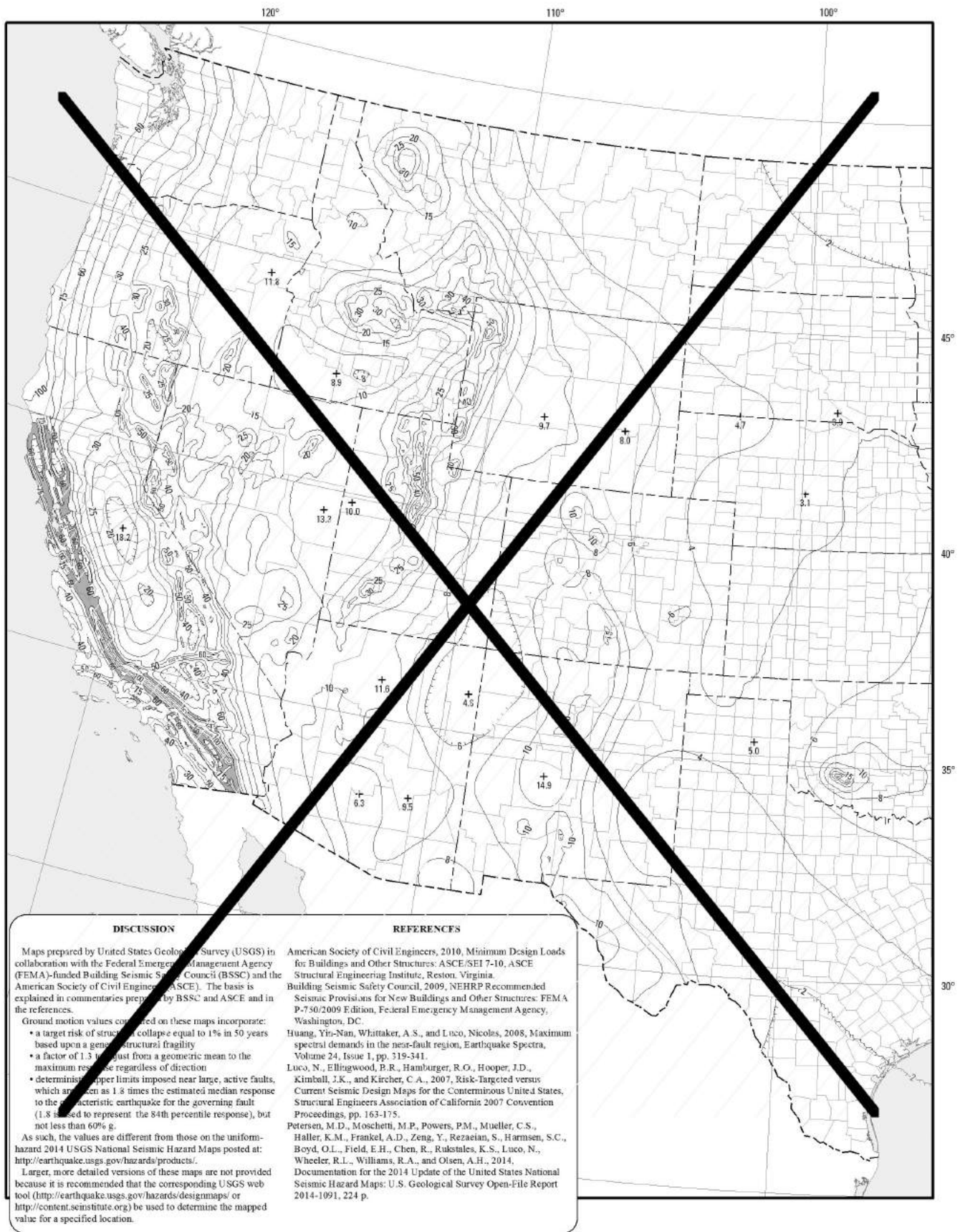
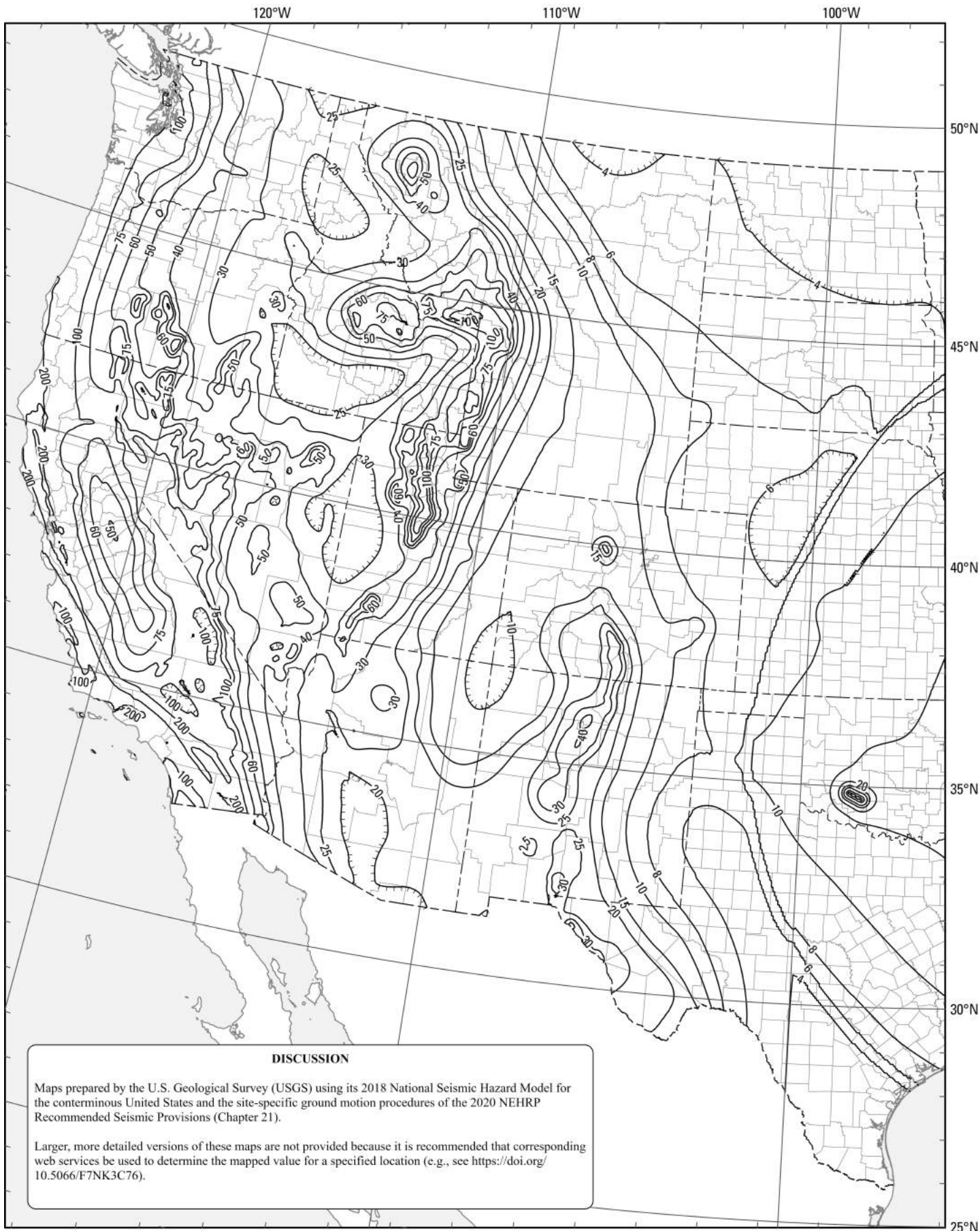

FIGURE 1613.2-1(3) RISK-TARGETED MAXIMUM CONSIDERED EARTHQUAKE (MCE_R) GROUND MOTION RESPONSE ACCELERATIONS FOR THE CONTERMINOUS UNITED STATES OF 1-SECOND SPECTRAL RESPONSE ACCELERATION (5% OF CRITICAL DAMPING)



Notes:

Maps prepared by USGS in collaboration with the FEMA-funded BSSC and ASCE. The basis is explained in commentaries prepared by BSSC and ASCE and in the references.

Ground motion values contoured on these maps incorporate:

- a. A target risk of structural collapse equal to 1% in 50 years based upon a generic structural fragility,
- b. A factor of 1.3 to adjust from a geometric mean to the maximum response regardless of direction, and
- c. Deterministic upper limits imposed near large, active faults, which are taken as 1.8 times the estimated median response to the characteristic earthquake for the governing fault (1.8 is used to represent the 84th percentile response), but not less than 60% g.

As such, the values are different from those on the uniform-hazard 2014 USGS National Seismic Hazard Maps posted at <https://doi.org/10.5066/F7HT2MHG>.

Larger, more detailed versions of these maps are not provided because it is recommended that the corresponding USGS web tool (<https://doi.org/10.5066/F7NK3C76>) be used to determine the mapped value for a specified location.

User Note: The USGS Seismic Design Geodatabase is available at the ASCE 7 Hazard Tool <https://asce7hazardtool.online/> or an approved equivalent.

FIGURE 1613.2.1(3)
S_{M1} for the default site conditions for the coterminous United States.

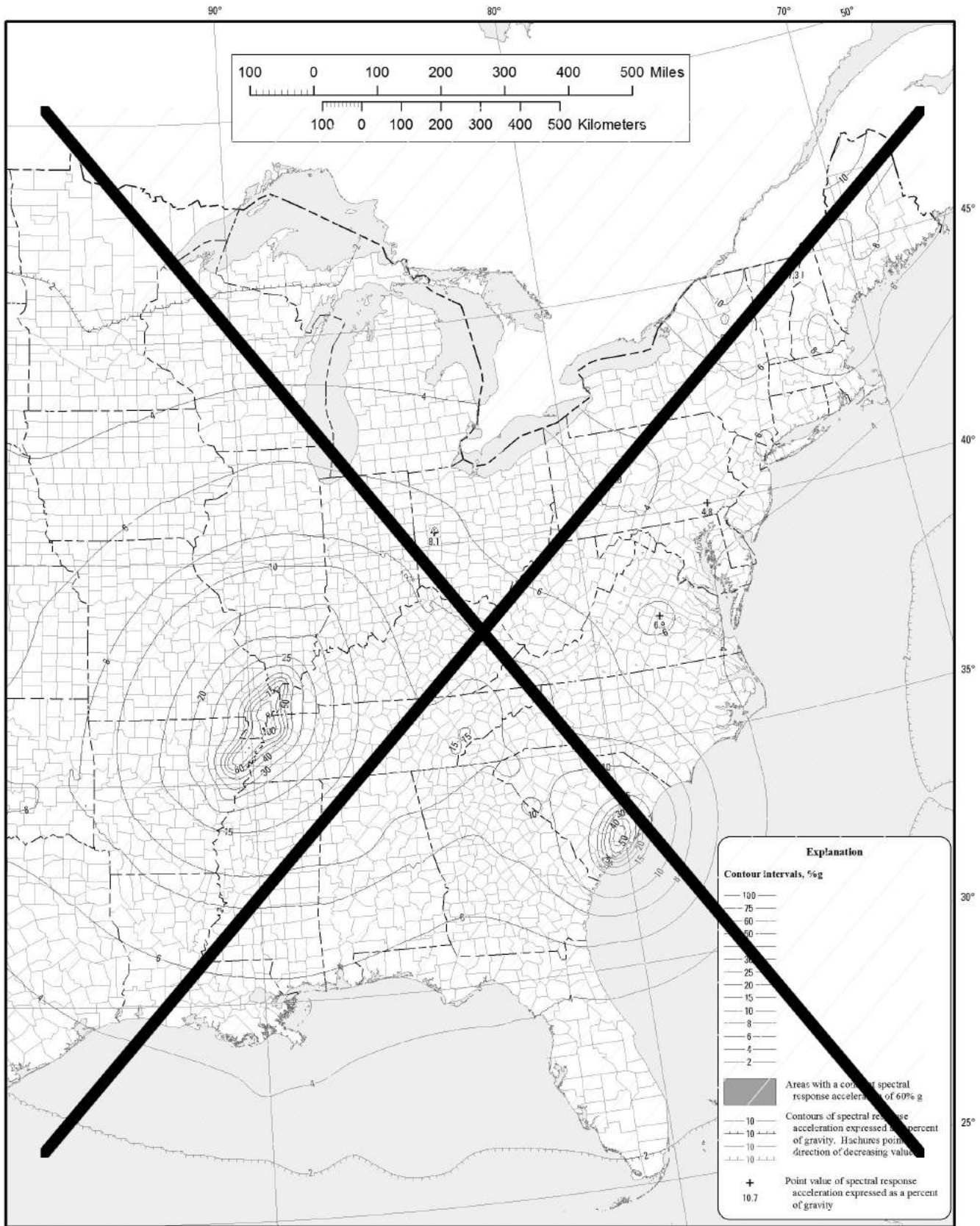

FIGURE 1613.2.1(4) RISK-TARGETED MAXIMUM CONSIDERED EARTHQUAKE (MCE_E) GROUND MOTION RESPONSE ACCELERATIONS FOR THE COTERMINOUS UNITED STATES OF 1-SECOND SPECTRAL RESPONSE ACCELERATION (5% OF CRITICAL DAMPING)

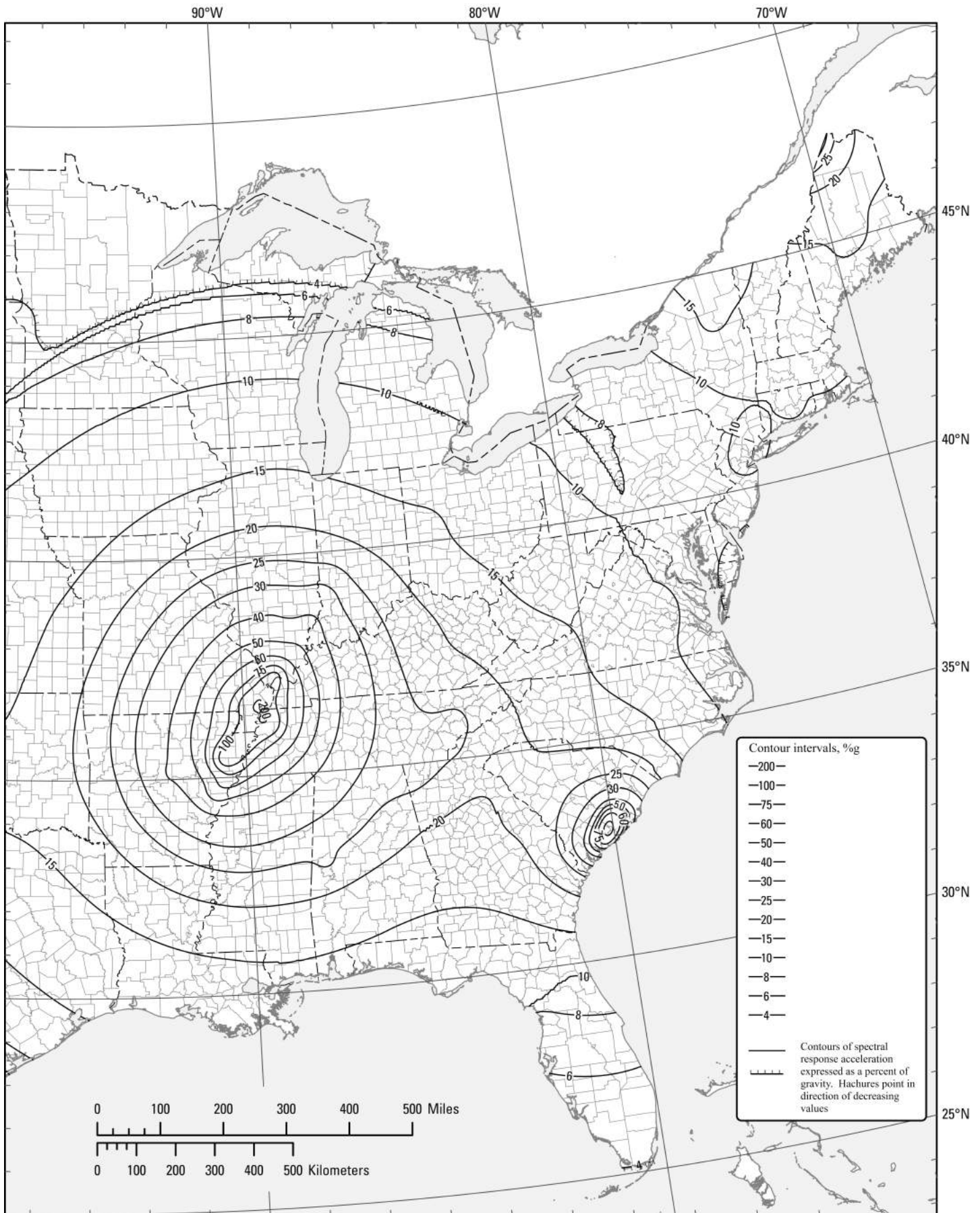
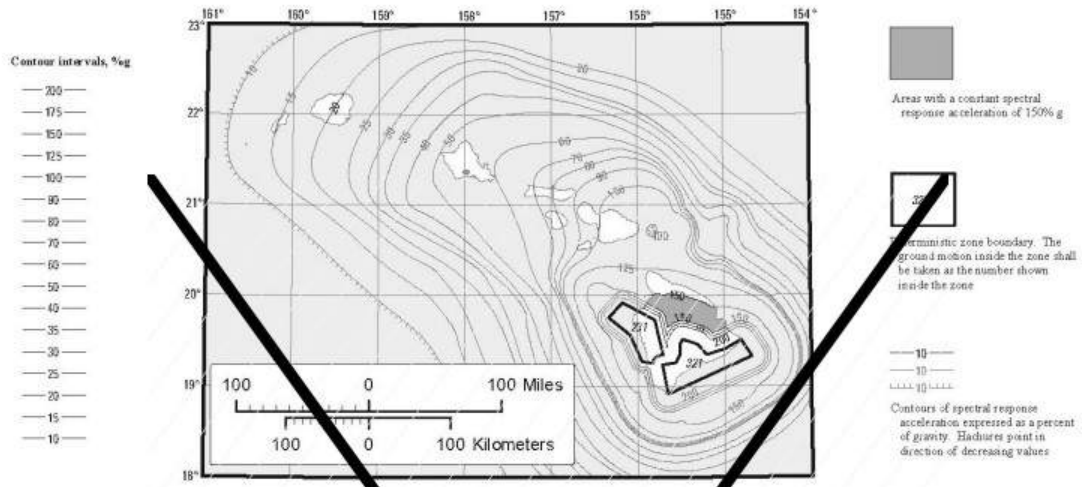
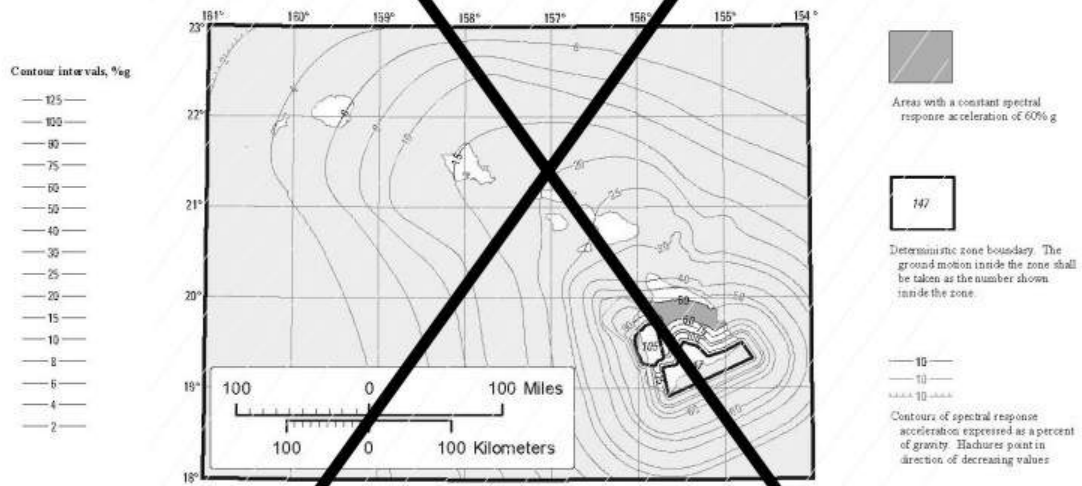

FIGURE 1613.2.1(4)
(Continued). S_{M1} for the default site conditions for the coterminous United States.



0.2 Second Spectral Response Acceleration (5% of Critical Damping)



1.0 Second Spectral Response Acceleration (5% of Critical Damping)

DISCUSSION	REFERENCES
<p>Maps prepared by United States Geological Survey (USGS) in collaboration with the Federal Emergency Management Agency (FEMA)-funded Building Seismic Safety Council (BSSC) and the American Society of Civil Engineers (ASCE). The basis is explained in commentaries prepared by BSSC and ASCE and in the references:</p> <ul style="list-style-type: none"> • Ground motion values contoured on these maps incorporate: <ul style="list-style-type: none"> • a target risk of structural collapse equal to 1% in 50 years based upon a generic structural fragility • deterministic upper limits imposed near large, active faults, which are taken as 1.5 times the estimated median response to the characteristic earthquake for the fault (1.5 is used to represent the 94th percentile response), but not less than 150% and 60% g for 0.2 and 1.0 sec, respectively. <p>As such, the values are different from those on the uniform-hazard 1998 USGS National Seismic Hazard Maps for Hawaii posted at http://earthquake.usgs.gov/hazmaps.</p> <p>Larger, more detailed versions of these maps are not provided because it is recommended that the corresponding USGS web tool (http://earthquake.usgs.gov/designmaps/ or http://icount.cr.usgs.edu) be used to determine the mapped value for a specified location.</p>	<p>Building Seismic Safety Council, 2009, NEHRP Recommended Seismic Provisions for New Buildings and Other Structures, FEMA-750/2009 Edition, Federal Emergency Management Agency, Washington, DC.</p> <p>Huang, Yin-Nan, Whittaker, A.S., and Luco, Nicolas, 2008, Maximum spectral demands in the near-fault region, <i>Earthquake Spectra</i>, Volume 24, Issue 1, pp. 319-341.</p> <p>Klein, F., Frankel, A.D., Mueller, C.S., Weston, R.L., and Okubo, P., 2001, Seismic hazard in Hawaii: high rate of large earthquakes and probabilistic ground-motion maps, <i>Bulletin of the Seismological Society of America</i>, Volume 91, pp. 479-498.</p> <p>Luco, Nicolas, Ellingwood, B.R., Hamburger, R.O., Hooper, J.D., Kimball, J.K., and Kircher, C.A., 2007, Risk-Targeted versus Current Seismic Design Maps for the Conterminous United States, <i>Structural Engineers Association of California 2007 Convention Proceedings</i>, pp. 163-175.</p>

FIGURE 1613.2-1(5) RISK-TARGETED MAXIMUM CONSIDERED EARTHQUAKE (MCE_R) GROUND MOTION RESPONSE ACCELERATIONS FOR HAWAII OF 0.2- AND 1-SECOND SPECTRAL RESPONSE ACCELERATION (5% OF CRITICAL DAMPING)

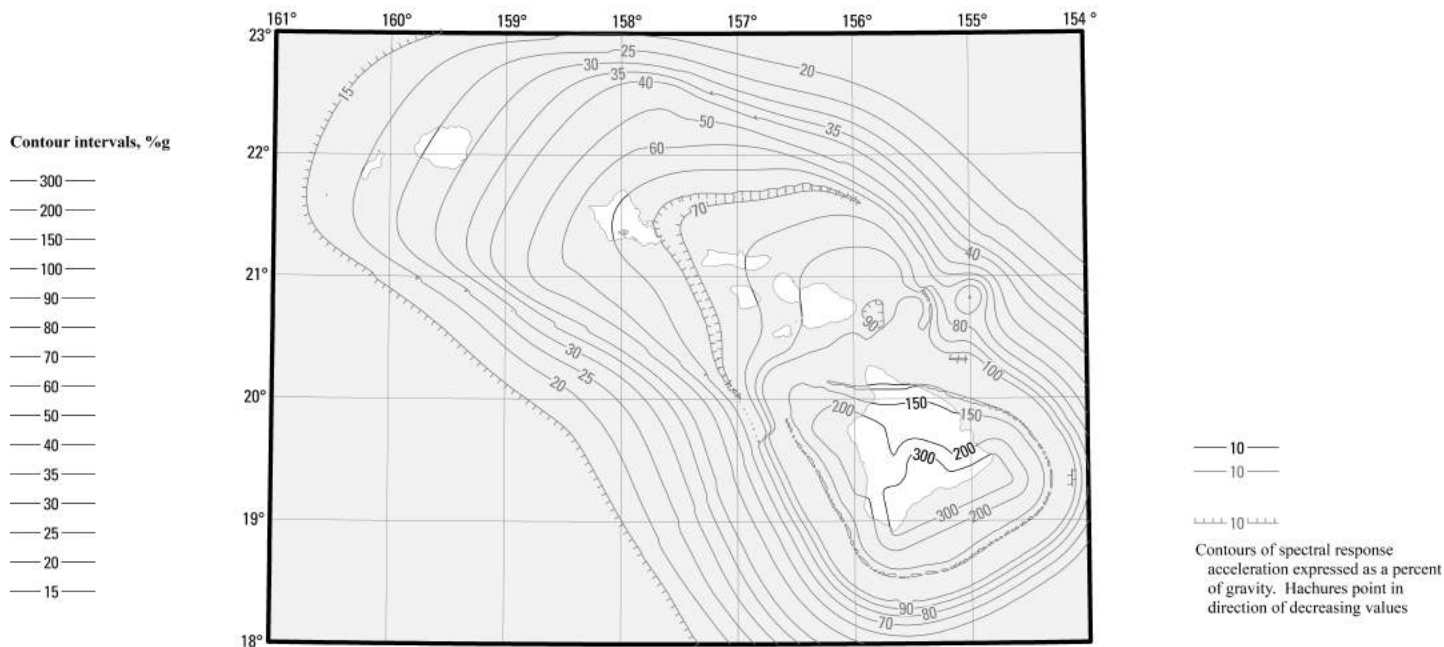

S_{MS}

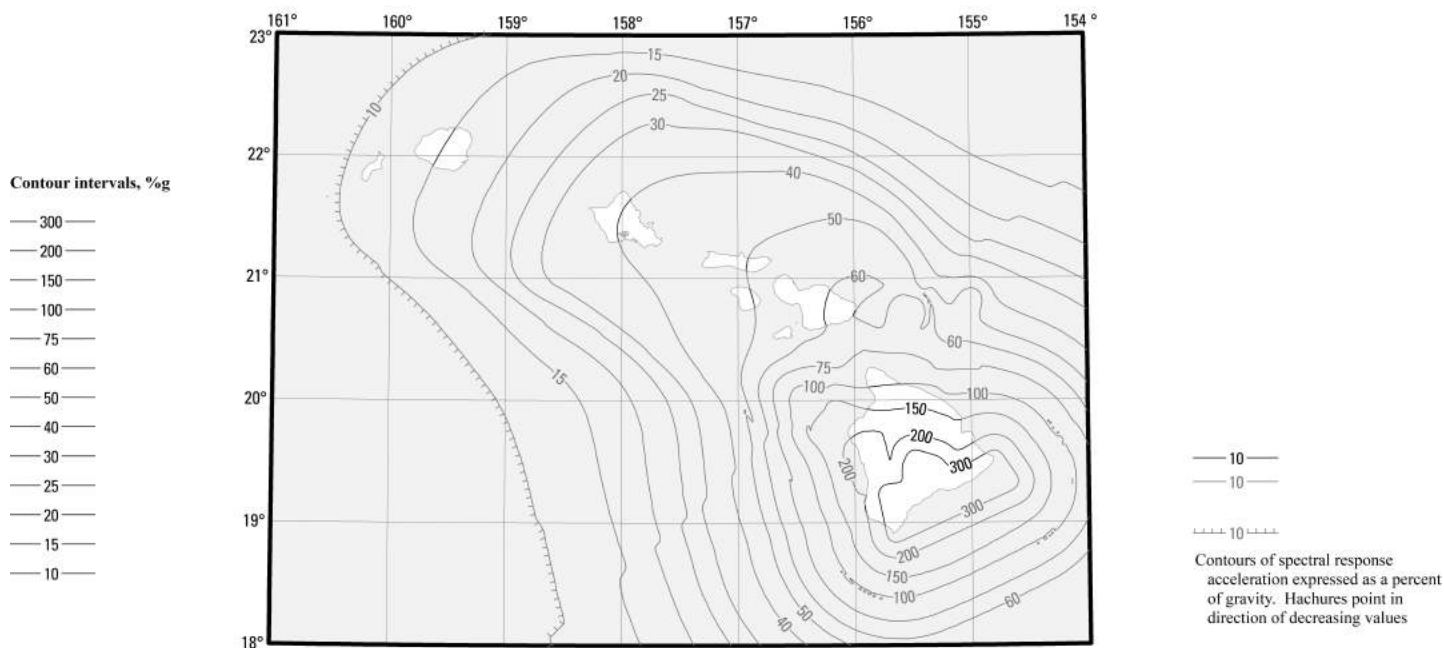

S_{Ml}

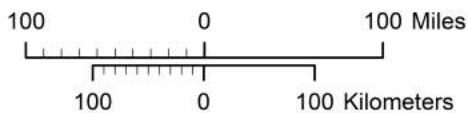

DISCUSSION

Maps prepared by the U.S. Geological Survey (USGS) using its 1998 National Seismic Hazard Model for Hawaii, the site-specific ground motion procedures of the 2020 NEHRP Recommended Seismic Provisions (Chapter 21), and the FEMA P-2078 procedures for developing multi-period response spectra of non-continuous United States sites.

Larger, more detailed versions of these maps are not provided because it is recommended that corresponding web services be used to determine the mapped value for a specified location (e.g., see <https://doi.org/10.5066/F7NK3C76>).

Notes:

Maps prepared by USGS in collaboration with the FEMA-funded BSSC and ASCE. The basis is explained in commentaries prepared by BSSC and ASCE and in the references.

Ground motion values contoured on these maps incorporate:

- a. A target risk of structural collapse equal to 1% in 50 years based upon a generic structural fragility, and
- b. Deterministic upper limits imposed near large, active faults, which are taken as 1.8 times the estimated median response to the characteristic earthquake for the fault (1.8 is used to represent the 84th percentile response), but not less than 150% and 60% g for 0.2 and 1.0 s, respectively.

- As such, the values are different from those on the uniform-hazard 1998 USGS National Seismic Hazard Maps for Hawaii posted at <https://doi.org/10.5066/F7HT2MHG>.

Larger, more detailed versions of these maps are not provided because it is recommended that the corresponding USGS web tool (<https://doi.org/10.5066/F7NK3C76>) be used to determine the mapped value for a specified location.

- User Note: The USGS Seismic Design Geodatabase is available at the ASCE 7 Hazard Tool <https://asce7hazardtool.online/> or an approved equivalent.

FIGURE 1613.2.1(5)
S_{MS} and S_{M1} for the default site conditions for Hawaii.

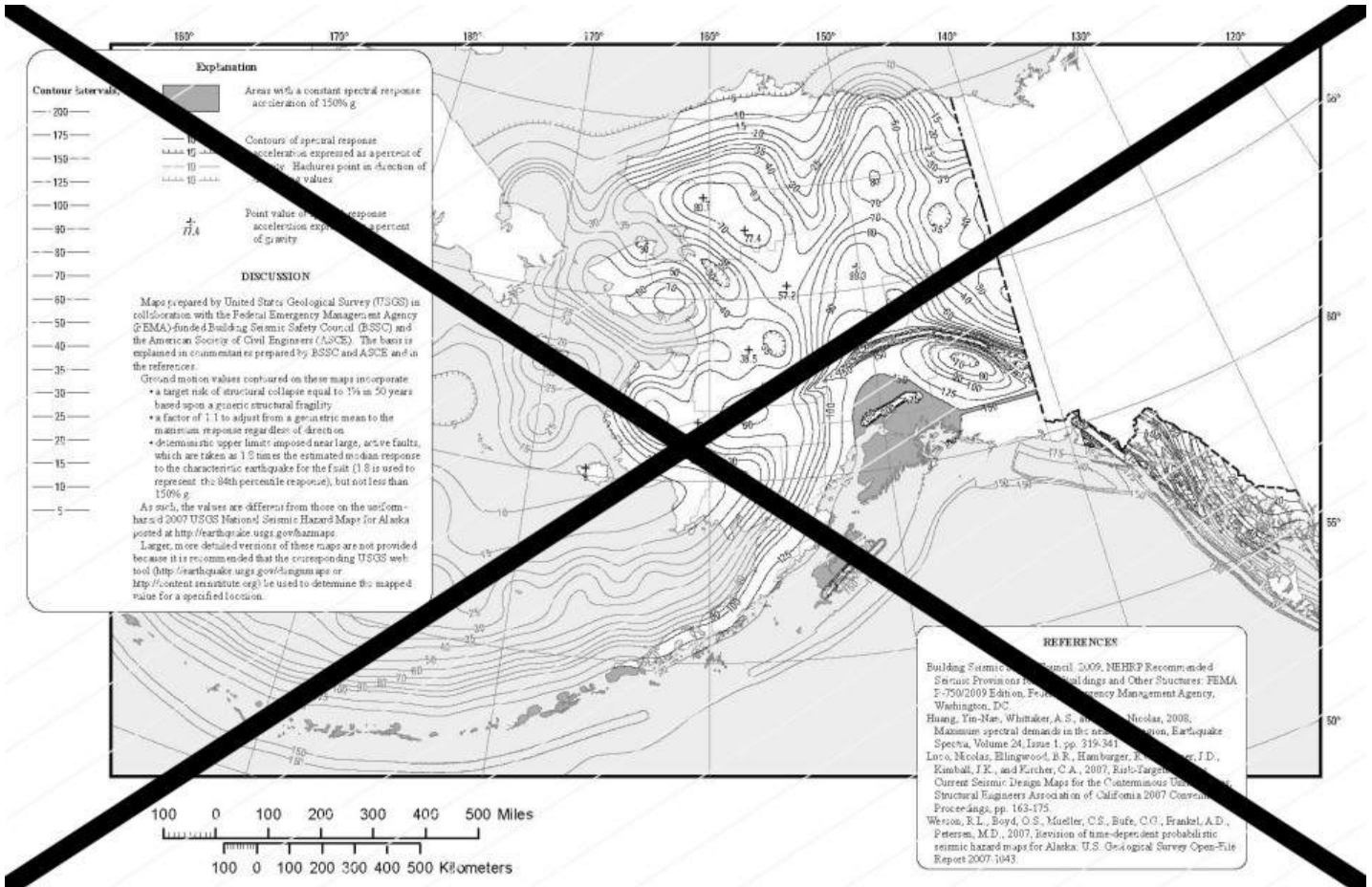
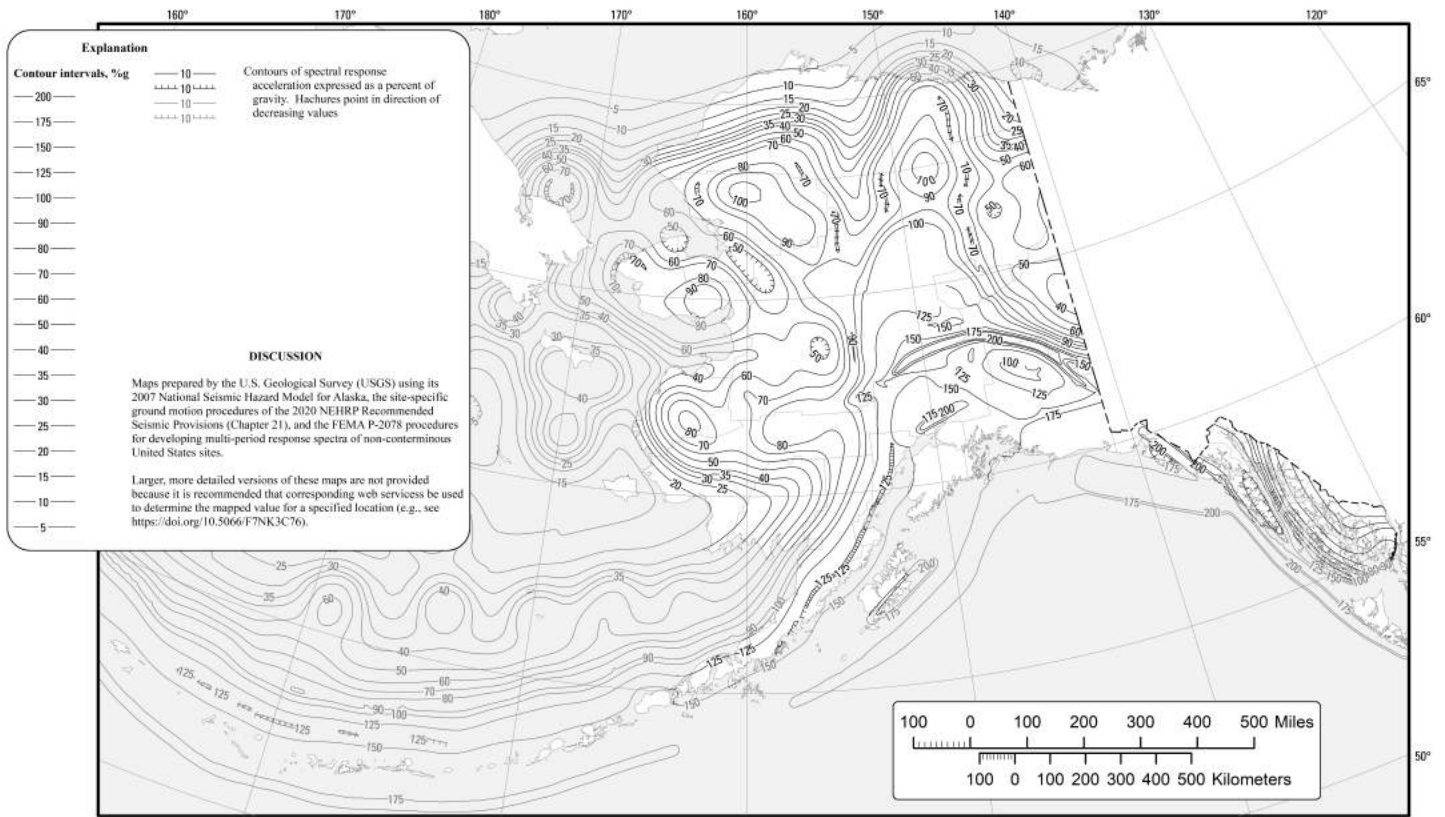

FIGURE 1613.2-1(6) RISK-TARGETED MAXIMUM CONSIDERED EARTHQUAKE (MCE_R) GROUND MOTION RESPONSE ACCELERATIONS FOR ALASKA OF 02-SECOND SPECTRAL RESPONSE ACCELERATION (5% OF CRITICAL DAMPING)



Notes:

Maps prepared by USGS in collaboration with the FEMA-funded BSSC and ASCE. The basis is explained in commentaries prepared by BSSC and ASCE and in the references. Ground motion values contoured on these maps incorporate:

- a. A target risk of structural collapse equal to 1% in 50 years based upon a generic structural fragility.
- b. A factor of 1.1 to adjust from a geometric mean to the maximum response regardless of direction, and
- c. Deterministic upper limits imposed near large, active faults, which are taken as 1.8 times the estimated median response to the characteristic earthquake for the fault (1.8 is used to represent the 84th percentile response), but not less than 150% g.

As such, the values are different from those on the uniform-hazard 2007 USGS National Seismic Hazard Maps for Alaska posted at <https://doi.org/10.5066/F7HT2MHG>.

Larger, more detailed versions of these maps are not provided because it is recommended that the corresponding USGS web tool (<https://doi.org/10.5066/F7NK3C76>) be used to determine the mapped value for a specified location.

User Note: The USGS Seismic Design Geodatabase is available at the ASCE 7 Hazard Tool <https://asce7hazardtool.online/> or an approved equivalent.

FIGURE 1613.2.1(6)
S_{MS} for the default site conditions for Alaska.

Revise as follows:

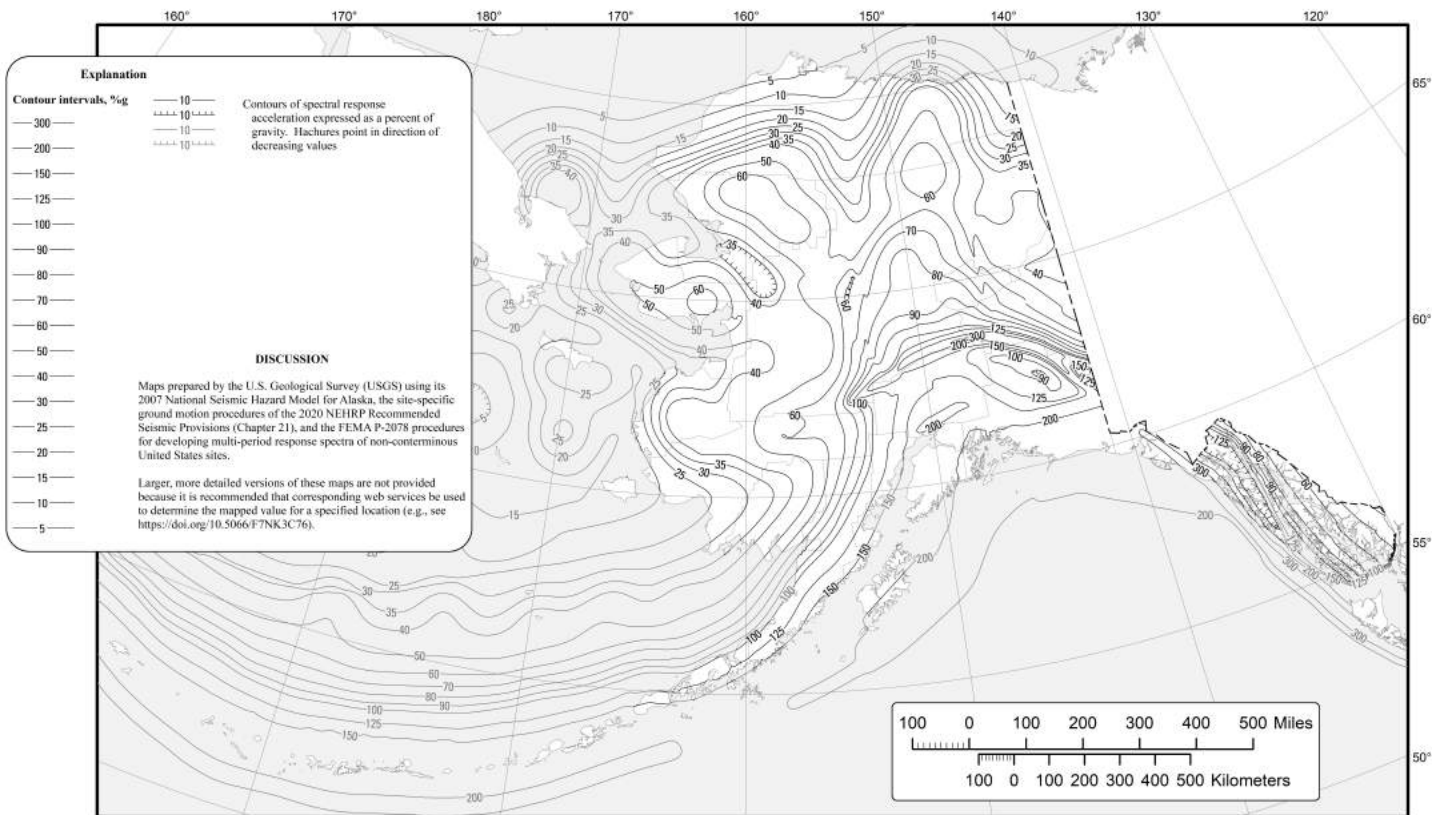
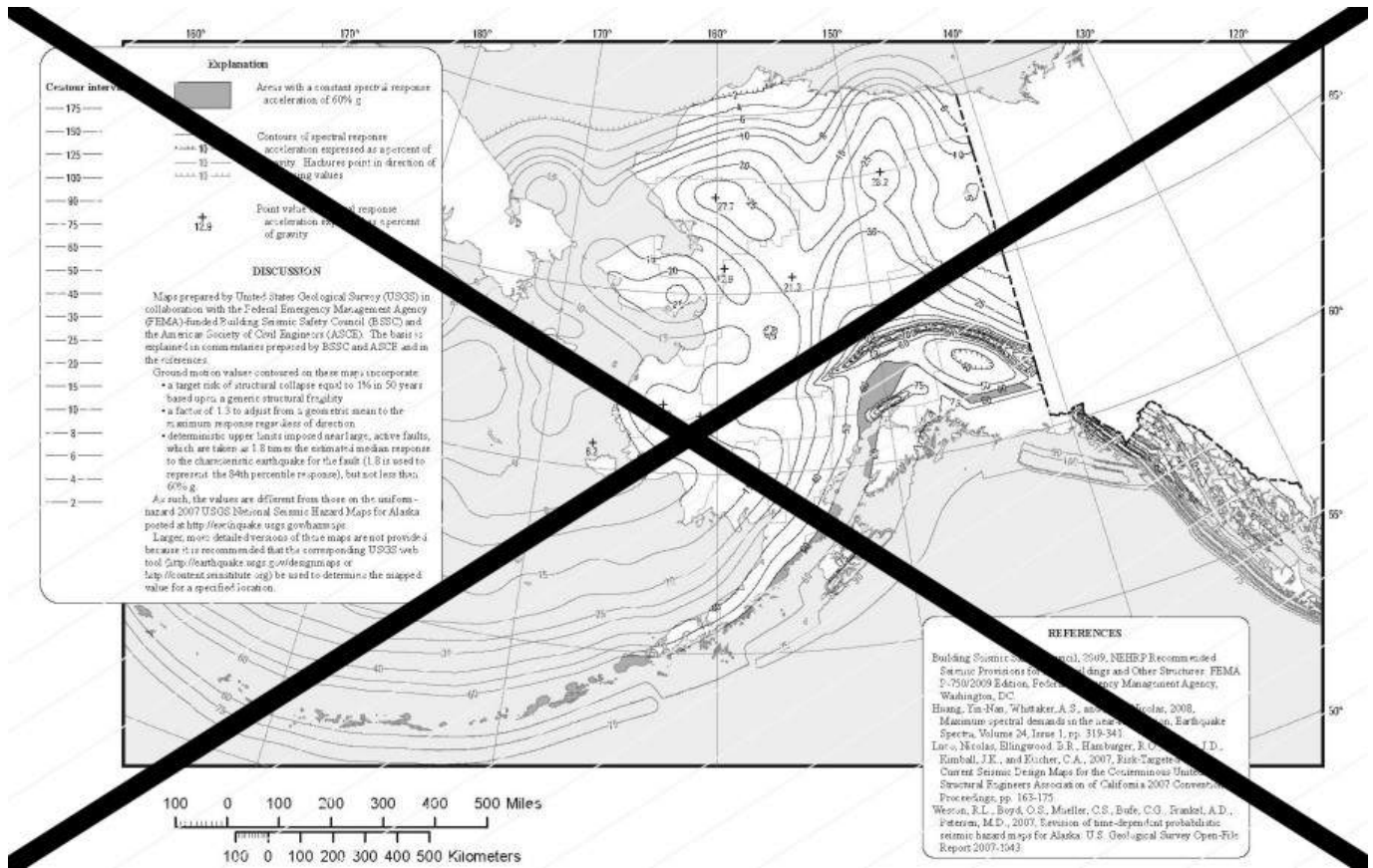

Notes:

Maps prepared by USGS in collaboration with the FEMA-funded BSSC and ASCE. The basis is explained in commentaries prepared by BSSC and ASCE and in the references. Ground motion values contoured on these maps incorporate:

- a. A target risk of structural collapse equal to 1% in 50 years based upon a generic structural fragility,
- b. A factor of 1.3 to adjust from a geometric mean to the maximum response regardless of direction, and
- c. Deterministic upper limits imposed near large, active faults, which are taken as 1.8 times the estimated median response to the characteristic earthquake for the fault (1.8 is used to represent the 84th percentile response), but not less than 60% g.

As such, the values are different from those on the uniform-hazard 2007 USGS National Seismic Hazard Maps for Alaska posted at <https://doi.org/10.5066/F7HT2MHG>.

Larger, more detailed versions of these maps are not provided because it is recommended that the corresponding USGS web tool (<https://doi.org/10.5066/F7NK3C76>) be used to determine the mapped value for a specified location.

User Note: The USGS Seismic Design Geodatabase is available at the ASCE 7 Hazard Tool <https://asce7hazardtool.online/> or an approved equivalent.

FIGURE 1613.2.1(7)
S_{M1} for the default site conditions for Alaska.

Delete and substitute as follows:

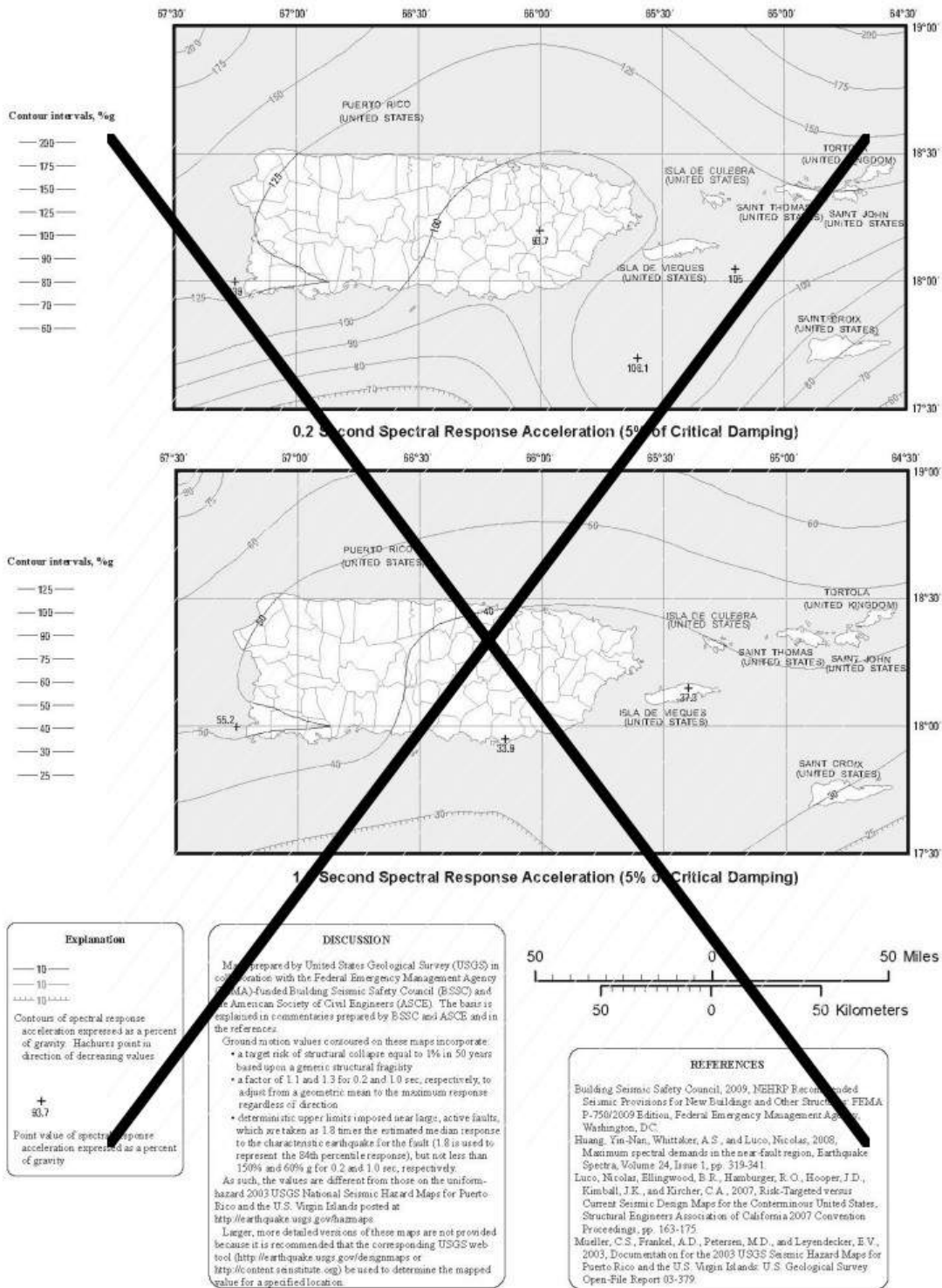
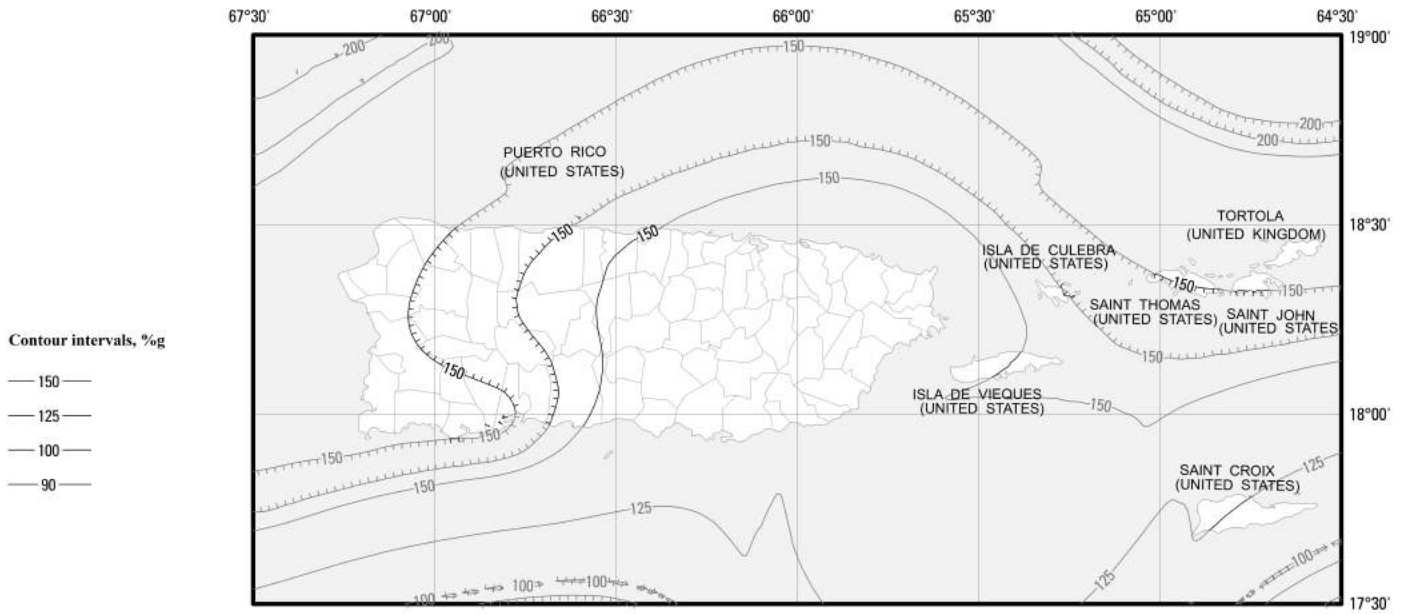
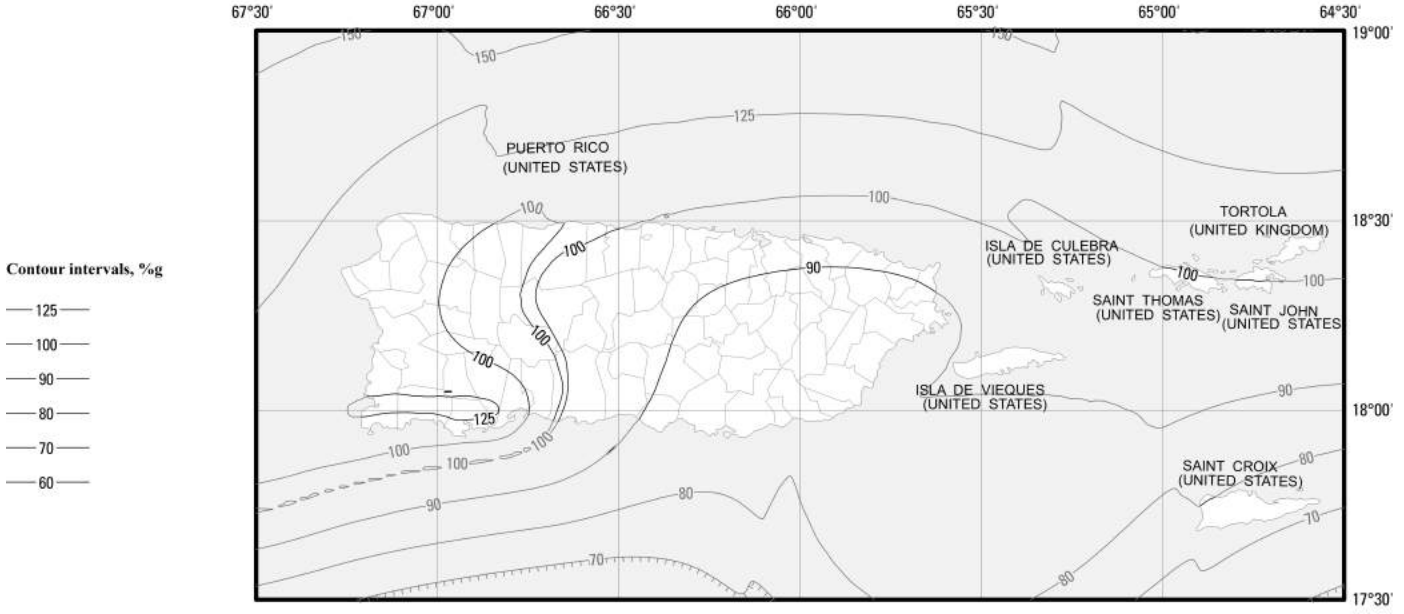

FIGURE 1613.2.1(8) RISK-TARGETED MAXIMUM CONSIDERED EARTHQUAKE (MCE_H) GROUND MOTION RESPONSE ACCELERATIONS FOR PUERTO RICO AND THE UNITED STATES VIRGIN ISLANDS OF 0.2- AND 1-SECOND SPECTRAL RESPONSE ACCELERATION (5% OF CRITICAL DAMPING)



S_{MS}



S_{MI}

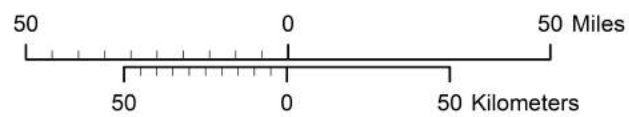

Explanation

— 10 —
 — 10 —
 - - - 10 - - -

Contours of spectral response acceleration expressed as a percent of gravity. Hachures point in direction of decreasing values

DISCUSSION

Maps prepared by the U.S. Geological Survey (USGS) using its 2003 National Seismic Hazard Model for Puerto Rico and the United States Virgin Islands, the site-specific ground motion procedures of the 2020 NEHRP Recommended Seismic Provisions (Chapter 21), and the FEMA P-2078 procedures for developing multi-period response spectra of non-conterminous United States sites.

Larger, more detailed versions of these maps are not provided because it is recommended that corresponding web services be used to determine the mapped value for a specified location (e.g., see <https://doi.org/10.5066/F7NK3C76>).

Notes:

Maps prepared by USGS in collaboration with the FEMA-funded BSSC and ASCE. The basis is explained in commentaries prepared by BSSC and

ASCE and in the references. Ground motion values contoured on these maps incorporate:

- a. A target risk of structural collapse equal to 1% in 50 years based upon a generic structural fragility.
- b. A factor of 1.1 and 1.3 for 0.2 and 1.0 s, respectively, to adjust from a geometric mean to the maximum response regardless of direction, and
- c. Deterministic upper limits imposed near large, active faults, which are taken as 1.8 times the estimated median response to the characteristic earthquake for the fault (1.8 is used to represent the 84th percentile response), but not less than 150% and 60% g for 0.2 and 1.0 s, respectively.

As such, the values are different from those on the uniform-hazard 2003 USGS National Seismic Hazard Maps for Puerto Rico and the US Virgin Islands posted at <https://doi.org/10.5066/F7HT2MHG>.

Larger, more detailed versions of these maps are not provided because it is recommended that the corresponding USGS web tool (<https://doi.org/10.5066/F7NK3C76>) be used to determine the mapped value for a specified location.

-
User Note: The USGS Seismic Design Geodatabase is available at the ASCE 7 Hazard Tool <https://asce7hazardtool.online/> or an approved equivalent.

FIGURE 1613.2.1(8)
S_{MS} and S_{M1} for the default site conditions for Puerto Rico and the US Virgin Islands.

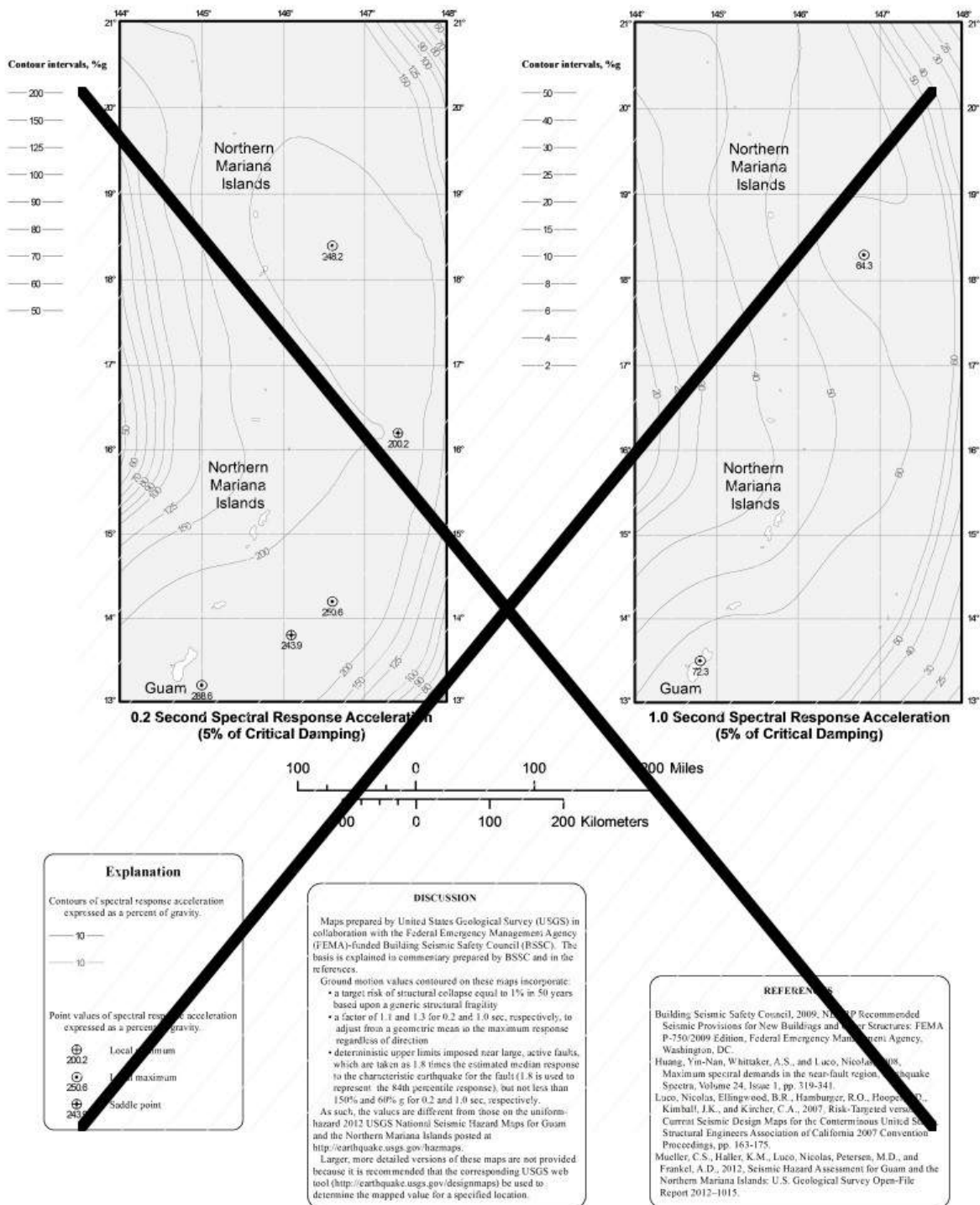
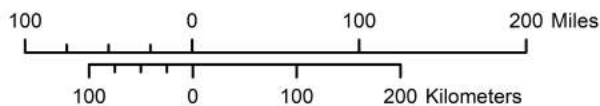
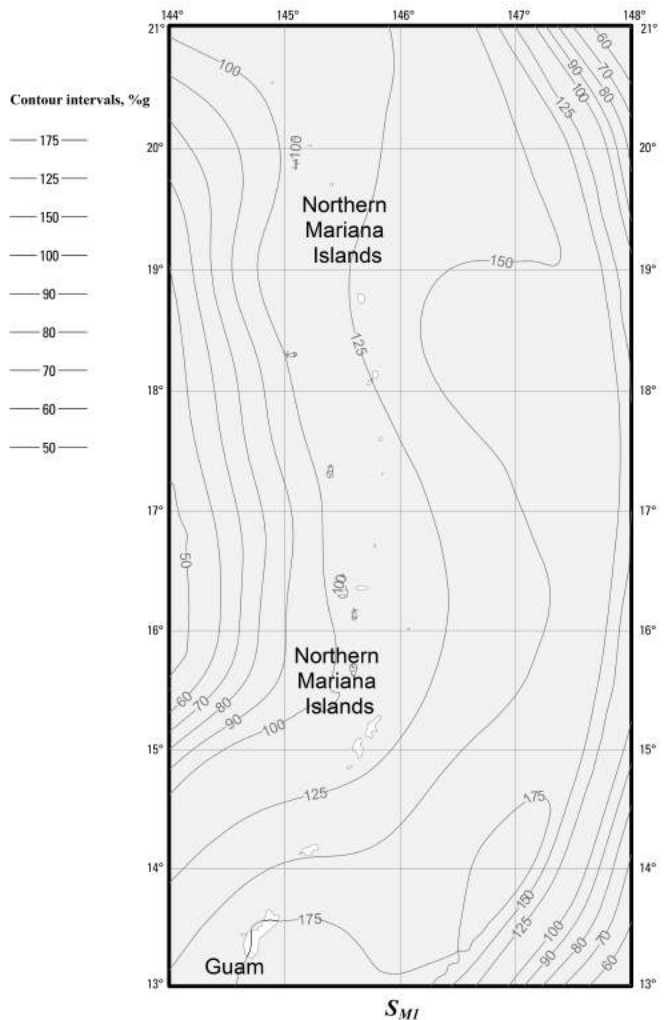
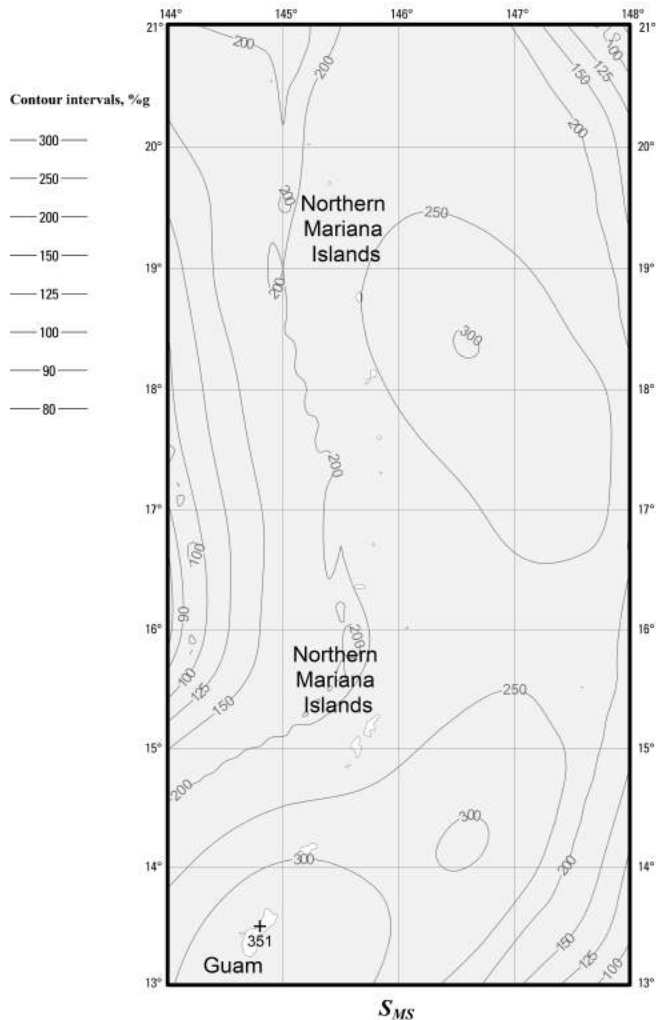

FIGURE 1613.2.1(9) RISK-TARGETED MAXIMUM CONSIDERED EARTHQUAKE (MCE_{R}) GROUND MOTION RESPONSE ACCELERATIONS FOR GUAM AND THE NORTHERN MARIANA ISLANDS OF 0.2- AND 1-SECOND SPECTRAL RESPONSE ACCELERATION (5% OF CRITICAL DAMPING)



Explanation	
Contours of spectral response acceleration expressed as a percent of gravity.	
— 10 —	
— 10 —	

DISCUSSION

Maps prepared by the U.S. Geological Survey (USGS) using its 2012 National Seismic Hazard Model for Guam and the Northern Mariana Islands, the site-specific ground motion procedures of the 2020 NEHRP Recommended Seismic Provisions (Chapter 21), and the FEMA P-2078 procedures for developing multi-period response spectra of non-contiguous United States sites.

Larger, more detailed versions of these maps are not provided because it is recommended that corresponding web services be used to determine the mapped value for a specified location (e.g., see <https://doi.org/10.5066/F7NK3C76>).

Notes:

Maps prepared by USGS in collaboration with the FEMA-funded BSSC. The basis is explained in commentary prepared by BSSC and in the references.

Ground motion values contoured on these maps incorporate:

- A target risk of structural collapse equal to 1% in 50 years based upon a generic structural fragility.
- A factor of 1.1 and 1.3 for 0.2 and 1.0 s, respectively, to adjust from a geometric mean to the maximum response regardless of direction, and
- Deterministic upper limits imposed near large, active faults, which are taken as 1.8 times the estimated median response to the characteristic earthquake for the governing fault (1.8 is used to represent the 84th percentile response), but not less than 150% and 60% g for 0.2 and 1.0 s, respectively.

As such, the values are different from those on the uniform-hazard 2012 USGS National Seismic Hazard Maps for Guam and the Northern Mariana Islands posted at

<https://doi.org/10.5066/F7HT2MHG>.

Larger, more detailed versions of these maps are not provided because it is recommended that the corresponding USGS web tool

(<https://doi.org/10.5066/F7NK3C76>) be

used to determine the mapped value for a specified location.

-
User Note: The USGS Seismic Design Geodatabase is available at the ASCE 7 Hazard Tool <https://asce7hazardtool.online/> or an approved equivalent.

FIGURE 1613.2.1(9)

S_{MS} and S_{M1} for the default site conditions for Guam and the Northern Mariana Islands.

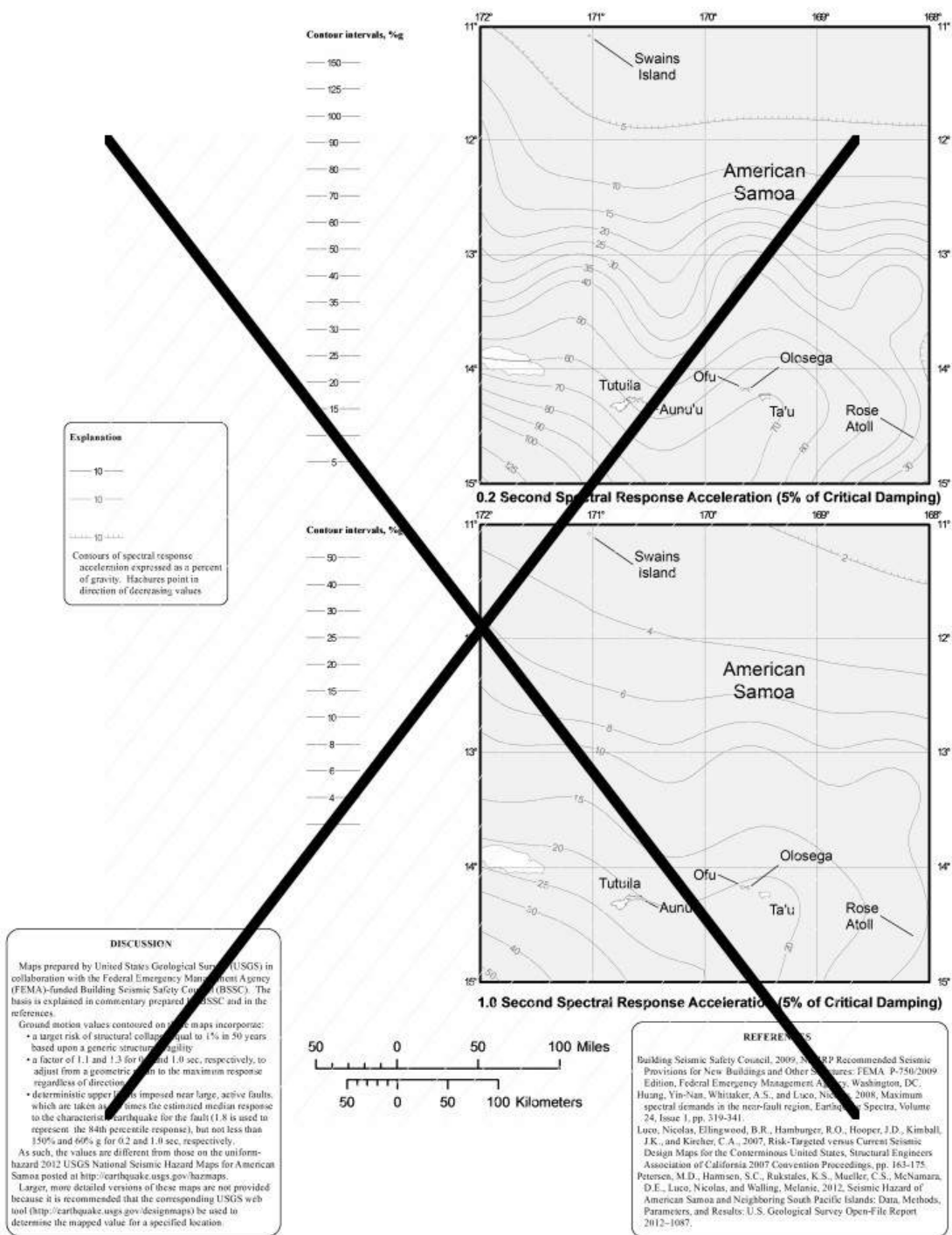

FIGURE 1613.2.1(10) RISK-TARGETED MAXIMUM CONSIDERED EARTHQUAKE (MCE_R) GROUND MOTION RESPONSE ACCELERATIONS FOR AMERICAN SAMOA OF 0.2- AND 1-SECOND SPECTRAL RESPONSE ACCELERATION (5% OF CRITICAL DAMPING)

Contour intervals, %g



Explanation	
	10
	10
	10
Contours of spectral response acceleration expressed as a percent of gravity. Hachures point in direction of decreasing values	

Contour intervals, %g

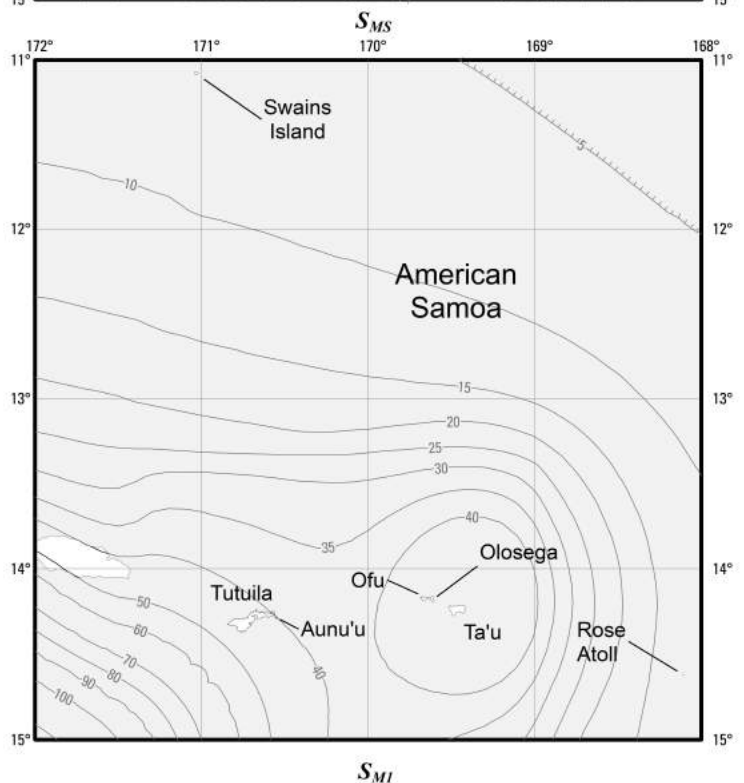
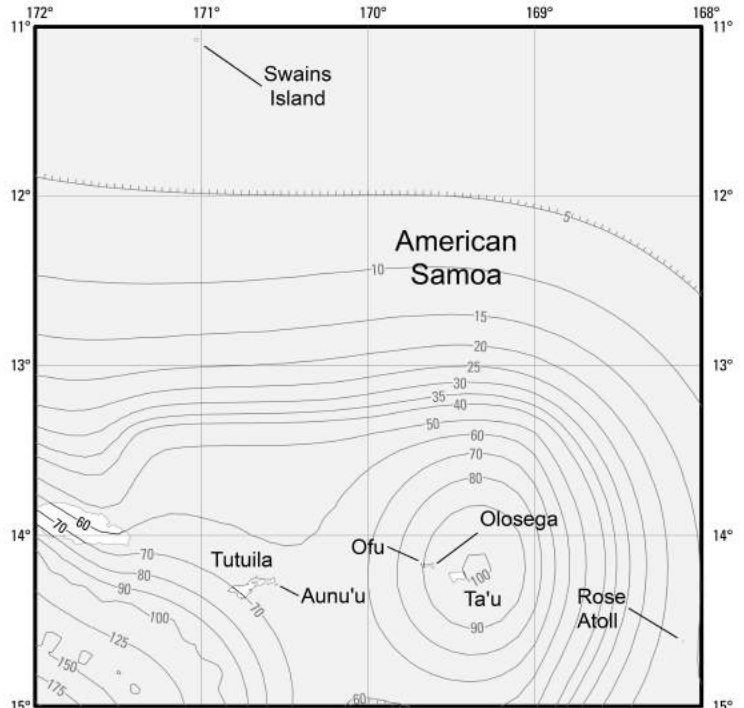
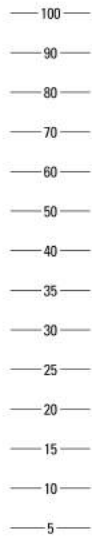

DISCUSSION

Maps prepared by the U.S. Geological Survey (USGS) using its 2012 National Seismic Hazard Model for American Samoa, the site-specific ground motion procedures of the 2020 NEHRP Recommended Seismic Provisions (Chapter 21), and the FEMA P-2078 procedures for developing multi-period response spectra of non-continuous United States sites.

Larger, more detailed versions of these maps are not provided because it is recommended that corresponding web services be used to determine the mapped value for a specified location (e.g., see <https://doi.org/10.5066/F7NK3C76>).

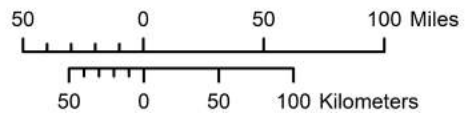

Notes:

Maps prepared by USGS in collaboration with the FEMA-funded BSSC. The basis is explained in commentary prepared by BSSC and in the references. Ground motion values contoured on these maps incorporate:

- a. A target risk of structural collapse equal to 1% in 50 years based upon a generic structural fragility.

- b. A factor of 1.1 and 1.3 for 0.2 and 1.0 s, respectively, to adjust from a geometric mean to the maximum response regardless of direction, and
- c. Deterministic upper limits imposed near large, active faults, which are taken as 1.8 times the estimated median response to the characteristic earthquake for the fault (1.8 is used to represent the 84th percentile response), but not less than 150% and 60% g for 0.2 and 1.0 s, respectively.

As such, the values are different from those on the uniform-hazard 2012 USGS National Seismic Hazard Maps for American Samoa posted at <https://doi.org/10.5066/F7HT2MHG>.

Larger, more detailed versions of these maps are not provided because it is recommended that the corresponding USGS web tool (<https://doi.org/10.5066/F7NK3C76>) be used to determine the mapped value for a specified location.

User Note: The USGS Seismic Design Geodatabase is available at the ASCE 7 Hazard Tool <https://asce7hazardtool.online/> or an approved equivalent.

FIGURE 1613.2.1(10)
S_{MS} and S_{M1} for the default site conditions for American Samoa.

Delete without substitution:

1613.2.2 Site class definitions. Based on the site soil properties, the site shall be classified as *Site Class* A, B, C, D, E or F in accordance with Chapter 20 of ASCE 7.

Where the soil properties are not known in sufficient detail to determine the site class, *Site Class* D, subjected to the requirements of Section 1613.2.3, shall be used unless the *building official* or geotechnical data determines that *Site Class* E or F soils are present at the site.

Where site investigations that are performed in accordance with Chapter 20 of ASCE 7 reveal rock conditions consistent with *Site Class* B, but site-specific velocity measurements are not made, the *site coefficients* F_a and F_v shall be taken at unity (1.0).

1613.2.3 Site coefficients and adjusted maximum considered earthquake spectral response acceleration parameters. The maximum considered earthquake spectral response acceleration for short periods, S_{MS} , and at 1-second period, S_{M1} , adjusted for site class effects shall be determined by Equations 16-20 and 16-21, respectively:

$$S_{MS} = F_a S_S \tag{Equation 16-20}$$

$$S_{M1} = F_v S_1 \tag{Equation 16-21}$$

but S_{MS} shall not be taken less than S_{M1} . Except when determining the seismic design category in accordance with Section 1613.2.5.

where:

F_a = Site coefficient defined in Table 1613.2.3(1).

F_v = Site coefficient defined in Table 1613.2.3(2).

S_S = The mapped spectral accelerations for short periods as determined in Section 1613.2.1.

S_1 = The mapped spectral accelerations for a 1-second period as determined in Section 1613.2.1.

Where *Site Class* D is selected as the default site class per Section 1613.2.2, the value of F_a shall be not less than 1.2. Where the simplified design procedure of ASCE 7 Section 12.14 is used, the value of F_a shall be determined in accordance with ASCE 7 Section 12.14.8.1, and the values of F_v , S_{MS} and S_{M1} need not be determined.

TABLE 1613.2.3(1) VALUES OF SITE COEFFICIENT F_a^a

SITE CLASS	MAPPED RISK TARGETED MAXIMUM CONSIDERED EARTHQUAKE (MCE_{TR}) SPECTRAL RESPONSE ACCELERATION PARAMETER AT SHORT PERIOD					
	$S_s \leq 0.25$	$S_s = 0.50$	$S_s = 0.75$	$S_s = 1.00$	$S_s = 1.25$	$S_s \geq 1.5$
A	0.8	0.8	0.8	0.8	0.8	0.8
B	0.9	0.9	0.9	0.9	0.9	0.9
C	1.3	1.3	1.2	1.2	1.2	1.2
D	1.6	1.4	1.2	1.1	1.0	1.0
E	2.4	1.7	1.3	Note b	Note b	Note b
F	Note b	Note b	Note b	Note b	Note b	Note b

- a. Use straight line interpolation for intermediate values of mapped spectral response acceleration at short period, S_s .
- b. Values shall be determined in accordance with Section 11.4.8 of ASCE 7.

TABLE 1613.2.3(2) VALUES OF SITE COEFFICIENT F_v ^a

SITE CLASS	MAPPED RISK TARGETED MAXIMUM CONSIDERED EARTHQUAKE (MCE_{RT}) SPECTRAL RESPONSE ACCELERATION PARAMETER AT 1-SECOND PERIOD					
	$S_1 \leq 0.1$	$S_1 = 0.2$	$S_1 = 0.3$	$S_1 = 0.4$	$S_1 = 0.5$	$S_1 \geq 0.6$
A	0.8	0.8	0.8	0.8	0.8	0.8
B	0.8	0.8	0.8	0.8	0.8	0.8
C	1.5	1.5	1.5	1.5	1.5	1.4
D	2.4	2.2 ^e	2.0 ^e	1.9 ^e	1.8 ^e	1.7 ^e
E	4.2	3.3 ^e	2.8 ^e	2.4 ^e	2.2 ^e	2.0 ^e
F	Note b	Note b	Note b	Note b	Note b	Note b

- a. Use straight line interpolation for intermediate values of mapped spectral response acceleration at 1-second period, S_1 .
- b. Values shall be determined in accordance with Section 11.4.8 of ASCE 7.
- c. See requirements for site-specific ground motions in Section 11.4.8 of ASCE 7.

Revise as follows:

1613.2.4.2 Design spectral response acceleration parameters. Five-percent damped design spectral response acceleration at short periods, S_{DS} , and at 1-second period, S_{D1} , shall be determined from Equations 16-22.20 and Equation 16-23.21, respectively:

$$S_{DS} = \frac{2}{3} S_{MS} \tag{Equation 16-22.20}$$

$$S_{D1} = \frac{2}{3} S_{M1} \tag{Equation 16-23.21}$$

where:

S_{MS} = The maximum considered earthquake spectral response accelerations for short period as determined in Section 1613.2.3.1.

S_{M1} = The maximum considered earthquake spectral response accelerations for 1-second period as determined in Section 1613.2.3.1.

1613.2.5.3 Determination of seismic design category. Structures classified as *Risk Category* I, II or III that are located where the mapped spectral response acceleration parameter at 1-second period, S_1 , is greater than or equal to 0.75 shall be assigned to *Seismic Design Category* E. Structures classified as *Risk Category* IV that are located where the mapped spectral response acceleration parameter at 1-second period, S_1 , is greater than or equal to 0.75 shall be assigned to *Seismic Design Category* F. It shall be permitted to use the values of S_{M1} obtained from Figures 1613.2.1 (1) through 1613.2.2 (10) in lieu of S_1 to determine seismic design category. Other structures shall be assigned to a *seismic design category* based on their *risk category* and the design spectral response acceleration parameters, S_{DS} and S_{D1} , determined in accordance with Section 1613.2.4.2 or the site-specific procedures of ASCE 7. Each building and structure shall be assigned to the more severe *seismic design category* in accordance with Table 1613.2.5.3(1) or 1613.2.5.3(2), irrespective of the fundamental period of vibration of the structure, T . User Note: It is recommended that the USGS web tool (<https://doi.org/10.5066/F7NK3C76>) be used to determine the mapped parameter values for a specified location, including S_1 . The USGS mapped values from the USGS web tool are available from the ASCE 7 Hazard Tool <https://asce7hazardtool.online/> or an approved equivalent.

TABLE 1613.2.5-3(1) SEISMIC DESIGN CATEGORY BASED ON SHORT-PERIOD (0.2 second) RESPONSE ACCELERATION

VALUE OF S_{DS}	RISK CATEGORY		
	I or II	III	IV
$S_{DS} < 0.167g$	A	A	A
$0.167g \leq S_{DS} < 0.33g$	B	B	C
$0.33g \leq S_{DS} < 0.50g$	C	C	D
$0.50g \leq S_{DS}$	D	D	D

TABLE 1613.2.5.3(2) SEISMIC DESIGN CATEGORY BASED ON 1-SECOND PERIOD RESPONSE ACCELERATION

VALUE OF S_{D1}	RISK CATEGORY		
	I or II	III	IV
$S_{D1} < 0.067g$	A	A	A
$0.067g \leq S_{D1} < 0.133g$	B	B	C
$0.133g \leq S_{D1} < 0.20g$	C	C	D
$0.20g \leq S_{D1}$	D	D	D

1613.2.5.3.1 Alternative seismic design category determination. Where S_1 is less than 0.75, the *seismic design category* is permitted to be determined from Table 1613.2.5.3(1) alone where all of the following apply:

1. In each of the two *orthogonal* directions, the approximate fundamental period of the structure, T_a , in each of the two *orthogonal* directions determined in accordance with Section 12.8.2.1 of ASCE 7, is less than $0.8 T_s$ determined in accordance with Section ~~11.8.6~~ 11.4.5.2 of ASCE 7.
2. In each of the two *orthogonal* directions, the fundamental period of the structure used to calculate the *story drift* is less than T_s .
3. Equation 12.8-2 of ASCE 7 is used to determine the seismic response coefficient, C_s .
4. The *diaphragms* are rigid or are permitted to be idealized as rigid in accordance with Section 12.3.1 of ASCE 7 or, for *diaphragms* permitted to be idealized as flexible in accordance with Section 12.3.1 of ASCE 7, the distances between vertical elements of the *seismic force-resisting system* do not exceed 40 feet (12 192 mm).

1613.2.5.3.2 Simplified design procedure. Where the alternate simplified design procedure of ASCE 7 is used, the *seismic design category* shall be determined in accordance with ASCE 7.

1613.3 Ballasted photovoltaic panel systems. Ballasted, roof-mounted *photovoltaic panel systems* need not be rigidly attached to the roof or supporting structure. Ballasted non-penetrating systems shall be designed and installed only on roofs with slopes not more than one unit vertical in 12 units horizontal. Ballasted nonpenetrating systems shall be designed to resist sliding and uplift resulting from lateral and vertical forces as required by Section 1605, using a coefficient of friction determined by acceptable engineering principles. In structures assigned to *Seismic Design Category* C, D, E or F, ballasted nonpenetrating systems shall be designed to accommodate seismic displacement determined by nonlinear response-hi *story* or other *approved* analysis or shake-table testing, using input motions consistent with ASCE 7 lateral and vertical seismic forces for nonstructural components on roofs.

Staff Analysis: CC# S127-22 and CC# S128-22 addresses requirements in a different or contradicting manner. The committee is urged to make their intentions clear with their actions on these proposals.

Reason Statement: This proposal is a coordination proposal to bring the 2024 IBC up to date with the provisions of the 2022 edition of ASCE/SEI 7 *Minimum Design Loads and Associated Criteria for Buildings and Other Structures* (ASCE/SEI 7-22). The ASCE/SEI 7 maps introduces the use of multi-period response spectra (MPRS), to improve the accuracy of the frequency content of earthquake design ground motions and to enhance the reliability of the seismic design parameters derived from these ground motions. These improvements make better use of the available earth science, which has, in general, sufficiently advanced to accurately define spectral response for different site conditions over a broad range of periods. The result of the MPRS is to incorporate increased spectral demand for structures with mid-range fundamental periods on soft-soil sites where ground motion hazard is dominated by large magnitude events. Use of MPRS eliminates the need for site-specific hazard analysis, as required by ASCE 7-16.

In summary, the new maps that have been proposed for inclusion into Section 1613 for the spectral response acceleration parameters S_{MS} and S_{M1} for default site conditions are the same maps that are included in ASCE/SEI 7-22. These parameter maps replace the former S_s and S_1 maps because, in ASCE/SEI 7-22, site amplification is included directly in the derivation of values for S_{MS} and S_{M1} by the U.S. Geological Survey (USGS), using the 2018 National Seismic Hazard Model (NSHM) for the conterminous U.S. and the FEMA P-2078 procedures for the states and territories outside of the conterminous U.S.

These new maps have been developed for the default site class, which is the more critical spectral response of Site Class C, CD and D for design when soil properties are not known in sufficient detail to determine the site class. This is, in concept, consistent with ASCE 7-16 which effectively requires the more critical of Site Class C and D to be used for design when soil properties are not known in sufficient detail to determine the site class. For sites where Site Class DE, E, or F soils are present, the spectral response acceleration parameters need to be determined in accordance with ASCE/SEI 7.

Note that it shall be permitted to use the values of S_{M1} obtained from Figure 1613.2.1(1) through 1613.2.1(10) in lieu of S_1 to determine the seismic design category in Section 1613 (as this is conservative) and that these new S_{MS} and S_{M1} parameters are still sufficient to assign the building's seismic design category per newly renumbered Section 1613.2.3.

A summary of the coordination changes is provided below.

Section 1613.1 Scope – The second half of Exception 1 is deleted in this proposal because the short-period spectral response acceleration (S_s) maps are no longer needed. The exception for one- and two-family dwellings will be based solely on being assigned to *Seismic Design Category A*, B or C.

Section 1613.2.1 Mapped acceleration parameters

is being renamed to **Risk-Targeted Maximum Considered Earthquake (MCE_R) spectral response acceleration parameters** to be consistent with the information being provided in the updated S_{MS} and S_{M1} maps that are being reproduced from ASCE/SEI 7-22. Maps for the short-period spectral acceleration parameter S_s , and the 1-second spectral acceleration parameter, S_1 , are no longer being generated.

Section 1613.2.3 Determination of seismic design category

has only minor renumbering changes due deletions of other sections. The resulting seismic design category for default site conditions are conservative if the site class is known to be A, B, BC, C, CD, or D. ASCE/SEI 7-22 can be used in these cases.

Given the above, **Section 1613.2.2 Site class definitions** and **Section 613.2.3 Site Coefficients and adjusted maximum considered earthquake spectral response acceleration parameters** are no longer needed and are deleted in this proposal.

Finally, **Tables 1613.2.3(1) and Table 1613.2.3(2)**, the F_a and F_v tables, are also deleted since these site amplification factors are no longer needed.

The remaining sections are renumbered to be consistent with these deletions.

Cost Impact: The code change proposal will not increase or decrease the cost of construction

This proposal coordinates the IBC with the referenced design load standard *ASCE/SEI 7 Minimum Design Loads and Associated Criteria for Buildings and Other Structures*. ASCE/SEI 7 will be updated to the 2022 edition from the 2016 edition as an Administrative Update to the 2024 I-Codes.

The code change proposal will slightly increase the cost of construction in some regions and slightly decrease it in other regions due to regional updates in the seismic hazard model. In aggregate, the cost of construction is not changed.

Specifically, any impact on construction cost, as reflected in design loads, will vary by site location, spectral response period and site class. For certain combinations of site location, spectral response period and site class, proposed design spectral acceleration parameter values (S_{DS} and S_{D1}) are larger than those of ASCE 7-16, while for other combinations of site location, spectral response period and site class, proposed values of S_{DS} and S_{D1} are smaller than those of ASCE 7-16. However, parameter values of S_{MS} and S_{M1} (which are used to determine design loads) included in ASCE 7-22 are generally within +/-15% of those of ASCE 7-16 for sites in the conterminous US assuming default site conditions.

S127-22

S128-22

IBC: 1613.1, 1613.2, 1613.2.1, FIGURE 1613.2.1(1), FIGURE 1613.2.1(2), FIGURE 1613.2.1(3), FIGURE 1613.2.1(5), FIGURE 1613.2.1(6), FIGURE 1613.2.1(7), FIGURE 1613.2.1(8), FIGURE 1613.2.1(9), FIGURE 1613.2.1(10), 1613.2.2, 1613.2.3, TABLE 1613.2.3(1), TABLE 1613.2.3(2), 1613.2.4, 1613.2.5, TABLE 1613.2.5(1), TABLE 1613.2.5(2), 1613.2.5.1, 1613.2.5.2, 1613.3, SECTION 202, 1810.3.9.4.2.1, 1603.1.5, J104.4, L101.1

Proponents: Kelly Cobeen, representing Federal Emergency Management Agency/Applied Technology Council - Seismic Code Support Committee (kcobeen@wje.com); Michael Mahoney, representing FEMA (mike.mahoney@fema.dhs.gov); John Hooper, representing ATC/FEMA SCSC (jhooper@mka.com); Sanaz Rezaeian, representing USGS (srezaeian@usgs.gov); Nicolas Luco, representing U.S. Geological Survey

2021 International Building Code

Revise as follows:

1613.1 Scope. Every structure, and portion thereof, including nonstructural components that are permanently attached to structures and their supports and attachments, shall be designed and constructed to resist the effects of earthquake motions in accordance with Chapters 11, 12, 13, 15, 17 and 18 of ASCE 7, as applicable. The *seismic design category* for a structure is permitted to be determined in accordance with Section 1613 or ASCE 7.

Exceptions:

1. Detached one- and two-family dwellings, assigned to *Seismic Design Category* A, B or C_{s-1} , or located where the mapped short-period spectral response acceleration, S_s , is less than 0.4 g.
2. The *seismic force-resisting system* of wood-frame buildings that conform to the provisions of Section 2308 are not required to be analyzed as specified in this section.
3. Agricultural storage structures intended only for incidental human occupancy.
4. Structures that require special consideration of their response characteristics and environment that are not addressed by this code or ASCE 7 and for which other regulations provide seismic criteria, such as vehicular bridges, electrical transmission towers, hydraulic structures, buried utility lines and their appurtenances and nuclear reactors.
5. References within ASCE 7 to Chapter 14 shall not apply, except as specifically required herein.

1613.2 Determination of *Seismic Design Category* Seismic ground motion values. Structures shall be assigned to a *Seismic Design Category* based on one of the following methods unless the authority having jurisdiction or geotechnical data determines that *Site Class* DE, E or F soils are present at the site. Where *Site Class* DE, E or F soils are present, the *Seismic Design Category* shall be determined in accordance with ASCE 7. Seismic ground motion values shall be determined in accordance with this section.

1. Using Figures 1613.2(1) through 1613.2(6) based on the structure *Risk Category*, or
2. Determined in accordance with ASCE 7.

Delete without substitution:

1613.2.1 Mapped acceleration parameters. The parameters S_s and S_{s1} shall be determined from the 0.2 and 1-second spectral response accelerations shown on Figures 1613.2.1(1) through 1613.2.1(10). Where S_{s1} is less than or equal to 0.04 and S_s is less than or equal to 0.15, the structure is permitted to be assigned *Seismic Design Category* A.

Delete and substitute as follows:

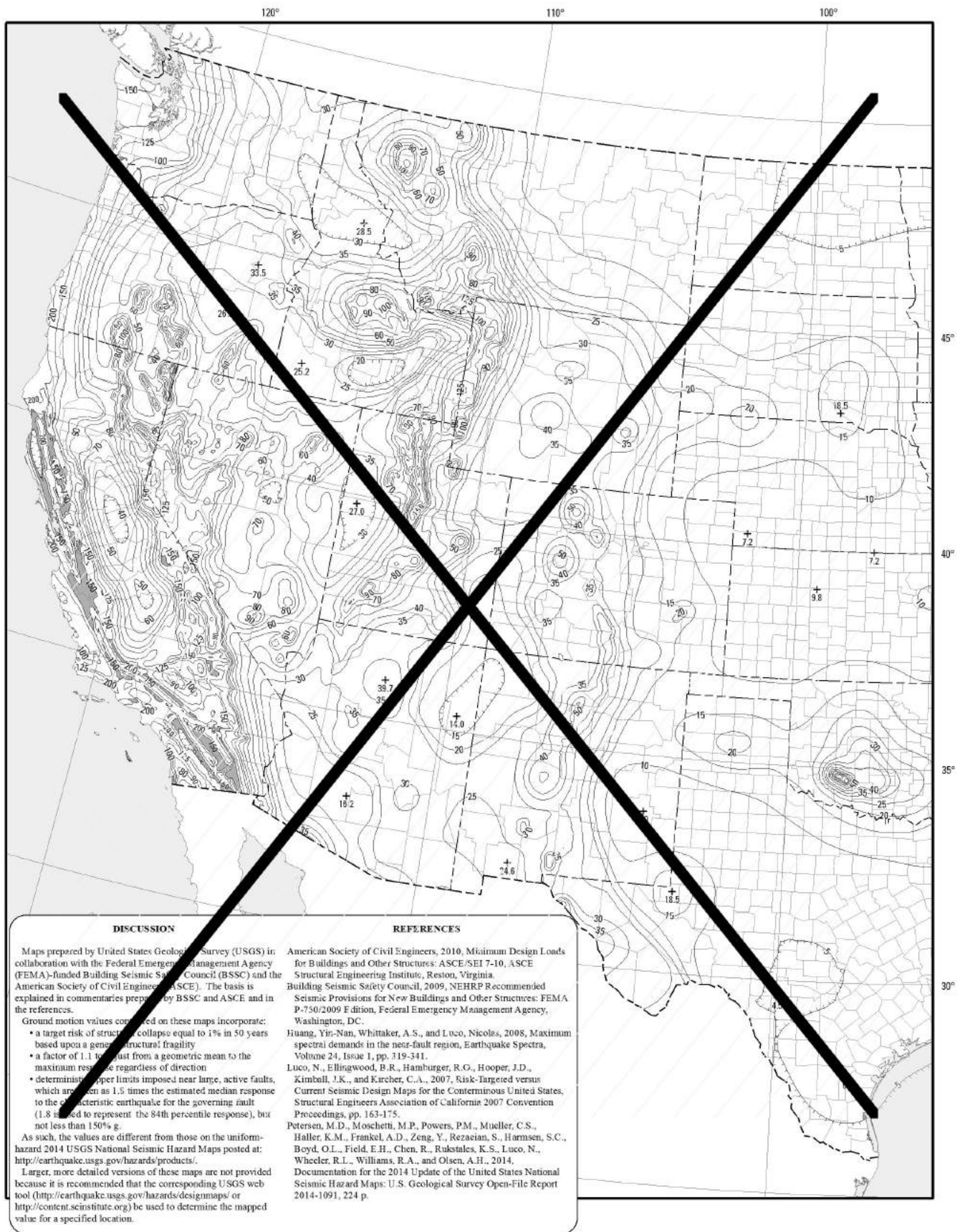

FIGURE 1613.2-1(1) RISK-TARGETED MAXIMUM CONSIDERED EARTHQUAKE (MCE_R) GROUND MOTION RESPONSE ACCELERATIONS FOR THE CONTERMINOUS UNITED STATES OF 02-SECOND SPECTRAL RESPONSE ACCELERATION (5% OF CRITICAL DAMPING)

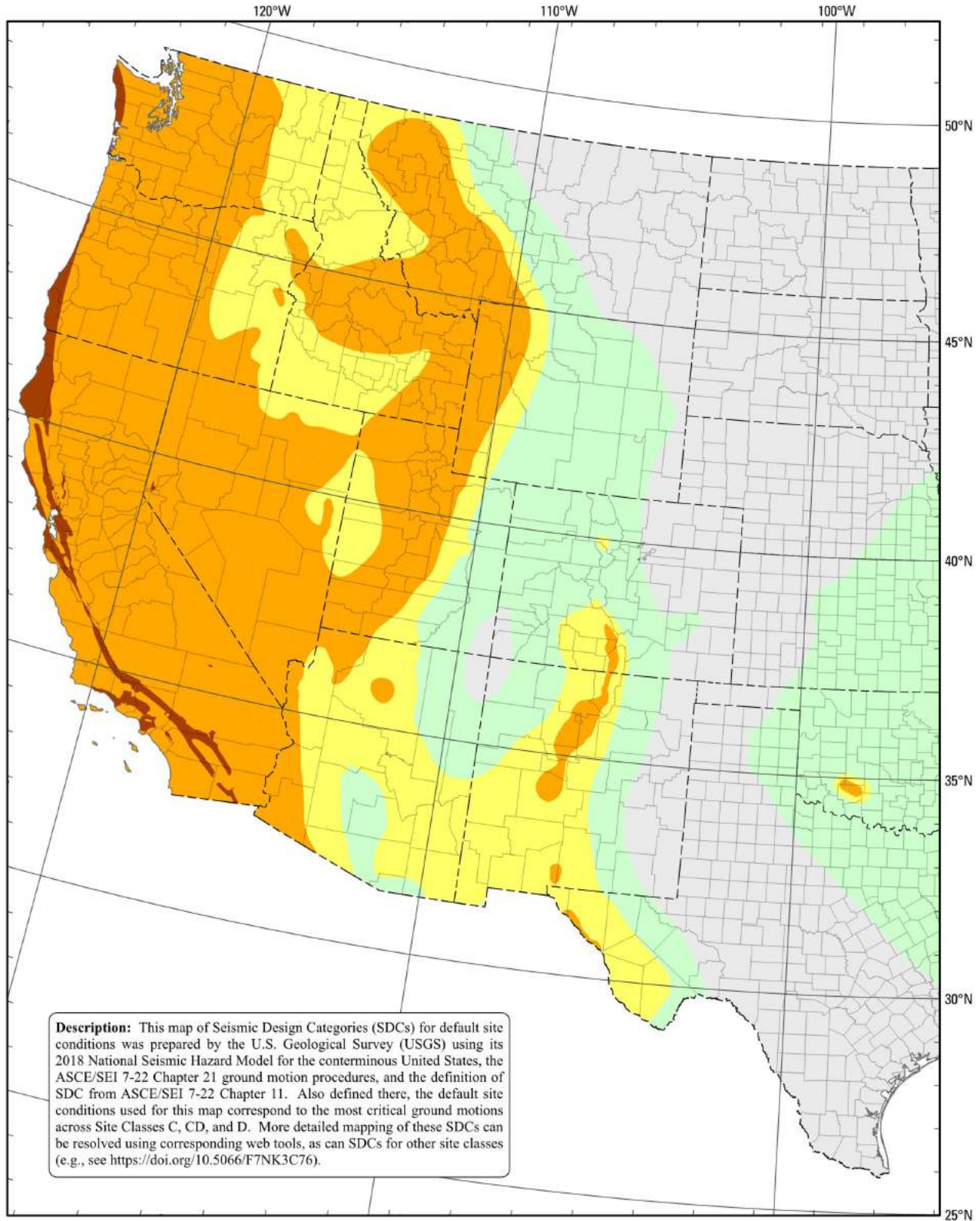

FIGURE 1613.2.1(1) SEISMIC DESIGN CATEGORIES FOR DEFAULT SITE CONDITIONS FOR THE CONTERMINOUS UNITED STATES RISK-TARGETED MAXIMUM CONSIDERED EARTHQUAKE (MCE_R) GROUND MOTION RESPONSE ACCELERATIONS FOR THE CONTERMINOUS UNITED STATES OF 02-SECOND SPECTRAL RESPONSE ACCELERATION (5% OF CRITICAL DAMPING)

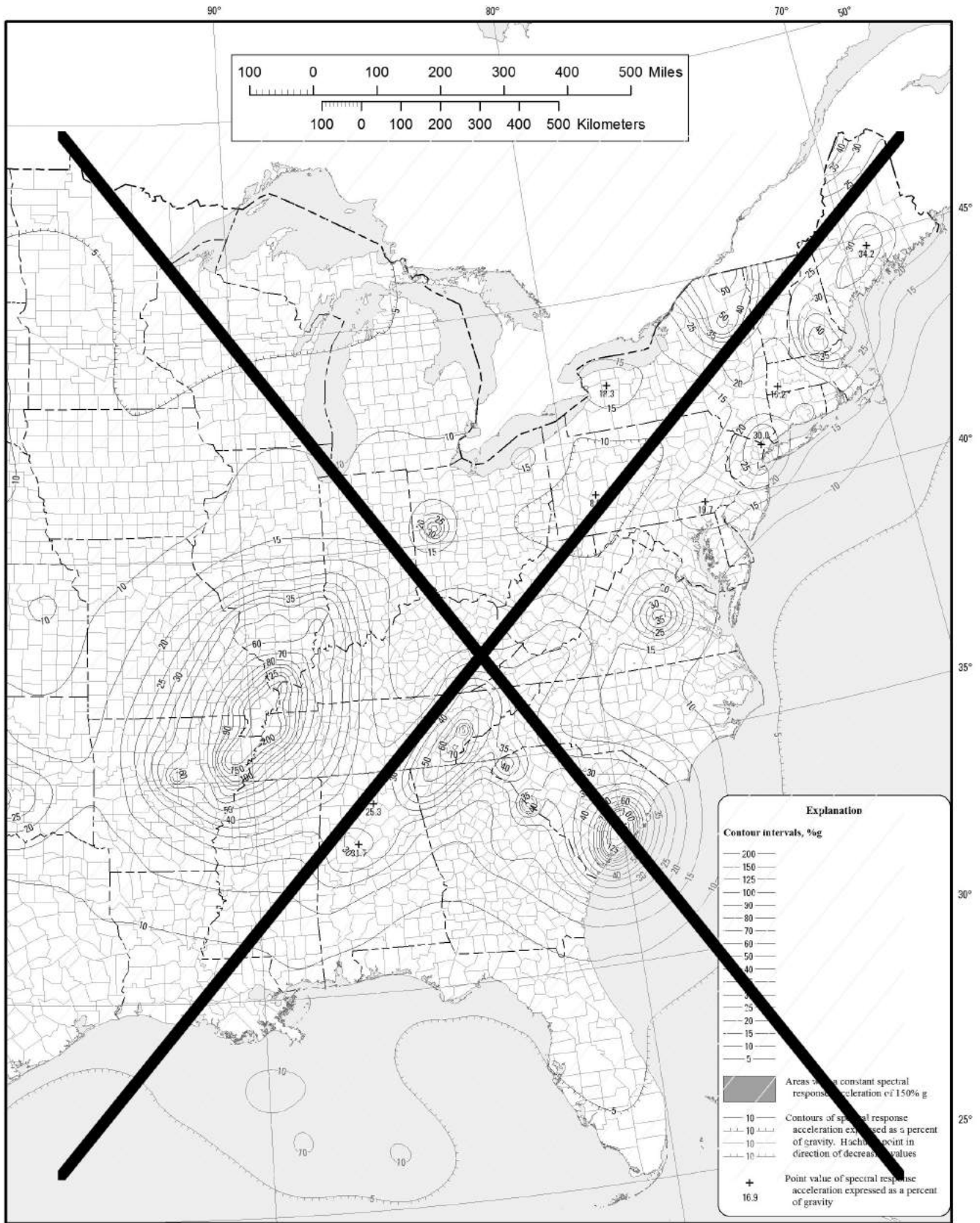

Figure 1613.3.1(1)-continued Risk-Targeted Maximum Considered Earthquake (MCE_R) Ground Motion for the Conterminous United States of 0.2-Second Spectral Response Acceleration (5% of Critical Damping)

FIGURE 1613.2.1(2) RISK-TARGETED MAXIMUM CONSIDERED EARTHQUAKE (MCE_R) GROUND MOTION RESPONSE ACCELERATIONS FOR THE CONTERMINOUS UNITED STATES OF 0.2-SECOND SPECTRAL RESPONSE ACCELERATION (5% OF CRITICAL DAMPING)

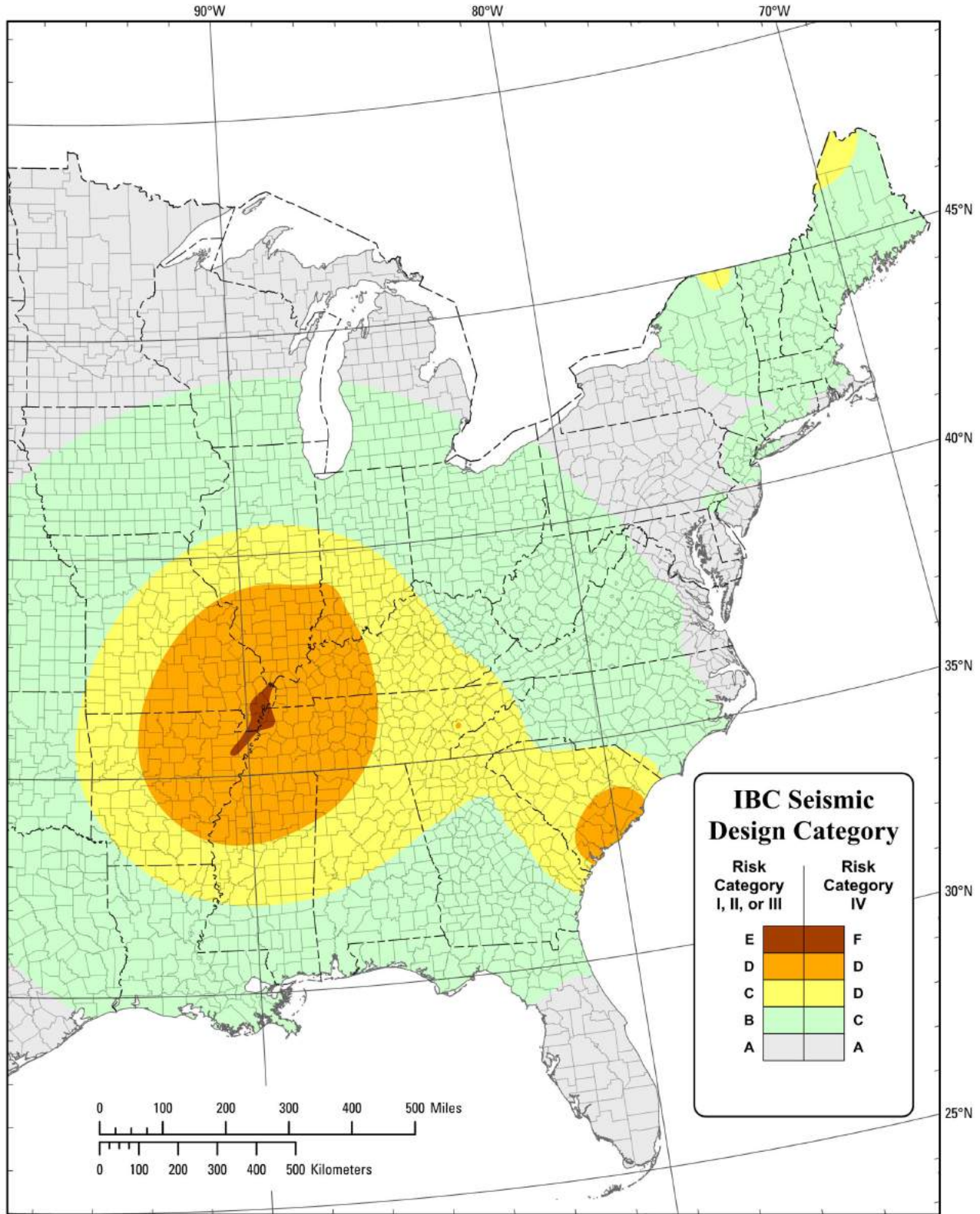

FIGURE 1613.2.1(1) CONTINUED

**SEISMIC DESIGN CATEGORIES FOR DEFAULT SITE CONDITIONS FOR THE CONTERMINOUS UNITED STATES
 RISK-TARGETED MAXIMUM CONSIDERED EARTHQUAKE (MCE_R) GROUND MOTION RESPONSE ACCELERATIONS FOR THE
 CONTERMINOUS UNITED STATES OF 02-SECOND SPECTRAL RESPONSE ACCELERATION (5% OF CRITICAL DAMPING)**

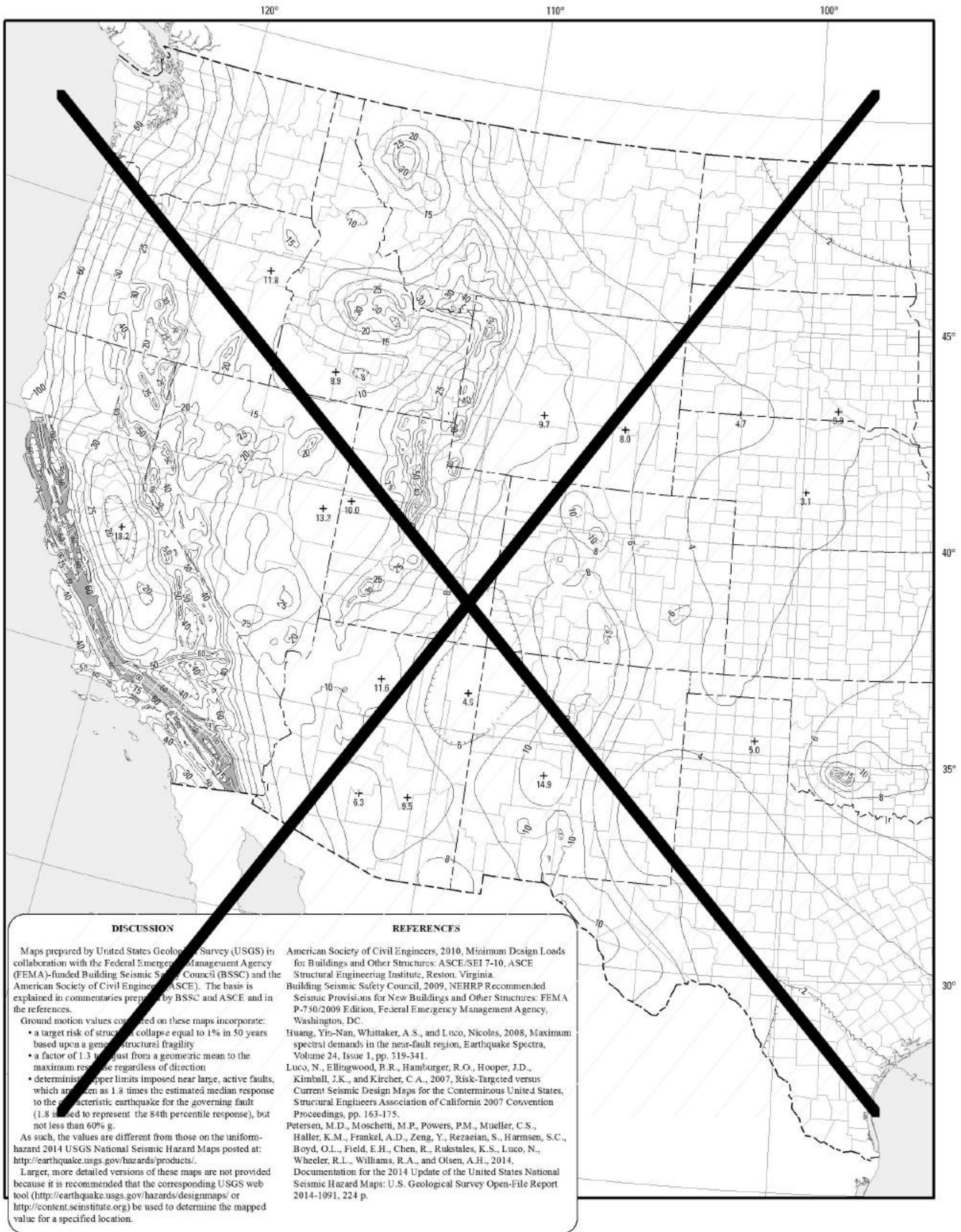
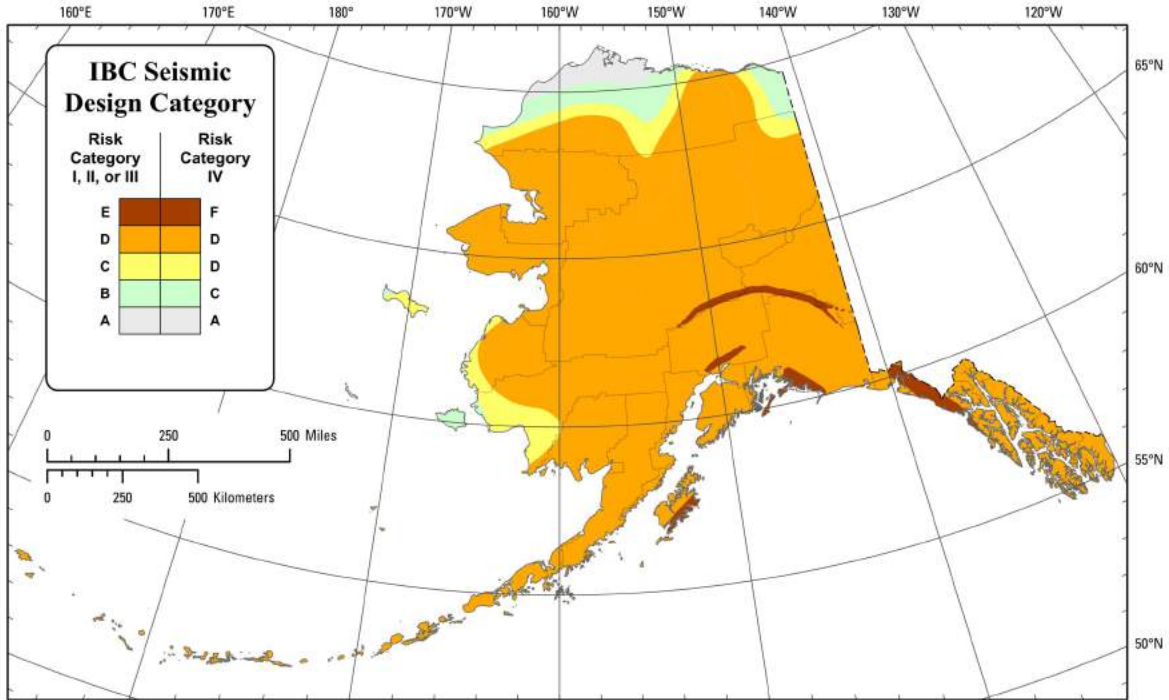
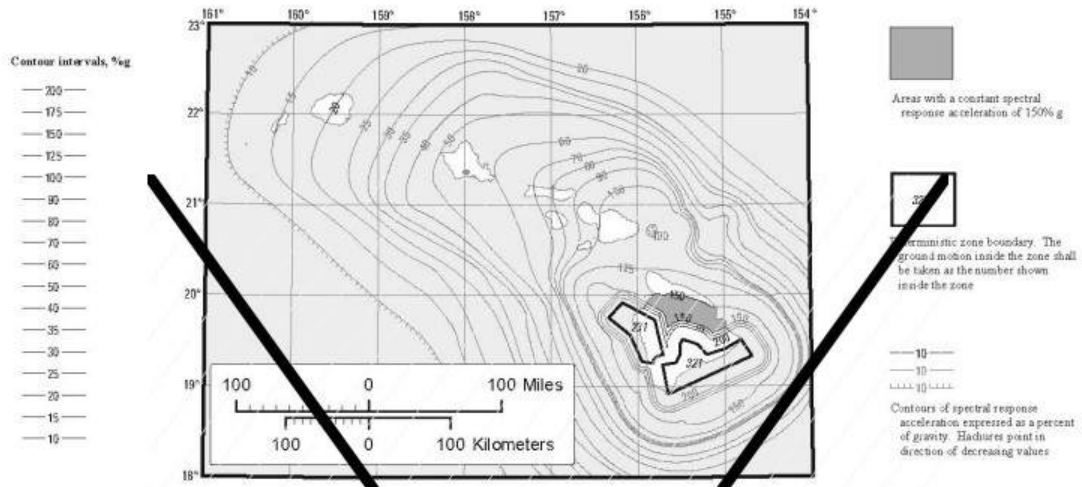

FIGURE 1613.2-1(3) RISK-TARGETED MAXIMUM CONSIDERED EARTHQUAKE (MCE_R) GROUND MOTION RESPONSE ACCELERATIONS FOR THE CONTERMINOUS UNITED STATES OF 1-SECOND SPECTRAL RESPONSE ACCELERATION (5% OF CRITICAL DAMPING)



Description: This map of Seismic Design Categories (SDCs) for default site conditions was prepared by the U.S. Geological Survey (USGS) using its 2007 National Seismic Hazard Model for Alaska, the ASCE/SEI 7-22 Chapter 21 ground motion procedures, the FEMA P-2078 procedures for developing multi-period response spectra at non-conterminous U.S. sites, and the definition of SDC from ASCE/SEI 7-22 Chapter 11. Also defined there, the default site conditions used for this map correspond to the most critical ground motions across Site Classes C, CD, and D. More detailed mapping of these SDCs can be resolved using corresponding web tools, as can SDCs for other site classes (e.g., see <https://doi.org/10.5066/F7NK3C76>).

FIGURE 1613.2.1(2)
SEISMIC DESIGN CATEGORIES FOR DEFAULT SITE CONDITIONS FOR ALASKA
RISK-TARGETED MAXIMUM CONSIDERED EARTHQUAKE (MCE_R) GROUND MOTION RESPONSE ACCELERATIONS FOR THE
CONTERMINOUS UNITED STATES OF 1-SECOND SPECTRAL RESPONSE ACCELERATION (5% OF CRITICAL DAMPING)



0.2 Second Spectral Response Acceleration (5% of Critical Damping)

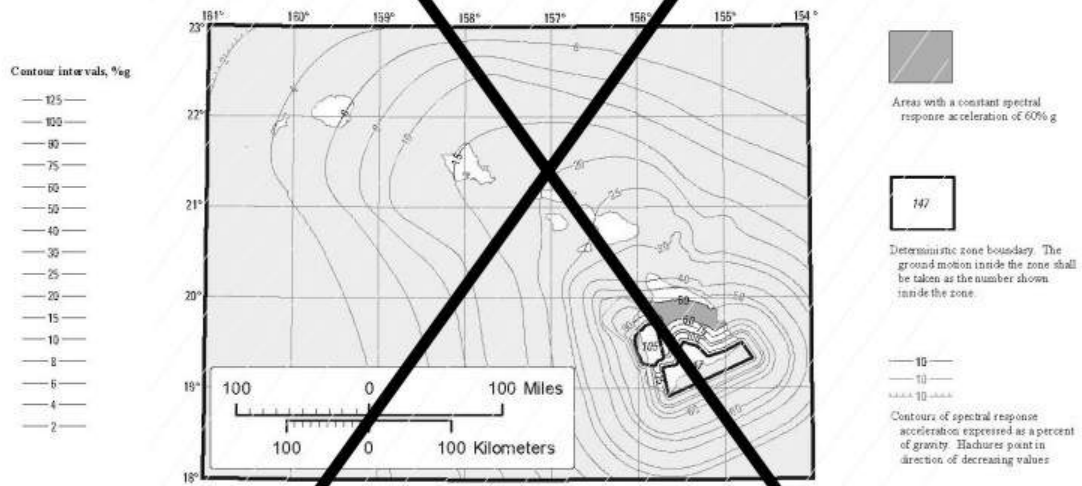

1.0 Second Spectral Response Acceleration (5% of Critical Damping)

DISCUSSION	REFERENCES
<p>Maps prepared by United States Geological Survey (USGS) in collaboration with the Federal Emergency Management Agency (FEMA)-funded Building Seismic Safety Council (BSSC) and the American Society of Civil Engineers (ASCE). The basis is explained in commentaries prepared by BSSC and ASCE and in the references:</p> <ul style="list-style-type: none"> • Ground motion values contoured on these maps incorporate: <ul style="list-style-type: none"> • a target risk of structural collapse equal to 1% in 50 years based upon a generic structural fragility • deterministic upper limits imposed near large, active faults, which are taken as 1.5 times the estimated median response to the characteristic earthquake for the fault (1.5 is used to represent the 94th percentile response), but not less than 150% and 60% g for 0.2 and 1.0 sec, respectively. <p>As such, the values are different from those on the uniform-hazard 1998 USGS National Seismic Hazard Maps for Hawaii posted at http://earthquake.usgs.gov/hazmaps.</p> <p>Larger, more detailed versions of these maps are not provided because it is recommended that the corresponding USGS web tool (http://earthquake.usgs.gov/designmaps/ or http://icount.cr.usgs.edu) be used to determine the mapped value for a specified location.</p>	<p>Building Seismic Safety Council, 2009, NEHRP Recommended Seismic Provisions for New Buildings and Other Structures, FEMA-750/2009 Edition, Federal Emergency Management Agency, Washington, DC.</p> <p>Huang, Yin-Nan, Whittaker, A.S., and Luco, Nicolas, 2008, Maximum spectral demands in the near-fault region, <i>Earthquake Spectra</i>, Volume 24, Issue 1, pp. 319-341.</p> <p>Klein, F., Frankel, A.D., Mueller, C.S., Weston, R.L., and Okubo, P., 2001, Seismic hazard in Hawaii: high rate of large earthquakes and probabilistic ground-motion maps, <i>Bulletin of the Seismological Society of America</i>, Volume 91, pp. 479-498.</p> <p>Luco, Nicolas, Ellingwood, B.R., Hamburger, R.O., Hooper, J.D., Kimball, J.K., and Kircher, C.A., 2007, Risk-Targeted versus Current Seismic Design Maps for the Conterminous United States, <i>Structural Engineers Association of California 2007 Convention Proceedings</i>, pp. 163-175.</p>

FIGURE 1613.2-1(5) RISK-TARGETED MAXIMUM CONSIDERED EARTHQUAKE (MCE_R) GROUND MOTION RESPONSE ACCELERATIONS FOR HAWAII OF 0.2- AND 1-SECOND SPECTRAL RESPONSE ACCELERATION (5% OF CRITICAL DAMPING)

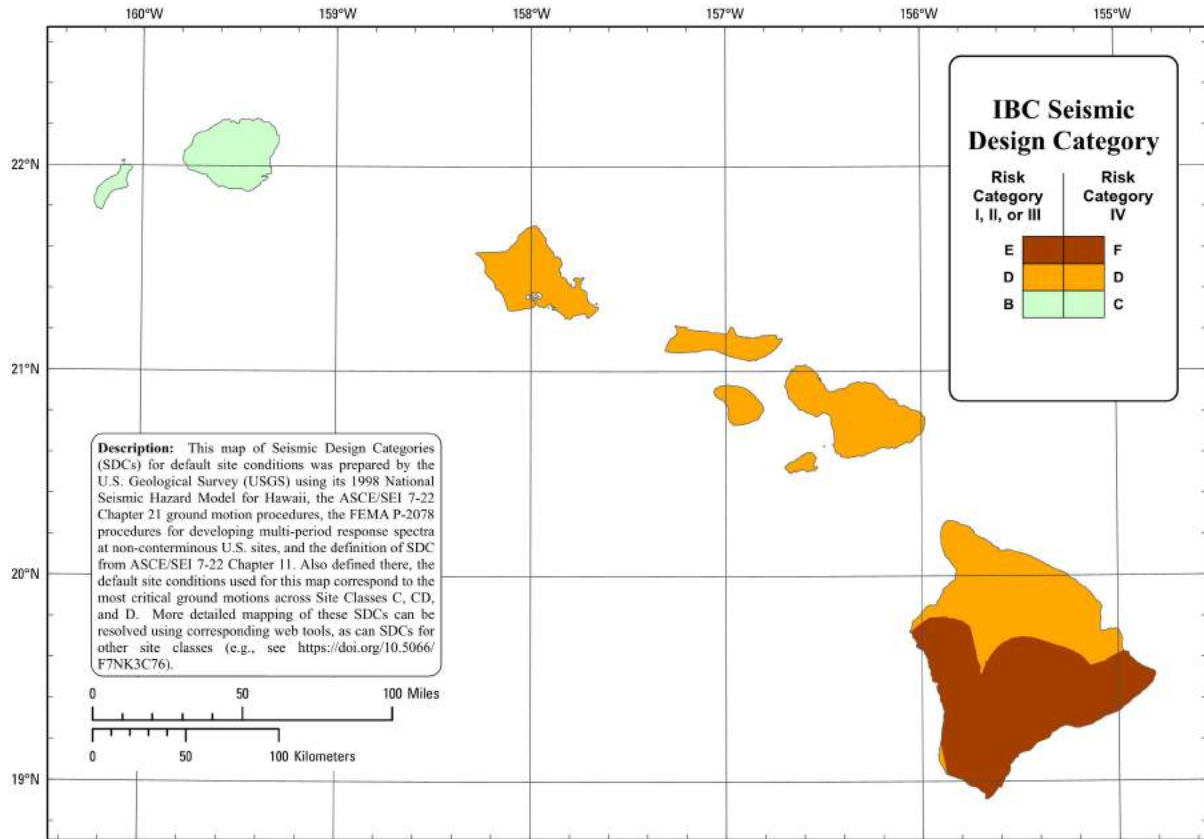

FIGURE 1613.2.1(3)
SEISMIC DESIGN CATEGORIES FOR DEFAULT SITE CONDITIONS FOR HAWAII
RISK-TARGETED MAXIMUM CONSIDERED EARTHQUAKE (MCE_R) GROUND MOTION RESPONSE ACCELERATIONS FOR HAWAII OF 02- AND 1-SECOND SPECTRAL RESPONSE ACCELERATION (5% OF CRITICAL DAMPING)

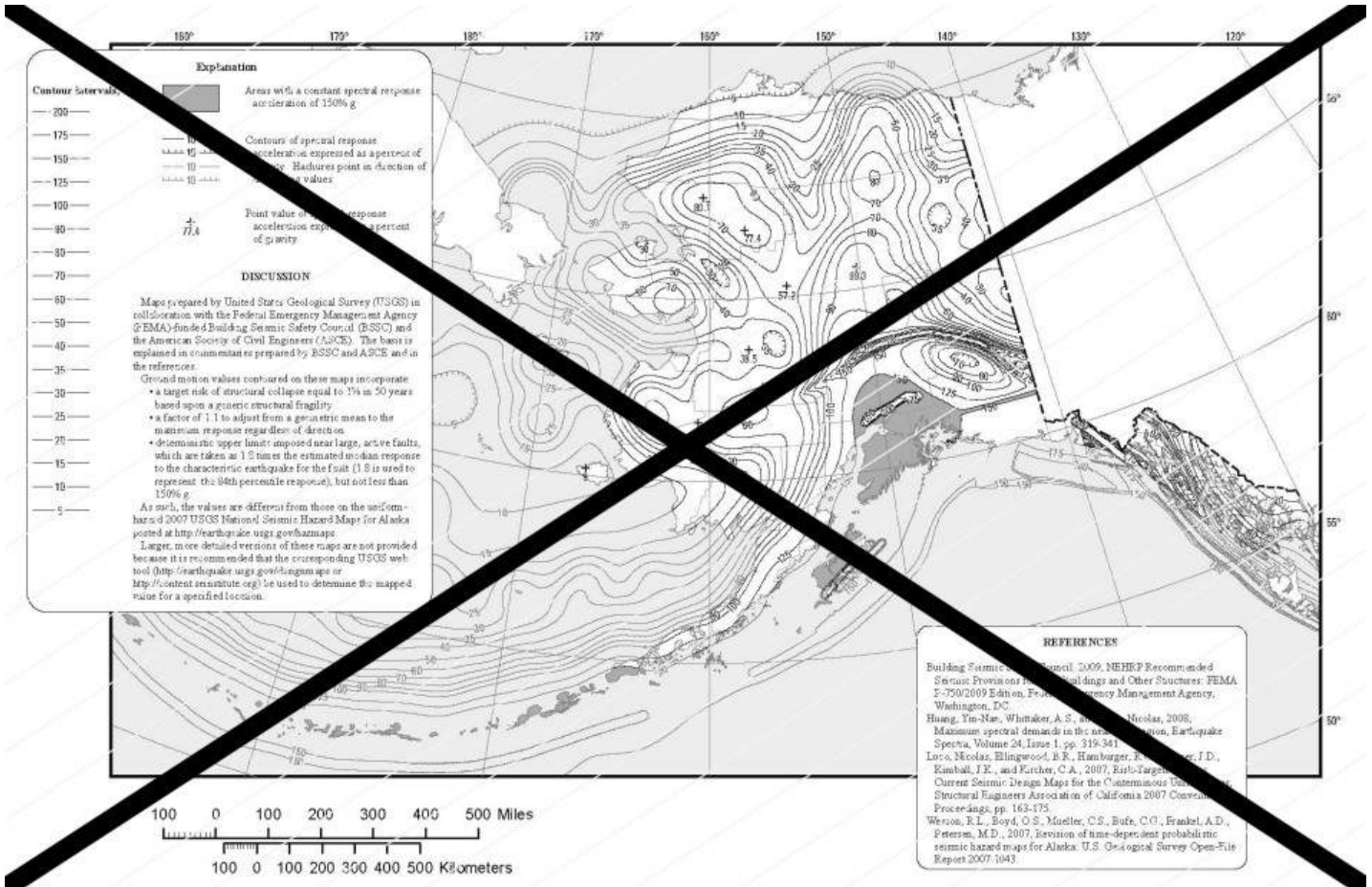

FIGURE 1613.2.1(6) RISK-TARGETED MAXIMUM CONSIDERED EARTHQUAKE (MCE_p) GROUND MOTION RESPONSE ACCELERATIONS FOR ALASKA OF 02-SECOND SPECTRAL RESPONSE ACCELERATION (5% OF CRITICAL DAMPING)



Description: This map of Seismic Design Categories (SDCs) for default site conditions was prepared by the U.S. Geological Survey (USGS) using its 2003 National Seismic Hazard Model for Puerto Rico and the U.S. Virgin Islands, the ASCE/SEI 7-22 Chapter 21 ground motion procedures, the FEMA P-2078 procedures for developing multi-period response spectra at non-continuous U.S. sites, and the definition of SDC from ASCE/SEI 7-22 Chapter 11. Also defined there, the default site conditions used for this map correspond to the most critical ground motions across Site Classes C, CD, and D.

FIGURE 1613.2.1(4)

SEISMIC DESIGN CATEGORIES FOR DEFAULT SITE CONDITIONS FOR PUERTO RICO AND THE UNITED STATES VIRGIN ISLANDS RISK-TARGETED MAXIMUM CONSIDERED EARTHQUAKE (MCE_p) GROUND MOTION RESPONSE ACCELERATIONS FOR ALASKA OF

02-SECOND SPECTRAL RESPONSE ACCELERATION (5% OF CRITICAL DAMPING)

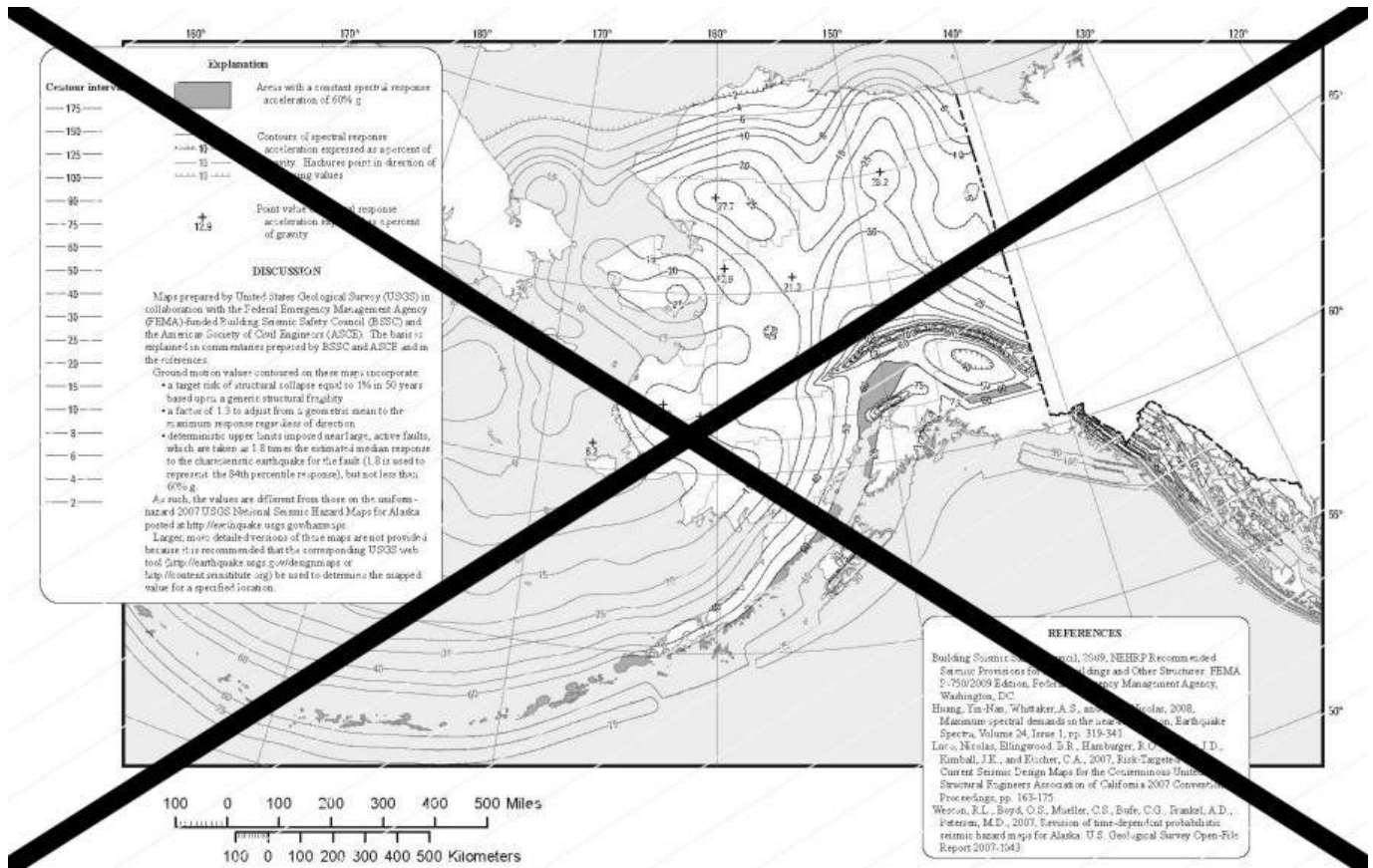

FIGURE 1613.2.1(7) RISK-TARGETED MAXIMUM CONSIDERED EARTHQUAKE (MCE_R) GROUND MOTION RESPONSE ACCELERATIONS FOR ALASKA OF 10-SECOND SPECTRAL RESPONSE ACCELERATION (5% OF CRITICAL DAMPING)

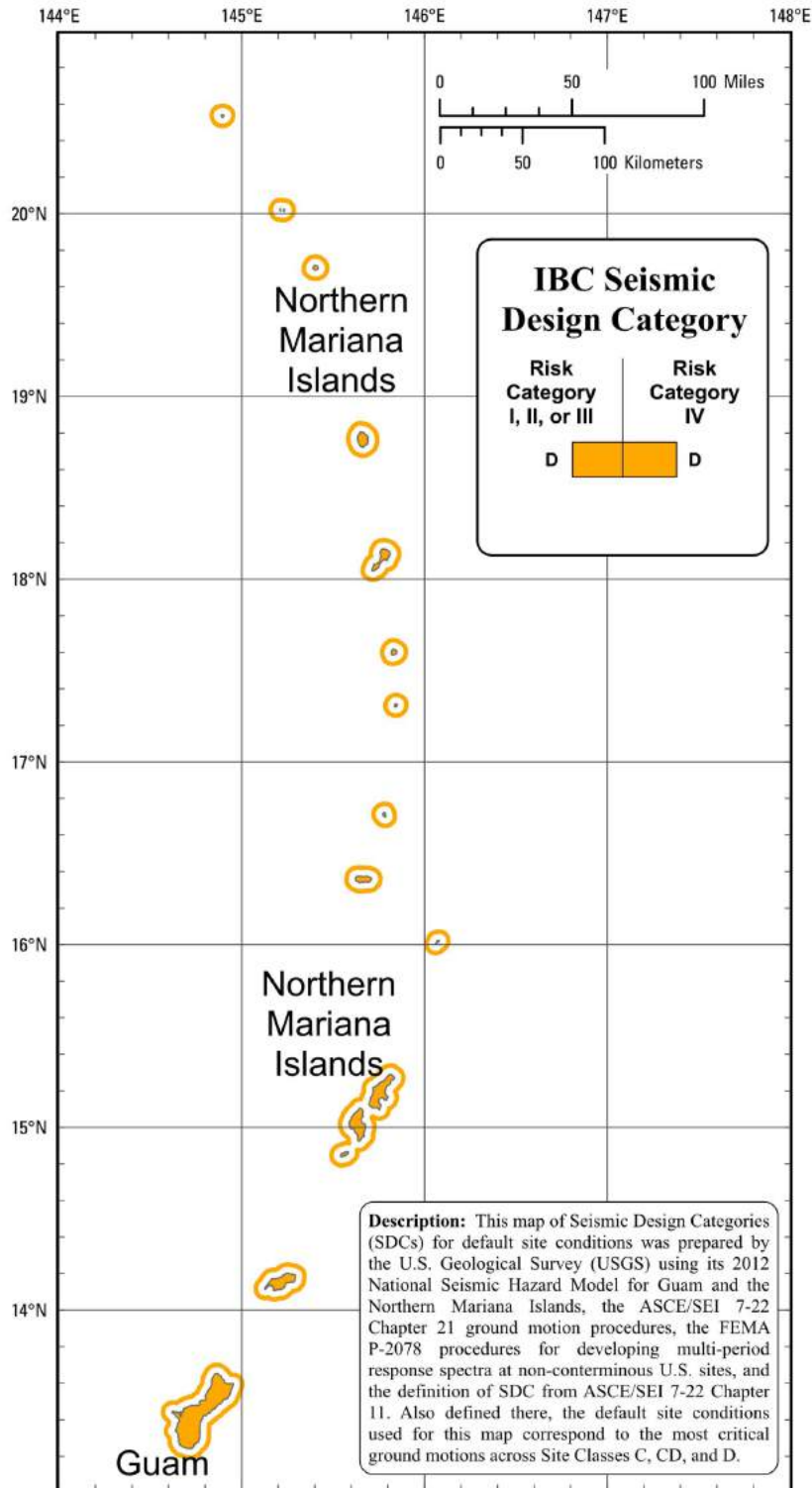

FIGURE 1613.2.1(5)

**SEISMIC DESIGN CATEGORIES FOR DEFAULT SITE CONDITIONS FOR GUAM AND THE NORTHERN MARIANA ISLANDS
 RISK-TARGETED MAXIMUM CONSIDERED EARTHQUAKE (MCE_p) GROUND MOTION RESPONSE ACCELERATIONS FOR ALASKA OF
 10-SECOND SPECTRAL RESPONSE ACCELERATION (5% OF CRITICAL DAMPING)**

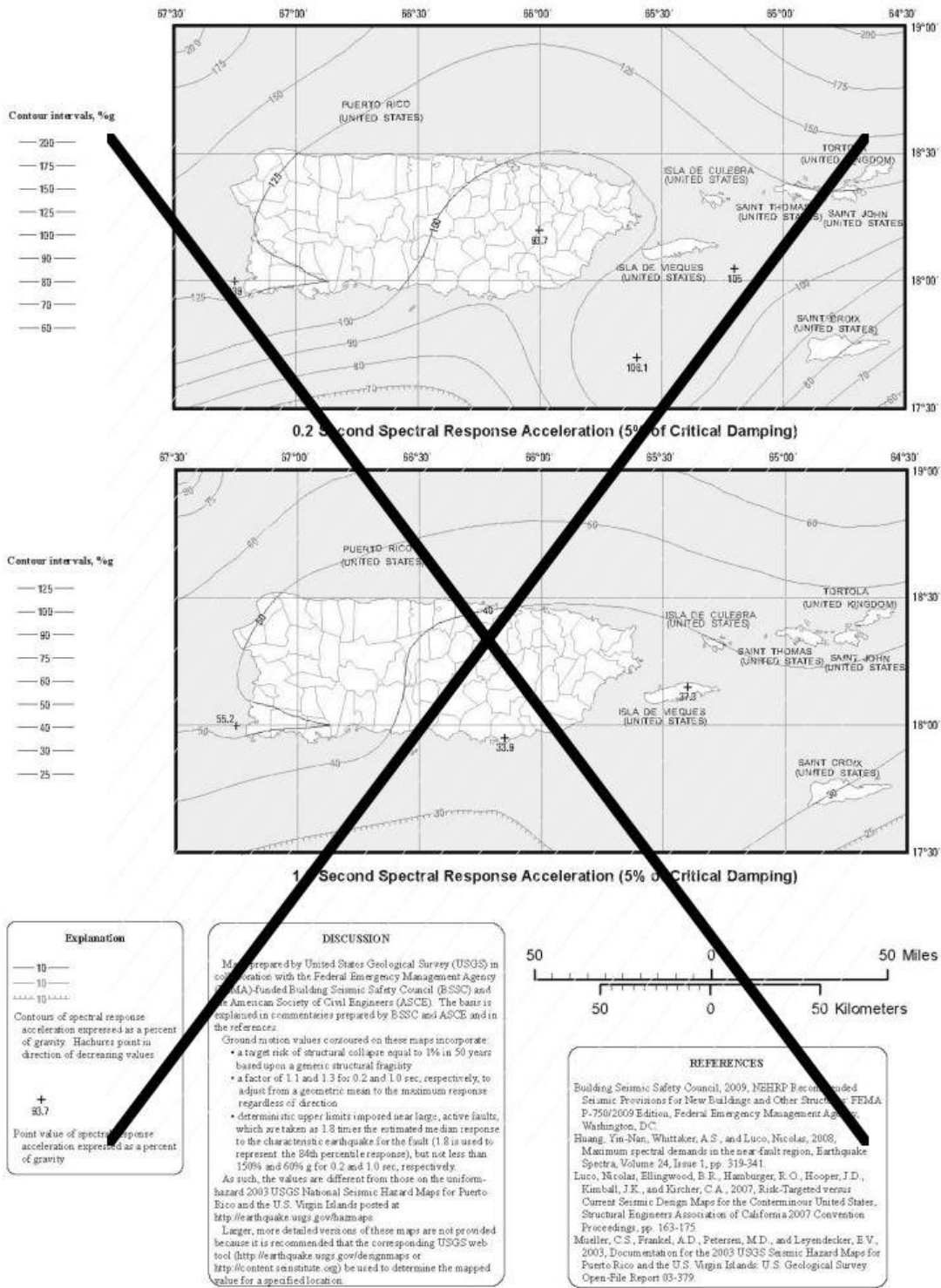
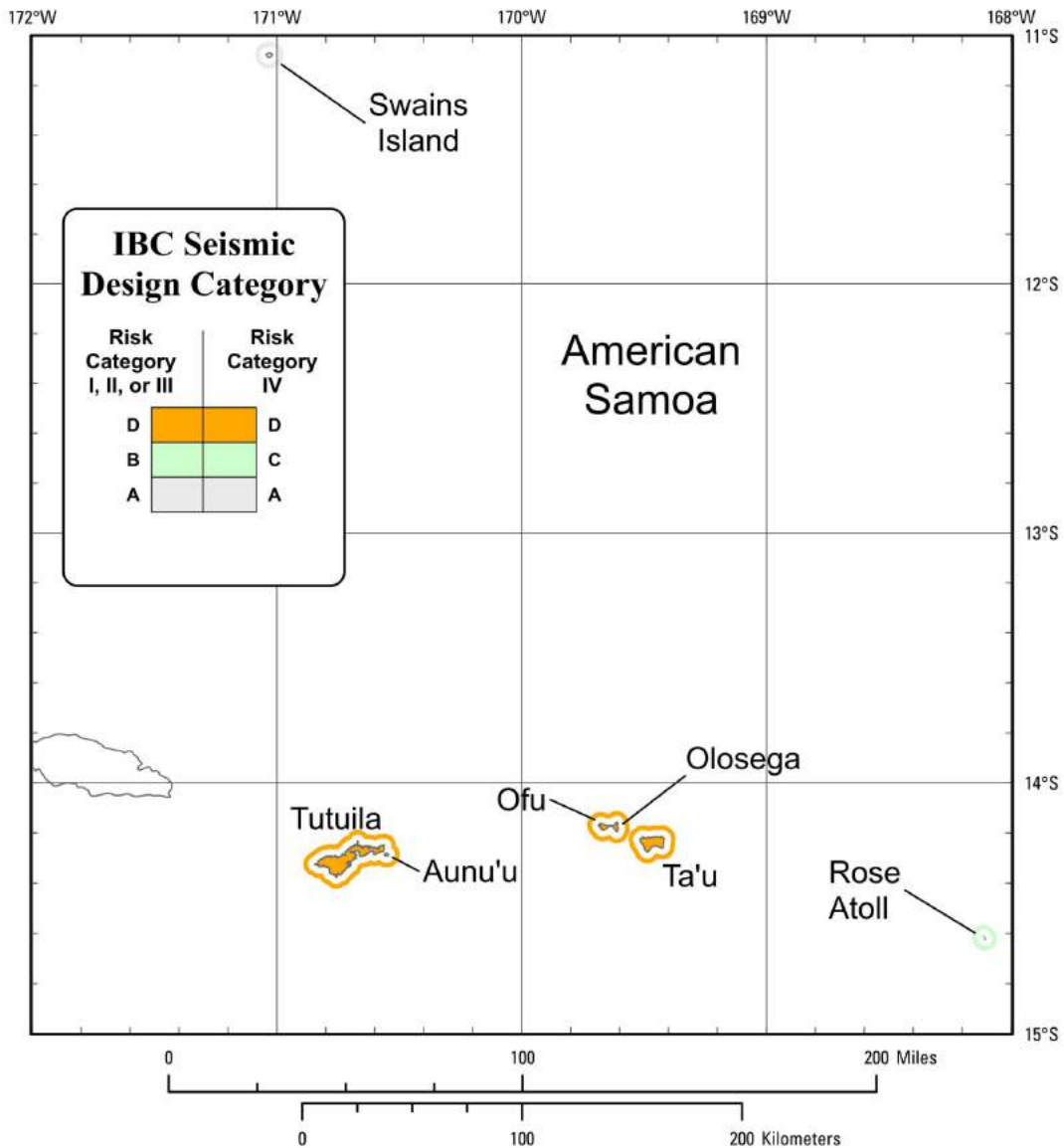

FIGURE 1613.2.1(8) RISK-TARGETED MAXIMUM CONSIDERED EARTHQUAKE (MCE_H) GROUND MOTION RESPONSE ACCELERATIONS FOR PUERTO RICO AND THE UNITED STATES VIRGIN ISLANDS OF 0.2- AND 1-SECOND SPECTRAL RESPONSE ACCELERATION (5% OF CRITICAL DAMPING)



Description: This map of Seismic Design Categories (SDCs) for default site conditions was prepared by the U.S. Geological Survey (USGS) using its 2012 National Seismic Hazard Model for American Samoa, the ASCE/SEI 7-22 Chapter 21 ground motion procedures, the FEMA P-2078 procedures for developing multi-period response spectra at non-conterminous U.S. sites, and the definition of SDC from ASCE/SEI 7-22 Chapter 11. Also defined there, the default site conditions used for this map correspond to the most critical ground motions across Site Classes C, CD, and D.

FIGURE 1613.2.1(6)

SEISMIC DESIGN CATEGORIES FOR DEFAULT SITE CONDITIONS FOR AMERICAN SAMOA
RISK-TARGETED MAXIMUM CONSIDERED EARTHQUAKE (MCE_p) GROUND MOTION RESPONSE ACCELERATIONS FOR PUERTO RICO
AND THE UNITED STATES VIRGIN ISLANDS OF 02- AND 1-SECOND SPECTRAL RESPONSE ACCELERATION (5% OF CRITICAL
DAMPING)

Delete without substitution:

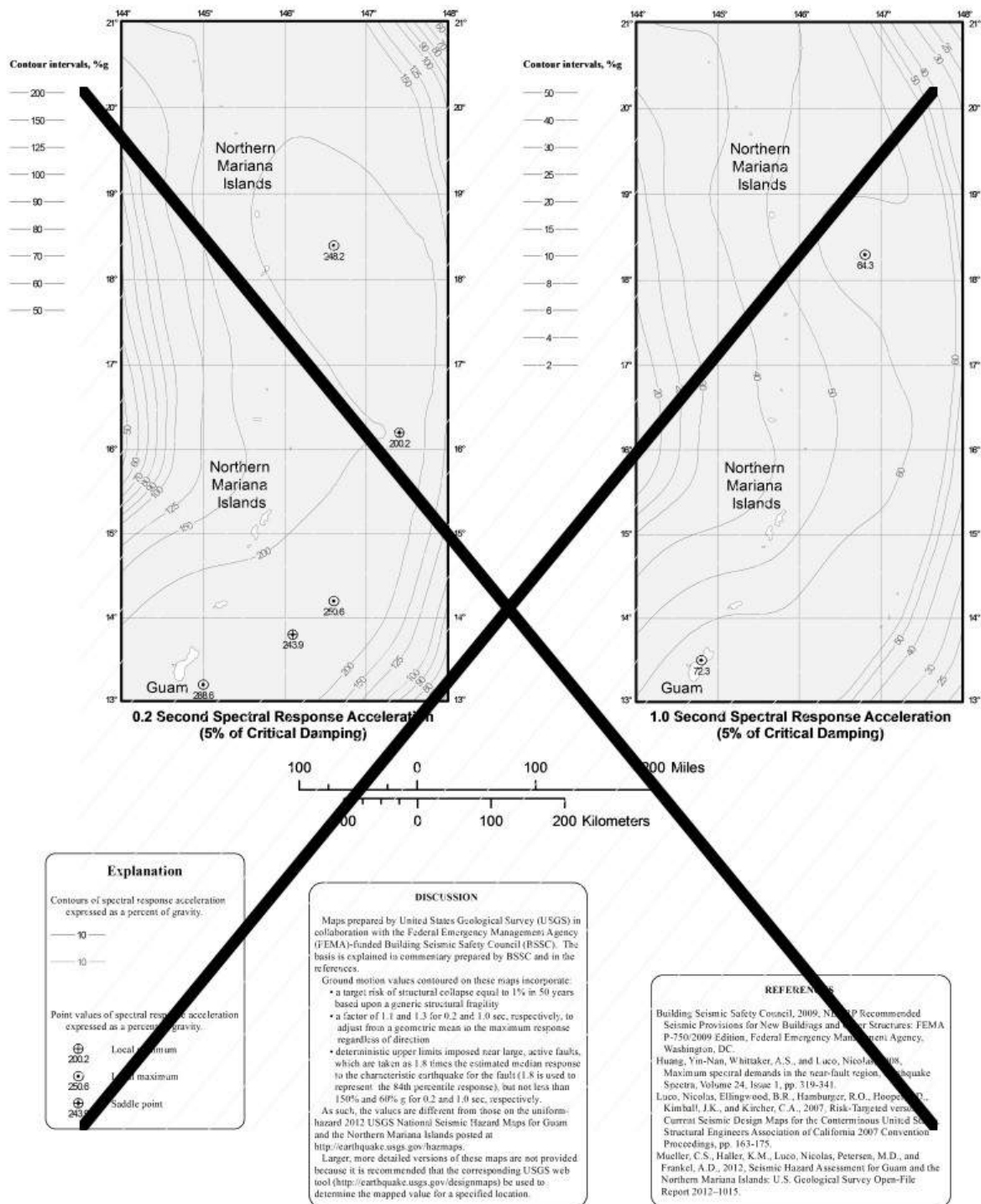

FIGURE 1613.2.1(9) RISK-TARGETED MAXIMUM CONSIDERED EARTHQUAKE (MCE_{R}) GROUND MOTION RESPONSE ACCELERATIONS FOR GUAM AND THE NORTHERN MARIANA ISLANDS OF 0.2- AND 1-SECOND SPECTRAL RESPONSE ACCELERATION (5% OF CRITICAL DAMPING)

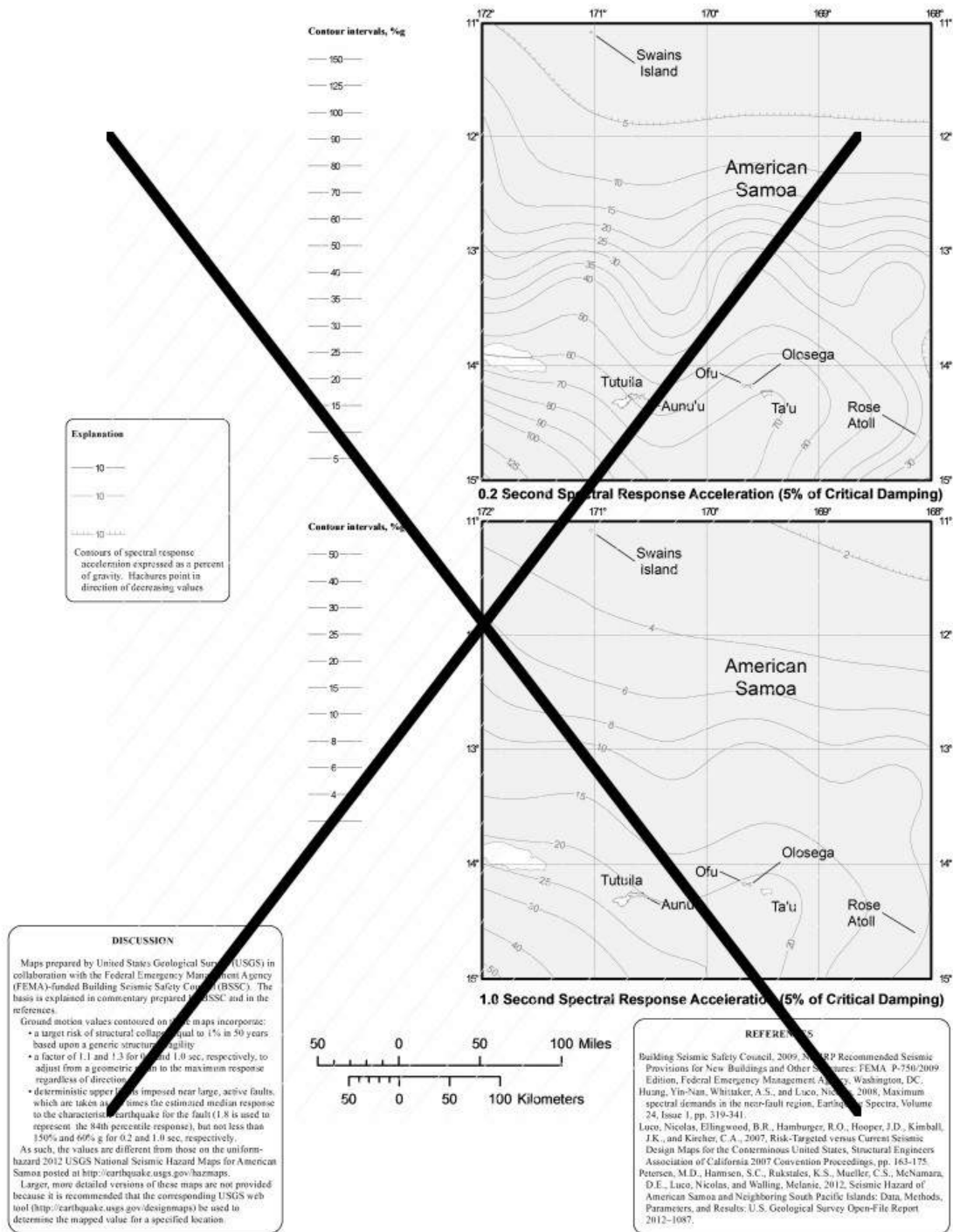

FIGURE 1613.2.1(10) RISK-TARGETED MAXIMUM CONSIDERED EARTHQUAKE (MCE_R) GROUND MOTION RESPONSE ACCELERATIONS FOR AMERICAN SAMOA OF 0.2- AND 1-SECOND SPECTRAL RESPONSE ACCELERATION (5% OF CRITICAL DAMPING)

1613.2.2 Site class definitions. Based on the site soil properties, the site shall be classified as *Site Class A, B, C, D, E or F* in accordance with Chapter 20 of ASCE 7.

Where the soil properties are not known in sufficient detail to determine the site class, *Site Class D*, subjected to the requirements of Section 1613.2.3, shall be used unless the *building official* or geotechnical data determines that *Site Class E or F* soils are present at the site.

Where site investigations that are performed in accordance with Chapter 20 of ASCE 7 reveal rock conditions consistent with *Site Class B*, but site-specific velocity measurements are not made, the *site coefficients* F_a and F_v shall be taken at unity (1.0).

1613.2.3 Site coefficients and adjusted maximum considered earthquake spectral response acceleration parameters. The maximum

considered earthquake spectral response acceleration for short periods, S_{MS} , and at 1-second period, S_{M1} , adjusted for site class effects shall be determined by Equations 16-20 and 16-21, respectively:

$$S_{MS} = F_a S_S \quad \text{(Equation 16-20)}$$

$$S_{M1} = F_v S_1 \quad \text{(Equation 16-21)}$$

but S_{MS} shall not be taken less than S_{M1} . Except when determining the seismic design category in accordance with Section 1613.2.5.

where:

F_a = Site coefficient defined in Table 1613.2.3(1).

F_v = Site coefficient defined in Table 1613.2.3(2).

S_S = The mapped spectral accelerations for short periods as determined in Section 1613.2.1.

S_1 = The mapped spectral accelerations for a 1-second period as determined in Section 1613.2.1.

Where Site Class D is selected as the default site class per Section 1613.2.2, the value of F_a shall be not less than 1.2. Where the simplified design procedure of ASCE 7 Section 12.14 is used, the value of F_a shall be determined in accordance with ASCE 7 Section 12.14.8.1, and the values of F_v , S_{MS} and S_{M1} need not be determined.

TABLE 1613.2.3(1) VALUES OF SITE COEFFICIENT F_a^a

SITE CLASS	MAPPED RISK TARGETED MAXIMUM CONSIDERED EARTHQUAKE (MCE_{TR}) SPECTRAL RESPONSE ACCELERATION PARAMETER AT SHORT PERIOD					
	$S_s \leq 0.25$	$S_s = 0.50$	$S_s = 0.75$	$S_s = 1.00$	$S_s = 1.25$	$S_s \geq 1.5$
A	0.8	0.8	0.8	0.8	0.8	0.8
B	0.9	0.9	0.9	0.9	0.9	0.9
C	1.3	1.3	1.2	1.2	1.2	1.2
D	1.6	1.4	1.2	1.1	1.0	1.0
E	2.4	1.7	1.3	Note b	Note b	Note b
F	Note b	Note b	Note b	Note b	Note b	Note b

- a. Use straight line interpolation for intermediate values of mapped spectral response acceleration at short period, S_s .
- b. Values shall be determined in accordance with Section 11.4.8 of ASCE 7.

TABLE 1613.2.3(2) VALUES OF SITE COEFFICIENT F_v ^a

SITE CLASS	MAPPED RISK TARGETED MAXIMUM CONSIDERED EARTHQUAKE (MCE_{RT}) SPECTRAL RESPONSE ACCELERATION PARAMETER AT 1-SECOND PERIOD					
	$S_{\tau} \leq 0.1$	$S_{\tau} = 0.2$	$S_{\tau} = 0.3$	$S_{\tau} = 0.4$	$S_{\tau} = 0.5$	$S_{\tau} \geq 0.6$
A	0.8	0.8	0.8	0.8	0.8	0.8
B	0.8	0.8	0.8	0.8	0.8	0.8
C	1.5	1.5	1.5	1.5	1.5	1.4
D	2.4	2.2 ^e	2.0 ^e	1.9 ^e	1.8 ^e	1.7 ^e
E	4.2	3.3 ^e	2.8 ^e	2.4 ^e	2.2 ^e	2.0 ^e
F	Note b	Note b	Note b	Note b	Note b	Note b

- a. Use straight-line interpolation for intermediate values of mapped spectral response acceleration at 1-second period, S_{τ} .
- b. Values shall be determined in accordance with Section 11.4.8 of ASCE 7.
- c. See requirements for site-specific ground motions in Section 11.4.8 of ASCE 7.

1613.2.4 Design spectral response acceleration parameters. Five-percent damped design spectral response acceleration at short periods, S_{DS} , and at 1-second period, S_{D1} , shall be determined from Equations 16-22 and Equation 16-23, respectively:

$$S_{DS} = \frac{2}{3} S_{MS} \tag{Equation 16-22}$$

$$S_{D1} = \frac{2}{3} S_{M1} \tag{Equation 16-23}$$

where:

S_{MS} —The maximum considered earthquake spectral response accelerations for short period as determined in Section 1613.2.3.

S_{M1} —The maximum considered earthquake spectral response accelerations for 1-second period as determined in Section 1613.2.3.

1613.2.5 Determination of seismic design category. Structures classified as *Risk Category* I, II or III that are located where the mapped spectral response acceleration parameter at 1-second period, S_{τ} , is greater than or equal to 0.75 shall be assigned to *Seismic Design Category* E. Structures classified as *Risk Category* IV that are located where the mapped spectral response acceleration parameter at 1-second period, S_{τ} , is greater than or equal to 0.75 shall be assigned to *Seismic Design Category* F. Other structures shall be assigned to a *seismic design category* based on their *risk category* and the design spectral response acceleration parameters, S_{DS} and S_{D1} , determined in accordance with Section 1613.2.4 or the site-specific procedures of ASCE 7. Each building and structure shall be assigned to the more severe *seismic design category* in accordance with Table 1613.2.5(1) or 1613.2.5(2), irrespective of the fundamental period of vibration of the structure, T .

TABLE 1613.2.5(1) SEISMIC DESIGN CATEGORY BASED ON SHORT-PERIOD (0.2-second) RESPONSE ACCELERATION

VALUE OF S_{DS}	RISK CATEGORY		
	I or II	III	IV
$S_{DS} < 0.167g$	A	A	A
$0.167g \leq S_{DS} < 0.33g$	B	B	C
$0.33g \leq S_{DS} < 0.50g$	C	C	D
$0.50g \leq S_{DS}$	D	D	D

TABLE 1613.2.5(2) SEISMIC DESIGN CATEGORY BASED ON 1-SECOND PERIOD RESPONSE ACCELERATION

VALUE OF S_{D+}	RISK CATEGORY		
	I or II	III	IV
$S_{D+} < 0.067g$	A	A	A
$0.067g \leq S_{D+} < 0.133g$	B	B	C
$0.133g \leq S_{D+} < 0.20g$	C	C	D
$0.20g \leq S_{D+}$	D	D	D

1613.2.5.1 Alternative seismic design category determination. Where S_{D+} is less than 0.75, the seismic design category is permitted to be determined from Table 1613.2.5(1) alone where all of the following apply:

1. In each of the two *orthogonal* directions, the approximate fundamental period of the structure, T_{eff} in each of the two *orthogonal* directions determined in accordance with Section 12.8.2.1 of ASCE 7, is less than 0.8 T_g determined in accordance with Section 11.8.6 of ASCE 7.
2. In each of the two *orthogonal* directions, the fundamental period of the structure used to calculate the story drift is less than T_g .
3. Equation 12.8-2 of ASCE 7 is used to determine the seismic response coefficient, C_s .
4. The *diaphragms* are rigid or are permitted to be idealized as rigid in accordance with Section 12.3.1 of ASCE 7 or, for *diaphragms* permitted to be idealized as flexible in accordance with Section 12.3.1 of ASCE 7, the distances between vertical elements of the seismic force-resisting system do not exceed 40 feet (12 192 mm).

Revise as follows:

1613.3 1613.2.5.2 Simplified design procedure. Where the alternate simplified design procedure of ASCE 7 is used, the seismic design category shall be determined in accordance with ASCE 7.

1613.4 1613.3 Ballasted photovoltaic panel systems. Ballasted, roof-mounted *photovoltaic panel systems* need not be rigidly attached to the roof or supporting structure. Ballasted non-penetrating systems shall be designed and installed only on roofs with slopes not more than one unit vertical in 12 units horizontal. Ballasted nonpenetrating systems shall be designed to resist sliding and uplift resulting from lateral and vertical forces as required by Section 1605, using a coefficient of friction determined by acceptable engineering principles. In structures assigned to *Seismic Design Category* C, D, E or F, ballasted nonpenetrating systems shall be designed to accommodate seismic displacement determined by nonlinear response-hi *story* or other *approved* analysis or shake-table testing, using input motions consistent with ASCE 7 lateral and vertical seismic forces for nonstructural components on roofs.

Delete without substitution:

~~**[BS] RISK TARGETED MAXIMUM CONSIDERED EARTHQUAKE (MCE_R) GROUND MOTION RESPONSE ACCELERATIONS.** The most severe earthquake effects considered by this code, determined for the orientation that results in the largest maximum response to horizontal ground motions and with adjustment for targeted risk.~~

Revise as follows:

[BS] SITE CLASS. A classification assigned to a site based on the types of soils present and their engineering properties as defined in Chapter 20 of ASCE/SEI-7. Section 1613.2.2.

Delete without substitution:

~~**[BS] SITE COEFFICIENTS.** The values of F_a and F_v indicated in Table 1613.2.3(1) and Table 1613.2.3(2), respectively.~~

Revise as follows:

1810.3.9.4.2.1 Site Classes A through DE. For *Site Class* A, B, BC, C, CD, D or DE sites, transverse confinement reinforcement shall be provided in the element in accordance with Sections 18.7.5.2, 18.7.5.3 and 18.7.5.4 of ACI 318 within three times the least element dimension of the bottom of the pile cap. A transverse spiral reinforcement ratio of not less than one-half of that required in Table 18.10.6.4(g) of ACI 318 shall be permitted.

1603.1.5 Earthquake design data. The following information related to seismic loads shall be shown, regardless of whether seismic loads govern the design of the lateral force-resisting system of the structure:

1. Risk category.
2. Seismic importance factor, I_e .
3. ~~Mapped~~ Spectral response acceleration parameters, S_S and S_1 .

4. *Site class.*
5. Design spectral response acceleration parameters, S_{DS} and S_{D1} .
6. *Seismic design category.*
7. Basic seismic force-resisting system(s).
8. Design base shear(s).
9. Seismic response coefficient(s), CS .
10. Response modification coefficient(s), R .
11. Analysis procedure used.

J104.4 Liquefaction study. For sites with mapped maximum considered earthquake spectral response accelerations at short periods (S_s) greater than 0.5g as determined by Chapter 11 of ASCE 7 Section 1613, a study of the liquefaction potential of the site shall be provided and the recommendations incorporated in the plans.

Exception: A liquefaction study is not required where the *building official* determines from established local data that the liquefaction potential is low.

L101.1 General. Every structure located where the 1-second spectral response acceleration, S_1 , determined in accordance with Chapter 11 of ASCE 7 Section 1613.2, is greater than 0.40 and either exceeds six stories in height with an aggregate floor area of 60,000 square feet (5574 m²) or more, or exceeds 10 *stories* in height regardless of floor area, shall be equipped with not fewer than three approved recording accelerographs. The accelerographs shall be interconnected for common start and common timing.

Staff Analysis: CC# S127-22 and CC# S128-22 addresses requirements in a different or contradicting manner. The committee is urged to make their intentions clear with their actions on these proposals.

Reason Statement: This proposal simplifies IBC Section 1613 by providing Seismic Design Category (SDC) maps that users can reference to quickly determine a project's SDC based on default site conditions. These maps are intended to replace current ground motion response accelerations maps in the IBC and have been derived based on the new multi-period response spectra (MPRS) procedures of ASCE/SEI 7-22. This proposal is an alternative to a similar ASCE proposal that updates the seismic maps.

The SDC maps are one of two methods that will be provided in the IBC to determine SDC. Users are still allowed to determine the SDC following ASCE/SEI 7-22 provisions, where more refined information such as site-specific soils data can be considered.

The introduction of SDC maps within the IBC will address 2 primary issues:

1. SDC maps are intuitive and can be used directly by all disciplines and users.
2. Use of SDC maps will reduce the total number of maps that would otherwise be required to reflect updated ASCE/SEI 7-22 provisions.

Use by all Disciplines

SDC maps shifts determination of SDC per the ASCE/SEI 7-22 provisions from the user to USGS (map developer), for default site classes. These maps will allow building officials, non-structural engineers, component manufacturers, etc. to quickly identify a conservative SDC based on location alone.

The current process to determine the SDC under the 2021 IBC begins with users identifying S_s and S_1 from one of the 10 risk-targeted maximum considered earthquake (MCE_R) ground motion response acceleration maps. In combination with coefficients based on soil type, these parameters are then used to determine S_{MS} and S_{M1} , followed by S_{DS} and S_{D1} , and the user ultimately determines SDC based on the S_{DS} and S_{D1} values. This can in many instances be reduced to a one-step process if the SDC maps in this proposal are adopted.

Total Number of Maps

Should this proposal of six SDC maps not be adopted, the new MPRS procedures of ASCE/SEI 7-22 (as per the ASCE proposal) will result in more maps. Because site class coefficients (F_a and F_v) have been incorporated into the new MPRS procedures, S_1 and S_s maps are no longer relevant and F_a and F_v are no longer utilized or specified in ASCE 7. In lieu of the S_s and S_1 values previously provided by MCE_R maps, ground motion acceleration maps will now provide S_{DS} and S_{D1} values directly. Following are the number of maps that would be required per the USGS, depending on the site conditions made available for the user. This SDC map proposal will include a total of 6 maps, the least possible number of maps in Section 1613.

- 12 maps: S_{MS} and S_{M1} maps for default site conditions only
- 54 maps: SDC maps for all site classes

- 108 maps: S_{MS} and S_{M1} maps for all site classes

Technical Information

The SDC maps in Section 1613.2 have been derived based on the ASCE/SEI 7-22 procedures, so the results will be consistent between the SDC maps and ASCE/SEI 7-22 ground motion maps, for default site conditions. Both sets of maps are based on the 2018 U.S. Geological Survey (USGS) National Seismic Hazard Model (NSHM) for the conterminous U.S., the ground motion procedures (Chapter 21) of ASCE/SEI 7-22, and the definition of SDC (Chapter 11) in ASCE/SEI 7-22. The maps for the states and territories outside of the conterminous U.S. are based on the FEMA P-2078 procedures, referenced in ASCE/SEI 7-22. FEMA P-2078 procedures allow the multi-period response spectra (MPRS) to be approximated for Alaska, Hawaii, Guam and the Northern Mariana Islands, and American Samoa, where older USGS NSHMs did not provide the full spectrum and site classes for MPRS in these states and territories.

Incorporated into both the SDC maps in this proposal and the ASCE/SEI 7 maps is the use of multi-period response spectra (MPRS), introduced by ASCE/SEI 7-22 to improve the accuracy of the frequency content of earthquake design ground motions and to enhance the reliability of the seismic design parameters derived from these ground motions. These improvements make better use of the available earth science, which has, in general, sufficiently advanced to accurately define spectral response for different site conditions over a broad range of periods. The result of the MPRS is to incorporate increased spectral demand for structures with mid-range fundamental periods on soft-soil sites where ground motion hazard is dominated by large magnitude events. Use of MPRS eliminates the need for site-specific hazard analysis, as required by ASCE 7-16 on soil sites in areas of high seismicity. Internet tools such as those found on the ASCE and ATC websites will continue to be available to provide values of S_{DS} , S_{D1} and S_1 in a very simple way based on longitude/latitude or address to permit determination by AHJs and engineers for all structures where MPRS are not needed for design. It should be noted, all design values needed for design including seismic ground motion parameter are now available for free on the ASCE website.

For the conterminous U.S., the proposed updates to the IBC SDC maps, like the map updates already adopted by the 2020 NEHRP Provisions and ASCE/SEI 7-22, are based on (1) recommendations of the Project 17 collaboration between the Building Seismic Safety Council (BSSC) and the USGS (BSSC, 2019), and (2) the 2018 update of the USGS NSHM (Petersen et al., 2020) for the conterminous U.S. The Project 17 recommendations include modifications to (1) site-class effects, (2) spectral periods defining short-period and one-second ground-motion parameters, (3) deterministic caps on the otherwise probabilistic ground motions, and (4) maximum-direction scale factors. The updates in the 2018 USGS NSHM from the previous (2014) version (used in the 2018 and 2021 versions of the IBC include incorporation of (1) new NGA-East and other ground-motion models for the central and eastern U.S., (2) deep sedimentary basin effects in the Los Angeles, Seattle, San Francisco, and Salt Lake City regions, (3) earthquakes that occurred in 2013 through 2017, and (4) updated weights for the western U.S. ground-motion models.

Summary of Specific Changes

Section 1613.1 Scope – Exception 1 for one- and two-family dwellings will be based solely on being assigned to *Seismic Design Category A, B or C*.

Section 1613.2 Seismic ground motion values

is being renamed to **Determination of seismic design category**, consistent with the proposal to incorporate SDC maps. The SDC maps are based on default site conditions, as assigned by ASCE/SEI 7. Where Site Class DE, E, or F soils are present, the determination of seismic design category needs to be in accordance with ASCE/SEI 7-22. For all other site classifications, two options for assigning SDC are provided: (1) using the SDC maps for default site conditions or (2) going through procedures outlined in ASCE/SEI 7-22 for any site class. Use of the proposed SDC maps (option 1) will provide an upper bound assignment of SDC for all sites except for Site Class DE, E, or F soils; this is intended to provide quick and easy information for instances when further refinement of SDC assignment is not desired. For instances where further refinement is desired, the ASCE/SEI 7-22 provisions (option 2) are the appropriate tool.

The user is instructed to use the maps to determine SDC based on the structure's assigned Risk Category. It is important to note that for a given location, there is only one map provided; each map contains a dual scale in the legend, one portion assigning SDC for Risk Categories I, II and III, and the second portion assigning SDC for Risk Category IV.

It is noted that these SDC maps have been specifically developed for the IBC, as seen by the legend which indicates "IBC Seismic Design Category." These are different and distinct from the IRC Seismic Design Category maps, which have been developed with rules and assumptions specific to dwellings that fall within the scope of the IRC.

Except for the renumbered **Section 1613.3 Simplified design procedure** (previously 1613.2.5.2), the remainder of Section 1613 is deleted by this proposal. The information in these sections is no longer current or necessary.

<https://www.cdpassess.com/proposal/8312/25387/files/download/2931/>

Bibliography: BSSC, 2019. BSSC Project 17 Final Report, Development of the Next Generation of Seismic Design Value Maps for the 2020 NEHRP Provisions, National Institute of Building Sciences, Washington, D.C., December 2019.

Petersen et al., 2019. "The 2018 update of the US National Seismic Hazard Model: Overview of model and implications," Earthquake Spectra, Earthquake Engineering Research Institute, Oakland, CA, November 2019.

Cost Impact: The code change proposal will not increase or decrease the cost of construction

The code change proposal will slightly increase the cost of construction in some regions and slightly decrease it in other regions. In aggregate, the cost of construction is not changed. Specifically, any impact on construction cost, as reflected in design loads, will vary by site location, spectral response period and site class. For certain combinations of site location, spectral response periods and site class, proposed design spectral acceleration parameter values (S_{DS} and S_{D1}) are larger than those of ASCE 7-16, while for other combinations of site location, spectral response periods and site class, proposed values of S_{DS} and S_{D1} are smaller than those of ASCE 7-16. However, parameter values of S_{MS} and S_{M1} (which are used to determine design loads) included in ASCE 7-22 are generally within +/- 15% of those of ASCE 7-16 for sites in the conterminous US assuming default site conditions.

S128-22

S129-22

IBC: 1613.1

Proponents: John-Jozef Proczka, representing Self (John-jozef.proczka@phoenix.gov)

2021 International Building Code

Revise as follows:

1613.1 Scope. Every structure, and portion thereof, including nonstructural components that are permanently attached to structures and their supports and attachments, shall be designed and constructed to resist the effects of earthquake motions in accordance with Chapters 11, 12, 13, 15, 17 and 18 of ASCE 7, as applicable. The *seismic design category* for a structure is permitted to be determined in accordance with Section 1613 or ASCE 7.

Exceptions:

1. Detached one- and two-family dwellings, assigned to *Seismic Design Category* A, B or C, or located where the mapped short-period spectral response acceleration, S_S , is less than 0.4 g.
2. The *seismic force-resisting system* of wood-frame buildings that conform to the provisions of Section 2308 are not required to be analyzed as specified in this section.
3. Agricultural storage structures intended only for incidental human occupancy that are not adjacent to occupiable structures other than detached one- and two-family dwellings nor a lot line within a horizontal distance equal to the agricultural storage structure's height.
4. Structures that require special consideration of their response characteristics and environment that are not addressed by this code or ASCE 7 and for which other regulations provide seismic criteria, such as vehicular bridges, electrical transmission towers, hydraulic structures, buried utility lines and their appurtenances and nuclear reactors.
5. References within ASCE 7 to Chapter 14 shall not apply, except as specifically required herein.

Reason Statement: Microbreweries that are also restaurants or other places of assembly with high occupant loads are becoming increasingly common. These types of businesses can have tall and heavy silos and tanks that can be considered agricultural storage - depending on what is stored, directly adjacent to them. These silos and tanks are also frequently installed adjacent to other occupiable businesses where they happen to be built next to the microbrewery or the microbrewery is built next to them.

The existing wording of the exception is intended to be applied to rural farming situations where the agricultural silos are near detached one-and two-family dwellings where the lives at risk associated with their failure is much lower than that associated with these structures in urban environments.

Note that this section does not invoke the definition of *agricultural building* but even that definition would not solve the problem.

Cost Impact: The code change proposal will increase the cost of construction

The cost of the design of agricultural storage structures that are adjacent to occupiable buildings will increase.

S129-22

S130-22

IBC: 1613.1, NEMA (New), (New)

Proponents: Bryan Holland, representing National Electrical Manufacturers Association (NEMA) (bryan.holland@nema.org); Megan Hayes, representing NEMA (megan.hayes@nema.org)

2021 International Building Code

Revise as follows:

1613.1 Scope. Every structure, and portion thereof, including nonstructural components that are permanently attached to structures and their supports and attachments, shall be designed and constructed to resist the effects of earthquake motions in accordance with Chapters 11, 12, 13, 15, 17 and 18 of ASCE 7, as applicable. The *seismic design category* for a structure is permitted to be determined in accordance with Section 1613 or ASCE. Electrical equipment shall comply with the provisions of this section and NEMA EESCTG 1-2019 NEMA Seismic Guideline 1—General Requirements for Seismic Qualification of Electrical Equipment for Commercial Building Codes.

Exceptions:

1. Detached one- and two-family dwellings, assigned to *Seismic Design Category* A, B or C, or located where the mapped short-period spectral response acceleration, S_S , is less than 0.4 g.
2. The *seismic force-resisting system* of wood-frame buildings that conform to the provisions of Section 2308 are not required to be analyzed as specified in this section.
3. Agricultural storage structures intended only for incidental human occupancy.
4. Structures that require special consideration of their response characteristics and environment that are not addressed by this code or ASCE 7 and for which other regulations provide seismic criteria, such as vehicular bridges, electrical transmission towers, hydraulic structures, buried utility lines and their appurtenances and nuclear reactors.
5. References within ASCE 7 to Chapter 14 shall not apply, except as specifically required herein.

Add new text as follows:

NEMA

National Electrical Manufactures Association
1300 17th Street North, Suite 900
Rosslyn, VA 22209

NEMA EESCTG 1-2019, NEMA Seismic Guideline 1—General Requirements for Seismic Qualification of Electrical Equipment for Commercial Building Codes

Staff Analysis: A review of the standard proposed for inclusion in the code, NEMA EESCTG 1-2019 NEMA Seismic Guideline 1—General Requirements for Seismic Qualification of Electrical Equipment for Commercial Building Codes, with regard to some of the key ICC criteria for referenced standards (Section 3.6 of CP#28) will be posted on the ICC website on or before March 16, 2022.

Reason Statement: The purpose of this guide is to define the general requirements for seismic qualification of electrical equipment to conform with model building code provisions for earthquake resistance. These provisions are intended to improve the performance of essential and non-essential electrical equipment and distribution systems subject to strong ground shaking and more specifically to acceleration sensitive electrical equipment rigidly attached to the building structure or foundation. The electrical equipment seismic qualification requirements contained within the guide establish seismic conformance to both IBC and ASCE/SEI 7 seismic design provisions.

Cost Impact: The code change proposal will not increase or decrease the cost of construction
The code change proposal will not increase or decrease the cost of construction. Compliance with the NEMA EESCTG 1-2019 Guide ensures the provisions of Section 1613 of the IBC and applicable Chapters of ASCE 7 are being met.

S130-22

S131-22

IBC: 1613.3

Proponents: Ronald LaPlante, Division of State Architect, representing Federal Emergency Management Agency/Applied Technology Council - Seismic Code Support Committee (ron.laplante@dgs.ca.gov); Kelly Cobeen, representing Federal Emergency Management Agency/Applied Technology Council - Seismic Code Support Committee (kcobeen@wje.com); Michael Mahoney, representing FEMA (mike.mahoney@fema.dhs.gov)

2021 International Building Code

Revise as follows:

1613.3 Ballasted photovoltaic panel systems. ~~Ballasted, roof-mounted photovoltaic panel systems shall comply with ASCE 7 Chapter 13, except the use of Exception Item 7 in Section 13.6.12 is permitted in structures assigned to Seismic Design Category C, D, or E. need not be rigidly attached to the roof or supporting structure. Ballasted non-penetrating systems shall be designed and installed only on roofs with slopes not more than one unit vertical in 12 units horizontal. Ballasted nonpenetrating systems shall be designed to resist sliding and uplift resulting from lateral and vertical forces as required by Section 1605, using a coefficient of friction determined by acceptable engineering principles. In structures assigned to Seismic Design Category C, D, E or F, ballasted nonpenetrating systems shall be designed to accommodate seismic displacement determined by nonlinear response history or other approved analysis or shake table testing, using input motions consistent with ASCE 7 lateral and vertical seismic forces for nonstructural components on roofs.~~

Staff Analysis: CC# S131-22 and CC# S132-22 addresses requirements in a different or contradicting manner. The committee is urged to make their intentions clear with their actions on these proposals.

Reason Statement: The provisions in IBC Section 1613.3 were added initially in the 2015 IBC to implement the recommendations contained in the Structural Engineers Association of California report titled "Structural Seismic Requirements and Commentary for Rooftop Solar Photovoltaic Arrays" (SEAOC PV1-2012) as there were no specific requirements for these systems in ASCE 7-10. The IBC provision was broadly written to permit the use of the methods outlined in SEAOC PV1 without any direct reference. The following edition of ASCE 7 contained specific provisions in ASCE 7-16 Section 13.6.12 for Rooftop Solar Panels that adopted the specific prescriptive method outlined in SEAOC PV1 for unattached ballasted solar arrays. These provisions were further developed in ASCE 7-22. Now that the ASCE 7 provisions have been developed, the IBC provisions in this section are no longer needed.

The IBC provisions require complex analysis to determine the seismic displacements for unattached arrays, whereas, the ASCE 7 provisions provide both a simple prescriptive calculation while also permitting a more complex analysis approach. Furthermore, there is lack of consistency in the industry on the array interconnection requirements and deformation compatibility requirements for unattached arrays which are not addressed in the IBC language, whereas, the ASCE 7 provisions provide specific requirements to address these issues.

This proposal strikes the majority of the IBC language and adds a direct reference to ASCE 7. This proposal also expands the Exception Item 7 in ASCE 7 Section 13.6.12 to also include Seismic Design Category (SDC) E. The ASCE 7 provisions limit the maximum roof slope supporting unattached arrays to a slope of 1 in 20 (3 degrees) since the SEAOC PV1 seismic displacement formula that ASCE 7 adopted is based on this same limitation. Exception Item 7 permits the roof slope supporting unattached arrays to be increased to a maximum slope of 1 in 12 (4.7 degrees) where justified by testing and analysis, which parallels the current IBC limits and requirements. However, the ASCE 7 exception is limited to Seismic Design Categories C and D only. The seismic displacement determination from nonlinear analysis and shake table testing are applicable to all levels of seismicity, and therefore, should be permitted in SDC E. Note that SDC F is not included in the proposal since the ASCE 7 provisions do not permit unattached arrays on Risk Category IV structures (SDC F is only applicable to Risk Category IV structures).

The ASCE 7 provision requires an independent peer review when analysis, such as nonlinear time history analysis, are used to compute the seismic displacements for unattached systems on roof slopes steeper than 1 in 20 (3 degrees). This is consistent with the peer review requirements in ASCE 7 Chapter 16 when nonlinear response history analysis are utilized in the building design.

Cost Impact: The code change proposal will not increase or decrease the cost of construction

The code change proposal will not, in general, overall increase or decrease the cost of construction. On most projects it will result in less design effort to utilize the prescriptive requirements in ASCE 7 in lieu of the analysis method described in the IBC, and in some cases, may cause more design effort or fee when a peer review may be required on steeper roof slopes.

S131-22

S132-22

IBC: 1613.3

Proponents: Joseph Cain, representing Solar Energy Industries Association (SEIA) (JoeCainPE@gmail.com)

2021 International Building Code

Revise as follows:

1613.3 Ballasted photovoltaic panel systems. Ballasted, roof-mounted *photovoltaic (PV) panel systems* need not be rigidly attached to the roof or supporting structure. ~~Ballasted non-penetrating systems~~ Ballasted, unattached PV panel systems shall be designed and installed only on roofs with slopes not more than one unit vertical in 12 units horizontal. ~~Ballasted nonpenetrating systems~~ Ballasted, unattached PV panel systems shall be designed to resist sliding and uplift using design methods and associated criteria from ASCE 7, resulting from lateral and vertical forces as required by Section 1605, using a coefficient of friction determined by acceptable engineering principles. ~~In structures assigned to Seismic Design Category G, D, E or F, ballasted nonpenetrating systems shall be designed to accommodate seismic displacement determined by nonlinear response history or other approved analysis or shake table testing, using input motions consistent with ASCE 7 lateral and vertical seismic forces for nonstructural components on roofs.~~

Staff Analysis: CC# S131-22 and CC# S132-22 addresses requirements in a different or contradicting manner. The committee is urged to make their intentions clear with their actions on these proposals.

Reason Statement: Ballasted, unattached PV systems are considered in ASCE 7-16 Section 13.6.12, which will have some updates in ASCE 7-22. As ASCE 7 language is now in effect, we believe there is general agreement that the language in IBC Section 1613.3 can be simplified. It is important to keep the language in IBC Section 1613.3 that indicates ballasted, unattached PV systems can only be installed on roof with slopes not more than 1:12.

Cost Impact: The code change proposal will not increase or decrease the cost of construction
This proposal will neither increase nor decrease the cost of construction, as it is just a simplification of language for IBC Section 1613.3 now that ASCE 7 language has matured.

S132-22

S133-22

IBC: 1613.4 (New)

Proponents: Kelly Cobeen, representing Federal Emergency Management Agency/Applied Technology Council - Seismic Code Support Committee (kcobeen@wje.com); Michael Mahoney, representing FEMA (mike.mahoney@fema.dhs.gov); Robert Bachman, representing FEMA/ATC Seismic Code Support Committee (rebachmanse@aol.com)

2021 International Building Code

Add new text as follows:

1613.4 NFPA 13 sprinkler systems. NFPA 13 sprinkler systems, including their anchorage and bracing, shall comply with the seismic design force requirements of ASCE 7 Section 13.3.1.

Reason Statement: The seismic design force equations for nonstructural components provided in Chapter 13 of ASCE/SEI 7-22 have significantly changed since the ASCE 7-16 edition. Sprinkler systems are considered nonstructural components. The current version of NFPA 13 is based on ASCE 7-16 and does not satisfy the ASCE 7-22 seismic requirements and significant changes are required to bring them into compliance. NFPA has been advised that significant changes are needed and it is their intent to attempt to include in their next version scheduled for publication in 2022 or to publish a Tentative Interim Amendment (TIA) after the next edition is published. In the meantime, this proposed language will alert the user and the authority having jurisdiction that the seismic design requirements of ASCE 7-22 must also be satisfied in addition to those of NFPA 13. Hopefully by the time the 2024 IBC will be enforced, the next edition will have been updated to include the needed revisions to comply with ASCE 7-22 or a TIA will have been published so that the user and authority having jurisdiction will have a version of NFPA 13 which will satisfy ASCE 7-22 seismic design requirements.

The proposed change is only required if the edition of ASCE 7 is updated from ASCE 7-16 to ASCE 7-22, as per other code change proposals. Should the update to ASCE 7-22 not be adopted, it is recommended that this code change be disapproved.

Cost Impact: The code change proposal will not increase or decrease the cost of construction

The code change proposal will not, in general, increase or decrease the overall cost of construction. However, for individual structures, this proposal may reduce the nonstructural component seismic design forces constructed using lateral force-resisting system with higher ductility, which are commonly used regions of high seismic risk while for structures using low or moderate ductility systems the seismic design forces may increase.

S133-22

S134-22

IBC: SECTION 1616 (New), 1616.1 (New)

Proponents: Mike Nugent, representing Building Code Action Committee (bcac@iccsafe.org)

2021 International Building Code

Add new text as follows:

SECTION 1616 **FIRE LOADS**

1616.1 General. Where the structural fire protection of structural elements is designed considering system-level behavior or realistic fire exposures, the design shall be in accordance with ASCE 7. Where the structural fire protection is designed per this section, all other provisions of Chapter 7 shall apply.

Reason Statement: American Society of Civil Engineers/Structural Engineering Institute (ASCE/SEI) has developed industry consensus on performance-based structural fire design within the ASCE/SEI 7 standard [1] as demonstrated in their freely-available ASCE/SEI Design Guide (Performance-Based Structural Fire Design: Exemplar Designs of Four Regionally Diverse Buildings using ASCE 7-16, Appendix E) [2]. For the first time in U.S. practice, this standard establishes the process that enables designers to upgrade structures (e.g., structural connections) to be intrinsically safer to fire effects (e.g., restrained thermal expansion/contraction and large deflections) in order to better protect building occupants and firefighters from structural collapse due to uncontrolled fire events. Also, ASCE/SEI 7 Appendix E works within the greater ASCE/SEI 7 context which is important to ensure that fire effects are analyzed in a similar fashion as other structural loads (e.g., wind and seismic). Notably, ASCE/SEI 7 Appendix E Section E.3 requires for a structural fire design to comply with the requirements of ASCE/SEI 7 Section 1.3.1.3, which details peer review requirements among other structural engineering aspects. Lastly, the standard is structured to formally integrate building officials into the design process in a similar manner as performance-based structural engineering is conducted for other design hazards (e.g., blast, seismic, and wind). In summary, this code change proposal adds the appropriate reference to the ASCE/SEI 7 standard for performance-based structural fire design. Importantly, ASCE/SEI 7 Appendix E Appendix E provides material-neutral and critical overarching requirements. This proposal is submitted by the ICC Building Code Action Committee (BCAC).

BCAC was established by the ICC Board of Directors in July 2011 to pursue opportunities to improve and enhance assigned International Codes or portions thereof. In 2020 and 2021 the BCAC has held several virtual meetings open to any interested party. In addition, there were numerous virtual Working Group meetings for the current code development cycle, which included members of the committee as well as interested parties. Related documents and reports are posted on the BCAC website at <https://www.iccsafe.org/products-and-services/i-codes/code-development/cs/building-code-action-committee-bcac/>.

<https://www.cdaccess.com/proposal/8203/24809/files/download/2858/>

<https://www.cdaccess.com/proposal/8203/24809/files/download/2840/>

<https://www.cdaccess.com/proposal/8203/24809/files/download/2839/>

Bibliography: [1] ASCE/SEI 7: Minimum Design Loads and Associated Criteria for Buildings and Other Structures, Appendix E: Performance-Based Design Procedures for Fire Effects on Structures, American Society of Civil Engineers: Structural Engineering Institute, 2016
[2] ASCE/SEI Performance-Based Structural Fire Design: Exemplar Designs of Four Regionally Diverse Buildings using ASCE 7-16, Appendix E, American Society of Civil Engineers: Structural Engineering Institute and Charles Pankow Foundation, 2020 <
<https://ascelibrary.org/doi/book/10.1061/9780784482698> >.

The following attachment (free/open source) per Reference [1] and [2]: <https://eshare.element.com/url/3udcsdqruhpdngk>

Also, the following link where the Design Guide can be freely viewed or downloaded (simply click "PDF"): [Performance-Based Structural Fire Design | Books \(ascelibrary.org\)](https://ascelibrary.org/doi/book/10.1061/9780784482698)

Cost Impact: The code change proposal will not increase or decrease the cost of construction

The proposed code change would have no direct impact on construction costs since alternative methods are already being conducted in practice and the performance-based structural fire design procedures in ASCE/SEI 7 represent current industry best practices.

S134-22

S135-22

IBC: 1701.1

Proponents: Gregory Robinson, representing National Council of Structural Engineers Associations (grobenson@lbyd.com)

2021 International Building Code

Revise as follows:

1701.1 Scope. The provisions of this chapter shall govern the quality, workmanship and requirements for materials covered. Materials of construction and tests shall conform to the applicable standards listed in this code. Compliance with approved construction documents shall be verified through inspections set forth in Chapter 1, as well as tests, special inspections, structural observations, and submittals to the building official set forth in this chapter.

Reason Statement: This proposal clarifies the purpose of special inspections and tests, etc., that are part of Chapter 17 and in addition to those required by Chapter 1. While this section indicates materials are to be tested, the chapter also includes special inspections, which are performed on construction work and are in addition to Chapter 1 inspections. Providing such clarity enables Owners and Building Officials to align expectations as to what is provided by the Building Official and what the Owner needs to hire for special inspections and materials testing, as well as structural observations. In addition, some components and systems, such as prefabricated assemblies, require a certificate of compliance per Section 1704.5.

Cost Impact: The code change proposal will not increase or decrease the cost of construction. The code change proposal will not increase or decrease the cost of construction. This proposal clarifies code intent. These changes are not expected to affect cost of construction.

S135-22

S136-22

IBC: 1704.2.4

Proponents: Gregory Robinson, representing National Council of Structural Engineers Associations (grobenson@lbyd.com)

2021 International Building Code

Revise as follows:

1704.2.4 Report requirement. *Approved agencies shall keep records of special inspections and tests. The approved agency shall submit all reports of special inspections and tests to the building official and to the registered design professional in responsible charge at frequencies required by the approved construction documents or building official. All reports shall describe the nature and extent of inspections and tests, the location within the structure where the inspections and tests were performed, and indicate that work inspected or tested was or was not completed in conformance to approved construction documents. Discrepancies shall be brought to the immediate attention of the contractor for correction. If they are not corrected, the discrepancies shall be brought to the attention of the building official and to the registered design professional in responsible charge prior to the completion of that phase of the work. A final report documenting required special inspections and tests, and correction of any discrepancies noted in the inspections or tests, shall be submitted at a point in time agreed upon prior to the start of work by the owner or the owner's authorized agent to the building official.*

Reason Statement: This clarifies the nature of acceptable special inspection and test reports. The current code language lacks clarity regarding such reports. Many reports submitted are vague in nature and lacking key information about the inspection performed and where. This proposal addresses the need for more information on the reports to confirm that code required inspections and tests have been performed.

Cost Impact: The code change proposal will not increase or decrease the cost of construction. This proposal clarifies code intent. These changes are not expected to affect cost of construction.

S136-22

S137-22

IBC: 1704.3, 1704.3.1

Proponents: Gregory Robinson, representing National Council of Structural Engineers Associations (grobinson@lbyd.com)

2021 International Building Code

1704.3 Statement of special inspections. Where *special inspections* or tests are required by Section 1705, the *registered design professional in responsible charge* shall prepare a statement of *special inspections* in accordance with Section 1704.3.1 for submittal by the applicant in accordance with Section 1704.2.3.

Exception: The statement of *special inspections* is permitted to be prepared by a qualified person *approved* by the *building official* for construction not designed by a *registered design professional*.

Revise as follows:

1704.3.1 Content of statement of special inspections. The statement of *special inspections* shall identify the following:

1. The materials, systems, components and work required to have *special inspections* or tests by the *building official* or by the *registered design professional* responsible for each portion of the work.
2. The type and extent of each *special inspection*.
3. The type and extent of each test.
4. Additional requirements for *special inspections* or tests for seismic or wind resistance as specified in Sections 1705.12, 1705.13 and 1705.14.
5. For each type of *special inspection*, identification as to whether it will be continuous *special inspection*, periodic *special inspection* or performed in accordance with the notation used in the referenced standard where the inspections are defined.
6. Deferred submittal items that may require a supplemental statement of special inspections to be prepared.

Reason Statement: This proposal is complimentary to the proposed modifications to Section 107.3.4.1.1. The proposed language is intended to have the registered design professional in responsible charge, who is responsible for the overall preparation and submission of the statement of special inspections, to identify the deferred submittal items within the statement of special inspections that may require additional special inspections and tests, etc., so that the building official and owner know the associated special inspections and tests have not been provided, yet, but they may be expected as part of the deferred submittal. This proposal clarifies that some items have not been fully designed at the time of permit application. Item 1 of Section 1704.3.1 already indicates that the determination of which special inspections or tests are required for work related to deferred submittals by the design professional responsible for its design. The building official and owner, however, may not know that such work will have special inspections or tests that have not been identified in the statement of special inspections submitted at the time of application for permit. Substantial structural systems, components, and connections (e.g., precast concrete structural members and connections, as well as steel moment connections) are often deferred to the contractor to provide the most economical, locally-available solutions for the owner. If these special inspections or tests for work that is part of the deferred submittal are not provided by the registered professional responsible for its design, because they did not know they were responsible for it and thought the architect- or engineer-of-record would specify all special inspections and tests, it could jeopardize the life-safety of the building due to critical elements not undergoing special inspections or tests in accordance with the Code. Overall, this language clarifies that the work related to deferred submittals shall have special inspections or tests determined by the design professional responsible for its design.

Cost Impact: The code change proposal will not increase or decrease the cost of construction

The code change proposal will not increase or decrease the cost of construction, although, by alerting the owner of forthcoming special inspections and tests that are in addition to those specified in the statement of special inspections submitted at time of application for permit, the associated costs are not unexpected. This proposal clarifies code intent. These changes are not expected to affect cost of construction.

S137-22

S138-22

IBC: 1704.3.1

Proponents: Gregory Robinson, representing National Council of Structural Engineers Associations (grobinson@lbyd.com)

2021 International Building Code

Revise as follows:

1704.3.1 Content of statement of special inspections. The statement of *special inspections* shall identify the following:

1. The materials, systems, components and work required to have *special inspections* or tests by the *building official* or by the *registered design professional* responsible for each portion of the work.
2. The type and extent of each *special inspection*.
3. The type and extent of each test.
4. Additional requirements for *special inspections* or tests for seismic or wind resistance as specified in Sections 1705.12, 1705.13 and 1705.14.
5. For each type of *special inspection*, identification as to whether it will be continuous *special inspection*, periodic *special inspection* or performed in accordance with the notation used in the referenced standard where the inspections are defined.

For deferred submittals, a list of special inspections, tests and structural observations for materials and work described within the deferred submittal shall be included with the deferred submittal.

Reason Statement: The proposed language is intended to have the registered design professional(s) responsible for the design of the deferred submittal item(s) prepare a supplemental list of special inspections to identify the additional tests and special inspections, etc. for the deferred submittal items. This proposal clarifies that some items have not been fully designed at the time of permit application. Item 1 of Section 1704.3.1 already indicates that the determination of which special inspections or tests are required for work related to deferred submittals is by the design professional responsible for its design. The building official and owner, however, may not know that such work will have special inspections or tests that have not been identified in the statement of special inspections submitted at the time of application for permit. Substantial structural systems, components, and connections (e.g., precast concrete structural members and connections, as well as steel moment connections) are often deferred to the contractor to provide the most economical, locally-available solutions for the owner. If these special inspections or tests for work that is part of the deferred submittal are not provided by the registered professional responsible for its design, because they did not know they were responsible for it and thought the architect- or engineer-of-record would specify all special inspections and tests, it could jeopardize the life-safety of the building due to critical elements not undergoing special inspections or tests in accordance with the Code. Overall, this language clarifies that the work related to deferred submittals shall have special inspections or tests determined by the design professional responsible for its design.

Cost Impact: The code change proposal will not increase or decrease the cost of construction

The code change proposal will not increase or decrease the cost of construction, although, by alerting the owner of forthcoming special inspections and tests that are in addition to those specified in the statement of special inspections submitted at time of application for permit, the associated costs are not unexpected. This proposal clarifies code intent. These changes are not expected to affect cost of construction.

S138-22

S139-22

IBC: 1704.6, 1704.6.1, 1704.7 (New)

Proponents: Gregory Robinson, representing National Council of Structural Engineers Associations (grobinson@lbyd.com)

2021 International Building Code

Revise as follows:

1704.6 Structural observations. Where required by the provisions of Section 1704.6.1, the owner or the owner's authorized agent shall employ a *registered design professional* to perform *structural observations* acceptable to the registered design professional in responsible charge of the structural design to be a structural observer performing structural observations. The structural observer shall visually observe the construction at representative locations of structural systems, details and load paths in accordance with the statement of structural observations in Section 1704.7 for general conformance to the approved construction documents. *Structural observation* does not include or waive the responsibility for the inspections in Section 110 or the *special inspections* in Section 1705 or other sections of this code. Prior to the commencement of construction work requiring structural observations, identification of the structural observer shall be communicated to the building official ~~observations, the structural observer shall submit to the building official a written statement identifying the frequency and extent of structural observations~~. At the conclusion of the work included in the permit, the structural observer shall submit to the *building official* a written statement that the structural observations-site visits have been made in accordance with the statement of structural observations and identify any reported deficiencies that, to the best of the structural observer's knowledge, have not been resolved.

1704.6.1 Structural observations for structures. *Structural observations* shall be provided for those structures where one or more of the following conditions exist:

1. The structure is classified as *Risk Category III* or *IV*.
2. The structure is a *high-rise building*.
3. The structure is assigned to *Seismic Design Category E*, and is greater than two stories above the grade plane.
4. Such observation is required by the *registered design professional* responsible for the structural design.
5. Such observation is ~~specifically~~ required by the *building official*.

Add new text as follows:

1704.7 Statement of structural observations. Where structural observations are required by Section 1704.6, the registered design professional responsible for the structural design shall prepare a statement of structural observations for submittal to the building official as a condition for permit issuance. The statement of structural observations shall include the following:

1. The extent of structural observations.
2. The construction stages at which structural observations shall occur.
3. Documentation required, reporting of any identified structural discrepancies, and submittal requirements for observations.
4. Written statement by the structural observer at the conclusion of the work in accordance with Section 1704.6.

Reason Statement: The proposal requires that when applicable, a plan for structural observations, along with documentation requirements for those, is submitted simultaneously with the statement of special inspections as a comprehensive program and a condition for a permit. Previous similar proposals were rejected, in part, due to requiring information be provided when such information is typically unknown at the time, such as identification of the structural observer to be employed by the owner or owner's representative. The current proposal addresses this prior concern through requiring communication to the building official the identification of the structural observer prior to commencing construction requiring structural observations rather than prior to permit issuance. Previous recommendations to prior proposals also included adding a list of discrepancies to be documented. Rather than specifically identify discrepancies, which may inadvertently limit structural observations to the detriment of the project, the broad requirement to identify structural discrepancies is included in the structural observation documentation, along with submittal requirements of such, in the new Section 1704.7 proposal. Further modifications provided to clarify code intent regarding the nature of structural observations and competency of the structural observer.

Cost Impact: The code change proposal will not increase or decrease the cost of construction

No inspection tasks are added or eliminated, the overall program of construction quality assurance (tests, inspections, and observations) is clearly defined at time of permitting.

S139-22

S140-22

IBC: 1705.1, 1705.1.1, 1705.1.2 (New)

Proponents: Joseph Cain, representing Solar Energy Industries Association (SEIA) (JoeCainPE@gmail.com)

2021 International Building Code

1705.1 General. *Special inspections* and tests of elements and nonstructural components of buildings and structures shall meet the applicable requirements of this section.

1705.1.1 Special cases. *Special inspections* and tests shall be required for proposed work that is, in the opinion of the *building official*, unusual in its nature, such as, but not limited to, the following examples:

1. Construction materials and systems that are alternatives to materials and systems prescribed by this code.
2. Unusual design applications of materials described in this code.
3. Materials and systems required to be installed in accordance with additional manufacturer's instructions that prescribe requirements not contained in this code or in standards referenced by this code.

Add new text as follows:

1705.1.2 Ground-mounted photovoltaic (PV) panel systems. *Special inspections and tests shall not be required for ground-mounted photovoltaic (PV) panel systems serving Group R-3 buildings. The building official shall be permitted to modify or exempt special inspection requirements for deep foundation elements for ground-mounted PV panel systems.*

Reason Statement: A requirement for continuous Special Inspection for foundations for photovoltaic panel systems is overly restrictive. For smaller installations -- such as residential ground-mounted photovoltaic panel systems -- continuous special inspection beyond the AHJ/County inspection adds project cost disproportionate to the risk to the project. Most AHJ/County Building Officials have agreed that special inspection is not necessary or reasonable for these small systems.

The first statement in proposed Section 1705.1.2 seeks to formalize the exemption that is commonly applied to small systems.

Large-scale (often called "utility scale") photovoltaic power plants often have tens of thousands of small piles. As project financing often involves third-party investors, existing measures of quality control are already in place. The developer and/or EPC (Engineer, Procure, Construct) contractor often use a rigorous design and testing process to optimize pile specifications, as part of value engineering. As part of their risk-management process, project financiers often use third-party Independent Engineers (IE's) to ensure quality controls are in place. Under current practice, it is extremely uncommon for local Building Officials to require Special Inspection for "deep" foundations for photovoltaic panel systems, regardless of the absence of an exception for these systems.

Large-scale photovoltaic power plants usually incorporate rigorous design and quality control steps, as follows:

1. Foundation elements designed by analysis, based on geotechnical investigation.
2. As thousands of small piles are used in a photovoltaic power plant, optimization of design usually includes preconstruction pile load testing conducted on site. Independent Engineers (IE's) often review test reports.
3. EPC contractor has their own internal quality control.
4. A representative sample of production piles (for example, 1 percent) are usually proof-tested during construction, to ensure adequate pile capacities are being achieved. Adjustments are made if necessary to meet the demand.
5. County/AHJ inspectors usually conduct periodic observation of pile installation. For large-scale power plants, these inspectors are often third-party inspectors.
6. IE's usually conduct site visits to observe installation methods and review inspection reports and production pile load test reports. A final report is prepared by the IE.

Owing to this rigorous program of quality control, continuous special inspection of "deep" foundations is highly redundant. A Special Inspector could be required to be on-site for one to three months watching piles being installed, even though the same piles are already being observed and monitored by the Developer, the EPC Contractor, the AHJ/County inspector, and the Independent Engineer.

The second statement in proposed Section 1705.1.2 seeks to allow the Building Official the flexibility allow modifications or exemptions to special inspection requirements, without taking away any such authority. For example, a Building Official could decide that an agreed-upon frequency of

periodic special inspection, or might be satisfied with quality controls in place on behalf of the owner or EPC.

Cost Impact: The code change proposal will not increase or decrease the cost of construction

This proposal will not increase the cost of construction. In some cases, this proposal could decrease the cost of construction, where continuous special inspection is no longer a stated requirement for ground-mounted photovoltaic panel systems.

S140-22

S141-22

IBC: 1705.2.2 (New), AISC Chapter 35 (New)

Proponents: Jon-Paul Cardin, representing American Institute of Steel Construction (jcardin@steel.org)

2021 International Building Code

Add new text as follows:

1705.2.2 Structural Stainless Steel. *Special inspections* and nondestructive testing of structural stainless steel elements in buildings and portions thereof shall be in accordance with the quality assurance inspection requirements of AISC 370.

Add new standard(s) as follows:

AISC

American Institute of Steel
130 East Randolph Street, Suite 2000
Chicago, IL 60601-6219

ANSI/AISC 370-21

Specification for Structural Stainless Steel Buildings

Staff Analysis: A review of the standard proposed for inclusion in the code, AISC ANSI/AISC 370-21 Specification for Structural Stainless Steel Buildings, with regard to some of the key ICC criteria for referenced standards (Section 3.6 of CP#28) will be posted on the ICC website on or before March 16, 2022.

Reason Statement: AISC 370 - Specification for Structural Stainless Steel Buildings is a new specification developed as a consensus document using ANSI-accredited procedures to provide a uniform practice in the design of structural stainless steel framed buildings. AISC 370 Chapter N addresses the minimum requirements for quality control, quality assurance, and nondestructive testing for structural stainless steel systems for buildings and other structures. The reference to this specification for the design, fabrication and erection of structural stainless steel is proposed to be added to Chapter 22 in another code change proposal. Reference to this standard in IBC Chapter 17 provides design professionals and building professionals with standardized methods for special inspection and nondestructive testing of these structures.

The AISC 370 Specification can be downloaded for free at www.aisc.org/publications/steel-standards/

Bibliography: AISC, "ANSI/AISC 370 - Specification for Structural Stainless Steel Buildings", American Institute of Steel Construction, Chicago, IL, 2021 edition.

Cost Impact: The code change proposal will increase the cost of construction

It is likely that the special inspection and nondestructive testing of structural stainless steel buildings and other structures was already being accomplished. However, if it was not being conducted, then these proposed provisions in the building code will ensure that they are accomplished in accordance with AISC 370.

S141-22

S142-22

IBC: 1705.2.5 (New), SECTION 202 (New), Table 1705.2.5 (New)

Proponents: Gregory Robinson, representing National Council of Structural Engineers Associations (grobinson@lbyd.com)

2021 International Building Code

Add new text as follows:

1705.2.5 Metal building systems. Special inspections of metal building systems shall be performed in accordance with Sections 1705.2.1, 1705.2.2, 1705.2.3, and 1705.2.4, and in accordance with Table 1705.2.5. The *approved agency* shall perform inspections of the erected *metal building system* to verify compliance with the *approved construction documents*.

Add new definition as follows:

METAL BUILDING SYSTEMS. Metal building systems are professionally engineered structures that typically include basic metal elements such as primary rigid frames, orthogonal braced frames, as well as secondary members such as wall girts and roof purlins, cladding, and rollover bracing, all designed to act as an integrated building system.

Add new text as follows:

Table 1705.2.5 SPECIAL INSPECTIONS OF METAL BUILDING SYSTEMS

<u>TYPE</u>	<u>CONTINUOUS SPECIAL INSPECTION</u>	<u>PERIODIC SPECIAL INSPECTION</u>
1. <u>Installation of rafter / beam flange braces and column flange braces.</u>	---	X
2. <u>Installation of purlins and girts, including specified lapping.</u>	---	X
3. <u>Purlin and girt restraint / bridging / bracing.</u>	---	X
4. <u>Installation of X-bracing, including proper tightening of X-bracing.</u>	---	X

Staff Analysis: CC# S142-22 and CC# S197-22 addresses requirements in a different or contradicting manner. The committee is urged to make their intentions clear with their actions on these proposals.

Reason Statement: This proposal is complimentary to the proposed changes for metal building systems in Chapter 22. Metal building systems are generally highly optimized structures that are heavily dependent on bracing components to work per the design intent. The bracing components often consist of materials that aren't considered to be "structural steel," and therefore inspection of the completed installation of those critical components are often overlooked.

Metal building systems typically contain components that may be made of different types of metal, such as structural steel, cold-formed steel and cables. While the individual components are often covered by the various special inspections and tests found in Section 1705.2.1 through 1705.2.4, the systems used in metal building systems are often unique and not covered by other sections. In addition, metal building systems are generally highly-optimized structures that are heavily dependent on bracing components to work per the design intent. The bracing components often consist of materials that are not considered to be "structural steel," and therefore inspection of the completed installation of those critical components are often overlooked. Therefore, the proposed language is intended to add requirements for commonly-used systems not covered elsewhere.

Cost Impact: The code change proposal will increase the cost of construction
 The code change proposal may slightly increase the cost of construction, although the new special inspections will improve life-safety by reducing the incorrect construction of metal building systems.

S142-22

S143-22

IBC: TABLE 1705.3

Proponents: Stephen Skalko, representing Precast/Prestressed Concrete Institute (svskalko@svskalko-pe.com); Edith Smith, representing Precast/Prestressed Concrete Institute (esmith@pci.org)

2021 International Building Code

Revise as follows:

TABLE 1705.3 REQUIRED SPECIAL INSPECTIONS AND TESTS OF CONCRETE CONSTRUCTION

Portions of table not shown remain unchanged.

TYPE		CONTINUOUS SPECIAL INSPECTION	PERIODIC SPECIAL INSPECTION	REFERENCED STANDARD ^a	IBC REFERENCE
2. Reinforcing bar welding:					
a.	Verify weldability of reinforcing bars other than ASTM A706;	-	X		
b.	Inspect welding of reinforcement for special moment frames, boundary elements of special structural walls, and coupling beams.	X	-	AWS D1.4 ACI 318: 26.6.4 <u>26.13.3</u>	—
c.	Inspect welded reinforcement splices; and	X	-		
d.	Inspect single-pass fillet welds, maximum $\frac{5}{16}$ " ; and	-	X		
e.	Inspect all other welds.	X	X		
		X	X		

For SI: 1 inch = 25.4 mm.

Reason Statement: This proposed change coordinates the special inspection provisions for welding of reinforcing steel in the IBC with the provisions in Section 26.13.3 of ACI 318. New Item 2(b) adds the requirement for continuous inspection of welding of reinforcement in special moment frames, boundary elements of special structural walls, and coupling beams as required by ACI 318 Section 26.13.2(d). Because of the critical nature of welded reinforcement splices, new Item 2(c) is added to require continuous special inspection of all welded reinforcement splices. Existing Item 2(b) for periodic inspection of single pass fillet welds is renumbered as Item (d). And existing Item 2(c) for special inspection of all other welds is renumbered as Item 2(e) and revised to permit these welds to be performed as a periodic special inspection since the critical welds covered by new Items 2(b) and 2(c) have been re-introduced into the table.

A review of the 2012 or any earlier edition of the IBC would show that the inspection requirements were essentially the same as what is now proposed (and as they are also in ACI 318-19). The requirements have been in their current form since the 2015 IBC, as the result of Code Change S148-12. That code change was said to be organizational; yet it turned out to be a very substantive change. This proposed change corrects the inconsistency.

Cost Impact: The code change proposal will decrease the cost of construction

The cost of precast concrete construction, where welding of reinforcing bars is not uncommon, should decrease modestly through the elimination of unnecessary continuous special inspection in many cases.

S143-22

S144-22

IBC: 1705.4, SECTION 2109

Proponents: Jason Thompson, representing Masonry Alliance for Codes and Standards (jthompson@ncma.org)

The primary section number and title shown as deleted (2109) includes the deletion of all sections and subsections within it. For clarity, the full text of these deletions is not shown.

2021 International Building Code

Revise as follows:

1705.4 Masonry construction. *Special inspections* and tests of masonry construction shall be performed in accordance with the quality assurance program requirements of TMS 402 and TMS 602.

Exception: *Special inspections* and tests shall not be required for:

1. ~~Glass unit masonry or masonry veneer designed in accordance with Section 2110 or Chapter 14. Empirically designed masonry, glass unit masonry or masonry veneer designed in accordance with Section 2109, Section 2110 or Chapter 14, respectively, where they are part of a structure classified as Risk Category I, II or III.~~
2. Masonry foundation walls constructed in accordance with Table 1807.1.6.3(1), 1807.1.6.3(2), 1807.1.6.3(3) or 1807.1.6.3(4).
3. Masonry fireplaces, masonry heaters or masonry chimneys installed or constructed in accordance with Section 2111, 2112 or 2113, respectively.

Delete without substitution:

SECTION 2109 EMPIRICAL DESIGN OF ADOBE MASONRY

Reason Statement: The option for empirically designed masonry has been removed from the 2022 edition of TMS 402. As such, references to these provisions from the IBC are also being deleted - including all of Section 2109 of the IBC. Of note, the scope of Section 2109 is limited to empirically designed adobe masonry construction. Although there is a reference to the empirical design provisions of TMS 402 in Section 2109, there are questions as to whether the use of the empirical design provisions of TMS 402, which were developed for clay and concrete masonry construction, are appropriate and applicable to adobe masonry construction.

Cost Impact: The code change proposal will not increase or decrease the cost of construction
This code change proposal simply deletes a historical design method that is no longer included in the referenced standard.

S144-22

S145-22

IBC: 1705.7, 1705.8, 1705.9

Proponents: Joseph Cain, representing Solar Energy Industries Association (SEIA) (JoeCainPE@gmail.com)

2021 International Building Code

Revise as follows:

1705.7 Driven deep foundations. *Special inspections* and tests shall be performed during installation of driven *deep foundation* elements as specified in Table 1705.7. The approved geotechnical report and the construction documents prepared by the *registered design professionals* shall be used to determine compliance.

Exceptions:

1. Driven *deep foundations* for *ground-mounted photovoltaic (PV) panel systems* serving Group R-3 buildings.
2. The *building official* shall be permitted to modify or exempt *special inspection* requirements for driven *deep foundations* for *ground-mounted photovoltaic panel systems*.

1705.8 Cast-in-place deep foundations. *Special inspections* and tests shall be performed during installation of cast-in-place *deep foundation* elements as specified in Table 1705.8. The *approved* geotechnical report and the *construction documents* prepared by the *registered design professionals* shall be used to determine compliance.

Exceptions:

1. Cast-in-place *deep foundations* for *ground-mounted photovoltaic (PV) panel systems* serving Group R-3 buildings.
2. The *building official* shall be permitted to modify or exempt *special inspection* requirements for cast-in-place *deep foundations* for *ground-mounted photovoltaic panel systems*.

1705.9 Helical pile foundations. *Continuous special inspections* shall be performed during installation of *helical pile* foundations. The information recorded shall include installation equipment used, pile dimensions, tip elevations, final depth, final installation torque and other pertinent installation data as required by the *registered design professional* in responsible charge. The *approved* geotechnical report and the *construction documents* prepared by the *registered design professional* shall be used to determine compliance.

Exceptions:

1. *Helical pile* foundations for *ground-mounted photovoltaic (PV) panel systems* serving Group R-3 buildings.
2. The *building official* shall be permitted to modify or exempt *special inspection* requirements for *helical pile foundations* for *ground-mounted photovoltaic panel systems*.

Reason Statement: A requirement for continuous Special Inspection for foundations for photovoltaic panel systems is overly restrictive. For smaller installations -- such as residential ground-mounted photovoltaic panel systems -- continuous special inspection beyond the AHJ/County inspection adds project cost disproportionate to the risk to the project. Most AHJ/County Building Officials have agreed that special inspection is not necessary or reasonable for these small systems.

Proposed Exception 1 seeks to formalize the exemption that is commonly applied to small systems.

Large-scale (often called "utility scale") photovoltaic power plants often have tens of thousands of small piles. As project financing often involves third-party investors, existing measures of quality control are already in place. The developer and/or EPC (Engineer, Procure, Construct) contractor often use a rigorous design and testing process to optimize pile specifications, as part of value engineering. As part of their risk-management process, project financiers often use third-party Independent Engineers (IE's) to ensure quality controls are in place. Under current practice, it is extremely uncommon for local Building Officials to require Special Inspection for "deep" foundations for photovoltaic panel systems, regardless of the absence of an exception for these systems.

Large-scale photovoltaic power plants usually incorporate rigorous design and quality control steps, as follows:

1. Foundation elements designed by analysis, based on geotechnical investigation.
2. As thousands of small piles are used in a photovoltaic power plant, optimization of design usually includes preconstruction pile load testing conducted on site. Independent Engineers (IE's) often review test reports.
3. EPC contractor has their own internal quality control.

4. A representative sample of production piles (for example, 1 percent) are usually proof-tested during construction, to ensure adequate pile capacities are being achieved. Adjustments are made if necessary to meet the demand.

5. County/AHJ inspectors usually conduct periodic observation of pile installation. For large-scale power plants, these inspectors are often third-party inspectors.

6. IE's usually conduct site visits to observe installation methods and review inspection reports and production pile load test reports. A final report is prepared by the IE.

Owing to this rigorous program of quality control, continuous special inspection of "deep" foundations is highly redundant. A Special Inspector could be required to be on-site for one to three months watching piles being installed, even though the same piles are already being observed and monitored by the Developer, the EPC Contractor, the AHJ/County inspector, and the Independent Engineer.

Proposed Exception 2 seeks to allow the Building Official the flexibility allow modifications or exemptions to special inspection requirements, without taking away any such authority. For example, a Building Official could decide that an agreed-upon frequency of periodic special inspection, or might be satisfied with quality controls in place on behalf of the owner or EPC.

Cost Impact: The code change proposal will not increase or decrease the cost of construction

This proposal will not increase the cost of construction. In some cases, this proposal could decrease the cost of construction, where continuous special inspection is no longer a stated requirement for ground-mounted photovoltaic panel systems.

S146-22

IBC: 1705.21 (New)

Proponents: Paul Armstrong, representing MBCEA

2021 International Building Code

Add new text as follows:

1705.21 Metal building assembly. Special inspections for new and altered metal building systems shall be as required by Section 1705.21.1 and Table 1705.21.

Exception: Special inspections are not required if the metal building assembler has a Metal Building Assembler accreditation from an approved nationally recognized accrediting body.

1705.21 Required Verification and Inspection of Metal Buildings

<u>Special Inspection and Verification</u>	<u>Continuous Inspection</u>	<u>Periodic Inspection</u>
<u>1. Inspection of properly installed primary structural components including verification of anchor bolt locations</u>	---	X
<u>2. Inspection of properly installed structural bolts and fasteners</u>	---	X
<u>3. Verify use of manufacturer's drawings and instructions and compliance with both</u>	---	X
<u>4. Primary and secondary steel members have not been modified without manufacturer approval</u>	---	X
<u>5. Framework properly plumbed and squared and then all bolts tightened</u>	---	X
<u>6. Secondary members are straight and true and in according to locations shown on manufacturer's drawings</u>	---	X
<u>7. Roof and wall sheets are properly aligned, lapped and fully fastened and are free from oil canning</u>	---	X
<u>8. Sheeting fasteners are properly installed and aligned with screws or rivets filling all drilled holes</u>	---	X
<u>9. Mastics properly installed at laps and at manufacturer's requirements.</u>	---	X
<u>10. Trims are properly installed, straight, true, cut and terminated</u>	---	X
<u>11. Insulation is properly installed and free from sags, rips, tears and snags</u>	---	X

Reason Statement: The added special inspection requirements are necessary to address the problems with the installation of metal buildings. Structural failures have occurred due to a lack of understand how these buildings are designed and constructed. There is very little training for local jurisdictional inspection staff and it is recognized that the approved manufacturer's installation instructions/requirements are difficult to understand without very detailed checklists. End users and architects also struggle with compliance from Metal Building assemblers. The added special inspection requirements will improve the performance of metal buildings by providing much better quality control. It will also add value to the end user of such buildings by ensuring the longevity of the built systems.

Cost Impact: The code change proposal will increase the cost of construction
There will be a slight increase in the cost of construction due to the special inspection costs.

S146-22

S147-22

IBC: 1709.5, WDMA Chapter 35 (New)

Proponents: Jeff Inks, representing Window & Door Manufacturers Association (jinks@wdma.com); Craig Drumheller, representing Window & Door Manufacturers Association (cdrumheller@wdma.com)

2021 International Building Code

Revise as follows:

1709.5 Exterior window and door assemblies. The design pressure rating of exterior windows and doors in buildings shall be determined in accordance with Section 1709.5.1 or 1709.5.2. For exterior windows and doors tested in accordance with Section 1709.5.1 or 1709.5.2, required design wind pressures determined from ASCE 7 shall be permitted to be converted to allowable stress design by multiplying by 0.6.

Exception: Structural wind load design pressures for window or door assemblies other than the size tested in accordance with Section 1709.5.1 or 1709.5.2 shall be permitted to be different than the design value of the tested assembly, provided that such pressures are determined by accepted engineering analysis or validated by an additional test of the window or door assembly to the alternative allowable design pressure in accordance with Section 1709.5.2. Components of the alternate size assembly shall be the same as the tested or labeled assembly. Where engineering analysis is used, it shall be performed in accordance with the analysis procedures of AAMA 2502 or WDMA I.S. 11.

Add new standard(s) as follows:

WDMA

Window and Door Manufacturers Association
2025 M Street NW, Suite 800
Washington, DC 20006

WDMA I.S. 11-2018

Industry Standard for Voluntary Analytical Method for Design Pressure (DP) Ratings of Fenestration Products

Staff Analysis: The proposal is referencing an updated version of an existing referenced standard. Therefore the updated version is considered a new standard. A review of the standard proposed for inclusion in the code, WDMA I.S. 11–2018 Industry Standard for Voluntary Analytical Method for Design Pressure (DP) Ratings of Fenestration Products, with regard to some of the key ICC criteria for referenced standards (Section 3.6 of CP#28) will be posted on the ICC website on or before March 16, 2022.

Reason Statement: The exception under 1709.5 Exterior window and door assemblies, allows for comparative analysis to be used for determining design pressures of different sized products within a given fenestration product line based on the testing and rating of a prototype unit/s for that product line. As required by the exception under 1709.5, comparative analysis determinations for this purpose must be in accordance with accepted engineering analysis and in accordance with AAMA 2502. *Comparative Analysis Procedure for Window and Door Products*. Comparative analysis alleviates the need for costly testing of all sizes within a product line that isn't necessary saving considerable construction costs and providing greater design flexibility, especially for specialty and custom products.

Consistent with AAMA 2502, WDMA I.S. 11 - *Industry Standard for Voluntary Analytical Method for Design Pressure (DP) Ratings of Fenestration Products* provides standardized accepted engineering analysis procedures for accurately determining design pressure ratings of window and door assemblies based on comparative analysis accordingly. WDMA I.S. 11 has been included as an accepted comparative analysis methodology for window and door assemblies in section 609.3.1 Comparative analysis of The *International Residential Code* (IRC) since the 2015 edition. Adding WDMA I.S. 11 as an additional comparative analysis option in the exception under section 1709.5 will allow even greater cost effective design flexibility and will also make the IBC consistent with the same requirements in the IRC.

Cost Impact: The code change proposal will not increase or decrease the cost of construction. Including WDMA I.S. 11 does however provide an additional cost saving option for determining design pressures for window and door assemblies using comparative analysis in accordance with the provisions of 1709.5.

S147-22

S148-22

IBC: 1803.5.1, ASTM Chapter 35 (New)

Proponents: Lori Simpson, representing GeoCoalition (lsimpson@langan.com); Daniel Stevenson, representing GeoCoalition (dstevenson@berkelapg.com)

2021 International Building Code

Revise as follows:

1803.5.1 Classification. Soil materials shall be classified in accordance with ASTM D2487. Rock shall be classified in accordance with ASTM D5878.

Add new standard(s) as follows:

ASTM

ASTM International
100 Barr Harbor Drive, P.O. Box C700
West Conshohocken, PA 19428

D5878-19

Standard Guides for Using Rock-Mass Classification Systems for Engineering Purpose

Staff Analysis: A review of the standard proposed for inclusion in the code, ASTM D5878-19 Standard Guides for Using Rock-Mass Classification Systems for Engineering Purpose, with regard to some of the key ICC criteria for referenced standards (Section 3.6 of CP#28) will be posted on the ICC website on or before March 16, 2022.

Reason Statement: Rock should be classified in accordance with a standard for consistency.

Bibliography: ASTM D5878 Standard Guides for Using Rock-Mass Classification Systems for Engineering Purposes

Cost Impact: The code change proposal will not increase or decrease the cost of construction
No change to cost - this change is to make rock classification in accordance with a standard.

S148-22

S149-22

IBC: 1803.5.2

Proponents: Lori Simpson, representing GeoCoalition (lsimpson@langan.com); Daniel Stevenson, representing GeoCoalition (dstevenson@berkelapg.com)

2021 International Building Code

Revise as follows:

1803.5.2 Questionable soil and rock. Where the classification, strength, moisture sensitivity or compressibility of the soil or rock is in doubt or where a load-bearing value superior to that specified in this code is claimed, the *building official* shall be permitted to require that a geotechnical investigation be conducted.

Reason Statement:

1. Rock should be included as part of the evaluation of questionable material
2. "Moisture-sensitive" is also a questionable characteristic that the building official may consider when requiring a geotechnical investigation.

Cost Impact: The code change proposal will not increase or decrease the cost of construction
this change includes rock and adds "moisture sensitive" as a questionable characteristics, which will not change the cost of construction

S149-22

S150-22

IBC: 1803.5.3, ASTM Chapter 35 (New)

Proponents: Lori Simpson, representing GeoCoalition (lsimpson@langan.com); Daniel Stevenson, representing GeoCoalition (dstevenson@berkelapg.com)

2021 International Building Code

Revise as follows:

1803.5.3 Expansive or collapsible soil. In areas likely to have expansive or collapsible soil or weathered rock, the *building official* shall require soil tests to determine where such soils do exist. The presence of expansive or collapsible soil or weathered rock shall be determined using the procedures described in ASTM D4546.

Alternatively, for expansive soils, soils meeting all four of the following provisions shall be considered to be expansive, except that tests to show compliance with Items 1, 2 and 3 shall not be required if the test prescribed in Item 4 is conducted:

1. Plasticity index (PI) of 15 or greater, determined in accordance with ASTM D4318
2. More than 10 percent of the soil particles pass a No.200 sieve (75 µm), determined in accordance with ASTM D422.
3. More than 10 percent of the soil particles are less than 5 micrometers in size, determined in accordance with ASTM D422.
4. Expansion index greater than 20, determined in accordance with ASTM D4829.

Add new standard(s) as follows:

ASTM

ASTM International
100 Barr Harbor Drive, P.O. Box C700
West Conshohocken, PA 19428

D4546-21

Standard Test Methods for One-Dimensional Swell or Collapse of Soils

Staff Analysis: A review of the standard proposed for inclusion in the code, ASTM D4546-21 Standard Test Methods for One-Dimensional Swell or Collapse of Soils, with regard to some of the key ICC criteria for referenced standards (Section 3.6 of CP#28) will be posted on the ICC website on or before March 16, 2022.

A review of the standard proposed for inclusion in the code, ASTM D6913/D6913M-17 Standard Test Methods for Particle-Size Distribution (Gradation) of Soils Using Sieve Analysis, with regard to some of the key ICC criteria for referenced standards (Section 3.6 of CP#28) will be posted on the ICC website on or before March 16, 2022.

Reason Statement:

1. The title change is because the volume change can be either expansive or collapsible. Collapsible soil has not been previously addressed in the code.
2. The revised D4546 (Standard Test Method for One-dimensional Swell or Collapse of Soils) is the recognized standard that deals with expansive and collapsible soils. The proposed modification to this section brings the IBC into consistency with current ASTM standard procedures.
3. This section still allows for expansive soils to be identified using the tests indicated in the current code, by providing this option as an alternative to using D4546.

Bibliography:

1. ASTM D4546 Standard Test Methods for One-Dimensional Swell or Collapse of Soils
2. ASTM D6913 Standard Test Methods for Particle-Size Distribution (Gradation) of Soils Using Sieve Analysis

Cost Impact: The code change proposal will not increase or decrease the cost of construction
Changes use current ASTM standards and do not affect cost of construction.

S150-22

S151-22

IBC: 1803.5.3, ASTM Chapter 35 (New)

Proponents: Lori Simpson, representing GeoCoalition (lsimpson@langan.com); Daniel Stevenson, representing GeoCoalition (dstevenson@berkelapg.com)

2021 International Building Code

Revise as follows:

1803.5.3 Expansive soil. In areas likely to have expansive soil, the *building official* shall require soil tests to determine where such soils do exist. Soils meeting all four of the following provisions shall be considered to be expansive, except that tests to show compliance with Items 1, 2 and 3 shall not be required if the test prescribed in Item 4 is conducted:

1. Plasticity index (PI) of 15 or greater, determined in accordance with ASTM D4318
2. More than 10 percent of the soil particles pass a No.200 sieve (75 µm), determined in accordance with ASTM ~~D422~~ D6913.
3. More than 10 percent of the soil particles are less than 5 micrometers in size, determined in accordance with ASTM ~~D422~~ D6913.
4. Expansion index greater than 20, determined in accordance with ASTM D4829.

Add new standard(s) as follows:

ASTM

ASTM International
100 Barr Harbor Drive, P.O. Box C700
West Conshohocken, PA 19428

D6913/D6913M-17

Standard Test Methods for Particle-Size Distribution (Gradation) of Soils Using Sieve Analysis

Staff Analysis: A review of the standard proposed for inclusion in the code, ASTM D6913/D6913M-17 Standard Test Methods for Particle-Size Distribution (Gradation) of Soils Using Sieve Analysis, with regard to some of the key ICC criteria for referenced standards (Section 3.6 of CP#28) will be posted on the ICC website on or before March 16, 2022.

Reason Statement: ASTM has retired the older standard D422 and replaced it with D6913.

Bibliography: ASTM D6913 Standard Test Methods for Particle-Size Distribution (Gradation) of Soils Using Sieve Analysis

Cost Impact: The code change proposal will not increase or decrease the cost of construction Updated to current ASTM standard and does not affect cost of construction.

S151-22

S152-22

IBC: 1803.5.4

Proponents: Lori Simpson, representing GeoCoalition (lsimpson@langan.com); Daniel Stevenson, representing GeoCoalition (dstevenson@berkelapg.com)

2021 International Building Code

Revise as follows:

1803.5.4 ~~Ground-water table~~ Groundwater. A ~~subsurface soil~~ geotechnical investigation shall be performed to determine ~~whether~~ if:

1. the existing ~~ground-water table~~ Groundwater is above or within 5 feet (1524 mm) below the elevation of the *lowest floor* level where such floor is located below the finished ground level adjacent to the foundation; and
2. the groundwater depth will affect the design and construction of buildings and structures.

Exception: A ~~subsurface soil~~ investigation to determine the location of the ~~ground-water table~~ shall not be required where waterproofing is provided in accordance with Section ~~1805~~.

Reason Statement:

- "Groundwater" is the more accepted term than "ground-water". ICC might want to review this editorially throughout the IBC code.
- Knowing the location of groundwater levels are critical for designing and constructing underground structure elements, foundations, and earth retention systems.
- "Geotechnical investigation" is the term being used throughout Section 1803.5, not "subsurface soil investigation".
- The exception related to waterproofing is deleted because the inclusion of waterproofing does not eliminate the need to know the location of the groundwater for other purposes, such as hydrostatic pressures as referenced in 1805.2.
- "Table" is removed from both title and text because there is often no singular "level" or "table"

Cost Impact: The code change proposal will not increase or decrease the cost of construction this change proposal will not change the cost of construction because the hydrostatic pressure already needed to be accounted for.

S152-22

S153-22

IBC: 1803.5.6

Proponents: Lori Simpson, representing GeoCoalition (lsimpson@langan.com); Daniel Stevenson, representing GeoCoalition (dstevenson@berkelapg.com)

2021 International Building Code

Revise as follows:

1803.5.6 Rock strata. Where ~~subsurface explorations at the project site indicate variations in the structure of rock on which foundations are to be constructed on or in rock, a sufficient number of borings shall be drilled to sufficient depths to~~ the geotechnical investigation shall assess the variations in rock strata depth, competency, of the rock and its load-bearing capacity.

Reason Statement:

1. The proposed change clarifies the current code provision while preserving its intent.
2. "Geotechnical investigation" is the preferred term rather than "subsurface exploration."
3. There are methods other than borings to investigate depth of rock, including cone penetration testing, test pits, geophysics.
4. Delete "sufficient" as it is vague and therefore unenforceable.
5. The provision to assess rock depth variation was implied but not clearly stated.

Cost Impact: The code change proposal will not increase or decrease the cost of construction
This change maintains the current intent of the code.

S153-22

S154-22 Part I

PART 1-IBC: 1805.1.2.1

PART 2 - IRC: R408.7

Proponents: Gregory Wilson, representing FEMA (gregory.wilson2@fema.dhs.gov); Rebecca Quinn, representing DHS Federal Emergency Management Agency (rcquinn@earthlink.net)

THIS IS A 2 PART CODE CHANGE. PART I WILL BE HEARD BY THE INTERNATIONAL BUILDING CODE-STRUCTURAL COMMITTEE. PART II WILL BE HEARD BY THE INTERNATIONAL RESIDENTIAL CODE-BUILDING COMMITTEE. SEE THE TENTATIVE HEARING ORDER FOR THESE COMMITTEES.

2021 International Building Code

Revise as follows:

1805.1.2.1 Flood hazard areas. For buildings and structures in *flood hazard areas* as established in Section 1612.3, the finished ground level of an under-floor space such as a crawl space shall be equal to or higher than the outside finished ground level on one side or more.

Exception: Under-floor spaces of Group R-3 buildings that meet the following requirements ~~of FEMA TB 11~~:

1. The velocity of floodwater at the site does not exceed 5 feet per second.
2. The interior grade of the under-floor space is not more than 2 feet below the lowest adjacent exterior grade.
3. The height of the under-floor space, measured from the interior grade of the under-floor space to the top of the foundation wall is not more than 4 feet at any point.
4. There is an adequate drainage system that removes floodwater from the interior area of the under-floor space.

S154-22 Part I

S154-22 Part II

PART 2 - IRC: R408.7

Proponents: Gregory Wilson, representing FEMA (gregory.wilson2@fema.dhs.gov); Rebecca Quinn, representing DHS Federal Emergency Management Agency (rcquinn@earthlink.net)

2021 International Residential Code

Revise as follows:

R408.7 Flood resistance. For buildings located in flood hazard areas as established in Table R301.2:

1. Walls enclosing the under-floor space shall be provided with flood openings in accordance with Section R322.2.2.
2. The finished ground level of the under-floor space shall be equal to or higher than the outside finished ground level on at least one side.

Exception: Under-floor spaces that meet the following requirements: ~~of FEMA TB 11-1.~~

1. The velocity of floodwater at the site does not exceed 5 feet per second.
2. The interior grade of the under-floor space is not more than 2 feet below the lowest adjacent exterior grade.
3. The height of the under-floor space, measured from the interior grade of the under-floor space to the top of the foundation wall is not more than 4 feet at any point.
4. There is an adequate drainage system that removes floodwater from the interior area of the under-floor space.

Reason Statement: The basic requirements of the National Flood Insurance Program prohibit areas of buildings that are below grade on all sides (except nonresidential buildings that are designed to be dry floodproofed). That limitation applies to crawlspaces that have the interior grade below the exterior grade on all sides. The exception in this section refers to NFIP Technical Bulletin 11, which outlines limitations to allow below-grade crawlspaces, specifically limitations on wall height and how far below grade the interior can extend. Importantly, TB 11 requires jurisdictions to adopt the specified requirements in the exception to allow for construction of such below-grade spaces.

The proposed replaces the reference to TB 11 with itemized lists that capture the limitations in TB 11. Not only does this eliminate the need for buildings and designers to find and interpret TB 11, it eliminates the need for communities to adopt the specific requirements.

If this code change proposal is successful, the codes will no longer refer to TB 11 and TB 11 should be removed from the list of referenced standards in both codes.

Bibliography: NFIP Technical Bulletin 11, Crawlspace Construction for Buildings Located in Special Flood Hazard Areas, Interim Guidance (2001), <https://www.fema.gov/emergency-managers/risk-management/building-science/national-flood-insurance-technical-bulletins>

Cost Impact: The code change proposal will not increase or decrease the cost of construction

The code change proposal replaces the reference to NFIP Technical Bulletin 11 with a list of requirements from NFIP Technical Bulletin 11. There is no change to the technical content of the provisions, rather the requirements are stated instead of referencing a publication. By listing existing requirements, there will be no cost impact when approving this proposal.

S154-22 Part II

S155-22

IBC: 1806.2

Proponents: Lori Simpson, representing GeoCoalition (lsimpson@langan.com); Daniel Stevenson, representing GeoCoalition (dstevenson@berkelapg.com)

2021 International Building Code

Revise as follows:

1806.2 Presumptive load-bearing values. The load-bearing values used in design for supporting soils and rock near the surface shall not exceed the values specified in Table 1806.2 unless data to substantiate the use of higher values are submitted and *approved*. Where the *building official* has reason to doubt the classification, strength or compressibility of the soil or rock, the requirements of Section 1803.5.2 shall be satisfied. Presumptive load-bearing values shall apply to materials with similar physical and engineering characteristics ~~and dispositions~~. ~~Mud~~ Very soft to soft clay or silt (CL, CH, MH, ML), very loose to loose silt (ML), organic silt, and organic clays (OL, OH), peat (Pt) or unprepared and undocumented fill shall not be assumed to have a presumptive load-bearing capacity unless data to substantiate the use of such a value are submitted.

Exception: A presumptive load-bearing capacity shall be permitted to be used where the *building official* deems the load-bearing capacity of ~~mud, organic silt or unprepared fill~~ is adequate for the support of lightweight or temporary structures.

Reason Statement:

1. Rock is added because presumptive values are provided for rock in Table 1806.2.
2. A "disposition" is not a recognized geotechnical term.
3. Soils are classified in accordance with ASTM D2487, as specified in section 1803.5.1; therefore, soil classifications are shown to conform. "Mud" is not a recognized geotechnical "Class of Material".
4. "Undocumented" fill is a more appropriate term than "unprepared" because there is no record of how it was placed (i.e. it is "undocumented"); therefore, it is assumed that it was not adequately compacted.

Bibliography: ASTM D2487 Standard Practice for Classification of Soils for Engineering Purposes (Unified Soil Classification System)

Cost Impact: The code change proposal will not increase or decrease the cost of construction. This only changes terminology and does not affect cost of construction.

S155-22

S157-22

IBC: 1807.2.5 (New), 1807.2.5.1 (New), 1807.2.5.2 (New), 1807.2.5.3 (New)

Proponents: Peter Zvingilas, representing Region VI; John Grenier, representing National Council of Structural Engineers Associations (NCSEA) (jgrenier@greniereng.com)

2021 International Building Code

Add new text as follows:

1807.2.5 Guards at retaining walls. Guards shall be provided in accordance with Sections 1807.2.5.1 through 1807.2.5.3.

1807.2.5.1 Guards. A guard shall be located along the top of a retaining wall located along open-sided walking surfaces that are located more than 30 inches (762 mm) measured vertically to the surface or grade below at the exposed face of the retaining wall. Guards shall be adequate in strength and attachment in accordance with Section 1607.9.

Exceptions:

1. Where other barrier(s) are provided that is approved by the building official.
2. Where a retaining wall is located where it is not accessible to the public, as determine by the building official, a guard shall not be required.

1807.2.5.2 Height. Required guards at retaining walls shall comply with the height requirements of section 1015.3.

1807.2.5.3 Opening limitations. Required guards shall comply with the opening limitations of Section 1015.4.

Reason Statement: To add language to clarify where and how a guard is to be installed on top of a retaining wall that would pose a danger of a fall.

- The code is currently silent on the requirement for guards on top of retaining walls. These conditions commonly occur on sites (not necessarily buildings that are addressed in Chapter 10) at public places (parks; schools; etc.) that need to have guards.
- The exception #2 provides a method for conditions where a retaining wall is not accessible to the public and a guard would not be warranted and would be wasteful.
- Section 1807.2.5.3 Opening Limitations, provides a method to allow the 21" sphere criteria to be used for certain non-public occupancies (industrial sites, etc.).
- The 30" height requirement is consistent with section **1015.2**; and section **105.2 Work exempt from permit**, items #4 (retaining walls less than 4' do not require a permit, however that is measured from the bottom of the footing so the grade difference would essentially be 30"), and item # 6 (which is where a sidewalk or driveway with over a 30" grade change would be required to be permitted).

Cost Impact: The code change proposal will not increase or decrease the cost of construction
The cost of construction will not increase by this change. This change clarifies what is already being done in the industry.

S157-22

S158-22

IBC: 1807.3

Proponents: Andy Williams, representing National Frame Building Association (panelcladsolutions@gmail.com)

2021 International Building Code

Revise as follows:

1807.3 Embedded posts and poles. Designs to resist both axial and lateral *loads* employing posts or poles as columns embedded in earth or in concrete footings in earth shall be in accordance with Sections 1807.3.1 through 1807.3 or in accordance with ASABE EP 486.3.

Reason Statement: This proposal adds a reference for ASABE EP 486.3 to Section 1807.3 (Embedded posts and poles) where discussion of this type of foundation takes place. ASABE EP 486.3 is currently referenced in Table 2306.1 along with the other ASABE Engineering Practice (EP) standards recognized for use in post frame design. While the other EPs reference wood framing elements and issues used in post-frame construction, EP 486.3 is specifically designed to aid in the determination of soil strength for shallow post and pier foundation design.

Since the initial 2000 IBC, the National Frame Building Association (NFBA) has received a number of inquiries from building officials requesting why there is not reference to this design standard in Chapter 18 Soils and Foundations where it truly belongs. Addition of EP 486.3 to Section 1807.3 puts the foundation and soil design reference for post frame construction in the appropriate chapter and keeps the building official from having to link this already recognized reference standard in Table 2306.1 to foundation design based on the requirements of Chapter 18.

National Frame Building Association (NFBA) is a trade association that promotes the interests of the post-frame construction industry and its members including post-frame builders, suppliers, manufacturers, building material dealers, code and design professionals, and structural engineers.

Cost Impact: The code change proposal will not increase or decrease the cost of construction. This proposal simply moves an existing referenced standard from Chapter 23 to Chapter 18. No additional testing or costs should be associated with this move.

S158-22

S159-22

IBC: 1807.3.1

Proponents: John-Jozef Proczka, representing Self (john-jozef.proczka@phoenix.gov)

2021 International Building Code

Revise as follows:

1807.3.1 Limitations. The design procedures outlined in this section are subject to the following limitations:

1. The frictional resistance for structural walls and slabs on silts and clays shall be limited to one-half of the normal force imposed on the soil by the ~~dead load~~ weight of the footing or slab.
2. Posts embedded in earth shall not be used to provide lateral support for structural or nonstructural materials such as plaster, masonry or concrete unless bracing is provided that develops the limited deflection required.

Wood poles shall be treated in accordance with AWPA U1 for sawn timber posts (Commodity Specification A, Use Category 4B) and for round timber posts (Commodity Specification B, Use Category 4B).

Reason Statement: This change brings the wording of this section more in line with the wording of 1806.3.2. Additionally, this change clarifies that the physics of the situation depending on the dead load, and not on just the weight of the footing itself.

Cost Impact: The code change proposal will decrease the cost of construction. This change will allow the structure's dead load to be used instead of just the weight of the footing. This may allow for smaller foundations.

S159-22

S160-22

IBC: 1807.3.2.2

Proponents: John-Jozef Proczka, representing Self (john-jozef.proczka@phoenix.gov)

2021 International Building Code

Revise as follows:

1807.3.2.2 Constrained. The following formula shall be used to determine the depth of embedment required to resist lateral *loads* where lateral constraint is provided at the ground surface, such as by a rigid floor or pavement. Hot-mix asphaltic concrete shall not be considered a rigid pavement.

$$d = \sqrt{\frac{4.25Ph}{S_3b}} \quad \text{(Equation 18-2)}$$

or alternatively

$$d = \sqrt{\frac{4.25M_g}{S_3b}} \quad \text{(Equation 18-3)}$$

where:

M_g = Moment in the post at grade, in foot-pounds (kN-m).

S_3 = Allowable lateral soil-bearing pressure as set forth in Section 1806.2 based on a depth equal to the depth of embedment in pounds per square foot (kPa).

Reason Statement: This code change will answer the common question that arises when an embedded post or pole foundation is used with an adjacent hot-mix asphaltic concrete pavement surface.

Hot-mix asphaltic concrete does not undergo a chemical reaction to obtain its stiffness like portland cement does. Hot-mix asphaltic concrete's stiffness is entirely dependent on its temperature, as such it may behave like a rigid floor surface when it is very cold, but does not do so when it is hot. This transient stiffness nature makes it inappropriate to use as a rigid constraint to reduce a footing's embedment under lateral loads which may occur regardless of the temperature.

Cost Impact: The code change proposal will increase the cost of construction

This proposal will increase the cost of foundations that inappropriately assume that asphaltic concrete is capable of providing a rigid constraint.

S160-22

S161-22

IBC: 1808.2

Proponents: John-Jozef Proczka, representing Self (john-jozef.proczka@phoenix.gov)

2021 International Building Code

Revise as follows:

1808.2 Design for capacity and settlement. Foundations shall be so designed that the allowable vertical and lateral bearing capacity ~~capacities~~ of the soil ~~are is~~ not exceeded, the sliding resistance is not exceeded, and that differential settlement is minimized. Where geotechnical investigations are conducted, the allowable bearing capacities and sliding resistance of the soil shall not exceed the values in the geotechnical report. Foundations in areas with expansive soils shall be designed in accordance with the provisions of Section 1808.6 .

Reason Statement: There are two proposed changes:

1. Clarify that where geotechnical investigations are conducted that the soil capacity then needs to be in accordance with the values shown in the report from Section 1803.6. This would not allow the presumptive load-bearing values of the soil to be used where a registered design professional has determined the soil at the site is not sufficient to use those values. It should be noted that geotechnical reports rarely report smaller values than the presumptive values, but where they do it is inappropriate to use presumptive values.

2. Alter the wording such that recognition of vertical and lateral bearing capacities of the soil and lateral sliding resistance of the soil are all specifically invoked, where before they had to be assumed to be contained simply in "allowable bearing capacity".

Cost Impact: The code change proposal will increase the cost of construction

This proposal will increase the cost of construction on sites that have a geotechnical investigation and that investigation discovers that the soil at the site is worse than the presumptive load bearing values present in the code. This situation is rare.

S161-22

S162-22

IBC: 1808.8.6

Proponents: Kelly Cobeen, representing self (kcobeen@wje.com); Ronald LaPlante, Division of State Architect, representing Self (ron.laplante@dgs.ca.gov)

2021 International Building Code

Revise as follows:

1808.8.6 Seismic requirements. See Section 1905 for additional requirements for foundations of structures assigned to *Seismic Design Category* C, D, E or F.

For structures assigned to *Seismic Design Category* C, D, E or F, provisions of Section 18.13 of ACI 318 shall apply where not in conflict with the provisions of Sections 1808 through 1810.

Exceptions Exception:

- 1- Detached one- and two-family dwellings of *light-frame construction* and two stories or less above *grade plane* are not required to comply with the provisions of Section 18.13 of ACI 318.
- 2- ~~Section 18.13.4.3(a) of ACI 318 shall not apply.~~

Reason Statement: This proposal updates IBC requirements to provide consistency with ACI 318-19. This provision is made applicable to Seismic Design Categories C through F to be consistent with ACI 318.

Exception 2 is deleted because both ACI 318 and IBC now require closely spaced ties for three pile diameters below the pile cap.

Cost Impact: The code change proposal will decrease the cost of construction
The proposal will reduce the cost of construction a very small amount by reducing the extent of closely spaced ties.

S162-22

S163-22

IBC: 1809.6

Proponents: Justin Spivey, representing Self (jspivey@wje.com)

2021 International Building Code

Revise as follows:

1809.6 Location of footings. Footings on granular soil shall be so located that the line drawn between the lower edges of ~~adjoining adjacent~~ footings shall not have a slope steeper than 30 degrees (0.52 rad) with the horizontal, unless the material supporting the higher footing is braced or retained or otherwise laterally supported in an *approved* manner or a greater slope has been properly established by engineering analysis.

Reason Statement: A distinction is needed between adjacent (Webster: close or near) and adjoining (Webster: touching or bounding at a point or line); adjoining is the more restrictive term as it requires contact. Especially in urban environments, *buildings* or non-building *structures* may be separated by a public alley or otherwise close enough that demolition, excavation, or construction activities for one *building* or non-building *structure* may affect another without direct contact, i.e., adjacent but not adjoining. This and other related proposals being submitted in this cycle do not seek to address the numerous instances where adjacent and adjoining appear to be used interchangeably—most frequently in IBC Chapters 4, 7, 9, 10, and 23; instead, they seek to resolve inconsistent usage of adjacent and adjoining as a modifier of the words property, *structure*, *building*, and footing in IBC Chapters 18 and 33 and Appendix J and in IEBC Chapter 15.

Cost Impact: The code change proposal will increase the cost of construction

This proposal does not change the spirit of the provision, but changes the letter slightly. There is a chance the revised wording will curtail questionable or creative interpretations and thus increase initial cost, but to the extent it encourages proper protection of adjacent property, it will lower the risk of damage, reduce or eliminate the cost of repairs and/or litigation, and thereby decrease total cost.

S163-22

S164-22

IBC: 1809.7, TABLE 1809.7, 1809.8, 1809.9

Proponents: Mike Nugent, representing Building Code Action Committee (bcac@iccsafe.org)

2021 International Building Code

Revise as follows:

1809.7 Prescriptive footings for light-frame construction. Where a specific design is not provided, concrete or masonry-unit footings supporting walls of *light-frame construction* shall be permitted to be designed in accordance with Table 1809.7. The *light-frame construction* supported by these footings shall comply with all of the following:

1. The light frame construction shall be designed in accordance with Section 2211.1.2, 2308, or 2309.
2. The light frame construction shall not exceed the limitations specified in Section 2308.2.
3. Floor and roof framing tributary width shall not exceed 16 feet (4877 mm), with an additional maximum roof overhang of 2 feet (610 mm).
4. The soil shall not be expansive and shall have a minimum allowable vertical bearing pressure of 1,500 psf (71.8 kN/m²).

TABLE 1809.7 PRESCRIPTIVE FOOTINGS SUPPORTING WALLS OF LIGHT-FRAME CONSTRUCTION^{a, b, c, d, e, f}

NUMBER OF FLOORS AND ROOFS SUPPORTED BY THE FOOTING ^f	WIDTH OF FOOTING (inches)	THICKNESS OF FOOTING (inches)
1	12	6
2	15	6
3	18 23	8 ^g

For SI: 1 inch = 25.4 mm, 1 foot = 304.8 mm.

- a. Depth of footings shall be in accordance with Section 1809.4.
- b. The ground under the floor shall be permitted to be excavated to the elevation of the top of the footing.
- c. Interior stud-bearing walls shall be permitted to be supported by isolated footings. The footing width and length shall be twice the width shown in this table, and footings shall be spaced not more than 6 feet on center.
- d. See Section 1905 for additional requirements for concrete footings of structures assigned to Seismic Design Category C, D, E or F.
- e. For thickness of foundation walls, see Section 1807.1.6.
- f. ~~Footings shall be permitted to support a roof in addition to the stipulated number of floors. Footings supporting roof only shall be as required for supporting one floor. Footing projections shall not exceed the thickness of the footing.~~
- g. ~~Plain concrete footings for Group R-3 occupancies shall be permitted to be 6 inches thick.~~

1809.8 Plain concrete footings. The edge thickness of plain concrete footings supporting walls ~~of other than light-frame construction~~ shall be not less than 8 inches (203 mm) where placed on soil or rock.

Exception-Exceptions:

1. For plain concrete footings supporting Group R-3 occupancies, the edge thickness is permitted to be 6 inches (152 mm), provided that the footing does not extend beyond a distance greater than the thickness of the footing on either side of the supported wall.
2. The edge thickness of plain concrete footings shall be permitted to be designed in accordance with Section 1809.7.

1809.9 Masonry-unit footings. The design, materials and construction of masonry-unit footings shall comply with Sections 1809.9.1 and 1809.9.2, and the provisions of Chapter 21.

Exception: Where a specific design is not provided, masonry-unit footings shall be permitted to be designed in accordance with Section 1809.7 supporting walls of light-frame construction shall be permitted to be designed in accordance with Table 1809.7.

Reason Statement: *Light-frame construction* is only defined by the repetitive nature of its structural elements and has no tie to loading. This footing table is intended to only be applied to lightly loaded prescriptive construction, but the wording of the section currently allows any type of *light-frame construction*.

There are many buildings with very heavy foundation loads that meet the definition of *light-frame construction* and are not appropriate to place on the prescriptive foundations in Table 1809.7. This is also true with highly loaded shear walls. This proposal clarifies that the intent of these prescriptive provisions is tied with conventional-similar light-frame construction of Section 2308.

The limitations placed on these footings are taken from the limitations of *conventional light-frame construction* but also includes the tributary widths that are used in the IRC prescriptive footing tables. These limitations are necessary as AWC’s WFCM and AISI’s S230 allow higher snow load, wind load, and seismic design categories than are present in *conventional light-frame construction*. Additionally, no identified tributary width currently exists for the use of this table.

This table’s ability to be used with a roof in addition to the number of floors being supported is removed as when calculating the foundations - it was found not to conform to code limits for soil bearing. The similar table that existed in the 2012 IRC and its previous versions limited the number of stories of the building – not the number of floors supported. This change reduces the table from being able to support a 4-story building to a 3-story building, which aligns with the 2012 IRC foundation table as well as the conventional light-frame construction limitations. The only additional change needed to make the table work was for the width that supports a three-story building and the change aligns with the 2012 IRC footing table.

Section 1808.6 would still be applicable to expansive soils, so this table should not apply to those soils. However, other questionable soil will require a geotechnical investigation where the allowable vertical foundation bearing pressure could be determined to be at least 1,500psf to use this table.

The changes to 1809.8 and 1809.9 are necessary to invoke the same limitations as the base section where masonry and plain concrete footings are used.

The restriction of the footing projection thickness is taken from IRC limitations of the same thing.

This proposal is submitted by the ICC Building Code Action Committee (BCAC).

BCAC was established by the ICC Board of Directors in July 2011 to pursue opportunities to improve and enhance assigned International Codes or portions thereof. In 2020 and 2021 the BCAC has held several virtual meetings open to any interested party. In addition, there were numerous virtual Working Group meetings for the current code development cycle, which included members of the committee as well as interested parties. Related documents and reports are posted on the BCAC website at <https://www.iccsafe.org/products-and-services/i-codes/code-development/cs/building-code-action-committee-bcac/>.

Cost Impact: The code change proposal will increase the cost of construction

This proposal clarifies that the intent of the table is only to be applied to **lightly loaded** prescriptive construction, not for any type of *light-frame construction as stated in the 2021 IBC*. *Light-frame construction* is defined by the repetitive nature of its structural elements and has no tie to loading.

Clarifying the table limitations will ensure the table is not used for larger, more heavily-loaded light-frame structures that would overload the tabulated footing sizes, or in high-wind and high-seismic conditions where footings supporting the lateral force-resisting system need to be designed for such forces.

This code change proposal will increase the cost of construction by requiring non-prescriptive design of footings supporting structures that do not meet the clarified limitations.

S164-22

S165-22

IBC: 1809.14 (New), 1810.3.12

Proponents: Ronald LaPlante, Division of the State Architect, representing Federal Emergency Management Agency/Applied Technology Council - Seismic Code Support Committee (ron.laplante@dgs.ca.gov); Kelly Cobeen, representing Federal Emergency Management Agency/Applied Technology Council - Seismic Code Support Committee (kcobeen@wje.com); Michael Mahoney, representing FEMA (mike.mahoney@fema.dhs.gov)

2021 International Building Code

Add new text as follows:

1809.14 Grade beams. Grade beams shall comply with the provisions of ACI 318.

Exception: Grade Beams not subject to differential settlement exceeding one-fourth of the thresholds specified in ASCE 7 Table 12.13-3 and designed to resist the seismic load effects including overstrength factor in accordance with Section 2.3.6 or 2.4.5 of ASCE 7 need not comply with ACI 318 Section 18.13.3.1.

Revise as follows:

1810.3.12 Grade beams. Grade beams shall comply with the provisions of ACI 318.

Exception: Grade beams not subject to differential settlement exceeding one-fourth of the thresholds specified in ASCE 7 Table 12.13-3 and designed to resist the seismic load effects including overstrength factor in accordance with Section 2.3.6 or 2.4.5 of ASCE 7 need not comply with ACI 318 Section 18.13.3.1.

Reason Statement: The exception in IBC Section 1810.3.12 for grade beams in deep foundation systems is being modified as follows: 1) Clarify that it is only the ductile detailing provisions in ACI 318 Section 18.13.3.1 are exempt when the grade beams are designed for the overstrength factor and that all the other provision of ACI 318 are still applicable, such as durability, reinforcing steel cover, etc. 2) Further limit the exception to only be permissible when differential settlements are less than one-fourth of those in ASCE 7-22 Table 12.13-3 since ASCE 7-22 Section 12.13.9 exempts foundation elements from complying with deformation ductility requirements when they are less than this limit. This is needed to be clarified for deep foundation since ASCE 7-22 Section 12.13.9.3.1 permits downdrag of pile design to be based on significant differential settlement. Differential settlement exceeding this limit (one-fourth of those in ASCE 7 Table 12.13-3) may impose moments and shears in the grade beam that exceed those computed with the seismic load effects including overstrength factor, in which case the ductile detailing requirements for grade beams in ACI Section 18.13.3.1 would be required.

IBC Section 1809.14 is a new section to add the same grade beam provisions contained in the Deep Foundation Section 1810 to the Shallow Foundations Section 1809. The same provisions are applicable to both deep and shallow grade beam foundations.

Cost Impact: The code change proposal will increase the cost of construction

The code change proposal will not, in general, increase or decrease the overall cost of construction. These provisions provide alternatives and options for the designer to select the most economical approach to choose between ductile detailing (hoops and ties) or, perhaps, detail a larger foundation or more longitudinal reinforcement. For grade beams in deep foundations, this proposal limits the use of the exception to certain soil conditions which may have a slight cost impact.

S165-22

S166-22

IBC: 1810.2.2

Proponents: Daniel Stevenson, representing GeoCoalition; Lori Simpson, representing GeoCoalition (lsimpson@langan.com)

2021 International Building Code

Revise as follows:

1810.2.2 Stability. *Deep foundation* elements shall be braced to provide lateral stability in all directions. Three or more elements connected by a rigid cap shall be considered to be braced, provided that the elements are located in radial directions from the centroid of the group not less than 60 degrees (1 rad) apart. A two-element group in a rigid cap shall be considered to be braced along the axis connecting the two elements. Methods used to brace *deep foundation* elements shall be subject to the approval of the *building official*.

Deep foundation elements supporting walls shall be placed alternately in lines spaced not less than 1 foot (305 mm) apart and located symmetrically under the center of gravity of the wall load carried, unless effective measures are taken to provide for eccentricity and lateral forces, or the foundation elements are adequately braced to provide for lateral stability.

Exceptions:

1. Isolated cast-in-place *deep foundation* elements without lateral bracing shall be permitted where the least horizontal dimension is not less than 2 feet (610 mm), adequate lateral support in accordance with Section 1810.2.1 is provided for the entire height and analysis demonstrates that the element can support the required loads, including mislocations required by Section 1810.3.1.3, with neither harmful distortion nor instability in the structure~~the height does not exceed 12 times the least horizontal dimension.~~
2. A single row of *deep foundation* elements without lateral bracing is permitted for one- and two-family dwellings and lightweight construction not exceeding two *stories above grade plane* or 35 feet (10 668 mm) in *building height*, provided that the centers of the elements are located within the width of the supported wall.

Reason Statement:

- Element length (referred to in this code section as "height") alone is not an adequate indication of the need for deep foundation elements to be braced.
- Eliminating the 12 times the least horizontal dimension requirement will allow for greater economy by allowing for unbraced elements with greater lengths.
- Permitting elements to be unbraced based on length alone can result in unsafe conditions. Regardless of the element length, an analysis should be performed to determine if bracing is required. Research shows that shorter elements often have a greater need for bracing than longer elements. See attached white paper "Evaluating Lateral Bracing Code Requirements for Large Diameter Foundations", published by The Deep Foundations Institute (2021). The requirement to perform an analysis to determine if bracing is required will result in increased safety. Note the need for such an analysis is already implied by Section 1810.1.

<https://www.cdaccess.com/proposal/8661/25706/files/download/2945/>

Cost Impact: The code change proposal will decrease the cost of construction

This code change proposal will decrease the cost of construction by not forcing the use of bracing where analysis shows that bracing is not required.

S166-22

S167-22

IBC: 1810.3.2.8

Proponents: Daniel Stevenson, representing GeoCoalition (dstevenson@berkelapg.com); Lori Simpson, representing GeoCoalition (lsimpson@langan.com)

2021 International Building Code

Revise as follows:

1810.3.2.8 Justification of higher allowable stresses. Use of allowable stresses ~~greater than those specified in Section in table 1810.3.2.6 that must be justified in accordance with this section~~ shall be permitted where supporting data justifying such higher stresses is ~~filed with~~ submitted to and approved by the building official. Such substantiating data shall include the following:

1. A geotechnical investigation in accordance with Section 1803.
2. Load tests in accordance with Section 1810.3.3.1.2, regardless of the load supported by the element.

The design and installation of the deep foundation elements shall be under the direct supervision of a *registered design professional* knowledgeable in the field of soil mechanics and deep foundations who shall submit a report to the *building official* stating that the elements as installed satisfy the design criteria.

Reason Statement:

- This section as currently written could override the allowable stresses in Table 1810.3.2.6 when a pile passes a load test.
- Table 1810.3.2.6 references Section 1810.3.2.8, and Table 1810.3.2.6 references Table 1810.3.2.6, thereby creating a circular reference. This proposal eliminates the circular reference.
- Several foundation types in Table 1810.3.2.6 have multiple allowable stresses for the same material type. For example, Table 1810.3.2.6 allows for an allowable compressive stress of $0.5F_y$ for steel piles when justified in accordance with 1810.3.2.8, and $0.35F_y$ otherwise. This proposal is intended to make this clear.

Cost Impact: The code change proposal will not increase or decrease the cost of construction
This proposal is intended to clarify the code.

S167-22

S168-22

IBC: 1810.3.3.2

Proponents: Daniel Stevenson, representing GeoCoalition; Lori Simpson, representing GeoCoalition (lsimpson@langan.com)

2021 International Building Code

Revise as follows:

1810.3.3.2 Allowable lateral load. Where required by the design, the lateral load capacity of a single *deep foundation* element or a group thereof shall be determined by an *approved* method of analysis or by lateral load tests to not less than twice the proposed design working *load*. The resulting allowable lateral load shall not be more than one-half of the *load* that produces a gross lateral movement of 1 inch (25 mm) at the lower of the top of the foundation element and the ground surface, unless it can be shown that the predicted lateral movement shall cause neither harmful distortion of, nor instability in, the structure, nor cause any element to be loaded beyond its capacity. When piles are used in groups, group effects shall be evaluated in accordance with Section 1810.2.5.

Reason Statement:

- In the second sentence, "allowable load" is revised to "allowable lateral load" to clarify that the subject is allowable lateral load, and not allowable axial load.
- When a load test is performed on a single foundation element, engineers may not realize that the results usually need to be adjusted for elements used in groups. A sentence was added to the end of this section to clarify that group effects still must be evaluated for foundation elements used in groups.

Cost Impact: The code change proposal will not increase or decrease the cost of construction
This code change proposal only clarifies existing code requirements.

S168-22

S169-22

IBC: 1810.3.8

Proponents: Ronald LaPlante, Division of State Architect, representing Federal Emergency Management Agency/Applied Technology Council - Seismic Code Support Committee (ron.laplante@dgs.ca.gov); Kelly Cobeen, representing Federal Emergency Management Agency/Applied Technology Council - Seismic Code Support Committee (kcobeen@wje.com); Michael Mahoney, representing FEMA (mike.mahoney@fema.dhs.gov)

2021 International Building Code

Revise as follows:

1810.3.8 Precast concrete piles. Precast concrete piles shall be designed and detailed in accordance with ACI 318.

Exceptions:

1. For precast prestressed piles in *Seismic Design Category C*, the minimum volumetric ratio of spirals or circular hoops required by Section 18.13.5.10.4 of ACI 318 shall not apply in cases where the design includes full consideration of load combinations specified in ASCE 7, Section 2.3.6 or Section 2.4.5 and the applicable overstrength factor, Ω_0 . In such cases, minimum transverse reinforcement index shall be as specified in Section 13.4.5.6 of ACI 318.
2. For precast prestressed piles in *Seismic Design Categories D through F and in Site Class A, B, BC, C, CD, D or DE sites*, the minimum volumetric ratio of spirals or circular hoops required by Section 18.13.5.10.5(c) of ACI 318 shall not apply in cases where the design includes full consideration of load combinations specified in ASCE 7, Section 2.3.6 or Section 2.4.5 and the applicable overstrength factor, Ω_0 . In such cases, minimum transverse reinforcement shall be as specified in Section 13.4.5.6 of ACI 318.

Reason Statement: Precast piles in Seismic Design Category D through F and in Site Class E or F sites may be subject to significant lateral deformations as a result of site soils that are either liquefiable or not considered competent to provide lateral support to the pile. Pile confinement reinforcement is required in these conditions to provide the necessary ductile performance where flexural yielding may occur because of these incompetent soils. The soil induced movements are capable of imposing moments and curvature on the piles that exceed those determined with the load combinations with overstrength factor. As a result, this proposal does not permit the use of exception #2 for Site Class E or F sites in Seismic Design Categories D through F. This proposal does not extend this restriction to exception #1 for sites in Seismic Design Category C due to the lower ground motion intensity at these sites. This change is consistent with IBC Section 1810.3.9.4.2.2 and ACI 318-19 Section 18.13.5.5 and Table 18.13.5.7.1 which require more ductile detailing in cast-in-place piles in Site Class E and F sites.

Cost Impact: The code change proposal will increase the cost of construction

The code change proposal may result in a small increase in construction cost for precast piles in foundations on Site Class E and F by requiring more confinement ties.

S169-22

S170-22

IBC: 1810.3.9.2

Proponents: John-Jozef Proczka, representing Self (john-jozef.proczka@phoenix.gov)

2021 International Building Code

Revise as follows:

1810.3.9.2 Required reinforcement. Where subject to uplift or where the required moment strength determined using the load combinations of ASCE 7, Section 2.3 exceeds the design cracking moment determined in accordance with Section 1810.3.9.1 , cast-in-place deep foundations not enclosed by a structural steel pipe or tube shall be reinforced. Where reinforcement is required it shall be in compliance with Chapter 20 of ACI 318.

Reason Statement: This proposal will provide requirements for what form reinforcement must take when it is required. Currently there are no requirements, especially for seismic design category A and B and it leads to the question of what is meant by reinforcement. Can it be bamboo, aluminum, wood, steel? What ASTMs shall reinforcement conform to? Can it be prestressed? What is the required cover to protect the reinforcement from corrosion?

ACI 318 is not applicable to most deep foundations, but the basic form that reinforcement takes, as already robustly explored in ACI 318, should be applicable.

ACI 318 Chapter 20 contains:

- Required material properties (ASTMs)
- Design properties (modulus of elasticity, calculation of yield strength)
- Durability requirements (cover, prestressing encasement)

Cost Impact: The code change proposal will increase the cost of construction
This proposal will restrict the types of reinforcement that can be considered "reinforcement".

S170-22

S171-22

IBC: 1810.3.11.2

Proponents: Daniel Stevenson, representing GeoCoalition (dstevenson@berkelapg.com); Lori Simpson, representing GeoCoalition (lsimpson@langan.com)

2021 International Building Code

Revise as follows:

1810.3.11.2 Seismic Design Categories D through F. For structures assigned to *Seismic Design Category D, E or F, deep foundation* element resistance to uplift forces or rotational restraint shall be provided by anchorage into the pile cap, designed considering the combined effect of axial forces due to uplift and bending moments due to fixity to the pile cap. Anchorage shall develop not less than 25 percent of the strength of the element in tension. Anchorage into the pile cap shall comply with the following:

1. ~~In the case of~~ For elements required to resist uplift, the anchorage shall be capable of developing the least of the following:
 - 1.1. The nominal tensile strength of the longitudinal reinforcement in a concrete element.
 - 1.2. The nominal tensile strength of a steel element.
 - 1.3. The frictional force developed between the element and the soil multiplied by 1.3.

Exception: The anchorage is permitted to be designed to resist the axial tension force resulting from the seismic load effects including overstrength factor in accordance with Section 2.3.6 or 2.4.5 of ASCE 7.

2. ~~In the case of~~ For elements required to provide rotational restraint, the anchorage shall be designed to resist the axial and shear forces, and moments resulting from the seismic *load effects* including overstrength factor in accordance with Section 2.3.6 or 2.4.5 of ASCE 7 or the anchorage shall be capable of developing the full axial, bending and shear nominal strength of the element.
3. The connection between the pile cap and the steel H-piles or unfilled steel pipe piles in structures assigned to *Seismic Design Category D, E or F* shall be designed for a tensile force of not less than 10 percent of the pile compression capacity.

Exceptions:

1. Connection tensile capacity need not exceed the strength required to resist seismic *load effects* including overstrength of ASCE 7 Section 12.4.3 or 12.14.3.2.
2. Connections need not be provided where the foundation or supported structure does not rely on the tensile capacity of the piles for stability under the design seismic force.

Where the vertical lateral-force-resisting elements are columns, the pile cap flexural strengths shall exceed the column flexural strength. The connection between batter piles and pile caps shall be designed to resist the nominal strength of the pile acting as a short column. Batter piles and their connection shall be designed to resist forces and moments that result from the application of seismic *load effects* including overstrength factor in accordance with Section 2.3.6 or 2.4.5 of ASCE 7.

Reason Statement:

- The existing code language is confusing and can appear contradictory. For example, the requirements of "...not less than 25 percent of the strength of the element in tension", and then later "The nominal tensile strength..." appear contradictory if one does not realize that the more restrictive requirement is only for elements that are required to resist uplift forces. The revised phrases clarify that the more restrictive requirements in subsections 1 and 2 only apply to elements required to resist uplift forces or provide rotational restraint.
- ASCE section 12.13.6.5 is nearly identical to IBC 1810.3.11.2. ASCE 7 section 12.13.6.5 contains the sentence "For piles required to resist uplift or provide rotational restraint, anchorage into the pile cap shall comply with the following:". Changing the phrases "In the case of uplift" to "For piles required to resist uplift" and "In the case of rotational restraint" to "For piles required to provide rotational restraint" adds clarity creates more consistency between IBC and the referenced standard ASCE 7.

Cost Impact: The code change proposal will not increase or decrease the cost of construction

This proposal is a clarification of existing code requirements. However, it could potentially reduce the cost of construction in cases where the existing code language is misinterpreted.

S171-22

S172-22

IBC: 1810.4.5

Proponents: Daniel Stevenson, representing GeoCoalition (dstevenson@berkelapg.com); Lori Simpson, representing GeoCoalition (lsimpson@langan.com)

2021 International Building Code

Revise as follows:

1810.4.5 Vibratory driving. Vibratory drivers shall only be used to install *deep foundation* elements where the element load capacity is verified by load tests in accordance with Section 1810.3.3.1.2. ~~The installation of production elements shall be controlled according to power consumption, rate of penetration or other *approved* means that ensure element capacities equal or exceed those of the test elements.~~

Exceptions:

1. The pile installation is completed by driving with an impact hammer in accordance with Section 1810.3.3.1.1.
2. The pile is to be used only for lateral resistance.

The installation of production elements shall be controlled according to power consumption, rate of penetration or other *approved* means that ensure element capacities equal or exceed those of the test elements.

Reason Statement: The second sentence (The installation of...) has been moved to after the exception, to clarify that the exception only applies to the first sentence and not the second sentence. The requirements for the installation of production piles that are contained in the second sentence should still be applicable, even if an exception is used.

Cost Impact: The code change proposal will not increase or decrease the cost of construction. This proposal only clarifies existing code requirements.

S172-22

S173-22

IBC: 1901.2, SECTION 1907, 1907.1 (New), 1907.2 (New), 1907.1

Proponents: Mike Nugent, representing Building Code Action Committee (bcac@iccsafe.org); Stephen Szoke, representing American Concrete Institute (steve.szoke@concrete.org)

2021 International Building Code

Revise as follows:

1901.2 Plain and reinforced concrete. Structural concrete shall be designed and constructed in accordance with the requirements of this chapter and ACI 318 as amended in Section 1905 of this code. ~~Except for the provisions of Sections 1904 and 1907, the design and construction of slabs on grade shall not be governed by this chapter unless they transmit vertical loads or lateral forces from other parts of the structure to the soil.~~

SECTION 1907 MINIMUM SLAB PROVISIONS—SLABS-ON-GROUND

Add new text as follows:

1907.1 General. Non-structural slabs-on-ground shall comply with Section 1904 and this Section. Structural slabs-on-ground shall comply with all applicable provisions of this Chapter. Slabs-on-ground shall be considered structural where designed to one of the following:

1. Transmit loads or resist lateral forces from other parts of the structure to the soil.
2. Transmit loads or resist lateral forces from other parts of the structure to foundations
3. Serve as tributary area for resisting uplift or overturning forces.

1907.2 Thickness. The thickness of concrete floor slabs supported directly on the ground shall be not less than 3½ inches (89 mm).

Revise as follows:

~~1907.1~~ **1907.3 General- Vapor retarder.** ~~The thickness of concrete floor slabs supported directly on the ground shall be not less than 3½ inches (89 mm).~~ A 6-mil (0.006 inch; 0.15 mm) polyethylene vapor retarder with joints lapped not less than 6 inches (152 mm) shall be placed between the base course or subgrade and the concrete floor slab, or other *approved* equivalent methods or materials shall be used to retard vapor transmission through the floor slab.

Exception: A vapor retarder is not required:

- For detached structures accessory to occupancies in Group R-3, such as garages, utility buildings or other unheated facilities.
- For unheated storage rooms having an area of less than 70 square feet (6.5 m²) and carports attached to occupancies in Group R-3.
- For buildings of other occupancies where migration of moisture through the slab from below will not be detrimental to the intended occupancy of the building.
- For driveways, walks, patios and other flatwork that will not be enclosed at a later date.
- Where *approved* based on local site conditions.

Reason Statement: This proposal:

1. Renames Section 1907 to “Slabs-on-Ground” as this section is not applicable to interim floor slabs or other slabs not on ground.
2. Moves all slab-on-ground requirements into one section by eliminating text in section 1901.2
3. Clarifies scenarios where slabs-on-ground are structural, adding language that addresses slabs on ground used as part of a diaphragm systems, transferring loads to micro-piles, etc. and as dead weight to resist overturning or uplift forces.
4. The proposal divided the existing text of 1907.1 into two sections. 1907.2 for the thickness of concrete floor slabs and 1907.3 for Vapor retarder.

This proposal is submitted by the ICC Building Code Action Committee (BCAC).

BCAC was established by the ICC Board of Directors in July 2011 to pursue opportunities to improve and enhance assigned International Codes or portions thereof. In 2020 and 2021 the BCAC has held several virtual meetings open to any interested party. In addition, there were numerous virtual Working Group meetings for the current code development cycle, which included members of the committee as well as interested parties. Related documents and reports are posted on the BCAC website at <https://www.iccsafe.org/products-and-services/i-codes/code-development/cs/building-code-action-committee-bcac/>.

Cost Impact: The code change proposal will not increase or decrease the cost of construction
This code change is a clarification of the requirements

S173-22

S174-22

IBC: 1901.2, 1901.2.1 (New), ACI Chapter 35 (New), ASTM Chapter 35 (New)

Proponents: Stephen Szoke, representing American Concrete Institute (steve.szoke@concrete.org); Jerzy Zemajtis, representing NEx, An ACI Center of Excellence for Nonmetallic Building Materials (jerzy.zemajtis@nonmetallic.org); John Busel, representing American Composites Manufacturers Association (jbusel@acmanet.org); Scott Campbell, representing NRMCA (scampbell@nrmca.org); Doug Gremel, representing Owens Corning Infrastructure Solutions (douglas.gremel@owenscorning.com); Carl Larosche, representing ACI (clarosche@wje.com); William O'Donnell, representing DeSimone Consulting Engineers (william.odonnell@de-simone.com); Matthew D'Ambrosia, representing MJ2 Consulting (matt@mj2consulting.com); Keith Kesner, representing CVM (kkesner3006@gmail.com); antonio de luca, representing Thornton Tomasetti

2021 International Building Code

1901.2 Plain and reinforced concrete. Structural concrete shall be designed and constructed in accordance with the requirements of this chapter and ACI 318 as amended in Section 1905 of this code. Except for the provisions of Sections 1904 and 1907, the design and construction of slabs on grade shall not be governed by this chapter unless they transmit vertical *loads* or lateral forces from other parts of the structure to the soil.

Add new text as follows:

1901.2.1 Structural concrete with GFRP reinforcement. Cast-in-place structural concrete internally reinforced with glass fiber reinforced polymer (GFRP) reinforcement conforming to ASTM D7957 and designed in accordance with ACI CODE 440 shall be permitted only for structures assigned to Seismic Design Category A.

Add new standard(s) as follows:

ACI

American Concrete Institute
38800 Country Club Drive
Farmington Hills, MI 48331-3439

CODE 440-22

Structural Concrete Buildings Reinforced Internally with Fiber Reinforced Polymer (FRP) Bars – Code Requirements

ASTM

ASTM International
100 Barr Harbor Drive, P.O. Box C700
West Conshohocken, PA 19428

D7957/D7957M-17

Standard Specification for Solid Round Glass Fiber Reinforced Polymer Bars for Concrete Reinforcement

Staff Analysis: A review of the standard proposed for inclusion in the code, ACI CODE 440-22 Structural Concrete Buildings Reinforced Internally with Fiber Reinforced Polymer (FRP) Bars – Code Requirements, with regard to some of the key ICC criteria for referenced standards (Section 3.6 of CP#28) will be posted on the ICC website on or before March 16, 2022.

A review of the standard proposed for inclusion in the code, ASTM D7957/D7957M-17 Standard Specification for Solid Round Glass Fiber Reinforced Polymer Bars for Concrete Reinforcement, with regard to some of the key ICC criteria for referenced standards (Section 3.6 of CP#28) will be posted on the ICC website on or before March 16, 2022.

Reason Statement: This proposal adds a new referenced standard: ACI CODE 440-22: Structural Concrete Buildings Reinforced Internally with Fiber Reinforced Polymer (FRP) Bars – Code Requirements.

The addition of this new standard allows the design and construction of cast-in-place reinforced concrete using non-metallic reinforcement bars. Currently the design and construct requirements contained in the standard are limited to use in Seismic Design Category A. ACI Committee 440 developed this standard to provide for public health and safety by establishing minimum requirements for strength, stability, serviceability, durability, and integrity of GFRP reinforced concrete structures.

The standard not only provides a means of establishing minimum requirements for the design and construction of GFRP reinforced concrete, but for acceptance of design and construction of GFRP reinforced concrete structures by the building officials or their designated representatives.

The standard applies to GFRP reinforced concrete structures designed and constructed under the requirements of the general building code.

GFRP reinforced concrete is especially beneficial for satisfying a demand for improved resistance to corrosion in highly corrosive environments, such as reinforced concrete exposed to salt water, salt air, or de-icing salts.

This standard establishes minimum requirements for GFRP reinforced concrete in a similar fashion as ACI 318 Building Code Requirements for Structural Concrete establishes minimum requirements for structural concrete reinforced with steel reinforcement. A separate standard is needed, as GFRP reinforcement behaves differently than steel reinforcement.

Currently GFRP is accepted for use to reinforce highway bridge decks. Acceptance is primarily in areas where deicing salts are used on the roads and cause severe corrosion to conventional steel reinforcement. This proposed change provides minimum requirements for other applications

where GFRP reinforced concrete is being considered, such as marine and coastal structures, parking garages, water tanks, and structures supporting MRI machines. Design reasons to use GFRP bars in structures are: resistance to corrosion in the presence of chloride ions, lack of interference with electromagnetic fields, and low thermal conductivity.

Currently the standard prohibits the use concrete internally reinforced with GFRP for applications where fire resistance ratings are required. Chapter 6 of the International Building code cites applications for floors, roofs, walls, partitions and primary and secondary structural frames where a fire resistance ratings are not required.

The code requirements may be viewed at: <https://www.concrete.org/publications/standards/upcomingstandards.aspx>

Cost Impact: The code change proposal will not increase or decrease the cost of construction

This proposal adds alternative materials for the design and construction of reinforced structural concrete in Seismic Design Category A and does not preclude the use of conventional reinforced concrete. Thus there is no cost impact.

S174-22

S175-22

IBC: 1901.2, 1902.1, 1902.1.1, 1902.1.2, 1901.3, 1903.2, 1903.3, 1903.4, SECTION 1905, 1905.1, 1905.1.1, SECTION 202 (New), SECTION 202, 1905.1.2, 1905.1.3, 1905.1.4, 1905.3.1 (New), 1905.1.5, 1905.1.6, 1905.5.1 (New), 1905.1.7, 1905.6.1 (New), 1905.6.2 (New), 1905.1.8, 1905.7.1 (New), 1905.7.2 (New)

Proponents: Mike Nugent, representing Building Code Action Committee (bcac@iccsafe.org); Kelly Cobeen, representing Federal Emergency Management Agency/Applied Technology Council - Seismic Code Support Committee (kcobeen@wje.com); Michael Mahoney, representing FEMA (mike.mahoney@fema.dhs.gov); Kerry Sutton, representing American Concrete Institute (kerry.sutton@concrete.org)

2021 International Building Code

Revise as follows:

1901.2 Plain and reinforced concrete. Structural concrete shall be designed and constructed in accordance with the requirements of this chapter and ACI 318 as ~~amended~~ supplemented in Section 1905 of this code. Except for the provisions of Sections 1904 and 1907, the design and construction of slabs on grade shall not be governed by this chapter unless they transmit vertical *loads* or lateral forces from other parts of the structure to the soil.

1902.1 General. Coordination of terminology used in ACI 318 and ASCE 7 shall be in accordance with Sections 1902.1.1 ~~and 1902.1.2~~.

1902.1.1 Design displacement . Design displacement shall be the Design Earthquake Displacement, δ_{DE} , defined in ASCE 7 Section 12.8.6.3. For diaphragms that can be idealized as rigid in accordance with ASCE 7 Section 12.3.1.2, δ_{pi} displacement due to diaphragm deformation corresponding to the design earthquake, is permitted to be taken as zero. Design displacement at each level shall be the total lateral deflection at the level calculated for the design earthquake using the procedures defined in Section 12.8.6 of ASCE 7.

Delete without substitution:

~~**1902.1.2 Special structural wall.** Special structural walls made of cast-in-place or precast concrete shall comply with the requirements of Sections 18.2.4 through 18.2.8, 18.10 and 18.11 of ACI 318, as applicable, in addition to the requirements for *ordinary reinforced concrete structural walls* or *ordinary precast structural walls*, as applicable. Where ASCE 7 refers to a "special reinforced concrete shear wall," it shall be deemed to mean a "special structural wall."~~

Revise as follows:

1901.3 Anchoring to concrete. Anchoring to concrete shall be in accordance with ACI 318 as ~~amended~~ supplemented in Section 1905, and applies to cast-in (headed bolts, headed studs and hooked J- or L-bolts), post-installed expansion (torque-controlled and displacement-controlled), undercut, screw, and adhesive anchors.

Delete without substitution:

~~**1903.2 Special inspections.** Where required, special inspections and tests shall be in accordance with Chapter 17.~~

Revise as follows:

~~**1903.2**~~ **1903.3 Glass fiber-reinforced concrete.** Glass fiber-reinforced concrete (GFRC) and the materials used in such concrete shall be in accordance with the PCI MNL 128 standard.

~~**1903.3**~~ **1903.4 Flat wall insulating concrete form (ICF) systems.** Insulating concrete form material used for forming flat concrete walls shall conform to ASTM E2634.

SECTION 1905

SEISMIC REQUIREMENTS MODIFICATIONS TO ACI 318

1905.1 General. In addition to the provisions of ACI 318, structural concrete shall comply with the requirements of Section 1905.
~~The text of ACI 318 shall be modified as indicated in Sections 1905.1.1 through 1905.1.8.~~

~~**1905.2**~~ ~~**1905.1.1 ACI 318, Section 23.**~~ Modify existing definitions and add the following definitions to ACI 318, Section 2.3.

Add new definition as follows:

CAST-IN-PLACE CONCRETE EQUIVALENT DIAPHRAGM. A cast-in-place noncomposite topping slab diaphragm, as defined in Section 18.12.5, or a diaphragm constructed with precast concrete components that uses closure strips between precast components with detailing that meets the requirements of ACI 318 for the *Seismic Design Category* of the structure.

Revise as follows:

DETAILED PLAIN CONCRETE STRUCTURAL WALL. A wall complying with the requirements of Chapter 14, and Section 1905.5 of the *International Building Code* including 14.6.2.

ORDINARY STRUCTURAL PLAIN CONCRETE STRUCTURAL WALL. A wall complying with the requirements of Chapter 14, *excluding* 14.6.2.

Add new definition as follows:

PRECAST CONCRETE DIAPHRAGM. A diaphragm constructed with precast concrete components, with or without a cast-in-place topping, that includes the use of discrete connectors or joint reinforcement to transmit diaphragm forces.

Delete without substitution:

1905.1.2 ACI 318, Section 1821. Modify ACI 318 Sections 18.2.1.2 and 18.2.1.6 to read as follows:

- ~~• 18.2.1.2—Structures assigned to Seismic Design Category A shall satisfy requirements of Chapters 1 through 17 and 19 through 26; Chapter 18 does not apply. Structures assigned to Seismic Design Category B, C, D, E or F shall satisfy 18.2.1.3 through 18.2.1.7, as applicable. Except for structural elements of plain concrete complying with Section 1905.1.7 of the International Building Code, structural elements of plain concrete are prohibited in structures assigned to Seismic Design Category C, D, E or F.~~
- ~~• 18.2.1.6—Structural systems designated as part of the seismic force-resisting system shall be restricted to those permitted by ASCE 7. Except for Seismic Design Category A, for which Chapter 18 does not apply, the following provisions shall be satisfied for each structural system designated as part of the seismic force-resisting system, regardless of the seismic design category:
 - (a) Ordinary moment frames shall satisfy 18.3.
 - (b) Ordinary reinforced concrete structural walls and ordinary precast structural walls need not satisfy any provisions in Chapter 18.
 - (c) Intermediate moment frames shall satisfy 18.4.
 - (d) Intermediate precast structural walls shall satisfy 18.5.
 - (e) Special moment frames shall satisfy 18.6 through 18.9.
 - (f) Special structural walls shall satisfy 18.10.
 - (g) Special structural walls constructed using precast concrete shall satisfy 18.11.~~

~~Special moment frames and special structural walls shall also satisfy 18.2.4 through 18.2.8.~~

Revise as follows:

1905.3 1905.1.3 Intermediate precast structural walls ACI 318, Section 185. Intermediate precast structural walls shall comply with Section 18.5 of ACI 318 and this section.

Modify ACI 318, Section 18.5 by adding new Section 18.5.2.2 and renumbering existing Sections 18.5.2.2 and 18.5.2.3 to become 18.5.2.3 and 18.5.2.4, respectively.

- ~~• 18.5.2.2—Connections that are designed to yield shall be capable of maintaining 80 percent of their design strength at the deformation induced by the design displacement or shall use Type 2 mechanical splices.~~
- 18.5.2.3—Elements of the connection that are not designed to yield shall develop at least $1.5 S_y$.
- 18.5.2.4—In structures assigned to SDG D, E or F, wall piers shall be designed in accordance with 18.10.8 or 18.14 in ACI 318.

Delete without substitution:

1905.1.4 ACI 318, Section 1811. Modify ACI 318, Section 18.11.2.1 to read as follows:

- ~~• 18.11.2.1—Special structural walls constructed using precast concrete shall satisfy all the requirements of 18.10 for cast-in-place special structural walls in addition to 18.5.2.~~

Add new text as follows:

1905.3.1 Connections designed to yield. Connections that are designed to yield shall be capable of maintaining 80 percent of their design strength at the deformation induced by the design displacement or shall use Type 2 mechanical splices.

Revise as follows:

1905.4 1905.1.5 Foundations designed to resist earthquake forces ACI 318, Section 181311. Foundations resisting earthquake-induced forces or transferring earthquake-induced forces between a structure and ground shall comply with the requirements of 18.13 and other applicable provisions of ACI 318 unless modified by Chapter 18 of the International Building Code.

~~Modify ACI 318, Section 18.13.1.1 to read as follows:~~

- ~~• 18.13.1.1—Foundations resisting earthquake-induced forces or transferring earthquake-induced forces between a structure and ground~~

shall comply with the requirements of 18.13 and other applicable provisions of ACI 318 unless modified by Chapter 18 of the International Building Code.

1905.5 ~~1905.1.6~~ Detailed plain concrete structural walls. ACI 318, Section 14.6. Detailed plain concrete structural walls are walls conforming to the requirements of ordinary plain concrete structural walls and Section 1905.5.1 of the *International Building Code*.

Modify ACI 318, Section 14.6 by adding new Section 14.6.2 to read as follows:

- ~~14.6.2—Detailed plain concrete structural walls.~~
- ~~14.6.2.1—Detailed plain concrete structural walls are walls conforming to the requirements of ordinary structural plain concrete walls and 14.6.2.2.~~
- ~~14.6.2.2—Reinforcement shall be provided as follows:~~

(a) Vertical reinforcement of at least 0.20 square inch (129 mm²) in cross-sectional area shall be provided continuously from support to support at each corner, at each side of each opening and at the ends of walls. The continuous vertical bar required beside an opening is permitted to substitute for one of the two No. 5 bars required by 14.6.1.

(b) Horizontal reinforcement at least 0.20 square inch (129 mm²) in cross-sectional area shall be provided:

1. Continuously at structurally connected roof and floor levels and at the top of walls.

2. At the bottom of load-bearing walls or in the top of foundations where doweled to the wall.

3. At a maximum spacing of 120 inches (3048 mm).

Reinforcement at the top and bottom of openings, where used in determining the maximum spacing specified in Item 3 above, shall be continuous in the wall.

Add new text as follows:

1905.5.1 Reinforcement. Reinforcement shall be provided as follows:

- Vertical reinforcement of at least 0.20 square inch (129 mm²) in cross-sectional area shall be provided continuously from support to support at each corner, at each side of each opening, and at the ends of walls. The continuous vertical bar required beside an opening is permitted to substitute for one of the two No. 5 bars required by 14.6.1.
- Horizontal reinforcement at least 0.20 square inch (129 mm²) in cross-sectional area shall be provided:
 1. Continuously at structurally connected roof and floor levels and at the top of walls.
 2. At the bottom of load-bearing walls or in the top of foundations where doweled to the wall.
 3. At a maximum spacing of 120 inches (3048 mm).

Reinforcement at the top and bottom of openings, where used in determining the maximum spacing specified in Item 3 above, shall be continuous in the wall.

Revise as follows:

1905.6 ~~1905.1.7~~ Structural plain concrete. ACI 318, Section 14.1.4. Structural plain concrete elements shall comply with this section in lieu of Section 14.1.4 of ACI 318. Delete ACI 318, Section 14.1.4 and replace with the following:

- ~~14.1.4—Plain concrete in structures assigned to Seismic Design Category C, D, E or F.~~
- ~~14.1.4.1—Structures assigned to Seismic Design Category C, D, E or F shall not have elements of structural plain concrete, except as follows:~~
 - ~~Structural plain concrete basement, foundation or other walls below the base as defined in ASCE 7 are permitted in detached one- and two-family dwellings three stories or less in height constructed with stud-bearing walls. In dwellings assigned to Seismic Design Category D or E, the height of the wall shall not exceed 8 feet (2438 mm), the thickness shall be not less than 7½ inches (190 mm), and the wall shall retain no more than 4 feet (1219 mm) of unbalanced fill. Walls shall have reinforcement in accordance with 14.6.1.~~
 - ~~Isolated footings of plain concrete supporting pedestals or columns are permitted, provided the projection of the footing beyond the face of the supported member does not exceed the footing thickness.~~

Exception: In detached one- and two-family dwellings three stories or less in height, the projection of the footing beyond the face of the supported member is permitted to exceed the footing thickness.
 - ~~Plain concrete footings supporting walls are permitted, provided the footings have at least two continuous longitudinal reinforcing bars. Bars shall not be smaller than No. 4 and shall have a total area of not less than 0.002 times the gross cross-sectional area of the footing. For footings that exceed 8 inches (203 mm) in thickness, a minimum of one bar shall be provided at the top and bottom of the footing. Continuity of reinforcement shall be provided at corners and intersections.~~

Exceptions:

- ~~1. In Seismic Design Categories A, B and C, detached one- and two-family dwellings three stories or less in height constructed with stud-bearing walls are permitted to have plain concrete footings without longitudinal reinforcement.~~
- ~~2. For foundation systems consisting of a plain concrete footing and a plain concrete stemwall, a minimum of one bar shall be provided at the top of the stemwall and at the bottom of the footing.~~
- ~~3. Where a slab on ground is cast monolithically with the footing, one No. 5 bar is permitted to be located at either the top of the slab or bottom of the footing.~~

Add new text as follows:

1905.6.1 Seismic Design Categories A and B. In structures assigned to Seismic Design Category A or B, detached one- and two-family dwellings three stories or less in height constructed with stud-bearing walls are permitted to have plain concrete footings without longitudinal reinforcement.

1905.6.2 Seismic Design Categories C, D, E and F. Structures assigned to Seismic Design Category C, D, E or F shall not have elements of structural plain concrete, except as follows:

- Structural plain concrete basement, foundation or other walls below the base as defined in ASCE/SEI 7 are permitted in detached one- and two-family dwellings three stories or less in height constructed with stud-bearing walls. In dwellings assigned to Seismic Design Category D or E, the height of the wall shall not exceed 8 feet (2438 mm), the thickness shall be not less than $7\frac{1}{2}$ inches (190 mm), and the wall shall retain no more than 4 feet (1219 mm) of unbalanced fill. Walls shall have reinforcement in accordance with 14.6.1.
- Isolated footings of plain concrete supporting pedestals or columns are permitted, provided the projection of the footing beyond the face of the supported member does not exceed the footing thickness.

Exception: In detached one- and two-family dwellings three stories or less in height, the projection of the footing beyond the face of the supported member is permitted to exceed the footing thickness.

- Plain concrete footings supporting walls are permitted, provided the footings have at least two continuous longitudinal reinforcing bars. Bars shall not be smaller than No. 4 and shall have a total area of not less than 0.002 times the gross cross-sectional area of the footing. For footings that exceed 8 inches (203 mm) in thickness, a minimum of one bar shall be provided at the top and bottom of the footing. Continuity of reinforcement shall be provided at corners and intersections.

Exceptions:

1. Where assigned to Seismic Design Category C, detached one- and two-family dwellings three stories or less in height constructed with stud-bearing walls are permitted to have plain concrete footings without longitudinal reinforcement.
2. For foundation systems consisting of a plain concrete footing and a plain concrete stemwall, a minimum of one bar shall be provided at the top of the stemwall and at the bottom of the footing.
3. Footings cast monolithically with a slab-on-ground shall have not fewer than one No. 4 bar at the top and bottom of the footing or one No. 5 bar or two No. 4 bars in the middle third of the footing depth.

Revise as follows:

1905.7 1905.1.8 Design requirements for anchors ACI-318, Section 17.23. Modify ACI-318 Sections 17.10.5.2, 17.10.5.3(d) and 17.10.6.2 to read as follows:

- 17.10.5.2 — ~~Where the tensile component of the strength-level earthquake force applied to anchors exceeds 20 percent of the total factored anchor tensile force associated with the same load combination, anchors and their attachments shall be designed in accordance with 17.10.5.3. The anchor design tensile strength shall be determined in accordance with 17.10.5.4.~~

~~**Exception:** Anchors designed to resist wall out-of-plane forces with design strengths equal to or greater than the force determined in accordance with ASCE 7 Equation 12.11-1 or 12.14-10 shall be deemed to satisfy Section 17.10.5.3(d).~~

- 17.10.5.3(d) — ~~The anchor or group of anchors shall be designed for the maximum tension obtained from design load combinations that include E, with E increased by Ω_p . The anchor design tensile strength shall be calculated from 17.10.5.4.~~
- 17.10.6.2 — ~~Where the shear component of the strength-level earthquake force applied to anchors exceeds 20 percent of the total factored anchor shear force associated with the same load combination, anchors and their attachments shall be designed in accordance with 17.10.6.3. The anchor design shear strength for resisting earthquake forces shall be determined in accordance with 17.7.~~

Exceptions:

~~1. For the calculation of the in-plane shear strength of anchor bolts attaching wood sill plates of bearing or nonbearing walls of light-frame wood structures to foundations or foundation stem walls, the in-plane shear strength in accordance with 17.7.2 and 17.7.3 need not be computed and 17.10.6.3 shall be deemed to be satisfied provided all of the following are met:~~

~~1.1. The allowable in-plane shear strength of the anchor is determined in accordance with ANSI/AWC NDS Table 12E for lateral design values parallel to grain.~~

~~1.2. The maximum anchor nominal diameter is $\frac{5}{8}$ inch (16 mm).~~

~~1.3. Anchor bolts are embedded into concrete a minimum of 7 inches (178 mm).~~

~~1.4. Anchor bolts are located a minimum of $1\frac{3}{4}$ inches (45 mm) from the edge of the concrete parallel to the length of the wood sill plate.~~

~~1.5. Anchor bolts are located a minimum of 15 anchor diameters from the edge of the concrete perpendicular to the length of the wood sill plate.~~

~~1.6. The sill plate is 2-inch (51 mm) or 3-inch (76 mm) nominal thickness.~~

~~2. For the calculation of the in-plane shear strength of anchor bolts attaching cold-formed steel track of bearing or nonbearing walls of light-frame construction to foundations or foundation stem walls, the in-plane shear strength in accordance with 17.7.2 and 17.7.3 need not be computed and 17.10.6.3 shall be deemed to be satisfied provided all of the following are met:~~

~~Allowable in-plane shear strength of exempt anchors, parallel to the edge of concrete, shall be permitted to be determined in accordance with AISI S100 Section J3.3.1.~~

~~2.1. The maximum anchor nominal diameter is $\frac{5}{8}$ inch (16 mm).~~

~~2.2. Anchors are embedded into concrete a minimum of 7 inches (178 mm).~~

~~2.3. Anchors are located a minimum of $1\frac{3}{4}$ inches (45 mm) from the edge of the concrete parallel to the length of the track.~~

~~2.4. Anchors are located a minimum of 15 anchor diameters from the edge of the concrete perpendicular to the length of the track.~~

~~2.5. The track is 33 to 68 mil (0.84 mm to 1.73 mm) designation thickness.~~

~~3. In light-frame construction bearing or nonbearing walls, shear strength of concrete anchors less than or equal to 1 inch [25 mm] in diameter attaching sill plate or track to foundation or foundation stem wall need not satisfy 17.10.6.3(a) through (c) when the design strength of the anchors is determined in accordance with 17.7.2.1(c).~~

Add new text as follows:

1905.7.1 Anchors in tension. The following exception is permitted to ACI 318 Section 17.10.5.2:

Exception: Anchors designed to resist wall out-of-plane forces with *design strengths* equal to or greater than the force determined in accordance with ASCE/SEI 7 equation 12.11-1 or 12.14-1 shall be deemed to satisfy Section 17.10.5.3(d) of ACI 318.

1905.7.2 Anchors in shear. The following exceptions are permitted to ACI 318 Section 17.10.6.2:

Exceptions:

1. For the calculation of the in-plane shear strength of anchor bolts attaching wood sill plates of bearing or nonbearing walls of light-frame wood structures to foundations or foundation stemwalls, the in-plane shear strength in accordance with 17.7.2 and 17.7.3 need not be computed and 17.10.6.3 of ACI 318 shall be deemed to be satisfied provided all of the following are met:

1.1. The allowable in-plane shear strength of the anchor is determined in accordance with ANSI/AWC NDS Table 12E for lateral design values parallel to grain.

1.2. The maximum anchor nominal diameter is $\frac{5}{8}$ inch (16 mm).

1.3. Anchor bolts are embedded into concrete a minimum of 7 inches (178 mm).

1.4. Anchor bolts are located a minimum of $1\frac{3}{4}$ inches (45 mm) from the edge of the concrete parallel to the length of the wood sill plate.

1.5. Anchor bolts are located a minimum of 15 anchor diameters from the edge of the concrete perpendicular to the length of the wood sill plate.

1.6. The sill plate is 2-inch (51 mm) or 3-inch (76 mm) nominal thickness.

2. For the calculation of the in-plane shear strength of anchor bolts attaching cold-formed steel track of bearing or nonbearing walls of light-frame construction to foundations or foundation stemwalls, the in-plane shear strength in accordance with 17.7.2 and 17.7.3 need not be computed and 17.10.6.3 shall be deemed to be satisfied provided all of the following are met:

Allowable in-plane shear strength of exempt anchors, parallel to the edge of concrete, shall be permitted to be determined in accordance with AISI S100 Section J3.3.1.

2.1. The maximum anchor nominal diameter is $\frac{5}{8}$ inch (16 mm).

2.2. Anchors are embedded into concrete a minimum of 7 inches (178 mm).

2.3. Anchors are located a minimum of $1\frac{3}{4}$ inches (45 mm) from the edge of the concrete parallel to the length of the track.

2.4. Anchors are located a minimum of 15 anchor diameters from the edge of the concrete perpendicular to the length of the track.

2.5. The track is 33 to 68 mil (0.84 mm to 1.73 mm) designation thickness.

3. In light-frame construction bearing or nonbearing walls, shear strength of concrete anchors less than or equal to 1 inch [25 mm] in diameter attaching sill plate or track to foundation or foundation stemwalls need not satisfy 17.10.6.3(a) through (c) when the design strength of the anchors is determined in accordance with 17.7.2.1(c).

Reason Statement: This proposal makes a conceptual change in Section 1905, without introducing any substantive change. The section is reformatted so that, instead of amending certain sections of ACI 318 19, it contains provisions that are supplemental to those of ACI 318-19. The new format is believed to be more user-friendly. As part of this format change existing provisions have been relocated to the following new subsections: 1905.3.1, 1905.5.1, 1905.6.1, 1905.7.1, and 1905.7.2.

1901.2, 1901.3 - The changes reflect the conceptual change in section 1905.

1902.1 - The two existing subsections are deleted as being unnecessary. The new Subsection 1902.1 .1 is added in view of the introduction of Design Earthquake displacement in ACE 7-22, which includes diaphragm displacement under the Design Earthquake. To avoid unnecessary calculations, the latter is permitted to be taken equal to zero for diaphragms that can be idealized as rigid.

1903.2 (old numbering) - This section is deleted because it is a repeat of Section 1901.6.

1903.2 - This is essentially the correction of an error. The 2021 IBC already refers to PCI 128-19 *Specification for Glass Fiber Reinforced Concrete Panels* in chapter 35. However, Section 1903.3, now 1903.2, still refers to the old PCI MNL 128, which was a recommended practice document, not a standard.

1905.1 - The language implements the conceptual change made to Section 1905

1905.2 - The two new definitions are introduced because they have been added to Chapter 14 of ASCE 7-22, which will not be adopted by the 2024 IBC.

1905.1 .2 (old numbering) - This is deleted as being unnecessary.

1905.3 - Deletions and additions implement the conceptual change made to Section 1905.

1905.1 .4 (old numbering) - This is deleted as being unnecessary.

1905.4 - Additions and deletions implement the conceptual change made to Section 1905

1905.5 - Additions and deletions implement the conceptual change made to Section 1905. The remaining text of 1905.5 is improved for ease of use.

1905.6 - In addition to reflecting the conceptual change mentioned above, changes have been made to correct a structural problem with the existing section. The section is applicable to SDC C, D, E, and F structures. Yet, there is an exception made for SDC A, B structures. This has now been straightened out.

1905.7 - In addition to implementing the conceptual change made to Section 1905, much unnecessary text is deleted to produce a much more streamlined section.

This proposal is submitted by the ICC Building Code Action Committee (BCAC).

BCAC was established by the ICC Board of Directors in July 2011 to pursue opportunities to improve and enhance assigned International Codes or

portions thereof. In 2020 and 2021 the BCAC has held several virtual meetings open to any interested party. In addition, there were numerous virtual Working Group meetings for the current code development cycle, which included members of the committee as well as interested parties. Related documents and reports are posted on the BCAC website at <https://www.iccsafe.org/products-and-services/i-codes/code-development/cs/building-code-action-committee-bcac/>.

Cost Impact: The code change proposal will not increase or decrease the cost of construction
No substantive change has been made in the entire chapter.

S175-22

S176-22

IBC: 1901.5

Proponents: Stephen Szoke, representing American Concrete Institute (steve.szoke@concrete.org)

2021 International Building Code

Delete without substitution:

~~1901.5 Construction documents. The construction documents for structural concrete construction shall include:~~

- ~~1. The specified compressive strength of concrete at the stated ages or stages of construction for which each concrete element is designed.~~
- ~~2. The specified strength or grade of reinforcement.~~
- ~~3. The size and location of structural elements, reinforcement and anchors.~~
- ~~4. Provision for dimensional changes resulting from creep, shrinkage and temperature.~~
- ~~5. The magnitude and location of prestressing forces.~~
- ~~6. Anchorage length of reinforcement and location and length of lap splices.~~
- ~~7. Type and location of mechanical and welded splices of reinforcement.~~
- ~~8. Details and location of contraction or isolation joints specified for plain concrete.~~
- ~~9. Minimum concrete compressive strength at time of posttensioning.~~
- ~~10. Stressing sequence for posttensioning tendons.~~
- ~~11. For structures assigned to Seismic Design Category D, E or F, a statement if slab on grade is designed as a structural diaphragm.~~

Reason Statement: This proposal removes truncated list of items to be cited in construction documents, thereby removing inconsistencies between ACI 318 and the IBC. Further, this proposal eliminates the problems associated with maintaining lists in both the IBC and 318. Since IBC Section [A] 102.4.1 Conflicts. States: "Where conflicts occur between provisions of this code and referenced codes and standards, the provisions of this code shall apply," the full list of items to appear in construction documents as required by ACI 318 is not applicable and only the truncated list in the IBC applies.

This section provides no benefit to the user, but simply creates conflicts and confusion. Except for the required related to fire performance of fireplaces in Section 2111 Masonry Fireplaces, there is no comparable list of requirements in Chapter 21 Masonry. The requirements for items to be included in the construction documents for masonry are only contained in the referenced standards: The Masonry Society 402—2016: Building Code for Masonry Structures and 602—2016: Specification for Masonry Structures, avoiding conflicts and confusion. Similarly, except for some specific information exclusive to steel joists and wood trusses, the building code defers to the appropriate reference standards. The same should be applicable for structural concrete construction.

ACI recommends approval as submitted to avoid conflicts and confusion and to eliminate the problems of trying to maintain identical lists in multiple documents. Should a truncated list be beneficial for reference purposes, such a truncated list could be published in the commentary to the IBC, but not as code requirements that deviate from ACI 318.

Cost Impact: The code change proposal will not increase or decrease the cost of construction. There is no change to the design or construction requirements.

S176-22

S177-22

IBC: 1903.3, 1903.4 (New), 1903.4, ASTM Chapter 35 (New)

Proponents: Stephen Szoke, representing American Concrete Institute (steve.szoke@concrete.org); Scott Campbell, representing NRMCA (scampbell@nrmca.org); John Busel, representing American Composites Manufacturers Association (jbusel@acmanet.org); Doug Gremel, representing Owens Corning Infrastructure Solutions (douglas.gremel@owenscorning.com); Jerzy Zemajtis, NEx, An ACI Center of Excellence for Nonmetallic Building Materials, representing NEx, An ACI Center of Excellence for Nonmetallic Building Materials (jerzy.zemajtis@nonmetallic.org)

2021 International Building Code

1903.3 Glass fiber-reinforced concrete. *Glass fiber-reinforced concrete (GFRC) and the materials used in such concrete shall be in accordance with the PCI MNL 128 standard.*

Add new text as follows:

1903.4 Glass fiber reinforced polymer bars. Glass fiber reinforced polymer (GFRP) bars used as concrete reinforcement shall conform to ASTM D7957.

Revise as follows:

~~1903.4~~ **1903.5 Flat wall insulating concrete form (ICF) systems.** Insulating concrete form material used for forming flat concrete walls shall conform to ASTM E2634.

Add new standard(s) as follows:

ASTM

ASTM International
100 Barr Harbor Drive, P.O. Box C700
West Conshohocken, PA 19428

D7957/D7957M-2017

Standard Specification for Solid Round Glass Fiber Reinforced Polymer Bars for Concrete Reinforcement

Staff Analysis: A review of the standard proposed for inclusion in the code, ASTM D7957/D7957M-2017 Standard Specification for Solid Round Glass Fiber Reinforced Polymer Bars for Concrete Reinforcement, with regard to some of the key ICC criteria for referenced standards (Section 3.6 of CP#28) will be posted on the ICC website on or before March 16, 2022.

Reason Statement: This code change adds another type of reinforcement bars, glass fiber reinforced polymer bars. This makes the IBC more current and reflects technological advancements being integrated into standards. GFRP bars are particularly beneficial where a high degree of corrosion resistance is required.

This proposal is recommended so that new materials currently being used in concrete construction are clearly permitted in the International Building Code where qualified by compliance with an appropriate standard specification.

Cost Impact: The code change proposal will not increase or decrease the cost of construction. The proposal allows an additional type of reinforcement bars for use in concrete.

S177-22

S178-22

IBC: [BS] 202, SECTION 202, SECTION 202 (New), TABLE 1903.5.1 (New), 1903.5.2 (New), 1903.5 (New), 1903.5.1 (New), 2103.1.2 (New), 2205.3 (New), 2205.3.1 (New), 2205.3.2 (New), TABLE 2205.3.3 (New), 2303.8 (New), 2403.6 (New), 2205.3.3 (New), ASTM Chapter 35 (New), ISO Chapter 35 (New)

Proponents: Weby Bowles, representing New Buildings Institute (weby@newbuildings.org); Kimberly Cheslak, NBI, representing NBI (kim@newbuildings.org); jim edelson, representing NBI (jim@newbuildings.org)

Add new definition as follows:

CONCRETE, LIGHTWEIGHT. Concrete containing lightweight aggregate and having an equilibrium density determined by ASTM C567.

2021 International Building Code

Revise as follows:

[BS] **CONCRETE.** Mixture of cementitious material, fine aggregate, coarse aggregate and water, with or without admixture.

Carbonate aggregate. Concrete made with aggregates consisting mainly of calcium or magnesium carbonate, such as limestone or dolomite, and containing 40 percent or less quartz, chert or flint.

Cellular. A lightweight insulating concrete made by mixing a preformed foam with Portland cement slurry and having a dry unit weight of approximately 30 pcf (480 kg/m³).

Lightweight aggregate. Concrete made with aggregates of expanded clay, shale, slag or slate or sintered fly ash or any natural lightweight aggregate meeting ASTM C330 and possessing equivalent fire-resistance properties and weighing 85 to 115 pcf (1360 to 1840 kg/m³).

Perlite. A lightweight insulating concrete having a dry unit weight of approximately 30 pcf (480 kg/m³) made with perlite concrete aggregate. Perlite aggregate is produced from a volcanic rock which, when heated, expands to form a glass-like material of cellular structure.

Sand-lightweight. Concrete made with a combination of expanded clay, shale, slag, slate, sintered fly ash, or any natural lightweight aggregate meeting ASTM C330 and possessing equivalent fire-resistance properties and natural sand. Its unit weight is generally between 105 and 120 pcf (1680 and 1920 kg/m³).

Siliceous aggregate. Concrete made with normal-weight aggregates consisting mainly of silica or compounds other than calcium or magnesium carbonate, which contains more than 40-percent quartz, chert or flint.

Vermiculite. A light weight insulating concrete made with *vermiculite* concrete aggregate which is laminated micaceous material produced by expanding the ore at high temperatures. When added to a Portland cement slurry the resulting concrete has a dry unit weight of approximately 30 pcf (480 kg/m³).

2021 International Building Code

Add new definition as follows:

CARBON DIOXIDE EQUIVALENT (CO₂e). A measure used to compare the impact of various greenhouse gases based on their global warming potential (GWP). CO₂e approximates the time-integrated warming effect of a unit mass of a given greenhouse gas relative to that of carbon dioxide (CO₂). GWP is an index for estimating the relative global warming contribution of atmospheric emissions of 1 kg of a particular greenhouse gas compared to emissions of 1 kg of CO₂. The following GWP values are used based on a 100-year time horizon: 1 for CO₂, 25 for methane (CH₄), and 298 for nitrous oxide (N₂O).

COMMUNITY RENEWABLE ENERGY FACILITY. A facility that produces energy harvested from *renewable energy resources* and is qualified as a community energy facility under applicable jurisdictional statutes and rules.

FINANCIAL RENEWABLE ENERGY POWER PURCHASE AGREEMENT (PPA). A financial arrangement between a renewable electricity generator and a purchaser wherein the purchaser pays or guarantees a price to the generator for the project's renewable generation. Also known as a "financial power purchase agreement" and "virtual power purchase agreement."

FLAT GLASS. A type of glass, initially produced in plane form. Common uses include, but are not limited to, windows, glass doors, and transparent walls. Flat glass is in contrast to container glass, glass fiber (insulation) and optical communication. Flat glass has a higher magnesium oxide and sodium oxide content than container glass and a lower silica, calcium oxide, and aluminum.

ON-SITE RENEWABLE ENERGY. Energy from *renewable energy resources* harvested at the building site.

PHYSICAL RENEWABLE ENERGY POWER PURCHASE AGREEMENT (PPA). A contract for the purchase of renewable electricity from a specific renewable electricity generator to a purchaser of renewable electricity.

PLATE GLASS. See “Flat glass”

RENEWABLE ENERGY RESOURCES. Energy from solar, wind, biomass or hydro, or extracted from hot fluid or steam heated within the earth.

SHEET GLASS. See “Flat glass”

Add new text as follows:

**TABLE 1903.5.1
CO₂e LIMITS IN MIXTURE**

Specified compressive strength f'_c , psi	Maximum kg/m ³ (SI)	High-early strength	Lightweight concrete
		Maximum kg/m ³ (SI)	Maximum kg/m ³ (SI)
up to 2499	302	408	578
2500-3499	382	516	578
3500-4499	432	583	626
4500-5499	481	649	675
5500-6499	505	682	N/A
6500 and greater	518	680	N/A

1903.5.2 CO₂e Limit Method - Project. Total CO₂e (CO₂e_{proj}) of all concrete placed at the building project shall not exceed the project limit (CO₂e_{allowed}) determined using Table 1903.5.1 and Equation 1903.5.2

Equation 1903.5.2

$$CO_{2e_{proj}} < CO_{2E_{allowed}}$$

where: $CO_{2E_{proj}} = \sum CO_{2E_n} v_n$ and $CO_{2E_{allowed}} = \sum CO_{2E_{lim}} v_n$
and

n = the total number of concrete mixtures for the project

CO_{2E_n} = the global warming potential for mixture n per mixture EPD, kg/m³

$CO_{2E_{lim}}$ = the global warming potential limit for mixture n per Table 1903.5.1, kg/m³

v_n = the volume of mixture n concrete to be placed

1903.5 Embodied CO₂e of concrete materials. Concrete products used in the building project shall be in accordance with Sections 1903.5.1 or 1903.5.2.

Exceptions:

1. Precast concrete.
2. Masonry units complying with Section 2103.1.2.
3. Projects where no concrete suppliers with product-specific environmental product declarations (EPD) for concrete are located within 100 miles of the project site, where Type III industry-wide EPDs and an inventory of CO₂e values for all concrete mixes are provided to the AHJ.

1903.5.1 CO₂e Limit Method - Mixture. The total CO₂e of the concrete mixes used in the project shall not exceed the value given in Table 1903.5.1 based on the compressive strength of the product. CO₂e content shall be documented by a product-specific Type III Environmental Product Declaration (EPD) for each product. EPDs used for compliance with this section shall be certified as complying with the goal and scope for the cradle-to-gate requirements in accordance with ISO 14025 and ISO 21930 and be available in a publicly accessible database.

2103.1.2 Embodied CO₂e disclosure of masonry units. Product-specific Type III Environmental Product Declarations (EPD) shall be submitted for 75% of masonry units, by cost. EPDs used for compliance with this section shall be certified as complying with the goal and scope for the cradle-to-gate requirements in accordance with ISO Standards 14025 and 21930 and be available in a publicly accessible database.

2205.3 Embodied CO₂e of steel products. Structural steel, hollow steel section, steel plate, and concrete reinforcing steel bar products used in the building shall comply with Section 2205.3.1, and one of either 2205.3.2 or 2205.3.3.

2205.3.1 EPD Disclosure. Product-specific Type III Environmental Product Declarations (EPD) shall be submitted for 75% of steel products, based on cost. EPDs used for compliance with this section shall be certified as complying with the goal and scope for the cradle-to-gate requirements in accordance with ISO Standards 14025 and 21930 and be available in a publicly accessible database.

2205.3.2 Steel Production. A minimum of 75% of steel products listed in this section, based on cost, shall be produced in a facility or facilities that comply with one of the following:

1. On the date of procurement is independently, or as part of an aggregation of facilities, a Green Power Partner in the United States Environmental Protection Agency (U.S. EPA) Green Power Partnership program, or an equivalent renewable power procurement registry as approved by the AHJ.
2. Not less than 50% of the energy sourced for production at the facility is a *renewable energy resource* as documented from one or more of the following:
 - 2.1. *On-site renewable energy system*
 - 2.2. *Off-site renewable energy system owned by the production facility owner*
 - 2.3. *Community renewable energy facility*
 - 2.4. *Physical Renewable Energy PPA*
 - 2.5. *Financial Renewable Energy PPA*

**TABLE 2205.3.3
CO₂e LIMIT PER STEEL PRODUCT**

	Steel Product	Mill kg CO₂e/kg^a	Fabrication kg CO₂e/kg^b
Structural Steel	Structural Sections	0.99	1.22
Structural Steel	Hollow Structural Sections	1.71	1.99
Structural Steel	Plate	1.47	1.73
Concrete Reinforcing Bars		0.89	0.98

- a. Applies when an EPD declares mill-only material (cradle to mill gate).
- b. Applies when an EPD declares mill material plus U.S. industry average fabrication impacts (cradle to fabricator gate).

2303.8 Embodied CO₂e disclosure of wood products. Environmental Product Declarations (EPD) shall be submitted for 75% of wood products and members, based on cost. Type III EPDs used for compliance with this section shall be certified as complying with the goal and scope for the cradle-to-gate requirements in accordance with ISO 14025 and ISO 21930 and be available in a publicly accessible database.

2403.6 Embodied CO₂e disclosure of glass products. Type III Environmental Product Declarations (EPD) shall be submitted for 75% of flat glass products, based on cost. EPDs used for compliance with this section shall be certified as complying with the goal and scope for the cradle-to-gate requirements in accordance with ISO 14025 and ISO 21930 and be available in a publicly accessible database.

2205.3.3 Steel Product CO₂e Limits. A minimum of 75% of steel products, based on cost, shall not exceed the total CO₂e values in Table 2205.3.3 based on product type.

Add new standard(s) as follows:

ASTM

ASTM International
100 Barr Harbor Drive, P.O. Box C700
West Conshohocken, PA 19428

C567/C567M-19

Standard Test Method for Determining Density of Structural Lightweight Concrete

ISO

International Organization for Standardization
Chemin de Blandonnet 8 CP 401 1214 Vernier
Geneva, Switzerland

ISO 14025:2006

Environmental labels and declarations — Type III environmental declarations — Principles and procedure

ISO 21930:2017

Sustainability in buildings and civil engineering works — Core rules for environmental product declarations of construction products and service

Reason Statement: 1903.5 Embodied CO₂e of concrete materials:

Language in this proposal builds on the success of the Marin County Low Carbon Concrete Code[1], setting achievable targets based on current U.S.-based EPDs. The CO₂e limits are set on the 75th percentile of the concrete GWPs evaluated, meaning, 75% of the GWP values (not 75% of the EPDs) comply with the limits set. The values encourage the lowest 25% of the U.S. market’s concrete to perform and report improved performance through EPDs. Several nationally available alternative manufacturing processes and materials provide opportunities to reduce concrete’s embodied carbon. Alternative cements and supplementary cementitious materials, aggregate sourcing, chemical admixtures, and plant efficiency are a few of the opportunities for creating lower embodied carbon concrete.

Concrete is one of the top two materials in building construction and a primary contributor to embodied carbon in buildings. A recent case study analysis by RMI shows that simply by specifying concrete products with lower CO₂e content, the embodied carbon of a commercial construction project can be reduced up to 33%. [2]

To build a building, construction professionals buy concrete (which contains cement used with water as a binder to adhere particles of sand and rock, known as aggregate) from a ready-mix supplier. Although each of concrete’s constituent materials offer opportunities for reductions in embodied carbon, the high embodied carbon of concrete is primarily driven by the manufacture of one key ingredient—ordinary Portland cement. Portland cement is the most common cementitious binder used in concrete mixtures in the U.S., and the U.S. cement industry is one of the largest contributors to U.S.-borne emissions at 68.3 million metric tons (MMT) of CO₂e per year. [3] The building construction industry’s demand for concrete accounts for an estimated 51% of total Portland cement produced in the U.S. [4]

2103.1.2 Embodied CO2e disclosure of masonry units.

Language in this section recognizes the complete lack of data around masonry unit products. Recognized in the Clean Future Act as a product on the secondary list of materials, masonry units, are required to submit EPDs to increase the amount of data.[5]

2205.3 Embodied CO2e of steel products.

Language in this proposal recognizes the international dataset available to set targets across multiple steel products. Products with the most data have been targeted at (75%) of international values, eliminating the worst performing products. All structural steel products are required to submit EPDs to increase the amount of data for future updates to model code language. Steel is the second most widely used materials in building construction and a primary contributor to embodied carbon in buildings. The U.S. steel industry is responsible for 104.6 MMT of CO2 emissions annually, a contribution that makes up 2% of total U.S. emissions.[3] Steel destined for the built environment is responsible for 46 MMT of CO2 emissions annually, nearly half of the total annual emissions from the steel industry.[3] Many types of steel products made with different manufacturing techniques are found in buildings. Hot-rolled structural steel is the predominant structural framing material used in building construction, holding 46% of the market share for structural framing materials for nonresidential and multistory residential construction in 2017. [6] Steel reinforcing or “rebar,” which is typically embedded in structural concrete, can also be a major use of steel and source of embodied carbon in buildings. A recent case study analysis by RMI shows that simply by specifying rebar products with lower CO2e content, the embodied carbon of a typical commercial construction project can be reduced up to 10%.[2]

2303.8 Embodied CO2e disclosure of wood products.

Language in this section recognizes the complete lack of data and inconsistent consensus on climate-smart wood products. Recognized in the Clean Future Act[5] as a product on the secondary list of materials, wood products regulated in Chapter 23 are required to submit EPDs to increase the amount of data for future updates to model code language. Jurisdictions can revise the percentage of materials subject to the requirements as necessary to meet their own needs.

2403.6 Embodied CO2e disclosure of glass products.

Language in this section recognizes the complete lack of data around flat glass products. Recognized in the Clean Future Act[5] as a product on the secondary list of materials, flat glass are required to submit EPDs to increase the amount of data for future updates to model code language.

Bibliography: [1] Marin County, Carbon Concrete Requirements, Chapter 19.07, November 2021, https://library.municode.com/ca/marin_county/codes/municipal_code?nodeId=TIT19MACOBUCO

[2] Matt Jungclaus, Rebecca Esau, Victor Olgyay, and Audrey Rempher, *Low-Cost, High-Value Opportunities to Reduce Embodied Carbon in Buildings*, RMI, 2021.

[3] *Inventory of U.S. Greenhouse Gas Emissions and Sinks: 1990–2018*, US Environmental Protection Agency, 2020, <https://www.epa.gov/sites/production/files/2020-04/documents/us-ghg-inventory-2020-main-text.pdf>; and “Manufacturing Energy and Carbon Footprint,” US Department of Energy, https://www.energy.gov/sites/prod/files/2018/10/f56/2014_mecs_cement_energy_footprint.pdf.

[4] *2019 U.S. Cement Industry Annual Yearbook*, Portland Cement Association, 2019, <https://www.cement.org/morereports/2018-us-cement-industry-annual-yearbook>.

[5] *GSA Green Building Advisory Committee Advice Letter: Policy Recommendations for Procurement of Low Embodied Energy and Carbon Materials by Federal Agencies*, U.S. General Services Administration, February 17 2021, <https://www.gsa.gov/governmentwide-initiatives/federal-highperformance-green-buildings/policy/green-building-advisory-committee/advice-letters-and-resolutions>

[6] *Structural Steel: An Industry Overview*, American Institute of Steel Construction, August 2018, https://www.aisc.org/globalassets/aisc/publications/white-papers/structural_steel_industry_overview_2018.pdf.

Cost Impact: The code change proposal will not increase or decrease the cost of construction

The impact of the embodied carbon considerations in code to project teams can be cost-neutral when the requirements are specified and administered efficiently. As described in the code_GWP limits for concrete mixes are set through an evaluation of national EPDs and their GWP values; data available for many regional concrete suppliers indicate that local markets can outperform the national average and is well-positioned to meet the code criteria. The optimizations needed to produce compliant concrete mixes can be achieved primarily by reducing cement in concrete mixes, through strategies like high performance aggregate selection or cement substitution. These interventions can be made without a cost impact if the criteria are effectively communicated to ready-mix suppliers. For projects necessitating a quick concrete curing time, the code allows for a 130% GWP increase for high, early strength concrete because this concrete often requires additional cement. Low embodied carbon concrete does not require onerous changes to upstream industrial processes.

For steel products, the GWP limits were established using a percentage of the Type III industry-wide EPDs for each product, considering whether the product is directly from the mill or has been fabricated. The energy related to steel product manufacturing dominates the calculated embodied carbon of the final product. Therefore, products manufactured with electricity, over natural gas, and in regions with lower carbon energy grids, will have lower embodied carbon. International steel production's energy is sourced from more extensive coal and natural gas percentages than is found in the U.S., making American-made steel lower in carbon than most steel derived from Asian countries.

A recent case study analysis by RMI shows that simply by specifying concrete products with lower CO₂e content, the embodied carbon of a commercial construction project can be reduced up to 33%. Similarly, specifying rebar with lower CO₂e content can reduce the embodied carbon of a typical commercial construction project up to 10%. Both of these specifications were indicated to have a cost premium of less than 1%. Additional project-level research has shown a cost savings due to structural material efficiency as by right-sizing structural members, up to a 5% cost savings on structural materials has been achieved.

S178-22

S179-21

IBC: SECTION 1907, 1907.1

Proponents: Mark Domogala, Basement Systems Inc., representing Basement Systems Inc. (rd@basementsystems.com)

2021 International Building Code

SECTION 1907 MINIMUM SLAB PROVISIONS

Revise as follows:

1907.1 General. The thickness of concrete floor slabs supported directly on the ground shall be not less than 3½ inches (89 mm). A 6-mil (0.006 inch; 0.15 mm) polyethylene vapor retarder with joints lapped not less than 6 inches (152 mm) shall be placed between the base course or subgrade and the concrete floor slab, or other *approved* equivalent methods or materials shall be used to retard vapor transmission through the floor slab.

~~Exception~~ Exceptions:

1. A vapor retarder is not required:
 1. For detached structures accessory to occupancies in Group R-3, such as garages, utility buildings or other unheated facilities.
 2. For unheated storage rooms having an area of less than 70 square feet (6.5 m2) and carports attached to occupancies in Group R-3.
 3. For buildings of other occupancies where migration of moisture through the slab from below will not be detrimental to the intended occupancy of the building.
 4. For driveways, walks, patios and other flatwork that will not be enclosed at a later date.
 5. Where *approved* based on local site conditions.
2. Minimum thickness of concrete floor slabs supported directly on the ground having interior drainage systems. For installation of perimeter drain systems on the interior of a dwelling minimum floor thickness to be no less than 2-1/2" inches thick 6" to 8" away from interior walls.

Reason Statement: To allow for interior drainage systems to be installed with an exception to the current 3-1/2" minimum thick concrete on slab requirement. The interior drainage system is to be installed in existing homes under the perimeter of basement floor. The floor would be restored to a minimum thickness of 2-1/2" of concrete.

The current language does not allow for water drainage strategies with revised minimum slab on ground thickness along the interior perimeter of foundation.

See attached file WaterGuard Cross Section Installation Illustration_11-05-2018-membrane.pdf

WaterGuard Installation Cross Section

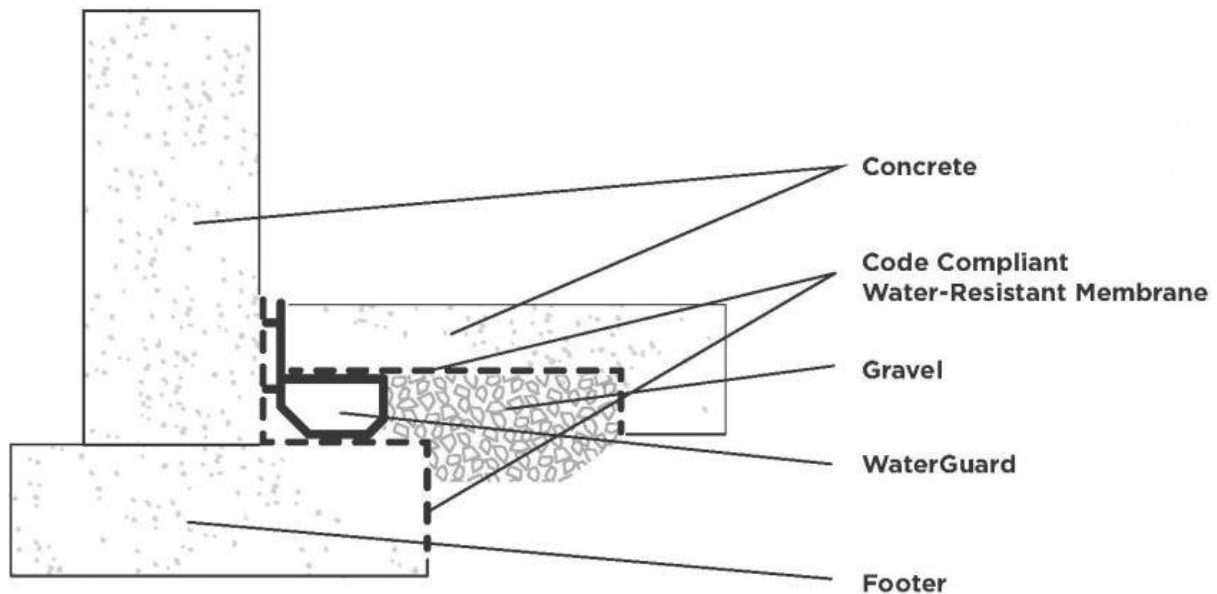

Figure 1.

Cost Impact: The code change proposal will not increase or decrease the cost of construction

As secondary strategy for draining ground water from around the foundation from the inside of a dwelling, the cost benefit and savings outweigh the cost and benefit of replacing or initially installing a footing drain system on the exterior of an existing dwelling. When exterior foundation footing drain systems fail, new footing drains need to be installed. For dwellings where exterior footing drains were not part of the original construction of the foundation system, exterior footing drains would need to be installed for the first time. Replacement of, or initial installation of, external footing drains require major outside excavation. In all cases several features of an existing dwelling often need to be altered or removed and then replaced to install new exterior footing drains since the dwellings is existing and not new construction. This disruption could range from plantings removals to removing stairs and porches, decks, sidewalks etc.... to gain access to the external foundation footing. This event poses major environmental disruption and is highly expensive depending on dwelling size. Cost on average is ~\$26000. Dwelling size is driving cost factor.

An interior drainage system is the least invasive way to manage ground water that will eventually make its way into a below grade space. Cost impact for interior drainage takes into consideration minimal amount of labor and material cost and less invasive approach when compared to external excavation to install or replace footing drainage. Cost for internal drainage on average is \$5,500 - \$15,500.

An interior drainage system is the least invasive way to manage interior ground water infiltration and is more cost effective compared to external footing drain replacement.

5000 PSI prepackaged cement mix is used to restore the portion of the floor that is removed for installation. 2500 PSI is the minimum allowed for flooring.

The current language in IBC section 1907 and 1907.1 does not allow for secondary water removal strategies with revised minimum slab on ground thickness for installation along the interior perimeter of foundation.

Additional Exception Reason:

To allow for interior drainage systems to be installed with an exception to the 3-1/2" minimum thick concrete on slab current requirement. The interior drainage system is to be installed around perimeter of interior below grade space using the interior side top of the footing to install level for proper water drainage to a mechanical discharge system or drain to daylight.

S180-22

IBC: 1907.1

Proponents: Joseph Summers, representing ICC Region VI (summersj@cityofgroton-ct.gov)

2021 International Building Code

Revise as follows:

1907.1 General. The thickness of concrete floor slabs supported directly on the ground shall be not less than 3¹/₂ inches (89 mm). A 10-mil ~~6-mil~~ (~~0.006~~ 0.010 inch; ~~0.15~~ 0.254 mm) polyethylene vapor retarder with joints lapped not less than 6 inches (152 mm) shall be placed between the base course or subgrade and the concrete floor slab, or other *approved* equivalent methods or materials shall be used to retard vapor transmission through the floor slab.

Exception: A vapor retarder is not required:

1. For detached structures accessory to occupancies in Group R-3, such as garages, utility buildings or other unheated facilities.
2. For unheated storage rooms having an area of less than 70 square feet (6.5 m²) and carports attached to occupancies in Group R-3.
3. For buildings of other occupancies where migration of moisture through the slab from below will not be detrimental to the intended occupancy of the building.
4. For driveways, walks, patios and other flatwork that will not be enclosed at a later date.
5. Where *approved* based on local site conditions.

Reason Statement: This change would be consistent with the vapor barrier requirements found in section R506.2.3 of the 2021 IRC and most commercial contractors do not use anything less than 10-mil under floor slabs.

Cost Impact: The code change proposal will increase the cost of construction. The use of 10-mil poly vs. 6-mil poly will increase the cost of a typical home < \$200. 10-mil poly is approximately 30% more than 6-mil poly.

S180-22

S181-22

IBC: CHAPTER 21, SECTION 2102, 2102.1, 2107.2.1, 2109.2.1.2.4

Proponents: Phillip Samblanet, representing The Masonry Society (psamblanet@masonrysociety.org); Jason Thompson, representing Masonry Alliance for Codes and Standards (jthompson@ncma.org)

2021 International Building Code

CHAPTER 21 MASONRY

SECTION 2102 NOTATIONS

Revise as follows:

2102.1 General. The following notations are used in the chapter:

NOTATIONS.

d_b	=	Diameter of reinforcement, inches (mm).
F_s	=	Allowable tensile or compressive stress in reinforcement, psi (MPa).
f_r	=	Modulus of rupture, psi (MPa).
f_s	=	Computed stress in reinforcement due to design loads, psi (MPa).
f'_{AAC}	=	Specified compressive strength of AAC masonry, the minimum compressive strength for a class of AAC masonry as specified in TMS 602, psi (MPa).
$f'_{m,28}$	=	Specified compressive strength of masonry at age of 28 days, psi (MPa).
$f'_{m,t}$	=	Specified compressive strength of masonry at the time of prestress transfer, psi (MPa).
K	=	The lesser of the masonry cover, clear spacing between adjacent reinforcement, or five times d_b, inches (mm).
L_s	=	Distance between supports, inches (mm).
l_d	=	Required development length or lap length of reinforcement, inches (mm).
P	=	The applied load at failure, pounds (N).
S_t	=	Thickness of the test specimen measured parallel to the direction of load, inches (mm).
S_w	=	Width of the test specimen measured parallel to the loading cylinder, inches (mm).

2107.2.1 Lap splices. The minimum length of lap splices for reinforcing bars in tension or compression, l_d , shall be:

$$l_d = 0.002d_b f_s$$

For SI:

$$l_d = 0.29d_b f_s$$

but not less than 12 inches (305 mm). The length of the lapped splice shall be not less than 40 bar diameters.

where:

d_b = Diameter of reinforcement, inches (mm).

f_s = Computed stress in reinforcement due to design loads, psi (MPa).

In regions of moment where the design tensile stresses in the reinforcement are greater than 80 percent of the allowable steel tension stress, F_s , the lap length of splices shall be increased not less than 50 percent of the minimum required length, but need not be greater than 72 d_b . Other equivalent means of stress transfer to accomplish the same 50 percent increase shall be permitted. Where epoxy coated bars are used, lap length shall be increased by 50 percent.

2109.2.1.2.4 Modulus of rupture determination. The modulus of rupture shall be determined by the equation:

$$f_r = 3 PL_s / [2 S_w (S_t^2)]$$

(Equation 21-2)

where, for the purposes of this section only:

S_w = Width of the test specimen measured parallel to the loading cylinder, inches (mm).

f_r = Modulus of rupture, psi (MPa).

L_s = Distance between supports, inches (mm).

S_t = Thickness of the test specimen measured parallel to the direction of load, inches (mm).

P = The applied load at failure, pounds (N).

Reason Statement: In an effort to delete redundant and unneeded content to keep the provisions as short and direct as possible, a number of minor changes are being proposed. The Notation shown deleted in Section 2102 no longer appear in this Chapter, nor could the proponent find them in the IBC. They are used by referenced standards and are defined in those standards. But since they no longer appear to be used directly in the IBC, they should be deleted for clarity.

The term f_s is defined in 2107.2, but not in this section, so it is proposed moving that notation to 2102.

Other terms are defined both in 2102, and in 2017.2 and in 2109. The redundant definitions are proposed to be deleted in 2107.2 and 2109.

Cost Impact: The code change proposal will not increase or decrease the cost of construction

This change would simply delete unneeded or redundant notation. As such, there is no construction cost impact.

S181-22

S182-22

IBC: 2103.2.4, TMS Chapter 35 (New)

Proponents: Phillip Samblanet, representing The Masonry Society (psamblanet@masonrysociety.org); Jason Thompson, representing Masonry Alliance for Codes and Standards (jthompson@ncma.org)

2021 International Building Code

Revise as follows:

2103.2.4 Mortar for adhered masonry veneer. *Mortar* for use with *adhered masonry veneer* shall conform to Section 13.3 of TMS 402 ~~ASTM C270 for Type N or S, or shall comply with ANSI A118.4 for latex-modified Portland cement mortar.~~

Add new standard(s) as follows:

TMS

The Masonry Society
105 South Sunset Street, Suite Q
Longmont, CO 80501-6172

402-22

Building Code Requirements for Masonry Structures

Staff Analysis: The proposal is referencing an updated version of an existing referenced standard. Therefore the updated version is considered an new standard. A review of the standard proposed for inclusion in the code, TMS 402-22 Building Code Requirements for Masonry Structures, with regard to some of the key ICC criteria for referenced standards (Section 3.6 of CP#28) will be posted on the ICC website on or before March 16, 2022.

Reason Statement: Provisions for adhered veneer have been extensively discussed and updated in the 2022 TMS 402 to be more rationally based using a minimum mortar/unit bond strength value. This change updates the mortar requirements to comply with those provisions. Setting bed mortars are required by TMS 402/602-22 to be latex-modified mortars complying with ANSI A118.4 or A118.15 due to their increased bond strength. Setting bed mortars meeting ASTM C270 Type N or S are only permitted when testing is conducted on the specific mortar/unit combination to be used in construction.

Cost Impact: The code change proposal will increase the cost of construction

This change updates requirements for mortar for adhered masonry veneer. In most cases, because these mortars are currently used and required, there is no increase in the cost of construction. For some construction, there could be a minor increase in the cost of mortar used for these systems to achieve better performance.

S182-22

S183-22

IBC: 2107.2, 2107.2.1, 2107.3, 2108.2, 2108.3, TMS Chapter 35 (New)

Proponents: Phillip Samblanet, representing The Masonry Society (psamblanet@masonrysociety.org); Jason Thompson, representing Masonry Alliance for Codes and Standards (jthompson@ncma.org)

2021 International Building Code

Revise as follows:

2107.2 TMS 402, Section ~~61611~~ 6.1.7.1, lap splices. As an alternative to Section ~~6.1.6.1.1~~ 6.1.7.1, it shall be permitted to design lap splices in accordance with Section 2107.2.1.

2107.2.1 Lap splices. The minimum length of lap splices for reinforcing bars in tension or compression, l_d , shall be:

$$l_d = 0.002d_b f_s$$

For SI:

$$l_d = 0.29d_b f_s$$

but not less than 12 inches (305 mm). The length of the lapped splice shall be not less than 40 bar diameters.

where:

d_b = Diameter of reinforcement, inches (mm).

f_s = Computed stress in reinforcement due to design loads, psi (MPa).

In regions of moment where the design tensile stresses in the reinforcement are greater than 80 percent of the allowable steel tension stress, F_s , the lap length of splices shall be increased not less than 50 percent of the minimum required length, but need not be greater than 72 d_b . Other equivalent means of stress transfer to accomplish the same 50 percent increase shall be permitted. Where epoxy coated bars are used, lap length shall be increased by 50 percent.

2107.3 TMS 402, Section ~~61611~~ 6.1.7, splices of reinforcement. Add to/Modify Section ~~6.1.6.1~~ 6.1.7 as follows:

- ~~6.1.6.1.1~~ 6.1.7 – Splices of reinforcement. Lap splices, welded splices or mechanical splices are permitted in accordance with the provisions of this section. Welding shall conform to AWS D1.4. Welded splices shall be of ASTM A706 steel reinforcement. Reinforcement larger than No. 9 (M #29) shall be spliced using mechanical connections in accordance with Section ~~6.1.6.1.3~~ 6.1.7.2.

2108.2 TMS 402, Section ~~61511~~ 6.1.6, development. Modify/Add the second paragraph of Section ~~6.1.6.3.16~~ 6.1.5.1.4 as follows:

The required development length of reinforcement shall be determined by Equation (6-1), but shall be not less than 12 inches (305 mm) and need not be greater than 72 d_b .

2108.3 TMS 402, Section 61611, splices. Modify/Add to Sections ~~6.1.6.1.2~~ and ~~6.1.6.1.3~~ 6.1.7.2.1 and 6.1.7.3.1 as follows:

- ~~6.1.6.1.2~~ 6.1.7.3.1 – A welded splice shall have the bars butted and welded to develop not less than 125 percent of the yield strength, f_y , of the bar in tension or compression, as required. ~~Welded splices shall be of ASTM A706 steel reinforcement. Welded splices shall not be permitted in plastic hinge zones of intermediate or special reinforced walls.~~
- ~~6.1.6.1.3~~ 6.1.7.2.1 – Mechanical splices shall be classified as Type 1 or 2 in accordance with Section 18.2.7.1 of ACI 318. Type 1 mechanical splices shall not be used within a plastic hinge zone or within a beam-column joint of intermediate or special *reinforced masonry* shear walls. Type 2 mechanical splices are permitted in any location within a member.

Add new standard(s) as follows:

TMS

The Masonry Society
105 South Sunset Street, Suite Q
Longmont, CO 80501-6172

402-22

Building Code Requirements for Masonry Structures

Staff Analysis: The proposal is referencing an updated version of an existing referenced standard. Therefore the updated version is considered an new standard. A review of the standard proposed for inclusion in the code, TMS 402-22 Building Code Requirements for Masonry Structures, with regard to some of the key ICC criteria for referenced standards (Section 3.6 of CP#28) will be posted on the ICC website on or before March 16, 2022.

Reason Statement: The cited references have been moved. In addition, some of the requirements shown to be deleted are now included in TMS 402, and are thus no longer required in the IBC directly (as they would be redundant). No technical changes have been proposed in this change. The intent is just to update references and to remove redundancy.

Cost Impact: The code change proposal will not increase or decrease the cost of construction. This change simply deletes redundant requirements and updates references. As such, there is no impact on construction costs.

S184-22

IBC: 2109.1.1, 2109.2

Proponents: Phillip Samblanet, representing The Masonry Society (psamblanet@masonrysociety.org)

2021 International Building Code

Revise as follows:

2109.1.1 Limitations. The use of empirical design of adobe masonry shall be limited as noted in Section A.1.2 of TMS 402-16. In buildings that exceed one or more of the limitations of Section A.1.2 of TMS 402-16, masonry shall be designed in accordance with the engineered design provisions of Section 2101.2 or the foundation wall provisions of Section 1807.1.5. Section A.1.2.2 of TMS 402-16 shall be modified as follows:

- A.1.2.2 – *Wind*. Empirical requirements shall not apply to the design or construction of masonry for buildings, parts of buildings, or other structures to be located in areas where V_{asd} as determined in accordance with Section 1609.3.1 of the *International Building Code* exceeds 110 mph.

2109.2 Adobe construction. *Adobe construction* shall comply with this section and shall be subject to the requirements of this code for Type V construction, Appendix A of TMS 402-16, and this section.

Reason Statement: This change ties this section specifically to the 2016 edition of TMS 402 to maintain the reference to the noted Appendix. TMS 402 is being updated in 2022, and other IBC references should be updated to that more current edition. Those updates are considered with other proposed changes. Revisions to the 2022 standard include many enhancements and a few corrections that should be referenced in the 2024 I-Codes. Section 2109 is a hold over from the legacy codes, and it was tied to an empirical design method that was included in earlier issues of TMS 402 as Appendix A for some basic requirements for adobe masonry. However, that appendix is no longer supported by the Committee that develops TMS 402 for new buildings, and as such, it has been deleted from the 2022 edition. To maintain the adobe provisions, a specific reference to the 2016 edition is being added, otherwise, the references will be broken.

Reason empirical design provisions are not included in TMS 402-22 are many, but fundamentally, the Committee believes they are no longer appropriate with newer materials, construction methods, and building types. In the past, when buildings had fewer windows, smaller openings, more cross walls, and shorter walls, the provisions were used and worked reasonably. Because materials have changed, fewer multi-wythe walls are used, walls have become thinner, and cross walls that supported other walls are rarely used. For these and other reasons, the appendix is no longer supported.

Cost Impact: The code change proposal will not increase or decrease the cost of construction

This change allows a standard currently referenced by the I-Code to continue to be used, while other portions of the I-Codes will be updated to the newer standard. For this section, there is no construction cost impact as the 2024 IBC requirements would be consistent with those in the 2021 IBC.

S184-22

S185-22

IBC: 2109.1.1

Proponents: John-Jozef Proczka, representing Self (john-jozef.proczka@phoenix.gov)

2021 International Building Code

Revise as follows:

2109.1.1 Limitations. The use of empirical design of adobe masonry shall be limited as noted in Section A.1.2 of TMS 402. In buildings that exceed one or more of the limitations of Section A.1.2 of TMS 402, masonry shall be designed in accordance with the engineered design provisions of Section 2101.2 or the foundation wall provisions of Section 1807.1.5.

Section ~~A.1.2.2~~ A.1.2.3 of TMS 402 shall be modified as follows:

- ~~A.1.2.2~~ A.1.2.3 – *Wind*. Empirical requirements shall not apply to the design or construction of masonry for buildings, parts of buildings, or other structures to be located in areas where V_{asd} as determined in accordance with Section 1609.3.1 of the *International Building Code* exceeds 110 mph.

Reason Statement: This code change proposal corrects what appears to be a longstanding typographical error. As the code currently stands the seismic section of TMS 402 Appendix A is eliminated and states wind limitations twice in A1.2.2 and A1.2.3.

There are those who assume this is not a typographical error, but an attempt to completely undo the TMS 402 seismic requirements of Appendix A in the IBC. This is not the case. TMS 402 is specific about what SDCs are allowed and in what capacities.

Cost Impact: The code change proposal will increase the cost of construction

Depending on one's current interpretation of the typographical error this will either have no impact or will restrict adobe masonry to only certain situations in certain SDCs.

S185-22

S186-22

IBC: 2110.1, TMS Chapter 35 (New)

Proponents: Phillip Samblanet, representing The Masonry Society (psamblanet@masonrysociety.org); Jason Thompson, representing Masonry Alliance for Codes and Standards (jthompson@ncma.org)

2021 International Building Code

Revise as follows:

2110.1 General. *Glass unit masonry* construction shall comply with Chapter ~~1413~~ of TMS 402 and this section.

Add new standard(s) as follows:

TMS

The Masonry Society
105 South Sunset Street, Suite Q
Longmont, CO 80501-6172

402-22

Building Code Requirements for Masonry Structures

Staff Analysis: The proposal is referencing an updated version of an existing referenced standard. Therefore the updated version is considered an new standard. A review of the standard proposed for inclusion in the code, TMS 402-22 Building Code Requirements for Masonry Structures, with regard to some of the key ICC criteria for referenced standards (Section 3.6 of CP#28) will be posted on the ICC website on or before March 16, 2022.

Reason Statement: This is an editorial change to simply update the reference based on TMS 402-22.

Cost Impact: The code change proposal will not increase or decrease the cost of construction
This change simply updates a refence citation. As such, there is no impact on construction costs.

S186-22

S187-22

IBC: CHAPTER 22, SECTION 2201, 2201.1, 2201.2 (New), 2201.3 (New), 2201.4 (New), 2201.5 (New), SECTION 2202, 2202.1, SECTION 2203, 2203.1, SECTION 2204, 2204.1, 2204.2, 2204.3, SECTION 2205, 2205.1, 2205.2, 2205.2.1, 2205.2.1.1, 2205.2.1.2, 2205.2.2, SECTION 2206, 2206.1, 2206.2, 2206.2.1, 2203 (New), 2203.1 (New), SECTION 2210, 2210.1, 2210.2, 2204.2.1 (New), 2204.2.2 (New), 2205 (New), 2205.1 (New), SECTION 2211, 2211.1, 2211.1.1, 2211.1.1.1, 2211.1.1.2, 2211.1.2, 2211.1.3, 2211.1.3.1, 2211.1.3.2, 2211.1.3.3, 2211.2, 2207 (New), 2210.1.1, 2210.1.1.1, 2210.1.1.2, 2210.1.1.3, SECTION 2207, 2207.1, 2207.1.1, 2207.2, 2207.3, 2207.4, 2207.5, SECTION 2209, 2209.1, 2209.2, 2209.3, SECTION 2208, 2208.1, AISC Chapter 35 (New), AISI Chapter 35 (New)

Proponents: Jon-Paul Cardin, representing American Iron and Steel Institute (jcardin@steel.org)

2021 International Building Code

CHAPTER 22 STEEL

SECTION 2201 GENERAL

2201.1 Scope. The provisions of this chapter govern the quality, design, fabrication and erection of steel construction.

Add new text as follows:

2201.2 Identification. Identification of steel members shall be in accordance with the applicable reference standards within this chapter. Other steel furnished for structural load-carrying purposes shall be identified for conformity to the ordered grade in accordance with the specified ASTM standard or other specification and the provisions of this chapter. Where the steel grade is not readily identifiable from marking and test records, the steel shall be tested to verify conformity to such standards.

2201.3 Protection. The protection of steel members shall be in accordance with the applicable reference standards within this chapter.

2201.4 Connections. The design and installation of steel connections shall be in accordance with the applicable reference standards within this chapter. For *special inspection* of welding or installation of high-strength bolts, see Section 1705.2.

2201.5 Anchor Rods. Anchor rods shall be set in accordance with the *approved construction documents*. The protrusion of the threaded ends through the connected material shall fully engage the threads of the nuts, but shall not be greater than the length of the threads on the bolts.

Delete without substitution:

~~SECTION 2202 IDENTIFICATION OF STEEL FOR STRUCTURAL PURPOSES~~

~~**2202.1 General.** Identification of *structural steel elements* shall be in accordance with AISC 360. Identification of cold-formed steel members shall be in accordance with AISI S100. Identification of cold-formed steel *light frame construction* shall also comply with the requirements contained in AISI S240 or AISI S220, as applicable. Other steel furnished for structural load-carrying purposes shall be properly identified for conformity to the ordered grade in accordance with the specified ASTM standard or other specification and the provisions of this chapter. Where the steel grade is not readily identifiable from marking and test records, the steel shall be tested to verify conformity to such standards.~~

~~SECTION 2203 PROTECTION OF STEEL FOR STRUCTURAL PURPOSES~~

~~**2203.1 General.** Painting of *structural steel elements* shall be in accordance with AISC 360. Painting of open web steel joists and joist girders shall be in accordance with SJI 100 and SJI 200. Individual structural members and assembled panels of *cold-formed steel construction* shall be protected against corrosion in accordance with the requirements contained in AISI S100. Protection of cold-formed steel *light frame construction* shall be in accordance with AISI S240 or AISI S220, as applicable.~~

~~SECTION 2204 CONNECTIONS~~

~~**2204.1 Welding.** The details of design, workmanship and technique for welding and qualification of welding personnel shall be in accordance with the specifications listed in Sections 2205, 2206, 2207, 2208, 2210 and 2211. For *special inspection* of welding, see Section 1705.2.~~

~~**2204.2 Bolting.** The design, installation and inspection of bolts shall be in accordance with the requirements of Sections 2205, 2206, 2207, 2210 and 2211. For *special inspection* of the installation of high-strength bolts, see Section 1705.2.~~

~~**2204.3 Anchor rods.** Anchor rods shall be set in accordance with the *approved construction documents*. The protrusion of the threaded ends~~

through the connected material shall fully engage the threads of the nuts but shall not be greater than the length of the threads on the bolts.

Revise as follows:

SECTION 2205 2202

STRUCTURAL STEEL AND COMPOSITE STRUCTURAL STEEL AND CONCRETE

~~2205.1~~ 2202.1 **General.** The design, fabrication and erection of *structural steel elements* and composite structural steel and concrete elements in buildings, structures and portions thereof shall be in accordance with AISC 360.

~~2205.2~~ 2202.2 **Seismic design.** Where required, the seismic design, fabrication and erection of buildings, structures and portions thereof shall be in accordance with Section ~~2205.2.1~~ 2202.2.1 or ~~2205.2.2~~ 2202.2.2, as applicable.

~~2205.2.1~~ 2202.2.1 **Structural steel seismic force-resisting systems and composite structural steel and concrete seismic force-resisting systems.** The design, detailing, fabrication and erection of structural steel *seismic force-resisting systems* and composite structural steel and concrete *seismic force-resisting systems* shall be in accordance with the provisions of Section ~~2205.2.1.1~~ 2202.2.1.1 or ~~2205.2.1.2~~ 2202.2.1.2, as applicable.

~~2205.2.1.1~~ 2202.2.1.1 **Seismic Design Category B or C.** Structures assigned to *Seismic Design Category B* or *C* shall be of any construction permitted in Section ~~2205.2.202~~. Where a response modification coefficient, R , in accordance with ASCE 7, Table 12.2-1, is used for the design of structures assigned to *Seismic Design Category B* or *C*, the structures shall be designed and detailed in accordance with the requirements of AISC 341. Beam-to-column moment connections in structural steel special moment frames and intermediate moment frames shall be prequalified in accordance with AISC 341, Section K1, qualified by testing in accordance with AISC 341, Section K2, or shall be prequalified in accordance with AISC 358.

Exception: The response modification coefficient, R , designated for "Steel systems not specifically detailed for seismic resistance, excluding cantilever column systems" in ASCE 7, Table 12.2-1, shall be permitted for structural steel systems designed and detailed in accordance with AISC 360, and need not be designed and detailed in accordance with AISC 341.

~~2205.2.1.2~~ 2202.2.1.2 **Seismic Design Category D, E or F.** Structures assigned to *Seismic Design Category D*, *E* or *F* shall be designed and detailed in accordance with AISC 341, except as permitted in ASCE 7, Table 15.4-1. Beam-to-column moment connections in structural steel special moment frames and intermediate moment frames shall be prequalified in accordance with AISC 341, Section K1, qualified by testing in accordance with AISC 341, Section K2, or shall be prequalified in accordance with AISC 358.

~~2205.2.2~~ 2202.2.2 **Structural steel elements.** The design, detailing, fabrication and erection of *structural steel elements* in *seismic force-resisting systems* other than those covered in Section ~~2205.2.1~~ 2202.2.1, including struts, *collectors*, chords and foundation elements, shall be in accordance with AISC 341 where either of the following applies:

1. The structure is assigned to *Seismic Design Category D*, *E* or *F*, except as permitted in ASCE 7, Table 15.4-1.
2. A response modification coefficient, R , greater than 3 in accordance with ASCE 7, Table 12.2-1, is used for the design of the structure assigned to *Seismic Design Category B* or *C*.

Delete without substitution:

SECTION 2206

COMPOSITE STRUCTURAL STEEL AND CONCRETE STRUCTURES

~~2206.1~~ **General.** Systems of *structural steel elements* acting compositely with reinforced concrete shall be designed in accordance with AISC 360 and ACI 318, excluding ACI 318 Chapter 14.

~~2206.2~~ **Seismic design.** Where required, the seismic design, fabrication and erection of composite steel and concrete systems shall be in accordance with Section ~~2206.2.1~~.

~~2206.2.1~~ **Seismic requirements for composite structural steel and concrete construction.** Where a response modification coefficient, R , in accordance with ASCE 7, Table 12.2-1, is used for the design of systems of structural steel acting compositely with reinforced concrete, the structures shall be designed and detailed in accordance with the requirements of AISC 341.

Add new text as follows:

2203

STRUCTURAL STAINLESS STEEL

2203.1 **General.** The design, fabrication, and erection of austenitic and duplex structural stainless steel shall be in accordance with AISC 370.

Revise as follows:

SECTION 2210 2204

COLD-FORMED STEEL

~~2210.1 2204.1~~ **General.** The design of cold-formed carbon and low-alloy steel structural members not covered in Sections 2206 through 2209 of this chapter shall be in accordance with AISI S100. The design of cold-formed stainless steel structural members shall be in accordance with ASCE 8. Gold-formed steel light-frame construction shall comply with Section 2211. The design of cold-formed steel diaphragms shall be in accordance with additional provisions of AISI S310 as applicable. Where required, the seismic design of cold-formed steel structures shall be in accordance with the additional provisions of Section ~~2210.2 2204.2~~.

~~2210.2 2204.2~~ **Seismic design requirements for cold-formed steel structures.** The design and detailing of cold-formed steel seismic force-resisting systems shall be in accordance with Section 2204.2.1 and 2204.2.2 as applicable. Where a response modification coefficient, R , in accordance with ASCE 7, Table 12.2-1, is used for the design of cold-formed steel structures, the structures shall be designed and detailed in accordance with the requirements of AISI S100, ASCE 8, or, for cold-formed steel special bolted moment frames, AISI S400.

Add new text as follows:

2204.2.1 CFS Special Bolted Moment Frames. Where a response modification coefficient, R , in accordance with ASCE 7, Table 12.2-1, is used for the design of cold-formed steel special bolted moment frames, the structures shall be designed and detailed in accordance with the requirements of AISI S400.

2204.2.2 Cold-formed steel seismic force resisting systems. The response modification coefficient, R , designated for "Steel systems not specifically detailed for seismic resistance, excluding cantilever column systems" in ASCE 7, Table 12.2-1, shall be permitted for systems designed and detailed in accordance with AISI S100 and need not be designed and detailed in accordance with AISI S400.

2205

COLD-FORMED STAINLESS STEEL

2205.1 General. The design of cold-formed stainless steel structural members shall be in accordance with ASCE 8.

Revise as follows:

SECTION 2211 2206

COLD-FORMED STEEL LIGHT-FRAME CONSTRUCTION

~~2211.1 2206.1~~ **Structural framing systems.** For cold-formed steel *light-frame construction*, the design and installation of the following structural framing systems, including their members and connections, shall be in accordance with AISI S240, and Sections ~~2211.1.1 2206.1.1~~ through ~~2211.1.3 2206.1.3~~, as applicable:

1. Floor and roof systems.
2. Structural walls.
3. Shear walls, strap-braced walls and diaphragms that resist in-plane lateral loads.
4. Trusses.

~~2211.1.1 2206.1.1~~ **Seismic design requirements for cold-formed steel structural systems.** The design of cold-formed steel *light-frame construction* to resist seismic forces shall be in accordance with the provisions of Section ~~2211.1.1.1 2206.1.1.1~~ or ~~2211.1.1.2 2206.1.1.2~~, as applicable.

~~2211.1.1.1 2206.1.1.1~~ **Seismic Design Categories B and C.** Where a response modification coefficient, R , in accordance with ASCE 7, Table 12.2-1 is used for the design of cold-formed steel *light-frame construction* assigned to *Seismic Design Category B* or *C*, the *seismic force-resisting system* shall be designed and detailed in accordance with the requirements of AISI S400.

Exception: The response modification coefficient, R , designated for "Steel systems not specifically detailed for seismic resistance, excluding cantilever column systems" in ASCE 7, Table 12.2-1, shall be permitted for systems designed and detailed in accordance with AISI S240 and need not be designed and detailed in accordance with AISI S400

~~2211.1.1.2 2206.1.1.2~~ **Seismic Design Categories D through F.** In cold-formed steel *light-frame construction* assigned to *Seismic Design Category D*, *E* or *F*, the *seismic force-resisting system* shall be designed and detailed in accordance with AISI S400.

~~2211.1.2 2206.1.2~~ **Prescriptive framing.** Detached one- and two-family *dwelling*s and *townhouses*, less than or equal to three *stories above grade plane*, shall be permitted to be constructed in accordance with AISI S230 subject to the limitations therein.

~~2211.1.3 2206.1.3~~ **Truss design.** Cold-formed steel trusses shall comply with the additional provisions of Sections ~~2211.1.3.1 2206.1.3.1~~, through ~~2211.1.3.3 2206.1.3.3~~.

~~2211.1.3.1~~ **2206.1.3.1 Truss design drawings.** The truss design drawings shall conform to the requirements of Section I1 of AISI S202 and shall be provided with the shipment of trusses delivered to the job site. The truss design drawings shall include the details of permanent *individual truss member* restraint/bracing in accordance with Section I1.6 of AISI S202 where these methods are utilized to provide restraint/bracing.

~~2211.1.3.2~~ **2206.1.3.2 Trusses spanning 60 feet or greater.** The owner or the owner's authorized agent shall contract with a *registered design professional* for the design of the temporary installation restraint/bracing and the permanent *individual truss member* restraint/bracing for trusses with clear spans 60 feet (18 288 mm) or greater. *Special inspection* of trusses over 60 feet (18 288 mm) in length shall be in accordance with Section 1705.2.

~~2211.1.3.3~~ **2206.1.3.3 Truss quality assurance.** Trusses not part of a manufacturing process that provides requirements for quality control done under the supervision of a third-party quality control agency in accordance with AISI S240 Chapter D shall be fabricated in compliance with Sections 1704.2.5 and 1705.2, as applicable.

~~2211.2~~ **2206.2 Nonstructural framing systems members.** For cold-formed steel *light-frame construction*, the design and installation of nonstructural members and connections shall be in accordance with AISI S220.

Add new text as follows:

2207 STEEL DECK

Revise as follows:

~~2210.1.1~~ **2207.1 General Steel decks.** The design and construction of cold-formed steel decks shall be in accordance with this section. The design of cold-formed steel diaphragms shall be in accordance with additional provisions of AISI S310 as applicable.

~~2210.1.1.1~~ **2207.1.1 Noncomposite steel floor decks.** Noncomposite steel floor decks shall be permitted to be designed and constructed in accordance with ANSI/SDI-NC1.0.

~~2210.1.1.2~~ **2207.1.2 Steel roof deck.** Steel *roof decks* shall be permitted to be designed and constructed in accordance with ANSI/SDI-RD1.0.

~~2210.1.1.3~~ **2207.1.3 Composite slabs on steel decks.** Composite slabs of concrete and steel deck shall be permitted to be designed and constructed in accordance with SDI-C.

SECTION 2207-2208 STEEL JOISTS

~~2207.1~~ **2208.1 General.** The design, manufacture and use of open-web *steel joists* and joist girders shall be in accordance with either SJI 100 or SJI 200, as applicable.

~~2207.1.1~~ **2208.1.1 Seismic design.** Where required, the seismic design of buildings shall be in accordance with the additional provisions of Section ~~2205.2~~ 2202.2 or ~~2211.1.1~~ 2206.1.1.

~~2207.2~~ **2208.2 Design.** The *registered design professional* shall indicate on the *construction documents* the *steel joist* and *steel joist girder* designations from ~~the specifications listed in Section 2207.1 SJI 100 or SJI 200;~~ and shall indicate the requirements for joist and joist girder design, layout, end supports, anchorage, bridging design that differs from ~~the SJI 100 or SJI 200 specifications listed in Section 2207.1;~~ bridging termination connections and bearing connection design to resist uplift and lateral *loads*. These documents shall indicate special requirements as follows:

1. Special *loads* including:
 - 1.1. Concentrated *loads*.
 - 1.2. Nonuniform *loads*.
 - 1.3. Net uplift *loads*.
 - 1.4. Axial *loads*.
 - 1.5. End moments.
 - 1.6. Connection forces.

2. Special considerations including:
 - 2.1. Profiles for joist and joist girder configurations that differ from those defined by ~~the SJI 100 or SJI 200 specifications listed in Section 2207.1.~~
 - 2.2. Oversized or other nonstandard web openings.
 - 2.3. Extended ends.

3. Live and total *load* deflection criteria for joists and joist girder configurations that differ from those defined by ~~the SJI 100 or SJI 200 specifications listed in Section 2207.1.~~

~~2207.3~~ **2208.3 Calculations.** The *steel joist* and joist girder manufacturer shall design the *steel joists* and *steel joist* girders in accordance with the SJI 100 or SJI 200 specifications listed in Section 2207.1 to support the *load* requirements of Section ~~2207.2~~ 2208.2. The *registered design professional* shall be permitted to require submission of the *steel joist* and joist girder calculations as prepared by a *registered design professional* responsible for the product design. Where requested by the *registered design professional*, the *steel joist* manufacturer shall submit design calculations with a cover letter bearing the seal and signature of the joist manufacturer's *registered design professional*. In addition to the design calculations submitted under seal and signature, the following shall be included:

1. Bridging design that differs from ~~the SJI 100 or SJI 200 specifications listed in Section 2207.1,~~ such as cantilevered conditions and net uplift.
2. Connection design for:
 - 2.1. Connections that differ from ~~the SJI 100 or SJI 200 specifications listed in Section 2207.1,~~ such as flush-framed or framed connections.
 - 2.2. Field splices.
 - 2.3. Joist headers.

~~2207.4~~ **2208.4 Steel joist drawings.** *Steel joist* placement plans shall be provided to show the *steel joist* products as specified on the *approved construction documents* and are to be utilized for field installation in accordance with specific project requirements as stated in Section ~~2207.2~~ 2208.2. *Steel joist* placement plans shall include, at a minimum, the following:

1. Listing of applicable *loads* as stated in Section ~~2207.2~~ 2208.2 and used in the design of the *steel joists* and joist girders as specified in the *approved construction documents*.
2. Profiles for joist and joist girder configurations that differ from those defined by ~~the SJI 100 or SJI 200 specifications listed in Section 2207.1.~~
3. Connection requirements for:
 - 3.1. Joist supports.
 - 3.2. Joist girder supports.
 - 3.3. Field splices.
 - 3.4. Bridging attachments.
4. Live and total *load* deflection criteria for joists and joist girder configurations that differ from those defined by ~~the SJI 100 or SJI 200 specifications listed in Section 2207.1.~~
5. Size, location and connections for bridging.
6. Joist headers.

Steel joist placement plans do not require the seal and signature of the joist manufacturer's *registered design professional*.

~~2207.5~~ **2208.5 Certification.** At completion of manufacture, the *steel joist* manufacturer shall submit a *certificate of compliance* to the owner or the owner's authorized agent for submittal to the *building official* as specified in Section 1704.5 stating that work was performed in accordance with *approved construction documents* and with SJI 100 or SJI 200, as applicable ~~specifications listed in Section 2207.1.~~

SECTION 2209 STEEL STORAGE RACKS

Revise as follows:

2209.1 Steel storage racks General. The design, testing and utilization of steel *storage racks* made of cold-formed or hot-rolled steel structural

members shall be in accordance with RMI ANSI/MH 16.1. The design testing, and utilization of steel cantilevered storage racks made of cold-formed or hot-rolled steel structural members shall be in accordance with ANSI/MH 16.3. Where required by ASCE 7, the seismic design of steel storage racks shall be in accordance with Section 15.5.3 of ASCE 7.

~~2209.2 Steel cantilevered storage racks - Seismic design.~~ The design, testing and utilization of steel cantilevered storage racks made of cold-formed or hot-rolled steel structural members shall be in accordance with RMI ANSI/MH 16.3. Where required by ASCE 7, the seismic design of steel storage racks and cantilevered steel storage racks shall be in accordance with Section 15.5.3 of ASCE 7.

~~2209.3 Certification.~~ For rack steel storage racks structures that are 8 feet (2438 mm) in height or greater to the top load level and assigned to Seismic Design Category D, E, or F at completion of the storage rack installation, a certificate of compliance shall be submitted to the owner or the owner's authorized agent stating that the work was performed in accordance with approved construction documents.

SECTION ~~2208~~ 22010 STEEL CABLE STRUCTURES

~~2208.1~~ 2210.1 General. The design, fabrication and erection including related connections, and protective coatings of steel cables for buildings shall be in accordance with ASCE 19.

Add new standard(s) as follows:

AISC

American Institute of Steel
130 East Randolph Street, Suite 2000
Chicago, IL 60601-6219

ANSI/AISC 370-21 Specification for Structural Stainless Steel Buildings

AISI

American Iron and Steel Institute
25 Massachusetts Avenue, NW Suite 800
Washington, DC 20001

S310-20 w/S1-22 North American Standard for the Design of Steel Deck Diaphragms, 2020 Edition, with Supplement 1, 2022 Edition

Staff Analysis: A review of the standard proposed for inclusion in the code, AISC ANSI/AISC 370-21 Specification for Structural Stainless Steel Buildings, with regard to some of the key ICC criteria for referenced standards (Section 3.6 of CP#28) will be posted on the ICC website on or before March 16, 2022.

A review of the standard proposed for inclusion in the code, AISI S310-20 w/S1-22 North American Standard for the Design of Steel Deck Diaphragms, 2020 Edition, with Supplement 1, 2022 Edition, with regard to some of the key ICC criteria for referenced standards (Section 3.6 of CP#28) will be posted on the ICC website on or before March 16, 2022.

Reason Statement: This code change proposal is intended to be an editorial reorganization of IBC Chapter 22 for the purpose of providing better flow, usability, and clarification of steel provisions in the building code. The steel provisions within Chapter 22 of the IBC have been pieced together as they have been developed over the life of the document. This process has resulted in provisions that are technically accurate, but can seem disorganization and confusing from the perspective of the user. The following reasoning is provided for the revisions proposed in each section of this document:

Section 2201: I am proposing to include existing sections on Identification (2202), Protection of Steel for Structural Purposes (2203), and Connections (2204) as subsections under General Section 2201. Each of the existing sections (2202, 2203, 2204) simply serve as pointers to the other product specific sections, and in turn reference standards, within Chapter 22. I have retained the concept of addressing these topics through the applicable reference standards and any additional provisions on each topic. This proposed revision simply consolidates the language to provide a more concise path under the General steel section.

Section 2202: I am proposing to combine the existing Structural Steel (Section 2205) and Composite Structural Steel and Concrete Structures (2206) sections into one section (2202). Both AISC 360 and AISC 341 (referenced in Sections 2205 and 2206) contain the provisions for both Structural Steel and Composite Structural Steel and Concrete as well as the necessary references to ACI 318. The proposal to combine the two sections simply eliminates unnecessary duplication while maintaining the necessary provisions.

Section 2203: This section introduces a new section on Structural Stainless Steel and the new AISC 370 - *Specification for Structural Stainless Steel Buildings*. I am proposing this section, and reference standard, in this proposal primarily for purposes of coordination with respect to section numbering. I am proposing to add these provisions to directly follow those of structural steel as a logical flow of the chapter. This standard was developed as a consensus document using ANSI-accredited procedures to provide a uniform practice in the design of structural stainless steel-framed buildings and other structures.

The AISC 370 Specification is available for free download at www.aisc.org/publications/steel-standards/

Section 2204: These proposed revisions are intended to clarify when to use AISI S100 – *North American Specification for the Design of Cold-*

Formed Steel Structural Members. The following cold-formed steel product design standards are developed based on the applicable provisions of AISI S100: AISI framing standards (AISI S220, S240, S400), Steel Deck Institute, Steel Joist Institute, Steel Rack Institute (for cold-formed racks). It is the intention that the product design standards are the primary resource for the design of these specific systems. In lieu of provisions within the product specific design standards, AISI S100 provisions are permitted to be used for the design of applicable cold-formed steel members or systems. The proposed language clarifies that the design standards referenced in the following product specific sections are to be used for the design of those members and systems.

Section 2204.2 also provides clarification regarding the design of cold-formed steel seismic force resisting systems not covered in the following sections.

Section 2205: This section splits the cold-formed stainless-steel provisions into its own section as it references a separate ASCE 8 Standard for the design. The ASCE 8 standard was previously referenced under the existing cold-formed steel section (2210).

Section 2206: This section on cold-formed steel light-framed construction remains essentially unchanged with some minor reference section renumbering.

Section 2207: This section follows the format of the rest of Chapter 22 by splitting out the steel deck provisions into its own section as the Steel Deck Institute develops a series of design standards specific to the design and detailing of steel deck members and systems. These provisions were previously referenced under the existing cold-formed steel section (2210).

Section 2208: This section on steel joists remains essentially unchanged with some minor reference section renumbering.

Section 2209: I have proposed minor reformatting revisions to this section on steel storage racks. To coordinate with the format of the other sections, I am proposing to have the subsections categorized as "general design provisions" and "seismic design provisions" as opposed to categorized by product. The technical content of the provisions remain unchanged.

Section 2210: This section on steel cable structures remains unchanged with just renumbering of the section.

This proposal is a coordinated effort with the American Institute for Steel Construction (AISC), Steel Joist Institute (SJI), Steel Deck Institute (SDI), Metal Building Manufacturers Association (MBMA), Rack Manufacturers Association (RMA), and the steel framing industry. There are concurrent code change proposals submitted on behalf of MBMA, to add Metal Building Systems, and SDI, to revise Section 2207, that have been coordinated with AISI and this proposal. Those proposals are intended to work jointly with, and do not conflict with, this proposal.

Bibliography: AISC, "ANSI/AISC 370 - Specification for Structural Stainless Steel Buildings", American Institute of Steel Construction, Chicago, IL, 2021 edition.

Cost Impact: The code change proposal will not increase or decrease the cost of construction. This code change proposal is intended to be an editorial reorganization of existing provisions, and will not impact cost of construction.

S187-22

S188-22

IBC: 2205.2 (New)

Proponents: Jon-Paul Cardin, representing American Institute of Steel Construction (jcardin@steel.org)

2021 International Building Code

Add new text as follows:

2205.2 Delegated Connection Design. When the design of structural steel connections is delegated in the *construction documents* to a third party, the *registered design professional* shall be permitted to require submission of the calculations for the delegated connection designs. Those connection design calculations shall be prepared by a *registered design professional* in responsible charge for the delegated connection design. Where required by the *registered design professional*, the third party shall submit design calculations with a cover letter bearing the seal and signature of the *registered design professional* in responsible charge of the delegated connection designs.

Reason Statement: The intent of this proposal is to clarify the requirements for deferred submittals as they relate to delegated connection design in structural steel construction. The proposed language follows the requirements as listed in the AISC Code of Standard Practice (CoSP) for delegated connection design. The language also parallels the provisions in IBC Section 2207.3 (Steel Joist - Calculations) regarding design calculations prepared by a third party *registered design professional* in responsible charge for the delegated design. These provisions will provide clarity for structural steel construction regarding the accepted practice and requirements for delegated design of connections.

Bibliography: "Code of Standard Practice for Steel Buildings and Bridges", ANSI/AISC 303-16, American Institute of Steel Construction, 2016, Chicago, IL

Cost Impact: The code change proposal will not increase or decrease the cost of construction. This code change proposal is based on the current practice in the structural steel design and construction industry. The proposal is intended to clarify already accepted requirements, and therefore will not increase the cost of construction.

S188-22

S189-22

IBC: 2207.2, 2207.4

Proponents: Jon-Paul Cardin, representing Steel Joist Institute (jcardin@steel.org)

2021 International Building Code

Revise as follows:

2207.2 Design. The *registered design professional* shall indicate on the *construction documents* the *steel joist* and *steel joist girder* designations from the specifications listed in Section 2207.1; and shall indicate the requirements for joist and joist girder design, layout, end supports, anchorage, bridging design that differs from the SJI specifications listed in Section 2207.1, bridging termination connections and bearing connection design to resist uplift and lateral *loads*. These documents shall indicate special requirements as follows:

1. Special *loads* including:
 - 1.1. Concentrated *loads*.
 - 1.2. Nonuniform *loads*.
 - 1.3. Net uplift *loads*.
 - 1.4. Axial *loads*.
 - 1.5. End moments.
 - 1.6. Connection forces.
2. Special considerations including:
 - 2.1. Profiles for joist and joist girder configurations that differ from those defined by the SJI specifications listed in Section 2207.1.
 - 2.2. Oversized or other nonstandard web openings.
 - 2.3. Extended ends.
3. ~~Live and total load deflection~~ Deflection criteria for joists and joist girder configurations that differ from those defined by the SJI specifications listed in Section 2207.1.

2207.4 Steel joist drawings. *Steel joist* placement plans shall be provided to show the *steel joist* products as specified on the *approved construction documents* and are to be utilized for field installation in accordance with specific project requirements as stated in Section 2207.2. *Steel joist* placement plans shall include, at a minimum, the following:

1. Listing of applicable *loads* as stated in Section 2207.2 and used in the design of the *steel joists* and joist girders as specified in the *approved construction documents*.
2. Profiles for joist and joist girder configurations that differ from those defined by the SJI specifications listed in Section 2207.1.
3. Connection requirements for:
 - 3.1. Joist supports.
 - 3.2. Joist girder supports.
 - 3.3. Field splices.
 - 3.4. Bridging attachments.
4. ~~Live and total load deflection~~ Deflection criteria for joists and joist girder configurations that differ from those defined by the SJI specifications listed in Section 2207.1.
5. Size, location and connections for bridging.
6. Joist headers.

Steel joist placement plans do not require the seal and signature of the joist manufacturer's *registered design professional*.

Reason Statement: This code change proposal is intended to correlate the language in the IBC with that used in the Steel Joist Institute (SJI) specifications with respect to deflection considerations. The SJI 100 and SJI 200 Specifications refer to the "deflection due to the design live load" for consideration of deflection criteria. Therefore, there is no SJI requirement or reference to provide total load criteria for steel joist deflection calculation. The 2021 IBC Section 2207 identifies that open-web steel joists shall be in accordance with SJI 100 or SJI 200, as applicable. The IBC

states “Live and total load deflection criteria as defined by the SJI specifications” shall be provided, yet SJI has no total load deflection criteria requirement. The difference in language between the 2021 IBC and the SJI Specifications cause confusion for designers and building officials with respect to the loads used to calculate deflection of steel joist members. This code change will correlate the language in the IBC and the SJI Specifications and provide clarification, while also remaining clear that the designer shall list any deflection criteria they deem to be required.

Bibliography: SJI 100—20: 45th Edition Standard Specifications, Load Tables and Weight Tables for K-Series, LH-Series, DLH-Series and Joist Girders

SJI 200—15: 2nd Edition Standard Specifications, Weight Tables and Bridging Tables for CJ-Series Composite Steel Joists

Cost Impact: The code change proposal will not increase or decrease the cost of construction
This code change proposal is simply clarifying requirements of current provisions.

S189-22

S190-22

IBC: SECTION 2209

Proponents: Paul Armstrong, representing MHI

2021 International Building Code

Revise as follows:

SECTION 2209

~~STEEL STORAGE RACKS~~ MATERIAL HANDLING STRUCTURES

Reason Statement: This is an editorial change only to revise the title of Section 2209 to more accurately reflect the variety of steel storage systems that are in use today. The term "Material Handling Structures" is more inclusive of all such systems and the industry's terminology.

Cost Impact: The code change proposal will not increase or decrease the cost of construction
This is a purely editorial proposal.

S190-22

S191-22

IBC: 2209.3 (New), MHI Chapter 35 (New)

Proponents: Paul Armstrong, representing MHI

2021 International Building Code

Add new text as follows:

2209.3 Industrial boltless steel shelving. The design, testing and utilization of industrial boltless steel shelving shall be in accordance with ANSI/MH 28.2. Where required by ASCE 7, the seismic design of industrial boltless steel shelving shall be in accordance with Chapter 15 of ASCE 7.

Add new standard(s) as follows:

MHI

Material Handling Institute
8720 Red Oak Blvd. Suite 201
Charlotte, NC 28217

ANSI/MH 28.2-2022

Design, Testing and Utilization of Industrial Boltless Steel Shelving

Staff Analysis: A review of the standard proposed for inclusion in the code, MHI ANSI/MH 28.2-2022 Design, Testing and Utilization of Industrial Boltless Steel Shelving, with regard to some of the key ICC criteria for referenced standards (Section 3.6 of CP#28) will be posted on the ICC website on or before March 16, 2022.

Reason Statement: The Storage Manufacturer's Association (SMA) of the Material Handling Industry (MHI) has developed a standard for the design, testing and utilization of industrial boltless steel shelving with the assistance of the FEMA Seismic Code Support committee. This is the industry standard for industrial boltless steel shelving systems already in use today.

Cost Impact: The code change proposal will decrease the cost of construction. The inclusion of this standard will provide a single industry accepted set of criteria for this type of material handling system. As a result, the cost of construction will reduce by complying with only one set of requirements.

S191-22

S192-21

IBC: 2209.4 (New), MHI Chapter 35 (New)

Proponents: Paul Armstrong, MHI, representing MHI (paul@7arms.com)

2021 International Building Code

Add new text as follows:

2209.4 Material handling stairs, ladders and guards. The design and installation of stairs, ladders and guarding serving material handling structures shall be in accordance with ANSI/MH 32.1.

Add new standard(s) as follows:

MHI

Material Handling Institute
8720 Red Oak Blvd. Suite 201
Charlotte, NC 28217

ANSI/MH 32.1-2018

Stairs, Ladders and Open-Edge Guards for Use with Material Handling Structures

Staff Analysis: A review of the standard proposed for inclusion in the code, MHI ANSI/MH 32.1-2018 Stairs, Ladders and Open-Edge Guards for Use with Material Handling Structures, with regard to some of the key ICC criteria for referenced standards (Section 3.6 of CP#28) will be posted on the ICC website on or before March 16, 2022.

Reason Statement: The Material Handling Industry (MHI) has two product groups, Rack Manufacturer's Institute (RMI) and Storage Manufacturer's Association (SMA), that have compared and compiled OSHA and Building Code that apply to employee access ways serving various materials handling types of structures. The RMI and SMA have developed this compiled information into an ANSI consensus Standard ANSI/MH 32.1. This will give consistency and consistent interpretations between employee safety regulations promulgated by OSHA and the adopted IBC in local and state jurisdictions.

Cost Impact: The code change proposal will decrease the cost of construction

In a number of projects across the U.S. local jurisdictions have interpreted that Chapter 10 Means of Egress criteria applies to employee only access ways serving material handling structures. This will allow for less costly access devices to be used that are in compliance with OSHA regulations.

S192-21

S193-22

IBC: 2209.4 (New), MHI Chapter 35 (New)

Proponents: Paul Armstrong, representing MHI

2021 International Building Code

Add new text as follows:

2209.4 Industrial steel work platforms. The design, testing and utilization of industrial steel work platforms shall be in accordance with ANSI/MH 28.3. Where required by ASCE 7, the seismic design of industrial steel work platforms shall be in accordance with Chapter 15 of ASCE 7.

Add new standard(s) as follows:

MHI

Material Handling Institute
8720 Red Oak Blvd. Suite 201
Charlotte, NC 28217

ANSI/MH 28.3-22

Design, Testing and Utilization of Industrial Steel Work Platforms

Staff Analysis: A review of the standard proposed for inclusion in the code, MHI ANSI/MH 28.3–22 Design, Testing and Utilization of Industrial Steel Work Platforms, with regard to some of the key ICC criteria for referenced standards (Section 3.6 of CP#28) will be posted on the ICC website on or before March 16, 2022.

Reason Statement: The Storage Manufacturer's Association (SMA) of the Material Handling Industry (MHI) has developed a standard for the design, testing and utilization of industrial steel work platforms with the assistance of the FEMA Seismic Code Support committee. This is the industry standard for industrial steel work platforms already used today.

Cost Impact: The code change proposal will decrease the cost of construction

The inclusion of this standard will provide a single industry accepted set of criteria for this type of material handling structure. As a result, the cost of construction will reduce by complying with only one set of requirements.

S193-22

S194-22

IBC: 2210.1.1, 2210.1.1.1, 2210.1.1.2, 2210.1.1.3, CHAPTER 35, SDI Chapter 35

Proponents: Thomas Sputo, Steel Deck Institute, representing Steel Deck Institute (tsputo50@gmail.com)

2021 International Building Code

Revise as follows:

2210.1.1 Steel decks. The design and construction of cold-formed steel floor and roof decks and composite slabs of concrete and steel deck shall be in accordance with ~~this section~~ SDI-SD.

Delete without substitution:

~~**2210.1.1.1 Noncomposite steel floor decks.** Noncomposite steel floor decks shall be permitted to be designed and constructed in accordance with ANSI/SDI-NC1.0.~~

~~**2210.1.1.2 Steel roof deck.** Steel roof decks shall be permitted to be designed and constructed in accordance with ANSI/SDI-RD1.0.~~

~~**2210.1.1.3 Composite slabs on steel decks.** Composite slabs of concrete and steel deck shall be permitted to be designed and constructed in accordance with SDI-C.~~

CHAPTER 35 REFERENCED STANDARDS

Delete and substitute as follows:

SDI

Steel Deck Institute
2661 Clearview Road #3
Allison Park, PA 15101

~~SDI-NC—2017~~ ~~Standard for Noncomposite Steel Floor Deck~~

SDI SD-2022 Standard for Steel Deck

Delete without substitution:

SDI

Steel Deck Institute
2661 Clearview Road #3
Allison Park, PA 15101

~~SDI-RD—2017~~ ~~Standard for Steel Roof Deck~~

~~SDI-C—2017~~ ~~Standard for Composite Steel Floor Deck—Slabs~~

Staff Analysis: A review of the standard proposed for inclusion in the code, SDI SD-2022 Standard for Steel Deck, with regard to some of the key ICC criteria for referenced standards (Section 3.6 of CP#28) will be posted on the ICC website on or before March 16, 2022.

Reason Statement: The three previous SDI Steel Deck Standards (RD, NC, C) were combined into a single standard that covers both roof and floor deck applications (SD). This proposal removes the RD, NC, and C Standards and substitutes the new combined SD Standard. The new single Standard is easier to use than the three previous Standards. This proposal also removes the permissive language from the charging statement and makes the use of the SD Standard mandatory rather than permitted. The SD Standard was developed as a consensus standard under ANSI rules and is attached to this proposal.

Bibliography: ANSI/SDI SD-2022 *Standard for Steel Deck* (PDF attached to proposal).

Cost Impact: The code change proposal will not increase or decrease the cost of construction. The new SD Standard combines the content of the RD, NC, and C Standards into a single document with minimal technical changes. Because changes to the content were minimal, no changes to cost of construction are expected.

S195-22

IBC: 2211.3 (New)

Proponents: Jay Crandell, P.E., ABTG/ARES Consulting, representing Foam Sheathing Committee of the American Chemistry Council
(jcrandell@aresconsulting.biz)

2021 International Building Code

Add new text as follows:

2211.3 Foam plastic insulating sheathing. Where foam plastic *insulating sheathing* is used as exterior sheathing or in addition to other exterior sheathing, it shall comply with Chapter 26 and Chapter 14. Screw fastener connections for cladding and furring attachment through foam plastic *insulating sheathing* to cold-formed steel framing shall comply with Section 2603.12.

Reason Statement: When applying foam plastic insulating sheathing as continuous insulation to cold-formed steel framing (typical for energy code compliance), it is necessary to consider fire safety requirements, vapor control requirements, and cladding attachment requirements in both Chapter 14 and Chapter 26. These are key “links” that are needed to ensure that a code-compliant application of foam plastic insulating sheathing is achieved for cold-formed steel wall assemblies. And, it will help users properly integrate foam sheathing on a cold-formed steel structure.

Cost Impact: The code change proposal will not increase or decrease the cost of construction

This proposal does not change cost and provides appropriate references for application of foam plastic insulating sheathing on cold-formed steel wall assemblies.

S195-22

S196-22

IBC: 2211.3 (New); IPC: 307.2, 307.3 (New), [BS] C101.5, [BS] C101.6; IMC: [BS] 302.5, [BS] 302.5.2, [BS] 302.5.3; IFGC: [BS] 302.6, [BS] 302.7

Proponents: Mike Nugent, representing Building Code Action Committee (bcac@iccsafe.org)

2021 International Building Code

Add new text as follows:

2211.3 Cutting, notching, and boring. The cutting, notching and boring of holes in cold-formed steel framing members shall be in accordance with AISI S240 for structural members and AISI S220 for non-structural members.

2021 International Plumbing Code

Revise as follows:

307.2 Cutting, notching and boring in wood framing, or bored holes. A wood framing member shall not be cut, notched or bored in excess of limitations specified in the *International Building Code*.

Add new text as follows:

307.3 Cutting, notching and boring in cold-formed steel framing. The cutting, notching and boring of holes in cold-formed steel framing members shall be in accordance with AISI S240 for structural members and AISI S220 for non-structural members.

Delete without substitution:

~~[BS] C101.5 Cutting, notching and boring holes in cold-formed steel framing.~~ Flanges and lips of load-bearing cold-formed steel framing members shall not be cut or notched. Holes in webs of load-bearing cold-formed steel framing members shall be permitted along the centerline of the web of the framing member and shall not exceed the dimensional limitations, penetration spacing or minimum hole edge distance as prescribed by the registered design professional. Cutting, notching and boring holes of steel floor/roof decking shall be as prescribed by the registered design professional.

~~[BS] C101.6 Cutting, notching and boring holes in nonstructural cold-formed steel wall framing.~~ Flanges and lips of nonstructural cold-formed steel wall studs shall not be cut or notched. Holes in webs of nonstructural cold-formed steel wall studs shall be permitted along the centerline of the web of the framing member, shall not exceed 1 $\frac{1}{2}$ inches (38 mm) in width or 4 inches (102 mm) in length, and the holes shall not be spaced less than 24 inches (610 mm) center to center from another hole or less than 10 inches (254 mm) from the bearing end.

2021 International Mechanical Code

Revise as follows:

[BS] 302.5 Cutting, notching and boring in cold-formed steel framing. The cutting, notching and boring of holes in cold-formed steel framing members shall be in accordance with AISI S240 for structural members and AISI S220 for non-structural members. The cutting, notching and boring of steel framing members shall comply with Sections 302.5.1 through 302.5.3.

Delete without substitution:

~~[BS] 302.5.2 Cutting, notching and boring holes in cold-formed steel framing.~~ Flanges and lips of load-bearing cold-formed steel framing members shall not be cut or notched. Holes in webs of load-bearing cold-formed steel framing members shall be permitted along the centerline of the web of the framing member and shall not exceed the dimensional limitations, penetration spacing or minimum hole edge distance as prescribed by the registered design professional. Cutting, notching and boring holes of steel floor/roof decking shall be as prescribed by the registered design professional.

~~[BS] 302.5.3 Cutting, notching and boring holes in non-structural cold-formed steel wall framing.~~ Flanges and lips of nonstructural cold-formed steel wall studs shall not be cut or notched. Holes in webs of nonstructural cold-formed steel wall studs shall be permitted along the centerline of the web of the framing member, shall not exceed 1 $\frac{1}{2}$ inches (38 mm) in width or 4 inches (102 mm) in length, and shall not be spaced less than 24 inches (610 mm) center to center from another hole or less than 10 inches (254 mm) from the bearing end.

2021 International Fuel Gas Code

Revise as follows:

[BS] 302.6 Cutting, notching and boring holes in cold-formed steel framing. The cutting, notching and boring of holes in cold-formed steel framing members shall be in accordance with AISI S240 for structural members and AISI S220 for non-structural members. Flanges and lips of load-bearing, cold-formed steel framing members shall not be cut or notched. Holes in webs of load-bearing, cold-formed steel framing members shall be permitted along the centerline of the web of the framing member and shall not exceed the dimensional limitations, penetration spacing or minimum

hole edge distance as prescribed by the *registered design professional*. Cutting, notching and boring holes of steel floor/roof decking shall be as prescribed by the *registered design professional*.

Delete without substitution:

~~**[BS] 302.7 Cutting, notching and boring holes in non-structural cold-formed steel wall framing.** Flanges and lips of nonstructural cold-formed steel wall studs shall be permitted along the centerline of the web of the framing member, shall not exceed 1½ inches (38 mm) in width or 4 inches (102 mm) in length, and the holes shall not be spaced less than 24 inches (610 mm) center to center from another hole or less than 10 inches (254 mm) from the bearing end.~~

Staff Analysis: CC# S196-22 and CC# S224-22 addresses requirements in a different or contradicting manner. The committee is urged to make their intentions clear with their actions on these proposals.

Reason Statement: This proposal sets uniform requirements for field modifications to cold-formed steel framing members (cutting, notching, and boring holes) in accordance with AISI standards.

Currently, the IFGC, IMC, and IPC all provide guidance on modification of cold-formed steel framing elements within the path of utilities. Although the guidance provided by each code is similar, they are not identical in wording or scope and are handled differently within each document.

Differences include but are not limited to:

- IFGC, IMC: The cutting and notching criteria is within the main body of the code.
- IFGC, IMC: Includes direction for wood, steel, cold-formed steel, and non-structural cold-formed steel materials.
- IPC: Points to the IBC for cutting and notching criteria but provides Appendix C as an alternate.
- IPC Appendix C:
 - Includes some, but not all, cutting and notching criteria and limitations found within the IFGC and IMC.
 - Does not address steel and cold-formed materials.

This will provide clear and consistent criteria across all trades on how to field modify framing members and when modification of such members requires input from a design professional.

This proposal is submitted by the ICC Building Code Action Committee (BCAC).

BCAC was established by the ICC Board of Directors in July 2011 to pursue opportunities to improve and enhance assigned International Codes or portions thereof. In 2020 and 2021 the BCAC has held several virtual meetings open to any interested party. In addition, there were numerous virtual Working Group meetings for the current code development cycle, which included members of the committee as well as interested parties. Related documents and reports are posted on the BCAC website at <https://www.iccsafe.org/products-and-services/i-codes/code-development/cs/building-code-action-committee-bcac/>.

Cost Impact: The code change proposal will not increase or decrease the cost of construction

This proposal is a coordination of existing cutting, notching and boring provisions that are already used in practice but are not identical between codes or fully aligned with AISI standards.

S196-22

S197-22

IBC: SECTION 202 (New), SECTION 2212 (New), 2212.1 (New), 2212.1.1 (New), 2212.1.1.1 (New), 2212.1.1.2 (New), 2212.1.1.3 (New), 2212.1.1.4 (New), 2212.2 (New)

Proponents: W Lee Shoemaker, representing Metal Building Manufacturers Association (lshoemaker@mbma.com)

2021 International Building Code

Add new definition as follows:

METAL BUILDING SYSTEM. An integrated set of fabricated components and assemblies that form a complete or partial building shell that is designed by the manufacturer. This system typically includes but is not limited to primary framing comprised of built-up structural steel members, secondary members that are cold-formed steel or open-web steel joists, a metal panel roof system and exterior wall cladding. The system is manufactured in a manner that permits plant and/or field inspection prior to assembly or erection.

Add new text as follows:

SECTION 2212 **Metal Building Systems**

2212.1 General. The design, fabrication and erection of a metal building system shall be in accordance with the additional provisions of this section.

2212.1.1 Design. The design of metal building systems shall be in accordance with Sections 2212.1.1.1 through 2212.1.1.4, as applicable.

2212.1.1.1 Structural Steel. The design, fabrication and erection of structural steel shall be in accordance with Section 2205.

2212.1.1.2 Cold-Formed Steel. The design of cold-formed carbon and low-alloy steel structural members shall be in accordance with Section 2210.

2212.1.1.3 Steel Joists. The design of steel joists shall be in accordance with Section 2207.

2212.1.1.4 Steel Cable. The design, fabrication and erection including related connections of steel cables shall be in accordance with Section 2208.

2212.2 Seismic Design. Where required, the seismic design, fabrication and erection of the structural steel seismic force-resisting system shall be in accordance with Section 2205.2.1 or 2205.2.2, as applicable.

Staff Analysis: CC# S142-22 and CC# S197-22 addresses requirements in a different or contradicting manner. The committee is urged to make their intentions clear with their actions on these proposals.

Reason Statement: This addition to Chapter 22 and the accompanying new definition will clarify what the design requirements are for a metal building system. Metal building systems are significantly different from other forms of steel construction, especially regarding the shared design responsibilities between the metal building system manufacturer and registered design professional for the project. Furthermore, with clarification of the design requirements for the different parts of the metal building system, the special inspection requirements will be better defined. This might be viewed as an unnecessary clarification, but many construction documents are being used that list nonexistent "MBMA Standards" as the governing design requirements. This will be a real benefit to designers and building officials and lead to better construction documents and better construction.

Cost Impact: The code change proposal will not increase or decrease the cost of construction. This clarification of design requirements will not impact the cost of construction.

S197-22

S198-22

IBC: 2103.1

Proponents: Phillip Samblanet, representing The Masonry Society (psamblanet@masonrysociety.org); Jason Thompson, representing Masonry Alliance for Codes and Standards (jthompson@ncma.org)

2021 International Building Code

Revise as follows:

2103.1 Masonry units. Concrete *masonry units*, clay or shale *masonry units*, stone *masonry units*, *glass unit masonry* and *AAC masonry units* shall comply with Article 2.3 of TMS 602. Architectural *cast stone* shall conform to ~~ASTM C1364 and~~ TMS 504. ~~Adhered manufactured stone masonry veneer units shall conform to ASTM C1670.~~

Exception: *Structural clay tile* for nonstructural use in fireproofing of structural members and in wall furring shall not be required to meet the compressive strength specifications. The *fire-resistance rating* shall be determined in accordance with ASTM E119 or UL 263 and shall comply with the requirements of Table 705.5.

Reason Statement: In an effort to delete redundant provisions, the reference to ASTM C1364 is proposed for deletion because TMS 504 requires compliance with that standard. Likewise, TMS 602 now addresses adhered manufactured stone masonry veneer (it did not previously) making the last sentence redundant and unneeded as it is covered by the reference to TMS 602, Article 2.3.

Cost Impact: The code change proposal will not increase or decrease the cost of construction. This change simply deletes redundant requirements. As such, there is no impact on construction costs.

S198-22

S199-22

IBC: 2301.2, 2304.11.3.1, 2304.11.4.1

Proponents: David Tyree, representing American Wood Council (dtyree@awc.org)

2021 International Building Code

Revise as follows:

2301.2 ~~Nominal Sizes~~ Dimensions. For the purposes of this chapter, where dimensions of lumber are specified, they shall be deemed to be nominal dimensions unless specifically designated as actual dimensions (see Section 2304.2). Where dimensions of *cross-laminated timber* thickness are specified, they shall be deemed to be actual dimensions.

2304.11.3.1 Cross-laminated timber floors. *Cross-laminated timber* shall be not less than 4 inches (102 mm) in ~~actual~~ thickness. *Cross-laminated timber* shall be continuous from support to support and mechanically fastened to one another. *Cross-laminated timber* shall be permitted to be connected to walls without a shrinkage gap providing swelling or shrinking is considered in the design. Corbelling of masonry walls under the floor shall be permitted to be used.

2304.11.4.1 Cross-laminated timber roofs. *Cross-laminated timber* roofs shall be not less than 3 inches (76 mm) ~~nominal~~ in thickness and shall be continuous from support to support and mechanically fastened to one another.

Reason Statement: Clarify that cross-laminated timber (CLT) thickness is an actual dimension and describe CLT thickness consistently. In 2304.11.3.1 delete "actual", and in 2304.11.4.1 delete "nominal". With these changes CLT thickness will appear consistently with existing use in 2304.11.2.1 and 602.4.4.2.

Cost Impact: The code change proposal will not increase or decrease the cost of construction. This change implements consistent terminology for CLT thickness.

S199-22

S200-22

IBC: 2303.1, 2303.1.4

Proponents: David Tyree, representing American Wood Council (dtyree@awc.org)

2021 International Building Code

Revise as follows:

2303.1 General. Structural sawn lumber; end-jointed lumber; *prefabricated wood I-joists*; *structural glued-laminated timber*; *cross-laminated timber*; *wood structural panels*; fiberboard sheathing (where used structurally); *hardboard* siding (where used structurally); *particleboard*; *preservative-treated wood*; structural log members; *structural composite lumber*; round timber poles and piles; *fire-retardant-treated wood*; hardwood plywood; wood trusses; joist hangers; nails; and staples shall conform to the applicable provisions of this section.

2303.1.4 ~~Structural glued cross~~ Cross-laminated timber. Cross-laminated timbers shall be manufactured and identified in accordance with ANSI/APA PRG 320.

Reason Statement: Adds cross-laminated timber to list of products in Section 2303.1 and updates name for consistency in Section 2303.1.4.

Cost Impact: The code change proposal will not increase or decrease the cost of construction
This proposal updates general requirements to include cross-laminated timber.

S200-22

S201-22

IBC: 2303.2, 2303.2.1 (New), ASTM Chapter 35 (New)

Proponents: Marcelo Hirschler, representing GBH International (mmh@gbhint.com)

2021 International Building Code

Revise as follows:

2303.2 Fire-retardant-treated wood. *Fire-retardant-treated wood* is any wood product that, when impregnated with chemicals by a pressure process or other means during manufacture, shall have, when tested in accordance with ASTM E84 or UL 723, a *listed flame spread index* of 25 or less. ~~Additionally, the~~ The ASTM E84 or UL 723 test shall be continued for ~~a~~ an additional 20-minute period and the flame front shall not progress more than 10¹/₂ feet (3200 mm) beyond the centerline of the burners at any time during the test.

Add new text as follows:

2303.2.1 Alternate fire testing. A wood product impregnated with chemicals by a pressure process or other means during manufacture, which, when tested to ASTM E2768, has a listed flame spread index of 25 or less and where the flame front does not progress more than 10.5 feet (3200 mm) beyond the centerline of the burners at any time during the test, shall also be considered fire-retardant-treated wood.

Add new standard(s) as follows:

ASTM

ASTM International
100 Barr Harbor Drive, P.O. Box C700
West Conshohocken, PA 19428

E2768 -11(2018) Standard Test Method for Extended Duration Surface Burning Characteristics of Building Materials (30 min Tunnel Test)

Staff Analysis: A review of the standard proposed for inclusion in the code, ASTM E2768 -11(2018) Standard Test Method for Extended Duration Surface Burning Characteristics of Building Materials (30 min Tunnel Test), with regard to some of the key ICC criteria for referenced standards (Section 3.6 of CP#28) will be posted on the ICC website on or before March 16, 2022.

Reason Statement: ASTM E2768 was developed specifically intended for code use. It is a standardized version of ASTM E84 with the extension from 10 minutes to 30 minutes (meaning an additional 20 minutes) and it measures exactly what the extended ASTM E84 does, namely flame spread index and flame front progression beyond the centerline of the burners. This standard is already included in the IWUIC and the language proposed is consistent with the IWUIC language.

The change to the existing section is for language consistency (the exact same language is being proposed in the IRC). It is best to state that the test is continued for "an additional" 20 minutes.

Note that this change adds a new section without deleting any existing section. Thus, sections 2303.2.1 through 2303.2.9 will have to be renumbered as 2303.2.2 through 2303.2.10.

Cost Impact: The code change proposal will not increase or decrease the cost of construction. This is simple clarification/ ASTM E2768 is the same as the extended ASTM E84 test.

S201-22

S202-22

IBC: 2303.2.5, 2303.2.5.1, 2303.2.5.2

Proponents: David Tyree, representing American Wood Council (dtyree@awc.org)

2021 International Building Code

Revise as follows:

2303.2.5 ~~Strength adjustments~~ Design values. Design values for ~~untreated lumber and wood structural panels, fire-retardant-treated wood,~~ including connection design values, shall be subject to all adjustments applicable to untreated wood as specified in this chapter and shall be further adjusted to account for the effects of the fire-retardant treatment. Section 2303.1, shall be adjusted for fire-retardant-treated wood. Adjustments to design values for the effects of the fire-retardant treatment shall be based on an *approved* method of investigation that takes into consideration ~~the effects of~~ the anticipated temperature and humidity to which the *fire-retardant-treated wood* will be subjected, the type of treatment and the redrying procedures. Adjustments to flexural design values for fire-retardant-treated plywood shall be determined in accordance with Section 2303.2.5.1. Adjustments to flexural, tension, compression and shear design values for fire-retardant-treated lumber shall be determined in accordance with Section 2303.2.5.2.

2303.2.5.1 ~~Wood structural panels~~ Fire-retardant-treated plywood. The effect of treatment and ~~the method of~~ redrying after treatment, and any treatment-based effects due to exposure to high temperatures and high humidities on the flexure properties of fire-retardant-treated softwood plywood shall be determined in accordance with ASTM D5516. The test data developed ~~by in accordance with~~ ASTM D5516 shall be used to develop treatment adjustment factors, maximum loads and spans, or both, for untreated plywood design values in accordance with ASTM D6305. Each manufacturer shall publish the allowable maximum *loads* and spans for service as floor and roof sheathing for its treatment based on the adjusted design values and taking into account the climatological location.

2303.2.5.2 Fire-retardant-treated lumber. For each species of wood that is treated, the effects of ~~the treatment, the method of~~ and redrying after treatment and any treatment-based effects due to exposure to high temperatures and high humidities on the allowable design properties of fire-retardant-treated lumber shall be determined in accordance with ASTM D5664. The test data developed ~~by in accordance with~~ ASTM D5664 shall be used to develop modification-treatment adjustment factors for use at or near room temperature and at elevated temperatures and humidity in accordance with ASTM D6841. Each manufacturer shall publish the ~~modification-treatment adjustment~~ modification-treatment adjustment factors for service at maximum temperatures of not less than 80°F (27°C) and for roof framing. The roof framing modification factors shall take into consideration the climatological location.

Reason Statement: Section 2303.2.5 is revised to clarify that design values for fire-retardant-treated wood products are subject to all of the adjustments for untreated wood products and also must be adjusted to account for the effect of the fire-retardant treatment. This clarification aligns with ASTM D5664/D6841 for lumber and ASTM D5516/D6305 for plywood. In both cases, the fire-retardant treatment adjustment factors isolate the additional effect of the fire-retardant treatment, but do not address how the constituent untreated wood materials themselves need to be adjusted for typical application conditions. For this reason, design values for fire-retardant-treated wood products must be adjusted by factors that are applicable to untreated wood as well as the treatment adjustment factors.

A new sentence is added at the end of 2303.2.5 to reference 2303.2.5.1 and 2303.2.5.2 as strictly pertaining to fire-retardant-treated plywood and fire-retardant-treated lumber, respectively. These subsequent sections have also been revised accordingly, to reflect the fact that the standards referenced therein are specific to fire-retardant-treated plywood and fire-retardant-treated lumber, respectively.

Cost Impact: The code change proposal will not increase or decrease the cost of construction

This change provides clarification of the requirements consistent with the intent of existing code provisions and referenced standards.

S202-22

S203-22

IBC: 2303.2.5, 2303.2.5.3 (New), ASTM Chapter 35 (New)

Proponents: Jason Smart, representing American Wood Council (jsmart@awc.org); David Tyree, representing American Wood Council (dtyree@awc.org)

2021 International Building Code

Revise as follows:

2303.2.5 Strength adjustments. Design values for untreated lumber, and *wood structural panels*, as specified in Section 2303.1, shall be adjusted for *fire-retardant-treated wood*. Adjustments to design values shall be based on an *approved* method of investigation that takes into consideration the effects of the anticipated temperature and humidity to which the *fire-retardant-treated wood* will be subjected, the type of treatment and redrying procedures. Design values and treatment adjustment factors for fire-retardant-treated laminated veneer lumber shall be determined in accordance with 2303.2.5.3.

Add new text as follows:

2303.2.5.3 Fire-retardant-treated laminated veneer lumber. The effect of treatment and redrying after treatment and any treatment-based effects due to exposure to high temperatures and high humidities on the allowable design properties of fire-retardant-treated laminated veneer lumber shall be determined in accordance with ASTM D8223. Each manufacturer shall publish reference design values and treatment-based design value adjustment factors in accordance with ASTM D8223, taking into account the climatological location.

Add new standard(s) as follows:

ASTM

ASTM International
100 Barr Harbor Drive, P.O. Box C700
West Conshohocken, PA 19428

D8223-19

Standard Practice for Evaluation of Fire-Retardant Treated Laminated Veneer Lumber

Staff Analysis: A review of the standard proposed for inclusion in the code, ASTM D8223-19 Practice for Evaluation of Fire-Retardant Treated Laminated Veneer Lumber, with regard to some of the key ICC criteria for referenced standards (Section 3.6 of CP#28) will be posted on the ICC website on or before March 16, 2022.

Reason Statement: This change adds provisions for fire-retardant-treated laminated veneer lumber design values and adjustments for treatment effects to be developed in accordance with the new ASTM standard D8223. The provision requiring that each manufacturer publish reference design values and treatment-based design value adjustment factors is consistent with similar existing provisions in 2303.2.5.1 and 2305.2.5.2.

Cost Impact: The code change proposal will not increase or decrease the cost of construction

This proposal adds provisions addressing development of design values and adjustments for fire-retardant-treated laminated veneer lumber (LVL), which is currently not specifically addressed by the code. It does not affect when or where FRT LVL can be used as a building element.

S203-22

S204-22

IBC: 2303.2.5, 2303.2.5.3 (New), ASTM Chapter 35 (New)

Proponents: Mike Eckhoff, representing Hoover Treated Wood Products, Inc. (meckhoff@frtw.com); James Gogolski, representing Hoover Treated Wood Products, Inc. (jgogolski@frtw.com)

2021 International Building Code

Revise as follows:

2303.2.5 Strength. Design value adjustments. Design values for untreated lumber, ~~and wood structural panels, and structural composite lumber,~~ as specified in Section 2303.1, shall be adjusted for *fire-retardant-treated wood*. Adjustments to design values shall be based on an *approved* method of investigation that takes into consideration the effects of the anticipated temperature and humidity to which the *fire-retardant-treated wood* will be subjected, the type of treatment and redrying procedures.

Add new text as follows:

2303.2.5.3 Structural composite lumber. The effect of treatment and redrying after treatment and any treatment-based effects due to exposure to high temperatures and high humidities on the allowable design properties of fire-retardant-treated laminated veneer lumber shall be determined in accordance with ASTM D8223. Each manufacturer shall publish reference design values and treatment-based design value adjustment factors in accordance with ASTM D8223.

Add new standard(s) as follows:

ASTM

ASTM International
100 Barr Harbor Drive, P.O. Box C700
West Conshohocken, PA 19428

D8223-19

Practice for Evaluation of Fire-Retardant Treated Laminated Veneer Lumber

Staff Analysis: A review of the standard proposed for inclusion in the code, ASTM D8223-19 Practice for Evaluation of Fire-Retardant Treated Laminated Veneer Lumber, with regard to some of the key ICC criteria for referenced standards (Section 3.6 of CP#28) will be posted on the ICC website on or before March 16, 2022.

Reason Statement: This change adds provisions for fire-retardant-treated laminated veneer lumber design values and adjustments for treatment effects to be developed in accordance with the new ASTM standard D8223.

Cost Impact: The code change proposal will not increase or decrease the cost of construction. Currently in the IBC, strength adjustments for fire-retardant-treated (FRT) wood structural panels and FRT lumber are contained in Sections 2303.2.5.1 and 2303.2.5.2, respectively. This proposal will add a third section for determining the strength adjustments for FRT structural composite lumber using the new standard ASTM D8223-19: Practice for Evaluation of Fire-Retardant Treated Laminated Veneer Lumber.

Any potential increase in the cost of construction will be due to the difference between the costs of the raw materials (e.g., untreated LVL vs. untreated dimensional lumber), **NOT** because of the added fire-retardant treatment as the process and thus, cost, for fire-retardant-treating structural composite lumber and untreated dimensional lumber is identical.

S204-22

S205-22

IBC: 2303.3 (New)

Proponents: Marcelo Hirschler, representing GBH International (mmh@gbhint.com)

2021 International Building Code

Add new text as follows:

2303.3 Fire-retardant coated wood. The required flame spread index or smoke-developed index of an interior wood surface shall not be permitted to be achieved by the application on site of fire-retardant coatings, paints or solutions to surfaces. The application of factory-manufactured laminated products complying with Section 803.11 or the application of facings or veneers complying with Section 803.12 shall be acceptable methods of improving the flame spread index or smoke-developed index of such surfaces. Such factory-manufactured products shall not be considered fire-retardant-treated wood.

Reason Statement: The IBC implicitly does not allow the use of fire retardant coatings added on site in new construction. The reason for that not being permitted is that it is not possible to properly control the adequate application of a surface treatment by a person working on site, which means that there is no assurance that the application will result in the surface being appropriately fire safe. Section 2303.2.2 explicitly prohibits the use of paints, coatings, stains or surface treatments as means to obtain fire retardant treated wood.

2303.2.2 Other means during manufacture. *For wood products impregnated with chemicals by other means during manufacture, the treatment shall be an integral part of the manufacturing process of the wood product. The treatment shall provide permanent protection to all surfaces of the wood product. The use of paints, coating, stains or other surface treatments is not an approved method of protection as required in this section.*

The language proposed mirrors exactly the language in Chapter 8 of the IBC, which distinguishes between laminated (or faced) products that are factory-produced and those that are applied on site. This also mirrors the requirements issued by ASTM when it developed practices ASTM E2404 and ASTM E2579. Sections 803.11 and 803.12 of the IBC explain how to assess the flame spread index and smoke developed index of wood substrates with added laminations, facings, or veneers, while making a clear distinction between those that are factory produced (803.11) and those that are applied on site (803.12). Neither section allows coatings to be used in new construction.

803.11 Laminated products factory produced with a wood substrate. *Laminated products factory produced with a wood substrate shall comply with one of the following:*

- 1. The laminated product shall meet the criteria of Section 803.1.1.1 when tested in accordance with NFPA 286 using the product-mounting system, including adhesive, as described in Section 5.8 of NFPA 286.*
- 2. The laminated product shall have a Class A, B, or C flame spread index and smoke-developed index, based on the requirements of Table 803.13, in accordance with ASTM E84 or UL 723. Test specimen preparation and mounting shall be in accordance with ASTM E2579.*

803.12 Facings or wood veneers intended to be applied on site over a wood substrate. *Facings or veneers intended to be applied on site over a wood substrate shall comply with one of the following:*

- 1. The facing or veneer shall meet the criteria of Section 803.1.1.1 when tested in accordance with NFPA 286 using the product mounting system, including adhesive, as described in Section 5.9 of NFPA 286.*
- 2. The facing or veneer shall have a Class A, B or C flame spread index and smoke-developed index, based on the requirements of Table 803.13, in accordance with ASTM E84 or UL 723. Test specimen preparation and mounting shall be in accordance with ASTM E2404.*

The IFC does allow fire-retardant coatings to be used to bring the underlying surface up to code in section 803.4.

803.4 Fire-retardant coatings. *The required flame spread or smoke-developed index of surfaces in existing buildings shall be allowed to be achieved by application of approved fire-retardant coatings, paints or solutions to surfaces having a flame spread index exceeding that allowed. Such applications shall comply with NFPA 703 and the required fire retardant properties shall be maintained or renewed in accordance with the manufacturer's instructions. The fire retardant paint, coating or solution shall have been assessed by testing over the same substrate to be used in the application.*

What this proposal does is make it explicit what is now implicit, namely that coatings are not allowed to be used on-site to improve the flame spread index or smoke developed index of wood surfaces. However, it is permissible to bring to the site laminations, facings or veneers that have already been coated at a manufacturing facility.

(This proposal is intended to add a section and not to replace an existing section. Sections 2303.3 and subsequent ones would have to be renumbered.)

Cost Impact: The code change proposal will not increase or decrease the cost of construction
This is clarification of an implicit code requirement.

S206-22

IBC: TABLE 2304.6.1

Proponents: Borjen Yeh, representing APA - The Engineered Wood Association (borjen.yeh@apawood.org)

2021 International Building Code

Revise as follows:

TABLE 2304.6.1 MAXIMUM ALLOWABLE STRESS BASIC DESIGN WIND SPEED, V_{asd} , PERMITTED FOR WOOD STRUCTURAL PANEL WALL SHEATHING USED TO RESIST WIND PRESSURES^{a, b, c}

MINIMUM NAIL		MINIMUM WOOD STRUCTURAL PANEL SPAN RATING	MINIMUM NOMINAL PANEL THICKNESS (inches)	MAXIMUM WALL STUD SPACING (inches)	PANEL NAIL SPACING		MAXIMUM ALLOWABLE STRESS BASIC DESIGN WIND SPEED, V_{asd} ^d (MPH)		
Size	Penetration (inches)				Edges (inches o.c.)	Field (inches o.c.)	Wind exposure category		
							B	C	D
6d common (2.0" x 0.113")	1.5	24/0	$\frac{3}{8}$	16	6	12	<u>140</u> 140	<u>115</u> 90	<u>110</u> 85
		24/16	$\frac{7}{16}$	16	6	12	<u>150</u> 140	<u>125</u> 100	<u>115</u> 90
						6	<u>190</u> 150	<u>160</u> 125	<u>150</u> 110
8d common (2.5" x 0.131")	1.75	24/16	$\frac{7}{16}$	16	6	12	<u>170</u> 130	<u>140</u> 110	<u>135</u> 105
						6	<u>190</u> 150	<u>160</u> 125	<u>150</u> 110
				24	6	12	<u>140</u> 110	<u>115</u> 90	<u>110</u> 85
						6	<u>140</u> 110	<u>115</u> 90	<u>110</u> 85

For SI: 1 inch = 25.4 mm, 1 mile per hour = 0.447 m/s.

- Panel strength axis shall be parallel or perpendicular to supports. Three-ply plywood sheathing with studs spaced more than 16 inches on center shall be applied with panel strength axis perpendicular to supports.
- The table is based on wind pressures acting toward and away from building surfaces in accordance with Section 30.7.4 of ASCE 7. Lateral requirements shall be in accordance with Section 2305 or 2308.
- Wood structural panels with span ratings of wall-16 or wall-24 shall be permitted as an alternative to panels with a 24/0 span rating. Plywood siding rated 16 on center or 24 on center shall be permitted as an alternative to panels with a 24/16 span rating. Wall-16 and plywood siding 16 on center shall be used with studs spaced not more than 16 inches on center.
- ~~V_{asd} shall be determined in accordance with Section 1609.3.1.~~

Reason Statement: This proposal changes the table format from the allowable stress design wind speed (V_{asd}) to the basic design wind speed (V) for consistency with the rest of the IBC. This proposal evaluates the stud and panel capacities, nail withdrawal resistance, and nail-head pull-through capacities in the same manner as the existing table, resulting in comparable design requirements as the V values that are soft-converted from V_{asd} values in accordance with Section 1609.3.1. The tabulated V values are also consistent with those values already published in the 2021 IRC Table R602.3(3). For Footnote (b), Section 30.7 in the previous ASCE 7-10 should be Section 30.4 in ASCE 7-16. Since the revised table is in the format of basic design wind speed, the existing Footnote (d) is no longer required and should be deleted.

Cost Impact: The code change proposal will not increase or decrease the cost of construction. This code change proposal updates the table format, which results in comparable design requirements as the current table when the allowable stress design wind speed is soft-converted to the basic design wind speed in accordance with Section 1609.3.1.

S207-22

IBC: TABLE 2304.6.1

Proponents: David Tyree, representing American Wood Council (dtyree@awc.org); Philip Line, representing American Wood Council (pline@awc.org)

2021 International Building Code

Revise as follows:

TABLE 2304.6.1 MAXIMUM ALLOWABLE STRESS DESIGN WIND SPEED, V_{asd} PERMITTED FOR WOOD STRUCTURAL PANEL WALL SHEATHING USED TO RESIST WIND PRESSURES^{a, b, c}

MINIMUM NAIL		MINIMUM WOOD STRUCTURAL PANEL SPAN RATING	MINIMUM NOMINAL PANEL THICKNESS (inches)	MAXIMUM WALL STUD SPACING (inches)	PANEL NAIL SPACING		MAXIMUM ALLOWABLE STRESS DESIGN WIND SPEED, V_{asd} ^d (MPH)		
Size	Penetration (inches)				Edges (inches o.c.)	Field (inches o.c.)	Wind exposure category		
							B	C	D
6d common (2.0" x 0.113")	1.5	24/0	$\frac{3}{8}$	16	6	12 ^e	110	90	85
		24/16	$\frac{7}{16}$	16	6	12 ^e	110	100	90
						6 ^e	150	125	110
8d common (2.5" x 0.131")	1.75	24/16	$\frac{7}{16}$	16	6	12 ^e	130	110	105
						6 ^e	150	125	110
				24	6	12 ^e	110	90	85
						6 ^e	110	90	85

For SI: 1 inch = 25.4 mm, 1 mile per hour = 0.447 m/s.

- Panel strength axis shall be parallel or perpendicular to supports. Three-ply plywood sheathing with studs spaced more than 16 inches on center shall be applied with panel strength axis perpendicular to supports.
- The table is based on wind pressures acting toward and away from building surfaces in accordance with Section 30.7 of ASCE 7. Lateral requirements shall be in accordance with Section 2305 or 2308.
- Wood structural panels with span ratings of wall-16 or wall-24 shall be permitted as an alternative to panels with a 24/0 span rating. Plywood siding rated 16 on center or 24 on center shall be permitted as an alternative to panels with a 24/16 span rating. Wall-16 and plywood siding 16 on center shall be used with studs spaced not more than 16 inches on center.
- V_{asd} shall be determined in accordance with Section 1609.3.1.
- Where the specific gravity of the wood species used for wall framing is greater than or equal to 0.35 but less than 0.42 in accordance with AWC NDS, nail spacing in the field of the panel shall be multiplied by 0.67. Where the specific gravity of the wood species used for wall framing is less than 0.35, fastening of the wall sheathing shall be designed in accordance with AWC NDS.

Reason Statement: This change recognizes the minimum specific gravity basis of 0.42 for the fastener spacing and provides a prescriptive option (i.e., multiply spacing by 0.67) for framing of species with lower specific gravity down to specific gravity equal to 0.35. Engineered design of the fastening is required when specific gravity of the species used for wall framing is less than 0.35.

Cost Impact: The code change proposal will increase the cost of construction. Increased cost of construction will occur where low specific gravity wood species are used. For wood species with specific gravity of 0.35, closer fastener spacing is required to provide equivalent withdrawal performance to the 0.42 specific gravity basis of the existing fastening schedule without requiring engineered design.

S207-22

S208-22

IBC: 2304.6.2 (New), TABLE 2308.5.11

Proponents: Jay Crandell, P.E., ABTG/ARES Consulting, representing Foam Sheathing Committee of the American Chemistry Council
(jcrandell@aresconsulting.biz)

2021 International Building Code

Add new text as follows:

2304.6.2 Foam plastic insulating sheathing. Where foam plastic *insulating sheathing* is used as exterior sheathing or in addition to other exterior sheathing, it shall comply with Chapter 14 and Chapter 26.

Revise as follows:

TABLE 2308.5.11 MINIMUM THICKNESS OF WALL SHEATHING

SHEATHING TYPE	MINIMUM THICKNESS	MAXIMUM WALL STUD SPACING
Diagonal wood boards	$\frac{5}{8}$ inch	24 inches on center
Structural fiberboard	$\frac{1}{2}$ inch	16 inches on center
Wood structural panel	In accordance with Tables 2308.6.3(2) and 2308.6.3(3)	—
M-S “Exterior Glue” and M-2 “Exterior Glue” particleboard	In accordance with Section 2306.3 and Table 2308.6.3(4)	—
Gypsum sheathing	$\frac{1}{2}$ inch	16 inches on center
Reinforced cement mortar	1 inch	24 inches on center
Hardboard panel siding	In accordance with Table 2308.6.3(5)	—
Foam plastic <i>insulating sheathing</i> ^a	<u>In accordance with Sections 2304.6.2 and 2603.10</u>	---

For SI: 1 inch = 25.4 mm.

- a. Where foam plastic insulating sheathing is installed over or under one of the other sheathing materials listed in the table, compliance with Section 2603.10 with regard to foam sheathing thickness and maximum stud spacing is not required.

Reason Statement: Foam sheathing materials are commonly applied as exterior wall sheathing on conventional wood frame walls and should be included in Section 2304.6 and in Table 2308.5.11. It will help ensure that appropriate requirements are applied for use of foam plastic insulating sheathing on conventional wood frame construction.

Foam sheathing may be applied as the sole exterior sheathing material provided it has thickness and strength to resist required wind loads in accordance with Section 2603.10 for a given stud spacing. Foam sheathing also is commonly used as “over-” or “under-” sheathing together with one of the other sheathing materials listed in the table. For this latter condition of dual sheathing materials, footnote ‘a’ is added to the table because the other exterior sheathing materials resist 100 percent of the design wind load (in which case foam sheathing serves only as continuous insulation or perhaps also as the water-resistive barrier system). This proposal fills a gap in the prescriptive sheathing materials recognized in Chapter 23.

Cost Impact: The code change proposal will not increase or decrease the cost of construction

This proposal adds no new requirements to the code, but clarifies the option and requirements for using foam sheathing with engineered and conventional wood frame construction.

S209-22

IBC: TABLE 2304.8(2)

Proponents: David Tyree, representing American Wood Council (dtyree@awc.org)

2021 International Building Code

Revise as follows:

TABLE 2304.8(2) SHEATHING LUMBER, MINIMUM GRADE REQUIREMENTS: BOARD GRADE

SOLID FLOOR OR ROOF SHEATHING	SPACED ROOF SHEATHING	GRADING RULES
Utility	Standard	NLGA, <u>PLIB</u> /WCLIB, <u>or</u> WWPA
4 common or utility	3 common or standard	NLGA, <u>PLIB</u> /WCLIB, WWPA, NLSB or NELMA
No. 3	No. 2	SPIB
Merchantable	Construction common	RIS

Reason Statement: Update to reflect changes in PS20-20 and consolidation of West Coast Lumber Inspection Bureau (WCLIB) under Pacific Lumber Inspection Bureau (PLIB). Northern Softwood Lumber Bureau (NLSB) has been dissolved.

Cost Impact: The code change proposal will not increase or decrease the cost of construction. This change updates applicable grading rules for consistency with PS20.

S209-22

S210-22

IBC: CHAPTER 23, SECTION 2304, TABLE 2304.8(3), TABLE 2304.8(5), 2308.2.3, TABLE 2308.4.1.1(1), TABLE 2308.7.2(3), TABLE 2308.7.2(4), TABLE 2308.7.2(5), TABLE 2308.7.2(6), TABLE 2308.7.3.1, CHAPTER 24, SECTION 2404, 2404.2

Proponents: Jennifer Goupil, representing Structural Engineering Institute of ASCE (jgoupil@asce.org)

2021 International Building Code

CHAPTER 23 WOOD

SECTION 2304 GENERAL CONSTRUCTION REQUIREMENTS

Revise as follows:

TABLE 2304.8(3) ALLOWABLE SPANS AND LOADS FOR WOOD STRUCTURAL PANEL SHEATHING AND SINGLE-FLOOR GRADES CONTINUOUS OVER TWO OR MORE SPANS WITH STRENGTH AXIS PERPENDICULAR TO SUPPORTS^a

SHEATHING GRADES		ROOF ^b				FLOOR ^c
Panel span rating roof/floor span	Panel thickness (inches)	Maximum span (inches)		Load ^d (psf)		Maximum span (inches)
		With edge support ^e	Without edge support	Total load	Live load	
16/0	3/8	16	16	40	30	0
20/0	3/8	20	20	40	30	0
24/0	3/8, 7/16, 1/2	24	20 ^f	40	30	0
24/16	7/16, 1/2	24	24	50	40	16
32/16	15/32, 1/2, 5/8	32	28	40	30	16 ^g
40/20	19/32, 5/8, 3/4, 7/8	40	32	40	30	20 ^{g,h}
48/24	23/32, 3/4, 7/8	48	36	45	35	24
54/32	7/8, 1	54	40	45	35	32
60/32	7/8, 1 1/8	60	48	45	35	32
SINGLE FLOOR GRADES		ROOF ^b				FLOOR ^c
Panel span rating	Panel thickness (inches)	Maximum span (inches)		Load ^e (psf)		Maximum span (inches)
		With edge support ^e	Without edge support	Total load	Live load	
16 o.c.	1/2, 19/32, 5/8	24	24	50	40	16 ^g
20 o.c.	19/32, 5/8, 3/4	32	32	40	30	20 ^{g,h}
24 o.c.	23/32, 3/4	48	36	35	25	24
32 o.c.	7/8, 1	48	40	50	40	32
48 o.c.	1 3/32, 1 1/8	60	48	50	40	48

For SI: 1 inch = 25.4 mm, 1 pound per square foot = 0.0479 kN/m².

- a. Applies to panels 24 inches or wider.
- b. Uniform load deflection limitations 1/180 of span under live load plus dead load, 1/240 under live load only.
- c. Panel edges shall have approved tongue-and-groove joints or shall be supported with blocking unless 1/4-inch minimum thickness underlayment or 1 1/2 inches of approved cellular or lightweight concrete is placed over the subfloor, or finish floor is 3/4-inch wood strip. Allowable uniform load based on deflection of 1/360 of span is 100 pounds per square foot except the span rating of 48 inches on center is based on a total load of 65 pounds per square foot.
- d. Allowable load at maximum span. Where the total load includes snow, use allowable stress design snow loads.
- e. Tongue-and-groove edges, panel edge clips (one midway between each support, except two equally spaced between supports 48 inches on center), lumber blocking or other. Only lumber blocking shall satisfy blocked diaphragm requirements. Where the total load includes snow, use allowable stress design snow loads.
- f. For 1/2-inch panel, maximum span shall be 24 inches.
- g. Span is permitted to be 24 inches on center where 3/4-inch wood strip flooring is installed at right angles to joist.
- h. Span is permitted to be 24 inches on center for floors where 1 1/2 inches of cellular or lightweight concrete is applied over the panels.

TABLE 2304.8(5) ALLOWABLE LOAD (PSF) FOR WOOD STRUCTURAL PANEL ROOF SHEATHING CONTINUOUS OVER TWO OR MORE SPANS AND STRENGTH AXIS PARALLEL TO SUPPORTS (Plywood structural panels are five-ply, five-layer unless otherwise noted)^a

PANEL GRADE	THICKNESS (inch)	MAXIMUM SPAN (inches)	LOAD AT MAXIMUM SPAN (psf)	
			Live	Total ^c
Structural I sheathing	7/16	24	20	30
	15/32	24	35 ^b	45 ^b
	1/2	24	40 ^b	50 ^b
	19/32, 5/8	24	70	80
	23/32, 3/4	24	90	100
Sheathing, other grades covered in DOC PS 1 or DOC PS 2	7/16	16	40	50
	15/32	24	20	25
	1/2	24	25	30
	19/32	24	40 ^b	50 ^b
	5/8	24	45 ^b	55 ^b
	23/32, 3/4	24	60 ^b	65 ^b

For SI: 1 inch = 25.4 mm, 1 pound per square foot = 0.0479 kN/m².

- Uniform load deflection limitations $1/180$ of span under live load plus dead load, $1/240$ under live load only. Edges shall be blocked with lumber or other approved type of edge supports.
- For composite and four-ply plywood structural panel, load shall be reduced by 15 pounds per square foot.
- Where the total load includes snow, use allowable stress design snow loads.

2308.2.3 Allowable loads. Loads shall be in accordance with Chapter 16 and shall not exceed the following:

- Average *dead loads* shall not exceed 15 psf (718 N/m²) for combined roof and ceiling, *exterior walls*, floors and partitions.

Exceptions:

- Subject to the limitations of Section 2308.6.10, stone or masonry *vener* up to the less of 5 inches (127 mm) thick or 50 pounds per square foot (2395 N/m²) and installed in accordance with Chapter 14 is permitted to a height of 30 feet (9144 mm) above a noncombustible foundation, with an additional 8 feet (2439) permitted for *gable* ends.
- Concrete or masonry fireplaces, heaters and chimneys shall be permitted in accordance with the provisions of this code.

- Live loads* shall not exceed 40 psf (1916 N/m²) for floors.

Exception: *Live loads* for concrete slab-on-ground floors in *Risk Categories* I and II shall be not more than 125 psf.

- Ground snow *loads* shall not exceed 50 psf (2395 N/m²).

Revise as follows:

TABLE 2308.4.1.1(1) HEADER AND GIRDER SPANS^{a, b} FOR EXTERIOR BEARING WALLS (Maximum spans for Douglas fir-larch, hem-fir, Southern pine and spruce-pine-fir and required number of jack studs)

Portions of table not shown remain unchanged.

GIRDERS AND HEADERS SUPPORTING	SIZE	GROUND SNOW LOAD, $p_g(ASD)$ (psf) ^e																	
		30						50						70					
		Building width ^c (feet)																	
		12		24		36		12		24		36		12		24		36	
		Span ^f	NJ ^d	Span ^f	NJ ^d	Span ^f	NJ ^d	Span ^f	NJ ^d	Span ^f	NJ ^d	Span ^f	NJ ^d	Span ^f	NJ ^d	Span ^f	NJ ^d	Span ^f	NJ ^d
Roof and ceiling	1-2 x 6	4-0	1	3-1	2	2-7	2	3-5	1	2-8	2	2-3	2	3-0	2	2-4	2	2-0	2
	1-2 x 8	5-1	2	3-11	2	3-3	2	4-4	2	3-4	2	2-10	2	3-10	2	3-0	2	2-6	3
	1-2 x 10	6-0	2	4-8	2	3-11	2	5-2	2	4-0	2	3-4	3	4-7	2	3-6	3	3-0	3
	1-2 x 12	7-1	2	5-5	2	4-7	3	6-1	2	4-8	3	3-11	3	5-5	2	4-2	3	3-6	3
	2-2 x 4	4-0	1	3-1	1	2-7	1	3-5	1	2-7	1	2-2	1	3-0	1	2-4	1	2-0	1
	2-2 x 6	6-0	1	4-7	1	3-10	1	5-1	1	3-11	1	3-3	2	4-6	1	3-6	2	2-11	2
	2-2 x 8	7-7	1	5-9	1	4-10	2	6-5	1	5-0	2	4-2	2	5-9	1	4-5	2	3-9	2
	2-2 x 10	9-0	1	6-10	2	5-9	2	7-8	2	5-11	2	4-11	2	6-9	2	5-3	2	4-5	2
	2-2 x 12	10-7	2	8-1	2	6-10	2	9-0	2	6-11	2	5-10	2	8-0	2	6-2	2	5-2	3
	3-2 x 8	9-5	1	7-3	1	6-1	1	8-1	1	6-3	1	5-3	2	7-2	1	5-6	2	4-8	2
	3-2 x 10	11-3	1	8-7	1	7-3	2	9-7	1	7-4	2	6-2	2	8-6	1	6-7	2	5-6	2
	3-2 x 12	13-2	1	10-1	2	8-6	2	11-3	2	8-8	2	7-4	2	10-0	2	7-9	2	6-6	2
	4-2 x 8	10-11	1	8-4	1	7-0	1	9-4	1	7-2	1	6-0	1	8-3	1	6-4	1	5-4	2
	4-2 x 10	12-11	1	9-11	1	8-4	1	11-1	1	8-6	1	7-2	2	9-10	1	7-7	2	6-4	2
	4-2 x 12	15-3	1	11-8	1	9-10	2	13-0	1	10-0	2	8-5	2	11-7	1	8-11	2	7-6	2
	1-2 x 6	3-3	1	2-7	2	2-2	2	3-0	2	2-4	2	2-0	2	2-9	2	2-2	2	1-10	2
	1-2 x 8	4-1	2	3-3	2	2-9	2	3-9	2	3-0	2	2-6	3	3-6	2	2-9	2	2-4	3
	1-2 x 10	4-11	2	3-10	2	3-3	3	4-6	2	3-6	3	3-0	3	4-1	2	3-3	3	2-9	3
	1-2 x 12	5-9	2	4-6	3	3-10	3	5-3	2	4-2	3	3-6	3	4-10	3	3-10	3	3-3	4
	2-2 x 4	3-3	1	2-6	1	2-2	1	3-0	1	2-4	1	2-0	1	2-8	1	2-2	1	1-10	1
	2-2 x 6	4-10	1	3-9	1	3-3	2	4-5	1	3-6	2	3-0	2	4-1	1	3-3	2	2-9	2
	2-2 x 8	6-1	1	4-10	2	4-1	2	5-7	2	4-5	2	3-9	2	5-2	2	4-1	2	3-6	2

GIRDERS AND HEADERS Roof, ceiling and center-bearing floor	SIZE	GROUND SNOW LOAD, p_s (psf)																	
		30						50						70					
		Building width (feet)																	
		12		24		36		12		24		36		12		24		36	
		Span	NJ	Span	NJ	Span	NJ	Span	NJ	Span	NJ	Span	NJ	Span	NJ	Span	NJ	Span	NJ
Roof, ceiling and center-bearing floor	2-2 x 10	7-3	2	5-8	2	4-10	2	6-8	2	5-3	2	4-5	2	6-1	2	4-10	2	4-1	2
	2-2 x 12	8-6	2	6-8	2	5-8	2	7-10	2	6-2	2	5-3	3	7-2	2	5-8	2	4-10	3
	3-2 x 8	7-8	1	6-0	1	5-1	2	7-0	1	5-6	2	4-8	2	6-5	1	5-1	2	4-4	2
	3-2 x 10	9-1	1	7-2	2	6-1	2	8-4	1	6-7	2	5-7	2	7-8	2	6-1	2	5-2	2
	3-2 x 12	10-8	2	8-5	2	7-2	2	9-10	2	7-8	2	6-7	2	9-0	2	7-1	2	6-1	2
	4-2 x 8	8-10	1	6-11	1	5-11	1	8-1	1	6-4	1	5-5	2	7-5	1	5-11	1	5-0	2
	4-2 x 10	10-6	1	8-3	2	7-0	2	9-8	1	7-7	2	6-5	2	8-10	1	7-0	2	6-0	2
	4-2 x 12	12-4	1	9-8	2	8-3	2	11-4	2	8-11	2	7-7	2	10-4	2	8-3	2	7-0	2
Roof, ceiling and one clear span floor	1-2 x 6	2-11	2	2-3	2	1-11	2	2-9	2	2-1	2	1-9	2	2-7	2	2-0	2	1-8	2
	1-2 x 8	3-9	2	2-10	2	2-5	3	3-6	2	2-8	2	2-3	3	3-3	2	2-6	3	2-2	3
	1-2 x 10	4-5	2	3-5	3	2-10	3	4-2	2	3-2	3	2-8	3	3-11	2	3-0	3	2-6	3
	1-2 x 12	5-2	2	4-0	3	3-4	3	4-10	3	3-9	3	3-2	4	4-7	3	3-6	3	3-0	4
	2-2 x 4	2-11	1	2-3	1	1-10	1	2-9	1	2-1	1	1-9	1	2-7	1	2-0	1	1-8	1
	2-2 x 6	4-4	1	3-4	2	2-10	2	4-1	1	3-2	2	2-8	2	3-10	1	3-0	2	2-6	2
	2-2 x 8	5-6	2	4-3	2	3-7	2	5-2	2	4-0	2	3-4	2	4-10	2	3-9	2	3-2	2
	2-2 x 10	6-7	2	5-0	2	4-2	2	6-1	2	4-9	2	4-0	2	5-9	2	4-5	2	3-9	3
	2-2 x 12	7-9	2	5-11	2	4-11	3	7-2	2	5-7	2	4-8	3	6-9	2	5-3	3	4-5	3
	3-2 x 8	6-11	1	5-3	2	4-5	2	6-5	1	5-0	2	4-2	2	6-1	1	4-8	2	4-0	2
	3-2 x 10	8-3	2	6-3	2	5-3	2	7-8	2	5-11	2	5-0	2	7-3	2	5-7	2	4-8	2
	3-2 x 12	9-8	2	7-5	2	6-2	2	9-0	2	7-0	2	5-10	2	8-6	2	6-7	2	5-6	3
	4-2 x 8	8-0	1	6-1	1	5-1	2	7-5	1	5-9	2	4-10	2	7-0	1	5-5	2	4-7	2
	4-2 x 10	9-6	1	7-3	2	6-1	2	8-10	1	6-10	2	5-9	2	8-4	1	6-5	2	5-5	2
	4-2 x 12	11-2	2	8-6	2	7-2	2	10-5	2	8-0	2	6-9	2	9-10	2	7-7	2	6-5	2

GIRDERS AND HEADERS SUPPORTING	SIZE	GROUND SNOW LOAD, p_g (psf)																	
		30						50						70					
		Building width (feet)																	
		12		24		36		12		24		36		12		24		36	
		Span	NJ	Span	NJ	Span	NJ	Span	NJ	Span	NJ	Span	NJ	Span	NJ	Span	NJ	Span	NJ
Roof, ceiling and two center-bearing floors	1-2 x 6	2-8	2	2-1	2	1-10	2	2-7	2	2-0	2	1-9	2	2-5	2	1-11	2	1-8	2
	1-2 x 8	3-5	2	2-8	2	2-4	3	3-3	2	2-7	2	2-2	3	3-1	2	2-5	3	2-1	3
	1-2 x 10	4-0	2	3-2	3	2-9	3	3-10	2	3-1	3	2-7	3	3-8	2	2-11	3	2-5	3
	1-2 x 12	4-9	3	3-9	3	3-2	4	4-6	3	3-7	3	3-1	4	4-3	3	3-5	3	2-11	4
	2-2 x 4	2-8	1	2-1	1	1-9	1	2-6	1	2-0	1	1-8	1	2-5	1	1-11	1	1-7	1
	2-2 x 6	4-0	1	3-2	2	2-8	2	3-9	1	3-0	2	2-7	2	3-7	1	2-10	2	2-5	2
	2-2 x 8	5-0	2	4-0	2	3-5	2	4-10	2	3-10	2	3-3	2	4-7	2	3-7	2	3-1	2
	2-2 x 10	6-0	2	4-9	2	4-0	2	5-8	2	4-6	2	3-10	3	5-5	2	4-3	2	3-8	3
	2-2 x 12	7-0	2	5-7	2	4-9	3	6-8	2	5-4	3	4-6	3	6-4	2	5-0	3	4-3	3
	3-2 x 8	6-4	1	5-0	2	4-3	2	6-0	1	4-9	2	4-1	2	5-8	2	4-6	2	3-10	2
	3-2 x 10	7-6	2	5-11	2	5-1	2	7-1	2	5-8	2	4-10	2	6-9	2	5-4	2	4-7	2
	3-2 x 12	8-10	2	7-0	2	5-11	2	8-5	2	6-8	2	5-8	3	8-0	2	6-4	2	5-4	3
	4-2 x 8	7-3	1	5-9	1	4-11	2	6-11	1	5-6	2	4-8	2	6-7	1	5-2	2	4-5	2
	4-2 x 10	8-8	1	6-10	2	5-10	2	8-3	2	6-6	2	5-7	2	7-10	2	6-2	2	5-3	2
	4-2 x 12	10-2	2	8-1	2	6-10	2	9-8	2	7-8	2	6-7	2	9-2	2	7-3	2	6-2	2
	1-2 x 6	2-3	2	1-9	2	1-5	2	2-3	2	1-9	2	1-5	3	2-2	2	1-8	2	1-5	3
	1-2 x 8	2-10	2	2-2	3	1-10	3	2-10	2	2-2	3	1-10	3	2-9	2	2-1	3	1-10	3
	1-2 x 10	3-4	2	2-7	3	2-2	3	3-4	3	2-7	3	2-2	4	3-3	3	2-6	3	2-2	4
	1-2 x 12	4-0	3	3-0	3	2-7	4	4-0	3	3-0	4	2-7	4	3-10	3	3-0	4	2-6	4
	2-2 x 4	2-3	1	1-8	1	1-4	1	2-3	1	1-8	1	1-4	1	2-2	1	1-8	1	1-4	2
	2-2 x 6	3-4	1	2-6	2	2-2	2	3-4	2	2-6	2	2-2	2	3-3	2	2-6	2	2-1	2
	2-2 x 8	4-3	2	3-3	2	2-8	2	4-3	2	3-3	2	2-8	2	4-1	2	3-2	2	2-8	3
	2-2 x 10	5-0	2	3-10	2	3-2	3	5-0	2	3-10	2	3-2	3	4-10	2	3-9	3	3-2	3
	2-2 x 12	5-11	2	4-6	3	3-9	3	5-11	2	4-6	3	3-9	3	5-8	2	4-5	3	3-9	3

Roof, ceiling and two clear span floors GIRDERS AND HEADERS SUPPORTING	SIZE	GROUND SNOW LOAD, p_g (psf)																	
		30						50						70					
		Building width (feet)																	
		12			24			36			12			24			36		
		Span	NJ	Span	NJ	Span	NJ	Span	NJ	Span	NJ	Span	NJ	Span	NJ	Span	NJ	Span	NJ
	3-2 × 8	5-3	1	4-0	2	3-5	2	5-3	2	4-0	2	3-5	2	5-1	2	3-11	2	3-4	2
	3-2 × 10	6-3	2	4-9	2	4-0	2	6-3	2	4-9	2	4-0	2	6-1	2	4-8	2	4-0	3
	3-2 × 12	7-5	2	5-8	2	4-9	3	7-5	2	5-8	2	4-9	3	7-2	2	5-6	3	4-8	3
	4-2 × 8	6-1	1	4-8	2	3-11	2	6-1	1	4-8	2	3-11	2	5-11	1	4-7	2	3-10	2
	4-2 × 10	7-3	2	5-6	2	4-8	2	7-3	2	5-6	2	4-8	2	7-0	2	5-5	2	4-7	2
	4-2 × 12	8-6	2	6-6	2	5-6	2	8-6	2	6-6	2	5-6	2	8-3	2	6-4	2	5-4	3

For SI: 1 inch = 25.4 mm, 1 pound per square foot = 0.0479 kPa.

- a. Spans are given in feet and inches.
- b. Spans are based on minimum design properties for No. 2 grade lumber of Douglas fir-larch, hem-fir, Southern pine and spruce-pine fir.
- c. Building width is measured perpendicular to the ridge. For widths between those shown, spans are permitted to be interpolated.
- d. NJ = Number of jack studs required to support each end. Where the number of required jack studs equals one, the header is permitted to be supported by an approved framing anchor attached to the full-height wall stud and to the header.
- e. Use 30 psf allowable stress design ground snow load for cases in which allowable stress design ground snow load is less than 30 psf and the roof live load is equal to or less than 20 psf.
- f. Spans are calculated assuming the top of the header or girder is laterally braced by perpendicular framing. Where the top of the header or girder is not laterally braced (for example, cripple studs bearing on the header), tabulated spans for headers consisting of 2 × 8, 2 × 10, or 2 × 12 sizes shall be multiplied by 0.70 or the header or girder shall be designed.

TABLE 2308.7.2(3) RAFTER SPANS FOR COMMON LUMBER SPECIES (Ground snow load, $p_{g(asd)}$ = 30 psf, ceiling not attached to rafters, $L/\Delta = 180$)

Portions of table not shown remain unchanged.

RAFTER SPACING (inches)	SPECIES AND GRADE		DEAD LOAD = 10 psf					DEAD LOAD = 20 psf				
			2 x 4	2 x 6	2 x 8	2 x 10	2 x 12	2 x 4	2 x 6	2 x 8	2 x 10	2 x 12
			Maximum rafter spans ^a									
			(ft. - in.)	(ft. - in.)	(ft. - in.)	(ft. - in.)	(ft. - in.)	(ft. - in.)	(ft. - in.)	(ft. - in.)	(ft. - in.)	(ft. - in.)
12	Douglas Fir-Larch	SS	10-0	15-9	20-9	Note b	Note b	10-0	15-9	20-1	24-6	Note b
	Douglas Fir-Larch	#1	9-8	14-9	18-8	22-9	Note b	9-0	13-2	16-8	20-4	23-7
	Douglas Fir-Larch	#2	9-5	13-9	17-5	21-4	24-8	8-5	12-4	15-7	19-1	22-1
	Douglas Fir-Larch	#3	7-1	10-5	13-2	16-1	18-8	6-4	9-4	11-9	14-5	16-8
	Hem-Fir	SS	9-6	14-10	19-7	25-0	Note b	9-6	14-10	19-7	24-1	Note b
	Hem-Fir	#1	9-3	14-4	18-2	22-2	25-9	8-9	12-10	16-3	19-10	23-0
	Hem-Fir	#2	8-10	13-7	17-2	21-0	24-4	8-4	12-2	15-4	18-9	21-9
	Hem-Fir	#3	7-1	10-5	13-2	16-1	18-8	6-4	9-4	11-9	14-5	16-8
	Southern Pine	SS	9-10	15-6	20-5	Note b	Note b	9-10	15-6	20-5	25-4	Note b
	Southern Pine	#1	9-6	14-10	19-0	22-3	26-0	9-0	13-5	17-0	19-11	23-7
	Southern Pine	#2	8-7	12-11	16-4	19-5	22-10	7-8	11-7	14-8	17-4	20-5
	Southern Pine	#3	6-7	9-9	12-4	15-0	17-9	5-11	8-9	11-0	13-5	15-10
	Spruce-Pine-Fir	SS	9-3	14-7	19-2	24-6	Note b	9-3	14-7	18-8	22-9	Note b
	Spruce-Pine-Fir	#1	9-1	13-9	17-5	21-4	24-8	8-5	12-4	15-7	19-1	22-1
	Spruce-Pine-Fir	#2	9-1	13-9	17-5	21-4	24-8	8-5	12-4	15-7	19-1	22-1
	Spruce-Pine-Fir	#3	7-1	10-5	13-2	16-1	18-8	6-4	9-4	11-9	14-5	16-8
16	Douglas Fir-Larch	SS	9-1	14-4	18-10	23-9	Note b	9-1	13-9	17-5	21-3	24-8
	Douglas Fir-Larch	#1	8-9	12-9	16-2	19-9	22-10	7-10	11-5	14-5	17-8	20-5
	Douglas Fir-Larch	#2	8-2	11-11	15-1	18-5	21-5	7-3	10-8	13-6	16-6	19-2
	Douglas Fir-Larch	#3	6-2	9-0	11-5	13-11	16-2	5-6	8-1	10-3	12-6	14-6
	Hem-Fir	SS	8-7	13-6	17-10	22-9	Note b	8-7	13-6	17-1	20-10	24-2
	Hem-Fir	#1	8-5	12-5	15-9	19-3	22-3	7-7	11-1	14-1	17-2	19-11
	Hem-Fir	#2	8-0	11-9	14-11	18-2	21-1	7-2	10-6	13-4	16-3	18-10
	Hem-Fir	#3	6-2	9-0	11-5	13-11	16-2	5-6	8-1	10-3	12-6	14-6
	Southern Pine	SS	8-11	14-1	18-6	23-8	Note b	8-11	14-1	18-5	21-11	25-11
	Southern Pine	#1	8-7	13-0	16-6	19-3	22-10	7-10	11-7	14-9	17-3	20-5
	Southern Pine	#2	7-6	11-2	14-2	16-10	19-10	6-8	10-0	12-8	15-1	17-9
	Southern Pine	#3	5-9	8-6	10-8	13-0	15-4	5-2	7-7	9-7	11-7	13-9
	Spruce-Pine-Fir	SS	8-5	13-3	17-5	22-1	25-7	8-5	12-9	16-2	19-9	22-10
	Spruce-Pine-Fir	#1	8-2	11-11	15-1	18-5	21-5	7-3	10-8	13-6	16-6	19-2
	Spruce-Pine-Fir	#2	8-2	11-11	15-1	18-5	21-5	7-3	10-8	13-6	16-6	19-2
	Spruce-Pine-Fir	#3	6-2	9-0	11-5	13-11	16-2	5-6	8-1	10-3	12-6	14-6
	Douglas Fir-Larch	SS	8-7	13-6	17-9	21-8	25-2	8-7	12-6	15-10	19-5	22-6
	Douglas Fir-Larch	#1	7-11	11-8	14-9	18-0	20-11	7-1	10-5	13-2	16-1	18-8
	Douglas Fir-Larch	#2	7-5	10-11	13-9	16-10	19-6	6-8	9-9	12-4	15-1	17-6
	Douglas Fir-Larch	#3	5-7	8-3	10-5	12-9	14-9	5-0	7-4	9-4	11-5	13-2
	Hem-Fir	SS	8-1	12-9	16-9	21-4	24-8	8-1	12-4	15-7	19-1	22-1
	Hem-Fir	#1	7-9	11-4	14-4	17-7	20-4	6-11	10-2	12-10	15-8	18-2
	Hem-Fir	#2	7-4	10-9	13-7	16-7	19-3	6-7	9-7	12-2	14-10	17-3

RAFTER SPACING (inches)	SPECIES AND GRADE		DEAD LOAD = 10 psf					DEAD LOAD = 20 psf				
			2 x 4	2 x 6	2 x 8	2 x 10	2 x 12	2 x 4	2 x 6	2 x 8	2 x 10	2 x 12
			Maximum rafter spans									
			(ft. - in.)	(ft. - in.)	(ft. - in.)	(ft. - in.)	(ft. - in.)	(ft. - in.)	(ft. - in.)	(ft. - in.)	(ft. - in.)	(ft. - in.)
19.2	Hem-Fir	#3	5-7	8-3	10-5	12-9	14-9	5-0	7-4	9-4	11-5	13-2
	Southern Pine	SS	8-5	13-3	17-5	22-3	Note b	8-5	13-3	16-10	20-0	23-7
	Southern Pine	#1	8-0	11-10	15-1	17-7	20-11	7-1	10-7	13-5	15-9	18-8
	Southern Pine	#2	6-10	10-2	12-11	15-4	18-1	6-1	9-2	11-7	13-9	16-2
	Southern Pine	#3	5-3	7-9	9-9	11-10	14-0	4-8	6-11	8-9	10-7	12-6
	Spruce-Pine-Fir	SS	7-11	12-5	16-5	20-2	23-4	7-11	11-8	14-9	18-0	20-11
	Spruce-Pine-Fir	#1	7-5	10-11	13-9	16-10	19-6	6-8	9-9	12-4	15-1	17-6
	Spruce-Pine-Fir	#2	7-5	10-11	13-9	16-10	19-6	6-8	9-9	12-4	15-1	17-6
	Spruce-Pine-Fir	#3	5-7	8-3	10-5	12-9	14-9	5-0	7-4	9-4	11-5	13-2
24	Douglas Fir-Larch	SS	7-11	12-6	15-10	19-5	22-6	7-8	11-3	14-2	17-4	20-1
	Douglas Fir-Larch	#1	7-1	10-5	13-2	16-1	18-8	6-4	9-4	11-9	14-5	16-8
	Douglas Fir-Larch	#2	6-8	9-9	12-4	15-1	17-6	5-11	8-8	11-0	13-6	15-7
	Douglas Fir-Larch	#3	5-0	7-4	9-4	11-5	13-2	4-6	6-7	8-4	10-2	11-10
	Hem-Fir	SS	7-6	11-10	15-7	19-1	22-1	7-6	11-0	13-11	17-0	19-9
	Hem-Fir	#1	6-11	10-2	12-10	15-8	18-2	6-2	9-1	11-6	14-0	16-3
	Hem-Fir	#2	6-7	9-7	12-2	14-10	17-3	5-10	8-7	10-10	13-3	15-5
	Hem-Fir	#3	5-0	7-4	9-4	11-5	13-2	4-6	6-7	8-4	10-2	11-10
	Southern Pine	SS	7-10	12-3	16-2	20-0	23-7	7-10	11-10	15-0	17-11	21-2
	Southern Pine	#1	7-1	10-7	13-5	15-9	18-8	6-4	9-6	12-0	14-1	16-8
	Southern Pine	#2	6-1	9-2	11-7	13-9	16-2	5-5	8-2	10-4	12-3	14-6
	Southern Pine	#3	4-8	6-11	8-9	10-7	12-6	4-2	6-2	7-10	9-6	11-2
	Spruce-Pine-Fir	SS	7-4	11-7	14-9	18-0	20-11	7-1	10-5	13-2	16-1	18-8
	Spruce-Pine-Fir	#1	6-8	9-9	12-4	15-1	17-6	5-11	8-8	11-0	13-6	15-7
	Spruce-Pine-Fir	#2	6-8	9-9	12-4	15-1	17-6	5-11	8-8	11-0	13-6	15-7
Spruce-Pine-Fir	#3	5-0	7-4	9-4	11-5	13-2	4-6	6-7	8-4	10-2	11-10	

Check sources for availability of lumber in lengths greater than 20 feet.

For SI: 1 inch = 25.4 mm, 1 foot = 304.8 mm, 1 pound per square foot = 0.0479 kPa.

- a. The tabulated rafter spans assume that ceiling joists are located at the bottom of the attic space or that some other method of resisting the outward push of the rafters on the bearing walls, such as rafter ties, is provided at that location. Where ceiling joists or rafter ties are located higher in the attic space, the rafter spans shall be multiplied by the adjustment factors in Table 2308.7.2(7).
- b. Span exceeds 26 feet in length.

TABLE 2308.7.2(4) RAFTER SPANS FOR COMMON LUMBER SPECIES (Ground snow load, $p_{g(asd)}$ = 50 psf, ceiling not attached to rafters, $L/\Delta = 180$)

Portions of table not shown remain unchanged.

RAFTER SPACING (inches)	SPECIES AND GRADE		DEAD LOAD = 10 psf					DEAD LOAD = 20 psf				
			2 x 4	2 x 6	2 x 8	2 x 10	2 x 12	2 x 4	2 x 6	2 x 8	2 x 10	2 x 12
			Maximum rafter spans ^a									
			(ft. - in.)	(ft. - in.)	(ft. - in.)	(ft. - in.)	(ft. - in.)	(ft. - in.)	(ft. - in.)	(ft. - in.)	(ft. - in.)	(ft. - in.)
12	Douglas Fir-Larch	SS	8-5	13-3	17-6	22-4	26-0	8-5	13-3	17-0	20-9	24-0
	Douglas Fir-larch	#1	8-2	12-0	15-3	18-7	21-7	7-7	11-2	14-1	17-3	20-0
	Douglas Fir-larch	#2	7-8	11-3	14-3	17-5	20-2	7-1	10-5	13-2	16-1	18-8
	Douglas Fir-larch	#3	5-10	8-6	10-9	13-2	15-3	5-5	7-10	10-0	12-2	14-1
	Hem-Fir	SS	8-0	12-6	16-6	21-1	25-6	8-0	12-6	16-6	20-4	23-7
	Hem-Fir	#1	7-10	11-9	14-10	18-1	21-0	7-5	10-10	13-9	16-9	19-5
	Hem-Fir	#2	7-5	11-1	14-0	17-2	19-11	7-0	10-3	13-0	15-10	18-5
	Hem-Fir	#3	5-10	8-6	10-9	13-2	15-3	5-5	7-10	10-0	12-2	14-1
	Southern Pine	SS	8-4	13-1	17-2	21-11	Note b	8-4	13-1	17-2	21-5	25-3
	Southern Pine	#1	8-0	12-3	15-6	18-2	21-7	7-7	11-4	14-5	16-10	20-0
	Southern Pine	#2	7-0	10-6	13-4	15-10	18-8	6-6	9-9	12-4	14-8	17-3
	Southern Pine	#3	5-5	8-0	10-1	12-3	14-6	5-0	7-5	9-4	11-4	13-5
	Spruce-Pine-Fir	SS	7-10	12-3	16-2	20-8	24-1	7-10	12-3	15-9	19-3	22-4
	Spruce-Pine-Fir	#1	7-8	11-3	14-3	17-5	20-2	7-1	10-5	13-2	16-1	18-8
	Spruce-Pine-Fir	#2	7-8	11-3	14-3	17-5	20-2	7-1	10-5	13-2	16-1	18-8
	Spruce-Pine-Fir	#3	5-10	8-6	10-9	13-2	15-3	5-5	7-10	10-0	12-2	14-1
16	Douglas Fir-Larch	SS	7-8	12-1	15-10	19-5	22-6	7-8	11-7	14-8	17-11	20-10
	Douglas Fir-Larch	#1	7-1	10-5	13-2	16-1	18-8	6-7	9-8	12-2	14-11	17-3
	Douglas Fir-Larch	#2	6-8	9-9	12-4	15-1	17-6	6-2	9-0	11-5	13-11	16-2
	Douglas Fir-Larch	#3	5-0	7-4	9-4	11-5	13-2	4-8	6-10	8-8	10-6	12-3
	Hem-Fir	SS	7-3	11-5	15-0	19-1	22-1	7-3	11-5	14-5	17-8	20-5
	Hem-Fir	#1	6-11	10-2	12-10	15-8	18-2	6-5	9-5	11-11	14-6	16-10
	Hem-Fir	#2	6-7	9-7	12-2	14-10	17-3	6-1	8-11	11-3	13-9	15-11
	Hem-Fir	#3	5-0	7-4	9-4	11-5	13-2	4-8	6-10	8-8	10-6	12-3
	Southern Pine	SS	7-6	11-10	15-7	19-11	23-7	7-6	11-10	15-7	18-6	21-10
	Southern Pine	#1	7-1	10-7	13-5	15-9	18-8	6-7	9-10	12-5	14-7	17-3
	Southern Pine	#2	6-1	9-2	11-7	13-9	16-2	5-8	8-5	10-9	12-9	15-0
	Southern Pine	#3	4-8	6-11	8-9	10-7	12-6	4-4	6-5	8-1	9-10	11-7
	Spruce-Pine-Fir	SS	7-1	11-2	14-8	18-0	20-11	7-1	10-9	13-8	15-11	19-4
	Spruce-Pine-Fir	#1	6-8	9-9	12-4	15-1	17-6	6-2	9-0	11-5	13-11	16-2
	Spruce-Pine-Fir	#2	6-8	9-9	12-4	15-1	17-6	6-2	9-0	11-5	13-11	16-2
	Spruce-Pine-Fir	#3	5-0	7-4	9-4	11-5	13-2	4-8	6-10	8-8	10-6	12-3
	Douglas Fir-Larch	SS	7-3	11-4	14-6	17-8	20-6	7-3	10-7	13-5	16-5	19-0
	Douglas Fir-Larch	#1	6-6	9-6	12-0	14-8	17-1	6-0	8-10	11-2	13-7	15-9
	Douglas Fir-Larch	#2	6-1	8-11	11-3	13-9	15-11	5-7	8-3	10-5	12-9	14-9
	Douglas Fir-Larch	#3	4-7	6-9	8-6	10-5	12-1	4-3	6-3	7-11	9-7	11-2
	Hem-Fir	SS	6-10	10-9	14-2	17-5	20-2	6-10	10-5	13-2	16-1	18-8
	Hem-Fir	#1	6-4	9-3	11-9	14-4	16-7	5-10	8-7	10-10	13-3	15-5

RAFTER SPACING (inches)	SPECIES AND GRADE		DEAD LOAD = 10 psf					DEAD LOAD = 20 psf				
			2 x 4	2 x 6	2 x 8	2 x 10	2 x 12	2 x 4	2 x 6	2 x 8	2 x 10	2 x 12
			Maximum rafter spans									
			(ft. - in.)	(ft. - in.)	(ft. - in.)	(ft. - in.)	(ft. - in.)	(ft. - in.)	(ft. - in.)	(ft. - in.)	(ft. - in.)	(ft. - in.)
19.2	Hem-Fir	#2	6-0	8-9	11-1	13-7	15-9	5-7	8-1	10-3	12-7	14-7
	Hem-Fir	#3	4-7	6-9	8-6	10-5	12-1	4-3	6-3	7-11	9-7	11-2
	Southern Pine	SS	7-1	11-2	14-8	18-3	21-7	7-1	11-2	14-2	16-11	20-0
	Southern Pine	#1	6-6	9-8	12-3	14-4	17-1	6-0	9-0	11-4	13-4	15-9
	Southern Pine	#2	5-7	8-4	10-7	12-6	14-9	5-2	7-9	9-9	11-7	13-8
	Southern Pine	#3	4-3	6-4	8-0	9-8	11-5	4-0	5-10	7-4	8-11	10-7
	Spruce-Pine-Fir	SS	6-8	10-6	13-5	16-5	19-1	6-8	9-10	12-5	15-3	17-8
	Spruce-Pine-Fir	#1	6-1	8-11	11-3	13-9	15-11	5-7	8-3	10-5	12-9	14-9
	Spruce-Pine-Fir	#2	6-1	8-11	11-3	13-9	15-11	5-7	8-3	10-5	12-9	14-9
	Spruce-Pine-Fir	#3	4-7	6-9	8-6	10-5	12-1	4-3	6-3	7-11	9-7	11-2
24	Douglas Fir-Larch	SS	6-8	10-3	13-0	15-10	18-4	6-6	9-6	12-0	14-8	17-0
	Douglas Fir-Larch	#1	5-10	8-6	10-9	13-2	15-3	5-5	7-10	10-0	12-2	14-1
	Douglas Fir-Larch	#2	5-5	7-11	10-1	12-4	14-3	5-0	7-4	9-4	11-5	13-2
	Douglas Fir-Larch	#3	4-1	6-0	7-7	9-4	10-9	3-10	5-7	7-1	8-7	10-0
	Hem-Fir	SS	6-4	9-11	12-9	15-7	18-0	6-4	9-4	11-9	14-5	16-8
	Hem-Fir	#1	5-8	8-3	10-6	12-10	14-10	5-3	7-8	9-9	11-10	13-9
	Hem-Fir	#2	5-4	7-10	9-11	12-1	14-1	4-11	7-3	9-2	11-3	13-0
	Hem-Fir	#3	4-1	6-0	7-7	9-4	10-9	3-10	5-7	7-1	8-7	10-0
	Southern Pine	SS	6-7	10-4	13-8	16-4	19-3	6-7	10-0	12-8	15-2	17-10
	Southern Pine	#1	5-10	8-8	11-0	12-10	15-3	5-5	8-0	10-2	11-11	14-1
	Southern Pine	#2	5-0	7-5	9-5	11-3	13-2	4-7	6-11	8-9	10-5	12-3
	Southern Pine	#3	3-10	5-8	7-1	8-8	10-3	3-6	5-3	6-7	8-0	9-6
	Spruce-Pine-Fir	SS	6-2	9-6	12-0	14-8	17-1	6-0	8-10	11-2	13-7	15-9
	Spruce-Pine-Fir	#1	5-5	7-11	10-1	12-4	14-3	5-0	7-4	9-4	11-5	13-2
Spruce-Pine-Fir	#2	5-5	7-11	10-1	12-4	14-3	5-0	7-4	9-4	11-5	13-2	
Spruce-Pine-Fir	#3	4-1	6-0	7-7	9-4	10-9	3-10	5-7	7-1	8-7	10-0	

Check sources for availability of lumber in lengths greater than 20 feet.

For SI: 1 inch = 25.4 mm, 1 foot = 304.8 mm, 1 pound per square foot = 0.0479 kPa.

- a. The tabulated rafter spans assume that ceiling joists are located at the bottom of the attic space or that some other method of resisting the outward push of the rafters on the bearing walls, such as rafter ties, is provided at that location. Where ceiling joists or rafter ties are located higher in the attic space, the rafter spans shall be multiplied by the adjustment factors in Table 2308.7.2(7).
- b. Span exceeds 26 feet in length.

TABLE 2308.7.2(5) RAFTER SPANS FOR COMMON LUMBER SPECIES (Ground snow load, $p_{g(asd)} = 30$ psf, ceiling attached to rafters, $L/\Delta = 240$)

Portions of table not shown remain unchanged.

RAFTER SPACING (inches)	SPECIES AND GRADE		DEAD LOAD = 10 psf					DEAD LOAD = 20 psf				
			2 x 4	2 x 6	2 x 8	2 x 10	2 x 12	2 x 4	2 x 6	2 x 8	2 x 10	2 x 12
			Maximum rafter spans ^a									
			(ft. - in.)	(ft. - in.)	(ft. - in.)	(ft. - in.)	(ft. - in.)	(ft. - in.)	(ft. - in.)	(ft. - in.)	(ft. - in.)	(ft. - in.)
12	Douglas Fir-Larch	SS	9-1	14-4	18-10	24-1	Note b	9-1	14-4	18-10	24-1	Note b
	Douglas Fir-Larch	#1	8-9	13-9	18-2	22-9	Note b	8-9	13-2	16-8	20-4	23-7
	Douglas Fir-Larch	#2	8-7	13-6	17-5	21-4	24-8	8-5	12-4	15-7	19-1	22-1
	Douglas Fir-Larch	#3	7-1	10-5	13-2	16-1	18-8	6-4	9-4	11-9	14-5	16-8
	Hem-Fir	SS	8-7	13-6	17-10	22-9	Note b	8-7	13-6	17-10	22-9	Note b
	Hem-Fir	#1	8-5	13-3	17-5	22-2	25-9	8-5	12-10	16-3	19-10	23-0
	Hem-Fir	#2	8-0	12-7	16-7	21-0	24-4	8-0	12-2	15-4	18-9	21-9
	Hem-Fir	#3	7-1	10-5	13-2	16-1	18-8	6-4	9-4	11-9	14-5	16-8
	Southern Pine	SS	8-11	14-1	18-6	23-8	Note b	8-11	14-1	18-6	23-8	Note b
	Southern Pine	#1	8-7	13-6	17-10	22-3	Note b	8-7	13-5	17-0	19-11	23-7
	Southern Pine	#2	8-3	12-11	16-4	19-5	22-10	7-8	11-7	14-8	17-4	20-5
	Southern Pine	#3	6-7	9-9	12-4	15-0	17-9	5-11	8-9	11-0	13-5	15-10
	Spruce-Pine-Fir	SS	8-5	13-3	17-5	22-3	Note b	8-5	13-3	17-5	22-3	Note b
	Spruce-Pine-Fir	#1	8-3	12-11	17-0	21-4	24-8	8-3	12-4	15-7	19-1	22-1
	Spruce-Pine-Fir	#2	8-3	12-11	17-0	21-4	24-8	8-3	12-4	15-7	19-1	22-1
	Spruce-Pine-Fir	#3	7-1	10-5	13-2	16-1	18-8	6-4	9-4	11-9	14-5	16-8
16	Douglas Fir-Larch	SS	8-3	13-0	17-2	21-10	Note b	8-3	13-0	17-2	21-3	24-8
	Douglas Fir-Larch	#1	8-0	12-6	16-2	19-9	22-10	7-10	11-5	14-5	17-8	20-5
	Douglas Fir-Larch	#2	7-10	11-11	15-1	18-5	21-5	7-3	10-8	13-6	16-6	19-2
	Douglas Fir-Larch	#3	6-2	9-0	11-5	13-11	16-2	5-6	8-1	10-3	12-6	14-6
	Hem-Fir	SS	7-10	12-3	16-2	20-8	25-1	7-10	12-3	16-2	20-8	24-2
	Hem-Fir	#1	7-8	12-0	15-9	19-3	22-3	7-7	11-1	14-1	17-2	19-11
	Hem-Fir	#2	7-3	11-5	14-11	18-2	21-1	7-2	10-6	13-4	16-3	18-10
	Hem-Fir	#3	6-2	9-0	11-5	13-11	16-2	5-6	8-1	10-3	12-6	14-6
	Southern Pine	SS	8-1	12-9	16-10	21-6	Note b	8-1	12-9	16-10	21-6	25-11
	Southern Pine	#1	7-10	12-3	16-2	19-3	22-10	7-10	11-7	14-9	17-3	20-5
	Southern Pine	#2	7-6	11-2	14-2	16-10	19-10	6-8	10-0	12-8	15-1	17-9
	Southern Pine	#3	5-9	8-6	10-8	13-0	15-4	5-2	7-7	9-7	11-7	13-9
	Spruce-Pine-Fir	SS	7-8	12-0	15-10	20-2	24-7	7-8	12-0	15-10	19-9	22-10
	Spruce-Pine-Fir	#1	7-6	11-9	15-1	18-5	21-5	7-3	10-8	13-6	16-6	19-2
	Spruce-Pine-Fir	#2	7-6	11-9	15-1	18-5	21-5	7-3	10-8	13-6	16-6	19-2
	Spruce-Pine-Fir	#3	6-2	9-0	11-5	13-11	16-2	5-6	8-1	10-3	12-6	14-6
	Douglas Fir-Larch	SS	7-9	12-3	16-1	20-7	25-0	7-9	12-3	15-10	19-5	22-6
	Douglas Fir-Larch	#1	7-6	11-8	14-9	18-0	20-11	7-1	10-5	13-2	16-1	18-8
	Douglas Fir-Larch	#2	7-4	10-11	13-9	16-10	19-6	6-8	9-9	12-4	15-1	17-6
	Douglas Fir-Larch	#3	5-7	8-3	10-5	12-9	14-9	5-0	7-4	9-4	11-5	13-2
	Hem-Fir	SS	7-4	11-7	15-3	19-5	23-7	7-4	11-7	15-3	19-1	22-1
	Hem-Fir	#1	7-2	11-4	14-4	17-7	20-4	6-11	10-2	12-10	15-8	18-2
	Hem-Fir	#2	6-10	10-9	13-7	16-7	19-3	6-7	9-7	12-2	14-10	17-3

19.2 RAFTER SPACING (inches)	SPECIES AND GRADE		DEAD LOAD = 10 psf					DEAD LOAD = 20 psf				
			2 x 4	2 x 6	2 x 8	2 x 10	2 x 12	2 x 4	2 x 6	2 x 8	2 x 10	2 x 12
			Maximum rafter spans									
			(ft. - in.)	(ft. - in.)	(ft. - in.)	(ft. - in.)	(ft. - in.)	(ft. - in.)	(ft. - in.)	(ft. - in.)	(ft. - in.)	(ft. - in.)
19.2	Hem-Fir	#3	5-7	8-3	10-5	12-9	14-9	5-0	7-4	9-4	11-5	13-2
	Southern Pine	SS	7-8	12-0	15-10	20-2	24-7	7-8	12-0	15-10	20-0	23-7
	Southern Pine	#1	7-4	11-7	15-1	17-7	20-11	7-1	10-7	13-5	15-9	18-8
	Southern Pine	#2	6-10	10-2	12-11	15-4	18-1	6-1	9-2	11-7	13-9	16-2
	Southern Pine	#3	5-3	7-9	9-9	11-10	14-0	4-8	6-11	8-9	10-7	12-6
	Spruce-Pine-Fir	SS	7-2	11-4	14-11	19-0	23-1	7-2	11-4	14-9	18-0	20-11
	Spruce-Pine-Fir	#1	7-0	10-11	13-9	16-10	19-6	6-8	9-9	12-4	15-1	17-6
	Spruce-Pine-Fir	#2	7-0	10-11	13-9	16-10	19-6	6-8	9-9	12-4	15-1	17-6
	Spruce-Pine-Fir	#3	5-7	8-3	10-5	12-9	14-9	5-0	7-4	9-4	11-5	13-2
24	Douglas Fir-Larch	SS	7-3	11-4	15-0	19-1	22-6	7-3	11-3	14-2	17-4	20-1
	Douglas Fir-Larch	#1	7-0	10-5	13-2	16-1	18-8	6-4	9-4	11-9	14-5	16-8
	Douglas Fir-Larch	#2	6-8	9-9	12-4	15-1	17-6	5-11	8-8	11-0	13-6	15-7
	Douglas Fir-Larch	#3	5-0	7-4	9-4	11-5	13-2	4-6	6-7	8-4	10-2	11-10
	Hem-Fir	SS	6-10	10-9	14-2	18-0	21-11	6-10	10-9	13-11	17-0	19-9
	Hem-Fir	#1	6-8	10-2	12-10	15-8	18-2	6-2	9-1	11-6	14-0	16-3
	Hem-Fir	#2	6-4	9-7	12-2	14-10	17-3	5-10	8-7	10-10	13-3	15-5
	Hem-Fir	#3	5-0	7-4	9-4	11-5	13-2	4-6	6-7	8-4	10-2	11-10
	Southern Pine	SS	7-1	11-2	14-8	18-9	22-10	7-1	11-2	14-8	17-11	21-2
	Southern Pine	#1	6-10	10-7	13-5	15-9	18-8	6-4	9-6	12-0	14-1	16-8
	Southern Pine	#2	6-1	9-2	11-7	13-9	16-2	5-5	8-2	10-4	12-3	14-6
	Southern Pine	#3	4-8	6-11	8-9	10-7	12-6	4-2	6-2	7-10	9-6	11-2
	Spruce-Pine-Fir	SS	6-8	10-6	13-10	17-8	20-11	6-8	10-5	13-2	16-1	18-8
	Spruce-Pine-Fir	#1	6-6	9-9	12-4	15-1	17-6	5-11	8-8	11-0	13-6	15-7
	Spruce-Pine-Fir	#2	6-6	9-9	12-4	15-1	17-6	5-11	8-8	11-0	13-6	15-7
Spruce-Pine-Fir	#3	5-0	7-4	9-4	11-5	13-2	4-6	6-7	8-4	10-2	11-10	

Check sources for availability of lumber in lengths greater than 20 feet.

For SI: 1 inch = 25.4 mm, 1 foot = 304.8 mm, 1 pound per square foot = 0.0479 kPa.

- a. The tabulated rafter spans assume that ceiling joists are located at the bottom of the attic space or that some other method of resisting the outward push of the rafters on the bearing walls, such as rafter ties, is provided at that location. Where ceiling joists or rafter ties are located higher in the attic space, the rafter spans shall be multiplied by the adjustment factors in Table 2308.7.2(7).
- b. Span exceeds 26 feet in length.

TABLE 2308.7.2(6) RAFTER SPANS FOR COMMON LUMBER SPECIES (Ground snow load, $p_{g(asd)}$ = 50 psf, ceiling attached to rafters, $L/\Delta = 240$)

Portions of table not shown remain unchanged.

RAFTER SPACING (inches)	SPECIES AND GRADE		DEAD LOAD = 10 psf					DEAD LOAD = 20 psf				
			2 x 4	2 x 6	2 x 8	2 x 10	2 x 12	2 x 4	2 x 6	2 x 8	2 x 10	2 x 12
			Maximum rafter spans ^a									
			(ft. - in.)	(ft. - in.)	(ft. - in.)	(ft. - in.)	(ft. - in.)	(ft. - in.)	(ft. - in.)	(ft. - in.)	(ft. - in.)	(ft. - in.)
12	Douglas Fir-Larch	SS	7-8	12-1	15-11	20-3	24-8	7-8	12-1	15-11	20-3	24-0
	Douglas Fir-Larch	#1	7-5	11-7	15-3	18-7	21-7	7-5	11-2	14-1	17-3	20-0
	Douglas Fir-Larch	#2	7-3	11-3	14-3	17-5	20-2	7-1	10-5	13-2	16-1	18-8
	Douglas Fir-Larch	#3	5-10	8-6	10-9	13-2	15-3	5-5	7-10	10-0	12-2	14-1
	Hem-Fir	SS	7-3	11-5	15-0	19-2	23-4	7-3	11-5	15-0	19-2	23-4
	Hem-Fir	#1	7-1	11-2	14-8	18-1	21-0	7-1	10-10	13-9	16-9	19-5
	Hem-Fir	#2	6-9	10-8	14-0	17-2	19-11	6-9	10-3	13-0	15-10	18-5
	Hem-Fir	#3	5-10	8-6	10-9	13-2	15-3	5-5	7-10	10-0	12-2	14-1
	Southern Pine	SS	7-6	11-10	15-7	19-11	24-3	7-6	11-10	15-7	19-11	24-3
	Southern Pine	#1	7-3	11-5	15-0	18-2	21-7	7-3	11-4	14-5	16-10	20-0
	Southern Pine	#2	6-11	10-6	13-4	15-10	18-8	6-6	9-9	12-4	14-8	17-3
	Southern Pine	#3	5-5	8-0	10-1	12-3	14-6	5-0	7-5	9-4	11-4	13-5
	Spruce-Pine-Fir	SS	7-1	11-2	14-8	18-9	22-10	7-1	11-2	14-8	18-9	22-4
	Spruce-Pine-Fir	#1	6-11	10-11	14-3	17-5	20-2	6-11	10-5	13-2	16-1	18-8
	Spruce-Pine-Fir	#2	6-11	10-11	14-3	17-5	20-2	6-11	10-5	13-2	16-1	18-8
	Spruce-Pine-Fir	#3	5-10	8-6	10-9	13-2	15-3	5-5	7-10	10-0	12-2	14-1
16	Douglas Fir-Larch	SS	7-0	11-0	14-5	18-5	22-5	7-0	11-0	14-5	17-11	20-10
	Douglas Fir-Larch	#1	6-9	10-5	13-2	16-1	18-8	6-7	9-8	12-2	14-11	17-3
	Douglas Fir-Larch	#2	6-7	9-9	12-4	15-1	17-6	6-2	9-0	11-5	13-11	16-2
	Douglas Fir-Larch	#3	5-0	7-4	9-4	11-5	13-2	4-8	6-10	8-8	10-6	12-3
	Hem-Fir	SS	6-7	10-4	13-8	17-5	21-2	6-7	10-4	13-8	17-5	20-5
	Hem-Fir	#1	6-5	10-2	12-10	15-8	18-2	6-5	9-5	11-11	14-6	16-10
	Hem-Fir	#2	6-2	9-7	12-2	14-10	17-3	6-1	8-11	11-3	13-9	15-11
	Hem-Fir	#3	5-0	7-4	9-4	11-5	13-2	4-8	6-10	8-8	10-6	12-3
	Southern Pine	SS	6-10	10-9	14-2	18-1	22-0	6-10	10-9	14-2	18-1	21-10
	Southern Pine	#1	6-7	10-4	13-5	15-9	18-8	6-7	9-10	12-5	14-7	17-3
	Southern Pine	#2	6-1	9-2	11-7	13-9	16-2	5-8	8-5	10-9	12-9	15-0
	Southern Pine	#3	4-8	6-11	8-9	10-7	12-6	4-4	6-5	8-1	9-10	11-7
	Spruce-Pine-Fir	SS	6-5	10-2	13-4	17-0	20-9	6-5	10-2	13-4	16-8	19-4
	Spruce-Pine-Fir	#1	6-4	9-9	12-4	15-1	17-6	6-2	9-0	11-5	13-11	16-2
	Spruce-Pine-Fir	#2	6-4	9-9	12-4	15-1	17-6	6-2	9-0	11-5	13-11	16-2
	Spruce-Pine-Fir	#3	5-0	7-4	9-4	11-5	13-2	4-8	6-10	8-8	10-6	12-3
	Douglas Fir-Larch	SS	6-7	10-4	13-7	17-4	20-6	6-7	10-4	13-5	16-5	19-0
	Douglas Fir-Larch	#1	6-4	9-6	12-0	14-8	17-1	6-0	8-10	11-2	13-7	15-9
	Douglas Fir-Larch	#2	6-1	8-11	11-3	13-9	15-11	5-7	8-3	10-5	12-9	14-9
	Douglas Fir-Larch	#3	4-7	6-9	8-6	10-5	12-1	4-3	6-3	7-11	9-7	11-2
	Hem-Fir	SS	6-2	9-9	12-10	16-5	19-11	6-2	9-9	12-10	16-1	18-8
	Hem-Fir	#1	6-1	9-3	11-9	14-4	16-7	5-10	8-7	10-10	13-3	15-5

RAFTER SPACING (inches)	SPECIES AND GRADE		DEAD LOAD = 10 psf					DEAD LOAD = 20 psf				
			2 x 4	2 x 6	2 x 8	2 x 10	2 x 12	2 x 4	2 x 6	2 x 8	2 x 10	2 x 12
			Maximum rafter spans									
			(ft. - in.)	(ft. - in.)	(ft. - in.)	(ft. - in.)	(ft. - in.)	(ft. - in.)	(ft. - in.)	(ft. - in.)	(ft. - in.)	(ft. - in.)
19.2	Hem-Fir	#2	5-9	8-9	11-1	13-7	15-9	5-7	8-1	10-3	12-7	14-7
	Hem-Fir	#3	4-7	6-9	8-6	10-5	12-1	4-3	6-3	7-11	9-7	11-2
	Southern Pine	SS	6-5	10-2	13-4	17-0	20-9	6-5	10-2	13-4	16-11	20-0
	Southern Pine	#1	6-2	9-8	12-3	14-4	17-1	6-0	9-0	11-4	13-4	15-9
	Southern Pine	#2	5-7	8-4	10-7	12-6	14-9	5-2	7-9	9-9	11-7	13-8
	Southern Pine	#3	4-3	6-4	8-0	9-8	11-5	4-0	5-10	7-4	8-11	10-7
	Spruce-Pine-Fir	SS	6-1	9-6	12-7	16-0	19-1	6-1	9-6	12-5	15-3	17-8
	Spruce-Pine-Fir	#1	5-11	8-11	11-3	13-9	15-11	5-7	8-3	10-5	12-9	14-9
	Spruce-Pine-Fir	#2	5-11	8-11	11-3	13-9	15-11	5-7	8-3	10-5	12-9	14-9
	Spruce-Pine-Fir	#3	4-7	6-9	8-6	10-5	12-1	4-3	6-3	7-11	9-7	11-2
24	Douglas Fir-Larch	SS	6-1	9-7	12-7	15-10	18-4	6-1	9-6	12-0	14-8	17-0
	Douglas Fir-Larch	#1	5-10	8-6	10-9	13-2	15-3	5-5	7-10	10-0	12-2	14-1
	Douglas Fir-Larch	#2	5-5	7-11	10-1	12-4	14-3	5-0	7-4	9-4	11-5	13-2
	Douglas Fir-Larch	#3	4-1	6-0	7-7	9-4	10-9	3-10	5-7	7-1	8-7	10-0
	Hem-Fir	SS	5-9	9-1	11-11	15-2	18-0	5-9	9-1	11-9	14-5	15-11
	Hem-Fir	#1	5-8	8-3	10-6	12-10	14-10	5-3	7-8	9-9	11-10	13-9
	Hem-Fir	#2	5-4	7-10	9-11	12-1	14-1	4-11	7-3	9-2	11-3	13-0
	Hem-Fir	#3	4-1	6-0	7-7	9-4	10-9	3-10	5-7	7-1	8-7	10-0
	Southern Pine	SS	6-0	9-5	12-5	15-10	19-3	6-0	9-5	12-5	15-2	17-10
	Southern Pine	#1	5-9	8-8	11-0	12-10	15-3	5-5	8-0	10-2	11-11	14-1
	Southern Pine	#2	5-0	7-5	9-5	11-3	13-2	4-7	6-11	8-9	10-5	12-3
	Southern Pine	#3	3-10	5-8	7-1	8-8	10-3	3-6	5-3	6-7	8-0	9-6
	Spruce-Pine-Fir	SS	5-8	8-10	11-8	14-8	17-1	5-8	8-10	11-2	13-7	15-9
	Spruce-Pine-Fir	#1	5-5	7-11	10-1	12-4	14-3	5-0	7-4	9-4	11-5	13-2
	Spruce-Pine-Fir	#2	5-5	7-11	10-1	12-4	14-3	5-0	7-4	9-4	11-5	13-2
Spruce-Pine-Fir	#3	4-1	6-0	7-7	9-4	10-9	3-10	5-7	7-1	8-7	10-0	

Check sources for availability of lumber in lengths greater than 20 feet.

For SI: 1 inch = 25.4 mm, 1 foot = 304.8 mm, 1 pound per square foot = 0.0479 kPa.

- a. The tabulated rafter spans assume that ceiling joists are located at the bottom of the attic space or that some other method of resisting the outward push of the rafters on the bearing walls, such as rafter ties, is provided at that location. Where ceiling joists or rafter ties are located higher in the attic space, the rafter spans shall be multiplied by the adjustment factors in Table 2308.7.2(7).

TABLE 2308.7.3.1 RAFTER TIE CONNECTIONSⁱ

RAFTER SLOPE	TIE SPACING (inches)	LIVE LOAD ONLY ^g			GROUND SNOW LOAD, $P_g(bsd)$ (pounds per square foot)					
					30 pounds per square foot			50 pounds per square foot		
		Roof span (feet)								
		12	24	36	12	24	36	12	24	36
Required number of 16d common (3 ¹ / ₂ " x 0.162") nails per connection ^{a, b, c, d, e, f, h}										
3:12	12	3	5	8	3	6	9	5	9	13
	16	4	7	10	4	8	12	6	12	17
	19.2	4	8	12	5	10	14	7	14	21
	24	5	10	15	6	12	18	9	17	26
	32	7	13	20	8	16	24	12	23	34
	48	10	20	29	12	24	35	17	34	51
4:12	12	3	4	6	3	5	7	4	7	10
	16	3	5	8	3	6	9	5	9	13
	19.2	3	6	9	4	7	11	6	11	16
	24	4	8	11	5	9	13	7	13	19
	32	5	10	15	6	12	18	9	17	26
	48	8	15	22	9	18	26	13	26	38
5:12	12	3	3	5	3	4	6	3	6	8
	16	3	4	6	3	5	7	4	7	11
	19.2	3	5	7	3	6	9	5	9	13
	24	3	6	9	4	7	11	6	11	16
	32	4	8	12	5	10	14	7	14	21
	48	6	12	18	7	14	21	11	21	31
7:12	12	3	3	4	3	3	4	3	4	6
	16	3	3	5	3	4	5	3	5	8
	19.2	3	4	5	3	4	6	3	6	9
	24	3	5	7	3	5	8	4	8	11
	32	3	6	9	4	7	10	5	10	15
	48	5	9	13	5	10	15	8	15	22
9:12	12	3	3	3	3	3	3	3	3	5
	16	3	3	4	3	3	4	3	4	6
	19.2	3	3	4	3	4	5	3	5	7
	24	3	4	5	3	4	6	3	6	9
	32	3	5	7	3	6	8	4	8	12
	48	4	7	10	4	8	12	6	12	17
12:12	12	3	3	3	3	3	3	3	3	4
	16	3	3	3	3	3	3	3	3	5
	19.2	3	3	3	3	3	4	3	4	6
	24	3	3	4	3	3	5	3	5	7
	32	3	4	5	3	4	6	3	6	9
	48	3	5	8	3	6	9	5	9	13

For SI: 1 inch = 25.4 mm, 1 foot = 304.8 mm, 1 pound per square foot = 47.8 N/m².

a. 10d common (3" x 0.148") nails shall be permitted to be substituted for 16d common (3¹/₂" x 0.162") nails where the required number of nails is taken as 1.2 times the required number of 16d common nails, rounded up to the next full nail.

- b. Rafter tie heel joint connections are not required where the ridge is supported by a load-bearing wall, header or ridge beam.
- c. Where intermediate support of the rafter is provided by vertical struts or purlins to a load-bearing wall, the tabulated heel joint connection requirements are permitted to be reduced proportionally to the reduction in span.
- d. Equivalent nailing patterns are required for ceiling joist to ceiling joist lap splices.
- e. Connected members shall be of sufficient size to prevent splitting due to nailing.
- f. For allowable stress design snow loads less than 30 pounds per square foot, the required number of nails is permitted to be reduced by multiplying by the ratio of actual snow load plus 10 divided by 40, but not less than the number required for no snow load.
- g. Applies to roof live load of 20 psf or less.
- h. Tabulated heel joint connection requirements assume that ceiling joists or rafter ties are located at the bottom of the attic space. Where ceiling joists or rafter ties are located higher in the attic, heel joint connection requirements shall be increased by the adjustment factors in Table 2308.7.3.1(1).
- i. Tabulated requirements are based on 10 psf roof dead load in combination with the specified roof snow load and roof live load.

CHAPTER 24
GLASS AND GLAZING
SECTION 2404
WIND, SNOW, SEISMIC AND DEAD LOADS ON GLASS

Revise as follows:

2404.2 Sloped glass. Glass sloped more than 15 degrees (0.26 rad) from vertical in skylights, *sunrooms*, sloped roofs and other exterior applications shall be designed to resist the most critical combinations of loads determined by Equations 24-2, 24-3 and 24-4.

$$F_g = 0.6W_o - D \quad \text{(Equation 24-2)}$$

$$F_g = 0.6W_i + D + \theta \cdot 0.35S \quad \text{(Equation 24-3)}$$

$$F_g = 0.3W_i + D + 0.7S \quad \text{(Equation 24-4)}$$

where:

D = Glass *dead load* psf (kN/m²).

For glass sloped 30 degrees (0.52 rad) or less from horizontal,

$$= 13 t_g \text{ (For SI: } 0.0245 t_g \text{)}$$

For glass sloped more than 30 degrees (0.52 rad) from horizontal,

$$= 13 t_g \cos \theta \text{ (For SI: } 0.0245 t_g \cos \theta \text{)}$$

F_g = Total *load*, psf (kN/m²) on glass.

S = Snow *load*, psf (kN/m²) as determined in Section 1608 from the reliability-targeted (strength-based) maps in Figures 1608.2(1) through 1608.2(4).

t_g = Total glass thickness, inches (mm) of glass panes and plies.

W_i = Inward wind force, psf (kN/m²) due to basic design *wind speed*, V, as calculated in Section 1609.

W_o = Outward wind force, psf (kN/m²) due to basic design wind speed, V, as calculated in Section 1609.

θ = Angle of slope from horizontal.

Exception: The performance grade rating of *unit skylights* and *tubular daylighting devices* shall be determined in accordance with Section 2405.5.

The design of sloped glazing shall be based on Equation 24-5.

$$F_g \leq F_{ga}$$

(Equation 24-5)

where:

F_g = Total *load* on the glass as determined by Equations 24-2, 24-3 and 24-4.

F_{ga} = Short duration *load* resistance of the glass as determined in accordance with ASTM E1300 for Equations 24-2 and 24-3; or the long duration *load* resistance of the glass as determined in accordance with ASTM E1300 for Equation 24-4.

Reason Statement: This proposal is a coordination proposal to bring the 2024 IBC up to date with the provisions of the 2022 edition of ASCE/SEI 7 Minimum Design Loads and Associated Criteria for Buildings and Other Structures (ASCE/SEI 7-22). ASCE 7 will be updated to the 2022 edition from the 2016 edition as an Administrative update in the 2024 I-Codes.

This proposal is a companion to the ASCE proposal to update the ground snow provisions in Section 1608.2 to the reliability-targeted (strength-based) maps.

This proposal includes coordination items for all existing allowable stress design tables to use the newly defined allowable stress design snow load, $p_{g(ASD)}$, as described in the new Section 1602.1 and covered by Section 1608.2.1.

Cost Impact: The code change proposal will not increase or decrease the cost of construction

This code change is a coordination proposal intended to maintain the tables and equations using allowable stress design loads. Therefore, this change will not result in any cost impacts.

S210-22

S211-22

IBC: 2304.10.1

Proponents: David Tyree, representing American Wood Council (dtyree@awc.org); Jason Smart, representing American Wood Council (jsmart@awc.org)

2021 International Building Code

Revise as follows:

2304.10.1 ~~Connection fire-resistance rating~~ **Fire protection of connections.** ~~Fire-resistance ratings for connections in~~ Connections used with fire-resistance-rated members and in fire-resistance-rated assemblies of Type IV-A, IV-B or IV-C construction shall be protected for the time associated with the *fire-resistance rating*. Protection time shall be determined by one of the following:

1. Testing in accordance with Section 703.2 where the connection is part of the *fire-resistance* test.
2. Engineering analysis that demonstrates that the temperature rise at any portion of the connection is limited to an average temperature rise of 250°F (139°C), and a maximum temperature rise of 325°F (181°C), for a time corresponding to the required *fire-resistance* rating of the structural element being connected. For the purposes of this analysis, the connection includes connectors, fasteners and portions of wood members included in the structural design of the connection.

Reason Statement: Revise title and description of section requirements to avoid using the term “fire-resistance rating” as it applies to connections. The provisions of Section 2304.10.1 are for determining fire protection of connections; there is no standardized test for establishing a fire-resistance rating of a connection in and of itself. This change clarifies the code intent that connections are required to be protected for the time associated with the fire-resistance rating, as required by Sections 704.2 and 704.3.

Cost Impact: The code change proposal will not increase or decrease the cost of construction. This change clarifies the requirements for fire protection of connections.

S211-22

S212-22

IBC: 2304.10.1, AWC Chapter 35 (New)

Proponents: Jason Smart, representing American Wood Council (jsmart@awc.org); David Tyree, representing American Wood Council (dtyree@awc.org)

2021 International Building Code

Revise as follows:

2304.10.1 Connection fire-resistance rating. *Fire-resistance* ratings for connections in Type IV-A, IV-B or IV-C construction shall be determined by one of the following:

1. Testing in accordance with Section 703.2 where the connection is part of the *fire-resistance* test.
2. Engineering analysis in accordance with the AWC FDS or other approved method that demonstrates that the temperature rise at any portion of the connection is limited to an average temperature rise of 250° F (139° C), and a maximum temperature rise of 325° F (181° C), for a time corresponding to the required *fire-resistance* rating of the structural element being connected. For the purposes of this analysis, the connection includes connectors, fasteners and portions of wood members included in the structural design of the connection.

Add new standard(s) as follows:

AWC

American Wood Council
222 Catoctin Circle SE, Suite 201
Leesburg, VA 20175

AWC FDS-2022

Fire Design Specification (FDS) for Wood Construction

Staff Analysis: A review of the standard proposed for inclusion in the code, AWC FDS-2022 Fire Design Specification (FDS) for Wood Construction, with regard to some of the key ICC criteria for referenced standards (Section 3.6 of CP#28) will be posted on the ICC website on or before March 16, 2022.

Reason Statement: A reference is added in 2304.10.1(2) to the American Wood Council Fire Design Specification (FDS), which includes provisions for the design of fire protection for wood connections. The Fire Design Specification is available on AWC's website (<https://awc.org/codes-standards/publications/fds-2021>) and is being developed as an AWC standards in accordance with AWC's consensus standards development process. Completion is anticipated to occur prior to the Public Comment Hearing.

Cost Impact: The code change proposal will not increase or decrease the cost of construction. The proposal provides a reference to the AWC FDS, which contains provisions that provide an acceptable means by which the analysis in 2303.10.1(2) may be performed; however, it does not necessarily preclude the use of other analysis methods.

S212-22

S213-22

IBC: TABLE 2304.10.2

Proponents: David Tyree, representing American Wood Council (dtyree@awc.org); Philip Line, representing American Wood Council (pline@awc.org)

2021 International Building Code

Revise as follows:

TABLE 2304.10.2 FASTENING SCHEDULE

Portions of table not shown remain unchanged.

DESCRIPTION OF BUILDING ELEMENTS	NUMBER AND TYPE OF FASTENER ^g	SPACING AND LOCATION	
Wood structural panels (WSP), subfloor, roof and interior wall sheathing to framing and particleboard wall sheathing to framing^a			
		Edges (inches)	Intermediate supports (inches)
30. $\frac{3}{8}$ " – $\frac{1}{2}$ "	6d common or deformed ($2" \times 0.113"$); or $2\frac{3}{8}" \times 0.113"$ nail (subfloor and wall)	6	12
	8d common or deformed ($2\frac{1}{2}" \times 0.131" \times 0.281"$ head) <u>nail</u> (roof); or RSRS-01 ($2\frac{3}{8}" \times 0.113" \times 0.281"$ head) nail (roof) ^d	6 ^e	6 ^e
	$1\frac{3}{4}"$ 16 gage staple, $\frac{7}{16}"$ crown (subfloor and wall)	4	8
	$2\frac{3}{8}" \times 0.113" \times 0.266"$ head nail (roof)	3 ^f	3 ^f
	$1\frac{3}{4}"$ 16 gage staple, $\frac{7}{16}"$ crown (roof)	3 ^f	3 ^f
31. $\frac{19}{32}"$ – $\frac{3}{4}"$	8d common ($2\frac{1}{2}" \times 0.131"$); or deformed ($2" \times 0.113"$) (subfloor and wall)	6	12
	8d common or deformed ($2\frac{1}{2}" \times 0.131" \times 0.281"$ head) <u>nail</u> (roof); or RSRS-01 ($2\frac{3}{8}" \times 0.113" \times 0.281"$ head) nail (roof) ^d	6 ^e	6 ^e
	$2\frac{3}{8}" \times 0.113" \times 0.266"$ head nail; or $2"$ 16 gage staple, $\frac{7}{16}"$ crown	4	8

For SI: 1 inch = 25.4 mm.

- a. Nails spaced at 6 inches at intermediate supports where spans are 48 inches or more. For nailing of wood structural panel and particleboard diaphragms and shear walls, refer to Section 2305. Nails for wall sheathing are permitted to be common, box or casing.
- b. Spacing shall be 6 inches on center on the edges and 12 inches on center at intermediate supports for nonstructural applications. Panel supports at 16 inches (20 inches if strength axis in the long direction of the panel, unless otherwise marked).
- c. Where a rafter is fastened to an adjacent parallel ceiling joist in accordance with this schedule and the ceiling joist is fastened to the top plate in accordance with this schedule, the number of toenails in the rafter shall be permitted to be reduced by one nail.
- d. RSRS-01 is a Roof Sheathing Ring Shank nail meeting the specifications in ASTM F1667.
- e. Tabulated fastener requirements apply where the ultimate design wind speed is less than 140 mph. For wood structural panel roof sheathing attached to gable-end roof framing and to intermediate supports within 48 inches of roof edges and ridges, nails shall be spaced at 4 inches on center where the ultimate design wind speed is greater than 130 mph in Exposure B or greater than 110 mph in Exposure C. Spacing exceeding 6 inches on center at intermediate supports shall be permitted where the fastening is designed per the AWC NDS. Where the specific gravity of the wood species used for roof framing is greater than or equal to 0.35 but less than 0.42 in accordance with AWC NDS, fastening of roof sheathing shall be with RSRS-03 ($2\frac{1}{2}" \times 0.131" \times 0.281"$ head) nails unless alternative fastening is designed in accordance with AWC NDS. Where the specific gravity of the wood species used for roof framing is less than 0.35, fastening of the roof sheathing shall be designed in accordance with AWC NDS.
- f. Fastening is only permitted where the ultimate design wind speed is less than or equal to 110 mph and where fastening is to wood framing of a species with specific gravity greater than or equal to 0.42 in accordance with AWC NDS.
- g. Nails and staples are carbon steel meeting the specifications of ASTM F1667. Connections using nails and staples of other materials, such as stainless steel, shall be designed by acceptable engineering practice or approved under Section 104.11.

Reason Statement: Fastening of roof sheathing to resist wind uplift forces per ASCE 7-16 and to agree with 2018 Wood Frame Construction Manual tables is based on wood framing of species with specific gravity equal to 0.42 (per proposal S173-19). For applications using species with lower specific gravity as wood roof framing (i.e., specific gravity less than 0.42 but equal to or greater than 0.35), the footnote is expanded to require use of the RSRS-03 nail unless alternative fastening is designed. The use of RSRS-03 nail (a standard ring shank nail) will maintain the same fastener spacing recommendations within the scope of applicability which is up to 140 mph wind speed. Engineered design of the fastening is required when specific gravity of the wood species used for roof framing is less than 0.35. Footnote f is revised to recognize the 0.42 specific gravity limit in addition to the existing wind speed limit of 110 mph for the prescribed nail and staple where used for roof sheathing fastening.

Cost Impact: The code change proposal will increase the cost of construction. Increased cost of construction will occur where low specific gravity wood species are used. For wood species with specific gravity of 0.35, the added ring shank nail option for resisting ASCE 7 wind uplift forces will provide equivalent withdrawal performance to the 0.42 specific gravity and smooth nail basis of the existing fastening schedule without requiring engineered design.

S214-22

IBC: TABLE 2304.10.2

Proponents: David Tyree, representing American Wood Council (dtyree@awc.org); Philip Line, representing American Wood Council (pline@awc.org)

2021 International Building Code

Revise as follows:

TABLE 2304.10.2 FASTENING SCHEDULE

Portions of table not shown remain unchanged.

DESCRIPTION OF BUILDING ELEMENTS	NUMBER AND TYPE OF FASTENER ^g	SPACING AND LOCATION	
Wood structural panels (WSP), subfloor, roof and interior wall sheathing to framing and particleboard wall sheathing to framing^a			
		Edges (inches)	Intermediate supports (inches)
31. $1\frac{19}{32}$ " – $3\frac{1}{4}$ "	8d common ($2\frac{1}{2}$ " × 0.131"); or deformed (2 " × 0.113") (subfloor and wall)	6	12
	8d common or deformed ($2\frac{1}{2}$ " × 0.131" × 0.281" head) (roof) or RSRS-01 ($2\frac{3}{8}$ " × 0.113") nail (roof) ^d	6 ^e	6 ^e
	$2\frac{3}{8}$ " × 0.113" × 0.266" head nail; or 2" 16 gage staple, $\frac{7}{16}$ " crown (subfloor and wall)	4	8

For SI: 1 inch = 25.4 mm.

- a. Nails spaced at 6 inches at intermediate supports where spans are 48 inches or more. For nailing of wood structural panel and particleboard diaphragms and shear walls, refer to Section 2305. Nails for wall sheathing are permitted to be common, box or casing.
- b. Spacing shall be 6 inches on center on the edges and 12 inches on center at intermediate supports for nonstructural applications. Panel supports at 16 inches (20 inches if strength axis in the long direction of the panel, unless otherwise marked).
- c. Where a rafter is fastened to an adjacent parallel ceiling joist in accordance with this schedule and the ceiling joist is fastened to the top plate in accordance with this schedule, the number of toenails in the rafter shall be permitted to be reduced by one nail.
- d. RSRS-01 is a Roof Sheathing Ring Shank nail meeting the specifications in ASTM F1667.
- e. Tabulated fastener requirements apply where the ultimate design wind speed is less than 140 mph. For wood structural panel roof sheathing attached to gable-end roof framing and to intermediate supports within 48 inches of roof edges and ridges, nails shall be spaced at 4 inches on center where the ultimate design wind speed is greater than 130 mph in Exposure B or greater than 110 mph in Exposure C. Spacing exceeding 6 inches on center at intermediate supports shall be permitted where the fastening is designed per the AWC NDS.
- f. Fastening is only permitted where the ultimate design wind speed is less than or equal to 110 mph.
- g. Nails and staples are carbon steel meeting the specifications of ASTM F1667. Connections using nails and staples of other materials, such as stainless steel, shall be designed by acceptable engineering practice or approved under Section 104.11.

Reason Statement: Clarify applicability of 0.113" nail and staple fastener type to subfloor and wall applications consistent with similar usage of 0.113" nail and staples for thinner sheathing.

Cost Impact: The code change proposal will not increase or decrease the cost of construction. The proposal is a clarification of existing requirements.

S215-22

IBC: 2304.10.6, ASTM Chapter 35 (New)

Proponents: Rick Allen, representing ISANTA (rallen@isanta.org)

2021 International Building Code

Revise as follows:

2304.10.6 Fasteners and connectors in contact with preservative-treated and fire-retardant-treated wood. Fasteners, including nuts and washers, and connectors in contact with *preservative-treated* and *fire-retardant-treated wood* shall be in accordance with Sections 2304.10.6.1 through 2304.10.6.4. The coating weights for zinc-coated fasteners shall be in accordance with ASTM A153 Class D or ASTM A641 Class 3S [1 oz/ft² (305 g/m²)]. Stainless steel driven fasteners shall be in accordance with the material requirements of ASTM F1667.

Add new standard(s) as follows:

ASTM

ASTM International
100 Barr Harbor Drive, P.O. Box C700
West Conshohocken, PA 19428

A641/A641M-19

Specification for Zinc-coated (Galvanized) Carbon Steel Wire

Staff Analysis: The proposal is referencing an updated version of an existing referenced standard currently in the IRC. Therefore the updated version is considered an new standard. A review of the standard proposed for inclusion in the code, ASTM A641/A641M-2019 Specification for Zinc-coated (Galvanized) Carbon Steel Wire, with regard to some of the key ICC criteria for referenced standards (Section 3.6 of CP#28) will be posted on the ICC website on or before March 16, 2022.

Reason Statement: Rationale: Galvanized nails are made from wire. The wire may be uncoated or galvanized. Nails that are made from uncoated wire are hot-dip galvanized after forming to specification A153 Class D which provides a minimum average coating weight of 1 oz./ft². Nails that are made from galvanized wire are made from wire coated to specification A641 Class 3S which provides a minimum average coating weight of 1 oz/ft².

Although commercially available and used for many years, Class 3S was added to Specification A641 in 2019

Specification A641 Class 3S was added to ASTM F1667 in 2020.

Cost Impact: The code change proposal will not increase or decrease the cost of construction proposal will not add or reduce cost. proposal aligns with current industry practices

S215-22

S216-22

IBC: 2304.10.6 (New)

Proponents: Jay Crandell, P.E., ABTG/ARES Consulting, representing Foam Sheathing Committee of the American Chemistry Council
(jcrandell@aresconsulting.biz)

2021 International Building Code

Add new text as follows:

2304.10.6 Fastening of cladding through foam plastic insulating sheathing to wood members. Cladding and furring connections through foam plastic *insulating sheathing* to wood framing shall be in accordance with Section 2603.13.

Reason Statement: Fastening requirements for cladding and components attached to wood framing through a layer of foam sheathing must be addressed in accordance with Section 2603.13. These are relatively new requirements and are important for proper, code-compliant use of foam sheathing materials on wood construction. But, they are located in different places of the code and experience indicates that many users don't readily connect together these requirements. This proposal does not add any new requirement, it simply makes the code more transparent.

Cost Impact: The code change proposal will not increase or decrease the cost of construction
This proposal clarifies requirements and adds no new requirement or cost.

S216-22

S217-21

IBC: 2304.11.1.1

Proponents: Jonathan Siu, Self, representing Washington Association of Building Officials Technical Code Development Committee; Micah Chappell, representing Washington Association of Building Officials (micah.chappell@seattle.gov)

2021 International Building Code

Revise as follows:

2304.11.1.1 Columns. Minimum dimensions of columns shall be in accordance with Table 2304.11. Columns shall be ~~continuous or superimposed throughout all stories and~~ connected in an *approved* manner. Columns shall be continuous or superimposed throughout all stories of Type IV-HT construction. Girders and beams at column connections shall be closely fitted around columns and adjoining ends shall be cross tied to each other, or intertied by caps or ties, to transfer horizontal *loads* across joints. Wood bolsters shall not be placed on tops of columns unless the columns support roof *loads* only. Where traditional heavy timber detailing is used, connections shall be by means of reinforced concrete or metal caps with brackets, by properly designed steel or iron caps, with pintles and base plates, by timber splice plates affixed to the columns by metal connectors housed within the contact faces, or by other *approved* methods.

Reason Statement: 2021 IBC Section 2304.11.1.1 requires continuous column lines for all heavy timber construction types (IV-A, IV-B, IV-C, IV-HT). That is, columns must line up vertically, from foundation to roof—no transfers of column loads via slabs or beams to other columns are permitted. This puts unnecessary restrictions on the structural design of all mass timber buildings. This historical limitation on column load transfers intended for “traditional” heavy timber construction is not justified for the new Types IV-A, IV-B, or IV-C construction, nor should load transfer be restricted for podium construction in Section 510.

This proposal solves the problem by allowing column load transfers to occur in Types IV-A/B/C construction and in podium construction by specifying the restriction on column load transfers only applies to Type IV-HT construction (“traditional” heavy timber).

I believe this is an issue the ICC Ad-Hoc Committee on Tall Wood Buildings (TWB) overlooked in their deliberations when they wrote the new provisions for mass timber in the 2021 IBC. While the TWB discussed many fire/life safety and structural issues, they did not delve deeply into the structural detailing provisions existing in the code, so this issue was not identified.

Background:

IBC Section 2304.11 governs the sizes and some of the structural detailing requirements for heavy timber. All mass timber is required to comply with this section (see the definition for Mass Timber, and Section 602.4). Section 2304.11.1.1 deals with the detailing for columns. As written in the current code, the second sentence essentially requires heavy timber column lines to be continuous vertically, from foundation to roof:

- “Columns shall be continuous or superimposed throughout all stories and connected in an *approved* manner [emphasis mine].”

“Continuous or superimposed” means column loads cannot be transferred horizontally via beams of any material (fire-resistance rated or not) to other columns, or by a concrete transfer slab to columns or walls. In podium construction (Section 510.2), the continuity requirement plus a literal reading of “throughout all stories” dictates steel or concrete columns are required to be placed in the Type IA podium under every heavy timber column, and continue through the podium to the foundation.

The column continuity requirement has been in the codes for many decades, including the 1956 edition of the Seattle Building Code, which I presume was based on a legacy code. I did not research further back than that.

Discussion:

From a purely structural engineering standpoint, there is no reason for this restriction. Any transfer beam or slab would have to be designed for the loads in accordance with the structural provisions in the code. Transfer beams, girders, and slabs are common in all types of construction.

From a fire protection standpoint, an argument can be made for requiring column continuity for “traditional” heavy timber construction (Type IV-HT), where there is no requirement for fire-resistance ratings for connections. For example, if a transfer beam were supporting a column supporting multiple stories, the failure of a single unprotected transfer beam connection could trigger a multi-story collapse. While this proposal is not eliminating the requirement, it is noteworthy that no other type of construction has this requirement for column continuity. For example, steel transfer beams supporting columns are allowed in all types of construction, as long as the beams and connections are provided with the required fire-resistance rating. Unprotected steel transfer beams and connections are allowed in Types IIB, IIIB, and VB construction.

In Types IV-A, -B, and -C construction, the connections are required to have a fire-resistance rating (see AWC/NDS Section 16.1). For mass timber, wood char is allowed to account for some of the protection in Types IV-A and -B construction, and all of the protection in Type IV-C. Since the connections have a fire-resistance rating, there is not the same potential for failure described above for Type IV-HT. It does not make sense from a fire protection standpoint that loads cannot be transferred horizontally where there is rated construction. Steel and concrete beams are allowed to support columns, provided the beams, including their connections, are appropriately protected. There is no reason to treat fire-

resistance-rated mass timber differently.

Some states, including the State of Washington, have adopted these provisions into their current codes. As these new types of construction are being explored by design professionals, they are posing questions to local building officials or requesting interpretations for issues that do not appear to have been covered in TWB discussions. This code change proposal is intended to address one of those questions by clarifying the application of the code through limiting the historical requirement for column continuity to "traditional" Type IV-HT construction, where it was originally intended to apply.

Cost Impact: The code change proposal will not increase or decrease the cost of construction
Because this is a clarification in the application of the code provisions, there is no increase or decrease in the cost of the construction.

S217-21

S218-22

IBC: 2305.1, 2305.1.2 (New)

Proponents: David Tyree, representing American Wood Council (dtyree@awc.org)

2021 International Building Code

Revise as follows:

2305.1 General. Structures using wood ~~frame shear walls~~ or wood ~~frame diaphragms~~ to resist wind, and seismic or other lateral loads shall be designed and constructed in accordance with AWC SDPWS and the applicable provisions of Sections 2305, 2306 and 2307.

Add new text as follows:

2305.1.2 Permanent load duration. Permanent loads are associated with permanent load duration as defined by the ANSI/AWC NDS. For wood shear walls and wood diaphragms designed to resist loads of permanent load duration, the design unit shear capacities shall be taken as the AWC SDPWS nominal unit shear capacities, multiplied by 0.2 for use with *Allowable Stress Design* in Section 2306 and 0.3 for use with *Load and Resistance Factor Design* in Section 2307.

Reason Statement: Proposal revises Section 2305.1 to use “wood shear walls” and “wood diaphragms” instead of “wood-frame” shear walls and diaphragms to account for both wood-frame and cross-laminated timber shear walls and diaphragms in AWC SDPWS. Reference to the SDPWS is appropriate for design of wood shear walls and diaphragms to resist wind and seismic, but for resistance to permanent lateral loads, such as soil loads in foundation design, the nominal unit shear capacities in SDPWS need further reduction to account for long-term effects. Permanent loads are associated with permanent load duration as defined by ANSI/AWC NDS.

Cost Impact: The code change proposal will not increase or decrease the cost of construction

This change clarifies applicability of SDPWS reference for wood shear walls and wood diaphragms and provides requirements for use of SDPWS values for permanent load applications.

S218-22

S219-22

IBC: TABLE 2308.6.3(1)

Proponents: David Tyree, representing American Wood Council (dtyree@awc.org); Philip Line, representing American Wood Council (pline@awc.org)

2021 International Building Code

Revise as follows:

TABLE 2308.6.3(1) BRACING METHODS

Portions of table not shown remain unchanged.

METHODS, MATERIAL	MINIMUM THICKNESS	FIGURE	CONNECTION CRITERIA ^a	
			Fasteners	Spacing
GB Gypsum board (Double sided)	$\frac{1}{2}$ " or $\frac{5}{8}$ " by not less than 4' wide to studs at maximum of 24" o.c.		Section 2506.2 for exterior and interior sheathing: 5d annual ringed cooler nails ($1\frac{5}{8}$ " x 0.086") or 1 $\frac{1}{4}$ " screws (Type W or S) for $\frac{1}{2}$ " gypsum board or 1 $\frac{5}{8}$ " screws (Type W or S) for $\frac{5}{8}$ " gypsum board	For all braced wall panel locations: 7" o.c. along panel edges (including top and bottom plates) and 7" o.c. in the field

For SI: 1 foot = 304.8 mm, 1 degree = 0.01745 rad.

- a. Method LIB shall have gypsum board fastened to one or more side(s) with nails or screws

Reason Statement: The term "annual ringed" is incorrect and may have been intended to describe "annular ringed". However, "5d cooler nails" are commonly prescribed for gypsum board attachment and likely intended over "annular ringed" for consistency with nail descriptions in Table 2508.6 and Tables 721.1(1), 721.1(2), and 721.1(3). 5d cooler nails are also prescribed for gypsum board bracing at interior locations per Table R602.10.4 and R702.3.5.

Cost Impact: The code change proposal will not increase or decrease the cost of construction. This change is a clarification that leads to consistent nail description for this application.

S220-22

IBC: 2306.1.3, 2306.1.4 (New)

Proponents: Jason Smart, representing American Wood Council (jsmart@awc.org); David Tyree, representing American Wood Council (dtyree@awc.org)

2021 International Building Code

Revise as follows:

2306.1.3 Preservative-treated wood allowable stresses ~~stress adjustments~~. The allowable unit stresses for *preservative-treated wood* conforming to AWPAs U1 and M4 need not be adjusted for treatment, but are subject to other adjustments. Load duration factors greater than 1.6 shall not be used in the structural design of *preservative-treated wood* members.

The allowable unit stresses for fire-retardant-treated wood, including fastener values, shall be developed from an approved method of investigation that considers the effects of anticipated temperature and humidity to which the fire-retardant-treated wood will be subjected, the type of treatment and the redrying process. Other adjustments are applicable except that the impact load duration shall not apply.

Add new text as follows:

2306.1.4 Fire-retardant-treated wood allowable stresses. The allowable unit stresses for *fire-retardant-treated wood*, including connection design values, shall be developed in accordance with the provisions of Section 2303.2.5. Load duration factors greater than 1.6 shall not be used in the structural design of *fire-retardant-treated wood* members.

Reason Statement: Provisions pertaining to fire-retardant-treated wood are broken into a separate section from those pertaining to preservative-treated wood, due to the fact that they are handled differently. Adjustments for treatment are not necessary for preservative-treated wood conforming with AWPAs U1 and M4, whereas adjustments are necessary for fire-retardant-treated wood. The scope of existing Section 2306.1.3 is narrowed to address only preservative-treated wood.

A new Section 2306.1.4, referencing the applicable provisions in Section 2305.2.5, is created to address fire-retardant-treated wood.

A new sentence is added to both sections stating that load duration factors, as used in the NDS, shall not exceed 1.6. This clarifies the current prohibition on use of the impact load duration factor and provides consistency with AWC NDS provisions for both preservative-treated wood and fire-retardant-treated wood.

Cost Impact: The code change proposal will not increase or decrease the cost of construction.

This change provides clarification of the requirements consistent with the intent of existing code provisions and referenced standards.

S220-22

S222-22

IBC: SECTION 202 (New), 2308.2.7 (New), 2308.2

Proponents: Kelly Cobeen, representing Federal Emergency Management Agency/Applied Technology Council - Seismic Code Support Committee (kcobeen@wje.com); Michael Mahoney, representing FEMA (mike.mahoney@fema.dhs.gov); J Daniel Dolan, representing Seismic Code Support Committee (jddolan@wsu.edu)

2021 International Building Code

Add new definition as follows:

[BS] CRIPPLE WALL CLEAR HEIGHT. The vertical height of a cripple wall from the top of the foundation to the underside of floor framing above.

Add new text as follows:

2308.2.7 Hillside light-frame construction. Design in accordance with Section 2308.1.1 shall be provided for the floor immediately above the cripple walls or post and beam systems and all structural elements and connections from this floor down to and including connections to the foundation and design of the foundation to transfer lateral loads from the framing above in buildings where all of the following apply:

1. The grade slope exceeds 1 unit vertical in 5 units horizontal where averaged across the full length of any side of the building, and
2. The tallest cripple wall clear height exceeds 7 feet (2134 mm), or where a post and beam system occurs at the building perimeter, the post and beam system tallest post clear height exceeds 7 feet (2134 m), and
3. Of the total plan area below the lowest framed floor, whether open or enclosed, less than 50 percent is occupiable space having interior wall finishes conforming to Section 2304.7 or Chapter 25 of this code.

Exception: Light-frame buildings in which the lowest framed floor is supported directly on concrete or masonry walls over the full length of all sides except the downhill side of the building are exempt from this provision.

Revise as follows:

2308.2 Limitations. Buildings are permitted to be constructed in accordance with the provisions of *conventional light-frame construction*, subject to the limitations in Sections 2308.2.1 through ~~2308.2.6~~ 2308.2.7.

Reason Statement: This proposal provides correlation between the prescriptive provisions of IBC Section 2308 and the provisions of IRC Section R301.2.2.6 Item 8, added in the 2021 IRC with the intent of improving the seismic performance of wood-light-frame hillside buildings. A related modification has been made in ASCE/SEI 7-22 to provide additional guidance to engineers designing wood light-frame hillside buildings. As part of work contributing to *Vulnerability-Based Seismic Assessment and Retrofit of One- and Two-Family Dwellings Volume 1 - Prestandard* (FEMA P-1100, 2018), it was identified that for light-frame buildings on steep hillsides (Figure 1), adequate seismic performance does not occur when seismic design is based on typical seismic force distribution assumptions (tributary area, flexible diaphragm). Whether loading is in the cross-slope or out-of-hill direction (Figure 2), seismic forces follow the stiffest load path to the uphill foundation, rather than distributing uniformly to all the bracing walls in the way assumed in development of IBC Section 2308 seismic bracing provisions. For this reason, design using the IBC Section 2308 bracing provisions will not provide adequate seismic performance. This change proposal triggers an engineered lateral force design for the lower portion of hillside buildings by adding the hillside building configuration to the already existing list of Section 2308.2 limitations.

This building configuration was illustrated to be vulnerable in the 1994 Northridge, California Earthquake. The Earthquake Spectra Northridge Earthquake Reconnaissance Report (Volume 2, EERI, 1996) reported 117 significantly damaged hillside buildings of the bearing wall type and 40 of the post and beam (stilt) type. Fifteen dwellings were reported to have collapsed or were so near collapse that they were immediately demolished and another fifteen came close to collapsing. HUD (1994) also reported significant damage to hillside buildings. As examples of vulnerable hillside building performance, Figure 3 illustrates a building that pulled about six inches away from the uphill foundation, but did not collapse, and Figure 4 illustrates one of the buildings that collapsed in the 1994 earthquake.

Blaney et. Al. (2018) illustrates results from numerical studies used in development of FEMA P-1100. Figure 18 of this reference indicates that for a studied hillside building, the probability of collapse in the risk-adjusted maximum considered earthquake (MCE_R) was reduced by more than a factor of seven by changing from typical prescriptive bracing practice to an engineered methodology that considered the seismic response. More background on building past performance and the numerical studies are found in FEMA P-1100.

The Item 1 grade slope trigger is used to limit applicability of this provision to buildings that are on sites with a significant slope (Figure 5). Averaging the grade slope along the side of the building is intended to focus on the overall drop in grade elevation across the building and not trigger the irregularity based only on limited areas of higher grade slope. This is consistent with the numerical studies that form the basis of this proposal. For

most buildings this criterion will be evaluated by looking at each of the four primary elevations. For large and more complex buildings, additional “sides” will need to be evaluated.

Item 2 adds a second trigger of downhill cripple wall height greater than 7'-0" (Figure 6) or downhill post clear height in post and pier building (Figure 7) based on the FEMA P-1100 numerical studies. The studies showed that for buildings with cripple walls greater than 7'-0" prescriptive design can lead to significantly diminished seismic performance. The reduction in performance was not as great with cripple walls of seven feet or less.

Item 3 adds a trigger where a significant portion of the underfloor area does not have interior finishes, as the strength and stiffness of seismic bracing are significantly diminished when interior finish materials are not present. Figure 3 shows a dwelling where none of the underfloor area is enclosed. Figure 1 shows a dwelling where 100% of this underfloor area is enclosed. If this has interior finishes than Item 3 would not be applicable. If Figure 1 does not have interior finishes then Item 3 would be applicable.

All three items must be applicable in order for dwelling to require engineered design. These triggers were observed to be the points at which damage and displacements at the uphill foundation were thought to significantly increase the likelihood of collapse.

The exception scopes out engineered design of hillside buildings that have full-height concrete or masonry walls (Figure 8) because this configuration was not part of the numerical studies that form the basis of this proposal. For a building with a simple rectangular floor plan, full height concrete or masonry walls would need to occur on three sides to qualify for the exception. For a more complex building plan configuration, additional concrete or masonry walls would be required to qualify for the exception. Buildings are permitted to have doors and windows in the concrete or masonry walls and still qualify for the exception. In all buildings the concrete or masonry walls will need to conform to applicable IBC provisions.

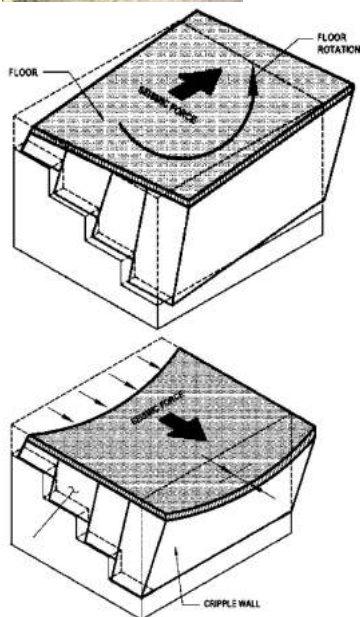

Figure 1 Hillside light-frame structure. Figure 2. Hillside structure cross-slope and out-of-hill loading.



Figure 3. Hillside building pulled away from uphill foundation in the 1994 Northridge, California Earthquake (Credit: City of Los Angeles Department of Building and Safety). Red arrow shows location where floor framing has pulled six to eight inches away from the uphill foundation.



Figure 4. Hillside building collapse in the 1994 Northridge, California Earthquake (Credit: City of Los Angeles Department of Building and Safety).

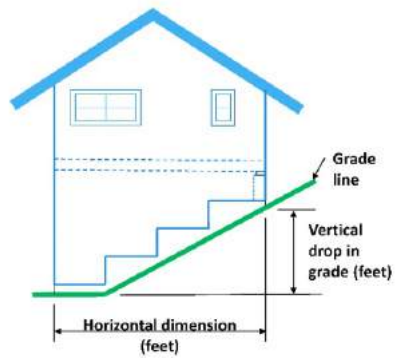

Figure 5. Grade slope triggering the hillside building engineered design exceeds 1 vertical in 5 horizontal across the full width of any side of the building.

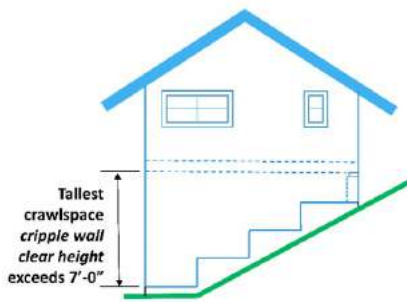

Figure 6. Downhill cripple wall height triggering the hillside building engineered design.

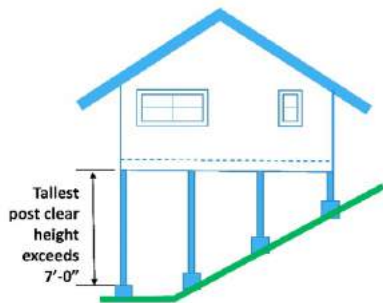

Figure 7. Downhill post height triggering the hillside building engineered design.

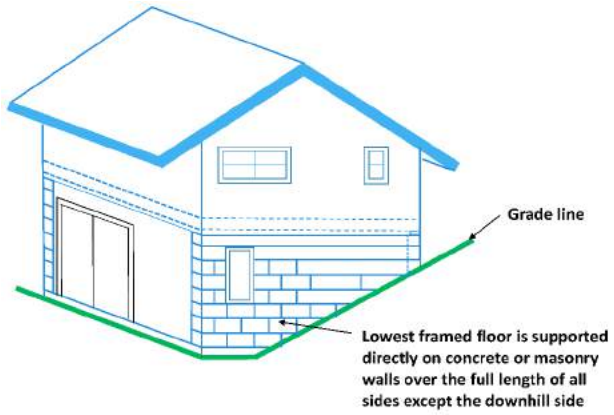

Figure 8. Concrete or masonry wall configuration that does not tripper the hillside building engineered design.

Cost Impact: The code change proposal will increase the cost of construction

This proposal is anticipated to increase the number of dwellings required to have an engineered lateral force design for moderately steep to very steep sites. In regions where these dwellings are believed to already be predominantly engineered, the cost impact is thought to be negligible. In other regions where these dwellings are not predominantly engineered, additional costs will be incurred for engineered design and more robust anchorage to the foundation.

S223-22

IBC: 2308.1, 2308.1.1, 2308.1.2, 2308.2, 2308.3 (New), 2308.4 (New), 2308.5 (New), 2308.8, 2308.8.1, 2308.8.2

Proponents: Mike Nugent, representing Building Code Action Committee (bcac@iccsafe.org)

2021 International Building Code

Revise as follows:

2308.1 General. The requirements of this section are intended for buildings of conventional light-frame construction not exceeding the height limitations of Section 2308.2.1. Other construction methods are permitted to be used, provided that a satisfactory design is submitted showing compliance with other provisions of this code. Interior nonload-bearing partitions, ceilings and curtain walls of *conventional light-frame construction* are not subject to the limitations of Section 2308.2. Detached one- and two-family dwellings and townhouses not more than three *stories above grade plane* in height with a separate *means of egress* and their accessory structures shall comply with the *International Residential Code*.

Delete without substitution:

~~**2308.1.1 Portions exceeding limitations of conventional light-frame construction.** Where portions of a building of otherwise *conventional light-frame construction* exceed the limits of Section 2308.2, those portions and the supporting load path shall be designed in accordance with accepted engineering practice and the provisions of this code. For the purposes of this section, the term "portions" shall mean parts of buildings containing volume and area such as a room or a series of rooms. The extent of such design need only demonstrate compliance of the nonconventional light-framed elements with other applicable provisions of this code and shall be compatible with the performance of the conventional light-framed system.~~

~~**2308.1.2 Connections and fasteners.** Connectors and fasteners used in conventional construction shall comply with the requirements of Section 2304.10.~~

2308.2 Limitations. Buildings are permitted to be constructed in accordance with the provisions of *conventional light-frame construction*, subject to the limitations in Sections 2308.2.1 through 2308.2.6.

Add new text as follows:

2308.3 Portions or elements exceeding limitations of conventional light frame construction. Where a building of otherwise *conventional light-frame construction* contains portions or structural elements that exceed the limits of Section 2308.2, those portions or elements, and the supporting load path, shall be designed in accordance with accepted engineering practice and the provisions of this code. For the purposes of this section, the term "portions" shall mean parts of buildings containing volume and area such as a room or a series of rooms. The extent of such design need only demonstrate compliance of the nonconventional light-framed elements with other applicable provisions of this code and shall be compatible with the performance of the conventional light-framed system.

2308.4 Structural elements or systems not described herein. Where a building of otherwise conventional construction contains structural elements or systems not described in Section 2308, these elements or systems shall be designed in accordance with accepted engineering practice and the provisions of this code. The extent of such design need only demonstrate compliance of the nonconventional elements with other applicable provisions of this code and shall be compatible with the performance of the conventionally framed system.

2308.5 Connections and fasteners. Connectors and fasteners used in conventional construction shall comply with the requirements of Section 2304.10.

Delete without substitution:

~~**2308.8 Design of elements.** Combining of engineered elements or systems and conventionally specified elements or systems shall be permitted subject to the limits of Sections 2308.8.1 and 2308.8.2.~~

~~**2308.8.1 Elements exceeding limitations of conventional construction.** Where a building of otherwise conventional construction contains structural elements exceeding the limits of Section 2308.2, these elements and the supporting *load* path shall be designed in accordance with accepted engineering practice and the provisions of this code.~~

~~**2308.8.2 Structural elements or systems not described herein.** Where a building of otherwise conventional construction contains structural elements or systems not described in Section 2308, these elements or systems shall be designed in accordance with accepted engineering practice and the provisions of this code. The extent of such design need only demonstrate compliance of the nonconventional elements with other applicable provisions of this code and shall be compatible with the performance of the conventionally framed system.~~

Reason Statement: The purpose of this code change is to emphasize the limitations on story height for conventional construction and to editorially rearrange related sections so they make more sense.

Section 2308 contains prescriptive construction requirements for small wood-frame construction that is outside the scope of the IRC. Just like in the IRC, in order to keep things simple there needs to be limits on things like environmental loads, live and dead loads, number of stories, and sizes of certain building elements. Section 2308.2 provides these limitations. However, the section before that, 2308.1.1, allows "portions" of buildings that exceed these limits to be built as long as the portion is designed. The BCAC believes the intent is to permit exceeding the limits in certain cases, but not to permit exceeding the story height limits of Section 2308.2.1. So the first change adds the limitation in the very first section

that the story limitation of 2308.2.1 is the absolute minimum, just as the IRC does.

Looking at the organization of this section, 2308.1.1 describes what to do when “portions” exceed the limitations. Then 2308.2 describes all the limitations. Then much later in the section, 2308.8 describes what to do when “elements” exceed the limits for Conventional Construction.

It makes more sense to have the limitations at the beginning of the section, and then combine the sections on “portions” and “elements” that exceed the limitations right after that.

The section on “design of elements” seems unrelated enough that it should have its own section, also at the beginning of the Section. Finally, Section 2308.1.2 on Fasteners and Connectors seems like it should not be placed before the limitations of the entire section. It is proposed to move it after the sections on Limitations and design of portions and elements that exceed those limitations.

This proposal is submitted by the ICC Building Code Action Committee (BCAC).

BCAC was established by the ICC Board of Directors in July 2011 to pursue opportunities to improve and enhance assigned International Codes or portions thereof. In 2020 and 2021 the BCAC has held several virtual meetings open to any interested party. In addition, there were numerous virtual Working Group meetings for the current code development cycle, which included members of the committee as well as interested parties. Related documents and reports are posted on the BCAC website at <https://www.iccsafe.org/products-and-services/i-codes/code-development/cs/building-code-action-committee-bcac/>.

Cost Impact: The code change proposal will not increase or decrease the cost of construction
This code change is a clarification of current code requirements.

S223-22

S224-22

IBC: SECTION 2308.3 (New), 2308.3.1 (New), 2308.3.2 (New), 2308.3.2.1 (New), 2308.3.3 (New), 2308.3.4 (New), 2308.3.5 (New), 2308.4.2.4, 2308.5.9, 2308.5.10, 2308.7.4; IPC: 307.2, 307.3 (New), [BS] C101.1, [BS] C101.2, [BS] C101.3; IMC: [BS] 302.3, [BS] 302.3.1, [BS] 302.3.2, [BS] 302.3.3; IFGC: [BS] 302.3, [BS] 302.3.2, [BS] 302.3.3, [BS] 302.3.4

Proponents: Mike Nugent, representing Building Code Action Committee (bcac@iccsafe.org)

2021 International Building Code

Add new text as follows:

SECTION 2308.3 CUTTING, NOTCHING AND BORING

2308.3.1 Scope. The provisions of Section 2308.3 shall only apply to dimensional wood framing and shall not include engineered wood products, heavy timber, or pre-fabricated/manufactured wood assemblies.

2308.3.2 Floor joists, roof rafters, and ceiling joists. Notches on framing ends shall not exceed one-fourth the member depth. Notches in the top or bottom of the member shall not exceed one-sixth the depth and shall not be located in the middle third of the span. A notch not more than one-third of the depth is permitted in the top of a rafter or ceiling joist not further from the face of the support than the depth of the member. Holes bored in members shall not be within 2 inches (51 mm) of the top or bottom of the member and the diameter of any such hole shall not exceed one-third the depth of the member. Where the member is notched, the hole shall not be closer than 2 inches (51 mm) to the notch.

2308.3.2.1 Ceiling joists. Where ceiling joists also serve as floor joists, they shall be considered floor joists within this section.

2308.3.3 Wall studs. In exterior walls and bearing partitions, a wood stud shall not be cut or notched in excess of 25 percent of its depth. In nonbearing partitions that do not support loads other than the weight of the partition, a stud shall not be cut or notched in excess of 40 percent of its depth.

2308.3.4 Bored holes. The diameter of bored holes in wood studs shall not exceed 40 percent of the stud depth. The diameter of bored holes in wood studs shall not exceed 60 percent of the stud depth in nonbearing partitions. The diameter of bored holes in wood studs shall not exceed 60 percent of the stud depth in any wall where each stud is doubled, provided that not more than two such successive doubled studs are so bored. The edge of the bored hole shall not be closer than $\frac{5}{8}$ inch (15.9 mm) to the edge of the stud. Bored holes shall not be located at the same section of stud as a cut or notch.

2308.3.5 Limitations. In designated lateral-force resisting system assemblies designed in accordance with this code and greater than three-stories in height or in Seismic Design Categories C, D, E, and F, the cutting, notching and boring of wall studs shall be as prescribed by the registered design professional.

In structures designed in accordance with the International Residential Code, modification of wall studs shall comply with the International Residential Code.

Delete without substitution:

~~**2308.4.2.4 Notches and holes.** Notches on the ends of joists shall not exceed one-fourth the joist depth. Notches in the top or bottom of joists shall not exceed one-sixth the depth and shall not be located in the middle third of the span. Holes bored in joists shall not be within 2 inches (51 mm) of the top or bottom of the joist and the diameter of any such hole shall not exceed one-third the depth of the joist.~~

~~**2308.5.9 Cutting and notching.** In exterior walls and bearing partitions, a wood stud shall not be cut or notched in excess of 25 percent of its depth. In nonbearing partitions that do not support loads other than the weight of the partition, a stud shall not be cut or notched in excess of 40 percent of its depth.~~

~~**2308.5.10 Bored holes.** The diameter of bored holes in wood studs shall not exceed 40 percent of the stud depth. The diameter of bored holes in wood studs shall not exceed 60 percent of the stud depth in nonbearing partitions. The diameter of bored holes in wood studs shall not exceed 60 percent of the stud depth in any wall where each stud is doubled, provided that not more than two such successive doubled studs are so bored. The edge of the bored hole shall not be closer than $\frac{5}{8}$ inch (15.9 mm) to the edge of the stud. Bored holes shall not be located at the same section of stud as a cut or notch.~~

~~**2308.7.4 Notches and holes.** Notching at the ends of rafters or ceiling joists shall not exceed one-fourth the depth. Notches in the top or bottom of the rafter or ceiling joist shall not exceed one-sixth the depth and shall not be located in the middle one-third of the span, except that a notch not more than one-third of the depth is permitted in the top of the rafter or ceiling joist not further from the face of the support than the depth of the member. Holes bored in rafters or ceiling joists shall not be within 2 inches (51 mm) of the top and bottom and their diameter shall not exceed one-third the depth of the member.~~

2021 International Plumbing Code

Revise as follows:

307.2 Cutting, notching and boring of cold-formed steel framing, or bored holes. A cold-formed framing member shall not be cut, notched or bored in excess of limitations specified in the *International Building Code*.

Add new text as follows:

307.3 Cutting, notching and boring of wood framing. The cutting, notching and boring of structural wood framing members shall comply with Section 2308.3 of the *International Building Code*.

Delete without substitution:

~~[BS] C101.1 Joist notching.~~ Notches on the ends of joists shall not exceed one-fourth the joist depth. Holes bored in joists shall not be within 2 inches (51 mm) of the top or bottom of the joist, and the diameter of any such hole shall not exceed one-third the depth of the joist. Notches in the top or bottom of joists shall not exceed one-sixth the depth and shall not be located in the middle third of the span.

~~[BS] C101.2 Stud cutting and notching.~~ In exterior walls and bearing partitions, a wood stud shall not be cut or notched in excess of 25 percent of its depth. In nonbearing partitions that do not support loads other than the weight of the partition, a stud shall not be cut or notched in excess of 40 percent of its depth.

~~[BS] C101.3 Bored holes.~~ The diameter of bored holes in wood studs shall not exceed 40 percent of the stud depth. The diameter of bored holes in wood studs shall not exceed 60 percent of the stud depth in nonbearing partitions. The diameter of bored holes in wood studs shall not exceed 60 percent of the stud depth in any wall where each stud is doubled, provided that not more than two such successive doubled studs are so bored. The edge of the bored hole shall be not closer than $\frac{5}{8}$ inch (15.9 mm) to the edge of the stud. Bored holes shall not be located at the same section of stud as a cut or notch.

2021 International Mechanical Code

Revise as follows:

~~[BS] 302.3 Cutting, notching and boring in wood framing.~~ The cutting, notching and boring of wood framing members shall comply with Sections 2308.3 of the *International Building Code*, 302.3.1 through 302.3.4.

Delete without substitution:

~~[BS] 302.3.1 Joist notching.~~ Notches on the ends of joists shall not exceed one-fourth the joist depth. Holes bored in joists shall not be within 2 inches (51 mm) of the top or bottom of the joist, and the diameter of any such hole shall not exceed one-third the depth of the joist. Notches in the top or bottom of joists shall not exceed one-sixth the depth and shall not be located in the middle third of the span.

~~[BS] 302.3.2 Stud cutting and notching.~~ In exterior walls and bearing partitions, a wood stud shall not be cut or notched in excess of 25 percent of its depth. In nonbearing partitions that do not support loads other than the weight of the partition, a stud shall not be cut or notched in excess of 40 percent of its depth.

~~[BS] 302.3.3 Bored holes.~~ The diameter of bored holes in wood studs shall not exceed 40 percent of the stud depth. The diameter of bored holes in wood studs shall not exceed 60 percent of the stud depth in nonbearing partitions. The diameter of bored holes in wood studs shall not exceed 60 percent of the stud depth in any wall where each stud is doubled, provided that not more than two such successive doubled studs are so bored. The edge of the bored hole shall be not closer than $\frac{5}{8}$ inch (15.9 mm) to the edge of the stud. Bored holes shall be not located at the same section of stud as a cut or notch.

2021 International Fuel Gas Code

Revise as follows:

~~[BS] 302.3 Cutting, notching and boring in wood members.~~ The cutting, notching and boring of wood framing members shall comply with Sections 2308.3 of the *International Building Code*, 302.3.1 through 302.3.4.

Delete without substitution:

~~[BS] 302.3.2 Joist notching and boring.~~ Notching at the ends of joists shall not exceed one-fourth the joist depth. Holes bored in joists shall not be within 2 inches (51 mm) of the top and bottom of the joist and their diameters shall not exceed one-third the depth of the member. Notches in the top or bottom of the joist shall not exceed one-sixth the depth and shall not be located in the middle one-third of the span.

~~[BS] 302.3.3 Stud cutting and notching.~~ In exterior walls and bearing partitions, any wood stud is permitted to be cut or notched to a depth not exceeding 25 percent of its width. Cutting or notching of studs to a depth not greater than 40 percent of the width of the stud is permitted in nonload-bearing partitions supporting no loads other than the weight of the partition.

~~[BS] 302.3.4 Bored holes.~~ The diameter of bored holes in wood studs shall not exceed 40 percent of the stud depth. The diameter of bored holes in wood studs shall not exceed 60 percent of the stud depth in nonbearing partitions. The diameter of bored holes in wood studs shall not exceed 60 percent of the stud depth in any wall where each stud is doubled, provided that not more than two such successive doubled studs are so bored. The edge of the bored hole shall be not closer than $\frac{5}{8}$ inch (15.9 mm) to the edge of the stud. Bored holes shall not be located at the same section of

~~stud-as-a-cut-or-notch-~~

Staff Analysis: CC# S196-22 and CC# S224-22 addresses requirements in a different or contradicting manner. The committee is urged to make their intentions clear with their actions on these proposals.

Reason Statement: This proposal consolidates similar wood cutting, notching and boring criteria from the IFGC, IMC, IPC, and IBC into a single location in the IBC, and does not impose new requirements or restrict any practices currently allowed within the I-Codes. The proposed language draws from current language in the IPC, IMC, and IFGC and IBC provisions in the conventional light-framed section. The existing language was used to the greatest extent possible and relocated to minimize technical changes.

Within the IBC, existing wood framing notching, cutting and boring provisions have been relocated into a single new Section 2308.3. This reorganization into one location makes the IBC provisions easy to find and will provide clear and consistent criteria across all trades on how to field modify framing members and when modification of such members requires input from a design professional.

Structural framing members are frequently modified in the field by non-structural trades, to facilitate the installation of mechanical, electrical, plumbing, and other utilities. Especially in conventional light-framed wood construction, such modifications are rarely overseen by a design professional with knowledge of critical framing elements that should remain unmodified and the role they play within the structure.

It is unrealistic to expect field personnel to continually seek the guidance of a design professional for every framing member requiring modification. However, modifications of critical framing members have the potential to negatively impact the integrity of the structure and the utility systems that rely on that structure for support. The resulting structural deficiencies caused by field modifications to framing members may only be realized during significant high-wind, seismic, impact, or other loading events that, while within the normal structure design criteria, are outside every day operating conditions. At best, such deficiencies may be realized by local deformation of finish materials and at worst, by partial or full collapse of a structure.

Currently, the IFGC, IMC, IPC, and IBC all provide guidance on modification of structural framing elements within the path of utilities. Although the guidance provided by each code is similar, they are not identical in wording or scope and are handled differently within each document.

Differences include but are not limited to:

- IFGC, IMC: The cutting and notching criteria is within the main body of the code.
- IFGC, IMC: Includes direction for wood, steel, cold-formed steel, and non-structural cold-formed steel materials.
- IPC: Points to the IBC for cutting and notching criteria but provides Appendix C as an alternate. • IPC Appendix C
 - Includes some, but not all, cutting and notching criteria and limitations found within the IFGC and IMC.
 - Does not address steel and cold-formed materials.

This proposal is submitted by the ICC Building Code Action Committee (BCAC).

BCAC was established by the ICC Board of Directors in July 2011 to pursue opportunities to improve and enhance assigned International Codes or portions thereof. In 2020 and 2021 the BCAC has held several virtual meetings open to any interested party. In addition, there were numerous virtual Working Group meetings for the current code development cycle, which included members of the committee as well as interested parties. Related documents and reports are posted on the BCAC website at <https://www.iccsafe.org/products-and-services/i-codes/code-development/cs/building-code-action-committee-bcac/>.

Cost Impact: The code change proposal will not increase or decrease the cost of construction

The proposal consolidates existing and slightly varied provisions from multiple locations into one location within the wood chapter of the International Building Code.

S224-22

S225-22

IBC: 2308.4.4.1, FIGURE 2308.4.4.1(1), 2308.7.6.1

Proponents: Mike Nugent, representing Building Code Action Committee (bcac@iccsafe.org)

2021 International Building Code

Revise as follows:

2308.4.4.1 Openings in floor diaphragms in Seismic Design Categories B, C, D and E. Openings in horizontal *diaphragms* in *Seismic Design Categories* B, C, D and E with a dimension that is greater than 4 feet (1219 mm) perpendicular to the joists or rafters shall be constructed with metal ties and blocking in accordance with this section and Figure 2308.4.4.1(1). Metal ties shall be not less than 0.058 inch [1.47 mm (16 galvanized gage)] in thickness by 1½ inches (38 mm) in width and shall have a yield stress not less than 33,000 psi (227 Mpa). Blocking shall extend not less than the dimension of the opening in the direction of the tie and blocking. Ties shall be attached to blocking in accordance with the manufacturer's instructions but with not less than eight 16d common nails on each side of the header-~~joist~~-trimmer intersection.

Delete and substitute as follows:

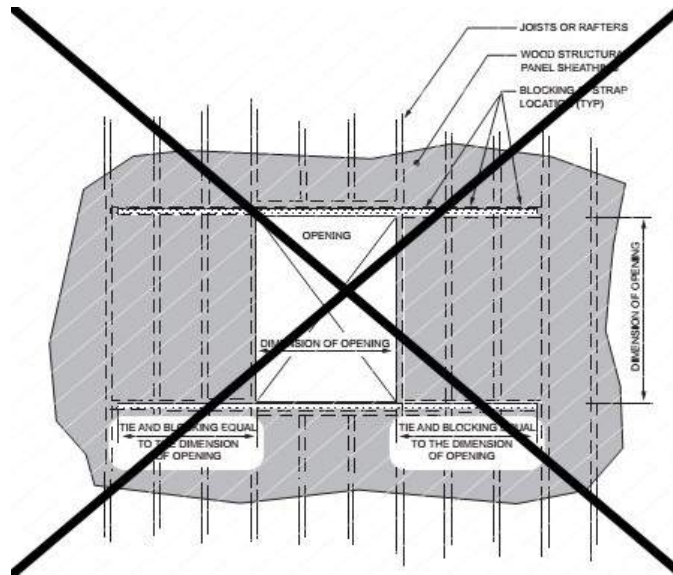

FIGURE 2308.4.4.1(1) OPENINGS IN FLOOR AND ROOF DIAPHRAGMS

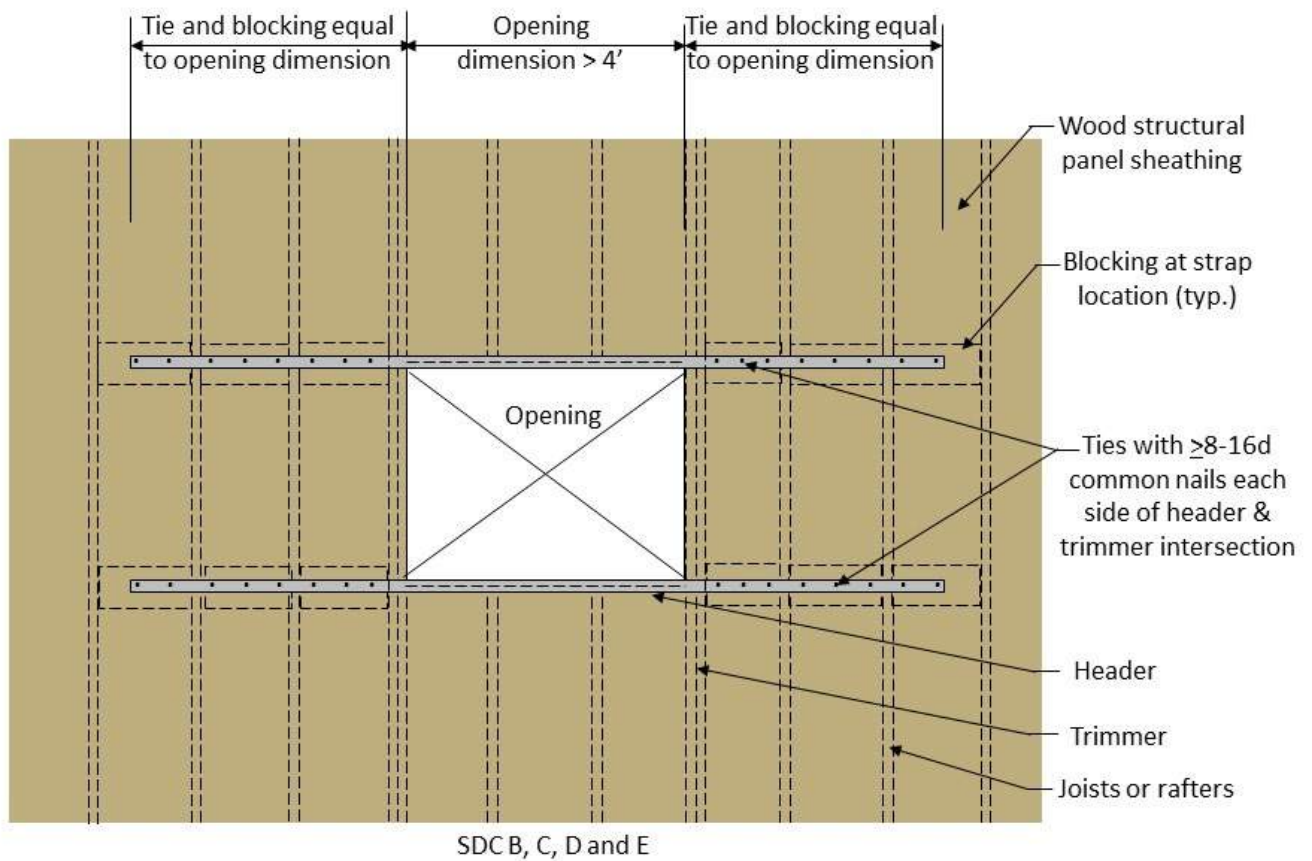

FIGURE 2308.4.4.1(1) OPENINGS IN FLOOR AND ROOF DIAPHRAGMS

Revise as follows:

2308.7.6.1 Openings in roof diaphragms in Seismic Design Categories B, C, D and E. In buildings classified as *Seismic Design Category B, C,*

D or E. openings in horizontal *diaphragms* with a dimension that is greater than 4 feet (1219 mm) perpendicular to the joists or rafters shall be constructed with metal ties and blocking in accordance with this section and Figure 2308.4.4.1(1). Metal ties shall be not less than 0.058 inch [1.47 mm (16 galvanized gage)] in thickness by 1½ inches (38 mm) in width and shall have a yield stress not less than 33,000 psi (227 Mpa). Blocking shall extend not less than the dimension of the opening in the direction of the tie and blocking. Ties shall be attached to blocking in accordance with the manufacturer's instructions but with not less than eight 16d common nails on each side of the header-~~joist~~-trimmer intersection.

Reason Statement: This proposal clarifies the current code text by adding “perpendicular to the joists or rafters”, replaces joist by trimmer and revise Figure 2308.4.4.1(1). The purpose of this prescriptive solution is “to strengthen openings greater than 4 feet in dimension perpendicular to the joists and provide a general means for a load path in these specific cases in lieu of requiring an engineered design.” The text of Sections 2308.4.4.1 and 2308.7.6.1 indicates that this provision applies when a floor diaphragm opening exceeds 4 feet. It details blocking and strapping perpendicular to the joists.

Sections 2308.4.4 and 2308.7.6.1 indicate that trimmers are to be doubled when the header span exceeds 4 feet, so the current Figure 2308.4.4.1(1) should be revised to show a double trimmer on each side of the opening. Since those trimmers are typically continuous, they act as collectors on either side of the opening parallel to the joists. Additional revisions to the figure as shown provide consistency with the code text. In summary, proposed changes to Figure 2308.4.4.1(1) include the following:

- Double trimmer shown on each side of the opening
- Remove vertical dimension of the opening
- Add opening dimension >4' perpendicular to joists
- Add nailing requirements as shown based on code text

This proposal is submitted by the ICC Building Code Action Committee (BCAC).

BCAC was established by the ICC Board of Directors in July 2011 to pursue opportunities to improve and enhance assigned International Codes or portions thereof. In 2020 and 2021 the BCAC has held several virtual meetings open to any interested party. In addition, there were numerous virtual Working Group meetings for the current code development cycle, which included members of the committee as well as interested parties. Related documents and reports are posted on the BCAC website at <https://www.iccsafe.org/products-and-services/i-codes/code-development/cs/building-code-action-committee-bcac/>.

Cost Impact: The code change proposal will not increase or decrease the cost of construction
This is a clarification of the current code text.

S225-22

S227-22

IBC: 2308.7.5, TABLE 2308.7.5

Proponents: Randy Shackelford, representing Simpson Strong-Tie Co. (rshackelford@strongtie.com)

2021 International Building Code

Revise as follows:

2308.7.5 Wind uplift. The roof construction shall have rafter and truss ties to the wall below. Resultant uplift *loads* shall be transferred to the foundation using a continuous *load* path. The rafter or truss to wall connection shall comply with Tables 2304.10.2 and 2308.7.5.

Exception: The truss to wall connection shall be permitted to be determined from the uplift forces as specified on the *truss design drawings* or as shown on the *construction documents*.

TABLE 2308.7.5 REQUIRED RATING OF APPROVED UPLIFT CONNECTORS (pounds)^{a, b, c, e, f, g, h}

NOMINAL BASIC DESIGN WIND SPEED, V_{asd} i	ROOF SPAN (feet)							OVERHANGS (pounds/feet) ^d
	12	20	24	28	32	36	40	
EXPOSURE B								
85 <u>90</u>	<u>-72</u> <u>64</u>	<u>-120</u> <u>85</u>	<u>-145</u> <u>96</u>	<u>-169</u> <u>107</u>	<u>-193</u> <u>117</u>	<u>-217</u> <u>128</u>	<u>-241</u> <u>139</u>	<u>-38.55</u>
90 <u>100</u>	<u>-91</u> <u>102</u>	<u>-151</u> <u>139</u>	<u>-181</u> <u>158</u>	<u>-212</u> <u>177</u>	<u>-242</u> <u>195</u>	<u>-272</u> <u>214</u>	<u>-302</u> <u>233</u>	<u>-43.22</u>
100 <u>110</u>	<u>-131</u> <u>144</u>	<u>-281</u> <u>199</u>	<u>-262</u> <u>226</u>	<u>-305</u> <u>254</u>	<u>-349</u> <u>282</u>	<u>-393</u> <u>310</u>	<u>-436</u> <u>338</u>	<u>-53.36</u>
110 <u>120</u>	<u>-175</u> <u>190</u>	<u>-292</u> <u>265</u>	<u>-351</u> <u>302</u>	<u>-409</u> <u>339</u>	<u>-467</u> <u>377</u>	<u>-526</u> <u>414</u>	<u>-584</u> <u>452</u>	<u>-64.56</u>
130	<u>-240</u>	<u>-335</u>	<u>-382</u>	<u>-431</u>	<u>-479</u>	<u>-528</u>	<u>-576</u>	
140	<u>-294</u>	<u>-411</u>	<u>-470</u>	<u>-530</u>	<u>-590</u>	<u>-650</u>	<u>-710</u>	
EXPOSURE C								
90	<u>-126</u>	<u>-175</u>	<u>-199</u>	<u>-223</u>	<u>-247</u>	<u>-272</u>	<u>-296</u>	
100	<u>-179</u>	<u>-250</u>	<u>-285</u>	<u>-320</u>	<u>-356</u>	<u>-391</u>	<u>-426</u>	
110	<u>-238</u>	<u>-332</u>	<u>-380</u>	<u>-428</u>	<u>-476</u>	<u>-525</u>	<u>-573</u>	
120	<u>-302</u>	<u>-424</u>	<u>-485</u>	<u>-547</u>	<u>-608</u>	<u>-669</u>	<u>-731</u>	
130	<u>-371</u>	<u>-521</u>	<u>-597</u>	<u>-674</u>	<u>-751</u>	<u>-828</u>	<u>-904</u>	
140	<u>-446</u>	<u>-628</u>	<u>-719</u>	<u>-812</u>	<u>-904</u>	<u>-997</u>	<u>-1090</u>	
EXPOSURE D								
90	<u>-166</u>	<u>-232</u>	<u>-265</u>	<u>-298</u>	<u>-311</u>	<u>-364</u>	<u>-396</u>	
100	<u>-229</u>	<u>-321</u>	<u>-367</u>	<u>-413</u>	<u>-459</u>	<u>-505</u>	<u>-551</u>	
110	<u>-298</u>	<u>-418</u>	<u>-478</u>	<u>-539</u>	<u>-601</u>	<u>-662</u>	<u>-723</u>	
120	<u>-373</u>	<u>-526</u>	<u>-603</u>	<u>-679</u>	<u>-756</u>	<u>-833</u>	<u>-910</u>	
130	<u>-455</u>	<u>-641</u>	<u>-734</u>	<u>-829</u>	<u>-924</u>	<u>-1020</u>	<u>-1114</u>	
140	<u>-544</u>	<u>-767</u>	<u>-878</u>	<u>-992</u>	<u>-1106</u>	<u>-1220</u>	<u>-1333</u>	

For SI: 1 inch = 25.4 mm, 1 foot = 304.8 mm, 1 mile per hour = 1.61 km/hr, 1 pound = 0.454 Kg, 1 pound/foot = 14.5939 N/m.

- a. The uplift connection requirements are based on a ~~33~~ 30-foot mean roof height located in Exposure B. For Exposure C or D and for other mean roof heights, multiply the loads by the following adjustment coefficients:

EXPOSURE	Mean Roof Height (feet)									
	15	20	25	30	35	40	45	50	55	60
B	1.001	1.001	1.001	1.001	1.051	1.091	1.121	1.161	1.19	1.22
C	1.211	1.291	1.351	1.401	1.451	1.491	1.531	1.561	1.59	1.62
D	1.471	1.551	1.611	1.661	1.701	1.741	1.781	1.811	1.84	1.87

- b. The uplift connection requirements are based on the framing being spaced 24 inches on center. Multiply by 0.67 for framing spaced 16 inches on center and multiply by 0.5 for framing spaced 12 inches on center.
- c. The uplift connection requirements include an allowance for 10 pounds of dead load.
- d. The uplift connection requirements ~~do not account for~~ include the effects of 24" overhangs. ~~The magnitude of the loads shall be increased by adding the overhang loads found in the table. The overhang loads are based on framing spaced 24 inches on center. The overhang loads given shall be multiplied by the overhang projection and added to the roof uplift value in the table.~~
- e. The uplift connection requirements are based on wind loading on end zones as defined in Figure 28.3-1 of ASCE 7. Connection loads for connections located a distance of 20 percent of the least horizontal dimension of the building from the corner of the building are permitted to be reduced by multiplying the table connection value by 0.75 ~~and multiplying the overhang load by 0.8.~~

- f. For wall-to-wall and wall-to-foundation connections, the capacity of the uplift connector is permitted to be reduced by 100 pounds for each full wall above. (For example, if a 500-pound rated connector is used on the roof framing, a 400-pound rated connector is permitted at the next floor level down).
- g. Interpolation is permitted for intermediate values of V_{asd} and roof spans.
- h. The rated capacity of approved tie-down devices is permitted to include up to a 60-percent increase for wind effects where allowed by material specifications.
- i. V_{asd} shall be determined in accordance with Section 1609.3.4.

Reason Statement: The reason for this code change is to update the roof to wall connection loads to comply with the IBC referenced wind design standard, ASCE 7-16. The current loads are based on a very old version of ASCE 7. That can be seen by the use of the term V-asd. ASD wind loads have not been used since ASCE 7-10. The wind uplift loads need to be updated to the Ultimate Wind Speeds (now just called Basic Design Wind Speeds) used in ASCE 7-16 (and ASCE 7-22). That way the windspeeds will match the required Basic Design Windspeeds of Figures 1609.3(1) through 1609.3(12).

By adding a Basic Wind Speed down to 90 mph, there will be entries for the new lower Basic Wind Speed maps. Without these entries, users in those areas would have to use the entry for 85 mph V-asd, which converts to nearly 110 mph, meaning they would be overdesigning.

The new exception is added to allow the truss to wall connection to be designed using either the loads on the truss design drawings or the construction documents. That language is meant to be similar to Section R802.11.1, Truss uplift resistance, in the IRC.

This code change will not be affected if ASCE 7-22 is adopted as a referenced standard in the 2024 IBC.

Bibliography: American Wood Council

ANSI/AWC WFCM—2018: Wood Frame Construction Manual for One- and Two-Family Dwellings

ASCE/SEI American Society of Civil Engineers

ASCE 7—16 with Supplement 1: Minimum Design Loads and Associated Criteria for Buildings and Other Structures

Cost Impact: The code change proposal will increase the cost of construction

Depending on the Basic Wind Speed, this code change can either increase or decrease the cost of construction.

In areas with higher Basic Wind Speed, there may be an increase in costs, as the listed wind loads were previously incorrect.

Comparing 110 mph Basic Windspeed to 90 mph ASD, the uplift loads are around 15% greater for common roof spans. That small of a difference frequently will not make a difference in the choice of connector for roof to wall connection.

However, for lower Basic Wind Speed areas, there will be a cost savings. The new table has the benefit of being able to use this table for lower windspeeds as shown in the new Basic Wind Speed Maps, which would not have been possible without these changes. Using the lowest listed V-asd, 85 mph, and then converting to Basic Wind Speeds using Section 1609.3.1, only Basic windspeeds above 110 could be used, because when converted that results in 85 mph V-asd. With the new tables Basic Wind Speeds between less than 110 down to 90 mph will have table entries, so they will have lower costs.

S228-22

IBC: 2405.2, 2405.3, 2405.3.1 (New), 2405.3.2 (New), 2405.3.3 (New), 2405.3.4 (New)

Proponents: Jennifer Hatfield, representing Fenestration & Glazing Industry Alliance (formerly AAMA) (jen@jhatfieldandassociates.com)

2021 International Building Code

Revise as follows:

2405.2 Allowable glazing materials and limitations. Sloped glazing shall be any of the following materials, subject to the listed limitations.

1. For monolithic glazing systems, the glazing material of the single light or layer shall be laminated glass with a minimum 30-mil (0.76 mm) polyvinyl butyral (or equivalent) interlayer, wired glass, light-transmitting plastic materials meeting the requirements of Section ~~2607~~ 2606, heat-strengthened glass or fully tempered glass.
2. For multiple-layer glazing systems, each light or layer shall consist of any of the glazing materials specified in Item 1.

Annealed glass is permitted to be used as specified in Exceptions 2 and 3 of Section 2405.3.

Laminated glass and plastic materials described in Items 1 and 2 shall not require the screening or height restrictions provided in Section 2405.3.

For additional requirements for plastic skylights, see Section 2610. Glass-block construction shall conform to the requirements of Section 2110.1.

2405.3 Screening. ~~Where used in monolithic glazing systems, annealed, heat-strengthened, fully tempered and wired glass shall have broken glass retention screens, where required, installed below the glazing material. The screens and their fastenings shall be: capable of supporting twice the weight of the glazing; firmly and substantially fastened to the framing members; and installed within 4 inches (102 mm) of the glass. The screens shall be constructed of a noncombustible material not thinner than No. 12 B&S gage (0.0808 inch) with mesh not larger than 1 inch by 1 inch (25 mm by 25 mm). In a corrosive atmosphere, structurally equivalent noncorrosive screen materials shall be used. Annealed, heat-strengthened, fully tempered and wired glass, where used in multiple-layer glazing systems as the bottom glass layer over the walking surface, shall be equipped with screening that conforms to the requirements for monolithic glazing systems.~~

Exception: ~~In monolithic and multiple-layer sloped glazing systems, the following applies:~~

- ~~1. Fully tempered glass installed without protective screens where glazed between intervening floors at a slope of 30 degrees (0.52 rad) or less from the vertical plane, shall have the highest point of the glass 10 feet (3048 mm) or less above the walking surface.~~
- ~~2. Screens are not required below any glazing material, including annealed glass, where the walking surface below the glazing material is permanently protected from the risk of falling glass or the area below the glazing material is not a walking surface.~~
- ~~3. Any glazing material, including annealed glass, is permitted to be installed without screens in the sloped glazing systems of commercial or detached noncombustible greenhouses used exclusively for growing plants and not open to the public, provided that the height of the greenhouse at the ridge does not exceed 30 feet (9144 mm) above grade.~~
- ~~4. Screens shall not be required in individual dwelling units in Groups R-2, R-3 and R-4 where fully tempered glass is used as single glazing or as both panes in an insulating glass unit, and the following conditions are met:~~
 - ~~4.1. Each pane of the glass is 16 square feet (1.5 m²) or less in area.~~
 - ~~4.2. The highest point of the glass is 12 feet (3658 mm) or less above any walking surface or other accessible area.~~
 - ~~4.3. The glass thickness is ³/₄ inch (4.8 mm) or less.~~
- ~~5. Screens shall not be required for laminated glass with a 15-mil (0.38 mm) polyvinyl butyral (or equivalent) interlayer used in individual dwelling units in Groups R-2, R-3 and R-4 within the following limits:~~
 - ~~5.1. Each pane of glass is 16 square feet (1.5 m²) or less in area.~~
 - ~~5.2. The highest point of the glass is 12 feet (3658 mm) or less above a walking surface or other accessible area.~~

Add new text as follows:

2405.3.1 Screens under monolithic glazing. Heat-strengthened glass and fully tempered glass shall have screens installed below the full area of the glazing material.

2405.3.2 Screens under multiple-layer glazing. Heat-strengthened glass, fully tempered glass and wired glass used as the bottom glass layer shall have screens installed below the full area of the glazing material.

2405.3.3 Screening in monolithic and multiple-layer sloped glazing systems. In monolithic and multiple-layer sloped glazing systems, the following applies:

1. Fully tempered glass shall be permitted to be installed without retention screens where glazed between intervening floors at a slope of 30 degrees (0.52 rad) or less from the vertical plane, and having the highest point of the glass 10 feet (3048 mm) or less above the walking surface.
2. Retention screens are not required below any glazing material, including annealed glass, where the walking surface below the glazing material is permanently protected from the risk of falling glass or the area below the glazing material is not a walking surface.
3. Any glazing material, including annealed glass, is permitted to be installed without retention screens in the sloped glazing systems of commercial or detached noncombustible greenhouses used exclusively for growing plants and not open to the public, provided that the height of the greenhouse at the ridge does not exceed 30 feet (9144 mm) above grade.
4. Retention screens shall not be required in individual dwelling units in Groups R-2, R-3 and R-4 where fully tempered glass is used as single glazing or as both panes in an insulating glass unit, and all of the following conditions are met:
 - 4.1. Each pane of the glass is 16 square feet (1.5 m²) or less in area.
 - 4.2. The highest point of the glass is 12 feet (3658 mm) or less above any walking surface or other accessible area.
 - 4.3. The glass thickness is $\frac{3}{16}$ inch (4.8 mm) or less.
5. Retention screens shall not be required for laminated glass with a 15-mil (0.38 mm) polyvinyl butyral (or equivalent) interlayer used in individual dwelling units in Groups R-2, R-3 and R-4 where both of the following conditions are met:
 - 5.1. Each pane of glass is 16 square feet (1.5 m²) or less in area.
 - 5.2. The highest point of the glass is 12 feet (3658 mm) or less above a walking surface or other accessible area.

2405.3.4 Screens not required. For all other types of glazing complying with Section 2405.2, retention screens shall not be required.

Reason Statement: In section 2405.2, this proposal is correcting an inaccurate reference. The current reference to Section 2607 should be replaced with a reference to Section 2606. Section 2606 is where the general requirements and properties for light transmitting plastic are located, which is what item 1 of Section 2405.2 is speaking about. Section 2607, addressing light-transmitting plastic wall panels, is not germane to skylights and sloped glazing, as there are no performance requirements for plastic glazing materials listed in 2607. The performance requirements are in Section 2606.

In section 2405.3, this proposal is simply trying to make the language clearer on when screens are and are not required. There are no changes being made to what is or is not currently required when it comes to screening. The proposal is laying out the section with new subsections, in an attempt to make it easier for both the code user and enforcement, and eliminate interpretation issues that have occurred in the field.

In this proposed re-ordering of section 2405.3, it tells code users first what the screening requirements are, when used. Then in the following subsections, the proposal clearly lays out how screens must be installed for monolithic glazing and multiple layer glazing, followed by a subsection on the exceptions from screening for those types of sloped glazing systems when they meet certain criteria, and ending with a subsection for what types of glazing do not require screening.

Finally, this proposal provides a bit of clean-up and consistency of wording by ensuring in all places the term "retention screen" is used and making changes such as having "conditions are met" in both places instead of different wording.

Cost Impact: The code change proposal will not increase or decrease the cost of construction

The proposal will have no effect on the cost of construction as the changes presented are not meant to alter the current requirements but simply meant to provide better clarity and more consistency.

S228-22

S229-22

IBC: 2406.1

Proponents: Thom Zaremba, Roetzel & Andress, representing National Glass Association (tzaremba@ralaw.com); Nicholas Resetar, representing Glazing Industry Code Committee (GICC) (nresetar@ralaw.com)

2021 International Building Code

Revise as follows:

2406.1 Human impact loads. All glass panes in individual glazed areas, including glass mirrors, single panes of glass and all panes in multi-pane glass assemblies in hazardous locations as defined in Section 2406.4 shall comply with Sections 2406.1.1 through 2406.1.4.

Exception: Mirrors and other glass panels mounted or hung on a surface that provides a continuous backing support.

Reason Statement: In recent months, the glass industry has received reports of multi-pane glass assemblies imported from outside the United States where the outermost panes are marked as safety glazing, but center pane(s) in these multi-pane assemblies, are annealed glass which breaks dangerously when broken by human impact. Nothing in either safety glazing standard - namely CPSC 16 CFR 1201 and ANSI Z97.1 - prohibits this since they establish acceptance criteria ONLY for individual glass panes, not for multi-panel glass assemblies. Accordingly, the adoption of this proposal is critical to ensure that multi-pane glass assemblies installed in hazardous locations are safe in the event of human impact and to ensure that potentially dangerous annealed panes of glass are not intermingled with safety glazing in multi-pane glass assemblies.

Cost Impact: The code change proposal will increase the cost of construction

For anyone incorporating non-safety annealed glass panes into multi-pane glass assemblies believing that such assemblies can properly be installed in hazardous locations, this proposal will increase the cost of construction. However, it is believed that most multi-pane glass assemblies manufactured in the United States do not follow the practice of incorporating non-safety annealed glass into multi-pane glass assemblies. Consequently, if this proposal is adopted, there should be very little, if any, actual increase in the cost of construction.

S229-22

S230-22

IBC: 2406.4.3

Proponents: Gwenyth Searer, representing myself (gsearer@wje.com)

2021 International Building Code

Revise as follows:

2406.4.3 Glazing in windows. Glazing in an individual fixed or operable panel that meets all of the following conditions shall be considered to be a hazardous location:

1. The exposed area of an individual pane is greater than 9 square feet (0.84 m²).
2. The bottom edge of the glazing is less than 18 inches (457 mm) above the floor.
3. The top edge of the glazing is greater than 36 inches (914 mm) above the floor.
4. One or more walking surface(s) are within 36 inches (914 mm), measured horizontally and in a straight line, of the plane of the glazing.

Exceptions:

1. Decorative glazing.
2. Where a horizontal rail is installed on the accessible side(s) of the glazing 34 to 38 inches (864 to 965 mm) above the walking surface. The rail shall be capable of withstanding a horizontal *load* of 50 pounds per linear foot (730 N/m) without contacting the glass and be not less than 1½ inches (38 mm) in cross-sectional height.
3. Outboard panes in insulating glass units or multiple glazing where the bottom exposed edge of the glass is ~~25 8 feet (7620 2438 mm)~~ or more above any grade, roof, walking surface or other horizontal or sloped (within 45 degrees of horizontal) (0.79 rad) surface adjacent to the glass exterior.

Staff Analysis: CC# S230-22 and CC# S231-22 addresses requirements in a different or contradicting manner. The committee is urged to make their intentions clear with their actions on these proposals.

Reason Statement: According to the Commentary for IBC Section 2406.4.3, the purpose of safety glazing is to "provide protection where the glazed opening could be mistaken for a passageway or clear opening that someone might be able to walk through, fall into, or otherwise be accidentally forced into." For areas that meet all four criteria listed in Section 2406.4.3, safety glazing is required. The criteria are used to determine whether or not someone could be near the glass, fall into the glass, break the glass, and then fall through the glass.

The provision does have a few exceptions, including decorative glazing and locations where a horizontal rail is present that would act like a guard. These make sense, since the provision is intended to require safety glazing where someone could fall through the glass. The third and final exception, however, is for outboard panes of insulating glass units where the bottom edge of the glass is 25 feet or more above any grade, roof, walking surface, or other horizontal or sloped surface. With a minimum height of 25 feet, this third exception is overly restrictive. Again, the purpose of the safety glazing is to prevent someone from falling through the glass, but in the case of Exception 3, the height at which the exception kicks in is unnecessarily high. The proponent is not aware of any cases where passersby were hovering or flying 8 to 24 feet above any adjacent walking or working surface and managed to fall against and through an insulated glass unit (IGU).

This proposal lowers the height at which the exception can be used to just 8 feet. Even that seems quite high and is more onerous than the requirements for the safety glazing on the interiors of buildings. Nevertheless, it is a reasonable reduction and will effectively limit the area of safety glazing where safety glazing is required on the outboard panes of IGUs to just one story above the any adjacent walking or working surface instead of 25 feet. Further, since fully tempered glass can be vulnerable to breakage due to gradual growth of nickel-sulfide inclusions, it seems reasonable to avoid the use of fully-tempered glass unless necessary from a strength or impact perspective.

Cost Impact: The code change proposal will decrease the cost of construction

This proposal lowers the height at which safety glazing can be omitted from the outboard pane of insulating glass units from 25 feet to 8 feet. So where safety glazing was previously required (e.g., anywhere from 8 to 25 feet above a walking or working surface), no safety glazing will be required in the outboard pane of glass in these areas. Since safety glazing is more expensive than annealed or heat-treated glass, this relaxation of the requirements will lower costs of insulating glass units in this range of height.

S230-22

S231-22

IBC: 2406.4.3

Proponents: Gwenyth Searer, representing myself (gsearer@wje.com)

2021 International Building Code

Revise as follows:

2406.4.3 Glazing in windows. Glazing in an individual fixed or operable panel that meets all of the following conditions shall be considered to be a hazardous location:

1. The exposed area of an individual pane is greater than 9 square feet (0.84 m²).
2. The bottom edge of the glazing is less than 18 inches (457 mm) above the floor, roof, or adjacent walking surface.
3. The top edge of the glazing is greater than 36 inches (914 mm) above the floor, roof, or adjacent walking surface.
4. One or more walking surface(s) are within 36 inches (914 mm), measured horizontally and in a straight line, of the plane of the glazing.

Exceptions:

1. Decorative glazing.
2. Where a horizontal rail is installed on the accessible side(s) of the glazing 34 to 38 inches (864 to 965 mm) above the walking surface. The rail shall be capable of withstanding a horizontal *load* of 50 pounds per linear foot (730 N/m) without contacting the glass and be not less than 1½ inches (38 mm) in cross-sectional height.
3. ~~For insulating glass units or windows with multiple layers of glazing, these requirements pertain only to the layer(s) on the accessible side(s) of the windows. Outboard panes in insulating glass units or multiple glazing where the bottom exposed edge of the glass is 18 inches (457 mm) or more above any adjacent exterior surface, above 25 feet (7620 mm) or more above any grade, roof, walking surface or other horizontal or sloped (within 45 degrees of horizontal) (0.79 rad) surface adjacent to the glass exterior.~~

Staff Analysis: CC# S230-22 and CC# S231-22 addresses requirements in a different or contradicting manner. The committee is urged to make their intentions clear with their actions on these proposals.

Reason Statement: According to the Commentary for IBC Section 2406.4.3, the purpose of safety glazing is to "provide protection where the glazed opening could be mistaken for a passageway or clear opening that someone might be able to walk through, fall into, or otherwise be accidentally forced into." For areas that meet all four criteria listed in Section 2406.4.3, safety glazing is required. The criteria are used to determine whether or not someone could be near the glass, fall into the glass, break the glass, and then fall through the glass. The provision also provides three exceptions, but the third exception is complicated, and its intent is not particularly clear.

Rightly or wrongly, engineers and architects are fairly commonly interpreting Exception 3 as triggering the need for safety glazing on the exterior surfaces of the building. This does not appear to be the intent, but the provision is worded so confusingly that we have seen ground-floor, second-floor, and even third-floor windows being specified with or replaced with safety glazing on the exterior surface due to the poor wording of Exception 3. Of course, it makes zero sense to have a more stringent requirement for safety glazing on the exterior surfaces of the building (i.e., up to 25 feet above a roof or walking surface) than on the interior (only where the glass is less than 18 inches above the walking surface). It also makes zero sense to require safety glazing on the exterior when the window is an IGU but not when the glass is single-pane. So something needs to be done. The question is what.

This proposal attempts to fix the existing format and make the requirement blind to whether a fall out of a building, a fall into a building, or a fall through a window that does not result in a person entering or leaving a building (e.g., an interior window with floor walking surface on both sides) is the concern. It recognizes that we probably do want to prevent situations where people on the exterior of the building (whether on a roof or adjacent walking surface) could fall through a window and INTO a building. This seems to be a dramatically less common occurrence than people falling through windows and OUT of a building, but it does appear to be a concern where windows are located at the roof level (e.g., a clerestory) or along a walkway that may be higher than the immediately adjacent floor in the building and a fall into a building could result in serious injury (beyond cuts) from the glass. However, because the existing provision is -- and has always been -- blind to the fall distance, the provision would presumably also need to address the concern of people falling into a building where the interior and exterior walking surfaces are coplanar.

So in this proposal, we suggest adding the words ", roof, or adjacent walking surface" to Conditions 2 and 3, and we are proposing to simplify Exception 3 to explain that for IGUs and window with multiple layers of glass, only the layer(s) on the sides of the window that can be impacted need to be safety glass. Note that the term "accessible" is already used in Exception 2.

So this proposal makes the requirements equal, whether the person could fall OUT through a window; THROUGH a window, but not out of the building; or IN through a window.

Note that another reasonable interpretation could be to assess the possibility of people falling INTO a building as exceedingly rare and not the intent of the original wording at all. Thus we could leave Conditions 2 and 3 alone and just reword Exception 3. Perhaps something along the lines of "Exception 3. For windows with insulating glass units and windows with multiple layers of glass, these requirements only apply to the layer(s) of glass exposed to potential impact from the floor side(s)." That, combined with the reason statement of this proposal, should be sufficient to make it clear that there is no intent to address the exceedingly rare occurrence of people falling through windows INTO buildings. To avoid cluttering up the hearing with multiple versions of this proposal, I will propose this secondary option as a Floor Mod.

Cost Impact: The code change proposal will increase the cost of construction

Although the most rational interpretation is that the intent of the current provision is to prevent people falling OUT through a window, Exception 3 is worded so poorly that designers are interpreting it as requiring safety glazing to prevent people from falling INTO a building. Since the consequences of that interpretation are so severe (i.e., glass whose bottom is up to 25 feet high) is being required to be safety glazing, this proposal will result in reduced costs where that interpretation is being taken. Conversely, this proposal will result in increased costs where the interpretation is that the current intent is to prevent people from falling THROUGH windows but only when the fall begins on the inside of the building (and they either end up on the outside of the building or they end up on the interior because they fell through an interior window), and that safety glazing is NOT required for any circumstance when people can fall INTO a building.

In the end, depending on the project, the application, and the interpretation, this proposal may either increase or decrease the cost of construction, and it is not possible to quantify this at all because it depends on all three variables. The best we can do is clean up the language so that the intent is clear (and, in this case, consistent as to whether the concern is people falling out of a building through a window, falling through an interior window but not leaving the building, or falling into a building through a window).

S231-22

S232-22

IBC: 2406.5

Proponents: Thom Zaremba, Roetzel & Andress, representing National Glass Association (tzaremba@ralaw.com); Nicholas Resetar, representing Glazing Industry Code Committee (GICC) (nresetar@ralaw.com)

2021 International Building Code

Revise as follows:

2406.5 Fire department access panels. Fire department glass access panels shall be of tempered glass. For multi-panel glass assemblies ~~insulating glass units~~, all panes shall be tempered glass.

Staff Analysis: CC# S232-22 and CC# S233-22 addresses requirements in a different or contradicting manner. The committee is urged to make their intentions clear with their actions on these proposals.

Reason Statement: If adopted, this proposal will make no technical changes to the requirements of Section 2406.1. The proposal is, simply, to make the language of this section of Chapter 24 consistent with another glass industry proposal to update the language of Section 2406.1 to include multi-pane glass assemblies.

Cost Impact: The code change proposal will not increase or decrease the cost of construction. This proposal is entirely editorial and makes no technical changes to the requirements of Section 2406.1. Consequently, there will be no increase or decrease in the cost of construction.

S232-22

S233-21

IBC: 2406.5

Proponents: Jeffrey S Grove, P.E. FSFPE, Jensen Hughes, representing Jensen Hughes (jgrove@jensenhughes.com)

2021 International Building Code

Delete without substitution:

~~**2406.5 Fire department access panels.** Fire department glass access panels shall be of tempered glass. For insulating glass units, all panes shall be tempered glass.~~

Staff Analysis: CC# S232-22 and CC# S233-22 addresses requirements in a different or contradicting manner. The committee is urged to make their intentions clear with their actions on these proposals.

Reason Statement: IBC section 403.4.7 permits fixed windows to be used for post-fire smoke purge in high rise buildings if they can be cleared by firefighters. At first glance, section 2406 is intended to coordinate with 403.4.7.

However, section 2406 was added to the 1993 BOCA code in response to concerns presented at the initial code hearing regarding a code change proposal associated with safety glazing. While the term “access panels” did not appear in the 1993 BOCA code (nor does it occur in the current IBC), the language is similar to the requirement for smoke control in high rise buildings that was in the 1990 edition of the BOCA code.

The 1990 edition of the BOCA code required “tempered glass panels or operable windows” for smoke control in high rise buildings. While the requirement for smoke control in high rise buildings was deleted beginning with the 1993 edition of the BOCA code, the language in what is now 2406.5 was added in 1993 to coordinate with the language of the deleted requirement. Given that 2406.3 was added in response to floor action, it was not coordinated with changes made to chapter 4.

The requirement for post fire smoke removal in high rise buildings was reintroduced into the IBC in the 2009 edition (see 403.4.7). The code change proposal that added what is now section 403.4.7 (G64-07/08) stated that tempered glazing could be used. However, the language in G53-07/08 for tempered glazing was removed by the IFC Code Development Committee (see G64-07/06), with the stated reason that “this modification is a clearer statement of the desired performance characteristic of fixed windows.”

Research conducted by the U.S. General Services Administration evaluated the ability of firefighters to remove glazing using standard forcible entry tools (axe, hooligan bar, or pike pole). Laminated and untreated glazing was evaluated. Firefighters were able to clear all types of glazing evaluated within 64 seconds or less. (Stone, H. “Forcible Entry Demonstrations – Air-blast Resistant Window Systems,” Prepared for General Services Administration, July 10, 2003.)

In brief, it was not the intent of the 1993 edition of the BOCA code to require tempered glazing for fixed windows that were used for smoke control. Additionally, it was not the intent when the requirement for post fire smoke removal was reintroduced in the 2009 edition of the IBC to require tempered glass.

Cost Impact: The code change proposal will decrease the cost of construction
By providing other means of smoke removal from a building, these provisions are no longer necessary.

S233-21

S234-22

IBC: 2409.1

Proponents: John-Jozef Proczka, representing Self (john-jozef.proczka@phoenix.gov)

2021 International Building Code

Revise as follows:

2409.1 Glass walkways. Glass installed as a part of a floor/ceiling assembly as a walking surface and constructed with laminated glass shall comply with ASTM E2751 or with the *load* requirements specified in Chapter 16 under the provisions of Section 104.11. Such assemblies shall comply with the *fire-resistance rating* and marking requirements of this code where applicable.

Reason Statement: ASTM E2751 provides an obvious and robust method of compliance. However "or with the load requirements specified in Chapter 16" does not. Structural design has two primary sides: load and resistance. The current option completely leaves resistance requirements unknown and unspecified.

It is obvious that this type of glass walkway scenario would need engineered design to appropriate load resistance standards, but without invoking Section 104.11 it leaves this "option" confusingly specified, such that 104.11 may not be applicable.

Deleting "or with the load requirements specified in Chapter 16" is one possible solution to this problem, but then designs besides ASTM E2751 would need code modifications to overcome impracticality arguments.

Cost Impact: The code change proposal will not increase or decrease the cost of construction

This code change proposal just clarifies that the alternative material, design, and method of construction provisions are applicable where ASTM E2751 is not followed.

S234-22

S235-22

IBC: 2407.1.1

Proponents: Thom Zaremba, Roetzel & Andress, representing National Glass Association (tzaremba@ralaw.com); Nicholas Resetar, representing Glazing Industry Code Committee (GICC) (nresetar@ralaw.com)

2021 International Building Code

Revise as follows:

2407.1.1 Loads. Glass *handrails* and guards and their support systems shall be designed to withstand the *loads* specified in Section 1607.9 . Glass *handrails* and *guards* shall be designed using a factor of safety of four. Calculated stresses for the loads specified in Section 1607.9 shall be less than or equal to 3,000 psi (20.7 MPa) for heat strengthened glass and less than or equal to 6,000 psi (41.4 MPa) for fully tempered glass.

Reason Statement: An often asked question is: "How do you determine whether a glass handrail or guard is designed using a safety factor of four?" This code change proposal is intended to provide guidance to those designing glass handrails or guards to a factor of safety of four. First, the maximum stress carrying capabilities of the two types of glass that may be used in the design of glass handrails and guards - namely heat strengthened glass and fully tempered glass - must be known. These values are well known and published by the glass industry. (See bibliography). Heat strengthened glass is able to bear stresses of 12,000 psi while fully tempered glass is able to bear stresses of 24,000 psi. Second, the professional designing the glass handrail or guard must calculate the stresses applicable to the loads specified in Section 1607.9. Finally, to determine whether the glass handrail or guard will have a safety factor of four, the maximum published stresses for the type of glass being used, either heat strengthened glass or fully tempered glass, must be divided by 4. Those values - namely, 3,000 psi for heat strengthened glass and 6,000 psi for fully tempered glass - must, in turn, be less than or equal to the calculated stresses for the loads specified in Section 1607.9. If they are, the glass handrail or guard will be designed with a safety factor of four since the calculated stresses for the loads required by Section 1607.9 will be 1/4 or less of the stress carrying capability of the type of glass being used in the design.

Bibliography: National Glass Association - NGA Technical Paper FM 05-12 (2018) formerly FGMD 05-1212 (2018).
<http://www.glassdynamicsllc.com/temperedglass.html>

<https://www.scientificamerican.com/article/how-is-tempered-glass-mad/>

Cost Impact: The code change proposal will not increase or decrease the cost of construction

This code change will not change the cost of construction. It simply clarifies the glass stress values to be used and compared to the calculated stresses applicable to the loads specified in Section 1607.9 in order to determine whether a glass handrail or guard will achieve a factor of safety of four.

S235-22

S236-22

IBC: 2407.1.1

Proponents: Stephen Kerr, representing Self (skerr@jwa-se.com)

2021 International Building Code

Revise as follows:

2407.1.1 Loads. Glass *handrails* and guards and their support systems shall be designed to withstand the *loads* specified in Section 1607.9 . Glass elements in *handrails* and *guards* shall be designed using a factor of safety of four.

Reason Statement: In guard and handrail applications glass is often used in conjunction with other materials as part of a system. Section 2407.1.1 describes "Glass handrails and guards **and their support systems** shall be designed to withstand the loads specified in Section 1607.9." The purpose of this proposal is to emphasize that it is only the glass that needs to be designed for the safety factor of four. The non-glass support systems that are part of the glass guard should consider the factors of safety for the individual materials (concrete, aluminum, masonry, steel or wood) which are designed in accordance with Chapters 19-24.

IBC Commentary Figure 2407.1 shows several materials as part of the glass guards. The commentary discusses that "Nominally identical glass panels inherently have a wide variation in strength. The safety factor of four is used in the design to minimize the likelihood that breakage will occur below the design loads." This requirement remains unchanged with this proposal. The other elements of a glass handrail or guard system: the top rail or handrail where used in Section 2407.1.2, posts, base shoes or anchors should not be required to have the design factor of safety equal to four, rather factor of safeties based on the material reliability.

Cost Impact: The code change proposal will not increase or decrease the cost of construction
The intent of this proposal is editorial. General practice for glass guard systems it to limit the safety factor of four to the glass and not the other materials.

S236-22

S239-22

IBC: TABLE 2508.1, 2508.2, GA Chapter 35 (New)

Proponents: Tim Earl, representing the Gypsum Association (tearl@gbhint.com)

2021 International Building Code

Revise as follows:

TABLE 2508.1 INSTALLATION OF GYPSUM CONSTRUCTION

MATERIAL	STANDARD
Gypsum board and gypsum panel products	GA 216; ASTM C840
Gypsum sheathing and gypsum panel products	ASTM C1280; <u>GA-253</u>
Gypsum veneer base	ASTM C844
Interior lathing and furring	ASTM C841
Steel framing for gypsum board and gypsum panel products	ASTM C754; C1007

2508.2 Limitations. *Gypsum wallboard or gypsum plaster* shall not be used in any exterior surface where such gypsum construction will be exposed directly to the weather. *Gypsum wallboard* shall not be used where there will be direct exposure to water or continuous high humidity conditions. *Gypsum sheathing* shall be installed on exterior surfaces in accordance with ASTM C1280 or GA-253.

Add new standard(s) as follows:

GA

Gypsum Association
962 Wayne Avenue, Suite 620
Silver Spring, MD 20910

GA-253-2021

Application of Gypsum Sheathing

Staff Analysis: The proposal is referencing an updated version of an existing referenced standard. Therefore the updated version is considered an new standard. A review of the standard proposed for inclusion in the code, GA-253-2021 Application of Gypsum Sheathing, with regard to some of the key ICC criteria for referenced standards (Section 3.6 of CP#28) will be posted on the ICC website on or before March 16, 2022.

Reason Statement: This change will align the IBC with the IRC by adding this GA specification as an alternate to the ASTM standard. In practice there is no difference between the two documents. GA 253 is already referenced in the IRC.

Cost Impact: The code change proposal will not increase or decrease the cost of construction. This simply adds a reference to an equivalent standard that is already referenced in the IRC.

S239-22

S240-22 Part I

IBC: 2510.6

Proponents: Theresa Weston, representing Rainscreen Association in North America (RAiNA) (holtweston88@gmail.com)

THIS IS A 2 PART CODE CHANGE. PART I WILL BE HEARD BY THE IBC STRUCTURAL CODE COMMITTEE. PART II WILL BE HEARD BY THE IRC-B CODE COMMITTEE. SEE THE TENTATIVE HEARING ORDER FOR THESE COMMITTEES.

2021 International Building Code

Revise as follows:

2510.6 Water-resistive barriers. *Water-resistive barriers* shall be installed as required in Section 1403.2 and, where applied over ~~wood-based~~ exterior sheathing, shall comply with Section 2510.6.1 or 2510.6.2.

S240-22 Part I

S240-22 Part II

IRC: R703.7.3

Proponents: Theresa Weston, representing Rainscreen Association in North America (RAINA) (holtweston88@gmail.com)

2021 International Residential Code

Revise as follows:

R703.7.3 Water-resistive barriers. Water-resistive barriers shall be installed as required in Section R703.2 and, where applied over ~~wood-based exterior~~ sheathing, shall comply with Section R703.7.3.1 or R703.7.3.2.

Reason Statement: While drainage is part of the general Weather Protection provisions in 1402.2 (unless a wall system demonstrates compliance under 1402.2 Exception 2), a means of achieving drainage in stucco systems is only explicit for systems over wood-based sheathing. There are other exterior sheathing materials that are sensitive to, and can be deteriorated by water. The provisions for explicit drainage have been included for stucco over wood-based sheathing for many years. While initially these provisions initially addressed stucco cracking due water-absorption by wood-based sheathing. The understanding of the purpose of two layer systems evolved over the years to focus on the drainage that two layer systems provide.¹ The code began including drainage for stucco systems over wood-based sheathing in 2006 and explicitly required drainage between the two layers of water-resistive barrier in 2012. The water management provisions were subsequently expanded to respond to regional climatic challenges. This proposal expands explicit drainage to stucco systems applied over any exterior sheathing. Documented stucco moisture issues have been reported and are not confined to wood-based sheathing systems. The protections provided by these requirements should be afforded to all sheathed construction.

Bibliography: 1) Theresa A. Weston, "Stucco Systems: A Review of Reported Data and Code and Standard Development", *Proceedings of the 4th Residential Design & Construction Conference*, State College, PA, February 2018

2) Fine Homebuilding Editors, "Home-Building Cyclopedia, Water-Resistive Barriers" <https://www.finehomebuilding.com/project-guides/insulation/water-resistive-barriers>

3) Brian Pontolillo, "Rainscreen products for Stucco Installations", *Green Building Advisor*, July 5, 2019, <https://www.greenbuildingadvisor.com/article/what-to-install-behind-stucco>

4) Dave Barrett, "The Renewal of Trust in Residential Construction, Commission of Inquiry into the Quality of Condominium Construction in British Columbia", June 1998.

Cost Impact: The code change proposal will increase the cost of construction

The proposal will not increase the cost of construction for assemblies with wood-based sheathing, as there are no technical changes for these assemblies. However, the proposal will increase the cost of construction for stucco assemblies containing non-wood-based exterior sheathings. For dry climates the cost will be for adding a second layer of water-resistive barrier to the assembly. Housewrap, which is a representative water-resistive barrier, is estimated to cost \$0.17 per square foot.² For moist and marine climates, there are a variety of systems which could be used to satisfy the requirements, with estimated costs ranging from \$0.30 to \$1.90 per square foot.³ This first cost increase is balanced against potential future costs for remediation if moisture damage occurs. It has been reported that stucco remediation can cost up to 288% of the original cost of the stucco construction.⁴

S240-22 Part II

S241-22 Part I

IBC: 2510.6, 2510.6.1

Proponents: Theresa Weston, representing Rainscreen Association in North America (RAiNA) (holtweston88@gmail.com)

THIS IS A 2 PART CODE CHANGE. PART I WILL BE HEARD BY THE IBC STRUCTURAL CODE COMMITTEE. PART II WILL BE HEARD BY THE IRC-B CODE COMMITTEE. SEE THE TENTATIVE HEARING ORDER FOR THESE COMMITTEES.

2021 International Building Code

2510.6 Water-resistive barriers. *Water-resistive barriers* shall be installed as required in Section 1403.2 and, where applied over wood-based sheathing, shall comply with Section 2510.6.1 or 2510.6.2.

Revise as follows:

2510.6.1 Dry climates. One of the following shall apply for dry (B) climate zones:

1. The water-resistive barrier shall be two layers of 10-minute Grade D paper or have a water resistance equal to or greater than two layers of water-resistive barrier complying with ASTM E2556, Type I. The individual layers shall be installed independently such that each layer provides a separate continuous plane and any flashing, installed in accordance with Section 1404.4 and intended to drain to the water-resistive barrier, is directed between the layers.
2. The *water-resistive barrier* shall be 60-minute Grade D paper or have a water resistance equal to or greater than one layer of *water-resistive barrier* complying with ASTM E2556, Type II. The *water-resistive barrier* shall be separated from the stucco by a layer of foam plastic insulating sheathing or other nonwater absorbing layer, ~~or a drainage space.~~ A means of drainage, as prescribed in 1402.2, shall be provided to the exterior side of the water-resistive barrier.

S241-22 Part I

S241-22 Part II

IRC: R703.7.3, R703.7.3.1

Proponents: Theresa Weston, representing Rainscreen Association in North America (RAINA) (holtweston88@gmail.com)

2021 International Residential Code

Revise as follows:

R703.7.3 Water-resistive barriers. Water-resistive barriers shall be installed as required in Section R703.2 and, where applied over wood-based sheathing, shall comply with Section R703.7.3.1 or R703.7.3.2.

Exception: Where the *water-resistive barrier* that is applied over wood-based sheathing has a water resistance equal to or greater than that of 60-minute Grade D paper and is separated from the stucco by an intervening, substantially nonwater-absorbing layer or designed drainage space.

R703.7.3.1 Dry climates . In Dry (B) climate zones indicated in Figure N1101.7, *water-resistive barriers* shall comply with one of the following:

1. The *water-resistive barrier* shall be two layers of 10-minute Grade D paper or have a water resistance equal to or greater than two layers of a *water-resistive barrier* complying with ASTM E2556, Type I. The individual layers shall be installed independently such that each layer provides a separate continuous plane. Flashing installed in accordance with Section R703.4 and intended to drain to the *water-resistive barrier* shall be directed between the layers.
2. The *water-resistive barrier* shall be 60-minute Grade D paper or have a water resistance equal to or greater than one layer of a *water-resistive barrier* complying with ASTM E2556, Type II. The *water-resistive barrier* shall be separated from the stucco by a layer of foam plastic *insulating sheathing* or other non-water-absorbing layer, ~~or a designed drainage space.~~ A means of drainage, as prescribed in R703.1.1, shall be provided to the exterior side of the water-resistive barrier.

Reason Statement: This is a clarification of the Dry Climate Option 2 to emphasize that a means of drainage (as required in 1402.2) is included in the design of the water-resistive barrier system. It is consistent with interpretation of 1402.2 included in ICC-ES AC11 Acceptance Criteria for Cementitious Exterior Wall Coatings:

“Details shall be submitted of a drainage system based on drainage performance testing. The applicant must submit a testing proposal to ICC-ES prior to testing. Precedent for a testing procedure can be found in the ICC-ES Acceptance Criteria for EIFS Clad Drainage Wall Assemblies (AC235), Section 4.10.”

Cost Impact: The code change proposal will not increase or decrease the cost of construction

This proposal modifies the existing compliance option to describe how the requirements from other code sections are applied when using this option. The proposal improves the alignment between existing code requirements and industry practices.

S241-22 Part II

S242-21

IBC: 2510.6.1

Proponents: Craig Conner, representing self (craig.conner@mac.com); Joseph Lstiburek, representing Myself (joe@buildingscience.com)

2021 International Building Code

Revise as follows:

2510.6.1 Dry climates. One of the following shall apply for dry (B) climate zones:

1. The water-resistive barrier shall be two layers of 10-minute Grade D paper or have a water resistance equal to or greater than two layers of water-resistive barrier complying with ASTM E2556, Type I. The individual layers shall be installed independently such that each layer provides a separate continuous plane and any flashing, installed in accordance with Section 1404.4 and intended to drain to the water-resistive barrier, is directed between the layers.
2. The *water-resistive barrier* shall be 60-minute Grade D paper or have a water resistance equal to or greater than one layer of *water-resistive barrier* complying with ASTM E2556, ~~Type II~~ Type I. The *water-resistive barrier* shall be separated from the stucco by a layer of foam plastic insulating sheathing or other nonwater absorbing layer, or a drainage space.

Reason Statement: The text in 2. is inconstant with the text in 1. In 1 the two layers of water-resistive barrier need to comply with ASTM E2556, Type I. In 2 there are also two layers....the outer layer is "a layer of foam plastic insulating sheathing or other nonwater absorbing layer, or a drainage space". The outer layer as defined provides equivalent performance to a single layer of water-resistive barrier complying with ASTM E2556, Type I. The inner layer can therefore also be a layer of water-resistive barrier complying with ASTM E2556, Type I to provide equivalency between 1. and 2. Requiring the water-resistive barrier to comply with ASTM E2556, Type II limits the choice of materials such as fluid applied water-resistive barriers and sheathing integral water-resistive barriers.

Cost Impact: The code change proposal will decrease the cost of construction
The code change proposal decreases the cost of construction as Type 1 is less in cost than Type 2.

S242-21

S243-22 Part I

IBC: 2510.6.2

Proponents: Mark Fowler, representing Stucco Manufacturers Association (mark@markfowler.org)

THIS IS A 2 PART CODE CHANGE. PART I WILL BE HEARD BY THE IBC STRUCTURAL CODE COMMITTEE. PART II WILL BE HEARD BY THE IRC-B CODE COMMITTEE. SEE THE TENTATIVE HEARING ORDER FOR THESE COMMITTEES.

2021 International Building Code

Revise as follows:

2510.6.2 Moist or marine climates. In moist (A) or marine (C) climate zones, *water-resistive barrier* shall comply with one of the following:

1. In addition to complying with Item 1 or 2 of Section 2510.6.1, a space or drainage material not less than $\frac{3}{16}$ inch (4.8 mm) in depth shall be applied to the exterior side of the *water-resistive barrier*.
2. In addition to complying with Item 2 of Section 2510.6.1, drainage on the exterior side of the *water-resistive barrier* shall have a minimum drainage efficiency of 90 percent as measured in accordance with ASTM E2273 or Annex A2 of ASTM E2925.

Exception: In Climate Zone 3C, compliance with Section 2510.6.1 shall be permitted.

S243-22 Part I

S243-22 Part II

IRC: R703.7.3.2

Proponents: Mark Fowler, representing Stucco Manufacturers Association (mark@markfowler.org)

2021 International Residential Code

Add new text as follows:

R703.7.3.2 Moist or marine climates. In the Moist (A) or Marine (C) climate zones indicated in Figure N1101.7, *water-resistive barriers* shall comply with one of the following:

1. In addition to complying with Section R703.7.3.1, a space or drainage material not less than $\frac{3}{16}$ inch (5 mm) in depth shall be added to the exterior side of the *water-resistive barrier*.
2. In addition to complying with Section R703.7.3.1, Item 2, drainage on the exterior of the *water-resistive barrier* shall have a drainage efficiency of not less than 90 percent, as measured in accordance with ASTM E2273 or Annex A2 of ASTM E2925.

Exception: In Climate Zone 3C, compliance with Section R703.7.3.1 shall be permitted.

Reason Statement: Two layers Grade D paper has proven effective since it was introduced into the code back in 1982. the Climate Zone 3C is below the low wind-driven rain region (<16 " annually) and aligns more reasonably with drier climates. It will preserve the stucco markets in Santa Barbara, San Jose and other coastal cities that are large stucco proven markets using two layers Grade D paper over wood-based sheathings.

Bibliography: Mark Fowler

Executive Director of the Stucco Manufacturers Assoc. , Author of the Plaster and Drywall Systems Manual, Northwest wall and Ceiling Bureau Stucco Resource Guide, over 100 technical papers on Cement plaster and organizational member of ASTM C 1063 and C 926 , as well as ACI 524. past chairman of the California State Apprenticeship committee for Plaster Tenders and on the committee for plastering.

Licensed lath and Plastering contractor (CSLB C35 1983) and registered in the Industry Expert Program by the state.

Editorial Director for Walls and Ceilings Magazine, the oldest trade magazine in the US for wall and ceiling trades

Project Manager at Soltner Group Architects in Seattle, WA. Specialized in Building Envelope failures for the Northwest

The SMA proposal has the support of its membership , that include SMA manufacturers, contractors and dealers.

Cost Impact: The code change proposal will decrease the cost of construction

This proposal will go back to what can help keep stucco affordable to moderate priced homes. The addition of rain screen should be an optional upgrade and not forced on the public to benefit special interest. This proposal returns that section with proven stucco performance back to pre 2021 code mandates.

S243-22 Part II

S244-21

IBC: [BS] 2606.5

Proponents: John-Jozef Proczka, City of Phoenix, representing self (john-jozef.proczka@phoenix.gov)

2021 International Building Code

Revise as follows:

[BS] 2606.5 Structural requirements. Light-transmitting plastic materials in their assembly shall be of adequate strength and durability to withstand the *loads* indicated in Chapter 16 Technical data shall be submitted to establish stresses, maximum unsupported spans and such other information for the various thicknesses and forms used as deemed necessary by the *building official* under the provisions of Section 104.11.

Reason Statement: The provisions in the code for alternative materials, design, or methods of construction in Section 104.11 are appropriate to deal with the structural requirements of light-transmitting plastic. By including vague structural requirements in the code for light-transmitting plastic the applicability of the alternative material, design, or method of construction provisions is called into question. This proposal would clarify that the provisions of Section 104.11 apply.

The entire removal of Section 2606.5 would also be appropriate.

Cost Impact: The code change proposal will not increase or decrease the cost of construction just clarification of what is already present

S244-21

