

Alloy™

Splashbacks



EB
BUSHBOARD
A WILSONART COMPANY

Inspired by Innovation, Driven by Choice



Splashbacks that can add the finishing touch to any modern kitchen design

Bring your dream kitchen design to life with a beautifully patterned splashback that fills the entire wall space behind your hob, without compromising safety.

With **Alloy**, say goodbye to tiles and hello to a high performance, statement splashback you can place wherever you want.

Your **Alloy** splashback is fire-safe behind any hob and waterproof behind any sink; with simple sizing and no need for an expensive glass cover, to break up your design with a stainless steel hob panel.

Just cut, fit and cook.

Alloy[™]

What is a Splashback?

Until recently, simple wall tiles were the easiest and most popular way to protect kitchen walls from cooking splashes of grease or water.

Tiles, however, can be a real pain to clean and maintain over time. Tile grout gets mouldy and starts to look old really quickly.

A splashback is smooth, stylish and easy-to-clean solution to protect kitchen walls.

What is an Alloy Splashback?

Alloy splashbacks are patterned or coloured aluminium splashbacks, crafted to give you complete design freedom all around the kitchen - even in the Hot Zone behind the hob, unlike other splashbacks.

Alloy is a fire-resistant aluminium composite panel, available in different variations & sizes with aluminium trims. **Alloy** can be used in combination for wall lining or as a kitchen splashback, in a wide variety of kitchen design layouts. The 4mm thick panel system is uniquely manufactured using a composite substrate and has excellent rigidity and toughness but is also lightweight, making **Alloy** easy to install, clean and maintain.

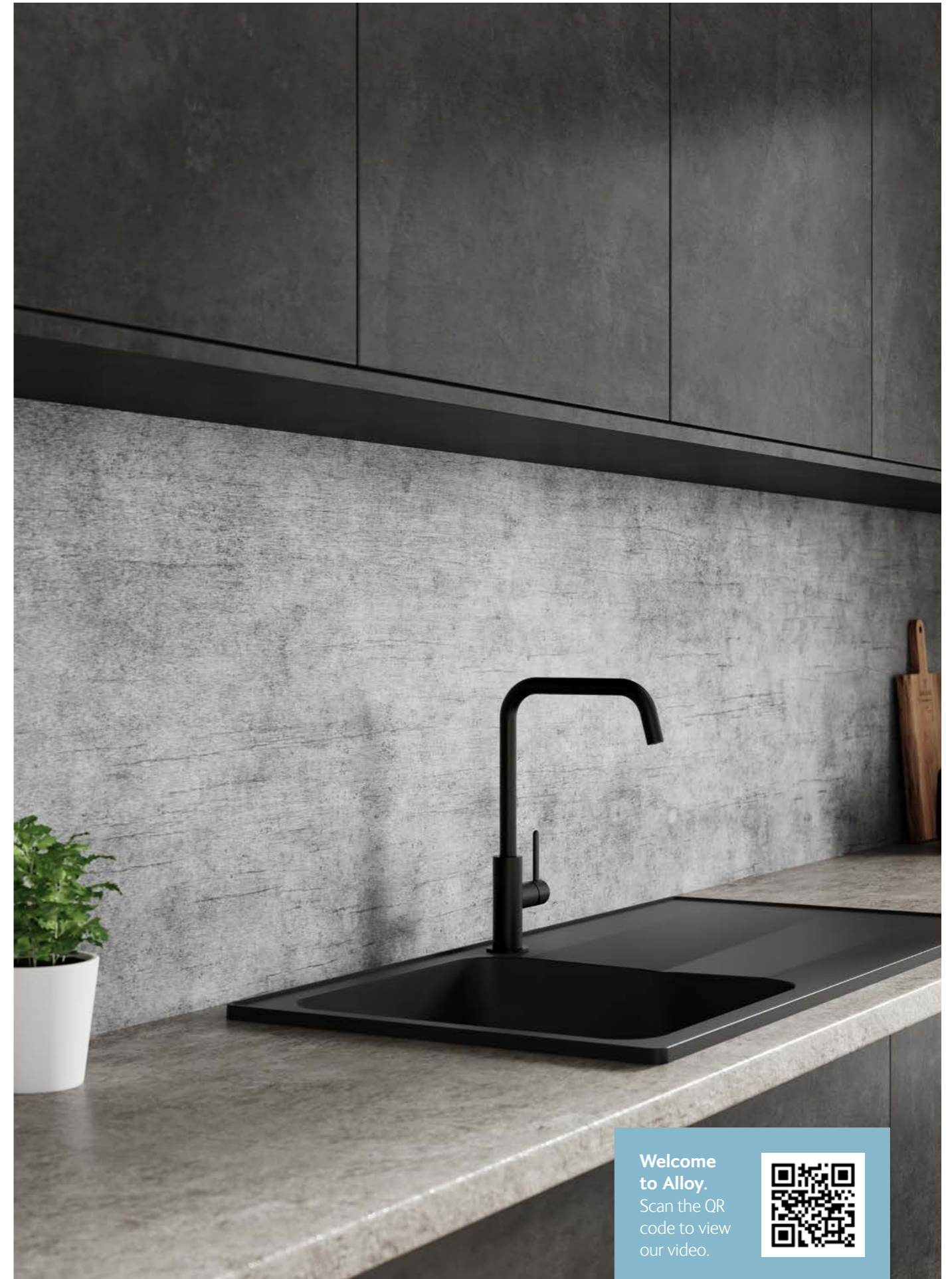

Welcome to Alloy.
Scan the QR code to view our video.



Why Alloy?

Easy to Clean

Unlike tiles there is no messy and mouldy grout to clean, Alloy is incredibly easy to clean. Simply wipe down with a moist cloth and a mild detergent. Job done.

Quick & Easy Installation

Installing an Alloy splashback is easy and mess-free. Alloy splashbacks can be cut to size with basic tools and attached to the wall with adhesive. For an Easy Installation overview, please refer to page 36.

Beautiful Unique Designs

Choose from 30 designs, either solid colours or beautiful patterns, crafted to bring your kitchen vision to life. Inspired by traditional tiles, geometric patterns and natural materials, every design works with multiple kitchen trends to build your dream kitchen.

Lifetime Guarantee

Alloy splashbacks are guaranteed for their lifetime. We will make good by repair and/or replacement any Alloy Splashback which can be shown to have failed by reason of defects in its manufacture, subject to fair wear and tear.

Hot Zone Safe

Alloy splashbacks are steam, heat and fire resistant making them certified to be placed in the Hot Zone. This allows you to fill the full wall behind your hob right up to hood height without breaking your design with glass or stainless steel panels behind the hob.

Hardwearing & Scratch Resistant

Other splashbacks are damaged by steam and scratched by cleaning but Alloy Splashbacks are tough and hardwearing. You can place your Alloy splashback behind any hob or sink without compromising its look, feel or material integrity.

Alloy film guide.
Scan the QR code to view our video.



Alloy versus the alternatives

	Alloy	Tiles	Glass	Acrylic	Painted
Range of both Colours and Décors					
Budget friendly			Product cost is high plus large install cost due to templating	Generally premium cost	
Can be installed behind hob				Requires separate glass section for behind hob	
Available quickly			Glass has to be measured, templated and then manufactured to order		
Easy to install		Tradesperson generally required	Expert installation required	Tradesperson generally required	
Can be cut on site			Cannot be cut on site, making installation much harder		N/A
Easy to maintain		Grout requires constant care and cleaning			Not hardy enough to withstand constant wiping down
Durable				Acrylic marks and scratches easily	Paint flakes and scrapes easily
Mould Resistant		Grout gets mouldy and dirty very quickly			Damp areas can cause paint to get mouldy and flake off

Alloy Splashbacks are not only beautiful but incredibly practical for your home. Take a look at our chart on the right to see how Alloy outperforms all alternatives.

Alloy Ranges

Choose from 30 versatile Décor & Colour designs curated to bring your kitchen vision to life.

The **Alloy** range has been inspired by modern kitchen trends, traditional tiles, geometric patterns and natural materials.



Alloy Colour

Transform your kitchen with the deep rich colours of the **Alloy Colour** range. They can either blend seamlessly with the background or make a statement with a bold pop of colour. Available in gloss, matt or brushed designs - **Alloy Colour** is the perfect modern finish for any kitchen.

Alloy Décor

Alloy Décor is a beautiful range of decorative splashbacks designed to represent the earthy tones of nature and bolder modern, more geometric designs. Nothing beats our **Alloy Décor** range for a stunning instant kitchen transformation.

Alloy Colour

With **Alloy Colour**, you can have the feel of a painted feature wall, with all the modern benefits that **Alloy** brings. Our matt colours, such as Hadrian Green, as shown to the right, has all the stunning depth of colour and chalky feel of luxurious modern house paint.

Best of all though, unlike paint, **Alloy Colour** designs can be simply wiped clean with mild detergent and will not dry and crack.



Hadrian Green



Alloy samples.
Scan the QR
code to order
for free.





Brushed Titanium Splashback with ZENITH Marmo Grigio Worktop

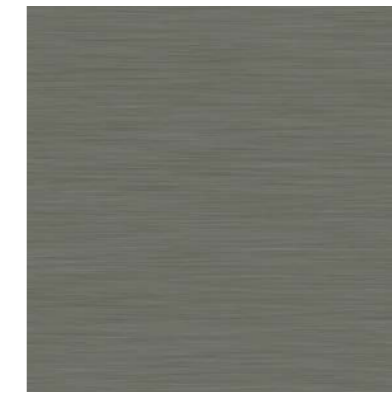

Brushed Titanium



Neptune Blue



Neptune Blue Splashback ZENITH Cloudy Nova Breakfast bar and Worktop

Alloy Colour in gloss, like Neptune Blue, as seen above, is a great way to add a pop of colour to your kitchen, and a glossy reflective surface can make any space seem larger and more open.

Our Brushed metal designs are not only practical but are a superb way of giving a modern industrial look to any interior.

Alloy Colour

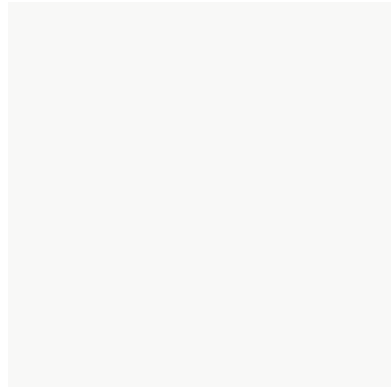

Glacier White

Sometimes you can't go wrong with beautiful, simple, brilliant white.

In this kitchen, the **Alloy** Glacier White splashback perfectly balances against the modern grey walls, whilst the gloss finish adds a sense of depth to the kitchen, making the space feel both larger and brighter.

Finished with a high gloss reflective surface, messy cooks can rest assured that **Alloy** Splashbacks are super easy to clean by simply wiping down with a cloth. An ideal solution for those who want the simple look, but without the mess paint attracts.



Alloy Colour



Smoked Rose Splashback **OPTIONS** Gardenia Worktop



Smoked Rose



Battleship Grey



Battleship Grey Hob Panel

Smoked Rose is a subtle pastel colour that, as shown here, works brilliantly with the dark green cabinets used. Smoked Rose is a modern colour shade with a warm and soothing feeling that can work wonderfully in a luxurious kitchen.

Battleship Grey offers an ultra-smooth matt finish for those wanting to add depth to their kitchen, a stunning soft grey, perfect for a standout hob panel.

Alloy Colour

We recommend ordering a sample before purchasing, as all images are representative.
To order a sample please visit: www.bushboard.co.uk/alloy

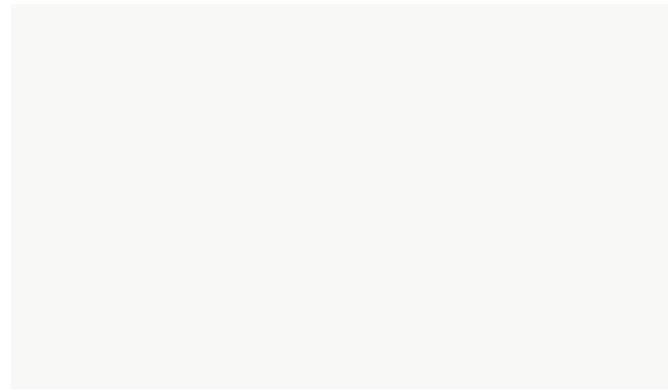

Glacier White Gloss



Terra Grey Gloss



Seafoam Green Matt



Hadrian Green Matt



Deep Sea Blue Matt



Neptune Blue Gloss



Battleship Grey Matt



Midnight Grey Matt



Malibu Grey Gloss



Smoked Rose Matt

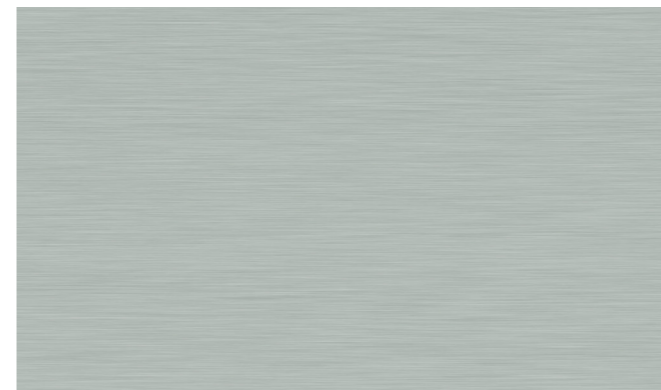

Brushed Steel Brushed

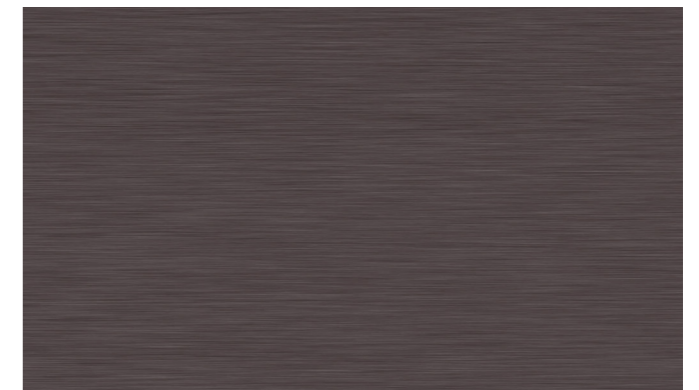

Brushed Copper Brushed

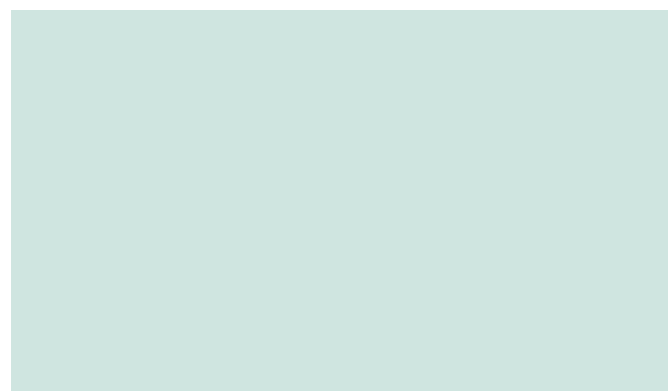

Seabreeze Green Gloss



Storm Blue Gloss



Brushed Titanium Brushed

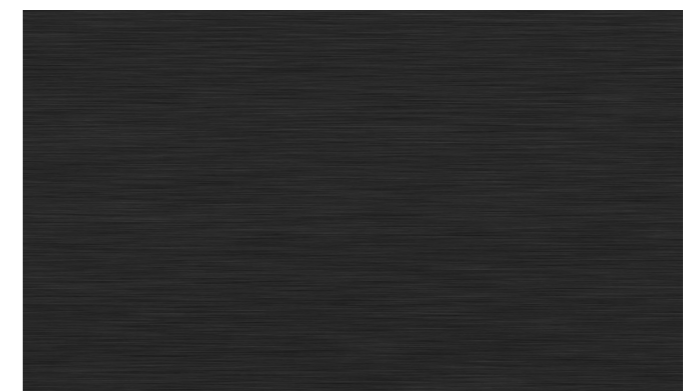

Brushed Carbon Brushed

Alloy Décor

 **MADE IN
BRITAIN**

Our **Alloy Décor** range allows you to create a unique design statement in your kitchen; from marble to woods and modern geometric effects.

Fluted Oak is one of our newest designs and one of which we are particularly fond. Horizontal lines can create a sense of width in your kitchen, and the beautiful wood grain pattern adds a lovely natural sense of serenity. We paired it here with a simple worktop to let Fluted Oak be the star of the show.



Fluted Oak



**Alloy
samples.**
Scan the QR
code to order
for free.





Heritage Walnut Splashback with **OPTIONS Nagoshi Pine** Worktop



Heritage Walnut



Viking Oak



Viking Oak Splashback with **OMEGA Brasilia** Worktop

A daring combination of classic wood and contemporary geometry, Heritage Walnut left, has an unmistakably midcentury feel with the gold pattern overlaying the rich walnut background. We've used a brass tap to really set the kitchen off.

With its wood texture, Timber finish, Viking Oak above, both looks and feels like real wood. Using **Alloy**, you can get all the beauty of natural wood in your kitchen, but without the extensive maintenance.



Brooklyn Concrete Splashback with **OPTIONS** Woodstone Grey Worktop



Brooklyn Concrete



Urban Steel



Urban Steel Splashback with **OMEGA** Urban Caldeira Worktop

We love industrial kitchen design, and both Brooklyn Concrete and Urban Steel are perfect for creating this trendy interior design idea.

To balance out the industrial feel, we'd recommend plenty of plants to add a pop of colour to complete the look.



Alloy Décor

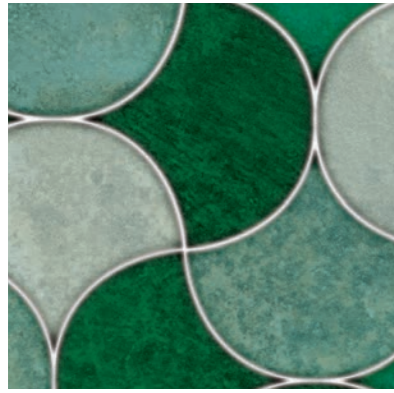

Emerald Scallop

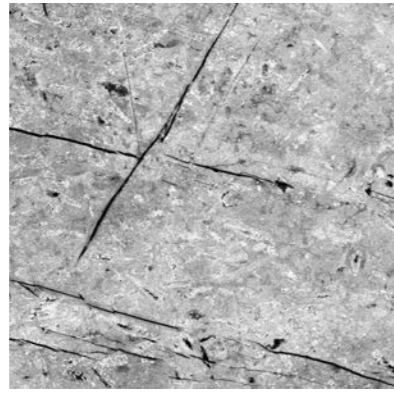

Fossil Marble



Emerald Scallop Hob Panel with **OPTIONS** Walnut Appalaches Worktop

Emerald Scallop is one of our most daring designs and can be made the focal point of any kitchen space. Beautiful shades of green give the impression of a Mediterranean stained glass window. Simply gorgeous.

With its stone texture Fossil Marble not only looks like marble but feels like it as well. All the look of natural stone and all the modern **Alloy** benefits.



Fossil Marble Splashback with **ZENITH** Marmo Grigio Worktop

Alloy Décor

We recommend ordering a sample before purchasing, as all images are representative.
To order a sample please visit: www.bushboard.co.uk/alloy



Carrara Marble Herringbone Shell

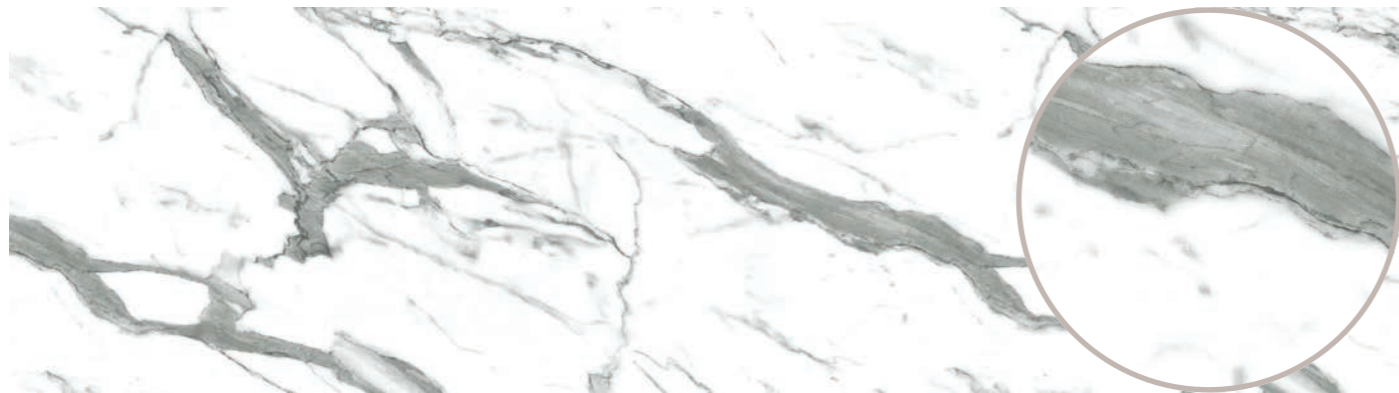

White Marble Shell

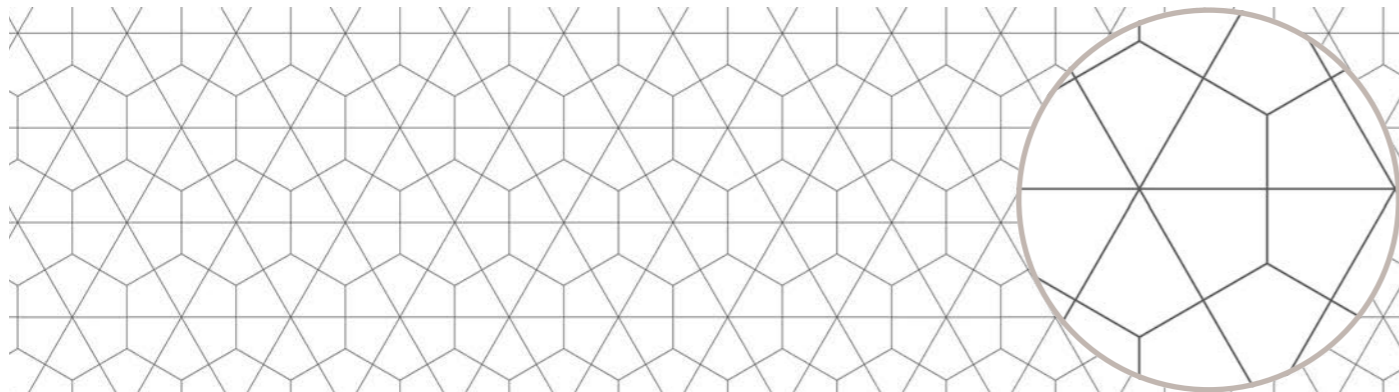

Geometry Shell

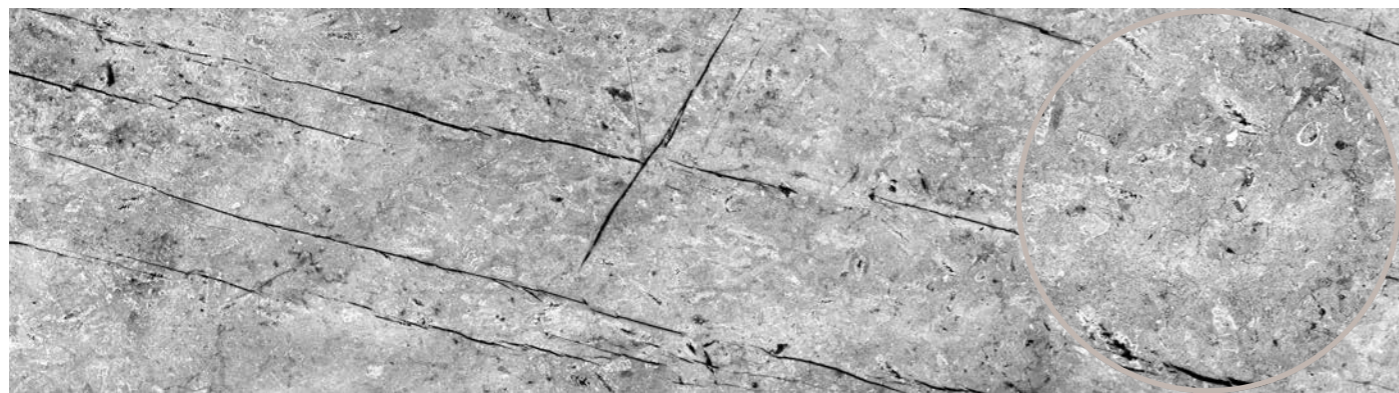

Fossil Marble Pietra



Nordic Oak Timber



Viking Oak Timber



Fluted Oak Timber



Heritage Walnut Shell

Alloy Décor

We recommend ordering a sample before purchasing, as all images are representative.
To order a sample please visit: www.bushboard.co.uk/alloy

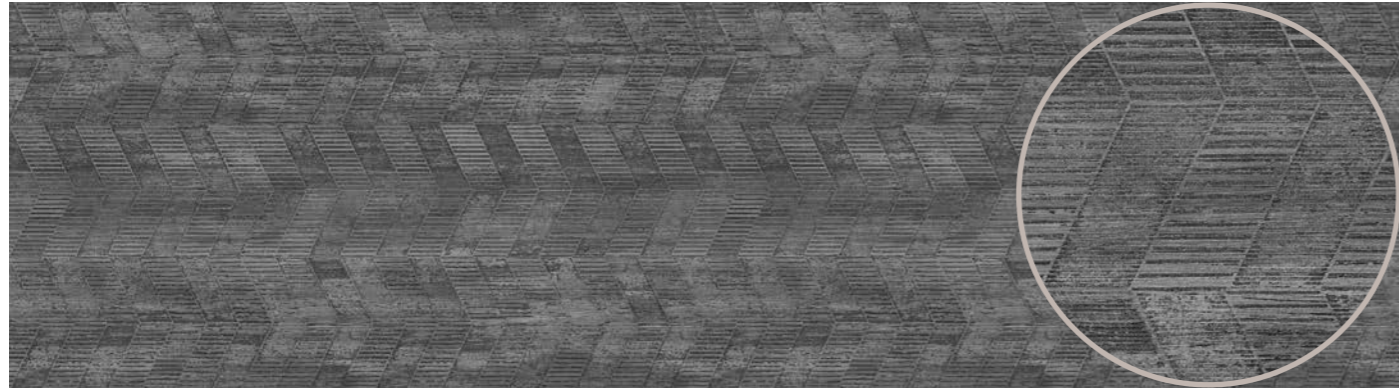

Concrete Chevron Timber



Emerald Scallop Pietra



Urban Steel Pietra

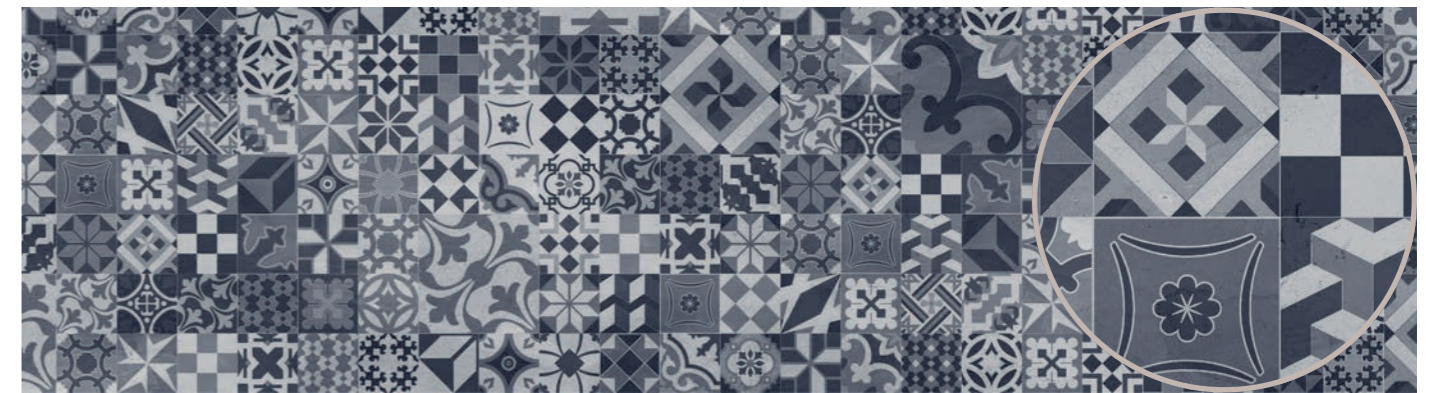

Modern Victoria Shell



Brooklyn Concrete Timber

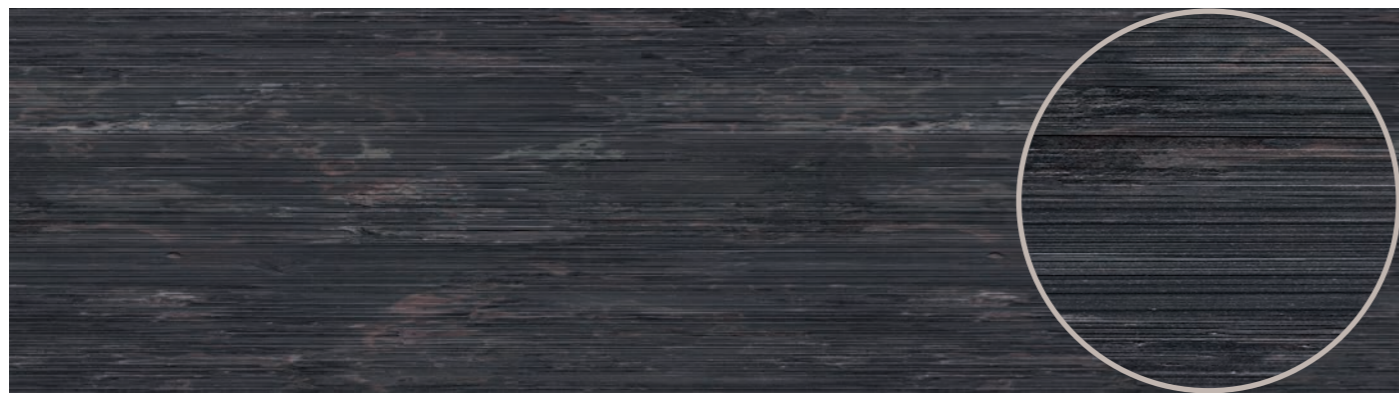

Charred Cedar Timber

Alloy Textures



Timber

Timber is a subtle woodgrain texture, mimicking the natural lines of wood and oak products.



Pietra

Pietra is a stone inspired texture, offering subtle bumps designed to enhance the decor.



Shell

Shell is a soft matt texture offering a smooth finish to complete the look.

Alloy Sizes

You need uncompromising design, so why compromise?

Alloy Splashbacks come in four sizes, but you're not limited by the size of the panel you buy - it's easy to cut your panels to the size and shape you need.

High Rise Splashback – The 750mm height of the high rise splashback allows you to fill the wall right up to hood height with design whilst being safe in the knowledge they are certified to be there. You don't need to interrupt the design with a different panel type to protect your home

Mid Rise Splashback – The Mid Rise splashback's 600mm height is ideal for use behind a sink, or filling the space behind a hob between worktop and upper cabinets.

For a focused area of design a hob panel is the perfect solution. Choose between two different sizes both with an 800mm height.

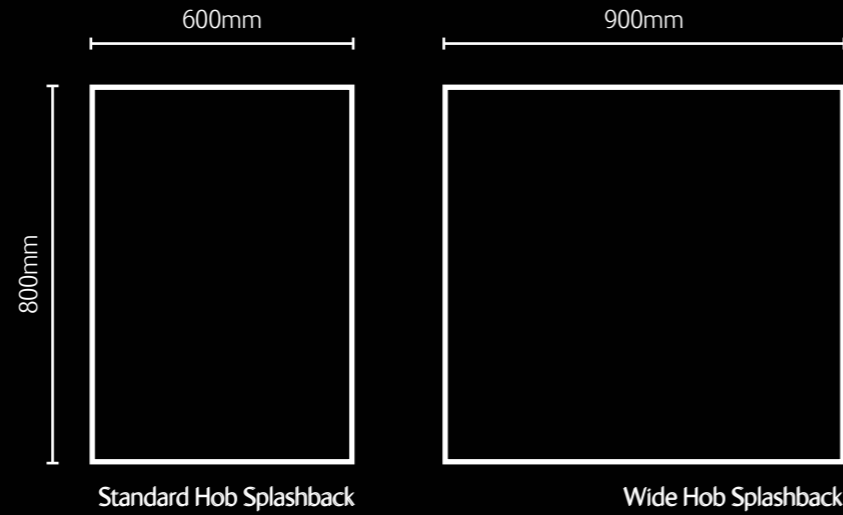

Standard Hob Splashback



Wide Hob Splashback



High Rise Splashback



Mid Rise Splashback

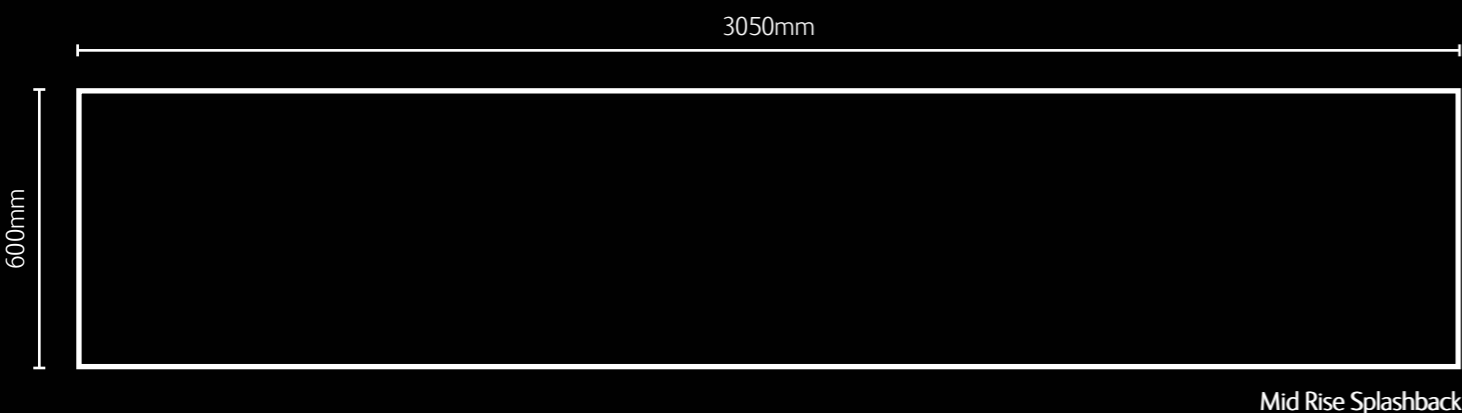
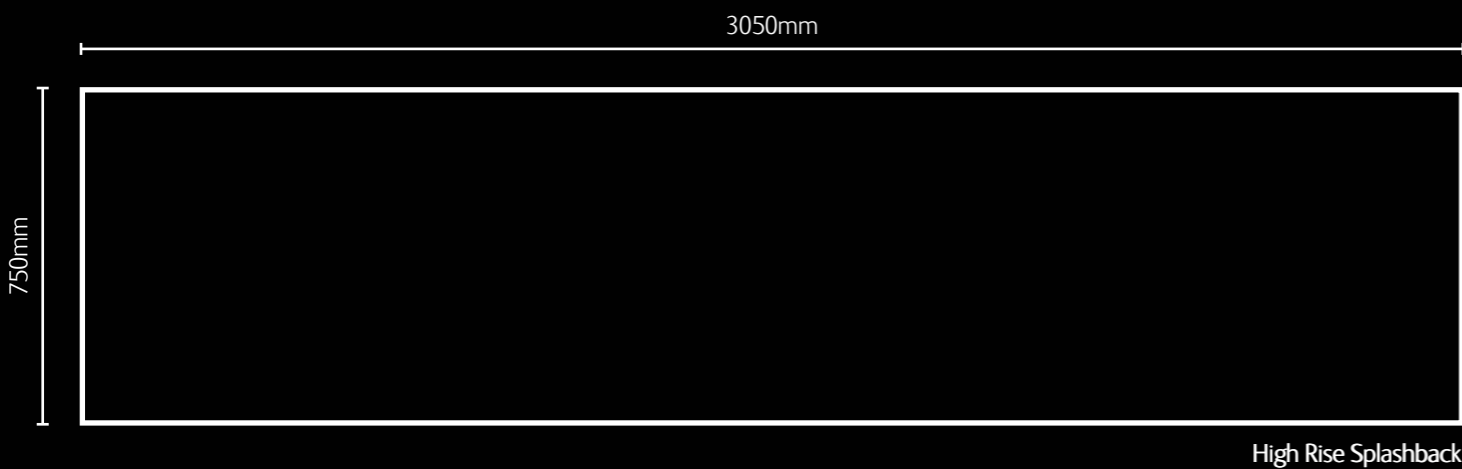

Alloy Easy and Fast Installation

Alloy video installation guide. Scan the QR code to view installation video.



Just cut, fit and cook.

Alloy splashbacks are quick and easy to install, with no professional fitting required. To view our installation video or download our installation instructions visit www.bushboard.co.uk/alloy

Installation.

Alloy splashbacks can be jointed with simple Butt Joints or by using our beautiful aluminium trims available in both Matt Silver and Anthracite.

Trims are available to neatly fit either an internal or external corner, and edge trims create a sleek finish.

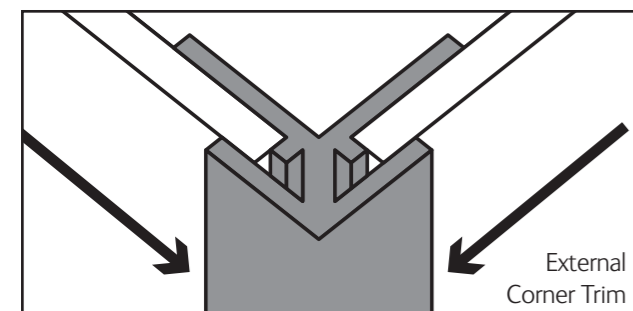
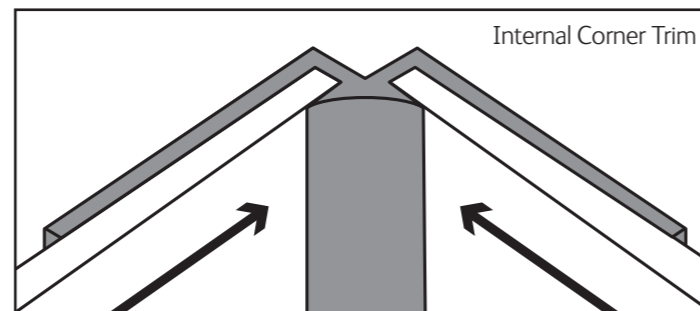
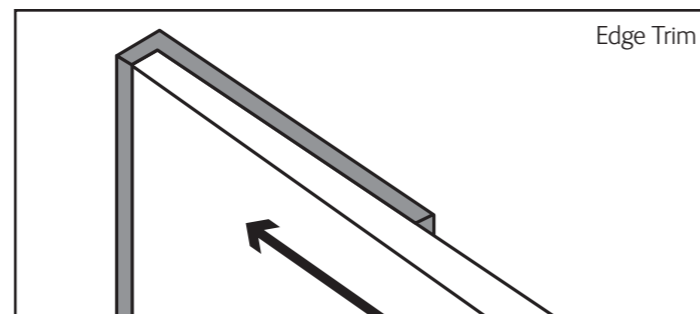
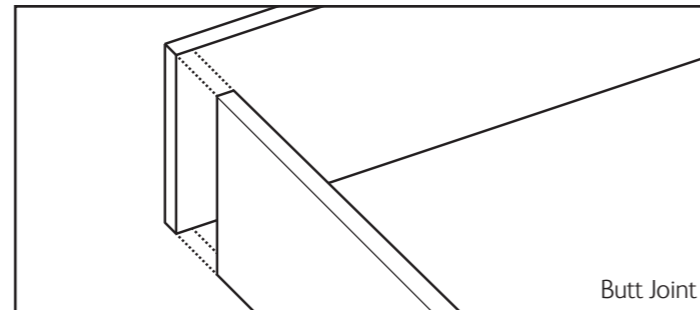

Trim Finishes



Alloy Complete Adhesive and Sealant

Complete Adhesive and Sealant

We know the importance of the final installation, that's why we've developed Complete, our bespoke adhesive and sealant which should be used when installing your Alloy Splashbacks.

Complete is available as an adhesive used to adhere your splashback to the wall and a colour matched sealant used to complete your installation around any joints or edges.

Our unique installation adhesive is technically superior and should be used to bond the panels to the wall. As this is not seen it is a cost effective neutral colour.

Complete sealant is available in a range of colour options, either choose from our recommendation for your splashback or match to your worktop. The sealant colours in our matrix on page 39 are our suggestions, feel free to use any colour from the selection that you deem more suitable to coordinate with your chosen splashback. It's flexible, super strong and will not shrink or breakdown like silicone.



Jet Black
Slate Grey
Basalt Grey
Pewter Grey
Silver Grey
Ash Grey
Ice White
Olive Green
Mushroom
Neutral
Fudge
Chestnut
Chocolate

Alloy Lifetime Guarantee

Our Testing.

Alloy splashbacks are beautiful, but they're also tough, performing exceptionally well during European Standards testing. Due to the nature of the aluminium material, they are 100% post consumer recyclable. For technical data please visit:

www.bushboard.co.uk/alloy

Lifetime Guarantee.

Alloy Splashbacks are guaranteed for their lifetime. Bushboard will make good by repair and/or replacement (at its discretion) any Alloy Splashback of its manufacture which can be shown to have failed by reason of defects in its manufacture, subject to fair wear and tear, provided the product has been installed and used in accordance with the manufacturer's instructions and that the products are used for their intended purpose.

Proof of date and place of purchase required. This guarantee is in addition to your statutory rights as a consumer and does not affect your rights in any way.

Alloy Maintenance

Keep it Clean.

Alloy splashbacks are high performance with low maintenance. We recommend keeping yours in top condition with the following steps:

Remove splashes, oil and grime by wiping clean with your preferred gentle household cleaner.

Use a soft, non-abrasive cloth. We recommend a microfibre cloth or sponge

Alloy Overview

ALLOY NAME	COMPLETE	Splashback 3050 x 750 x 4mm	Splashback 3050 x 600 x 4mm	Hob Panel 600 x 800 x 4mm	Hob Panel 900 x 800 x 4mm
Battleship Grey	Pewter Grey	●	●	●	●
Brooklyn Concrete	Silver Grey	●	●	●	●
Brushed Carbon	Jet Black	●	●	●	●
Brushed Copper	Chestnut	●	●	●	●
Brushed Steel	Silver Grey	●	●	●	●
Brushed Titanium	Pewter Grey	●	●	●	●
Carrara Marble Herringbone	Silver Grey	●	●	●	●
Charred Cedar	Jet Black	●	●	●	●
Concrete Chevron	Basalt Grey	●	●	●	●
Deep Sea Blue	Slate Grey	●	●	●	●
Emerald Scallop	Ash Grey	●	●	●	●
Fluted Oak	Fudge	●	●	●	●
Fossil Marble	Silver Grey	●	●	●	●
Geometry	Ice White	●	●	●	●
Glacier White	Ice White	●	●	●	●
Hadrian Green	Olive Green	●	●	●	●
Heritage Walnut	Chocolate	●	●	●	●
Malibu Grey	Ash Grey	●	●	●	●
Midnight Grey	Jet Black	●	●	●	●
Modern Victoria	Basalt Grey	●	●	●	●
Neptune Blue	Silver Grey	●	●	●	●
Nordic Oak	Fudge	●	●	●	●
Seabreeze Green	Silver Grey	●	●	●	●
Seafoam Green	Neutral	●	●	●	●
Smoked Rose	Neutral	●	●	●	●
Storm Blue	Basalt Grey	●	●	●	●
Terra Grey	Mushroom	●	●	●	●
Urban Steel	Basalt Grey	●	●	●	●
Viking Oak	Chocolate	●	●	●	●
White Marble	Silver Grey	●	●	●	●

Alloy Overview

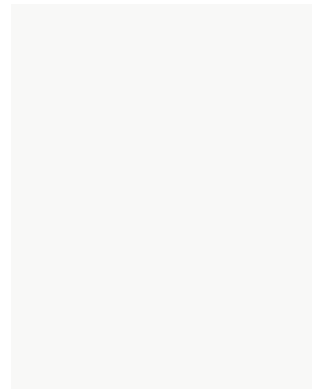

Glacier White Gloss

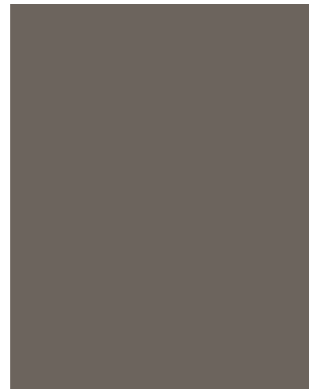

Terra Grey Gloss



Malibu Grey Gloss



Smoked Rose Matt



Carrara Marble Herringbone Shell

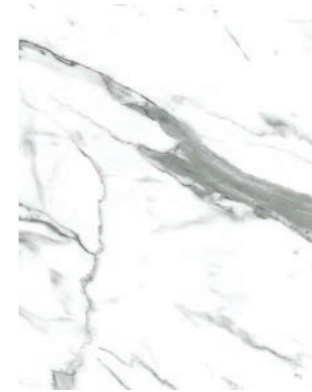

White Marble Shell



Geometry Shell

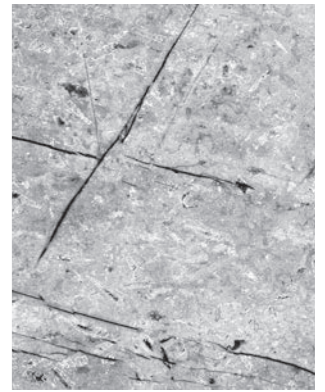

Fossil Marble Pietra



Deep Sea Blue Matt



Neptune Blue Gloss



Battleship Grey Matt



Storm Blue Gloss



Nordic Oak Timber



Viking Oak Timber



Fluted Oak Timber



Heritage Walnut Shell

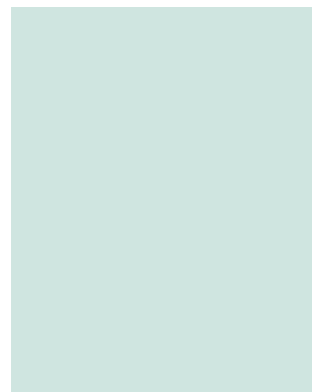

Seabreeze Green Gloss



Seafoam Green Matt

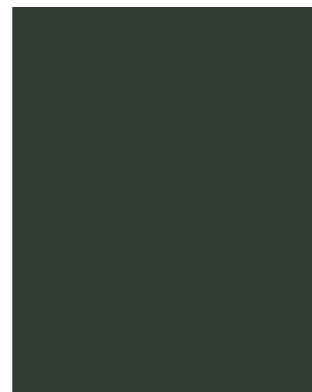

Hadrian Green Matt



Midnight Grey Matt



Concrete Chevron Timber



Urban Steel Pietra



Brooklyn Concrete Timber



Charred Cedar Timber

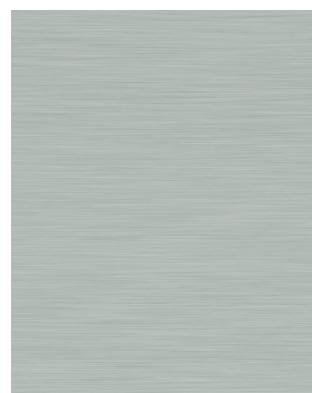

Brushed Steel Brushed



Brushed Titanium Brushed



Brushed Copper Brushed



Brushed Carbon Brushed

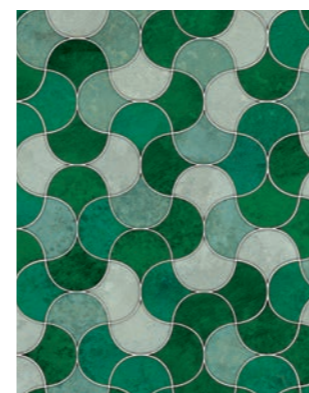

Emerald Scallop Pietra



Modern Victoria Shell

Alloy samples.
Scan the QR code to order for free.



Alloy What next?

Find a Retailer

We have thousands of retail partners in the UK who proudly stock our products.

Experts there can give you advice on design and installation as you explore the full range of Alloy samples in store.

www.bushboard.co.uk/home-owners

Order Samples

Order your free sample on the Bushboard website to get the true impact of Alloy Splashbacks in real life.

We recommend ordering samples before ordering your product to ensure it's perfect for you.

www.bushboard.co.uk/alloy-splashbacks

Visit Website

For further information on Alloy Splashbacks, visit the Bushboard website which hosts everything you'll need, from design inspiration to technical documents and installation videos.

Plus you can mock up your dream kitchen using our Design Studio.

www.bushboard.co.uk



www.bushboard.co.uk

tel: 01933 232 272

email: businesssupport@bushboard.co.uk

BB
BUSHBOARD
A WILSONART COMPANY

Complementary Worktops

BB options

Our range of classic worktops, available as 38mm Postformed, with 50 stunning designs to choose from.



OMEGA[™] KITCHEN SURFACES

Available Summer 2023

For a contemporary look, the Omega range offers 25 stunning designs with added flexibility of choosing your thickness and profile.



ZENITH

Super hardwearing and thin, Zenith is the perfect alternative to stone offering a solid surface worktop with a sleek 12.5mm thickness.



