

Shaping the Future of the Electrical PLM, CAD and Simulation

IGE+XAO GROUP CORPORATE DOCUMENTATION





**Innovative software
applications**

Providing clients with innovative software applications to increase the productivity and quality of electrical installation design, manufacturing and maintenance processes...

... this is the main mission the IGE+XAO Group set out to achieve through our range of software and services. Since our creation in 1986, the IGE+XAO Group has implemented a strong and ambitious strategy focusing on Marketing and Innovation to ensure we meet our clients' needs.

Through our Marketing strategy, we are constantly striving to increase our market share in France, as well as overseas. We have achieved this up to now, not only through our subsidiaries and offices across 21 countries, but also through our network of professional partners based in 22 countries. Today, IGE+XAO has sold over 86,000 licences across the globe and our clients range from craftsmen to multinational corporations in all industrial and service areas.

Our Innovation strategy has been implemented through a Research & Development investment representing 26% of our annual revenue.

With more than 180 engineers and technicians throughout the world, our development teams are constantly creating and improving our products and technologies.

In 2017, our Research & Development engineers will be working on the life cycle of electrical installation (electrical PLM), collaborative tools, automated cabling (2D and 3D), harness manufacturing, system engineering, and functional simulation with a view to improving productivity and quality. Supporting our commercial success, the Group has a strong financial structure with significant cash reserves and minimal liabilities.

I am extremely confident in our Group's capacity to expand within its field in years to come.

I trust you will enjoy reading about the IGE+XAO Group and finding out more about us and I would like to take this opportunity to thank, most sincerely, our clients and partners who have made us what we are today.

© David Brous



Alain Di Crescenzo
Chairman and CEO

A stylized, handwritten signature in white ink on a blue background.

“30 years of experience

Over 86,000 licences sold

32 locations in 21 countries

More than 390 employees

Listed on **NYSE Euronext** since

March 1997 ”



www.ige-xao.com

The IGE+XAO Group

Historically, the Group began by developing, selling and maintaining CAD (Computer Aided Design) software dedicated to the electrical industry. Electrical CAD software applications are used to design and maintain the electrical side of manufacturing processes and end products.

Today, CAD is the main business of the Group and represents 70% of its revenue.

From the late 90's, the IGE+XAO Group has started the development of a software suite covering the overall requirements of the electrical harnesses design market. This new market has led the Group to build, as early as 2005, a complete and dedicated PLM (Product Lifecycle Management) software range. These solutions have attracted numerous global players in aeronautics and transportation such as Airbus, Airbus Helicopters, Embraer or Alstom.

Since mid-2014, with the purchase of Prosyst, IGE+XAO offers a complete software range for electrical installation functional simulation.



© David Bécus

Alain Di Crescenzo
Chairman and CEO



Charles Baudron
Vice president

Shaping the Future
of the Electrical PLM,
CAD and Simulation



-  **Headquarters**
-  **Subsidiaries**
-  **Distributors**
-  **Laboratory**

History of the Group

- 1986/1987:** Creation of **IGE**.
- 1988/1989:** Creation of a development and commercial subsidiary in **Poland**.
- 1991/1992:** Acquisition of **XAO Industrie** and Creation of the **IGE+XAO Group**.
- 1992/1993:** Creation of a commercial subsidiary in **Italy**.
- 1993/1994:** Creation of a commercial subsidiary in **Spain**.
- 1994/1995:** Creation of a commercial agency in **Germany**.
Creation of a development subsidiary in **Bulgaria**.
- 1997/1998:** Introduction of the **IGE+XAO Group** on the **Paris Stock Exchange**.
Creation of a commercial subsidiary in **Canada**.
Acquisition of **Schneider Electric's** Electrical CAD activity (called Handel).
- 1998/1999:** Creation of a commercial subsidiary in the **United Kingdom**.
- 1999/2000:** Creation of a commercial subsidiary in **Germany**.
- 2000/2001:** Acquisition of **Ingedata Développement** (France), **Tessdata BV** (Netherlands), **CAE Development ApS** (51%) & **CADdy Denmark A/S** (49%).
- 2001/2002:** Acquisition of a 19% stake of **Anyware Technologies**.
- 2002/2003:** Creation of a second commercial agency in **Germany**.
- 2004/2005:** Acquisition of the remaining 49% of **CAE Development ApS**.
- 2005/2006:** Creation of a commercial subsidiary in the **USA**.
Creation of a commercial agency in **China**.
Buy-out of **HIBATEC - Switzerland**.
- 2006/2007:** Creation of **EHMS** with the Labinal Group.
Creation of **S2E CONSULTING** with the **Sogeclair Group**.
Acquisition of **Compodata**.
- 2007/2008:** Creation of subsidiaries in **China** and **Tunisia**.
- 2008/2009:** Creation of a subsidiary in **Morocco**.
- 2009/2010:** Creation of a subsidiary in **Madagascar**.
- 2010/2011:** Launching of a wide **Chinese** sales network based on 3 IGE+XAO commercial agencies and 14 business partners.
Creation of a new office in Wadowice, **Poland**.
- 2011/2012:** Creation of a subsidiary in **Turkey**.
- 2012/2013:** Creation of a new office in **Tarnow, Poland**.
- 2013/2014:** Acquisition of the remaining 51% of **IGE+XAO Danmark A/S**.
Acquisition of 80% of **Prosyst SAS**.
Headquarters moving-out to ZAC Ramassiers - Colomiers.
- 2014/2015:** Creation of a subsidiary in **Greece** and **Brazil**.
- 2015/2016:** Creation of a subsidiary in **Belgium** as well as an office in **Russia**.



ABB, AgustaWestland SPA, Air France KLM, Airbus, Albus Helicopters, AKKA, Akyapak, Alestis Aerospace, Alpatron, Alstom, ANURAG, Arcelormittal, AREVA Group, Aries Estructuras Aerospaciales, Assytem, Astrium SAS, ATEL Netz Ag, BAM, Bauer GmbH, BBR GmbH, BE Aerospace Ltd, Beghin-Say, Beijing zhong xin xing ye keji, Benteler, Bosal, Bouygues, Brembo SPA, CABS, Carrier, CEA, Cegelec, Cermex, Chengdu Xinzhu Road & Bridge Machinery Co. Ltd, Coca Cola, COMAU (Fiat), Composite Engineering Inc., ContiTech Vibration Control, Cote SAS, Daf-Trucks, Dalkia, Danone, DCNS, DFM ZANAM-LEGMET Sp. z o.o., DHL, DRASS ENERGY SRL, Dredging International, Dunlop, Eaton Leonard Europe, EC Engineering, ECL, EDF, Eiffage Energie, ELV SPA, Embraer, Endurance Wind Power, Enexis, Euchner GmbH, European Space Agency (ESA), Fabricom, FAdeA SA, Faiveley, Faurecia, Fokker Elmo, Footlocker, Fromagerie BEL, Fuji Seal Group, Galileo Avionica, GDF Suez, General de Ingeniería INHISSET, General Dynamics European Land Systems- Germany, GPI, GSU/Eneco, Guérin Systèmes (Tetra Pack Group), Guinault, Hager, Haribo, Helibras, Hellenic Air Force, Henniez, Heuliez, Honda Aircraft Co., Honeywell, Houdijk Holland bv, Hydro Quebec, IMAC inc, Ineo, ITER, JSC ISS-Reshetnev Company, Kestrel Aerospace, Kocher Plastik GmbH, Kraft Foods, Labinal, Latelec, Legrand, Leroy Somer, Lindt, Lotus Bakeries, LVMH, Mairie de Paris, Manitowoc Crane Group, MBDA, Metso Brasil Indústria e Comércio Ltda, Michelin, Microturbo (Groupe Safran), Moëller Electric (Eaton) , Motorflug Baden-Baden GmbH, Motorola, Mühlenberg Interiors (EDAG Group) , NATO, Nestlé, Neu Railways, Nexans, NMBS/SNCB, Nomos Systems, Northrop Grumman, Panasonic, Perrier, PESA Bydgoszcz SA Holding, Philips, Prinoth, Potez Aeronautique, Priva, PSA Peugeot Citroën, Qi Qi Ha Er, RATP, Reel, Reims Aviation, Renault, Renault Trucks, Renson, Rio Tinto Alcan, Rolls-Royce Marine, RUAG AVIATION SA, S.A.B.C.A, Safran, Sagem, Saint Yorre, Samson AG, Saur, SCAM SPA, Schlumberger, Schneider Electric, SELEX SPA, SENER Ingeniería y Sistemas, S.A., Sepro, Shanghai Electric, Shanghai Rail Traffic, Sidel-Cermex, Siemens, Siemens Windpower, Sierra Nevada Corporation, Smurfit Kappa, SNCB, SNCF, Socata, SOGETI HT, Spie, Srbijagas, Sterela, Suez, Swedish Match Cigars NV, TEMSA, Thales, Toyota forklifts, Trakcja Polska S.A., Unilever, Valeo, Vallourec Talc de Luzenac, Van der Leun, Veolia Environnement, Vestas, Vesuvius, Vinci Energies, Volkswagen Group, VOSSLOH, Vulcanair SPA, Wabco GmbH, Wago, Wenzel Elektronik GmbH, Whirlpool Europe SRL, Xella, Wienerberger, ZF Sachs...

An important customer base

As of July 31st, 2016 the IGE+XAO Group has delivered over 86,000 licences and serves as many as 40,000 customers throughout the world.

These customers belong to a wide range of industries including:

- Automotive
- Transportation
- Power generation
- Electrical and electronic equipment
- Food, chemical and steel industries
- Building and public works
- Engineering companies
- Machine building
- Automation

Number of licences sold

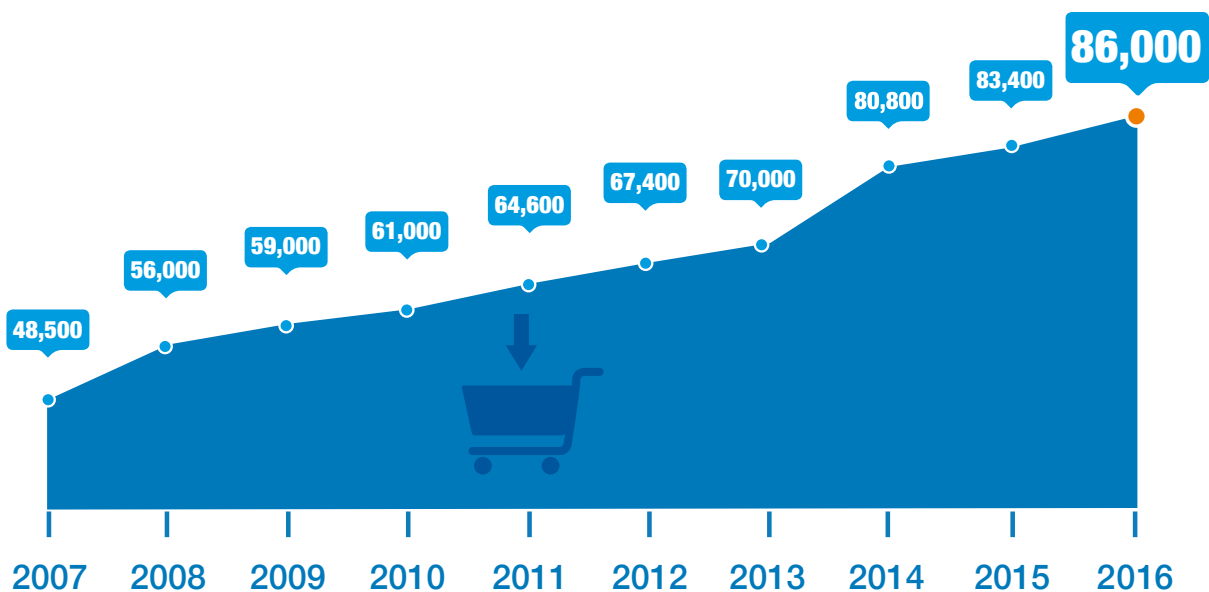

- 
- ✓ **Openness**
 - ✓ **Boldness**
 - ✓ **Dynamism**
 - ✓ **Professionalism**
 - ✓ **Consideration for
customers and staff**



Only one business

390 people focused on Electrical CAD and PLM

Strong values

Strong and shared values are key to the Group success.

All employees and managers carry daily the Group values to new employees, partners and suppliers.



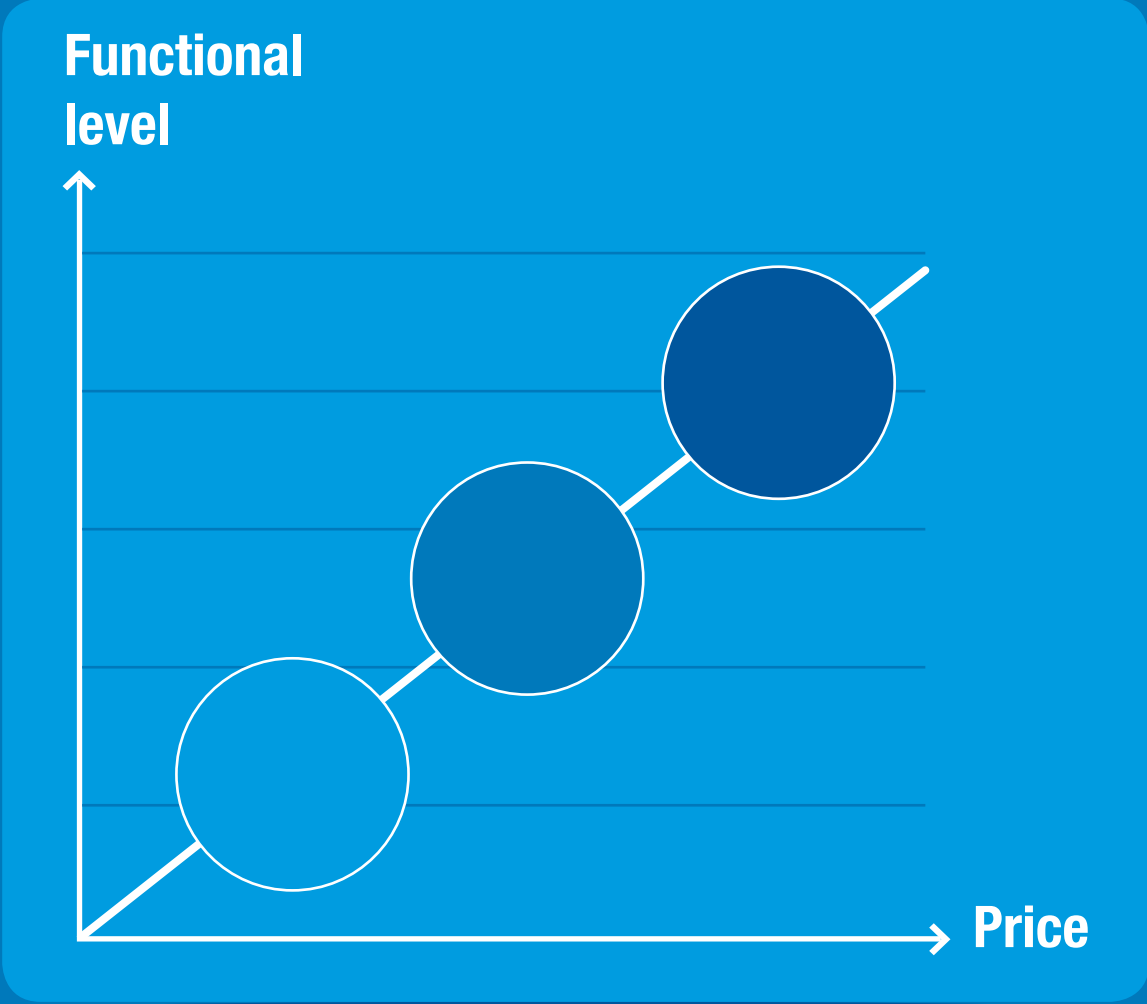

One solution for every company size



Very Small
Businesses



Small and Medium
Businesses



Key Accounts

A clear strategy

A strong presence in 8 industries

In each identified industry, IGE+XAO covers all requirements with a complete range of modular products...



Aerospace



Equipment & Machinery



Automotive



Automation & Plant



Railway



Power generation & Energy



Shipbuilding



Construction





















... with the ambition to be the partner for all companies whatever their size.



A clear strategy

A strong international presence

The IGE+XAO Group is present in 21 countries through its 32 offices:

- | | | |
|--|---|--|
|  Belgium |  Greece |  Russia |
|  Brazil |  Germany |  Spain |
|  Bulgaria |  Italy |  Switzerland |
|  Canada |  Madagascar |  Tunisia |
|  China |  Morocco |  Turkey |
|  Denmark |  Netherlands (The) |  United Kingdom |
|  France |  Poland |  USA |

A network of distributors/partners represents the Group in 22 additional countries:

- | | | |
|--|--|--|
|  Albania |  Czech Republic |  Montenegro |
|  Austria |  Hungary |  New Zealand |
|  Australia |  India |  Portugal |
|  Belarus |  Kazakhstan |  Romania |
|  Bosnia and Herzegovina |  Kosovo |  Serbia |
|  Colombia |  Lebanon |  Slovakia |
|  Croatia |  Macedonia FYR |  Slovenia |
| | |  South Korea |



A clear strategy

➔ AN EFFICIENT GLOBAL R&D ORGANIZATION

Development teams are located all over the world.



➔ INNOVATION

During the 2015/2016 tax year, the Research and Development activity represented 26% of the Group revenue.

Our Research and Development program is focused on two key areas:

- **Business** – dealing with automatic generation of schematics, automatic cabling, system engineering, harness manufacturing, dimensioning and simulation.
- **Technology** – dealing with concurrent engineering, product lifecycle management (PLM), product data management (PDM) and Cloud applications.



An organization built around our clients

In response to the market fast-moving needs, the IGE+XAO Group has put in place an «extended enterprise» organization :

SEE One Corporate consists of "R&D", commercial support, sales management, HR, finance, international support and global key accounts management.

SEE One Incorporated embraces the Group's consolidated commercial subsidiaries.

SEE One Alliances includes jointly owned companies:

- EHMS (created with Labinal).
- S2E Consulting (created with Sogclair).
- Prosyst.



SEE One Partners is comprised of the IGE+XAO Group's technological and commercial partners.

Technological partners: Dassault Systèmes, Labinal, Microsoft, Safran, Siemens PLM Software, Sogclair, SolidWorks...

Commercial partners: Labinal, Moeller Electric Eaton, Schneider Electric, Sogclair, Weidmüller, as well as all the companies distributing the Group's products in countries where IGE+XAO is not represented.



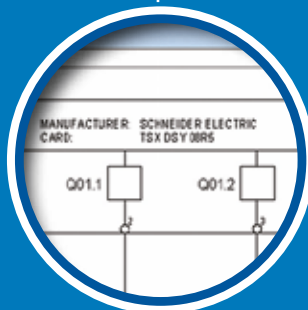
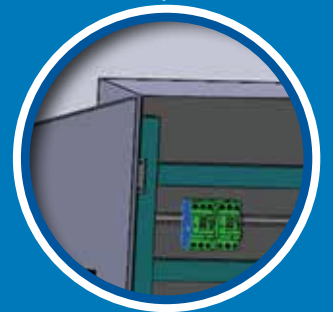
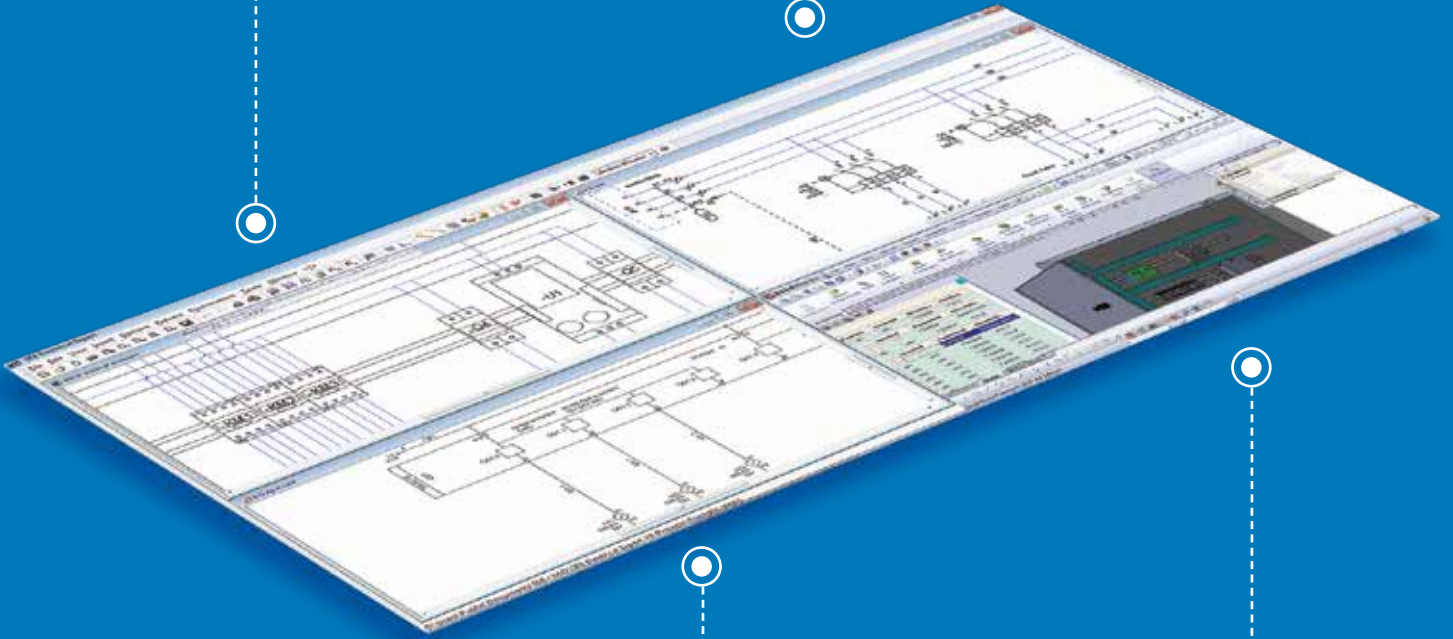
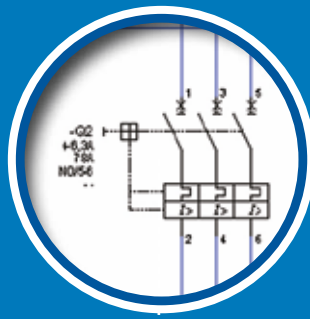
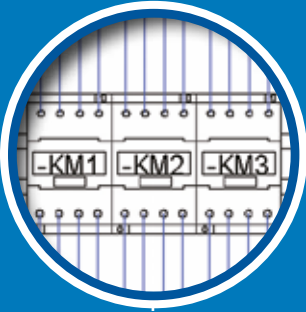

Value-added services

IGE+XAO service portfolio:

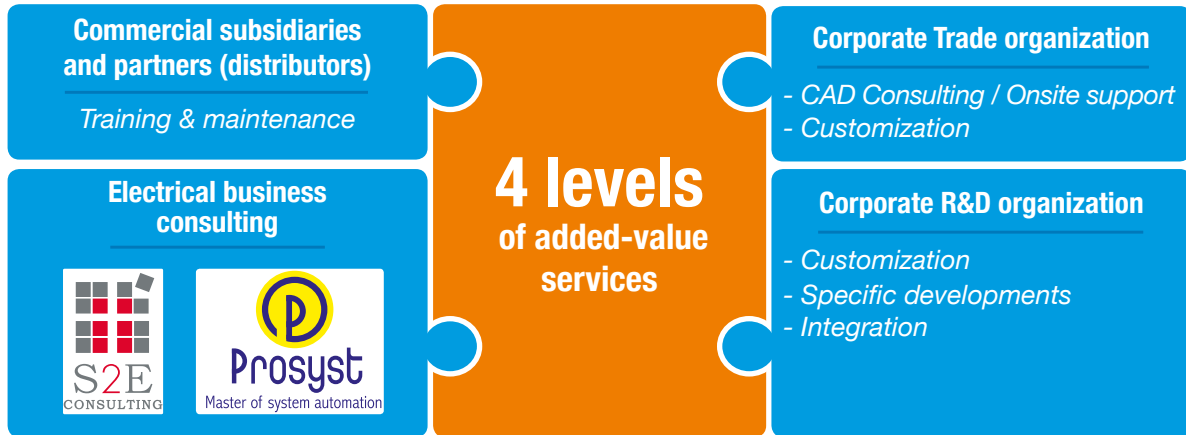

Fully aware that our clients' needs go beyond the software package, our Group offers value-added services.

Training sessions adapted to clients' needs and worldwide telephone helpline.

Over 70 experts are available to our clients for:

- Training worldwide.
- Assisting clients in more than 12 languages throughout the world.

Dedicated team to customize the software to our clients' needs.

The "**Assistance +**" team supports our clients in implementing and integrating IGE+XAO solutions. Services include CAD consulting, onsite support and customization. Our R&D team also provides specific developments as well as integration services.

Value-added consulting.

Created in collaboration with the SOGECLAIR Group, S2E Consulting offers assistance and consulting services dedicated to system engineering and optimization of electrical design processes.

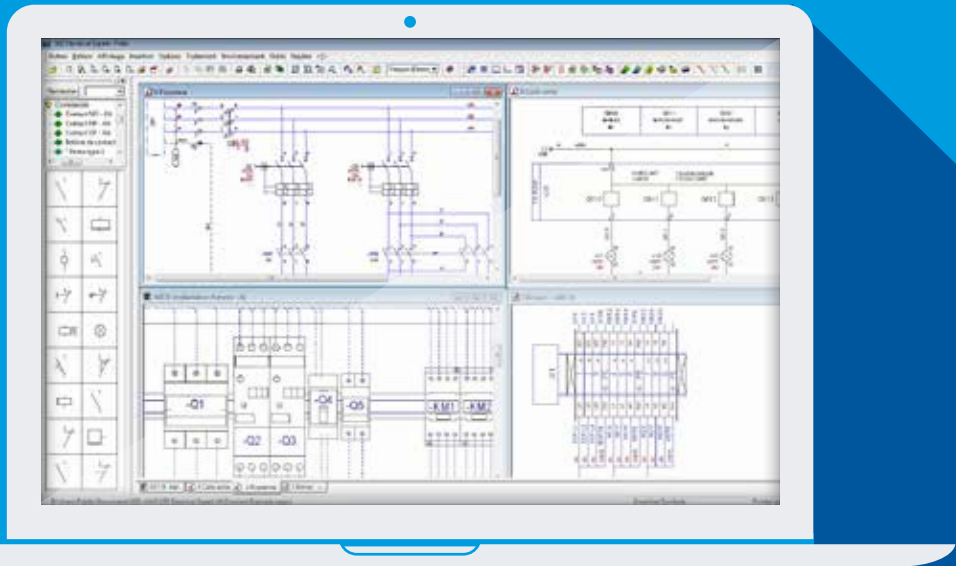

A solid presence in 8 industries

16 products, 6 functional domains and 8 strategic industries



Aerospace



Equipment & Machinery



Automotive



Automation & Plant



Railway



Power generation & Energy



Shipbuilding



Construction

The Group objective is to provide software packages precisely tailored to each industry. Solutions cover requirements that go from simple electrical schematics to electrical installation PLM (Product Lifecycle Management) .

For each industry, the offer has been segmented in 6 domains:

- System design
- Electrical design (the core business of IGE+XAO)
- Electrical manufacturing
- Data management
- Communication
- Simulation and diagnostic

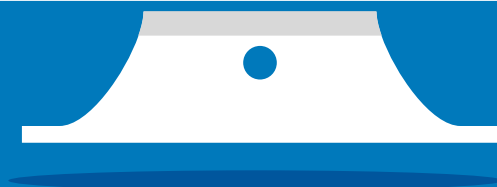
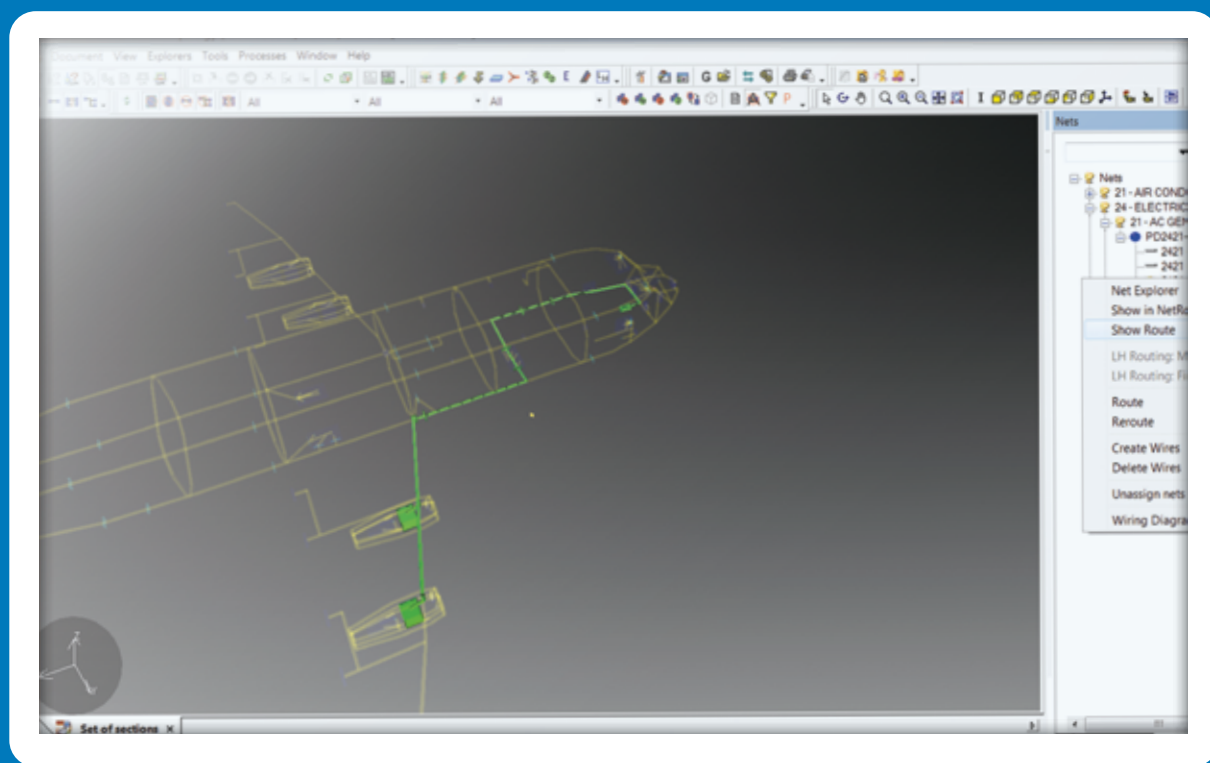



Aerospace

The Aerospace Industry is facing stiff challenges:

- Increasing number of equipment
- Numerous configuration support
- More and more complex cabling
- Heterogeneous software tools
- Production time reduction

To meet these challenges, the IGE+XAO Group has developed a complete range of software solutions with strong competitive advantages

- Powerful PLM (Product Lifecycle Management) suite
- Complete offer that goes from design to manufacturing
- High level of integration
- Scalable solutions (from stand alone to PLM)

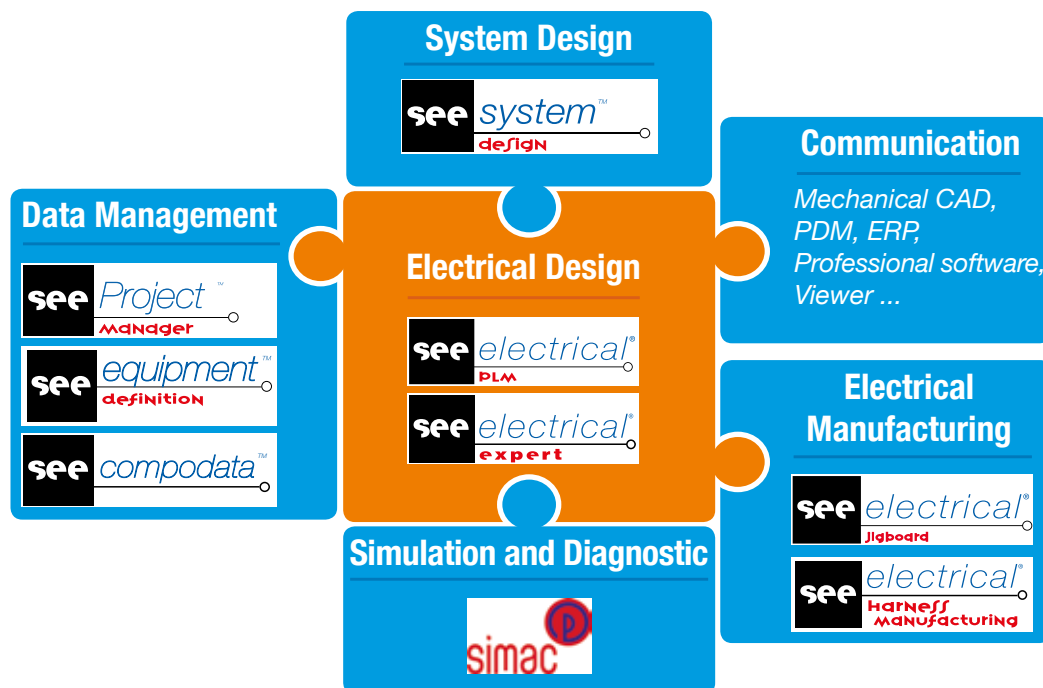

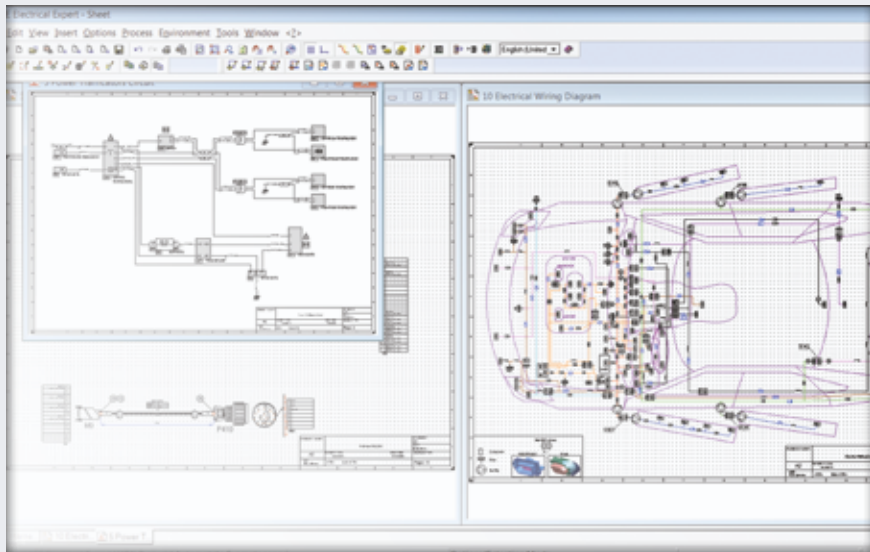
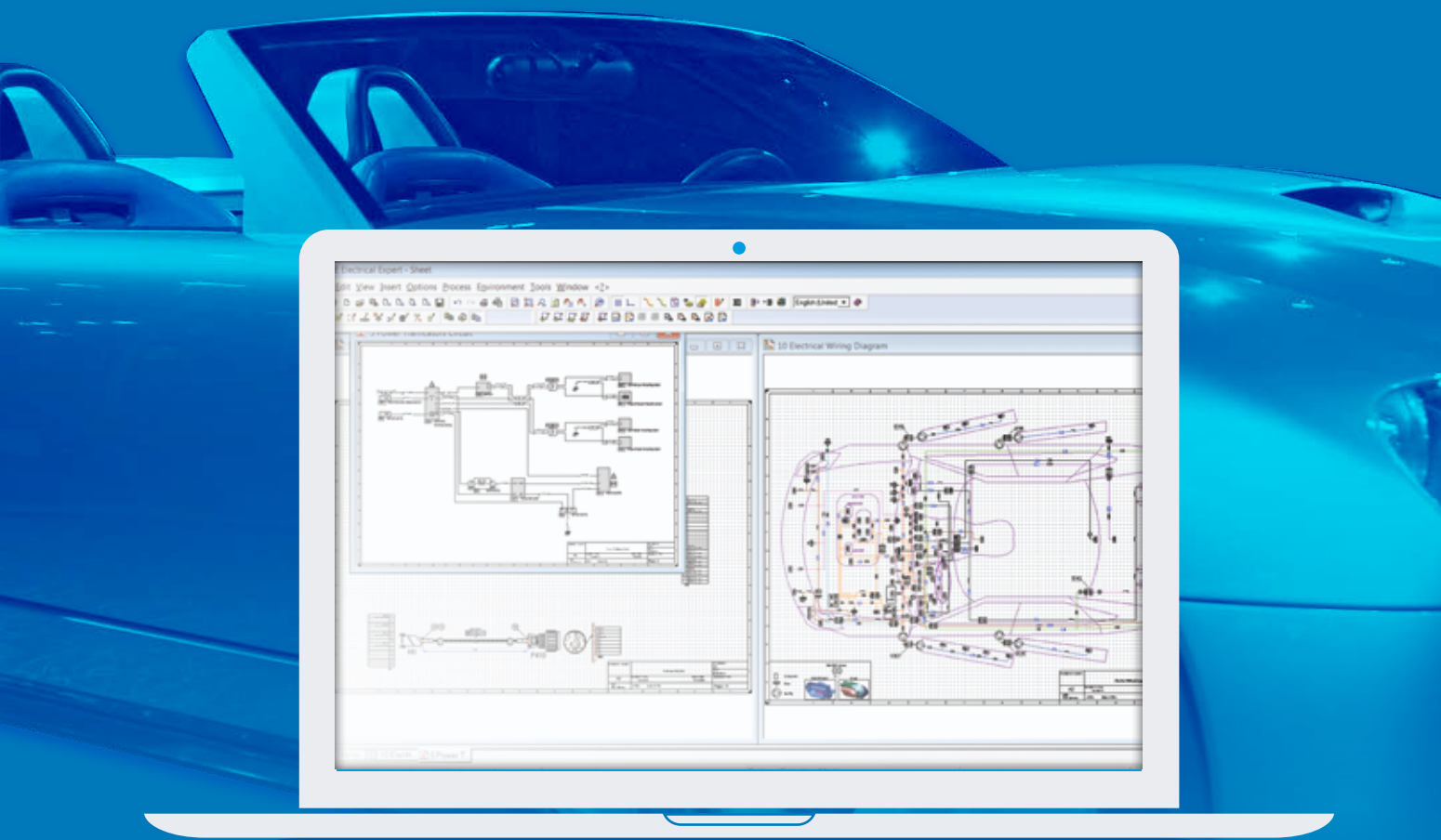



Automotive

- Hybrid vehicle technologies
 - Shorter development time
 - Option management
 - Increasingly complex electronic content...
- ... are some of the challenges that engineers in the Automotive Industry have to solve daily.

To assist them, the IGE+XAO Group has developed a complete range of software solutions with strong competitive advantages

- Powerful PLM (Product Lifecycle Management) suite
- Automotive specific functions
- High level of integration
- Configuration management (options and variants)

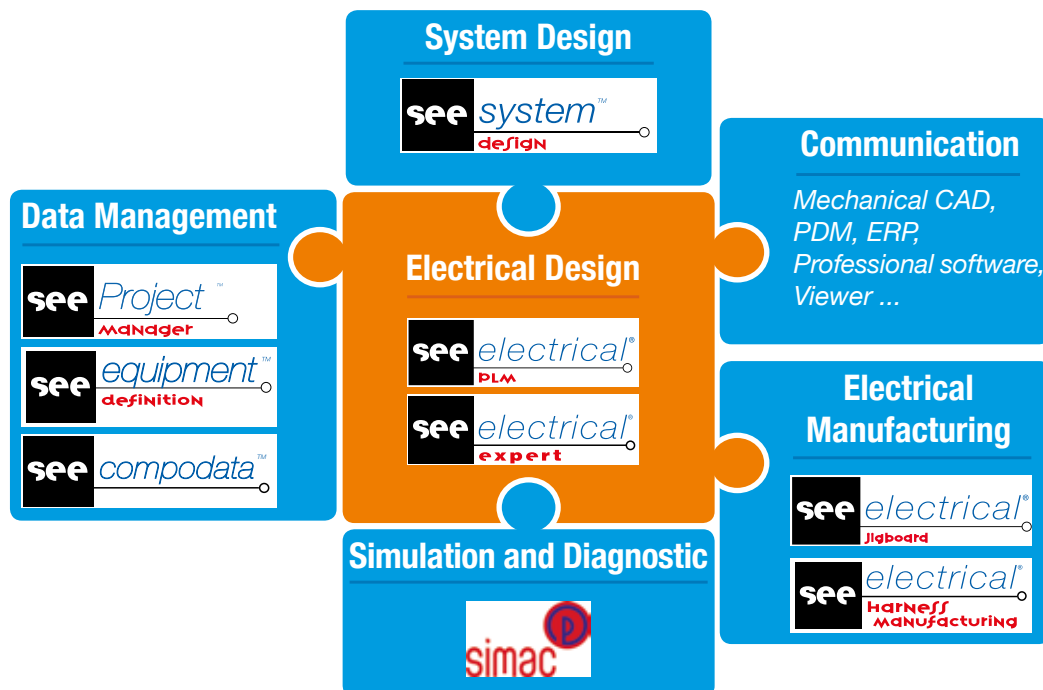

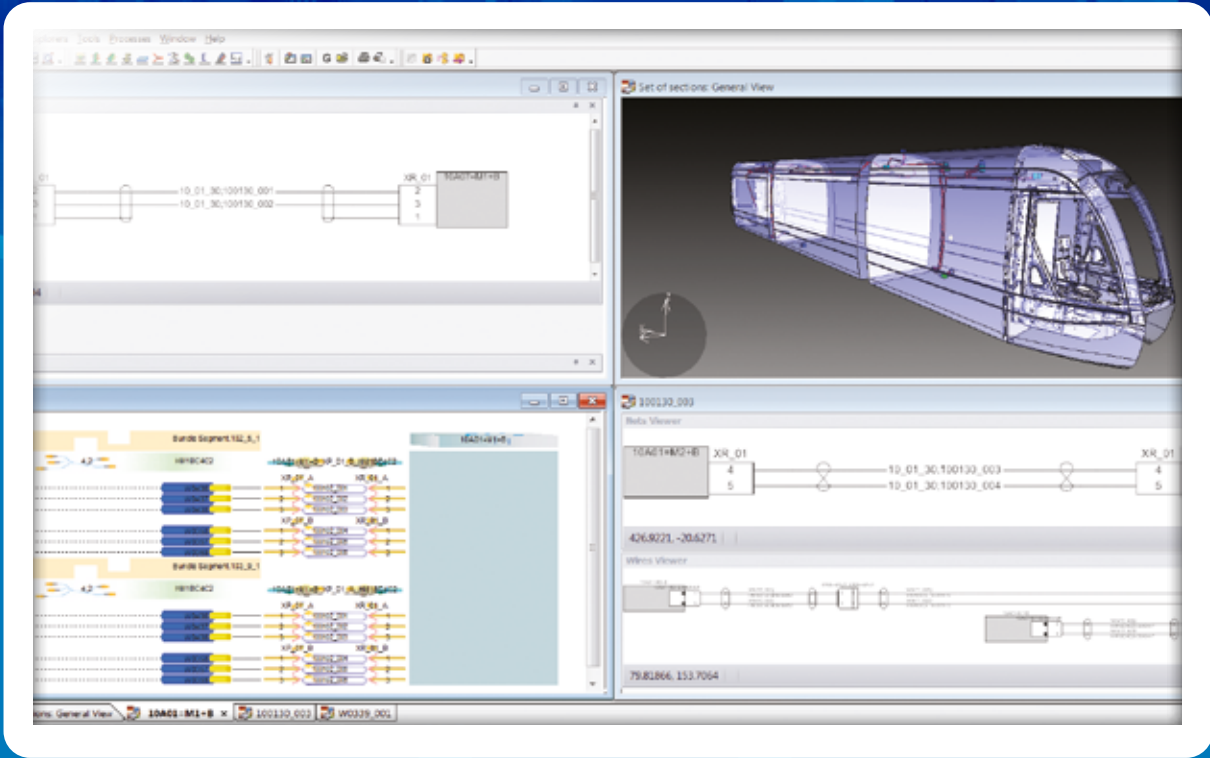



Railway

- “Intelligent train”
 - Equipment reliability
 - Safety
 - Eco efficiency
 - Additional comfort and services...
- ... are key issues such on which Railway design engineers work daily.

To cope with these issues, the IGE+XAO Group has developed an innovative and complete range of software solutions offering competitive advantages

- Powerful PLM (Product Lifecycle Management) suite
- Railway specific functions
- High level of integration
- Traceability

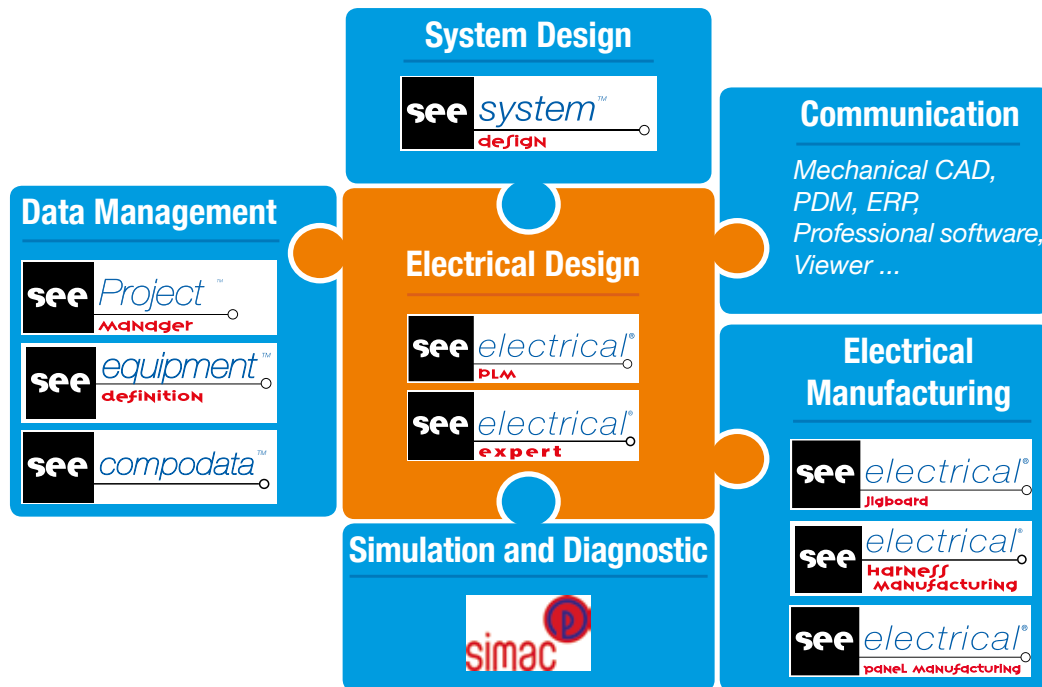

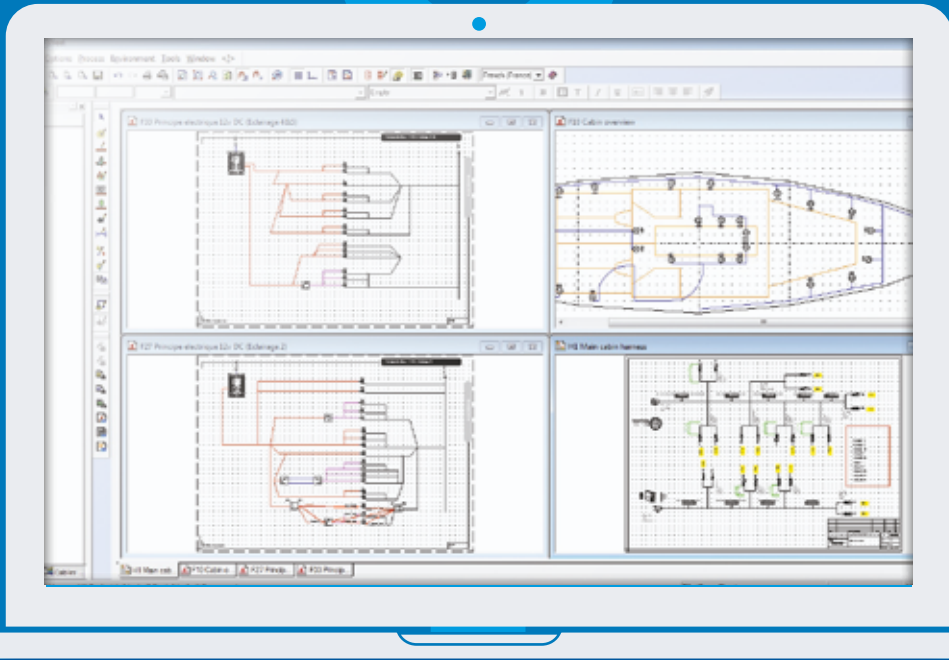



Shipbuilding

- “Smart” ship
 - Increasing number of equipment
 - Operational condition guarantee
 - Ship lifelong evolutions
 - Cost optimization...
- ... are some of the trends that engineers in the Shipbuilding Industry have to think about everyday.

To answer these trends, the IGE+XAO Group has developed a complete range of software solutions with strong competitive advantages

- Complete Visio-based offer that goes from functional design to schematics and cabling generation
- Communication capabilities (PLM and CAD integration)
- Collaborative design
- Multi function (hydraulics, pneumatics, electrical...)
- Configuration management (options and variants, versioning/maturity)

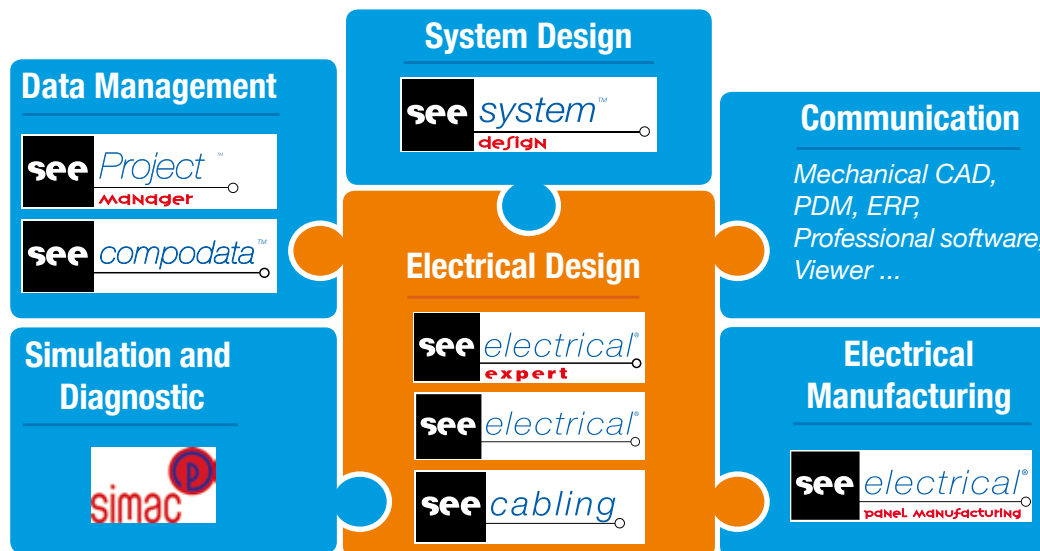

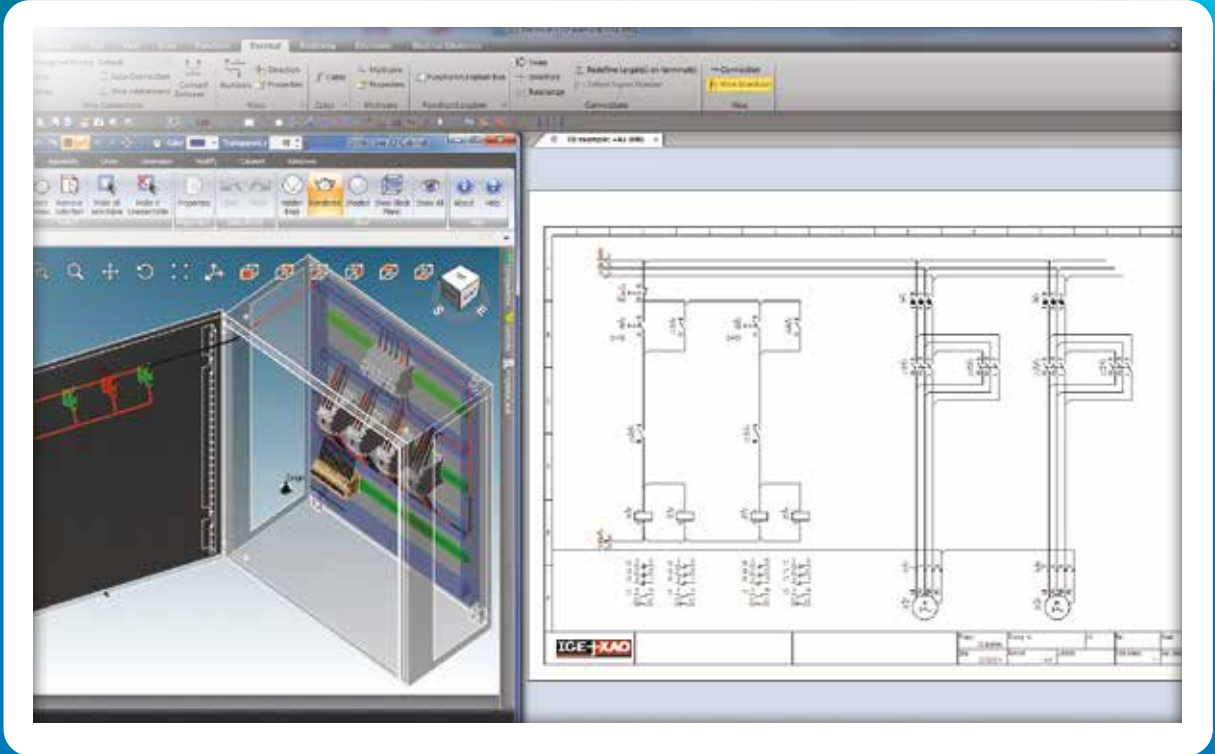
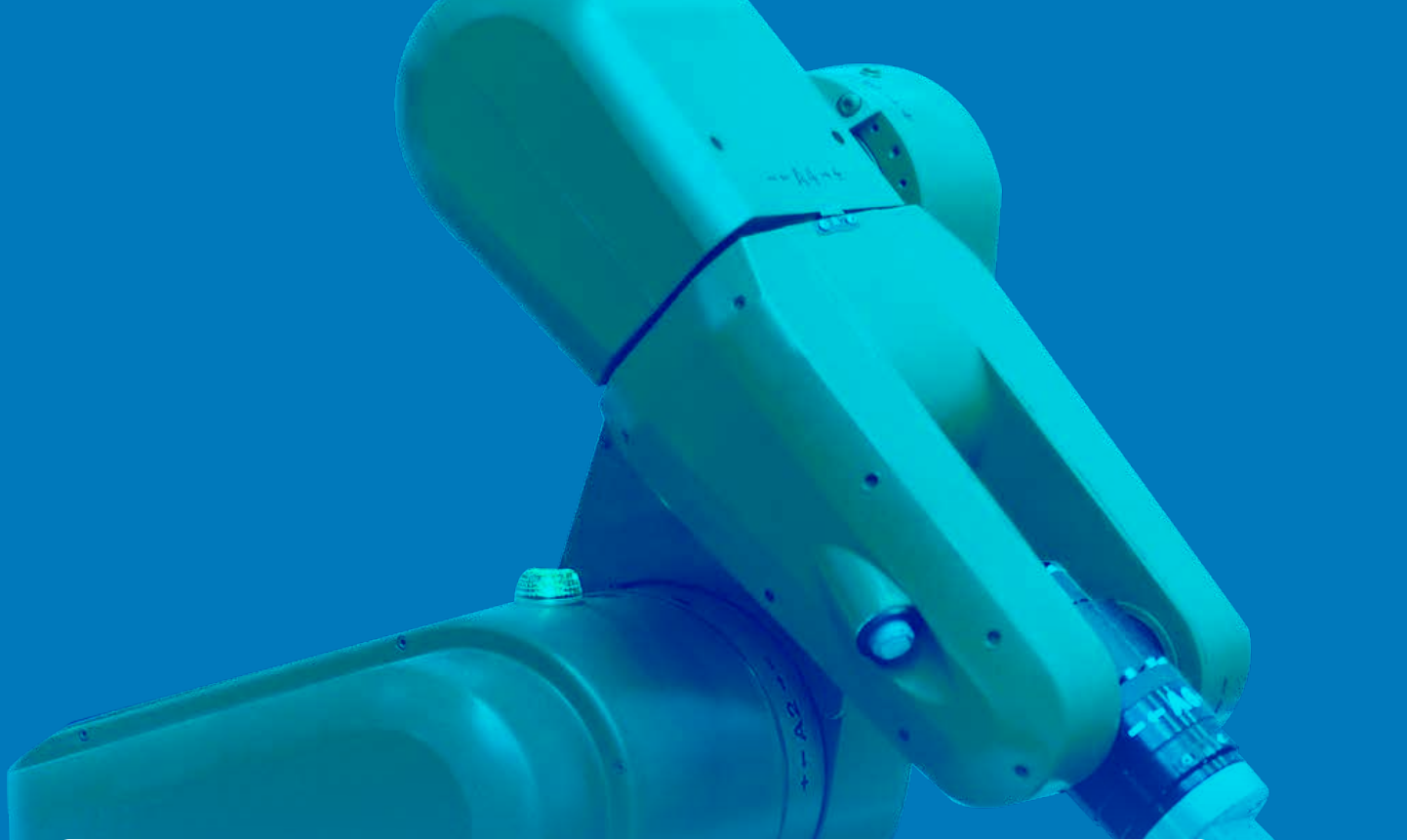



Equipment & Machinery

The Equipment & Machinery Industry has to meet several challenges:

- More and more complex equipment
- Customization
- Reliability

The IGE+XAO Group has developed a complete range of software solutions with strong competitive advantages

- One solution for every company size
- One of the most complete product ranges on the market
- Communication capabilities
- Customizable and scalable solutions
- Expertise from large customer base
- Strong partnership with key electrical equipment players
- Wire harnesses expertise
- Automatic schematic generation

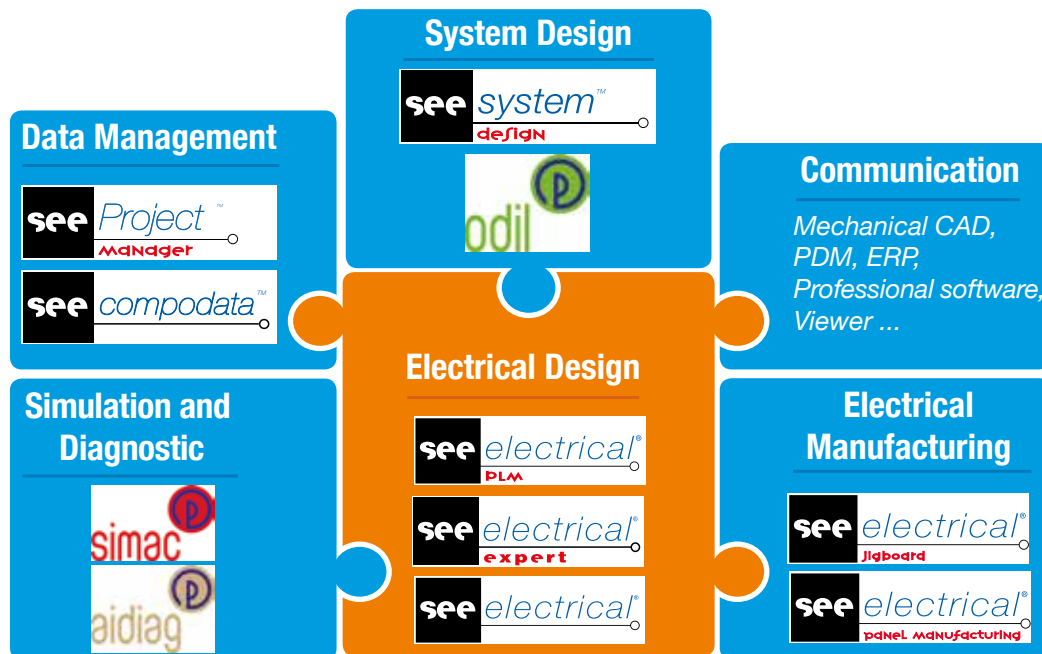

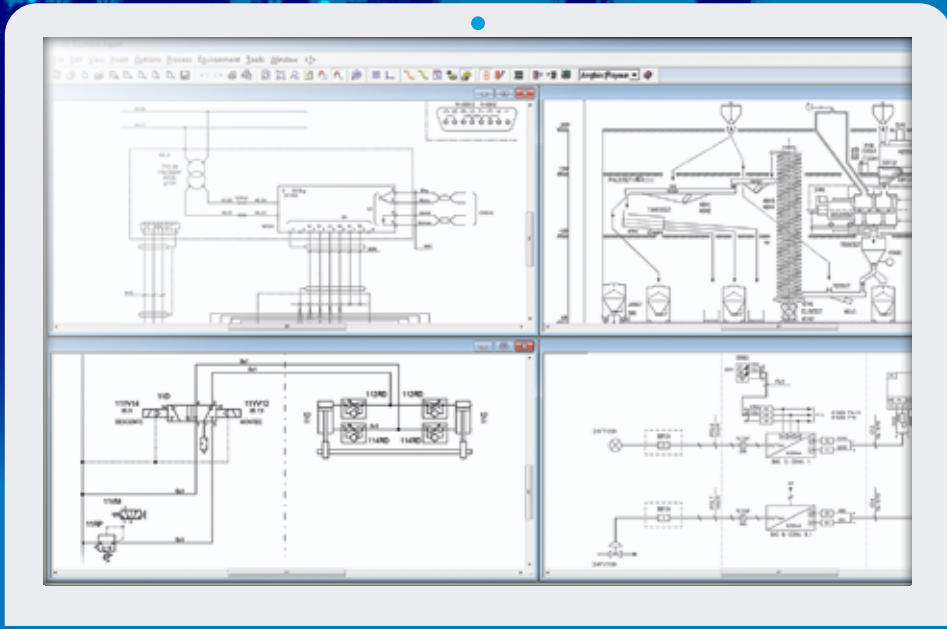



Automation & Plant

- Tight capital
- Lifetime cost optimization
- Reliability
- Predictive maintenance
- Flexibility...

...are some of the issues facing the Automation and Plant industry.

The IGE+XAO Group has developed a complete range of software solutions with strong competitive advantages

- One solution for every company size
- One of the most complete offer on the market
- Communication capabilities
- Best-in-class features
- Complete environment (CEI, IEC, symbols...)
- Customizable and scalable solutions
- "Easy to use" packages
- Large customer base
- Quality verification functions

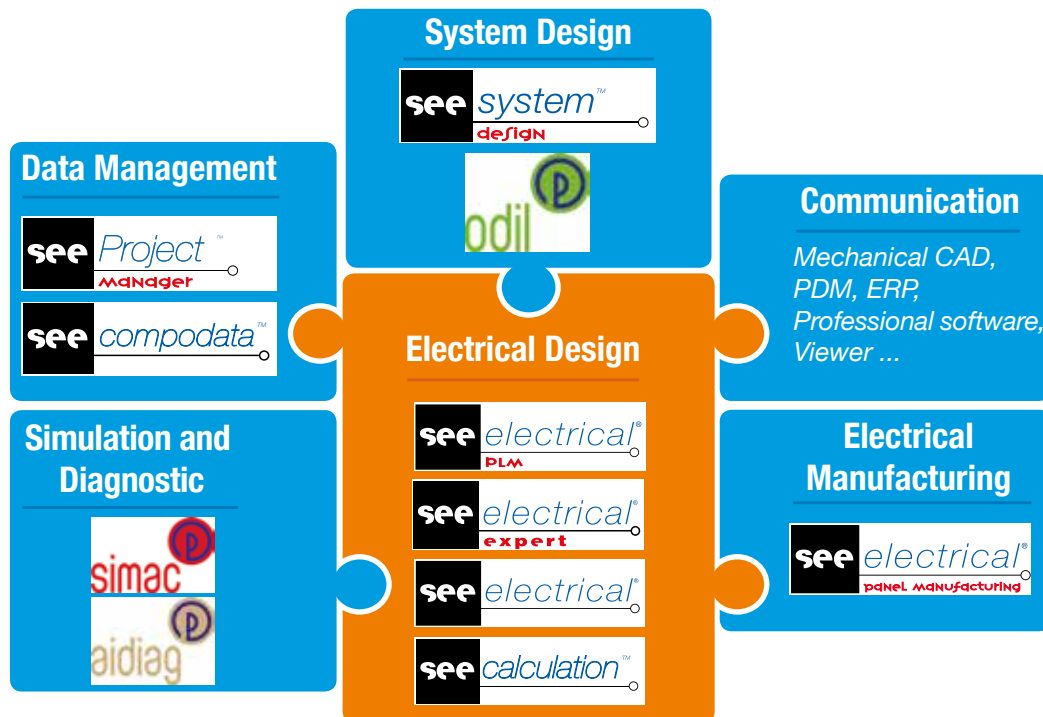

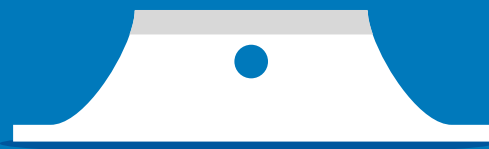
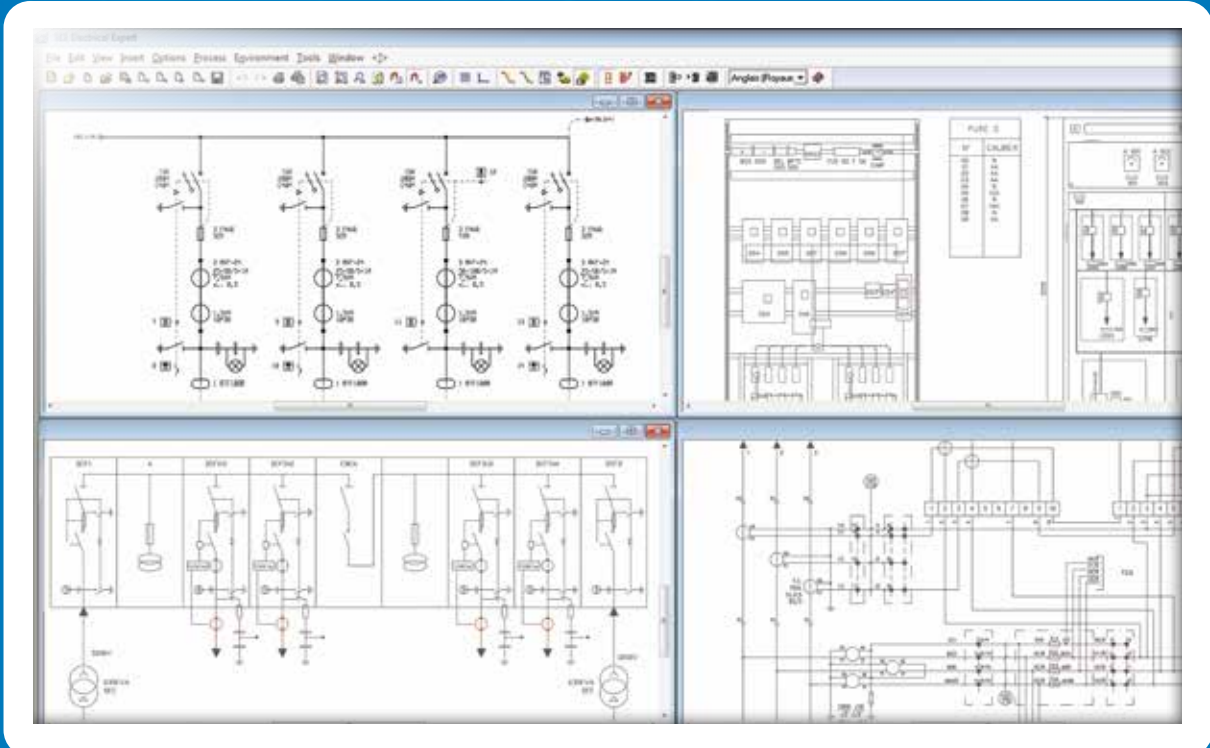
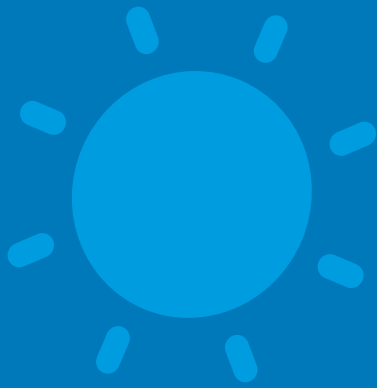



Power Generation & Energy Industry

- Safety
- Alternative & sustainable energies
- Smart supply and demand
- Smart grid
- 24/7 operations
- Environmental regulations...

... are some of the problems engineers in the Power Generation & Energy Industry have to cope with.

The IGE+XAO Group has developed a complete range of software solutions with strong competitive advantages

- Complete offer from a powerful Visio-based offer to “on-the-shelf” easy to use packages
- Communication capabilities
- Very large project management
- Collaborative solution
- Customizable and scalable solutions

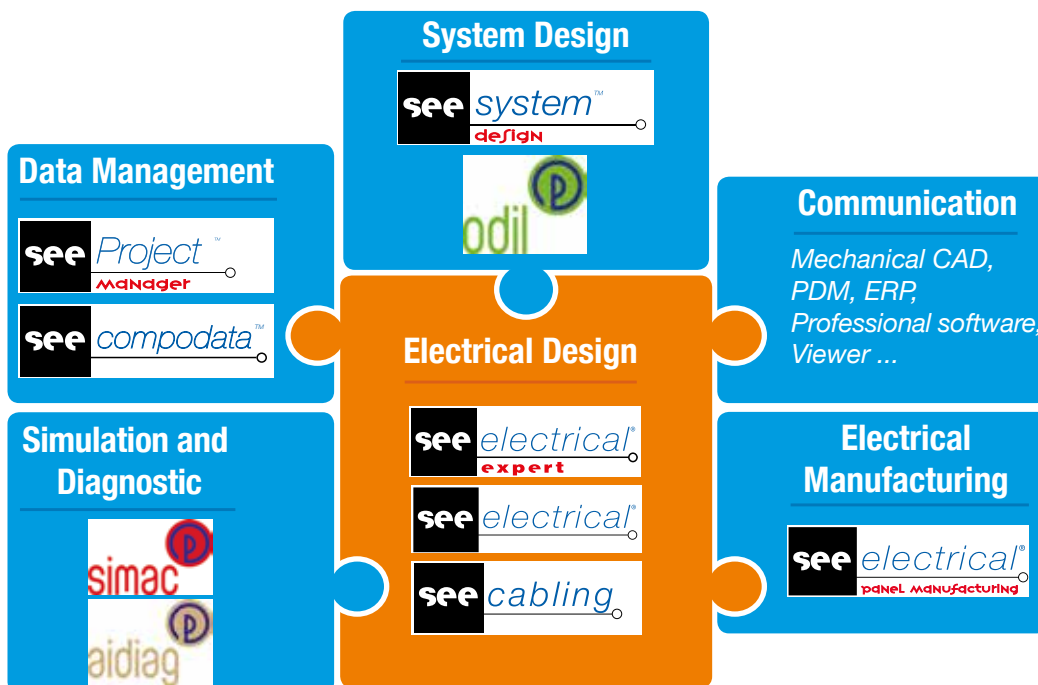

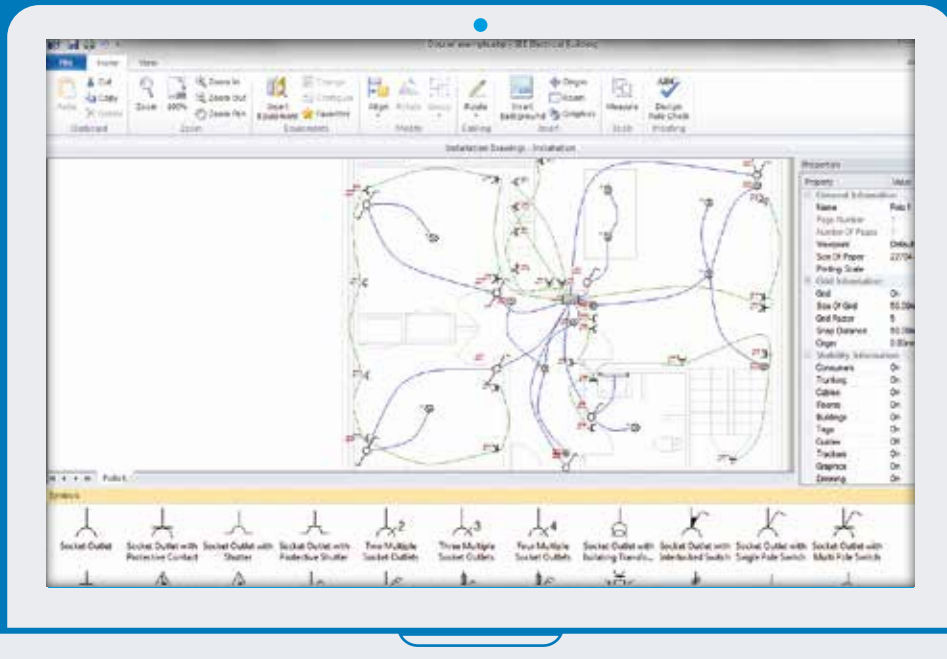



Construction Industry

- Smart buildings
 - Increasing number of equipment (datacom)
 - Importance of standards / regulations
- are important drivers for the Construction industry.

The Group has developed a complete range of software solutions with strong competitive advantages

- Automatic schematic generation
- "All in one" product
- Easy-to-use calculation package
- Communication capabilities

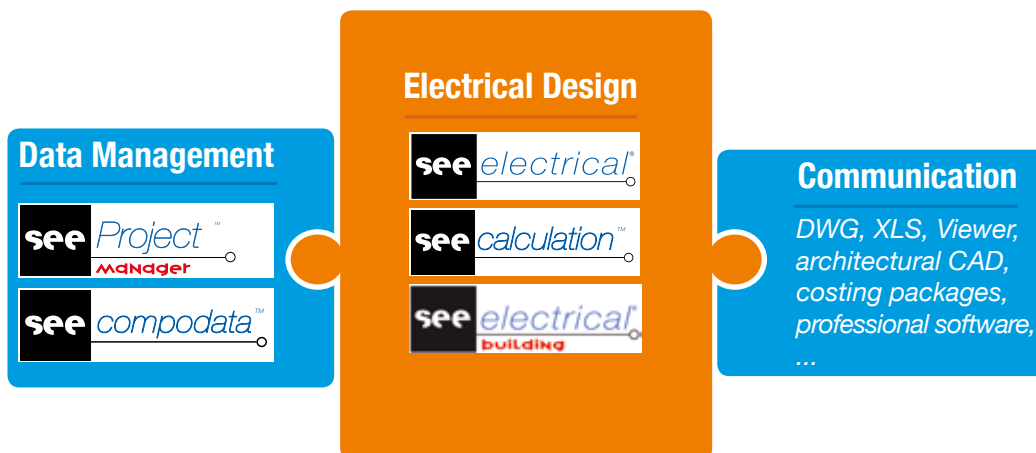



IGE+XAO LOCATIONS

Headquarters www.ige-xao.com

16 bd Déodat de Séverac
CS 90 312
31 773 COLOMIERS CEDEX
FRANCE
Ph: +33 (0)5 62 74 36 36
Fax: +33 (0)5 62 74 36 37

IGE+XAO Belgium www.ige-xao.be

Vorstlaan 90
1170 BRUSSEL
Ph: +32 (0)2 219 09 59
Fax : +31 (0)45 572 74 73

IGE+XAO Bulgaria www.ige-xao.bg

205 Al. Stamboliyski Blvd.
1309 SOFIA
Ph: +359 2 8101 145
Fax: +359 2 8101 117

IGE+XAO Brazil www.ige-xao.com

Rua Nabor Antonio Crozariol,
nº 259, sala 2, CEP - 12092-762,
TAUBATÉ - SAO PAULO
Ph: +33 0562743636
Fax: +33 0562743637

IGE+XAO Canada www.ige-xao.com

7777, Boul. Louis-H. Lafontaine
suite 201 - Montréal (Anjou)
QUÉBEC H1K 4E4
Ph: 1-514-353-3445
Fax: 1-514-353-6857

IGE+XAO China www.ige-xao.com.cn

Room 20S5 Huatai Securities
Building,
No.90 East ZhongShan Road
NANJING
postcode : 210002
Ph : +86(0)25-8689 0716
Fax : +86(0)25-8465 0564

IGE+XAO France www.ige-xao.fr

72, av. de la République
92 320 CHÂTILLON
Ph: +33 (0)1 55 48 17 77
Fax: +33 (0)1 55 48 17 90

3, rue de Lorraine
44240 LA CHAPELLE SUR
ERDRE
Ph: +33 (0)2 51 89 72 12
Fax: +33 (0)2 51 89 14 72

Centre Etoile Valentine 5
Traverse de la Montre - Bât. B4
13 011 MARSEILLE
Ph: +33 (0)4 91 44 89 06
Fax: +33 (0)4 91 87 60 53

106, rue de la Liberté
38 180 SEYSSINS
Ph: +33 (0)4 76 70 16 42
Fax: +33 (0)4 76 70 16 09

30 rue des frères Dana
59 300 VALENCIENNES
Ph: +33 (0)3 27 30 59 59
Fax: +33 (0)3 27 30 59 60

IGE+XAO Germany www.ige-xao.de

Marie-Bernays-Ring 19a
D-41199
MÖNCHENGLADBACH
Ph: +49 (0)2166 13 39 10
Fax: +49 (0)2166 13 39 110

Im Wöhr 2
D-76437 RASTATT
Ph: +49 (0)7222 77 47 40
Fax : +49 (0)7222 77 47 59

IGE+XAO Greece www.ige-xao.gr

3 Promitheos str
GR- 54627 THESSALONIKI
Ph: +30 23 10 24 49 11
Fax: +30 23 10 24 49 66

IGE+XAO Italy www.ige-xao.it

Via delle Canovine, 46
I-24126 BERGAMO
Ph: +39 0354 596 167
Fax: +39 0354 243 793

IGE+XAO Madagascar www.ige-xao.com

Immeuble SANTA, Antanimena,
24 rue Naka Rabemanantsoa,
LOT IVG 204 101
ANTANANARIVO
Ph: +261 20 22 249 19

IGE+XAO Morocco www.ige-xao.com

24, rue Ali Abderrazak
Quartier Racine Extension
1er étage
20100 CASABLANCA
Ph: +212 5 22 23 05 55
Fax: +212 5 22 23 05 55

IGE+XAO Nordic www.ige-xao.dk

Bistrupvej 22
3460 BIRKERØD- DENMARK
Ph: +45 45 94 21 00
Fax: +45 45 94 21 01

IGE+XAO Netherlands www.ige-xao.com

Beersdalweg 84 A
6412 PE HEERLEN
Ph: +31 (0)45 561 16 36
Fax : +31 (0)45 572 74 73

IGE+XAO Poland www.ige-xao.com.pl

Pl. Na Stawach 3
30-107 KRAKÓW
Ph: +48 (0)12 630 30 30
Fax : +48 (0)12 630 30 37

ul. Strusińska 2
33-100 TARNÓW

ul. Doktora Józefa Putka 9
34-100 WADOWICE

IGE+XAO Russia <http://www.ige-xao.ru>

Novodanilovskaya
Naberezhnaya street 4A
117105 MOSCOW
Ph: +7 926 177 3732

IGE+XAO Spain www.ige-xao.es

Parque Empresarial Neisa Sur
Edif. N°7
Av. andalucia Km 10,5
E-28021 MADRID
Ph: +34 91 797 90 71
Fax : +34 91 505 34 68

IGE+XAO Switzerland www.ige-xao.ch

Rue de Flore 5
CH-2502 BIEL/BIENN
Ph: +41 (0) 32-365 93 93
Fax: +41 (0) 32-365 93 69

IGE+XAO Tunisia www.ige-xao.com

Pôle technologique El Ghazela
Bloc I2 Rdc A04
Rte de Raoued km 3,5
2088 ARIANA
Ph: +216 70 83 45 45
Fax : +216 71 85 63 24

IGE+XAO Turkey www.ige-xao.com/tr

Atatürk Mah. Ataşehir Bulvarı
Gardenya Plaza 3 K:4 N:22,
34758 Ataşehir
İSTANBUL
Ph: 90-216, 988, 16, 00

Altınova Mah.
BUTTIM B5 Blok No:1426,
16250 Osmangazi
BURSA
Ph: 90-530-498 91 77

IGE+XAO UK www.ige-xao.co.uk

Eliot Park Innovation Centre
4 Barling Way
NUNEATON
Warwickshire
CV10 7RH
Ph: +44 (0)247 679 6426
Fax : +44 (0)247 679 6427

IGE+XAO USA www.ige-xao.com

2540 King Arthur Blvd.
Suite 209-M
LEWISVILLE, TX 75056
Ph: +1 (972) 410-3610
Fax: +1 (972) 410-3611



www.ige-xao.com