



# Intel® Server Board S3420GP

## *Technical Product Specification*

*Intel order number E65697-010*



**Revision 2.4**

**January, 2011**

**Enterprise Platforms and Services Division - Marketing**

---

## Revision History

Date	Revision Number	Modifications
Feb. 2009	0.3	Initial release.
May 2009	0.5	Update block diagram.
July. 2009	0.9	Updated POST error code and diagram.
Aug. 2009	1.0	Updated MTBF.
Nov. 2009	1.1	Additional details for memory configuration.
Dec. 2009	1.2	Added Intel® Server Board S3420GPV details.
Dec. 2009	2.0	Updated processor name.
Jan. 2010	2.1	Corrected the typo.
Apr. 2010	2.2	Corrected the typo, updated processor name and remove CCC certification marking information.
July. 2010	2.3	Corrected the typo.
Jan.2011	2.4	<ul style="list-style-type: none"><li>• Corrected the typo. Added RDIMM support on S3420GPV.</li><li>• Updated Table 45.</li><li>• Add USB device readiness beep code information.</li></ul>

## ***Disclaimers***

Information in this document is provided in connection with Intel® products. No license, express or implied, by estoppel or otherwise, to any intellectual property rights is granted by this document. Except as provided in Intel's Terms and Conditions of Sale for such products, Intel assumes no liability whatsoever, and Intel disclaims any express or implied warranty, relating to sale and/or use of Intel products including liability or warranties relating to fitness for a particular purpose, merchantability, or infringement of any patent, copyright or other intellectual property right. Intel products are not intended for use in medical, life saving, or life sustaining applications. Intel may make changes to specifications and product descriptions at any time, without notice.

Designers must not rely on the absence or characteristics of any features or instructions marked "reserved" or "undefined." Intel reserves these for future definition and shall have no responsibility whatsoever for conflicts or incompatibilities arising from future changes to them.

The Intel® Server Board S3420GP may contain design defects or errors known as errata which may cause the product to deviate from published specifications. Current characterized errata are available on request.

Intel Corporation server boards contain a number of high-density VLSI and power delivery components that need adequate airflow to cool. Intel's own chassis are designed and tested to meet the intended thermal requirements of these components when the fully integrated system is used together. It is the responsibility of the system integrator that chooses not to use Intel developed server building blocks to consult vendor datasheets and operating parameters to determine the amount of airflow required for their specific application and environmental conditions. Intel Corporation cannot be held responsible if components fail or the server board does not operate correctly when used outside any of their published operating or non-operating limits.

Intel, Pentium, Itanium, and Xeon are trademarks or registered trademarks of Intel Corporation.

\*Other brands and names may be claimed as the property of others.

Copyright © 2011 Intel Corporation

## Table of Contents

<b>1. Introduction</b> .....	<b>1</b>
1.1 Chapter Outline .....	1
1.2 Server Board Use Disclaimer.....	1
<b>2. Overview</b> .....	<b>2</b>
2.1 Intel® Server Board S3420GP Feature Set.....	2
2.2 Server Board Layout .....	5
2.2.1 Server Board Connector and Component Layout .....	6
2.2.2 Intel® Server Board S3420GP Mechanical Drawings.....	8
2.2.3 Server Board Rear I/O Layout .....	14
<b>3. Functional Architecture</b> .....	<b>15</b>
3.1 Processor Sub-System .....	17
3.1.1 Intel® Xeon® Processor 3400 Series.....	17
3.1.2 Intel® Core™ Processor i3-500 Series and Intel® Pentium® Processor G6950.....	17
3.1.3 Intel® Turbo Boost Technology .....	17
3.1.4 Simultaneous Multithreading (SMT) .....	18
3.1.5 Enhanced Intel SpeedStep® Technology.....	18
3.2 Memory Subsystem.....	18
3.2.1 Memory Sizing and Configuration.....	18
3.2.2 Post Error Codes .....	19
3.2.3 Publishing System Memory .....	20
3.2.4 Memory Map and Population Rules.....	21
3.3 Intel® 3420 Chipset PCH.....	24
3.4 I/O Sub-system.....	25
3.4.1 PCI Express Interface .....	25
3.4.2 Serial ATA Support.....	26
3.4.3 USB 2.0 Support .....	26
3.5 Optional Intel® SAS Entry RAID Module AXX4SASMOD.....	27
3.6 Integrated Baseboard Management Controller .....	27
3.6.1 Integrated BMC Embedded LAN Channel.....	29
3.6.2 Optional RMM3 Advanced Management Board .....	29
3.6.3 Serial Ports .....	30
3.6.4 Floppy Disk Controller .....	30
3.6.5 Keyboard and Mouse Support .....	30
3.6.6 Wake-up Control .....	31
3.7 Video Support.....	31
3.7.1 Intel® Server Board S3420GPLX and Intel® Server Board S3420GPLC .....	31
3.7.2 Video for Intel® Server Board S3420GPV.....	32
3.8 Network Interface Controller (NIC) .....	33
3.8.1 GigE Controller 82574L.....	33

3.8.2	GigE PHY 82578DM .....	33
3.8.3	MAC Address Definition .....	33
3.9	Intel® I/O Acceleration Technology 2 (Intel® I/OAT2) .....	34
3.9.1	Direct Cache Access (DCA).....	34
3.10	Intel® Virtualization Technology for Directed I/O (Intel® VT-d).....	34
<b>4.</b>	<b>Platform Management .....</b>	<b>35</b>
4.1	Feature Support .....	35
4.1.1	IPMI 2.0 Features.....	35
4.1.2	Non-IPMI Features .....	36
4.2	Optional Advanced Management Feature Support.....	37
4.2.1	Enabling Advanced Management Features .....	37
4.2.2	Keyboard, Video, Mouse (KVM) Redirection.....	37
4.2.3	Media Redirection .....	38
4.2.4	Web Services for Management (WS-MAN).....	38
4.2.5	Local Directory Authentication Protocol (LDAP).....	39
4.2.6	Embedded Webserver .....	39
4.3	Management Engine (ME) .....	39
<b>5.</b>	<b>Server Management Capability for Intel® Server Board S3420GPV .....</b>	<b>40</b>
5.1	Super I/O .....	40
5.1.1	Key Features of Super I/O .....	40
5.1.2	Sensor and Hardware Monitor .....	40
5.1.3	Fan controller (Manual).....	42
5.1.4	Voltage and Temperature Status Screen .....	44
5.2	SMBIOS.....	45
5.2.1	Data Storage .....	45
5.3	Event log and Viewer .....	45
5.3.1	Event Log Viewer in Setup.....	45
<b>6.</b>	<b>BIOS User Interface .....</b>	<b>47</b>
6.1	Logo/Diagnostic Screen .....	47
6.2	BIOS Boot Popup Menu.....	47
6.3	BIOS Setup utility .....	47
6.3.1	Operation.....	48
6.3.2	Server Platform Setup Utility Screens .....	50
6.4	Loading BIOS Defaults.....	74
<b>7.</b>	<b>Connector/Header Locations and Pin-outs .....</b>	<b>76</b>
7.1	Board Connector Information .....	76
7.2	Power Connectors.....	76
7.3	System Management Headers .....	77
7.3.1	Intel® Remote Management Module 3 (Intel® RMM3) Connector .....	77
7.3.2	LCP/IPMB Header.....	78
7.3.3	HSBP Header.....	78

7.3.4	SGPIO Header .....	79
7.4	Front Control Panel Connector .....	79
7.4.1	Power Button .....	80
7.4.2	Reset Button .....	80
7.4.3	NMI Button .....	80
7.4.4	System Status Indicator LED .....	80
7.5	I/O Connectors .....	81
7.5.1	VGA Connector .....	81
7.5.2	Rear NIC and USB connector .....	82
7.5.3	SATA .....	83
7.5.4	50-pin PCI Express* Connector .....	83
7.5.5	Serial Port Connectors .....	84
7.5.6	USB Connector .....	84
7.6	PCI Express* Slot/PCI Slot/Riser Card Slot / .....	85
7.7	Fan Headers .....	90
<b>8.</b>	<b>Jumper Blocks .....</b>	<b>91</b>
8.1	CMOS Clear and Password Reset Usage Procedure .....	92
8.1.1	Clearing the CMOS .....	92
8.1.2	Clearing the Password .....	92
8.2	Integrated BMC Force Update Procedure (only for the Intel® Server Board S3420GPLX and S3420GPLC) .....	93
8.3	ME Force Update Jumper .....	93
8.4	BIOS Recovery Jumper .....	94
<b>9.</b>	<b>Intel® Light Guided Diagnostics .....</b>	<b>95</b>
9.1	System Status LED (For the Intel® Server Board S3420GPLX and S3420GPLC) .....	95
9.2	Post Code Diagnostic LEDs .....	96
<b>10.</b>	<b>Design and Environmental Specifications .....</b>	<b>97</b>
10.1	Intel® Server Board S3420GP Design Specifications .....	97
10.2	Board-level Calculated MTBF .....	97
10.3	Server Board Power Requirements .....	98
10.3.1	Processor Power Support .....	98
10.4	Power Supply Output Requirements .....	99
10.4.1	Grounding .....	99
10.4.2	Standby Outputs .....	99
10.4.3	Remote Sense .....	99
10.4.4	Voltage Regulation .....	100
10.4.5	Dynamic Loading .....	100
10.4.6	Capacitive Loading .....	100
10.4.7	Closed-loop Stability .....	100
10.4.8	Common Mode Noise .....	101
10.4.9	Ripple/Noise .....	101

10.4.10	Timing Requirements .....	101
10.4.11	Residual Voltage Immunity in Standby Mode.....	103
10.4.12	Protection Circuits .....	103
<b>11.</b>	<b>Regulatory and Certification Information.....</b>	<b>105</b>
11.1	Product Regulatory Compliance .....	105
11.1.1	Product Safety Compliance .....	105
11.1.2	Product EMC Compliance – Class A Compliance.....	105
11.1.3	Certifications/Registrations/Declarations .....	106
11.1.4	Product Ecology Requirements .....	106
11.2	Product Regulatory Compliance Markings .....	107
11.3	Electromagnetic Compatibility Notices .....	109
11.3.1	FCC Verification Statement (USA) .....	109
11.3.2	ICES-003 (Canada).....	110
11.3.3	Europe (CE Declaration of Conformity) .....	110
11.3.4	VCCI (Japan).....	110
11.3.5	BSMI (Taiwan).....	111
11.3.6	RRL (Korea) .....	111
	<b>Appendix A: Integration and Usage Tips .....</b>	<b>112</b>
	<b>Appendix B: Integrated BMC Sensor Tables.....</b>	<b>113</b>
	<b>Appendix C: POST Code Diagnostic LED Decoder .....</b>	<b>119</b>
	<b>Appendix D: POST Code Errors.....</b>	<b>123</b>
	<b>Appendix E: Supported Intel® Server Chassis .....</b>	<b>128</b>
	<b>Glossary .....</b>	<b>129</b>
	<b>Reference Documents .....</b>	<b>132</b>

## List of Figures

Figure 1. Intel® Server Board S3420GPLX Picture .....	5
Figure 2. Intel® Server Board S3420GP Layout.....	6
Figure 3. Intel® Server Board S3420GP – Key Connector and LED Indicator IDENTIFICATION	8
Figure 4. Intel® Server Board S3420GP – Hole and Component Positions .....	9
Figure 5. Intel® Server Board S3420GP – Major Connector Pin Location (1 of 2).....	10
Figure 6. Intel® Server Board S3420GP –Major Connector Pin Location (2 of 2).....	11
Figure 7. Intel® Server Board S3420GP – Primary Side Keepout Zone.....	12
Figure 8. Intel® Server Board S3420GP – Secondary Side Keepout Zone.....	13
Figure 9. Intel® Server Board S3420GP Rear I/O Layout.....	14
Figure 10. Intel® Server Board S3420GP Functional Block Diagram For S3420GPLX .....	15
Figure 11. Intel® Server Board S3420GP Functional Block Diagram From S3420GPLC.....	16
Figure 12. Intel® Server Board S3420GP Functional Block Diagram From S3420GPV .....	17
Figure 13. Integrated BMC Hardware .....	29
Figure 14. Server Management Bus (SMBUS) Block Diagram .....	35
Figure 15. Setup Utility — Hardware Monitor Screen Display .....	41
Figure 16. Setup Utility — Fan controller (Manual) Display.....	43
Figure 17. Setup Utility — Voltage and Temperature Status Screen .....	44
Figure 18. Event Log Viewer .....	46
Figure 19. Setup Utility – Main Screen Display.....	51
Figure 20. Setup Utility – Advanced Screen Display .....	53
Figure 21. Setup Utility – Processor Configuration Screen Display .....	54
Figure 22. Setup Utility – Memory Configuration Screen Display.....	56
Figure 23. Setup Utility – Mass Storage Controller Configuration Screen Display .....	58
Figure 24. Setup Utility – Serial Port Configuration Screen Display.....	59
Figure 25. Setup Utility – USB Controller Configuration Screen Display .....	60
Figure 26. Setup Utility – PCI Configuration Screen Display.....	62
Figure 27. Setup Utility – System Acoustic and Performance Configuration Screen Display.....	63
Figure 28. Setup Utility – Security Configuration Screen Display.....	64
Figure 29. Setup Utility – Server Management Configuraiton Screen Display.....	66
Figure 30. Setup Utility – Console Redirection Screen Display.....	67
Figure 31. Setup Utility – Server Management System Information Screen Display.....	69
Figure 32. Setup Utility – Boot Options Screen Display .....	70
Figure 33. Setup Utility – Delete Boot Option Screen Display.....	71
Figure 34. Setup Utility — Hard Disk Order Screen Display.....	72
Figure 35. Setup Utility – CDROM Order Screen Display .....	72
Figure 36. Setup Utility — Floppy Order Screen Display.....	73
Figure 37. Setup Utility – Network Device Order Screen Display.....	73
Figure 38. Setup Utility – Boot Manager Screen Display.....	74
Figure 39. Jumper Blocks (J1A2, J1F1, J1F3, J1F2 and J1F5) .....	91



Figure 40. Power Distribution Block Diagram .....	98
Figure 41. Output Voltage Timing.....	102
Figure 42. Turn On/Off Timing (Power Supply Signals) .....	103
Figure 43. Diagnostic LED Placement Diagram .....	119

## List of Tables

Table 1. Intel® Server Board S3420GP Feature Set .....	2
Table 2. Major Board Components .....	7
Table 3. Standard Platform DIMM Nomenclature .....	21
Table 4. Memory Configuration Table .....	22
Table 5. UDIMM memory configuration rule .....	23
Table 6. UDIMM Maximum configuration .....	23
Table 7. RDIMM memory configuration rule .....	24
Table 8. RDIMM Maximum configuration .....	24
Table 9. Optional RMM3 Advanced Management Board Features .....	30
Table 10. Serial B Header (J1B1) Pin-out .....	30
Table 11. Video Modes .....	31
Table 12. Dual Video Modes .....	32
Table 13. Setup Utility — Hardware Monitor Screen Fields .....	41
Table 14. Setup Utility — Hardware Monitor Screen Fields .....	43
Table 15. Setup Utility — Voltage and Temperature Status Fields .....	44
Table 16. BIOS Setup Page Layout .....	48
Table 17. BIOS Setup: Keyboard Command Bar .....	49
Table 18. Setup Utility – Main Screen Fields .....	51
Table 19. Setup Utility – Advanced Screen Display Fields .....	53
Table 20. Setup Utility – Processor Configuration Screen Fields .....	54
Table 21. Setup Utility – Memory Configuration Screen Fields .....	56
Table 22. Setup Utility – Mass Storage Controller Configuration Screen Fields .....	58
Table 23. Setup Utility – Serial Ports Configuration Screen Fields .....	59
Table 24. Setup Utility – USB Controller Configuration Screen Fields .....	61
Table 25. Setup Utility – PCI Configuration Screen Fields .....	62
Table 26. Setup Utility – System Acoustic and Performance Configuration Screen Fields .....	63
Table 27. Setup Utility – Security Configuration Screen Fields .....	64
Table 28. Setup Utility – Server Management Configuration Screen Fields .....	66
Table 29. Setup Utility – Console Redirection Configuration Fields .....	68
Table 30. Setup Utility – Server Management System Information Fields .....	69
Table 31. Setup Utility – Boot Options Screen Fields .....	70
Table 32. Setup Utility – Delete Boot Option Fields .....	72
Table 33. Setup Utility — Hard Disk Order Fields .....	72
Table 34. Setup Utility – CDROM Order Fields .....	73
Table 35. Setup Utility — Floppy Order Fields .....	73
Table 36. Setup Utility – Network Device Order Fields .....	74
Table 37. Setup Utility – Boot Manager Screen Fields .....	74
Table 38. Board Connector Matrix .....	76
Table 39. Baseboard Power Connector Pin-out (J9A1) .....	77

Table 40. SSI Processor Power Connector Pin-out (J9C1).....	77
Table 41. Intel® RMM3 Connector Pin-out (J2C1).....	78
Table 42. LPC/IPMB Header Pin-out (J1H2).....	78
Table 43. HSBP Header Pin-out (J1J1).....	78
Table 44. SGPIO Header Pin-out (J1J3).....	79
Table 45. Front Panel SSI Standard 24-pin Connector Pin-out (J1C1).....	79
Table 46. System Status LED Indicator States.....	80
Table 47. VGA Connector Pin-out (J7A1).....	81
Table 48. RJ-45 10/100/1000 NIC Connector Pin-out (J5A1).....	82
Table 49. RJ-45 10/100/1000 NIC Connector Pin-out (J6A1).....	82
Table 50. SATA Connector Pin-out (J1H4, J1H1, J1G1, J1H3, J1G3, J1F4).....	83
Table 51. 50-pin PCI Express* Connector Pin-out (J2H1).....	83
Table 52. External Serial A Port Pin-out (J8A1).....	84
Table 53. Internal 9-pin Serial B Header Pin-out (J1B2).....	84
Table 54. Internal USB Connector Pin-out ( J1E1, J1D1).....	84
Table 55. Pin-out of Internal USB Connector for Floppy ( J1J2).....	85
Table 56. Pin-out of Internal USB Connector for low-profile Intel® Z-U130 Value Solid State Drive (J3F2).....	85
Table 57. Pin-out of adaptive riser slot/PCI Express slot 6.....	85
Table 58. SSI 4-pin Fan Header Pin-out (J6D1, J1J4, J6J2, J7J1, J6B1).....	90
Table 59. Server Board Jumpers (J1F1, J1F2, J1F3, J1F5, J1A2).....	91
Table 60. Front Panel Status LED Behavior Summary.....	95
Table 61. POST Code Diagnostic LED Location.....	96
Table 62. Server Board Design Specifications.....	97
Table 63. Intel® Xeon® Processor TDP Guidelines.....	98
Table 64. 350-W Load Ratings.....	99
Table 65. Voltage Regulation Limits.....	100
Table 66. Transient Load Requirements.....	100
Table 67. Capacitive Loading Conditions.....	100
Table 68. Ripple and Noise.....	101
Table 69. Output Voltage Timing.....	101
Table 70. Turn On/Off Timing.....	102
Table 71. Over-Current Protection (OCP).....	104
Table 72. Over-voltage Protection (OVP) Limits.....	104
Table 73. Integrated BMC Core Sensors.....	115
Table 74. POST Progress Code LED Example.....	119
Table 75. Diagnostic LED POST Code Decoder.....	120
Table 76. POST Error Messages and Handling.....	123
Table 77. POST Error Beep Codes.....	127

**<This page is intentionally left blank.>**

# 1. Introduction

---

This Technical Product Specification (TPS) provides board specific information detailing the features, functionality, and high-level architecture of the Intel® Server Board S3420GP.

In addition, you can obtain design-level information for specific subsystems by ordering the External Product Specifications (EPS) or External Design Specifications (EDS) for a given subsystem. EPS and EDS documents are not publicly available and must be ordered through your local Intel representative.

## 1.1 Chapter Outline

This document is divided into the following chapters:

- Chapter 1 – Introduction
- Chapter 2 – Server Board Overview
- Chapter 3 – Functional Architecture
- Chapter 4 – Platform Management
- Chapter 5 – BIOS User Interface
- Chapter 6 – Connector/Header Locations and Pin-outs
- Chapter 7 – Jumpers Blocks
- Chapter 8 – Intel® Light-Guided Diagnostics
- Chapter 9 – Design and Environmental Specifications
- Chapter 10 – Regulatory and Certification Information
- Chapter 11 – Regulatory and Certification Information
- Appendix A – Integration and Usage Tips
- Appendix B – Integrated BMC Sensor Tables
- Appendix C – POST Code Diagnostic LED Decoder
- Appendix D – POST Code Errors
- Appendix E – Supported Intel® Server Chassis
- Glossary
- Reference Documents

## 1.2 Server Board Use Disclaimer

Intel Corporation server boards contain a number of high-density VLSI and power delivery components that need adequate airflow to cool. Intel ensures through its own chassis development and testing that when Intel server building blocks are used together, the fully integrated system meets the intended thermal requirements of these components. It is the responsibility of the system integrator who chooses not to use Intel developed server building blocks to consult vendor datasheets and operating parameters to determine the amount of airflow required for their specific application and environmental conditions. Intel Corporation cannot be held responsible if components fail or the server board does not operate correctly when used outside any of their published operating or non-operating limits.

## 2. Overview

The Intel® Server Board S3420GP is a monolithic printed circuit board (PCB) with features designed to support entry-level servers. It has three board SKUs: S3420GPLX, S3420GPLC, and S3420GPV.

### 2.1 Intel® Server Board S3420GP Feature Set

**Table 1. Intel® Server Board S3420GP Feature Set**

Feature	Description
Processor	Support for one Xeon® Processor 3400 Series or Intel® Core™ Processor i3-500 Series or Intel® Pentium® Processor G6950 in FC-LGA 1156 socket package. <ul style="list-style-type: none"> <li>2.5 GT/s point-to-point DMI interface to PCH</li> <li>LGA 1156 pin socket</li> </ul>
Memory	Two memory channels with support for 1066/1333 MHz ECC Unbuffered (UDIMM) or ECC Registered (RDIMM) (Intel® Xeon® Processor 3400 Series only) DDR3. Intel® Server Board S3420GPLX and S3420GPLC <ul style="list-style-type: none"> <li>Up to 2 UDIMMs or 3 RDIMM (Intel® Xeon® Processor 3400 Series only) per channel</li> <li>32 GB max with x8 ECC RDIMM (2 Gb DRAM) and 16 GB max with x8 ECC UDIMM (2 Gb DRAM)</li> </ul> Intel® Server Board S3420GPV <ul style="list-style-type: none"> <li>Up to 2 UDIMMs or 2 RDIMM (Intel® Xeon® Processor 3400 Series only) per channel</li> <li>16 GB max with x8 ECC UDIMM (2 Gb DRAM) and 16 GB max with x8 ECC RDIMM (2 Gb DRAM)</li> </ul>
Chipset	Intel® Server board S3420GPLX <ul style="list-style-type: none"> <li>Support for Intel® 3420 Chipset Platform Controller Hub (PCH)</li> <li>ServerEngines* LLC Pilot II BMC controller (Integrated BMC)</li> <li>PCI Express* switch</li> </ul> Intel® Server board S3420GPLC <ul style="list-style-type: none"> <li>Support for Intel® 3420 Chipset Platform Controller Hub (PCH)</li> <li>ServerEngines* LLC Pilot II BMC controller (Integrated BMC)</li> </ul> Intel® Server board S3420GPV <ul style="list-style-type: none"> <li>Support for Intel® 3420 Chipset Platform Controller Hub (PCH)</li> </ul>
I/O	External connections: <ul style="list-style-type: none"> <li>DB-15 video connectors</li> <li>DB-9 serial Port A connector</li> <li>Four ports on two USB/LAN combo connectors at rear of board.</li> </ul> Internal connections: <ul style="list-style-type: none"> <li>Two USB 2x5 pin headers, each supporting two USB 2.0 ports (Only one header for Intel® Server board S3420GPV)</li> <li>One 2x5 Serial Port B header (Intel® Server board S3420GPLX and S3420GPLC)</li> <li>Six SATA II connectors</li> <li>One connector supports for optional Intel® Remote Management Module 3 (Intel® Server board S3420GPLX)</li> </ul>

Feature	Description
Add-in PCI Card, PCI Express* Card	<p>Intel® Server Board S3420GPLX</p> <ul style="list-style-type: none"> <li>▪ Slot1: One 3.3V/5V PCI 32 bit/33 MHz connector.</li> <li>▪ Slot2: One PCI Express* Gen1 x4 (x1 throughput) connector.</li> <li>▪ Slot3: One PCI Express* Gen1 x8 (x4 throughput) connector.</li> <li>▪ Slot4: One PCI Express* Gen2 x8 (x4 throughput) connector.</li> <li>▪ Slot5: One PCI Express* Gen2 x8 (x8 throughput) connector.</li> <li>▪ Slot6: One PCI Express* Gen2 x16 (x8 throughput) connector.</li> </ul> <p>Intel® Server Board S3420GPLC/ S3420GPV</p> <ul style="list-style-type: none"> <li>▪ Slot1: One 3.3V/5V PCI 32 bit/33 MHz connector.</li> <li>▪ Slot3: One PCI Express* Gen1 x8 (x4 throughput) connector.</li> <li>▪ Slot5: One PCI Express* Gen2 x8 (x8 throughput) connector.</li> <li>▪ Slot6: One PCI Express* Gen2 x16 (x8 throughput) connector.</li> </ul>
System Fan Support	Five 4-pin fan headers supporting four system fans and one processor.
Video	<p>Intel® Server Board S3420GPLX/ S3420GPLC</p> <ul style="list-style-type: none"> <li>▪ Onboard ServerEngines* LLC Pilot II BMC Controller</li> <li>▪ Integrated 2D Video Controller with 8MB Video Memory</li> <li>▪ 64-MB DDR2 667 MHz Memory</li> </ul> <p>Intel® Server Board S3420GPV</p> <ul style="list-style-type: none"> <li>▪ Silicon Motion SM712GX04LF02-BA</li> </ul>
Onboard Hard Drive	<p>Support for six Serial ATA II hard drives through six onboard SATA II connectors with SW RAID 0, 1, 5, and 10.</p> <p>Intel® Server Board S3420GPLX:</p> <ul style="list-style-type: none"> <li>▪ Up to four SAS hard drives through option Intel® SAS Entry RAID Module card</li> </ul>
RAID Support	<p>Intel® Server Board S3420GPLX /S3420GPLC/S3420GPV</p> <ul style="list-style-type: none"> <li>▪ Intel® Rapid Storage RAID through onboard SATA connectors provides SATA RAID 0, 1, 5 and 10.</li> <li>▪ Intel® Embedded Server RAID Technology II through onboard SATA connectors provides SATA RAID 0, 1, and 10.</li> </ul> <p>Intel® Server Board S3420GPLX</p> <ul style="list-style-type: none"> <li>▪ Intel® Embedded Server RAID Technology II through optional Intel® SAS Entry RAID Module AXX4SASMOD provides SAS RAID 0, 1, and 10 with optional RAID 5 support provided by the Intel® RAID Activation Key AXXRAKSW5</li> <li>▪ IT/IR RAID through optional Intel® SAS Entry RAID Module AXX4SASMOD provides entry level hardware RAID 0, 1, 10, and native SAS pass through mode</li> <li>▪ Four ports full featured SAS/SATA hardware RAID through optional Intel® Integrated RAID Module SROMBSASMR (AXXROMBSASMR) provides RAID 0, 1, 5, 6 and striping capability for spans 10, 50, 60.</li> </ul>
LAN	<ul style="list-style-type: none"> <li>▪ One Gigabit Ethernet device 82574L connect to PCI-E x1 interfaces on the PCH.</li> <li>▪ One Gigabit Ethernet PHY 82578DM connected to PCH through PCI-E x1 interface.</li> </ul>

Feature	Description
Server Management	Intel® Server Board S3420GPLX/S3420GPLC: Onboard LLC Pilot II Controller (iBMC) <ul style="list-style-type: none"><li>▪ Integrated Baseboard Management Controller (Integrated BMC), IPMI 2.0 compliant</li><li>▪ Integrated 2D video controller on PCI-E x1</li></ul> Intel® Server Board S3420GPLX <ul style="list-style-type: none"><li>▪ Intel® Remote Management Module III (RMM3)</li></ul>



## 2.2 Server Board Layout

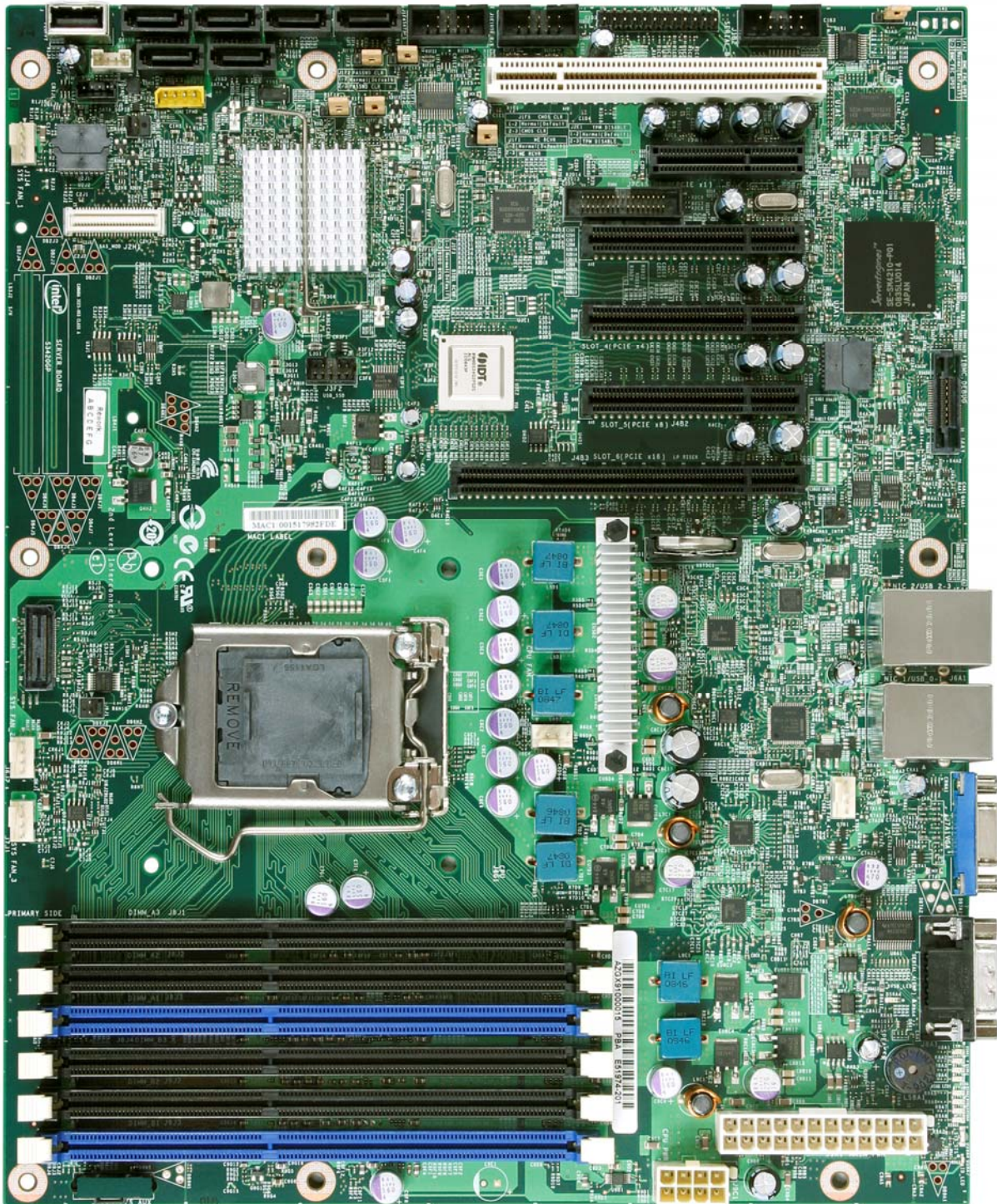
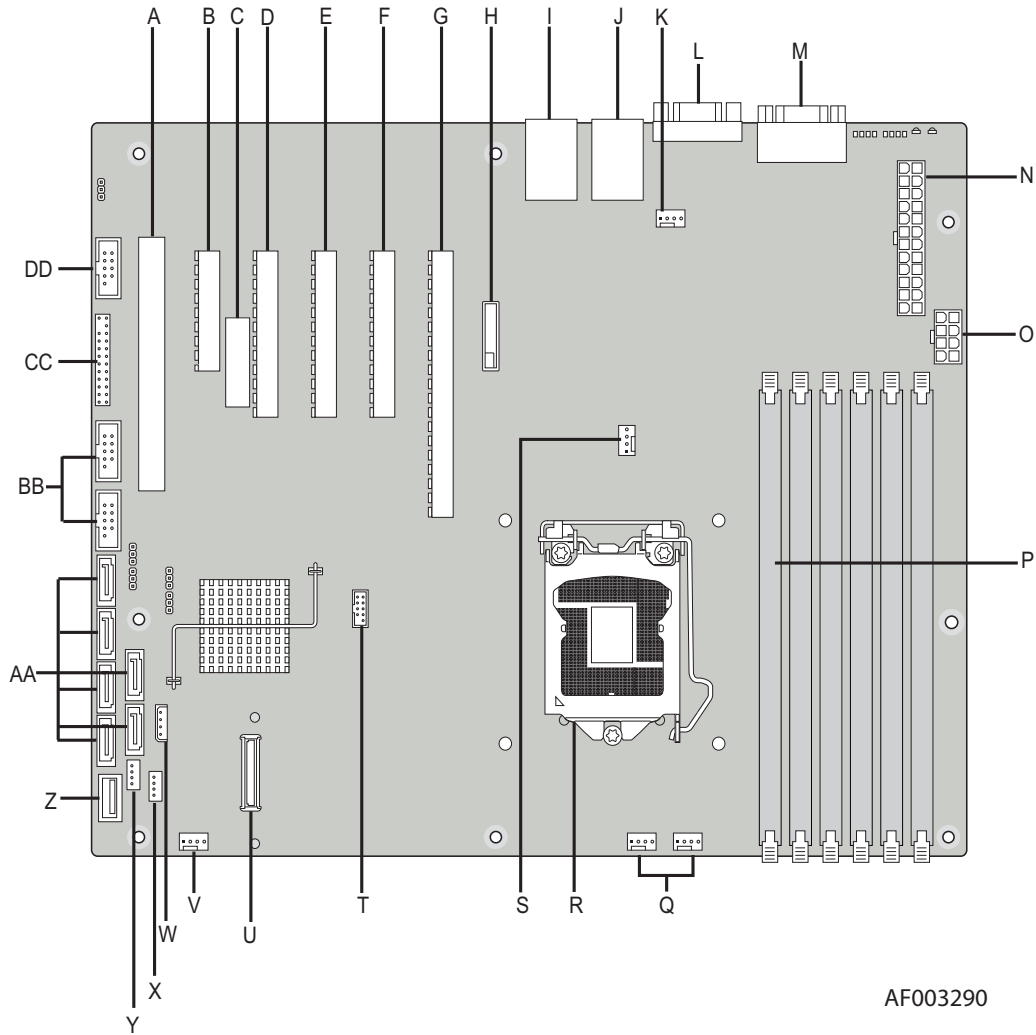

Figure 1. Intel® Server Board S3420GPLX Picture

### 2.2.1 Server Board Connector and Component Layout

The following figure shows the board layout of the server board. Each connector and major component is identified by a number or letter, and Table 2 provides the description.

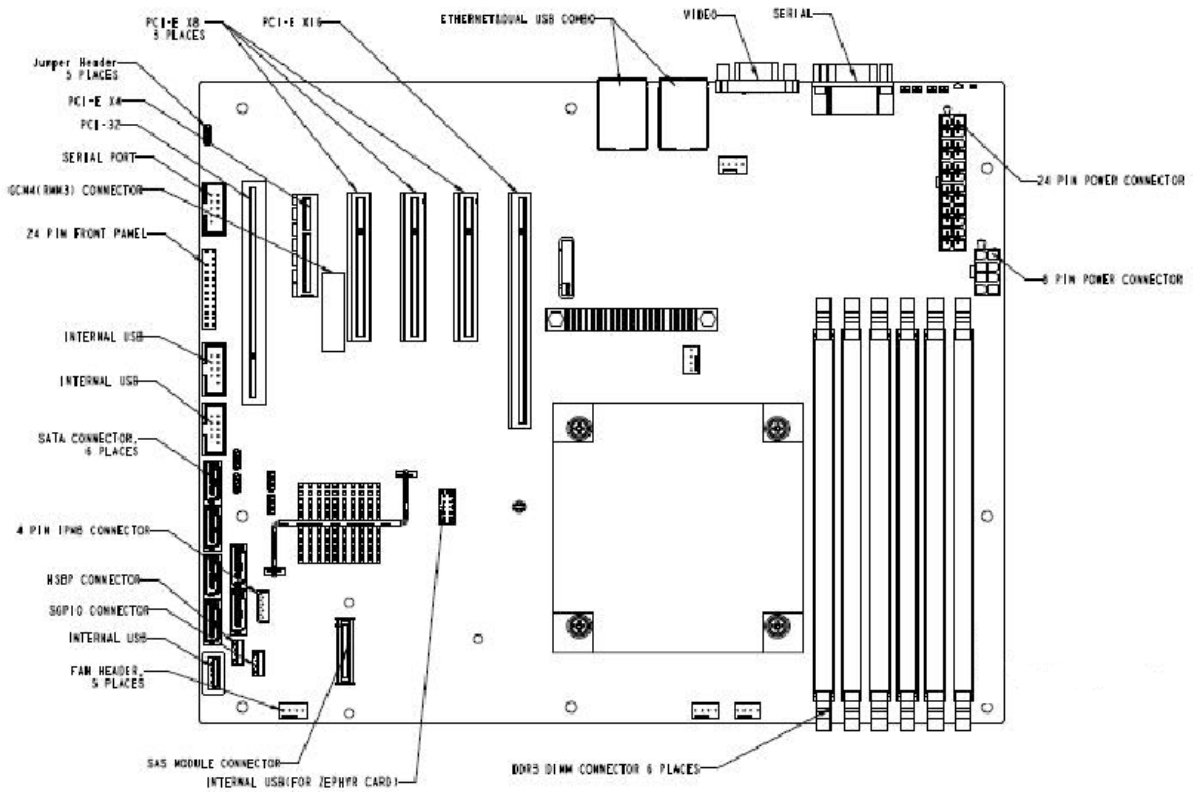

**Figure 2. Intel® Server Board S3420GP Layout**

**Table 2. Major Board Components**

	Description		Description
A	Slot 1, 32 Mbit/33 MHz PCI	Q	System FAN2 and System FAN 3
B	Slot 2, PCI Express* Gen1 x1 (x4 connector) (Intel Server Board S3420GPLX only)	R	CPU connector
C	Intel RMM3 Connector(Intel Server Board S3420GPLX only)	S	CPU Fan connector
D	Slot 3, PCI Express* Gen1 x4 (PCI Express* Gen2 compliant)	T	USB SSD connector (Intel® Server Board S3420GPLX and S3420GPLC)
E	Slot 4, PCI Express* Gen2 x4 (x8 connector) (x8 connector)( Intel® Server Board S3420GPLX only)	U	50-pin PCI Express* connector (Intel® Server Board S3420GPLX only)
F	Slot 5. PCI Express* Gen2 x8 (x8 connector)	V	System FAN 1 (Intel® Server Board S3420GPLX and S3420GPLC)
G	Slot 6, PCI Express* Gen2 x8 (x16 connector)	W	IPMB(Intel® Server Board S3420GPLX and S3420GPLC)
H	CMOS battery	X	SATA_SGPIO
I	Ethernet and Dual USB COMBO	Y	HSBP (Intel® Server Board S3420GPLX and S3420GPLC)
J	Ethernet and Dual USB COMBO	Z	USB Floppy (Intel® Server Board S3420GPLX and S3420GPLC)
K	System FAN 4	AA	Six SATA ports
L	Video port	BB	Internal USB Connector ( One for Internal USB header on Intel® Server Board S3420GPV)
M	External Serial port	CC	Front Panel Connector
N	Main Power Connector	DD	Internal Serial Port (Intel® Server Board S3420GPLX and S3420GPLC)
O	CPU Power connector		
P	DIMM slots (4 slots on Intel® Server Board S3420GPV)		

## 2.2.2 Intel® Server Board S3420GP Mechanical Drawings



**Figure 3. Intel® Server Board S3420GP – Key Connector and LED Indicator IDENTIFICATION**

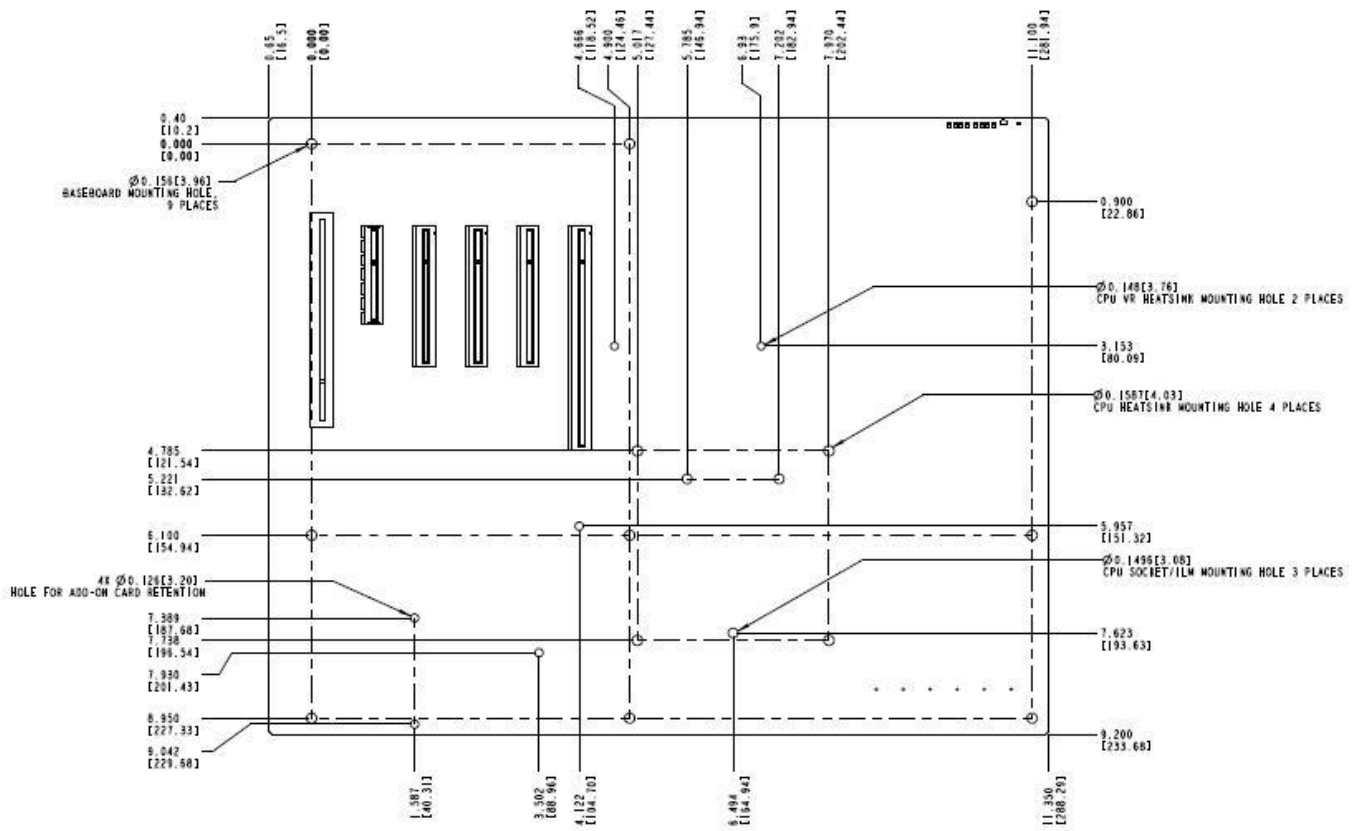

Figure 4. Intel® Server Board S3420GP – Hole and Component Positions

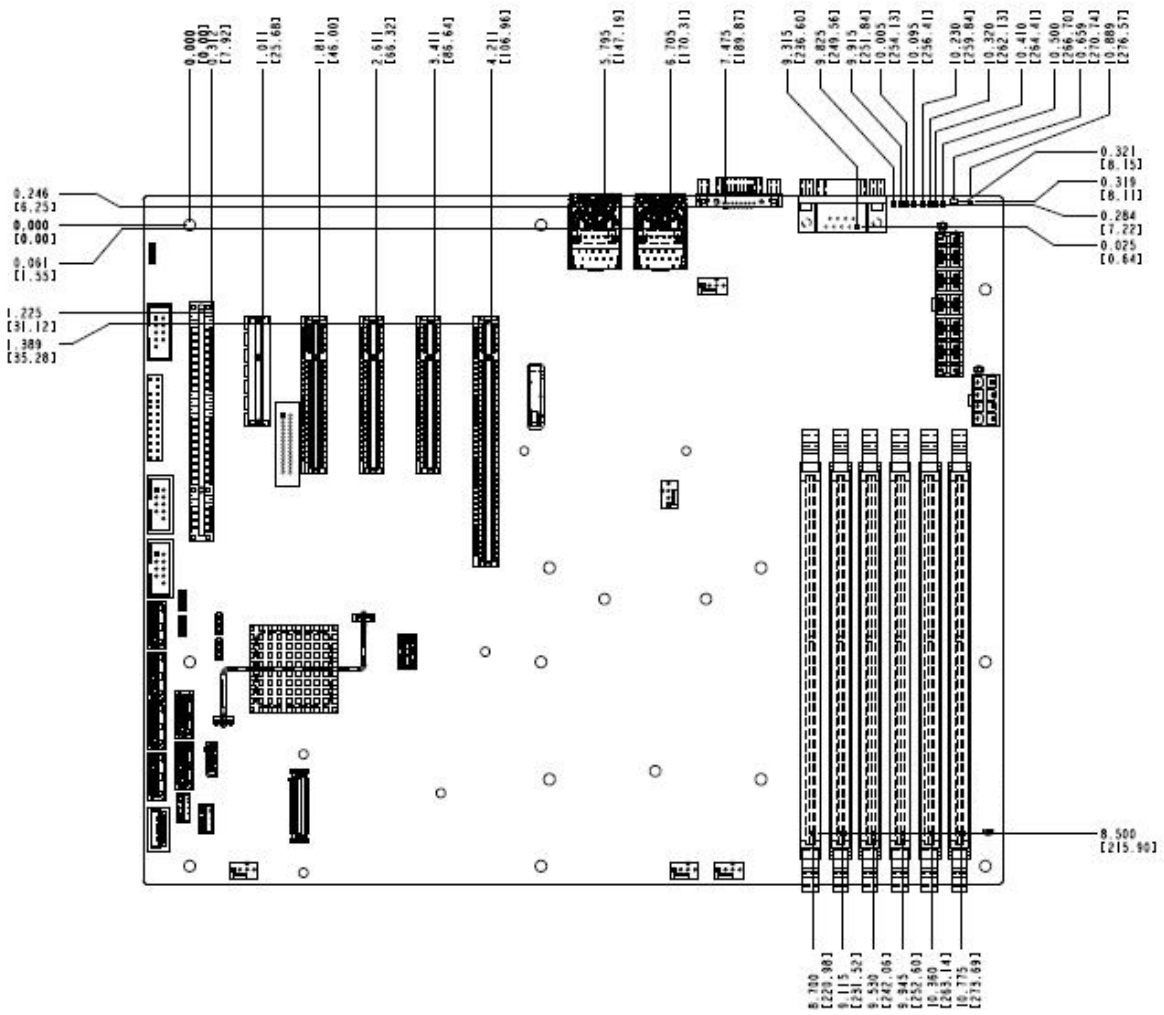

Figure 5. Intel® Server Board S3420GP – Major Connector Pin Location (1 of 2)

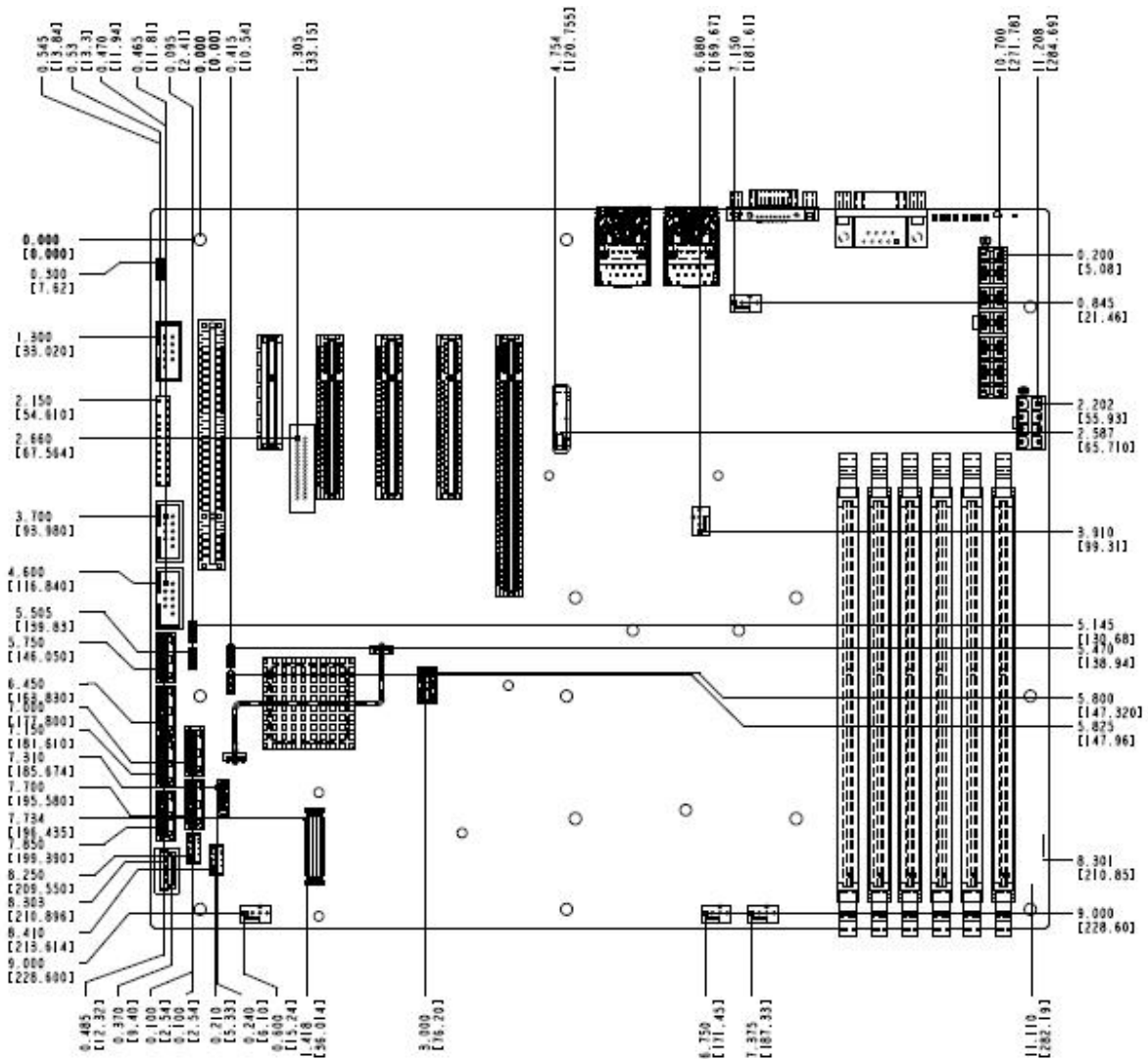

Figure 6. Intel® Server Board S3420GP –Major Connector Pin Location (2 of 2)

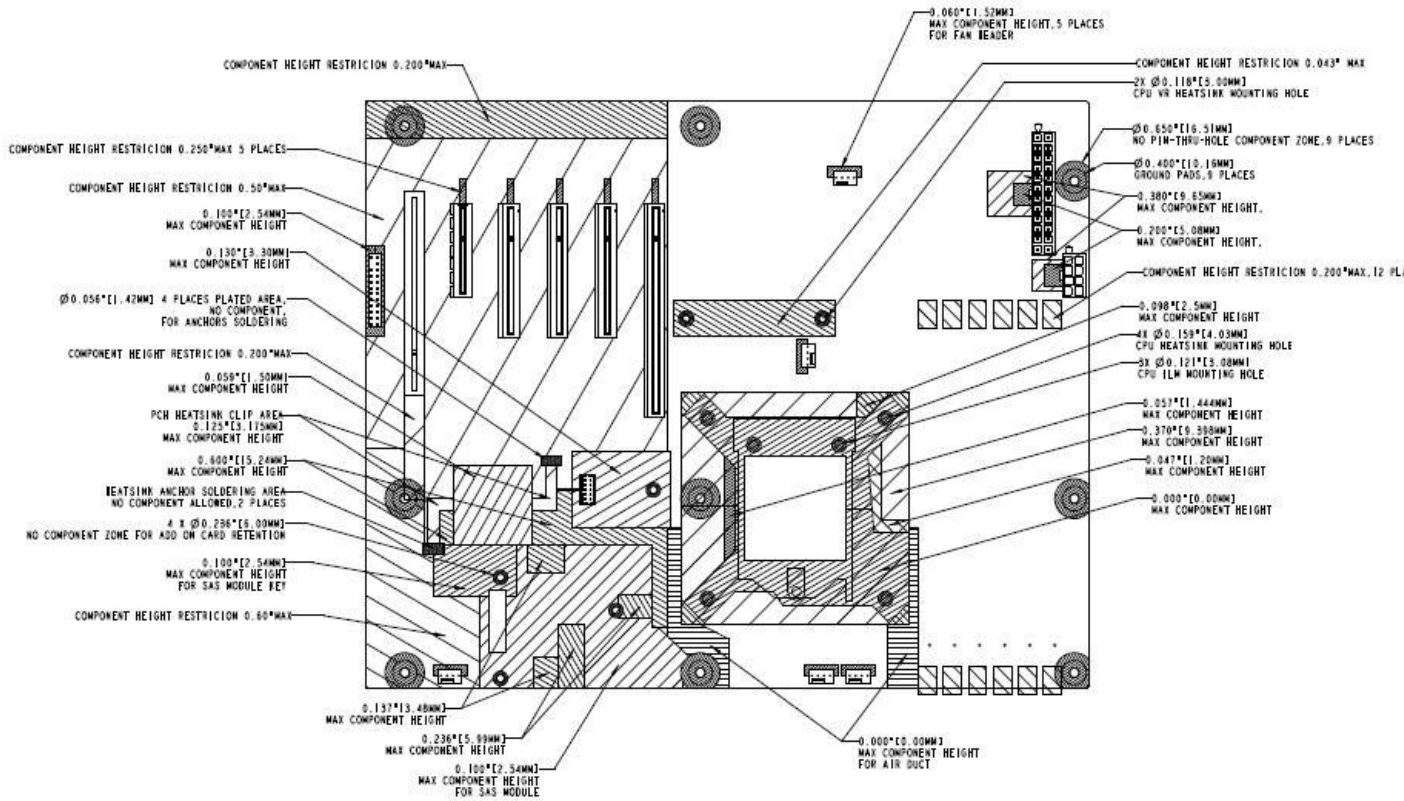

Figure 7. Intel® Server Board S3420GP – Primary Side Keepout Zone



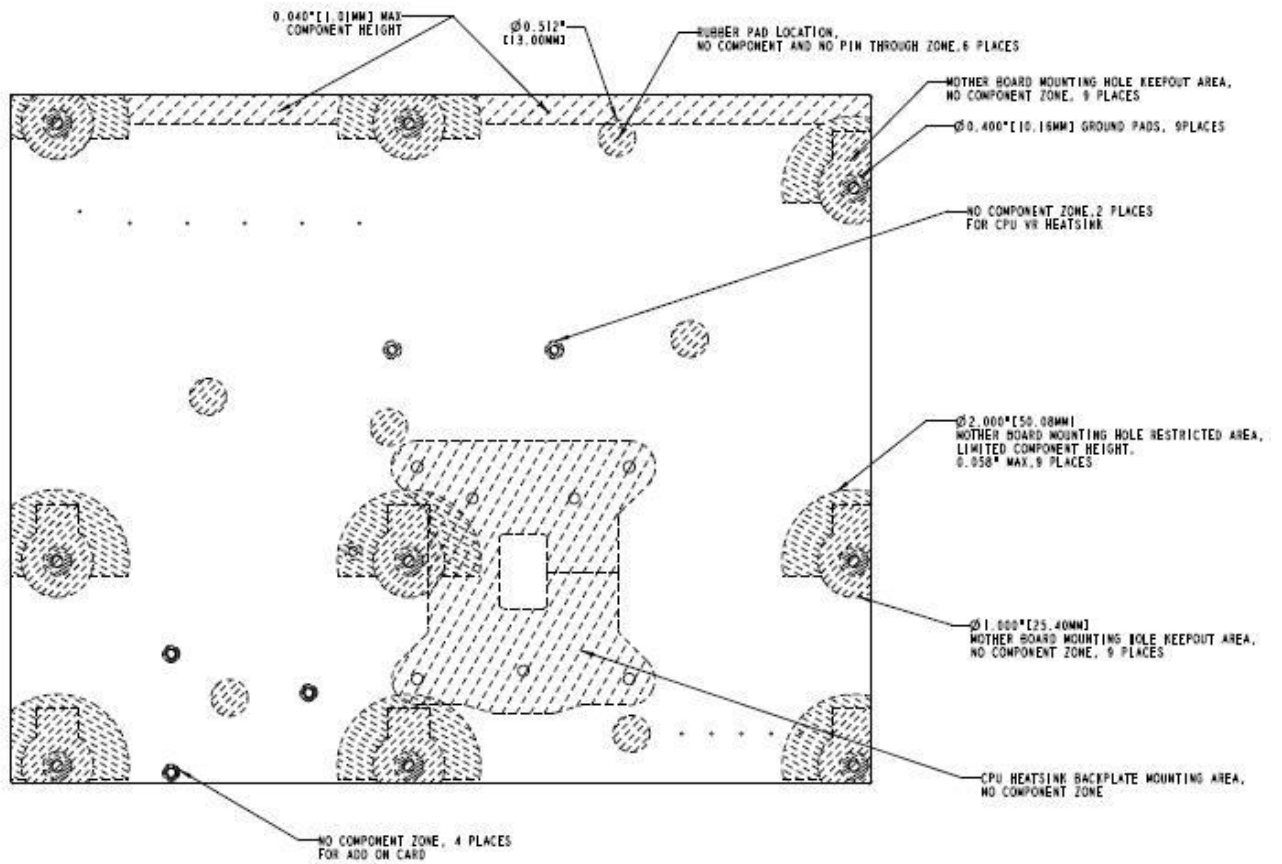
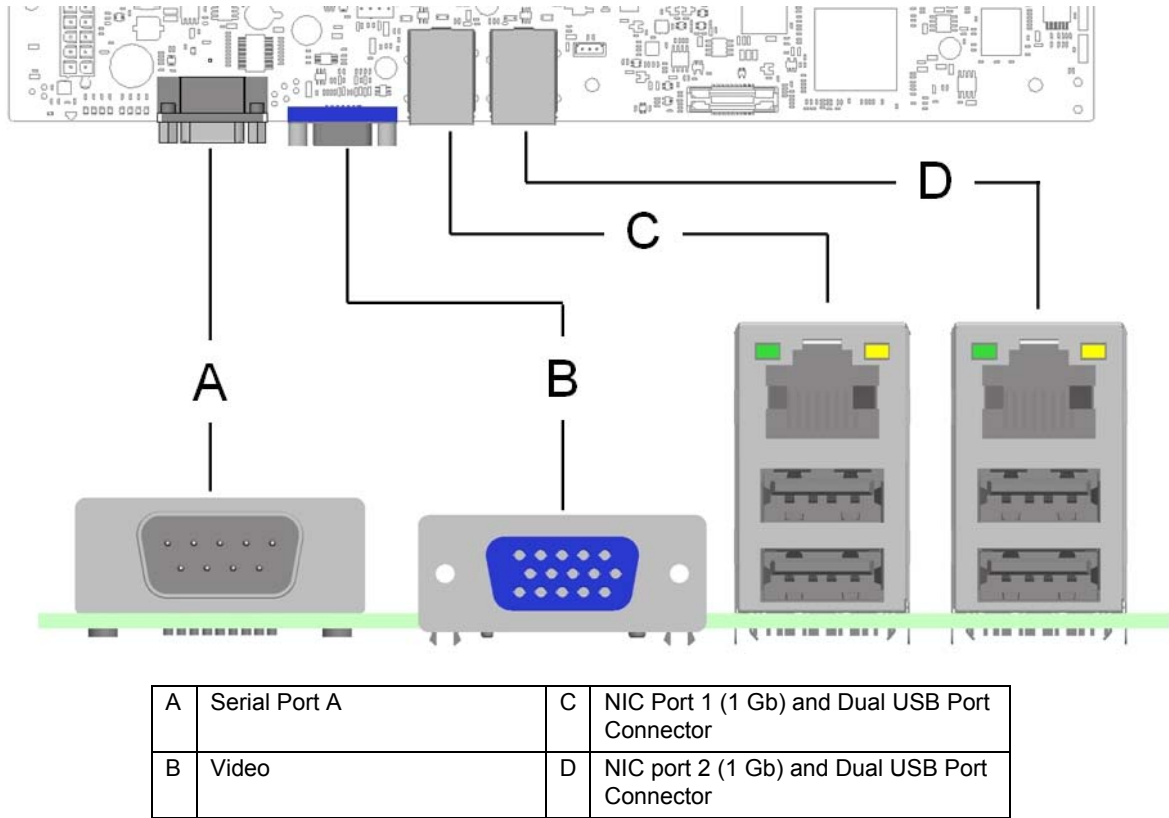

Figure 8. Intel® Server Board S3420GP – Secondary Side Keepout Zone

### 2.2.3 Server Board Rear I/O Layout

The following figure shows the layout of the rear I/O components for the server board.



**Figure 9. Intel® Server Board S3420GP Rear I/O Layout**

### 3. Functional Architecture

The architecture and design of the Intel® Server Board S3420GP is based on the Intel® 3420 Chipset. The chipset is designed for systems based on the Intel® Xeon® Processor 3400 Series or Intel® Core™ i3-500 Desktop Processor Series or Intel® Pentium® Processor Processor G6950 in the FC-LGA 1156 socket package. The chipset contains two main components:

- Intel® 3420 Chipset
- PCI Express\* switch (Intel® Server Board S3420GPLX only).

This chapter provides a high-level description of the functionality associated with each chipset component and the architectural blocks that make up the server board.

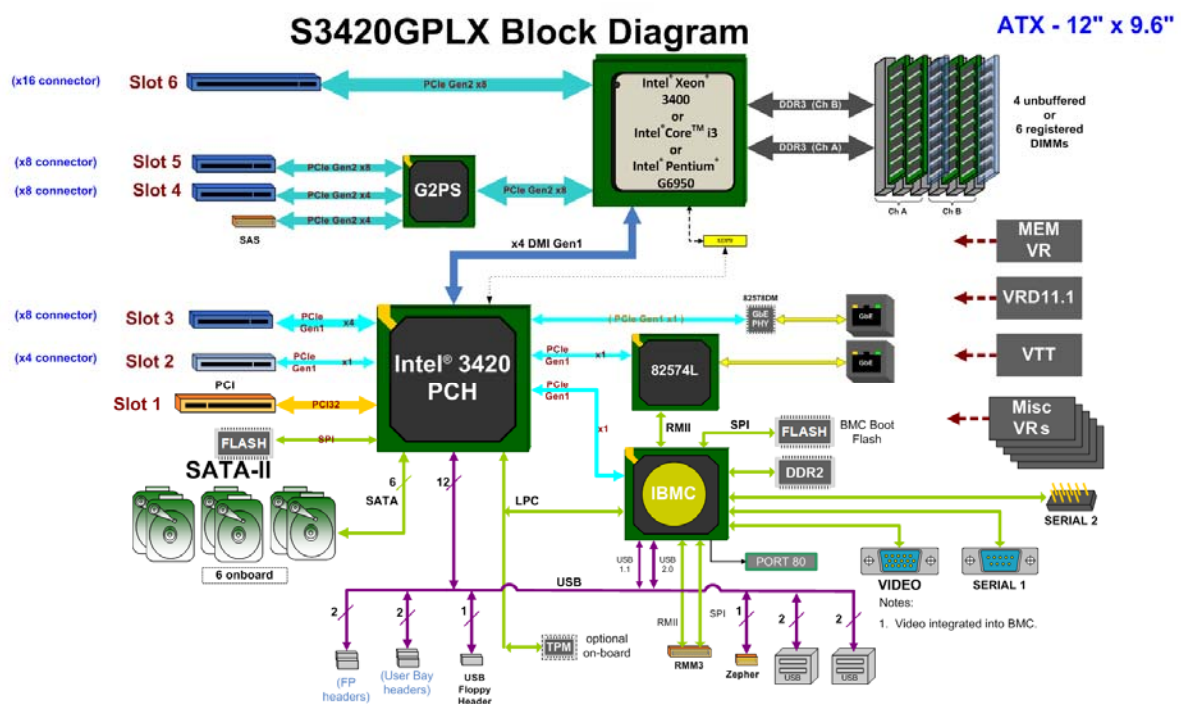

Figure 10. Intel® Server Board S3420GP Functional Block Diagram For S3420GPLX

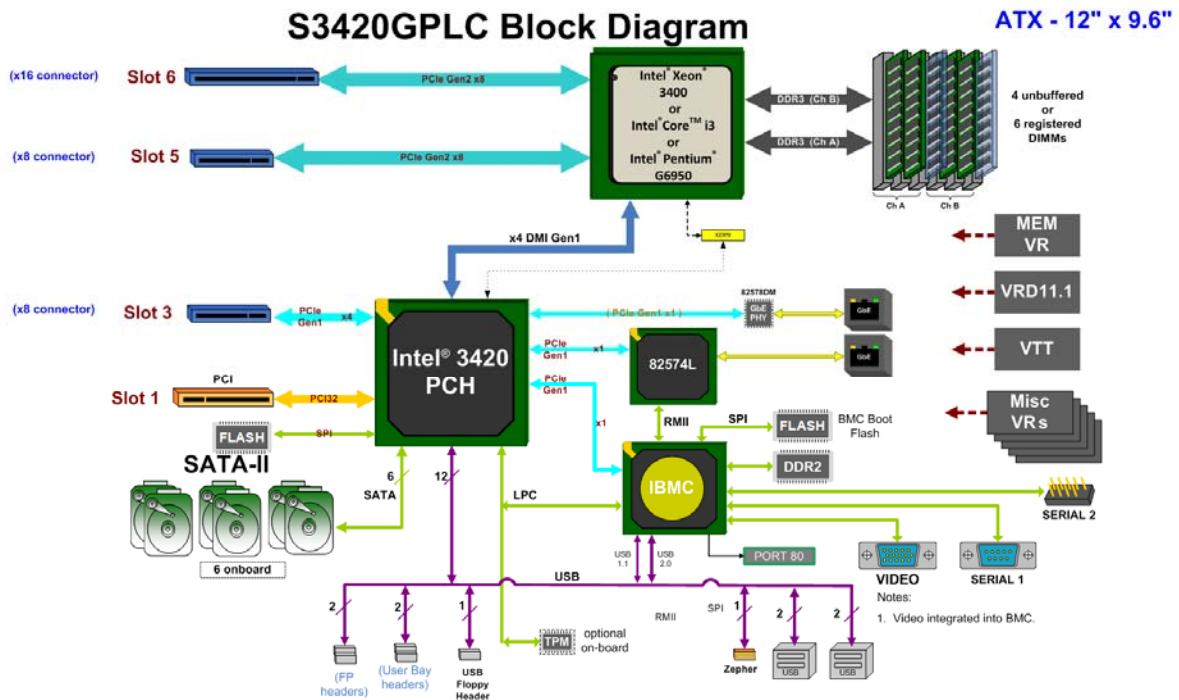
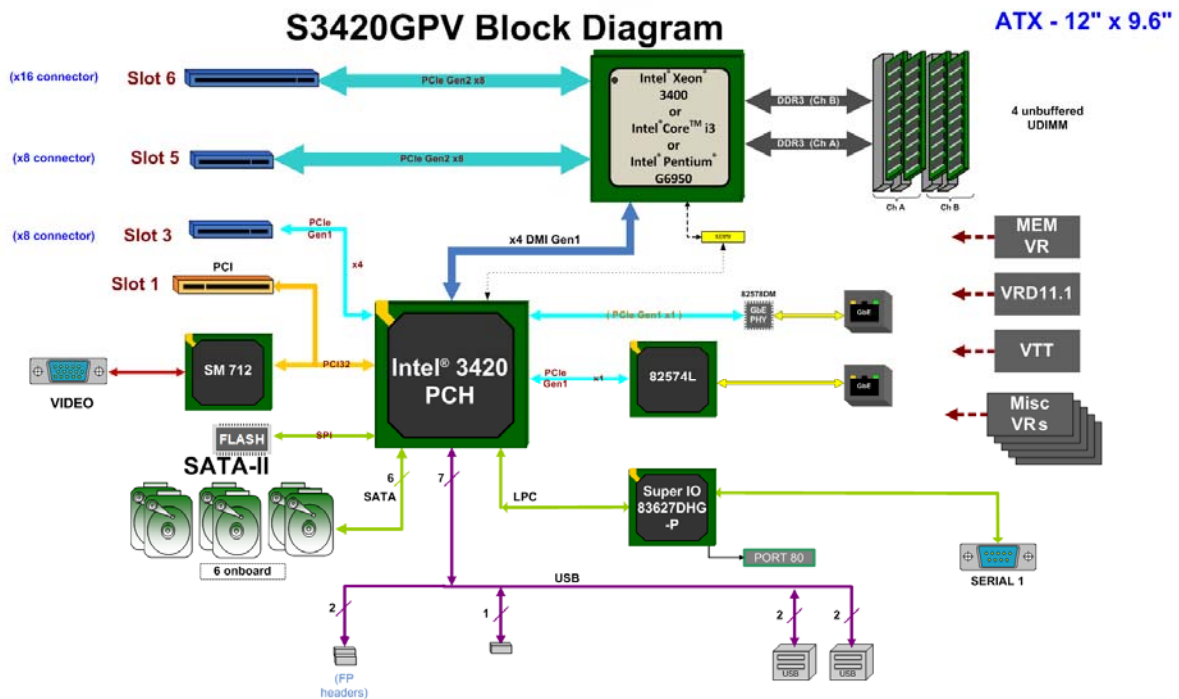

Figure 11. Intel® Server Board S3420GP Functional Block Diagram From S3420GPLC



**Figure 12. Intel® Server Board S3420GP Functional Block Diagram From S3420GPV**

## 3.1 Processor Sub-System

The Intel® Server Board S3420GP supports the following processor:

- Intel® Xeon® Processor 3400 series
- Intel® Core™ Processor i3-500 Desktop series
- Intel® Pentium® Processor G6950

The Intel® Xeon® 3400 Processor Series are made up of multi-core processors based on the 45 nm processor technology. The Intel® Core™ Processor i3-500 Series and Intel® Pentium® Processor G6950 are made up of dual core processor based on the 32 nm processor technology.

### 3.1.1 Intel® Xeon® Processor 3400 Series

The Intel® Xeon® Processor 3400 Series highly integrated solution variant is composed of four Nehalem-based processor cores.

- FC-LGA 1156 socket package with 2.5 GT/s.
- Up to 95 W Thermal Design Power (TDP); processors with higher TDP are not supported.

The server board does not support previous generations of the Intel® Xeon® processors.

### 3.1.2 Intel® Core™ Processor i3-500 Series and Intel® Pentium® Processor G6950

The Intel® Duo Core™ Processor i3-500 Series and Intel® Pentium® Processor G6950 highly integrated solution variant is composed of two processor cores.

- FC-LGA 1156 socket package with 2.5 GT/s.
- Up to 95 W Thermal Design Power (TDP); processors with higher TDP are not supported.

Please get the detail supported processor list from Intel website.

### 3.1.3 Intel® Turbo Boost Technology

Intel® Turbo Boost Technology is featured on certain processors in the Intel® Xeon® Processor 3400 Series. Intel® Turbo Boost Technology opportunistically and automatically allows the processor to run faster than the marked frequency if the processor is operating below power, temperature, and current limits. This results in increased performance for both multi-threaded and single-threaded workloads.

Intel® Turbo Boost Technology operation:

- Turbo Boost operates under Operating System control – It is only entered when the operating system requests the highest (P0) performance state.
- Turbo Boost operation can be enabled or disabled by BIOS.

- Turbo Boost converts any available power and thermal headroom into higher frequency on active cores. At nominal marked processor frequency, many applications consume less than the rated processor power draw.
- Turbo Boost availability is independent of the number of active cores.
- Maximum Turbo Boost frequency depends on the number of active cores and varies by processor configuration.
- The amount of time the system spends in Turbo Boost operation depends on workload, operating environment, and platform design.

If the processor supports the Intel® Turbo Boost Technology feature, the BIOS Setup provides an option to enable or disable this feature. The default state is enabled.

### 3.1.4 Simultaneous Multithreading (SMT)

Most Intel® Xeon® processors support Simultaneous Multithreading (SMT). The BIOS detects processors that support this feature and enables the feature during POST.

If the processor supports this feature, the BIOS Setup provides an option to enable or disable this feature. The default is enabled.

### 3.1.5 Enhanced Intel SpeedStep® Technology

Most processors support the Enhanced Intel SpeedStep® technology. This technology changes the processor operating ratio and voltage similar to the Thermal Monitor 1 (TM1) feature. The BIOS implements this technology in conjunction with the TM1 feature. The BIOS enables a combination of TM1 and TM2 according to the processor BIOS writer's guide.

## 3.2 Memory Subsystem

The Intel® Xeon® Processor 3400 Series has an Integrated Memory Controller (IMC) in its package. Each Intel® Xeon® Processor 3400 Series produces up to two DDR3 channels of memory. Each DDR3 channel in the IMC supports up to three DDR3 RDIMM slots or up to two UDIMM slots. The DDR3 RDIMM frequency can be 800/1066/1333 MHz. DDR3 UDIMM frequency can be 1066/1333 MHz. All RDIMMs and UDIMMs include ECC (Error Correction Code) operation. Various speeds and memory technologies are supported.

---

**Note:** Intel® Xeon® Processor L3406 only supports DDR3 Unbuffered DIMM (UDIMM).

---

The Intel® Core™ Processor i3-500 Series and Intel® Pentium® Processor G6950 have an Integrated Memory Controller (IMC) supports DDR3 protocols with two independent, 64-bit wide channels each accessing one or two DIMMs. Only DDR3 UDIMM can be supported with the Intel® Core® i3-500 Desktop Processor Series and Intel® Pentium® Processor G6950.

RAS (Reliability, Availability, and Serviceability) is not supported on the Intel® Server Board S3420GP.

### 3.2.1 Memory Sizing and Configuration

The Intel® Server Board S3420GP supports various memory module sizes and configurations. These combinations of sizes and configurations are valid only for DDR3 DIMMs approved by Intel Corporation.

S3420GP supports:

- DIMM sizes of 1 GB, 2 GB, 4 GB, and 8 GB.
- DIMMs composed of DRAM using 2 Gb technology.
- DRAMs organized as single rank, dual rank, or quad rank DIMMS.
- DIMM speeds of 800, 1066, or 1333 MT/s.
- Registered or Unregistered (unbuffered) DIMMs (RDIMMs or UDIMMs).

---

**Note:** UDIMMs should be ECC, and may or may not have thermal sensors; RDIMMs must have ECC and must have thermal sensors.

---

S3420GP has the following limitations:

- 256 Mb technology, x4 DRAM on UDIMM, and quad rank UDIMM are NOT supported
- x16 DRAM on UDIMM is not supported on combo routing
- Memory suppliers not productizing native 800 ECC UDIMMs
- Intel® Xeon® 3400 Series support all timings defined by JEDEC.
- 256 Mb/512 Mb technology, x4 and x16 DRAMs on RDIMM are NOT supported
- All channels in a system will run at the fastest common frequency
- No mixing of registered and unbuffered DIMMs
- No mixing of different ranks or speeds on UDIMM or RDIMM.

### 3.2.2 Post Error Codes

The range {0xE0 - 0xEF} of POST codes is used for memory errors in early POST. In late POST, this range is used for reporting other system errors.

- **0xE8 - No Usable Memory Error:** If no memory is available, the system emits POST Diagnostic LED code 0xE8 and halts the system.
- **0xE8 - Configuration Error:** If a DDR3 DIMM has no SPD information, the BIOS treats the DIMM slot as if no DDR3 DIMM is present on it. Therefore, if this is the only DDR3 DIMM installed in the system, the BIOS halts with POST Diagnostic LED code 0xE8 (no usable memory) and halts the system.
- **0xEB - Memory Test Error:** If a DDR3 DIMM or a set of DDR3 DIMMs on the same memory channel (row) fails HW Memory BIST but usable memory remains available, the BIOS emits a beep code and displays POST Diagnostic LED code 0xEB momentarily during the beeping and then continues POST. If all of the memory fails HW Memory BIST, the system acts as if no memory is available, beeping and halting with the POST Diagnostic LED code 0xE8 (No Usable Memory) displayed.
- **0xEA - Channel Training Error:** If the memory initialization process is unable to properly perform the DQ/DQS training on a memory channel, the BIOS emits a beep code and displays POST Diagnostic LED code 0xEA momentarily during the beeping. If there is usable memory in the system on other channels, POST memory initialization continues. Otherwise, the system halts with POST Diagnostic LED code 0xEA staying displayed.
- **0xED - Population Error:** If the installed memory contains a mix of RDIMMs and UDIMMs, the system halts with POST Diagnostic LED code 0xED.

- **0xEE - Mismatch Error:** If more than two quad-ranked DIMMs are installed on any channel in the system, the system halts with POST Diagnostic LED code 0xEE.

### 3.2.3 Publishing System Memory

- The BIOS displays the Total Memory of the system during POST if Quiet Boot is disabled in the BIOS setup. This is the total size of memory discovered by the BIOS during POST, and is the sum of the individual sizes of installed DDR3 DIMMs in the system.
- The BIOS displays the Effective Memory of the system in the BIOS Setup. The term Effective Memory refers to the total size of all active DDR3 DIMMs (not disabled) and not used as redundant units.
- The BIOS provides the total memory of the system in the main page of the BIOS setup. This total is the same as the amount described by the first bullet in this section.
- If Quiet Boot is disabled, the BIOS displays the total system memory on the diagnostic screen at the end of POST. This total is the same as the amount described by the first bullet in this section.
- The BIOS provides the total amount of memory in the system.

#### 3.2.3.1 Memory Reservation for Memory-mapped Functions

A region of size 40 MB of memory below 4 GB is always reserved for mapping chipset, processor, and BIOS (flash) spaces as memory-mapped I/O regions. This region appears as a loss of memory to the operating system. In addition to this loss, the BIOS creates another reserved region for memory-mapped PCIe functions, including a standard 64 MB or 256 MB of standard PCI Express\* MMIO configuration space.

If PAE is turned on in the operating system, the operating system reclaims all these reserved regions.

In addition to this memory reservation, the BIOS creates another reserved region for memory-mapped PCI Express\* functions, including a standard 64 MB or 256 MB of standard PCI Express\* Memory Mapped I/O (MMIO) configuration space. This is based on the selection of Maximize Memory below 4 GB in the BIOS Setup.

If this is set to Enabled, the BIOS maximizes usage of memory below 4 GB for an operating system without PAE capability by limiting PCI Express\* Extended Configuration Space to 64 buses rather than the standard 256 buses. This is done using the MAX\_BUS\_NUMBER feature offered by the Intel® S3420 I/O Hub and a variably-sized Memory Mapped I/O region for the PCI Express\* functions.

#### 3.2.3.2 High-Memory Reclaim

When 4 GB or more of physical memory is installed (physical memory is the memory installed as DDR3 DIMMs), the reserved memory is lost. However, the Intel® 3420 chipset provides a feature called high-memory reclaim, which allows the BIOS and operating system to remap the lost physical memory into system memory above 4 GB (the system memory is the memory the processor can see).

The BIOS always enables high-memory reclaim if it discovers installed physical memory equal to or greater than 4 GB. For the operating system, the reclaimed memory is recoverable only if the PAE feature in the processor is supported and enabled. Most operating systems support this feature. For details, see the relevant operating system manuals.



### 3.2.3.3 ECC Support

Only ECC memory is supported on this platform.

### 3.2.4 Memory Map and Population Rules

The following nomenclature is followed for DIMM sockets:

---

**Note:** Intel® Server Board S3420GP may support up to three DIMM sockets per channel.

---

**Table 3. Standard Platform DIMM Nomenclature**

Channel A			Channel B		
A1	A2	A3	B1	B2	B3

#### 3.2.4.1 TableMemory Subsystem Operating Frequency Determination

The rules for determining the operating frequency of the memory channels are simple, but not necessarily straightforward. There are several limiting factors, including the number of DIMMs on a channel and organization of the DIMM - that is, either single-rank (SR), dual-rank (DR), or quad-rank (QR):

- The speed of the processor's IMC is the maximum speed possible.
- The speed of the slowest component – the slowest DIMM or the IMC – determines the maximum frequency, subject to further limitations.
- A single 1333-MHz DIMM (SR or DR) on a channel may run at full 1333-MHz speed.
- If two SR/DR DIMMs are installed on a channel, the speed is limited to 1066 MHz.
- A single QR RDIMM on a channel is limited to 1066 MHz.
- Two QR RDIMMs or a mix of QR + SR/DR on a channel is limited to 800 MHz.

#### 3.2.4.2 Memory Subsystem Nomenclature

1. DIMMs are organized into physical slots on DDR3 memory channels that belong to processor sockets.
2. The memory channels are identified as channels A, B.
3. For Intel® Xeon® 3400 Series, each socket can support a maximum of six DIMM sockets (three DIMM sockets per channel), which can support a maximum of six DIMM sockets.
4. The Intel® Xeon® Processor 3400 Series on the Intel® Server Board S3420GP is populated on the processor socket. It has an Integrated Memory Controller (IMC). The IMC provides two DDR3 channels and groups DIMMs on the board into an autonomous memory.
5. The DIMM identifiers on the silkscreen on the board provide information about the channel and the processor socket to which they belong. For example, DIMM\_A1 is the first slot on channel A.

#### 3.2.4.3 Memory Upgrade Rules

Upgrading the system memory requires careful positioning of the DDR3 DIMMs based on the following factors:

- Existing DDR3 DIMM population
- DDR3 DIMM characteristics
- Optimization techniques used by the supported processors to maximize memory bandwidth

In the Independent Channel mode, all DDR3 channels operate independently. Slot-to-slot DIMM matching is not required across channels (for example, A1 and B1 do not have to match each other in terms of size, organization, and timing). DIMMs within a channel do not have to match in terms of size and organization, but they operate in the minimal common frequency. Also, Independent Channel mode can be used to support single DIMM configuration in channel A and in the Single Channel mode.

You must observe the following general rules when selecting and configuring memory to obtain the best performance from the system.

1. DDR3 RDIMMs must always be populated using a fill-farthest method.
2. DDR3 UDIMMs must always be populated on DIMM A1/A2/B1/B2.
3. Intel® Xeon® Processor 3400 Series support either RDIMMs or UDIMMs.
4. Intel® Xeon® Processor L3406, Intel® Core™ Processor i3-500 series or Intel® Pentium® Processor G6950 only support UDIMMs.
5. RDIMM and UDIMM CAN NOT be mixed.
6. The minimal memory set is {DIMMA1}.
7. DDR3 DIMMs on adjacent slots on the same channel do not need to be identical.

Each socket supports a maximum of six slots. Standard Intel® server boards and systems that use the Intel® 3420 chipset support three slots per DDR3 channel, two DDR3 channels per socket, and only one socket is supported on the Intel® Server Board S3420GP.

### 3.2.4.4 Memory Configuration Table

**Table 4. Memory Configuration Table**

	Channel A			Channel B		
	A1	A2	A3	B1	B2	B3
<b>RDIMM</b>	X					
	X	X				
	X	X	X			
	X			X		
	X	X		X		
	X	X	X	X		
	X	X		X	X	
	X	X	X	X	X	

	Channel A			Channel B		
	A1	A2	A3	B1	B2	B3
	X	X	X	X	X	X
<b>UDIMM</b>	X					
	X	X				
	X			X		
	X	X		X		
	X	X		X	X	

This table defines half of the valid memory configurations. You can exchange Channel A DIMMs with the DIMMs on Channel B to get another half.

### 3.2.4.5 UDIMM Configuration rules

DIMM slots per channel	DIMMs populated per channel	Speed	Ranks per channel
2	1	1066, 1333	Single Rank, Dual Rank
2	2	1066, 1333	Single Rank, Dual Rank

**Table 5. UDIMM memory configuration rule**

To get the maximum memory size on UDIMM, you get the detail information from below table.

Max Memory Possible	1Gb DRAM Technology	2Gb DRAM Technology
Single Rank UDIMM	4GB (4x 1GB DIMMs)	8GB (4x 2GB DIMMs)
Dual Rank UDIMMs	8GB (4x 2GB DIMMs)	16GB (4x 4GB DIMMs)

**Table 6. UDIMM Maximum configuration**

Intel® Server Board S3420GP has the following limitations on UDIMM.

- Not support 800MHz ECC UDIMMs
- No support for LV DIMMs
- 256Mb technology, x4 DRAM on UDIMM and quad rank UDIMM are NOT supported
- x16 DRAM is not supported on combo routing
- All channels in a system will run at the fastest common frequency
- No mixing of registered and unbuffered DIMMs
- Non-ECC UDIMMs not supported
- Mixing ECC and non-ECC UDIMMs anywhere on the platform will prevent the system to boot/function correctly

### 3.2.4.6 RDIMM Configuration rules

DIMM slots per channel	DIMMs populated per channel	Speed	Ranks per channel
3	1	1066, 1333	Single Rank, Dual Rank
3	1	1066	Quad Rank
3	2	1066, 1333	Single Rank, Dual Rank
3	2	800*	Quad Rank
3	3**	800*	Single Rank, Dual Rank

**Table 7. RDIMM memory configuration rule**

To get the maximum memory size on RDIMM, refer to the following table:

Max Memory Possible	1Gb DRAM Technology	2Gb DRAM Technology
Single Rank RDIMM	6GB (6x 1GB DIMMs)	12GB (6x 2GB DIMMs)
Dual Rank RDIMMs	12GB (6x 2GB DIMMs)	24GB (6x 4GB DIMMs)
Quad Rank RDIMMs	16GB (4x 4GB DIMMs)	32GB (4x 8GB DIMMs)

**Table 8. RDIMM Maximum configuration**

Intel® Server Board S3420GP has the following limitations on RDIMM:

---

**Note:** Intel® Server Board S3420GPV has two DIMM slots per channel on board and totally four DIMM slots which support maximum RDIMM size to 16GB (4x 4GB DIMMs) because of thermal limitation without BMC control.

---

- No support for LV DIMMs
- 256Mb/512Mb technology, x4 and x16 DRAMs on RDIMM are NOT supported
- All channels in a system will run at the fastest common frequency
- No mixing of registered and unbuffered DIMMs

---

**Note :** 1066MHz or 1333MHz RDIMMs run at 800MHz.

---

## 3.3 Intel® 3420 Chipset PCH

The Intel® 3420 Chipset component is the Platform Controller Hub (PCH). The PCH is designed for use with Intel® processor in a UP server platform. The role of the PCH in Intel® Server Board S3420GP is to manage the flow of information between its eleven interfaces:

- DMI interface to Processor

- PCI Express\* Interface
- PCI Interface
- SATA Interface
- USB Host Interface
- SMBus Host Interface
- SPI Interface
- LPC interface to IBMC
- JTAG interface
- LAN interface
- ACPI interface

## 3.4 I/O Sub-system

Intel® 3420 Chipset PCH provides extensive I/O support.

### 3.4.1 PCI Express Interface

Two different PCI-E configurations on single board are dependent on different board SKUs:

- **Intel® Server Board S3420GPLX**  
One PCI-E X16 slot connected to the PCI-E ports of CPU. Two PCI-E x8 slots and one SAS module connected to PCI-E ports of PCIe switch. One PCI-E X8 slot and one PCI-E x4 slot connected to the PCI-E ports of PCH.
- **Intel® Server Board S3420GPLC**  
One PCI-E X16 slot and one PCI-E X8 slot connected to the PCI-E ports of CPU. One PCI-E x8 slot connected to the PCI-E ports of PCH.
- **Intel® Server Board S3420GPV**  
One PCI-E X16 slot and one PCI-E X8 slot connected to the PCI-E ports of CPU. One PCI-E x8 slot connected to the PCI-E ports of PCH.

There is one 32-bit, 33-MHz, 3.3-V/5-V PCI slot.

Compatibility with the PCI addressing model is maintained to ensure all existing applications and drivers operate unchanged.

The PCI Express\* configuration uses standard mechanisms as defined in the PCI Plug-and-Play specification. The initial recovered clock speed of 1.25 GHz results in 2.5 Gb/s/direction, which provides a 250-MB/s communications channel in each direction (500 MB/s total). This is close to twice the data rate of classic PCI. The fact that 8b/10b encoding is used accounts for the 250 MB/s where quick calculations would imply 300 MB/s. The external graphics ports support 5.0 GT/s speed as well. Operating at 5.0 GT/s results in twice as much bandwidth per lane as compared to 2.5 GT/s operation.

When operating with two PCI Express\* controllers, each controller can operate at either 2.5 GT/s or 5.0 GT/s. The PCI Express\* architecture is specified in three layers: Transaction Layer, Data Link Layer, and Physical Layer. The partitioning in the component is not necessarily along these same boundaries.

### 3.4.2 Serial ATA Support

The Intel® 3420 Chipset has two integrated SATA host controllers that support independent DMA operation on up to six ports and supports data transfer rates of up to 3.0 GB/s (300 MB/s). The SATA controller contains two modes of operation – a legacy mode using I/O space and an AHCI mode using memory space.

Software that uses legacy mode does not have AHCI capabilities. The Intel® 3420 Chipset supports the Serial ATA Specification, Revision 1.0a. The Ixex Peak also supports several optional sections of the Serial ATA II: Extensions to Serial ATA 1.0 Specification, Revision 1.0 (AHCI support is required for some elements).

#### 3.4.2.1 Intel® Matrix Storage Technology

The Intel® 3420 Chipset provides support for Intel® Matrix Storage Technology, providing both AHCI (see above for details on AHCI) and integrated RAID functionality. The industry leading RAID capability provides high-performance RAID 0, 1, 5, and 10 functionality on up to six SATA ports of PCH. Matrix RAID support is provided to allow multiple RAID levels to be combined on a single set of hard drives, such as RAID 0 and RAID 1 on two disks. Other RAID features include hot spare support, SMART alerting, and RAID 0 autos replace. Software components include an Option ROM for pre-boot configuration and boot functionality, a Microsoft Windows\* compatible driver, and a user interface to configure and manage the RAID capability of the Intel® 3420 Chipset.

### 3.4.3 USB 2.0 Support

On the Intel® 3420 Chipset, the USB controller functionality is provided by the dual EHCI controllers with an interface for up to ten USB 2.0 ports. All ports are high-speed, full-speed, and low-speed capable.

- Four external connectors are located on the back edge of the server board.
- Two internal 2x5 header (J1E2 and J1D1) are provided, each supporting two optional USB 2.0 ports.
- One port on internal vertical connector to support NIC.
- One port on 1x4pin (J1J2) on-board header on Intel® Server Board S3420GPLX and S3420GPLC) to support floppy.

#### 3.4.3.1 Native USB Support

During the power-on self test (POST), the BIOS initializes and configures the USB subsystem. The BIOS is capable of initializing and using the following types of USB devices.

- USB Specification-compliant keyboards
- USB Specification-compliant mouse
- USB Specification-compliant storage devices that utilize bulk-only transport mechanism

USB devices are scanned to determine if they are required for booting.

The BIOS supports USB 2.0 mode of operation, and as such supports USB 1.1 and USB 2.0 compliant devices and host controllers.

During the pre-boot phase, the BIOS automatically supports the hot addition and hot removal of USB devices and a short beep is emitted to indicate such an action. For example, if a USB device is hot plugged, the BIOS detects the device insertion, initializes the device, and makes it available to the user. During POST, when the USB controller is initialized, it emits a short beep for each USB device plugged into the system as they were all just “hot added”.

Boards and systems based on the Intel® Server Board S3420GPLX or S3420GPLC are designed to indicate USB readiness by a series of beep codes during POST, before video becomes available. These beeps indicate that the USB is powered and initialized. Devices such as a pen drive or USB CD/DVD ROM drive attached to external USB port will generate a beep code once the device is recognized, powered and initialized. These beep codes do not signal any error. They signal USB and external device readiness during POST.

Only on-board USB controllers are initialized by BIOS. This does not prevent the operating system from supporting any available USB controllers including add-in cards.

### 3.4.3.2 Legacy USB Support

The BIOS supports PS/2 emulation of USB keyboards and mouse. During POST, the BIOS initializes and configures the root hub ports and searches for a keyboard and/or a mouse on the USB hub and then enables the devices that are recognized.

## 3.5 Optional Intel® SAS Entry RAID Module AXX4SASMOD

The Intel® Server Board S3420GPLX provides one 50-pin PCI Express\* connector (J2H1) for the installation of an optional Intel® SAS Entry RAID Module AXX4SASMOD. Once the optional Intel® SAS Entry RAID Module AXX4SASMOD is detected, the x4 PCI Express\* links from the PCI switches to the 50-pin PCI Express\* connector. The optional Intel® SAS Entry RAID Module AXX4SASMOD includes a SAS1064e controller that supports x4 PCI Express\* link widths and is a single-function PCI Express\* end-point device.

The SAS controller supports the SAS protocol as described in the Serial Attached SCSI Standard, version 1.0, and also supports SAS 1.1 features. A 32-bit external memory bus off the SAS1064e controller provides an interface for Flash ROM and NVSRAM (Non-volatile Static Random Access Memory) devices.

The optional Intel® SAS Entry RAID Module AXX4SASMOD provides four SAS connectors that support up to four hard drives with a non-expander backplane or up to eight hard drives with an expander backplane.

4 ports full featured SAS/SATA hardware RAID through optional Intel® Integrated RAID Module SROMBSASMR (AXXROMBSASMR), provides RAID 0, 1, 5, 6 and striping capability for spans 10, 50, 60.

## 3.6 Integrated Baseboard Management Controller

The Intel® Server Board S3420GPLX and Intel® Server Board S3420GPLC have the integrated baseboard management controller, but Intel® Server Board S3420GPV does not have the integrated baseboard management control.

The ServerEngines\* LLC Pilot II Integrated BMC is provided by an embedded ARM9 controller and associated peripheral functionality that is required for IPMI-based server management. Firmware usage of these hardware features is platform-dependant.

The following is a summary of the Integrated BMC management hardware features used by the ServerEngines\* LLC Pilot II Integrated BMC:

- 250 MHz 32-bit ARM9 Processor
- Memory Management Unit (MMU)
- Two 10/100 Ethernet Controllers with NC-SI support
- 16-bit DDR2 667 MHz interface
- Dedicated RTC
- 12 10-bit ADCs
- Eight Fan Tachometers
- Four PWMs
- Battery-backed Chassis Intrusion I/O Register
- JTAG Master
- Six I<sup>2</sup>C interfaces
- General-purpose I/O Ports (16 direct, 64 serial)

Additionally, the ServerEngines\* Pilot II part integrates a super I/O module with the following features:

- KCS/BT Interface
- Two 16C550 Serial Ports
- Serial IRQ Support
- 12 GPIO Ports (shared with BMC)
- LPC to SPI Bridge
- SMI and PME Support

The Pilot II contains an integrated KVM subsystem and graphics controller with the following features:

- USB 2.0 for keyboard, mouse, and storage devices
- USB 1.1 interface for legacy PS/2 to USB bridging
- Hardware Video Compression for text and graphics
- Hardware encryption
- 2D Graphics Acceleration
- DDR2 graphics memory interface
- Up to 1600x1200 pixel resolution
- PCI Express\* x1 support



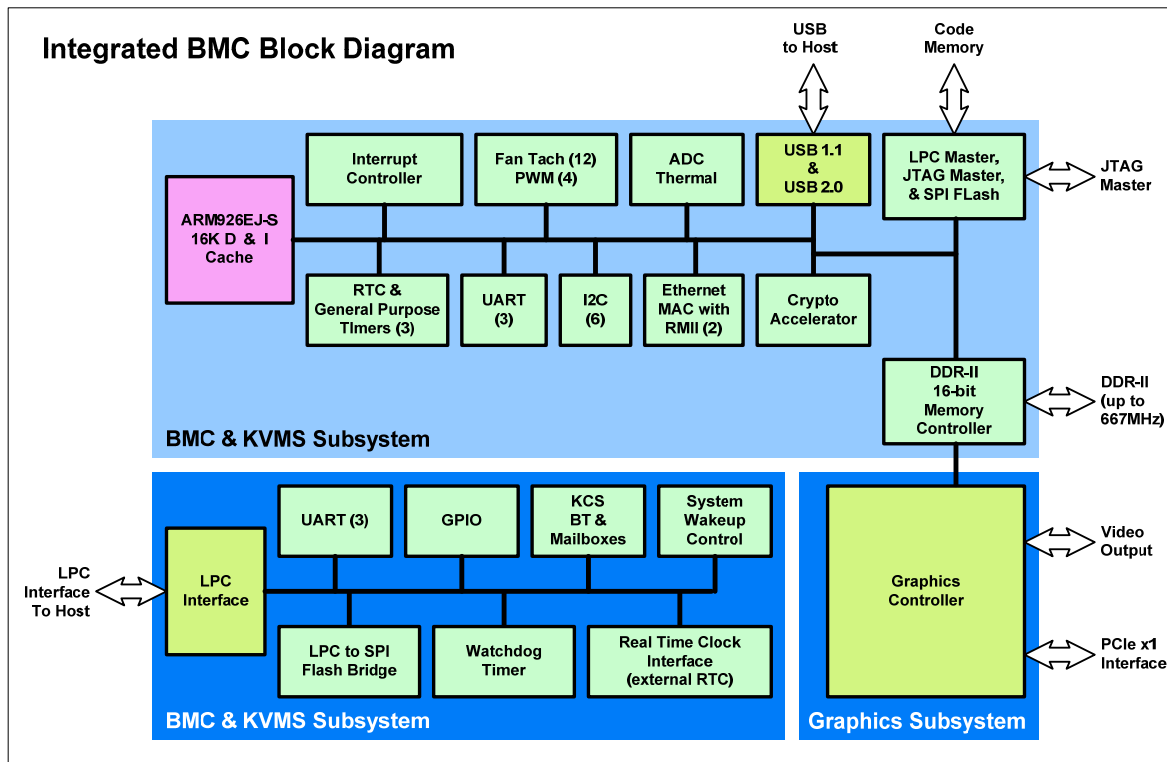

Figure 13. Integrated BMC Hardware

### 3.6.1 Integrated BMC Embedded LAN Channel

The Integrated BMC hardware includes two dedicated 10/100 network interfaces.

**Interface 1:** This interface is available from either of the available NIC ports in system that can be shared with the host. Only one NIC may be enabled for management traffic at any time. To change the NIC enabled for management traffic, please use the “Write LAN Channel Port” OEM IPMI command. The default active interface is port 1 (NIC1).

**Interface 2:** This interface is available from the optional RMM3 which is a dedicated management NIC that is not shared with the host.

For these channels, support can be enabled for IPMI-over-LAN and DHCP.

For security reasons, embedded LAN channels have the following default settings:

- IP Address: Static
- All users disabled

### 3.6.2 Optional RMM3 Advanced Management Board

Intel® Server Board S3420GPLX provides one RMM3 module slot. RMM3 advanced management board serves two purposes:

- Give the customer the option to add a dedicated management 100 Mbit LAN interface to the product.
- Provide additional flash space, enabling the Advanced Management functions to support WS-MAN and CIMON.

**Table 9. Optional RMM3 Advanced Management Board Features**

Feature	Description
KVM Redirection	Remote console access via keyboard, video, and mouse redirection over LAN.
USB Media Redirection	Remote USB media access over LAN.
WS-MAN	Full SMASH profiles for WS-MAN based consoles.

### 3.6.3 Serial Ports

The server board provides two serial ports: an external DB9 serial port connector and an internal DH-10 serial header.

The rear DB9 serial A port is a fully-functional serial port that can support any standard serial device.

The Serial B port is an optional port accessed through a 9-pin internal DH-10 header (J1B1). You can use a standard DH-10 to DB9 cable to direct serial A port to the rear of a chassis. The serial B interface follows the standard RS-232 pin-out as defined in the following table.

**Table 10. Serial B Header (J1B1) Pin-out**

Pin	Signal Name	Serial Port B Header Pin-out
1	DCD	
2	DSR	
3	RX	
4	RTS	
5	TX	
6	CTS	
7	DTR	
8	RI	
9	GND	

### 3.6.4 Floppy Disk Controller

The server board does not support a floppy disk controller interface. However, the system BIOS recognizes USB floppy devices.

### 3.6.5 Keyboard and Mouse Support

The server board does not support PS/2 interface keyboards and mouse. However, the system BIOS recognizes USB specification-compliant keyboard and mouse.

### 3.6.6 Wake-up Control

The super I/O contains functionality that allows various events to power on and power off the system.

## 3.7 Video Support

### 3.7.1 Intel® Server Board S3420GPLX and Intel® Server Board S3420GPLC

The server board includes on-board Server Engine\* LLC Pilot II\* Controller with 64 MB DDR2 memory in which 8MB is usable/accessible memory for iBMC video/graphic display functions. The graphic controller internally has access to larger memory for the internal operations. The 32MB memory reported by display driver is the attached memory. Attached memory can be 32MB or greater but only 8MB is accessible for display functions. The SVGA subsystem supports a variety of modes, up to 1600 x 1200 resolution under 2D. It also supports both CRT and LCD monitors up to a 100 Hz vertical refresh rate..

The video is accessed using a standard 15-pin VGA connector found on the back edge of the server board. The on-board video controller can be disabled using the BIOS Setup utility or when an add-in video card is detected. The system BIOS provides the option for dual-video operation when an add-in video card is configured in the system.

#### 3.7.1.1 Video Modes

The integrated video controller supports all standard VGA modes. The following table shows the 2D modes supported for both CRT and LCD.

**Table 11. Video Modes**

2D Mode Resolution	2D Video Mode Support (Color Bit)				Monitor Refresh Rate (Hz)
	8 bpp	16 bpp	24 bpp	32 bpp	
640x480	Supported	Supported	Supported	Supported	
	60, 72, 75, 85	60, 72, 75, 85	60, 72, 75, 85	60, 72, 75, 85	Monitor Refresh Rate (Hz)
800x600	Supported	Supported	Supported	Supported	
	56, 60, 72, 75, 85	56, 60, 72, 75, 85	56, 60, 72, 75, 85	56, 60, 72, 75, 85	Monitor Refresh Rate (Hz)
1024x768	Supported	Supported	Supported	Supported	
	60, 70, 75, 85	60, 70, 75, 85	60, 70, 75, 85	60, 70, 75, 85	Monitor Refresh Rate (Hz)
1152x864	Supported	Supported	Supported	N/A	
	75	75	75	N/A	Monitor Refresh Rate (Hz)
1280x1024	Supported	Supported	Supported	N/A	
	60, 75, 85	60, 75, 85	60	N/A	Monitor Refresh Rate

2D Mode Resolution	2D Video Mode Support (Color Bit)				(Hz)
	8 bpp	16 bpp	24 bpp	32 bpp	
1440x900	Supported	Supported	Supported	N/A	
	60	60	60	N/A	Monitor Refresh Rate (Hz)
1600x1200	Supported	Supported	N/A	N/A	
	60, 65, 70, 75, 85	60, 65, 70	N/A	N/A	Monitor Refresh Rate (Hz)

### 3.7.1.2 Dual Video

The BIOS supports both single-video and dual-video modes. The dual-video mode is disabled by default.

- In the single mode (dual monitor video = disabled), the on-board video controller is disabled when an add-in video card is detected.
- In single mode, the onboard video controller is disabled when an add-in video card is detected.
- In dual mode, the onboard video controller is enabled and is the primary video device. The external video card is allocated resources and is considered the secondary video device.
- When KVM is enabled in iBMC FW, dual video is enabled.

**Table 12. Dual Video Modes**

Onboard Video	Enabled Disabled	Onboard video controller. <b>Warning:</b> System video is completely disabled if this option is disabled and an add-in video adapter is not installed.
Dual Monitor Video	Enabled Disabled	If enabled, both the onboard video controller and an add-in video adapter are enabled for system video. The onboard video controller becomes the primary video device.

### 3.7.2 Video for Intel® Server Board S3420GPV

SM712 is a one video chip from Silicon Motion, Inc (SMI). It is one in SMI's LynxEM family. It is PCI 2.1 compliant with the standard PCI 33MHz & 66 MHz PCI Master/Slave interface.

- 33 MHz & 66 MHz PCI Master/Slave interface
- PCI 2.1 compliant
- Memory control is provided for the 4MB internal memory
- Support 640x480, 800x600, 1024x768 resolution and up to 85Hz.
- Dual Video mode is supported.

## 3.8 Network Interface Controller (NIC)

The Intel® Server Board S3420GPLX, S3420GPLC and S3420GPV support two network interfaces, One is provided from the onboard Intel® 82574L GbE PCI Express network controller; the other is the onboard Intel® 82578 Gigabit Network controller.

### 3.8.1 GigE Controller 82574L

The 82574 family (82574L and 82574IT) are single, compact, low-power components that offer a fully-integrated Gigabit Ethernet Media Access Control (MAC) and Physical Layer (PHY) port. The 82574 uses the PCI Express\* architecture and provides a single-port implementation in a relatively small area so it can be used for server and client configurations as a LAN on Motherboard (LOM) design.

External interfaces provided on the 82574:

- PCIe Rev. 2.0 (2.5 GHz) x1
- MDI (Copper) standard IEEE 802.3 Ethernet interface for 1000BASE-T, 100BASE-TX, and 10BASE-T applications (802.3, 802.3u, and 802.3ab)
- NC-SI or SMBus connection to a Manageability Controller (MC)
- IEEE 1149.1 JTAG (note that BSDL testing is NOT supported)

### 3.8.2 GigE PHY 82578DM

The 82578 is a single port Gigabit Ethernet Physical Layer Transceiver (PHY). It connects to the Media Access Controller (MAC) through a dedicated interconnect. The 82578DM supports operation at 1000/100/10 Mb/s data rates. The PHY circuitry provides a standard IEEE 802.3 Ethernet interface for 1000BASE-T, 100BASE-TX, and 10BASE-T applications (802.3, 802.3u, and 802.3ab).

The 82578 operates with the Platform Controller Hub (PCH) chipset that incorporates the MAC.

The 82578 interfaces with its MAC through two interfaces: PCIe-based and SMBus. The PCIe (main) interface is used for all link speeds when the system is in an active state (S0) while the SMBus is used only when the system is in a low power state (Sx). In SMBus mode, the link speed is reduced to 10 Mb/s. The PCIe interface incorporates two aspects: a PCIe SerDes (electrically) and a custom logic protocol.

### 3.8.3 MAC Address Definition

Each Intel® Server Board S3420GPLX has the following four MAC addresses assigned to it at the Intel factory:

- NIC 1 MAC address
- NIC 2 MAC address – Assigned the NIC 1 MAC address +1
- Integrated BMC LAN Channel MAC address – Assigned the NIC 1 MAC address +2
- Intel® Remote Management Module 3 (Intel® RMM3) MAC address – Assigned the NIC 1 MAC address +3

Each Intel® Server Board S3420GPLC has the following three MAC addresses assigned to it at the Intel factory:

- NIC 1 MAC address
- NIC 2 MAC address – Assigned the NIC 1 MAC address +1

- Integrated BMC LAN Channel MAC address – Assigned the NIC 1 MAC address +2

Each Intel® Server Board S3420GPV has the following two MAC addresses assigned to it at the Intel® factory:

- NIC 1 MAC address
- NIC 2 MAC address – Assigned the NIC 1 MAC address +1

### 3.9 Intel® I/O Acceleration Technology 2 (Intel® I/OAT2)

The Intel® 3420 chipset series platforms do not support Intel® I/O Acceleration Technology.

#### 3.9.1 Direct Cache Access (DCA)

Direct Cache Access (DCA) is not supported on Intel® Xeon® Processor 3400 Series.

### 3.10 Intel® Virtualization Technology for Directed I/O (Intel® VT-d)

The Intel® 3420 chipset provides hardware support for implementation of Intel® Virtualization Technology with Directed I/O (Intel® VT-d). Intel VT-d Technology consists of technology components that support the virtualization of platforms based on Intel® Architecture Processor. Intel VT-d Technology enables multiple operating systems and applications to run in dependent partitions. A partition behaves like a virtual machine (VM) and provides isolation and protection across partitions. Each partition is allocated its own subset of host physical memory.

The Intel® Virtualization Technology is designed to support multiple software environments sharing the same hardware resources. The Intel® Virtualization Technology can be enabled or disabled in the BIOS setup. The default behavior is disabled.

---

**Note:** If the setup options are changed to enable or disable the Virtualization Technology setting in the processor, the user must perform an AC power cycle for the changes to take effect.

---

## 4. Platform Management

This chapter is only for The Intel® Server Board S3420GPLX and Intel® Server Board S3420GPLC.

The platform management subsystem is based on the Integrated BMC features of the ServerEngines\* Pilot II. The onboard platform management subsystem consists of communication buses, sensors, system BIOS, and server management firmware. The following diagram provides an overview of the Server Management Bus (SMBUS) architecture used on this server board.

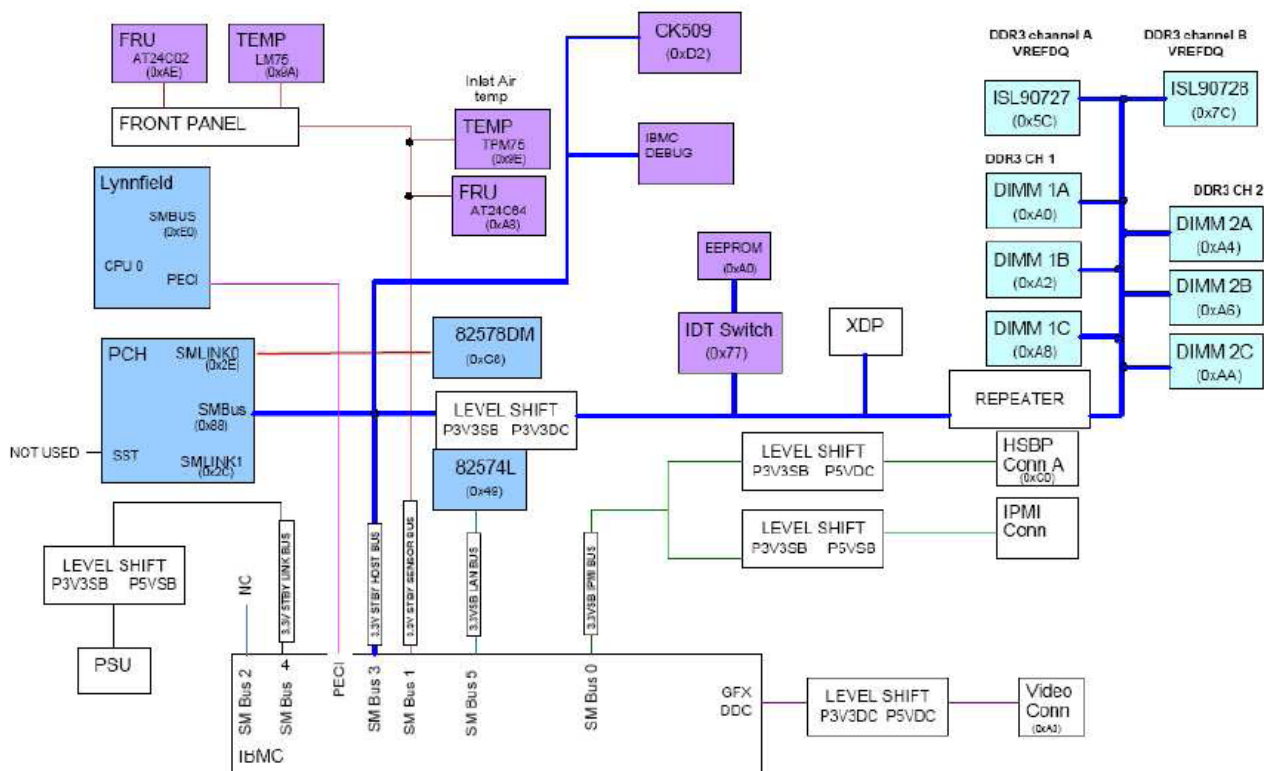

Figure 14. Server Management Bus (SMBUS) Block Diagram

### 4.1 Feature Support

#### 4.1.1 IPMI 2.0 Features

- Integrated Baseboard Management Controller (Integrated BMC).
- IPMI Watchdog timer.
- Messaging support, including command bridging and user/session support.
- Chassis device functionality, including power/reset control and BIOS boot flags support.
- Event receiver device: The Integrated BMC receives and processes events from other platform subsystems.

- Field replaceable unit (FRU) inventory device functionality: The Integrated BMC supports access to system FRU devices using IPMI FRU commands.
- System event log (SEL) device functionality: The Integrated BMC supports and provides access to a SEL.
- Sensor device record (SDR) repository device functionality: The Integrated BMC supports storage and access of system SDRs.
- Sensor device and sensor scanning/monitoring: The Integrated BMC provides IPMI management of sensors. It polls sensors to monitor and report system health.
- IPMI interfaces.
  - Host interfaces include system management software (SMS) with receive message queue support and server management mode (SMM).
  - Terminal mode serial interface
  - IPMB interface
  - LAN interface that supports the IPMI-over-LAN protocol (RMCP, RMCP+)
- Serial-over-LAN (SOL)
- ACPI state synchronization: The Integrated BMC tracks ACPI state changes provided by the BIOS.
- Integrated Baseboard Management Controller (Integrated BMC) self test: The Integrated BMC performs initialization and run-time self tests, and makes results available to external entities.

For more information, refer to the IPMI 2.0 Specification.

#### 4.1.2 Non-IPMI Features

The Integrated BMC supports the following non-IPMI features. This list does not preclude support for future enhancements or additions.

- In-circuit Integrated BMC firmware update.
- Fault resilient booting (FRB): FRB2 is supported by the watchdog timer functionality
- Chassis intrusion detection and chassis intrusion cable presence detection.
- Basic fan control using TControl version 2 SDRs.
- Acoustic management: Support for multiple fan profiles.
- Signal testing support: The Integrated Baseboard Management Controller (Integrated BMC) provides test commands for setting and getting platform signal states.
- The Integrated Baseboard Management Controller (Integrated BMC) generates diagnostic beep codes for fault conditions.
- System GUID storage and retrieval.
- Front panel management: The Integrated Baseboard Management Controller (Integrated BMC) controls the system status LED and chassis ID LED. It supports secure lockout of certain front panel functionality and monitors button presses. The chassis ID LED is turned on using a front panel button or a command.
- Power state retention
- Power fault analysis
- Intel® Light-Guided Diagnostics



- Power unit management: Support for power unit sensor. The Integrated Baseboard Management Controller (Integrated BMC) handles power-good dropout conditions.
- DIMM temperature monitoring: New sensors and improved acoustic management using closed-loop fan control algorithm taking into account DIMM temperature readings.
- Address Resolution Protocol (ARP): The Integrated BMC sends and responds to ARPs (supported on embedded NICs)
- Dynamic Host Configuration Protocol (DHCP): The Integrated BMC performs DHCP (supported on embedded NICs).
- Platform environment control interface (PECI) thermal management support.
- E-mail alerting
- Embedded web server
- Integrated KVM
- Integrated Remote Media Redirection
- Lightweight Directory Authentication Protocol (LDAP) support

## 4.2 Optional Advanced Management Feature Support

This section explains the advanced management features supported by the Integrated Baseboard Management Controller (Integrated BMC) firmware.

### 4.2.1 Enabling Advanced Management Features

The Integrated BMC enables the advanced management features only when it detects the presence of the Intel® Remote Management Module 3 (Intel® RMM3) card. Without the Intel® RMM3, the advanced features are dormant. Only the Intel® Server Board S3420GPLX has a RMM3 module interface.

#### 4.2.1.1 Intel® RMM3

The Intel® RMM3 provides the Integrated BMC with an additional dedicated network interface. The dedicated interface consumes its own LAN channel. Additionally, the Intel® RMM3 provides additional flash storage for advanced features like Web Services for Management (WS-MAN).

### 4.2.2 Keyboard, Video, Mouse (KVM) Redirection

The Integrated BMC firmware supports keyboard, video, and mouse redirection over LAN. This feature is available remotely from the embedded web server as a Java applet. This feature is enabled only when the Intel® RMM3 is present. The client system must have a Java Runtime Environment (JRE) version 5.0 or later to run the KVM or media redirection applets.

#### 4.2.2.1 Keyboard and Mouse

The keyboard and mouse are emulated by the Integrated BMC as USB human interface devices.

#### 4.2.2.2 Video

Video output from the KVM subsystem is equivalent to the video output on the local console. Video redirection is available after video is initialized by the system BIOS. The KVM video resolution and refresh rates will always match the values set in the operating system.

### 4.2.2.3 Availability

Up to two remote KVM sessions are supported. The default inactivity timeout is 30 minutes; however, this can be changed through the embedded web server. Remote KVM activation does not disable the local system keyboard, video, or mouse. Unless the feature is disabled locally, remote KVM is not deactivated by local system input.

KVM sessions persist across system reset but not across an AC power loss.

## 4.2.3 Media Redirection

The embedded web server provides a Java applet to enable remote media redirection. This may be used in conjunction with the remote KVM feature or as a standalone applet.

The media redirection feature is intended to allow system administrators or users to mount a remote IDE or USB CD-ROM, floppy drive, or a USB flash disk as a remote device to the server. Once mounted, the remote device appears just like a local device to the server, allowing system administrators or users to install software (including operating systems), copy files, update the BIOS, and so forth, or boot the server from this device.

The following capabilities are supported:

- The operation of remotely mounted devices is independent of the local devices on the server. Both remote and local devices are usable in parallel
- Either IDE (CD-ROM, floppy) or USB devices can be mounted as a remote device to the server.
- It is possible to boot all supported operating systems from the remotely mounted device and to boot from disk IMAGE (\*.IMG) and CD-ROM or DVD-ROM ISO files. Refer to the Tested/supported Operating System List for more information.
- It is possible to mount at least two devices concurrently.
- The mounted device is visible to (and useable by) the managed system's operating system and BIOS in both pre-boot and post-boot states.
- The mounted device shows up in the BIOS boot order and it is possible to change the BIOS boot order to boot from this remote device.
- It is possible to install an operating system on a bare metal server (no operating system present) using the remotely mounted device. This may also require the use of KVM-r to configure the operating system during install.

If either a virtual IDE or virtual floppy device is remotely attached during system boot, both virtual IDE and virtual floppy are presented as bootable devices. It is not possible to present only a single mounted device type to the system BIOS.

### 4.2.3.1 Availability

The default inactivity timeout is 30 minutes, but may be changed through the embedded web server.

Media redirection sessions persist across system reset but not across an AC power loss.

## 4.2.4 Web Services for Management (WS-MAN)

The Integrated BMC firmware supports the Web Services for Management (WS-MAN) specification, version 1.0.

### 4.2.5 Local Directory Authentication Protocol (LDAP)

The Integrated BMC firmware supports the Local Directory Authentication Protocol (LDAP) protocol for user authentication.

---

**Note:** IPMI users/passwords and sessions are not supported over LDAP.

---

### 4.2.6 Embedded Webserver

The Integrated BMC provides an embedded web server for out-of-band management. User authentication is handled by IPMI user names and passwords. Base functionality for the embedded web server includes:

- Power Control – Limited control based on IPMI user privilege.
- Sensor Reading – Limited access based on IPMI user privilege.
- SEL Reading – Limited access based on IPMI user privilege.
- KVM/Media Redirection – Limited access based on IPMI user privilege. Only available when the Intel® RMM3 is present.
- IPMI User Management – Limited access based on IPMI user privilege.

The web server is available on all enabled LAN channels.

See Appendix B for Integrated BMC core sensors.

## 4.3 Management Engine (ME)

Intel Management Engine is tied to essential platform functionality. This Management Engine firmware includes the following applications:

- Platform Clocks – Tune PCH clock silicon to the parameters of a specific board, configure clocks at run time, power management clocks.
- Thermal Report – ME FW reports thermal and power information available only on PECI to host accessible registers/Embedded Controller via SMBus.

## 5. Server Management Capability for Intel® Server Board S3420GPV

---

### 5.1 Super I/O

#### 5.1.1 Key Features of Super I/O

The W83627DHG-P is from the Nuvoton's Super I/O product line. This family features the LPC (Low Pin Count) interface. This interface is more economical than its ISA counterpart. It has approximately forty pins less, yet it provides as great performance. In addition, the improvement allows even more efficient operation of software, BIOS, and device drivers.

The W83627DHG-P provides below key features

- Meet LPC Spec. 1.01
- Integrated hardware monitor functions
- Support ACPI (Advanced Configuration and Power Interface)
- Support up to 2 16550-compatible UARTs ports
- 8042-based keyboard controller
- Smart Fan control system
- Five fan-speed monitoring inputs
- Four fan-speed controls
- GPIO
- Support PECI 1.0 and 1.1a Specifications

#### 5.1.2 Sensor and Hardware Monitor

Hardware Monitor Screen allows the user to configure Fan speed control and show the monitored voltage to user. To access this screen from the BIOS Main screen, choose **Server Management > Hardware Monitor**.

Fan Speed Control management has two options.

- Auto – is for SC5299UP chassis support.
- 300m, 900m, 1500m, 3000m can be selected according to the local altitude where the system is placed to assure the system is properly cooled. The default altitude setting is 900m.

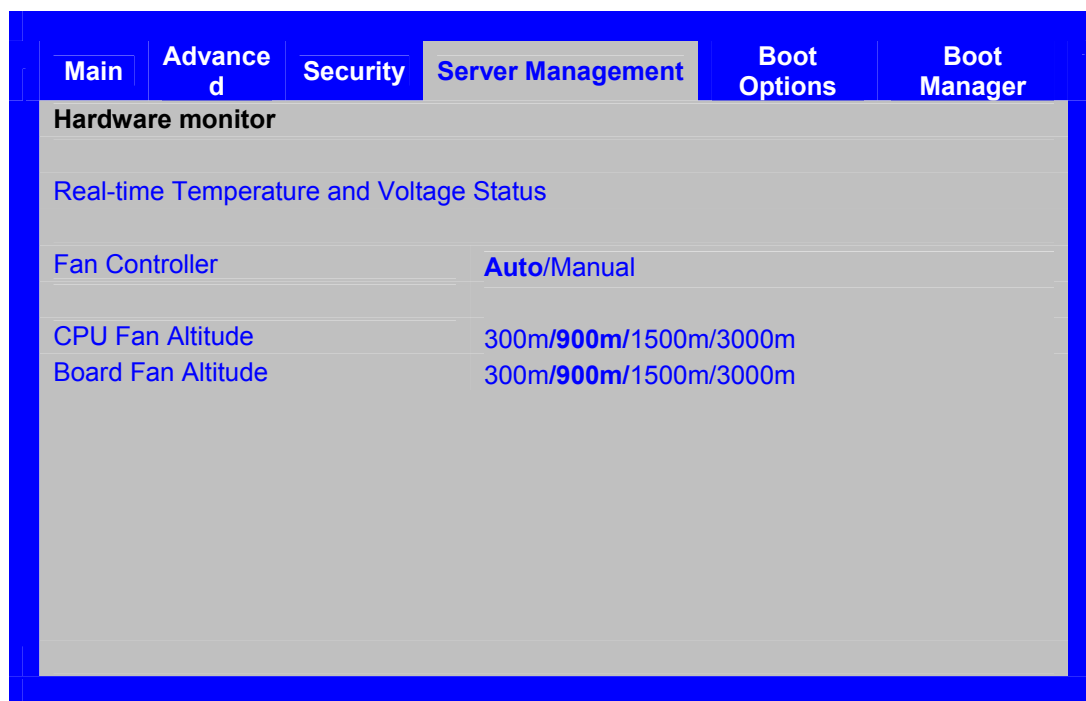

**Figure 15. Setup Utility — Hardware Monitor Screen Display**

**Table 13. Setup Utility — Hardware Monitor Screen Fields**

Setup Item	Options	Help Text
Voltage and Temperature Status		display monitored voltage, current Fan speed PWM and temperature
CPU Fan Controller	Auto Manual	CPU temperature control policy Auto - Fan speed control setting by default Manual - user adjust Fan speed control setting value manually
CPU Fan Altitude	300m/900m/1500m/3000m	Select CPU FAN default PWM according to altitude under Auto mode
Board Fan Altitude	300m/900m/1500m/3000m	Select Board Fan default PWM according to altitude under Auto mode
Hysteresis	2 Degree Celsius 3 Degree Celsius 4 Degree Celsius	Hysteresis – is used to smoothing the FAN speed transition when temperature approaching temperature target upward or downward. Select Hysteresis to keep FAN at the same speed within the range
Default Fan PWM	40% 60% 80% 100%	Select Default FAN PWM to make FAN speed keep the invariable speed when temperature is below FSC temperature target at low user conditions. This delivers optimized acoustic level

---

**Note:** The two options of Hysteresis and Default Fan PWM apply to all the four fans

---

### 5.1.3 Fan controller (Manual)

Fan controller (Manual) allows the user to configure Fan speed control manually. To access this screen from the Main screen, choose **Server Management > Hardware Monitor > Fan controller (Manual)**.

[Manual] is designed for the third party chassis which supports four fan headers. Each of them has four minimum fan PWM output selections 40%, 60%, 80%, and 100% and associated with different cooling capabilities as well as different acoustic levels. The default PWM is 100% and can be customized to 40%, 60%, 80% according to the third party chassis cooling capability and acoustic requirement.

Hysteresis is used to prevent fan oscillation when temperature is crossing the target control temperature back and forth.

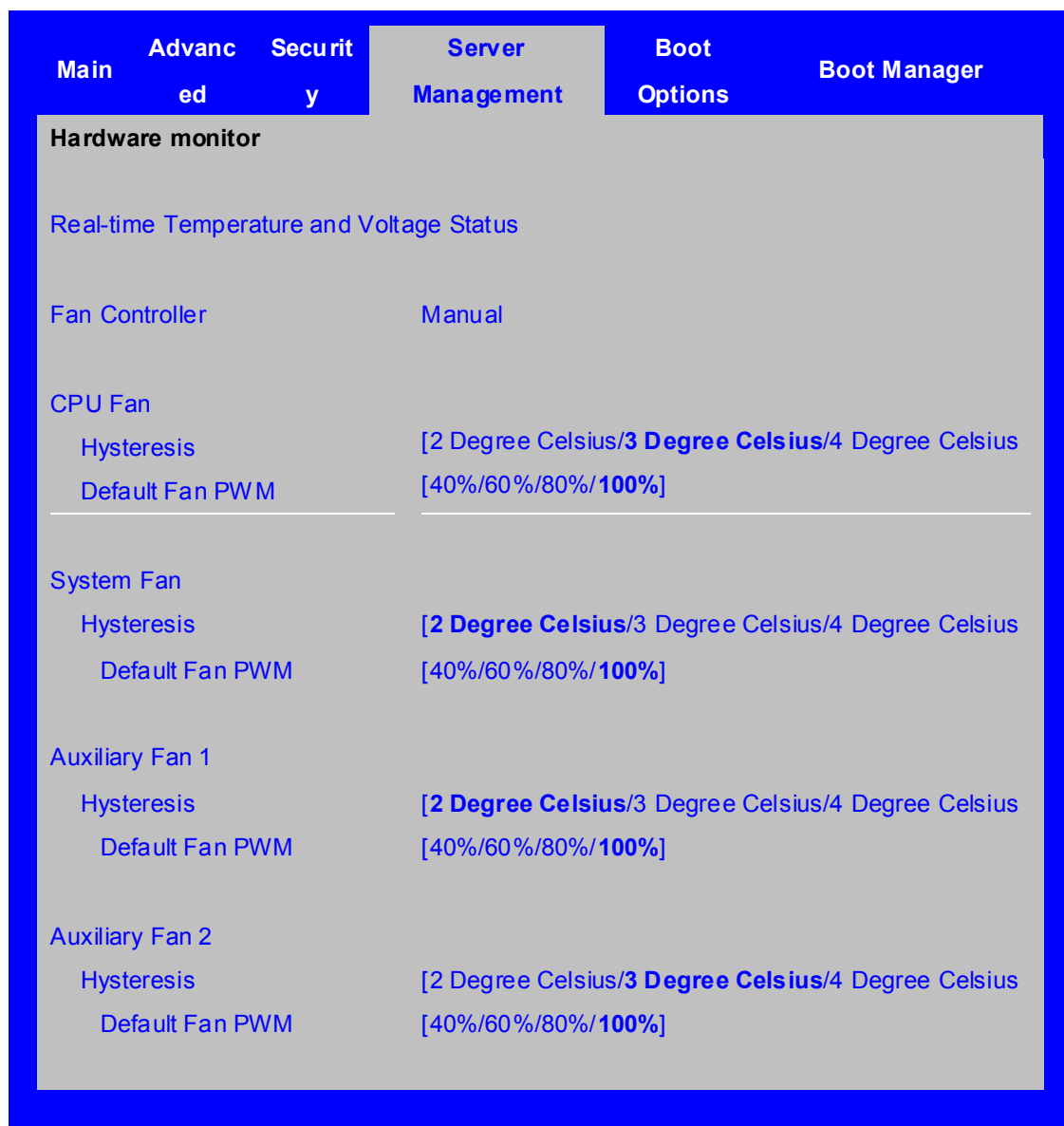

**Figure 16. Setup Utility — Fan controller (Manual) Display**

**Table 14. Setup Utility — Hardware Monitor Screen Fields**

Setup Item	Options	Help Text	Comments
Voltage and Temperature Status		display monitored voltage, current Fan speed PWM and temperature	
CPU Fan Controller	Auto Manual	CPU temperature control policy Auto - Fan speed control setting by default Manual - user adjust Fan speed control setting value manually	

Setup Item	Options	Help Text	Comments
CPU Fan Altitude	300m/ <b>900m</b> /1500m/3000m	Select CPU FAN default PWM according to altitude under Auto mode	
System Fan Altitude	300m/ <b>900m</b> /1500m/3000m	Select Board Fan default PWM according to altitude under Auto mode	
Hysteresis	2 Degree Celsius 3 Degree Celsius 4 Degree Celsius	Hysteresis – is used to smoothing the FAN speed transition when temperature approaching temperature target upward or downward. Select Hysteresis to keep FAN at the same speed within the range	
Default Fan PWM	40% 60% 80% 100%	Select Default FAN PWM to make FAN speed keep the invariable speed when temperature is below FSC temperature target at low customized conditions. This delivers optimized acoustic level	The change can not take effect immediately by increasing the PWM. It requires a power cycle or a thermal event to take the change in effect.
<b>Note:</b> the two options of Hysteresis and Default Fan PWM apply to all the four Fans			

### 5.1.4 Voltage and Temperature Status Screen

Display monitored voltage, current Fan speed PWM and temperature

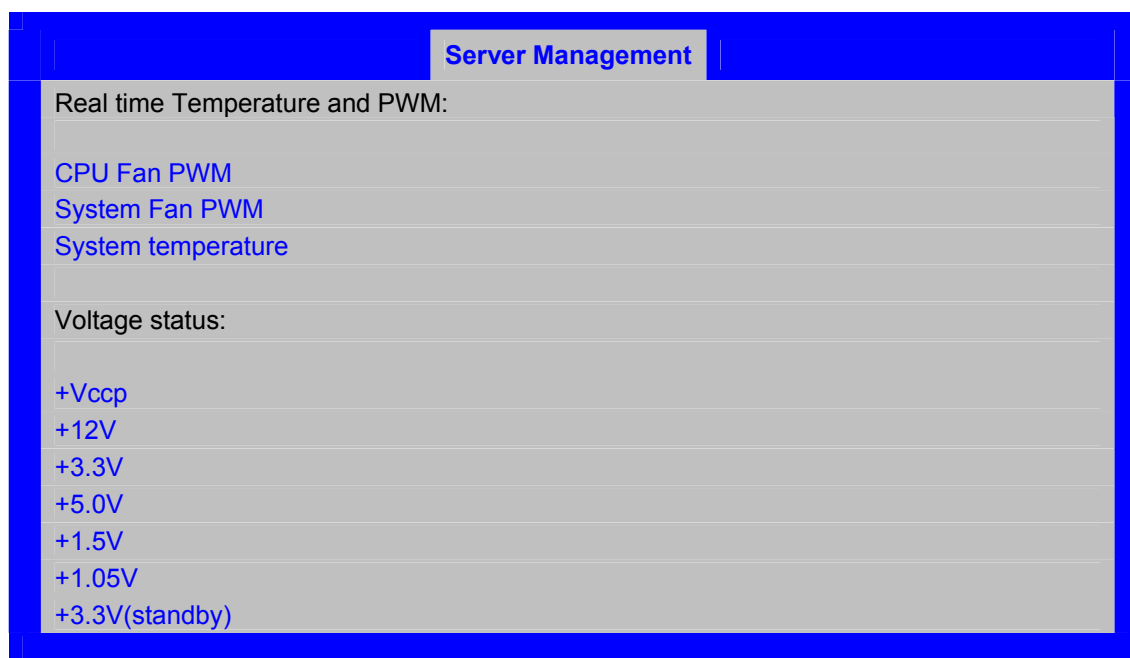

Figure 17. Setup Utility — Voltage and Temperature Status Screen

Table 15. Setup Utility — Voltage and Temperature Status Fields



Setup Item	Comments
CPU Fan PWM	Get and display CPU fan PWM periodically
System Fan PWM	Get and display system fan PWM periodically
System temperature	Get and display current system temperature monitored by system sensor
+Vccp	Get and display +Vccp voltage periodically
+12V	Get and display +12 voltage periodically
+3.3V	Get and display +3.3 voltage periodically
+5.0V	Get and display +5.0V voltage periodically
+1.5V	Get and display +1.5V voltage periodically
+1.05V	Get and display +1.05 voltage periodically
+3.3V(standby)	Get and display +3.3V(standby)voltage periodically

## 5.2 SMBIOS

### 5.2.1 Data Storage

On Intel® Server Board S3420GPLX and Intel® Server Board S3420GPLC with iBMC, the SMBIOS type 1, 2, 3 are from FRUSDR by BMC. But on Intel® Server Board S3420GPV, SMBIOS type 1, 2, 3 are stored in BIOS flash during manufactory build, so it's also non-volatile data storage.

BIOS retrieve the SMBIOS data from flash during POST, and it builds the SMBIOS type 1, 2, 3 into SMBIOS table and then transfers the control to operating system. Operating system and system management software can use the SMBIOS table for system management purpose.

## 5.3 Event log and Viewer

### 5.3.1 Event Log Viewer in Setup

On Intel® Server Board S3420GPLX and Intel® Server Board S3420GPLC, there is a dedicated utility to view the event log. There is no IPMI support - the way to view the event log in BIOS Setup, on Intel® Server Board S3420GPV.

There is one page in BIOS setup for event log viewer. It is located in Error Manager Page.

The screenshot shows a window titled "Error Manager" with a table of event logs. The table has three columns: "No.", "Event Info", and "Time". The events are listed in descending order of time, with the most recent at the top.

No.	Event Info	Time
005	M-BIT MEM ECC Error CPU0 Ch 0 Dimm0	10/15/09 15:12:23
004	S-BIT MEM ECC Error CPU0 Ch 0 Dimm0	10/15/09 15:11:25
003	PCIE UNCOR ERR Bus0 Dev 1C Fun0	10/15/09 15:08:36
002	MEM Parity Error CPU0 Ch 0 Dimm0	10/15/09 15:07:11
001	Thermal Trip Occurred.	10/15/09 15:05:05

**Figure 18.** Event Log Viewer

The Event log viewer is at another page than the BIOS error manager. The event log viewer can display many log in one page. Each event log is displayed in one line. The latest one is on the top. When there are more event logs on one page, Page Up and Page Down keys can be used. There is a scroll bar to allow end-users to view the logs from top to bottom.

## 6. BIOS User Interface

---

### 6.1 Logo/Diagnostic Screen

The logo/Diagnostic Screen displays in one of two forms:

- If Quiet Boot is enabled in the BIOS setup, a logo splash screen displays. By default, Quiet Boot is enabled in the BIOS setup. If the logo displays during POST, press <Esc> to hide the logo and display the diagnostic screen.
- If a logo is not present in the flash ROM or if Quiet Boot is disabled in the system configuration, the summary and diagnostic screen displays.

The diagnostic screen displays the following information:

- BIOS ID
- Platform name
- Total memory detected (Total size of all installed DDR3 DIMMs)
- Processor information (Intel branded string, speed, and number of physical processor identified)
- Keyboards detected (if plugged in)
- Mouse devices detected (if plugged in)

### 6.2 BIOS Boot Popup Menu

The BIOS Boot Specification (BBS) provides for a Boot Popup Menu invoked by pressing the <F6> key during POST. The BBS popup menu displays all available boot devices. The list order in the popup menu is not the same as the boot order in the BIOS setup; it simply lists the bootable devices from which the system can be booted.

When a User Password or Administrator Password is active in Setup, the password is to access the Boot Popup Menu.

### 6.3 BIOS Setup utility

The BIOS setup utility is a text-based utility that allows the user to configure the system and view current settings and environment information for the platform devices. The Setup utility controls the platform's built-in devices, boot manager, and error manager.

The BIOS setup interface consists of a number of pages or screens. Each page contains information or links to other pages. The advanced tab in Setup displays a list of general categories as links. These links lead to pages containing a specific category's configuration.

The following sections describe the look and behavior for platform setup.

### 6.3.1 Operation

The BIOS Setup has the following features:

- Localization - The BIOS Setup uses the Unicode standard and is capable of displaying setup forms in all languages currently included in the Unicode standard. The Intel® server board BIOS is only available in English.
- Console Redirection - The BIOS Setup is functional through console redirection over various terminal emulation standards. This may limit some functionality for compatibility (for example, color usage or some keys or key sequences or support of pointing devices).

#### 6.3.1.1 Setup Page Layout

The setup page layout is sectioned into functional areas. Each occupies a specific area of the screen and has dedicated functionality. The following table lists and describes each functional area.

**Table 16. BIOS Setup Page Layout**

Functional Area	Description
Title Bar	The title bar is located at the top of the screen and displays the title of the form (page) the user is currently viewing. It may also display navigational information.
Setup Item List	The Setup Item List is a set of controllable and informational items. Each item in the list occupies the left column of the screen. A Setup Item may also open a new window with more options for that functionality on the board.
Item Specific Help Area	The Item Specific Help area is located on the right side of the screen and contains help text for the highlighted Setup Item. Help information may include the meaning and usage of the item, allowable values, effects of the options, and so forth.
Keyboard Command Bar	The Keyboard Command Bar is located at the bottom right of the screen and continuously displays help for keyboard special keys and navigation keys.

#### 6.3.1.2 Entering BIOS Setup

To enter the BIOS Setup, press the F2 function key during boot time when the OEM or Intel logo displays. The following message displays on the diagnostics screen and under the Quiet Boot logo screen:

```
Press <F2> to enter setup
```

When the Setup is entered, the Main screen displays. However, serious errors cause the system to display the Error Manager screen instead of the Main screen.

#### 6.3.1.3 Keyboard Commands

The bottom right portion of the Setup screen provides a list of commands used to navigate through the Setup utility. These commands display at all times.

Each Setup menu page contains a number of features. Each feature is associated with a value field except those used for informative purposes. Each value field contains configurable parameters. Depending on the security option chosen and, in effect, by the password, a menu

feature's value may or may not be changed. If a value cannot be changed, its field is made inaccessible and appears grayed out.

**Table 17. BIOS Setup: Keyboard Command Bar**

Key	Option	Description
<Enter>	Execute Command	The <Enter> key is used to activate sub-menus when the selected feature is a sub-menu, or to display a pick list if a selected option has a value field, or to select a sub-field for multi-valued features like time and date. If a pick list is displayed, the <Enter> key selects the currently highlighted item, undoes the pick list, and returns the focus to the parent menu.
<Esc>	Exit	The <Esc> key provides a mechanism for backing out of any field. When the <Esc> key is pressed while editing any field or selecting features of a menu, the parent menu is re-entered. When the <Esc> key is pressed in any sub-menu, the parent menu is re-entered. When the <Esc> key is pressed in any major menu, the exit confirmation window is displayed and the user is asked whether changes can be discarded. If "No" is selected and the <Enter> key is pressed, or if the <Esc> key is pressed, the user is returned to where they were before <Esc> was pressed, without affecting any existing settings. If "Yes" is selected and the <Enter> key is pressed, the setup is exited and the BIOS returns to the main System Options Menu screen.
↑	Select Item	The up arrow is used to select the previous value in a pick list, or the previous option in a menu item's option list. The selected item must then be activated by pressing the <Enter> key.
↓	Select Item	The down arrow is used to select the next value in a menu item's option list, or a value field's pick list. The selected item must then be activated by pressing the <Enter> key.
←→	Select Menu	The left and right arrow keys are used to move between the major menu pages. The keys have no affect if a sub-menu or pick list is displayed.
<Tab>	Select Field	The <Tab> key is used to move between fields. For example, <Tab> can be used to move from hours to minutes in the time item in the main menu.
-	Change Value	The minus key on the keypad is used to change the value of the current item to the previous value. This key scrolls through the values in the associated pick list without displaying the full list.
+	Change Value	The plus key on the keypad is used to change the value of the current menu item to the next value. This key scrolls through the values in the associated pick list without displaying the full list. On 106-key Japanese keyboards, the plus key has a different scan code than the plus key on the other keyboards, but will have the same effect.
<F9>	Setup Defaults	Pressing <F9> causes the following to display:  <div style="border: 1px solid black; padding: 5px; width: fit-content; margin: 10px auto;">           Load Optimized Defaults?            Yes      No         </div> If "Yes" is highlighted and <Enter> is pressed, all Setup fields are set to their default values. If "No" is highlighted and <Enter> is pressed, or if the <Esc> key is pressed, the user is returned to where they were before <F9> was pressed without affecting any existing field values.

Key	Option	Description
<F10>	Save and Exit	<p>Pressing &lt;F10&gt; causes the following message to display:</p> <div style="border: 1px solid black; padding: 5px; margin: 10px 0;"> <p>Save configuration and reset?                      Yes      No</p> </div> <p>If “Yes” is highlighted and &lt;Enter&gt; is pressed, all changes are saved and the Setup is exited. If “No” is highlighted and &lt;Enter&gt; is pressed, or the &lt;Esc&gt; key is pressed, the user is returned to where they were before &lt;F10&gt; was pressed without affecting any existing values.</p>

### 6.3.1.4 Menu Selection Bar

The Menu Selection Bar is located at the top of the BIOS Setup Utility screen. It displays the major menu selections available to the user. By using the left and right arrow keys, the user can select the menus listed here. Some menus are hidden and become available by scrolling off the left or right of the current selections.

## 6.3.2 Server Platform Setup Utility Screens

The following sections describe the screens available for the configuration of a server platform. In these sections, tables are used to describe the contents of each screen. These tables follow the following guidelines:

- The Setup Item, Options, and Help Text columns in the tables document the text and values displayed on the BIOS Setup screens.
- In the Options column, the default values display in bold. These values are not displayed in bold on the BIOS Setup screen; the bold text in this document serves as a reference point.
- The Comments column provides additional information where it may be helpful. This information does not display on the BIOS Setup screens.
- Information enclosed in angular brackets (< >) in the screen shots identifies text that can vary, depending on the option(s) installed. For example, <Current Date> is replaced by the actual current date.
- Information enclosed in square brackets ([ ]) in the tables identifies areas where the user must type in text instead of selecting from a provided option.
- Whenever information is changed (except Date and Time), the system requires a save and reboot to take place. Pressing <ESC> discards the changes and boots the system according to the boot order set from the last boot.

### 6.3.2.1 Main Screen

The Main screen is the first screen displayed when the BIOS Setup is entered, unless an error occurred. If an error occurred, the Error Manager screen displays instead.

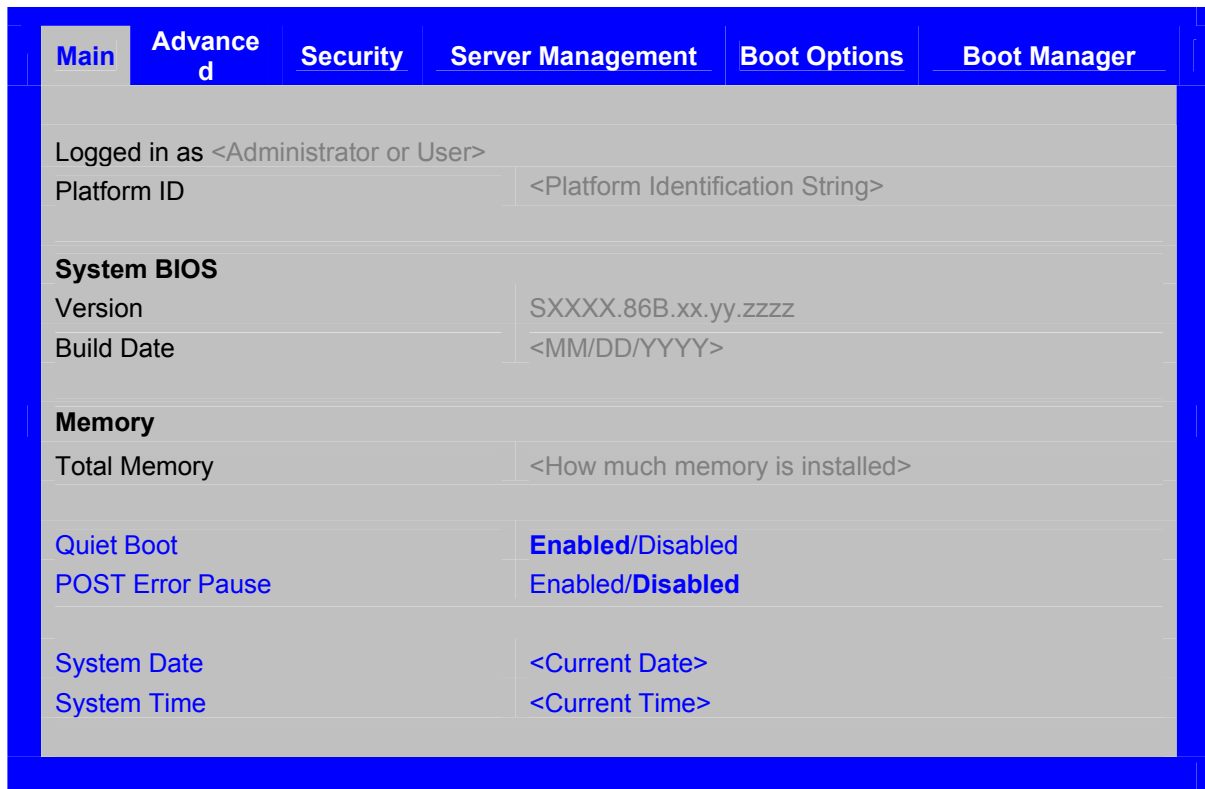

Figure 19. Setup Utility – Main Screen Display

Table 18. Setup Utility – Main Screen Fields

Setup Item	Options	Help Text	Comments
Logged in as			<b>Information only.</b> Displays password level that setup is running in: Administrator or User. With no passwords set, Administrator is the default mode.
Platform ID			<b>Information only.</b> Displays the Platform ID. LX SKU: S3420GPX LC SKU: S3420GPC V SKU: S3420GPV
System BIOS			
Version			<b>Information only.</b> Displays the current BIOS version. xx = major version yy = minor version zzzz = build number
Build Date			<b>Information only.</b> Displays the current BIOS build date.
Memory			

Setup Item	Options	Help Text	Comments
Size			<b>Information only.</b> Displays the total physical memory installed in the system, in MB or GB. The term physical memory indicates the total memory discovered in the form of installed DDR3 DIMMs.
Quiet Boot	Enabled Disabled	[Enabled] – Display the logo screen during POST.  [Disabled] – Display the diagnostic screen during POST.	
POST Error Pause	Enabled Disabled	[Enabled] – Go to the Error Manager for critical POST errors. [Disabled] – Attempt to boot and do not go to the Error Manager for critical POST errors.	If enabled, the POST Error Pause option takes the system to the error manager to review the errors when major errors occur. Minor and fatal error displays are not affected by this setting.
System Date	[Day of week MM/DD/YYYY]	System Date has configurable fields for Month, Day, and Year. Use [Enter] or [Tab] key to select the next field. Use [+] or [-] key to modify the selected field.	
System Time	[HH:MM:SS]	System Time has configurable fields for Hours, Minutes, and Seconds. Hours are in 24-hour format. Use [Enter] or [Tab] key to select the next field. Use [+] or [-] key to modify the selected field.	

### 6.3.2.2 Advanced Screen

The **Advanced** screen provides an access point to configure several options. On this screen, the user selects the option they want to configure. Configurations are performed on the selected screen, and not directly on the **Advanced** screen.

To access this screen from the Main screen, press the right arrow until the **Advanced** screen is chosen.



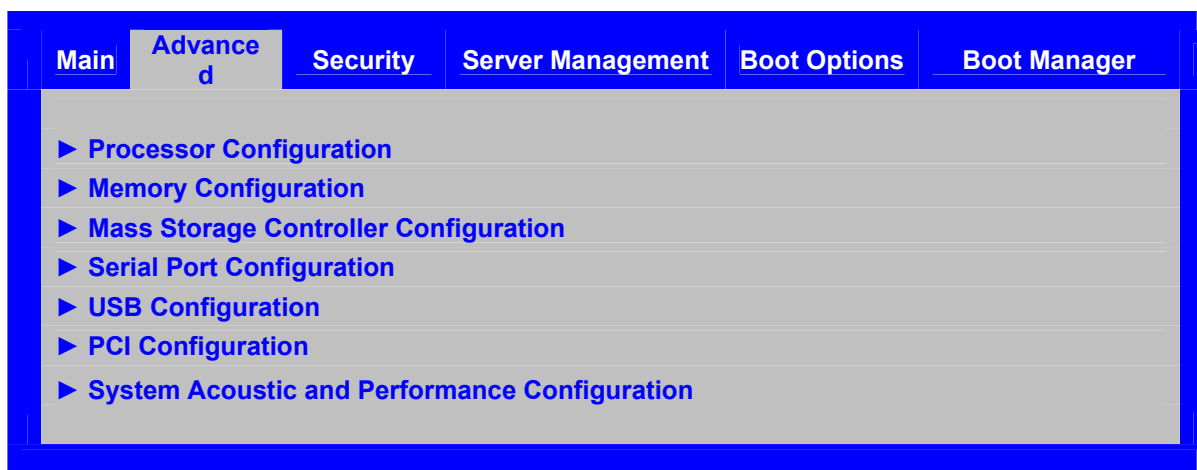

**Figure 20. Setup Utility – Advanced Screen Display**

**Table 19. Setup Utility – Advanced Screen Display Fields**

Setup Item	Help Text
Processor Configuration	View/Configure processor information and settings.
Memory Configuration	View/Configure memory information and settings.
Mass Storage Controller Configuration	View/Configure mass storage controller information and settings.
Serial Port Configuration	View/Configure serial port information and settings.
USB Configuration	View/Configure USB information and settings.
PCI Configuration	View/Configure PCI information and settings.
System Acoustic and Performance Configuration	View/Configure system acoustic and performance information and settings.

### 6.3.2.2.1 Processor Screen

The Processor screen allows the user to view the processor core frequency, system bus frequency, and to enable or disable several processor options. This screen also allows the user to view information about a specific processor.

To access this screen from the Main screen, select **Advanced > Processor**.



**Figure 21. Setup Utility – Processor Configuration Screen Display**

**Table 20. Setup Utility – Processor Configuration Screen Fields**

Setup Item	Options	Help Text	Comments
Processor ID			<b>Information only.</b> Processor CPUID.
Processor Frequency			<b>Information only.</b> Current frequency of the processor.
Core Frequency			<b>Information only.</b> Frequency at which the processor are currently running.
Microcode Revision			<b>Information only.</b> Revision of the loaded microcode.
L1 Cache RAM			<b>Information only.</b> Size of the Processor L1 Cache.

Setup Item	Options	Help Text	Comments
L2 Cache RAM			<b>Information only.</b> Size of the Processor L2 Cache
L3 Cache RAM			<b>Information only.</b> Size of the Processor L3 Cache.
Processor Version			<b>Information only.</b> ID string from the Processor.
Current QPI Link Speed			<b>Information only.</b> Current speed that the QPI Link is using.
QPI Link Frequency			<b>Information only.</b> Current frequency that the QPI Link is using.
Intel® Turbo Boost Technology	Enabled Disabled	Intel® Turbo Boost Technology allows the processor to automatically increase its frequency if it is running below power, temperature, and current specifications.	This option is only visible if all processor in the system support Intel® Turbo Boost Technology.
Enhanced Intel SpeedStep® Technology	Enabled Disabled	Enhanced Intel SpeedStep® Technology allows the system to dynamically adjust processor voltage and core frequency, which can result in decreased average power consumption and decreased average heat production. Contact your OS vendor regarding OS support of this feature.	
Intel® Hyper-Threading Technology	Enabled Disabled	Intel® HT Technology allows multithreaded software applications to execute threads in parallel within the processor. Contact your OS vendor regarding OS support of this feature.	
Core Multi-Processing	All 1 2	Enable 1, 2 or All cores of installed processor packages.	
Execute Disable Bit	Enabled Disabled	Execute Disable Bit can help prevent certain classes of malicious buffer overflow attacks. Contact your OS vendor regarding OS support of this feature.	
Intel® Virtualization Technology	Enabled Disabled	Intel® Virtualization Technology allows a platform to run multiple operating systems and applications in independent partitions. <b>Note:</b> A change to this option requires the system to be powered off and then back on before the setting takes effect.	
Intel® Virtualization Technology for Directed I/O	Enabled Disabled	Enable/Disable Intel® Virtualization Technology for Directed I/O. Report the I/O device assignment to VMM through DMAR ACPI Tables	
Pass-through DMA Support	Enabled Disabled	Enable/Disable Intel® VT-d Pass-through DMA support.	Only visible when Intel® Virtualization Technology for Directed I/O is enabled.
Hardware Prefetcher	Enabled Disabled	Hardware Prefetcher is a speculative prefetch unit within the processor(s). <b>Note:</b> Modifying this setting may affect system performance.	

Setup Item	Options	Help Text	Comments
Adjacent Cache Line Prefetch	Enabled Disabled	[Enabled] - Cache lines are fetched in pairs (even line + odd line). [Disabled] - Only the current cache line required is fetched. <b>Note:</b> Modifying this setting may affect system performance.	

### 6.3.2.2.2 Memory Screen

The Memory screen allows the user to view details about the system memory DDR3 DIMMs installed. This screen also allows the user to open the Configure Memory RAS and Performance screen.

To access this screen from the Main screen, select **Advanced > Memory**.

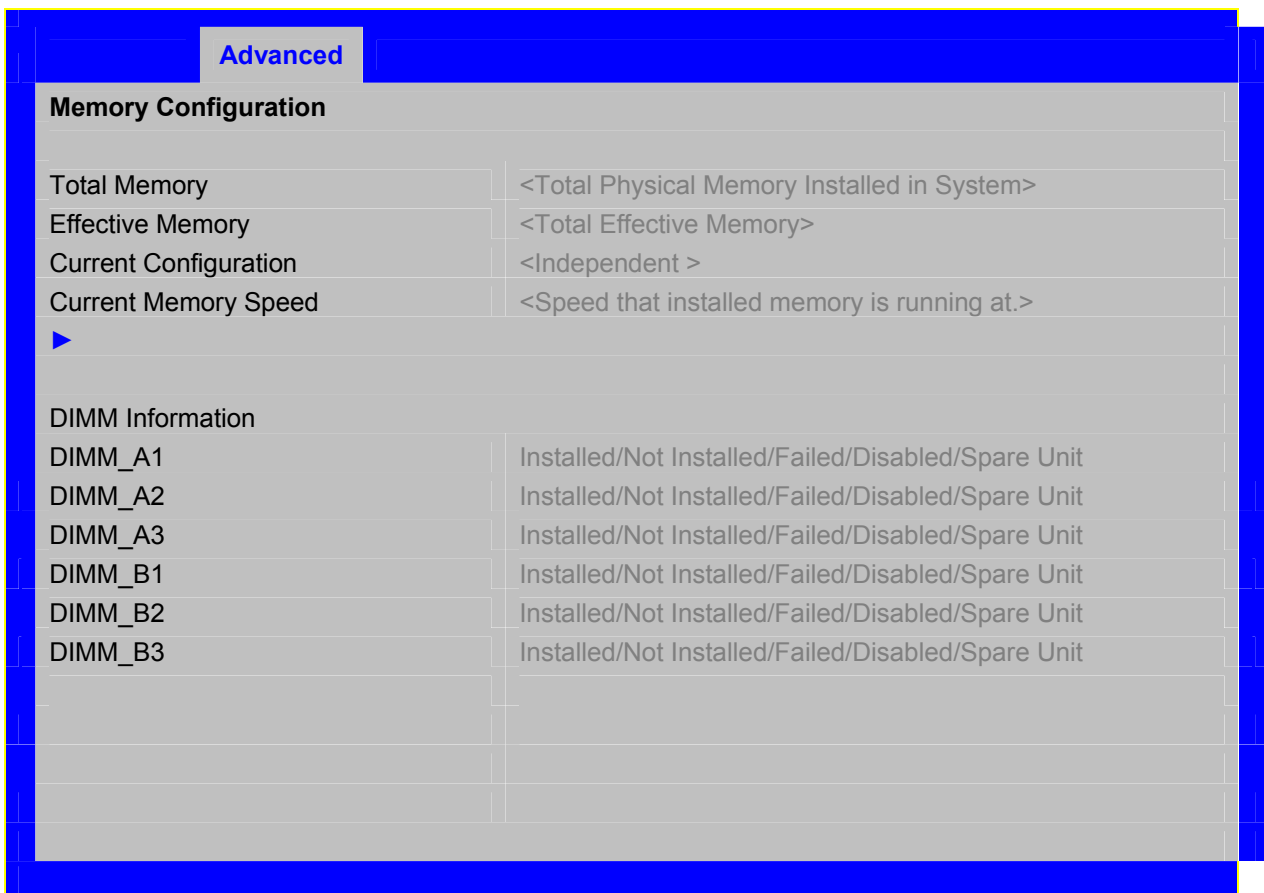

**Figure 22. Setup Utility – Memory Configuration Screen Display**

**Table 21. Setup Utility – Memory Configuration Screen Fields**

Setup Item	Comments
Total Memory	<b>Information only.</b> The amount of memory available in the system in the form of installed DDR3 DIMMs in units of MB or GB.

Setup Item	Comments
Effective Memory	<b>Information only.</b> The amount of memory available to the operating system in MB or GB. The Effective Memory is the difference between the Total Physical Memory and the sum of all memory reserved for internal usage, RAS redundancy and SMRAM. This difference includes the sum of all DDR3 DIMMs that failed Memory BIST during POST, or were disabled by the BIOS during memory discovery phase to optimize memory configuration.
Current Configuration	<b>Information only.</b> Displays one of the following: <b>Independent Mode:</b> System memory is configured for optimal performance and efficiency and no RAS is enabled. <b>Sparing Mode:</b> System memory is configured for RAS with optimal effective memory.
Current Memory Speed	<b>Information only.</b> Displays the speed the memory is running at.
DIMM_XY	Displays the state of each DIMM socket present on the board. Each DIMM socket field reflects one of the following possible states: <b>Installed:</b> There is a DDR3 DIMM installed in this slot. <b>Not Installed:</b> There is no DDR3 DIMM installed in this slot. <b>Disabled:</b> The DDR3 DIMM installed in this slot was disabled by the BIOS to optimize memory configuration. <b>Failed:</b> The DDR3 DIMM installed in this slot is faulty/malfunctioning. <b>Spare Unit:</b> The DDR3 DIMM is functioning as a spare unit for memory RAS purposes. <b>Note:</b> X denotes the Channel Identifier and Y denote the DIMM Identifier within the Channel.

### 6.3.2.2.3 Mass Storage Controller Screen

The Mass Storage screen allows the user to configure the SATA/SAS controller when it is present on the baseboard, midplane, or backplane of an Intel system.

To access this screen from the Main menu, select **Advanced > Mass Storage**.

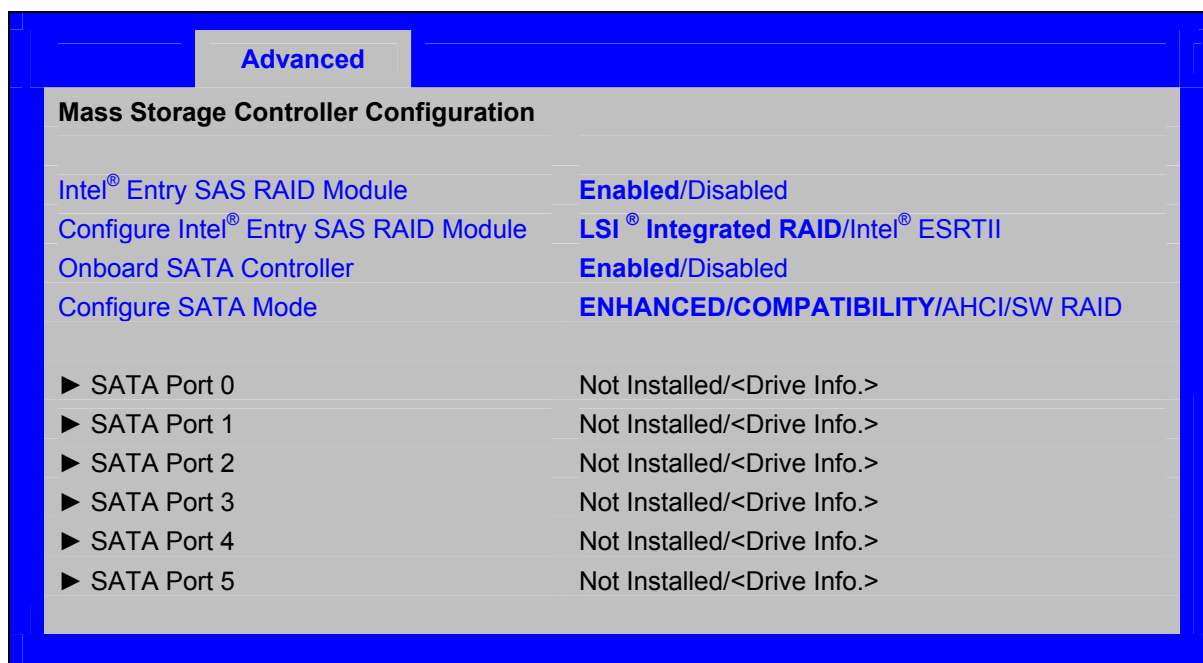

Figure 23. Setup Utility – Mass Storage Controller Configuration Screen Display

Table 22. Setup Utility – Mass Storage Controller Configuration Screen Fields

Setup Item	Options	Help Text	Comments
Intel® Entry SAS RAID Module	Enabled Disabled	Enabled or Disable the Intel® SAS Entry RAID Module	Unavailable if the SAS Module (AXX4SASMOD) is not present. <b>Note:</b> This option is not available on some models.
Configure Intel® Entry SAS RAID Module	LSI® Integrated RAID Intel® ESRTII	LSI® Integrated RAID - Supports RAID 0, RAID 1, and RAID 1e, as well as IT (JBOD) mode; Intel® ESRTII - Intel® Embedded Server RAID Technology II, which supports RAID 0, RAID 1, RAID 10.	Unavailable if the SAS Module (AXX4SASMOD) is disabled or not present <b>Note:</b> This option is not available on some models.
Onboard SATA Controller	Enabled Disabled	Onboard Serial ATA (SATA) controller.	
SATA Mode	ENHANCED COMPATIBILITY AHCI Intel ESRT2 Matrix RAID	[ENHANCED] - Supports up to 6 SATA ports with IDE Native Mode. [COMPATIBILITY] - Supports up to 4 SATA ports[0/1/2/3] with IDE Legacy mode and 2 SATA ports[4/5] with IDE Native Mode. [AHCI] - Supports all SATA ports using the Advanced Host Controller Interface. [Intel ESRT2] - Supports RAID 0/1/10 with Intel® Embedded Software RAIDII Technology. [Matrix RAID] – Supports RAID levels 0/1/10 and 5 with Intel® Matrix Storage RAID Technology.	Disappears when the Onboard SATA Controller is disabled.

Setup Item	Options	Help Text	Comments
SATA Port 0	< Not Installed/Drive information>		<b>Information only.</b> This field is unavailable when RAID Mode is enabled.
SATA Port 1	< Not Installed/Drive information>		<b>Information only.</b> This field is unavailable when RAID Mode is enabled.
SATA Port 2	< Not Installed/Drive information>		<b>Information only.</b> This field is unavailable when RAID Mode is enabled.
SATA Port 3	< Not Installed/Drive information>		<b>Information only.</b> This field is unavailable when RAID Mode is enabled.
SATA Port 4	< Not Installed/Drive information>		<b>Information only.</b> This field is unavailable when RAID Mode is enabled.
SATA Port 5	< Not Installed/Drive information>		<b>Information only.</b> This field is unavailable when RAID Mode is enabled.

#### 6.3.2.2.4 Serial Ports Screen

The Serial Ports screen allows the user to configure the Serial A [COM 1] and Serial B [COM2] ports.

To access this screen from the Main screen, select **Advanced > Serial Port**.



**Figure 24. Setup Utility – Serial Port Configuration Screen Display**

**Table 23. Setup Utility – Serial Ports Configuration Screen Fields**

Setup Item	Options	Help Text
Serial A Enable	Enabled Disabled	Enable or Disable Serial port A.
Address	3F8h 2F8h 3E8h 2E8h	Select Serial port A base I/O address.

Setup Item	Options	Help Text
IRQ	3 4	Select Serial port A interrupt request (IRQ) line.
Serial B Enable	Enabled Disabled	Enable or Disable Serial port B.
Address	3F8h 2F8h 3E8h 2E8h	Select Serial port B base I/O address.
IRQ	3 4	Select Serial port B interrupt request (IRQ).

### 6.3.2.2.5 USB Configuration Screen

The USB Configuration screen allows the user to configure the USB controller options.

To access this screen from the Main screen, select **Advanced > USB Configuration**.

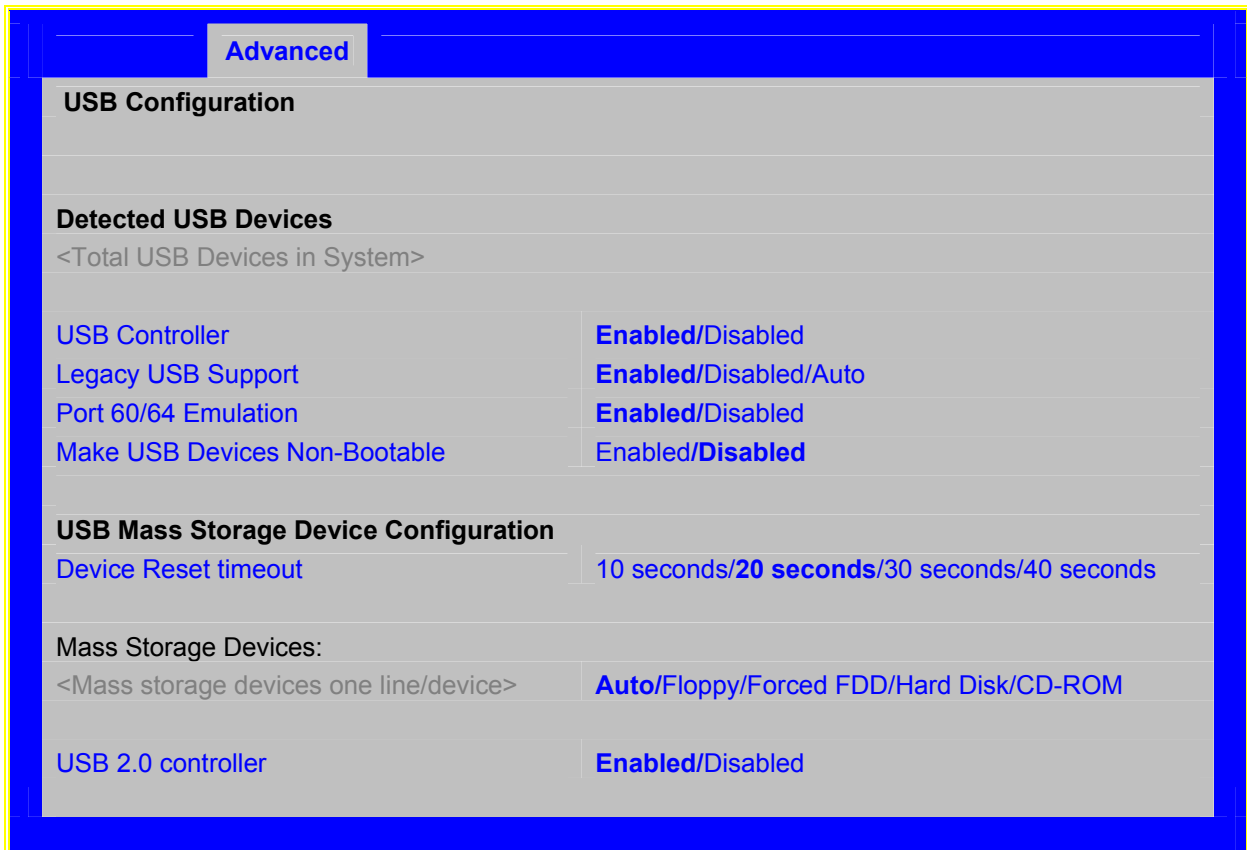

Figure 25. Setup Utility – USB Controller Configuration Screen Display



**Table 24. Setup Utility – USB Controller Configuration Screen Fields**

Setup Item	Options	Help Text	Comments
Detected USB Devices			Information only. Shows the number of USB devices in the system.
USB Controller	Enabled Disabled	[Enabled] - All onboard USB controllers are turned on and accessible by the OS. [Disabled] - All onboard USB controllers are turned off and inaccessible by the OS.	
Legacy USB Support	Enabled Disabled Auto	USB device boot support and PS/2 emulation for USB keyboard and USB mouse devices. [Auto] - Legacy USB support is enabled if a USB device is attached.	Grayed out if the USB Controller is disabled.
Port 60/64 Emulation	Enabled Disabled	I/O port 60h/64h emulation support. <b>Note:</b> This may be needed for legacy USB keyboard support when using an OS that is USB unaware.	Grayed out if the USB Controller is disabled.
Make USB Devices Non-Bootable	Enabled Disabled	Exclude USB in Boot Table. [Enabled] - This removes all USB Mass Storage devices as Boot options. [Disabled] - This allows all USB Mass Storage devices as Boot options.	Grayed out if the USB Controller is disabled.
Device Reset timeout	10 sec 20 sec 30 sec 40 sec	USB Mass Storage device Start Unit command timeout. Setting to a larger value provides more time for a mass storage device to be ready, if needed.	Grayed out if the USB Controller is disabled.
One line for each mass storage device in system	Auto Floppy Forced FDD Hard Disk CD-ROM	[Auto] - USB devices less than 530 MB are emulated as floppies. [Forced FDD] - HDD formatted drive are emulated as a FDD (e.g., ZIP drive).	Hidden if no USB Mass storage devices are installed. Grayed out if the USB Controller is disabled. This setup screen can show a maximum of eight devices on this screen. If more than eight devices are installed in the system, the USB Devices Enabled shows the correct count, but only displays the first eight devices here.
USB 2.0 controller	Enabled Disabled	Onboard USB ports are enabled to support USB 2.0 mode. Contact your OS vendor regarding OS support of this feature.	Grayed out if the USB Controller is disabled.

### 6.3.2.2.6 PCI Screen

The PCI Screen allows the user to configure the PCI add-in cards, onboard NIC controllers, and video options.

To access this screen from the Main screen, select **Advanced > PCI**.

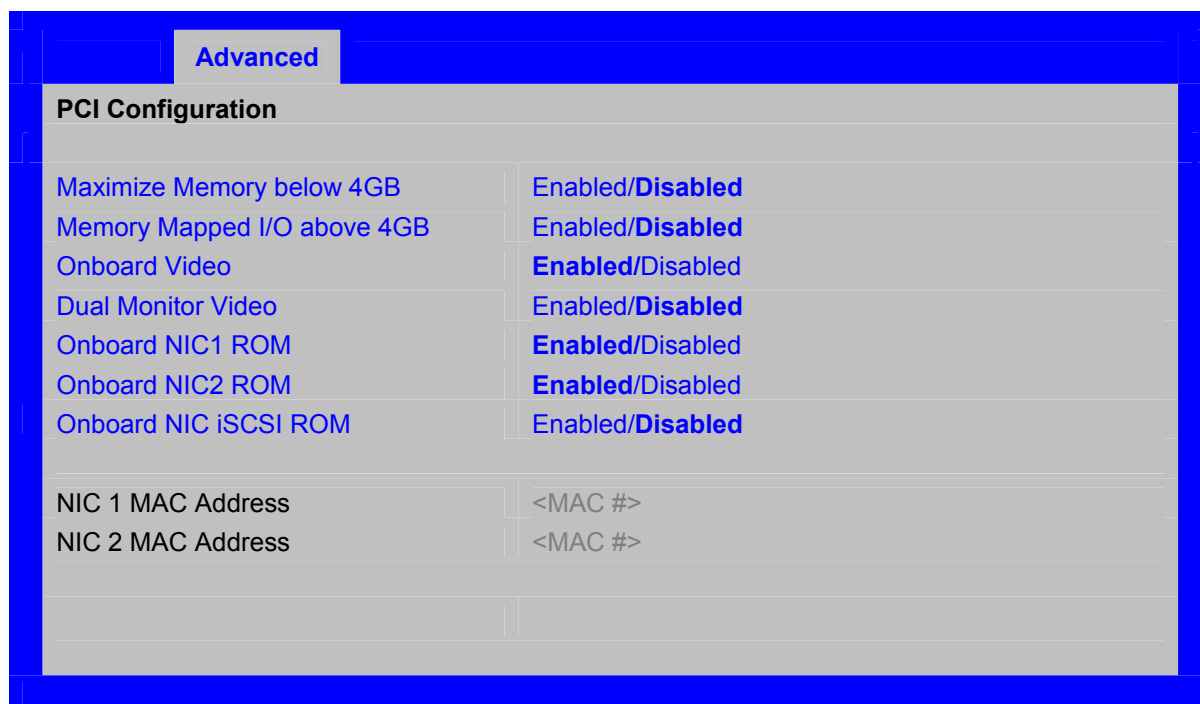

**Figure 26. Setup Utility – PCI Configuration Screen Display**

**Table 25. Setup Utility – PCI Configuration Screen Fields**

Setup Item	Options	Help Text	Comments
Maximize Memory below 4GB	Enabled Disabled	If enabled, the BIOS maximizes usage of memory below 4 GB for OS without PAE by limiting PCIE Extended Configuration Space to 64 buses.	
Memory Mapped I/O above 4GB	Enabled Disabled	Enable or disable memory mapped I/O of 64-bit PCI devices to 4 GB or greater address space.	
Onboard Video	Enabled Disabled	Onboard video controller. <b>Warning:</b> System video is completely disabled if this option is disabled and an add-in video adapter is not installed.	When disabled, the system requires an add-in video card for the video to be seen. <b>Note:</b> This option is not available on some models.
Dual Monitor Video	Enabled Disabled	If enabled, both the onboard video controller and an add-in video adapter are enabled for system video. The onboard video controller becomes the primary video device.	<b>Note:</b> This option does not appear on some models.
Onboard NIC1 ROM	Enabled Disabled	If enabled, loads the embedded option ROM for the onboard network controllers. <b>Warning:</b> If [Disabled] is selected, NIC1 cannot be used to boot or wake the system.	
Onboard NIC2 ROM	Enabled Disabled	If enabled, loads the embedded option ROM for the onboard network controllers. <b>Warning:</b> If [Disabled] is selected, NIC2 cannot be used to boot or wake the system.	

Setup Item	Options	Help Text	Comments
Onboard NIC iSCSI ROM	Enabled Disabled	If enabled, loads the embedded option ROM for the onboard network controllers.  <b>Warning:</b> If [Disabled] is selected, NIC1 and NIC2 cannot be used to boot or wake the system.	This option is grayed out and not accessible if either the NIC1 or NIC2 ROMs are enabled. <b>Note:</b> This option is not available on some models.
NIC 1 MAC Address	No entry allowed		<b>Information only.</b> 12 hex digits of the MAC address.
NIC 2 MAC Address	No entry allowed		<b>Information only.</b> 12 hex digits of the MAC address.

### 6.3.2.2.7 System Acoustic and Performance Configuration

The System Acoustic and Performance Configuration screen allows the user to configure the thermal characteristics of the system.

To access this screen from the Main screen, select **Advanced > System Acoustic and Performance Configuration**.

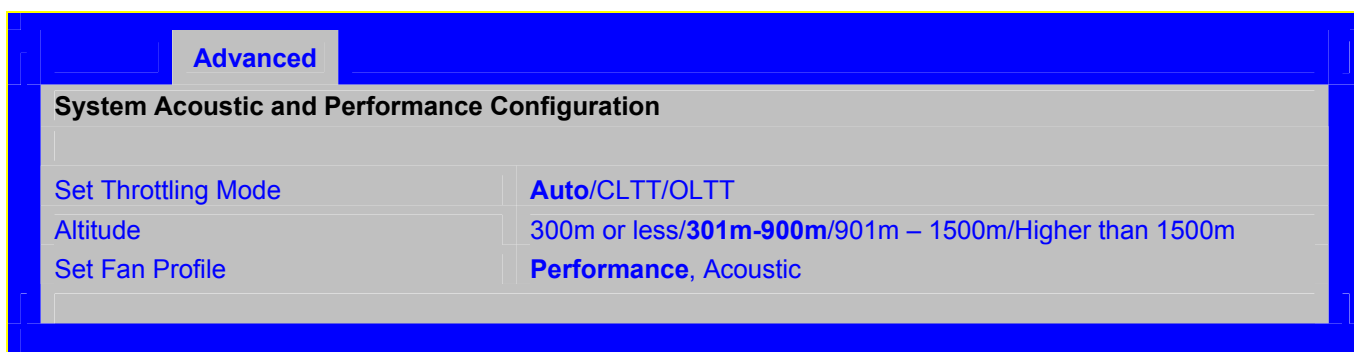

Figure 27. Setup Utility – System Acoustic and Performance Configuration Screen Display

Table 26. Setup Utility – System Acoustic and Performance Configuration Screen Fields

Setup Item	Options	Help Text	Comments
Set Throttling Mode	Auto CLTT OLTT	[Auto] – Auto Throttling mode. [CLTT] – Closed Loop Thermal Throttling Mode. [OLTT] – Open Loop Thermal Throttling Mode.	<b>Note:</b> The OLTT option is shown for <b>informational purposes only</b> . If the user selects OLTT, the BIOS overrides that selection if the system can support CLTT. OLTT is configured only when UDIMMs without Thermal Sensors are installed.

Setup Item	Options	Help Text	Comments
Altitude	300m or less 301m-900m 901m-1500m Higher than 1500m	[300m or less] (980ft or less) Optimal performance setting near sea level. [301m - 900m] (980ft - 2950ft) Optimal performance setting at moderate elevation. [901m – 1500m] (2950ft – 4920ft) Optimal performance setting at high elevation. [Higher than 1500m] (4920ft or greater) Optimal performance setting at the highest elevations.	<b>Note:</b> This option is not available on some models.
Set Fan Profile	Performance Acoustics	[Performance] - Fan control provides primary system cooling before attempting to throttle memory. [Acoustic] - The system will favor using throttling of memory over boosting fans to cool the system if thermal thresholds are met.	This option is grayed out if CLTT is enabled. <b>Note:</b> This option is not available on some models.

### 6.3.2.3 Security Screen

The Security screen allows the user to enable and set the user and administrative password and to lock out the front panel buttons so they cannot be used.

Trusted Platform Module (TPM) security is NOT supported on the Intel® Server S3420GP board.

To access this screen from the Main screen, select **Security**.

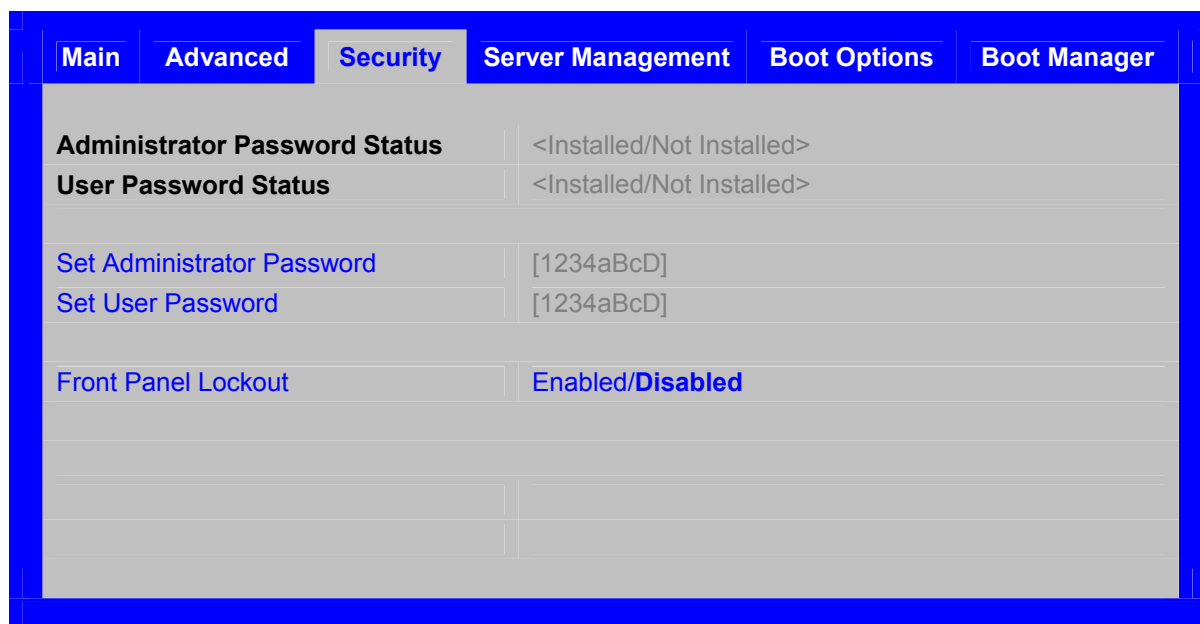

Figure 28. Setup Utility – Security Configuration Screen Display

Table 27. Setup Utility – Security Configuration Screen Fields

Setup Item	Options	Help Text	Comments
Administrator Password Status	<Installed Not Installed>		<b>Information only.</b> Indicates the status of the administrator password.

Setup Item	Options	Help Text	Comments
User Password Status	<Installed Not Installed>		<b>Information only.</b> Indicates the status of the user password.
Set Administrator Password	[123aBcD]	Administrator password is used to control change access in BIOS Setup Utility. Only alphanumeric characters can be used. Maximum length is 7 characters. It is case sensitive. <b>Note:</b> Administrator password must be set in order to use the user account.	This option is only to control access to the setup. Administrator has full access to all the setup items. Clearing the Administrator password also clears the user password.
Set User Password	[123aBcD]	User password is used to control entry access to BIOS Setup Utility. Only alphanumeric characters can be used. Maximum length is 7 characters. It is case sensitive. <b>Note:</b> Removing the administrator password also automatically removes the user password.	Available only if the administrator password is installed. This option only protects the setup. User password only has limited access to the setup items.
Front Panel Lockout	Enabled Disabled	If enabled, locks the power button and reset button on the system's front panel. If [Enabled] is selected, power and reset must be controlled via a system management interface.	

#### 6.3.2.4 Server Management Screen

The Server Management screen allows the user to configure several server management features. This screen also provides an access point to the screens for configuring console redirection and displaying system information.

To access this screen from the Main screen, select **Server Management**.

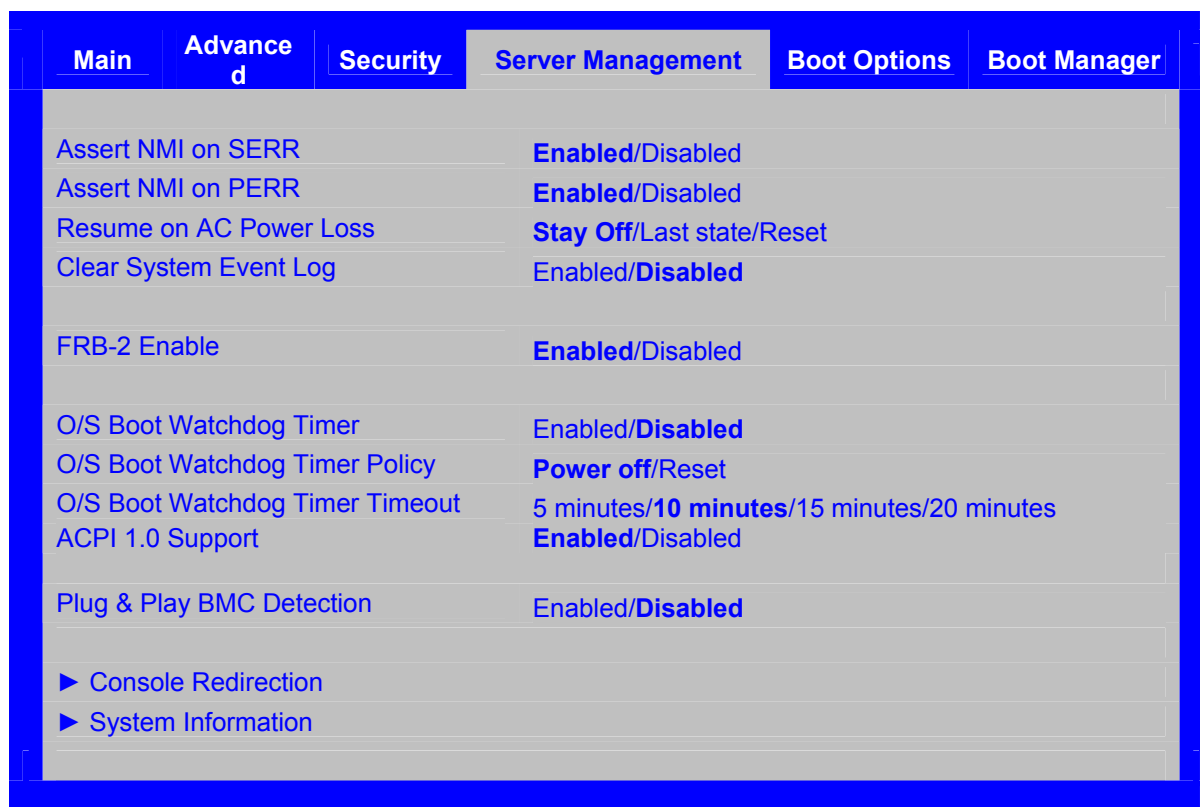

**Figure 29. Setup Utility – Server Management Configuration Screen Display**

**Table 28. Setup Utility – Server Management Configuration Screen Fields**

Setup Item	Options	Help Text	Comments
Assert NMI on SERR	Enabled Disabled	On SERR, generate an NMI and log an error. <b>Note:</b> [Enabled] must be selected for the Assert NMI on PERR setup option to be visible.	
Assert NMI on PERR	Enabled Disabled	On PERR, generate an NMI and log an error. <b>Note:</b> This option is only active if the Assert NMI on SERR option is [Enabled] selected.	
Resume on AC Power Loss	Stay Off Last state Reset	System action to take on AC power loss recovery. [Stay Off] - System stays off. [Last State] - System returns to the same state before the AC power loss. [Reset] - System powers on.	
Clear System Event Log	Enabled Disabled	If enabled, clears the System Event Log. All current entries will be lost. <b>Note:</b> This option is reset to [Disabled] after a reboot.	
FRB-2 Enable	Enabled Disabled	Fault Resilient Boot (FRB). If enabled, the BIOS programs the BMC watchdog timer for approximately 6 minutes. If the BIOS does not complete POST before the timer expires, the BMC resets the system.	

Setup Item	Options	Help Text	Comments
O/S Boot Watchdog Timer	Enabled Disabled	If enabled, the BIOS programs the watchdog timer with the timeout value selected. If the OS does not complete booting before the timer expires, the BMC resets the system and an error is logged. Requires OS support or Intel Management Software.	
O/S Boot Watchdog Timer Policy	Power Off Reset	If the OS boot watchdog timer is enabled, this is the system action taken if the watchdog timer expires. [Reset] - System performs a reset. [Power Off] - System powers off.	Grayed out when the O/S Boot Watchdog Timer is disabled.
O/S Boot Watchdog Timer Timeout	5 minutes 10 minutes 15 minutes 20 minutes	If the OS watchdog timer is enabled, this is the timeout value used by the BIOS to configure the watchdog timer.	Grayed out when the O/S Boot Watchdog Timer is disabled.
Plug & Play BMC Detection	Enabled Disabled	If enabled, the BMC is detectable by OSs that support plug and play loading of an IPMI driver. Do not enable if your OS does not support this driver.	
ACPI 1.0 Support	Enabled Disabled	[Enabled] - Publish ACPI 1.0 version of FADT in Root System Description Table. This may be required for compatibility with OS versions that only support ACPI 1.0.	Needs to be [Enabled] for Microsoft Windows 2000* support.
Console Redirection		View/Configure console redirection information and settings.	Takes the user to the Console Redirection screen.
System Information		View system information	Takes the user to the System Information screen.

#### 6.3.2.4.1 Console Redirection Screen

The Console Redirection screen allows the user to enable or disable console redirection and to configure the connection options for this feature.

To access this screen from the Main screen, select **Server Management > Console Redirection**.

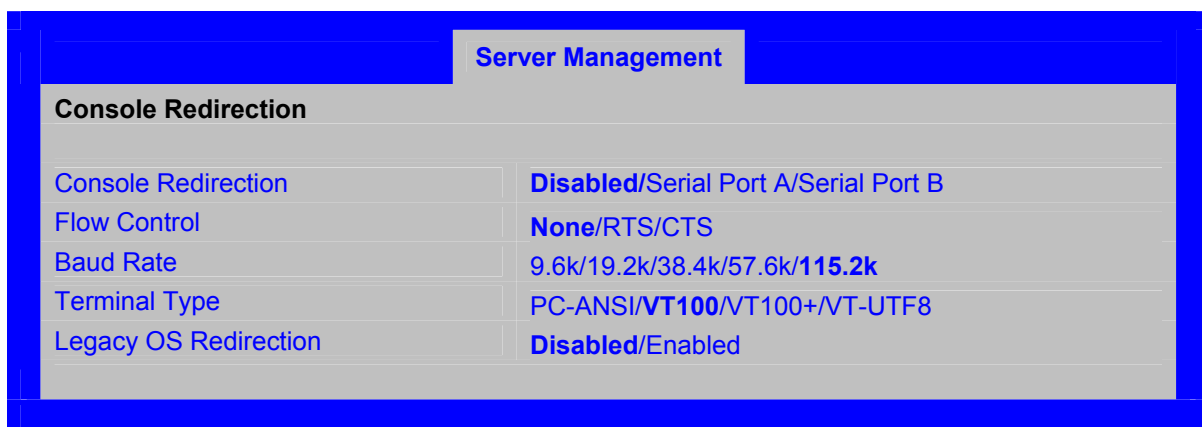

Figure 30. Setup Utility – Console Redirection Screen Display

**Table 29. Setup Utility – Console Redirection Configuration Fields**

Setup Item	Options	Help Text
Console Redirection	Disabled Serial Port A Serial Port B	Console redirection allows a serial port to be used for server management tasks. [Disabled] - No console redirection. [Serial Port A] - Configure serial port A for console redirection. [Serial Port B] - Configure serial port B for console redirection. Enabling this option disables the display of the Quiet Boot logo screen during POST.
Flow Control	None RTS/CTS	Flow control is the handshake protocol. Setting must match the remote terminal application. [None] - Configure for no flow control. [RTS/CTS] - Configure for hardware flow control.
Baud Rate	9600 19.2K 38.4K 57.6K 115.2K	Serial port transmission speed. Setting must match the remote terminal application.
Terminal Type	PC-ANSI VT100 VT100+ VT-UTF8	Character formatting used for console redirection. Setting must match the remote terminal application.
Legacy OS Redirection	Disabled Enabled	This option enables legacy OS redirection (i.e., DOS) on serial port. If it is enabled, the associated serial port is hidden from the legacy OS.

### 6.3.2.5 Server Management System Information Screen

The Server Management System Information screen allows the user to view part numbers, serial numbers, and firmware revisions.

To access this screen from the Main screen, select **Server Management > System Information**.



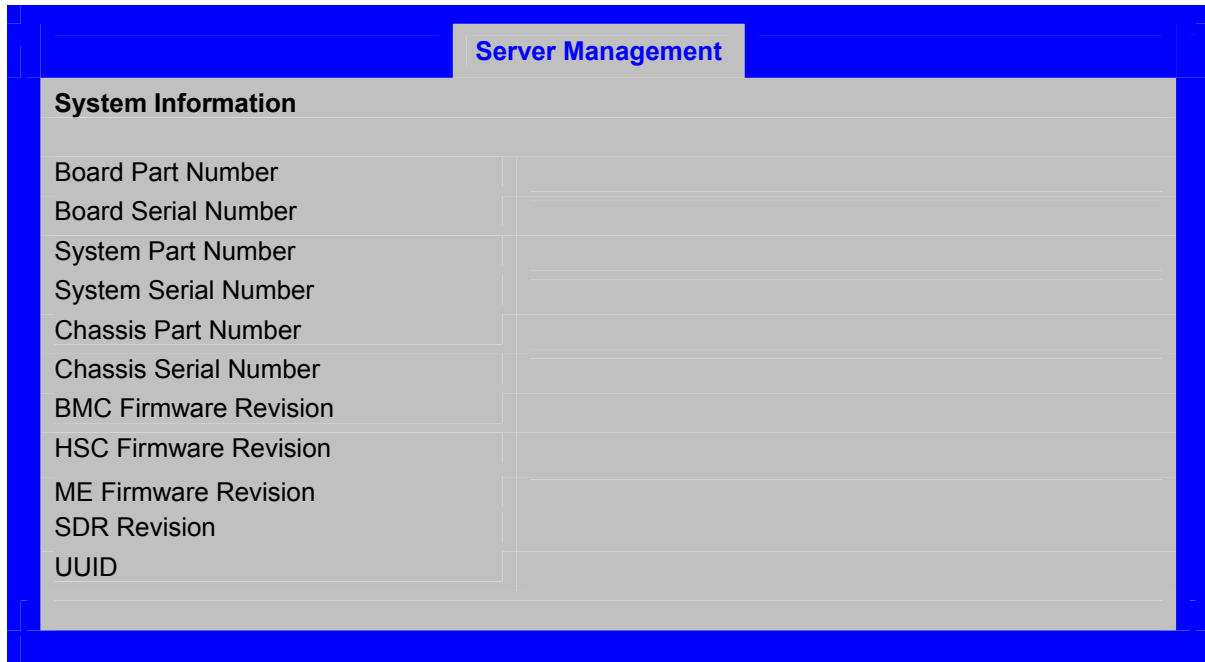

**Figure 31. Setup Utility – Server Management System Information Screen Display**

**Table 30. Setup Utility – Server Management System Information Fields**

Setup Item	Comments
Board Part Number	Information only
Board Serial Number	Information only
System Part Number	Information only
System Serial Number	Information only
Chassis Part Number	Information only
Chassis Serial Number	Information only
BMC Firmware Revision	Information only
HSC Firmware Revision	Information only
ME Firmware Revision	Information only
SDR Revision	Information only
UUID	Information only

### 6.3.2.6 Boot Options Screen

The Boot Options screen displays any bootable media encountered during POST, and allows the user to configure the preferred boot device.

To access this screen from the Main screen, select **Boot Options**.

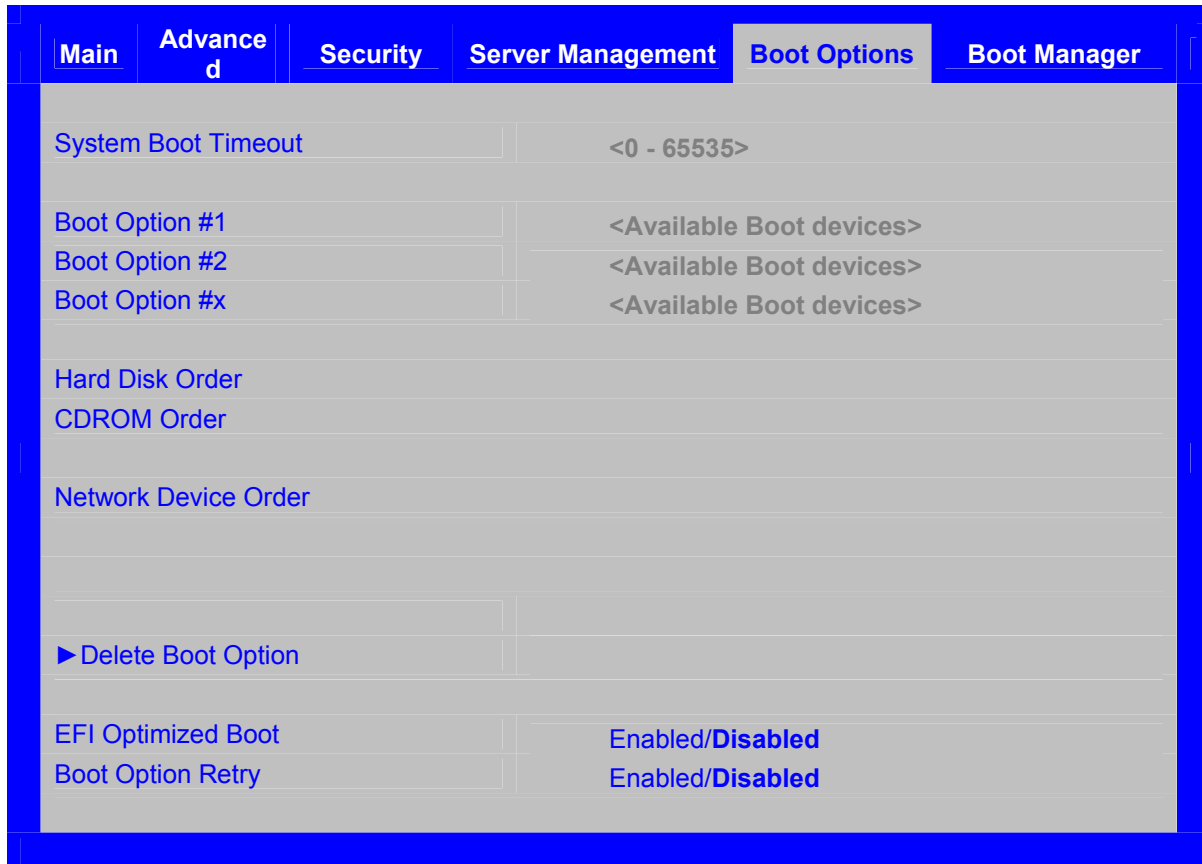

**Figure 32. Setup Utility – Boot Options Screen Display**

**Table 31. Setup Utility – Boot Options Screen Fields**

Setup Item	Options	Help Text	Comments
Boot Timeout	0 - 65535	The number of seconds the BIOS should pause at the end of POST to allow the user to press the [F2] key for entering the BIOS Setup utility. Valid values are 0-65535. Zero is the default. A value of 65535 causes the system to go to the Boot Manager menu and wait for user input for every system boot.	After entering the preferred timeout, press the Enter key to register that timeout value to the system. These settings are in seconds.
Boot Option #x	Available boot devices.	Set system boot order by selecting the boot option for this position.	
Hard Disk Order		Set the order of the legacy devices in this group.	Visible when one or more hard disk drives are in the system.
CDROM Order		Set the order of the legacy devices in this group.	Visible when one or more CD-ROM drives are in the system.
Floppy Order		Set the order of the legacy devices in this group.	Visible when one or more floppy drives are in the system.
Network Device Order		Set the order of the legacy devices in	Visible when one or more of

Setup Item	Options	Help Text	Comments
		this group.	these devices are available in the system.
BEV Device Order		Set the order of the legacy devices in this group.	Visible when one or more of these devices are available in the system.
Add New Boot Option		Add a new EFI boot option to the boot order.	This option is only visible if an EFI bootable device is available to the system (for example, a USB drive).
Delete Boot Option		Remove an EFI boot option from the boot order.	If the EFI shell is deleted, you can restore it by setting CMOS defaults (F9).
EFI Optimized Boot	Enabled Disabled	If enabled, the BIOS only loads modules required for booting EFI-aware Operating Systems.	
Boot Option Retry	Enabled Disabled	If enabled, this continually retries non-EFI-based boot options without waiting for user input.	

If all types of bootable devices are installed in the system, the default boot order is:

1. CD/DVD-ROM
2. Floppy Disk Drive
3. Hard Disk Drive
4. PXE Network Device
5. BEV (Boot Entry Vector) Device
6. EFI Shell and EFI Boot paths

**6.3.2.6.1 Delete Boot Option Screen**

The Delete Boot Option screen allows the user to remove an EFI boot option from the boot order.

To access this screen from the Main screen, select **Boot Options > Delete Boot Options**.

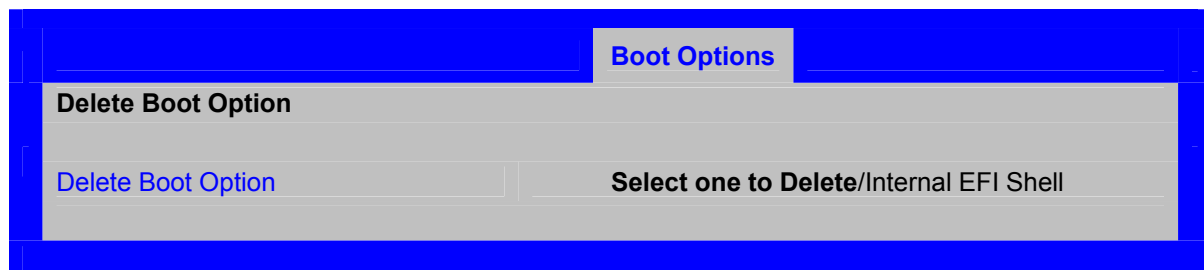

**Figure 33. Setup Utility – Delete Boot Option Screen Display**

**Table 32. Setup Utility – Delete Boot Option Fields**

Setup Item	Options	Help Text
Delete Boot Option	Select one to Delete Internal EFI Shell	Remove an EFI boot option from the boot order.

**6.3.2.6.2 Hard Disk Order Screen**

The Hard Disk Order screen allows the user to control the hard disks.

To access this screen from the Main screen, choose **Boot Options > Hard Disk Order**.

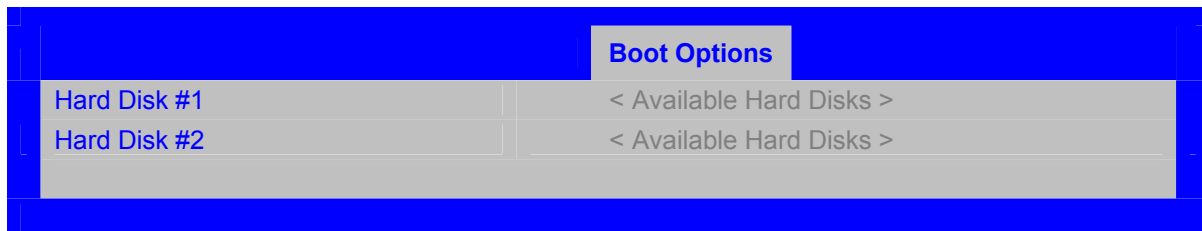

**Figure 34. Setup Utility — Hard Disk Order Screen Display**

**Table 33. Setup Utility — Hard Disk Order Fields**

Setup Item	Options	Help Text
Hard Disk #1	Available Legacy devices for this Device group.	Set system boot order by selecting the boot option for this position.
Hard Disk #2	Available Legacy devices for this Device group.	Set system boot order by selecting the boot option for this position.

**6.3.2.6.3 CDROM Order Screen**

The CDROM Order screen allows the user to control the CDROM devices.

To access this screen from the Main screen, select **Boot Options > CDROM Order**.

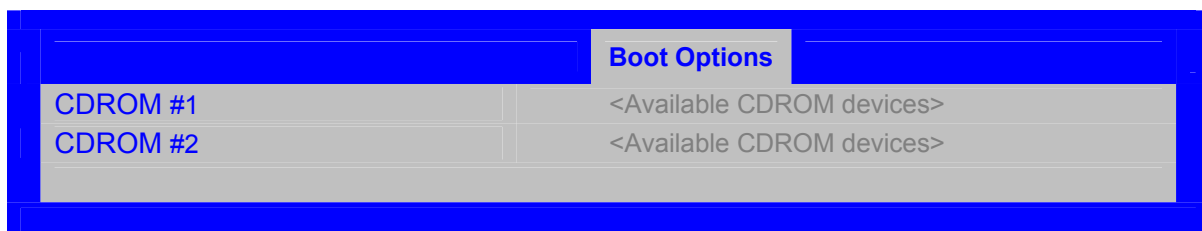

**Figure 35. Setup Utility – CDROM Order Screen Display**

**Table 34. Setup Utility – CDROM Order Fields**

Setup Item	Options	Help Text
CDROM #1	Available Legacy devices for this Device group.	Set system boot order by selecting the boot option for this position.
CDROM #2	Available Legacy devices for this Device group.	Set system boot order by selecting the boot option for this position.

**6.3.2.6.4 Floppy Order Screen**

The Floppy Order screen allows the user to control the floppy drives.

To access this screen from the Main screen, choose **Boot Options > Floppy Order**.

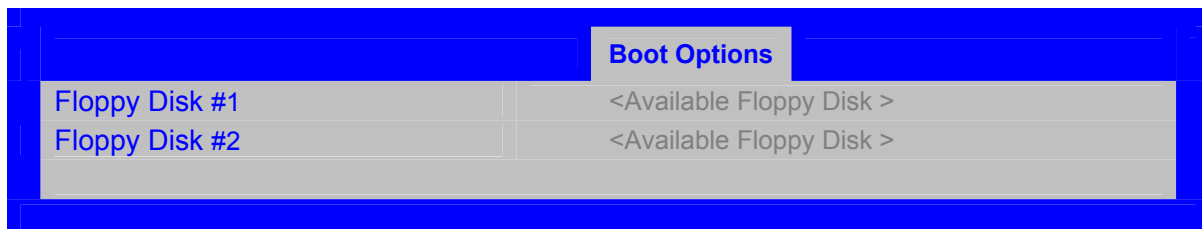

**Figure 36. Setup Utility — Floppy Order Screen Display**

**Table 35. Setup Utility — Floppy Order Fields**

Setup Item	Options	Help Text
Floppy Disk #1	Available Legacy devices for this Device group.	Set system boot order by selecting the boot option for this position.
Floppy Disk #2	Available Legacy devices for this Device group.	Set system boot order by selecting the boot option for this position.

**6.3.2.6.5 Network Device Order Screen**

The Network Device Order screen allows the user to control the network bootable devices.

To access this screen from the Main screen, select **Boot Options > Network Device Order**.

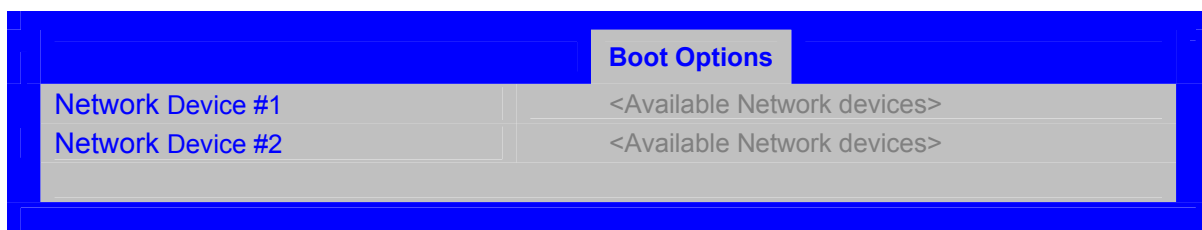

**Figure 37. Setup Utility – Network Device Order Screen Display**

**Table 36. Setup Utility – Network Device Order Fields**

Setup Item	Options	Help Text
Network Device #1	Available Legacy devices for this Device group.	Set system boot order by selecting the boot option for this position.
Network Device #2	Available Legacy devices for this Device group.	Set system boot order by selecting the boot option for this position.

### 6.3.2.7 Boot Manager Screen

The Boot Manager screen allows the user to view a list of devices available for booting, and to select a boot device for immediately booting the system.

To access this screen from the Main screen, select **Boot Manager**.

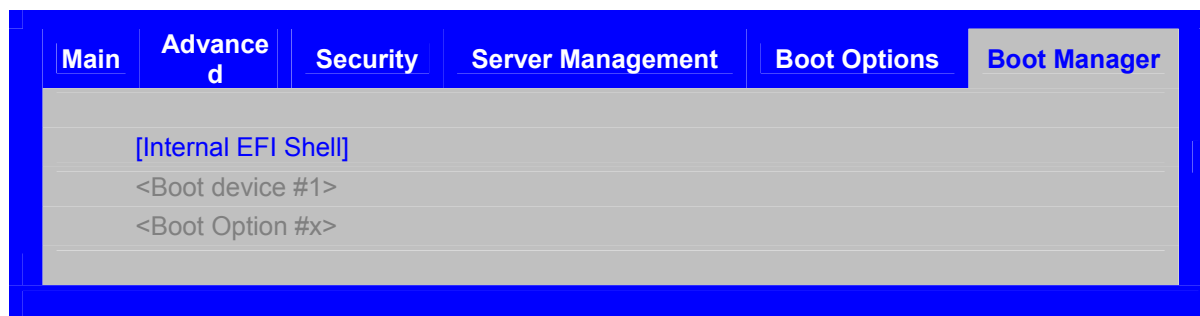

**Figure 38. Setup Utility – Boot Manager Screen Display**

**Table 37. Setup Utility – Boot Manager Screen Fields**

Setup Item	Help Text
Internal EFI Shell	Select this option to boot now. <b>Note:</b> This list is not the system boot option order. Use the Boot Options menu to view and configure the system boot option order.
Boot Device #x	Select this option to boot now. <b>Note:</b> This list is not the system boot option order. Use the Boot Options menu to view and configure the system boot option order.

## 6.4 Loading BIOS Defaults

Different mechanisms exist for resetting the system configuration to the default values. When a request to reset the system configuration is detected, the BIOS loads the default system configuration values during the next POST. You can send the request to reset the system to the defaults in the following ways:

- Pressing <F9> from within the BIOS Setup utility.
- Moving the clear system configuration jumper.

- IPMI command (set System Boot options command)
- Int15 AX=DA209
- Choosing Load User Defaults from the Exit page of the BIOS Setup loads user set defaults instead of the BIOS factory defaults.

The recommended steps to load the BIOS defaults are:

1. Power down the system (Do not remove AC power).
2. Move the Clear CMOS jumper from pins 1-2 to pins 2-3.
3. Move the Clear CMOS jumper from pins 2-3 to pins 1-2.
4. Power up the system.

## 7. Connector/Header Locations and Pin-outs

### 7.1 Board Connector Information

The following section provides detailed information regarding all connectors, headers, and jumpers on the server board. It lists all connector types available on the board and the corresponding reference designators printed on the silkscreen.

**Table 38. Board Connector Matrix**

Connector	Quantity	Reference Designators	Connector Type	Pin Count
Power supply	3	J9A1, J9C1	Main power CPU power	24 8
CPU	1	J6G1	CPU sockets	1156
Main memory	6	J8J3, J8J2, J8J1, J9J3, J9J2, J8J4	DIMM sockets	240
Intel® RMM3	1	J2C1	Header	34
50-pin PCI Express* Connector	1	J2H1	Header	50
CPU Fan	1	J6D1	Header	4
System Fans	4	J1J4, J6J2, J7J1, J6B1	Header	4
Battery	1	BT5C1	Battery holder	3
NIC/Stack 2x USB	2	J5A1, J6A1	Dual USB	8
Video	1	J7A1	External DSub	15
Serial port A	1	J8A1	Connector	9
Serial port B	1	J1B2	Header	9
Front panel	1	J4H3	Header	24
USB floppy	1	J1C1	Header	4
Dual- USB Internal Header	2	J1D1, J1E1	Header	10
PCI-E x16	1	J4B3	Card Edge	164
PCI-E x8	3	J2B2, J3B1, J4B2	Card Edge	98
PCI-E x4	1	J2B1	Card Edge	64
PCI 32	1	J1B1	Card Edge	120
XDP Connector	1	J5J1	Connector	60
Chassis Intrusion	1	J4B1	Header	2
Serial ATA	6	J1H4, J1H1, J1G1, J1H3, J1G3, J1F4	Header	7
IPMB	1	J1H2	Header	4
HSBP	1	J1J1	Header	4
Z-U130 USB	1	J3F2	Header	10
SATA_SGPIO	1	J1J3	Header	4

### 7.2 Power Connectors

The main power supply connection uses an SSI-compliant 2x12 pin connector (J9A1). In addition, there is one additional power related connector:

- One SSI-compliant 2x4 pin power connector (J9C1), which provides 12-V power to the CPU VRD.



The following tables define the connector pin-outs.

**Table 39. Baseboard Power Connector Pin-out (J9A1)**

Pin	Signal	Color	Pin	Signal	Color
1	+3.3 Vdc	Orange	13	+3.3 Vdc	Orange
2	+3.3 Vdc	Orange	14	-12 Vdc	Blue
3	GND	Black	15	GND	Black
4	+5 Vdc	Red	16	PS_ON#	Green
5	GND	Black	17	GND	Black
6	+5 Vdc	Red	18	GND	Black
7	GND	Black	19	GND	Black
8	PWRGD_PS	Gray	20	NC	White
9	5 VSB	Purple	21	+5 Vdc	Red
10	+12 Vdc	Yellow	22	+5 Vdc	Red
11	+12 Vdc	Yellow	23	+5 Vdc	Red
12	+3.3 Vdc	Orange	24	GND	Black

**Table 40. SSI Processor Power Connector Pin-out (J9C1)**

Pin	Signal	Color
1	GND	Black
2	GND	Black
3	GND	Black
4	GND	Black
5	+12 Vdc	Yellow/black
6	+12 Vdc	Yellow/black
7	+12 Vdc	Yellow/black
8	+12 Vdc	Yellow/black

## 7.3 System Management Headers

### 7.3.1 Intel® Remote Management Module 3 (Intel® RMM3) Connector

A 34-pin Intel® RMM 3 connector (J2C1) is included on the server board to support the optional Intel® Remote Management Module 3. This server board does not support third-party management cards.

---

**Note:** This connector is not compatible with the Intel® Remote Management Module (Intel® RMM) or the Intel® Remote Management Module 2 (Intel® RMM2).

---

**Table 41. Intel® RMM3 Connector Pin-out (J2C1)**

Pin	Signal Name	Pin	Signal Name
1	P3V3_AUX	2	RMII_IBMC_RMM3_MDIO
3	P3V3_AUX	4	RMII_IBMC_RMM3_MDC
5	GND	6	RMII_IBMC_RMM3_RXD1
7	GND	8	RMII_IBMC_RMM3_RXD0
9	GND	10	RMII_IBMC_RMM3_CRSDV
11	GND	12	CLK_50M_RMM3
13	GND	14	RMII_IBMC_RMM3_RX_ER
15	GND	16	RMII_IBMC_RMM3_TX_EN
17	GND	18	KEY
19	GND	20	RMII_IBMC_RMM3_TXD0
21	GND	22	RMII_IBMC_RMM3_TXD1
23	P3V3_AUX	24	SPI_IBMC_BK_CS_N
25	P3V3_AUX	26	TP_RMM3_SPI_WE
27	P3V3_AUX	28	SPI_IBMC_BK_DO
29	GND	30	SPI_IBMC_BK_CLK
31	GND	32	SPI_IBMC_BK_DI
33	GND	34	FM_RMM3_Present_N

### 7.3.2 LCP/IPMB Header

**Table 42. LPC/IPMB Header Pin-out (J1H2)**

Pin	Signal Name	Description
1	SMB_IPMB_5VSB_DAT	Integrated BMC IMB 5V standby data line
2	GND	Ground
3	SMB_IPMB_5VSB_CLK	Integrated BMC IMB 5V standby clock line
4	P5V_STBY	+5 V standby power

### 7.3.3 HSBP Header

**Table 43. HSBP Header Pin-out (J1J1)**

Pin	Signal Name
1	SMB_HSBP_5V_DAT
2	GND
3	SMB_HSBP_5V_CLK
4	FM_HSBP_ADD_C2

### 7.3.4 SGPIO Header

**Table 44. SGPIO Header Pin-out (J1J3)**

Pin	Signal Name	Description
1	SGPIO_CLOCK	SGPIO Clock Signal
2	SGPIO_LOAD	SGPIO Load Signal
3	SGPIO_DATAOUT0	SGPIO Data Out
4	SGPIO_DATAOUT1	SGPIO Data In

## 7.4 Front Control Panel Connector

The server board provides a 24-pin SSI front panel connector (J1C1) for use with Intel® and third-party chassis. The following table provides the pin-out for this connector.

**Table 45. Front Panel SSI Standard 24-pin Connector Pin-out (J1C1)**

Pin	Signal Name	Description	Pin	Signal Name	Description
1	P3V3_AUX (Power_LED_Anode)	Power LED +	2	P3V3_STBY	Front Panel Power
3	Key	No Connection	4	P5V_STBY (ID LED Anode)	ID LED +
5	FP_PWR_LED_N	Power LED -	6	FP_ID_LED_BUF_N	ID LED -
7	P3V3 (HDD_ACTIVITY_Anode)	HDD Activity LED+	8	FP_LED_STATUS_GR EEN_N	Status LED Green -
9	LED_HDD_ACTIVITY_N	HDD Activity LED-	10	FP_LED_STATUS_AM BER_N	Status LED Amber
11	FP_PWR_BTN_N	Power Button	12	NIC1_ACT_LED_N	NIC 1 Activity LED -
13	GND (Power Button GND)	Power Button Ground	14	NIC1_LINK_LED_N	NIC 1 Link LED -
15	RST_FP_BTN_N	Reset Button	16	SMB_SENSOR_3V3ST B_DATA	SMB Sensor DATA
17	GND (Reset GND)	Reset Button Ground	18	SMB_SENSOR_3V3ST B_CLK	SMB Sensor Clock
19	FP_ID_BTN_N	ID Button	20	FP_CHASS_INTRU	Chassis Intrusion
21	PU_FM_SIO_TEMP_SE NSOR	Front Panel Temperature Sensor	22	NIC2_ACT_LED_N	NIC 2 Activity LED -
23	FP_NMI_BTN_N	NMI Button	24	NIC2_LINK_LED_N	NIC 2 Link LED -

Combined system BIOS and the Integrated BMC support provide the functionality of the various supported control panel buttons and LEDs. The following sections describe the supported functionality of each control panel feature.

---

**Note:** Control panel features are also routed through the bridge board connector at location J1C1 as is implemented in Intel® Server Systems configured using a bridge board and a hot-swap backplane.

---

### 7.4.1 Power Button

The BIOS supports a front control panel power button. Pressing the power button initiates a request that the Integrated BMC forwards to the ACPI power state machines in the chipset. It is monitored by the Integrated BMC and does not directly control power on the power supply.

- **Power Button — Off to On**  
The Integrated BMC monitors the power button and the wake-up event signals from the chipset. A transition from either source results in the Integrated BMC starting the power-up sequence. Since the processor are not executing, the BIOS does not participate in this sequence. The hardware receives the power good and reset signals from the Integrated BMC and then transitions to an ON state.
- **Power Button — On to Off (Operating system absent)**  
The System Control Interrupt (SCI) is masked. The BIOS sets up the power button event to generate an SMI and checks the power button status bit in the ACPI hardware registers when an SMI occurs. If the status bit is set, the BIOS sets the ACPI power state of the machine in the chipset to the OFF state. The Integrated BMC monitors power state signals from the chipset and de-asserts PS\_PWR\_ON to the power supply. As a safety mechanism, if the BIOS fails to service the request, the Integrated BMC automatically powers off the system in 4 to 5 seconds.
- **Power Button — On to Off (Operating system present)**  
If an ACPI operating system is running, pressing the power button switch generates a request using SCI to the operating system to shut down the system. The operating system retains control of the system and the operating system policy determines the sleep state into which the system transitions, if any. Otherwise, the BIOS turns off the system.

### 7.4.2 Reset Button

The platform supports a front control panel reset button. Pressing the reset button initiates a request forwarded by the Integrated BMC to the chipset. The BIOS does not affect the behavior of the reset button.

### 7.4.3 NMI Button

The Intel® S3420GP Server Board family BIOS does not support the NMI button.

### 7.4.4 System Status Indicator LED

The Intel® Server Board S3420GP that uses the Intel® Xeon® Processor 3400 Series has a system status indicator LED on the front panel. This indicator LED has specific states and corresponding interpretation as shown in the following table.

**Table 46. System Status LED Indicator States**

Color	State	Criticality	Description
Green	Solid on	Ok	System booted and ready

Color	State	Criticality	Description
Green	~1 Hz blink	Degraded	System degraded: <ul style="list-style-type: none"> <li>▪ Non-critical temperature threshold asserted.</li> <li>▪ Non-critical voltage threshold asserted.</li> <li>▪ Non-critical fan threshold asserted.</li> <li>▪ Fan redundancy lost, sufficient system cooling maintained. This does not apply to non-redundant systems.</li> <li>▪ Power supply predictive failure.</li> <li>▪ Power supply redundancy lost. This does not apply to non-redundant systems.</li> <li>▪ Correctable errors over a threshold of 10 and migrating to a spare DIMM (memory sparing). This indicates the user no longer has spared DIMMs indicating a redundancy lost condition. Corresponding DIMM LED should light up.<sup>1</sup></li> </ul>
Amber	~1 Hz blink	Non-critical	Non-fatal alarm – system is likely to fail: <ul style="list-style-type: none"> <li>▪ CATERR asserted.</li> <li>▪ Critical temperature threshold asserted.</li> <li>▪ Critical voltage threshold asserted.</li> <li>▪ Critical fan threshold asserted.</li> <li>▪ VRD hot asserted.</li> <li>▪ SMI Timeout asserted.</li> </ul>
Amber	Solid on	Critical, non-recoverable	Fatal alarm – system has failed or shutdown: <ul style="list-style-type: none"> <li>▪ Thermtrip asserted.</li> <li>▪ Non-recoverable temperature threshold asserted.</li> <li>▪ Non-recoverable voltage threshold asserted.</li> <li>▪ Power fault/Power Control Failure.</li> <li>▪ Fan redundancy lost, insufficient system cooling. This does not apply to non-redundant systems.</li> </ul>
Off	N/A	Not ready	AC power off, if no degraded, non-critical, critical, or non-recoverable conditions exist.

**Notes:**

1. The BIOS detects these conditions and sends a Set Fault Indication command to the Integrated BMC to provide the contribution to the system status LED.
2. Support for upper non-critical limit is not provided in the default SDR configuration. However, if a user does enable this threshold in the SDR, then the system status LED should behave as described.

There is no precedence or lock-out mechanism for the control sources. When a new request arrives, all previous requests are terminated. For example, if the chassis ID LED is blinking and the chassis ID button is pressed, then the chassis ID LED changes to solid on. If the button is pressed again with no intervening commands, the chassis ID LED turns off.

## 7.5 I/O Connectors

### 7.5.1 VGA Connector

The following table details the pin-out definition of the VGA connector (J7A1).

**Table 47. VGA Connector Pin-out (J7A1)**

Pin	Signal Name	Description
1	V_IO_R_CONN	Red (analog color signal R)
2	V_IO_G_CONN	Green (analog color signal G)

Pin	Signal Name	Description
3	V_IO_B_CONN	Blue (analog color signal B)
4	TP_VID_CONN_B4	No connection
5	GND	Ground
6	GND	Ground
7	GND	Ground
8	GND	Ground
9	TP_VID_CONN_B9	No connection
10	GND	Ground
11	TP_VID_CONN_B11	No connection
12	V_IO_DDCDAT	DDCDAT
13	V_IO_HSYNC_CONN	HSYNC (horizontal sync)
14	V_IO_VSYNC_CONN	VSYNC (vertical sync)
15	V_IO_DDCCLK	DDCCLK

## 7.5.2 Rear NIC and USB connector

The server board provides two stacked RJ-45/2xUSB connectors side-by-side on the back edge of the board (J6A1, J5A1). The pin-out for NIC connectors are identical and defined in the following table.

**Table 48. RJ-45 10/100/1000 NIC Connector Pin-out (J5A1)**

Pin	Signal Name	Pin	Signal Name
1	P5V_USB_PWR75	2	USB_PCH_11_FB_DN
3	USB_PCH_11_FB_DP	4	GND
5	P5V_USB_PWR75	6	USB_PCH_10_FB_DN
7	USB_PCH_10_FB_DP	8	GND
9	P1V9_LAN2_R	10	NIC2_MDIP<0>
11	NIC2_MDIN<0>	12	NIC2_MDIP<1>
13	NIC2_MDIN<1>	14	NIC2_MDIP<2>
15	NIC2_MDIN<2>	16	NIC2_MDIP<3>
17	NIC2_MDIN<3>	18	GND
19	LED_NIC2_1	20	P3V3_AUX
21	LED_NIC2_LINK100_R_0	22	LED_NIC2_LINK1000_2

**Table 49. RJ-45 10/100/1000 NIC Connector Pin-out (J6A1)**

Pin	Signal Name	Pin	Signal Name
1	P5V_USB_PWR75	2	USB_PCH_11_FB_DN
3	USB_PCH_11_FB_DP	4	GND
5	P5V_USB_PWR75	6	USB_PCH_10_FB_DN
7	USB_PCH_10_FB_DP	8	GND
9	P1V8_PHY_VCT_R	10	NIC1_MDIP<0>
11	NIC1_MDIN<0>	12	NIC1_MDIP<1>
13	NIC1_MDIN<1>	14	NIC2_MDIP<2>
15	NIC1_MDIN<2>	16	NIC2_MDIP<3>
17	NIC1_MDIN<3>	18	GND
19	LED_NIC1_LINK_ACT_0_R	20	P3V3_AUX

Pin	Signal Name	Pin	Signal Name
21	LED_NIC1_2	22	LED_NIC1_LINK1000_1

### 7.5.3 SATA

The sever board provides up to six SATA connectors. The pin configuration for each connector is identical and defined in the following table.

**Table 50. SATA Connector Pin-out (J1H4, J1H1, J1G1, J1H3, J1G3, J1F4)**

Pin	Signal Name	Description
1	GND	Ground
2	SATA/SAS_TX_P_C	Positive side of transmit differential pair
3	SATA/SAS_TX_N_C	Negative side of transmit differential pair
4	GND	Ground
5	SATA/SAS_RX_N_C	Negative side of receive differential pair
6	SATA/SAS_RX_P_C	Positive side of receive differential pair
7	GND	Ground

### 7.5.4 50-pin PCI Express\* Connector

The Intel® Server Board S3420GPLX provides one 50-pin PCI Express\* connector for Intel® SAS Entry RAID Module AXX4SASMOD.

The pin configuration is identical and defined in the following table.

**Table 51. 50-pin PCI Express\* Connector Pin-out (J2H1)**

Pin	Signal Name	Pin	Signal Name
1	P3V3_AUX	2	P3V3_AUX
3	PE_RST_IO_MODULE_N	4	GND
5	GND	6	PE2_ESB_RXP_C<0>
7	GND	8	PE2_ESB_RXN_C<0>
9	PE2_ESB_TXP_C<0>	10	GND
11	PE2_ESB_TXN_C<0>	12	GND
13	GND	14	PE2_ESB_RXP_C<1>
15	GND	16	PE2_ESB_RXN_C<1>
17	PE2_ESB_TXP_C<1>	18	GND
19	PE2_ESB_TXN_C<1>	20	GND
21	GND	22	PE2_ESB_RXP_C<2>
23	GND	24	PE2_ESB_RXN_C<2>
25	PE2_ESB_TXP_C<2>	26	GND
27	PE2_ESB_TXN_C<2>	28	GND
29	GND	30	PE2_ESB_RXP_C<3>
31	GND	32	PE2_ESB_RXN_C<3>
33	PE2_ESB_TXP_C<3>	34	GND
35	PE2_ESB_TXN_C<3>	36	GND
37	GND	38	CLK_100M_LP_PCIE_SLOT3_P
39	GND	40	CLK_100M_LP_PCIE_SLOT3_N
41	PE_WAKE_N	42	GND
43	P3V3	44	P3V3

Pin	Signal Name	Pin	Signal Name
45	P3V3	46	P3V3
47	P3V3	48	P3V3
49	P3V3	50	P3V3

### 7.5.5 Serial Port Connectors

The server board provides one external DB9 Serial A port (J8A1) and one internal 9-pin serial B header (J1B2). The following tables define the pin-outs.

**Table 52. External Serial A Port Pin-out (J8A1)**

Pin	Signal Name	Description
1	SPA_DCD	DCD (carrier detect)
2	SPA_SIN_L	RXD (receive data)
3	SPA_SOUT_N	TXD (Transmit data)
4	SPA_DTR	DTR (Data terminal ready)
5	GND	Ground
6	SPA_DSR	DSR (data set ready)
7	SPA_RTS	RTS (request to send)
8	SPA_CTS	CTS (clear to send)
9	SPA_RI	RI (Ring Indicate)
10	NC	

**Table 53. Internal 9-pin Serial B Header Pin-out (J1B2)**

Pin	Signal Name	Description
1	SPB_DCD	DCD (carrier detect)
2	SPB_DSR	DSR (data set ready)
3	SPB_SIN_L	RXD (receive data)
4	SPB_RTS	RTS (request to send)
5	SPB_SOUT_N	TXD (Transmit data)
6	SPB_CTS	CTS (clear to send)
7	SPB_DTR	DTR (Data terminal ready)
8	SPB_RI	RI (Ring indicate)
9	SPB_EN_N	Enable
10	NC	

### 7.5.6 USB Connector

There are four external USB ports on two NIC/USB combinations. Section 5.5.2 details the pin-out of the connector.

Two 2x5 connector on the server board (J1E1, J1D1) provides an option to support an additional USB port, each connector supporting two USB ports. The following table defines the pin-out of the connector.

**Table 54. Internal USB Connector Pin-out ( J1E1, J1D1)**

Pin	Signal Name	Description
1	USB2_VBUS4	USB power (port 4)
2	USB2_VBUS5	USB power (port 5)



Pin	Signal Name	Description
3	USB_ICH_P4N_CONN	USB port 4 negative signal
4	USB_ICH_P5N_CONN	USB port 5 negative signal
5	USB_ICH_P4P_CONN	USB port 4 positive signal
6	USB_ICH_P5P_CONN	USB port 5 positive signal
7	Ground	
8	Ground	
9	Key	No pin
10	TP_USB_ICH_NC	Test point

One x connector (J1J2) on the server board provides an option to support a USB floppy connector.

**Table 55. Pin-out of Internal USB Connector for Floppy ( J1J2)**

Pin	Signal Name
1	+5V
2	USB_N
3	USB_P
4	GND

One 2x5 connectors (J3F2) on the server board provides an option to support an Intel® Z-U130 Value Solid State Drive. The following table defines the pin-out of the connector.

**Table 56. Pin-out of Internal USB Connector for low-profile Intel® Z-U130 Value Solid State Drive (J3F2)**

Pin	Signal Name	Description
1	+5V	USB power
2	NC	N/A
3	USB Data -	USB port ## negative signal
4	NC	N/A
5	USB Data +	USB port ## positive signal
6	NC	N/A
7	Ground	N/A
8	NC	N/A
9	Key	No pin
10	LED#	Activity LED

## 7.6 PCI Express\* Slot/PCI Slot/Riser Card Slot

A PCI-E Riser card will enable a PCI-E add-on card to be accommodated in the 1U chassis. The following table shows the pin-out for this riser slot.

**Table 57. Pin-out of adaptive riser slot/PCI Express slot 6**

Pin	Signal	Description	Pin	Signal	Description
B1	+12V	P12V	A1	PRSNT1_N	GND
B2	+12V	P12V	A2	+12V	P12V
B3	RSVD	P12V	A3	+12V	P12V

Pin	Signal	Description	Pin	Signal	Description
B4	GND	GND	A4	GND	GND
B5	SMCLK	PU_S6_SMBCLK	A5	JTAG2	P3V3_RISER_A5
B6	SMDATA	PU_S6_SMBDAT	A6	JTAG3	JTAG_S6_TDI
B7	GND	GND	A7	JTAG4	NC
B8	+3.3V	P3V3	A8	JTAG5	P3V3_RISER_A8
B9	JTAG1	JTAG_S6_TRST_N	A9	+3_3V	P3V3
B10	+3.3VAUX	P3V3_AUX	A10	+3_3V	P3V3
B11	WAKE_N	FM_PE_WAKE_N	A11	PERST_N	RST_PE_S236_N_R1
<b>KEY</b>			<b>KEY</b>		
<b>KEY</b>			<b>KEY</b>		
B12	RSVD	NC	A12	GND	GND
B13	GND	GND	A13	REFCLKP	CLK_100M_SLOT6A_DP
B14	PETP0	P2E_CPU_C_S6_TXP<7>	A14	REFCLKN	CLK_100M_SLOT6A_DPN
B15	PETN0	P2E_CPU_C_S6_TXN<7>	A15	GND	GND
B16	GND	GND	A16	PERP0	P2E_CPU_S6_RXP<7>
B17	PRSNT2_N	NC	A17	PERN0	P2E_CPU_S6_RXN<7>
B18	GND	GND	A18	GND	GND
B19	PETP1	P2E_CPU_C_S6_TXP<6>	A19	RSVD	NC
B20	PETN1	P2E_CPU_C_S6_TXN<6>	A20	GND	GND
B21	GND	GND	A21	PERP1	P2E_CPU_S6_RXP<6>
B22	GND	GND	A22	PERN1	P2E_CPU_S6_RXN<6>
B23	PETP2	P2E_CPU_C_S6_TXP<5>	A23	GND	GND
B24	PETN2	P2E_CPU_C_S6_TXN<5>	A24	GND	GND
B25	GND	GND	A25	PERP2	P2E_CPU_S6_RXP<5>
B26	GND	GND	A26	PERN2	P2E_CPU_S6_RXN<5>
B27	PETP3	P2E_CPU_C_S6_TXP<4>	A27	GND	GND
B28	PETN3	P2E_CPU_C_S6_TXN<4>	A28	GND	GND
B29	GND	GND	A29	PERP3	P2E_CPU_S6_RXP<4>
B30	RSVD	NC	A30	PERN3	P2E_CPU_S6_RXN<4>
B31	PRSNT2_N	NC	A31	GND	GND
B32	GND	GND	A32	RSVD	NC
End of x4			End of x4		
B33	PETP4	P2E_CPU_C_S6_TXP<3>	A33	RSVD	NC
B34	PETN4	P2E_CPU_C_S6_TXN<3>	A34	GND	GND
B35	GND	GND	A35	PERP4	P2E_CPU_S6_RXN<3>
B36	GND	GND	A36	PERN4	P2E_CPU_S6_RXP<3>
B37	PETP5	P2E_CPU_C_S6_TXP<2>	A37	GND	GND
B38	PETN5	P2E_CPU_C_S6_TXN<2>	A38	GND	GND
B39	GND	GND	A39	PERP5	P2E_CPU_S6_RXN<2>
B40	GND	GND	A40	PERN5	P2E_CPU_S6_RXP<2>
B41	PETP6	P2E_CPU_C_S6_TXP<1>	A41	GND	GND
B42	PETN6	P2E_CPU_C_S6_TXN<1>	A42	GND	GND
B43	GND	GND	A43	PERP6	P2E_CPU_S6_RXN<1>
B44	GND	GND	A44	PERN6	P2E_CPU_S6_RXP<1>
B45	PETP7	P2E_CPU_C_S6_TXP<0>	A45	GND	GND
B46	PETN7	P2E_CPU_C_S6_TXN<0>	A46	GND	GND
B47	GND	GND	A47	PERP7	P2E_CPU_S6_RXN<0>

Pin	Signal	Description	Pin	Signal	Description
B48	PRSNT2_N	NC	A48	PERN7	P2E_CPU_S6_RXP<0>
B49	GND	GND	A49	GND	GND
End of x8			End of x8		
B50	PETP8	NC	A50	RSVD	NC
B51	PETN8	NC	A51	GND	GND
B52	GND	GND	A52	PERP8	NC
B53	GND	GND	A53	PERN8	NC
B54	PETP9	NC	A54	GND	GND
B55	PETN9	NC	A55	GND	GND
B56	GND	GND	A56	PERP9	NC
B57	GND	GND	A57	PERN9	NC
B58	PETP10	NC	A58	GND	GND
B59	PETN10	NC	A59	GND	GND
B60	GND	GND	A60	PERP10	NC
B61	GND	GND	A61	PERN10	NC
B62	PEXP11	NC	A62	GND	GND
B63	PETN11	NC	A63	GND	GND
B64	GND	GND	A64	PERP11	NC
B65	GND	GND	A65	PERN11	NC
B66	PETP12	NC	A66	GND	GND
B67	PETN12	NC	A67	GND	GND
B68	GND	GND	A68	PERP12	NC
B69	GND	GND	A69	PERN12	NC
B70	PETP13	NC	A70	GND	GND
B71	PETN13	NC	A71	GND	GND
B72	GND	GND	A72	PERP13	NC
B73	GND	GND	A73	PERN13	NC
B74	PETP14	NC	A74	GND	GND
B75	PETN14	NC	A75	GND	GND
B76	GND	GND	A76	PERP14	NC
B77	GND	GND	A77	PERN14	NC
B78	PETP15	NC	A78	GND	GND
B79	PETN15	NC	A79	GND	GND
B80	GND	GND	A80	PERP15	NC
B81	PRSNT2_N	NC	A81	PERN15	NC
B82	RSVD	NC	A82	GND	GND

### Three PCI Express\* x8 connectors (J2B2, J3B1 and J4B2)

Pin	Signal	Pin	Signal	Pin	Signal	Pin	Signal
A1	PRSNT1#	B1	+12V	A26	HSIP[2]	B26	GND
A2	+12V	B2	+12V	A27	GND	B27	HSOP[3]
A3	+12V	B3	RESERVED	A28	GND	B28	HSON[3]
A4	GND	B4	GND	A29	HSIP[3]	B29	GND

Pin	Signal	Pin	Signal	Pin	Signal	Pin	Signal
A5	JTAG2/TCK	B5	SMCLK	A30	HSIN[3]	B30	RESERVED
A6	JTAG3/TDI	B6	SMDAT	A31	GND	B31	PRSNT2#
A7	JTAG4/TDO	B7	GND	A32	RESERVED	B32	GND
A8	JTAG5/TMS	B8	+3.3V	A33	RESERVED	B33	HSOP[4]
A9	+3.3V	B9	JTAG1/TRST#	A34	GND	B34	HSOP[4]
A10	+3.3V	B10	3.3VAUX	A35	HSIP[4]	B35	GND
A11	PERST#	B11	WAKE#	A36	HSIN[4]	B36	GND
A12	GND	B12	RESERVED	A37	GND	B37	HSOP[5]
A13	REFCLK+	B13	GND	A38	GND	B38	HSOP[5]
A14	REFCLK-	B14	HSOP[0]	A39	HSIP[5]	B39	GND
A15	GND	B15	HSOP[0]	A40	HSIN[5]	B40	GND
A16	HSIP[0]	B16	GND	A41	GND	B41	HSOP[6]
A17	HSIN[0]	B17	PRSNT2#	A42	GND	B42	HSOP[6]
A18	GND	B18	GND	A43	HSIP[6]	B43	GND
A19	RESERVED	B19	HSOP[1]	A44	HSIN[6]	B44	GND
A20	GND	B20	HSOP[1]	A45	GND	B45	HSOP[7]
A21	HSIP[1]	B21	GND	A46	GND	B46	HSOP[7]
A22	HSIN[1]	B22	GND	A47	HSIP[7]	B47	GND
A23	GND	B23	HSOP[2]	A48	HSIN[7]	B48	PRSNT2#
A24	GND	B24	HSOP[2]	A49	GND	B49	GND
A25	HSIP[2]	B25	GND				

**One PCI Express\* X4 connector (J2B1)**

Pin#	Signal	Pin#	Signal	Pin#	Signal	Pin#	Signal
A1	PRSNT1_N	B1	+12V	A17	PERN0	B17	PRSNT2_N
A2	+12V	B2	+12V	A18	GND	B18	GND
A3	+12V	B3	RSVD	A19	RSVD	B19	PETP1
A4	GND	B4	GND	A20	GND	B20	PETN1
A5	JTAG2	B5	SMCLK	A21	PERP1	B21	GND
A6	JTAG3	B6	SMDAT	A22	PERN1	B22	GND
A7	JTAG4	B7	GND	A23	GND	B23	PETP2
A8	JTAG5	B8	+3.3V	A24	GND	B24	PETN2

Pin#	Signal	Pin#	Signal	Pin#	Signal	Pin#	Signal
A9	+3.3V	B9	JTAG1	A25	PERP2	B25	GND
A10	+3.3V	B10	3.3VAUX	A26	PERN2	B26	GND
A11	PERST_N	B11	WAKE_N	A27	GND	B27	PETP3
A12	GND	B12	RSVD	A28	GND	B28	PETN3
A13	REFCLK+	B13	GND	A29	PERP3	B29	GND
A14	REFCLK-	B14	PETP0	A30	PERN3	B30	RSVD
A15	GND	B15	PETN0	A31	GND	B31	PRSNT2_N
A16	PERP0	B16	GND	A32	RSVD	B32	GND

**One PCI X32 connector (J1B1)**

Pin #	Signal	Pin #	Signal	Pin #	Signal	Pin #	Signal
B1	-12V	A1	TRST#	B32	AD[17]	A32	AD[16]
B2	TCK	A2	+12V	B33	C/BE[2]#	A33	+3.3V
B3	Ground	A3	TMS	B34	Ground	A34	FRAME#
B4	TDO	A4	TDI	B35	IRDY#	A35	Ground
B5	+5V	A5	+5V	B36	+3.3V	A36	TRDY#
B6	+5V	A6	INTA#	B37	DEVSEL#	A37	Ground
B7	INTB#	A7	INTC#	B38	Ground	A38	STOP#
B8	INTD#	A8	+5V	B39	LOCK#	A39	+3.3V
B9	PRSNT1#	A9	RSVD	B40	PERR#	A40	RSVD
B10	RSVD	A10	V_IO	B41	+3.3V	A41	RSVD
B11	PRSNT2#	A11	RSVD	B42	SERR#	A42	Ground
B12	GND	A12	GND	B43	+3.3V	A43	PAR
B13	GND	A13	GND	B44	C/BE[1]#	A44	AD[15]
B14	RSVD	A14	3.3Vaux	B45	AD[14]	A45	+3.3V
B15	Ground	A15	RST#	B46	Ground	A46	AD[13]
B16	CLK	A16	V_IO	B47	AD[12]	A47	AD[11]
B17	Ground	A17	GNT#	B48	AD[10]	A48	Ground
B18	REQ#	A18	Ground	B49	M66EN	A49	AD[09]
B19	V_IO	A19	PME#	B50	KEY	A50	KEY
B20	AD[31]	A20	AD[30]	B51	KEY	A51	KEY
B21	AD[29]	A21	+3.3V	B52	AD[08]	A52	C/BE[0]#
B22	Ground	A22	AD[28]	B53	AD[07]	A53	+3.3V
B23	AD[27]	A23	AD[26]	B54	+3.3V	A54	AD[06]
B24	AD[25]	A24	Ground	B55	AD[05]	A55	AD[04]
B25	+3.3V	A25	AD[24]	B56	AD[03]	A56	Ground
B26	C/BE[3]#	A26	IDSEL	B57	Ground	A57	AD[02]
B27	AD[23]	A27	+3.3V	B58	AD[01]	A58	AD[00]
B28	Ground	A28	AD[22]	B59	V_IO	A59	V_IO
B29	AD[21]	A29	AD[20]	B60	ACK64#	A60	REQ64#
B30	AD[19]	A30	Ground	B61	+5V	A61	+5V
B31	+3.3V	A31	AD[18]	B62	+5V	A62	+5V

## 7.7 Fan Headers

The server board provides five SSI-compliant 4-pin fan headers to be used as the CPU and chassis. The pin configuration for each of the 4-pin fan headers is identical and defined in the following table.

- One 4-pin fan headers are designated as processor cooling fans:
  - CPU fan (J6D1)
  - SYS1 fan (J1J4)
  - SYS2 fan (J6J2)
  - SYS3 fan (J7J1)
  - SYS4 fan (J6B1)

**Table 58. SSI 4-pin Fan Header Pin-out (J6D1, J1J4, J6J2, J7J1, J6B1)**

Pin	Signal Name	Type	Description
1	Ground	GND	Ground is the power supply ground
2	12 V	Power	Power supply 12 V
3	Fan Tach	In	FAN_TACH signal is connected to the Integrated BMC to monitor the fan speed
4	Fan PWM	Out	FAN_PWM signal to control fan speed

## 8. Jumper Blocks

The server board has several 3-pin jumper blocks that can be used to configure, protect, or recover specific features of the server board.

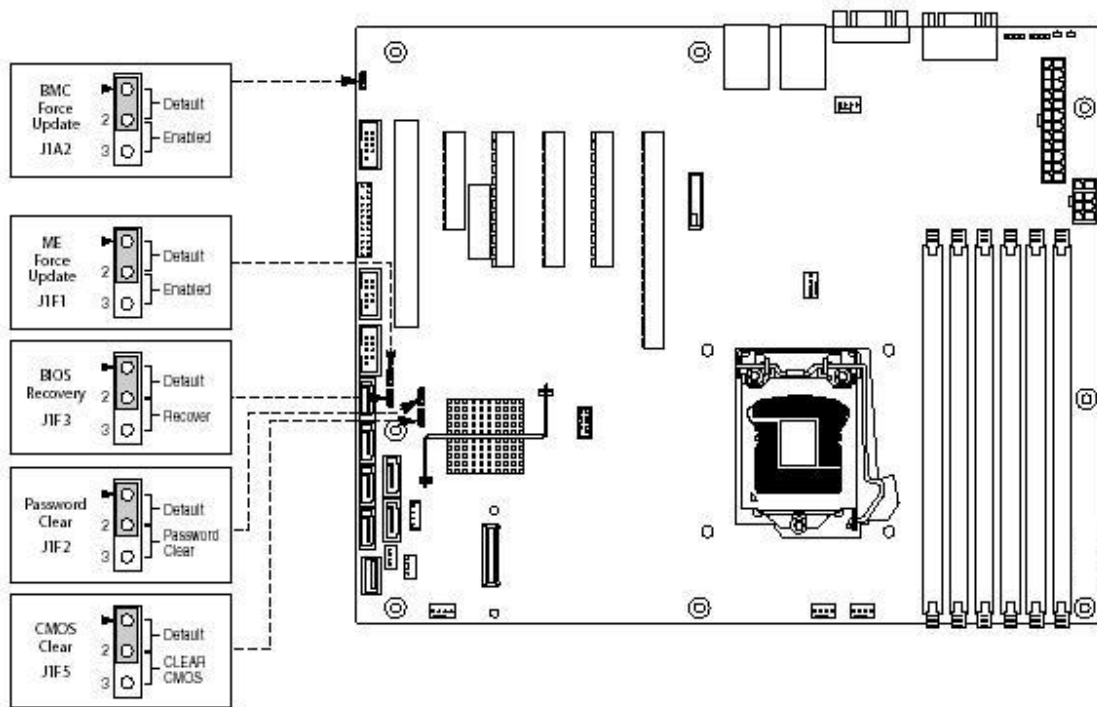

**Figure 39. Jumper Blocks (J1A2, J1F1, J1F3, J1F2 and J1F5)**

**Table 59. Server Board Jumpers (J1F1, J1F2, J1F3, J1F5, J1A2)**

Jumper Name	Pins	System Results
J1F5: CMOS Clear	1-2	These pins should have a jumper in place for normal system operation. (Default)
	2-3	If these pins are jumpered with AC power plugged, the CMOS settings are cleared within five seconds. These pins should not be jumpered for normal operation.
J1F1: ME Force Update	1-2	ME Firmware Force Update Mode – Disabled (Default)
	2-3	ME Firmware Force Update Mode – Enabled
J1F2: Password Clear	1-2	These pins should have a jumper in place for normal system operation. (Default)
	2-3	If these pins are jumpered, administrator and user passwords are cleared within 5-10 seconds after the system is powered on. These pins should not be jumpered for normal operation.
J1F3: BIOS Recovery	1-2	These pins should have a jumper in place for normal system operation. (Default)
	2-3	Given that the main system BIOS will not boot with these pins jumpered, system can only boot from EFI-bootable recovery media with the recovery BIOS image.
J1A2: BMC Force Update	1-2	Integrated BMC Firmware Force Update Mode – Disabled (Default)
	2-3	Integrated BMC Firmware Force Update Mode – Enabled

## 8.1 CMOS Clear and Password Reset Usage Procedure

The CMOS Clear (J1F5) and Password Reset (J1F2) recovery features are designed such that the desired operation can be achieved with minimal system downtime. The usage procedure for these two features has changed from previous generation Intel server boards. The following procedure outlines the new usage model.

### 8.1.1 Clearing the CMOS

To clear the CMOS, perform the following steps:

1. Power down the server. Do not unplug the power cord.
2. Open the server chassis. For instructions, see your server chassis documentation.
3. Move jumper (J1F5) from the default operating position (covering pins 1 and 2) to the reset/clear position (covering pins 2 and 3).
4. Wait five seconds.
5. Remove AC power.
6. Move the jumper back to the default position (covering pins 1 and 2).
7. Close the server chassis.
8. Power up the server.

The CMOS is now cleared and can be reset by going into the BIOS setup.

---

**Note:** Removing AC power before performing the CMOS clear operation causes the system to automatically power up and immediately power down, after the procedure is followed and AC power is re-applied. If this happens, remove the AC power cord again, wait 30 seconds, and re-install the AC power cord. Power up the system and proceed to the <F2> BIOS Setup utility to reset the preferred settings.

---

### 8.1.2 Clearing the Password

To clear the password, perform the following steps:

1. Power down the server. Do not unplug the power cord.
2. Open the chassis. For instructions, see your server chassis documentation.
3. Move jumper (J1F2) from the default operating position (covering pins 1 and 2) to the password clear position (covering pins 2 and 3).
4. Close the server chassis.
5. Power up the server and wait 10 seconds or until POST completes.
6. Power down the server.
7. Open the chassis and move the jumper back to the default position (covering pins 1 and 2).
8. Close the server chassis.
9. Power up the server.

The password is now cleared and can be reset by going into the BIOS setup.



## 8.2 Integrated BMC Force Update Procedure (only for the Intel® Server Board S3420GPLX and S3420GPLC)

When performing the standard Integrated BMC firmware update procedure, the update utility places the Integrated BMC into an update mode, allowing the firmware to load safely onto the flash device. In the unlikely event the Integrated BMC firmware update process fails due to the Integrated BMC not being in the proper update state, the server board provides an Integrated BMC Force Update jumper (J1A2), which forces the Integrated BMC into the proper update state. The following procedure should be completed in the event the standard Integrated BMC firmware update process fails.

1. Power down and remove the AC power cord.
2. Open the server chassis. For instructions, see your server chassis documentation.
3. Move jumper from the default operating position (covering pins 1 and 2) to the enabled position (covering pins 2 and 3).
4. Close the server chassis.
5. Reconnect the AC cord and power up the server.
6. Perform the Integrated BMC firmware update procedure as documented in the README.TXT file that is included in the given Integrated BMC firmware update package. After successful completion of the firmware update process, the firmware update utility may generate an error stating that the Integrated BMC is still in update mode.
7. Power down and remove the AC power cord.
8. Open the server chassis.
9. Move jumper from the enabled position (covering pins 2 and 3) to the disabled position (covering pins 1 and 2).
10. Close the server chassis.
11. Reconnect the AC cord and power up the server.

---

**Note:** Normal Integrated BMC functionality is disabled with the Force Integrated BMC Update jumper set to the enabled position. The server should never be run with the Integrated BMC Force Update jumper set in this position. This jumper setting should only be used when the standard firmware update process fails. This jumper should remain in the default/disabled position when the server is running normally.

---

## 8.3 ME Force Update Jumper

When performing the standard ME force update procedure, the update utility places the ME into an update mode, allowing the ME to load safely onto the flash device. In the unlikely event ME firmware update process fails due to ME not being in the proper update state, the server board provides an Integrated BMC Force Update jumper (J1F1), which forces the ME into the proper update state. The following procedure should be completed in the event the standard ME firmware update process fails.

1. Power down and remove the AC power cord.
2. Open the server chassis. For instructions, see your server chassis documentation.

3. Move jumper from the default operating position (covering pins 1 and 2) to the enabled position (covering pins 2 and 3).
4. Close the server chassis.
5. Reconnect the AC cord and power up the server.
6. Perform the ME firmware update procedure as documented in the README.TXT file that is included in the given ME firmware update package (same package as BIOS).
7. Power down and remove the AC power cord.
8. Open the server chassis.
9. Move jumper from the enabled position (covering pins 2 and 3) to the disabled position (covering pins 1 and 2).
10. Close the server chassis.
11. Reconnect the AC cord and power up the server.

## 8.4 BIOS Recovery Jumper

The following procedure boots the recovery BIOS and flashes the normal BIOS:

1. Turn off the system power.
2. Move the BIOS recovery jumper to the recovery state.
3. Insert a bootable BIOS recovery media containing the new BIOS image files.
4. Turn on the system power.

The BIOS POST screen will appear displaying the progress, and the system will boot to the EFI shell. The EFI shell then executes the Startup.nsh batch file to start the flash update process. The user should then switch off the power and return the recovery jumper to its normal position. The user should not interrupt the BIOS POST on the first boot after recovery.

When the flash update completes:

1. Remove the recovery media.
2. Turn off the system power.
3. Restore the jumper to its original position.
4. Turn on the system power.
5. Re-flash any custom blocks, such as user binary or language blocks.

The system should now boot using the updated system BIOS.

## 9. Intel® Light Guided Diagnostics

The server board has several on-board diagnostic LEDs to assist in troubleshooting board-level issues. This section shows where each LED is located on the server board and describes the function of each LED.

### 9.1 System Status LED (For the Intel® Server Board S3420GPLX and S3420GPLC)

The server board provides a system status indicator LED on the front panel. This indicator LED has specific states and corresponding interpretation as shown in the following table.

**Table 60. Front Panel Status LED Behavior Summary**

Color	State	Criticality	Description
Off	N/A	Not ready	AC power off. If no degraded, non-critical, critical, or non-recoverable conditions exist.
Amber	Solid on	Critical, non-recoverable	Fatal alarm – system has failed or shutdown: Thermtrip asserted. Non-recoverable temperature threshold asserted. Non-recoverable voltage threshold asserted. Power fault/Power Control Failure. Fan redundancy lost, insufficient system cooling. This does not apply to non-redundant systems. Uncorrectable memory error.
Amber	Blink	Non-critical	Non-fatal alarm – system is likely to fail: CATERR asserted. Critical temperature threshold asserted. Critical voltage threshold asserted. Critical fan threshold asserted. VRD hot asserted. SMI Timeout asserted. Correctable error threshold has been reached for a failing DDR3 DIMM.
Green	Solid on	System OK	System booted and ready.
Green	Blink	Degraded	System degraded: Non-critical temperature threshold asserted. Non-critical voltage threshold asserted. Non-critical fan threshold asserted. Fan redundancy lost, sufficient system cooling maintained. This does not apply to non-redundant systems. Power supply predictive failure. Unable to use all of the installed memory (more than one DDR3 DIMM installed). Correctable error threshold has been reached for a failing DDR3 DIMM on a given channel.

## 9.2 Post Code Diagnostic LEDs

During the system boot process, the BIOS executes several platform configuration processes, each of which is assigned a specific hex POST code number. As each configuration routine is started, the BIOS displays the POST code on the POST code diagnostic LEDs found on the back edge of the server board. To assist in troubleshooting a system hang during the POST process, The diagnostic LEDs can be used to identify the last POST process executed.

**Table 61. POST Code Diagnostic LED Location**

A	Status LED (For Intel® Server Board S3420GPLX and S3420GPLC)	F	Diagnostic LED #4
B	ID LED	G	Diagnostic LED #3
C	Diagnostic LED #7 (MSB LED)	H	Diagnostic LED #2
D	Diagnostic LED #6	I	Diagnostic LED #1
E	Diagnostic LED #5	J	Diagnostic LED #0 (LSB LED)

## 10. Design and Environmental Specifications

### 10.1 Intel® Server Board S3420GP Design Specifications

The operation of the server board at conditions beyond those shown in the following table may cause permanent damage to the system. Exposure to absolute maximum rating conditions for extended periods may affect system reliability.

**Table 62. Server Board Design Specifications**

Operating Temperature	0° C to 55° C <sup>1</sup> (32° F to 131° F)
Non-Operating Temperature	-40° C to 70° C (-40° F to 158° F)
DC Voltage	± 5% of all nominal voltages
Shock (Unpackaged)	Trapezoidal, 50 G, 170 inches/sec
Shock (Packaged)	
<20 pounds	36 inches
20 to <40 pounds	30 inches
40 to <80 pounds	24 inches
80 to <100 pounds	18 inches
100 to <120 pounds	12 inches
120 pounds	9 inches
Vibration (Unpackaged)	5 Hz to 500 Hz 3.13 g RMS random

<sup>1</sup> Chassis design must provide proper airflow to avoid exceeding the Intel® Xeon® processor maximum case temperature.

**Disclaimer Note:** Intel Corporation server boards contain a number of high-density VLSI and power delivery components that need adequate airflow to cool. Intel ensures through its own chassis development and testing that when Intel server building blocks are used together, the fully integrated system will meet the intended thermal requirements of these components. It is the responsibility of the system integrator who chooses not to use Intel developed server building blocks to consult vendor datasheets and operating parameters to determine the amount of airflow required for their specific application and environmental conditions. Intel Corporation cannot be held responsible, if components fail or the server board does not operate correctly when used outside any of their published operating or non-operating limits.

### 10.2 Board-level Calculated MTBF

This section provides results of MTBF (Mean Time Between Failures) testing done by a third party testing facility. MTBF is a standard measure for the reliability and performance of the board under extreme working conditions. The MTBF was measured at 20000 hours at 35 degrees Celsius.

The following table shows the MTBF for the server boards as configured from the factory;

Product Code	Calculated MTBF	Operating Temperature
Intel® Server Board S3420GPLX	335000 hours	35 degrees C
Intel® Server Board S3420GPLC	335000 hours	35 degrees C
Intel® Server Board S3420GPV	277139 hours	35 degrees C

### 10.3 Server Board Power Requirements

This section provides power supply design guidelines for a system using the Intel® Server Board S3420GP, including voltage and current specifications, and power supply on/off sequencing characteristics. The following diagram shows the power distribution implemented on this server board.

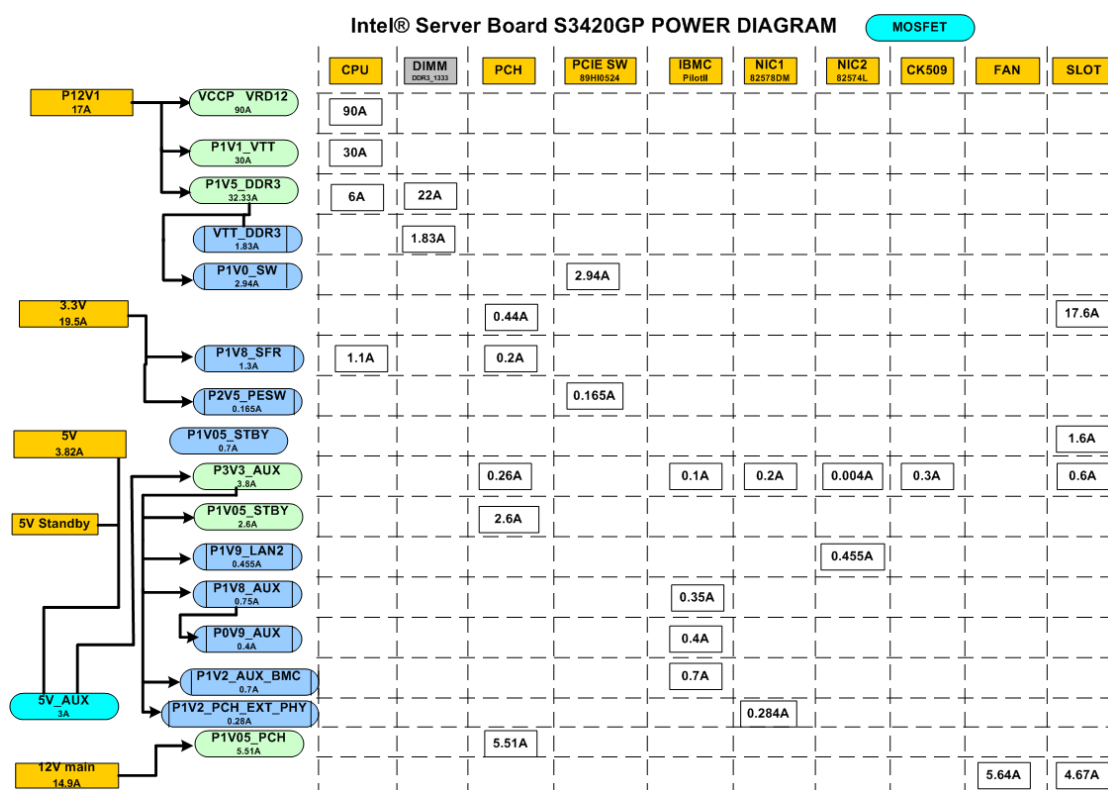

Figure 40. Power Distribution Block Diagram

#### 10.3.1 Processor Power Support

The server board supports the Thermal Design Power (TDP) guideline for Intel® Xeon® processor. The Flexible Motherboard Guidelines (FMB) were also followed to help determine the suggested thermal and current design values for anticipating future processor needs. The following table provides maximum values for I<sub>CC</sub>, TDP power and T<sub>CASE</sub> for the Intel® Xeon® Processor 3400 Series.

Table 63. Intel® Xeon® Processor TDP Guidelines

TDP Power	Maximum T <sub>CASE</sub>	I <sub>CC</sub> Maximum
95 W	67.0° C	150 A

## 10.4 Power Supply Output Requirements

This section is for reference purposes only. The intent is to provide guidance to system designers to determine a power supply for use with this server board. This section specifies the power supply requirements Intel used to develop a power supply for the Intel® Server System SR1630GP and SR1630HGP.

The following tables define two power and current ratings for this 350-W power supply. The combined output power of all outputs should not exceed the rated output power. The power supply must meet both static and dynamic voltage regulation requirements for the minimum loading conditions.

**Table 64. 350-W Load Ratings**

Voltage	Minimum Continuous	Maximum Continuous	Peak
+3.3 V	0.2A	14 A	
+5 V	1.0 A	18A	
+12 V	1.5A	24 A	28A
-12 V	0A	0.3A	
+5 VSB	0.1 A	2.0 A	2.5 A

**Notes:**

1. Maximum continuous total DC output power should not exceed 350 W.
2. Peak total DC output power should not exceed 400 W.
3. Peak power and peak current loading should be supported for a minimum of 12 seconds.
4. Combined 3.3 V/5 V power should not exceed 100 W.

### 10.4.1 Grounding

The grounds of the power supply output connector pins provide the power return path. The output connector ground pins are connected to the safety ground (power supply enclosure). This grounding is designed to ensure passing the maximum allowed common mode noise levels.

The power supply is provided with a reliable protective earth ground. All secondary circuits are connected to protective earth ground. Resistance of the ground returns to chassis does not exceed 1.0 mΩ. This path may be used to carry DC current.

### 10.4.2 Standby Outputs

The 5 VSB output is present when an AC input greater than the power supply turn on voltage is applied.

### 10.4.3 Remote Sense

The power supply has remote sense return (ReturnS) to regulate out ground drops for all output voltages: +3.3 V, +5 V, +12 V, -12 V, and 5 VSB. The power supply uses remote sense to regulate out drops in the system for the +3.3 V, +5 V, and 12 V outputs. The power supply must operate within specification over the full range of voltage drops from the power supply's output connector to the remote sense points.

### 10.4.4 Voltage Regulation

The power supply output voltages must stay within the following voltage limits when operating at steady state and dynamic loading conditions. These limits include the peak-peak ripple/noise. All outputs are measured with reference to the return remote sense signal (ReturnS).

**Table 65. Voltage Regulation Limits**

Parameter	Tolerance	Minimum	Normal	Maximum	Units
+ 3.3 V	- 5%/+5%	+3.14	+3.30	+3.46	Vrms
+ 5 V	- 5%/+5%	+4.75	+5.00	+5.25	Vrms
+ 12 V	- 5%/+5%	+11.40	+12.00	+12.60	Vrms
- 12 V	- 10%/+10%	-13.20	-12.00	-10.80	Vrms
+ 5 VSB	- 5%/+5%	+4.75	+5.00	+5.25	Vrms

### 10.4.5 Dynamic Loading

The output voltages remain within limits for the step loading and capacitive loading specified in the following table. The load transient repetition rate is tested between 50 Hz and 5 kHz at duty cycles ranging from 10%-90%. The load transient repetition rate is only a test specification. The  $\Delta$  step load may occur anywhere within the Min load to the Max load conditions.

**Table 66. Transient Load Requirements**

Output	$\Delta$ Step Load Size (See note 1)	Load Slew Rate	Test capacitive Load
+3.3 V	5.0 A	0.25 A/ $\mu$ sec	250 $\mu$ F
+5 V	6.0 A	0.25 A/ $\mu$ sec	400 $\mu$ F
12 V	11.0 A	0.25 A/ $\mu$ sec	500 $\mu$ F
+5 VSB	0.5 A	0.25 A/ $\mu$ sec	20 $\mu$ F

**Notes:**

- Step loads on each 12 V output may happen simultaneously and should be tested that way.

### 10.4.6 Capacitive Loading

The power supply is stable and meets all requirements with the following capacitive loading ranges.

**Table 67. Capacitive Loading Conditions**

Output	Minimum	Maximum	Units
+3.3 V	100	2200	$\mu$ F
+5 V	400	2200	$\mu$ F
+12 V	500	2200	$\mu$ F
-12 V	1	350	$\mu$ F
+5 VSB	20	350	$\mu$ F

### 10.4.7 Closed-loop Stability

The power supply is unconditionally stable under all line/load/transient load conditions including capacitive load ranges. A minimum of 45° phase margin and -10 dB-gain margin is required. The power supply manufacturer provides proof of the unit's closed-loop stability with local



sensing through the submission of Bode plots. Closed-loop stability is ensured at the maximum and minimum loads as applicable.

#### 10.4.8 Common Mode Noise

The Common Mode noise on any output does not exceed 350 mV pk-pk over the frequency band of 10 Hz to 20 MHz.

- The measurement is made across a 100Ω resistor between each of the DC outputs, including ground, at the DC power connector and chassis ground (power subsystem enclosure).
- The test setup uses a FET probe such as Tektronix\* model P6046 or equivalent.

#### 10.4.9 Ripple/Noise

The maximum allowed ripple/noise output of the power supply is defined in the following table. This is measured over a bandwidth of 0 Hz to 20 MHz at the power supply output connectors. A 10 μF tantalum capacitor is placed in parallel with a 0.1 μF ceramic capacitor at the point of measurement.

**Table 68. Ripple and Noise**

+3.3 V	+5 V	+12 V	-12 V	+5 VSB
50 mVp-p	50 mVp-p	120 mVp-p	120 mVp-p	50 mVp-p

#### 10.4.10 Timing Requirements

The timing requirements for the power supply operation are as follows:

- The output voltages must rise from 10% to within regulation limits ( $T_{vout\_rise}$ ) within 5 ms to 70 ms, except for 5 VSB, in which case it is allowed to rise from 1.0 ms to 25 ms.
- The +3.3 V, +5 V, and +12 V output voltages should start to rise approximately at the same time.
- All outputs must rise monotonically.
- The +5 V output must be greater than the +3.3 V output during any point of the voltage rise.
- The +5 V output must never be greater than the +3.3 V output by more than 2.25 V.
- Each output voltage should reach regulation within 50 ms ( $T_{vout\_on}$ ) of each other when the power supply is turned on.
- Each output voltage should fall out of regulation within 400 msec ( $T_{vout\_off}$ ) of each other when the power supply is turned off.

Figure 41 and Figure 42 shows the timing requirements for the power supply being turned on and off via the AC input with PSON held low and the PSON signal with the AC input applied.

**Table 69. Output Voltage Timing**

Item	Description	Minimum	Maximum	Units
$T_{vout\_rise}$	Output voltage rise time from each main output.	5.0 <sup>1</sup>	70 <sup>1</sup>	Msec
$T_{vout\_on}$	All main outputs must be within regulation of each other within this time.		50	Msec
$T_{vout\_off}$	All main outputs must leave regulation within this time.		700	Msec

**Note:**

1. The 5 VSB output voltage rise time should be from 1.0 ms to 25.0 ms.

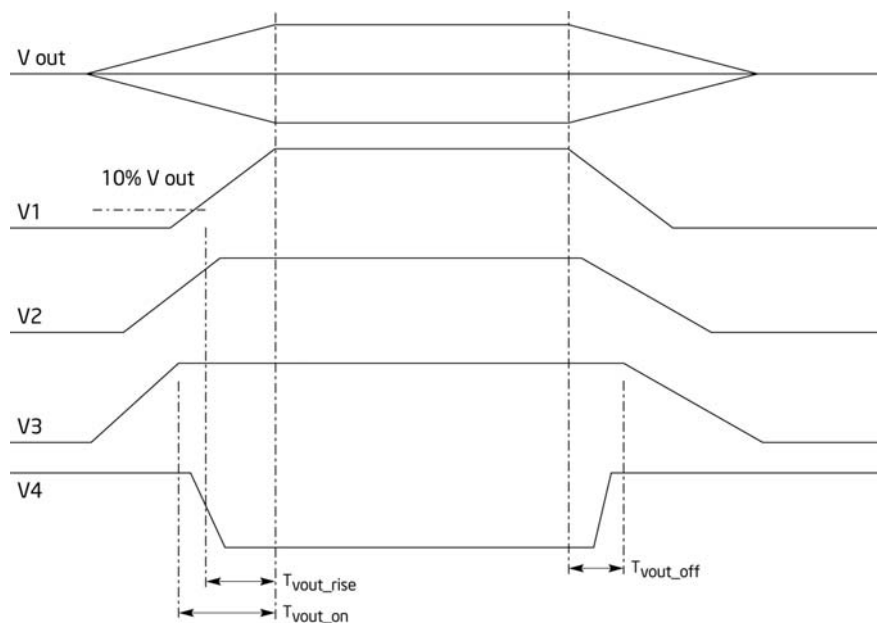
**Figure 41. Output Voltage Timing****Table 70. Turn On/Off Timing**

Item	Description	Minimum	Maximum	Units
$T_{sb\_on\_delay}$	Delay from AC being applied to 5 VSB being within regulation.	N/A	1500	Msec
$T_{ac\_on\_delay}$	Delay from AC being applied to all output voltages being within regulation.	N/A	2500	Msec
$T_{vout\_holdup}$	Duration for which all output voltages stay within regulation after loss of AC. Measured at 80% of maximum load.	21	N/A	Msec
$T_{pwok\_holdup}$	Delay from loss of AC to de-assertion of PWOK. Measured at 80% of maximum load.	20	N/A	Msec
$T_{pson\_on\_delay}$	Delay from PSON <sup>#</sup> active to output voltages within regulation limits.	5	400	Msec
$T_{pson\_pwok}$	Delay from PSON <sup>#</sup> deactive to PWOK being de-asserted.	N/A	50	Msec
$T_{pwok\_on}$	Delay from output voltages within regulation limits to PWOK asserted at turn on.	100	500	Msec
$T_{pwok\_off}$	Delay from PWOK de-asserted to output voltages (3.3 V, 5 V, 12 V, -12 V) dropping out of regulation limits.	1	N/A	Msec
$T_{pwok\_low}$	Duration of PWOK being in the de-asserted state during an off/on cycle using AC or the PSON signal.	100	N/A	Msec
$T_{sb\_vout}$	Delay from 5 VSB being in regulation to O/Ps being in regulation at AC turn on.	50	1000	Msec

Item	Description	Minimum	Maximum	Units
$T_{5VSB\_holdup}$	Duration for which the 5 VSB output voltage stays within regulation after loss of AC.	70	N/A	Msec

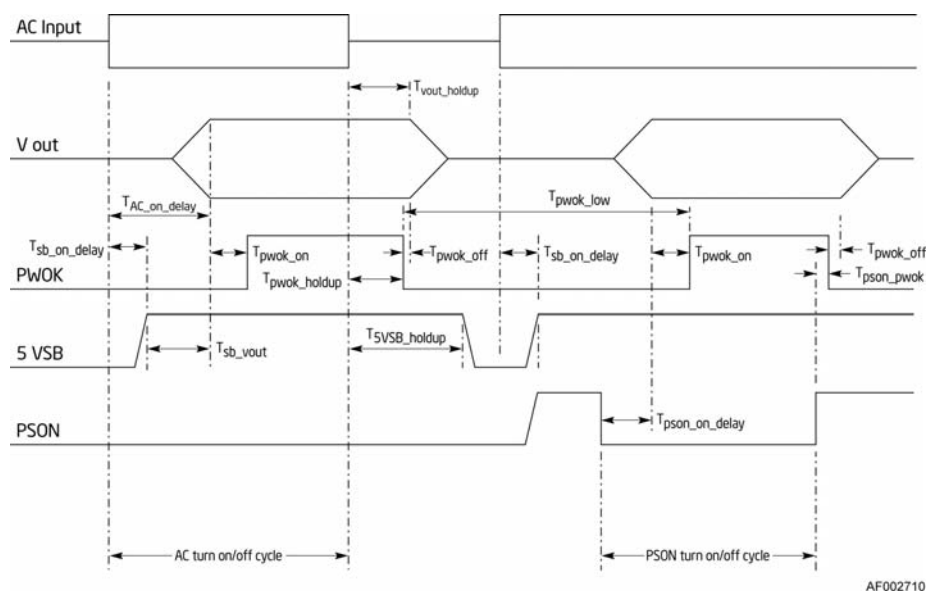

AF002710

**Figure 42. Turn On/Off Timing (Power Supply Signals)**

#### 10.4.11 Residual Voltage Immunity in Standby Mode

The power supply is immune to any residual voltage placed on its outputs (typically, a leakage voltage through the system from standby output) up to 500 mV. There is no additional heat generated nor stressing of any internal components with this voltage applied to any individual output and all outputs simultaneously. It also does not trip the power supply protection circuits during turn on.

The residual voltage at the power supply outputs for a no-load condition does not exceed 100 mV when AC voltage is applied and the PSON# signal is de-asserted.

#### 10.4.12 Protection Circuits

Protection circuits inside the power supply should cause only the power supply's main outputs to shut down. If the power supply latches off due to a protection circuit tripping, an AC cycle OFF for 15 seconds and a PSON# cycle HIGH for 1 second should reset the power supply.

##### 10.4.12.1 Over-current Protection (OCP)

The power supply has current limits to prevent the +3.3 V, +5 V, and +12 V outputs from exceeding the values shown in the following table. If the current limits are exceeded, the power supply shuts down and latches off. The latch is cleared by toggling the PSON# signal or using an AC power interruption. The power supply is not damaged from repeated power cycling in this condition. -12 V and 5 VSB are protected under over-current or shorted conditions so no damage can occur to the power supply. Auto-recovery feature is a requirement on 5 VSB rail.

**Table 71. Over-Current Protection (OCP)**

Voltage	Over Current Limit	
	Min	Max
+3.3V	15A	21A
+5V	20A	27A
+12V	30A	40A
-12V	0.625A	2A
5VSB	N/A	4A

**10.4.12.2 Over-Voltage Protection (OVP)**

The power supply over-voltage protection is locally sensed. The power supply shuts down and latches off after an over-voltage condition occurs. You can clear this latch by toggling the PSON<sup>#</sup> signal or using an AC power interruption. The following table contains the over-voltage limits. The values are measured at the output of the power supply's connectors. The voltage never exceeds the maximum levels when measured at the power pins of the power supply connector during any single point of fail. The voltage never trips any lower than the minimum levels when measured at the power pins of the power supply connector.

**Exception:** +5 VSB rail should be able to recover after an over-voltage condition occurs.

**Table 72. Over-voltage Protection (OVP) Limits**

Output Voltage	Minimum (V)	Maximum (V)
+3.3 V	3.9	4.5
+5 V	5.7	6.2
+12 V	13.3	14.5
-12 V	-13.3	-14.5
+5 VSB	5.7	6.5

## 11. Regulatory and Certification Information

---

### 11.1 Product Regulatory Compliance

**Intended Application** –This product is to be evaluated and certified as Information Technology Equipment (ITE), which may be installed in offices, schools, computer rooms, and similar commercial type locations. The suitability of this product for other product certification categories and/or environments (such as: medical, industrial, telecommunications, NEBS, residential, alarm systems, test equipment, etc.), other than an ITE application, will require further evaluation and may require additional regulatory approvals.

---

**Note:** The use and/or integration of telecommunication devices such as modems and/or wireless devices have not been planned for with respect to these systems. If there is any change of plan to use such devices, then telecommunication type certifications will require additional planning. If NEBS compliance is required for system level products, additional certification planning and design will be required.

---

#### 11.1.1 Product Safety Compliance

- CSA 60950-1 Certification (Canada) or cUL
- CE Declaration to EU Low Voltage Directive 2006/95/EC (Europe – EN60950-1)
- IEC60950-1 (International) CB Certificate & Report, (report to include all CB country national deviations)
- BSMI Declaration of Conformity (Taiwan)
- UL 60950-1 Recognition (USA)

#### 11.1.2 Product EMC Compliance – Class A Compliance

---

**Note:** This product requires complying with Class A EMC requirements. However, Intel targets a 10 db margin to support customer enablement.

---

- AS/NZS CISPR 22 Emissions (Australia/New Zealand)
- ICES-003 – (Canada)
- EN55022 - Emissions (Europe)
- EN55024 - Immunity (Europe)
- CE – EMC Directive 2004/108/EC (Europe)
- CISPR 22 – Emissions (International)
- KCC MIC Notice No. 1997-41 (EMC) & 1997-42 (EMI) (Korea)
- BSMI CNS13438 Emissions (Taiwan)
- FCC – Part 15 Emissions (USA) Verification

### 11.1.3 Certifications/Registrations/Declarations

- UL Certification (US/Canada)
- CE Declaration of Conformity (CENELEC Europe)
- FCC/ICES-003 Class A Attestation (USA/Canada)
- C-Tick Declaration of Conformity (Australia)
- MED Declaration of Conformity (New Zealand)
- BSMI Declaration (Taiwan)
- RRL Certification (Korea)
- GOST – Listed on one System License (Russia)
- Belarus – Listed on one System License (Belarus)
- Ecology Declaration (International)

### 11.1.4 Product Ecology Requirements







Intel restricts the use of banned substances in accordance with world wide product ecology regulatory requirements. Suppliers Declarations of Conformity to the banned substances must be obtained from all suppliers; and a Material Declaration Data Sheet (MDDS) must be produced to illustrate compliance. Due verification of random materials is required as a screening/audit to verify suppliers declarations.

The server board complies with the following ecology regulatory requirements:

- All materials, parts, and subassemblies must not contain restricted materials as defined in Intel's Environmental Product Content Specification of Suppliers and Outsourced Manufacturers – <http://supplier.intel.com/ehs/environmental.htm>.
- Europe - European Directive 2002/95/EC - Restriction of Hazardous Substances (RoHS)  
Threshold limits and banned substances are noted below.  
Quantity limit of 0.1% by mass (1000 PPM) for Lead, Mercury, Hexavalent Chromium, Polybrominated Biphenyls Diphenyl Ethers (PBB/PBDE)  
Quantity limit of 0.01% by mass (100 PPM) for Cadmium
- China RoHS
- All plastic parts that weigh >25gm shall be marked with the ISO11469 requirements for recycling. Example >PC/ABS<
- EU Packaging Directive
- CA. Lithium Perchlorate insert Perchlorate Material – Special handling may apply. Refer to <http://www.dtsc.ca.gov/hazardouswaste/perchlorate>.  
This notice is required by California Code of Regulations, Title 22, Division 4.5, Chapter 33: Best Management Practices for Perchlorate Materials. This product/part includes a battery which contains Perchlorate material.
- German Green Dot
- Japan Recycling

## 11.2 Product Regulatory Compliance Markings

The server board is provided with the following regulatory marks.

Regulatory Compliance	Region	Marking
UL Mark	USA/Canada	
CE Mark	Europe	
EMC Marking (Class A)	Canada	CANADA ICES-003 CLASS A
BSMI Marking (Class A)	Taiwan	
		D33025 警告使用者： 這是甲類的資訊產品，在居住的環境中使用時， 可能會造成射頻干擾，在這種情況下，使用者會 被要求採取某些適當的對策
C-tick Marking	Australia/New Zealand	 N232
RRL MIC Mark	Korea	 인증번호: CPU-S3420GP (A)
Country of Origin	Exporting Requirements	MADE IN xxxxx (Provided by label, not silk screen)
Model Designation	Regulatory Identification	S3420GP
PB Free Marking?	Environmental Requirements	Refer to Jedec Standard J-STD609
China RoHS Marking	China	
China Recycling Package Marking (Marked on packaging label)	China	

Regulatory Compliance	Region	Marking
Other Recycling Package Marking (Marked on packaging label)	Other Recycling Package Marks	 <p>The marking area contains two logos. On the left is the standard universal recycling symbol, a Mobius loop of three chasing arrows. On the right is a circular logo featuring a stylized corrugated cardboard box with an arrow pointing clockwise around it, and the text "Corrugated Recycles" in a bold, sans-serif font below the circle.</p>
Other Recycling Package Marking (Marked on packaging label)	CA. Lithium Perchlorate insert	<p>Perchlorate Material – Special handling may apply. See <a href="http://www.dtsc.ca.gov/hazardouswaste/perchlorate">www.dtsc.ca.gov/hazardouswaste/perchlorate</a></p> <p>This notice is required by California Code of Regulations, Title 22, Division 4.5, Chapter 33: Best Management Practices for Perchlorate Materials. This product/part includes a battery which contains Perchlorate material.</p>



## 11.3 Electromagnetic Compatibility Notices

### 11.3.1 FCC Verification Statement (USA)

This device complies with Part 15 of the FCC Rules. Operation is subject to two conditions: (1) This device may not cause harmful interference, and (2) this device must accept any interference received, including interference that may cause undesired operation.

Intel Corporation  
5200 N.E. Elam Young Parkway  
Hillsboro, OR 97124-6497  
Phone: 1-800-628-8686

This equipment has been tested and found to comply with the limits for a Class B digital device, pursuant to Part 15 of the FCC Rules. These limits are designed to provide reasonable protection against harmful interference in a residential installation. This equipment generates, uses, and can radiate radio frequency energy and, if not installed and used in accordance with the instructions, may cause harmful interference to radio communications. However, there is no guarantee that interference will not occur in a particular installation. If this equipment does cause harmful interference to radio or television reception, which can be determined by turning the equipment off and on, the user is encouraged to try to correct the interference by one or more of these measures:

- Reorient or relocate the receiving antenna.
- Increase the separation between the equipment and the receiver.
- Connect the equipment into an outlet on a circuit different from that to which the receiver is connected.
- Consult the dealer or an experienced radio/TV technician for help.

Any changes or modifications not expressly approved by the grantee of this device could void the user's authority to operate the equipment. The customer is responsible for ensuring compliance of the modified product.

All cables used to connect to peripherals must be shielded and grounded. Operation with cables, connected to peripherals that are not shielded and grounded may result in interference to radio and TV reception.

### 11.3.2 ICES-003 (Canada)

Cet appareil numérique respecte les limites bruits radioélectriques applicables aux appareils numériques de Classe B prescrites dans la norme sur le matériel brouilleur: "Appareils Numériques", NMB-003 édictée par le Ministre Canadian des Communications.

**English translation of the notice above:**

This digital apparatus does not exceed the Class B limits for radio noise emissions from digital apparatus set out in the interference-causing equipment standard entitled "Digital Apparatus," ICES-003 of the Canadian Department of Communications.

### 11.3.3 Europe (CE Declaration of Conformity)

This product has been tested in accordance too, and complies with the Low Voltage Directive (73/23/EEC) and EMC Directive (89/336/EEC). The product has been marked with the CE Mark to illustrate its compliance.

### 11.3.4 VCCI (Japan)

この装置は、情報処理装置等電波障害自主規制協議会（VCCI）の基準に基づくクラスB情報技術装置です。この装置は、家庭環境で使用することを目的としていますが、この装置がラジオやテレビジョン受信機に近接して使用されると、受信障害を引き起こすことがあります。  
取扱説明書に従って正しい取り扱いをして下さい。

**English translation of the notice above:**

This is a Class B product based on the standard of the Voluntary Control Council for Interference (VCCI) from Information Technology Equipment. If this is used near a radio or television receiver in a domestic environment, it may cause radio interference. Install and use the equipment according to the instruction manual.

### 11.3.5 BSMI (Taiwan)

The BSMI Certification Marking and EMC warning is located on the outside rear area of the product.

**警告使用者：**  
這是甲類的資訊產品，在居住的環境中使用時，可能會造成射頻干擾，在這種情況下，使用者會被要求採取某些適當的對策

### 11.3.6 RRL (Korea)

Following is the RRL certification information for Korea.



방송통신위원회

#### English translation of the notice above:

1. Type of Equipment (Model Name): On License and Product
2. Certification No.: On RRL certificate. Obtain certificate from local Intel representative
3. Name of Certification Recipient: Intel Corporation
4. Date of Manufacturer: Refer to date code on product
5. Manufacturer/Nation: Intel Corporation/Refer to country of origin marked on product

## **Appendix A: Integration and Usage Tips**

- When adding or removing components or peripherals from the server board, AC power must be removed. With AC power plugged into the server board, 5-Volt standby is still present even though the server board is powered off.
- Supports only Intel® Xeon® Processor 3400 Series with 95 W and less Thermal Design Power (TDP). Does not support previous generations of the Intel® Xeon® processor.
- On the back edge of the server board are diagnostic LEDs that display a sequence of amber POST codes during the boot process. If the server board hangs during POST, the LEDs displays the last POST event run before the hang.
- Supports only registered DDR3 DIMMs (RDIMMs) and unbuffered DDR3 DIMMs (UDIMMs). Does not support the mixing of RDIMMs and UDIMMs.
- For the best performance, the number of DDR3 DIMMs installed should be balanced across both processor sockets and memory channels. For example, a two-DIMM configuration performs better than a one-DIMM configuration. In a two-DIMM configuration, DIMMs should be installed in DIMM sockets A1 and A2. A six-DIMM configuration (DIMM sockets A1, A2, A3, B1, B2 and B3) performs better than a three-DIMM configuration (DIMM sockets A1, A2, and A3).
- The Intel® Remote Management Module 3 (Intel® RMM3) connector is not compatible with the Intel® Remote Management Module (Product Order Code - AXXRMM) or Intel® Remote Management Module 2 (Product Order Code - AXXRMM2).
- Clear the CMOS with the AC power cord plugged in. Removing the AC power before performing the CMOS clear operation causes the system to automatically power up and immediately power down after the CMOS clear procedure is followed and AC power is re-applied. If this happens, remove the AC power cord, wait 30 seconds, and then re-connect the AC power cord. Power up the system and proceed to the <F2> BIOS Setup utility to reset the needed settings.
- Normal Integrated BMC functionality is disabled with the force Integrated BMC update jumper set to the “enabled” position (pins 2-3). The server should never be run with the Integrated BMC force update jumper set in this position and should only be used when the standard firmware update process fails. This jumper should remain in the default (disabled) position (pins 1-2) when the server is running normally.
- When performing a normal BIOS update procedure, the BIOS recovery jumper must be set to its default position (pins 1-2).

## Appendix B: Integrated BMC Sensor Tables

This appendix lists the sensor identification numbers and information about the sensor type, name, supported thresholds, assertion and de-assertion information, and a brief description of the sensor purpose. See the Intelligent Platform Management Interface Specification, Version 2.0, for sensor and event/reading-type table information.

- **Sensor Type**

The Sensor Type values are the values enumerated in the Sensor Type Codes table in the IPMI specification. The Sensor Type provides the context in which to interpret the sensor, such as the physical entity or characteristic that is represented by this sensor.

- **Event/Reading Type**

The Event/Reading Type values are from the Event/Reading Type Code Ranges and Generic Event/Reading Type Codes tables in the IPMI specification. Digital sensors are a specific type of discrete sensor, which have only two states.

- **Event Offset/Triggers**

Event Thresholds are event-generating thresholds for threshold types of sensors.

- [u,l][nr,c,nc]: upper non-recoverable, upper critical, upper non-critical, lower non-recoverable, lower critical, lower non-critical
- uc, lc: upper critical, lower critical

Event Triggers are supported event-generating offsets for discrete type sensors. The offsets can be found in the Generic Event/Reading Type Codes or Sensor Type Codes tables in the IPMI specification, depending on whether the sensor event/reading type is generic or a sensor-specific response.

- **Assertion/De-assertion Enables**

Assertion and de-assertion indicators reveal the type of events the sensor generates:

- As: Assertions
- De: De-assertion

- **Readable Value/Offsets**

- Readable Value indicates the type of value returned for threshold and other non-discrete type sensors.
- Readable Offsets indicate the offsets for discrete sensors that are readable with the Get Sensor Reading command. Unless otherwise indicated, all event triggers are readable; Readable Offsets consist of the reading type offsets that do not generate events.

- **Event Data**

Event data is the data that is included in an event message generated by the sensor. For threshold-based sensors, the following abbreviations are used:

- R: Reading value
- T: Threshold value

- **Rearm Sensors**

The rearm is a request for the event status for a sensor to be rechecked and updated upon a transition between good and bad states. Rearming the sensors can be done manually or automatically. This column indicates the type supported by the sensor. The following abbreviations are used to describe a sensor:

- A: Auto-rearm
- M: Manual rearm

- **Default Hysteresis**

The hysteresis setting applies to all thresholds of the sensor. This column provides the count of hysteresis for the sensor, which can be 1 or 2 (positive or negative hysteresis).

- **Criticality**

Criticality is a classification of the severity and nature of the condition. It also controls the behavior of the Control Panel Status LED

- **Standby**

Some sensors operate on standby power. These sensors may be accessed and/or generate events when the main (system) power is off, but AC power is present.

**Table 73. Integrated BMC Core Sensors**

Sensor Name <sup>3</sup>	Sensor #	Platform Applicability	Sensor Type	Event / Reading Type	Event Offset Triggers	Contrib. To System Status	Assert / De-assert	Readable Value / Offsets	Event Data	Rearm	Stand-by
IPMI Watchdog	03h	All	Watchdog 2 23h	Sensor Specific 6Fh	00 - Timer expired, status only 01 - Hard reset 02 - Power down 03 - Power cycle 08 - Timer interrupt	OK	As	-	Trig Offset	A	X
Physical ScrtY	04h	Chassis Intrusion is chassis-specific	Physical Security 05h	Sensor Specific 6Fh	00 - Chassis intrusion	OK	As and De	-	Trig Offset	A	X
					04 - LAN least lost	Degraded					
FP Interrupt (NMI)	05h	All	Critical Interrupt 13h	Sensor Specific 6Fh	00 - Front panel NMI/diagnostic interrupt	OK	As	-	Trig Offset	A	-
System Event Log	07h	All	Event Logging Disabled 10h	Sensor Specific 6Fh	02 - Log area reset/cleared	OK	As	-	Trig Offset	A	X
System Event (System Event)	08h	All	System Event 12h	Sensor Specific 6Fh	04 - PEF action	OK	As	-	Trig Offset	A,I	X
BB +1.05 PCH	10h	All	Voltage 02h	Threshold 01h	[u,l] [c,nc]	nc = Degraded c = Non-fatal	As and De	Analog	R, T	A	-

Sensor Name <sup>3</sup>	Sensor #	Platform Applicability	Sensor Type	Event / Reading Type	Event Offset Triggers	Contrib. To System Status	Assert / De-assert	Readable Value / Offsets	Event Data	Rearm	Stand-by
BB +1.1V P1 Vccp	11h	All	Voltage 02h	Threshold 01h	[u,l] [c,nc]	nc = Degraded c = Non-fatal	As and De	Analog	R, T	A	–
BB +1.1V P2 Vccp	12h	All	Voltage 02h	Threshold 01h	[u,l] [c,nc]	nc = Degraded c = Non-fatal	As and De	Analog	R, T	A	–
BB +1.5V P1 DDR3	13h	All	Voltage 02h	Threshold 01h	[u,l] [c,nc]	nc = Degraded c = Non-fatal	As and De	Analog	R, T	A	–
BB +1.5V P2 DDR3	14h	All	Voltage 02h	Threshold 01h	[u,l] [c,nc]	nc = Degraded c = Non-fatal	As and De	Analog	R, T	A	–
BB +1.8V AUX	15h	All	Voltage 02h	Threshold 01h	[u,l] [c,nc]	nc = Degraded c = Non-fatal	As and De	Analog	R, T	A	X
BB +3.3V	16h	All	Voltage 02h	Threshold 01h	[u,l] [c,nc]	nc = Degraded c = Non-fatal	As and De	Analog	R, T	A	–
BB +3.3V STBY	17h	All	Voltage 02h	Threshold 01h	[u,l] [c,nc]	nc = Degraded c = Non-fatal	As and De	Analog	R, T	A	X
BB Vbat	18h	All	Voltage 02h	Generic 05h	01 - Limit exceeded	Non-fatal	As and De	–	Trig Offset	A	X



Sensor Name <sup>3</sup>	Sensor #	Platform Applicability	Sensor Type	Event / Reading Type	Event Offset Triggers	Contrib. To System Status	Assert / De-assert	Readable Value / Offsets	Event Data	Rearm	Stand-by
BB +5.0V	19h	All	Voltage 02h	Threshold 01h	[u,l] [c,nc]	nc = Degraded c = Non-fatal	As and De	Analog	R, T	A	-
BB +5.0V STBY	1Ah	All	Voltage 02h	Threshold 01h	[u,l] [c,nc]	nc = Degraded c = Non-fatal	As and De	Analog	R, T	A	X
BB +12.0V	1Bh	All	Voltage 02h	Threshold 01h	[u,l] [c,nc]	nc = Degraded c = Non-fatal	As and De	Analog	R, T	A	-
BB -12.0V	1Ch	All	Voltage 02h	Threshold 01h	[u,l] [c,nc]	nc = Degraded c = Non-fatal	As and De	Analog	R, T	A	-
Server board Temp	20h	All	Temperature 01h	Threshold 01h	[u,l] [c,nc]	nc = Degraded c = Non-fatal	As and De	Analog	R, T	A	X
Front panel temp	21h	All	Temperature 01h	Threshold 01h	[u,l] [c,nc]	nc = Degraded c = Non-fatal	As and De	Analog	R, T	A	X
PCH Thermal Margin	22h	All	Temperature 01h	Threshold 01h	-	-	-	Analog	-	-	-
Processor MEMTHRM MRGN	23h	All	Temperature 01h	Threshold 01h	-	-	-	Analog	-	-	-

Sensor Name <sup>3</sup>	Sensor #	Platform Applicability	Sensor Type	Event / Reading Type	Event Offset Triggers	Contrib. To System Status	Assert / De-assert	Readable Value / Offsets	Event Data	Rearm	Stand-by
Fan Tach Sensors	30h–34h	Chassis-specific	Fan 04h	Threshold 01h	[ ] [c,nc]	nc = Degraded c = Non-fatal <sup>2</sup>	As and De	Analog	R, T	M	
Processor Therm Margin	62h	All	Temperature 01h	Threshold 01h	–	–	–	Analog	–	–	–
Processor Therm Ctrl %	64h	All	Temperature 01h	Threshold 01h	[u] [c]	Non-fatal	As and De	Analog	Trig Offset	A	–
Processor VRD Temp	66h	All	Temperature 01h	Digital Discrete 05h	01 - Limit exceeded	Fatal	As and De	–	Trig Offset	M	–
CATERR	68h	All	Processor 07h	Digital Discrete 03h	01 – State Asserted	Non-fatal	As and De	–	Trig Offset	M	–
PCH Thermal Trip	6Ah	All	Temperature 01h	Digital Discrete 03h	01 – State Asserted	Fatal	As and De	–	Trig Offset	M	–

## Appendix C: POST Code Diagnostic LED Decoder

During the system boot process, the BIOS executes a number of platform configuration processes, each of which is assigned a specific hex POST code number. As each configuration routine is started, the BIOS displays the POST code to the POST Code Diagnostic LEDs on the back edge of the server board. To assist in troubleshooting a system hang during the POST process, you can use the diagnostic LEDs to identify the last POST process executed.

Each POST code is represented by the eight amber diagnostic LEDs. The POST codes are divided into two nibbles: an upper nibble and a lower nibble. The upper nibble bits are represented by diagnostic LEDs #4, #5, #6, and #7. The lower nibble bits are represented by diagnostics LEDs #0, #1, #2, and #3. If the bit is set in the upper and lower nibbles, then the corresponding LED is lit. If the bit is clear, then the corresponding LED is off.

The diagnostic LED #7 is labeled as “MSB”, and the diagnostic LED #0 is labeled as “LSB”.

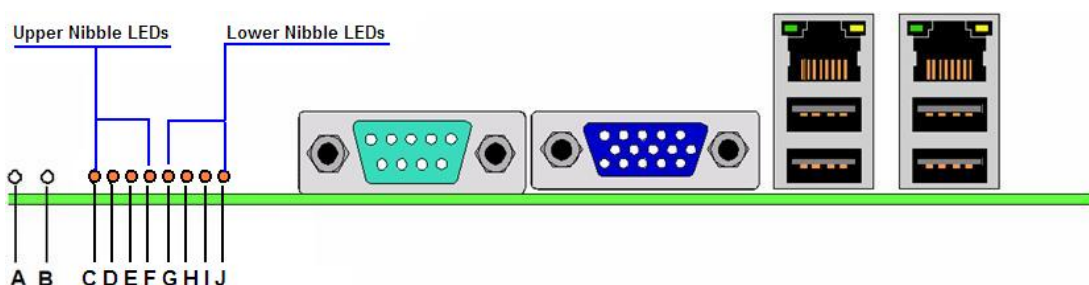

**Figure 43. Diagnostic LED Placement Diagram**

In the following example, the BIOS sends a value of ACh to the diagnostic LED decoder. The LEDs are decoded as follows:

**Table 74. POST Progress Code LED Example**

LEDs	Upper Nibble LEDs				Lower Nibble LEDs			
	MSB							LSB
	LED #7	LED #6	LED #5	LED #4	LED #3	LED #2	LED #1	LED #0
	8h	4h	2h	1h	8h	4h	2h	1h
Status	ON	OFF	ON	OFF	ON	OFF	ON	OFF
Results	1	0	1	0	1	1	0	0
	Ah				Ch			

- Upper nibble bits = 1010b = Ah; Lower nibble bits = 1100b = Ch; the two are concatenated as ACh.

**Table 75. Diagnostic LED POST Code Decoder**

Checkpoint	Diagnostic LED Decoder								Description
	0 = On, X=Off								
	Upper Nibble				Lower Nibble				
	MSB	8h	4h	2h	1h	8h	4h	2h	
LED	#7	#6	#5	#4	#3	#2	#1	#0	
<b>Host Processor</b>									
0x04h	X	X	X	X	X	O	X	X	Early processor initialization (flat32.asm) where system BSP is selected
0x10h	X	X	X	O	X	X	X	X	Power-on initialization of the host processor (Boot Strap Processor)
0x11h	X	X	X	O	X	X	X	O	Host processor cache initialization (including AP)
0x12h	X	X	X	O	X	X	O	X	Starting application processor initialization
0x13h	X	X	X	O	X	X	O	O	SMM initialization
<b>Chipset</b>									
0x21h	X	X	O	X	X	X	X	O	Initializing a chipset component
<b>Memory</b>									
0x22h	X	X	O	X	X	X	O	X	Reading configuration data from memory (SPD on FBDIMM)
0x23h	X	X	O	X	X	X	O	O	Detecting presence of memory
0x24h	X	X	O	X	X	O	X	X	Programming timing parameters in the memory controller
0x25h	X	X	O	X	X	O	X	O	Configuring memory parameters in the memory controller
0x26h	X	X	O	X	X	O	O	X	Optimizing memory controller settings
0x27h	X	X	O	X	X	O	O	O	Initializing memory, such as ECC init
0x28h	X	X	O	X	O	X	X	X	Testing memory
<b>PCI Bus</b>									
0x50h	X	O	X	O	X	X	X	X	Enumerating PCI buses
0x51h	X	O	X	O	X	X	X	O	Allocating resources to PCI buses
0x52h	X	O	X	O	X	X	O	X	Hot Plug PCI controller initialization
0x53h	X	O	X	O	X	X	O	O	Reserved for PCI bus
0x54h	X	O	X	O	X	O	X	X	Reserved for PCI bus
0x55h	X	O	X	O	X	O	X	O	Reserved for PCI bus
0x56h	X	O	X	O	X	O	O	X	Reserved for PCI bus
0x57h	X	O	X	O	X	O	O	O	Reserved for PCI bus
<b>USB</b>									
0x58h	X	O	X	O	O	X	X	X	Resetting USB bus
0x59h	X	O	X	O	O	X	X	O	Reserved for USB devices
<b>ATA/ATAPI/SATA</b>									
0x5Ah	X	O	X	O	O	X	O	X	Resetting SATA bus and all devices
0x5Bh	X	O	X	O	O	X	O	O	Detecting the presence of ATA device
0x5Ch	X	O	X	O	O	O	X	X	Enable SMART if supported by ATA device
0x5Dh	X	O	X	O	O	O	X	O	Reserved for ATA
<b>SMBUS</b>									
0x5Eh	X	O	X	O	O	O	O	X	Resetting SMBUS
0x5Fh	X	O	X	O	O	O	O	O	Reserved for SMBUS
<b>Local Console</b>									
0x70h	X	O	O	O	X	X	X	X	Resetting the video controller (VGA)
0x71h	X	O	O	O	X	X	X	O	Disabling the video controller (VGA)
0x72h	X	O	O	O	X	X	O	X	Enabling the video controller (VGA)
<b>Remote Console</b>									

Checkpoint	Diagnostic LED Decoder								Description
	0 = On, X=Off								
	Upper Nibble				Lower Nibble				
	MSB							LSB	
LED	8h	4h	2h	1h	8h	4h	2h	1h	
	#7	#6	#5	#4	#3	#2	#1	#0	
0x78h	X	O	O	O	O	X	X	X	Resetting the console controller
0x79h	X	O	O	O	O	X	X	O	Disabling the console controller
0x7Ah	X	O	O	O	O	X	O	X	Enabling the console controller
Keyboard (only USB)									
0x90h	O	X	X	O	X	X	X	X	Resetting the keyboard
0x91h	O	X	X	O	X	X	X	O	Disabling the keyboard
0x92h	O	X	X	O	X	X	O	X	Detecting the presence of the keyboard
0x93h	O	X	X	O	X	X	O	O	Enabling the keyboard
0x94h	O	X	X	O	X	O	X	X	Clearing keyboard input buffer
0x95h	O	X	X	O	X	O	X	O	Reserved for keyboard
Mouse (only USB)									
0x98h	O	X	X	O	X	X	O	X	Resetting the mouse
0x99h	O	X	X	O	X	X	O	O	Detecting the mouse
0x9Ah	O	X	X	O	X	O	O	X	Detecting the presence of mouse
0x9Bh	O	X	X	O	X	O	O	O	Enabling the mouse
Fixed Media									
0xB0h	O	X	O	O	X	X	X	X	Resetting fixed media device
0xB1h	O	X	O	O	X	X	X	O	Disabling fixed media device
0xB2h	O	X	O	O	X	X	O	X	Detecting presence of a fixed media device (SATA hard drive detection, etc.)
0xB3h	O	X	O	O	X	X	O	O	Enabling/configuring a fixed media device
Removable Media									
0xB8h	O	X	O	O	O	X	X	X	Resetting removable media device
0xB9h	O	X	O	O	O	X	X	O	Disabling removable media device
0xBAh	O	X	O	O	O	X	O	X	Detecting presence of a removable media device (SATA CDROM detection, etc.)
0xBCh	O	X	O	O	O	O	X	X	Enabling/configuring a removable media device
Boot Device Selection (BDS)									
0xD0	O	O	X	O	X	X	X	X	Entered the Boot Device Selection phase (BDS)
0xD1	O	O	X	O	X	X	X	O	Return to last good boot device
0xD2	O	O	X	O	X	X	O	X	Setup boot device selection policy
0xD3	O	O	X	O	X	X	O	O	Connect boot device controller
0xD4	O	O	X	O	X	O	X	X	Attempt flash update boot mode
0xD5	O	O	X	O	X	O	X	O	Transfer control to EFI boot
0xD6	O	O	X	O	X	O	O	X	Trying to boot device selection
0xDF	O	O	X	O	O	O	O	O	Reserved for boot device selection
Pre-EFI Initialization (PEI) Core									
0xE0h	O	O	O	X	X	X	X	X	Entered Pre-EFI Initialization phase (PEI)
0xE1h	O	O	O	X	X	X	X	O	Started dispatching early initialization modules (PEIM)
0xE2h	O	O	O	X	X	X	O	X	Initial memory found, configured, and installed correctly
0xE3h	O	O	O	X	X	X	O	O	Transfer control to the DXE Core
Driver eXecution Environment (DXE) Core									
0xE4h	O	O	O	X	X	O	X	X	Entered EFI driver execution phase (DXE)
0xE5h	O	O	O	X	X	O	X	O	Started dispatching drivers

Checkpoint	Diagnostic LED Decoder								Description
	O = On, X=Off								
	Upper Nibble				Lower Nibble				
	MSB							LSB	
LED	8h	4h	2h	1h	8h	4h	2h	1h	
	#7	#6	#5	#4	#3	#2	#1	#0	
0xE6h	O	O	O	X	X	O	O	X	Started connecting drivers
DXE Drivers									
0xE7h	O	O	O	X	O	O	X	O	Waiting for user input
0xE8h	O	O	O	X	O	X	X	X	Checking password
0xE9h	O	O	O	X	O	X	X	O	Entering BIOS setup
0xEAh	O	O	O	X	O	O	X	X	Flash Update
0xEEh	O	O	O	X	O	O	X	X	Calling Int 19. One beep unless silent boot is enabled.
0xEFh	O	O	O	X	O	O	X	O	Unrecoverable boot failure
Pre-EFI Initialization Module (PEIM)/Recovery									
0x30h	X	X	O	O	X	X	X	X	Crisis recovery has been initiated because of a user request
0x31h	X	X	O	O	X	X	X	O	Crisis recovery has been initiated by software (corrupt flash)
0x34h	X	X	O	O	X	O	X	X	Loading crisis recovery capsule
0x35h	X	X	O	O	X	O	X	O	Handing off control to the crisis recovery capsule
0x3Fh	X	X	O	O	O	O	O	O	Crisis recovery capsule failed integrity check of capsule descriptors
Runtime Phase/EFI Operating System Boot									
0XF2h	O	O	O	O	X	X	O	X	Signal that the OS has switched to virtual memory mode
0XF4h	O	O	O	O	X	O	X	X	Entering the sleep state
0XF5h	O	O	O	O	X	O	X	O	Exiting the sleep state
0XF8h	O	O	O	O	O	X	X	X	Operating system has requested EFI to close boot services has been cancelled.
Progress Code									
0XF9h	O	X	X	O	X	X	X	X	Resetting the keyboard
0FAh	O	X	X	O	X	X	X	O	Disabling the keyboard

## Appendix D: POST Code Errors

Whenever possible, the BIOS outputs the current boot progress codes on the video screen. Progress codes are 32-bit quantities plus optional data. The 32-bit numbers include class, subclass, and operation information. The class and subclass fields point to the type of hardware that is being initialized. The operation field represents the specific initialization activity. Based on the data bit availability to display progress codes, a progress code can be customized to fit the data width. The higher the data bit, the higher the granularity of information that can be sent on the progress port. The progress codes may be reported by the system BIOS or option ROMs.

The Response section in the following table is divided into three types:

- **No Pause:** The message displays on the screen during POST or in the Error Manager. The system continues booting with a degraded state. The user may want to replace the erroneous unit. The setup POST error Pause setting does not have any effect with this error.
- **Pause:** The message displays on the Error Manager screen, and an error is logged to the SEL. The setup POST error Pause setting determines whether the system pauses to the Error Manager for this type of error, where the user can take immediate corrective action or choose to continue booting.
- **Halt:** The message displays on the Error Manager screen, an error is logged to the SEL, and the system cannot boot unless the error is resolved. The user must replace the faulty part and restart the system. The setup POST error Pause setting does not have any effect with this error.

**Table 76. POST Error Messages and Handling**

Error Code	Error Message	Response
0012	CMOS date/time not set	Pause
0048	Password check failed	Halt
0108	Keyboard component encountered a locked error.	No Pause
0109	Keyboard component encountered a stuck key error.	No Pause
0113	Fixed Media The SAS RAID firmware cannot run properly. The user should attempt to reflash the firmware.	Pause
0140	PCI component encountered a PERR error.	Pause
0141	PCI resource conflict	Pause
0146	PCI out of resources error	Pause
0192	L3 cache size mismatch	Halt
0194	CPUID, processor family are different	Halt
0195	Front side bus mismatch	Pause
0196	Processor Model mismatch	Pause
0197	Processor speeds mismatched	Pause
0198	Processor family is unsupported.	Pause
019F	Processor and chipset stepping configuration is unsupported.	Pause
5220	CMOS/NVRAM Configuration Cleared	Pause
5221	Passwords cleared by jumper	Pause
5224	Password clear Jumper is Set.	Pause
8110	Processor 01 internal error (IERR) on last boot	Pause
8111	Processor 02 internal error (IERR) on last boot	Pause

Error Code	Error Message	Response
8120	Processor 01 thermal trip error on last boot	Pause
8121	Processor 02 thermal trip error on last boot	Pause
8130	Processor 01 disabled	Pause
8131	Processor 02 disabled	Pause
8140	Processor 01 Failed FRB-3 Timer.	No Pause
8141	Processor 02 Failed FRB-3 Timer.	No Pause
8160	Processor 01 unable to apply BIOS update	Pause
8161	Processor 02 unable to apply BIOS update	Pause
8170	Processor 01 failed Self Test (BIST).	Pause
8171	Processor 02 failed Self Test (BIST).	Pause
8180	Processor 01 BIOS does not support the current stepping for processor	No Pause
8181	Processor 02 BIOS does not support the current stepping for processor	No Pause
8190	Watchdog timer failed on last boot	Pause
8198	Operating system boot watchdog timer expired on last boot	Pause
8300	Integrated Baseboard Management Controller failed self-test	Pause
84F2	Integrated Baseboard Management Controller failed to respond	Pause
84F3	Integrated Baseboard Management Controller in update mode	Pause
84F4	Sensor data record empty	Pause
84FF	System event log full	No Pause
8500	Memory component could not be configured in the selected RAS mode.	Pause
8520	DIMM_A1 failed Self Test (BIST).	Pause
8521	DIMM_A2 failed Self Test (BIST).	Pause
8522	DIMM_A3 failed Self Test (BIST).	Pause
8523	DIMM_A4 failed Self Test (BIST).	Pause
8524	DIMM_B1 failed Self Test (BIST).	Pause
8525	DIMM_B2 failed Self Test (BIST).	Pause
8526	DIMM_B3 failed Self Test (BIST).	Pause
8527	DIMM_B4 failed Self Test (BIST).	Pause
8528	DIMM_C1 failed Self Test (BIST).	Pause
8529	DIMM_C2 failed Self Test (BIST).	Pause
852A	DIMM_C3 failed Self Test (BIST).	Pause
852B	DIMM_C4 failed Self Test (BIST).	Pause
852C	DIMM_D1 failed Self Test (BIST).	Pause
852D	DIMM_D2 failed Self Test (BIST).	Pause
852E	DIMM_D3 failed Self Test (BIST).	Pause
852F	DIMM_D4 failed Self Test (BIST).	Pause
8540	DIMM_A1 Disabled.	Pause
8541	DIMM_A2 Disabled.	Pause
8542	DIMM_A3 Disabled.	Pause
8543	DIMM_A4 Disabled.	Pause
8544	DIMM_B1 Disabled.	Pause
8545	DIMM_B2 Disabled.	Pause
8546	DIMM_B3 Disabled.	Pause
8547	DIMM_B4 Disabled.	Pause
8548	DIMM_C1 Disabled.	Pause
8549	DIMM_C2 Disabled.	Pause
854A	DIMM_C3 Disabled.	Pause



Error Code	Error Message	Response
854B	DIMM_C4 Disabled.	Pause
854C	DIMM_D1 Disabled.	Pause
854D	DIMM_D2 Disabled.	Pause
854E	DIMM_D3 Disabled.	Pause
854F	DIMM_D4 Disabled.	Pause
8560	DIMM_A1 Component encountered a Serial Presence Detection (SPD) fail error.	Pause
8561	DIMM_A2 Component encountered a Serial Presence Detection (SPD) fail error.	Pause
8562	DIMM_A3 Component encountered a Serial Presence Detection (SPD) fail error.	Pause
8563	DIMM_A4 Component encountered a Serial Presence Detection (SPD) fail error.	Pause
8564	DIMM_B1 Component encountered a Serial Presence Detection (SPD) fail error.	Pause
8565	DIMM_B2 Component encountered a Serial Presence Detection (SPD) fail error.	Pause
8566	DIMM_B3 Component encountered a Serial Presence Detection (SPD) fail error.	Pause
8567	DIMM_B4 Component encountered a Serial Presence Detection (SPD) fail error.	Pause
8568	DIMM_C1 Component encountered a Serial Presence Detection (SPD) fail error.	Pause
8569	DIMM_C2 Component encountered a Serial Presence Detection (SPD) fail error.	Pause
856A	DIMM_C3 Component encountered a Serial Presence Detection (SPD) fail error.	Pause
856B	DIMM_C4 Component encountered a Serial Presence Detection (SPD) fail error.	Pause
856C	DIMM_D1 Component encountered a Serial Presence Detection (SPD) fail error.	Pause
856D	DIMM_D2 Component encountered a Serial Presence Detection (SPD) fail error.	Pause
856E	DIMM_D3 Component encountered a Serial Presence Detection (SPD) fail error.	Pause
856F	DIMM_D4 Component encountered a Serial Presence Detection (SPD) fail error.	Pause
8580	DIMM_A1 Correctable ECC error encountered.	Pause after 10 occurrences
8581	DIMM_A2 Correctable ECC error encountered.	Pause after 10 occurrences
8582	DIMM_A3 Correctable ECC error encountered.	Pause after 10 occurrences
8583	DIMM_A4 Correctable ECC error encountered.	Pause after 10 occurrences
8584	DIMM_B1 Correctable ECC error encountered.	Pause after 10 occurrences
8585	DIMM_B2 Correctable ECC error encountered.	Pause after 10 occurrences
8586	DIMM_B3 Correctable ECC error encountered.	Pause after 10 occurrences
8587	DIMM_B4 Correctable ECC error encountered.	Pause after 10 occurrences
8588	DIMM_C1 Correctable ECC error encountered.	Pause after 10 occurrences
8589	DIMM_C2 Correctable ECC error encountered.	Pause after 10 occurrences
858A	DIMM_C3 Correctable ECC error encountered.	Pause after 10 occurrences
858B	DIMM_C4 Correctable ECC error encountered.	Pause after 10 occurrences
858C	DIMM_D1 Correctable ECC error encountered.	Pause after 10 occurrences
858D	DIMM_D2 Correctable ECC error encountered.	Pause after 10 occurrences
858E	DIMM_D3 Correctable ECC error encountered.	Pause after 10 occurrences
858F	DIMM_D4 Correctable ECC error encountered.	Pause after 10 occurrences
85A0	DIMM_A1 Uncorrectable ECC error encountered.	Pause
85A1	DIMM_A2 Uncorrectable ECC error encountered.	Pause
85A2	DIMM_A3 Uncorrectable ECC error encountered.	Pause
85A3	DIMM_A4 Uncorrectable ECC error encountered.	Pause
85A4	DIMM_B1 Uncorrectable ECC error encountered.	Pause
85A5	DIMM_B2 Uncorrectable ECC error encountered.	Pause
85A6	DIMM_B3 Uncorrectable ECC error encountered.	Pause
85A7	DIMM_B4 Uncorrectable ECC error encountered.	Pause
85A8	DIMM_C1 Uncorrectable ECC error encountered.	Pause
85A9	DIMM_C2 Uncorrectable ECC error encountered.	Pause

Error Code	Error Message	Response
85AA	DIMM_C3 Uncorrectable ECC error encountered.	Pause
85AB	DIMM_C4 Uncorrectable ECC error encountered.	Pause
85AC	DIMM_D1 Uncorrectable ECC error encountered.	Pause
85AD	DIMM_D2 Uncorrectable ECC error encountered.	Pause
85AE	DIMM_D3 Uncorrectable ECC error encountered.	Pause
85AF	DIMM_D4 Uncorrectable ECC error encountered.	Pause
8601	Override jumper is set to force boot from lower alternate BIOS bank of flash ROM	No Pause
8602	WatchDog timer expired (secondary BIOS may be bad!)	No Pause
8603	Secondary BIOS checksum fail	No Pause
8604	Chipset Reclaim of non critical variables complete.	No Pause
9000	Unspecified processor component has encountered a non specific error.	Pause
9223	Keyboard component was not detected.	No Pause
9226	Keyboard component encountered a controller error.	No Pause
9243	Mouse component was not detected.	No Pause
9246	Mouse component encountered a controller error.	No Pause
9266	Local Console component encountered a controller error.	No Pause
9268	Local Console component encountered an output error.	No Pause
9269	Local Console component encountered a resource conflict error.	No Pause
9286	Remote Console component encountered a controller error.	No Pause
9287	Remote Console component encountered an input error.	No Pause
9288	Remote Console component encountered an output error.	No Pause
92A3	Serial port component was not detected	Pause
92A9	Serial port component encountered a resource conflict error	Pause
92C6	Serial Port controller error	No Pause
92C7	Serial Port component encountered an input error.	No Pause
92C8	Serial Port component encountered an output error.	No Pause
94C6	LPC component encountered a controller error.	No Pause
94C9	LPC component encountered a resource conflict error.	Pause
9506	ATA/ATPI component encountered a controller error.	No Pause
95A6	PCI component encountered a controller error.	No Pause
95A7	PCI component encountered a read error.	No Pause
95A8	PCI component encountered a write error.	No Pause
9609	Unspecified software component encountered a start error.	No Pause
9641	PEI Core component encountered a load error.	No Pause
9667	PEI module component encountered an illegal software state error.	Halt
9687	DXE core component encountered an illegal software state error.	Halt
96A7	DXE boot services driver component encountered an illegal software state error.	Halt
96AB	DXE boot services driver component encountered invalid configuration.	No Pause
96E7	SMM driver component encountered an illegal software state error.	Halt
0xA022	Processor component encountered a mismatch error.	Pause
0xA027	Processor component encountered a low voltage error.	No Pause
0xA028	Processor component encountered a high voltage error.	No Pause
0xA421	PCI component encountered a SERR error.	Halt
0xA500	ATA/ATPI ATA bus SMART not supported.	No Pause
0xA501	ATA/ATPI ATA SMART is disabled.	No Pause
0xA5A0	PCI Express* component encountered a PERR error.	No Pause
0xA5A1	PCI Express* component encountered a SERR error.	Halt

Error Code	Error Message	Response
0xA5A4	PCI Express* IBIST error.	Pause
0xA6A0	DXE boot services driver Not enough memory available to shadow a legacy option ROM.	No Pause

## POST Error Beep Codes

The following table lists POST error beep codes. Prior to system video initialization, the BIOS uses these beep codes to inform users on error conditions. The beep code is followed by a user-visible code on POST Progress LEDs.

**Table 77. POST Error Beep Codes**

Beeps	Error Message	POST Progress Code	Description
3	Memory error	Multiple	System halted because a fatal error related to the memory was detected.

## **Appendix E: Supported Intel® Server Chassis**

The Intel® Server Board S3420GP is supported in the following Intel server chassis. Please refer to the latest *Configuration Guide* for detailed information at

<http://www.intel.com/support/motherboards/server/s3420gp/sb/CS-030741.htm>.

- Intel® Server Chassis SR1630
- Intel® Server Chassis SC5650UP
- Intel® Server Chassis SC5299UP
- Intel® Server Chassis SC5299BRP
- Intel® Server Chassis SC5299DP

## Glossary

This appendix contains important terms used in this document. For ease of use, numeric entries are listed first (for example, “82460GX”) followed by alpha entries (for example, “AGP 4x”). Acronyms are followed by non-acronyms.

Term	Definition
ACPI	Advanced Configuration and Power Interface
AP	Application Processor
APIC	Advanced Programmable Interrupt Control
ARP	Address Resolution Protocol
ASIC	Application Specific Integrated Circuit
ASMI	Advanced Server Management Interface
BIOS	Basic Input/Output System
BIST	Built-In Self Test
BMC	Baseboard Management Controller
Bridge	Circuitry connecting one computer bus to another, allowing an agent on one to access the other
BSP	Bootstrap Processor
Byte	8-bit quantity
CBC	Chassis Bridge Controller (A microcontroller connected to one or more other CBCs, together they bridge the IPMB buses of multiple chassis.
CEK	Common Enabling Kit
CHAP	Challenge Handshake Authentication Protocol
CMOS	Complementary Metal-oxide-semiconductor In terms of this specification, this describes the PC-AT compatible region of battery-backed 128 bytes of memory, which normally resides on the server board.
DHCP	Dynamic Host Configuration Protocol
DPC	Direct Platform Control
EEPROM	Electrically Erasable Programmable Read-Only Memory
EHCI	Enhanced Host Controller Interface
EMP	Emergency Management Port
EPS	External Product Specification
ESB2	Enterprise South Bridge 2
FBD	Fully Buffered DIMM
F MB	Flexible Mother Board
FRB	Fault Resilient Booting
FRU	Field Replaceable Unit
FSB	Front Side Bus
GB	1024 MB
GPA	Guest Physical Address
GPIO	General Purpose I/O
GTL	Gunning Transceiver Logic
HPA	Host Physical Address
HSC	Hot-swap Controller
Hz	Hertz (1 cycle/second)
I <sup>2</sup> C	Inter-Integrated Circuit Bus
IA	Intel® Architecture
IBF	Input Buffer

Term	Definition
ICH	I/O Controller Hub
ICMB	Intelligent Chassis Management Bus
IERR	Internal Error
IFB	I/O and Firmware Bridge
ILM	Independent Loading Mechanism
IMC	Integrated Memory Controller
INTR	Interrupt
I/OAT	I/O Acceleration Technology
IOH	I/O Hub
IP	Internet Protocol
IPMB	Intelligent Platform Management Bus
IPMI	Intelligent Platform Management Interface
IR	Infrared
ITP	In-Target Probe
KB	1024 bytes
KCS	Keyboard Controller Style
KVM	Keyboard, Video, Mouse
LAN	Local Area Network
LCD	Liquid Crystal Display
LDAP	Local Directory Authentication Protocol
LED	Light Emitting Diode
LPC	Low Pin Count
LUN	Logical Unit Number
MAC	Media Access Control
MB	1024 KB
MCH	Memory Controller Hub
MD2	Message Digest 2 – Hashing Algorithm
MD5	Message Digest 5 – Hashing Algorithm – Higher Security
ME	Management Engine
MMU	Memory Management Unit
ms	Milliseconds
MTTR	Memory Type Range Register
Mux	Multiplexor
NIC	Network Interface Controller
NMI	Nonmaskable Interrupt
OBF	Output Buffer
OEM	Original Equipment Manufacturer
Ohm	Unit of electrical resistance
OVP	Over-voltage Protection
PECI	Platform Environment Control Interface
PEF	Platform Event Filtering
PEP	Platform Event Paging
PIA	Platform Information Area (This feature configures the firmware for the platform hardware)
PLD	Programmable Logic Device
PMI	Platform Management Interrupt
POST	Power-On Self Test
PSMI	Power Supply Management Interface

Term	Definition
PWM	Pulse-Width Modulation
QPI	QuickPath Interconnect
RAM	Random Access Memory
RASUM	Reliability, Availability, Serviceability, Usability, and Manageability
RISC	Reduced Instruction Set Computing
RMII	Reduced Media-Independent Interface
ROM	Read Only Memory
RTC	Real-Time Clock (Component of ICH peripheral chip on the server board)
SDR	Sensor Data Record
SECC	Single Edge Connector Cartridge
SEEPROM	Serial Electrically Erasable Programmable Read-Only Memory
SEL	System Event Log
SIO	Server Input/Output
SMBUS	System Management BUS
SMI	Server Management Interrupt (SMI is the highest priority non-maskable interrupt)
SMM	Server Management Mode
SMS	Server Management Software
SNMP	Simple Network Management Protocol
SPS	Server Platform Services
SSE2	Streaming SIMD Extensions 2
SSE3	Streaming SIMD Extensions 3
SSE4	Streaming SIMD Extensions 4
TBD	To Be Determined
TDP	Thermal Design Power
TIM	Thermal Interface Material
UART	Universal Asynchronous Receiver/Transmitter
UDP	User Datagram Protocol
UHCI	Universal Host Controller Interface
URS	Unified Retention System
UTC	Universal Time Coordinate
VID	Voltage Identification
VRD	Voltage Regulator Down
VT	Virtualization Technology
Word	16-bit quantity
WS-MAN	Web Services for Management
ZIF	Zero Insertion Force

## ***Reference Documents***

Refer to the following documents for additional information:

- *Intel® Server Board S3420GP BIOS External Product Specification*
- *Intel® Server Board S3420GP Common Core Integrated BMC External Product Specification*