

# Intel® Server System SR2500ALBRPR Quick Start User's Guide

Thank you for buying an Intel® Server System. The following information will help you assemble your Intel® Server System SR2500ALBRPR and install components.

This guide and other supporting documents are located on the web at <http://support.intel.com/support/motherboards/server>.

If you are not familiar with ESD (Electrostatic Discharge) procedures used during system integration, please see the Intel® Server System SR2500ALBRP User's Guide, available on the Intel® Server Deployment Toolkit 2.0 CD or at <http://support.intel.com/support/motherboards/server/chassis/sr2500/howto.htm>.

Please boot to the Intel® Server Deployment Toolkit 2.0 CD first for BIOS and firmware configuration and updates.

Read all cautions and warnings first before starting your server system integration.

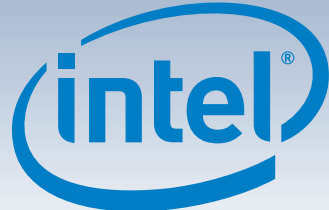

## Minimum Hardware Requirements

To avoid integration difficulties and possible damage to your system, make sure you have components from each category below.

- Processor:**
  - Minimum of one Dual-Core Intel® Xeon® processor 5000 sequence with 2 MB cache support.
- Heat Sink:**
  - 2U passive heat sink for each processor installed.
- Memory:**
  - Minimum of one 512 MB, DDR2 FBDIMM 533/667 MHz compliant 240-pin DIMM.
- Hard Disk Drives:**
  - SATA/SAS

## 1 Preparing the Chassis

Observe normal ESD (Electrostatic Discharge) procedures.

Place your Intel® Server Chassis on a flat anti-static surface to perform the following integration procedures. Always touch the chassis frame first, before reaching inside to make server board connections or to install components.

## 2 Remove Top Cover

- Remove the security screw.
- Depress the latch.
- Slide cover back and lift upward.

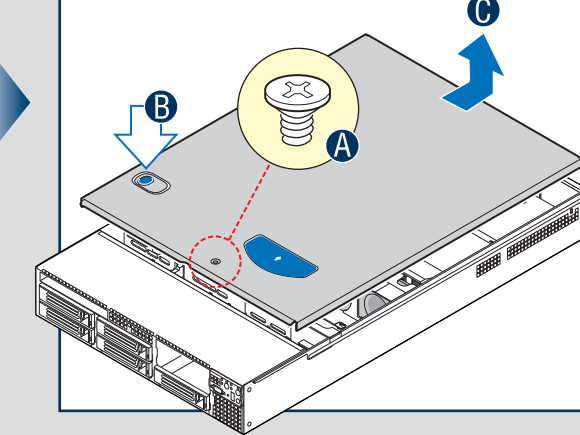

## 3 Remove Air Duct

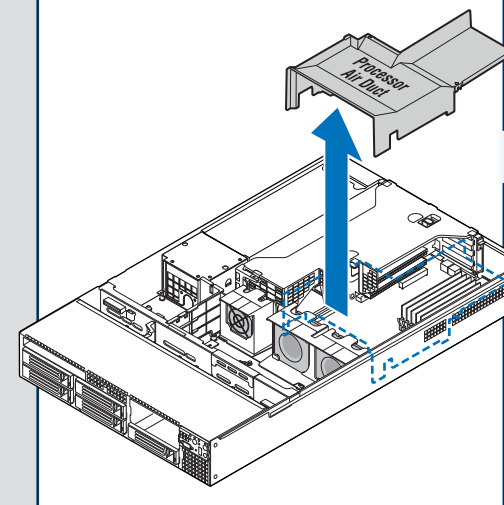

## 4 Remove Add-in Card Riser Assembly

To remove the riser: Grasp both riser latches with thumb and forefinger and pull up to release riser assembly. Lift straight up.

**CAUTION:** Place the riser assembly upside down to avoid damage to the riser card connector.

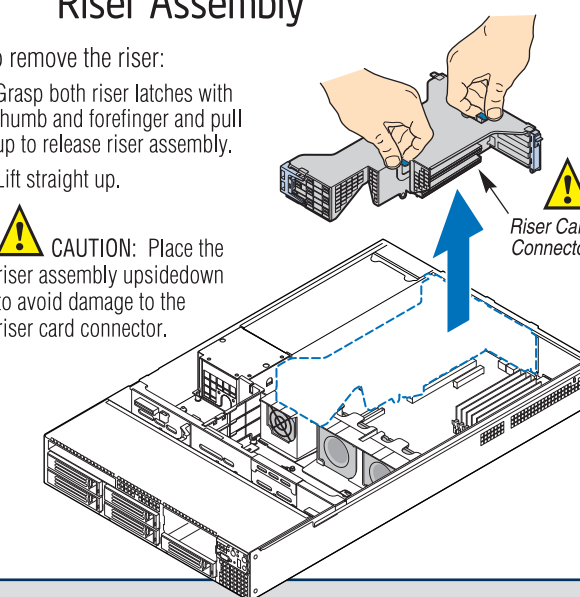

**IMPORTANT!** Before proceeding further, do the following:

Check your Intel® Server System for disconnected or loose cables and components that may have occurred during shipping.

### Warning

Read all caution and safety statements in this document before performing any of the instructions. Also see the Intel® Server Board and Server Chassis Safety Information document at: <http://support.intel.com/support/motherboards/server/sb/cs-010770.htm> for complete safety information.

### Warning

Installation and service of this product should only be performed by qualified service personnel to avoid risk of injury from electrical shock or energy hazard.

### Caution

Observe normal ESD (Electrostatic Discharge) procedures during system integration to avoid possible damage to server board and/or other components.

### Tools Required

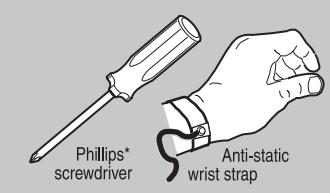

## 5 Install the Processor(s)

### Notes and Cautions:

- When opening a socket, DO NOT TOUCH the gold socket wires.
- When unpacking a processor, hold by the edges only to avoid touching the gold contacts.

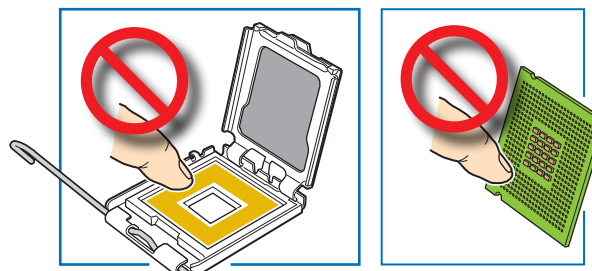

### A. Open the Socket Lever

- Push the lever handle down and away from the socket to release it.
- Pull the lever and open all the way.

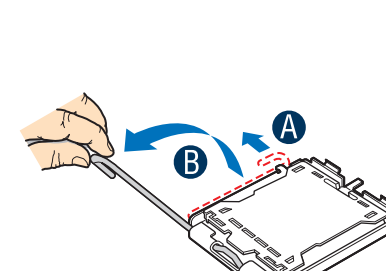

### B. Open the Load Plate

- Push the rear tab with your finger tip to bring the front end of the load plate up slightly.
- Open the load plate as shown.

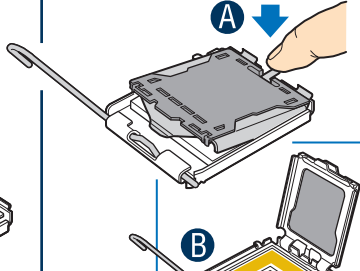

### C. Remove the Processor Protective Cover

- Take the processor out of the box and remove the protective shipping cover.



### D. Install the Processor

**CAUTION:** The underside of the processor has components that may damage the socket pins if installed improperly. Processor must align correctly with socket opening before installation. DO NOT DROP processor into socket!

- Orient the processor with the socket so that the processor cutouts match the socket notches.

- Install the processor.

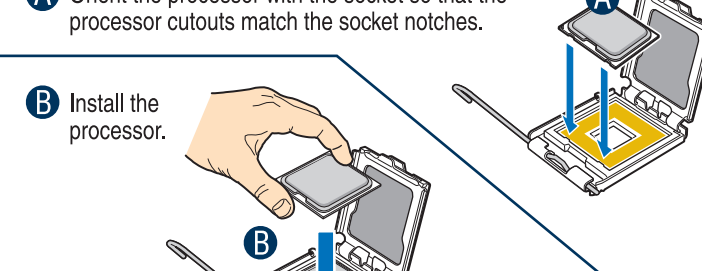

### E. Remove Socket Protective Cover

- Grasp the socket protective cover tab and pull away from the load plate as shown.
- Remove the socket protective cover and store for future use.

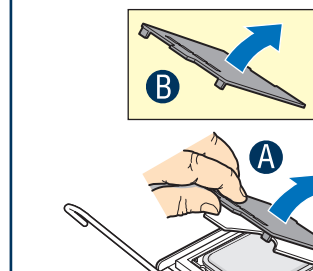

### F. Close Load Plate and Socket Lever

- Close the load plate all the way as shown.
- With your finger, push down on the load plate as shown.
- Close the socket lever and ensure that the load plate tab engages under the socket lever when fully closed.

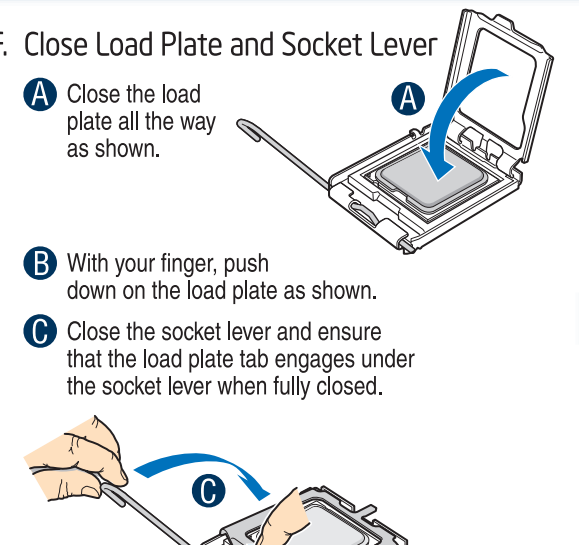

## 6 Install Heat Sink(s)

**CAUTION:** The heat sink has thermal interface material (TIM) on the underside of it. Use caution so that you do not damage the thermal interface material. Use gloves to avoid sharp edges.

- Remove the protective film on the TIM if present.
- Align heat sink fins to the front and back of the chassis for correct airflow. Airflow goes from front-to-back of chassis.
- Finger-tighten each fastener diagonally, according to the numbers shown.
- Securely re-tighten each fastener again in the same order as performed in step C.

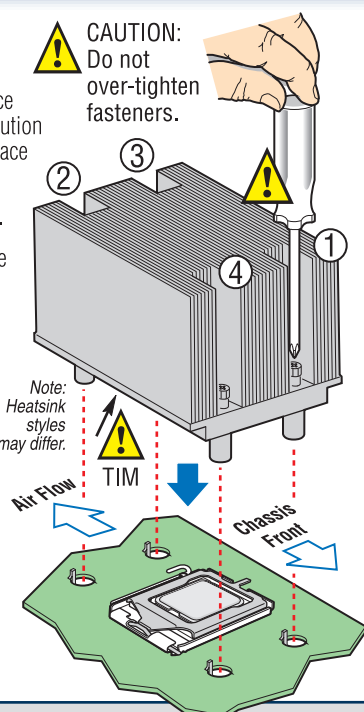

D31984-006



## 7 Install Memory DIMMs

### DDR2 FBDIMM Memory Identification:

This server board supports up to eight DDR2-533 or DDR2-667 Fully Buffered DIMMs (FBD memory). DDR2 DIMMs that are not FBD memory are not supported on this server board.

FBDIMM DDR2 memory varies in height. DO NOT MIX different DIMM heights and types.

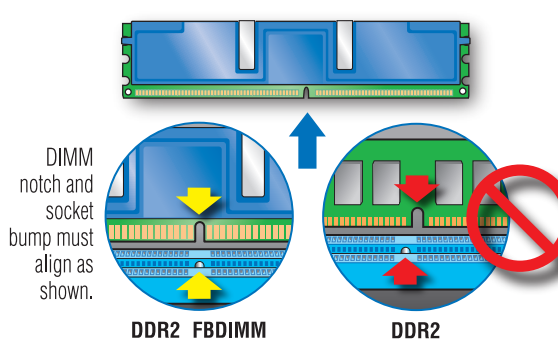

### Memory Configurations and Population Order:

Memory Type: Minimum of one 512MB, DDR2 FBDIMM 533/667 MHz compliant 240-pin DIMM. For best performance, a minimum of four DIMMs is recommended.

Populate DDR2 FBDIMMs in the order of A1, B1, C1, D1 and A2, B2, C2 and D2.

Note: For additional memory configurations, see the User Guide on the Intel® Server Deployment Toolkit 2.0 CD that accompanied your Intel® Server System SR2500ALBRPR, or go to: <http://support.intel.com/support/motherboards/server/chassis/sr2500>

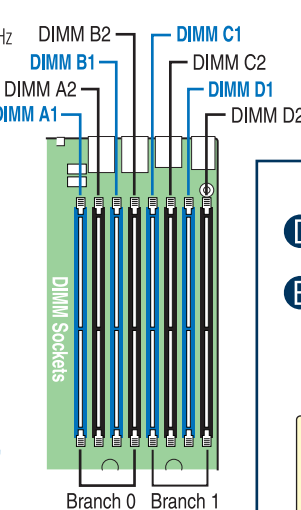

### To Install DIMMs:

**CAUTION:** Avoid touching contacts when handling or installing DIMMs.

- Open both DIMM socket levers.
- Note location of alignment notch.
- Insert DIMM making sure the connector edge of the DIMM aligns correctly with the slot.
- Push down firmly on the DIMM until it snaps into place and both levers close.
- IMPORTANT!** Visually check that each latch is fully closed and correctly engaged with each DIMM edge slot.

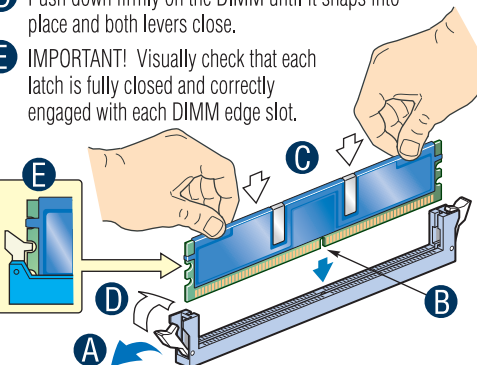

## 8 Install I/O Expansion Module (optional)

### Remove Module Covers

Prior to installing the I/O Expansion Module and/or the Intel® RMM Module, you must remove the corresponding module cover(s).

- Squeeze the sides of each cover to disengage from the chassis back panel and remove.

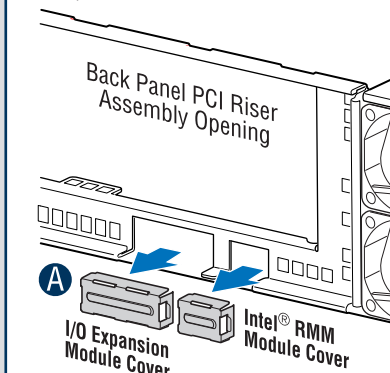

### Install I/O Expansion Module

- Install the three standoffs to the server board first.
- Attach module to the server board connector and matching standoff holes.

