

Intel® Server System SR1670HV Service Guide

Intel Part Number: E74138-004

A Guide for Technically Qualified Assemblers of Intel® Identified Subassemblies/Products

Disclaimer

Information in this document is provided in connection with Intel® products. No license, express or implied, by estoppel or otherwise, to any intellectual property rights is granted by this document. Except as provided in Intel's Terms and Conditions of Sale for such products, Intel assumes no liability whatsoever, and Intel disclaims any express or implied warranty, relating to sale and/or use of Intel products including liability or warranties relating to fitness for a particular purpose, merchantability, or infringement of any patent, copyright or other intellectual property right. Intel products are not designed, intended or authorized for use in any medical, life saving, or life sustaining applications or for any other application in which the failure of the Intel product could create a situation where personal injury or death may occur. Intel may make changes to specifications and product descriptions at any time, without notice.

Intel server boards contain a number of high-density VLSI and power delivery components that need adequate airflow for cooling. Intel's own chassis are designed and tested to meet the intended thermal requirements of these components when the fully integrated system is used together. It is the responsibility of the system integrator that chooses not to use Intel developed server building blocks to consult vendor datasheets and operating parameters to determine the amount of airflow required for their specific application and environmental conditions. Intel Corporation can not be held responsible if components fail or the server board does not operate correctly when used outside any of their published operating or non-operating limits.

Intel, Intel Pentium, and Intel Xeon are trademarks or registered trademarks of Intel Corporation or its subsidiaries in the United States and other countries.

* Other names and brands may be claimed as the property of others.

Copyright © 2010, Intel Corporation. All Rights Reserved

<This page is intentionally left blank.>

Preface

About this Manual

Thank you for purchasing and using the Intel® Server System SR1670HV.

This manual is written for system technicians who are responsible for troubleshooting, upgrading, and repairing this server system. This document provides a brief overview of the features of the board/chassis, a list of accessories or other components you may need, troubleshooting information, and instructions on how to add and replace components on the Intel® Server System SR1670HV. For the latest version of this manual, refer to the following Intel web site:

<http://support.intel.com/support/motherboards/server/SR1670HV/>

Manual Organization

Chapter 1 provides a brief overview of the Intel® Server System SR1670HV. In this chapter, you will find a list of the system features, product photos, and product diagrams to help you identify components and their locations.

Chapter 2 lists the hardware setup procedures you must perform when installing or removing system components.

Chapter 3 describes how to install the optional components.

Chapter 4 includes procedures to follow when replacing common FRUs.

Chapter 5 describes the functions of all server board jumpers, connectors, and LEDs.

Chapter 6 describes the update process and configurable features of the system BIOS

Chapter 7 provides an overview of the embedded SATA RAID options and how to configure RAID sets.

Chapter 8 provides instructions for installing the necessary drivers for different system components.

Chapter 9 provides an Issue Submittal form which can be used when reporting system issues back to Intel Corporation.

Chapter 10 provides Intel Support and Warranty information.

Chapter 11 details product safety information.

Additional Information and Software

Documentation and software for this server product are available on the Intel Resource CD that shipped with your Intel server product. Software updates and additional information can be obtained at the following Intel web site:

<http://support.intel.com/support/motherboards/server/SR1670HV/>









Unless otherwise indicated in the following table, once on this Web page, type the document or software name in the search field at the left side of the screen and select the option to search “This Product.”







For this information or software	Use this Document or Software
For in-depth technical information about this product	Technical Product Specification (TPS)
For information needed to provide service and support for this product	Service Guide – (This document)
Embedded RAID Configuration and Support	Intel® Matrix Storage Manager Users Manual LSI* Embedded MegaRAID Software Users Manual
SKU information, Spares and Accessories available for this Intel Server product	Spares and Configuration Guide
Hardware (peripheral boards, adapter cards) and operating systems that have been tested with this product	Tested Hardware and Operating System List
Processors that have been tested with this product	Supported Processors
DIMMs that have been tested with this product	Supported Memory
For drivers	Driver (for an extensive list of drivers available) Operating System Driver (for operating system drivers)
For firmware and BIOS updates	Firmware Update

Contents

1. Product Introduction	1
1.1 System Package Contents	1
1.2 System Features	1
1.3 Front Panel Features	2
1.4 Rear Panel Features	3
1.5 Internal Features	3
1.6 System LED Information	6
1.6.1 Front Control Panel LEDs	6
1.6.2 RJ-45 LAN Ports 1 and 2 LEDs	7
1.6.3 HDD Status LED	7
1.7 Cable Connections	7
1.7.1 Pre-Connected System Cables	8
2. Hardware Setup	9
2.1 Chassis Cover	9
2.1.1 Removing the Chassis Cover	9
2.2 Central Processing Unit (CPU)	9
2.2.1 Installing the Processor	10
2.2.2 Installing the Processor Heatsink	13
2.2.3 Removing the Processor Heatsink	14
2.3 System Memory	15
2.3.1 Overview	15
2.3.2 Memory Support	16
2.3.3 Installing a DIMM	18
2.3.4 Removing a DIMM	19
2.4 Installing a PCI Express* Add-In Card to the Riser Bracket	20
2.5 Installing the BMC Management Module	22
2.6 Hard Disk Drives	23
3. Installing the Rackmount Rail Kit	25
3.1 Attaching the Rails to the Server	25
3.2 Attaching the Rack Rails	26
3.3 Rackmounting the Server	27
4. System Service	28
4.1 Replacing Power Supply Units (PSUs)	28
4.2 Replacing System Fans	29
4.3 SATA/SAS BackPlane Replacement	30
4.4 Front Control Panel Replacement	33
5. Jumpers, Connectors, and LEDs	35
5.1 Configuration and Support Jumpers	35
5.1.1 Clear RTC RAM (CLRRTC1)	35
5.1.2 VGA Controller Setting (3-pin VGA_SW1)	36
5.1.3 DDR3 Voltage Control Setting (4-pin LVDDR3_SEL1, LVDDR3_SEL2)	36
5.1.4 LAN Controller Setting (3-pin LAN_SW1, LAN_SW2)	37

5.1.5	Intel® ICH10R SATA Port SW RAID Setting (3-pin RAID_SEL1)	37
5.1.6	Force BIOS Recovery Setting (3-pin RECOVERY1)	38
5.2	Server Board Connectors.....	39
5.2.1	Serial ATA Connectors (7-pin SATA1, SATA2, SATA3, SATA4)	39
5.2.2	Internal USB Connectors (A-Type USB4; 5x1 pin USB3)	39
5.2.3	System Fan Connectors (4-pin FRNT_FAN1, FRNT_FAN2, FRNT_FAN3, FRNT_FAN4).....	40
5.2.4	Serial General Purpose Input/Output Connector (6-1 pin SGPIO1)	40
5.2.5	BMC Management Module Header (BMC_FW1)	41
5.2.6	Power Supply SMBus Connectors (6x1 pin JP1, JP2)	41
5.2.7	Main Power Connectors (20-pin PWR1, 20-pin PWR2)	42
5.2.8	Peripheral Power Connector (4-pin PWR3).....	42
5.2.9	System Panel Connector (20-pin PANEL1).....	42
5.2.10	Auxiliary Panel Connector (20-pin AUX_PANEL1).....	44
5.3	Internal LEDs	45
5.3.1	Standby Power LED	45
5.3.2	CPU Warning LED (ERR_CPU1, ERR_CPU2)	45
5.3.3	System Identification LED	46
5.3.4	BMC LED (BMC_LED1)	46
6.	BIOS Updates and Configuration	47
6.1	Updating System BIOS	47
6.2	BIOS Recovery Process	48
6.3	BIOS Setup Utility	49
6.3.1	Accessing BIOS Setup Utility	50
6.3.2	BIOS Setup Features and Navigation	50
6.3.3	Main Menu.....	51
6.3.4	Advanced Menu.....	57
6.3.5	Server Menu	73
6.3.6	Boot Menu	75
6.3.7	Exit Menu.....	80
7.	Embedded SATA RAID	81
7.1	Selecting a RAID option	81
7.2	Enabling RAID in the BIOS Setup.....	82
7.3	SATA RAID Setup.....	82
7.3.1	LSI* Software RAID Configuration Utility.....	82
7.3.2	Intel® Matrix Storage Manager Configuration Utility.....	90
8.	Driver Installation	93
8.1	RAID Driver Installation.....	93
8.1.1	Creating a RAID Driver Disk.....	93
8.1.2	Installing the RAID Controller Driver.....	94
8.2	Intel® Chipset Device Installation.....	99
8.3	LAN Driver Installation	101
8.4	VGA Driver Installation.....	103
8.5	Management Applications and Utilities Installation	105
8.5.1	Running the Resource CD.....	105
8.5.2	Drivers Menu	105
8.5.3	Utilities Menu	106
8.5.4	Make Disk Menu.....	106

8.5.5	Contact Information	106
9.	Intel® Server Issue Report Form.....	107
10.	Getting Help	112
10.1	Warranty Information.....	112
11.	Safety Information	113
	Server Safety Information	114
	Safety Warnings & Cautions	114
	Intended Application Uses	115
	Site Selection	115
	Equipment Handling Practices	115
	Power and Electrical Warnings	115
	System Access Warnings	116
	Rack Mount Warnings.....	117
	Electrostatic Discharge (ESD).....	118
 	CAUTION	118
	Other Hazards.....	119
	CAUTION	119
	Sicherheitshinweise für den Server.....	120
	Sicherheitshinweise und Vorsichtsmaßnahmen	120
	Zielbenutzer der Anwendung	121
	Standortauswahl	121
	Handhabung von Geräten.....	121
	Warnungen zu Netzspannung und Elektrizität	121
	Warnhinweise für den Systemzugang.....	122
	Warnhinweise für Racks	123
	Elektrostatische Entladungen (ESD).....	124
 	VORSICHT	124
	Andere Gefahren.....	124
	VORSICHT	125
	Consignes de sécurité sur le serveur.....	126
	Sécurité : avertissements et mises en garde	126
	Domaines d'utilisation prévus	127
	Sélection d'un emplacement.....	127
	Pratiques de manipulation de l'équipement	127
	Alimentation et avertissements en matière d'électricité	127
	Avertissements sur l'accès au système	129
	Avertissements sur le montage en rack.....	129
	Décharges électrostatiques (ESD).....	130
 	ATTENTION	130
	Autres risques	130

 ATTENTION	131
Información de seguridad del servidor	132
Advertencias y precauciones sobre seguridad	132
Aplicaciones y usos previstos	133
Selección de la ubicación.....	133
Manipulación del equipo	133
Advertencias de alimentación y eléctricas	133
Advertencias el acceso al sistema	134
Advertencias sobre el montaje en bastidor	135
Descarga electrostática (ESD).....	136
  PRECAUCIÓN	136
Otros riesgos.....	136
 PRECAUCIÓN	137
服务器安全信息.....	138
安全警告与注意事项.....	138
预期应用使用.....	138
场地选择.....	139
设备操作规范.....	139
电源与电气警告	139
系统使用警告.....	140
机架固定件警告	141
静电放电 (ESD).....	141
  注意事项	141
其他危险.....	141
 注意事项	142

List of Figures

Figure 1. Server System Features	3
Figure 2. System Features – Back Panel	3
Figure 3. System Component Identification	4
Figure 4. Server Node Connectors and Components	5
Figure 5. Front Control Panel LEDs	6
Figure 6. RJ-45 Ports 1 and 2 LEDs	7
Figure 7. HDD Status LED	7
Figure 8. Cable Connections	8
Figure 9. Rear Panel Thumbscrews	9
Figure 10. Sliding the Chassis Cover	9
Figure 11. LGA1366 Socket	10
Figure 12. Retention Tab and Load Lever	11
Figure 13. Load Plate	11
Figure 14. PnP Cap	11
Figure 15. CPU Notch and Alignment Key	12
Figure 16. Applying Thermal Paste	12
Figure 17. Closing the Load Plate	13
Figure 18. Installing the Heatsink (Passive Heatsink Shown)	14
Figure 19. Removing the Heatsink	15
Figure 20. DDR3 DIMM Sockets Location	16
Figure 21. Unlocked Retaining Clips	19
Figure 22. Locked Retaining Clips	19
Figure 23. DIMM Notch	19
Figure 24. Riser Card Bracket	20
Figure 25. Removing the Screw from Slot Bay	20
Figure 26. PCI Express* x 16 Card	20
Figure 27. Pressing Riser Card Bracket for Golden Connectors to Fit	21
Figure 28. BMC_FW1 Header	22
Figure 29. Orienting the Management Module Card	22
Figure 30. Server Management LAN Port	22
Figure 31. Hard Disk Drives	23
Figure 32. Releasing the Drive Tray	23
Figure 33. Placing a SATAII/SAS Hard Disk Drive on the Tray	23
Figure 34. Pushing the Tray Lever	24
Figure 35. Rackmount Rail Kit Items	25
Figure 36. Screw positions on the rail	25
Figure 37. Attaching the Front End of the Server Rail to Side of Chassis	26
Figure 38. Sliding the Server Rail	26
Figure 39. Securing the Server Rail With Screws	26
Figure 40. Positioning the Rack Rail to 1U Space on Rack	27
Figure 41. Mounting Ear	27
Figure 42. Holding and Pressing the PSU Latch	28
Figure 43. Pulling Out the Failed PSU	28
Figure 44. Pushing the New PSU Into the Chassis	28
Figure 45. Disconnecting System Fan Cable	29
Figure 46. Lifting System Fan	29
Figure 47. Inserting Fan Into the Fan Cage	29

Figure 48. Restoring the Chassis Cover	30
Figure 49. Screws On Hard Disk Drive Bay Module	30
Figure 50. Sliding the Hard Disk Drive Bay Module	30
Figure 51. Connected Cables and Backplane Expose	31
Figure 52. Front Panel Cables	31
Figure 53. Cable Bundles in the Hard Disk Drive Bay Module	32
Figure 54. SATA Cable Connection Order	32
Figure 55. Aligning the Module with the Alignment Slots on the Chassis	33
Figure 56. Control Panel Module Screw	33
Figure 57	34
Figure 58 Detached Control Panel Module	34
Figure 59. Clear RTC RAM	35
Figure 60. VGA Controller Setting	36
Figure 61. DDR3 Voltage Control Setting	37
Figure 62. LAN Controller Setting	37
Figure 63. Intel® ICH10R SATA Port SW RAID Setting	38
Figure 64. Force BIOS Recovery Setting	38
Figure 65. SATA Connectors	39
Figure 66. USB 2.0 Connectors	39
Figure 67. Front Fan Connectors	40
Figure 68. Serial General Purpose I/O Connector	40
Figure 69. BMC Management Module Header	41
Figure 70. Power Supply SMBus Connectors	41
Figure 71. Main Power Connectors	42
Figure 72. Peripheral Power Connector (4-pin PWR3)	42
Figure 73. System Panel Connector	43
Figure 74. Auxiliary Panel Connector	44
Figure 75. Standby Power LED	45
Figure 76. ERR CPU LED	45
Figure 77. System Identification LED	46
Figure 78. BMC LED (BMC_LED1)	46
Figure 79. Updating the BIOS in DOS	48
Figure 80. Recovering the BIOS Using the Force BIOS Update Jumper	49
Figure 81. BIOS Menu Screen	50
Figure 82. Pop-Up Window	51
Figure 83. Main Menu	52
Figure 84. SATA1-4 Submenu	52
Figure 85. IDE Configuration Menu	54
Figure 86. AHCI Configuration Menu	55
Figure 87. Status of Auto-Detection of SATA Devices Menu	55
Figure 88. System Information Menu	56
Figure 89. System Memory Information Menu	56
Figure 90. Advanced Menu	57
Figure 91. CPU Configuration Menu	58
Figure 92. CPU Configuration Menu, Continued	58
Figure 93. Chipset Configuration Menu	61
Figure 94. CPU Bridge Chipset Configuration Menu	61
Figure 95. CPU Bridge Chipset Configuration Menu, Continued	62
Figure 96. North Bridge Chipset Configuration Menu	64
Figure 97. South Bridge Chipset Configuration Menu	64

List of Figures

Figure 98. Intel VT-d Configuration Menu	65
Figure 99. Legacy Device Configuration Menu	65
Figure 100. USB Configuration Menu	66
Figure 101. PCIPnP Configuration Menu	67
Figure 102. Power On Configuration Menu	68
Figure 103. Event Log Configuration Menu	69
Figure 104. Hardware Monitor Configuration Menu	70
Figure 105. Hardware Monitor Configuration Menu, Continued	70
Figure 106. PCI Express* Configuration Menu	71
Figure 107. ACPI Configuration Menu	71
Figure 108. Advanced ACPI Configuration Menu	72
Figure 109. Chipset ACPI Configuration Menu	72
Figure 110. General WHEA Configuration Menu	73
Figure 111. Server Menu	73
Figure 112. Remote Access Configuration Menu	74
Figure 113. Boot Menu	76
Figure 114. Boot Device Priority Menu	76
Figure 115. Boot Settings Configuration Menu	77
Figure 116. Security Settings Menu	78
Figure 117. Security Menu After Supervisor Password is Set	79
Figure 118. Exit Menu	80
Figure 119. RAID Option Jumper Block	81
Figure 120. POST screen showing LSI* MegaRAID Option ROM display	83
Figure 121. Utility Main Window	83
Figure 122. Configuration Menu Options	84
Figure 123. Array Selection Menu	84
Figure 124. Selecting the Configurable Array on Easy Configuration Menu	85
Figure 125. Virtual Drive Menu	85
Figure 126. Selecting the RAID Level	86
Figure 127. Enabling the Disk Write Cache Setting	86
Figure 128. Accepting the Virtual Drive Configuration	86
Figure 129. Completing RAID Configuration	87
Figure 130. Initialize Command	87
Figure 131. Virtual Drives (Selection) Pulldown Menu	88
Figure 132. Initialize Confirmation Dialog Box	88
Figure 133. Initialization Progress Bar	89
Figure 134. Selecting the Disk WC Option	89
Figure 135. Intel® Matrix Storage Manager Configuration Utility	90
Figure 136. Create RAID Volume Menu	91
Figure 137. Select Disks Screen	91
Figure 138. Create Volume Warning Message	92
Figure 139. Intel® Matrix Storage Manager Warning Message	92
Figure 140. Makedisk Menu	93
Figure 141. Microsoft Windows Server* Setup Menu	94
Figure 142. Specifying an Additional Device	95
Figure 143. Insert RAID Driver Disk Screen	95
Figure 144. Intel ICH8R/ICH9R/ICH10R/DO SATA RAID Controller Item	96
Figure 145. Installing Red Hat* Enterprise	96
Figure 146. Driver Disk Y/N Screen	97
Figure 147. Driver Disk Source	97

Figure 148. Insert Driver Disk Screen	97
Figure 149. More Driver Disks? Screen	97
Figure 150. Selecting the SuSe* Installation.....	98
Figure 151. Initializing the SuSe* Installation.....	98
Figure 152. Installation Option Selected on the Boot Options Screen	98
Figure 153. Driver Update Medium Screen	99
Figure 154. Intel Chipset Device Software Option	99
Figure 155. Intel® Chipset Device Software Window.....	100
Figure 156. License Agreement Window	100
Figure 157. Readme File Information Window.....	100
Figure 158. Setup Complete Window	101
Figure 159. Intel Network Connections Software Option	101
Figure 160. Intel Network Connections Software Window	102
Figure 161. Intel(R) Network Connections—InstallShield Wizard.....	102
Figure 162. License Agreement Terms.....	102
Figure 163. Intel(R) PROSet for Windows Device Manager Option	103
Figure 164. Beginning the Installation.....	103
Figure 165. Drivers Menu	104
Figure 166. Install Wizard for Aspeed* VGA Driver	104
Figure 167. Updating the VGA Driver	104
Figure 168. Completing the VGA Driver Installation	105
Figure 169. Drivers Menu	105
Figure 170. Utilities Menu	106
Figure 171. Make Disk Menu	106

List of Tables

Table 1. System Package Contents List	1
Table 2. System Feature Set	1
Table 3. Server Node Connectors and Components Descriptions	6
Table 4. Front Panel LEDs Descriptions	6
Table 5. RJ-45 Ports 1 and 2 LEDs Descriptions	7
Table 6. HDD LED Status Definitions	7
Table 7. Maximum Memory Allocation Using RDIMMs.....	16
Table 8. Supported RDIMM Configurations	17
Table 9. Supported UDIMM Configurations	17
Table 10. Memory Population Table	18

<This page intentionally left blank.>

1. Product Introduction

This chapter briefly describes the main features of the Intel® Server System SR1670HV.

1.1 System Package Contents

Check your system package for the following items.

Table 1. System Package Contents List

Model Name	Intel® Server System SR1670HV
Integrated System Components	<ul style="list-style-type: none"> ▪ 2 x Intel® Server Board S5500HV ▪ 2 x 770-W Single Power Supplies (non-redundant) ▪ 8 x Hot-swap 2.5-inch HDD trays ▪ 1 x SAS/SATA2 Backplane ▪ 2 x PCI Riser Card Assemblies ▪ 2 x Front Control Panels ▪ 1 x Power Distribution Board ▪ 8 x System Fans (40 mm x 56 mm)
Accessories	<ul style="list-style-type: none"> ▪ 1 x Semi-ball Bearing Rail Kit ▪ 2 x BMC Management Modules
Documentation & Software	<ul style="list-style-type: none"> ▪ Attention Document ▪ Intel Resource CD

1.2 System Features

The Intel® Server System SR1670HV is a 1U rackmount server integrating two, ½-width Intel® Server System Boards S5500HV. The server supports the Intel® Xeon® processor 5500 series, 5600 series and Intel® 5500 chipset, and provides the following feature set:

Table 2. System Feature Set

Feature	Description
Chassis Form Factor	1U Rack Mount Server
Server Board	2 x Intel® Server Boards S5500HV
Processors	Support for up to four Intel® Xeon® Processors 5500 Series and 5600 Series (two per server node)
Chipset	Intel® 5500 Chipset IOH Intel® 82801Jx I/O Controller Hub (ICH10R)
Memory	24 x DIMM slots (12 DIMM per server node/6 per processor) Support for 800/1066/1333 MT/s ECC registered (RDIMM) or unbuffered (UDIMM) DDR3 memory.

Feature	Description
On-board I/O	Per Server Node: <ul style="list-style-type: none"> ▪ 1 x External DB-9 Serial Port ▪ 2 x RJ-45 LAN ports (stacked) ▪ 1 x RJ-45 Management LAN port ▪ 3 x USB 2.0 ports (Front x 1, Rear x 2) ▪ 1 x Internal A-type USB Port ▪ 1 x VGA port
System Fan Support	Eight 4-pin managed system fan. (Four fans per server node)
Add-in Adapter Support	2 x PCI Express* X16 GEN2 slots supporting low-profile half height add-in cards (one per server node)
Video	On-board ASPEED* AST2050 with integrated Video Controller <ul style="list-style-type: none"> ▪ Integrated 2D Video Controller ▪ 8 MB Video Memory
Storage	8 x 2.5-inch hot-swap SATA Hard Drive Bays (Four drive bays per server node) Embedded support for the following RAID solutions: <ul style="list-style-type: none"> ▪ Intel® Matrix Storage Manager with Software RAID levels 0/1/5/10 (Windows* Only) ▪ LSI* Software RAID supporting RAID levels 0/1/10 (Windows and Linux)
Power Supply	Dual 770-W cold swap Power Supply modules. (non-redundant)
Networking	4 x 10/100/1000 Ethernet ports provided by Intel® 82574L PHYs with Intel® I/O Acceleration Technology (Two LAN ports per server node)
Server Management	<ul style="list-style-type: none"> ▪ On-board ASPEED AST2050 with integrated Baseboard Management Controller ▪ 2 x BMC Management Modules with IPMI 2.0 support (One per server node) ▪ 2 x 10/100 Management LAN port (One per server node)
System Dimensions	686 mm x 444 mm x 43.4 mm

1.3 Front Panel Features

The server system provides the following features on the system's front panel:

- Eight 2.5-inch Hot-swap SATA/SAS Hard Drive Bays—four for each installed server node.
- Dual independent front control panels—one for each installed server node.
- Features found on each front control panel include: System Power and System Reset buttons, LED indicators, and one 2.0 USB port.

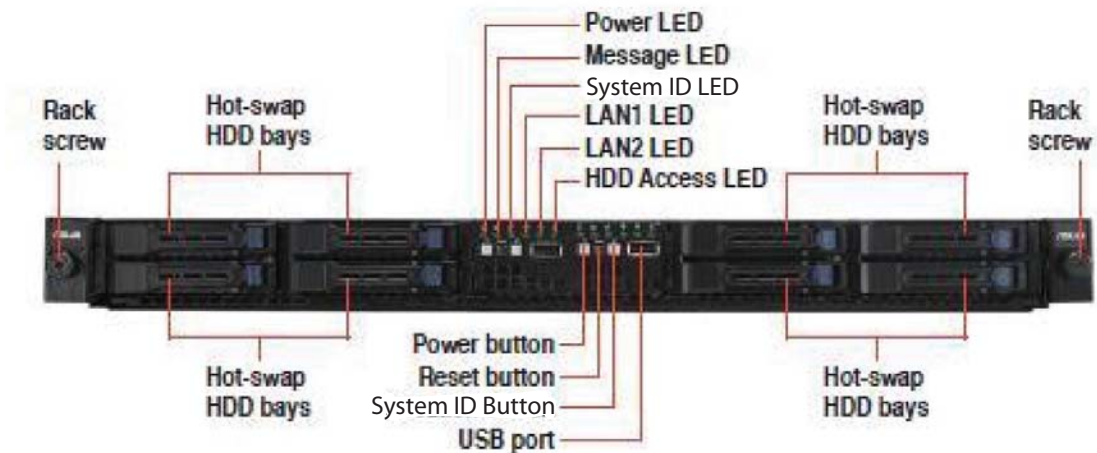

Figure 1. Server System Features

1.4 Rear Panel Features

You can find the following features on the server system back panel:

- Dual tool-less cold-swap, non-redundant power supplies—one for each installed server node.
- Add-in card slot covers for each installed server node.
- External I/O ports for each installed server node.

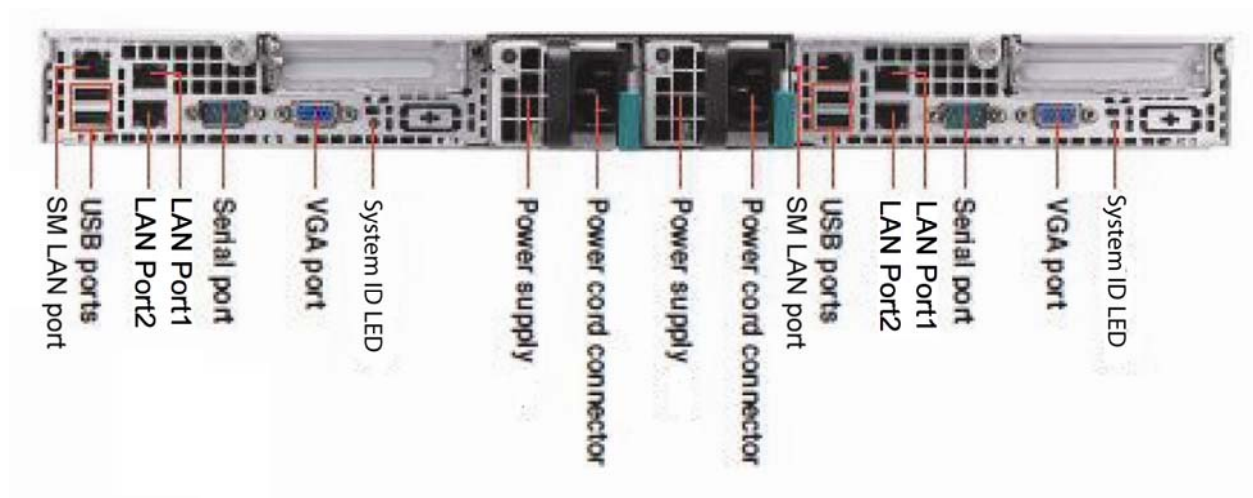

Figure 2. System Features – Back Panel

1.5 Internal Features

The following figure shows the internal features of the server system.

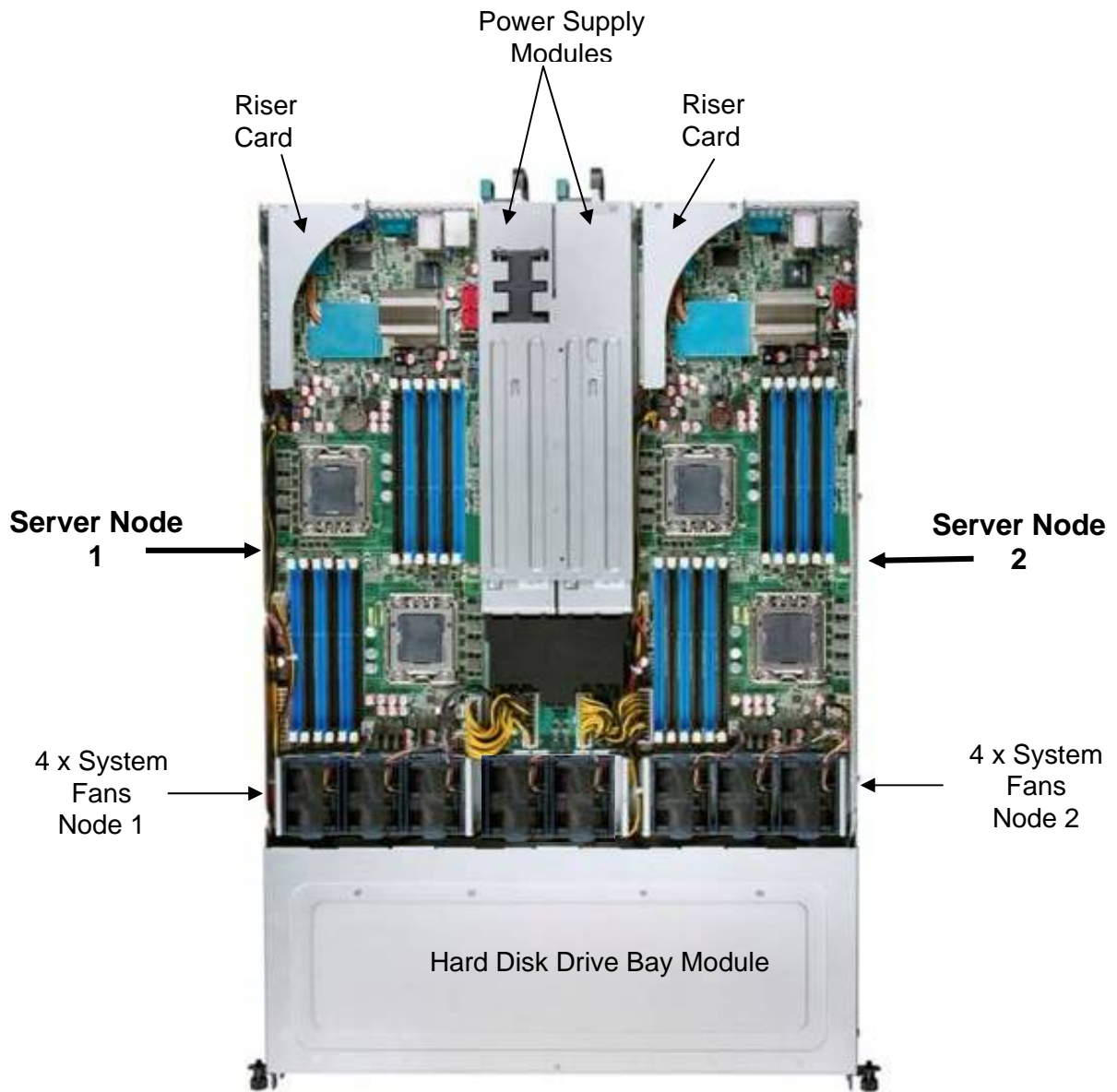

Figure 3. System Component Identification

The following figure identifies connectors and major components of each server node.

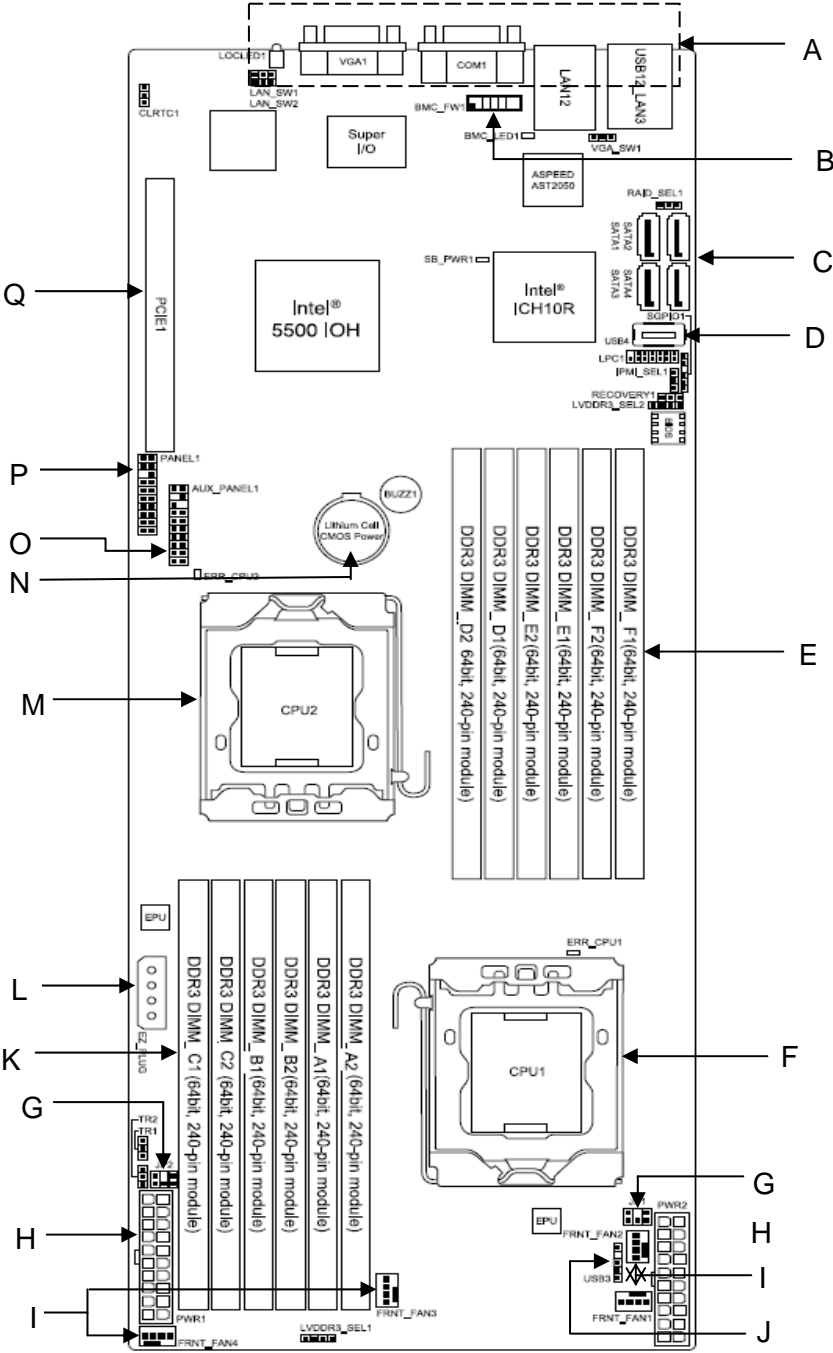

Figure 4. Server Node Connectors and Components

Table 3. Server Node Connectors and Components Descriptions

	Description		Description
A	Rear I/O Connectors	K	CPU 1 DIMM Slots (Slots A1– C2)
B	BMC Management Module connector	L	Peripheral Drive Power Connector – 4 pin
C	SATA Ports 1-4	M	CPU 2 - LGA 1366 Socket
D	Internal USB(4) 2.0 Port	N	CMOS Battery
E	CPU 2 DIMM Slots (Slots D1 – F2)	O	Auxiliary Front Panel Header
F	CPU 1 - LGA 1366 Socket	P	Front Panel Header
G	Power Supply SMBus - 2x3 Pin Header	Q	X16 GEN 2 PCI Express* Riser Card Slot
H	Main Power Connector – 20 pin		
I	System Fan Connectors		
J	USB(3) 2.0 - 1x5 Pin Header		

1.6 System LED Information

1.6.1 Front Control Panel LEDs

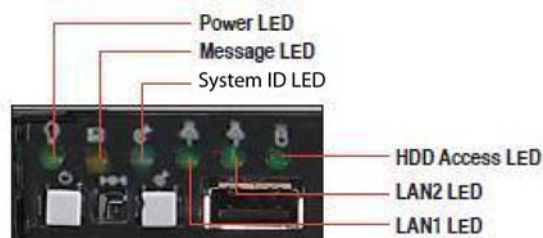

Figure 5. Front Control Panel LEDs

Table 4. Front Panel LEDs Descriptions

LED	Display Status	Description
Power LED	ON	System power ON
HDD Activity	OFF Blinking	No activity Read/write data into the HDD.
Message LED	OFF Blinking	System is normal; no incoming event. Indicates a HW monitor event.
System ID LED	OFF ON	Normal status Location switch is pressed (Press the location switch again to turn off). BMC reset in progress when re-plug Power cord
LAN LEDs	OFF Blinking ON	No LAN connection LAN is transmitting or receiving data. LAN connection is present.

1.6.2 RJ-45 LAN Ports 1 and 2 LEDs

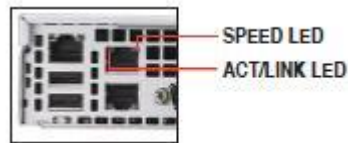

Figure 6. RJ-45 Ports 1 and 2 LEDs

Table 5. RJ-45 Ports 1 and 2 LEDs Descriptions

ACT/LINK LED		SPEED LED	
Status	Description	Status	Description
OFF	No link	OFF	10 Mbps connection
GREEN	Linked	Orange	100 Mbps connection
BLINKING	Data activity	Green	1 Gbps connection

1.6.3 HDD Status LED

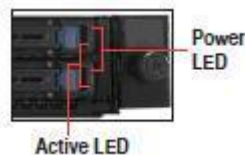

Figure 7. HDD Status LED

Table 6. HDD LED Status Definitions

LED	Status	Description
Power	Green Light ON	Power On (detection HDD present)
	Red Light ON	RAID HDD fail (HDD plug-in ready but detection error)
	G/R Blinking	RAID rebuilding
	OFF	HDD not found
Active	Green Blink	Data read/write to HDD

1.7 Cable Connections

NOTE: The bundled system cables are pre-connected before shipment. You do not need to disconnect these cables unless you must remove pre-installed components for servicing or to install additional devices.

Refer to Chapter 4, “System Service” for detailed information on the connections.

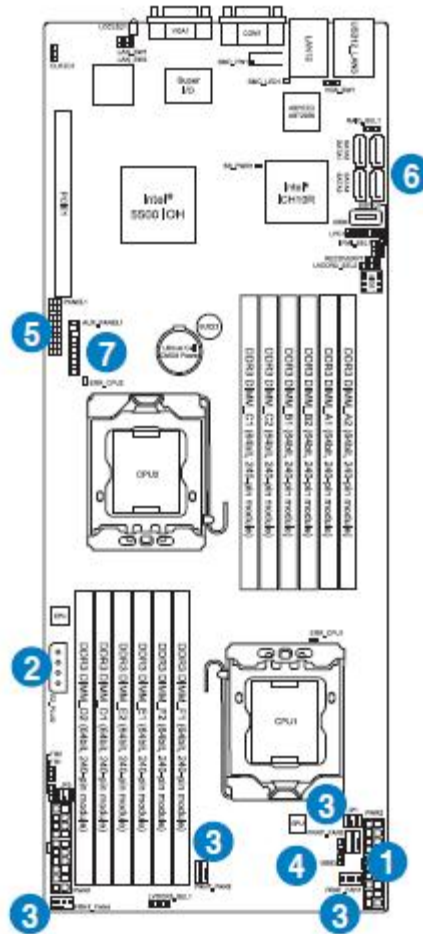

Figure 8. Cable Connections

1.7.1 Pre-Connected System Cables

1. 20-pin Main Power connector (from power supply to server board)
2. 4-pin Peripheral Power connector (from server board to add-in peripheral device)
3. System Fan connectors (from server board to system fans)
4. USB connector (from server board to front control panel)
5. Front Control Panel connector (from server board to front control panel)
6. SATA connectors (from server board to backplane)
7. Auxiliary Panel connector (from server board to front control panel)

2. Hardware Setup

2.1 Chassis Cover

2.1.1 Removing the Chassis Cover

1. Loosen the two thumbscrews on the rear panel to release the rear cover from the chassis.

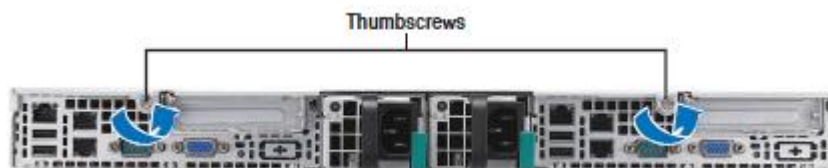

Figure 9. Rear Panel Thumbscrews

2. Firmly hold the cover and slide it toward the rear panel for about half an inch until disengages from the chassis.

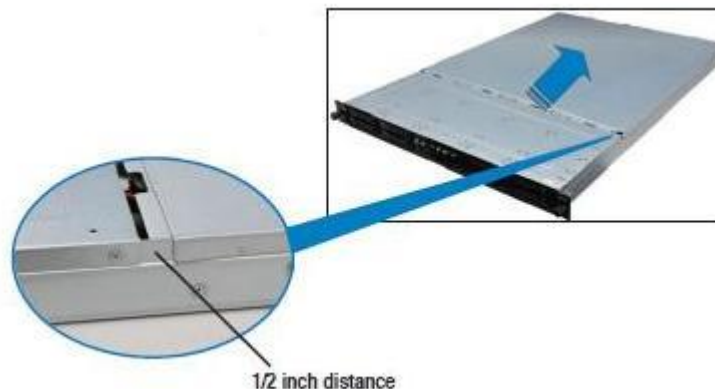

Figure 10. Sliding the Chassis Cover

3. Lift the cover from the chassis.

2.2 Central Processing Unit (CPU)

Each installed server node provides two surface mount LGA 1366 CPU sockets designed for the Intel® Xeon® Processor 5500 series and 5600 series.



CAUTIONS

Upon purchase of the server board, ensure the PnP caps are installed on each processor socket and the socket contacts are not bent. Contact

your retailer immediately if the PnP cap is missing, or if you see any damage to the PnP cap/socket contacts/server board components.

The PnP cap should be retained and re-used if the server is ever returned for service.

The product warranty does not cover damage to the socket contacts resulting from incorrect processor installation/removal, or misplacement/loss/incorrect removal of the PnP cap.

2.2.1 Installing the Processor

To install a processor:

1. Locate the processor socket on the server board.

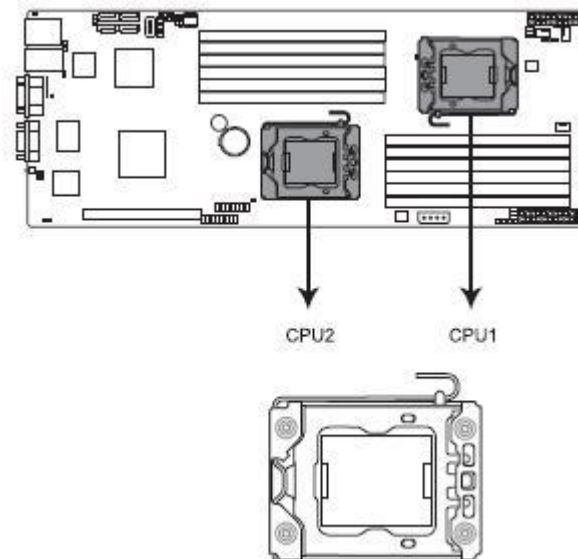

Figure 11. LGA1366 Socket

TIP

Before installing the processor, ensure the socket box is facing towards you and the load lever is on your left.

2. Press the load lever with your thumb (A), then move it to the left (B) until it is released from the retention tab.



CAUTION

To prevent damage to the socket pins, do not remove the PnP cap unless you are installing a processor.

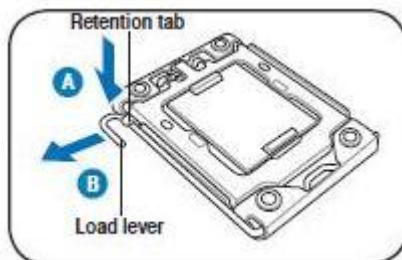

Figure 12. Retention Tab and Load Lever

3. Lift the load lever in the direction of the arrow to a 135° angle.

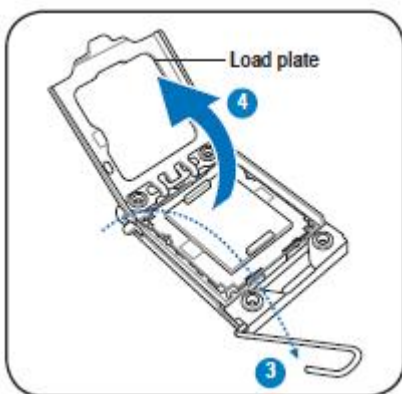

Figure 13. Load Plate

4. Lift the load plate with your thumb and forefinger to a 100° angle.
5. Remove the PnP cap from the processor socket.

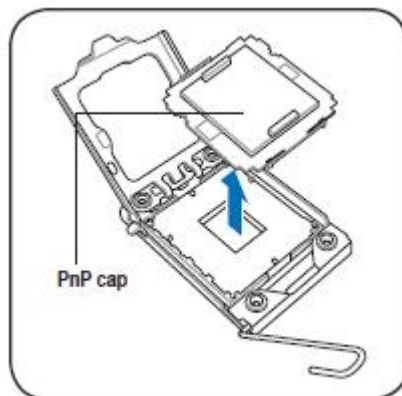

Figure 14. PnP Cap

6. Position the processor over the socket, making sure the gold triangle is on the bottom-left corner of the socket, and then fit the socket alignment key into the processor notch.



CAUTION

The processor fits in only one correct orientation. DO NOT force the processor into the socket to prevent bending the connectors on the socket and damaging the processor!

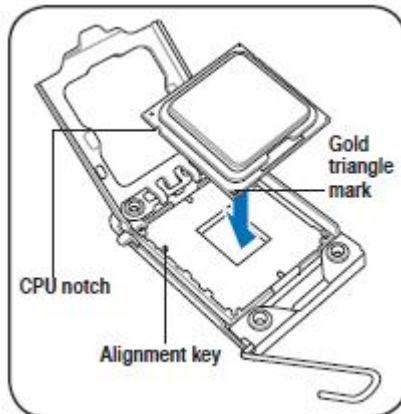

Figure 15. CPU Notch and Alignment Key

7. (Skip this step if your heatsink has pre-applied thermal interface material.) Apply several drops of thermal paste to the exposed area of the processor the heatsink will be in contact with, ensuring it is spread in an even, thin layer.

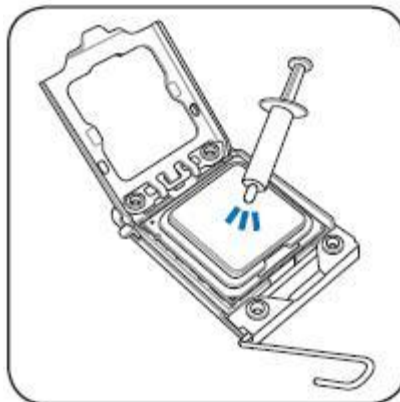

Figure 16. Applying Thermal Paste

NOTE: The processor fits in only one correct orientation. DO NOT force the processor into the socket to prevent bending the connectors on the socket and damaging the processor!



WARNING

The thermal paste is toxic and inedible. If it gets in your eyes or touches your skin, you must wash it off immediately and seek professional medical help.

TIP

To prevent contaminating the paste, DO NOT spread the paste with your finger directly.

8. Close the load plate (A), and then push the load lever (B) until it snaps into the retention tab.

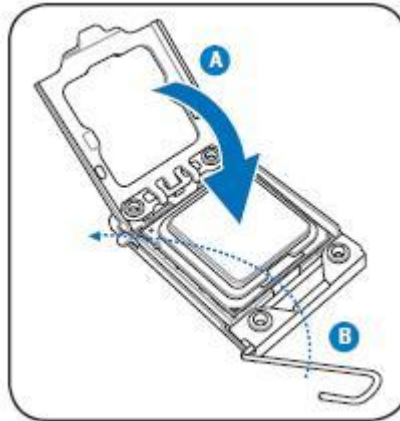

Figure 17. Closing the Load Plate

2.2.2 Installing the Processor Heatsink

You must install the processor before installing the heatsink.

Improper installation can damage the heatsink. Pay close attention to the steps and perform each step exactly as indicated to avoid damage.

The heatsink has Thermal Interface Material (TIM) located on the bottom of it. Use caution when you unpack the heatsink so you do not damage the TIM.

New unused heatsinks have adequate TIM on the bottom. If you are reusing a heatsink, make sure there is adequate TIM present on the heatsink to support processor cooling.

To install the heatsink, follow these steps:

1. Remove the protective film on the TIM if present.
2. Orient the heatsink over the processor as shown. You must position the heatsink fins as shown (Figure 18) to provide correct airflow through the system.
3. Set the heatsink over the processor, lining up the four captive screws with the four posts surrounding the processor.
4. Loosely screw in the captive screws on the heatsink corners in a diagonal manner according to the numbers shown (Figure 18) as follows:
 - a. Starting with the screw at location 1, engage the screw threads by giving it two rotations in the clockwise direction and stop. (**IMPORTANT:** Do not fully tighten.)
 - b. Proceed to the screw at location 2 and engage the screw threads by giving it two rotations and stop.
 - c. Engage screws at locations 3 and 4 by giving each screw two rotations and then stop.
5. Repeat steps 4a through 4c by giving each screw two rotations each time until all screws are lightly tightened up to a maximum of 8 inch-pounds torque.

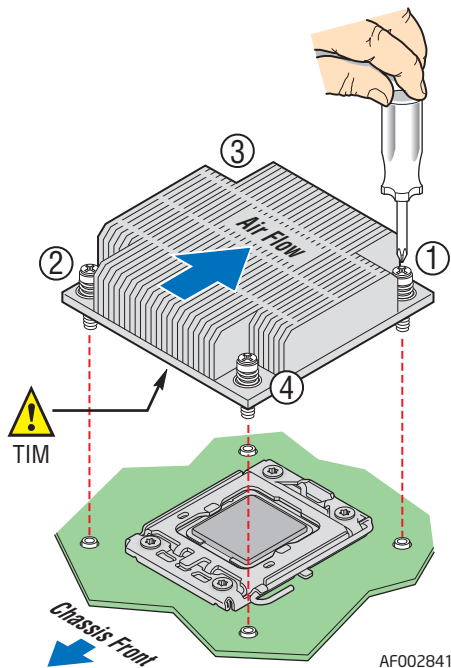

Figure 18. Installing the Heatsink (Passive Heatsink Shown)

2.2.3 Removing the Processor Heatsink

To remove or replace a processor, you must first remove the heatsink.



CAUTION

Improper removal can damage the heatsink. Pay close attention to the steps and perform each step exactly as indicated to avoid damage.

To remove the heatsink, follow these steps:

1. Loosen the four captive screws on the heatsink corners in a diagonal manner according to the numbers shown in Figure 19 as follows:
 - a. Starting with the screw at location 1, loosen it by giving it two rotations in the counter-clockwise direction and stop. (**IMPORTANT:** Do not loosen fully.)
 - b. Proceed to the screw at location 2 and loosen it by giving it two rotations and stop.
 - c. Loosen screws at locations 3 and 4 by giving each screw two rotations and then stop.
 - d. Repeat steps 3a through 3c by giving each screw two rotations each time until you loosen all screws.
2. Twist the heatsink slightly to break the seal between the heatsink and the processor.
3. Lift the heatsink from the processor. If it does not pull up easily, twist the heatsink again. Do not force the heatsink from the processor. Doing so could damage the processor.

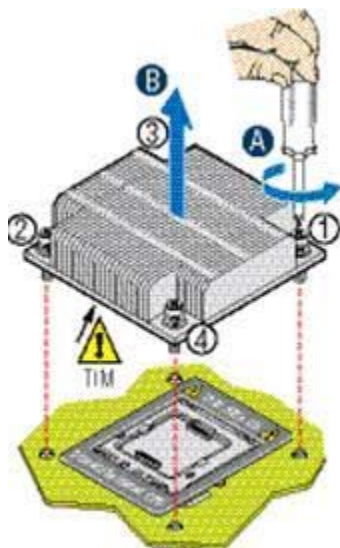

Figure 19. Removing the Heatsink

NOTE: Tighten the four heatsink screws in a diagonal sequence.



2.3 System Memory

2.3.1 Overview

Each installed server node supports twelve (12) DDR3 DIMM sockets—six for each installed processor.

NOTE: You should only install memory in DIMM sockets DIMM_D1 through DIMM_F2 when dual processors are installed on a given server node. On a given server node, DIMM sockets DIMM_D1 through DIMM_F2 are not enabled in single processor configurations.

The following figure illustrates the location of the DDR3 DIMM sockets.

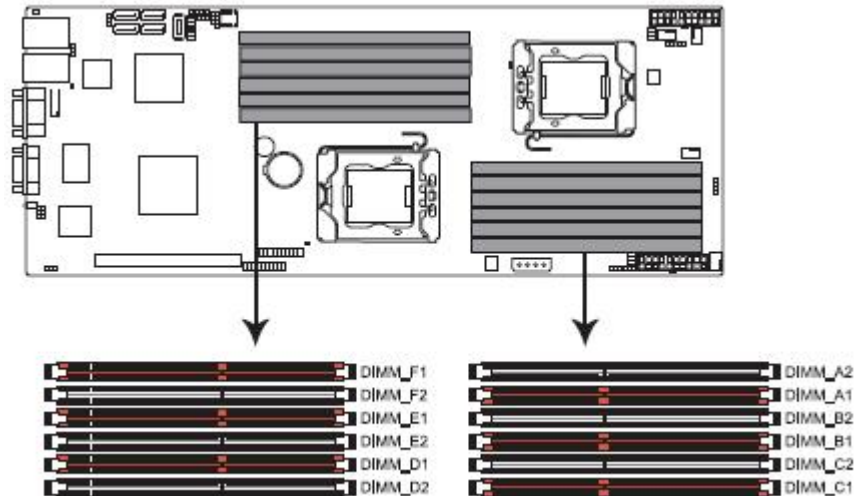

Figure 20. DDR3 DIMM Sockets Location

2.3.2 Memory Support

Supported memory follows the DDR3 specification and meets the following characteristics:

- 800 MHz, 1066 MHz or 1333 MHz operating frequencies
- Single-rank (SR), dual-rank (DR), and quad-rank (QR)
- Registered DIMM (RDIMM) or Unbuffered DIMM (UDIMM)
 - RDIMMs must be ECC only
 - UDIMMs can be ECC or non-ECC and can be mixed within a common configuration
 - The Channel Independent mode is the only memory RAS mode that supports non-ECC DIMMs.
 - The presence of a single non-ECC UDIMM results in the disabling of ECC functionality.
 - RDIMMs and UDIMMs cannot be mixed within a common system memory configuration

The following table shows the maximum memory amounts using RDIMM type memory:

Table 7. Maximum Memory Allocation Using RDIMMs

Single Rank RDIMMs 800 MHz and 1066 MHz	48 GB (12x 4GB DIMMs)
Dual Rank RDIMMs 800 MHz and 1066 MHz	96 GB (12x 8GB DIMMs)
Quad Rank RDIMMs (1) 800 MHz only	96 GB (12x 8GB DIMMs)

NOTE: Due to thermal requirements needed to support Quad Rank x4 DDR3 DIMMs, the Intel® Server System SR1670HV does not support this memory type.

2.3.2.1.1 Memory Population Rules

DIMM population requirements are dependent upon the number of slots per channel; number of DIMMs installed; and rank type. When installing memory, consider the following:

- Populate DIMMs by channel starting with the blue slot farthest from the CPU.
- All channels in a system will run at the fastest common frequency.
- RDIMMs and UDIMMs cannot be mixed.
- If two 1333 MHz-capable UDIMMs or RDIMMs is detected in the same channel, the BIOS will flag this as a warning and force the speed down to 1066 MHz.

Table 8. Supported RDIMM Configurations

DIMM Slots per Channel	DIMMs Populated per Channel	DIMM Type	Speeds	Ranks per DIMM	Population Rules
2	1	Registered DDR3 ECC	800, 1066, 1333	SR or DR	1. Any combination of x4 and x8 RDIMMs with 1Gb or 2Gb DRAM density
2	1	Registered DDR3 ECC	800, 1066	QR Only	
2	2	Registered DDR3 ECC	800, 1066	Mixing SR, DR	
2	2	Registered DDR3 ECC	800	Mixing SR, DR, QR	

- Does NOT support 256 Mb, 512 Mb, and 4 Gb DRAM technologies and x16 DRAM on RDIMM.
- If a quad-rank RDIMM is mixed with a single-rank or dual-rank DIMM on a given channel, you must populate the quad-rank DIMM in the lowest numbered slot.

Table 9. Supported UDIMM Configurations

DIMM Slots per Channel	DIMMs Populated per Channel	DIMM Type	Speeds	Ranks per DIMM	Population Rules
2	1	Unbuffered DDR3 (with or without ECC)	800, 1066, 1333	SR or DR	1. Any combination of x8 UDIMMs with 1 Gb or 2 Gb DRAM Density
2	2	Unbuffered DDR3 (with or without ECC)	800, 1066	Mixing SR, DR	

- Does NOT support 256 Mb, 512 Mb, and 4 Gb DRAM technologies; x4 DRAM on UDIMM and quad-rank UDIMM
- Mixing ECC and non-ECC UDIMMs anywhere on the platform forces the system to run in non-ECC mode.
- No RAS support for non-ECC UDIMMs.
- No x4 SDDC support with UDIMM with ECC; however, x8 SDDC is supported in lock step mode with x8 UDIMMs with ECC.

NOTE: Although non-ECC memory can be used in this server system, Intel does not plan to validate them and strongly discourages their use in a working server environment.

When installing DIMMs, you must follow the following population rules to deliver the best performance:

- Maximize number of channels populated first
- Balanced DIMM population across channels and sockets.

Table 10. Memory Population Table

CPU 1 Configuration						
	DIMM_A2	DIMM_A1	DIMM_B2	DIMM_B1	DIMM_C2	DIMM_C1
1 DIMM	-	☑	-	-	-	-
2 DIMMs	-	☑	-	☑	-	-
3 DIMMs	-	☑	-	☑	-	☑
4 DIMMs	☑	☑	-	☑	-	☑
6 DIMMs	☑	☑	☑	☑	☑	☑
CPU 2 Configuration						
	DIMM_D2	DIMM_D1	DIMM_E2	DIMM_E1	DIMM_F2	DIMM_F1
1 DIMM	-	☑	-	-	-	-
2 DIMMs	-	☑	-	☑	-	-
3 DIMMs	-	☑	-	☑	-	☑
4 DIMMs	☑	☑	-	☑	-	☑
6 DIMMs	☑	☑	☑	☑	☑	☑

With two processors installed, the system will operate only if the DIMM slots of one processor are populated. In this case, memory is shared between the two processors. However, due to the associated latency of this configuration, this is NOT a recommended operating mode.

You can find additional technical information for the memory sub-system in the Technical Product Specification (TPS).

2.3.3 Installing a DIMM



CAUTION

Before adding or removing DIMMs or other system components, you must unplug the power supply. Failure to do so may cause severe damage to both the server board and the components.

1. Unlock a DIMM socket by pressing the retaining clips outward.
2. Align a DIMM on the socket so the notch on the DIMM matches the break on the socket.

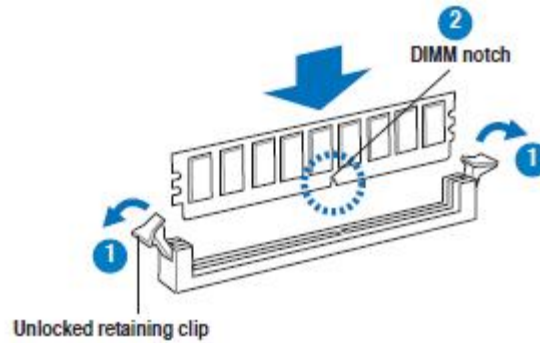

Figure 21. Unlocked Retaining Clips

TIP

- A DIMM is keyed with a notch so that it fits in only one direction. To avoid damaging the DIMM, DO NOT force a DIMM into a socket.
3. Firmly insert the DIMM into the socket until the retaining clips snap back into place and the DIMM is properly seated.

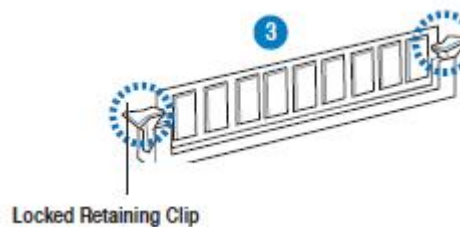

Figure 22. Locked Retaining Clips

2.3.4 Removing a DIMM

Follow these steps to remove a DIMM:

1. Simultaneously press the retaining clips on each side of the DIMM outward to disengage the DIMM from the socket.

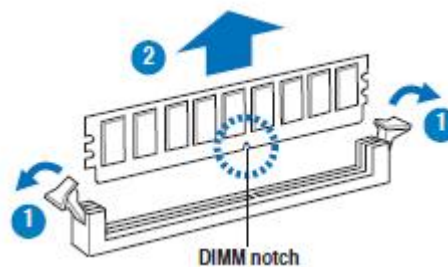

Figure 23. DIMM Notch

NOTE: Support the DIMM lightly with your fingers when pressing the retaining clips. The DIMM might get damaged when it flips out with extra force.

2. Remove the DIMM from the socket.

2.4 Installing a PCI Express* Add-In Card to the Riser Bracket

The system comes with a riser card bracket for each installed server node. To install a PCI Express* add-in card, you must remove the bracket assembly from the server using the following procedure:

To install a PCI Express* add-in card:

1. Firmly hold the riser card bracket, and then pull it up to detach it from the riser slot on the server board.

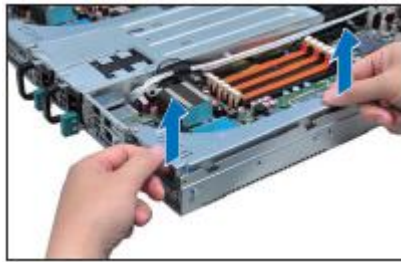

Figure 24. Riser Card Bracket

2. Place the riser card bracket on a flat and stable surface, and then remove the screw from the slot bay.



Figure 25. Removing the Screw from Slot Bay

3. Install a PCI Express* add-in card to the bracket as shown, and then secure the card with a screw.

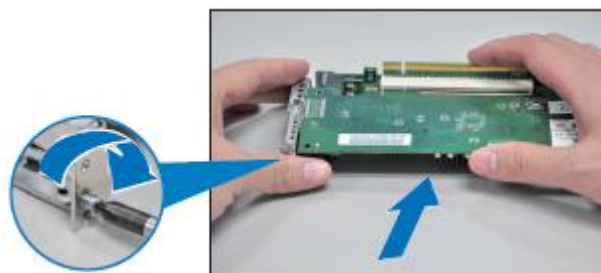

Figure 26. PCI Express* x 16 Card

4. Press the riser card bracket until the golden connectors completely fit the slot and the bracket aligns with the rear panel.



Figure 27. Pressing Rising Card Bracket for Golden Connectors to Fit

5. If applicable, connect the cable(s) to the card.

2.5 Installing the BMC Management Module

Complete the following steps to install the BMC Management Module onto the server board.

1. Locate the BMC_FW1 header on the server board.

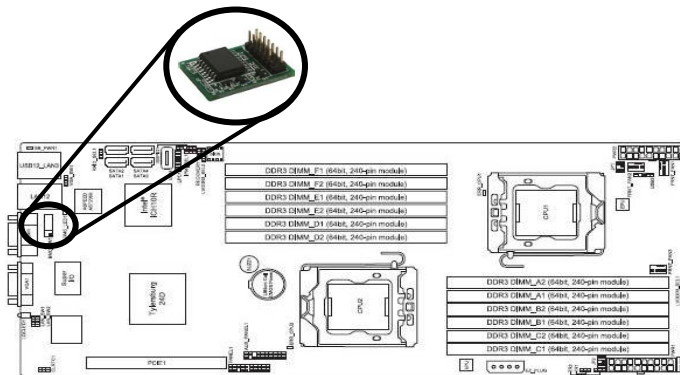

Figure 28. BMC_FW1 Header

2. Orient and press the management card in place.

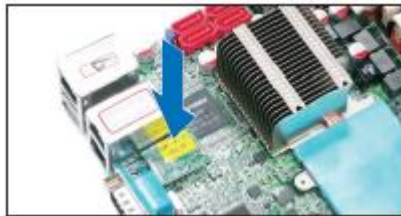

Figure 29. Orienting the Management Module Card

3. Insert the LAN cable plug into the Server Management LAN port located above the USB ports.



Figure 30. Server Management LAN Port

NOTE: With the BMC Management Module installed, each time the AC power cord is plugged into the server, there will be a delay of 45-60 seconds before the server powers on. During this time, the Blue System ID LED will turn on, and the power button will be disabled. This power on delay is required to reset the BMC controller on the BMC Management Module. Once the BMC reset is complete, the System ID LED will turn off, and the power button functionality will be re-enabled.

2.6 Hard Disk Drives

The system supports up to eight hot-swap 2.5-inch SATAII/SAS hard disk drives—four for each installed server node. Each installed hard disk is mounted to a drive tray. When inserted into a drive bay, the hard drive is blind-mated to a matching connector on a backplane, which is either cabled to SATA ports on each server node (default) or can be routed to add-in SAS/SAS RAID cards.

The hard drives for each server node are numbered as follows:

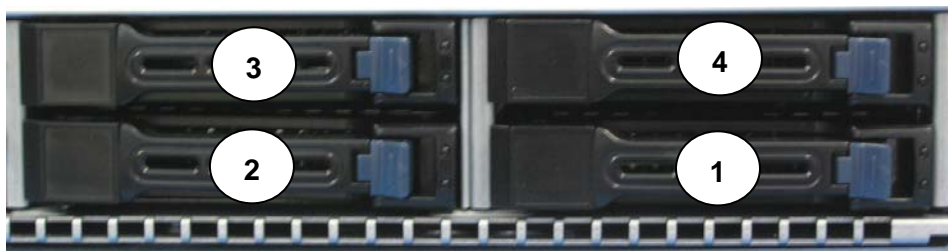

Figure 31. Hard Disk Drives

Each drive number corresponds to a matching SATA port number on the server board.

To install a hard drive:

1. Release the drive tray by pushing the spring lock to the right, and then pulling the tray lever outward. The drive tray ejects slightly after you pull out the lever.
2. Firmly hold the tray lever and pull the drive tray out of the bay.



Figure 32. Releasing the Drive Tray

3. Place a SATAII/SAS hard disk drive on the tray, and then secure it with its four screws.



Figure 33. Placing a SATAII/SAS Hard Disk Drive on the Tray

4. Carefully insert the drive assembly into a drive bay until contact is made with the backplane.
5. Push the tray lever in until it clicks and secures the drive tray in place. The drive tray is correctly placed when its front edge aligns with the bay edge.



Figure 34. Pushing the Tray Lever

6. Repeat Steps 1 through 5 to add additional hard drives to the system.

3. Installing the Rackmount Rail Kit

Your rackmount rail kit package contains:

- Two pairs of server rails (for the server)
- Two pairs of rack rails (for the rack)
- Nut-and-bolt type screws

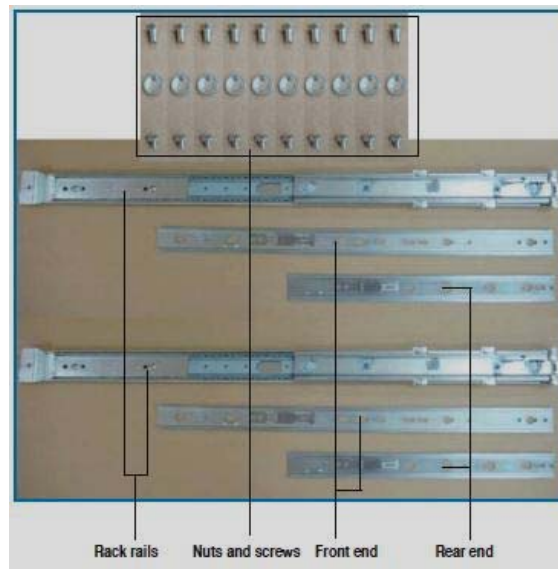

Figure 35. Rackmount Rail Kit Items

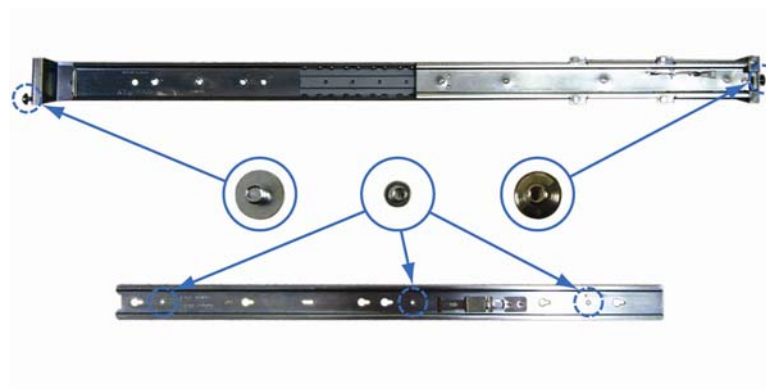

Figure 36. Screw positions on the rail

3.1 Attaching the Rails to the Server

To attach the server rails:

1. Attach the front end of the server rail to the side of the chassis, matching each of the three hooks to the holes on the rail, and then slide the rail towards the front panel until it locks into place.



Figure 37. Attaching the Front End of the Server Rail to Side of Chassis

2. Attach the rear end of the server rail to the side of the chassis, matching each of the two hooks to the hooks to the holes on the rail, and then slide the rail towards the front panel until it locks into place.



Figure 38. Sliding the Server Rail

3. Secure the server rail to the side of the chassis with two screws.



Figure 39. Securing the Server Rail With Screws

4. Repeat steps 1 through 3 to attach the second server rail to the other side of the chassis.

3.2 Attaching the Rack Rails

To attach the rack rails:

1. Select one unit of space (1U) on the rack where you want to install the server system.
2. Install the nuts on the holes of the 1U space on the rack front.
3. Install the nuts on the holes of the 1U space on the corresponding rack rear.
4. Measure the depth of the rack to determine the length of the rack rails.
5. Measure the rack rail when assembled to ensure it fits the rack.
6. Position the rack rail to the 1U space on the rack. Ensure the front end of the rack rail goes to the front of the rack space.



Figure 40. Positioning the Rack Rail to 1U Space on Rack

7. Secure the front end of the rail with two rack screws.
8. Secure the rear end of the rail with two rack screws.
9. Repeat steps 5 through 8 to assemble and attach the second rail.

3.3 Rackmounting the Server

To mount the server to the rack:

1. Align the server rails with the rack rails, and then push the server all the way to the depth of the rack.
2. Drive a screw on the mounting ear to secure the server in place.



Figure 41. Mounting Ear

4. System Service

4.1 Replacing Power Supply Units (PSUs)

Complete the following steps to replace a failed power supply unit (PSU).

NOTE: Installed power supply units (PSUs) provide no power redundancy. A failed PSU will bring down the respective server node. You can cold-swap the failed PSU while the other power supply unit is still functional.

To replace the failed PSU:

1. Disconnect the power cord.
2. Hold the PSU lever and press the PSU latch.



Figure 42. Holding and Pressing the PSU Latch

3. Firmly pull the failed PSU out of the server chassis.



Figure 43. Pulling Out the Failed PSU

4. Firmly push the new PSU into the chassis until the latch locks to the server chassis.



Figure 44. Pushing the New PSU Into the Chassis

4.2 Replacing System Fans

To uninstall the system fans:

CAUTION

Verify the system is powered off before removing any system fan from the system. The system fans operate at very high speeds and may cause serious injury.

1. Disconnect the system fan cable from the fan connector on the server board.



Figure 45. Disconnecting System Fan Cable

2. Lift the fan and set it aside.



Figure 46. Lifting System Fan

3. Repeat Steps 1 and 2 to uninstall other system fans.

To reinstall a system fan:

1. Insert the fan into the fan cage. The airflow directional arrow on the fan side should point towards the system rear panel.



Figure 47. Inserting Fan Into the Fan Cage

2. Connect the system fan cable to the fan connector on the server board.

3. Reinstall the chassis cover. Press down gently on the location above the system fans to ensure proper fan installation as shown in the following figure.



Figure 48. Restoring the Chassis Cover

4.3 SATA/SAS BackPlane Replacement

The system includes a single SATA/SAS backplane that is mounted to the back side of the hard disk drive (HDD) bay module. You can replace the backplane replacement by performing the following procedure:

1. Remove the system top cover.
2. Remove all hard disk drive assemblies from the drive bays.

NOTE: It is important to label each hard drive with the location from which it was taken from. You must return hard drives to the same place from which they were taken *once* you complete the backplane replacement procedure.

3. The HDD bay module is held in place by six screws, three on each side of the chassis. Remove all six screws.



Figure 49. Screws On Hard Disk Drive Bay Module

4. Slide the HDD bay module forward approximately ½ inch (1.27cm) and lift front edge of module from alignment guide slots.

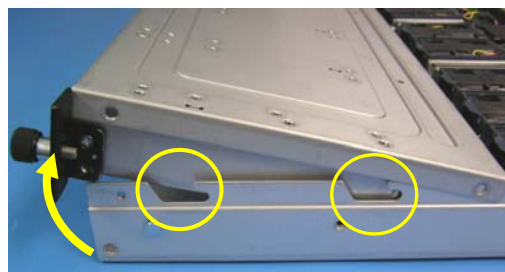

Figure 50. Sliding the Hard Disk Drive Bay Module

- Carefully rotate back and place the connected HDD bay module on top of the system fan assembly so all connected cables and backplane are exposed.



Figure 51. Connected Cables and Backplane Expose

- Note the location and connector type of each cable you must disconnect from the backplane. Disconnect all cables from the backplane and remove the bundled cables from the latched plastic cable holders.
- Place the HDD bay module onto a static-free surface.
- The backplane is fastened to the HDD bay module using 12 screws. Remove all screws from the backplane.
- Carefully pull back the backplane to expose the front panel cables connected to it.



Figure 52. Front Panel Cables

- Note the location of each of the four front panel cables and disconnect each from the backplane.

TIP

Label each 8-pin x 16-pin cable pair before disconnecting them from the backplane. Make sure you reconnect each cable pair to the correct backplane connectors.

- Unpack the replacement backplane.
- Reconnect the front panel cable pairs to the correct connectors on the backplane.

13. Carefully reposition the backplane over the guide pins on each side of the hard drive bay. Verify that all of the front panel cables are located completely within the open area behind the backplane.
14. Securely fasten all 12 screws into the backplane. Be careful not to overtighten them.
15. Reposition the hard drive bay module over the system fan assembly and reconnect all cables to the backplane. Reposition cable bundles within plastic cable holders.



Figure 53. Cable Bundles in the Hard Disk Drive Bay Module

NOTE: You must reconnect the SATA cables in the following order with the drive bay module still positioned in an upside down manner on top of the system fan assembly as shown

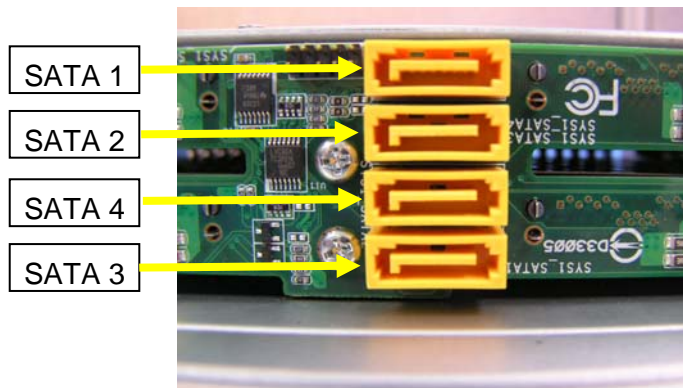

Figure 54. SATA Cable Connection Order

16. Carefully reposition the hard drive bay module on to the server chassis, such that the module falls within alignment slots on each side of the chassis.

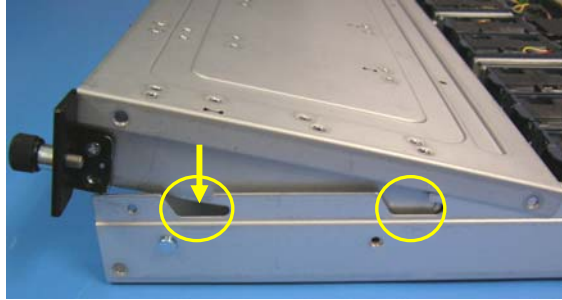

Figure 55. Aligning the Module with the Alignment Slots on the Chassis

17. Slide the hard drive bay module back until the screw holes are aligned.
18. Secure the HDD bay module to the chassis using the six screws, three on each side.
19. Install the hard drives into the same position from which they were removed.

4.4 Front Control Panel Replacement

The system includes two separate control panels (one for each server node) on the front of the chassis which are mounted onto a single removable module. In the event a control panel's features stop functioning and it is determined it should be replaced with a spare, you must perform the following procedure.

1. Power down both server modules and remove AC power.
2. Remove the single screw holding the Control Panel Module in place.

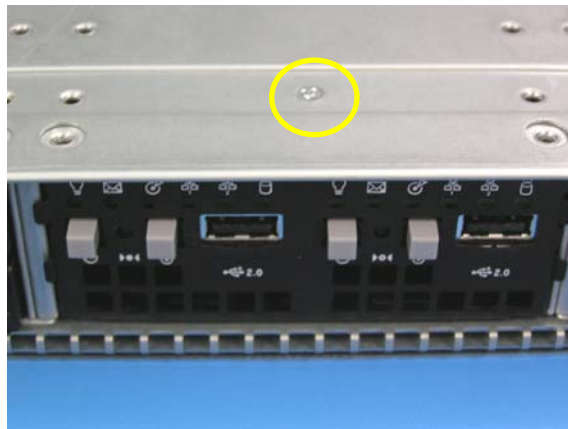

Figure 56. Control Panel Module Screw

3. Carefully pull back the Control Panel module until the cables are fully exposed and accessible.

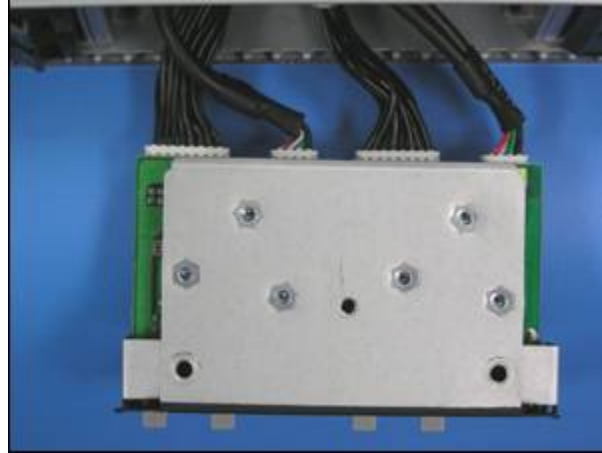

Figure 57 Control Panel Module Top view

4. Carefully detach each cable pair from both control panel boards.
5. Place the detached Control Panel module onto an anti-static surface.

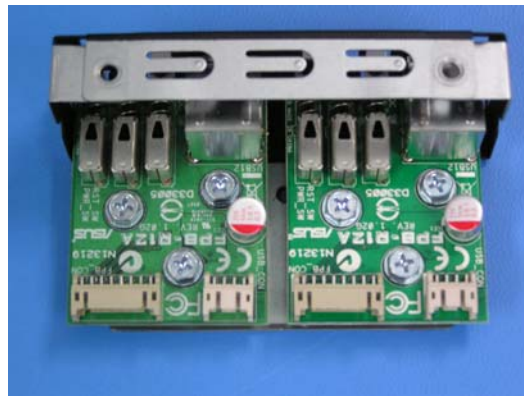

Figure 58 Detached Control Panel Module

6. Take out the faulty Control Panel board by removing the three screws that attach it to the module tray.
7. Unpack the replacement Control Panel board and place it onto the module tray, making sure the Control Panel buttons protrude out of the faceplate holes and screw holes are in alignment with the screw mounts.
8. Using the three screws, fasten the Control Panel board to the module tray. Be careful not to overtighten them.
9. Turn over the Control Panel Module and place it in front of the Module bay at the front of the system.
10. Reattach each cable pair to the appropriate Control Panel board.
11. Carefully slide the Control Panel Module back into the module bay until the screw holes are in alignment.
12. Using the single screw, fasten the Control Panel module to the chassis.

5. Jumpers, Connectors, and LEDs

5.1 Configuration and Support Jumpers

5.1.1 Clear RTC RAM (CLRTC1)

This jumper allows you to clear the Real Time Clock (RTC) RAM in CMOS. You can clear the CMOS memory of date, time, and system setup parameters by erasing the CMOS RTC RAM data. The onboard button cell battery powers the RAM data in CMOS, which includes system setup information such as system passwords.

To erase the RTC RAM:

1. Turn OFF the computer and unplug the power cord.
2. Move the jumper cap from pins 1–2 (default) to pins 2–3. Keep the cap on pins 2–3 for about 5 to 10 seconds, and then move the cap back to pins 1–2.
3. Plug in the power cord and turn ON the computer.
4. Hold down the <F2> key during the boot process and enter the BIOS setup to re-enter data.



CAUTION

Except when clearing the RTC RAM, never remove the cap on the CLRTC jumper default position. Removing the cap causes system boot failure!

NOTE: If the steps above do not help, remove the onboard battery and move the jumper again to clear the CMOS RTC RAM data. After the CMOS clearance, reinstall the battery.

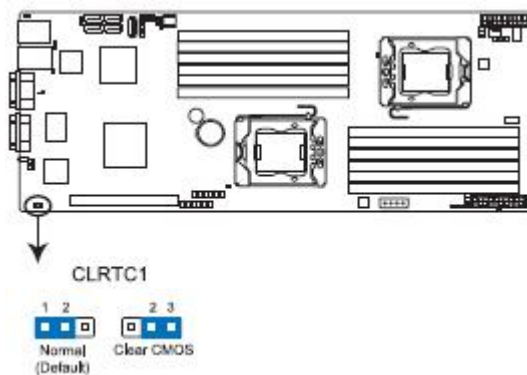

Figure 59. Clear RTC RAM

5.1.2 VGA Controller Setting (3-pin VGA_SW1)

This jumper allows you to enable or disable the onboard VGA controller. Set to pins 1–2 to activate the VGA feature.

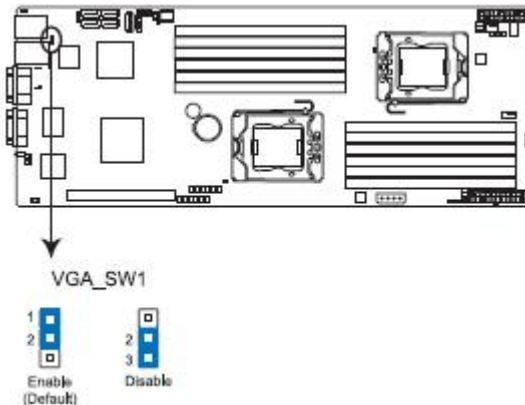

Figure 60. VGA Controller Setting

5.1.3 DDR3 Voltage Control Setting (4-pin LVDDR3_SEL1, LVDDR3_SEL2)

The server board provides DDR3 voltage control jumper blocks for each CPU bank of memory. These jumper blocks change the voltage level supplied to the DIMM bank, and should only be changed when low voltage DDR3 DIMMs are installed.

Set to pins 1–2 to select 1.5V BIOS control, pins 2–3 to select 1.2V Force or 3–4 to select 1.35V Force.



CAUTION

Moving these jumpers from their default position may cause irreparable damage. The use of LV (low voltage) DDR3 DIMMs on this server board is intended for future use only, and will only be supported after Intel has validated their functionality. This document will be updated with full usage information once validation is complete and tested LV DDR3 DIMMs are added to the Tested Memory List for this server board.

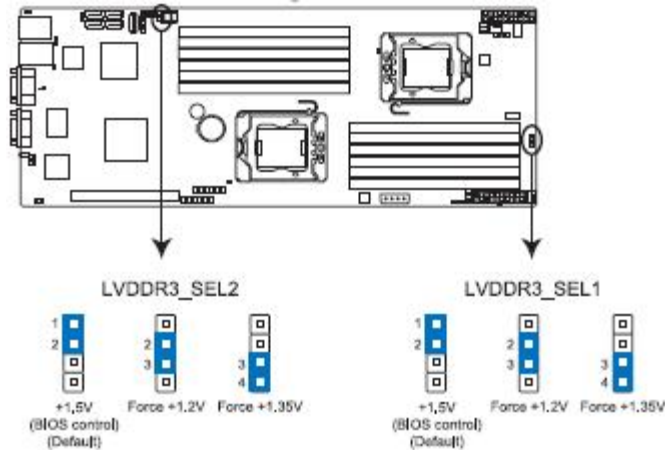

Figure 61. DDR3 Voltage Control Setting

5.1.4 LAN Controller Setting (3-pin LAN_SW1, LAN_SW2)

These jumpers allow you to enable or disable the onboard Intel® 82574L Gigabit LAN controllers. Set to pins 1-2 to activate the Gigabit LAN feature.

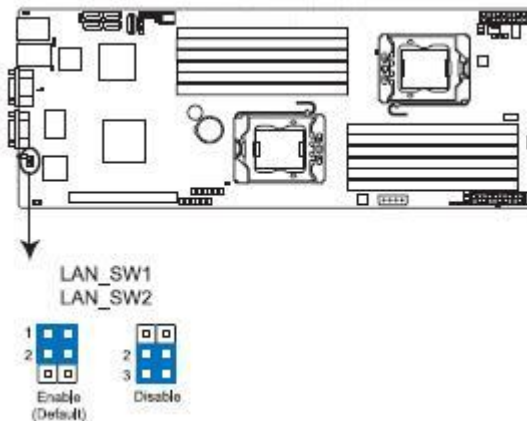

Figure 62. LAN Controller Setting

5.1.5 Intel® ICH10R SATA Port SW RAID Setting (3-pin RAID_SEL1)

This jumper allows you to select the Serial ATA RAID configuration utility to use when you create disk arrays. Place the jumper caps on pins 1-2 to select the LSI* SATA Software RAID utility (default); otherwise, place the jumper caps on pins 2-3 to use the Intel® Matrix Storage Manager (IMSM)

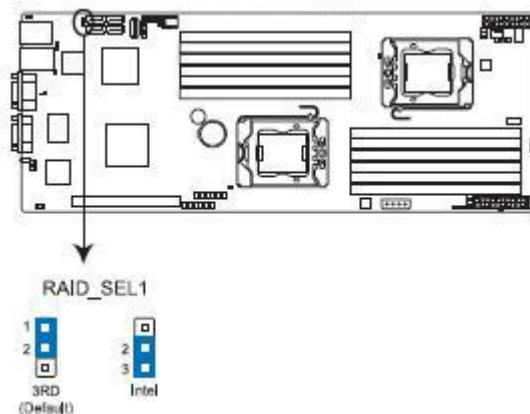

Figure 63. Intel® ICH10R SATA Port SW RAID Setting

5.1.6 Force BIOS Recovery Setting (3-pin RECOVERY1)

This jumper allows you to quickly update or recover the BIOS settings when it becomes corrupted.

To update the BIOS:

1. Prepare a USB flash disk that contains the original or latest BIOS for the server board (XXXXXX.ROM) and the AFUDOS.EXE utility.
2. Set the jumper to pins 2–3.
3. Insert the USB flash and turn on the system to update the BIOS.
4. Shut down the system.
5. Set the jumper back to pins 1-2.
6. Turn on the system.

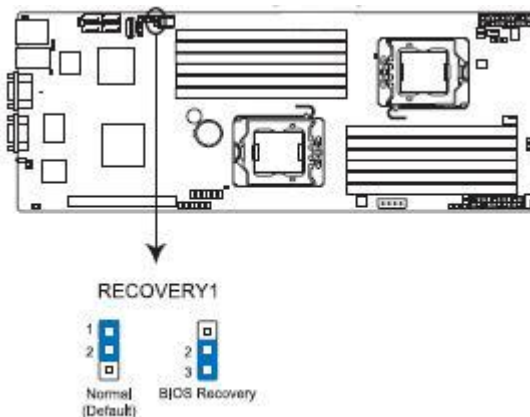

Figure 64. Force BIOS Recovery Setting

5.2 Server Board Connectors

5.2.1 Serial ATA Connectors (7-pin SATA1, SATA2, SATA3, SATA4)

Supported by the Intel® ICH10R chipset, these connectors are for the Serial ATA signal cables for Serial ATA hard disk drives that allow up to 3 Gb/s of data transfer rate.

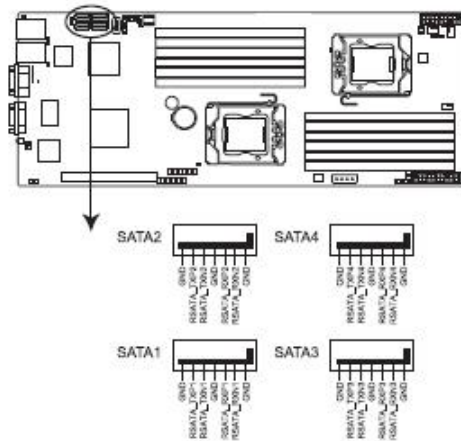

Figure 65. SATA Connectors

5.2.2 Internal USB Connectors (A-Type USB4; 5x1 pin USB3)

These connectors are for USB 2.0 ports. Connect the USB module cables to connectors USB3, and then install the modules to a slot opening at the back of the system chassis. These USB connectors comply with USB 2.0 specification which supports up to 480 Mbps connection speed.

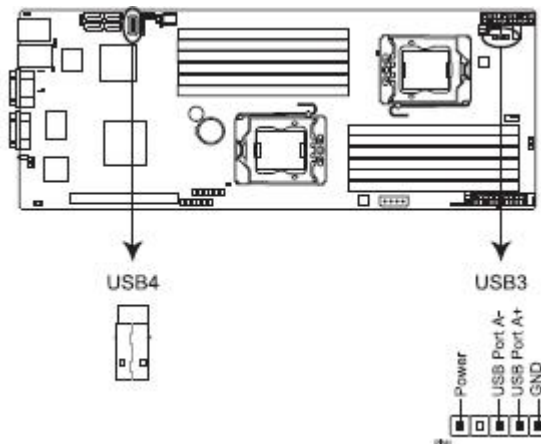

Figure 66. USB 2.0 Connectors

5.2.3 System Fan Connectors (4-pin FRNT_FAN1, FRNT_FAN2, FRNT_FAN3, FRNT_FAN4)

The system fan connectors support cooling fans of 350 mA–740 mA (8.88 W max.) or a total of 3.15 A–6.66 A (53.28 W max.) at +12V. Connect the fan cables to the fan connectors on the server board, ensuring the black wire of each cable matches the ground pin of the connector.



CAUTION

DO NOT forget to connect the fan cables to the fan connectors. Insufficient air flow inside the system may damage the server board components.

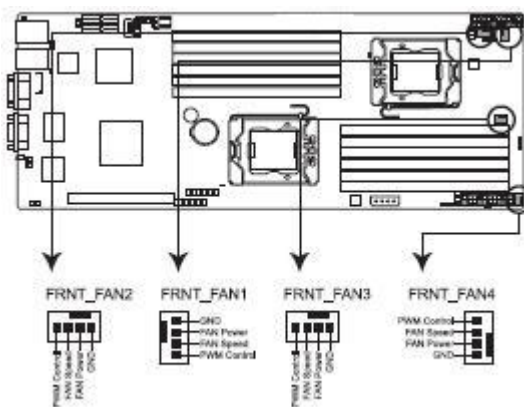

Figure 67. Front Fan Connectors

5.2.4 Serial General Purpose Input/Output Connector (6-1 pin SGPIO1)

This connector is used for the SGPIO peripherals for the LSI* Software RAID and Intel® Matrix RAID SATA LED.

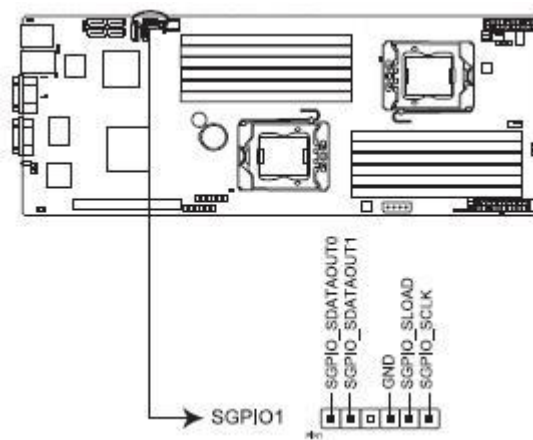

Figure 68. Serial General Purpose I/O Connector

5.2.5 BMC Management Module Header (BMC_FW1)

The BMC connector on the server board supports a BMC Management Module.

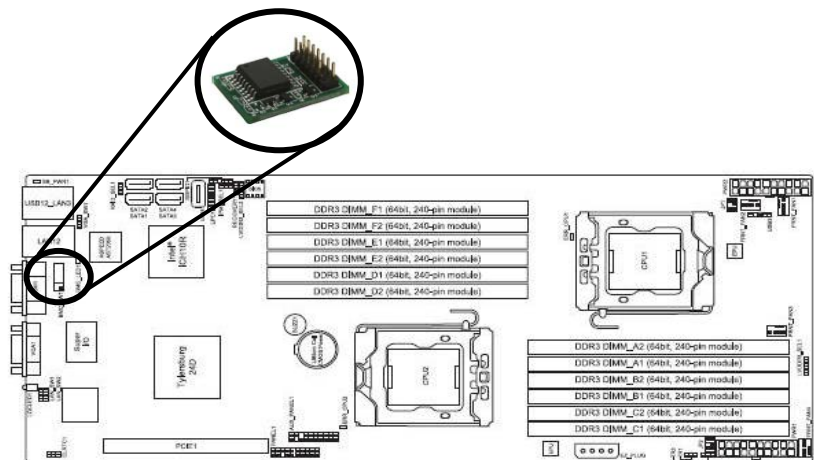

Figure 69. BMC Management Module Header

5.2.6 Power Supply SMBus Connectors (6x1 pin JP1, JP2)

These connectors allow you to connect SMBus (System Management Bus) to the power supply unit to read PSU information. Devices communicate with a SMBus host and/or other SMBus devices using the SMBus interface.

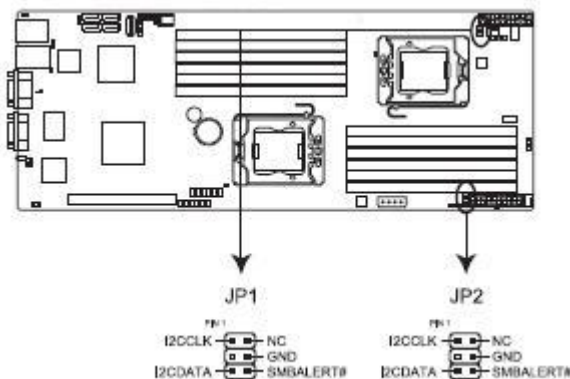

Figure 70. Power Supply SMBus Connectors

5.2.7 Main Power Connectors (20-pin PWR1, 20-pin PWR2)

The server board provides dual 20-pin ATX Main Power connectors. Both connectors have identical pin-outs and are not used concurrently.

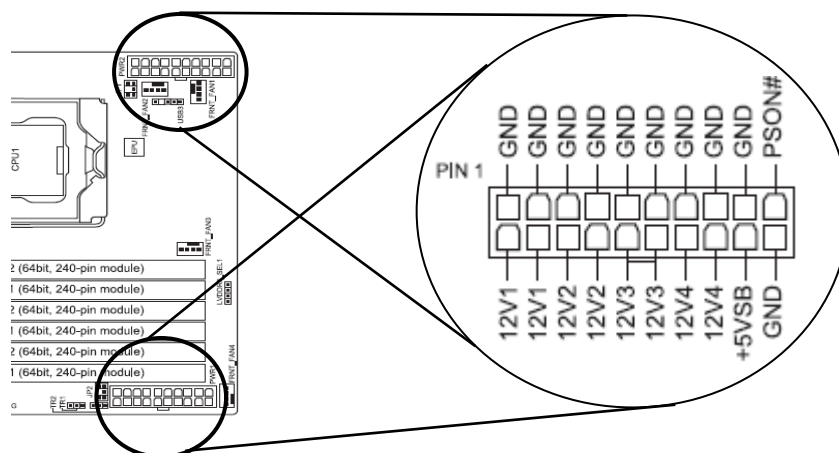

Figure 71. Main Power Connectors

5.2.8 Peripheral Power Connector (4-pin PWR3)

The server board provides a 4-pin peripheral power connector. This connector can supply power as needed to add-in peripheral devices such as hard drives or optical drives. This connector has the following pin-out and board location:

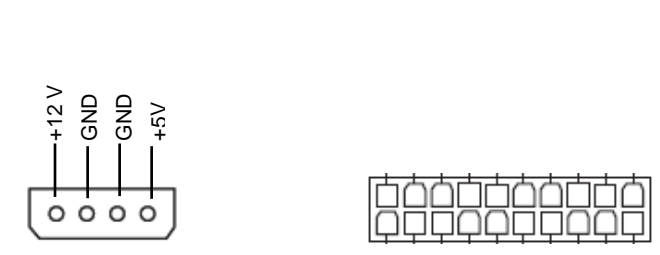

Figure 72. Peripheral Power Connector (4-pin PWR3)

5.2.9 System Panel Connector (20-pin PANEL1)

This connector supports several chassis-mounted functions.

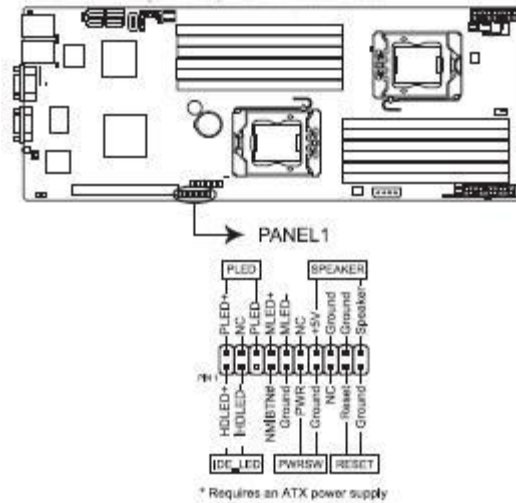

Figure 73. System Panel Connector

5.2.9.1 System power LED (3-pin PLED)

This 3-pin connector is for the system power LED. Connect the chassis power LED cable to this connector. The system power LED lights up when you turn on the system power and blinks when the system is in sleep mode.

5.2.9.2 System Message LED (2-pin MLED)

This 2-pin connector is for the message LED cable that connects to the front message LED. The message LED is controlled by the hardware monitor to indicate an abnormal event occurrence.

5.2.9.3 System warning speaker (4-pin SPEAKER)

This 4-pin connector is for the chassis-mounted system warning speaker. The speaker allows you to hear system beeps and warnings.

5.2.9.4 Hard disk drive activity LED (2-pin HDDLED)

This 2-pin connector is for the HDD Activity LED. Connect the HDD Activity LED cable to this connector. The IDE LED lights up or flashes when data is read from or written to the HDD.

5.2.9.5 Power button/soft-off button (2-pin PWR SW)

This connector is for the system power button. Pressing the power button turns the system on or puts the system in sleep or soft-off mode depending on the BIOS settings. Pressing the power switch for more than four seconds while the system is ON turns the system OFF.

5.2.9.6 Reset button (2-pin RESET)

This 2-pin connector is for the chassis-mounted reset button for system reboot without turning off the system power.

5.2.10 Auxiliary Panel Connector (20-pin AUX_PANEL1)

This connector is for additional front panel features including front panel SMB, locator LED and switch, chassis intrusion, and LAN LEDs.

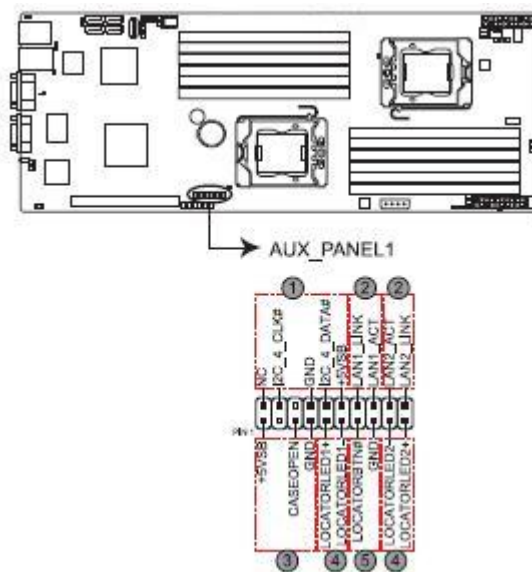

Figure 74. Auxiliary Panel Connector

5.2.10.1 Front panel SMB (6-1 pin FPSMB)

These leads connect the front panel SMBus cable.

5.2.10.2 LAN activity LED (2-pin LAN1_LED, LAN2_LED)

These leads are for Gigabit LAN activity LEDs on the front panel.

5.2.10.3 Chassis intrusion (4-1 pin CHASSIS)

These leads are for the intrusion detection feature for chassis with intrusion sensor or microswitch. When you remove any chassis component, the sensor triggers and sends a high-level signal to these leads to record a chassis intrusion event. The default setting is short CASEOPEN and GND pin by jumper cap to disable the function.

5.2.10.4 System ID LED (2-pin LOCATORLED1 and 2-pin LOCATORLED2)

These leads are for the locator LED1 and LED2 on the front panel. Connect the Locator LED cables to this 2-pin connector. The LEDs will light up when the Locator button is pressed.

5.2.10.5 System ID Button/Switch (2-pin LOCATORBTN)

These leads are for the locator button on the front panel. This button queries the state of the system locator.

5.3 Internal LEDs

5.3.1 Standby Power LED

The server board comes with a standby power LED. The green LED lights up to indicate that the system is ON, in sleep mode, or in soft-off mode. This is a reminder that you should shut down the system and unplug the power cable before removing or plugging in any server board component. The following illustration shows the location of the onboard LED.

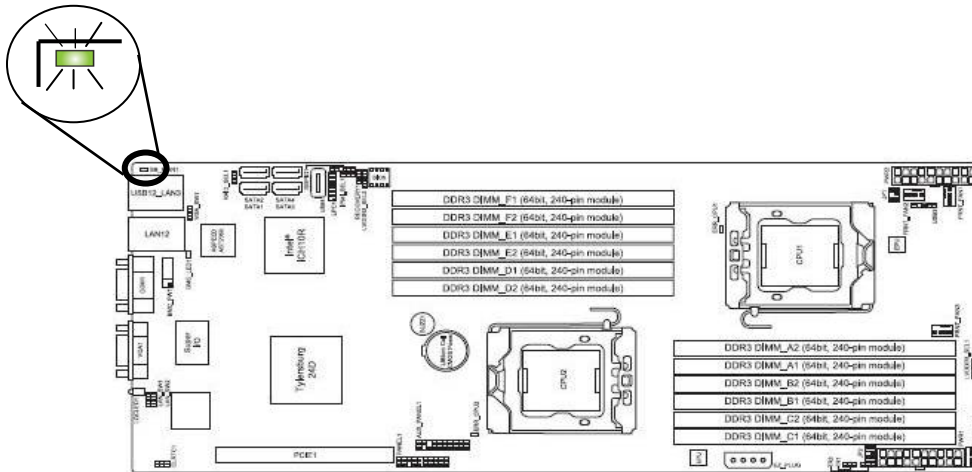

Figure 75. Standby Power LED

5.3.2 CPU Warning LED (ERR_CPU1, ERR_CPU2)

The CPU warning LEDs light up to indicate an impending failure of the corresponding CPU.

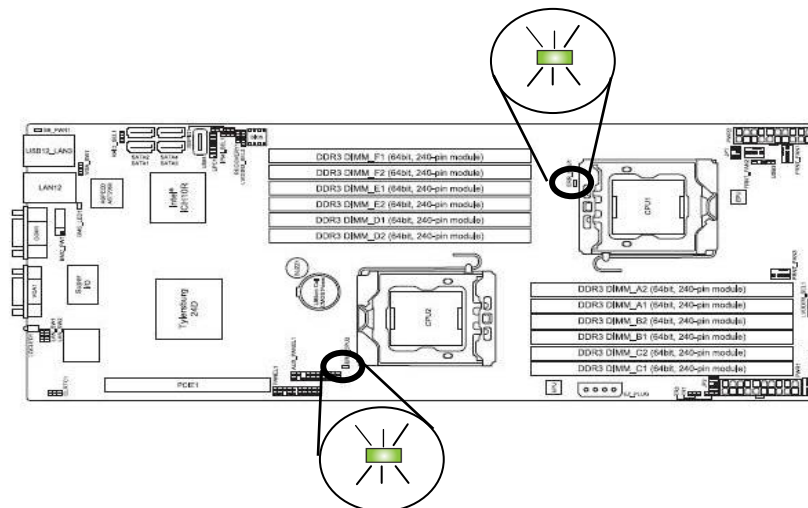

Figure 76. ERR CPU LED

5.3.3 System Identification LED

The server board includes a System ID LED. This LED illuminates when the System ID button on the front panel is pushed. This LED is used to identify the system when servicing is required in a racked environment.

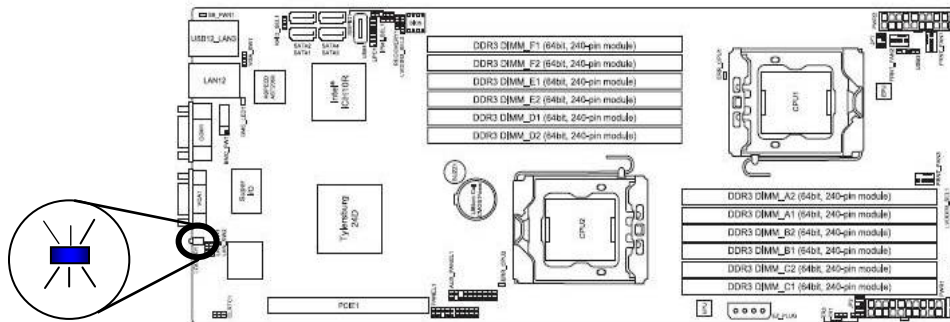

Figure 77. System Identification LED

NOTE: The blue system ID LED will turn on when plug power cord until the BMC reset complete.

5.3.4 BMC LED (BMC_LED1)

The server board includes a BMC LED. With the BMC Management Module installed, this LEDs blinks once per second to indicate the BMC is operating.

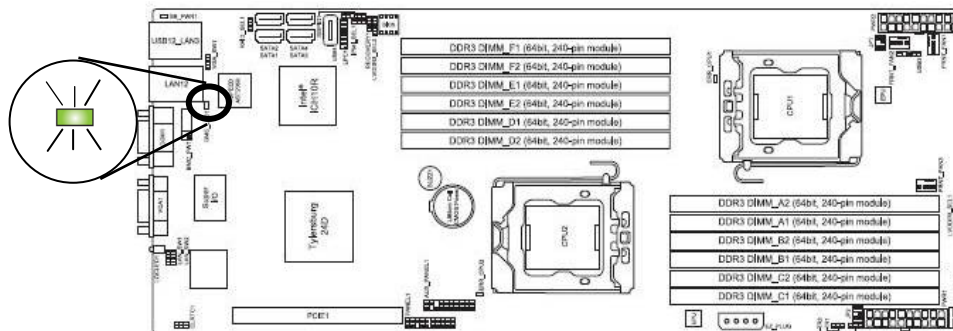

Figure 78. BMC LED (BMC_LED1)

6. BIOS Updates and Configuration

Your server system includes a BIOS which is used to configure critical system settings, ensuring best performance and reliability. In addition, it provides options that you can manually set to configure system features and functions to best meet custom operating environments. This section describes how to keep your system BIOS up to date, recover the BIOS in the unlikely event it gets corrupted, and access the BIOS Setup Utility used to configure many of its options.

6.1 Updating System BIOS

Periodically, Intel makes available a new BIOS release for its server products to enhance features or correct reported issues. You can download BIOS updates for this server system from Intel at the following web site:

<http://support.intel.com/support/motherboards/server/SR1670HV/>

The System Update or BIOS Update package includes the following files:

- **AFUDOS.EXE** – A DOS-based utility used to update the BIOS and provide additional support options.
- **xxxxxxx.ROM** – BIOS image file used by the AFUDOS utility.
- **BIOS##.BAT** – DOS Batch file used to update the BIOS by executing the AFUDOS utility with the appropriate command line options.
- **README.TXT** – Release notes for the BIOS Update describing changes.

NOTE: Prior to updating the System BIOS, Intel recommends reading the Release Notes to fully understand the changes made to the new release and determine how they may affect your system after the update is completed.

Before performing the BIOS update, Intel recommends noting all current BIOS Setup options. These will need to be reset to your desired settings after the BIOS Update has completed. See the *BIOS Setup Utility* section later for more information about this utility.

You should complete the following procedure to update the System BIOS:

1. Extract files from the BIOS Update Package to a DOS bootable USB Flash Drive.
2. Plug in the USB Flash Drive and reboot the server to boot from it.

NOTE: With the USB Flash drive plugged in, you may need to access the BIOS Setup Utility to configure the USB Flash Drive as the first Boot Drive in the system. See *BIOS Setup* later in this chapter for instructions on how to access the BIOS Setup utility and make this change.

3. At the DOS prompt, type the name of the batch file <BIOS##.BAT> where ## is the BIOS revision. The BIOS update begins as soon as the <ENTER> key is pressed.

```

A:\>afudos /1B8700DE6.ROM
AMI Firmware Update Utility - Version 1.19 (ASUS V2.07 (03.11.24BB))
Copyright (C) 2002 American Megatrends, Inc. All rights reserved.

WARNING!! Do not turn off power during flash BIOS
Reading file ..... done
Reading flash ..... done

Advance Check .....
Erasing flash ..... done
Writing flash ..... done
Verifying flash .... done

Please restart your computer

A:\>

```

Figure 79. Updating the BIOS in DOS

NOTE: DO NOT turn off the system or interrupt the BIOS update process. Doing so corrupts the BIOS and prevents your system from booting up. If your BIOS becomes corrupted for any reason, you must read and complete the *BIOS Recovery Process* described later in this section.

4. When the BIOS Update has completed successfully, you must reboot the system for the changes to take effect.
5. During POST, access the <F2> BIOS Setup Utility when prompted.
6. At the Main Menu Screen, press the <F9> key to reset BIOS defaults.
7. Reset any preferred BIOS option settings
8. Save the BIOS Settings and reboot server.

6.2 BIOS Recovery Process

In the unlikely event your system BIOS gets corrupted, you should complete the following BIOS recovery process:

1. Download the latest BIOS or System Update Package from the following Intel Web Site
<http://support.intel.com/support/motherboards/server/SR1670HV/>
2. Extract all the files from the update package to the root directory of a DOS bootable USB Flash Drive.
3. Remove the system top cover.
4. On the server node with the corrupt BIOS, move the “Force BIOS Update” jumper (as shown in the following diagram) from pins 1-2 (default) to pins 2-3.

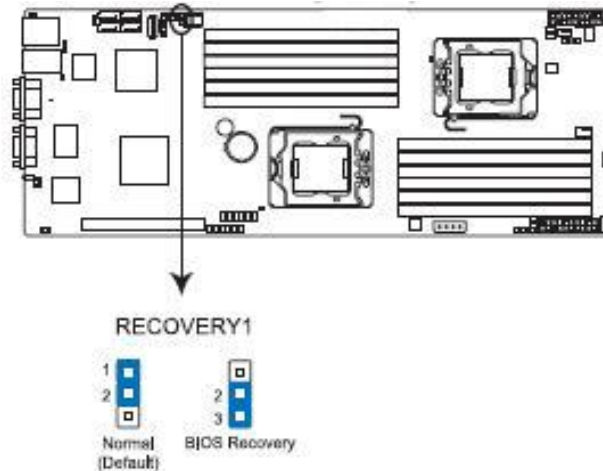

Figure 80. Recovering the BIOS Using the Force BIOS Update Jumper

5. Plug in the USB flash drive and power on the system. The BIOS update process begins automatically.
6. When the BIOS update has completed successfully, power down the system.
7. Set the *Force BIOS Update* jumper back to its default position.
8. Re-install the system top cover.
9. Power on the system and access the <F2> BIOS Setup utility .
10. Hit the <F9> key to load BIOS Setting Defaults.
11. Reset any preferred BIOS setup options.
12. Save the BIOS Settings and reboot the system.

6.3 BIOS Setup Utility

The server board includes an embedded BIOS Setup Utility that you can use to manually change various system features and functions to meet the needs of custom operating environments. This section provides an overview of the following topics:

- BIOS Setup Utility Access
- BIOS Setup Utility Navigation
- BIOS Setup Utility Menu Options Overview



CAUTION

Intel strongly suggests having only qualified persons with in-depth knowledge of server configuration make changes to BIOS settings. Incorrectly setting many of the options available can negatively impact the operation of the server.

Intel recommends using default BIOS settings whenever possible.

NOTE: Should the system operate in an undesired manner after making BIOS setting changes, default settings should be restored by either selecting the “Load Setup Defaults” option in the Exit Menu, or by hitting the <F9> key anytime while in the BIOS Setup Utility.

6.3.1 Accessing BIOS Setup Utility

The embedded BIOS Setup Utility is accessed by pressing the <F2> key while the system is conducting its Power-On Self Test (POST). As the system is booting up, the screen will display when you can access the BIOS Setup Utility.

6.3.2 BIOS Setup Features and Navigation

The BIOS Setup Utility is menu-driven. Each menu screen is divided into different display and selection areas.

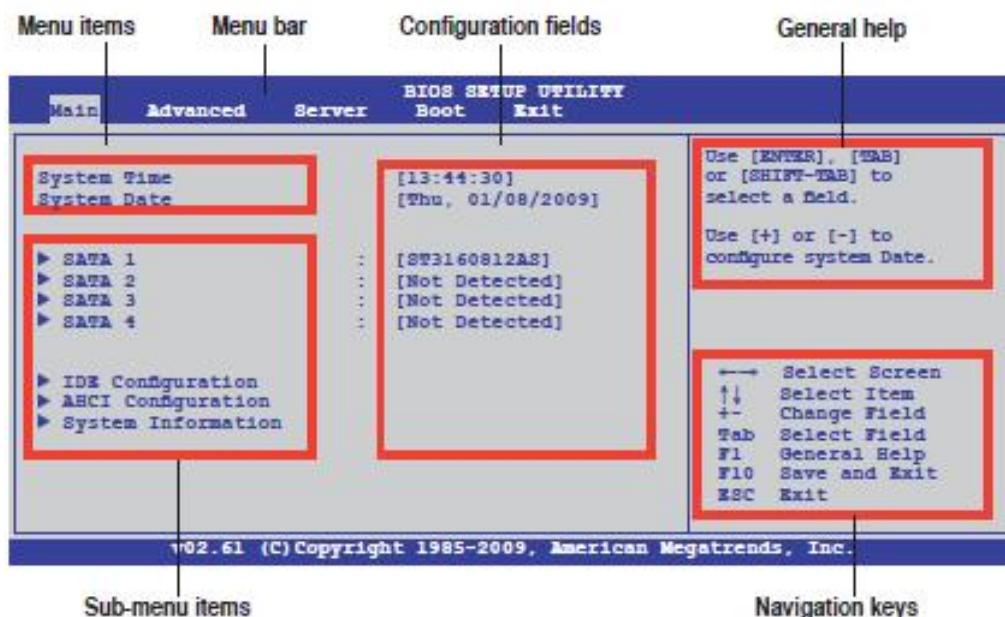

Figure 81. BIOS Menu Screen

6.3.2.1 Menu Bar

At the top of each menu screen is a Menu Bar that lists the top level Menu Options. To navigate through the Menu Bar, press the right or left arrow keys until the menu you need is highlighted and the menu options are displayed. The Menu Bar lists the following top level menus:

Main: Displays basic system information and provides options to view information and configure SATA devices attached to the server.

Advanced: Provides several sub-menus used to configure server sub-system features and functions. Care should be taken when changing options in this section. Making uninformed changes can alter system behavior to an undesired state.

Server: Provides sub-menus used to view/change IPMI and Remote Connectivity options.

Boot: Provides sub-menus used to view/change system boot options and system security.

Exit: Provides utility exit options and an option to load BIOS option default settings.

6.3.2.2 Navigation Keys

At the bottom-right corner of a menu screen are the navigation keys for that particular menu. Use the navigation keys to select items in the menu and change the settings.

6.3.2.3 Menu Items

Each menu option from the Menu Bar displays information, options, and sub-menus appropriate to the highlighted Menu Bar option. Use the up and down arrow keys to navigate to the displayed options and sub-menus. A scroll bar displays on the right side of a menu screen when there are items that do not fit on the screen.

Informational fields are colored in gray. These fields are for informational purposes only and cannot be changed.

Option Fields are colored in blue. Once highlighted, you can change the option to the preferred settings by typing in the change or pressing the <Enter Key> which may bring up a pop-up window, allowing you to select the preferred setting.



Figure 82. Pop-Up Window

Sub-menu fields are colored in blue and are identified by a solid blue triangle before each sub-menu field descriptor. Highlight the sub-menu you want to view and press the <Enter> key to display the sub-menu screen.

6.3.2.4 General Help

At the top right corner of the menu screen is a brief description of the selected item.

6.3.3 Main Menu

Upon entering the BIOS Setup Utility, the Main menu screen displays, providing options to view basic system information and view/configure any SATA devices detected.



Figure 83. Main Menu

6.3.3.1 System Time [xx/xx/xxxx]

This option displays and gives the option to change the system time.

6.3.3.2 System Date [Day xx/xx/xxxx]

This option displays and gives the option to change the system date.

6.3.3.3 SATA 1-4 Sub-Menus

These fields display devices that BIOS automatically detected as attached to the on-board SATA ports. A separate sub-menu is available to view/configure each detected device. Select a device item, and then press <Enter> to display the device information.



Figure 84. SATA1-4 Submenu

Fields displayed in gray are information that the BIOS has obtained directly from the device, and may include the following: Device Type, Vendor, Size, LBA Mode, Block

Mode, PIO Mode, Async DMA, Ultra DMA, and S.M.A.R.T. monitoring. These values are not user-configurable. If no device is detected on the selected SATA port, these fields display N/A.

6.3.3.3.1 LBA/Large Mode [Auto]

Enables or disables the LBA mode. Setting to [Auto] enables the LBA mode if the device supports this mode, and if the device was not previously formatted with LBA mode disabled.

Configuration options: [Disabled] [Auto]

6.3.3.3.2 Block (Multi-Sector Transfer) M [Auto]

Enables or disables data multi-sectors transfers. When set to [Auto], the data transfer from and to the device occurs multiple sectors at a time if the device supports multi-sector transfer feature. When set to [Disabled], the data transfer from and to the device occurs one sector at a time.

Configuration options: [Disabled] [Auto]

6.3.3.3.3 PIO Mode [Auto]

Allows you to select the data transfer mode.

Configuration options: [Auto] [0] [1] [2] [3] [4]

6.3.3.3.4 DMA Mode [Auto]

Sets the DMA mode. Configuration options: [Auto] [SWDMA0] [SWDMA1] [SWDMA2] [MWDMA0] [MWDMA1] [MWDMA2] [UDMA0] [UDMA1] [UDMA2] [UDMA3] [UDMA4] [UDMA5]

6.3.3.3.5 SMART Monitoring [Auto]

Sets the Smart Monitoring, Analysis, and Reporting Technology.

Configuration options: [Auto] [Disabled] [Enabled]

6.3.3.3.6 32Bit Data Transfer [Enabled]

Enables or disables 32-bit data transfer.

Configuration options: [Disabled] [Enabled]

6.3.3.4 IDE Configuration Sub-Menu

The items in this menu allow you to set or change the configurations for the IDE devices installed in the system. Select an item then press <Enter> if you want to configure the item.

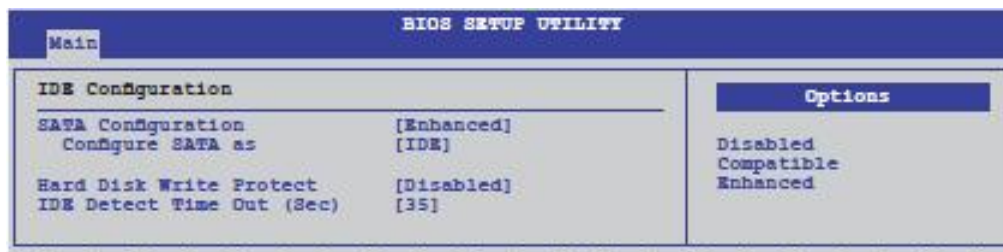

Figure 85. IDE Configuration Menu

6.3.3.4.1 SATA Configuration [Enhanced]

Configuration options: [Disabled] [Compatible] [Enhanced]

Configure SATA as [IDE]

Sets the configuration for the Serial ATA connectors supported by the Southbridge chip.
Configuration options: [IDE] [RAID] [AHCI]

TIPS

If you want to use the Serial ATA hard disk drives as Parallel ATA physical storage devices, keep the default setting [IDE].

If you want the Serial ATA hard disk drives to use the Advanced Host Controller Interface (AHCI), set this item to [AHCI]. The AHCI allows the onboard storage driver to enable advanced Serial ATA features that increases storage performance on random workloads by allowing the drive to internally optimize the order of commands.

If you want to use LSI*Software RAID or the Intel® Matrix Storage Technology configuration from the Serial ATA hard disk drives, set this item to [RAID].

6.3.3.4.2 Hard Disk Write Protect [Disabled]

Disables or enables device write protection. This is effective only if the device is accessed through the BIOS.

Configuration options: [Disabled] [Enabled]

6.3.3.4.3 IDE Detect Time Out (Sec) [35]

Selects the time out value for detecting ATA/ATAPI devices.

Configuration options: [0] [5] [10] [15] [20] [25] [30] [35]

6.3.3.5 AHCI Configuration Sub-Menu

This menu is the section for AHCI configuration.

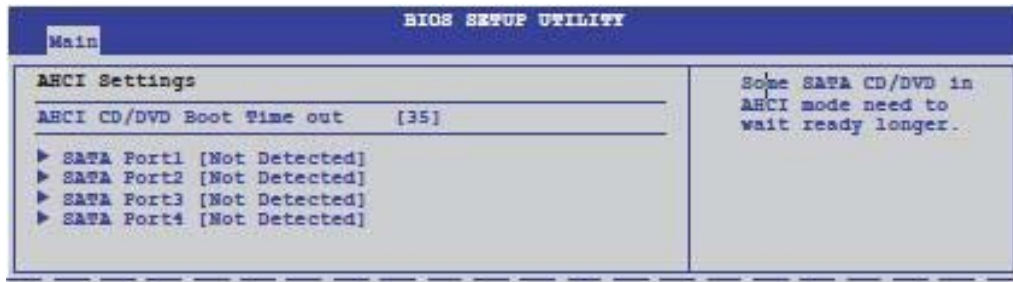

Figure 86. AHCI Configuration Menu

6.3.3.5.1 AHCI CD/DVD Boot Time out [35]

Selects the boot time out value for SATA CD/DVD devices in AHCI mode.

Configuration options: [0] [5] [10] [15] [20] [25] [30] [35]

6.3.3.5.2 SATA Port1-4 [XXXX]

Displays the status of auto-detection of SATA devices.

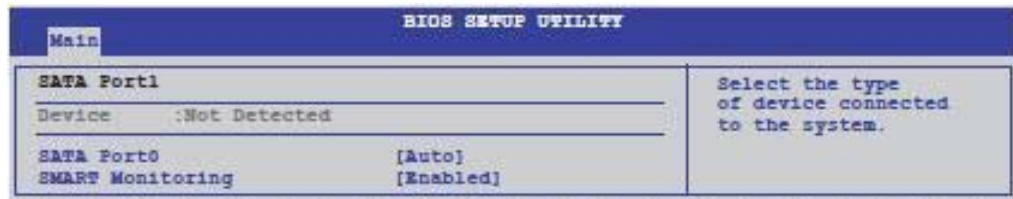

Figure 87. Status of Auto-Detection of SATA Devices Menu

6.3.3.5.3 SATA Port0 [Auto]

Allows you to select the type of device connected to the system.

Configuration options: [Auto] [Not Installed]

6.3.3.5.4 SMART Monitoring [Enabled]

Allows you to set the Self-Monitoring, Analysis and Reporting Technology.

Configuration options: [Disabled] [Enabled]

6.3.3.6 System Information Sub-Menu

This menu gives you an overview of the general system specifications. The BIOS automatically detects the items in this menu.



Figure 88. System Information Menu

6.3.3.6.1 AMIBIOS

Displays the auto-detected BIOS information.

6.3.3.6.2 Processor

Displays the auto-detected processor information.

6.3.3.6.3 System Memory

Displays the total system memory detected.

6.3.3.6.4 LAN# Address

Displays the MAC Address assigned to on-board LAN Ports 1 and 2

6.3.3.6.5 System Memory Information

Sub-Menu option that provides information for each detected DIMM attached to Processors 1 and 2. Information provided for each installed DIMM includes: Slot ID, size, rank, speed, and current operating temperature.

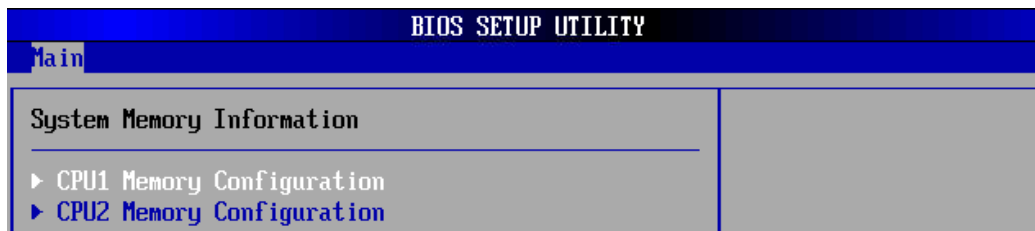

Figure 89. System Memory Information Menu

6.3.4 Advanced Menu

The Advanced menu items are used to view/change server sub-system options.



CAUTION

Intel strongly suggests having only qualified persons with in-depth knowledge of processor and chipset features make changes to the options available in the Advanced Menu. Incorrectly setting many of the options available within these sub-menus can negatively impact the operation of the server.

Intel recommends using default settings whenever possible.

If the system operate in an undesired manner after making BIOS setting changes, you should restore default settings by either selecting the “Load Setup Defaults” option in the Exit Menu, or pressing the <F9> key anytime while in the BIOS Setup Utility.



Figure 90. Advanced Menu

6.3.4.1 CPU Configuration Sub-Menu

The items in this menu display the CPU-related information that the BIOS automatically detects. Some items may not display if your CPU does not support the related functions.

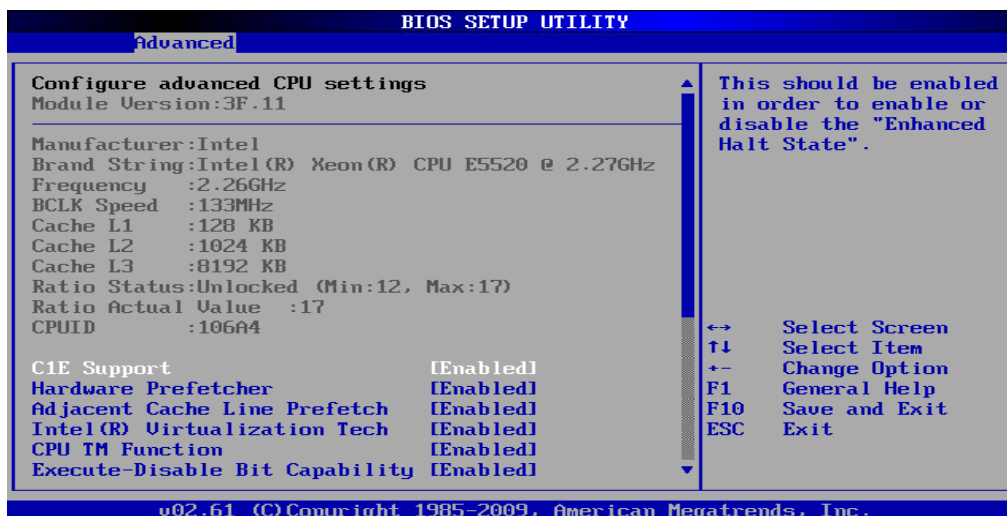

Figure 91. CPU Configuration Menu

Scroll down for more items.

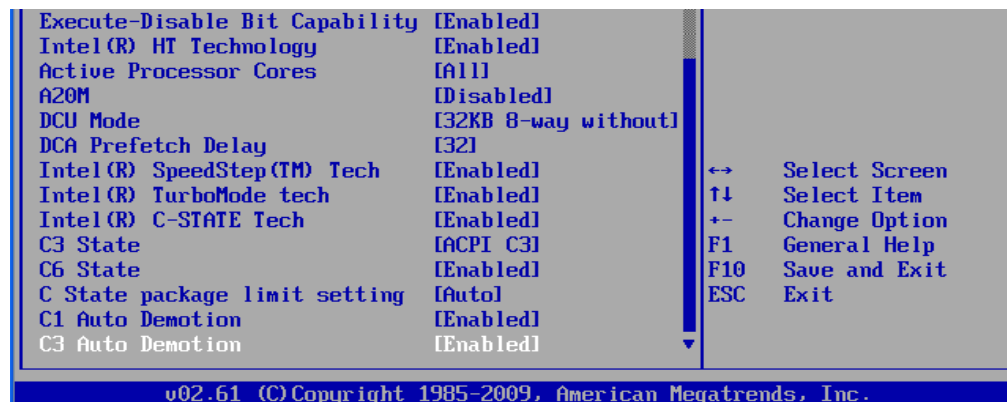

Figure 92. CPU Configuration Menu, Continued

6.3.4.1.1 C1E Support [Enabled]

Allows you to enable or disable Enhanced Halt State support.

Configuration options: [Disabled] [Enabled]

6.3.4.1.2 Hardware Prefetcher [Enabled]

Allows you to enable or disable the Hardware Prefetcher function.

Configuration options: [Disabled] [Enabled]

6.3.4.1.3 Adjacent Cache Line Prefetch [Enabled]

Allows you to enable or disable the Adjacent Cache Line Prefetch function.

Configuration options: [Disabled] [Enabled]

6.3.4.1.4 Intel® Virtualization Tech [Enabled]

The Intel® Virtualization Technology allows a hardware platform to run multiple operating systems separately and simultaneously, enabling one system to virtually function as several systems.

Configuration options: [Disabled] [Enabled]

6.3.4.1.5 CPU TM Function [Enabled]

This function enables the overheated CPU to throttle the clock speed to cool down.

Configuration options: [Disabled] [Enabled]

6.3.4.1.6 Execute-Disable Bit Capability [Enabled]

Allows you to enable or disable the No-Execution Page Protection Technology. Setting this item to [Disabled] forces the XD feature flag to always return to zero (0).

Configuration options: [Disabled] [Enabled]

6.3.4.1.7 Intel® HT Technology [Enabled]

Allows you to enable or disable the Intel® Hyper-Threading Technology function. When disabled, only one thread per activated core is enabled.

Configuration options: [Enabled] [Disabled]

6.3.4.1.8 Active Processor Cores [All]

Allows you to select the number of CPU cores to activate in each processor package.

Configuration options: [All] [1] [2]

6.3.4.1.9 A20M [Disabled]

Legacy operating systems and APs may need A20M enabled.

Configuration options: [Disabled] [Enabled]

6.3.4.1.10 DCU Mode [32KB 8-way without]

Allows you to select the mode for the Data Cache.

Configuration options: [32KB 8-way without ECC] [16KB 4-way with ECC]

6.3.4.1.11 DCA Prefetch Delay [32]

Allows you to select the time delay in bus clocks from snoop to prefetch.

Configuration options: [8] [16] [24] [32] [40]—[104] [112] [120]

6.3.4.1.12 Intel® SpeedStep (TM) Tech [Enabled]

When set to [Disabled], the CPU runs at its default speed. When set to [Enabled], the CPU speed is controlled by the operating system.

Configuration options: [Disabled] [Enabled]

6.3.4.1.13 Intel TurboMode Tech [Enabled]

When enabled, Turbo Mode allows processor cores to run faster than its marked frequency in certain conditions.

Configuration options: [Disabled] [Enabled]

6.3.4.1.14 Intel® C-STATE Tech [Enabled]

The Intel® C-State Technology allows the CPU to save more power under idle mode. Enable this item only when you install a C-State Technology-supported CPU.

Configuration options: [Disabled] [Enabled]

6.3.4.1.15 C3 State [ACPI C3]

Allows you to select the CPU action under C3 state.

Configuration options: [Disabled] [ACPI C2] [ACPI C3]

6.3.4.1.16 C6 State [Enabled]

Allows you to select the CPU action under C6 state.

Configuration options: [Disabled] [Enabled]

6.3.4.1.17 C State package limit setting [Auto]

This item displays only when you set the Intel(R) C-STATE Tech item to [Enabled]. We recommend that you set this item to [Auto] for BIOS to automatically detect the C-State mode supported by your CPU.

Configuration options: [Auto] [C1] [C3] [C6] [C7]

6.3.4.1.18 C1 Auto Demotion [Enabled]

When enabled, the processor conditionally demotes C3/C6/C7 requests to C1 based on on-core auto-demote information.

Configuration options: [Disabled] [Enabled]

6.3.4.1.19 C3 Auto Demotion [Enabled]

When enabled, the processor conditionally demotes C6/C7 requests to C3 based on on-core auto-demote information.

Configuration options: [Disabled] [Enabled]

6.3.4.2 Chipset Configuration Sub-Menu

The Chipset configuration menu allows you to change advanced chipset settings. Select an item then press <Enter> to display the sub-menu.

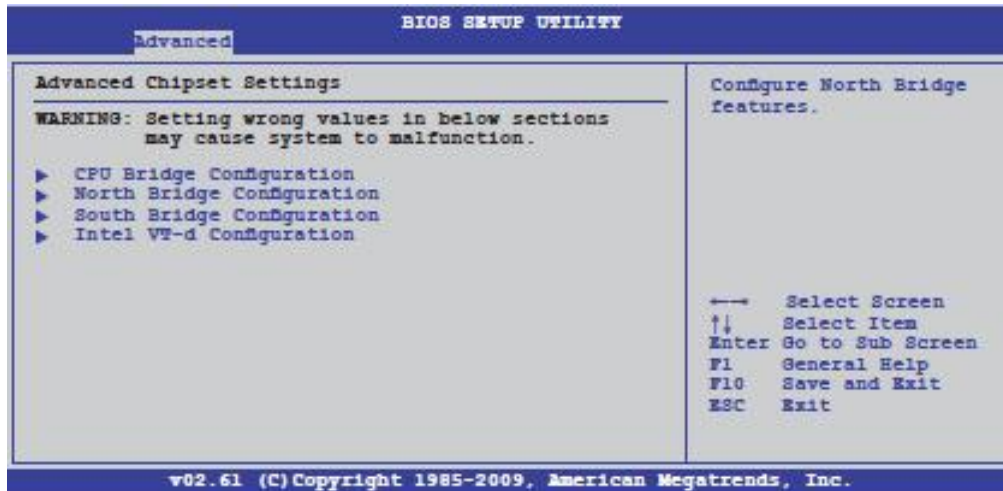

Figure 93. Chipset Configuration Menu

6.3.4.3 CPU Bridge Chipset Configuration Sub-Menu

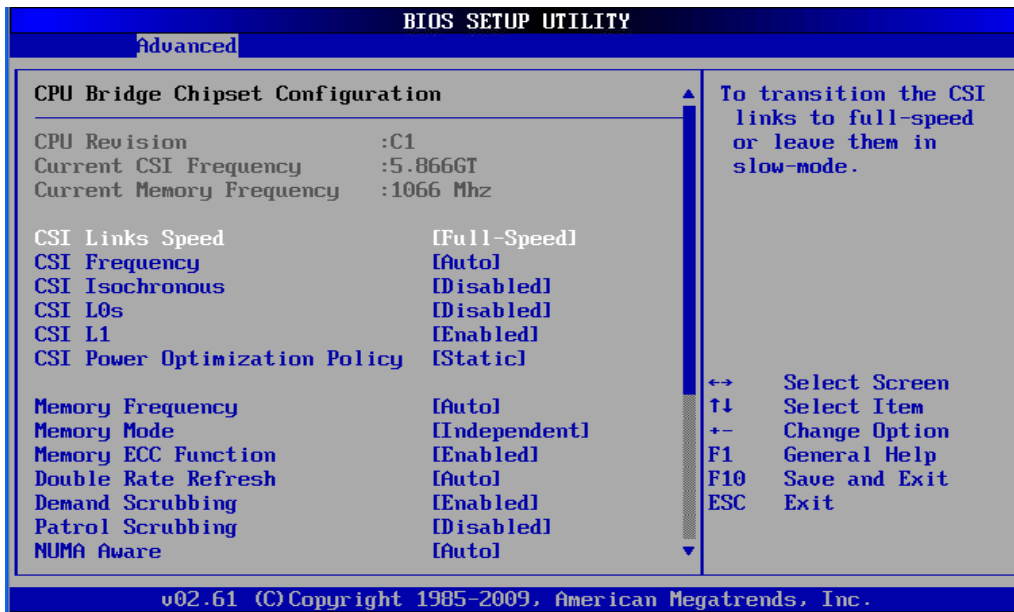

Figure 94. CPU Bridge Chipset Configuration Menu

Scroll down for more items.



Figure 95. CPU Bridge Chipset Configuration Menu, Continued

6.3.4.3.1 CSI Links Speed [Full-Speed]

Allows you to set the speed of CSI Links.

Configuration options: [Slow-Mode] [Full-Speed]

6.3.4.3.2 CSI Frequency [Auto]

Allows you to set the CSI frequency.

Configuration options: [Auto] [4.800GT] [5.866GT] [6.400GT]

6.3.4.3.3 CSI Isochronous [Disabled]

Configuration options: [Disabled] [Enabled]

6.3.4.3.4 CSI L0s [Disabled]

Configuration options: [Disabled] [Enabled]

6.3.4.3.5 CSI L1 [Enabled]

Configuration options: [Disabled] [Enabled]

6.3.4.3.6 CSI Power Optimization Policy [Static]

Configuration Options: [Adaptive] [Static] [Bypass]

6.3.4.3.7 Memory Frequency [Auto]

You may allow the system to detect DDR3 memory frequency via SPD or designate a specific frequency.

Configuration options: [Auto] [Force DDR-800] [Force DDR-1066] [Force DDR-1333]

6.3.4.3.8 Memory Mode [Independent]

Allows you to set Memory channel mode.

Configuration options: [Independent] [Channel Mirroring] [Lockstep] [Sparing]

6.3.4.3.9 Memory ECC Function [Enabled]

Allows you to enable or disable Memory ECC function.

Configuration options: [Disabled] [Enabled]

6.3.4.3.10 Double Rate Refresh [Auto]

Configuration options: [Disabled] [Auto]

6.3.4.3.11 Demand Scrubbing [Enabled]

Enables or disables the ECC demand scrub.

Configuration options: [Disabled] [Enabled]

6.3.4.3.12 Patrol Scrubbing [Disabled]

Enables or disables the ECC patrol scrub.

Configuration options: [Disabled] [Enabled]

6.3.4.3.13 NUMA Aware [Auto]

Configuration options: [Disabled] [Enabled]

6.3.4.3.14 Page Policy [Closed]

Configuration options: [Closed] [Open]

6.3.4.3.15 Adaptive Page [Disabled]

Configuration options: [Disabled] [Enabled]

6.3.4.3.16 Data Scramble [Enabled]

Configuration options: [Disabled] [Enabled]

6.3.4.3.17 Split Below 4 GB [Disabled]

Configuration options: [Disabled] [Auto]

6.3.4.3.18 Channel Interleaving [6:1]

Allows you to set the channel interleaving setting.

Configuration options: [1:1] [2:1] [4:1] [6:1]

6.3.4.3.19 Rank Interleaving [4:1]

Allows you to set the rank interleaving setting.

Configuration options: [1:1] [2:1] [4:1]

6.3.4.3.20 Memory Thermal Throttling [Auto]

Allows you to select the mode the system uses to determine when to throttle system memory.

Configuration options: [CLTT] [OLTT] [Disabled] [Auto]

Selecting CLTT forces the BIOS to enable CLTT throttling mode

Selecting OLTT forces the BIOS to enable OLTT throttling mode

Selecting Disabled configures the BIOS not to implement memory throttling on the system.

Selecting Auto allows the BIOS to determine which memory throttling mechanism to support. If BIOS detects that the installed DIMMs have the necessary thermal sensors, then CLTT will be enabled. If BIOS detects that the installed DIMMs have faulty or missing thermal sensors, then OLTT will be enabled.

When the Memory Thermal Throttling option is set to any setting except [Disabled], the following additional options displays on the screen:

NOTE: You should not change the following memory throttling settings from their defaults unless extensive performance benchmarking tests were conducted validating the changes. Making uninformed changes can negatively affect system performance.

6.3.4.3.21 Inlet Temperature [28]

Configuration options: [25] [28] [30] [35]

6.3.4.3.22 Temperature Rise to DIMM [10]

Configuration options: [0] [5] [10] [15]

6.3.4.3.23 Air Flow Velocity (M/s) [2]

Configuration options: [0.5] [1] [1.5] [2] [2.5] [3] [3.5] [4]

6.3.4.3.24 System Altitude (M) [Above 1500]

Configuration options: [Below 300] [301-900] [901-1500] [Above 1500]

6.3.4.4 North Bridge Chipset Configuration Sub-Menu

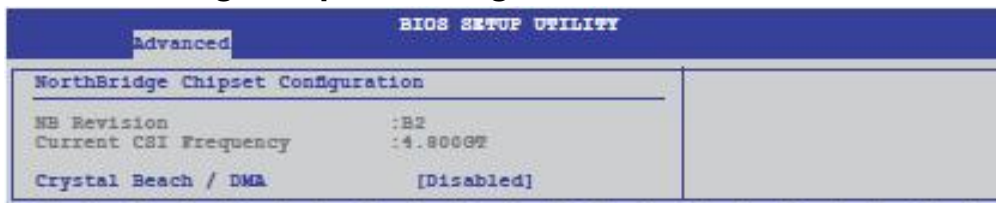

Figure 96. North Bridge Chipset Configuration Menu

6.3.4.4.1 Crystal Beach/DMA [Disabled]

Configuration options: [Disabled] [Auto]

6.3.4.5 South Bridge Chipset Configuration Sub-Menu

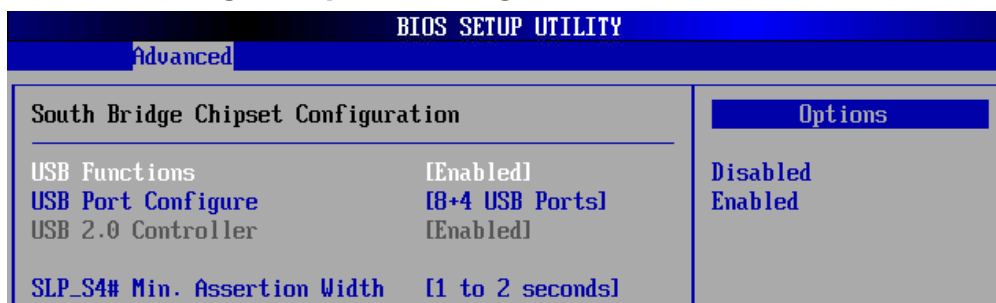

Figure 97. South Bridge Chipset Configuration Menu

6.3.4.5.1 USB Functions [Enabled]

Allows you to configure the amount of USB ports to be enabled.

Configuration options: [Disabled] [Enabled]

6.3.4.5.2 USB Port Configure [8+4 USB Ports]

This item disappears when you set the **USB Functions** item to [Disabled].

Configuration options: [6+6 USB Ports] [8+4 USB Ports]

6.3.4.5.3 USB 2.0 Controller [Enabled]

Allows you to enable or disable the USB 2.0 controller. This item becomes unconfigurable if you set the **USB Functions** item to [10 USB Ports] or [12 USB Ports].

Configuration options: [Enabled] [Disabled]

6.3.4.5.4 SLP_S4# Min. Assertion Width [1 to 2 seconds]

Configuration options: [4 to 5 seconds] [3 to 4 seconds] [2 to 3 seconds] [1 to 2 seconds]

6.3.4.6 Intel VT-d Configuration Sub-Menu

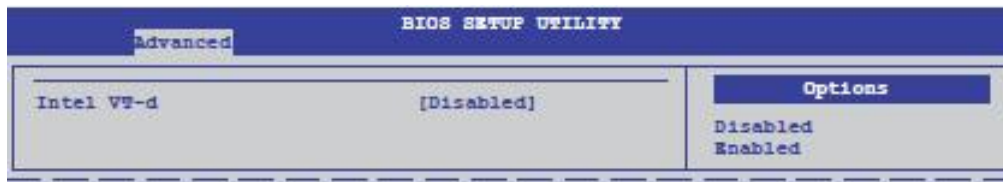

Figure 98. Intel VT-d Configuration Menu

6.3.4.6.1 Intel VT-d [Disabled]

Allows you to enable or disable the Intel® Virtualization Technology for Directed I/O.

Configuration options: [Disabled] [Enabled]

6.3.4.7 Legacy Device Configuration Sub-Menu

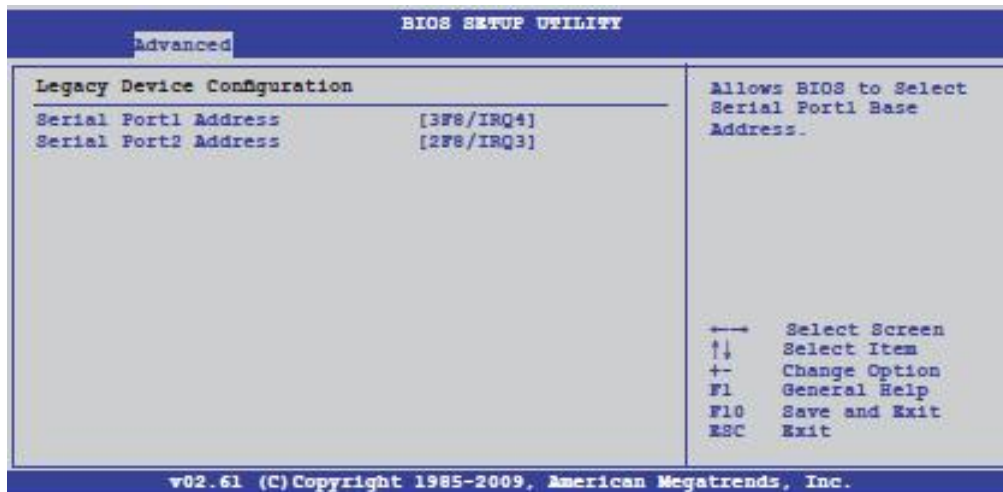

Figure 99. Legacy Device Configuration Menu

6.3.4.7.1 Serial Port1 Address [3F8/IRQ4]

Allows you to select the Serial Port1 base address.

Configuration options: [Disabled] [3F8/IRQ4] [3E8/IRQ4] [2E8/IRQ3]

6.3.4.7.2 Serial Port2 Address [2F8/IRQ3]

Allows you to select the Serial Port2 base address.

Configuration options: [Disabled] [2F8/IRQ3] [3E8/IRQ4] [2E8/IRQ3]

6.3.4.8 USB Configuration Sub-Menu



Figure 100. USB Configuration Menu

TIP

The following item appears only when you set USB Function to [Enabled].

6.3.4.8.1 Legacy USB Support [Enabled]

Allows you to enable or disable support for legacy USB devices. Setting to [Auto] allows the system to detect the presence of USB devices at startup. If detected, the USB controller legacy mode is enabled. If no USB device is detected, the legacy USB support is disabled.

Configuration options: [Disabled] [Enabled] [Auto]

TIP

The following item displays only when you set USB Function to [Enabled].

6.3.4.8.2 USB 2.0 Controller Mode [HiSpeed]

Allows you to set the USB 2.0 controller to HiSpeed (480 Mbps) or FullSpeed (12 Mbps). Configuration options: [FullSpeed] [HiSpeed]

6.3.4.8.3 BIOS EHCI Hand-Off [Enabled]

Enables or disables the BIOS EHCI hand-off support.

Configuration options: [Disabled] [Enabled]

6.3.4.9 PCIPnP Configuration Sub-Menu

The PCIPnP Configuration menu items allow you to change the advanced settings for PCI/PnP devices.



CAUTION

Take caution when changing the settings of the PCI/PnP Configuration menu items. Incorrect field values can cause the system to malfunction.

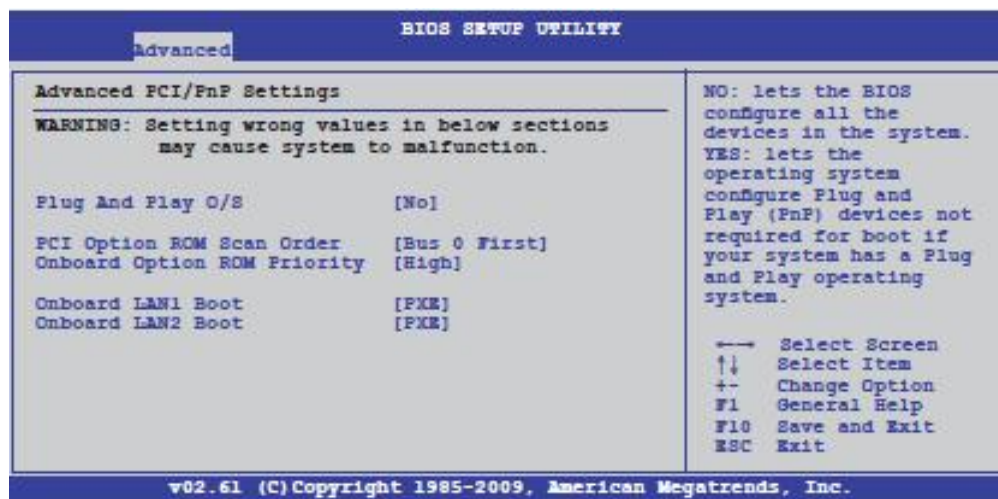

Figure 101. PCIPnP Configuration Menu

6.3.4.9.1 Plug And Play O/S [No]

When set to [No], BIOS configures all the devices in the system. When set to [Yes] and if you install a Plug and Play operating system, the operating system configures the Plug and Play devices not required for boot.

Configuration options: [No] [Yes]

6.3.4.9.2 PCI Option ROM Scan Order [Bus 0 First]

Allows you to select the PCI option ROM scanning order. The scanning of the option ROM starts from the lowest bus, device, and function number if you set this item to [Bus 0 First]; the scanning starts from the highest bus, device, and function number if you set this item to [Bus N First].

Configuration options: [Bus 0 First] [Bus N First]

6.3.4.9.3 Onboard Option ROM Priority [High]

Allows you to select the onboard option ROM priority. Configuration options: [Normal] [High]

6.3.4.9.4 Onboard LAN1/2 Boot [PXE]

Allows you to configure the boot mode for onboard LAN ports 1 and 2.

Configuration: [Disabled] [PXE] [iSCSI]

6.3.4.10 Power On Configuration Sub-Menu

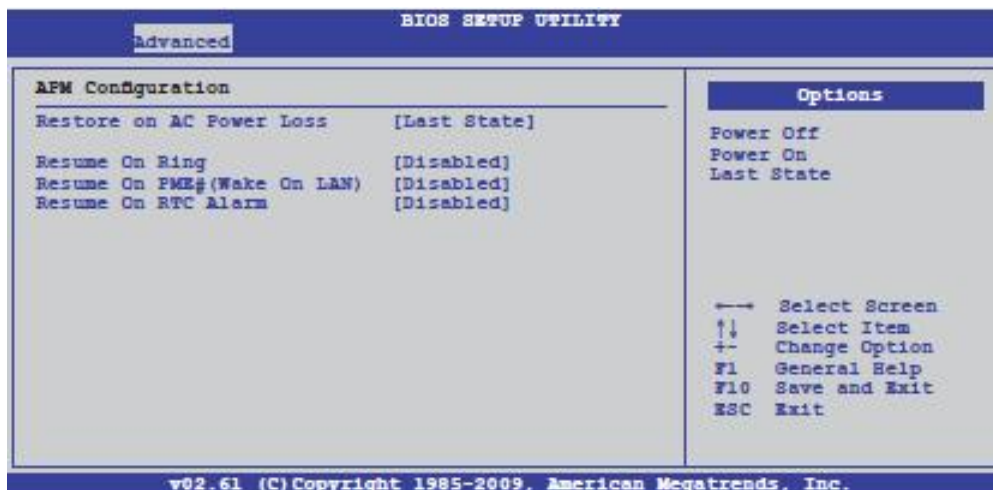

Figure 102. Power On Configuration Menu

6.3.4.10.1 Restore on AC Power Loss [Last State]

When set to [Power Off], the system goes into off state after an AC power loss. When set to [Power On], the system will reboot after an AC power loss. When set to [Last State], the system goes into either off or on state, whatever the system state was before the AC power loss.

Configuration options: [Power Off] [Power On] [Last State]

6.3.4.10.2 Resume On Ring [Disabled]

When set to [Enabled], the system enables RI to generate a wake event while the computer is in Soft-off mode.

Configuration options: [Disabled] [Enabled]

6.3.4.10.3 Resume On PME# (Wake On LAN) [Disabled]

When set to [Enabled], the system enables PME to generate a wake event while the computer is in Soft-off mode.

Configuration options: [Disabled] [Enabled]

6.3.4.10.4 Resume On RTC Alarm [Disabled]

Allows you to enable or disable RTC to generate a wake-up event.

Configuration options: [Disabled] [Enabled]

NOTE: The following items appear only when the Resume On RTC Alarm item is set to [Enabled].

6.3.4.10.5 RTC Alarm Date [15]

To set the alarm date, highlight this item and press the <+> or <-> key to make the selection.

6.3.4.10.6 System Time [12:30:30]

Use the <ENTER>, <TAB> or <SHIFT-TAB> key to select a field. Use the <+> or <-> key to configure alarm time.

6.3.4.11 Event Log Configuration Sub-Menu

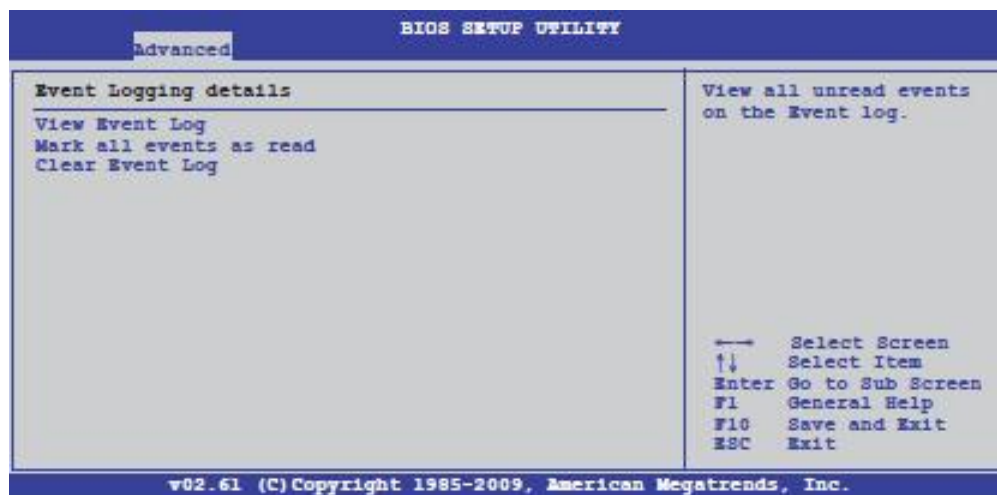

Figure 103. Event Log Configuration Menu

6.3.4.11.1 View Event Log

Press the <ENTER> key to view unread system event log.

6.3.4.11.2 Make all events as read

Press the <ENTER> key to mark all events as read. Select [Ok] to confirm the change.

6.3.4.11.3 Clear Event Log

Press the <ENTER> key to clear all system events. Select [Ok] to confirm the change.

6.3.4.12 Hardware Monitor Sub-Menu



Figure 104. Hardware Monitor Configuration Menu

Scroll down for more items.

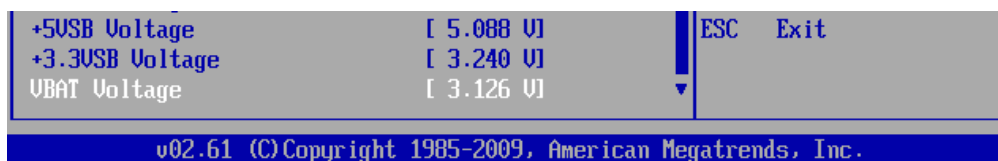

Figure 105. Hardware Monitor Configuration Menu, Continued

6.3.4.12.1 CPU1/2 Temperature [xxx°C/xxx°F]

The onboard hardware monitor automatically detects and displays the processor temperatures. Select [Ignored] if you do not want to display the detected temperatures.

6.3.4.12.2 System Fan1–4 Speed [xxxxRPM] or [Ignored]/[N/A]

The onboard hardware monitor automatically detects and displays the speed of pll system fans in rotations per minute (RPM). If the fan is not connected to the server board, the field shows [N/A].

6.3.4.12.3 Fan Speed Control

This option allows you to select whether or not the system fan speeds are monitored and controlled by the BMC or not.

Configuration options: [Full Speed Mode] [High Density Mode]

6.3.4.12.4 VCORE1/2 Voltage, +1.5V_P1/2DDR3 Voltage, +1.5V_ICH Voltage, P1/2VTT Voltage, +1.1V_IOH Voltage, +12V Voltage, +5V Voltage, +3.3V Voltage, +5VSB Voltage, +3VSB Voltage, VBAT Voltage

The onboard hardware monitor automatically detects the voltage output through the onboard voltage regulators. Select [Ignored] if you do not want to detect this item.

6.3.4.13 I/O Virtualization Sub-Menu

6.3.4.13.1 SR-IOV Supported [Disabled]

Configuration options: [Enable] [Disabled]

6.3.4.14 PCI Express* Configuration Sub-Menu



Figure 106. PCI Express* Configuration Menu

6.3.4.14.1 Active State Power-Management [Disabled]

Enables or disables the PCI Express* L0s and L1 link power states.

Configuration options: [Disabled] [Enabled]

6.3.4.15 ACPI Configuration Sub-Menu



Figure 107. ACPI Configuration Menu

6.3.4.15.1 Advanced ACPI Configuration Sub-Menu

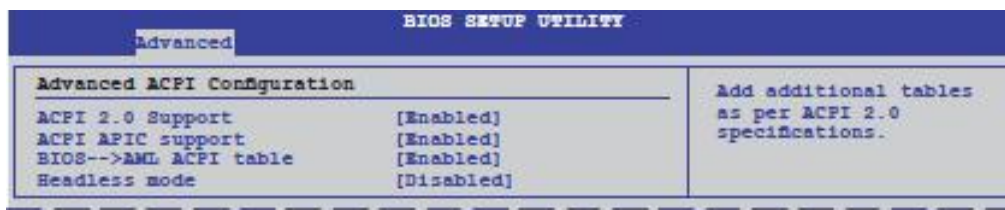

Figure 108. Advanced ACPI Configuration Menu

6.3.4.15.2 ACPI 2.0 Support [Enabled]

Specifies the Advanced Configuration and Power Interface (ACPI) version supported.
Configuration options: [Disabled] [Enabled]

6.3.4.15.3 ACPI APIC Support [Enabled]

Allows you to enable or disable the Advanced Configuration and Power Interface (ACPI) support in the Advanced Programmable Interrupt Controller (APIC). When set to Enabled, the ACPI APIC table pointer is included in the RSDT pointer list.

Configuration options: [Disabled] [Enabled]

6.3.4.15.4 BIOS-->AML ACPI table [Enabled]

Allows you to include the BIOS-->AML exchange table pointer to (X)RSDT pointer list.

Configuration options: [Disabled] [Enabled]

6.3.4.15.5 Headless mode [Disabled]

Allows you to enable or disable the Headless operation mode through ACPI.

Configuration options: [Disabled] [Enabled]

6.3.4.15.6 Chipset ACPI Configuration Sub-Menu

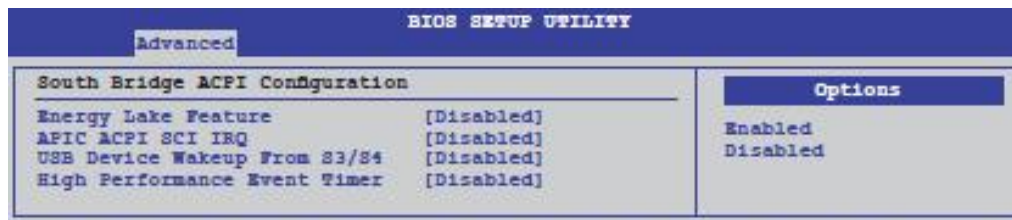

Figure 109. Chipset ACPI Configuration Menu

6.3.4.15.7 Energy Lake Feature [Disabled]

Allows you to enable or disable the Energy Lake feature.

Configuration options: [Enabled] [Disabled]

6.3.4.15.8 APIC ACPI SCI IRQ [Disabled]

Allows you to enable or disable the APIC ACPI SCI IRQ feature.

Configuration options: [Disabled] [Enabled]

6.3.4.15.9 High Performance Event Timer [Enabled]

Allows you to enable or disable the High Performance Event Timer feature.

Configuration options: [Disabled] [Enabled]

6.3.4.15.10 HPET Memory Address [FED00000h]

Configuration options: [FED00000h] [FED01000h] [FED002000h] [FED03000h]

6.3.4.16 General WHEA Configuration Sub-Menu

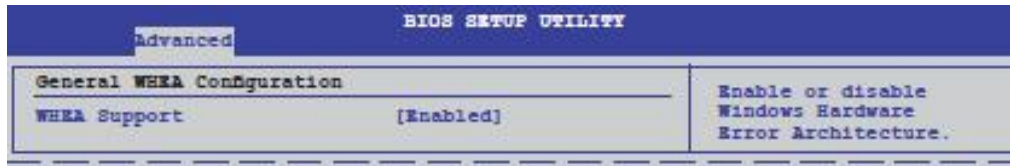

Figure 110. General WHEA Configuration Menu

6.3.4.16.1 WHEA Support [Enabled]

Allows you to enable or disable the Windows* Hardware Error Architecture (WHEA) support.

Configuration options: [Disabled] [Enabled]

6.3.5 Server Menu

Options in the Server Menu allow you to configure IPMI and Remote Connectivity options.



Figure 111. Server Menu

6.3.5.1 IPMI Configuration Sub-Menu

Information and Options found under this menu selection are only available with the BMC Management Module installed in the system.

6.3.5.1.1 BMC Firmware Version: #.##

Displays the BMC Firmware version of the BMC Management Module.

6.3.5.1.2 Set LAN# Configuration

Two sub-menus used to configure on-board LAN Port 1 and the Server Management LAN Port (LAN Port 3) for Serial-over-LAN support. Configurable LAN parameters in both these sub-menus include:

IP Address Source [DHCP Mode/Static Mode]

IP Address [000.000.000.000]

Subnet Mask [000.000.000.000]

Gateway Address [000.000.000.000]

6.3.5.1.3 View BMC System Event Log

Selecting this option opens a System Event Log window that displays system events generated by the BMC for board/system sensor threshold violations.

6.3.5.1.4 Clear BMC System Event Log

Selecting this option clears the BMC System Event Log of all entries.

6.3.5.1.5 BMC Watch Dog Timer Action [DISABLED]

Selecting this option allows the BMC to reset or power down the system if the operating system crashes or hangs. Available settings are Enable or Disabled.

6.3.5.2 Remote Access Configuration Sub-Menu

The items in this menu allow you to configure Remote Access features. Select an item and then press <Enter> to display the configuration options.

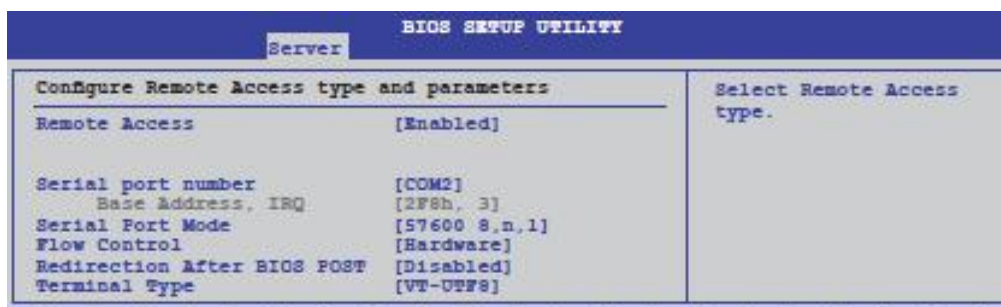

Figure 112. Remote Access Configuration Menu

6.3.5.2.1 Remote Access [Enabled]

Enables or disables the remote access feature.

Configuration options: [Disabled] [Enabled]

NOTE: The following items display only when Remote Access is set to [Enabled].

6.3.5.2.2 Serial port number [COM2]

Selects the serial port for console redirection.

Configuration options: [COM1] [COM2]

6.3.5.2.3 Base Address. IRQ [2F8h, 3]

This item is not user-configurable and changes with the configuration of Serial port number.

6.3.5.2.4 Serial port Mode [57600 8,n,1]

Sets the Serial port mode.

Configuration options: [115200 8,n,1] [57600 8,n,1] [38400 8,n,1] [19200 8,n,1] [09600 8,n,1]

6.3.5.2.5 Flow Control [Hardware]

Allows you to select the flow control for console redirection.

Configuration options: [None] [Hardware] [Software]

6.3.5.2.6 Redirection After BIOS POST [Disabled]

Sets the redirection mode after the BIOS Power-On Self-Test (POST). Some operating system may not work when set to [Always].

Configuration options: [Disabled] [Boot Loader] [Always]

6.3.5.2.7 Terminal Type [VT-UTF8]

Allows you to select the target terminal type.

Configuration options: [ANSI] [VT100] [VT-UTF8]

6.3.5.2.8 VT-UTF8 Combo Key Support [Enabled]

This item appears only when you set the Terminal Type item to [ANSI] or [VT100] and allows you to enable or disable the VT-UTF8 combo key support for ANSI or VT100 terminals.

Configuration options: [Disabled] [Enabled]

6.3.6 Boot Menu

The Boot menu items allow you to change the system boot options. Select an item and then press <Enter> to display the sub-menu.

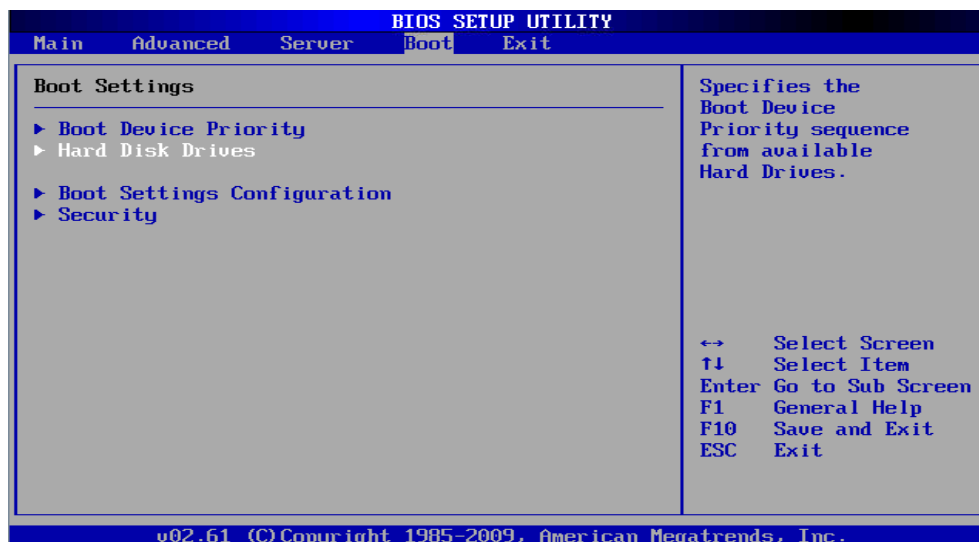

Figure 113. Boot Menu

6.3.6.1 Boot Device Priority

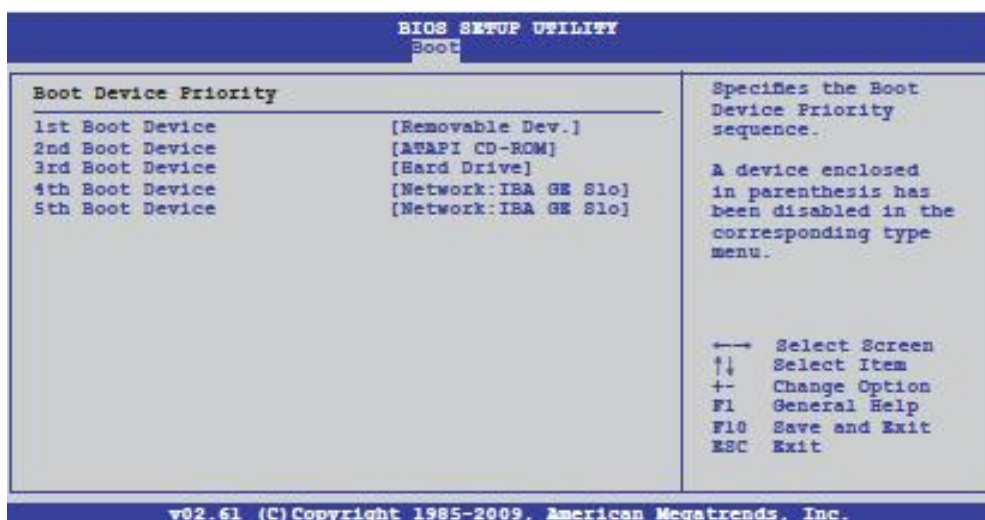

Figure 114. Boot Device Priority Menu

6.3.6.1.1 1st ~ xxth Boot Device [XXXXXXX]

These items specify the boot device priority sequence from the available devices. The number of device items that appears on the screen depends on the number of devices installed in the system. Configuration options: [xxxxx Drive] [Disabled]

6.3.6.2 Hard Disk Drives

Selecting this sub-menu allows you to set the priority for all detected hard drives. The hard drive set as the “1st Drive” will be listed in the Boot Device Priority List.

6.3.6.3 Boot Settings Configuration

Options in this sub-menu allow you to configure how the system should operate during the system boot process.



Figure 115. Boot Settings Configuration Menu

6.3.6.3.1 Quick Boot [Enabled]

Enabling this item allows the BIOS to skip some power-on self tests while booting, to decrease the time needed to boot the system. When set to [Disabled], BIOS performs all the POST items.

Configuration options: [Disabled] [Enabled]

6.3.6.3.2 Full Screen Logo [ENABLED]

When enabled, this option displays the full Logo Splash Screen during the boot process.

Configuration options: [Disabled] [Enabled]

6.3.6.3.3 AddOn ROM Display Mode [Force BIOS]

Allows you to set the display mode for Options ROM.

Configuration options: [Force BIOS] [Keep Current]

6.3.6.3.4 Bootup Num-Lock [On]

Allows you to select the power-on state for the NumLock key.

Configuration options: [Off] [On]

6.3.6.3.5 Wait For 'F1' If Error [Enabled]

When set to [Enabled], the system waits for the <F1> key to be pressed when a POST error occurs.

Configuration options: [Disabled] [Enabled]

6.3.6.3.6 Hit 'F2' Message Display [Enabled]

When set to [Enabled], the system displays the message "Press F2 to run Setup" during POST.

Configuration options: [Disabled] [Enabled]

6.3.6.3.7 Interrupt 19 Capture [Enabled]

When set to [Enabled], this function allows the option ROMs to trap Interrupt 19.

Configuration options: [Disabled] [Enabled]

6.3.6.4 Security

The Security menu items allow you to change the system security settings. Select an item then press <Enter> to display the configuration options.

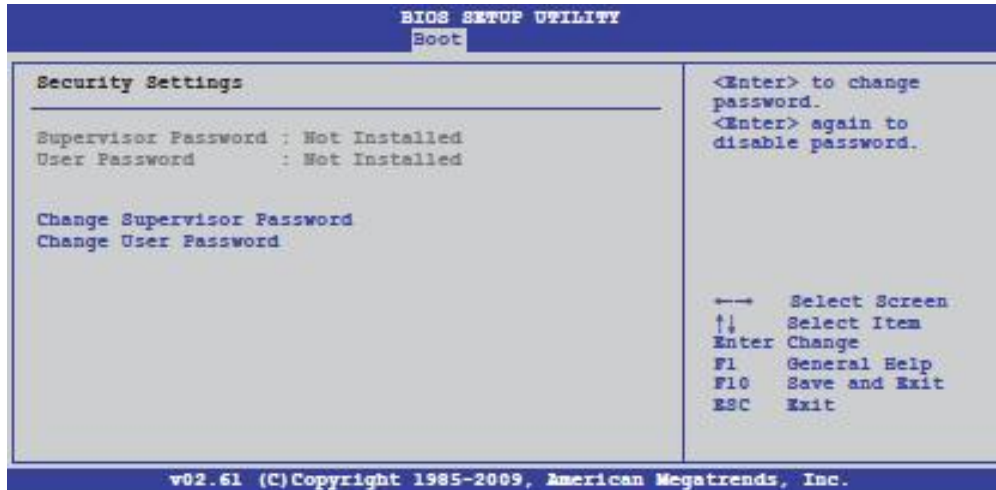

Figure 116. Security Settings Menu

Grayed out at the top of the screen are the current settings for the Supervisor and User passwords. These informational fields will show passwords for the Supervisor and User as **Installed** or **Not Installed**.

6.3.6.4.1 Change Supervisor Password

To set or change the Supervisor password:

1. Select the Change Supervisor Password option and press <Enter>.
2. In the pop-up window, type a password that consists of no more than six letters and/or numbers, then press <Enter>.
3. When prompted, confirm the password.

The message "Password Installed" displays after you successfully set your password.

To change the Supervisor password, repeat steps 1 through 3.

To clear the supervisor password:

1. Select the Change Supervisor Password option and press <Enter>.
2. In the pop-up window, hit the <Enter> key
3. The message "Password Uninstalled" displays.

NOTE: If you forget your BIOS password, you can clear it by erasing the CMOS Real-Time Clock (RTC) RAM. For information on how to erase the RTC RAM, refer to the “Configuration and Support Jumpers” section.

Once a Supervisor password is set, other system security options will display on the screen.

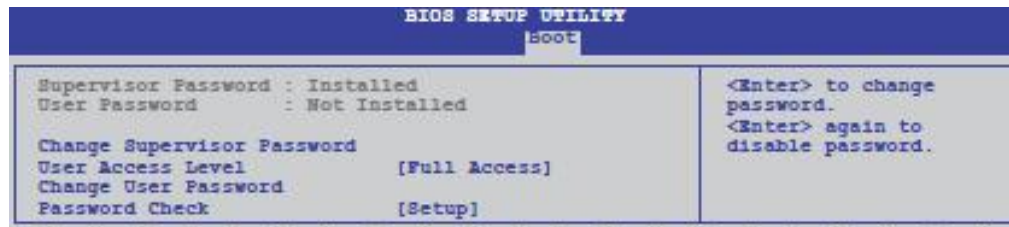

Figure 117. Security Menu After Supervisor Password is Set

6.3.6.4.2 User Access Level [Full Access]

This item allows you to set User access restrictions to the BIOS Setup Utility. Configuration options: [No Access] [View Only] [Limited] [Full Access]

No Access prevents user access to the Setup utility.

View Only allows access but does not allow changes to any field.

Limited allows changes only to selected fields, such as Date and Time.

Full Access allows viewing and changing all the fields in the Setup utility.

6.3.6.4.3 Change User Password

To set a User password:

1. Select the Change User Password option and press <Enter>.
2. In the pop-up window, type a password that consists of no more than six letters and/or numbers, then press <Enter>.
3. When prompted, confirm the password.

The message “Password Installed” displays after you set your password successfully.

To change the User password, repeat steps 1 through 3.

To clear a User password:

1. Select the Change User Password option and press <Enter>.
2. In the pop-up window, press the <Enter> key
3. The message “Password Uninstalled” displays.

6.3.6.4.4 Password Check [Setup]

When set to [Setup], BIOS checks for the User password when accessing the BIOS Setup utility. When set to [Always], BIOS checks for the User password both when accessing Setup and booting the system.

Configuration options: [Setup] [Always]

6.3.7 Exit Menu

Options in the Exit menu allow you to Save or Discard current changes made to the BIOS settings. Another option restores all BIOS setting defaults.



Figure 118. Exit Menu

6.3.7.1 Exit & Save Changes

Once you finish making BIOS changes, select this option to ensure the settings are saved to the CMOS RAM. When you select this option, a confirmation window displays. Select YES to save changes and Exit. The system will automatically reboot.

6.3.7.2 Exit & Discard Changes

Select this option only if you do not want to save the BIOS changes made. If you made changes to fields other than System Date, System Time, and Password, the BIOS asks for a confirmation before exiting.

6.3.7.3 Discard Changes

This option allows you to discard the selections you made and restore the previously saved values. After selecting this option, a confirmation displays. Select YES to discard any changes and load the previously saved values.

6.3.7.4 Load Setup Defaults

This option allows you to load the default values for each of the parameters on the Setup menus. When you select this option, a confirmation window displays. Select YES to load default values. Select Exit & Save Changes or make other changes before saving the values to the non-volatile RAM.

NOTE: Pressing the <F9> anytime while in the BIOS Setup Utility will also reset all BIOS setting defaults.

7. Embedded SATA RAID

This section provides an overview of the SATA Software RAID options embedded on the server board. It describes how to enable the RAID feature and configure RAID sets using either of the two SW RAID Configuration Utilities. For more in-depth RAID information including definitions, setup, and support, refer to the respective SATA SW RAID Users Guides included on the System Resource CD, or download them from the following Intel website:

<http://support.intel.com/support/motherboards/server/SR1670HV/>

7.1 Selecting a RAID option

Embedded on the server board are options to support either of two SATA Software RAID options:

LSI* SATA Software RAID (default) with support for RAID levels 0, 1, and 10 with drivers to support both Linux* and Microsoft Windows* operating systems.

Intel® Matrix Storage Manager with support for RAID levels 0, 1, 10, and 5 with drivers to support Microsoft Windows* operating systems only.

By default, the server board is configured to support the LSI SATA Software RAID option. To change options, you must move a jumper block on the server board. The following diagram shows the location of the jumper block and its settings.

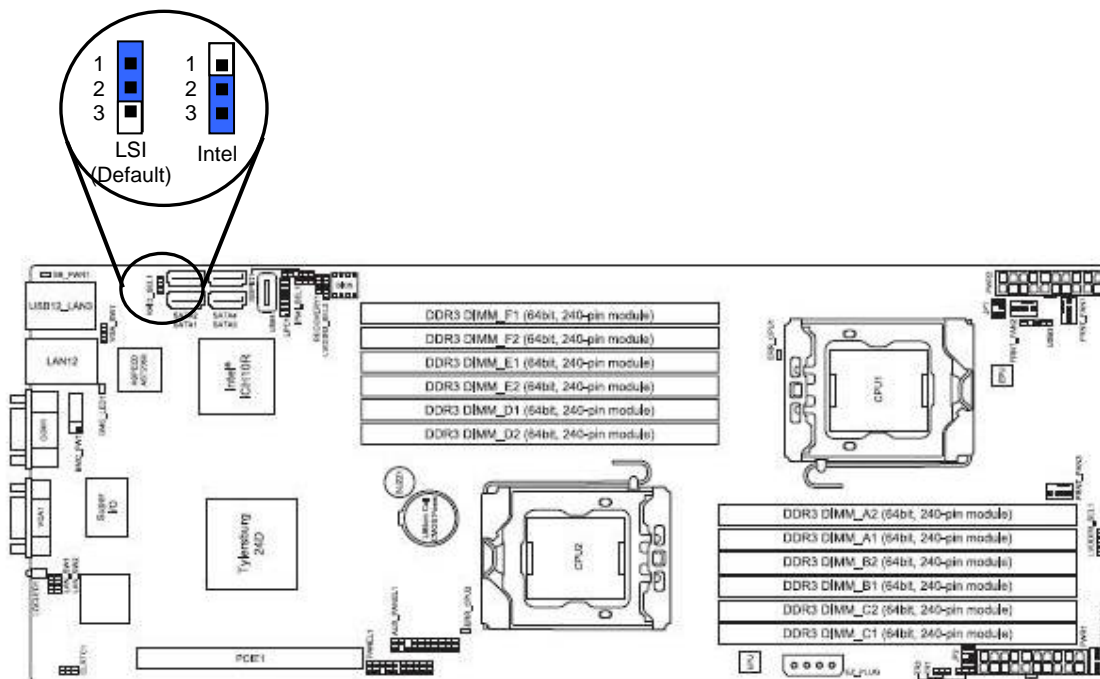

Figure 119. RAID Option Jumper Block

7.2 Enabling RAID in the BIOS Setup

By default, the BIOS does not enable RAID support. To enable this feature, you must set an option in the BIOS setup as described in the following procedure:

1. Enter the BIOS Setup (F2 Key) during POST.
2. Go to the MAIN menu, select IDE Configuration and press <Enter>
3. Set the Configure SATA As option to [RAID].
4. Save your changes and then exit BIOS Setup.

7.3 SATA RAID Setup

Depending on which SATA Software RAID option the server board is configured for, one of two embedded SATA RAID configuration utilities are used to configure hard disk drives to a RAID Set.

LSI* Software RAID Configuration Utility – <CNTRL M>

Intel® Matrix Storage Manager Utility – <CNTRL I>

Access to these utilities is achieved by entering the respective Hot-Key sequence when prompted during system POST.

TIP

To better access the RAID Configuration Utilities during POST, it is recommended to have the Full Screen Logo option set to Disabled. This option is located in the following BIOS Setup menu: Boot > Boot Settings Configuration.

7.3.1 LSI* Software RAID Configuration Utility

NOTE: Follow the procedures in this section only if the server board is configured to support the LSI* SATA Software RAID option. Otherwise, refer to the section describing the Intel® Matrix Storage Manager Utility.

This section provides an overview of how to setup a RAID set using SATA hard disk drives attached to the on-board SATA ports of the server board. For more in-depth information describing features and options of the LSI Software RAID Configuration Utility and other RAID support utilities, refer to the *LSI* MegaRAID Configuration Software Users Guide* included on the System Resource CD.

7.3.1.1 Accessing the LSI* Software RAID Configuration Utility

To access the LSI* Software RAID Configuration Utility

1. Power on the system. During POST, the LSI* MegaRAID option ROM automatically detects installed SATA hard disk drives and displays any existing RAID set(s).
2. Press the <Ctrl> + <M> hot-keys together to access the RAID configuration utility.

```

LSI MegaRAID Software RAID BIOS Version A.08 09161344R
LSI SATA RAID Found at PCI Bus No: Dev No:1F
Device present at Port 0      ST3160812AS      152114MB
Device present at Port 1      ST3160812AS      152114MB
Device present at Port 2      ST3160812AS      152114MB
Device present at Port 3      ST3160812AS      152114MB
Press Ctrl-M or Enter to run LSI Software RAID Setup Utility.

```

Figure 120. POST screen showing LSI* MegaRAID Option ROM display

The following screen displays:



Figure 121. Utility Main Window

At the bottom of the screen is the legend box. The keys on the legend box allow you to navigate through the setup menu options or execute commands. The keys on the legend box vary according to the menu level.

3. Select Configure.

7.3.1.2 Configuring a RAID Set

The LSI* Software RAID Configuration Utility allows you to create a RAID 0, RAID 1, or RAID 10 set using either of two options from the Configuration Menu: Easy and New.

Both options allow you to configure parameters for the RAID Set being created. The difference between the two is the New Configuration gives you the additional option to define the size and number of virtual drives to create within each RAID Set.

Use the following process to create a RAID set:

1. Select either the Easy Configuration or NEW Configuration from the Configuration Menu and press <Enter>.

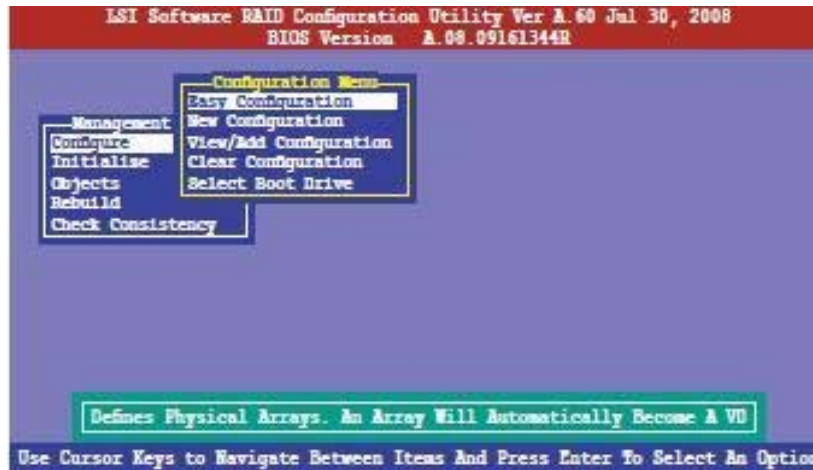

Figure 122. Configuration Menu Options

The ARRAY SELECTION MENU displays the drives connected to the SATA ports.

2. Use the up/down arrow key and <Space> key to select each drive you want to include in the RAID set.

As each drive is selected, the drive indicator changes from READY to ONLIN A[X]-[Y], where X is the array number, and Y is the drive number.

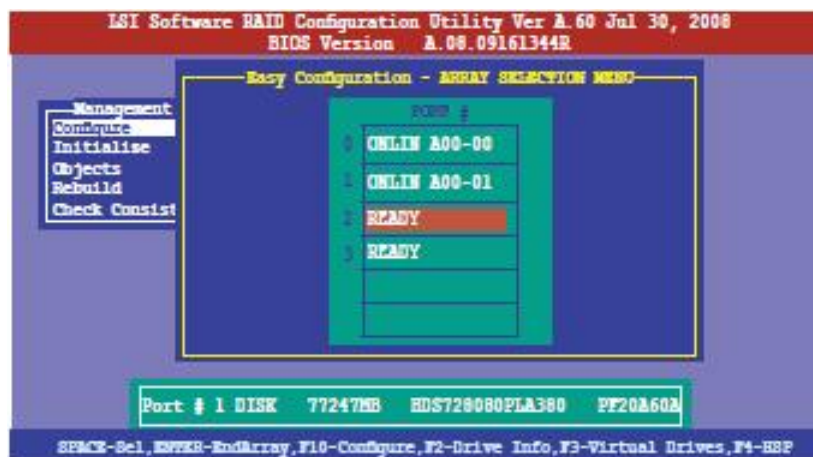

Figure 123. Array Selection Menu

Drive Selection Tips:

Information for selected hard disk drive will be displayed at the bottom of the screen.

You need at least two identical hard disk drives when creating a RAID 1 set.

You need at least four identical hard disk drives when creating a RAID 10 set.

2. After selecting each drive to be included in the RAID set, press the <F10> key to configure settings.
3. Press <Space> to select the configurable array.



Figure 124. Selecting the Configurable Array on Easy Configuration Menu

- Press <F10> again, the virtual drive information appears including a Virtual Drive menu that allows you to change the virtual drive parameters.

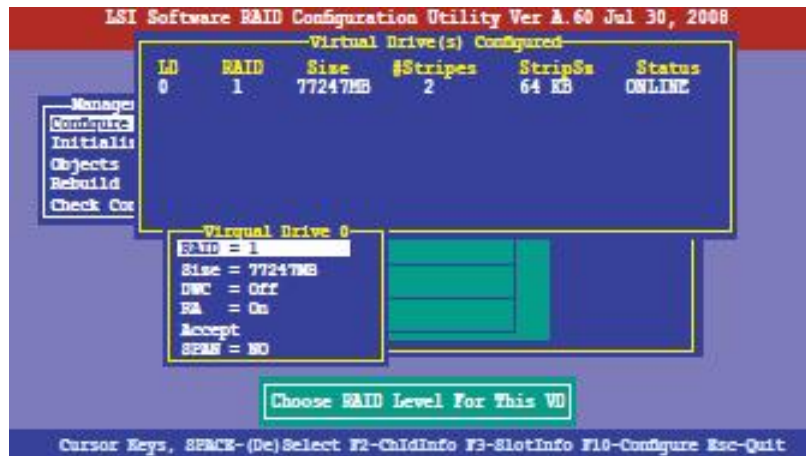

Figure 125. Virtual Drive Menu

- Select *RAID* from the *Virtual Drive* sub-menu, and then press <Enter>.
- Select the RAID level from the menu, and then press <Enter>.

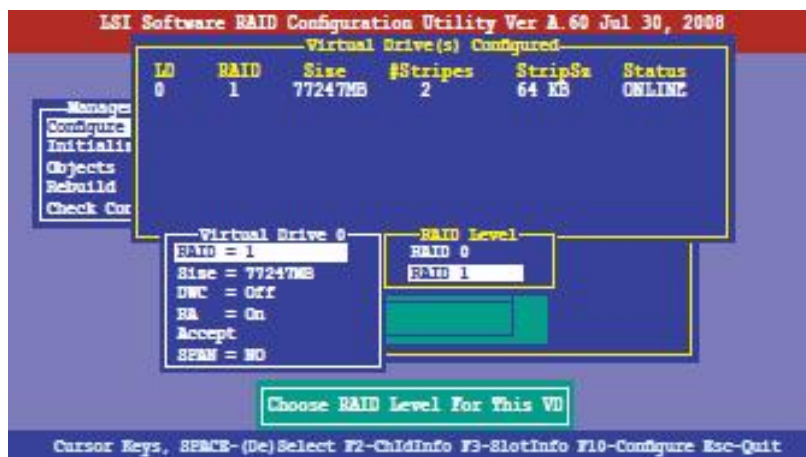

Figure 126. Selecting the RAID Level

7. When creating a RAID 1 or a RAID 10 set, select DWC from the Virtual Drive menu, and then press <Enter>.
8. Select On to enable the Disk Write Cache setting, and then press <Enter>.

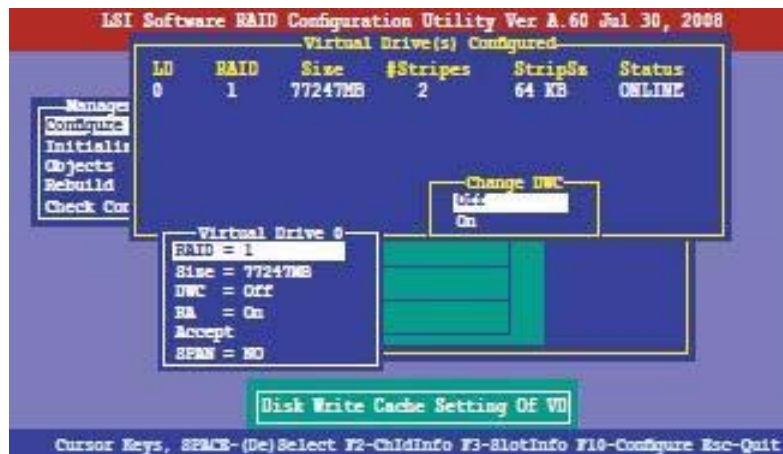

Figure 127. Enabling the Disk Write Cache Setting

NOTE: Enabling DWC can improve performance, but with the risk of data loss.

If the New Configuration option was selected from the Configuration Menu, you have the option to define the virtual drive size. Select Size from the Virtual Drive menu. The default value uses all available drive capacity. Entering a smaller value gives you the option to create multiple virtual drives within a common RAID set.

9. When finished setting the selected virtual drive configuration, select Accept from the menu, and then press <Enter>.

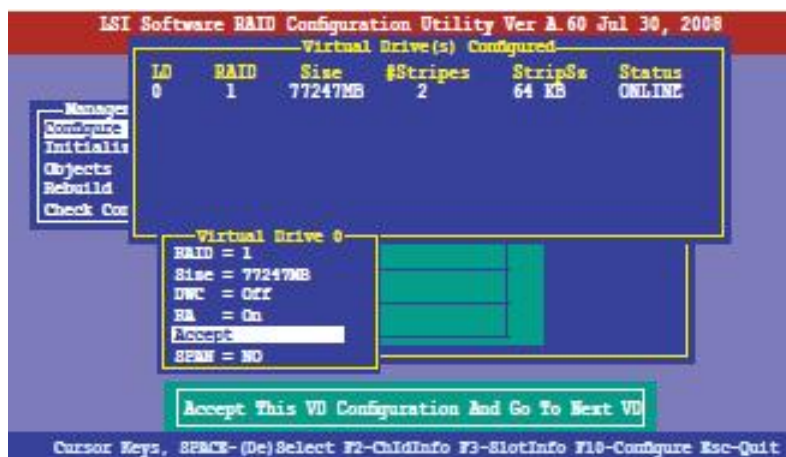

Figure 128. Accepting the Virtual Drive Configuration

10. Repeat the preceding steps to configure additional RAID sets if needed.
11. Press <Esc> to finish the RAID configuration.

- When prompted to save configuration, select Yes from the menu, and then press <Enter>.



Figure 129. Completing RAID Configuration

After creating RAID set(s), you must initialize the virtual drives. You can initialize the virtual drives using the *Initialize* from the *Management Menu*.

- From the Management Menu, select Initialize, and then press <Enter>.



Figure 130. Initialize Command

The screen displays the available RAID set(s) and prompts you to select the virtual drive to initialize.

- Use the arrow keys to select the virtual drive from the Virtual Drive selection, and then press <Space>.

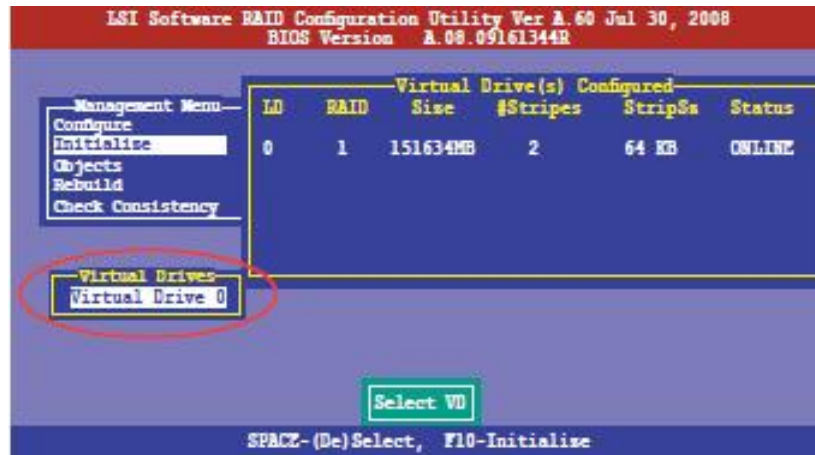

Figure 131. Virtual Drives (Selection) Pulldown Menu

- Press <F10> to start initialization. When prompted, select Yes from the Initialize? Dialog box, and then press <Enter>.

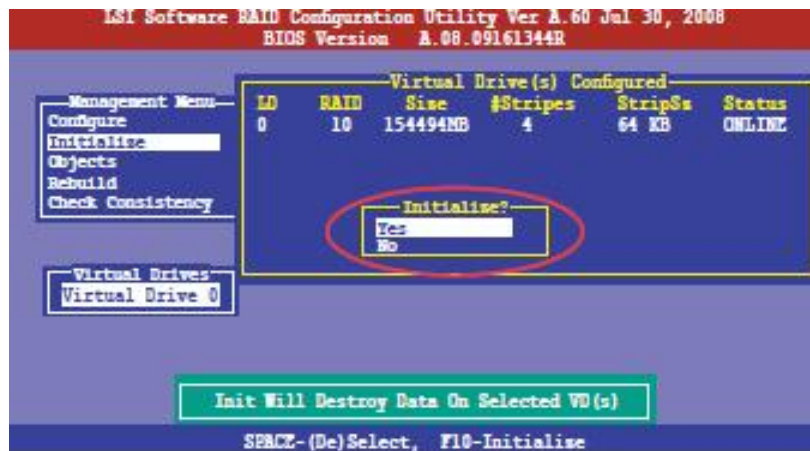

Figure 132. Initialize Confirmation Dialog Box

⚠ WARNING

Initializing a virtual drive erases all data on the drive.

A progress bar displays on screen. If necessary, pressing the <Esc> key can be used to stop the initialization process.

- When initialization is completed, press <Esc>.



Figure 133. Initialization Progress Bar

7.3.1.3 Enabling WriteCache

To improve performance, you have the option to enable the Write Cache feature of the RAID controller.

⚠ WARNING

When the WriteCache option is Enabled, data may be lost in the event of a power failure.

TIP

The Write Cache feature is recommended for RAID 1 and RAID 10 sets.

To enable Write Cache:

1. From the *Management Menu*, select *Objects > Adapter*, and then press <Enter> to display the adapter properties.
2. Select *Disk WC*, and then press <Enter> to turn on the option.

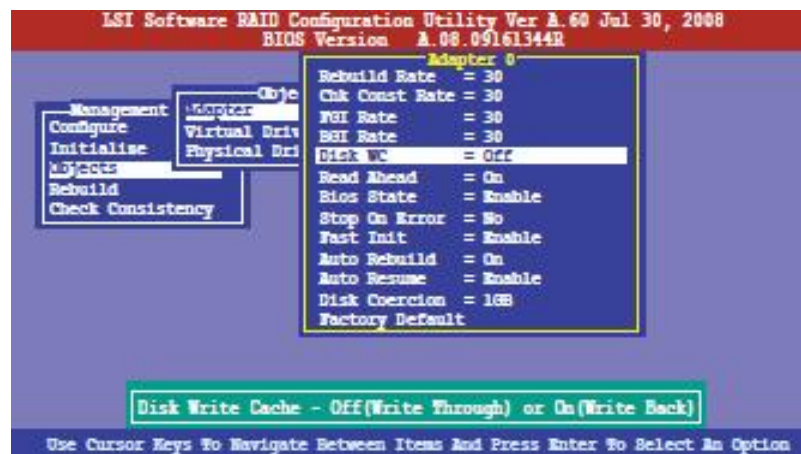

Figure 134. Selecting the Disk WC Option

7.3.2 Intel® Matrix Storage Manager Configuration Utility

NOTE: Follow the procedures in this section only if the server board is configured to support the Intel® Matrix Storage Manager RAID option. Otherwise, refer to the section describing the LSI* SATA Software RAID Utility.

This section provides an overview of how to setup a RAID set using SATA hard disk drives attached to the on-board SATA ports of the server board. For more in-depth information describing features and options of the Intel® Matrix Storage Manager and other RAID support utilities, please reference the *Intel® Matrix Storage Manager Users Guide* included on the System Resource CD.

7.3.2.1 Accessing the Intel® Matrix Storage Manager Configuration Utility

To access the Intel® Matrix Storage Manager Configuration utility:

1. Turn on the system. During POST, press the <Ctrl> + <I> keys to access the RAID configuration utility's main menu,

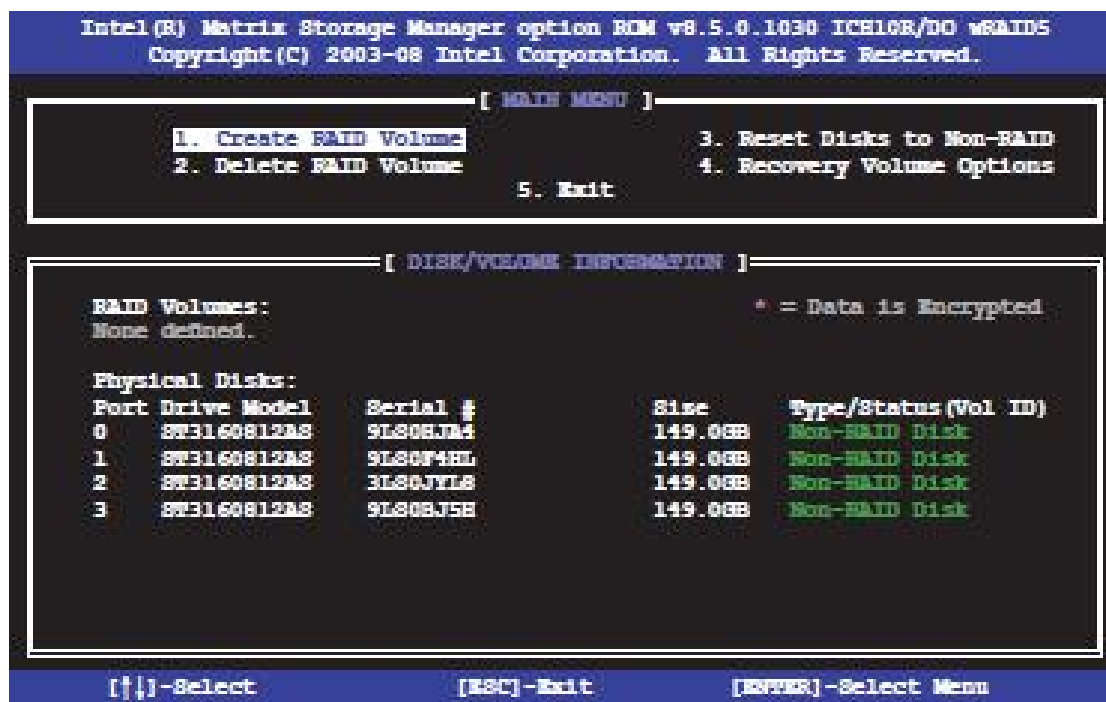

Figure 135. Intel® Matrix Storage Manager Configuration Utility

The navigation keys at the bottom of the screen allow you to move through the menus and select the menu options.

7.3.2.2 Creating a RAID Set

To create a RAID set:

1. From the *Main Menu*, select *1. Create RAID Volume* and press <Enter>. The following screen appears.

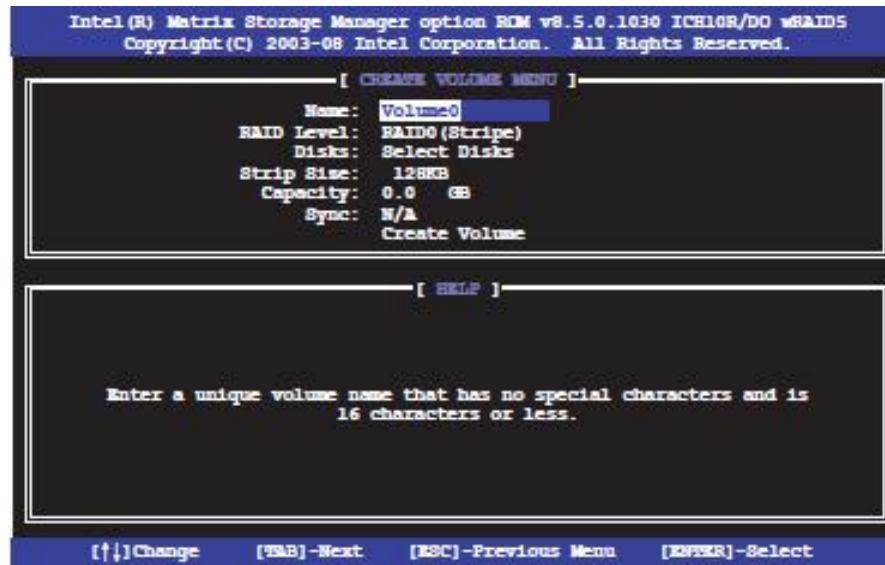

Figure 136. Create RAID Volume Menu

2. Enter a name for the RAID set and press <Enter>.
3. When the *RAID Level* option is selected, press the up/down arrow key to select a RAID level to create, and then press <Enter>.
4. When the *Disks* option is selected, press <Enter> to select the hard disk drives you want to include in the RAID set. The *SELECT DISKS* screen appears.

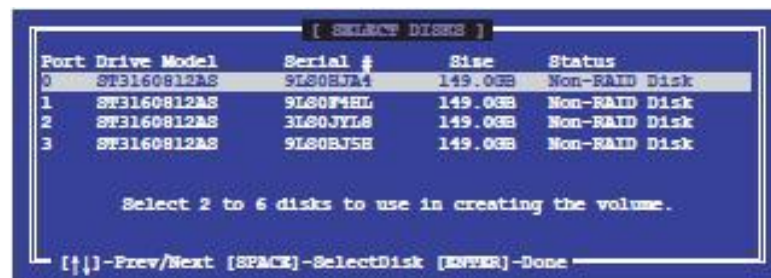

Figure 137. Select Disks Screen

5. Use the up/down arrow keys and <Space> key to select each drive to include in the RAID set.
6. Press <Enter> after completing your selections.
7. Use the up/down arrow key to select the stripe size for the RAID set (for RAID 0, 10 and 5 only), and then press <Enter>.

The available stripe size values range from 4 KB to 128 KB. The following are typical values:

- RAID 0: 128KB
- RAID 10: 64KB
- RAID 5: 64KB

When the *Capacity* option is selected, enter the RAID volume capacity you want and press <Enter>. The default value indicates the maximum allowed capacity.

When the *Create Volume* option is selected, press <Enter>. The following warning message displays:



Figure 138. Create Volume Warning Message

8. Press <Y> to create the RAID volume and return to the main menu, or <N> to go back to the CREATE VOLUME menu.
9. From the utility *Main Menu*, select 5. *Exit* and then press <Enter>. The following warning message appears.



Figure 139. Intel® Matrix Storage Manager Warning Message

10. Press <Y> to exit or press <N> to return to the utility main menu.

8. Driver Installation

8.1 RAID Driver Installation

After creating the RAID sets for your server board, you are now ready to install an operating system to the independent hard disk drive or bootable array. This section provides instructions on how to install the RAID controller drivers during operating system installation.

8.1.1 Creating a RAID Driver Disk

TIP

The system does not include a floppy drive. You must use a USB floppy drive when creating a SATA RAID driver disk.

TIP

If you created RAID sets with the LSI* Software RAID configuration utility, the boot priority of the SATA optical disk drive has to be manually set. Otherwise, the system will not boot from the connected SATA drives.

A floppy disk with the RAID driver is required when installing Windows® or Red Hat® Enterprise operating systems on to a specified RAID set. You can create a RAID driver disk in DOS (using the Makedisk application in the Resource CD).

8.1.1.1 Creating a RAID driver disk from an DOS environment:

1. Place the Resource CD into an optical drive.
2. Restart the computer, and then enter the BIOS Setup Utility.
3. Select the optical drive as the first boot priority
4. Save your changes and exit BIOS Setup.
5. Restart the computer allowing the system to boot from the Resource CD. The *Create Driver Diskette* menu displays.



Figure 140. Makedisk Menu

6. Use the arrow keys to select the type of RAID driver disk you want to create and press <Enter> to enter the sub-menu.

7. Locate the RAID driver and place a blank, high-density floppy disk into the floppy disk drive.
8. Press <Enter>.
9. Follow screen instructions to create the driver disk.

8.1.1.2 Creating a RAID driver disk from a Microsoft Windows* environment:

1. Start Microsoft Windows*.
2. Place the Resource CD into the optical drive.
3. Go to the Make Disk menu, and then select the type of RAID driver disk you want to create.
4. Insert a floppy disk into the floppy disk drive.
5. Follow the succeeding screen instructions to complete the process.

NOTE: Write-protect the floppy disk to avoid a computer virus infection.

8.1.1.3 Creating a RAID driver disk from a Red Hat* Enterprise Linux server environment:

1. Insert a blank formatted high-density floppy disk to the floppy disk drive.
2. Decompress the file into the floppy disk from the following path in the support DVD:
Example: For the LSI* Logic Embedded SATA RAID Driver:
`\Drivers\ICH10R LSI RAID\Driver\makedisk\Linux`
3. Eject the floppy disk.

8.1.2 Installing the RAID Controller Driver

8.1.2.1 Microsoft Windows Server* Operating System

During the Microsoft Windows Server* operating system installation:

To install the RAID controller driver when installing the Microsoft Windows Server* operating system:

1. Boot the computer using the Windows® Server installation DVD. The Windows® Server Operating System Setup starts.

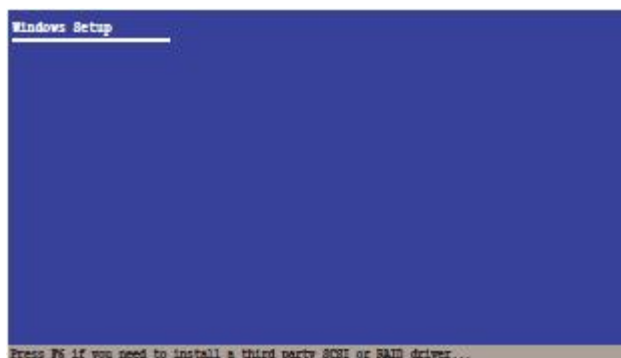

Figure 141. Microsoft Windows Server* Setup Menu

2. When prompted, Press <F6> to install a third-party driver.

- When prompted, press <S> to specify an additional device.

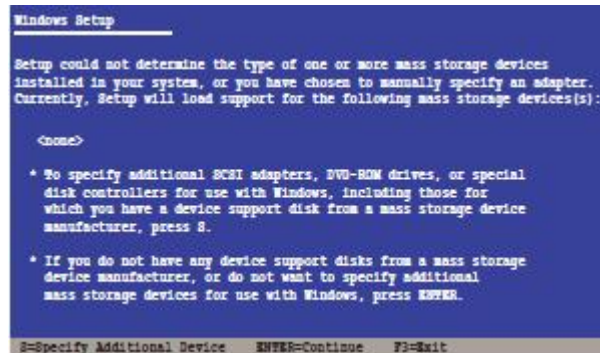

Figure 142. Specifying an Additional Device

- Insert the RAID driver disk you created earlier to the floppy disk drive, then press <Enter>.
- Select the RAID controller driver you need from the list, then press <Enter>.

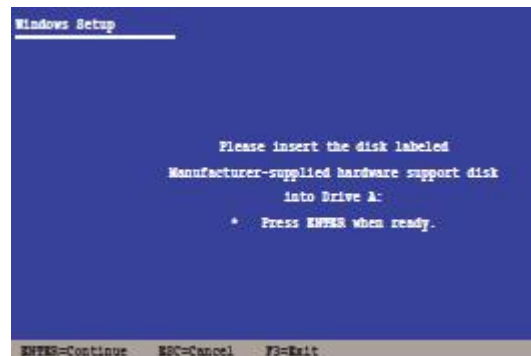

Figure 143. Insert RAID Driver Disk Screen

- The Microsoft Windows* Setup loads the RAID controller drivers from the RAID driver disk. When prompted, press <Enter> to continue installation.
- Setup then proceeds with the operating system installation. Follow the on-screen instructions to continue.

8.1.2.1.1 To an existing Microsoft Windows Server* operating system:

To install the RAID controller driver on an existing Microsoft Windows Server* operating system:

- Restart the computer, and then log in with Administrator privileges.
- Microsoft Windows* automatically detects the RAID controller and displays a New Hardware Found window. Click Cancel.
- Right-click the My Computer icon on the Microsoft Windows* desktop, and then select Properties from the menu.
- Click the Hardware tab, and then click the Device Manager button to display the list of devices installed in the system.
- Right-click the RAID controller item, then select Properties.
- Click the Driver tab, and then click the Update Driver button.
- The Upgrade Device Driver Wizard window appears. Click Next.
- Insert the RAID driver disk (you created earlier) into the floppy disk drive.

9. Select the option Install the software automatically (Recommended), and then click Next.
10. The wizard searches the RAID controller drivers. When found, click Next to install the drivers.
11. Click Finish after the driver installation is done.

8.1.2.1.2 To verify the RAID controller driver installation:

1. Right-click the My Computer icon on the Windows® desktop, and then select Properties from the menu.
2. Click the Hardware tab, and then click the Device Manager button.
3. Click the “+” sign before the item SCSI and RAID controllers, and then the Intel(R) ICH8R/ICH9R/ICH10R/DO SATA RAID Controller item should appear.

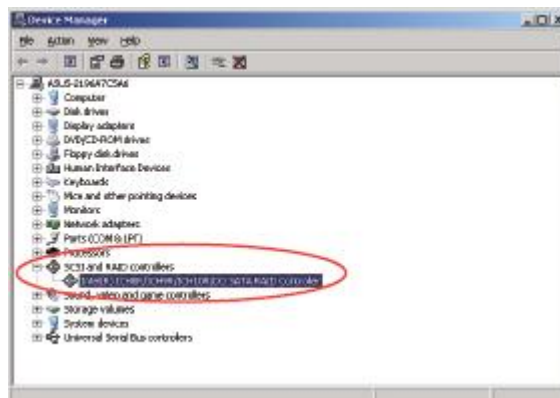

Figure 144. Intel ICH8R/ICH9R/ICH10R/DO SATA RAID Controller Item

NOTE: The screen differs based on the controller.

4. Right-click the RAID controller driver item, and then select Properties from the menu.
5. Click the Driver tab, and then click the Driver Details button to display the RAID controller drivers.
6. Click OK when finished.

8.1.2.2 Red Hat* Enterprise

To install the RAID controller driver when installing the Red Hat* Enterprise operating system:

1. Boot the system from the Red Hat* Installation CD.
2. At the boot:, type `linux dd`, and then press <Enter>.

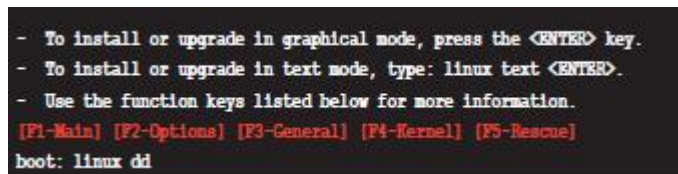

Figure 145. Installing Red Hat* Enterprise

3. Select Yes using the <Tab> key when asked if you have the driver disk, and then press <Enter>.

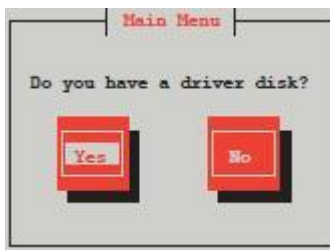

Figure 146. Driver Disk Y/N Screen

4. Select fd0 using the <tab> key when asked to select the driver disk source. Press <Tab> to move the cursor to OK, and then press <Enter>.

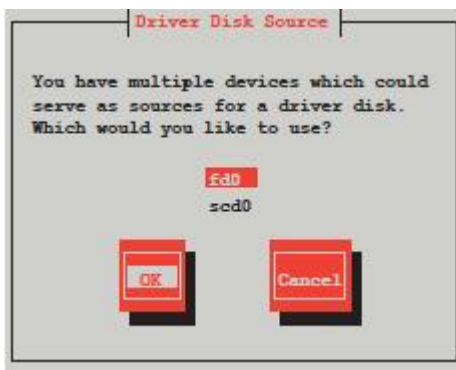

Figure 147. Driver Disk Source

5. Insert the Red Hat* Enterprise RAID driver disk to the floppy disk drive, select OK, and then press <Enter>.

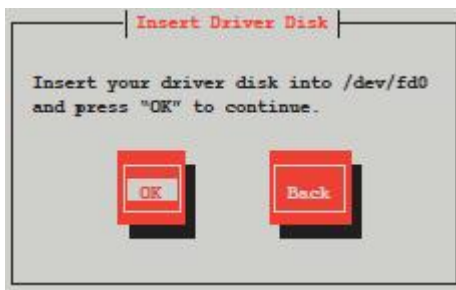

Figure 148. Insert Driver Disk Screen

6. When asked if you will load additional RAID controller drivers, select No, and then press <Enter>.



Figure 149. More Driver Disks? Screen

7. Follow the onscreen instructions to continue the operating system installation.

8.1.2.3 SUSE Linux Operating System

To install the RAID controller driver when installing the SUSE Linux Enterprise Server operating system.

1. Boot the system from the SUSE operating system installation CD.
2. Use the arrow keys to select the Installation from the Boot Options menu.

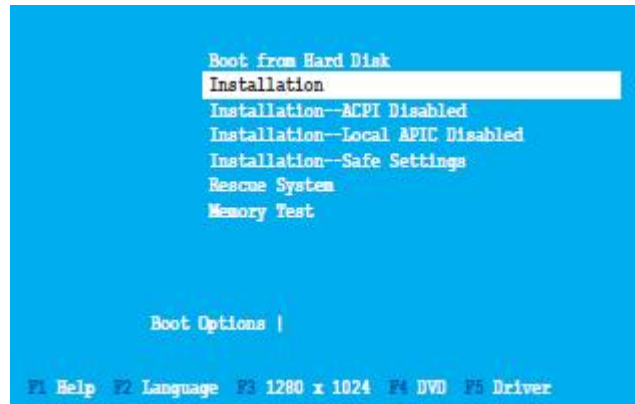

Figure 150. Selecting the SuSe* Installation

3. Press <F5>, then select Yes from the menu. Press <Enter>.

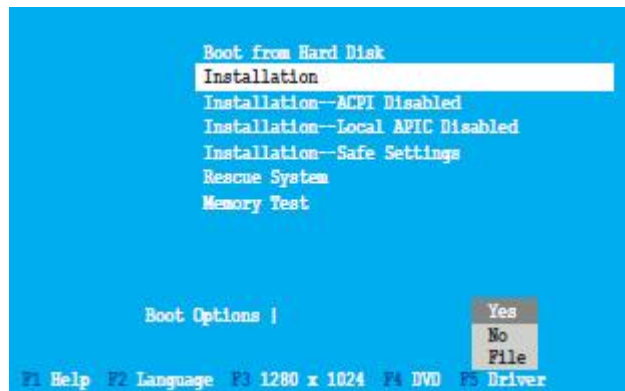

Figure 151. Initializing the SuSe* Installation

4. Insert the RAID driver disk to the floppy disk drive. Make sure Installation from the Boot Options menu is selected, and then press <Enter>.

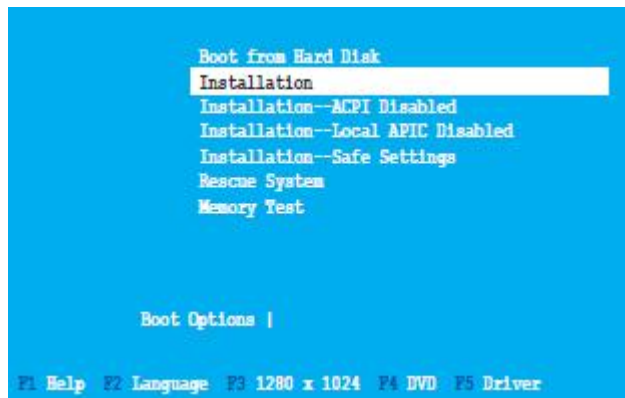

Figure 152. Installation Option Selected on the Boot Options Screen

- When the following screen displays, select the floppy disk drive (fd0) as the driver update medium. Select OK and then press <Enter>.

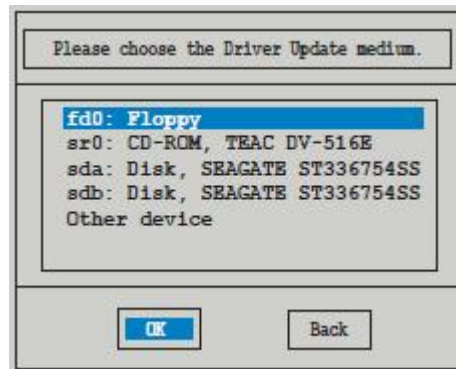

Figure 153. Driver Update Medium Screen

The drivers for the RAID controller are installed into the system.

8.2 Intel® Chipset Device Installation

This section provides instructions on how to install the Plug and Play components for the Intel® chipset on the system.

You must manually install the Intel® chipset software on a Microsoft Windows Server* operating system. To install the Intel® chipset device software:

- Restart the computer and then log on with Administrator privileges.
- Insert the server board/system Resource CD to the optical drive. The CD automatically displays the Drivers menu if Autorun is enabled in your computer.
- Click the item Intel Chipset Device Software from the menu.

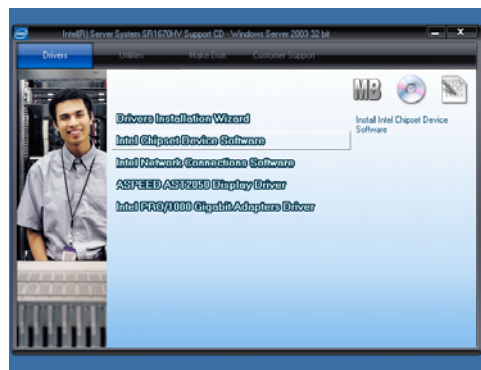

Figure 154. Intel Chipset Device Software Option

- The Intel® Chipset Device Software window appears. Click Next to start installation.



Figure 155. Intel® Chipset Device Software Window

5. Select Yes to accept the terms of the License Agreement and continue the process.



Figure 156. License Agreement Window

6. Read the Readme File Information and press Next to continue the installation.



Figure 157. Readme File Information Window

7. After completing the installation, click Finish to complete the setup process.



Figure 158. Setup Complete Window

8.3 LAN Driver Installation

This section provides instructions on how to install the Intel® Gigabit LAN controller drivers on a Microsoft Windows Server* operating system.

To install the LAN controller drivers:

1. Restart the computer, and then log on with Administrator privileges.
2. Insert the server board/system Resource CD to the optical drive. The CD automatically displays the Drivers menu if Autorun is enabled in your computer.

NOTE: Microsoft Windows* automatically detects the LAN controllers and displays a New Hardware Found window. Click Cancel to close this window.

If Autorun is NOT enabled in your computer, browse the contents of the Resource CD to locate the file ASSETUP.EXE from the BIN folder. Double-click the ASSETUP.EXE to run the CD.

3. Click the Intel Network Connections Software to begin installation.



Figure 159. Intel Network Connections Software Option

4. Click the Install Drivers and Software option to begin installation.



Figure 160. Intel Network Connections Software Window

5. Click Next when the Intel(R) Network Connections—InstallShield Wizard window displays.



Figure 161. Intel(R) Network Connections—InstallShield Wizard

6. Toggle I accept the terms in the license agreement and click Next to continue.

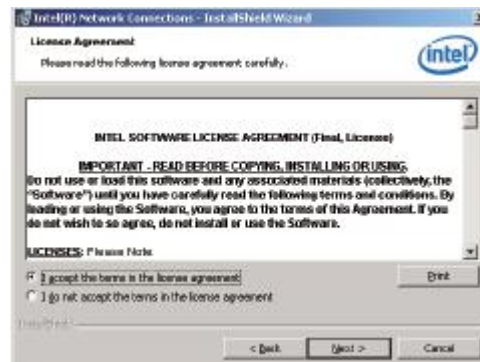

Figure 162. License Agreement Terms

7. Click the Intel(R) PROSet for Windows Device Manager box, and then click Next to start the installation.

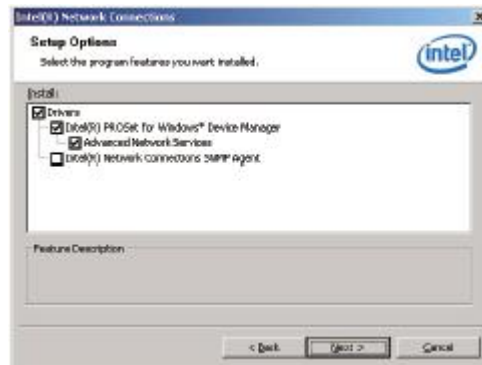

Figure 163. Intel(R) PROSet for Windows Device Manager Option

8. Follow the screen instructions to complete installation.

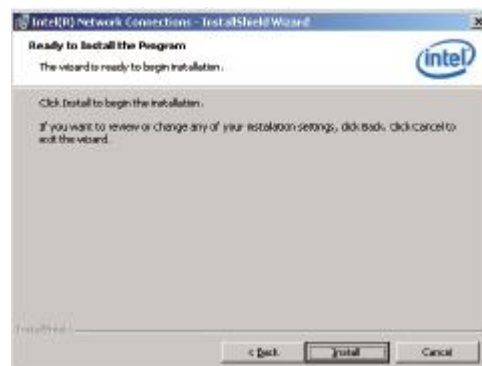

Figure 164. Beginning the Installation

9. When finished, click Finish to continue.

8.4 VGA Driver Installation

This section provides instructions on how to install the Aspeed® Video Graphics Adapter (VGA) driver.

You must manually install the Aspeed* VGA driver on a Windows® Server operating system.

To install the Aspeed* VGA driver:

1. Restart the computer, then log on with Administrator privileges.
2. Insert the server board/system Resource CD to the optical drive. The CD automatically displays the Drivers menu if Autorun is enabled in your computer.

The Drivers menu if Autorun is enabled in your computer.

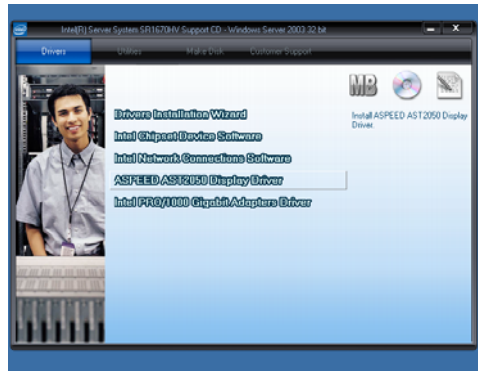

Figure 165. Drivers Menu

3. Click Next to start the installation.



Figure 166. Install Wizard for Aspeed* VGA Driver

4. Click Install to update the VGA driver.

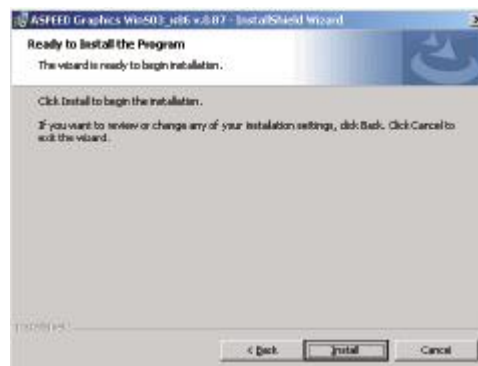

Figure 167. Updating the VGA Driver

5. When the installation completes, click Finish to restart your computer before using the program.



Figure 168. Completing the VGA Driver Installation

8.5 Management Applications and Utilities Installation

The Resource CD that came with the server contains drivers, management applications, and utilities that you can install to support specific server board features.

8.5.1 Running the Resource CD

Place the Resource CD into the optical drive. The CD automatically displays the Drivers menu if Autorun is enabled in your computer.

NOTE: If Autorun is NOT enabled in your computer, browse the contents of the Resource CD to locate the file ASSETUP.EXE from the BIN folder. Double-click the ASSETUP.EXE to run the CD.

8.5.2 Drivers Menu

The *Drivers* menu shows the available device drivers if the system detects installed devices. Install the necessary drivers to activate the devices.

NOTE: The screen display and driver options vary under different operating system versions.

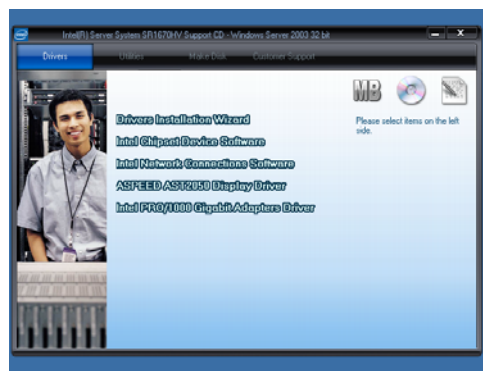

Figure 169. Drivers Menu

8.5.3 Utilities Menu

The *Utilities* menu displays the software applications and utilities the server board supports. Click an item to install.

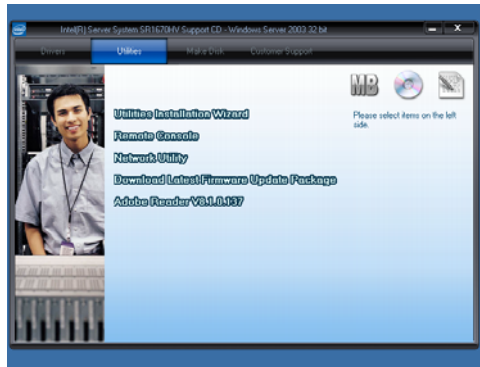

Figure 170. Utilities Menu

8.5.4 Make Disk Menu

The *Make Disk* menu provides options to create driver installation floppy disks for supported operating systems.

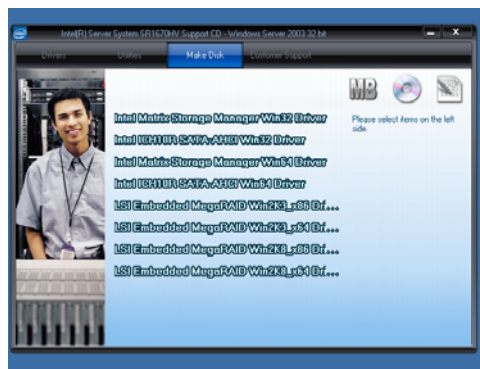

Figure 171. Make Disk Menu

8.5.5 Contact Information

For contact information, refer to the "Contact Information" section.

9. Intel® Server Issue Report Form

Issue Report Form (Rev 3.6)

Note: Filling out this form completely is required for any escalation.

=====

Customer Contact Information:

Customer Support Case #:

=====

Intel® Server Board or System:

(Example : S5500HV or SR1670HV)

=====

Server Chassis:

(Example SC5400. If third-party chassis used, indicate make and model.)

=====

Baseboard Information: (some information maybe found by accessing BIOS & going through the Server Management menu -> System Information)

Baseboard PBA/TA/AA # (Example: 123456-789):

- can be found on the white sticker label on the baseboard

System BIOS Version:

Intel® Remote Management Module Firmware Version (if applicable):

Intel® Management Module BMC Revision (if applicable) :

BMC/mBMC Version:

FRU/SDR Version:

HSC Version:

Has the latest BIOS been tried? (Yes/No):

Has the latest BMC/mBMC been tried? (Yes/No):

Has the latest IMM BMC been tried? (Yes/No):

Has the latest RMM Firmware been tried? (Yes/No):

Has the latest FRU/SDR been tried? (Yes/No):

Has the latest HSC been tried? (Yes/No):

=====

Processor information

	Type	Speed	sSpec	Thermal Solution
Processor 1				
Processor 2				
Processor 3				
Processor 4				

Thermal solution (Heatsink) examples:

(1U, Passive w/air ducting, Active w/fan, etc.)

=====

Memory

	Manufacturer	Part Number	DRAM Part Number	On Intel tested list?

Add-in adapters (Example: NICs, Management Adapters, Serial Expansion Cards, PCI-Express* Adapters, RAID Controllers, SCSI Controllers, etc.)

Type	Slot	Manufacturer	Model	Firmware

Third party hardware (Example: Example: KVM, Chassis, etc)

Description/Use	Manufacturer	Model	Firmware

Storage Devices (Example: SCSI, SATA, SAS, USB, Tape, etc.)

Manufacturer	Model	Type	Size	Firmware	In Hot-Swap Bay

=====

Operating System Information (Example: RedHat* Enterprise Linux, Microsoft* Windows* Server 2003, Service pack 1, OEM CD):

Manufacturer:

Version:

Language version (English, Arabic, Chinese (Simplified)):

Service Pack Level or Kernel Revision:

Distribution (OEM/Retail):

=====

Intel® RAID Controller: (Example SRCU42E)

RAID controller part number (PBA number):

RAID controller firmware version:

Has the latest RAID firmware been tried? (Yes/No):

RAID driver version:

Has the latest RAID driver been tried? (Yes/No):

RAID volumes configuration (disks & RAID level):

RAID volume use (Boot device/Data Volume):

Is BBU (Battery Backup Unit) installed? (Yes/No):

BBU part number:

=====

Detailed description of issue:

Troubleshooting tried:

Steps to replicate the issue:

=====

Issue impact statements:

Do you have any potential Intel system, or component purchases that this issue is holding up? If yes, please provide a brief description below.

Do you have systems already purchased that are not being delivered to your customers because of this issue? If yes, please provide a brief description below.

Have you returned systems or components to your place of purchase because of this issue? If yes, please provide a brief description below.

*All other brands and names are property of their respective owners.

10. Getting Help

If you encounter an issue with your server system, follow these steps to obtain support:

1. Visit the following Intel support web page:

<http://support.intel.com/support/motherboards/server>

This web page provides 24x7 support when you need it to get the latest and most complete technical support information on all Intel Enterprise Server and Storage Platforms. Information available at the support site includes:

- Latest BIOS, firmware, drivers and utilities

- Product documentation, installation and quick start guides

- Full product specifications, technical advisories and errata

- Compatibility documentation for memory, hardware add-in cards, chassis support matrix and operating systems

- Server and chassis accessory parts list for ordering upgrades or spare parts

- A searchable knowledgebase to search for product information throughout the support site

2. If you are still unable to obtain a solution to your issue, send an email to Intel's technical support center using the online form available at

<http://supportmail.intel.com/scripts-emf/welcome.aspx>

Lastly, you can contact an Intel support representative using one of the support phone numbers available at

<http://support.intel.com/support/9089.htm> (charges may apply). Intel customer support suggests filling out the issue report form available in Intel® Server Issue Report Form to better service the issue.

Intel also offers Channel Program members around-the-clock 24x7 technical phone support on Intel® server boards, server chassis, server RAID controller cards, and Intel® Server Management at <http://www.intel.com/reseller/>.

You will need to log in to the Reseller site to obtain the 24x7 number.

10.1 Warranty Information

To obtain warranty information, visit the following Intel web site:

<http://support.intel.com/support/motherboards/server/sb/CS-010807.htm>

11. Safety Information

Important Safety Instructions

Read all caution and safety statements in this document before performing any of the instructions. See also Intel Server Boards and Server Chassis Safety Information at <http://support.intel.com/support/motherboards/server/safecert.htm>.

Wichtige Sicherheitshinweise

Lesen Sie zunächst sämtliche Warn- und Sicherheitshinweise in diesem Dokument, bevor Sie eine der Anweisungen ausführen. Beachten Sie hierzu auch die Sicherheitshinweise zu Intel-Serverplatinen und -Servergehäusen unter <http://support.intel.com/support/motherboards/server/safecert.htm>.

重要安全指导

在执行任何指令之前，请阅读本文档中的所有注意事项及安全声明。和/或 <http://support.intel.com/support/motherboards/server/safecert.htm> 上的 Intel Server Boards and Server Chassis Safety Information（《Intel 服务器主板与服务器机箱安全信息》）。

Consignes de sécurité

Lisez attention toutes les consignes de sécurité et les mises en garde indiquées dans ce document avant de suivre toute instruction. Consultez Intel Server Boards and Server Chassis Safety Information rendez-vous sur le site <http://support.intel.com/support/motherboards/server/safecert.htm>.

Instrucciones de seguridad importantes

Lea todas las declaraciones de seguridad y precaución de este documento antes de realizar cualquiera de las instrucciones. Vea Intel Server Boards and Server Chassis Safety Information en <http://support.intel.com/support/motherboards/server/safecert.htm>.

English

Server Safety Information

This document applies to Intel® Server Boards, Intel® Server Chassis (pedestal and rack-mount) and installed peripherals. To reduce the risk of bodily injury, electrical shock, fire, and equipment damage, read this document and observe all warnings and precautions in this guide before installing or maintaining your Intel® server product.





In the event of a conflict between the information in this document and information provided with the product or on the website for a particular product, the product documentation takes precedence.

Your server should be integrated and serviced only by technically qualified persons.

You must adhere to the guidelines in this guide and the assembly instructions in your server manuals to ensure and maintain compliance with existing product certifications and approvals. Use only the described, regulated components specified in this guide. Use of other products/components will void the UL Listing and other regulatory approvals of the product, and may result in noncompliance with product regulations in the region(s) in which the product is sold.

Safety Warnings & Cautions

To avoid personal injury or property damage, before you begin installing the product, read, observe, and adhere to all of the following safety instructions and information. The following safety symbols may be used throughout the documentation and may be marked on the product and/or the product packaging.

CAUTION	<i>Indicates the presence of a hazard that may cause minor personal injury or property damage if the CAUTION is ignored.</i>
WARNING	<i>Indicates the presence of a hazard that may result in serious personal injury if the WARNING is ignored.</i>
	<i>Indicates potential hazard if indicated information is ignored.</i>
	<i>Indicates shock hazards that result in serious injury or death if safety instructions are not followed.</i>
	<i>Indicates hot components or surfaces.</i>
	<i>Indicates do not touch fan blades, may result in injury.</i>
	<i>Indicates to unplug all AC power cord(s) to disconnect AC power</i>

Intended Application Uses

This product was evaluated as Information Technology Equipment (ITE), which may be installed in offices, schools, computer rooms, and similar commercial type locations. The suitability of this product for other product categories and environments (such as medical, industrial, residential, alarm systems, and test equipment), other than an ITE application, may require further evaluation.

Site Selection

The system is designed to operate in a typical office environment. Choose a site that is:

- *Clean, dry, and free of airborne particles (other than normal room dust).*
- *Well-ventilated and away from sources of heat including direct sunlight and radiators.*
- *Away from sources of vibration or physical shock.*
- *Isolated from strong electromagnetic fields produced by electrical devices.*
- *In regions that are susceptible to electrical storms, we recommend you plug your system into a surge suppresser and disconnect telecommunication lines to your modem during an electrical storm.*
- *Provided with a properly grounded wall outlet.*
- *Provided with sufficient space to access the power supply cord(s), because they serve as the product's main power disconnect.*

Equipment Handling Practices

Reduce the risk of personal injury or equipment damage:

- *Conform to local occupational health and safety requirements when moving and lifting equipment.*
- *Use mechanical assistance or other suitable assistance when moving and lifting equipment.*
- *To reduce the weight for easier handling, remove any easily detachable components.*

Power and Electrical Warnings

CAUTION

The power button, indicated by the stand-by power marking, DOES NOT completely turn off the system AC power, 5V standby power is active whenever the system is plugged in. To remove power from system, you must unplug the AC power cord from the wall outlet. Your system may use more than one AC power cord. Make sure all AC power cords are unplugged. Make sure the AC power cord(s) is/are unplugged before you open the chassis, or add or remove any non hot-plug components.

Do not attempt to modify or use an AC power cord if it is not the exact type required. A separate AC cord is required for each system power supply.

The power supply in this product contains no user-serviceable parts. Do not open the power supply. Hazardous voltage, current and energy levels are present inside the power supply. Return to manufacturer for servicing.

When replacing a hot-plug power supply, unplug the power cord to the power supply being replaced before removing it from the server.

To avoid risk of electric shock, turn off the server and disconnect the power cord, telecommunications systems, networks, and modems attached to the server before opening it.

Power Cord Warnings

If an AC power cord was not provided with your product, purchase one that is approved for use in your country.

CAUTION

To avoid electrical shock or fire, check the power cord(s) that will be used with the product as follows:

- *Do not attempt to modify or use the AC power cord(s) if they are not the exact type required to fit into the grounded electrical outlets*
- *The power cord(s) must meet the following criteria:*
 - The power cord must have an electrical rating that is greater than that of the electrical current rating marked on the product.*
 - The power cord must have safety ground pin or contact that is suitable for the electrical outlet.*
- *The power supply cord(s) is/are the main disconnect device to AC power. The socket outlet(s) must be near the equipment and readily accessible for disconnection.*
- *The power supply cord(s) must be plugged into socket-outlet(s) that is /are provided with a suitable earth ground.*

System Access Warnings

CAUTION

To avoid personal injury or property damage, the following safety instructions apply whenever accessing the inside of the product:

- *Turn off all peripheral devices connected to this product.*
- *Turn off the system by pressing the power button to off.*
- *Disconnect the AC power by unplugging all AC power cords from the system or wall outlet.*

- *Disconnect all cables and telecommunication lines that are connected to the system.*
- *Retain all screws or other fasteners when removing access cover(s). Upon completion of accessing inside the product, refasten access cover with original screws or fasteners.*
- *Do not access the inside of the power supply. There are no serviceable parts in the power supply. Return to manufacturer for servicing.*
- *Power down the server and disconnect all power cords before adding or replacing any non hot-plug component.*
- *When replacing a hot-plug power supply, unplug the power cord to the power supply being replaced before removing the power supply from the server.*



CAUTION

If the server has been running, any installed processor(s) and heatsink(s) may be hot. Unless you are adding or removing a hot-plug component, allow the system to cool before opening the covers. To avoid the possibility of coming into contact with hot component(s) during a hot-plug installation, be careful when removing or installing the hot-plug component(s).



CAUTION

To avoid injury do not contact moving fan blades. If your system is supplied with a guard over the fan, do not operate the system without the fan guard in place.

Rack Mount Warnings

The equipment rack must be anchored to an unmovable support to prevent it from tipping when a server or piece of equipment is extended from it. The equipment rack must be installed according to the rack manufacturer's instructions.

Install equipment in the rack from the bottom up, with the heaviest equipment at the bottom of the rack.

Extend only one piece of equipment from the rack at a time.

You are responsible for installing a main power disconnect for the entire rack unit. This main disconnect must be readily accessible, and it must be labeled as controlling power to the entire unit, not just to the server(s).

To avoid risk of potential electric shock, a proper safety ground must be implemented for the rack and each piece of equipment installed in it.

Electrostatic Discharge (ESD)

  **CAUTION**

ESD can damage disk drives, boards, and other parts. We recommend that you perform all procedures at an ESD workstation. If one is not available, provide some ESD protection by wearing an antistatic wrist strap attached to chassis ground -- any unpainted metal surface -- on your server when handling parts.

Always handle boards carefully. They can be extremely sensitive to ESD. Hold boards only by their edges. After removing a board from its protective wrapper or from the server, place the board component side up on a grounded, static free surface. Use a conductive foam pad if available but not the board wrapper. Do not slide board over any surface.

Other Hazards

Battery Replacement



CAUTION

There is the danger of explosion if the battery is incorrectly replaced. When replacing the battery, use only the battery recommended by the equipment manufacturer.

Dispose of batteries according to local ordinances and regulations.

Do not attempt to recharge a battery.

Do not attempt to disassemble, puncture, or otherwise damage a battery.

Cooling and Airflow



CAUTION

Carefully route cables as directed to minimize airflow blockage and cooling problems.

For proper cooling and airflow, operate the system only with the chassis covers installed. Operating the system without the covers in place can damage system parts. To install the covers:

- 1. Check first to make sure you have not left loose tools or parts inside the system.*
- 2. Check that cables, add-in boards, and other components are properly installed.*
- 3. Attach the covers to the chassis according to the product instructions.*

Laser Peripherals or Devices



CAUTION

To avoid risk of radiation exposure and/or personal injury:

Do not open the enclosure of any laser peripheral or device

Laser peripherals or devices have are not user serviceable

Return to manufacturer for servicing

Deutsch

Sicherheitshinweise für den Server

Das vorliegende Dokument bezieht sich auf Intel® Serverplatinen, Intel® Servergehäuse (Standfuß und Rack) sowie installierte Peripheriegeräte. Es enthält Warnungen und Vorsichtsmaßnahmen zur Vermeidung von Gefahren durch Verletzung, Stromschlag, Feuer und Beschädigungen von Geräten. Lesen Sie diese Dokument daher sorgfältig, bevor Sie Ihr Intel® Serverprodukt installieren oder warten.





Bei Widersprüchen zwischen den hier vorliegenden Angaben und den Informationen im Lieferumfang des Produkts oder auf der Website des betreffenden Produkts hat die Produktdokumentation Vorrang.

Die Integration und Wartung des Servers darf nur durch technisch qualifizierte Personen erfolgen.

Um die Einhaltung der vorhandenen Zulassungen und Genehmigungen für das Produkt zu gewährleisten, sind die Richtlinien in diesem Handbuch sowie die Montageanleitungen in den Serverhandbüchern zu beachten. Verwenden Sie nur die beschriebenen, zugelassenen Komponenten, die im vorliegenden Handbuch angegeben werden. Die Verwendung anderer Produkte oder Komponenten führt zum Erlöschen der UL-Zulassung und anderer Genehmigungen für das Produkt. Dadurch kann das Produkt gegen Produktbestimmungen verstoßen, die im Verkaufsland gelten.

Sicherheitshinweise und Vorsichtsmaßnahmen

Um Verletzungen und Beschädigungen zu vermeiden, sollten Sie vor dem Beginn der Produktinstallation die nachfolgend aufgeführten Sicherheitshinweise und -informationen sorgfältig lesen und befolgen. In dem vorliegenden Handbuch sowie auf dem Produkt und auf der Verpackung werden folgende Sicherheitssymbole verwendet:

VORSICHT	Weist auf eine Gefahrenquelle hin, die bei Nichtbeachtung des VORSICHTSHINWEISES zu leichteren Verletzungen bzw. Sachbeschädigungen führen kann.
WARNUNG	Weist auf eine Gefahrenquelle hin, die bei Nichtbeachtung der WARNUNG zu ernstesten Verletzungen führen kann.
	Weist auf potentielle Gefahr bei Nichtbeachtung der angezeigten Informationen hin.
	Weist auf die Gefahr eines Stromschlags hin, der bei Nichtbeachtung der Sicherheitshinweise zu schweren oder tödlichen Verletzungen führen kann.
	Weist auf Verbrennungsgefahr an heißen Bauteilen bzw. Oberflächen hin.
	Weist darauf hin, daß das Anfassen des Gebläses zu Verletzungen führen kann.
	Bedeutet, alle Netzkabel abzuziehen und das Gerät von der Netzspannung zu trennen.

Zielbenutzer der Anwendung

Dieses Produkt wurde in seiner Eigenschaft als IT-Gerät getestet, das in Büros, Schulen, Computerräumen und ähnlichen öffentlichen Räumlichkeiten installiert werden kann. Die Eignung dieses Produkts für andere Einsatzbereiche als IT (z. B. Medizin, Industrie, Alarmsysteme oder Prüfgeräte) kann u. U. weitere Tests erfordern.

Standortauswahl

Das System ist für den Betrieb innerhalb normaler Büroumgebungen geeignet. Wählen Sie einen Standort, der folgenden Kriterien entspricht:

- *Sauber, trocken und frei von Partikeln in der Luft (außer dem normalen Raumstaub).*
- *Gut belüftet, nicht in der Nähe von Wärmequellen und keiner direkten Sonnenbestrahlung ausgesetzt.*
- *Nicht in der Nähe von Vibrations- oder Erschütterungsquellen.*
- *Abgeschirmt von starken elektromagnetischen Feldern, die durch elektrische Geräte erzeugt werden.*
- *In gewittergefährdeten Gebieten sollten Sie das System an einen Überspannungsschutz anschließen und bei einem Gewitter die Telekommunikationskabel zum Modem abziehen.*
- *Eine ordnungsgemäß geerdete Wandsteckdose muß vorhanden sein.*
- *Ausreichender Freiraum für den Zugang zu den Netzkabeln, da diese die Hauptvorrichtung zum Trennen des Produkts von der Stromversorgung sind.*

Handhabung von Geräten

Beachten Sie zur Vermeidung von Verletzungen oder Beschädigungen an den Geräten die folgenden Hinweise:

- *Halten Sie beim Transportieren und Anheben von Geräten die örtlichen Gesundheits- und Sicherheitsvorschriften ein.*
- *Verwenden Sie mechanische oder andere geeignete Hilfsmittel zum Transportieren oder Anheben von Geräten.*
- *Entfernen Sie alle Komponenten, die sich leicht abnehmen lassen, um das Gewicht zu reduzieren und die Handhabung zu erleichtern.*

Warnungen zu Netzspannung und Elektrizität

VORSICHT

Durch Betätigen der mit dem Standby-Symbol gekennzeichneten Netztaaste wird das System NICHT vollständig vom Netz getrennt. Es sind weiterhin 5 V aktiv, solange das System eingesteckt ist. Um das System vollständig vom Strom zu trennen, muß das Netzkabel aus der Steckdose abgezogen werden. Das System verfügt möglicherweise über mehrere Netzkabel. Vergewissern Sie sich in diesem Fall, daß alle Netzkabel

abgezogen sind. Wenn Sie Komponenten ein- oder ausbauen möchten, die nicht hot-plug-fähig sind, stellen Sie sicher, daß zuvor alle Netzkabel abgezogen sind.

Nehmen Sie keine Änderungen am Netzkabel vor, und verwenden Sie kein Kabel, das nicht genau dem geforderten Typ entspricht. Jedes Netzteil im System muß über ein eigenes Netzkabel angeschlossen werden.

Das Netzteil in diesem Produkt enthält keine Teile, die vom Benutzer gewartet werden können. Öffnen Sie das Netzteil nicht. Im Netzteil bestehen gefährliche Spannungen, Ströme und Energiequellen. Schicken Sie das Gerät für Wartungsarbeiten an den Hersteller zurück.

Wenn Sie ein hot-plug-fähiges Netzteil austauschen, ziehen Sie dessen Netzkabel ab, bevor Sie es aus dem Server ausbauen.

Zur Vermeidung von Stromschlägen schalten Sie den Server aus, und trennen Sie vor dem Öffnen des Geräts das Netzkabel sowie alle an den Server angeschlossene Telekommunikationssysteme, Netzwerke und Modems.

Hinweis für Netzkabel

Wenn kein Netzkabel mit dem Produkt geliefert wurde, kaufen Sie ein Kabel, das für die Benutzung in Ihrem Land zugelassen ist.

VORSICHT

Prüfen Sie zur Vermeidung von Stromschlag- oder Feuergefahr die mit dem Produkt zu verwendenden Netzkabel wie folgt:

- *Nehmen Sie keine Änderungen an einem Netzkabel vor, und benutzen sie es nicht, wenn es nicht genau in die geerdeten Netzsteckdosen paßt.*
- *Netzkabel müssen die folgenden Anforderungen erfüllen:*
 - Die Nennbelastbarkeit des Netzkabels muß mindestens so hoch sein wie die am Produkt angegebenen Nennstromaufnahme.*
 - Das Netzkabel muß einen zur Netzsteckdose passenden Schutzkontakt besitzen.*
- *Die Netzkabel sind die Hauptvorrichtung zum Trennen des Geräts vom Stromnetz. Die Steckdose muß in der Nähe der Anlage angebracht und gut erreichbar sein.*
- *Netzkabel müssen an eine ordnungsgemäß geerdete Steckdose angeschlossen sein.*

Warnhinweise für den Systemzugang

VORSICHT

Um Verletzungen und Beschädigungen zu vermeiden, sollten Sie vor Arbeiten im Produktinneren folgende Sicherheitsanweisungen beachten:

- *Schalten Sie alle am Produkt angeschlossenen Peripheriegeräte aus.*

- Schalten Sie das System mit dem Netzschalter aus.
- Trennen Sie das Gerät von der Stromquelle, indem Sie alle Netzkabel vom System bzw. aus der Steckdose ziehen.
- Ziehen Sie alle Kabel und alle an das System angeschlossenen Telekommunikationsleitungen ab.
- Bewahren Sie alle Schrauben und anderen Befestigungselemente gut auf, nachdem Sie die Gehäuseabdeckung entfernt haben. Wenn Sie Ihre Arbeiten im Systeminneren beendet haben, befestigen Sie die Gehäuseabdeckung mit den Originalschrauben bzw. -befestigungselementen.
- Führen Sie keine Arbeiten im Netzteil aus. Das Netzteil enthält keine für den Benutzer wartungsbedürftigen Teile. Schicken Sie das Gerät für Wartungsarbeiten an den Hersteller zurück.
- Schalten Sie den Server aus, und ziehen Sie alle Netzkabel ab, bevor Sie Komponenten ein- oder ausbauen, die nicht hot-plug-fähig sind.
- Wenn Sie ein hot-plug-fähiges Netzteil austauschen, ziehen Sie dessen Netzkabel ab, bevor Sie es aus dem Server ausbauen.

VORSICHT

War Ihr Server in Betrieb, können die installierten Prozessoren und Kühlkörper heiß sein. Sofern Sie keine Hot-Plug-Komponenten ein- oder ausbauen, warten Sie mit dem Abnehmen der Abdeckungen, bis das System abgekühlt ist. Gehen Sie beim Aus- oder Einbauen von Hot-Plug-Komponenten sorgfältig vor, um nicht mit heißen Komponenten in Berührung zu kommen.

VORSICHT

Berühren Sie nicht die rotierenden Lüfterflügel, um Verletzungen zu vermeiden. Falls Ihr System mit einer Lüfterabdeckung besitzt, darf es nicht ohne diese Abdeckung betrieben werden.

Warnhinweise für Racks

Das Geräte-Rack muß auf einer geeigneten, festen Unterlage verankert werden, um ein Umkippen zu vermeiden, wenn ein Server oder andere Geräte herausgezogen werden. Bei der Installation des Racks müssen die Anweisungen des Rack-Herstellers beachtet werden.

Gehen Sie bei der Installation von Geräten im Rack immer von unten nach oben vor, und bauen Sie das schwerste Gerät an der untersten Position im Rack ein.

Ziehen Sie jeweils immer nur ein Gerät aus dem Rack heraus.

Sie müssen für die gesamte Rack-Einheit einen Netztrennschalter einrichten. Dieser Netztrennschalter muß leicht zugänglich sein und über eine Kennzeichnung verfügen, die besagt, daß er die Stromzufuhr zur gesamten Einheit steuert und nicht nur zu den Servern.

Zur Vermeidung von Stromschlaggefahr müssen das Rack selbst und alle darin eingebauten Geräte ordnungsgemäß geerdet sein.

Elektrostatische Entladungen (ESD)

VORSICHT

Elektrostatische Entladungen können zur Beschädigung von Festplatten, Platinen und anderen Komponenten führen. Daher sollten Sie alle Arbeiten an einer ESD-Workstation ausführen. Steht ein solcher Arbeitsplatz nicht zur Verfügung, erzielen Sie einen gewissen Schutz vor elektrostatischen Entladungen durch Tragen einer Antistatik-Manschette, die Sie während der Arbeit zur Erdung an einem beliebigen unlackierten Metallteil des Computergehäuses befestigen.

Gehen Sie bei der Handhabung von Platinen immer mit größter Vorsicht vor. Sie können äußerst empfindlich gegenüber elektrostatischer Entladung sein. Halten Sie Platinen nur an den Kanten fest. Legen Sie die Platinen nach dem Auspacken aus der Schutzhülle oder nach dem Ausbau aus dem Server mit der Bauelementseite nach oben auf eine geerdete, statisch entladene Unterlage. Verwenden Sie dazu, sofern verfügbar, eine leitfähige Schaumstoffunterlage, aber nicht die Schutzhülle der Platine. Ziehen Sie die Platine nicht über eine Fläche.

Andere Gefahren

Batterieaustausch

VORSICHT

Wird die Batterie unsachgemäß ausgetauscht, besteht Explosionsgefahr. Verwenden Sie als Ersatz nur die vom Gerätehersteller empfohlene Batterie.

Beachten Sie bei der Entsorgung von Batterien die gültigen Bestimmungen.

Versuchen Sie nicht, eine Batterie aufzuladen.

Versuchen Sie nicht, eine Batterie zu öffnen oder sonstwie zu beschädigen.

Kühlung und Luftstrom

VORSICHT

Verlegen Sie Kabel sorgfältig entsprechend der Anleitung, um Störungen des Luftstroms und Kühlungsprobleme zu vermeiden.

Zur Gewährleistung des ordnungsgemäßen Kühlungs- und Luftstromverhaltens darf das System nur mit angebrachten Gehäuseabdeckungen betrieben werden. Die Inbetriebnahme des Systems ohne Abdeckung kann zur Beschädigung von Systemkomponenten führen. So bringen Sie die Abdeckung wieder an:

- 1. Vergewissern Sie sich zunächst, daß Sie keine Werkzeuge oder Teile im Gehäuse vergessen haben.*

2. Prüfen Sie, ob Kabel, Erweiterungskarten sowie weitere Komponenten ordnungsgemäß angebracht sind.
3. Befestigen Sie die Abdeckungen am Gehäuse des Produkts, wie in dessen Anleitung beschrieben.

Laser-Peripheriegeräte oder -Komponenten



VORSICHT

Beachten Sie zur Vermeidung von Strahlung und Verletzungen die folgenden Hinweise:

Öffnen Sie keinesfalls das Gehäuse von Laser-Peripheriegeräten oder Laser-Komponenten.

Laser-Peripheriegeräte oder -Komponenten besitzen keine für den Benutzer wartungsbedürftigen Teile.

Schicken Sie das Gerät für Wartungsarbeiten an den Hersteller zurück.

Français

Consignes de sécurité sur le serveur

Ce document s'applique aux cartes serveur Intel[®], au châssis de serveur Intel[®] (sur pieds et sur rack) et aux périphériques installés. Pour réduire les risques de dommages corporels, d'électrocution, d'incendie et de dommages matériels, lisez ce document et respectez tous les avertissements et précautions mentionnés dans ce guide avant d'installer ou de mettre à jour votre produit serveur Intel[®].





En cas de conflit entre les informations fournies dans ce document et celles livrées avec le produit ou publiées sur le site Web pour un produit particulier, la documentation du produit prime.

Votre serveur doit être intégré et entretenu uniquement par des techniciens qualifiés.

Vous devez suivre les informations de ce guide et les instructions d'assemblage des manuels de serveur pour vérifier et maintenir la conformité avec les certifications et approbations de produit existantes. Utilisez uniquement les composants décrits et réglementés spécifiés dans ce guide. L'utilisation d'autres produits/composants annulera la liste UL et les autres approbations réglementaires du produit, et le produit peut ne pas être conforme aux autres lois et réglementations locales applicables au produit.

Sécurité : avertissements et mises en garde

Pour éviter de vous blesser ou d'endommager votre équipement, lisez et respectez toutes les informations et consignes de sécurité avant de commencer l'installation du produit. Les symboles de sécurité suivants peuvent être utilisés tout au long de cette documentation et peuvent figurer sur le produit ou sur son emballage.

ATTENTION	Indique la présence d'un risque pouvant entraîner des blessures physiques mineures ou endommager légèrement le matériel si la mise en garde n'est pas prise en compte.
AVERTISSEMENT	Indique la présence d'un risque pouvant entraîner des blessures corporelles graves si l'avertissement n'est pas pris en compte.
	Indique un risque potentiel si les informations signalées ne sont pas prises en compte.
	Indique des risques d'électrocution pouvant entraîner des blessures corporelles graves ou mortelles si les consignes de sécurité ne sont pas respectées.
	Signale des composants ou des surfaces soumis à des températures élevées.
	Indique de ne pas toucher aux pales de ventilateur, car cela peut entraîner des blessures.
	Indique de débrancher tous les cordons d'alimentation secteur pour déconnecter l'alimentation.

Domaines d'utilisation prévus

Ce produit a été testé comme équipement informatique (ITE) et peut être installé dans des bureaux, des écoles, des salles informatiques et des endroits commerciaux similaires. L'utilisation du présent produit dans des catégories et environnements de produits et domaines d'application (par exemple, le domaine médical, industriel, résidentiel, les systèmes d'alarme et les appareils de contrôle) autres qu'ITE doit faire l'objet d'évaluations supplémentaires.

Sélection d'un emplacement

Le système est conçu pour fonctionner dans un environnement standard de bureau. Choisissez un emplacement respectant les conditions suivantes :

- *Propre, sec et exempt de particules en suspension (autres que la poussière normale d'une pièce).*
- *Bien ventilé et à l'écart des sources de chaleur telles que la lumière directe du soleil et les radiateurs.*
- *À l'écart des sources de vibration ou des chocs physiques.*
- *Isolé des champs électromagnétiques importants produits par des appareils électriques.*
- *Dans les régions sujettes aux orages magnétiques, nous vous recommandons de brancher votre système à un suppresseur de surtension et de déconnecter les lignes de télécommunication de votre modem pendant les orages.*
- *Équipé d'une prise murale reliée à la terre.*
- *Équipé d'un espace suffisant pour accéder aux cordons d'alimentation secteur, car ils servent de disjoncteur principal d'alimentation du produit.*

Pratiques de manipulation de l'équipement

Réduisez le risque de dommages personnels ou matériels :

- *Conformez-vous aux exigences de médecine du travail et de sécurité lorsque vous déplacez et soulevez le matériel.*
- *Utilisez l'assistance mécanique ou toute autre assistance appropriée lorsque vous déplacez et soulevez le matériel.*
- *Pour réduire le poids en vue de faciliter la manipulation, retirez tout composant amovible.*

Alimentation et avertissements en matière d'électricité

ATTENTION

Le bouton d'alimentation, indiqué par le symbole de mise en veille, NE COUPE PAS complètement l'alimentation secteur du système car le courant de veille 5 V reste actif lorsque le système est sous tension. Pour couper l'alimentation du système, vous devez

débrancher le cordon d'alimentation secteur de la prise murale. Votre système peut utiliser plusieurs cordons d'alimentation secteur. Assurez-vous que tous les cordons d'alimentation sont débranchés. Vous devez les débrancher avant d'ouvrir le châssis, d'ajouter ou de supprimer un composant non connectable à chaud.

N'essayez pas de modifier ou d'utiliser un cordon d'alimentation secteur s'il ne s'agit pas du type exact requis. Un cordon secteur est requis pour chaque alimentation système.

Le bloc d'alimentation de ce produit ne contient aucun composant réparable par l'utilisateur. N'ouvrez pas le bloc d'alimentation. L'intérieur de celui-ci est soumis à des niveaux dangereux de tension, de courant et d'énergie. Renvoyez-le au fabricant en cas de problème.

Lorsque vous remplacez un bloc d'alimentation à chaud, débranchez le cordon du bloc d'alimentation en cours de remplacement avant de le retirer du serveur.

Pour éviter tout risque d'électrocution, mettez le système hors tension et débranchez les cordons d'alimentation ainsi que les systèmes de télécommunication, réseaux et modems reliés au système avant d'ouvrir ce dernier.

Avertissements sur le cordon d'alimentation

Si aucun cordon d'alimentation secteur n'a été fourni avec votre produit, vous devez vous en procurer un qui soit approuvé pour une utilisation dans votre pays.

ATTENTION

Pour éviter tout risque d'électrocution ou d'incendie, vérifiez les cordons d'alimentation qui seront utilisés avec le produit comme suit :

- *N'essayez pas d'utiliser ou de modifier les cordons d'alimentation en CA s'ils ne correspondent pas exactement au type requis pour les prises électriques reliées à la terre.*
- *Les cordons d'alimentation doivent répondre aux critères suivants :*
 - Le cordon d'alimentation doit supporter une intensité supérieure à celle indiquée sur le produit.*
 - Le cordon d'alimentation doit posséder une broche ou un contact de mise à la terre approprié à la prise électrique.*
- *Les cordons d'alimentation électrique représentent le principal dispositif de déconnexion raccordé à l'alimentation secteur. Les prises de courant doivent se trouver à proximité de l'équipement et être facilement accessibles pour une déconnexion.*
- *Les cordons d'alimentation doivent être branchés sur des prises électriques correctement reliées à la terre.*

Avertissements sur l'accès au système

ATTENTION

Pour éviter de vous blesser ou d'endommager votre équipement, les consignes de sécurité suivantes s'appliquent chaque fois que vous accédez à l'intérieur du produit :

- Mettez hors tension tous les périphériques connectés à ce produit.
- Éteignez le système en appuyant sur le bouton d'alimentation.
- Déconnectez l'alimentation secteur en débranchant tous les cordons d'alimentation secteur du système ou de la prise murale.
- Déconnectez l'ensemble des câbles et lignes de télécommunication qui sont connectés au système.
- Mettez toutes les vis ou autres attaches de côté lorsque vous retirez les panneaux d'accès. Une fois que vous avez terminé d'accéder à l'intérieur du produit, refixez le panneau d'accès avec les vis ou attaches d'origine.
- N'essayez pas d'accéder à l'intérieur du bloc d'alimentation. Il ne contient aucune pièce réparable. Renvoyez-le au fabricant en cas de problème.
- Mettez le serveur hors tension et débranchez tous les cordons d'alimentation avant d'ajouter ou de remplacer tout composant non connectable à chaud.
- Lorsque vous remplacez le bloc d'alimentation à chaud, débranchez le cordon du bloc d'alimentation en cours de remplacement avant de retirer le bloc du serveur.

ATTENTION

Si le serveur a été utilisé, les processeurs et dissipateurs de chaleur installés peuvent être chauds. À moins que vous n'ajoutiez ou ne retiriez un composant connectable à chaud, laissez le système refroidir avant d'ouvrir les panneaux. Pour éviter tout risque d'entrer en contact avec un composant chaud lors d'une installation à chaud, prenez toutes les précautions nécessaires lorsque vous retirez ou installez des composants connectables à chaud.

ATTENTION

Pour éviter de vous blesser, ne touchez pas les pales de ventilateur en mouvement. Si votre système est fourni avec une protection sur le ventilateur, ne mettez pas le système en route sans la protection en place.

Avertissements sur le montage en rack

Le rack doit être fixé à un support inamovible pour éviter qu'il ne bascule lors de l'extension d'un serveur ou d'un élément de l'équipement. Le rack doit être installé conformément aux instructions du fabricant.

Installez les équipements dans le rack en partant du bas, en plaçant le plus lourd en bas du rack.

N'étendez qu'un seul élément de l'équipement à partir du rack à la fois.

Vous êtes responsable de l'installation d'un disjoncteur principal d'alimentation pour la totalité du rack. Ce disjoncteur principal doit être rapidement accessible et doit être étiqueté comme contrôlant toute l'unité, et pas uniquement le ou les serveurs.

Pour éviter tout risque d'électrocution, le rack et chaque élément de l'équipement installé dans le rack doivent être correctement reliés à la terre.

Décharges électrostatiques (ESD)

ATTENTION

Les décharges électrostatiques (ESD) peuvent endommager les lecteurs de disque dur, les cartes et d'autres pièces. Il est fortement conseillé d'effectuer l'ensemble des procédures décrites à un poste de travail protégé contre les ESD. Au cas où aucun poste de ce type ne serait disponible, protégez-vous contre les ESD en portant un bracelet antistatique relié à la masse du châssis (n'importe quelle surface métallique non peinte) de votre serveur lorsque que vous manipulez les pièces.

Manipulez toujours les cartes avec précaution. Elles peuvent être extrêmement sensibles aux ESD. Ne tenez les cartes que par leurs bords. Après avoir retiré une carte de son emballage de protection ou du serveur, placez-la sur une surface reliée à la terre, exempte de charge statique, composants orientés vers le haut. Utilisez si possible un tapis de mousse conducteur, mais pas l'emballage de la carte. Veillez à ce que la carte ne glisse sur aucune surface.

Autres risques

Remplacement de la pile

ATTENTION

Il existe un risque d'explosion si la pile n'est pas correctement remplacée. Lors du remplacement de la pile, utilisez uniquement celle recommandée par le fabricant du matériel.

Mettez la pile au rebut en vous conformant aux réglementations locales.

N'essayez pas de recharger une pile.

N'essayez pas de démonter, de percer ou d'endommager la pile d'une quelconque façon.

Refroidissement et ventilation

ATTENTION

Routez les câbles avec précaution comme indiqué pour minimiser les blocages de circulation d'air et les problèmes de refroidissement.

Safety Information

Afin de permettre une ventilation et un refroidissement corrects, ne mettez le système en marche que lorsque les panneaux du châssis sont en place. L'utilisation du système sans les panneaux peut endommager les composants système. Pour installer les panneaux :

- 1. Vérifiez tout d'abord que vous n'avez pas oublié d'outils ou de composants détachés à l'intérieur du système.*
- 2. Vérifiez que les câbles, les cartes d'extension et les autres composants sont correctement installés.*
- 3. Fixez les panneaux au châssis en suivant les instructions du produit.*

Périphériques laser



ATTENTION

Pour éviter tout risque d'exposition aux rayonnements et/ou de dommage personnel :

N'ouvrez pas l'enceinte d'un périphérique laser.

Les périphériques laser ne sont pas réparables par l'utilisateur.

Retournez-les au fabricant en cas de problème.

Español

Información de seguridad del servidor

Este documento se aplica a las tarjetas de servidor de Intel[®], las carcasas de servidor de Intel[®] (montaje en bastidor y en pedestal) y los dispositivos periféricos. Para reducir el riesgo de daños corporales, descargas eléctricas, fuego y en el equipo, lea este documento y preste atención a todas las advertencias y precauciones de esta guía antes de instalar o mantener el producto de servidor de Intel[®].





En el caso de que haya diferencias entre la información para un producto en particular contenida en este documento y la información proporcionada con dicho producto o en el sitio Web, la documentación del producto es la que prevalece.

Sólo personal técnico cualificado debe montar y prestar los servicios para el servidor.

Debe ceñirse a las directrices de esta guía y a las instrucciones de montaje de los manuales del servidor para asegurar y mantener el cumplimiento con las certificaciones y homologaciones existentes de los productos. Utilice sólo los componentes descritos y homologados que se especifican en esta guía. El uso de otros productos o componentes anulará la homologación UL y otras certificaciones oficiales del producto, pudiendo dejar de ser compatible con las normativas locales de los países en los que se comercializa.

Advertencias y precauciones sobre seguridad

Para reducir la posibilidad de que se produzcan lesiones personales o daños en la propiedad, antes de empezar a instalar el producto, lea, observe y cumpla toda la información e instrucciones de seguridad siguientes. Puede que se utilicen los siguientes símbolos de seguridad en la documentación y es posible que aparezcan en el producto o en su embalaje.

PRECAUCIÓN	Indica la existencia de un riesgo que podría causar lesiones personales o daños en la propiedad leves si no se tiene en cuenta la PRECAUCIÓN.
ADVERTENCIA	Indica la existencia de un riesgo que podría causar lesiones personales graves si no se tiene en cuenta la ADVERTENCIA.
	Indica un riesgo potencial si no se tiene en cuenta la información indicada.
	Indica riesgo de descargas eléctricas que podrían causar lesiones graves o la muerte si no se siguen las instrucciones de seguridad.
	Indica componentes o superficies calientes.
	Indica que no se deben tocar las aspas de los ventiladores, ya que de lo contrario se podrían producir lesiones.
	Indica que es necesario desenchufar los cables de alimentación de CA para desconectar la alimentación de CA

Aplicaciones y usos previstos

Este producto ha sido evaluado como equipo de tecnología informática (ITE) que puede instalarse en oficinas, escuelas, salas de equipos informáticos o lugares de ámbito comercial similares. Es posible que sea necesario llevar a cabo una evaluación adicional para comprobar si este producto es apropiado para otras categorías de productos y entornos además de las aplicaciones informáticas (por ejemplo, soluciones médicas, industriales, residenciales, sistemas de alarma y equipos de pruebas).

Selección de la ubicación

El sistema se ha diseñado para funcionar en un entorno normal de oficinas. Seleccione una ubicación que esté:

- *Limpia, seca y libre de macropartículas en suspensión en el aire (que no sean el polvo habitual de la habitación).*
- *Bien ventilada y alejada de fuentes de calor, incluida la luz solar directa y los radiadores.*
- *Alejada de fuentes de vibración o de golpes físicos.*
- *Aislada de campos electromagnéticos producidos por dispositivos eléctricos.*
- *En zonas propensas a tormentas eléctricas, se recomienda que conecte el servidor a un supresor de sobretensiones y desconecte las líneas de telecomunicaciones al módem durante una tormenta eléctrica.*
- *Provista de una toma de corriente alterna correctamente conectada a tierra.*
- *Provista de espacio suficiente para acceder a los cables de la fuente de alimentación ya que constituyen la desconexión principal de la alimentación.*

Manipulación del equipo

Reduzca el riesgo de daños personales o en el equipo:

- *Respete los requisitos de sanidad y seguridad laborales de su país cuando traslade y levante el equipo.*
- *Utilice medios mecánicos u otros que sean adecuados al trasladar o levantar el equipo.*
- *Para que el peso sea menor para manipularlo con más facilidad, extraiga los componentes que sean de fácil extracción.*

Advertencias de alimentación y eléctricas



PRECAUCIÓN

El botón de encendido, indicado con la marca del modo de reposo o stand-by, NO DESCONECTA completamente la alimentación de CA del sistema, ya que el modo de reposo de 5 V sigue activo mientras el sistema está enchufado. Para desconectar el sistema debe desenchufar el cable de alimentación de CA de la toma de la pared. Puede usar más de un cable de alimentación de CA con el sistema. Asegúrese de que todos los cables de alimentación de CA están desenchufados. Asegúrese de que los cables de

alimentación de CA estén desenchufado antes de abrir la carcasa, agregar o extraer cualquier componente que no es de conexión en funcionamiento.

No intente modificar ni utilizar un cable de alimentación de CA si no es del tipo exacto requerido. Se necesita un cable de CA para cada fuente de alimentación del sistema. La fuente de alimentación de este producto no contiene piezas que puedan ser reparadas por el usuario. No abra la fuente de alimentación. Dentro de la fuente de alimentación puede haber niveles de tensión, corriente y energía peligrosos. Devuélvala al fabricante para repararla.

Al reemplazar una fuente de alimentación de conexión en funcionamiento, desenchufe el cable de alimentación de la fuente de alimentación que va a reemplazar antes de extraerla del servidor.

Para evitar el riesgo de descargas eléctricas, antes de abrir el servidor, apáguelo, desconecte el cable de alimentación, los sistemas de telecomunicaciones, las redes y los módems conectados al mismo.

Advertencias sobre el cable de alimentación

Si no se ha proporcionado con el producto ningún cable de alimentación de CA, adquiera alguno cuyo uso esté aprobado en su país.

PRECAUCIÓN

Para evitar descargas eléctricas o fuego, revise los cables de alimentación que usará con el producto tal y como se describe a continuación:

- No intente modificar ni utilizar los cables de alimentación de CA si no son exactamente del modelo especificado para ajustarse a las tomas de corriente conectadas a tierra
- Los cables de alimentación deben reunir los siguientes requisitos:
 - El cable de alimentación debe disponer de una capacidad nominal de corriente eléctrica mayor que la capacidad especificada en el producto.
 - El cable de alimentación debe disponer de una patilla o contacto de conexión a tierra que sea apto para la toma de corriente.
- Los cables de la fuente de alimentación son los dispositivos de desconexión principales a la corriente alterna. El enchufe o enchufes de zócalo deben encontrarse cerca del equipo y el acceso a ellos debe poderse efectuar de forma inmediata con el fin de desconectarlos.
- Los cables de la fuente de alimentación deben estar conectados a los enchufes con una toma de tierra adecuada.

Advertencias el acceso al sistema

PRECAUCIÓN

Para evitar lesiones personales o daños en la propiedad, se aplican las siguientes instrucciones de seguridad siempre que se acceda al interior del producto:

- Apague todos los dispositivos periféricos conectados a este producto.
- Pulse el botón de alimentación para apagar el sistema.

- *Desconecte la alimentación de CA desenchufando los cables de alimentación de CA del sistema o de la toma de corriente alterna.*
- *Desconecte todos los cables y líneas de telecomunicación que estén conectados al sistema.*
- *Guarde todos los tornillos o elementos de fijación cuando retire las cubiertas de acceso. Cuando termine de operar en el interior del producto, vuelva a colocar los tornillos o los elementos de fijación originales de la cubierta de acceso.*
- *No acceda al interior de la fuente de alimentación. No hay elementos en la fuente de alimentación que usted pueda reparar y utilizar. Devuélvala al fabricante para repararla.*
- *Apague el servidor y desconecte todos los cables de alimentación antes de agregar o reemplazar cualquier componente que no es de conexión en funcionamiento.*
- *Al reemplazar una fuente de alimentación de conexión en funcionamiento, desenchufe el cable de alimentación de la fuente de alimentación que va a reemplazar antes de extraerla del servidor.*



PRECAUCIÓN

Si el servidor se ha estado ejecutando, los procesadores y disipadores de calor estarán recalentados. A no ser que esté instalando o extrayendo un componente de conexión en funcionamiento, deje que el sistema se enfríe antes de abrir las cubiertas. Para que no llegue a tocar los componentes que estén calientes cuando esté realizando una instalación de conexión en funcionamiento, tenga cuidado al extraer o instalar los componentes de conexión en funcionamiento.



PRECAUCIÓN

Para evitar posibles daños, no toque las aspas en movimiento de los ventiladores. Si el sistema se le ha suministrado con una protección para el ventilador, asegúrese de que cuando esté funcionando el sistema la protección esté en su sitio.

Advertencias sobre el montaje en bastidor

El bastidor del equipo se debe sujetar con un soporte fijo para evitar que se caiga cuando se extraiga un servidor o una pieza del mismo. El bastidor del equipo debe instalarse siguiendo las instrucciones del fabricante del bastidor.

Instale el equipo en el bastidor comenzando desde la parte de abajo, con el equipo más pesado en la parte inferior del bastidor.

Extraiga las piezas del equipo del bastidor de una a una.

El usuario es el responsable de la instalación de un dispositivo de desconexión de la alimentación principal para toda la unidad del bastidor. El acceso a este dispositivo de desconexión deberá ser de fácil acceso y deberán incluirse indicaciones que lo identifiquen como el control de alimentación eléctrica de toda la unidad, no sólo de los servidores.

Para evitar el riesgo de descargas eléctricas, deberá instalar una conexión a tierra apropiada para el bastidor y para cada pieza del equipo instalada en el mismo.

Descarga electrostática (ESD)

PRECAUCIÓN

Las descargas electrostáticas pueden dañar las unidades de disco, las tarjetas y otros componentes. Recomendamos que realice todos los procedimientos en una estación de trabajo protegida contra descargas electrostáticas. En caso de que no haya una disponible, protéjase de alguna forma contra las descargas llevando un brazalete antiestático conectado a la toma de tierra de la carcasa (cualquier superficie de metal que no esté pintada) del servidor cuando manipule las piezas.

Manipule siempre las tarjetas con el máximo cuidado. Pueden ser sumamente sensibles a las descargas electrostáticas. Sujételas sólo por los bordes. Una vez extraída la tarjeta de su envoltorio de protección o del servidor, colóquela con el lado de los componentes hacia arriba sobre una superficie con toma de tierra y sin carga estática. Utilice una almohadilla de espuma conductora si dispone de ella, pero nunca el envoltorio de la tarjeta. No deslice la tarjeta sobre ninguna superficie.

Otros riesgos

Sustitución de la batería

PRECAUCIÓN

Existe el peligro de explosión si la batería no se reemplaza correctamente. Al reemplazar la batería, utilice sólo la batería recomendada por el fabricante del equipo.

Deseche las baterías respetando la normativa local.

No intente recargar la batería.

No intente desmontar, pinchar o causar cualquier otro desperfecto a una batería.

Enfriamiento y circulación de aire

PRECAUCIÓN

El tendido de los cables debe realizarse cuidadosamente tal y como se le indica para reducir al mínimo los problemas de obstrucción de la ventilación y de refrigeración.

Para conseguir una refrigeración y corriente de aire adecuadas, compruebe que cuando sistema esté funcionando, las cubiertas de la carcasa están instaladas. Si utiliza el sistema sin las cubiertas, podría dañar sus componentes. Para instalar las cubiertas:

- 1. Compruebe primero que no ha dejado herramientas o piezas sueltas dentro del sistema.*
- 2. Compruebe que los cables, tarjetas adicionales y otros componentes están instalados correctamente.*
- 3. Sujete las cubiertas a la carcasa siguiendo las instrucciones del producto.*

Periféricos o dispositivos láser



PRECAUCIÓN

Para evitar el riesgo de la exposición a radiaciones o de daños personales:

No abra la caja de ningún periférico o dispositivo láser

Los periféricos o dispositivos láser no pueden ser reparados por el usuario

Haga que el fabricante los repare

简体中文

服务器安全信息

本文档适用于 Intel® 服务器主板、Intel® 服务器机箱（基座和机架固定件）和已安装的外设。为减少人身伤害、电击、火灾以及设备毁坏的危险，请在安装或维护 Intel® 服务器产品之前阅读本文档并遵循本指南中的所有警告和预防措施。





如果本文档中的信息与特定产品的随附信息或 Web 站点信息之间存在不一致，请以产品文档为准。

服务器须由合格的技术人员进行集成和维护。

必须遵守本指南的规定和服务器手册的装配指导，以确保符合现有的产品认证和审批。仅使用本指南中描述和规定的指定组件。使用其他产品/组件将使产品的 UL 认证和其他管理审批无效，并可能导致产品不符合销售地的产品法规。

安全警告与注意事项

为避免人身伤害与财产损失，安装本产品之前，请阅读以下所有安全指导和信息。下面所列的安全符号可能在整个文档中使用并可能标注于产品和/或产品包装之上。

注意	表示如果无视此“注意事项”，存在可能引起轻微人身伤害或财产损失的危险。
警告	表示如果无视此“警告”，存在可能引起严重人身伤害的危险。
	表示如果无视所示信息，即存在潜在的危险。
	表示如果不遵守安全指导，存在可导致严重伤害或死亡的电击危险。
	表示灼热组件或表面。
	表示请勿触摸风机叶片，否则可能致伤。
	表示拔下所有交流电线，断开交流电源

预期应用使用

根据评估，本产品为信息技术设备 (ITE)，可安装在办公室、学校、计算机房和类似的商业场所。本产品对于非 ITE 应用的其他产品种类和环境（如医疗、工业、住宅、报警系统和测试设备）的适用性尚有待进一步的评估。

场地选择

本系统专为在典型办公环境运行而设计。请选择符合以下条件的地点：

- 清洁、干燥，无气载微粒（而非一般的室内尘埃）。
- 通风良好，远离热源（包括直接日晒和散热器）。
- 远离振动源或物理震动。
- 与电气设备产生的强大电磁场隔离。
- 在易受闪电袭击的地区，我们建议将系统插入电涌抑制器并在闪电期间断开通信线路与调制解调器之间的连接。
- 提供正确接地的墙壁插座。
- 提供足够的空间，以便拿取电源供应线，因为这是本产品的主要电源断开器。

设备操作规范

减少人身伤害或设备受损的危险：

- 移举设备时遵守当地的职业健康与安全要求。
- 借助机械手段或其他合适的手段移举设备。
- 拆除一切易分离组件，以降低重量并方便操作。

电源与电气警告

注意事项

电源按钮（如待机电源标记所示）并不能完全关闭系统的交流电源，只要系统已接通电源，就存在 5V 待机电源。要从系统切断电源，须从墙壁电源插座中拔下交流电线。您的系统可能不止使用一根交流电线。请确保所有的交流电线都已拔下。打开机箱或增加或去除任何热插拔组件之前，确保交流电线已拔下。

若非所需的确切类型，请勿尝试修改或使用交流电线。系统的每个电源供应设备都需要一根单独的交流电线。

本产品的电源供应设备包含非用户维修部件。请勿打开电源供应设备。电源供应设备包含非常危险的电压级、电流级和能量级。请与生产商联系维修事宜。

替换热插拔电源供应设备时，请先拔下需替换的电源供应设备上的电源线，再将其从服务器上移除。

为避免电击，请在打开服务器之前，关闭服务器并断开服务器上连接的电源线、电信系统、网络和调制解调器。

电源线警告

如果产品未提供交流电线，请购买一根您所在国家批准使用的交流电线。

注意事项

为避免电击或火灾危险，请按如下所述对产品所用的电源线进行检查：

- 若非所需的符合接地插座的确切类型，请勿尝试修改或使用交流电线
- 电源线须符合以下标准：
 - 电源线电气额定值须大于产品上标注的电流额定值。
 - 电源线须拥有适合插座的安全接地插头或触点。
- 电源线为交流电源的主要断开设备。插座须靠近设备并可随时断开。
- 电源线须插入所提供的拥有合适接地的插座。

系统使用警告

注意事项

为避免人身伤害或财产损失，无论何时检查产品内部，以下安全指导都适用：

- 关闭所有与本产品相连的外设。
- 按下电源按钮至关闭状态，关闭系统。
- 从系统或墙壁插座上拔下所有交流电线，断开交流电源。
- 断开与系统相连的所有线缆和通信线路。
- 卸除舱口盖时，保留所有螺钉及其他紧固件。完成产品内部检查之后，请用螺钉或紧固件重新固定舱口盖。
- 请勿打开电源供应设备。电源供应设备内没有可维修部件。请与生产商联系维修事宜。
- 增加或替换任何非热插拔组件之前，请关闭服务器电源并断开所有电源线。
- 替换热插拔电源供应设备时，请先拔下需替换的电源供应设备上的电源线，然后再从服务器上移除电源供应设备。

注意事项

如果服务器一直在运行，任何已安装的处理器和吸热设备都可能很热。除非要增加或移除热插拔组件，否则请待系统冷却后再开盖。为避免在热插拔组件安装过程中接触灼热组件，移除或安装热插拔组件时务必小心。

注意事项

为避免受伤，请勿触摸运转的风机叶片。如果系统的风机上配有防护装置，请勿卸下风机防护装置运行系统。

机架固定件警告

设备的机架须固定在稳固的支座上，以防从中安装服务器或设备时倒塌。须按照机架生产商提供的安装说明进行安装。

从下往上将设备安装在机架上，最重的设备安装在机架的最底层。

一次只从机架上安装一件设备。

您须负责安装整个机架装置的主要电源断开设备。此主要断开设备须随时可用，且须标明为控制整个装置（而不仅限于服务器）的电源。

为避免潜在的电击危险，须对机架及其上所安装的每一件设备实行正确的安全接地。

静电放电 (ESD)

注意事项

ESD 会损坏磁盘驱动器、主板及其他部件。我们建议您执行 ESD 工作站的所有步骤。如果没有 ESD 工作站，则采取一些静电放电保护措施，操作部件时，戴上与服务器上的机箱接地或任何未喷漆金属表面连接的防静电腕带。

操作主板时始终保持小心。它们可能对 ESD 非常敏感。拿持主板时只接触边缘。从保护包装中或从服务器上取出主板后，请将主板组件侧面朝上放置在不带电的接地表面上。请使用导电泡沫垫（若有），不要使用主板包装。请勿将主板在任何表面上滑动。

其他危险

替换电池

注意事项

不正确替换电池可能导致爆炸危险。替换电池时，请只使用设备生产商推荐使用的电池。

请按当地法规处置电池。

请勿对电池充电。

请勿拆卸、刺穿或以其他方式损坏电池。

冷却和气流

注意事项

按照说明小心布置线缆，尽量减少气流阻塞和冷却问题。

为保证适当的冷却和气流，运行系统时请确保机箱盖已安装。未安装机箱盖即运行系统可能导致系统部件受损。安装机箱盖的步骤如下：

首先检查并确保系统内没有遗留的未固定工具或部件。

1. 检查线缆、内插板和其他组件已正确安装。
2. 按产品说明安装机箱盖。

激光外设或激光设备

注意事项

为避免幅射暴露和/或人身伤害：

请勿打开任何激光外设或激光设备的外壳

激光外设或激光设备为非用户维修设备

请与生产商联系维修事宜