



# Intel® Server System R1000RP Family

## *Technical Product Specification*

*Intel order number: G91532-003*



**Revision 2.0**

**June 2015**

---

## *Revision History*

Date	Revision Number	Modifications
April 2013	1.0	Initial release.
May 2013	1.1	Added a new system Intel® Server System R1304RPMSHOR.
May 2013	1.2	Removed the system Intel® Server System R1304RPOSHOR.
February 2014	1.3	Corrected the name of Intel® RAID Activation Key as RKSATA4R5.
June 2015	2.0	Added support for Intel® Xeon® processor E3-1200 V4 product family.

## *Disclaimers*

INFORMATION IN THIS DOCUMENT IS PROVIDED IN CONNECTION WITH INTEL PRODUCTS. NO LICENSE, EXPRESS OR IMPLIED, BY ESTOPPEL OR OTHERWISE, TO ANY INTELLECTUAL PROPERTY RIGHTS IS GRANTED BY THIS DOCUMENT. EXCEPT AS PROVIDED IN INTEL'S TERMS AND CONDITIONS OF SALE FOR SUCH PRODUCTS, INTEL ASSUMES NO LIABILITY WHATSOEVER AND INTEL DISCLAIMS ANY EXPRESS OR IMPLIED WARRANTY, RELATING TO SALE AND/OR USE OF INTEL PRODUCTS INCLUDING LIABILITY OR WARRANTIES RELATING TO FITNESS FOR A PARTICULAR PURPOSE, MERCHANTABILITY, OR INFRINGEMENT OF ANY PATENT, COPYRIGHT OR OTHER INTELLECTUAL PROPERTY RIGHT.

A "Mission Critical Application" is any application in which failure of the Intel Product could result, directly or indirectly, in personal injury or death. SHOULD YOU PURCHASE OR USE INTEL'S PRODUCTS FOR ANY SUCH MISSION CRITICAL APPLICATION, YOU SHALL INDEMNIFY AND HOLD INTEL AND ITS SUBSIDIARIES, SUBCONTRACTORS AND AFFILIATES, AND THE DIRECTORS, OFFICERS, AND EMPLOYEES OF EACH, HARMLESS AGAINST ALL CLAIMS COSTS, DAMAGES, AND EXPENSES AND REASONABLE ATTORNEYS' FEES ARISING OUT OF, DIRECTLY OR INDIRECTLY, ANY CLAIM OF PRODUCT LIABILITY, PERSONAL INJURY, OR DEATH ARISING IN ANY WAY OUT OF SUCH MISSION CRITICAL APPLICATION, WHETHER OR NOT INTEL OR ITS SUBCONTRACTOR WAS NEGLIGENT IN THE DESIGN, MANUFACTURE, OR WARNING OF THE INTEL PRODUCT OR ANY OF ITS PARTS.

Intel may make changes to specifications and product descriptions at any time, without notice. Designers must not rely on the absence or characteristics of any features or instructions marked "reserved" or "undefined". Intel reserves these for future definition and shall have no responsibility whatsoever for conflicts or incompatibilities arising from future changes to them. The information here is subject to change without notice. Do not finalize a design with this information.

The products described in this document may contain design defects or errors known as errata which may cause the product to deviate from published specifications. Current characterized errata are available on request.

Contact your local Intel sales office or your distributor to obtain the latest specifications and before placing your product order.

Copies of documents which have an order number and are referenced in this document, or other Intel literature, may be obtained by calling 1-800-548-4725, or go to: <http://www.intel.com/design/literature>.

## *Table of Contents*

<b>1. Introduction .....</b>	<b>1</b>
1.1 Chapter Outline .....	1
1.2 Server Board Use Disclaimer .....	1
<b>2. Product Overview .....</b>	<b>2</b>
2.1 System Views.....	4
2.2 System Dimensions.....	5
2.3 System Level Environmental Limits.....	5
2.4 System Features and Options Overview .....	7
2.4.1 Hot Swap Hard Drive Bay and Front Panel Options .....	7
2.4.2 Back Panel Features.....	8
2.4.3 Front Control Panel Options .....	8
2.5 Server Board Overview .....	9
2.5.1 Rear Component View .....	11
2.6 Available Front Bezel Support (Optional).....	11
2.7 Available Rack and Cabinet Mounting Kit Options.....	12
<b>3. Power Subsystem.....</b>	<b>13</b>
3.1 350W Fixed Power Supply .....	13
3.1.1 Mechanical Overview .....	13
3.1.2 Power Supply Module Efficiency .....	14
3.1.3 Power Cord Specification Requirements .....	14
3.1.4 AC Input Requirement.....	15
3.1.5 DC Output Specification .....	18
3.1.6 Protection Circuits .....	18
3.2 450W mini-ERPS Redundant Power Supply .....	19
3.2.1 Mechanical Overview .....	20
3.2.2 Power Supply Module Card Edge Connector .....	21
3.2.3 Power Supply Module Efficiency .....	22
3.2.4 Power Cord Specification Requirements .....	22
3.2.5 AC Input Requirement.....	22
3.2.6 DC Output Specification .....	26
3.2.7 Protection Circuits .....	26
<b>4 Thermal Management.....</b>	<b>28</b>
4.1 Thermal Operation and Configuration Requirements.....	28
4.2 Thermal Management Overview .....	29
4.2.1 Set Throttling Mode .....	29
4.2.2 Altitude.....	30
4.2.3 Set Fan Profile .....	30
4.2.4 Fan PWM Offset.....	30
4.2.5 Quiet Fan Idle Mode.....	30

4.2.6	Thermal Sensor Input for Fan Speed Control .....	30
4.3	System Fans .....	32
4.4	FRUSDR Utility .....	34
<b>5</b>	<b>System Storage and Peripheral Options.....</b>	<b>35</b>
5.1	2.5" Hard Disk Drive Support.....	35
5.1.1	2.5" Drive Hot-Swap Backplane Overview.....	36
5.1.2	Cypress* CY8C22545 Enclosure Management Controller.....	37
5.2	3.5" Hard Disk Drive Support.....	37
5.2.1	3.5" Drive Hot-Swap Backplane Overview.....	38
5.2.2	Cypress* CY8C22545 Enclosure Management Controller.....	39
5.3	SATA DOM Support.....	39
<b>6</b>	<b>Storage Controller Options Overview .....</b>	<b>40</b>
6.1	Embedded SATA Controller Support.....	40
<b>7</b>	<b>Front Control Panel and I/O Panel Overview .....</b>	<b>41</b>
7.1	I/O Panel Features .....	41
7.2	Control Panel Features .....	41
<b>8</b>	<b>Intel® Local Control Panel .....</b>	<b>46</b>
8.1	LCD Functionality.....	46
8.2	Main Menu .....	47
8.3	Event Menu.....	48
8.4	View Menu .....	48
8.4.1	System FW Version (SysFwVer) .....	48
8.4.2	System Information (SysInfo) .....	49
8.4.3	BMC IP Configuration.....	49
8.4.4	RMM4 IP Configuration .....	49
8.4.5	Power.....	50
8.4.6	Last Post Code (Last PC).....	50
8.5	Config Menu.....	50
8.5.1	IP Version .....	50
8.5.2	BMC IP.....	50
8.5.3	RMM4 IP.....	52
8.5.4	Boot Device.....	52
8.5.5	Banner .....	52
<b>9</b>	<b>PCIe Support and Riser Card Support .....</b>	<b>54</b>
9.1	Architectural Overview of the Server Board Riser Slots.....	54
<b>Appendix A: Integration and Usage Tips .....</b>		<b>57</b>
<b>Appendix B: POST Code LED Decoder .....</b>		<b>58</b>
<b>Appendix C: POST Code Errors.....</b>		<b>63</b>
<b>Glossary .....</b>		<b>69</b>
<b>Reference Documents .....</b>		<b>72</b>

## *List of Figures*

Figure 1. Product Drawing .....	2
Figure 2. System Photo.....	4
Figure 3. Chassis Dimension .....	5
Figure 4. System Components Overview .....	7
Figure 5. 3.5" Hard Drive Bay - 4 Drive Configuration .....	7
Figure 6. 2.5" Hard Drive Bay - 8 Drive Configuration .....	7
Figure 7. Back Panel Feature Identification (Redundant Power Supply as Shown) .....	8
Figure 8. Front Control Panel Options.....	8
Figure 9. Intel® Server Board S1200V3RPS.....	9
Figure 10. Intel® Server Board S1200V3RPO and S1200V3RPM .....	10
Figure 11. Intel® Server Board S1200V3RP Rear Components.....	11
Figure 12. Optional Front Bezel .....	11
Figure 13. Installing Front Bezel.....	12
Figure 14. 350W AC Power Supply Unit Enclosure Drawing .....	14
Figure 15. AC Power Cord .....	15
Figure 16. 450W AC PSU with PDB.....	20
Figure 17. 450W AC Power Supply Unit Dimension Overview .....	20
Figure 18. 450W AC Power Supply – Connector View.....	21
Figure 19. 450W Power Supply Module Output Power Connector .....	21
Figure 20. AC Power Cord .....	22
Figure 21. Fan Control Model.....	31
Figure 22. System Fan Identification .....	32
Figure 23. Removing a System Fan.....	32
Figure 24. Server Board System Fan Connector Locations.....	33
Figure 25. 2.5" Hard Drive Bay Drive Configuration .....	35
Figure 26. LED of HDD Carrier .....	35
Figure 27. The Front Side of 8 X 2.5" Hot Swap Backplane .....	36
Figure 28. The Back Side of 8 X 2.5" Hot Swap Backplane.....	36
Figure 29. 3.5" Hard Drive Bay Configuration.....	37
Figure 30. LED of HDD Carrier .....	37
Figure 31. The Front Side of 4 x 3.5" Hot Swap Backplane .....	38
Figure 32. The Back Side of 4 x 3.5" Hot Swap Backplane .....	38
Figure 33. InnoDisk* Low Profile SATA DOM.....	39
Figure 34. SATA_KEY Place.....	40
Figure 35. Front I/O Panel Features.....	41
Figure 36. Front Control Panel Features .....	42
Figure 37. Intel® Local Control Panel Option .....	46
Figure 38. LCP Background Color during Normal Operation .....	47
Figure 39. LCP Background Color during an Error .....	47

Figure 40. LCP Main Menu .....	47
Figure 41. LCP Event Menu .....	48
Figure 42. LCP View Menu .....	48
Figure 43. System Firmware Versions Menu.....	48
Figure 44. System Information Menu .....	49
Figure 45. LCP – BMC IP Configuration.....	49
Figure 46. LCP – RMM4 IP Configuration .....	50
Figure 47. LCP – Power Consumed by the System Currently .....	50
Figure 48. LCP – Last BIOS Post Code .....	50
Figure 49. LCP – Configure Menu Items .....	50
Figure 50. LCP – IP Version Configuration Screen .....	50
Figure 51. LCP – BMC IP Configuration Menu .....	51
Figure 52. LCP – BMC IP Source Configuration Menu .....	51
Figure 53. Screen Shot for Configuring IP Address, Subnet Mask, and Gateway.....	51
Figure 54. State Transition Diagram for Setting IP Address .....	52
Figure 55. Boot options Configuration Menu .....	52
Figure 56. Banner Configuration Menu .....	53
Figure 57. PCIe SLOT Drawing.....	55
Figure 58. 1U Riser Card Drawing .....	56
Figure 59. Diagnostic LED Location .....	58

## *List of Tables*

Table 1. System Feature Set.....	2
Table 2. System SKU Matrix .....	4
Table 3. System Environmental Limits Summary .....	5
Table 4. Output Load for Efficiency Test .....	14
Table 5. AC Power Cord Specifications .....	14
Table 6. Power Factor.....	15
Table 7. AC Input Voltage Range.....	15
Table 8. AC Line Sag Transient Performance .....	16
Table 9. AC Line Surge Transient Performance .....	17
Table 10. Performance Criteria .....	17
Table 11. Output Current Requirements.....	18
Table 12. Over Load Protection (OCP) Limits .....	19
Table 13. Over Voltage Protection (OVP) Limits .....	19
Table 14. 450W Power Supply Module Output Power Connector Pin-out .....	21
Table 15. 450WAC Power Supply Efficiency.....	22
Table 16. AC Power Cord Specifications.....	22
Table 17. AC Input Voltage Range.....	23
Table 18. AC Line Sag Transient Performance .....	24
Table 19. AC Line Surge Transient Performance .....	24
Table 20. Performance Criteria .....	25
Table 21. Load Ratings .....	26
Table 22. Over Current Limits .....	26
Table 23. Over Voltage Protection (OVP) Limits .....	27
Table 24. System Fan Connector Pin-out.....	34
Table 25. Drive Status LED States.....	35
Table 26. Drive Activity LED States.....	36
Table 27. System Status LED State Definitions.....	43
Table 28. Power/Sleep LED Functional States.....	45
Table 29. PCI Express* Speed Matrix for Each Configuration .....	54
Table 30. POST Progress Code LED Example .....	58
Table 31. Diagnostic LED POST Progress Codes.....	59
Table 32. MRC Progress Codes .....	61
Table 33. MRC Fatal Error Codes .....	62
Table 34. POST Error Message and Handling .....	63
Table 35. POST Error Beep Codes .....	67
Table 36. Integrated BMC Beep Codes.....	68



<This page is intentionally left blank.>



# 1. Introduction

---

This *Technical Product Specification (TPS)* provides system specific information detailing the features, functionality, and high-level architecture of the Intel® Server System R1000RP family. You can also reference the *Intel® Server Board S1200V3RP Family Technical Product Specification* to obtain greater detail of functionality and architecture of the server board integrated in this server system.

In addition, you can obtain design-level information for specific subsystems by ordering the *External Product Specifications (EPS)* or *External Design Specifications (EDS)* for a given subsystem. EPS and EDS documents are not publicly available. They are only made available under NDA with Intel and must be ordered through your local Intel representative. For a complete list of available documents, refer to the *Reference Documents* section at the end of this document.

The Intel® Server System R1000RP may contain design defects or errors known as errata which may cause the product to deviate from published specifications. Refer to the *Intel® Server Board S1200V3RP / Intel® Server System R1000RP Specification Update* for published errata.

## 1.1 Chapter Outline

This document is divided into the following chapters:

- Chapter 1 – Introduction
- Chapter 2 – Product Overview
- Chapter 3 – Power Subsystem
- Chapter 4 – Thermal Management
- Chapter 5 – System Storage and Peripheral Options
- Chapter 6 – Storage Controller Options Overview
- Chapter 7 – Front Control Panel and I/O Panel Overview
- Chapter 8 – Intel® Local Control Panel
- Chapter 9 – PCIe Support and Riser Card Support
- Appendix A – Integration and Usage Tips
- Appendix B – POST Code LED Decoder
- Appendix C – POST Code Errors
- Glossary
- Reference Documents

## 1.2 Server Board Use Disclaimer

Intel Corporation server boards support add-in peripherals and contain a number of high-density VLSI and power delivery components that need adequate airflow to cool. Intel ensures through its own chassis development and testing that when Intel® server building blocks are used together, the fully integrated system will meet the intended thermal requirements of these components. It is the responsibility of the system integrator who chooses not to use Intel developed server building blocks to consult vendor datasheets and operating parameters to determine the amount of air flow required for their specific application and environmental conditions. Intel Corporation cannot be held responsible if components fail or the server board does not operate correctly when used outside any of their published operating or non-operating limits.

## 2. Product Overview

This generation of Intel® 1U server platforms offers a variety of system options to meet the entry level computing. The Intel® Server System R1000RP product family is comprised of several available 1U rack mount server systems that are all integrated with an Intel® Server Board S1200V3RPS, S1200V3RPO, or S1200V3RPM.

This chapter provides a high-level overview of the system features. The following chapters provide greater detail for each major system component or feature.

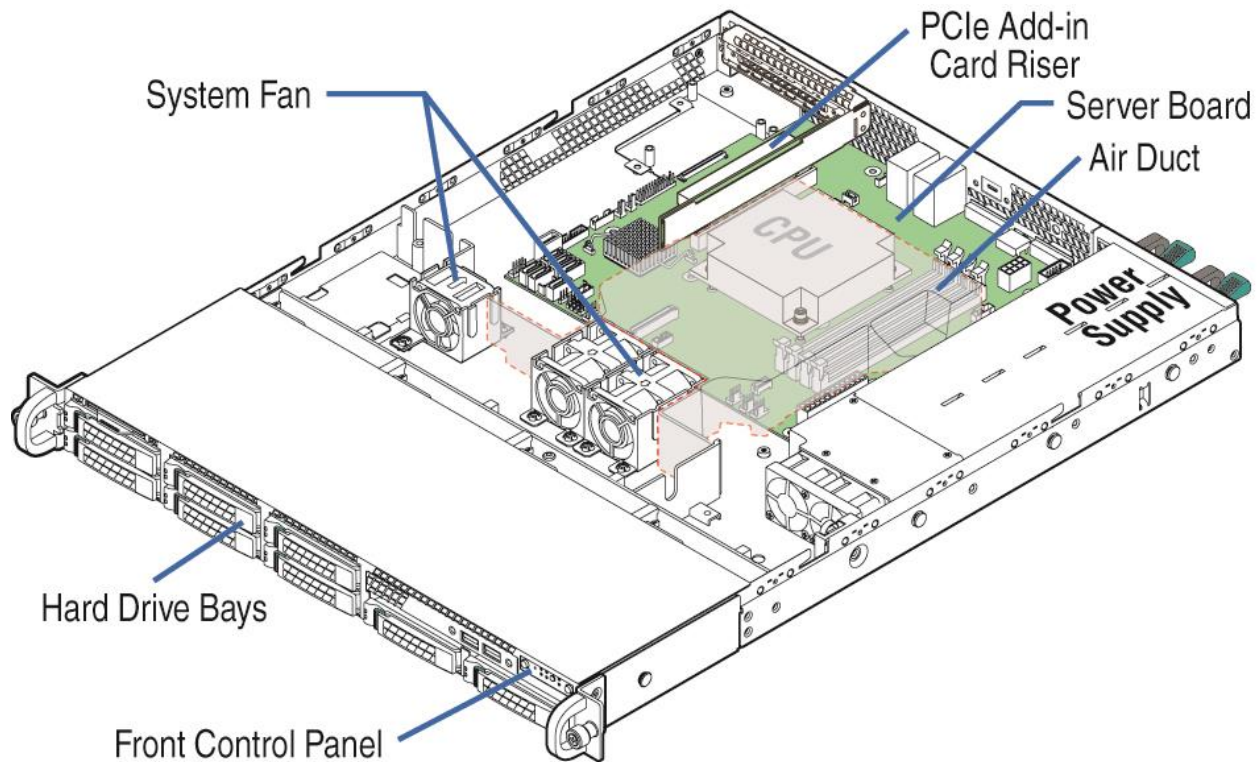

AF006168

**Figure 1. Product Drawing**

**Table 1. System Feature Set**

Feature	Description
Processor	<ul style="list-style-type: none"> <li>Support for one Intel® Xeon® processor E3-1200 V3 processor and Intel® Xeon® processor E3-1200 V4 product family (only support Intel® C226 Platform Controller Hub (PCH) chipset) in an LGA 1150 Socket H3 package with Thermal Design Power up to 95W.</li> <li>5 GT/s point-to-point DMI 2.0 interface to PCH.</li> </ul>
Memory	<ul style="list-style-type: none"> <li>Two memory channels, four memory DIMMs (Two memory DIMMs per channel).</li> <li>Support for 1333/1600 MT/s Unbuffered (UDIMM DDR3L ECC memory).</li> <li>No support for RDIMMs.</li> <li>No support for SODIMMs.</li> <li>No support for mixing ECC and non-ECC UDIMMs.</li> </ul>
Chipset	<ul style="list-style-type: none"> <li><b>S1200V3RPS</b> supports for Intel® C222 Platform Controller Hub (PCH) chipset.</li> <li><b>S1200V3RPO</b> supports for Intel® C224 Platform Controller Hub (PCH) chipset.</li> <li><b>S1200V3RPM</b> supports for Intel® C226 Platform Controller Hub (PCH) chipset.</li> </ul>

Feature	Description																				
System Connectors /Headers	<p>External I/O connectors:</p> <ul style="list-style-type: none"> <li>DB9 serial port A connection.</li> <li>One DB-15 video connector.</li> <li>Two RJ-45 NIC connectors for 10/100/1000 Mb connections through the two Intel® Ethernet Controller I210.</li> <li>Two USB 3.0 ports at the back of the board.</li> <li>Two USB 2.0 ports at the back of the board.</li> </ul> <p>Internal connectors/headers:</p> <ul style="list-style-type: none"> <li>One 2x10 pin USB 3.0 header, providing front panel support for two USB ports respectively on S1200V3RPO/S1200V3RPM.</li> <li>One 2x5 pin USB 2.0 headers, providing front panel support for two USB ports respectively.</li> <li>One internal 2x5 pin serial port B header.</li> <li>One internal Type-A USB 2.0 port.</li> <li>One 9 pin USB header for eUSB SSD.</li> <li>One 1x7 pin header for optional Intel® Local Control Panel support.</li> <li>One combined header consists of a 24-pin SSI-EEB compliant front panel header.</li> </ul>																				
System Fan Support	<p>Support for:</p> <ul style="list-style-type: none"> <li>One processor fan (4-pin header).</li> <li>Three front system fans (4-pin headers).</li> </ul>																				
Add-in Adapter Support	<p>Four expansion slots at most:</p> <ul style="list-style-type: none"> <li>Slot 7: PCI Express* Gen2 x1 electrical with x8 physical connector, from PCH.</li> <li>Slot 6: PCI Express* Gen3 x8 electrical with x16 physical connector, from processor.</li> <li>Slot 5: PCI Express* Gen2 x8 or x4 electrical with x8 physical connector, from processor.</li> <li>Slot 4: PCI Express* Gen2 x4 electrical with x8 physical connector, from PCH.</li> </ul> <p style="text-align: center;"><b>Slot Population Per SKU</b></p> <table border="1"> <thead> <tr> <th>SKU/Slot</th> <th>Slot 4</th> <th>Slot 5</th> <th>Slot 6</th> <th>Slot 7</th> </tr> </thead> <tbody> <tr> <td>S1200V3RPS</td> <td>Yes</td> <td>Yes</td> <td>Yes</td> <td>Yes</td> </tr> <tr> <td>S1200V3RPO</td> <td>NA</td> <td>NA</td> <td>Yes</td> <td>NA</td> </tr> <tr> <td>S1200V3RPM</td> <td>NA</td> <td>NA</td> <td>Yes</td> <td>NA</td> </tr> </tbody> </table>	SKU/Slot	Slot 4	Slot 5	Slot 6	Slot 7	S1200V3RPS	Yes	Yes	Yes	Yes	S1200V3RPO	NA	NA	Yes	NA	S1200V3RPM	NA	NA	Yes	NA
SKU/Slot	Slot 4	Slot 5	Slot 6	Slot 7																	
S1200V3RPS	Yes	Yes	Yes	Yes																	
S1200V3RPO	NA	NA	Yes	NA																	
S1200V3RPM	NA	NA	Yes	NA																	
On-board Video	<ul style="list-style-type: none"> <li>Integrated 2D video controller.</li> <li>Dual monitor video mode is supported.</li> <li>16 MB DDR3 Memory.</li> <li>Only S1200V3RPM supports integrated graphics support for processors with Intel® Graphics Technology.</li> </ul>																				
Hard Disk Drive Supported	<ul style="list-style-type: none"> <li>4x 3.5-inch SATA/SAS HDD bays (SKU: R1304RPSSFBN, R1304RPOSHBN, and R1304RPMSHOR).</li> <li>8x 2.5-inch SATA/SAS HDD bays (SKU: R1208RPOSHOR and R1208RPMSHOR).</li> </ul>																				
RAID Support	<ul style="list-style-type: none"> <li>Intel® RSTe SW RAID through onboard SATA connectors provides SATA RAID 0/1/10/5.</li> <li>Intel® Embedded Server RAID Technology II through onboard SATA connectors provides SATA RAID 0/1/10 and optional RAID 5 support provided by the Intel® RAID Activation Key RKSATA4R5.</li> <li>S1200V3RPO supports one optional internal SAS module connector which supports Intel® SAS or ROC modules with the product code of RMS25CB080, RMS25JB080, RMS25CB040, and RMS25JB040.</li> </ul>																				
LAN	Two Gigabit Ethernet Ports through the two Intel® Ethernet Controller I210 PHYs.																				
System Power	<ul style="list-style-type: none"> <li>350W Fixed (SKU: R1304RPSSFBN and R1304RPOSHBN).</li> <li>450W Redundant (SKU: R1208RPOSHOR, R1304RPMSHOR, and R1208RPMSHOR).</li> </ul>																				

Feature	Description
Server Management	<ul style="list-style-type: none"> <li>▪ Integrated Baseboard Management Controller, IPMI 2.0 compliant.</li> <li>▪ Support for Intel® Remote Management Module 4 solutions (Optional except on S1200V3RPS).</li> <li>▪ Support for Intel® Remote Management Module 4 Lite solutions (Optional except on S1200V3RPS).</li> <li>▪ Support for Intel® System Management Software.</li> <li>▪ Support for Intel® Intelligent Power Node Manager (Need PMBus*-compliant power supply).</li> </ul>

Note:

The USB ports on the front are USB 2.0 ports on Intel® Server System R1304RP family. The USB ports on the front can get USB 3.0 on Intel® Server System R1304RPOSHBN/R1208RPOSHOR/R1208RPMSHOR after updating the optional USB cable. You can get the product order code from *Intel® Server Board S1200V3RP Configure Guide*.

**Table 2. System SKU Matrix**

Board SKU vs Chassis	350W Fixed	450W Redundant
3.5" HDD	R1304RPSSFBN/ R1304RPOSHBN	R1304RPMSHOR
2.5" HDD	NA	R1208RPOSHORR/1208RPMSHOR

The 3.5" HDD systems can only support 3.5" HDDs or SSD. It cannot support 2.5" HDDs.

The Intel® Server System R1000RP family are supporting Intel® Xeon® processor E3-1200 V3/V4 series with TDP 95W and below. You can find a full list of supported processors at the Intel® Support website: [https://serverconfigurator.intel.com/sct\\_private/sct\\_app.aspx](https://serverconfigurator.intel.com/sct_private/sct_app.aspx).

## 2.1 System Views



**Figure 2. System Photo**

## 2.2 System Dimensions

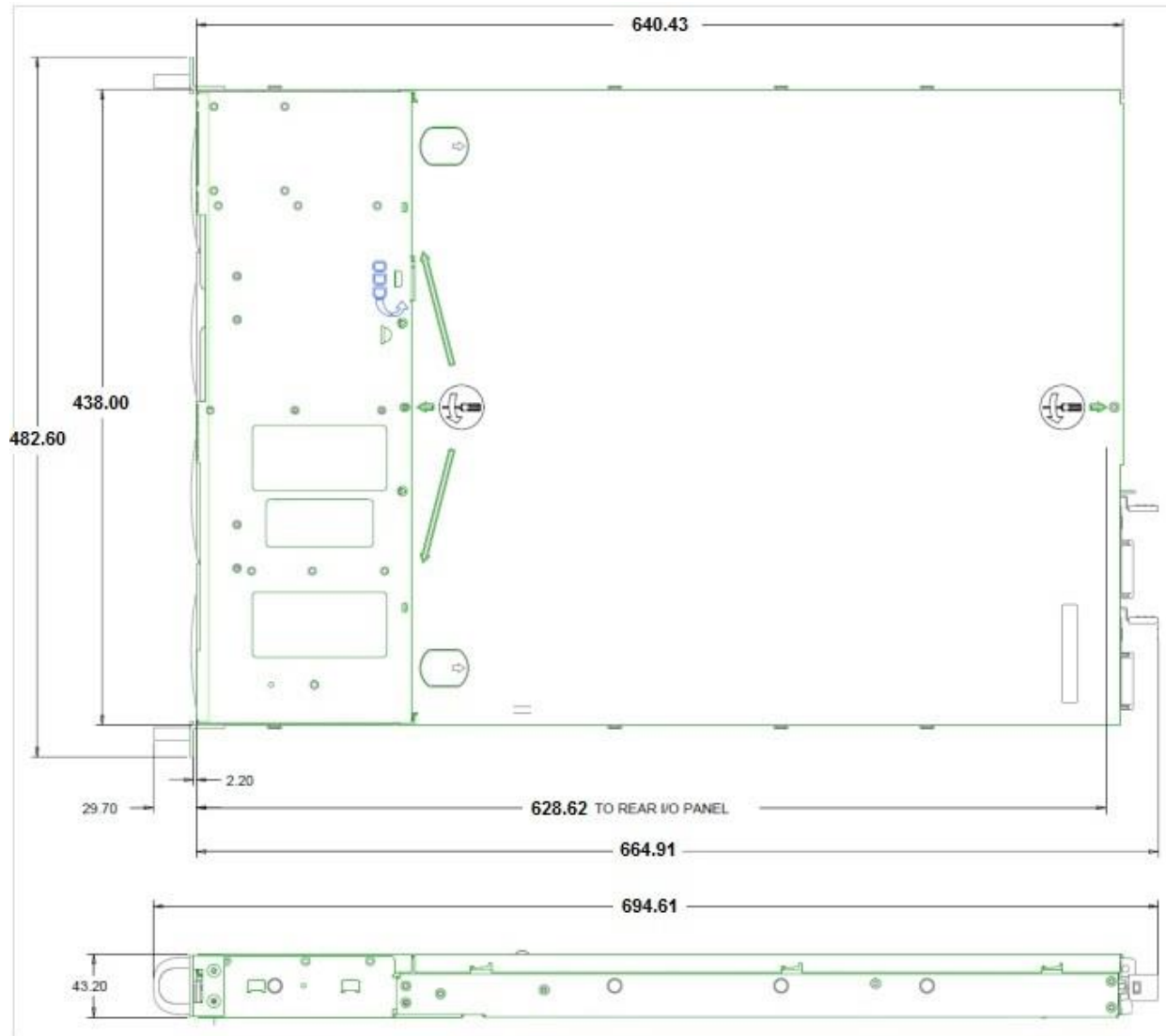

Figure 3. Chassis Dimension

## 2.3 System Level Environmental Limits

The following table defines the system level operating and non-operating environmental limits.

Table 3. System Environmental Limits Summary

Parameter		Limits
Temperature		
	Operating	ASHRAE Class A2 – Continuous Operation. 10°C to 35°C (50°F to 95°F) with the maximum rate of change not to exceed 10°C per hour.
	Shipping	-40°C to 70°C (-40°F to 158°F).
Altitude		

Parameter		Limits
	Operating	Support operation up to 3050m with ASHRAE class deratings.
Humidity		
	Shipping	50% to 90%, non-condensing with a maximum wet bulb of 28°C (at temperatures from 25°C to 35°C).
Shock		
	Operating	Half sine, <a href="#">2g</a> , 11 mSec.
	Unpackaged	Trapezoidal, <a href="#">25g</a> , velocity change is based on packaged weight.
	Packaged	Product Weight: ≥ 40 to < 80. Non-palletized Free Fall Height = 18 inches. Palletized (single product) Free Fall Height = NA.
Vibration		
	Unpackaged	5 Hz to 500 Hz 2.20 g RMS random.
	Packaged	5 Hz to 500 Hz 1.09 g RMS random.
AC-DC		
	Voltage	90 V to 132 V and 180 V to 264 V.
	Frequency	47 Hz to 63 Hz.
	Source Interrupt	No loss of data for power line drop-out of 12 mSec.
	Surge Non-operating and operating	Unidirectional
	Line to earth Only	AC Leads 2.0 kV I/O Leads 1.0 kV DC Leads 0.5 kV
ESD		
	Air Discharged	12.0 kV
	Contact Discharge	8.0 kV
Acoustics Sound Power Measured		
	Power in Watts	<300 W    ≥300 W    ≥600 W    ≥1000 W
	Servers/Rack Mount BA	7.0        7.0        7.0        7.0

**Note:**

See the *Intel® S1200V3RP Product Family Power Budget and Thermal Configuration Tool* for system configuration requirements and limitations.

---

**Disclaimer Note:** Intel ensures the unpackaged server board and system meet the shock requirement mentioned above through its own chassis development and system configuration. It is the responsibility of the system integrator to determine the proper shock level of the board and system if the system integrator chooses different system configuration or different chassis. Intel Corporation cannot be held responsible, if components fail or the server board does not operate correctly when used outside any of its published operating or non-operating limits.

---



## 2.4 System Features and Options Overview

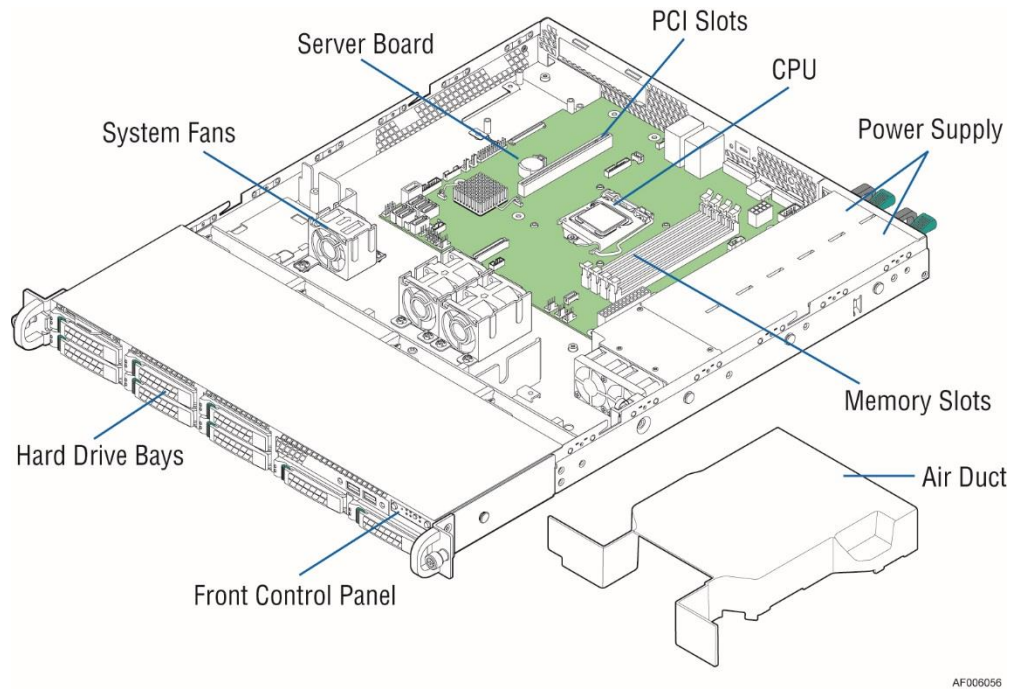

AF006056

Figure 4. System Components Overview

### 2.4.1 Hot Swap Hard Drive Bay and Front Panel Options

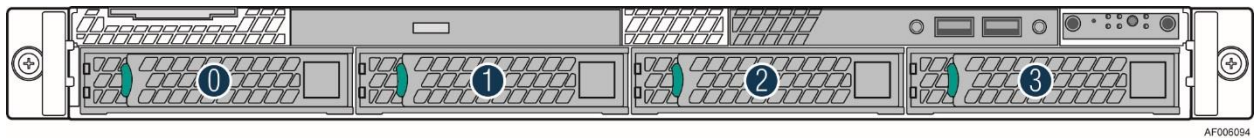

AF006094

Figure 5. 3.5" Hard Drive Bay - 4 Drive Configuration



AF006092

Figure 6. 2.5" Hard Drive Bay - 8 Drive Configuration

### 2.4.2 Back Panel Features

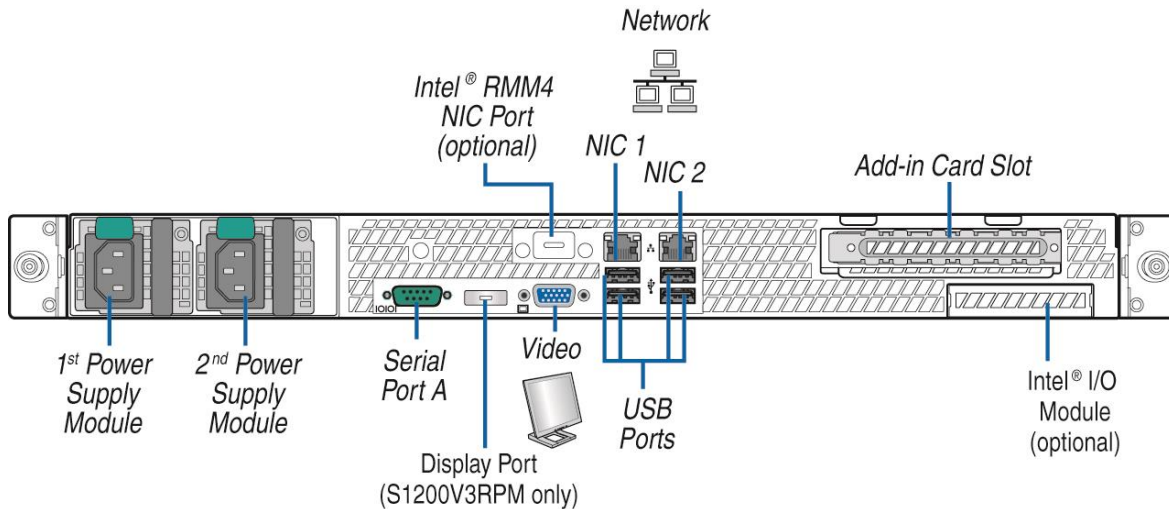

AF006079

Figure 7. Back Panel Feature Identification (Redundant Power Supply as Shown)

### 2.4.3 Front Control Panel Options

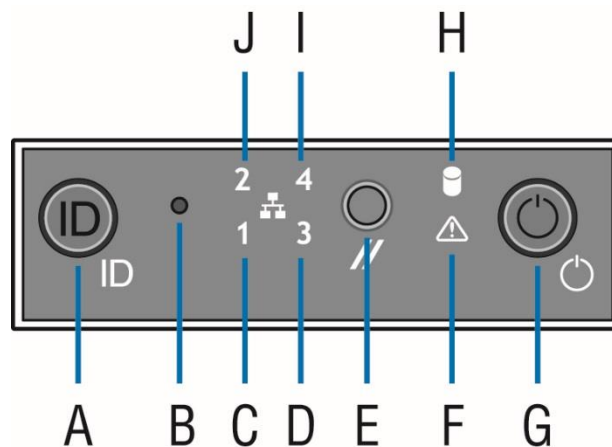

AF004065

Label	Description	Label	Description
A	System ID Button w/Integrated LED	F	System Status LED
B	NMI Button (recessed, tool required for use)	G	Power Button w/Integrated LED
C	NIC-1 Activity LED	H	Hard Drive Activity LED
D	NIC-3 Activity LED	I	NIC-4 Activity LED
E	System Cold Reset Button	J	NIC-2 Activity LED

Figure 8. Front Control Panel Options

## 2.5 Server Board Overview

The chassis is mechanically and functionally designed to the standard form factor and half width server board, including Intel® Server Board S1200V3RP. The following sections provide an overview of the server board feature sets.

The following figures show the layout of the server boards with each connector and major component identified.

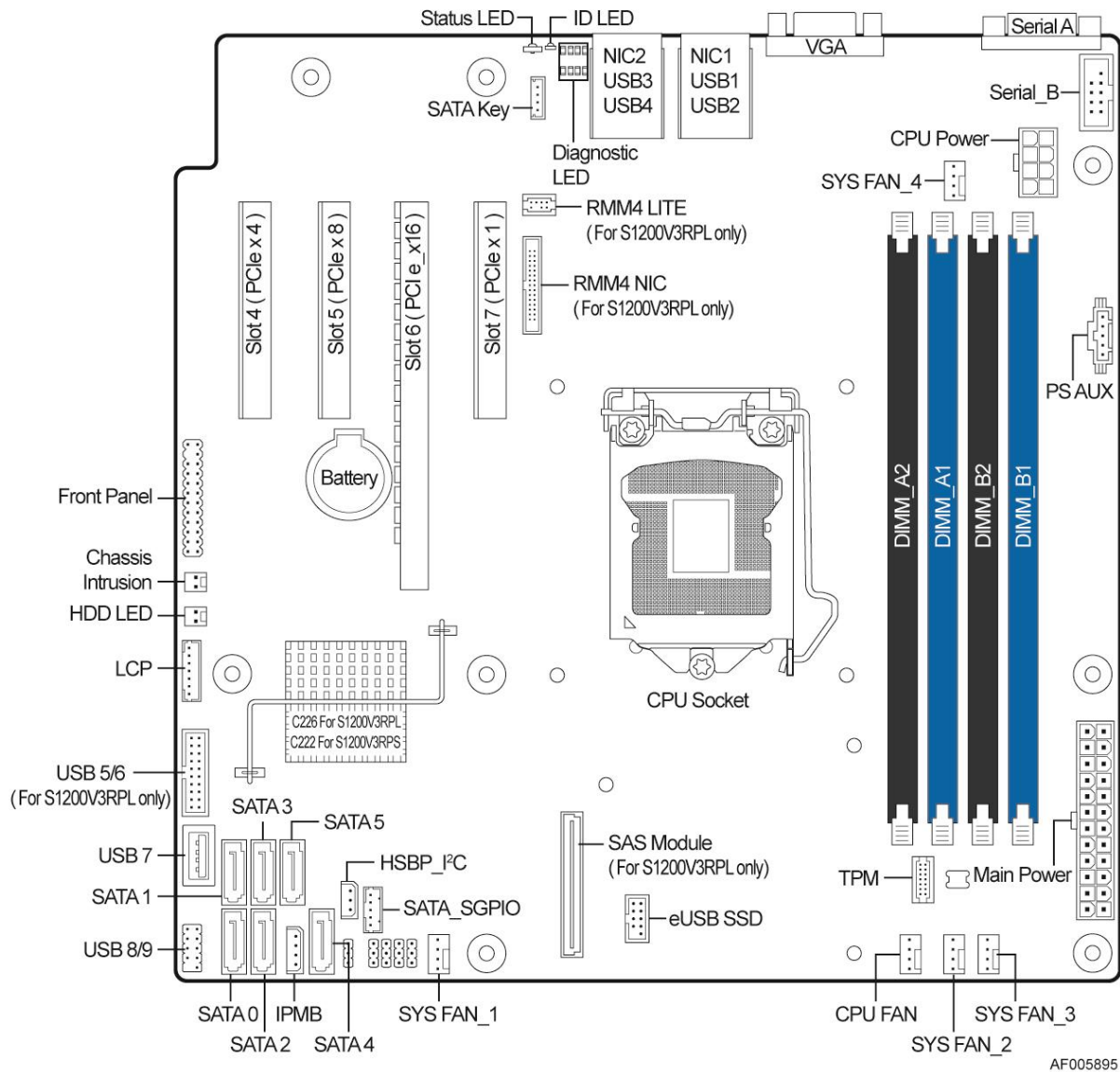

Figure 9. Intel® Server Board S1200V3RPS

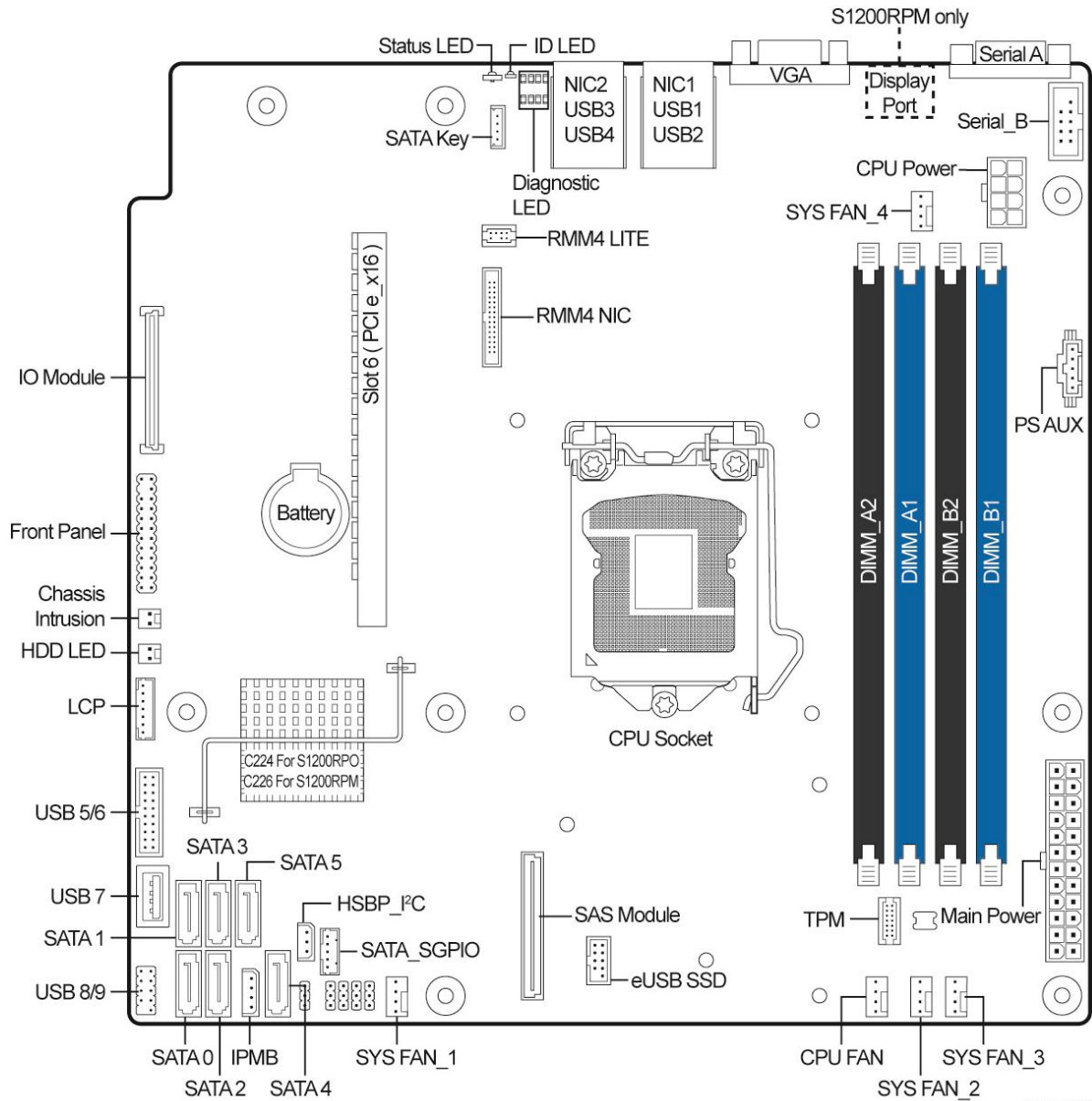
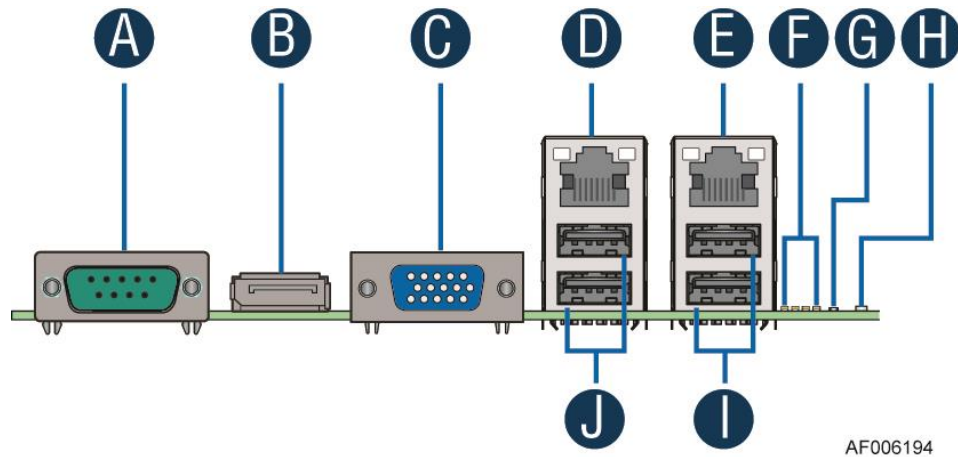

Figure 10. Intel® Server Board S1200V3RPO and S1200V3RPM

### 2.5.1 Rear Component View

The following figure shows the layout of the server board with each connector and major component identified. The description is given below in the table.



	Description		Description
A	Serial A port	F	Diagnostic LED
B	Display port (only for R1208RPMSHOR)	G	ID LED
C	DB15 Video out	H	Status LED
D	NIC port (RJ45)	I	USB connectors (USB 2.0)
E	NIC port (RJ45)	J	USB connectors (USB 3.0)

Figure 11. Intel® Server Board S1200V3RP Rear Components

### 2.6 Available Front Bezel Support (Optional)

The optional front bezel is made of molded plastic and uses a snap-on design. When installed, its design allows for maximum airflow to maintain system cooling requirements. The face of the bezel assembly includes optional snap-in identification badge and wave (shown) features to allow for customization.

(Intel® Product Order Code – A1UBEZEL)

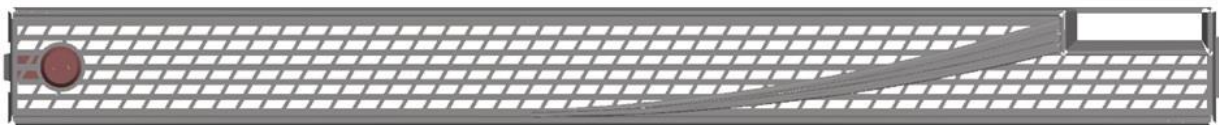

Figure 12. Optional Front Bezel

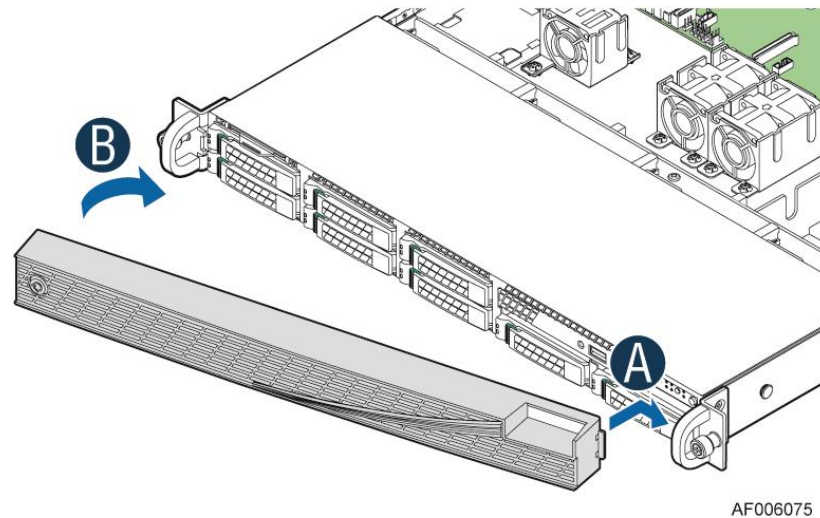

Figure 13. Installing Front Bezel

## 2.7 Available Rack and Cabinet Mounting Kit Options

- Tool-less rack mount rail kit – Intel® Product Code – AXXPRAIL
  - 1U and 4U compatible
  - 65 lbs maximum support weight
  - Tool-less installation
  - Full extension from rack
  - Optional cable management arm support
- Value rack mount rail kit – Intel® Product Code – AXXELVRAIL
  - 1U to 4U compatible
  - 110 lbs maximum support weight
  - Tool-less chassis attach
  - Tools required to attach rails to rack
  - 2/3 extension from rack
- Cable Management Arm – Intel® Product Code – AXX1U2UCMA (supported with AXXPRAIL only)
- 2-Post Fixed mount bracket kit – Intel® Product Code - AXX2POSTBRCKT

**CAUTION:** THE MAXIMUM RECOMMENDED SERVER WEIGHT FOR THE RACK RAILS CAN BE FOUND at <http://www.intel.com/support/motherboards/server/sb/CS-033655.htm>. EXCEEDING THE MAXIMUM RECOMMENDED WEIGHT OR MISALIGNMENT OF THE SERVER MAY RESULT IN FAILURE OF THE RACK RAILS HOLDING THE SERVER. Use of a mechanical assist to install and align server into the rack rails is recommended.

## 3. Power Subsystem

---

This chapter provides a high level overview of the power management features and specification data for the power supply options available for this server product. Specification variations are identified for each supported power supply. There are two power supply options available in Intel® Server System R1000RP Family: 350W fixed power supply and 450W redundant power supply.

The redundant power supply platform can have up to two power supply modules installed, supporting the following power supply configurations: 1+0 (single power supply), 1+1 Redundant Power, and 2+0 Combined Power (non-redundant). 1+1 redundant power and 2+0 combined power configurations are automatically configured depending on the total power draw of the system. If the total system power draw exceeds the power capacity of a single power supply module, power from the second power supply module will be utilized. If this occurs, power redundancy will be lost. In a 2+0 power configuration, total power available may be less than twice the rated power of the installed power supply modules due to the amount of heat produced with both supplies providing peak power. If system thermals exceed the programmed limits, platform management will attempt to keep the system operational.

In the event of a power supply failure, redundant 1+1 power supply configuration (for 450W AC platform) has support for hot-swap extraction and insertion.

### 3.1 350W Fixed Power Supply

This section describes the performance characteristic of a single-phase full range AC input, active power factor correction switching power supply with 350 Watts output including +12V1, +12V2, +5V, +3.3V, -12V, and +5VSB.

#### 3.1.1 Mechanical Overview

The physical size of the power supply enclosure is intended to accommodate power ranges from 350 W. The power supply size is 40 mm x 106 mm x 300 mm and has a wire harness for the DC outputs. The AC input plugs directly into the external face of the power supply; refer to the following figure for more information.

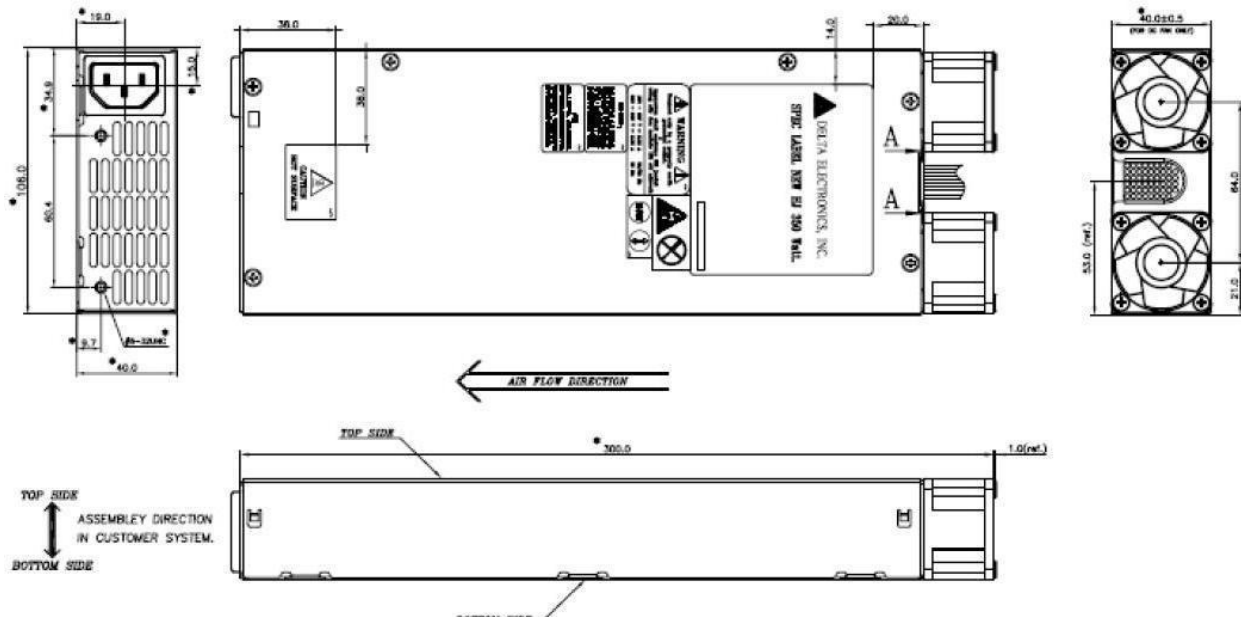

Figure 14. 350W AC Power Supply Unit Enclosure Drawing

### 3.1.2 Power Supply Module Efficiency

The power supply operates with efficiency  $\geq 85\%$  under 20% and 100% loads,  $\geq 88\%$  under 50% loads which are shown in the following table at 115V or 230V AC input voltages, 25°C.

Table 4. Output Load for Efficiency Test

Output	20% Load (A)	50% Load (A)	100% Load (A)
+3.3V	1.3	3.4	6.8
+5V	2.2	5.5	10.9
+12V1	2.2	5.4	10.8
+12V2	2.2	5.4	10.8
-12V	0.1	0.2	0.4
+5VSB	0.3	0.9	1.9

### 3.1.3 Power Cord Specification Requirements

The power cords used must meet the specification requirements listed in the following table.

Table 5. AC Power Cord Specifications

Cable Type	SJT
Wire Size	16 AWG
Temperature Rating	105°C



Cable Type	SJT
Amperage Rating	13 A
Voltage Rating	125 V

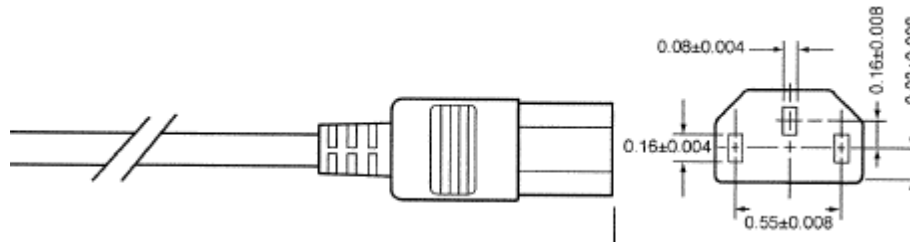

Figure 15. AC Power Cord

### 3.1.4 AC Input Requirement

#### 3.1.4.1 Power Factor

The PF shall align with server energy star 2.0 requirements. Power supplies must meet the minimum power factor requirements presented in the table below, for all loading conditions where the output power is greater than or equal to 75 watts.

Table 6. Power Factor

Output power	20% load	50% load	100% load
Power factor	0.8	0.9	0.98

#### 3.1.4.2 AC Input Voltage Specification

The power module shall operate over the range and limits shown in the following table.

Table 7. AC Input Voltage Range

PARAMETER	MIN	RATED	MAX	Max Input AC Current
Line Voltage (110)	90 Vrms	100-127 Vrms	140 Vrms	6 Arms1
Line Voltage (220)	180 Vrms	200-240 Vrms	264 Vrms	3 Arms2
Frequency	47 Hz	50/60 Hz	63 Hz	

Notes:

1. Maximum input current at low input voltage range shall be measured at 90VAC, at maximum load.
2. Maximum input current at high input voltage range shall be measured at 180VAC, at maximum load.
3. This requirement is not to be used for determining agency input current markings.

#### 3.1.4.3 AC Line Isolation Requirements

The power supply shall meet all safety agency requirements for dielectric strength. Additionally, power supply vendor must provide Intel with written confirmation of dielectric withstand test which includes voltage level, duration of test, and identification detailing how each power supply is marked to indicate that the dielectric withstand test is completed successfully. Transformers' isolation between primary and secondary windings must comply with the 3000Vac (4242VDC)

dielectric strength criteria. If the working voltage between primary and secondary dictates a higher dielectric strength test voltage, the highest test voltage should be used. In addition, the insulation system must comply with reinforced insulation as per safety standard IEC 950. Separation between the primary and secondary circuits, and primary to ground circuits, must comply with the IEC 950 spacing requirements.

#### 3.1.4.4 AC Line Dropout/Holdup

An AC line dropout is defined when the AC input drops to 0VAC at any phase angle of the nominal AC line voltage. An AC line dropout less than 12ms shall not cause any tripping of control signals or protection circuits for 350W output. If the AC line dropout over 12ms, the power supply should recover back to normal operation and meet all turn on requirements. Any dropout of the AC line shall not cause damage to the power supply.

#### 3.1.4.5 AC Line Fuse

The power supply should have one line fused in the single line fuse on the line (Hot) wire of the AC input. The line fusing must be acceptable for all safety agency requirements. The input fuse should be a slow blow type. AC inrush current must not cause the AC line fuse to blow under any conditions. All protection circuits in the power supply should not cause the AC fuse to blow unless a component in the power supply has failed. This includes DC output load short conditions.

#### 3.1.4.6 AC Inrush

The peak inrush current must not damage the PSU, or the input fuse must not blow under any conditions of load, temperature, and input voltage, including repeated, rapid cycling of the power line. Half cycle peak inrush current, peak repetitive input current, and worse case power factor must be provided by the vendor to assist with the UPS and line conditioning, sizing, and selection. No component will be stressed over its maximum specification. This must be demonstrated through measurements of the critical component specifications. The peak inrush current shall be less than 55A peak at 115VAC input and 230VAC input, cold start and 25°C.

#### 3.1.4.7 AC Line Leakage Current

The maximum leakage current to ground shall be less than 1.0mA-rms at 240Vac, 50Hz.

#### 3.1.4.8 AC Line Transient Specification

The AC line transient conditions are defined as sag and surge conditions. Sag conditions are also commonly referred to as “brownout”. Sag conditions are defined as the conditions when the AC line voltage drops below nominal voltage. Surge conditions are defined as the conditions when the AC line voltage rises above nominal voltage.

The power supply must meet the requirements under the following AC line sag and surge conditions.

**Table 8. AC Line Sag Transient Performance**

AC Line Sag (10sec interval between each sagging)				
Duration	Sag	Operating AC Voltage	Line Frequency	Performance Criteria
Continuous	10%	Nominal AC Voltage ranges	50/60Hz	No loss of function or performance

AC Line Sag (10sec interval between each sagging)				
Duration	Sag	Operating AC Voltage	Line Frequency	Performance Criteria
1 to 12ms	100%	Nominal AC Voltage ranges	50/60Hz	No loss of function or performance
> 12ms	>30%	Nominal AC Voltage ranges	50/60Hz	Loss of function acceptable, self recoverable

**Table 9. AC Line Surge Transient Performance**

AC Line Surge				
Duration	Surge	Operating AC Voltage	Line Frequency	Performance Criteria
Continuous	10%	Nominal AC Voltages	50/60Hz	No loss of function or performance
0 to ½ AC cycle	30%	Nominal AC Voltages	50/60Hz	No loss of function or performance

### 3.1.4.9 Susceptibility Requirements

The power supply shall meet the following electrical immunity requirements when connected to a cage with an external EMI filter which meets the criteria defined in the *SSI document EPS Power Supply Specification*. For further information on Intel standards, request a copy of the *Intel® Environmental Standards Handbook*.

**Table 10. Performance Criteria**

Level	Description
A	The apparatus shall continue to operate as intended. No degradation of performance.
B	The apparatus shall continue to operate as intended. No degradation of performance beyond spec limits.
C	Temporary loss of function is allowed provided the function is self-recoverable or can be restored by the operation of the controls.

### 3.1.4.10 Electrostatic Discharge Susceptibility

The power supply shall comply with the limits defined in EN 55024: 1998 using the IEC 61000-4-2:1995 test standard and performance criteria B defined in *Annex B of CISPR 24*.

**AIR DISCHARGE ±8kV**

**CONTACT DISCHARGE ±4kV**

### 3.1.4.11 Fast Transient/Burst

The power supply shall comply with the limits defined in EN55024: 1998/A1: 2001/A2: 2003 using the IEC 61000-4-4: Second edition: 2004-07 test standard and performance criteria B defined in *Annex B of CISPR 24*.

### 3.1.4.12 Radiated Immunity

The power supply shall comply with the limits defined in EN55024: 1998/A1: 2001/A2: 2003 using the IEC 61000-4-3: Edition 2.1: 2002-09 test standard and performance criteria A defined in *Annex B of CISPR 24*.

### 3.1.4.13 Surge Immunity

The power supply shall be tested with the system for immunity to AC Ring Wave and AC Unidirectional Wave, both up to 2kV. The power supply shall operate normally without any component damage under any condition.

**BI-WAVE**  $12\ \Omega \pm 2.0\text{kV}$  (Common mode)

$2\ \Omega \pm 1.0\text{kV}$  (Differential mode)

**RING-WAVE**  $500\text{A} \pm 2.0\text{kV}$  (Common mode)

$500\text{A} \pm 1.0\text{kV}$  (Differential mode)

### 3.1.4.14 Power Recovery

The power supply should recover automatically after an AC power failure. AC power failure is defined as any loss of AC power that exceeds the dropout criteria.

### 3.1.4.15 Voltage Interruptions

The power supply shall comply with the limits defined in EN55024: 1998/A1: 2001/A2: 2003 using the IEC 61000-4-11: Second Edition: 2004-03 test standard and performance criteria C defined in *Annex B of CISPR 24*.

## 3.1.5 DC Output Specification

### 3.1.5.1 Output Power/Currents

The following table defines the output power and current ratings.

**Table 11. Output Current Requirements**

Output	Minimum	Maximum	Output Power
+3.3V	0.1A	10A	33W
+5V	0.1A	16A	80W
+12V1	0.75A	18A	216W
+12V2	0.75A	18A	216W
-12V	0.0A	0.5A	6W
+5VSB	0.05A	2.5A	12.5W

Notes:

1. The total current of +12V1/2 will not exceed 28A.
2. The total output for this PSU is 350W.
3. The total output of +3.3V & +5V will not exceed 100W.

### 3.1.5.2 Standby Output

The 5VSB output should be present when an AC input greater than the power supply turn on voltage is applied.

## 3.1.6 Protection Circuits

The protection circuits inside the power supply should cause only the power supply's main outputs to shut down. If the power supply latches off due to a protection circuit tripping, an AC

cycle OFF for 15sec (with +5VSB/0.1A) and a PSON# cycle HIGH for one second shall be able to reset the power supply.

### 3.1.6.1 Over Current Protection (OCP)

Each output shall have individual OCP protection circuits. The PSU shall shut down and latch off after an over current condition occurs. Whereas OCP of +5VSB shall turn the power supply into “hiccup mode” until the OCP condition is removed. The values are measured at the PSU harness connectors and shall not be damaged from repeated power cycling in this condition. There shall be current sensors and limit circuits to shut down the entire power supply if the limit is exceeded. The limits are listed below.

**Table 12. Over Load Protection (OCP) Limits**

Output Voltage	Continuous Load	
	Current Limit MIN	Current Limit MAX
+12V1	18.2A	20A
+12V2	18.2A	20A
+5V	19.2A	24A
+3.3V	12A	15A
-12V		4A
+5VSB		4.5A

### 3.1.6.2 Over Voltage Protection (OVP)

Each output shall have individual OVP protection circuits built in and it shall be locally sensed. The PSU shall shut down and latch off after an over voltage condition occurs. The output voltages are measured at the harness connectors. The voltage shall never exceed the maximum levels when measured at the power pins of the output harness connector during any single point of fail. The voltage shall never trip any lower than the minimum levels when measured at the power pins of the connector.

**Table 13. Over Voltage Protection (OVP) Limits**

Output Voltage	OVP MIN (V)	OVP MAX (V)
+3.3V	3.7	4.5
+5V	5.7	6.5
+12V1/+12V2	13.3	15.6
-12V	-13.3	-15.6
+5VSB	5.7	6.5

### 3.1.6.3 Over Temperature Protection (OTP)

The power supply shall be protected against over temperature conditions caused by loss of fan cooling or excessive ambient temperature. In an OTP condition the PSU will shut down. When the power supply temperature drops to within specified limits, the power supply shall restore power automatically, while the +5VSB remains always on. The OTP trip level shall have a minimum of 4°C of ambient temperature hysteresis, so that the power supply will not oscillate on and off due to temperature recovery condition.

## 3.2 450W mini-ERPS Redundant Power Supply

The 450W 1+1 redundant power supply has two outputs: +12V DC and +5V Standby. There is one Power Distribution Board (PDB) for 450W AC 1+1 redundant power supply. The PDB is

designed to plug directly to the output connector of the power supply and it contains two DC/DC power converters to produce other required voltages: +3.3V and +5V. The PDB is integrated in the power supply cage.

### 3.2.1 Mechanical Overview

The following drawing is the cage which integrates the power supply units and the PDB.



Figure 16. 450W AC PSU with PDB

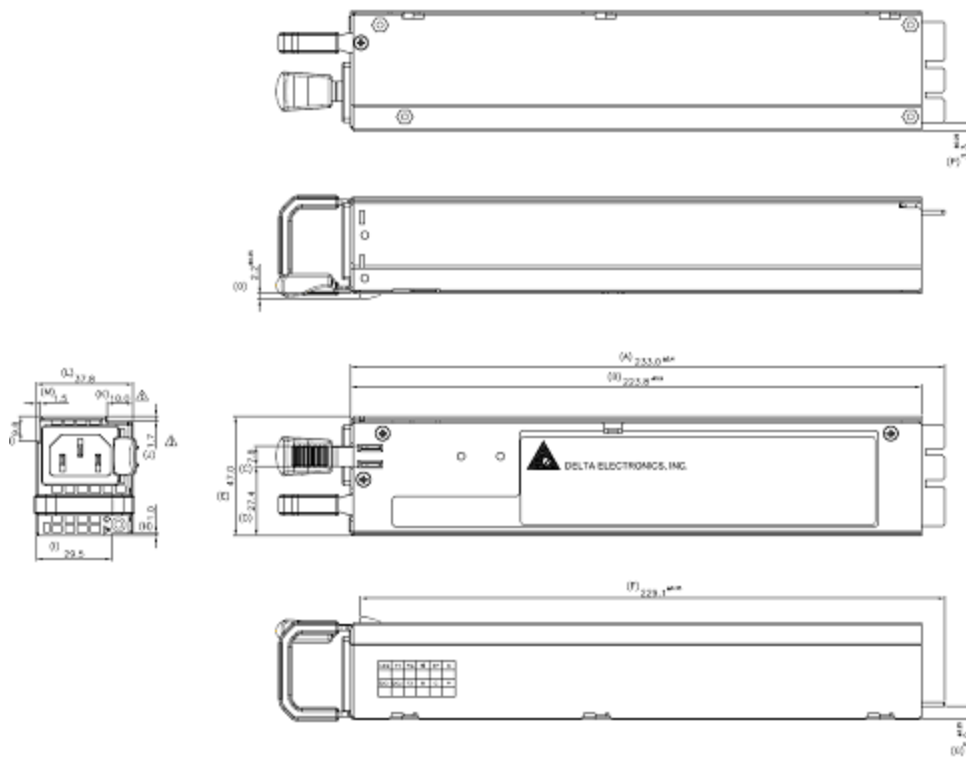

Figure 17. 450W AC Power Supply Unit Dimension Overview

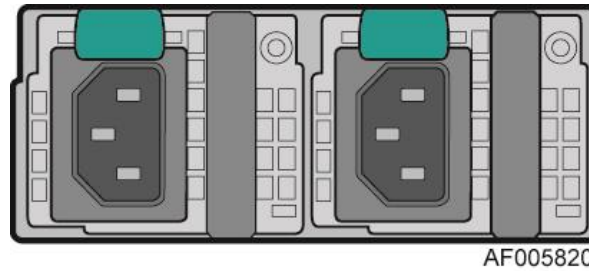

Figure 18. 450W AC Power Supply – Connector View

### 3.2.2 Power Supply Module Card Edge Connector

This 450W AC power supply module has 2x14 card edge output connection that plugs directly into a matching slot connector on power distribution board. The connector provides both power and communication signals.

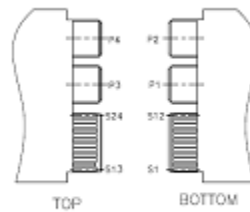

Figure 19. 450W Power Supply Module Output Power Connector

The following table defines the connector pin-out.

Table 14. 450W Power Supply Module Output Power Connector Pin-out

Pin	Definition	Pin	Definition
S1	NA	S2	NA
S3	L_MON	S4	ALERT
S5	SDA	S6	SCL
S7	PS_KILL	S8	PS_ON
S9	PS_OK	S10	SGND
S11	+5VSB	S12	+5VSB
S13	FAN_PLSE2	S14	PRESENT
S15	AO	S16	VCC2
S17	FAN_GND	S18	FAN_PWR
S19	FAN_PLSE	S20	FAN_VS
S21	RS+	S22	RS-
S23	+5VSB	S24	+5VSB
P1	+12V	P2	+12V
P3	SGND	P4	SGND

### 3.2.3 Power Supply Module Efficiency

The following table provides the required minimum efficiency level at various loading conditions. These are provided at three different load levels: 100%, 50%, and 20%.

**Table 15. 450WAC Power Supply Efficiency**

Loading	100% of maximum	50% of maximum	20% of maximum
Minimum Efficiency	88%	92%	88%

### 3.2.4 Power Cord Specification Requirements

The power cords used must meet the specification requirements listed in the following table.

**Table 16. AC Power Cord Specifications**

Cable Type	SJT
Wire Size	16 AWG
Temperature Rating	105°C
Amperage Rating	13 A
Voltage Rating	125 V

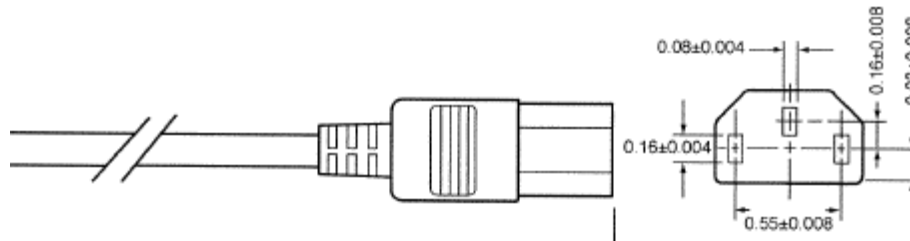

**Figure 20. AC Power Cord**

### 3.2.5 AC Input Requirement

#### 3.2.5.1 Power Factor

The power supply must meet the power factor requirements stated in the *Energy Star® Program Requirements for Computer Servers*. These requirements are stated below.

Output power	20% load	50% load	100% load
Power factor	0.8	0.9	0.95

Tested at 230VAC, 50Hz and 60Hz; and 115VAC, 60Hz.

#### 3.2.5.2 AC Input Voltage Specification

The power supply must operate within all specified limits over the following input voltage range. Harmonic distortion of up to 10% of the rated line voltage must not cause the power supply to go out of specified limits. Application of an input voltage below 85VAC should not cause damage to the power supply, including a blown fuse.



**Table 17. AC Input Voltage Range**

PARAMETER	MIN	RATED	VMAX	Start up VAC	Power Off VAC
Voltage (110)	90 Vrms	100-127 Vrms	140 Vrms	85VAC +/- 4VAC	70VAC +/- 5VAC
Voltage (220)	180 Vrms	200-240 Vrms	264 Vrms		
Frequency	47 Hz	50/60	63 Hz		

## Notes:

1. Maximum input current at low input voltage range shall be measured at 90VAC, at maximum load.
2. Maximum input current at high input voltage range shall be measured at 180VAC, at maximum load.
3. This requirement is not to be used for determining agency input current markings.

**3.2.5.3 AC Line Isolation Requirements**

The power supply shall meet all safety agency requirements for dielectric strength. Additionally, power supply vendor must provide Intel with written confirmation of dielectric withstand test which includes voltage level, duration of test, and identification detailing how each power supply is marked to indicate that the dielectric withstand test is completed successfully. Transformers' isolation between primary and secondary windings must comply with the 3000VAC (4242VDC) dielectric strength criteria. If the working voltage between primary and secondary dictates a higher dielectric strength test voltage, the highest test voltage should be used. In addition, the insulation system must comply with reinforced insulation as per safety standard IEC 950. Separation between the primary and secondary circuits, and primary to ground circuits, must comply with the IEC 950 spacing requirements.

**3.2.5.4 AC Line Dropout/Holdup**

An AC line dropout is defined to be when the AC input drops to 0VAC at any phase of the AC line for any length of time. During an AC dropout, the power supply must meet dynamic voltage regulation requirements. An AC line dropout of any duration should not cause tripping of control signals or protection circuits. If the AC dropout lasts longer than the holdup time, the power supply should recover and meet all turn on requirements. The power supply should meet the AC dropout requirement over rated AC voltages and frequencies. A dropout of the AC line for any duration should not cause damage to the power supply.

Loading	Holdup time
75%	12msec
100%	10msec

**3.2.5.5 AC Line Fuse**

The power supply should have one line fused in the single line fuse on the line (Hot) wire of the AC input. The line fusing must be acceptable for all safety agency requirements. The input fuse should be a slow blow type. AC inrush current must not cause the AC line fuse to blow under any conditions. All protection circuits in the power supply should not cause the AC fuse to blow unless a component in the power supply has failed. This includes DC output load short conditions.

### 3.2.5.6 AC Inrush

The peak inrush current must not damage the PSU, or the input fuse must not blow under any conditions of load, temperature, and input voltage, including repeated, rapid cycling of the power line. Half cycle peak inrush current, peak repetitive input current, and worse case power factor must be provided by the vendor to assist with the UPS and line conditioning, sizing, and selection. No component will be stressed over its maximum specification (I 2·t). This must be demonstrated through measurements of the critical component specifications.

### 3.2.5.7 AC Line Leakage Current

The maximum leakage current to ground for each power supply shall be 3.5mA when tested at 240VAC.

### 3.2.5.8 AC Line Transient Specification

The AC line transient conditions are defined as sag and surge conditions. Sag conditions are also commonly referred to as “brownout”. Sag conditions are defined as the conditions when the AC line voltage drops below nominal voltage. Surge conditions are defined as the conditions when the AC line voltage rises above nominal voltage.

The power supply must meet the requirements under the following AC line sag and surge conditions.

**Table 18. AC Line Sag Transient Performance**

AC Line Sag (10sec interval between each sagging)				
Duration	Sag	Operating AC Voltage	Line Frequency	Performance Criteria
0 to 1/2 AC cycle	95%	Nominal AC Voltage ranges	50/60Hz	No loss of function or performance
> 1 AC cycle	>30%	Nominal AC Voltage ranges	50/60Hz	Loss of function acceptable, self recoverable

**Table 19. AC Line Surge Transient Performance**

AC Line Surge				
Duration	Surge	Operating AC Voltage	Line Frequency	Performance Criteria
Continuous	10%	Nominal AC Voltages	50/60Hz	No loss of function or performance
0 to 1/2 AC cycle	30%	Mid-point of nominal AC Voltages	50/60Hz	No loss of function or performance

### 3.2.5.9 Susceptibility Requirements

The power supply shall meet the following electrical immunity requirements when connected to a cage with an external EMI filter which meets the criteria defined in the *SSI document EPS Power Supply Specification*. For further information on Intel standards, request a copy of the *Intel® Environmental Standards Handbook*.

**Table 20. Performance Criteria**

Level	Description
A	The apparatus shall continue to operate as intended. No degradation of performance.
B	The apparatus shall continue to operate as intended. No degradation of performance beyond spec limits.
C	Temporary loss of function is allowed provided the function is self-recoverable or can be restored by the operation of the controls.

### 3.2.5.10 Electrostatic Discharge Susceptibility

The power supply shall comply with the limits defined in EN 55024: 1998/A1: 2001/A2: 2003 using the IEC 61000-4-2: Edition 1.2: 2001-04 test standard and performance criteria B defined in *Annex B of CISPR 24*.

### 3.2.5.11 Fast Transient/Burst

The power supply shall comply with the limits defined in EN55024: 1998/A1: 2001/A2: 2003 using the IEC 61000-4-4: Second edition: 2004-07 test standard and performance criteria B defined in *Annex B of CISPR 24*.

### 3.2.5.12 Radiated Immunity

The power supply shall comply with the limits defined in EN55024: 1998/A1: 2001/A2: 2003 using the IEC 61000-4-3: Edition 2.1: 2002-09 test standard and performance criteria A defined in *Annex B of CISPR 24*.

### 3.2.5.13 Surge Immunity

The power supply shall be tested with the system for immunity to AC Unidirectional Wave; 2kV line to ground and 1kV line to line, per EN 55024: 1998/A1: 2001/A2: 2003, EN 61000-4-5: Edition 1.1:2001-04.

The pass criteria include:

- No unsafe operation is allowed under any condition.
- All power supply output voltage levels to stay within proper spec levels.
- No change in operating state or loss of data during and after the test profile.
- No component damage under any condition.

The power supply shall comply with the limits defined in EN55024: 1998/A1: 2001/A2: 2003 using the IEC 61000-4-5: Edition 1.1:2001-04 test standard and performance criteria B defined in *Annex B of CISPR 24*.

### 3.2.5.14 Power Recovery

The power supply should recover automatically after an AC power failure. AC power failure is defined as any loss of AC power that exceeds the dropout criteria.

### 3.2.5.15 Voltage Interruptions

The power supply shall comply with the limits defined in EN55024: 1998/A1: 2001/A2: 2003 using the IEC 61000-4-11: Second Edition: 2004-03 test standard and performance criteria C defined in *Annex B of CISPR 24*.

## 3.2.6 DC Output Specification

### 3.2.6.1 Output Power/Currents

The following table defines the output current ratings. Each output has a maximum and minimum current rating shown in Table 21. The power supply shall meet both static and dynamic voltage regulation requirements for the minimum dynamic load conditions. The power supply must meet only the static load voltage regulation requirements for the minimum static load conditions.

**Table 21. Load Ratings**

	+12V	+5VSB
MAX	36.26A	3A
MIN DYNAMIC	2A	0.5A
MIN STATIC	0.5A	0.1A

The combined output power of all outputs shall not exceed 405W @100~127VAC.

### 3.2.6.2 Standby Output

The 5VSB output should be present when an AC input greater than the power supply turn on voltage is applied.

## 3.2.7 Protection Circuits

The protection circuits inside the power supply should cause only the power supply's main outputs to shut down. If the power supply latches off due to a protection circuit tripping, an AC cycle OFF for 15sec and a PSON# cycle HIGH for 1sec shall be able to reset the power supply.

### 3.2.7.1 Current Limit (OCP)

The following are the over current protection limits for each output. For testing purposes, the overload currents of each tested output rail should be ramped at a minimum rate of 10 A/sec starting from full load. If the current limits are exceeded, the power supply should shut down and latch off. The latch will be cleared by toggling the PSON# signal or by an AC power interruption. The power supply should not be damaged from repeated power cycling in this condition. 5VSB must be protected under over current or shorted conditions, so that no damage can occur to the power supply. 5VSB will be auto-recovered after OCP limit is removed.

**Table 22. Over Current Limits**

Output	Min OCP	Max OCP
+12V	40 A	54 A
5Vstby	3.6A~8A	

### 3.2.7.2 Over Voltage Protection (OVP)

The power supply over voltage protection should be locally sensed. The power supply must shut down and latch off after an over voltage condition occurs. This latch shall be cleared by toggling the PSON# signal or by an AC power interruption. The following table contains the over voltage limits. The values are measured at the output of the power supply pins. The voltage should never exceed the maximum levels when measured at the power pins of the power supply connector during any single point of fail. The voltage should never trip any lower than the minimum levels when measured at the power pins of the power supply connector. 5VSB will be auto-recovered after the OVP limit is removed.

**Table 23. Over Voltage Protection (OVP) Limits**

OUTPUT VOLTAGE	PROTECTION POINT [ V]
+12 V	13.6V ~ 15.0V
5VSB	5.6V ~ 6.5V

### 3.2.7.3 Over Temperature Protection (OTP)

The power supply will be protected against over temperature conditions caused by loss of fan cooling or excessive ambient temperature. In an OTP condition, the PSU will shut down. When the power supply temperature drops to within specified limits, the power supply will restore power automatically, while the 12VSB remains always on. The OTP circuit must have a built in margin, so that the power supply will not oscillate ON and OFF due to the temperature recovering condition. The OTP trip level should have a minimum of 4°C of ambient temperature margin.

## 4 Thermal Management

---

The fully integrated system is designed to operate at external ambient temperatures of between 10°C and 35°C with limited excursion based operation up to 35°C. Working with integrated platform management, several features within the system are designed to move air in a front to back direction, through the system and over critical components in order to prevent them from overheating and allow the system to operate with best performance.

The Intel® Server System R1000RP product family supports short-term, excursion-based, operation up to 35°C (ASHRAE A2) with limited performance impact. The configuration requirements and limitations are described in the configuration matrix found in the *Intel® S1200V3RP Product Family Power Budget and Thermal Configuration Tool*, available to download online at [http://www.intel.com/p/en\\_US/support](http://www.intel.com/p/en_US/support).

The installation and functionality of several system components are used to maintain system thermals.

### 4.1 Thermal Operation and Configuration Requirements

To keep the system operating within supported maximum thermal limits, the system must meet the following operating and configuration guidelines:

- The system operating ambient is designed for sustained operation up to 35°C (ASHRAE Class A2).
  - When operating within the extended operating temperature range, the system performance may be impacted.
  - There is no long term system reliability impact when operating at the extended temperature range within the approved limits.
- Specific configuration requirements and limitations are documented in the configuration matrix found in the *Intel® Server Board S1200V3RP product family Power Budget and Thermal Configuration Guidelines Tool*, available to download online at [http://www.intel.com/p/en\\_US/support](http://www.intel.com/p/en_US/support).
- The processor and the CPU heatsink must be installed first.
- Memory Slot population requirements

**Note:** Specified memory slots can be populated with a DIMM or supplied DIMM Blank. Memory population rules apply when installing DIMMs. Install DIMMs in the order; Channels A, then Channels B. Start with the first DIMM (Blue Slot) on each channel, then slot 2. Only remove factory installed DIMM blanks when populating the slot with an actual memory module.
- All hard drive bays must be populated. Hard drive carriers can be populated with a hard drive or supplied drive blank.
- In single power supply configurations, the second power supply bay must have the supplied filler blank installed at all times.
- The system top-cover must be installed at all times.

## 4.2 Thermal Management Overview

In order to maintain the necessary airflow within the system, all of the previously listed components and top cover need to be properly installed. For best system performance, the external ambient temperature should remain below 35°C and all system fans should be operational. The system is designed for fan redundancy when the system is configured with two power supplies. If a single system fan fails (System fan or Power Supply Fan), integrated platform management will change the state of the System Status LED to flashing Green, report an error to the system event log, and automatically adjust fan speeds as needed to maintain system temperatures below maximum thermal limits.

**Note:** All system fans are controlled independently of each other. The fan control system may adjust fan speeds for different fans based on increasing/decreasing temperatures in different thermal zones within the chassis.

In the event that system thermals should continue to increase with the system fans operating at their maximum speed, platform management may begin to throttle bandwidth of either the memory subsystem or the processors or both, in order to keep components from overheating and keep the system operational. Throttling of these subsystems will continue until system thermals are reduced below preprogrammed limits.

If system temperatures increase to a point beyond the maximum thermal limits, the system will shut down, the System Status LED will change to a solid Amber state, and the event will be logged to the system event log.

**Note:** Sensor data records (SDRs) for any given system configuration must be loaded by the system integrator for proper thermal management of the system. SDRs are loaded using the FRUSDR utility.

An intelligent Fan Speed Control (FSC) and thermal management technology (mechanism) is used to maintain comprehensive thermal protection, deliver the best system acoustics, and improves fan power efficiency. Options in <F2> BIOS Setup (**BIOS > Advanced > System Acoustic and Performance Configuration**) allow for parameter adjustments based on the actual system configuration and usage. Refer to the following sections for a description of each setting.

### 4.2.1 Set Throttling Mode

This option is used to select the desired memory thermal throttling mechanism. Available settings include [Auto], [CLTM], and [OLTM].

**[Auto]** – Factory Default Setting: BIOS automatically detects and identifies the appropriate thermal throttling mechanism based on the DIMM type, airflow input, and DIMM sensor availability.

**[CLTM]** – Closed Loop Thermal Management: Would be used with an OEM chassis and DIMMs with TSOD. The firmware does not change the offset registers for closed loop during runtime, although the Management Engine can do so.

**[OLTM]** – Open Loop Thermal Management: Is intended for a system with UDIMMs which do not have TSOD. The thermal control registers are configured during POST, and the firmware

does not change them.

#### 4.2.2 Altitude

This option is used to select the proper altitude that the system will be used in. Available settings include [300m or less], [301m-900m], [901m-1500m], and [Above 1500m].

Selecting an altitude range that is lower than the actual altitude the system will be operating at, can cause the fan control system to operate less efficiently, leading to higher system thermals and lower system performance. If the altitude range selected is higher than the actual altitude the system will be operating at, the fan control system may provide better cooling but with higher acoustics and higher fan power consumption. If the altitude is not known, selecting a higher altitude is recommended in order to provide sufficient cooling.

#### 4.2.3 Set Fan Profile

This option is used to set the desired Fan Profile. Available settings include [Performance] and [Acoustic].

The Acoustic mode offers the best acoustic experience and appropriate cooling capability supporting the majority of the add-in cards used. Performance mode is designed to provide sufficient cooling capability covering all kinds of add-in cards on the market.

#### 4.2.4 Fan PWM Offset

This option is reserved for manual adjustment to the minimum fan speed curves. The valid range is from [0 to 100] which stands for 0% to 100% PWM adding to the minimum fan speed. This feature is valid when Quiet Fan Idle Mode is at Enabled state. The default setting is [0].

#### 4.2.5 Quiet Fan Idle Mode

This feature can be [Enabled] or [Disabled]. If enabled, the fans will either shift to a lower speed or stop when the aggregate sensor temperatures are satisfied, indicating the system is at ideal thermal/light loading conditions. When the aggregate sensor temperatures are not satisfied, the fans will shift back to normal control curves. If disabled, the fans will never shift into lower fan speeds or stop, regardless of whether the aggregate sensor temperatures are satisfied. The default setting is [Disabled].

**Note:** The above feature may or may not be in effect and depends on the actual thermal characteristics of the specified system.

#### 4.2.6 Thermal Sensor Input for Fan Speed Control

The BMC uses various IPMI sensors as inputs to control fan speed. Some of the sensors are actual physical sensors and some are virtual sensors derived from calculations.

The following IPMI thermal sensors are used as input to control fan speed:

- Front Panel Temperature Sensor<sup>1</sup>
- CPU Margin Sensors<sup>2, 4, 5</sup>
- DIMM Thermal Margin Sensors<sup>2, 4</sup>
- PCH Temperature Sensor<sup>3,5</sup>



- On-board Ethernet Controller Temperature Sensors<sup>3, 5</sup>
- Add-In Intel® SAS/IO Module Temperature Sensors<sup>3, 5</sup>
- PSU Thermal Sensor<sup>3, 8</sup>
- CPU VR Temperature Sensors<sup>3, 6</sup>
- DIMM VR Temperature Sensors<sup>3, 6</sup>
- BMC Temperature Sensor<sup>3, 6</sup>
- Global Aggregate Thermal Margin Sensors<sup>7</sup>
- I/O module Temperature Sensor (With option installed)
- Intel® ROC Module (With option installed)

**Notes:**

1. For fan speed control in Intel® chassis
2. Temperature margin from throttling threshold
3. Absolute temperature
4. PECEI value or margin value
5. On-die sensor
6. On-board sensor
7. Virtual sensor
8. Available only when PSU has PMBus\*
9. Calculated estimate

The following diagram illustrates the fan speed control structure.

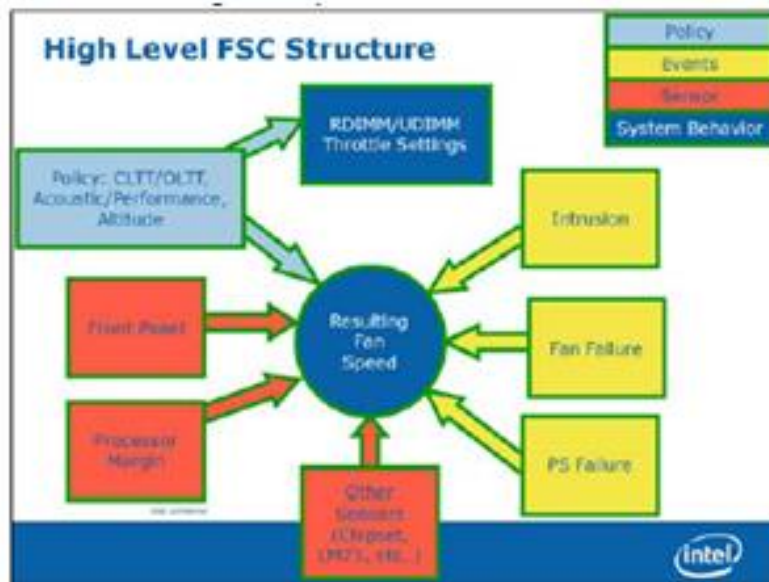

**Figure 21. Fan Control Model**

### 4.3 System Fans

Two managed dual rotor 40mm x 56mm system fans and one 40mm x 40 mm system fan provide the primary airflow for the system.

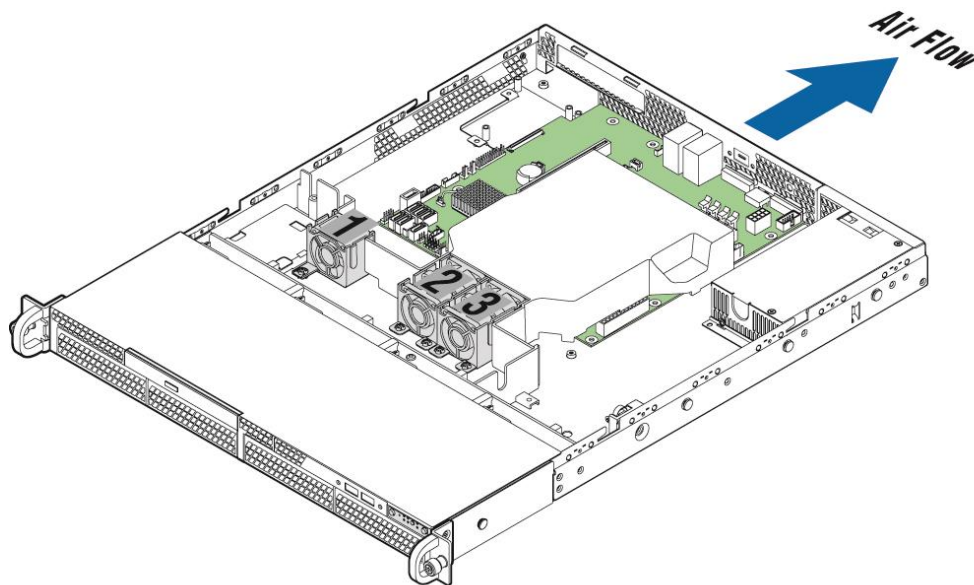

AF006082

**Figure 22. System Fan Identification**

Each system fan is mounted inside its own plastic fan housing which includes rotational vibration dampening features. The fan assemblies are held in place by fitting them over mounting pins coming up from the chassis base.

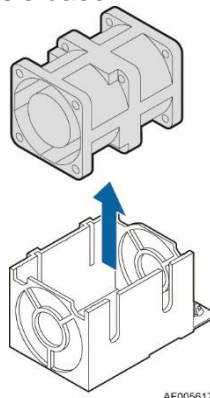

AF005617

**Figure 23. Removing a System Fan**

The system fan assembly is designed for ease of use and supports several features.

System fans are **not** hot-swappable.

Each fan and fan assembly is designed for tool-less insertion and extraction from the system. For instructions on fan replacement, see the *Intel® Server System R1000RP Service Guide*.

Fan speed for each fan is controlled by integrated platform management as controlled by the integrated BMC on the server board. As system thermals fluctuate high and low, the integrated BMC firmware will increase and decrease the speeds to specific fans to regulate system thermals.

Each fan has a tachometer signal that allows the integrated BMC to monitor its status.

Each fan has a 4-pin wire harness that connects to a matching connector on the server board.

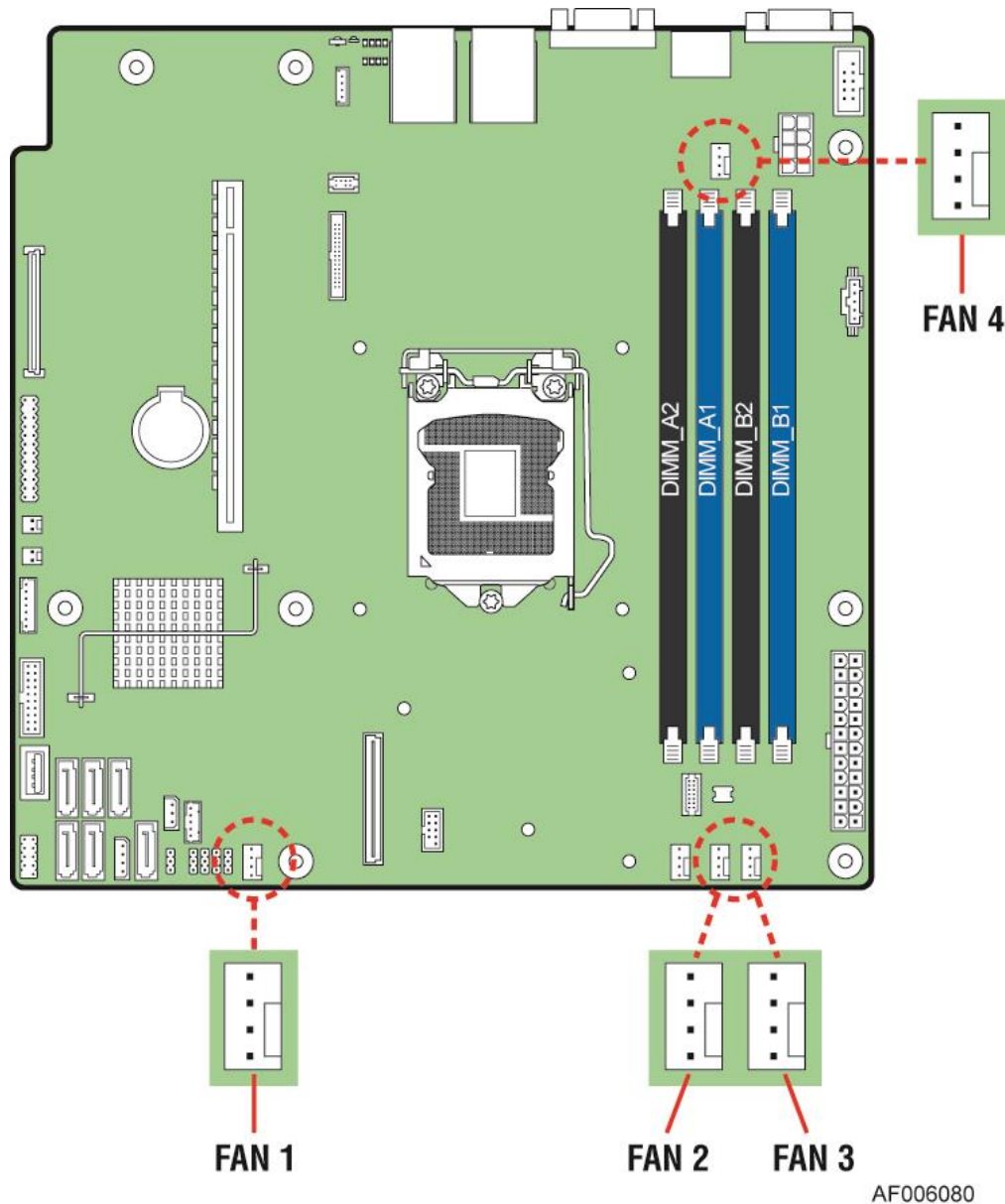

Figure 24. Server Board System Fan Connector Locations

**Table 24. System Fan Connector Pin-out**

Pin	Signal Name	Type	Description
1	Ground	GND	Ground is the power supply ground.
2	12V	Power	Power supply 12 V.
3	Fan Tach	In	FAN_TACH signal is connected to the BMC to monitor the fan speed.
4	Fan PWM	Out	FAN_PWM signal to control fan speed.

## 4.4 FRUSDR Utility

The purpose of the embedded platform management and fan control systems is to monitor and control various system features, and to maintain an efficient operating environment. Platform management is also used to communicate system health to supported platform management software and support mechanisms. The FRUSDR utility is used to program the server board with platform specific environmental limits, configuration data, and the appropriate sensor data records (SDRs), for use by these management features.

The FRUSDR utility must be run as part of the initial platform integration process before it is deployed into a live operating environment. It must be run with the system fully configured and each time the system configuration changes.

The FRUSDR utility for the given server platform can be run as part of the Intel® Server Deployment Toolkit and Management DVD that ships with each Intel® server, or can be downloaded from [http://www.intel.com/p/en\\_US/support](http://www.intel.com/p/en_US/support).

**Note:** The embedded platform management system may not operate as expected if the platform is not updated with accurate system configuration data. The FRUSDR utility must be run with the system fully configured and each time the system configuration changes, for accurate system monitoring and event reporting.

## 5 System Storage and Peripheral Options

The Intel® Server System R1000RP product family has support for many storage device options, including:

- Hot Swap 2.5" Hard Disk Drives
- Hot Swap 3.5" Hard Disk Drives
- SATA Optical Drive

Support for different storage and peripheral device options will vary depending on the system SKU. This section provides an overview of each available option.

### 5.1 2.5" Hard Disk Drive Support

The server is available with support for eight 2.5" hard disk drives as illustrated below.

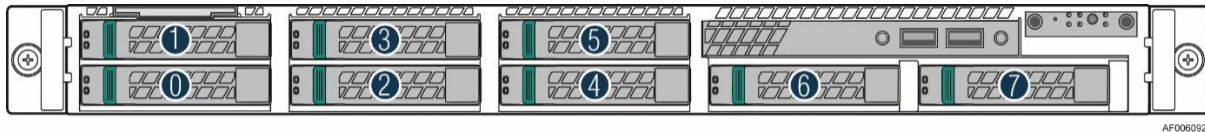

**Figure 25. 2.5" Hard Drive Bay Drive Configuration**

The drive bay can support either SATA or SAS hard disk drives. Mixing of drive types within the hard drive bay is not supported. Hard disk drive type is dependent on the type of host bus controller used, SATA only or SAS. Each 2.5" hard disk drive is mounted to a drive carrier, allowing for hot swap extraction and insertion. Drive carriers have a latching mechanism that is used to extract and insert drives from the chassis, and lock the tray in place.

Light pipes integrated into the drive tray assembly direct the light emitted from Amber drive status and Green activity LEDs located next to each drive connector on the backplane, to the drive tray faceplate, making them visible from the front of the system.

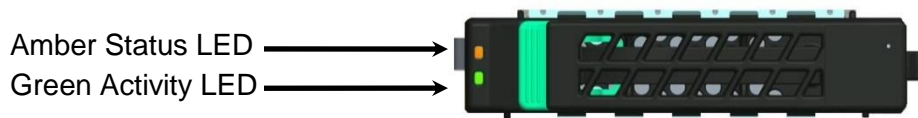

**Figure 26. LED of HDD Carrier**

**Table 25. Drive Status LED States**

<b>Amber</b>	Off	No access and no fault
	Solid On	Hard Drive Fault has occurred
	Blink	RAID rebuild in progress (1 Hz), Identify (2 Hz)

**Table 26. Drive Activity LED States**

Green	Condition	Drive Type	Behavior
	Power on with no drive activity	SAS	LED stays on
		SATA	LED stays off
	Power on with drive activity	SAS	LED blinks off when processing a command
		SATA	LED blinks on when processing a command
	Power on and drive spun down	SAS	LED stays off
		SATA	LED stays off
	Power on and drive spinning up	SAS	LED blinks
SATA		LED stays off	

### 5.1.1 2.5" Drive Hot-Swap Backplane Overview

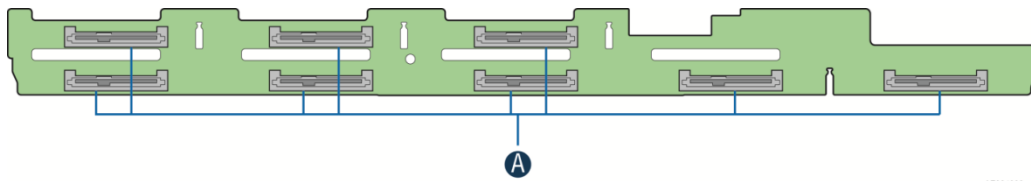

**Figure 27. The Front Side of 8 X 2.5" Hot Swap Backplane**

On the backside of each backplane are several connectors. The following illustration identifies each connector.

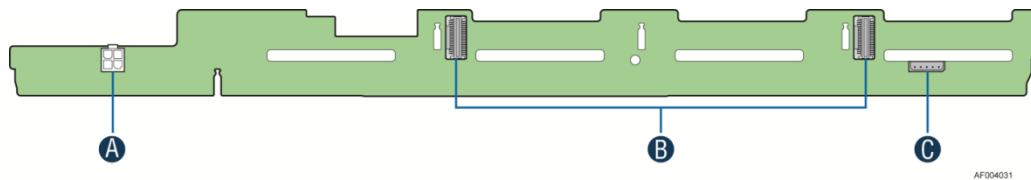

Label	Description
A	Power connector
B	4-port Mini-SAS cable connectors
C	SMBus*-In cable connector – From Server board

**Figure 28. The Back Side of 8 X 2.5" Hot Swap Backplane**

**A – Power Harness Connector:** The backplane includes a 2x2 connector supplying power to the backplane. Power is routed to the backplane through a power cable harness from the server board.

**B – Multi-port Mini-SAS Cable Connectors:** The backplane includes two multi-port mini-SAS cable connectors, each providing I/O signals for four SAS/SATA hard drives on the backplane. Cables can be routed from matching connectors on the server board, add-in SAS/SATA RAID cards, or optionally installed SAS expander cards.

**C – SMBus\* Cable Connectors:** The backplane includes a 1x5 cable connector used as a management interface to the server board.

### 5.1.2 Cypress\* CY8C22545 Enclosure Management Controller

The backplane supports enclosure management using a Cypress\* CY8C22545 Programmable System-on-Chip (PSoC\*) device. The CY8C22545 drives the hard drive activity/fault LED, hard drive present signal, and controls hard drive power-up during system power-on.

## 5.2 3.5" Hard Disk Drive Support

The server is available with support for four 3.5" hard disk drives as illustrated below.

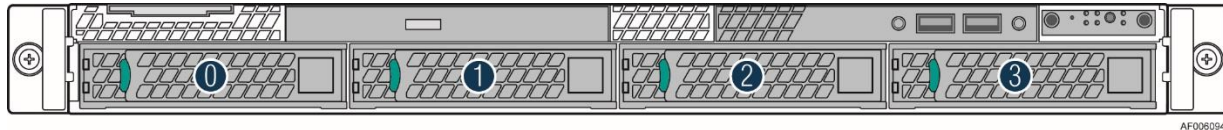

**Figure 29. 3.5" Hard Drive Bay Configuration**

The drive bay can support either SATA or SAS hard disk drives. Mixing of drive types within the hard drive bay is not supported. Hard disk drive type is dependent on the type of host bus controller used, SATA only or SAS. Each 3.5" hard disk drive is mounted to a drive tray, allowing for hot swap extraction and insertion. Drive trays have a latching mechanism that is used to extract and insert drives from the chassis, and lock the tray in place.

The hard drive carrier can also support 2.5" SSD. (**Note:** It is suggested not to use the 2.5" hard drive in the 3.5" carrier). Light pipes integrated into the drive tray assembly direct the light emitted from Amber drive status and Green activity LEDs located next to each drive connector on the backplane, to the drive tray faceplate, making them visible from the front of the system.

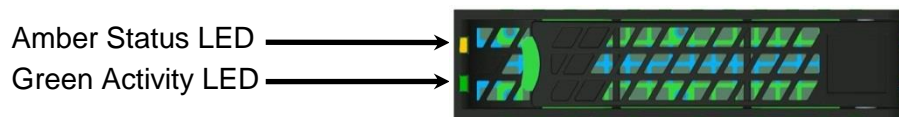

Amber	Off	No access and no fault	
	Solid On	Hard Drive Fault has occurred	
	Blink	RAID rebuild in progress (1 Hz), Identify (2 Hz)	

  

Green	Condition	Drive Type	Behavior
	Power on with no drive activity	SAS	LED stays on
		SATA	LED stays off
	Power on with drive activity	SAS	LED blinks off when processing a command
		SATA	LED blinks on when processing a command
	Power on and drive spun down	SAS	LED stays off
		SATA	LED stays off
	Power on and drive spinning up	SAS	LED blinks
SATA		LED stays off	

**Figure 30. LED of HDD Carrier**

### 5.2.1 3.5" Drive Hot-Swap Backplane Overview

On the front side of each back plane are mounted four hard disk drive interface connectors (A), each providing both power and I/O signals to attached hard disk drives.

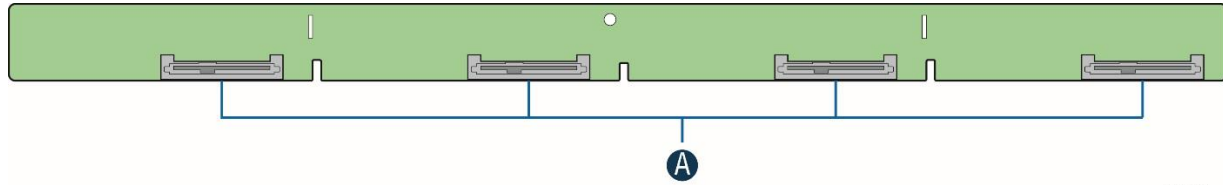

**Figure 31. The Front Side of 4 x 3.5" Hot Swap Backplane**

On the backside of each backplane are several connectors. The following illustration identifies each.

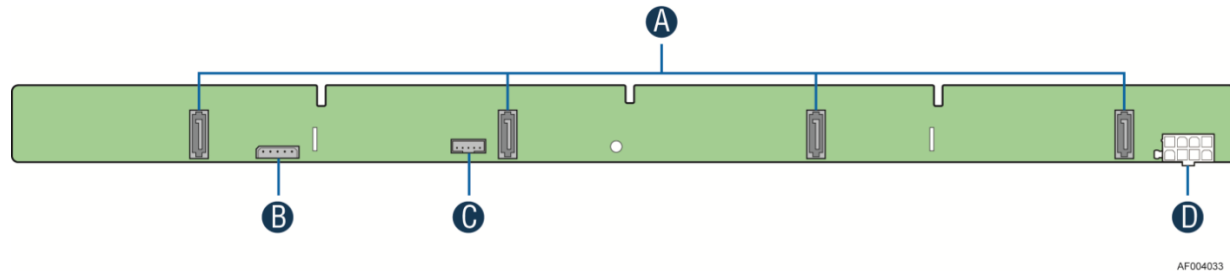

Label	Description
A	7-pin SATA/SAS I/O connectors
B	SMBus*-In cable connector – From Server board
C	SGPIO connector
D	Power connector

**Figure 32. The Back Side of 4 x 3.5" Hot Swap Backplane**

**A – 7-pin SATA I/O Connectors:** The backplane has four 7-pin SATA/SAS I/O connectors, one for each hard drive. A single multi-connector cable is routed from the backplane to a four port mini-SAS connector on the server board or other optionally installed SATA/SAS host bus adapter.

**B – SMBus\* Cable Connectors:** The backplane includes a 1x5 cable connector used as a management interface to the server board.

**C – SGPIO Cable Connector:** The SGPIO connector is a management interface used to control the hard drive fault LEDs on the backplane. The SGPIO signals are routed through a multi-connectors cable that is routed to a four port mini-SAS connector on the server board or other optionally installed SATA/SAS host bus adapter.

**D – Power Harness Connector:** The backplane includes a 2x2 connector supplying power to the backplane. Power is routed to the backplane through a power cable harness from the server board.



## 5.2.2 Cypress\* CY8C22545 Enclosure Management Controller

The backplanes support enclosure management using a Cypress\* CY8C22545 Programmable System-on-Chip (PSoC\*) device. The CY8C22545 drives the hard drive activity/fault LED, hard drive present signal, and controls hard drive power-up during the system power-on.

## 5.3 SATA DOM Support

The system has support for a vertical low profile InnoDisk\* SATA Disk-on-Module (DOM) device. The SATA DOM plugs directly into the 7-pin AHCI SATA port on the server board, which provides both power and I/O signals.



**Figure 33. InnoDisk\* Low Profile SATA DOM**

SATA DOM features include:

- Ultra Low Profile
- High speed and capacity
- Built-in VCC at pin 7

**Note:** Visit [http://www.intel.com/p/en\\_US/support](http://www.intel.com/p/en_US/support) for a list of supported InnoDisk\* SATA DOM parts.

## 6 Storage Controller Options Overview

---

The server platform supports many different embedded and add-in SATA/SAS controllers to provide a large number of possible storage configurations. This section provides an overview of the different options available.

### 6.1 Embedded SATA Controller Support

There are six 6Gb/s SATA ports on the motherboard. Intel® RSTe SW RAID through onboard SATA connectors provides SATA RAID 0/1/10/5. Intel® Embedded Server RAID Technology II through onboard SATA connectors provides SATA RAID 0/1/10 and optional RAID 5 support provided by the Intel® RAID Activation Key RKSATA4R5 on the connector of “SATA\_KEY”. S1200V3RPO and S1200V3RPM support one optional internal SAS module connector which supports Intel® SAS or ROC modules with the product code of RMS25CB080, RMS25JB080, RMS25CB040, and RMS25JB040.

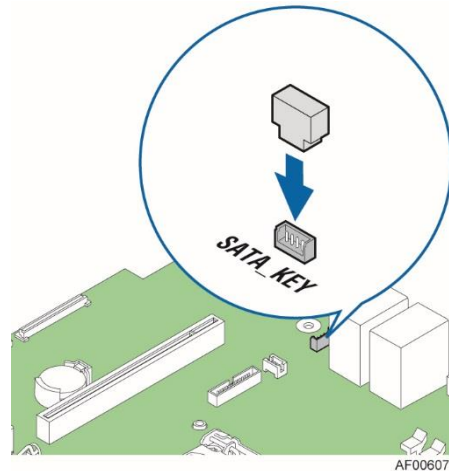
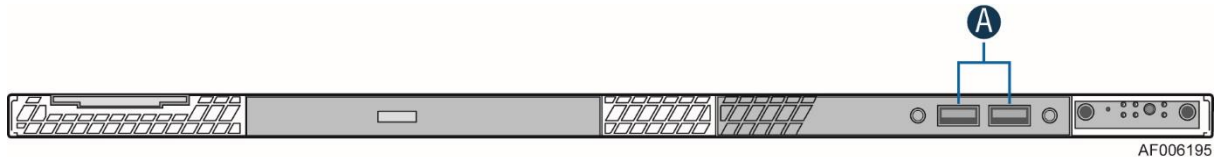

Figure 34. SATA\_KEY Place

## 7 Front Control Panel and I/O Panel Overview

On the front panel of all system configurations is a Control Panel providing push button system controls and LED indicators for several system features, and an I/O Panel providing USB ports and a video connector. This section describes the features and functions of both front panel options.

### 7.1 I/O Panel Features



Label	Description
A	USB ports

**Figure 35. Front I/O Panel Features**

**A – USB Ports:** The front I/O panel includes two USB ports. The USB ports are cabled to a 2x5 connector on the server board labeled “FP USB”.

**Note:** On systems that support 8x2.5” hard drives, the I/O Panel can be replaced with a SATA optical drive.

### 7.2 Control Panel Features

The system includes a control panel that provides push button system controls and LED indicators for several system features. Depending on the hard drive configuration, the front control panel may come in either of two formats; however, both provide the same functionality. This section provides a description for each front control panel feature.

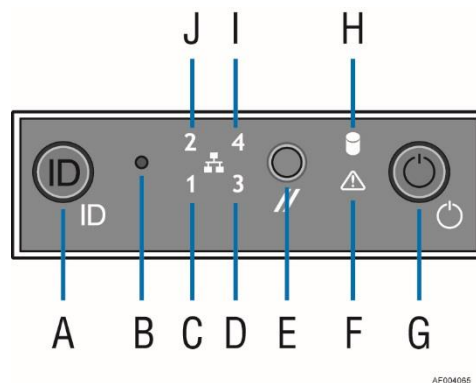

Label	Description	Label	Description
A	System ID Button with Integrated LED	F	System Status LED
B	NMI Button (recessed, tool required for use)	G	Power/Sleep Button with Integrated LED
C	NIC-1 Activity LED	H	Hard Drive Activity LED

Label	Description	Label	Description
D	NIC-3 Activity LED	I	NIC-4 Activity LED
E	System Cold Reset Button	J	NIC-2 Activity LED

**Figure 36. Front Control Panel Features**

**A – System ID Button w/Integrated LED:** Toggles the integrated ID LED and the Blue server board ID LED on and off. The System ID LED is used to identify the system for maintenance when installed in a rack of similar server systems. The System ID LED can also be toggled on and off remotely using the IPMI *Chassis Identify* command that causes the LED to blink for 15 seconds.

**B – NMI Button:** When the NMI button is pressed, it puts the server in a halt state and issues a non-maskable interrupt (NMI). This can be useful when performing diagnostics for a given issue where a memory download is necessary to help determine the cause of the problem. To prevent an inadvertent system halt, the actual NMI button is located behind the Front Control Panel faceplate where it is only accessible with the use of a small tipped tool like a pin or paper clip.

**C, D, I, and J – Network Activity LEDs:** The Front Control Panel includes an activity LED indicator for each on-board Network Interface Controller (NIC). When a network link is detected, the LED will turn on solid. The LED will blink once network activity occurs at a rate that is consistent with the amount of network activity that is occurring.

**E – System Cold Reset Button:** When pressed, this button will reboot and re-initialize the system.

**F – System Status LED:** The System Status LED is a bi-color (Green/Amber) indicator that shows the current health of the server system. The system provides two locations for this feature; one is located on the Front Control Panel, and the other is located on the back edge of the server board that is viewable from the back of the system. Both LEDs are tied together and show the same state. The System Status LED states are driven by the on-board platform management subsystem. The following table provides a description of each supported LED state.

Table 27. System Status LED State Definitions

Color	State	Criticality	Description
Off	System is not operating	Not ready	<ol style="list-style-type: none"> <li>1. System is powered off (AC and/or DC).</li> <li>2. System is in EuP Lot6 Off Mode.</li> <li>3. System is in S5 Soft-Off State.</li> <li>4. System is in S4 Hibernate Sleep State.</li> </ol>
Green	Solid on	Ok	Indicates that the System is running (in S0 State) and its status is 'Healthy'. The system is not exhibiting any errors. AC power is present and BMC has booted and manageability functionality is up and running.
Green	~1 Hz blink	Degraded - system is operating in a degraded state although still functional, or system is operating in a redundant state but with an impending failure warning	<p>System degraded:</p> <ol style="list-style-type: none"> <li>1. Redundancy loss, such as power-supply or fan. Applies only if the associated platform sub-system has redundancy capabilities.</li> <li>2. Fan warning or failure when the number of fully operational fans is more than minimum number needed to cool the system.</li> <li>3. Non-critical threshold crossed – Temperature (including HSBP temp), voltage, input power to power supply, output current for main power rail from power supply and Processor Thermal Control (Therm Ctrl) sensors.</li> <li>4. Power supply predictive failure occurred while redundant power supply configuration was present.</li> <li>5. Unable to use all of the installed memory (one or more DIMMs failed/disabled but functional memory remains available).</li> <li>6. Correctable Errors over a threshold and migrating to a spare DIMM (memory sparing). This indicates that the user no longer has spared DIMMs indicating a redundancy lost condition. Corresponding DIMM LED lit.</li> <li>7. Uncorrectable memory error has occurred in memory Mirroring Mode, causing Loss of Redundancy.</li> <li>8. Correctable memory error threshold has been reached for a failing DDR3 DIMM when the system is operating in fully redundant RAS Mirroring Mode.</li> <li>9. Battery failure.</li> <li>10. BMC executing in uBoot. (Indicated by Chassis ID blinking at Blinking at 3Hz). System in degraded state (no manageability). BMC uBoot is running but has not transferred control to BMC Linux*. Server will be in this state 6-8 seconds after BMC reset while it pulls the Linux* image into flash</li> <li>11. BMC booting Linux*. (Indicated by Chassis ID solid ON). System in degraded state (no manageability). Control has been passed from BMC uBoot to BMC Linux* itself. It will be in this state for ~10~20 seconds.</li> <li>12. BMC Watchdog has reset the BMC.</li> <li>13. Power Unit sensor offset for configuration error is asserted.</li> <li>14. HDD HSC is off-line or degraded.</li> </ol>

Color	State	Criticality	Description
Amber	~1 Hz blink	Non-critical - System is operating in a degraded state with an impending failure warning, although still functioning	<p>Non-fatal alarm – system is likely to fail:</p> <ol style="list-style-type: none"> <li>1. Critical threshold crossed – Voltage, temperature (including HSBP temp), input power to power supply, output current for main power rail from power supply, and PROCHOT (Therm Ctrl) sensors.</li> <li>2. VRD Hot asserted.</li> <li>3. Minimum number of fans to cool the system not present or failed.</li> <li>4. Hard drive fault.</li> <li>5. Power Unit Redundancy sensor – Insufficient resources offset (indicates not enough power supplies present).</li> <li>6. In non-sparing and non-mirroring mode if the threshold of correctable errors is crossed within the window.</li> <li>7. Correctable memory error threshold has been reached for a failing DDR3 DIMM when the system is operating in a non-redundant mode.</li> </ol>
Amber	Solid on	Critical, non-recoverable – System is halted	<p>Fatal alarm – system has failed or shutdown:</p> <ol style="list-style-type: none"> <li>1. CPU CATERR signal asserted.</li> <li>2. MSID mismatch detected (CATERR also asserts for this case).</li> <li>3. CPU 1 is missing.</li> <li>4. CPU Thermal Trip.</li> <li>5. No power good – power fault.</li> <li>6. DIMM failure when there is only 1 DIMM present and hence no good memory present.</li> <li>7. Runtime memory uncorrectable error in non-redundant mode.</li> <li>8. DIMM Thermal Trip or equivalent.</li> <li>9. SSB Thermal Trip or equivalent.</li> <li>10. CPU ERR2 signal asserted.</li> <li>11. BMC\Video memory test failed. (Chassis ID shows blue/solid-on for this condition).</li> <li>12. Both uBoot BMC FW images are bad. (Chassis ID shows blue/solid-on for this condition).</li> <li>13. 240VA fault.</li> <li>14. Fatal Error in processor initialization: <ol style="list-style-type: none"> <li>a. Processor family not identical.</li> <li>b. Processor model not identical.</li> <li>c. Processor core/thread counts not identical.</li> <li>d. Processor cache size not identical.</li> <li>e. Unable to synchronize processor frequency.</li> <li>f. Unable to synchronize QPI link frequency.</li> </ol> </li> </ol>

**G – Power/Sleep Button:** Toggles the system power on and off. This button also functions as a sleep button if enabled by an ACPI compliant operating system. Pressing this button will send a signal to the Integrated BMC, which will either power on or power off the system. The integrated LED is a single color (Green) and can support different indicator states as defined in Table 28.

**Table 28. Power/Sleep LED Functional States**

State	Power Mode	LED	Description
Power-off	Non-ACPI	Off	System power is off, and the BIOS has not initialized the chipset.
Power-on	Non-ACPI	On	System power is on.
S5	ACPI	Off	Mechanical is off, and the operating system has not saved any context to the hard disk.
S4	ACPI	Off	Mechanical is off. The operating system has saved context to the hard disk.
S3-S1	ACPI	Slow blink1	DC power is still on. The operating system has saved context and gone into a level of low-power state.
S0	ACPI	Steady on	System and the operating system are up and running.

**H – Drive Activity LED:** The drive activity LED on the front panel indicates drive activity from the on-board hard disk controllers. The server board also provides a header giving access to this LED for add-in controllers.

## 8 Intel® Local Control Panel

The Intel® Local Control Panel option (Intel® Product Order Code – AXXLCPANEL) utilizes a combination of control buttons and LCD display to provide system accessibility and monitoring.

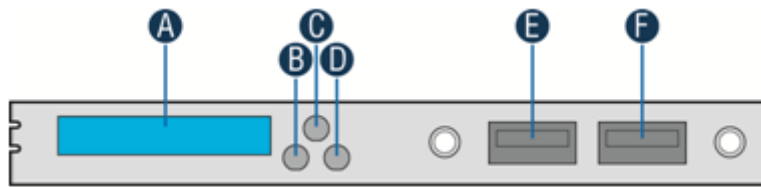

Label	Description	Functionality
A	LCD Display	One line 18 character display
B	Left Control Button	Moves the cursor backward one step or one character
C	“Enter” Button	Selects the menu item highlighted by the cursor
D	Right Control Button	Moves the cursor forward one step or one character
E	USB 2.0 Port	
F	USB 2.0 Port	

**Figure 37. Intel® Local Control Panel Option**

The LCD (Local Control Display) is a one line character display that resides on the front panel of the chassis. It can display a maximum of 18 characters at a time. This device also contains three buttons (Left, Right, and Enter). The user can select the content that needs to be displayed on the LCD screen by operating these buttons.

### 8.1 LCD Functionality

The LCD device provides the following features:

- Displays a banner when the system is healthy. The default banner is the server name.
- Displays active error messages when the system is not healthy.
- Provides basic server management configuration.
- Provides the ability to see asset information without having to open the chassis.

The LCD display is menu driven. Based on the user’s selection, respective menu items are displayed. As soon as AC Power is applied to the system, the LCD panel displays faults detected while the system is on standby power prior to the DC power on. If there are no faults, a banner is displayed. By default, the banner is a text string which displays the **Server Name**. The **Server Name** is the value specified as the product name in the product FRU information in the BMC FRU. Users can set any of the parameters under the banner configuration menu as a banner string.



When the system's status is degraded, the corresponding active event will be displayed in place of the banner. During an error, the background color will be light amber in color. The LCD panel displays the event with the highest severity that is most recent and is currently active (that is, in an asserted state). For the case that there are multiple active events with the same severity, the most recent event will be displayed. The LCD panel returns to a light blue background when there are no longer any degraded, non-fatal, or fatal events active. The LCD panel shall operate in lock-step with the system status LED. For example, if the system is operating normally and an event occurs that results in the system status LED to blink green, the LCD will display the degraded event that triggered the systems status LED to blink.

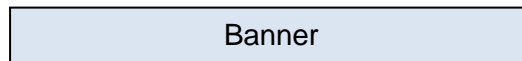

Figure 38. LCP Background Color during Normal Operation



Figure 39. LCP Background Color during an Error

If the user presses any button after the system is powered on, the main menu will be displayed. The main menu contains **Error**, **View**, and **Config** items. Based on the user's selection, respective sub menu items will be displayed. At any point of time, if there is no user intervention for more than 10 minutes, a default banner (if there is no active error event in the system) or an error event will be displayed.

The following sections discuss the individual menu items. In the following sections, it is assumed that no active event exists during the LCD display. If any event (fatal or non-fatal) occurs that degrades the system's performance, the color of the LCD background turns into light amber. Even though all the contents (full text) are shown in the example screen shots in the following sections, by default, only the first 18 characters are displayed when a particular menu item is selected. The remaining text can be viewed by using right or left buttons.

## 8.2 Main Menu

If the user presses any button, when the Banner/Error screen is displayed, the following main menu will be displayed. Using left and right scroll buttons, the cursor can be moved under any one of the following four menu items.

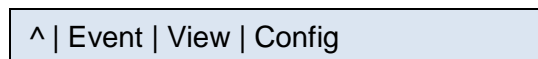
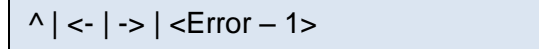

Figure 40. LCP Main Menu

If the user selects menu item ^, the LCD displays the previous screen, that is, Banner/Error string. Selecting the menu item means moving the cursor under that item using left or right buttons and pressing enter button subsequently. In all the following sections (or for any screen shot), if the user presses Enter button, when the cursor is under the symbol ^, it takes to the previous screen. Selection of any of the menu items **Event**, **View**, or **Config** leads the display to their corresponding screen shots and the details of these screen shots are given in the following sections.

## 8.3 Event Menu

In the **Event** menu, the LCD displays the following items. It displays all active error events in human readable text in chronological order. Informational events are not displayed. There is no upper limit on the number of active events which can be displayed. The severity of the event will be indicated as any, **Degraded**, **Non Fatal**, or **Fatal**.



^ | <- | -> | <Error – 1>

**Figure 41. LCP Event Menu**

The menu items <- and -> are used to traverse among the events. Selection of the menu item <- displays the previous event and the item -> displays the next event in human readable format. By default, the first event after the last power on will be displayed. If there are no events after the last power on, the fourth field is empty on the LCD screen.

By default, each error event scrolls automatically so that the entire error message can be read without pressing either the left or right scroll buttons. To stop auto scrolling, cursor has to be brought under the event message and the right button has to be pressed. Then the screen freezes. To start scrolling again right button has to be pressed when the cursor is under the event message. So, when the cursor is under event message, the right button decides whether to scroll or freeze the display of event message on the screen. When the cursor is under the event message, pressing enter button displays the failing FRU (if any) in an easily human readable format for that error event. Pressing Enter button alternatively switches the display between error message and the failing FRU (if any) information of that error message alternatively. If there is no FRU device associated with that error, Enter button has no effect when the cursor is under the error message. Left button moves the cursor under the previous token or menu item that is ->.

## 8.4 View Menu

The following screen is displayed when **View** is selected from the main menu.

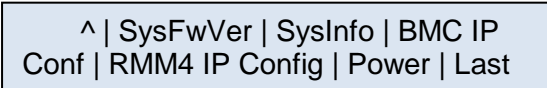

^ | SysFwVer | SysInfo | BMC IP  
Conf | RMM4 IP Config | Power | Last

**Figure 42. LCP View Menu**

Based on the user's selection, details of the specific item will be displayed. The following sub sections explain the above menu items in detail.

### 8.4.1 System Fw Version (SysFwVer)

Selecting **SysFwVer** item in the **View** menu displays the current firmware versions of the system as shown below.



^ | BIOS = xx.xx | BMC = xx.xx |  
ME = xx.xx | FRUSDR = xx.xx

**Figure 43. System Firmware Versions Menu**

This is a leaf node and there is no further traversal below this menu. User can only go to the previous screen by selecting the item **^**. This applies to all the items of **View** menu.

## 8.4.2 System Information (SysInfo)

Selecting **SysInfo** item in the **View** menu displays the server's name, model, GUID, asset tag, and custom string. It is also a leaf node like above menu. The blanks in the following display will be replaced by their values.

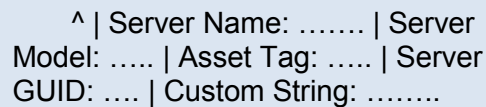

```

^ | Server Name: ..... | Server
Model: ..... | Asset Tag: ..... | Server
GUID: .... | Custom String: .....

```

**Figure 44. System Information Menu**

Each of the above fields is explained below:

- Server Name:** Value specified in the product name in the product FRU information in the main board BMC FRU.
- Server Model:** Value specified in the product part number in the product FRU information in the main board BMC FRU.
- Asset Tag:** Value specified in the product asset tag in the product FRU information in the main board BMC FRU.
- Server GUID:** System UUID stored by BIOS.
- Custom String:** Custom string placed by the OEM\end user.

## 8.4.3 BMC IP Configuration

Selecting **BMC IP Conf** item in the **View** menu displays the RMM4 IP configuration details. These details show whether the IP is configured using DHCP or Static, IP Address, Subnet Mask, and Gateway.

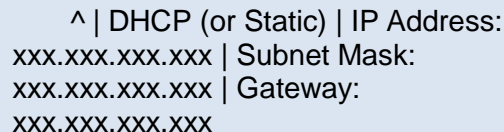

```

^ | DHCP (or Static) | IP Address:
xxx.xxx.xxx.xxx | Subnet Mask:
xxx.xxx.xxx.xxx | Gateway:
xxx.xxx.xxx.xxx

```

**Figure 45. LCP – BMC IP Configuration**

## 8.4.4 RMM4 IP Configuration

Selecting **RMM4 IP Conf** item in the **View** menu displays the BMC IP configuration details. These details show whether the IP is configured using DHCP or Static, IP Address, Subnet Mask, and Gateway.

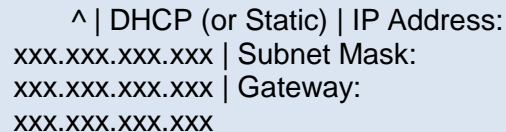

^ | DHCP (or Static) | IP Address:  
xxx.xxx.xxx.xxx | Subnet Mask:  
xxx.xxx.xxx.xxx | Gateway:  
xxx.xxx.xxx.xxx

Figure 46. LCP – RMM4 IP Configuration

### 8.4.5 Power

Selecting **Power** item in the **View** menu displays the amount of AC power drawn by the system in Watts.

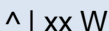

^ | xx W

Figure 47. LCP – Power Consumed by the System Currently

### 8.4.6 Last Post Code (Last PC)

Selecting **Last PC** item in the **View** menu displays the last BIOS POST code in hexadecimal.

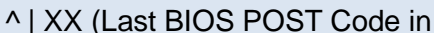

^ | XX (Last BIOS POST Code in

Figure 48. LCP – Last BIOS Post Code

## 8.5 Config Menu

If the user selects **Config** item in the main menu, the following options will be displayed to configure.

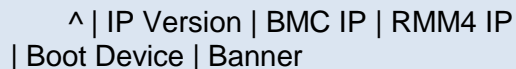

^ | IP Version | BMC IP | RMM4 IP  
| Boot Device | Banner

Figure 49. LCP – Configure Menu Items

The following sub sections will explain individual items of the configuration menu.

### 8.5.1 IP Version

If the user selects **IP Version** in the **Config** menu, the following options will be displayed. Based the user's selection, firmware will set the IP Version as either IPv4 or IPv6.



^ | IPv4 | IPv6

Figure 50. LCP – IP Version Configuration Screen

### 8.5.2 BMC IP

If the user selects **BMC IP** item in the **Config** menu, the following options will be displayed.

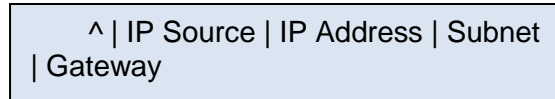

**Figure 51. LCP – BMC IP Configuration Menu**

Selection of the **IP Source** in the above menu leads to the following screen. Based on the user's selection in the following menu, the firmware sets the BMC IP source as either DHCP or Static.

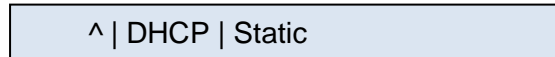

**Figure 52. LCP – BMC IP Source Configuration Menu**

If the user selects **DHCP** or if the existing IP source is DHCP, the other menu items, that is, **IP Address**, **Subnet**, and **Gateway** are not configurable. If the user selects **Static** or if the existing setting is static for IP source, the user is allowed to change the other menu items and the screen shot looks as follows.

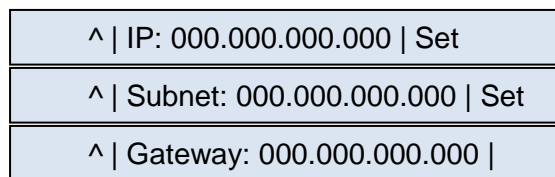

**Figure 53. Screen Shot for Configuring IP Address, Subnet Mask, and Gateway**

By default, the cursor will be under the symbol ^ and the IP address is displayed as 000.000.000.000. A right button will take the cursor to the first position (first 0) of the IP address. When the cursor is under the second menu item, the functionality of Left, Right, and Enter buttons is different from the previous screens. The second token consists of twelve 0 s' separated by period (.) character in IP address format. The behaviors of these buttons are as follows when the cursor is under this item:

1. Left and Right buttons inside the second menu item traverse among the 0 positions within the same item.
2. If the cursor is under last position inside the second menu item, a Right button will move the cursor to the next item, that is, **Set**.
3. If the cursor is under first position inside the second menu item, a Left button moves the cursor to the previous item, that is, ^.
4. First Enter button at any '0' position makes that position to be selected to increase or decrease the value at that position. The values allowed are between and including 0 and 9.
5. Any further Left or Right buttons will decrease or increase the value at that position.
6. Second Enter button at that position makes the cursor to be ready for moving left or right. Any further Left or Right button moves the cursor to previous or next position respectively.

7. The Enter button is used to select a position at the first time and to leave the position at the second time.

The following state transition diagram explains the above steps pictorially while setting an IP address using the LCD device. After entering an IP address, the user has to select **Set** item to set the entered IP address to the corresponding parameter (IP Address, Subnet Mask, or Gateway).

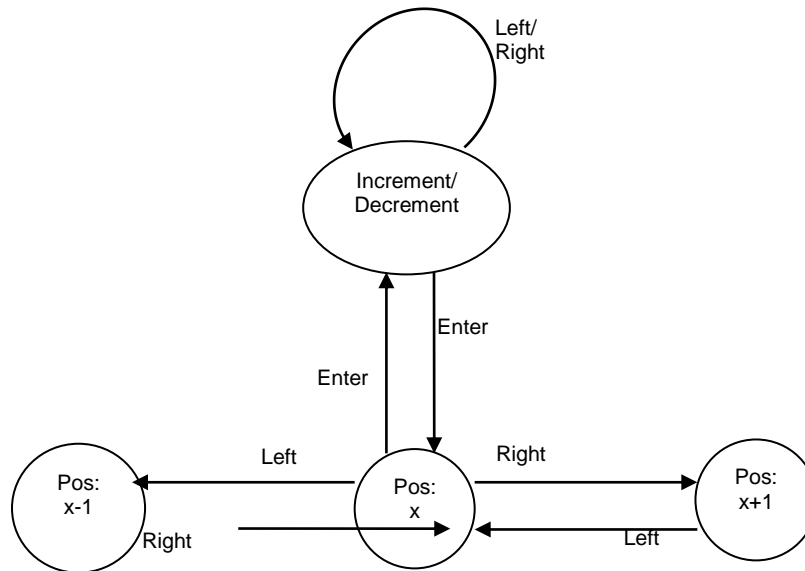

Figure 54. State Transition Diagram for Setting IP Address

### 8.5.3 RMM4 IP

The screen shots and the description in the previous section (**BMC IP**) are also applicable for **RMM4 IP** configuration menu.

### 8.5.4 Boot Device

If the user selects **Boot Device** in the **Config** menu, the following options will be displayed. The selected item will be set as the next boot option and it will not be a permanent change.

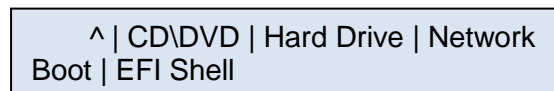
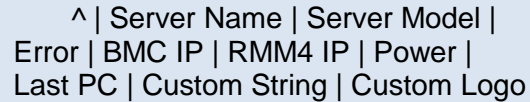

Figure 55. Boot options Configuration Menu

### 8.5.5 Banner

When the user selects **Banner** in the **Config** menu, the following options will be displayed. The selected item will be set as banner and the same will be displayed from next banner screen onwards.

A rectangular box with a light blue background and a thin black border. Inside the box, the text is arranged in three lines, separated by vertical bars. The first line contains '^ | Server Name | Server Model |'. The second line contains 'Error | BMC IP | RMM4 IP | Power |'. The third line contains 'Last PC | Custom String | Custom Logo'.

**Figure 56. Banner Configuration Menu**

Each of the menu items are explained below:

- **Server Name:** Displays the value specified in the product name in the product FRU information in the main board BMC FRU. The **Server Name** is the default banner.
- **Server Model:** Displays the value specified in the product part number in the product FRU information in the main board BMC FRU.
- **Error:** Displays the last active system event. The last active event may be degraded, non-critical, or critical only. It will not display an informational message. If the system is healthy, it displays **System Health Ok**.
- **BMC IP:** Displays the IPv4 or IPv6 address of BMC IP. If the BMC IP address is not configured, nothing is displayed.
- **RMM4 IP:** Displays the IPv4 or IPv6 address of RMM4 dedicated LAN IP. If the RMM4 IP is not set or not present, nothing is displayed.
- **Power:** Displays the current system power consumption in watts. The power consumed will be refreshed every minute.
- **Last PC:** Displays last BIOS post code.
- **Custom string:** Displays a customizable text string. The custom text string is modifiable through BIOS setup.
- **Custom Logo:** Displays a customizable bitmap logo. The OEM customized logo is programmed by the OEM and will be maintained during subsequent firmware updates.

## 9 PCIe Support and Riser Card Support

Intel® Server System R1304RPOSHBN, R1208RPOSHOR, and R1208RPMSHOR provide one PCI Express\* x16 slot through one riser card. Intel® Server System R1304RPSSFBN provides one PCI Express\* x8 slot through one riser card.

### 9.1 Architectural Overview of the Server Board Riser Slots

The following table lists the PCI Express\* slot on the three motherboards and the mapping to the systems.

**Table 29. PCI Express\* Speed Matrix for Each Configuration**

Board Name	System Name	System PCIe slot through Riser card		
S1200V3RPS	R1304RPSSFBN	PCI Express* Gen3 x8 on slot6		
S1200V3RPO	R1304RPOSHBN	Slot6	IO Module	SAS module
S1200V3RPM	R1208RPOSHOR R1208RPMSHOR	PCI Express* Gen2 x16 or Gen3 x8	Don't have add-in module	Don't have add-in module
		PCI Express* Gen3 x8 or don't have add-in card	PCI Express* Gen2 x8	Don't have add-in module
			Don't have add-in module	PCI Express* Gen2 x8
			PCI Express* Gen2 x4	PCI Express* Gen2 x4



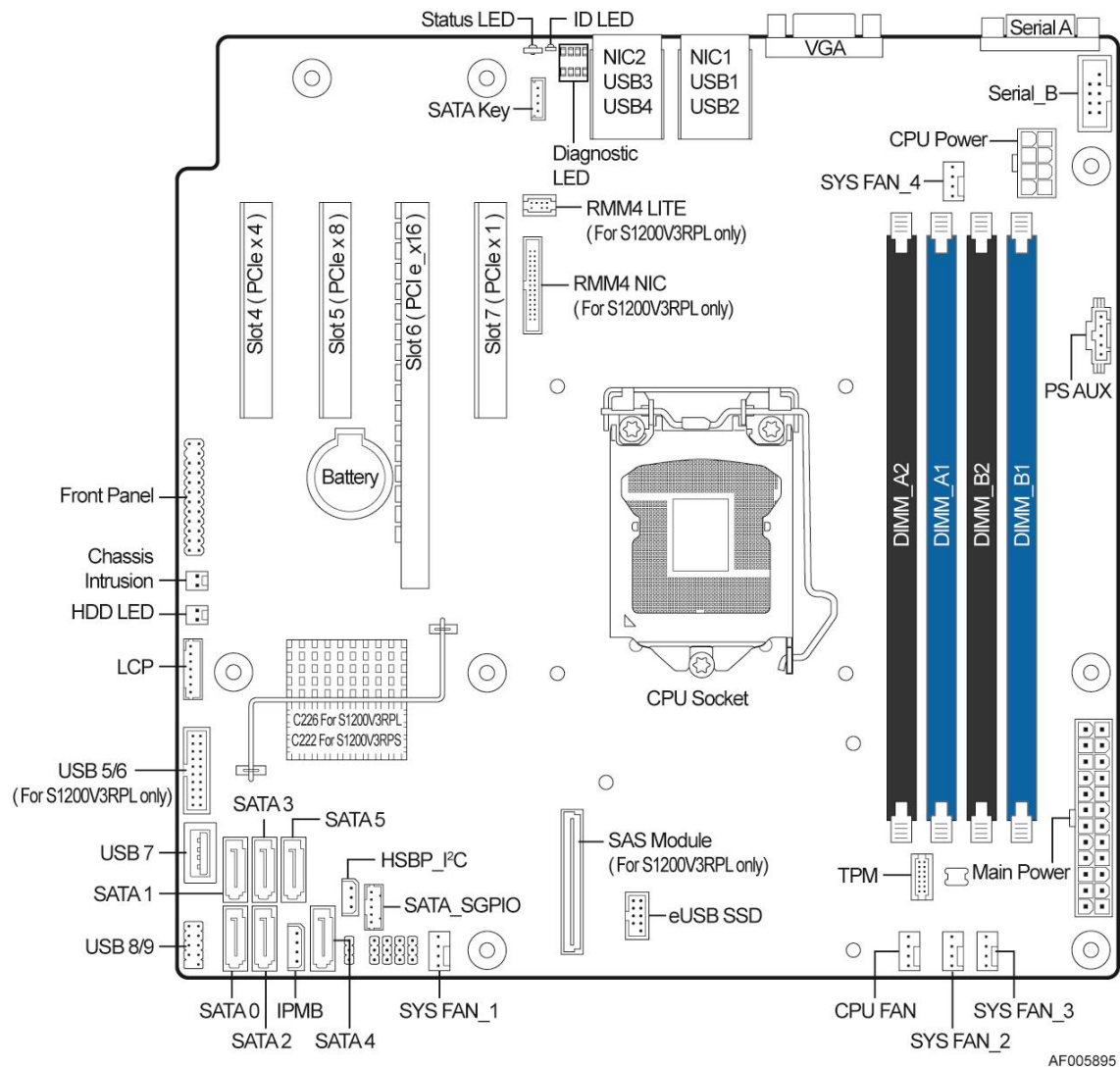

AF005895

Figure 57. PCIe SLOT Drawing

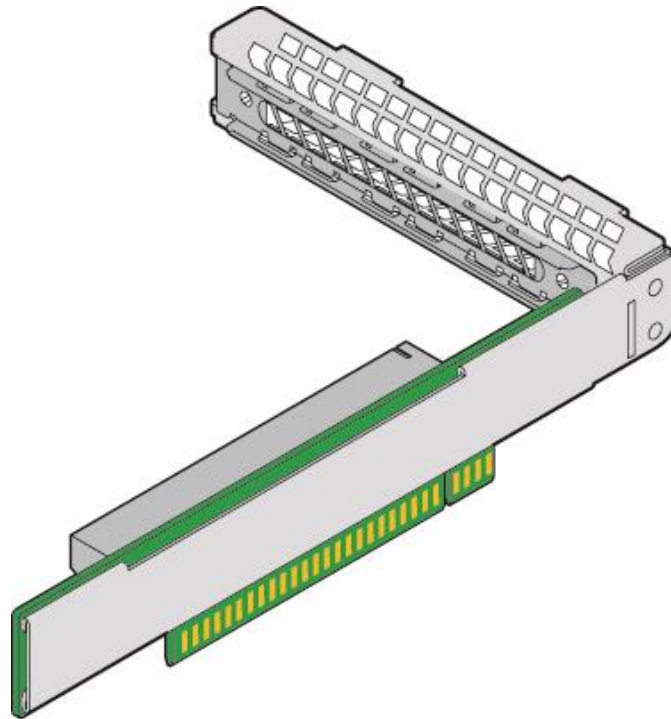

AF006196

**Figure 58. 1U Riser Card Drawing**

You can get the installation steps from the *Intel® Server System R1000RP Family Service Guide* to assemble the add-in video card.

## Appendix A: Integration and Usage Tips

Before attempting to integrate and configure your system, you should reference this section, which provides a list of useful information.

- After the system is integrated with processors, memory, and peripheral devices, the FRUSDR utility **must** be run to load the proper Sensor Data Record data to the integrated Server Management subsystem. Failure to run this utility may prevent Server Management from accurately monitoring system health and may affect system performance. The FRUSDR utility for this server system can either be run from the Intel® Deployment CDROM that came with your system or can be downloaded from the Intel® website referenced at the bottom of this page.
- To ensure the highest system reliability, make sure the latest system software is loaded on the server before deploying the system onto a live networking environment. This includes system BIOS, FRUSDR, BMC firmware, and hot-swap controller firmware. The system software can be updated using the Intel® Deployment DVD that came with your system or can be downloaded from the Intel® website referenced at the bottom of this page.
- System fans are not hot-swappable.
- Only supported memory validated by Intel should be used in this server system. A list of supported memory can be found in the *Intel® Server Board S1200V3RP Tested Memory List* which can be downloaded from the Intel® website referenced at the bottom of this page.
- This system supports the Intel® Xeon® processor E3-1200 V3/V4 series. You cannot use Intel® Xeon® processors not referenced on the supported processor list in this server system.
- You must use the CPU/memory air duct to maintain system thermals.
- To maintain system thermals, you must populate all hard drive bays with either a hard drive or drive blank.
- You must remove AC power from the system prior to opening the chassis for service.

You can download the latest system documentation, drivers, and system software from the Intel® Support website at [http://www.intel.com/p/en\\_US/support/highlights/server/R1000RP](http://www.intel.com/p/en_US/support/highlights/server/R1000RP).

## Appendix B: POST Code LED Decoder

As an aid to assist in troubleshooting a system hang that occurs during a system’s Power-On Self Test (POST) process, the server board includes a bank of eight POST Code Diagnostic LEDs on the back edge of the server board.

During the system boot process, Memory Reference Code (MRC) and System BIOS execute a number of memory initialization and platform configuration processes, each of which is assigned a specific hex POST code number. As each routine is started, the given POST code number is displayed to the POST Code Diagnostic LEDs on the back edge of the server board.

During a POST system hang, the displayed post code can be used to identify the last POST routine that was run prior to the error occurring, helping to isolate the possible cause of the hang condition.

Each POST code is represented by eight LEDs; four Green and four Amber. The POST codes are divided into two nibbles, an upper nibble and a lower nibble. The upper nibble bits are represented by Amber Diagnostic LEDs #4, #5, #6, and #7. The lower nibble bits are represented by Green Diagnostics LEDs #0, #1, #2, and #3. If the bit is set in the upper and lower nibbles, the corresponding LED is lit. If the bit is clear, the corresponding LED is off.

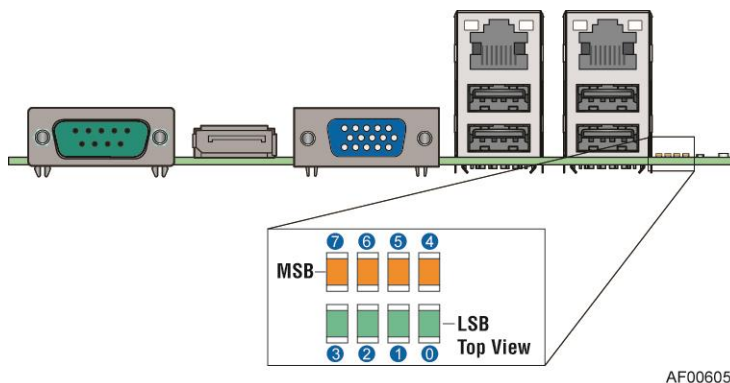

AF006053

**Figure 59. Diagnostic LED Location**

In the following example, the BIOS sends a value of ACh to the diagnostic LED decoder. The LEDs are decoded as follows.

**Note:** Diag LEDs are best read and decoded when viewing the LEDs from the back of the system.

**Table 30. POST Progress Code LED Example**

LEDs	Upper Nibble AMBER LEDs				Lower Nibble GREEN LEDs			
	MSB							LSB
	LED #7	LED #6	LED #5	LED #4	LED #3	LED #2	LED #1	LED #0
	8h	4h	2h	1h	8h	4h	2h	1h
Status	ON	OFF	ON	OFF	ON	ON	OFF	OFF
Results	1	0	1	0	1	1	0	0
	<b>Ah</b>				<b>Ch</b>			

Upper nibble bits = 1010b = Ah; Lower nibble bits = 1100b = Ch; the two are concatenated as ACh.

The following table provides a list of all POST progress codes.

**Table 31. Diagnostic LED POST Progress Codes**

Checkpoint	Diagnostic LED Decoder								Description
	1 = LED On, 0 = LED Off								
	Upper Nibble				Lower Nibble				
	MSB							LSB	
LED #	#7	#6	#5	#4	#3	#2	#1	#0	
<b>SEC Phase</b>									
01h	0	0	0	0	0	0	0	1	First POST code after CPU reset
02h	0	0	0	0	0	0	1	0	Microcode load begin
03h	0	0	0	0	0	0	1	1	CRAM initialization begin
04h	0	0	0	0	0	1	0	0	Pei Cache When Disabled
05h	0	0	0	0	0	1	0	1	SEC Core At Power On Begin.
06h	0	0	0	0	0	1	1	0	Early CPU initialization during Sec Phase.
07h	0	0	0	0	0	1	1	1	Early SB initialization during Sec Phase.
08h	0	0	0	0	1	0	0	0	Early NB initialization during Sec Phase.
09h	0	0	0	0	1	0	0	1	End Of Sec Phase.
0Eh	0	0	0	0	1	1	1	0	Microcode Not Found.
0Fh	0	0	0	0	1	1	1	1	Microcode Not Loaded.
<b>PEI Phase</b>									
10h	0	0	0	1	0	0	0	0	PEI Core
11h	0	0	0	1	0	0	0	1	CPU PEIM
15h	0	0	0	1	0	1	0	1	NB PEIM
19h	0	0	0	1	1	0	0	1	SB PEIM
MRC Process Codes – MRC Progress Code Sequence is executed - See Table 63									
PEI Phase continued...									
31h	0	0	1	1	0	0	0	1	Memory Installed
32h	0	0	1	1	0	0	1	0	CPU PEIM (Cpu Init)
33h	0	0	1	1	0	0	1	1	CPU PEIM (Cache Init)
34h	0	0	1	1	0	1	0	0	CPU PEIM (BSP Select)
35h	0	0	1	1	0	1	0	1	CPU PEIM (AP Init)
36h	0	0	1	1	0	1	1	0	CPU PEIM (CPU SMM Init)
4Fh	0	1	0	0	1	1	1	1	Dxe IPL started
<b>DXE Phase</b>									
60h	0	1	1	0	0	0	0	0	DXE Core started
61h	0	1	1	0	0	0	0	1	DXE NVRAM Init
62h	0	1	1	0	0	0	1	0	SB RUN Init
63h	0	1	1	0	0	0	1	1	Dxe CPU Init
68h	0	1	1	0	1	0	0	0	DXE PCI Host Bridge Init
69h	0	1	1	0	1	0	0	1	DXE NB Init
6Ah	0	1	1	0	1	0	1	0	DXE NB SMM Init
70h	0	1	1	1	0	0	0	0	DXE SB Init
71h	0	1	1	1	0	0	0	1	DXE SB SMM Init
72h	0	1	1	1	0	0	1	0	DXE SB devices Init
78h	0	1	1	1	1	0	0	0	DXE ACPI Init
79h	0	1	1	1	1	0	0	1	DXE CSM Init
90h	1	0	0	1	0	0	0	0	DXE BDS Started
91h	1	0	0	1	0	0	0	1	DXE BDS connect drivers
92h	1	0	0	1	0	0	1	0	DXE PCI Bus begin
93h	1	0	0	1	0	0	1	1	DXE PCI Bus HPC Init
94h	1	0	0	1	0	1	0	0	DXE PCI Bus enumeration
95h	1	0	0	1	0	1	0	1	DXE PCI Bus resource requested

Checkpoint	Diagnostic LED Decoder								Description
	1 = LED On, 0 = LED Off								
	Upper Nibble				Lower Nibble				
	MSB							LSB	
LED #	8h	4h	2h	1h	8h	4h	2h	1h	
	#7	#6	#5	#4	#3	#2	#1	#0	
96h	1	0	0	1	0	1	1	0	DXE PCI Bus assign resource
97h	1	0	0	1	0	1	1	1	DXE CON_OUT connect
98h	1	0	0	1	1	0	0	0	DXE CON_IN connect
99h	1	0	0	1	1	0	0	1	DXE SIO Init
9Ah	1	0	0	1	1	0	1	0	DXE USB start
9Bh	1	0	0	1	1	0	1	1	DXE USB reset
9Ch	1	0	0	1	1	1	0	0	DXE USB detect
9Dh	1	0	0	1	1	1	0	1	DXE USB enable
A1h	1	0	1	0	0	0	0	1	DXE IDE begin
A2h	1	0	1	0	0	0	1	0	DXE IDE reset
A3h	1	0	1	0	0	0	1	1	DXE IDE detect
A4h	1	0	1	0	0	1	0	0	DXE IDE enable
A5h	1	0	1	0	0	1	0	1	DXE SCSI begin
A6h	1	0	1	0	0	1	1	0	DXE SCSI reset
A7h	1	0	1	0	0	1	1	1	DXE SCSI detect
A8h	1	0	1	0	1	0	0	0	DXE SCSI enable
A9h	1	0	1	0	1	0	0	1	DXE verifying SETUP password
ABh	1	0	1	0	1	0	1	1	DXE SETUP start
ACh	1	0	1	0	1	1	0	0	DXE SETUP input wait
ADh	1	0	1	0	1	1	0	1	DXE Ready to Boot
A Eh	1	0	1	0	1	1	1	0	DXE Legacy Boot
AFh	1	0	1	0	1	1	1	1	DXE Exit Boot Services
B0h	1	0	1	1	0	0	0	0	RT Set Virtual Address Map Begin
B1h	1	0	1	1	0	0	0	1	RT Set Virtual Address Map End
B2h	1	0	1	1	0	0	1	0	DXE Legacy Option ROM init
B3h	1	0	1	1	0	0	1	1	DXE Reset system
B4h	1	0	1	1	0	1	0	0	DXE USB Hot plug
B5h	1	0	1	1	0	1	0	1	DXE PCI BUS Hot plug
B6h	1	0	1	1	0	1	1	0	DXE NVRAM cleanup
B7h	1	0	1	1	0	1	1	1	DXE Configuration Reset
00h	0	0	0	0	0	0	0	0	INT19
S3 Resume									
E0h	1	1	0	1	0	0	0	0	S3 Resume PEIM (S3 started)
E1h	1	1	0	1	0	0	0	1	S3 Resume PEIM (S3 boot script)
E2h	1	1	0	1	0	0	1	0	S3 Resume PEIM (S3 Video Repost)
E3h	1	1	0	1	0	0	1	1	S3 Resume PEIM (S3 OS wake)
BIOS Recovery									
F0h	1	1	1	1	0	0	0	0	PEIM which detected forced Recovery condition
F1h	1	1	1	1	0	0	0	1	PEIM which detected User Recovery condition
F2h	1	1	1	1	0	0	1	0	Recovery PEIM (Recovery started)
F3h	1	1	1	1	0	0	1	1	Recovery PEIM (Capsule found)
F4h	1	1	1	1	0	1	0	0	Recovery PEIM (Capsule loaded)

**POST Memory Initialization MRC Diagnostic Codes**

There are two types of POST Diagnostic Codes displayed by the MRC during memory initialization; Progress Codes and Fatal Error Codes.

The MRC Progress Codes are displays to the Diagnostic LEDs that show the execution point in the MRC operational path at each step.

Table 32. MRC Progress Codes

Checkpoint	Diagnostic LED Decoder								Description
	1 = LED On, 0 = LED Off								
	Upper Nibble				Lower Nibble				
	MSB							LSB	
LED	#7	#6	#5	#4	#3	#2	#1	#0	
<b>MRC Progress Codes</b>									
B0h	1	0	1	1	0	0	0	0	Detect DIMM population
B1h	1	0	1	1	0	0	0	1	Set DDR3 frequency
B2h	1	0	1	1	0	0	1	0	Gather remaining SPD data
B3h	1	0	1	1	0	0	1	1	Program registers on the memory controller level
B4h	1	0	1	1	0	1	0	0	Evaluate RAS modes and save rank information
B5h	1	0	1	1	0	1	0	1	Program registers on the channel level
B6h	1	0	1	1	0	1	1	0	Perform the JEDEC defined initialization sequence
B7h	1	0	1	1	0	1	1	1	Train DDR3 ranks
B8h	1	0	1	1	1	0	0	0	Initialize CLTT/OLTT
B9h	1	0	1	1	1	0	0	1	Hardware memory test and init
BAh	1	0	1	1	1	0	1	0	Execute software memory init
BBh	1	0	1	1	1	0	1	1	Program memory map and interleaving
BCh	1	0	1	1	1	1	0	0	Program RAS configuration
BFh	1	0	1	1	1	1	1	1	MRC is done

Memory initialization at the beginning of POST includes multiple functions, including discovery, channel training, validation that the DIMM population is acceptable and functional, initialization of the IMC and other hardware settings, and initialization of applicable RAS configurations.

When a major memory initialization error occurs and prevents the system from booting with data integrity, a beep code is generated, the MRC will display a fatal error code on the diagnostic LEDs, and a system halt command is executed. Fatal MRC error halts do NOT change the state of the System Status LED, and they do NOT get logged as SEL events. The following table lists all MRC fatal errors that are displayed to the Diagnostic LEDs.

Table 33. MRC Fatal Error Codes

Checkpoint	Diagnostic LED Decoder								Description
	1 = LED On, 0 = LED Off								
	Upper Nibble				Lower Nibble				
	MSB							LSB	
	8h	4h	2h	1h	8h	4h	2h	1h	
LED	#7	#6	#5	#4	#3	#2	#1	#0	
MRC Fatal Error Codes									
E8h	1	1	1	0	1	0	0	0	No usable memory error 01h = No memory was detected from the SPD read, or invalid config that causes no operable memory. 02h = Memory DIMMs on all channels of all sockets are disabled due to hardware memtest error. 3h = No memory installed. All channels are disabled.
E9h	1	1	1	0	1	0	0	1	Memory is locked by Intel® Trusted Execution Technology and is inaccessible
EAh	1	1	1	0	1	0	1	0	DDR3 channel training error 01h = Error on read DQ/DQS (Data/Data Strobe) init 02h = Error on Receive Enable 3h = Error on Write Leveling 04h = Error on write DQ/DQS (Data/Data Strobe)
EBh	1	1	1	0	1	0	1	1	Memory test failure 01h = Software memtest failure. 02h = Hardware memtest failed. 03h = Hardware Memtest failure in Lockstep Channel mode requiring a channel to be disabled. <i>This is a fatal error which requires a reset and calling MRC with a different RAS mode to retry.</i>
EDh	1	1	1	0	1	1	0	1	DIMM configuration population error 01h = Different DIMM types (UDIMM, RDIMM, LRDIMM) are detected installed in the system. 02h = Violation of DIMM population rules. 03h = The third DIMM slot cannot be populated when QR DIMMs are installed. 04h = UDIMMs are not supported in the third DIMM slot. 05h = Unsupported DIMM Voltage.
EFh	1	1	1	0	1	1	1	1	Indicates a CLTT table structure error



## Appendix C: POST Code Errors

Most error conditions encountered during POST are reported using **POST Error Codes**. These codes represent specific failures, warnings, or are informational. POST Error Codes may be displayed in the Error Manager display screen, and are always logged to the System Event Log (SEL). Logged events are available to System Management applications, including Remote and Out of Band (OOB) management.

There are exception cases in early initialization where system resources are not adequately initialized for handling POST Error Code reporting. These cases are primarily Fatal Error conditions resulting from initialization of processors and memory, and they are handed by a Diagnostic LED display with a system halt.

The following table lists the supported POST Error Codes. Each error code is assigned an error type which determines the action the BIOS will take when the error is encountered. Error types include Minor, Major, and Fatal. The BIOS action for each is defined as follows:

- **Minor:** The error message is displayed on the screen or on the Error Manager screen, and an error is logged to the SEL. The system continues booting in a degraded state. The user may want to replace the erroneous unit. The POST Error Pause option setting in the BIOS setup does not have any effect on this error.
- **Major:** The error message is displayed on the Error Manager screen, and an error is logged to the SEL. The POST Error **P**ause option setting in the BIOS setup determines whether the system pauses to the Error Manager for this type of error so the user can take immediate corrective action or the system continues booting.

Note that for 0048 “Password check failed”, the system halts, and then after the next reset/reboot will displays the error code on the Error Manager screen.

- **Fatal:** The system halts during post at a blank screen with the text “**Unrecoverable fatal error found. System will not boot until the error is resolved**” and “**Press <F2> to enter setup**” The POST Error Pause option setting in the BIOS setup does not have any effect with this class of error.

When the operator presses the **F2** key on the keyboard, the error message is displayed on the Error Manager screen, and an error is logged to the SEL with the error code. The system cannot boot unless the error is resolved. The user needs to replace the faulty part and restart the system.

**Note:** The POST error codes in the following table are common to all current generation Intel® server platforms. Features present on a given server board/system will determine which of the listed error codes are supported.

**Table 34. POST Error Message and Handling**

Error Code	Error Message	Response
0012	System RTC date/time not set	Major
0048	Password check failed	Major
0140	PCI component encountered a PERR error	Major
0141	PCI resource conflict	Major

Error Code	Error Message	Response
0146	PCI out of resources error	Major
0191	Processor core/thread count mismatch detected	Fatal
0192	Processor cache size mismatch detected	Fatal
0194	Processor family mismatch detected	Fatal
0195	Processor Intel® QPI link frequencies unable to synchronize	Fatal
0196	Processor model mismatch detected	Fatal
0197	Processor frequencies unable to synchronize	Fatal
5220	BIOS Settings reset to default settings	Major
5221	Passwords cleared by jumper	Major
5224	Password clear jumper is Set	Major
8130	Processor 01 disabled	Major
8131	Processor 02 disabled	Major
8132	Processor 03 disabled	Major
8133	Processor 04 disabled	Major
8160	Processor 01 unable to apply microcode update	Major
8161	Processor 02 unable to apply microcode update	Major
8162	Processor 03 unable to apply microcode update	Major
8163	Processor 04 unable to apply microcode update	Major
8170	Processor 01 failed Self Test (BIST)	Major
8171	Processor 02 failed Self Test (BIST)	Major
8172	Processor 03 failed Self Test (BIST)	Major
8173	Processor 04 failed Self Test (BIST)	Major
8180	Processor 01 microcode update not found	Minor
8181	Processor 02 microcode update not found	Minor
8182	Processor 03 microcode update not found	Minor
8183	Processor 04 microcode update not found	Minor
8190	Watchdog timer failed on last boot	Major
8198	OS boot watchdog timer failure	Major
8300	Baseboard management controller failed self-test	Major
8305	Hot Swap Controller failure	Major
83A0	Management Engine (ME) failed Self Test	Major
83A1	Management Engine (ME) Failed to respond.	Major
84F2	Baseboard management controller failed to respond	Major
84F3	Baseboard management controller in update mode	Major
84F4	Sensor data record empty	Major
84FF	System event log full	Minor
8500	Memory component could not be configured in the selected RAS mode	Major
8501	DIMM Population Error	Major
8520	DIMM_A1 failed test/initialization	Major
8521	DIMM_A2 failed test/initialization	Major
8522	DIMM_A3 failed test/initialization	Major
8523	DIMM_B1 failed test/initialization	Major
8524	DIMM_B2 failed test/initialization	Major
8525	DIMM_B3 failed test/initialization	Major
8526	DIMM_C1 failed test/initialization	Major
8527	DIMM_C2 failed test/initialization	Major
8528	DIMM_C3 failed test/initialization	Major
8529	DIMM_D1 failed test/initialization	Major
852A	DIMM_D2 failed test/initialization	Major
852B	DIMM_D3 failed test/initialization	Major
852C	DIMM_E1 failed test/initialization	Major
852D	DIMM_E2 failed test/initialization	Major
852E	DIMM_E3 failed test/initialization	Major
852F	DIMM_F1 failed test/initialization	Major
8530	DIMM_F2 failed test/initialization	Major
8531	DIMM_F3 failed test/initialization	Major
8532	DIMM_G1 failed test/initialization	Major
8533	DIMM_G2 failed test/initialization	Major

Error Code	Error Message	Response
8534	DIMM_G3 failed test/initialization	Major
8535	DIMM_H1 failed test/initialization	Major
8536	DIMM_H2 failed test/initialization	Major
8537	DIMM_H3 failed test/initialization	Major
8538	DIMM_I1 failed test/initialization	Major
8539	DIMM_I2 failed test/initialization	Major
853A	DIMM_I3 failed test/initialization	Major
853B	DIMM_J1 failed test/initialization	Major
853C	DIMM_J2 failed test/initialization	Major
853D	DIMM_J3 failed test/initialization	Major
853E	DIMM_K1 failed test/initialization	Major
853F (Go to 85C0)	DIMM_K2 failed test/initialization	Major
8540	DIMM_A1 disabled	Major
8541	DIMM_A2 disabled	Major
8542	DIMM_A3 disabled	Major
8543	DIMM_B1 disabled	Major
8544	DIMM_B2 disabled	Major
8545	DIMM_B3 disabled	Major
8546	DIMM_C1 disabled	Major
8547	DIMM_C2 disabled	Major
8548	DIMM_C3 disabled	Major
8549	DIMM_D1 disabled	Major
854A	DIMM_D2 disabled	Major
854B	DIMM_D3 disabled	Major
854C	DIMM_E1 disabled	Major
854D	DIMM_E2 disabled	Major
854E	DIMM_E3 disabled	Major
854F	DIMM_F1 disabled	Major
8550	DIMM_F2 disabled	Major
8551	DIMM_F3 disabled	Major
8552	DIMM_G1 disabled	Major
8553	DIMM_G2 disabled	Major
8554	DIMM_G3 disabled	Major
8555	DIMM_H1 disabled	Major
8556	DIMM_H2 disabled	Major
8557	DIMM_H3 disabled	Major
8558	DIMM_I1 disabled	Major
8559	DIMM_I2 disabled	Major
855A	DIMM_I3 disabled	Major
855B	DIMM_J1 disabled	Major
855C	DIMM_J2 disabled	Major
855D	DIMM_J3 disabled	Major
855E	DIMM_K1 disabled	Major
855F (Go to 85D0)	DIMM_K2 disabled	Major
8560	DIMM_A1 encountered a Serial Presence Detection (SPD) failure	Major
8561	DIMM_A2 encountered a Serial Presence Detection (SPD) failure	Major
8562	DIMM_A3 encountered a Serial Presence Detection (SPD) failure	Major
8563	DIMM_B1 encountered a Serial Presence Detection (SPD) failure	Major
8564	DIMM_B2 encountered a Serial Presence Detection (SPD) failure	Major
8565	DIMM_B3 encountered a Serial Presence Detection (SPD) failure	Major
8566	DIMM_C1 encountered a Serial Presence Detection (SPD) failure	Major
8567	DIMM_C2 encountered a Serial Presence Detection (SPD) failure	Major
8568	DIMM_C3 encountered a Serial Presence Detection (SPD) failure	Major
8569	DIMM_D1 encountered a Serial Presence Detection (SPD) failure	Major

Error Code	Error Message	Response
856A	DIMM_D2 encountered a Serial Presence Detection (SPD) failure	Major
856B	DIMM_D3 encountered a Serial Presence Detection (SPD) failure	Major
856C	DIMM_E1 encountered a Serial Presence Detection (SPD) failure	Major
856D	DIMM_E2 encountered a Serial Presence Detection (SPD) failure	Major
856E	DIMM_E3 encountered a Serial Presence Detection (SPD) failure	Major
856F	DIMM_F1 encountered a Serial Presence Detection (SPD) failure	Major
8570	DIMM_F2 encountered a Serial Presence Detection (SPD) failure	Major
8571	DIMM_F3 encountered a Serial Presence Detection (SPD) failure	Major
8572	DIMM_G1 encountered a Serial Presence Detection (SPD) failure	Major
8573	DIMM_G2 encountered a Serial Presence Detection (SPD) failure	Major
8574	DIMM_G3 encountered a Serial Presence Detection (SPD) failure	Major
8575	DIMM_H1 encountered a Serial Presence Detection (SPD) failure	Major
8576	DIMM_H2 encountered a Serial Presence Detection (SPD) failure	Major
8577	DIMM_H3 encountered a Serial Presence Detection (SPD) failure	Major
8578	DIMM_I1 encountered a Serial Presence Detection (SPD) failure	Major
8579	DIMM_I2 encountered a Serial Presence Detection (SPD) failure	Major
857A	DIMM_I3 encountered a Serial Presence Detection (SPD) failure	Major
857B	DIMM_J1 encountered a Serial Presence Detection (SPD) failure	Major
857C	DIMM_J2 encountered a Serial Presence Detection (SPD) failure	Major
857D	DIMM_J3 encountered a Serial Presence Detection (SPD) failure	Major
857E	DIMM_K1 encountered a Serial Presence Detection (SPD) failure	Major
857F	DIMM_K2 encountered a Serial Presence Detection (SPD) failure	Major
(Go to 85E0)		
85C0	DIMM_K3 failed test/initialization	Major
85C1	DIMM_L1 failed test/initialization	Major
85C2	DIMM_L2 failed test/initialization	Major
85C3	DIMM_L3 failed test/initialization	Major
85C4	DIMM_M1 failed test/initialization	Major
85C5	DIMM_M2 failed test/initialization	Major
85C6	DIMM_M3 failed test/initialization	Major
85C7	DIMM_N1 failed test/initialization	Major
85C8	DIMM_N2 failed test/initialization	Major
85C9	DIMM_N3 failed test/initialization	Major
85CA	DIMM_O1 failed test/initialization	Major
85CB	DIMM_O2 failed test/initialization	Major
85CC	DIMM_O3 failed test/initialization	Major
85CD	DIMM_P1 failed test/initialization	Major
85CE	DIMM_P2 failed test/initialization	Major
85CF	DIMM_P3 failed test/initialization	Major
85D0	DIMM_K3 disabled	Major
85D1	DIMM_L1 disabled	Major
85D2	DIMM_L2 disabled	Major
85D3	DIMM_L3 disabled	Major
85D4	DIMM_M1 disabled	Major
85D5	DIMM_M2 disabled	Major
85D6	DIMM_M3 disabled	Major
85D7	DIMM_N1 disabled	Major
85D8	DIMM_N2 disabled	Major
85D9	DIMM_N3 disabled	Major
85DA	DIMM_O1 disabled	Major
85DB	DIMM_O2 disabled	Major
85DC	DIMM_O3 disabled	Major
85DD	DIMM_P1 disabled	Major
85DE	DIMM_P2 disabled	Major
85DF	DIMM_P3 disabled	Major
85E0	DIMM_K3 encountered a Serial Presence Detection (SPD) failure	Major
85E1	DIMM_L1 encountered a Serial Presence Detection (SPD) failure	Major

Error Code	Error Message	Response
85E2	DIMM_L2 encountered a Serial Presence Detection (SPD) failure	Major
85E3	DIMM_L3 encountered a Serial Presence Detection (SPD) failure	Major
85E4	DIMM_M1 encountered a Serial Presence Detection (SPD) failure	Major
85E5	DIMM_M2 encountered a Serial Presence Detection (SPD) failure	Major
85E6	DIMM_M3 encountered a Serial Presence Detection (SPD) failure	Major
85E7	DIMM_N1 encountered a Serial Presence Detection (SPD) failure	Major
85E8	DIMM_N2 encountered a Serial Presence Detection (SPD) failure	Major
85E9	DIMM_N3 encountered a Serial Presence Detection (SPD) failure	Major
85EA	DIMM_O1 encountered a Serial Presence Detection (SPD) failure	Major
85EB	DIMM_O2 encountered a Serial Presence Detection (SPD) failure	Major
85EC	DIMM_O3 encountered a Serial Presence Detection (SPD) failure	Major
85ED	DIMM_P1 encountered a Serial Presence Detection (SPD) failure	Major
85EE	DIMM_P2 encountered a Serial Presence Detection (SPD) failure	Major
85EF	DIMM_P3 encountered a Serial Presence Detection (SPD) failure	Major
8604	POST Reclaim of non-critical NVRAM variables	Minor
8605	BIOS Settings are corrupted	Major
8606	NVRAM variable space was corrupted and has been reinitialized	Major
92A3	Serial port component was not detected	Major
92A9	Serial port component encountered a resource conflict error	Major
A000	TPM device not detected.	Minor
A001	TPM device missing or not responding.	Minor
A002	TPM device failure.	Minor
A003	TPM device failed self test.	Minor
A100	BIOS ACM Error	Major
A421	PCI component encountered a SERR error	Fatal
A5A0	PCI Express* component encountered a PERR error	Minor
A5A1	PCI Express* component encountered an SERR error	Fatal
A6A0	DXE Boot Service driver: Not enough memory available to shadow a Legacy Option ROM	Minor

## POST Error Beep Codes

The following table lists POST error beep codes. Prior to system video initialization, the BIOS uses these beep codes to inform users on error conditions. The beep code is followed by a user-visible code on POST Progress LEDs.

**Table 35. POST Error Beep Codes**

Beeps	Error Message	POST Progress Code	Description
1	USB device action	NA	Short beep sounded whenever a USB device is discovered in POST, or inserted or removed during runtime
1 long	Intel® TXT security violation	0xAE, 0xAF	System halted because Intel® Trusted Execution Technology detected a potential violation of system security.
3	Memory error	See Tables 28 and 29	System halted because a fatal error related to the memory was detected.
2	BIOS Recovery started	NA	Recovery boot has been initiated
4	BIOS Recovery failure	NA	BIOS recovery has failed. This typically happens so quickly after recovery was initiated that it sounds like a 2-4 beep code.

## Integrated BMC Beep Codes

The Integrated BMC may generate beep codes upon detection of failure conditions. Beep codes are sounded each time the problem is discovered, such as on each power-up attempt, but are not sounded continuously. Codes that are common across all Intel® server boards and systems that use same generation chipset are listed in the following table. Each digit in the code is represented by a sequence of beeps whose count is equal to the digit.

**Table 36. Integrated BMC Beep Codes**

Code	Reason for Beep	Associated Sensors
1-5-2-1	No CPUs installed or first CPU socket is empty.	CPU1 socket is empty, or sockets are populated incorrectly CPU1 must be populated before CPU2.
1-5-2-4	MSID Mismatch	MSID mismatch occurs if a processor is installed into a system board that has incompatible power capabilities.
1-5-4-2	Power fault	DC power unexpectedly lost (power good dropout) – Power unit sensors report power unit failure offset
1-5-4-4	Power control fault (power good assertion timeout).	Power good assertion timeout – Power unit sensors report soft power control failure offset
1-5-1-2	VR Watchdog Timer sensor assertion	VR controller DC power on sequence was not completed in time.
1-5-1-4	Power Supply Status	The system does not power on or unexpectedly powers off and a Power Supply Unit (PSU) is present that is an incompatible model with one or more other PSUs in the system.

## Glossary

Term	Definition
ACPI	Advanced Configuration and Power Interface
AP	Application Processor
APIC	Advanced Programmable Interrupt Control
ASIC	Application Specific Integrated Circuit
ASMI	Advanced Server Management Interface
BIOS	Basic Input/Output System
BIST	Built-In Self Test
BMC	Baseboard Management Controller
Bridge	Circuitry connecting one computer bus to another, allowing an agent on one to access the other
BSP	Bootstrap Processor
Byte	8-bit quantity
CBC	Chassis Bridge Controller (A microcontroller connected to one or more other CBCs, together they bridge the IPMB buses of multiple chassis.)
CEK	Common Enabling Kit
CHAP	Challenge Handshake Authentication Protocol
CMOS	In terms of this specification, this describes the PC-AT compatible region of battery-backed 128 bytes of memory, which normally resides on the server board
DPC	Direct Platform Control
EEPROM	Electrically Erasable Programmable Read-Only Memory
EHCI	Enhanced Host Controller Interface
EMP	Emergency Management Port
EPS	External Product Specification
ESB2-E	Enterprise South Bridge 2
FBD	Fully Buffered DIMM
FMB	Flexible Mother Board
FRB	Fault Resilient Booting
FRU	Field Replaceable Unit
FSB	Front Side Bus
GB	1024MB
GPIO	General Purpose I/O
GTL	Gunning Transceiver Logic
HSC	Hot-Swap Controller
Hz	Hertz (1 cycle/second)
I <sup>2</sup> C	Inter-Integrated Circuit Bus
IA	Intel® Architecture
IBF	Input Buffer
ICH	I/O Controller Hub
ICMB	Intelligent Chassis Management Bus
IERR	Internal Error
IFB	I/O and Firmware Bridge
INTR	Interrupt

Term	Definition
IP	Internet Protocol
IPMB	Intelligent Platform Management Bus
IPMI	Intelligent Platform Management Interface
IR	Infrared
ITP	In-Target Probe
KB	1024 bytes
KCS	Keyboard Controller Style
LAN	Local Area Network
LCD	Liquid Crystal Display
LED	Light Emitting Diode
LPC	Low Pin Count
LUN	Logical Unit Number
MAC	Media Access Control
MB	1024KB
MCH	Memory Controller Hub
MD2	Message Digest 2 – Hashing Algorithm
MD5	Message Digest 5 – Hashing Algorithm – Higher Security
ms	milliseconds
MTTR	Memory Type Range Register
Mux	Multiplexor
NIC	Network Interface Controller
NMI	Nonmaskable Interrupt
OBF	Output Buffer
OEM	Original Equipment Manufacturer
Ohm	Unit of electrical resistance
PDB	Power Distribution Board
PEF	Platform Event Filtering
PEP	Platform Event Paging
PIA	Platform Information Area (This feature configures the firmware for the platform hardware.)
PLD	Programmable Logic Device
PMI	Platform Management Interrupt
POST	Power-On Self Test
PSMI	Power Supply Management Interface
PWM	Pulse-Width Modulation
RAM	Random Access Memory
RASUM	Reliability, Availability, Serviceability, Usability, and Manageability
RISC	Reduced Instruction Set Computing
RMM3	Remote Management Module – 3 <sup>rd</sup> generation
RMM3 NIC	Remote Management Module – 3 <sup>rd</sup> generation dedicated management NIC
ROM	Read Only Memory
RTC	Real-Time Clock (Component of ICH peripheral chip on the server board.)
SDR	Sensor Data Record
SECC	Single Edge Connector Cartridge



Term	Definition
SEEPROM	Serial Electrically Erasable Programmable Read-Only Memory
SEL	System Event Log
SIO	Server Input/Output
SMI	Server Management Interrupt (SMI is the highest priority nonmaskable interrupt.)
SMM	Server Management Mode
SMS	Server Management Software
SNMP	Simple Network Management Protocol
SSI	Server System Infrastructure
TBD	To Be Determined
TIM	Thermal Interface Material
UART	Universal Asynchronous Receiver/Transmitter
UDP	User Datagram Protocol
UHCI	Universal Host Controller Interface
UTC	Universal time coordinate
VID	Voltage Identification
VRD	Voltage Regulator Down
Word	16-bit quantity
ZIF	Zero Insertion Force

## Reference Documents

Refer to the following documents for additional information:

- *Intel® Server Board S1200V3RP Technical Product Specification*
- *ACPI 3.0*: <http://www.acpi.info/spec.htm>
- *IPMI 2.0*
- *Data Center Management Interface Specification v1.0*, May 1, 2008: [www.intel.com/go/dcmi](http://www.intel.com/go/dcmi)
- *PCI Bus Power Management Interface Specification 1.1*: <http://www.pcisig.com/>
- *PCI Express\* Base Specification Rev 2.0*, Dec 06: <http://www.pcisig.com/>
- *PCI Express\* Card Electromechanical Specification, Rev 2.0*: <http://www.pcisig.com/>
- *PMBus\**: <http://pmbus.org>
- *SATA 2.6*: <http://www.sata-io.org/>
- *SMBIOS 2.4*
- *SSI-EEB 3.0*: <http://www.ssiforum.org/>
- *USB 1.1*: <http://www.usb.org>
- *USB 2.0*: <http://www.usb.org>
- *Windows\* Logo/SDG 3.0*
- *Intel® Dynamic Power Technology Node Manager 1.5 External Interface Specification using IPMI, 2007*. Intel Corporation.
- *Node Power and Thermal Management Architecture Specification v1.5, rev.0.79*. 2007, Intel Corporation.
- *Intel® Server System Integrated Baseboard Management Controller Core External Product Specification, 2007* Intel Corporation.
- *Intel® Thurley Server Platform Services IPMI Commands Specification, 2007*. Intel Corporation.
- *Intel® Server Safety and Regulatory, 2012*. Intel Corporation. (Intel® Order Code: G23122)
- *Intelligent Platform Management Bus Communications Protocol Specification, Version 1.0*, 1998. Intel Corporation, Hewlett-Packard\* Company, NEC\* Corporation, Dell\* Computer Corporation.
- *Platform Environmental Control Interface (PECI) Specification, Version 2.0*. Intel Corporation.
- *Platform Management FRU Information Storage Definition, Version 1.0, Revision 1.2*, 2002. Intel Corporation, Hewlett-Packard\* Company, NEC\* Corporation, Dell\* Computer Corporation: <http://developer.intel.com/design/servers/ipmi/spec.htm>.