

Intel<sup>®</sup> Server Board S5000PSL,  
Intel<sup>®</sup> Server Board S5000XSL,  
Intel<sup>®</sup> Workstation board S5000XVN,  
Intel<sup>®</sup> Server Chassis SC5400, and  
Intel<sup>®</sup> Entry Server Chassis SC5299-E

## Spares Parts List and Configuration Guide

A reference guide to help customers order the necessary components to configure the Intel<sup>®</sup> Server Board S5000PSL and Intel<sup>®</sup> Workstation Board S5000XVN with the appropriate Intel chassis.



Rev 2.0

April, 2010

~ Subject to Change ~

## **ChangeHistory:**

5/10/06 Rev 1.0: Deleted pre-production information.

5/10/06 Rev 1.1: Updated RAID MM#'s and MOQ, ROMB descriptions for RAK product codes.

5/22/06 Rev 1.11: Updated AXX6DRV3G and AXX4DRV3G descriptions.

5/23/06 Rev 1.12: Updated errors in RAID descriptions.

6/26/06 Rev 1.13: Corrected description for ASLIO, BB5000PSLSATA MM#, slides for 5100 series processors.

6/28/06 Rev 1.14: New MM# for ARIGRACK and ASLPWRCABLE.

9/1/06 Rev 1.20: New MM# for MCH ECO.

9/12/06 Rev 1.21: New MM# for AXX6FDSCSIFAN.

9/31/06 Rev 1.22: Updated Configuration presentation for AXXUSBFLOPPY.

11/13/06 Rev 1.3: Updated Configuration presentation for 5300 Series processors and ROMB / backplane support.

2/27/07 Rev 1.31: Added SC5400LXi information and SCSI HSBP and SCSI RAID cards to Configuration.

3/06/07 Rev 1.4: Added RMM2 Information.

3/06/07 Rev 1.41: Added AXX04HSBPYCBL.

8/07/07 Rev 1.5: Added Refresh SKUs.

11/09/07 Rev 1.6: New MM# for OEM 10-pack SKUs, corrected boxed board content, and removed MM# of Non-Refresh SKUs.

1/02/08 Rev 1.7: Updated boxed processor content and production RAID products.

1/15/09 Rev 1.8: Removed 4-pin power cable ASLPWRCABLE from the boxed board SKUs.

11/11/09 Rev 1.9: Added AXX04HSBPYCBL, updated the MM# of production board SKUs, added VMware vSphere\* Virtualization Software

04/01/10 Rev 2.0: Removed AXXRMM and AXXUSBFLOPPY, updated MM# of AXXSCD.

---

## **Disclaimer**

Information in this document is provided in connection with Intel® products. No license, express or implied, by estoppel or otherwise, to any intellectual property rights is granted by this document. Except as provided in Intel's Terms and Conditions of Sale for such products, Intel assumes no liability whatsoever, and Intel disclaims any express or implied warranty, relating to sale and/or use of Intel products including liability or warranties relating to fitness for a particular purpose, merchantability, or infringement of any patent, copyright or other intellectual property right. Intel products are not intended for use in medical, life saving, or life sustaining applications. Intel may make changes to specifications and product descriptions at any time, without notice.

\*Other brands and names may be claimed as the property of others. Intel, Pentium, Itanium, and Xeon are trademarks or registered trademarks of Intel Corporation.

All products, dates, and figures are preliminary and are subject to change without any notice.

Copyright © Intel Corporation 2007-2010.

## Contents

<b>Contents</b> .....	3
<b>Production SKU Details and Contents</b> .....	4
Production Configuration and Ordering Steps (Intel® Server Board S5000PSL / Intel® Server Board S5000XSL)	4
Production Configuration and Ordering Steps (S5000XVN) .....	8
Production Configuration .....	12
Production Board SKUs .....	15
Production Chassis .....	16
Production Spares and Accessories .....	18
Production RAID Products .....	23
VMware vSphere* Virtualization Software Configuration Guide for vSphere* SKUs	25

## Production SKU Details and Contents

Production Configuration and Ordering Steps (Intel® Server Board S5000PSL / Intel® Server Board S5000XSL)

This section highlights the ordering steps and configurations for the Intel® Server Board S5000PSL and Intel® Server Board S5000XSL server board families. More detailed information is in the following sections.

### Step 1 – Select a Server Board

<b>Server Board S5000PSLSATA</b> - 6 SATA 3Gb/s ports - S5000P Chipset (Boxed or OEM 10-pack) - Optional Remote Management Module Upgrade	<b>Server Board S5000XSLSATA</b> - 6 SATA 3Gb/s ports - S5000X Chipset (OEM 10-pack) - Optional Remote Management Module Upgrade	<b>Server Board S5000PSLSAS</b> - 4 SAS ports - S5000P Chipset (Boxed or OEM 10-pack) - Optional Remote Management Module Upgrade
<b>Server Board S5000PSLROMB</b> - 6 SATA 3Gb/s ports - Integrated Server RAID (8-port SAS with optional upgrade to hardware RAID) - S5000P Chipset (Boxed or OEM 5-pack) - Optional Remote Management Module Upgrade		

### Step 2 – Select an Intel Server Chassis

<b>SC5400LX</b> - Support for hot-swap power supplies (2 <sup>nd</sup> power supply is optional) - Supports hot-swap fans - Optional supports for one 4-drive bay <b>and/or</b> one 6-drive bay - Supports S5000PSL and S5000XSL server boards	<b>SC5400LXi</b> - Includes FXX830WPSU redundant power supply module. - Includes AXX6DRV3G 6-drive hot-swap, non-expanded, SATA/SAS supported backplane assembly - Supports S5000PSL and S5000XSL server boards
<b>SC5400Base</b> - Fixed 670W power supply and fans - Optional support for one 6-drive bay	<b>SC5299BRP</b> - Support for hot-swap 650W power supply and fixed fans - Optional support for one hot-swap 6-drive bay
<b>SC5299DP</b> - Fixed 550W power supply and fans - Optional support for one hot-swap 6-drive bay - Consult the Power Budget spreadsheet to verify configuration support on <a href="http://Support.Intel.com">Support.Intel.com</a>	<b>SC5400BRP</b> - Support for hot-swap power supplies (2 <sup>nd</sup> power supply is optional) - Fixed fans - Optional supports for one 4-drive bay <b>and/or</b> one 6-drive bay - Supports S5000PSL and S5000XSL server boards

### Step 3 – Select Optional Intel Drive Bays

<b>AXX6DRV3GEXP</b> - 6 drive hot-swap SAS backplane kit - Supported in SC5400 and SC5299 families - Requires 2 SAS ports for SAS or SATA drive support	<b>AXX4DRV3GEXP</b> - 4 drive hot-swap SAS backplane kit - SC5400BRP and SC5400LX only - Requires 2 SAS ports for SAS or SATA drive support
<b>AXX6DRV3G</b> - 6 drive hot-swap SAS/SATA backplane kit - Supported in SC5400 and SC5299 families - Requires 6 SAS ports for SAS and/or SATA drive support or 6 SATA ports for SATA drive support. Not supported with S5000PSLROMB or the SRCAS144E RAID card.	<b>AXX4DRV3G</b> - 4 drive hot-swap SAS/SATA backplane kit - SC5400BRP and SC5400LX only - Requires 4 SAS ports for SAS and/or SATA drive support or 4 SATA ports for SATA drive support. Not supported with S5000PSLROMB or the SRCAS144E RAID card.
<b>AXX4FIXDB</b> - 4 drive tool-less fixed kit - SC5400BRP and SC5400LX only	<b>AXX4SCSIDB</b> - 4 drive hot-swap SCSI backplane kit - SC5400BRP and SC5400LX only
<b>AXX6SCSIDB</b> - 6 drive hot-swap SCSI backplane kit - SC5299 requires optional APP3HSDBKIT	

### Step 4: Choose an optional Intel® Remote Management Module

<b>AXXRMM</b> - Intel® Remote Management Module - Enables KVM and advanced, remote manageability functionality
--

**Step 5: Choose an optional Intel® SAS/SATA RAID Controller**

**Key**  
 = Supported

The Intel Server Board S5000PSLROMB comes with Intel Integrated Server RAID. This ROMB Card consumes a PCI Express slot and provides 8 SAS ports. With the optional Activation Key (AXXRAK18E), hardware 0, 1, 5, 10, 50 RAID is activated.

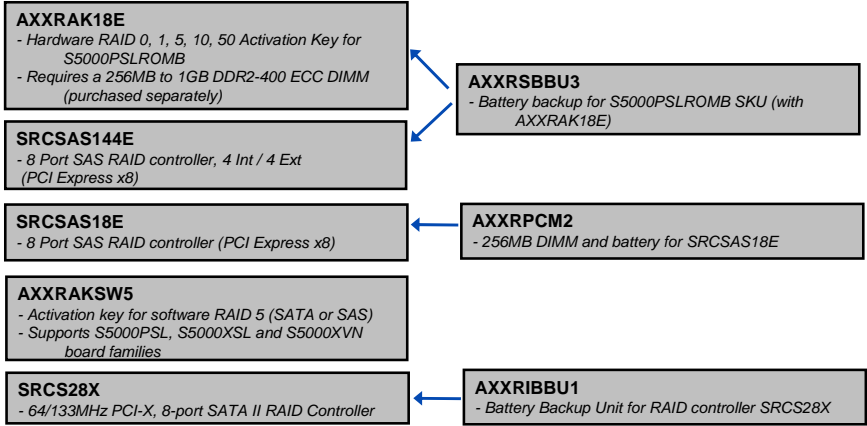

**Step 5a: Choose an optional Intel® SCSI RAID Controller**

**Key**  
 = Supported

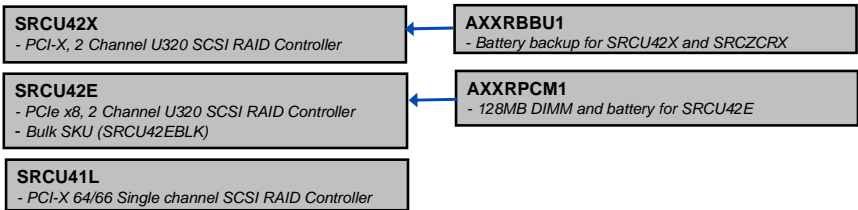

**Step 6: Choose an optional Intel® Local Control Panel**

**AXXLCPPED**  
- LCD accessory for SC5400 and SC5299 chassis families

**Step 7a: Choose Intel Server Chassis SC5400 family key accessories**

**Key**  
— = Supported

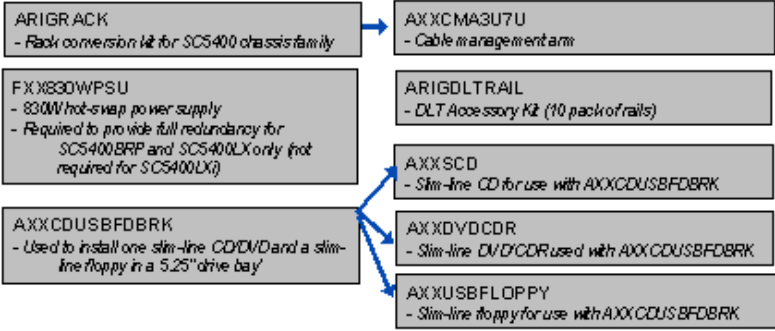

**Step 7b: Choose Intel Server Chassis SC5299 family key accessories**

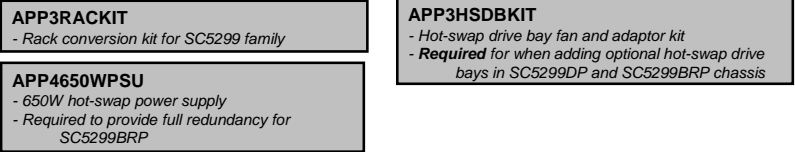

**Boxed Dual-Core Intel® Xeon® Processor 5000 Sequence**  
(includes passive heatsink for 2U+ rack mount and ducted chassis)

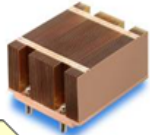

**Step 8a: Choose Intel® Xeon® Processor 5000 Sequence for Intel Server Chassis SC5400**

Processor Number	Product Code
X5460 (3.16 GHz, 1333 MHz FSB)	BX80574X5460P
X5450 (3.00 GHz, 1333 MHz FSB)	BX80574X5450P
E5450 (3.00 GHz, 1333 MHz FSB)	BX80574E5450P
E5440 (2.83 GHz, 1333 MHz FSB)	BX80574E5440P
E5430 (2.66 GHz, 1333 MHz FSB)	BX80574E5430P
E5420 (2.50 GHz, 1333 MHz FSB)	BX80574E5420P
E5410 (2.33 GHz, 1333 MHz FSB)	BX80574E5410P
E5405 (2.00 GHz, 1333MHz FSB)	BX80574E5405P
X5355 (2.67 GHz, 1333 MHz FSB)	BX80563X5355P
E5345 (2.33 GHz, 1333 MHz FSB)	BX80563E5345P
E5335 (2.00 GHz, 1333 MHz FSB)	BX80563E5335P
E5320 (1.86 GHz, 1066 MHz FSB)	BX80563E5320P
E5310 (1.60 GHz, 1066 MHz FSB)	BX80563E5310P
L5335 (2.00 GHz, 1333 MHz FSB, Low Voltage)	BX80563L5335P
L5320 (1.86 GHz, 1066 MHz FSB, Low Voltage)	BX80563L5320P
L5310 (1.60 GHz, 1066 MHz FSB, Low Voltage)	BX80563L5310P
X5260 (3.33 GHz, 1333 MHz FSB)	BX80573X5260P
E5205 (1.86 GHz, 1066 MHz FSB)	BX80573E5205P

Processor Number	Product Code
5160 (3.00 GHz, 1333 MHz FSB)	BX805565160P
5150 (2.66 GHz, 1333 MHz FSB)	BX805566150P
5148 (2.33 GHz, 1333 MHz FSB, Low Voltage)	BX805565148P
5140 (2.33 GHz, 1333 MHz FSB)	BX805565140P
5138 (2.13 GHz, 1066 MHz FSB, Low Voltage)	BX805565138P
5130 (2.00 GHz, 1333 MHz FSB)	BX805565130P
5128 (1.86 GHz, 1066 MHz FSB, Low Voltage)	BX805565128P
5120 (1.86 GHz, 1066 MHz FSB)	BX805565120P
5110 (1.60 GHz, 1066 MHz FSB)	BX805565110P
5080 (3.73 GHz, 1066 MHz FSB)	BX805555080P
5063 (3.20 GHz, 1066 MHz FSB)	BX805555063P
5060 (3.20 GHz, 1066 MHz FSB)	BX805555060P
5050 (3.00 GHz, 667 MHz FSB)	BX805555050P
5030 (2.67 GHz, 667 MHz FSB)	BX805555030P

**Boxed Dual-Core Intel® Xeon® Processor  
5000 Sequence  
(includes active heatsink)**



**Step 8b: Choose Intel® Xeon® Processor 5000 Sequence  
for Intel Entry Server Chassis SC5299 Family**

Processor Number	Product Code
X5460 (3.16 GHz, 1333 MHz FSB)	BX80574X5460A
X5450 (3.00 GHz, 1333 MHz FSB)	BX80574X5450A
E5450 (3.00 GHz, 1333 MHz FSB)	BX80574E5450A
E5440 (2.83 GHz, 1333 MHz FSB)	BX80574E5440A
E5430 (2.66 GHz, 1333 MHz FSB)	BX80574E5430A
E5420 (2.50 GHz, 1333 MHz FSB)	BX80574E5420A
E5410 (2.33 GHz, 1333 MHz FSB)	BX80574E5410A
E5405 (2.00 GHz, 1333MHz FSB)	BX80574E5405A
X5355 (2.67 GHz, 1333 MHz FSB)	BX80563X5355A
E5345 (2.33 GHz, 1333 MHz FSB)	BX80563E5345A
E5335 (2.00 GHz, 1333 MHz FSB)	BX80563E5335A
E5320 (1.86 GHz, 1066 MHz FSB)	BX80563E5320A
E5310 (1.60 GHz, 1066 MHz FSB)	BX80563E5310A
L5335 (2.00 GHz, 1333 MHz FSB, Low Voltage)	BX80563L5335A
L5320 (1.86 GHz, 1066 MHz FSB, Low Voltage)	BX80563L5320A
L5310 (1.60 GHz, 1066 MHz FSB, Low Voltage)	BX80563L5310A
X5260 (3.33 GHz, 1333 MHz FSB)	BX80573X5260A
E5205 (1.86 GHz, 1066 MHz FSB)	BX80573E5205A
5160 (3.00 GHz, 1333 MHz FSB)	BX805565160A
5150 (2.66 GHz, 1333 MHz FSB)	BX805566150A
5148 (2.33 GHz, 1333 MHz FSB, Low Voltage)	BX805565148A
5140 (2.33 GHz, 1333 MHz FSB)	BX805565140A
5138 (2.13 GHz, 1066 MHz FSB, Low Voltage)	BX805565138A
5130 (2.00 GHz, 1333 MHz FSB)	BX805565130A
5128 (1.86 GHz, 1066 MHz FSB, Low Voltage)	BX805565128A
5120 (1.86 GHz, 1066 MHz FSB)	BX805565120A
5110 (1.60 GHz, 1066 MHz FSB)	BX805565110A
5080 (3.73 GHz, 1066 MHz FSB)	BX805555080A
5063 (3.20 GHz, 1066 MHz FSB)	BX805555063A
5060 (3.20 GHz, 1066 MHz FSB)	BX805555060A
5050 (3.00 GHz, 667 MHz FSB)	BX805555050A
5030 (2.67 GHz, 667 MHz FSB)	BX805555030A

**Step 9: Accessories that will or may have to be purchased separately to create a complete system**

- **Memory**
  - 533 MHz or 667MHz DDR2 Fully-Buffered DIMMs with a full-DIMM heat spreader
  - For SL5000PSLROMB, a 256MB (or up to 1GB) ECC DDR2-400 DIMM is required and must be purchased separately
- **Cables**
  - 1-2 power cables (unless using a SC5400BASENA, SC5400BRPNA, SC5400LXNA, SC5299DPNA and SC5299BRPNA chassis in North America)
  - Ethernet cables
- **Hard disk drives, keyboard, monitor and mouse**
- **CD/DVD**
  - Unless using AXXCDUSBFDBRK, AXXUSBFLOPPY and AXXSCD or AXXDVDCDR (Step 7) in the SC5400 family of chassis

**Production Configuration and Ordering Steps (S5000XVN)**

This section highlights the ordering steps and configurations for the Intel® S5000XVN Workstation boards. More detailed information is in the following sections.

**Step 1 – Select a Workstation Board**

**Workstation Board S5000XVNSATA**

- 6 SATA 3Gb/s ports
- S5000X Chipset (Boxed or OEM 10-pack)

**Workstation Board S5000XVNSAS**

- 4 SAS ports
- S5000X Chipset (Boxed or OEM 10-pack)

**Step 2 – Select an Intel Server Chassis**

**SC5299WS**

- Fixed 670W power supply and fans
- Optional support for one hot-swap 6-drive bay

**SC5400Base**

- Fixed 670W power supply and fans
- Optional support for one 6-drive bay

**Step 3 – Select Optional Intel Drive Bays**

**AXX6DRV3GEXP**

- 6 drive hot-swap SAS backplane kit
- Supported in SC5400 and SC5299 families
- Requires 2 SAS ports for SAS or SATA drive support

**AXX6DRV3G**

- 6 drive hot-swap SAS/SATA backplane kit
- Supported in SC5400 and SC5299 families
- Requires 6 SAS ports for SAS and/or SATA drive support or 6 SATA ports for SATA drive support. Not supported with Intel RAID controller SRCAS144E.



**Step 4: Choose an optional Intel® SAS/SATA RAID Controller**

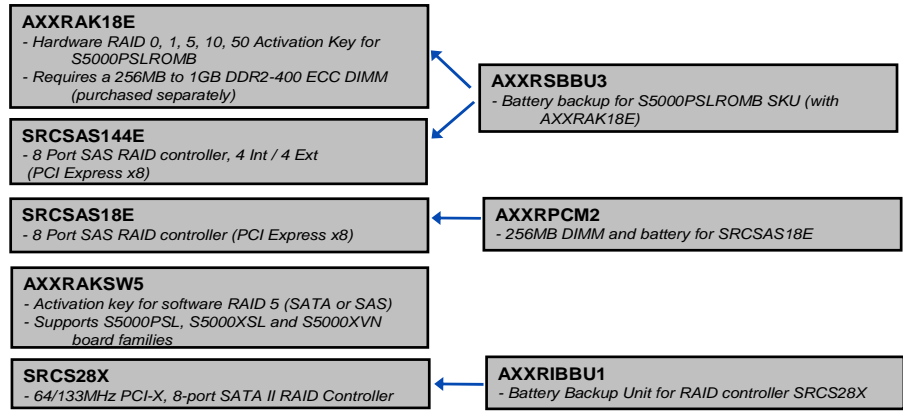
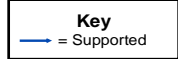

**Step 4a: Choose an optional Intel® SCSI RAID Controller**

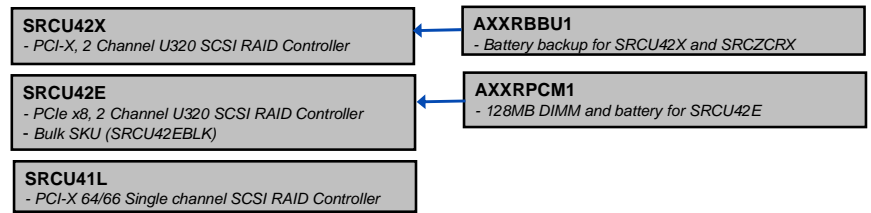
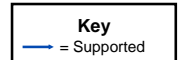

**Step 5: Choose an optional Intel® Local Control Panel**

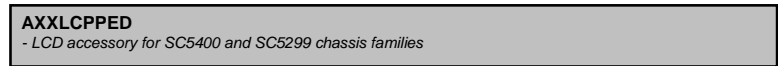

**Step 6a: Choose Intel Server Chassis SC5400 family key accessories**

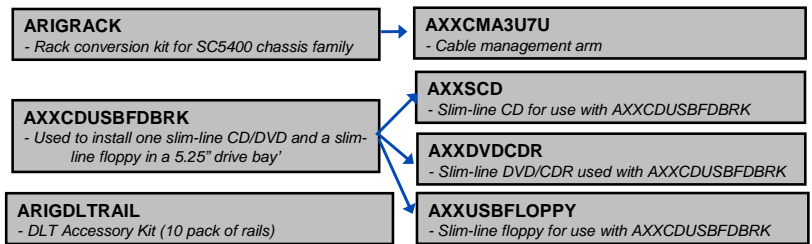
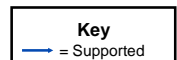

**Step 6b: Choose Intel Server Chassis SC5299 family key accessories**

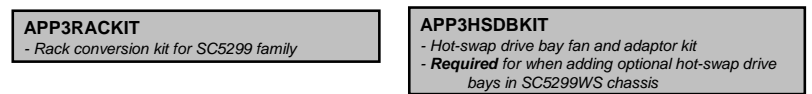

**Step 7b: Choose Intel Server Chassis SC5299 family key accessories**

- APP3RACKIT**  
- Rack conversion kit for SC5299 family
- APP4650WPSU**  
- 650W hot-swap power supply  
- Required to provide full redundancy for SC5299BRP

- APP3HSDBKIT**  
- Hot-swap drive bay fan and adaptor kit  
- **Required** for when adding optional hot-swap drive bays in SC5299DP and SC5299BRP chassis

**Boxed Dual-Core Intel® Xeon® Processor 5000 Sequence**  
(includes passive heatsink for 2U+ rack mount and ducted chassis)



**Step 8a: Choose Intel® Xeon® Processor 5000 Sequence for Intel Server Chassis SC5400**

Processor Number	Product Code
X5460 (3.16 GHz, 1333 MHz FSB)	BX80574X5460P
X5450 (3.00 GHz, 1333 MHz FSB)	BX80574X5450P
E5450 (3.00 GHz, 1333 MHz FSB)	BX80574E5450P
E5440 (2.83 GHz, 1333 MHz FSB)	BX80574E5440P
E5430 (2.66 GHz, 1333 MHz FSB)	BX80574E5430P
E5420 (2.50 GHz, 1333 MHz FSB)	BX80574E5420P
E5410 (2.33 GHz, 1333 MHz FSB)	BX80574E5410P
E5405 (2.00 GHz, 1333MHz FSB)	BX80574E5405P
X5355 (2.67 GHz, 1333 MHz FSB)	BX80563X5355P
E5345 (2.33 GHz, 1333 MHz FSB)	BX80563E5345P
E5335 (2.00 GHz, 1333 MHz FSB)	BX80563E5335P
E5320 (1.86 GHz, 1066 MHz FSB)	BX80563E5320P
E5310 (1.60 GHz, 1066 MHz FSB)	BX80563E5310P
L5335 (2.00 GHz, 1333 MHz FSB, Low Voltage)	BX80563L5335P
L5320 (1.86 GHz, 1066 MHz FSB, Low Voltage)	BX80563L5320P
L5310 (1.60 GHz, 1066 MHz FSB, Low Voltage)	BX80563L5310P
X5260 (3.33 GHz, 1333 MHz FSB)	BX80573X5260P
E5205 (1.86 GHz, 1066 MHz FSB)	BX80573E5205P
5160 (3.00 GHz, 1333 MHz FSB)	BX805565160P
5150 (2.66 GHz, 1333 MHz FSB)	BX805566150P
5148 (2.33 GHz, 1333 MHz FSB, Low Voltage)	BX805565148P
5140 (2.33 GHz, 1333 MHz FSB)	BX805565140P
5138 (2.13 GHz, 1066 MHz FSB, Low Voltage)	BX805565138P
5130 (2.00 GHz, 1333 MHz FSB)	BX805565130P
5128 (1.86 GHz, 1066 MHz FSB, Low Voltage)	BX805565128P
5120 (1.86 GHz, 1066 MHz FSB)	BX805565120P
5110 (1.60 GHz, 1066 MHz FSB)	BX805565110P
5080 (3.73 GHz, 1066 MHz FSB)	BX805555080P
5063 (3.20 GHz, 1066 MHz FSB)	BX805555063P
5060 (3.20 GHz, 1066 MHz FSB)	BX805555060P
5050 (3.00 GHz, 667 MHz FSB)	BX805555050P
5030 (2.67 GHz, 667 MHz FSB)	BX805555030P

**Boxed Dual-Core Intel® Xeon® Processor  
5000 Sequence  
(includes active heatsink)**



**Step 8b: Choose Intel® Xeon® Processor 5000 Sequence  
for Intel Entry Server Chassis SC5299 Family**

Processor Number	Product Code
X5460 (3.16 GHz, 1333 MHz FSB)	BX80574X5460A
X5450 (3.00 GHz, 1333 MHz FSB)	BX80574X5450A
E5450 (3.00 GHz, 1333 MHz FSB)	BX80574E5450A
E5440 (2.83 GHz, 1333 MHz FSB)	BX80574E5440A
E5430 (2.66 GHz, 1333 MHz FSB)	BX80574E5430A
E5420 (2.50 GHz, 1333 MHz FSB)	BX80574E5420A
E5410 (2.33 GHz, 1333 MHz FSB)	BX80574E5410A
E5405 (2.00 GHz, 1333MHz FSB)	BX80574E5405A
X5355 (2.67 GHz, 1333 MHz FSB)	BX80563X5355A
E5345 (2.33 GHz, 1333 MHz FSB)	BX80563E5345A
E5335 (2.00 GHz, 1333 MHz FSB)	BX80563E5335A
E5320 (1.86 GHz, 1066 MHz FSB)	BX80563E5320A
E5310 (1.60 GHz, 1066 MHz FSB)	BX80563E5310A
L5335 (2.00 GHz, 1333 MHz FSB, Low Voltage)	BX80563L5335A
L5320 (1.86 GHz, 1066 MHz FSB, Low Voltage)	BX80563L5320A
L5310 (1.60 GHz, 1066 MHz FSB, Low Voltage)	BX80563L5310A
X5260 (3.33 GHz, 1333 MHz FSB)	BX80573X5260A
E5205 (1.86 GHz, 1066 MHz FSB)	BX80573E5205A
5160 (3.00 GHz, 1333 MHz FSB)	BX805565160A
5150 (2.66 GHz, 1333 MHz FSB)	BX805566150A
5148 (2.33 GHz, 1333 MHz FSB, Low Voltage)	BX805565148A
5140 (2.33 GHz, 1333 MHz FSB)	BX805565140A
5138 (2.13 GHz, 1066 MHz FSB, Low Voltage)	BX805565138A
5130 (2.00 GHz, 1333 MHz FSB)	BX805565130A
5128 (1.86 GHz, 1066 MHz FSB, Low Voltage)	BX805565128A
5120 (1.86 GHz, 1066 MHz FSB)	BX805565120A
5110 (1.60 GHz, 1066 MHz FSB)	BX805565110A
5080 (3.73 GHz, 1066 MHz FSB)	BX805555080A
5063 (3.20 GHz, 1066 MHz FSB)	BX805555063A
5060 (3.20 GHz, 1066 MHz FSB)	BX805555060A
5050 (3.00 GHz, 667 MHz FSB)	BX805555050A
5030 (2.67 GHz, 667 MHz FSB)	BX805555030A

**Continue with Steps 8 and 9 in section above to  
order processors and non-Intel accessories**

## Production Configuration

This section contains information needed to order and configure the Intel® Server Chassis SC5400 and Intel® Server Chassis SC5299 KDKs with Intel® Server Board families S5000PSL, S5000XSL, and S5000XVN.

- 1) Production-boxed Intel Server Boards contain the following:
  - One baseboard with Common Enabling Kit (CEK) spring clips
  - ATX I/O shield, bumper, and label
  - Cables:
    - One IDE cable
    - One Serial B (COM2) cable
    - Six (6) SAS/SATA cables for “SATA” SKU
    - Two (2) SAS/SATA cables for “SAS” SKU
    - Two (2) SAS/SATA cables
    - One 4-port SAS/SATA “octopus” cable for other SKUs
  - Resource CD-ROM with utilities, drivers, documentation, and technical information
  - Compatible with Intel® Xeon® processor 5000 sequence
- 2) Production OEM 10-packs of Intel Server Boards contain the following:
  - One baseboard with Common Enabling Kit (CEK) spring clips
  - Compatible with Intel® Xeon® processor 5000 sequence
- 3) The production SC5400LXi KDK includes the same as features as the SC5400LX below as well as:
  - Redundant (1+0) 830W PFC power supply with dual-line cord support and includes an additional 830-W module for redundancy
  - Includes a 6-drive hot-swap, non-expanded, SATA/SAS supported backplane assembly.
  - One AC power cord is included only in SC5400LXINA
- 4) The production SC5400LX KDK includes:
  - Redundant (1+0) 830-W PFC power supply with dual-line cord support (full redundancy requires an additional 830-W module, which you must purchase separately)
  - Four redundant, hot-swap fans and ducting
  - Support for six, tool-free non-hot-swap hard drives. Upgradeable to ten cabled or ten (6+4 configuration) hot-swap SAS or SATA drives.
  - Cables (one each):
    - Front Panel Cable (baseboard header to front panel)
    - USB Cable (USB header to chassis front panel)
    - Pre-routed IDE cable
    - COM2 Cable
    - AC power cord is included only in SC5400LXNA

The Intel® Server Chassis SC5400 is designed to work with boxed Intel® Xeon® processor 5000 sequence using a 2U passive heat-sink.

5) The production SC5400BRP KDK includes:

- Redundant (1+0) 830-W PFC power supply with dual-line cord support (full redundancy requires an additional 830-W module, which you must purchase separately)
- Two non-redundant cooling fans
- Support for six tool-free non hot-swap hard drives. Upgradeable to ten cabled or ten (6+4 configuration) hot-swap SAS or SATA drives.
- Cables (one each):
  - Front Panel Cable (baseboard header to front panel)
  - USB Cable (USB header to chassis front panel)
  - Pre-routed IDE cable
  - COM2 Cable
  - AC power cord is included only in SC5400BRPNA

The Intel® Server Chassis SC5400 is designed to work with the boxed Intel® Xeon® processor 5000 sequence using a 2U passive heat sink.

6) The production SC5400 Base KDK includes:

- Non-redundant 670-W PFC power supply
- Two non-redundant cooling fans
- Support for six tool free non hot-swap hard drives. Upgradeable to six hot-swap SAS or SATA.
- Quick start guide
- Cables (one each):
  - Front Panel Cable (baseboard header to front panel)
  - USB Cable (USB header to chassis front panel)
  - Pre-routed IDE cables
  - COM2 Cable
  - AC power cord is included only with SC5400BASENA

The Intel® Server Chassis SC5400BASE is designed to work with the boxed Intel® Xeon® processor 5000 sequence using a 2U passive heat sink.

7) The production SC5299WS SKU includes:

- Non-redundant 670-W PFC power supply
- Two non-redundant cooling fans with ducting
- Support for six tool-free non hot-swap hard drives. Upgradeable to hot swap SAS/SATA 6-drive bay.
- Cables (one each):
  - Front Panel Cable (USB header t chassis front panel)
  - USB Cable (USB header to chassis front panel)
  - AC power cord is included in SC5299WSNA

- Chassis intrusion switch assembly
- The chassis is designed to work with the boxed Intel® Xeon® processor 5000 sequence using an active heat sink.

8) The production SC5299DP SKU includes:

- Non-redundant 550-W PFC power supply
- One non-redundant cooling fan
- Support for six, tool-free non-hot-swap hard drives. Upgradeable to hot swap SAS/SATA 6-drive bay. Note: Check the Power budget spreadsheet for supportable hard drive, memory, and PCI configurations.
- Cables (one each):
  - Front Panel Cable (USB header to chassis front panel)
  - USB Cable (USB header to chassis front panel)
  - AC power cord is included in SC5299DPNA
- Chassis intrusion switch assembly
- The chassis is designed to work with the boxed Intel® Xeon® processor 5000 sequence using an active heat-sink.

9) The production SC5299BRP SKU includes:

- Redundant (1+0) 650-W PFC power supply with dual-line cord support (full redundancy requires an additional 650-W module, which you must purchase separately)
- One non-redundant cooling fan
- Support for six, tool-free non-hot-swap hard drives. Upgradeable to hot swap SAS/SATA 6-drive bay.
- Cables (one each):
  - Front Panel Cable (USB header to chassis front panel)
  - USB Cable (USB header to chassis front panel)
  - AC power cord is included in SC5299BRPNA
- Chassis intrusion switch assembly
- The chassis is designed to work with the boxed Intel® Xeon® processor 5000 sequence using an active heat sink.

10) Common accessories include:

Hot Swap Drive Bays:

- **AXX6DRV3GEXP:** Expander-based 6-drive bay that supports SAS/SATA drives. Requires two free SAS ports from the integrated SAS controller, ROMB Card, or SAS RAID card.
- **AXX4DRV3GEXP:** Expander-based 4-drive bay that supports SAS/SATA drives. Requires two free SAS ports from the integrated SAS controller, ROMB Card, or SAS RAID card. Only supported in the Intel® Server Chassis SC5400 chassis family.
- **AXX6DRV3G:** 6-drive bay that supports SAS/SATA drives. Requires six free SAS or SATA ports. SAS hard drive support requires SAS connectors from a SAS enabled board SKU or SAS RAID Card. Not supported with S5000PSLROMB or the SRCAS144E RAID card.
- **AXX4DRV3G:** 4-drive bay that supports SAS/SATA drives. Requires four free SAS or SATA ports. SAS hard drive support requires SAS connectors from a SAS enabled board SKU or SAS RAID Card. Only supported in SC5400 chassis family and not supported with S5000PSLROMB or the SRCAS144E RAID card.

- **AXX6SCSIDB:** SCSI 6 Bay with hot docking SCSI back plane, and SAF-TE support.
- **AXX4SCSIDB:** SCSI 4 Bay with hot docking SCSI back plane, and SAF-TE support.

**FXX830WPSU:** Additional 830-W power supply module- required for full redundancy (for Intel® Server SC5400LX and SC5400BRP only)

**ARIGRACK:** Rack conversion kit (Intel® Server SC5400BASE, SC5400BRP and SC5400LX)

**APP3RACKIT:** Rack conversion kit (Intel® Entry Server Chassis SC5299-E chassis family).

**AXXRAK18E:** RAID activation key for the S500PSLROMB SKU that enables SAS hardware RAID. Requires a 256MB-1GB DDR2-400 ECC DIMM, which you must purchase separately.

**AXXRAKSW5:** Intel® RAID Activation Key AXXRAKSW5 to enable Intel® Embedded RAID technology for SAS and/or SATA Software RAID 5 on Intel® S5000PSL, S5000XSL, and S5000XVN board families.

**APP4650WPSU:** Additional 650-W power supply module- required for full redundancy for SC5299BRP only.

**APP3HSDBKIT:** Cooling and mounting kit required for 6-drive hot-swap backplanes installed in the Intel® Entry Server Chassis SC5299 chassis family.

**AXX04HSBPYCBL:** SCSI “Y Cable” with unique lengths for 4 drive and 6 drive bay. Permits cabling two backplanes to one SCSI/RAID channel for SC5400 chassis.

#### Production Board SKUs

Product Code	MM #	UPC	MOQ	Description
S5000XVNSATAR	901766	00735858196086	5	Workstation boxed board with S5000X chipset, six SATA ports and audio. Includes I/O shield, cables, and reference CD. (Refresh SKU)
S5000XVNSASR	901765	00735858196079	5	Workstation boxed board with S5000X, four SAS and two SATA ports. Includes I/O shield, cables, and reference CD. (Refresh SKU)
S5000PSLSATAR	901762	00735858196062	5	Boxed board with S5000P chipset and six SATA ports. Includes I/O shield, cables, and reference CD. (Refresh SKU)
S5000PSLSASR	901764	00735858196055	5	Boxed board with S5000P chipset, four SAS and two SATA ports. Includes I/O shield, cables, and reference CD. (Refresh SKU)
S5000PSLROMBR	901763	00735858196048	5	Boxed board with S5000P chipset, six SATA ports and Intel® Integrated RAID via 8-port SAS ROMB card (RAID activation requires optional key, Product code: AXXRAK18E and a 256MB-1GB DDR2-400 ECC DIMM purchased separately.) Includes I/O shield, cables, and reference CD. (Refresh SKU)
BB5000XVNSATAR	901726	00735858196192	10	OEM 10-pack of workstation board with S5000X chipset, six SATA ports, and audio. (Refresh SKU)

Product Code	MM #	UPC	MOQ	Description
BB5000XVNSASR	901725	00735858196185	10	OEM 10-pack of workstation board with S5000X chipset, four SAS ports, and two SATA ports. (Refresh SKU)
BB5000PSLSATAR	901721	00735858196161	10	OEM 10-pack of server board with S5000P chipset and six SATA ports. (Refresh SKU)
BB5000PSLSASR	901720	00735858196154	10	OEM 10-pack of server board with S5000P chipset, four SAS and two SATA ports. (Refresh SKU)
BB5000PSLROMBR	901719	00735858196147	5	OEM 5-pack of server board with S5000P chipset, six SATA ports and Intel® Integrated RAID via 8-port SAS ROMB card (RAID activation requires optional key, Product code: AXXRAK18E and a 256MB-1GB DDR2-400 ECC DIMM purchased separately.) (Refresh SKU)
BB5000XSLSATAR	901723	00735858196178	10	OEM 10-pack of server board with S5000X chipset and six SATA ports. (Refresh SKU)

#### Production Chassis

Product Code	MM #	UPC	MOQ	Description
SC5400BASE	877757	00735858180139	1	SC5400 Base Chassis with 670-W fixed PSU, 2 fixed chassis fans, 1 PSU fan. Supports up to six tool-free cabled drives, upgradeable to six hot-swap drives (SAS or SATA). Supports Intel® Server Board S5000PSL, Intel® Server Board S5000XSL, and Intel® Workstation Board S5000XVN board families. No power cord included.
SC5400BASENA	881189	00735858180153	1	Same as SC5400BASE with North American power cord included.
SC5400BRP	877804	00735858180146	1	SC5400 Base Redundant Power (BRP) Chassis with 830-W redundant PSU (optional, second PSU module is required for redundancy), two chassis fans, one PSU fan per module, includes fixed drive cage to support six tool-free cabled drives, upgradeable to ten fixed, cabled drives or ten (6+4 configuration) hot-swap SAS or SATA drives. Supports Intel® Server Board S5000PSL and Intel® Server Board S5000XSL board families. No power cord included.
SC5400BRPNA	880615	00735858180160	1	Same as SC5400BRP with North American power cord included.



Product Code	MM #	UPC	MOQ	Description
SC5400LX	877844	00735858180177	1	SC5400 LX Chassis with 830-W redundant PSU (optional, second PSU module is required for redundancy), four hot-swap redundant fans, one PSU fan per module, includes fixed drive cage to support six tool-free cabled drives, upgradeable to ten fixed, cabled drives or ten (6+4 configuration) hot-swap SAS or SATA drives. Supports Intel® Server Board S5000PSL and Intel® Server Board S5000XSL board families. No power cord included.
SC5400LXNA	880322	00735858180184	1	Same as SC5400LX with North American power cord included.
SC5400LXi	889156	00735858192491	1	SC5400 LX Chassis with two 830-W redundant PSU, four hot-swap redundant fans, one PSU fan per module, includes six drive HSBP, upgradeable to ten hot-swap SAS or SATA drives. Supports Intel® Server Board S5000PSL and Intel® Server Board S5000XSL board families. No power cord included.
SC5400LXiNA	889228	00735858192507	1	Same as SC5400LXi with North American power cord included.
SC5299WS	877873	00735858180337	1	SC5299WS with 670-W fixed PSU, supports up to 150-W workstation graphics card, two chassis fans, rackable with optional rack kit, supports up to six fixed drives, upgradeable to six Hot-Swap drives (SAS or SATA). Supports Intel® Workstation Board S5000XVN board family. No power cord included.
SC5299WSNA	880891	00735858182966	1	Same as SC5299WS with North American power cord.
SC5299DP	877875	00735858180320	1	SC5299DP with 550-W fixed PSU, one chassis fan, rackable with optional rack kit, supports up to six fixed drives, upgradeable to six Hot-Swap drives (SAS or SATA). <b>Check the Power budget spreadsheet for supportable hard drive, memory, and PCI configurations.</b> Supports Intel® Server Board S5000PSL and Intel® Server Board S5000XSL families post-launch. No power cord included.
SC5299DPNA	880985	00735858182959	1	Same as SC5299DP with North American power cord.
SC5299BRP	877864	00735858180344	1	SC5299BRP Base Redundant Power 650-W (optional, second PSU module is required for redundancy), one chassis fan, rackable with optional rack kit. Supports up to six fixed drives, upgradeable to six Hot-Swap drives (SAS or SATA). Supports Intel® Server Board S5000PSL and Intel® Server Board S5000XSL board families. No power cord included.
SC5299BRPNA	881190	00735858182942	1	Same as SC5299BRP with North American power cord.

Production Spares and Accessories

Product Code	MM #	UPC	Qty. Included	Description
AXX6DRV3GEXP	877235	00735858180283	1	SC5400/SC5299 6-drive hot-swap, expander, SATA/SAS backplane assembly. Requires two SAS ports from baseboard, ROMB card, or RAID card and is compatible with SAS or SATA 3.5-inch hard drives. Includes: backplane board, six drive carriers, two Data cables, 6-drive bay, IPMB cable, common installation guide, and SATA/SAS configuration label.
AXX4DRV3GEXP	877236	00735858180290	1	SC5400 4-drive hot-swap, expander, SATA/SAS backplane assembly. Requires two SAS ports from baseboard, ROMB card, or RAID card and is compatible with SAS or SATA 3.5-inch hard drives. Includes: Backplane board, four drive carriers, two data cables, 4-drive bay, IPMB cable, common installation guide, and SATA/SAS configuration label. Not supported in Intel® Server Chassis SC5400BASE.
AXX6DRV3G	877237	00735858180306	1	Intel® Server Chassis SC5400 / SC5299-E 6-drive hot-swap, non-expanded, SATA/SAS supported backplane assembly. Requires six SAS ports from RAID card for SAS (or SATA) 3.5-inch hard drive support or six SATA ports from baseboard or RAID card for SATA 3.5-inch hard drive support. Includes: Backplane board, six drive carriers, six data cables, 6-drive bay, IPMB cable, SES cable and SGPIO cable, common installation guide, and SATA/SAS configuration label. Not supported with S5000PSLROMB or the SRCASAS144E RAID card.
AXX4DRV3G	877238	00735858180313	1	Intel® Server Chassis SC5400 4-drive hot-swap, non-expanded, SATA/SAS supported backplane assembly. Requires four SAS ports from RAID card for SAS (or SATA) 3.5-inch hard drive support or four SATA ports from baseboard or RAID card for SATA 3.5-inch hard drive support. Includes: Backplane board, four drive carriers, four data cables, 4-drive bay, IPMB cable, SES cable and SGPIO cable, common installation guide, and SATA/SAS configuration label. Not supported with Intel® Server Chassis SC5400BASE, S5000PSLROMB, or the SRCASAS144E RAID card.
AXXRMM2	888501	0073585819240 8	1	Intel® Remote Management Module 2 for Intel® SC5000PSL server board family. Not supported in Intel® S5000XVN workstation board family.
FXX830WPSU	877872	00735858180269	1	SC5400LX and SC5400BRP 830-W optional, redundant power supply module.

Product Code	MM #	UPC	Qty. Included	Description
AXXLCPED	879579	00735858167956	1	Intel® Local Control Panel (LCD) for SC5400, SC5300, and SC5299 pedestal chassis. Fits in unused 5.25-inch peripheral bay.
ARIGRACK	880544 885459	00735858164603	1	SC5400/SC5300 pedestal to rack conversion kit. Includes: hinge cover, rack handles, intrusion switch jumper, new rail kit assembly, rack hardware kit, icon label, and installation guide.
ARIGRACKCVR	880720	00735858168496	1	SC5400/SC5300 optional unpainted removable side (top) cover. Can be used in rack conversion mode if unpainted top cover is needed.
AXXCMA3U7U	862119	00735858168533	1	Universal 3U though 7U Rack Mode Cable Management Arm (CMA). Requires ARIGRACK.
AXXCDUSBFDBRK	879232	0073585818062 7	1	Intel® Server Chassis SC5400 and Intel® Entry Server Chassis SC5299 family: 5.25-inch slim-line CD/DVD/Floppy bracket, hardware kit, interface board, and installation guide. Permits installation of a slim-line floppy (via USB) and slim-line optical drive in one 5.25-inch peripheral bay. (Slim-line optical and floppy drives are not included.)
AXXSCD	885100	00735858169271	1	Slim line CD for use with Intel® Server Chassis SC5400 adapter AXXCDUSBFDBRK.
AXXDVDCDR	880559	00735858164962	1	DVD/CDR slim line drive for SC5300. Supports DVD/CD and CD write. Works with Intel® Server Chassis SC5400 adapter AXXCDUSBFDBRK.
ARIG2HSFANKIT	877868	00735858180191	1	Intel® Server Chassis SC5400 hot-swap fan upgrade kit—two pairs of each fan, hot-swap fan cables (four each), installation guide, and label. Adds hot-swap, redundant cooling to Intel® SC5400BRP chassis.
ARIG2PMKIT	878328	00735858180207	1	Intel® Server Chassis SC5400 chassis preventive maintenance kit. Includes; front panel board, front panel cable, serial cable, USB cable, (1) 92mm hot-swap fan and plastic housing, (1) 120mm hot-swap fan and plastic housing, four each HS fan wires, (1) fixed 92 mm fan, (1) fixed 120mm fan, bezel intrusion switch, power supply filler panel, two sets (4) 5.25-inch tool-less bay rails, two sets (4) of fixed hard drive bay rails, and (1) IDE cable.
APP3HSDBKIT	882456	00735858177450	1	Hot-swap adapter bracket for use with all Intel® Entry Server Chassis SC5299-E and SC5295 chassis. <b>This accessory is required when using the 6 drive SATA/SAS hot-swap drive bays.</b>

Product Code	MM #	UPC	Qty. Included	Description
AXX4SCSIDB	880536	00735858164757	1	4-drive hot swap SCSI backplane assembly. Includes: Board, 4 drive carriers, SCSI cable, 4-drive bay, I <sup>2</sup> C Cable, and common installation guide.
AXX6SCSIDB	856604	00735858164764	1	SC5400/SC5299-E 6-drive hot swap SCSI backplane assembly. Includes: Board, six (each) drive carriers, SCSI cable, 6-drive bay, I <sup>2</sup> C Cable, and common installation guide (also compatible with SC5299).  Note: Requires APP3HSDBKITPP bracket kit when installing in Intel <sup>®</sup> SC5299 chassis.
AXX04HSBPYCBL	880717	00735858169882	10	SC5400 SCSI "Y Cable" with unique lengths for 4 drive and 6 drive bay. Permits cabling two backplanes to one SCSI/RAID channel.
APP3RACKIT	882457	00735858177375	1	Rack conversion kit for Intel <sup>®</sup> SC5295/SC5299-E chassis family. Includes rack rails and hardware for rack installation
APP4650WPSU	878018	00735858180375	1	Second redundant 650-W PSU for Intel <sup>®</sup> SC5299BRP chassis. Optional, second module is required to enable full, hot-swap power redundancy.
FXXRIGPKG	879286	00735858180610	1	Packaging spare for Intel <sup>®</sup> SC5400 chassis family.
AXX4FIXDB	857882	00735858164702	1	SC5400/SC5300 cabled 4 drive tool-less drive bay assembly. Includes hardware to mount four additional non-hot-swap drives (for a total of up to 10).
ASLIO	877948	00735858180733	50	50 Pack: I/O Shield for Intel <sup>®</sup> S5000PSLSATA, S5000 PSLAS, S5000XSLROMB, SC5400RA, S5000XVNSATA, S5000XVNSAS, BB5000XVNSATA, BB5000XVNSAS, BB5000PSLSATA, BB5000XLSATA, BB5000PSLSAS and BB5000XSLROMB. (MOQ = 50)
FRIG2PDB	877879	00735858180214	1	Intel <sup>®</sup> SC5400BRP/SC5400LX Power Distribution board, power supply cage, power supply filler panel. You can use this accessory to upgrade the Intel <sup>®</sup> Server Chassis SC5400BASE to the Intel <sup>®</sup> Server Chassis SC5400BRP with the purchase of the power supply module FXX830WPSU (two required for hot-swap, redundancy).

Product Code	MM #	UPC	Qty. Included	Description
FRIG2HSFANS	877882	00735858180238	1	Intel® SC5400LX hot swap fan spare kit. Includes one 92 mm and one 120 mm hot swap fan.
FRIG2FIXFANS	877885	00735858180245	1	Intel® Server Chassis SC5400 fixed fan spare kit. Includes one 92 mm and one 120 mm standalone fans (fixed fans for Intel® Server Chassis SC5400BASE and Intel® Server Chassis SC5400BRP).
FXXLPSASCBL	877903	00735858180252	1	Spare SAS "Octopus" cable for use with SAS ROMB card included with S5000PSLROMB and BB5000PSLROMB boards.
FXX670WPSU	877876	00735858180276	1	Intel® Server Chassis SC5400BASE and SC5299WS 670-W Power Supply Spare.
APP3STDBEZEL	871862	00735858177474	1	Spare bezel with door for SC5295DP/WS/BRP and SC5299-E chassis.
FPP4550WPSU	878012	00735858180351	1	Spare 550-W PSU for SC5299DP chassis.
FPP4BRPCAGE	878014	00735858180368	1	Spare SC5299BRP redundant power supply cage. Also used to upgrade SC5299DP/WS to redundant power configuration. Requires one (or two) APP4650WPSU to complete the upgrade. Includes power distribution board and filler (for empty module when only one module is installed). See Technical Product Specifications for instructions.
FPP4FANKIT4W	877984	00735858180405	1	SC5299-E 4 wire fan kit. Includes (1) 92mm for SC5299WS and (1) 120mm fan for SC5299-E.
FPP4PMKIT	878019	00735858180382	1	SC5299-E Preventive maintenance kit includes: <ul style="list-style-type: none"> <li>• (2) Plastic slides from Fixed drive bay</li> <li>• (1) CPU Duct</li> <li>• (1) Intrusion Switch Assembly</li> <li>• (1) USB Cable</li> <li>• (1) Plastic fan bracket</li> <li>• (1) Front Panel board (new for PP4)</li> <li>• (1) Front panel cable (24-pin for PP4)</li> <li>• (1) Front Panel Board (New for PP4)</li> <li>• (1) Power supply adapter Plate (For fixed power supply)</li> <li>• (1) Power supply tool-less power supply lock</li> <li>• (4) chassis feet</li> <li>• (1) Memory PP4 duct</li> <li>• (1) 120 MM Fan (4-wire PP4 new fan)</li> <li>• (1) 92 MM Fan (4-wire)</li> </ul>

Product Code	MM #	UPC	Qty. Included	Description
				<ul style="list-style-type: none"> <li>(1) Fixed HDD Fan Plate</li> <li>(1) 92 MM plastic Fan Bracket</li> </ul>
FXXPP4FPBRD	877393	00735858180399	1	Spare front panel for Intel® SC5299-E chassis.
ASLPWRCABLE	<del>882604</del> 879352	00735858182973	10	Converter cable to connect hard drive power connectors to the 2x2 pin Intel® Server Chassis S5000PSL and Intel® Workstation board S5000XVN connectors. Required for reference chassis that do not provide 2x2 connectors standard. MOQ = 10.
FXXIPMBCBL	878135	00735858180085	10	Pack of ten spare IPMB cables.
FXXSESCBL	877945	00735858180092	10	Pack of ten spare SES cables used for the Intel® Server Chassis S5000PSL ROMB solution.
FXXSGPIOCBL	877944	00735858180108	10	Spare SGPIO cable used for ESB2 RAID to backplane communications.
FXX4DRV3GBRD	879635	00735858180917	1	Spare board for AXX4DRV3G (4-drive backplane without an expander).
FXX4DRV3GEXPBRD	879633	00735858180931	1	Spare board for AXX4DRV3GEXP (4-drive backplane with an expander).
FXX6DRV3GBRD	879634	00735858180924	1	Spare board for AXX6DRV3G (6-drive backplane without an expander).
FXX4SCSIBRD	880547	00735858164740	1	Intel® Server Chassis SC5400 4-Drive SCSI Backplane Board only.
FXX6SCSIBRD	880512	00735858164733	1	Intel® Server Chassis SC5400 / SC5299 6 Drive SCSI Backplane Board only.
FXX6DRV3GEXPBRD	879632	00735858180948	1	Spare board for AXX6DRV3GEXP (6-drive backplane with an expander).
AXXFHDDBRK	868171	00735858172462	1	Intel® Server Chassis SC5400/SC5300 (Base, BRP, or LX) accessory bracket for hard drive.
ARIGDLTRAIL	856600	00735858164610	1	Intel® Server Chassis SC5400/SC5300 DLT Accessory Kit - left and right rails (ten Pack) Permits mounting a full-height 5.25-inch peripheral (for example, DLT tape drive) in two half-height bays.

Product Code	MM #	UPC	Qty. Included	Description
ARIGBEZPNL	860750	00735858168489	10	Intel® Server Chassis SC5400/SC5300 bezel branding panels- (1) upper and (1) lower bezel customization panel (10 sets)
FXX10DVCARBLK	880265	00735858181938	10	Hot swap drive carrier spare with black baffle. MOQ = 10
FPWRCABLENA	879287	00735858180740	1	North America Power cable for Intel® SC5400 family of chassis.  Note: This power cable is NOT the same cable as Intel® SC5300 or Intel® SC5295/5299 chassis families.
PWRCABLEUS	816324	00735858162883	1	Spare North American power cable for Intel® SC5300, SC5295, and SC5299 chassis families. Intel® SC5400 Chassis families must use PPWRCABLENA.
AXX6FDSCSIFAN	886578	00735858189644	1	Intel® Server Chassis SC5299-E fixed drive bay SCSI cooling fan. Required for proper cooling of SCSI drives in the standard fixed drive bay of the SC5299DP/WS/BRP chassis. Not required for hot-swap drive bays.

#### Production RAID Products

Product Code	MM #	UPC	MOQ	Description
FXXSROMBSAS18E	878959	00735858180450	5	Spare ROMB Card for S5000PSLROMB SKU only. Not supported in S5000PSLSAS, S5000PSLSATA, S5000XVNSATA or S5000XVNSAS.
AXXRAKSW5	878958	00735858181860	5	Intel® RAID Activation Key AXXRAKSW5 to enable SAS and/or SATA Software RAID 5 on S5000PSL, S5000XSL, S5000XVN, and S5000VSA board families.
AXXRAK18E	877661	00735858180443	5	Intel® RAID Activation Key - Enables full intelligent RAID on Motherboard (ROMB) solution on selected Intel® Server boards engineered around the Intel® 80333 IP at 500 MHz.  Requires a 256MB-1GB DDR2-400 ECC DIMM purchased separately.  For use with the S5000PSLROMB and BB5000PSLROMB SKUs. Not supported in S5000PSLSAS, S5000PSLSATA, S5000XVNSATA, or S5000XVNSAS.

Product Code	MM #	UPC	MOQ	Description
SRCSAS18E	879066	00735858178143	5	Intel® RAID Controller SRCSAS18E (Parowan) – PCIe x8, 8P SAS RAID Controller - Intel® 80333 IOP at 500 MHz, 256 MB DDR2 ECC DIMM.
SRCSATAWB	892456	00735858196420	5	Intel® RAID Controller SRCSATAWB (Willapa Bay) = PCIe x4, 8 port SATA RAID Controller, 128MB embedded memory, 16 physical devices, >8 requires expander backplane.  Includes two internal cables, Quick Start User's Guide, and CD-ROM with technical documentation and software. RoHS Compliant.
SRCSASRB	892598	00735858196437	5	Intel® RAID Controller SRCSASRB (Rocky Butte) - PCIe x4, 8P SAS RAID Controller, and 256MB embedded memory. RoHS Compliant.
SRCSASJV	892602	00735858196444	5	Intel® RAID Controller SRCSASJV (Jordan Valley) - PCIe x8, 8P SAS RAID Controller with Mux (ports can be configured as internal or external), ships with 51 2MB DIMM, and supports up to 1 GB DDR2 DIMM. RoHS Compliant.  <b>Note:</b> SRCSASJV supports either the RAID Smart Battery (AXXRSBBU3) or RAID Portable Cache Module (AXXRPCM3). Using both the AXXRSBBU3 and AXXRPCM3 is not supported.
SRCSAS144E	883470	00735858182621	5	Intel® RAID controller SRCSAS144E – PCIe x4, 8P (4 int/4 ext) SAS RAID Controller – Intel® 80333 IOP at 500 MHz, and 128 MB embedded memory. RoHS Compliant.
SRCS28X	879072	00735858171625	5	PCI-X 64/133MHz, eight port SATA II RAID controller.
AXXRPCM2	879067	00735858178150	5	Intel® Portable Cache Module AXXRPCM2 for use with SRCSAS18E – Combines 256 MB memory DIMM and battery; up to 72 hours retention.
AXXRPCM3	891156	00735858197854	5	Intel® Portable Cache Module AXXRPCM3 for use with SRCSASJV – Combines 256 MB DDR2 memory DIMM and battery; up to 72 hours retention. RoHS Compliant.
AXXRSBBU3	883471	00735858181853	5	Intelligent Battery Backup module for use with the Intel® RAID controller SRCSAS144E,  S5000PSLROMB/S5000PSLROMBR SKUs, and SRCSASJV. Provides up to 72 hours of cache memory retention (depending on memory capacity and the number of memory components on the DIMM to support the capacity).



Product Code	MM #	UPC	MOQ	Description
AXXRSBBU4	891157	00735858194518	5	Intelligent Battery Backup module for use with the Intel® RAID controller SRCATAWB and SRCASRB. Provides up to 72 hours of cache memory retention. RoHS Compliant.
AXXRIBBU1	879073	00735858171649	5	Battery Backup Unit for use with SRC28X. RoHS compliant.

MOQ = Minimum Order Quantity.

VMware vSphere\* Virtualization Software Configuration Guide for vSphere\* SKUs

### Product Descriptions – Overview

VMware vSphere\* software is now available when ordering an Intel® Server Board or Intel® Server System. Customers can only order these SKUs at the time they are ordering an Intel® Server Board or Intel® Server System. These SKUs cannot be ordered individually. The number of VMware vSphere SKU purchase has to coincide with number of system or boards purchased. Example: Order 10 boards – you can order 10 VMware SKUs. Customers will need to join VMware System Builder Program to get sales support from VMware. For support information please visit: <http://www.vmware.com/partners/partners.html>

### VMware vSphere\* and vCenter\* Server SKUs

The following VMware vSphere SKUs are offered when purchasing a qualifying Intel® Server Board or Intel® Server System. Each SKU contains a software product activation code for user to enter to download software and install. As directed on the certificate, the end user must register the product activation code with VMware at <http://www.vmware.com/code/intel> within 30 days to access VMware Software, Support and Subscription Services.

VMware vSphere\* and vCenter\* Server SKUs

- Essentials

This license activation code gives the user VMware vSphere\* 4 Essentials Bundle for 3 hosts (Max 2 processors per host and 6 cores per processor), with 1 year VMware Subscription.

- Essentials Plus

This license activation code gives the user VMware vSphere\* 4 Essentials Plus Bundle for 3 hosts (Max 2 processors per host and 6 cores per processor), with 1 year VMware Gold Support and Subscription.

- Standard

This license activation code gives the user VMware vSphere\* 4 Standard for 1 Processor (Max 6 cores per CPU), with 1 year VMware Gold Support and Subscription.

- Advanced

This license activation code gives the user VMware vSphere\* 4 Advanced for 1 Processor (Max 12 cores per CPU), with 1 year VMware Gold Support and Subscription.

- Enterprise Plus

This license activation code gives the user VMware vSphere\* 4 Enterprise Plus for 1 Processor (Max 12 cores per CPU), with 1 year VMware Gold Support and Subscription.

- VMware vCenter\* Server Standard for vSphere\*

This license activation code gives the user VMware vCenter\* Server 4 Standard for vSphere\* (Includes Orchestrator and Linked Mode), with 1 year VMware Gold Support and Subscription.

**VMware vSphere\* and VMware vCenter\* Standard – Order Codes:**

Product Code	MM	UPC	MOQ	Description
VMW4ESS	904791	735858212724	1	Software license activation code certificate for VMware vSphere* 4 Essentials Bundle for 3 hosts (Max 2 CPUs per host and 6 cores per CPU) with 1 year VMware Subscription.
VMW4ESSPLUS	904792	735858212731	1	Software license activation code certificate for VMware vSphere* 4 Essentials Plus Bundle for 3 hosts (Max 2 CPUs per host and 6 cores per CPU) with 1 year VMware Gold Support and Subscription.
VMW4STD	904793	735858212748	1	Software license activation code certificate for VMware vSphere* 4 Standard for 1 Processor (Max 6 cores per CPU) with 1 year VMware Gold Support and Subscription.
VMW4ADV	904797	735858212755	1	Software license activation code certificate for VMware vSphere* 4 Advanced for 1 Processor (Max 12 cores per CPU) with 1 year VMware Gold Support and Subscription.
VMW4ENTPLUS	904800	735858212762	1	Software license activation code certificate for VMware vSphere* 4 Enterprise Plus for 1 Processor (Max 12 cores per CPU) with 1 year VMware Gold Support and Subscription.
VMWVCSTD	904801	735858212779	1	Software license activation code certificate for VMware vCenter* Server 4 Standard (includes Orchestrator and Linked Mode) with 1 year VMware Gold Support and Subscription.

End of Configuration Guide