

Hardware User's Guide

Intel[®] RAID Controller SRCS16

A Guide for Technically Qualified Assemblers of Intel
Identified Subassemblies/Products

May 2004

Safety Warnings

WARNING: English

Important Safety Instructions

Read all caution and safety statements in this document before performing any of the instructions. See also Intel Server Boards and Server Chassis Safety Information on the Resource CD and/or at <http://support.intel.com>.

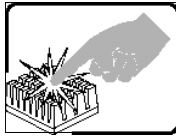
	<p>SAFETY STEPS: Whenever you remove the chassis covers to access the inside of the system, follow these steps:</p> <ol style="list-style-type: none">1. Turn off all peripheral devices connected to the system.2. Turn off the system by pressing the power button.3. Unplug all AC power cords from the system or from wall outlets.4. Label and disconnect all cables connected to I/O connectors or ports on the back of the system.5. Provide some electrostatic discharge (ESD) protection by wearing an antistatic wrist strap attached to chassis ground of the system-any unpainted metal surface-when handling components.6. Do not operate the system with the chassis covers removed.
	<p>A microprocessor and heat sink may be hot if the system has been running. Also, there may be sharp pins and edges on some board and chassis parts. Contact should be made with care. Consider wearing protective gloves.</p>

ADVERTENCIAS: Español

Instrucciones de seguridad importantes

Lea todas las declaraciones de seguridad y precaución de este documento antes de realizar cualquiera de las instrucciones. Vea Intel Server Boards and Server Chassis Safety Information en el CD Resource y/o en <http://support.intel.com>.

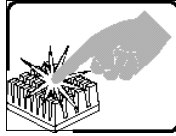
	<p>INSTRUCCIONES DE SEGURIDAD: Cuando extraiga la tapa del chasis para acceder al interior del sistema, siga las siguientes instrucciones:</p> <ol style="list-style-type: none">1. Apague todos los dispositivos periféricos conectados al sistema.2. Apague el sistema presionando el interruptor encendido/apagado.3. Desconecte todos los cables de alimentación CA del sistema o de las tomas de corriente alterna.4. Identifique y desconecte todos los cables enchufados a los conectores E/S o a los puertos situados en la parte posterior del sistema.5. Cuando manipule los componentes, es importante protegerse contra la descarga electrostática (ESD). Puede hacerlo si utiliza una muñequera antiestática sujeta a la toma de tierra del chasis - o a cualquier tipo de superficie de metal sin pintar.6. No ponga en marcha el sistema si se han extraído las tapas del chasis.
	<p>Si el sistema ha estado en funcionamiento, el microprocesador y el disipador de calor pueden estar aún calientes. También conviene tener en cuenta que en el chasis o en el tablero puede haber piezas cortantes o punzantes. Por ello, se recomienda precaución y el uso de guantes protectores.</p>

WARNUNG: Deutsch

Wichtige Sicherheitshinweise

Lesen Sie zunächst sämtliche Warn- und Sicherheitshinweise in diesem Dokument, bevor Sie eine der Anweisungen ausführen. Beachten Sie hierzu auch die Sicherheitshinweise zu Intel-Serverplatinen und -Servergehäusen auf der Ressourcen-CD oder unter <http://support.intel.com>.

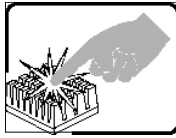
	<p>SICHERHEISSMASSNAHMEN: Immer wenn Sie die Gehäuseabdeckung abnehmen um an das Systeminnere zu gelangen, sollten Sie folgende Schritte beachten:</p> <ol style="list-style-type: none">1. Schalten Sie alle an Ihr System angeschlossenen Peripheriegeräte aus.2. Schalten Sie das System mit dem Hauptschalter aus.3. Ziehen Sie den Stromanschlußstecker Ihres Systems aus der Steckdose.4. Auf der Rückseite des Systems beschrifteten und ziehen Sie alle Anschlußkabel von den I/O Anschlüssen oder Ports ab.5. Tragen Sie ein geerdetes Antistatik Gelenkband, um elektrostatische Ladungen (ESD) über blanke Metallstellen bei der Handhabung der Komponenten zu vermeiden.6. Schalten Sie das System niemals ohne ordnungsgemäß montiertes Gehäuse ein.
	<p>Der Mikroprozessor und der Kühler sind möglicherweise erhitzt, wenn das System in Betrieb ist. Außerdem können einige Platinen und Gehäuseteile scharfe Spitzen und Kanten aufweisen. Arbeiten an Platinen und Gehäuse sollten vorsichtig ausgeführt werden. Sie sollten Schutzhandschuhe tragen.</p>

Der Mikroprozessor und der Kühler sind möglicherweise erhitzt, wenn das System in Betrieb ist. Außerdem können einige Platinen und Gehäuseteile scharfe Spitzen und Kanten aufweisen. Arbeiten an Platinen und Gehäuse sollten vorsichtig ausgeführt werden. Sie sollten Schutzhandschuhe tragen.

AVERTISSEMENT: Français

Consignes de sécurité

Lisez attention toutes les consignes de sécurité et les mises en garde indiquées dans ce document avant de suivre toute instruction. Consultez Intel Server Boards and Server Chassis Safety Information sur le CD Resource CD ou bien rendez-vous sur le site <http://support.intel.com>.

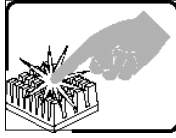
	<p>CONSIGNES DE SÉCURITÉ: Lorsque vous ouvrez le boîtier pour accéder à l'intérieur du système, suivez les consignes suivantes:</p> <ol style="list-style-type: none">1. Mettez hors tension tous les périphériques connectés au système.2. Mettez le système hors tension en mettant l'interrupteur général en position OFF (bouton-poussoir).3. Débranchez tous les cordons d'alimentation c.a. du système et des prises murales.4. Identifiez et débranchez tous les câbles reliés aux connecteurs d'E-S ou aux accès derrière le système.5. Pour prévenir les décharges électrostatiques lorsque vous touchez aux composants, portez une bande antistatique pour poignet et reliez-la à la masse du système (toute surface métallique non peinte du boîtier).6. Ne faites pas fonctionner le système tandis que le boîtier est ouvert.
	<p>Le microprocesseur et le dissipateur de chaleur peuvent être chauds si le système a été sous tension. Faites également attention aux broches aiguës des cartes et aux bords tranchants du capot. Nous vous recommandons l'usage de gants de protection.</p>

AVVERTENZA: Italiano

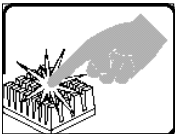
	<p>PASSI DI SICUREZZA: Qualora si rimuovano le coperture del telaio per accedere all'interno del sistema, seguire i seguenti passi:</p> <ol style="list-style-type: none">1. Spegner tutti i dispositivi periferici collegati al sistema.2. Spegner il sistema, usando il pulsante spento/accesso dell'interruttore del sistema.3. Togliere tutte le spine dei cavi del sistema dalle prese elettriche.4. Identificare e sconnettere tutti i cavi attaccati ai collegamenti I/O od alle prese installate sul retro del sistema.5. Qualora si tocchino i componenti, proteggersi dallo scarico elettrostatico (SES), portando un cinghia anti-statica dal polso che è attaccata alla presa a terra del telaio del sistema - qualsiasi superficie non dipinta - .6. Non far operare il sistema quando il telaio è senza le coperture.
	<p>Se il sistema è stato a lungo in funzione, il microprocessore e il dissipatore di calore potrebbero essere surriscaldati. Fare attenzione alla presenza di piedini appuntiti e parti taglienti sulle schede e sul telaio. È consigliabile l'uso di guanti di protezione.</p>

Regulatory and Certification Information

Product Regulatory Compliance

This RAID Controller Card complies with the following safety and electromagnetic compatibility (EMC) regulations.

Product Safety Compliance

- UL 1950 - CSA 950 (US/Canada)
- EN 60 950 (European Union)
- IEC60 950 (International)
- CE - Low Voltage Directive (73/23/EEC) (European Union)







Product EMC Compliance - Class B

- FCC /ICES-003 (USA/Canada)
- CISPR 22 (International)
- EN55022 (Europe)
- EN55024 (Europe)
- CE - EMC Directive 89/336/EEC (Europe)
- VCCI (Japan)
- AS/NZS 3548 (Australia / New Zealand)
- BSMI CNS13438 (Taiwan)
- RRL, MIC Notice No. 1997-41 (EMC) & 1997-42 (EMI) (Korea)

Product Regulatory Compliance Markings

The RAID Controller Card is marked with the following compliance markings. Some marking information may be provided on the packaging and/or in the product documentation due to limited marking space on the product.

- ETL NRTL Mark (US/Canada)
- FCC Mark (US)
- ICES-003 (Canada)
- CE Mark (Europe)
- VCCI Mark (Japan)
- MIC Mark (Korea)
- BSMI DOC Mark (Taiwan)
- ACA C-Tick Mark (Australia)

Regulatory Compliance	Country	Marking
ETL (NRTL) Mark	USA/Canada	
CE Mark	Europe	
FCC Marking (Class B)	USA	 Tested to Comply With FCC standards FOR HOME OR OFFICE USE
EMC Marking (Class B)	Canada	CANADA ICES-003 CLASS B CANADA NMB-003 CLASSE B
VCCI Marking (Class B)	Japan	<p>この装置は、情報処理装置等電波障害自主規制協議会（VCCI）の基準に基づくクラスB情報技術装置です。この装置は、家庭環境で使用することを目的としていますが、この装置がラジオやテレビジョン受信機に近接して使用されると、受信障害を引き起こすことがあります。 取扱説明書に従って正しい取り扱いをして下さい。</p> 
BSMI Marking (Class B) and EMC Warning	Taiwan	 <p>警告使用者： 這是甲類的資訊產品，在居住的環境中使用時，可能會造成射頻干擾，在這種情況下，使用者會被要求採取某些適當的對策</p>
RRL MIC Mark	Korea	
C-Tick Mark	Australia	

Electromagnetic Compatibility Notices

FCC Verification Statement (USA)

This device complies with Part 15 of the FCC Rules. Operation is subject to the following two conditions: (1) This device may not cause harmful interference, and (2) this device must accept any interference received, including interference that may cause undesired operation.

Intel Corporation
5200 N.E. Elam Young Parkway
Hillsboro, OR 97124-6497
Phone: 1-800-628-8686

This equipment has been tested and found to comply with the limits for a Class B digital device, pursuant to Part 15 of the FCC Rules. These limits are designed to provide reasonable protection against harmful interference in a residential installation. This equipment generates, uses, and can radiate radio frequency energy and, if not installed and used in accordance with the instructions, may cause harmful interference to radio communications. However, there is no guarantee that interference will not occur in a particular installation. If this equipment does cause harmful interference to radio or television reception, which can be determined by turning the equipment off and on, the user is encouraged to try to correct the interference by one or more of the following measures:

- Reorient or relocate the receiving antenna.
- Increase the separation between the equipment and the receiver.
- Connect the equipment into an outlet on a circuit different from that to which the receiver is connected.
- Consult the dealer or an experienced radio/TV technician for help.

Intel is not responsible for any radio or television interference caused by unauthorized modification of this equipment for substitution or attachment of connecting cables and equipment other than those specified by Intel. The correction of interferences caused by such unauthorized modification, substitution, or attachment will be the responsibility of the user.

This RAID Controller Card has been tested to comply with FCC Standards for home or office use.

ICES-003 (Canada)

This digital apparatus does not exceed the Class B limits for radio noise emissions from digital apparatus set out in the interference-causing equipment standard entitled "Digital Apparatus," ICES-003 of the Canadian Department of Communications.

Cet appareil numérique respecte les limites bruits radioélectriques applicables aux appareils numériques de Classe Aprescrites dans la norme sur le matériel brouilleur: "Appareils Numériques", NMB-003 édictée par le Ministre Canadien des Communications.

Europe (CE Declaration of Conformity)

This product has been tested in accordance too, and complies with the Low Voltage Directive (73/23/EEC) and EMC Directive (89/336/EEC). The product has been marked with the CE Mark to illustrate its compliance.

RRL (Korea)

English translation of the notice above:

1. Type of Equipment (Model Name): Model name on product
2. Certification No.: On RRL certificate. Obtain certificate from local Intel representative
3. Name of Certification Recipient: LSI Logic Corporation
4. Date of Manufacturer: Refer to date code on product
5. Manufacturer/Nation: LSI Logic Corporation/Refer to country of origin marked on product

INFORMATION IN THIS DOCUMENT IS PROVIDED IN CONNECTION WITH INTEL(R) PRODUCTS. NO LICENSE, EXPRESS OR IMPLIED, BY ESTOPPEL OR OTHERWISE, TO ANY INTELLECTUAL PROPERTY RIGHTS IS GRANTED BY THIS DOCUMENT. EXCEPT AS PROVIDED IN INTEL'S TERMS AND CONDITIONS OF SALE FOR SUCH PRODUCTS, INTEL ASSUMES NO LIABILITY WHATSOEVER, AND INTEL DISCLAIMS ANY EXPRESS OR IMPLIED WARRANTY, RELATING TO SALE AND/OR USE OF INTEL PRODUCTS INCLUDING LIABILITY OR WARRANTIES RELATING TO FITNESS FOR A PARTICULAR PURPOSE, MERCHANTABILITY, OR INFRINGEMENT OF ANY PATENT, COPYRIGHT OR OTHER INTELLECTUAL PROPERTY RIGHT. Intel products are not intended for use in medical, life saving, life sustaining applications. Intel may make changes to specifications and product descriptions at any time, without notice.

Intel is a trademark or registered trademark of Intel Corporation or its subsidiaries in the United States and other countries.

*Other names and brands may be claimed as the property of others.

Copyright © 2004 by Intel Corporation, portions Copyright 2003-2004 by LSI Logic Corporation. All rights reserved.

Preface

This guide is the hardware reference and user's guide for the Intel® RAID Controller SRCS16. It contains complete installation instructions and specifications.

For information about how to configure the SRCS16 controller, create arrays, and for an overview of the software drivers and utilities, see the *Intel RAID Software User's Guide*.

Audience

This document assumes that you have some familiarity with RAID controllers and related support devices. The people who benefit from this book are:

- Engineers who are designing a system that will use the SRCS16 controller
- Anyone installing an SRCS16 controller in their RAID system

Organization

This document has the following chapters and appendixes:

- Chapter 1, "Overview," provides a general overview of the SRCS16 controller.
- Chapter 2, "Hardware Installation," describes the procedures for installing the SRCS16 controller.
- Chapter 3, "Intel® RAID Controller SRCS16 Technical Reference," describes the technical specifications for the SRCS16 controller.
- Chapter A, "Glossary of Terms and Abbreviations," lists and explains the terms and abbreviations used in this manual.

Related Publications

Intel® RAID Software User's Guide, Intel Document No. C49617-003 (on the Resource CD included with the RAID controller)

Safety Instructions

Use the following safety guidelines to help protect your computer system from potential damage and to ensure your own personal safety. See also the Intel Server Boards and Server Chassis Safety Information at <http://support.intel.com/support/motherboards/server/safecert.htm>

When Using Your Computer System

As you use your computer system, observe the following safety guidelines:

CAUTION: Do not operate your computer system with any cover(s) (such as computer covers, bezels, filler brackets, and front-panel inserts) removed.

- To help avoid damaging your computer, be sure the voltage selection switch on the power supply is set to match the alternating current (AC) power available at your location:
 - 115 volts (V)/60 hertz (Hz) in most of North and South America and some Far Eastern countries such as Japan, South Korea, and Taiwan
 - 230 V/50 Hz in most of Europe, the Middle East, and the Far East. Also be sure your monitor and attached peripherals are electrically rated to operate with the AC power available in your location.
- To help avoid possible damage to the system board, wait five seconds after turning off the system before removing a component from the system board or disconnecting a peripheral device from the computer.
- To help prevent electric shock, plug the computer and peripheral power cables into properly grounded power sources. These cables are equipped with 3-prong plugs to ensure proper grounding. Do not use adapter plugs or remove the grounding prong from a cable. If you must use an extension cable, use a 3-wire cable with properly grounded plugs.
- To help protect your computer system from sudden, transient increases and decreases in electrical power, use a surge suppressor, line conditioner, or uninterruptible power supply.
- Be sure nothing rests on your computer system's cables and that the cables are not located where they can be stepped on or tripped over.
- Do not spill food or liquids on your computer. If the computer gets wet, consult the documentation that came with it.
- Do not push any objects into the openings of your computer. Doing so can cause fire or electric shock by shorting out interior components.
- Keep your computer away from radiators and heat sources. Also, do not block cooling vents. Avoid placing loose papers underneath your computer; do not place your computer in a closed-in wall unit or on a rug.

When Working Inside Your Computer

Notice: Do not attempt to service the computer system yourself, except as explained in this guide and elsewhere in Intel documentation. Always follow installation and service instructions closely.

- 1) Make a verified backup of all data stored on your computer.
- 2) Turn off your computer and any peripherals.
- 3) Disconnect your computer and peripherals from their power sources. Also disconnect any telephone or telecommunications lines from the computer.

Doing so reduces the potential for personal injury or shock.

Also note these safety guidelines:

- When you disconnect a cable, pull on its connector or on its strain-relief loop, not on the cable itself. Some cables have a connector with locking tabs; if you are disconnecting this type of cable, press in the locking tabs before disconnect the cable. As you pull connectors apart, keep them evenly aligned to avoid bending the connector pins. Before you connect a cable, make sure both connectors are correctly oriented and aligned.
- Handle components and cards with care. Do not touch the components or contacts on a card. Hold a card by its edges or by its metal mounting bracket. Hold a component such as a microprocessor chip by its edges, not by its pins.

Protecting Against Electrostatic Discharge

Static electricity can harm delicate components inside your computer. To prevent static damage, discharge static electricity from your body before you touch any of your computer's electronic components, such as the microprocessor. You can do so by touching an unpainted metal surface, such as the metal around the card-slot openings at the back of the computer.

As you continue to work inside the computer, periodically touch an unpainted metal surface to remove any static charge your body may have accumulated. In addition to the preceding precautions, you can also take the following steps to prevent damage from electrostatic discharge (ESD):

- When unpacking a static-sensitive component from its shipping carton, do not remove the component from the antistatic packing material until you are ready to install the component in your computer. Just before unwrapping the antistatic packaging, be sure to discharge static electricity from your body.
- When transporting a sensitive component, first place it in an antistatic container or packaging.
- Handle all sensitive components in a static-safe area. If possible, use antistatic floor pads and workbench pads.

Chapter 1

Overview

1.1	Overview	14
1.2	Features	14
1.3	Hardware	15
1.3.1	RAID Controller Configurations	15
1.3.2	Configuration on Disk	16
1.3.3	Drive Roaming	16

Chapter 2

Hardware Installation

2.1	Requirements	17
2.2	Installation	17
2.3	After You Have Installed the RAID Controller	20

Chapter 3

Intel® RAID Controller SRCS16 Technical Reference

3.1	Overview	21
3.2	Decoding the Audible Alarm	23
3.3	Technical Specifications	23
3.3.1	RAID Controller Specifications	23
3.3.2	Electrical Characteristics	24
3.3.3	Thermal and Atmospheric Characteristics	24
3.3.4	Safety Characteristics	24

Chapter A

Glossary of Terms and Abbreviations

Figures

1.1	Intel® RAID Controller SRCS16 Components	16
2.1	Installing the Battery Backup Unit.	18
2.2	Inserting the Intel® RAID Controller SRCS16 in a PCI Slot	19
3.1	Intel® RAID Controller SRCS16 Block Diagram	21
3.2	RAID Controller SRCS16 Board Layout.	22

Tables

1-1	Intel® RAID Controller SRCS16 Adapter Features	15
3-1	Intel® RAID Controller SRCS16 Connector and Jumper Description	22
3-2	RAID Controller SRCS16 Specifications	23
3-3	RAID Controller SRCS16 Maximum Power Requirements	24

Chapter 1

Overview

This section provides a general overview of the Intel® RAID Controller SRCS16. It consists of the following sections.

- Section 1.1, “Overview,” page 14
 - Section 1.2, “Features,” page 14
 - Section 1.3, “Hardware,” page 15
-

1.1 Overview

The RAID Controller SRCS16 provides a high-performance Intelligent Peripheral Component Interconnect to High Speed Serialized AT Attachment (PCI-to-Serial ATA) interface with Redundant Array of Independent Disks (RAID) control capabilities. Serial ATA RAID controllers provide reliability, high performance, and fault-tolerant disk subsystem management.

You can install the RAID Controller SRCS16 on a PCI bus and use it to connect Serial ATA drives to the host computer over a Serial ATA bus.

The RAID Controller SRCS16 is an ideal RAID solution for internal storage on workgroup, departmental, and enterprise systems. SATA RAID controllers offer a cost-effective way to implement RAID in a server.

The RAID Controller SRCS16 supports all major operating systems, such as Microsoft* Windows* XP, Microsoft* Windows* 2000, Microsoft* Windows Server* 2003, Novell* NetWare* 6.5, Red Hat* Linux* 9.0, Red Hat* Enterprise Linux* 3.0, and SuSE* Linux* 9.0.

Note: The operating systems supported by this controller may not be supported by your server board. Please refer to the tested OS list for your server board.

1.2 Features

Features of the RAID Controller SRCS16 include:

- Support for hard disk drives with capacities greater than 8 Gbytes
- Online RAID level migration
- RAID remapping
- No reboot necessary after expansion
- User-specified rebuild rate
- Support for RAID levels 0 (striping), 1 (mirroring), 5 (striping and parity data across all drives), 10 (mirroring and striping), and 50 (RAID 5 and striping)
- Advanced array configuration and management utilities
- NVRAM for storing RAID system configuration information and Configuration on Disk (COD); the firmware is stored in flash ROM for easy upgrade

- Up to 40 logical drives allowed per controller
- Up to 32 physical drives allowed per logical array
- S.M.A.R.T. technology is supported
- 64MB cache memory size
- User-configurable stripe size of 2, 4, 8, 16, 32, 64, or 128KB

In addition, the RAID Controller SRCS16 offers enclosure management through the same protocols used for SCSI Accessed Fault-Tolerant Enclosures (SAF-TE), using an I²C interface to communicate with the storage enclosure processor (SEP). This feature allows you to use RAID capabilities provided by the RAID Controller SRCS16 adapters in an enclosure containing your hard drives.

1.3 Hardware

You can install the Intel[®] RAID Controller SRCS16 in a computer with a motherboard that has 3.3V, 64-bit PCI slots.

The following subsections describe the hardware configuration and configuration-on-disk.

1.3.1 RAID Controller Configurations

Table 1-1 describes the features for the RAID Controller SRCS16. Figure 1.1 points out the major components of the RAID controller. Refer to Table 3-1 and to Figure 3.1 for jumper and connector options.

Table 1-1 Intel[®] RAID Controller SRCS16 Adapter Features

Feature	Description
Number of Ports	6, using 3 Silicon Image* SCL3112 controllers
Serial ATA Bus Speed	150 MHz
Serial ATA Data Transfer Rate ¹	1.5 Gbits/s
Intelligent RAID Management	Yes, using the Intel 80302 processor
PCI Bus Width and Speed	64-bit, 66 MHz
PCI Data Transfer Rate ¹	528 Mbytes/s
RAID Levels	0, 1, 5, 10, and 50
SDRAM Support	64 Mbytes ECC SDRAM
Cache Function	Write-back, Write-through, Adaptive Read Ahead, Non-Read Ahead, Read Ahead, Cache I/O, Direct I/O
Online Expansion	Yes
Hot Spare Pool	Yes
Hot Swap	Yes
Hardware Exclusive-OR	Yes
Enclosure Management Support	Yes
BIOS RAID Management Tools	WebBIOS
Software RAID Management Tools	Web Console

1. Theoretical transfer rate

Figure 1.1 Intel® RAID Controller SRCS16 Components

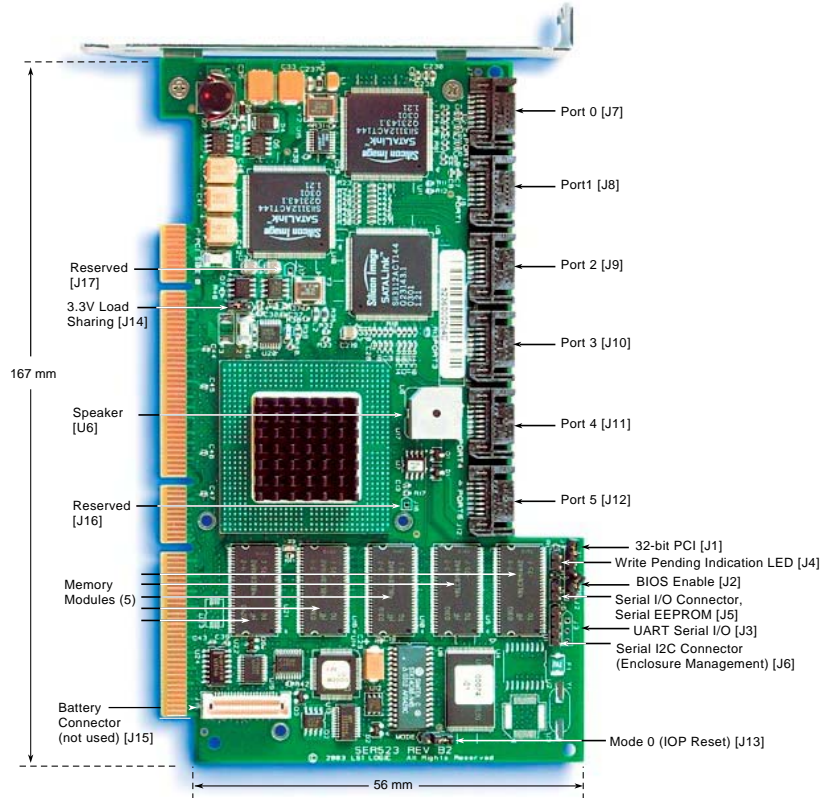

1.3.2 Configuration on Disk

Configuration on Disk saves configuration information both in NVRAM on the Intel® RAID Controller SRCS16 and on the disk drives attached to the controller. If the RAID Controller SRCS16 is replaced, the new controller detects the actual RAID configuration from the configuration information on the drives.

Note: Configuration on Disk does not work if you change both the RAID Controller SRCS16 and the SATA connectors to different connectors on the new RAID Controller SRCS16. It works only if you make one change at a time.

1.3.3 Drive Roaming

The RAID Controller SRCS16 supports drive roaming across ports on the same controller. Drive roaming lets a RAID Controller SRCS16 detect the actual RAID configuration, maintaining the integrity of the data on each disk drive, even if the disk drives have changed ports and/or target ID.

In addition, the RAID Controller SRCS16 offers enclosure management through the same protocols used for SCSI Accessed Fault-Tolerant Enclosures (SAF-TE), using an I²C interface to communicate with the storage enclosure processor (SEP). This feature allows you to use RAID capabilities provided by the RAID Controller SRCS16 adapters in an enclosure containing your hard drives.

Chapter 2

Hardware Installation

This chapter describes the procedures for installing the . It contains the following sections:

- Section 2.1, “Requirements,” page 17
 - Section 2.2, “Installation,” page 17
 - Section 2.3, “After You Have Installed the RAID Controller,” page 20
-

2.1 Requirements

The following items are required to install a Intel® RAID Controller SRCS16:

- An Intel® RAID Controller SRCS16 and operating system driver
- A host computer with an available 32- or 64-bit, 3.3 V PCI expansion slot
- The Resource CD
- The necessary internal SATA cables
- SATA hard disk drives and cables

Intel strongly recommends using an uninterruptible power supply (UPS).

2.2 Installation

This section provides detailed instructions for installing a RAID Controller SRCS16.

The following steps provide detailed installation instructions.

- 1) Unpack the RAID Controller SRCS16 and inspect it for damage.

Unpack and install the RAID controller in a static-free environment. Remove the RAID controller from the anti-static bag and inspect it for damage. Contact your Intel support representative if the RAID controller appears damaged.

- 2) Power down the system.

Turn off the computer and physically remove the power cord from the back of the power supply. Remove the cover from the computer chassis. Disconnect the system from any networks.

- 3) Configure the jumpers on the RAID Controller SRCS16.

Configure the jumper settings on the RAID controller. Chapter 3, “Intel® RAID Controller SRCS16 Technical Reference,” provides the jumper definitions and locations.

- 4) (Optional). Install the Battery Backup Unit.
 - a. Connect the wire from the battery backup unit to the RAID card. See letter A in the figure below.
 - b. Position the battery backup unit over the RAID card, lining up the connectors. See letter B in the figure below.
 - c. Press the battery backup unit onto the RAID card.
 - d. Turn over the RAID card / battery backup unit assembly.
 - e. Use the three screws included with the battery backup unit to secure the battery backup unit to the RAID card.

Figure 2.1 Installing the Battery Backup Unit

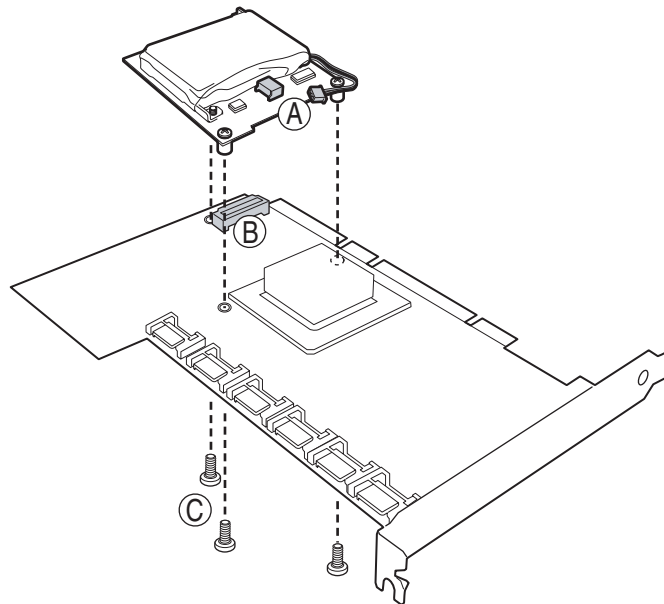

TP00747

- 5) Insert the RAID Controller SRCS16.

Align the RAID controller to a PCI slot. Press down gently but firmly to properly seat the RAID controller in the slot. Figure 2.2 shows how to insert the RAID Controller SRCS16 in a PCI slot.

Figure 2.2 Inserting the Intel® RAID Controller SRCS16 in a PCI Slot

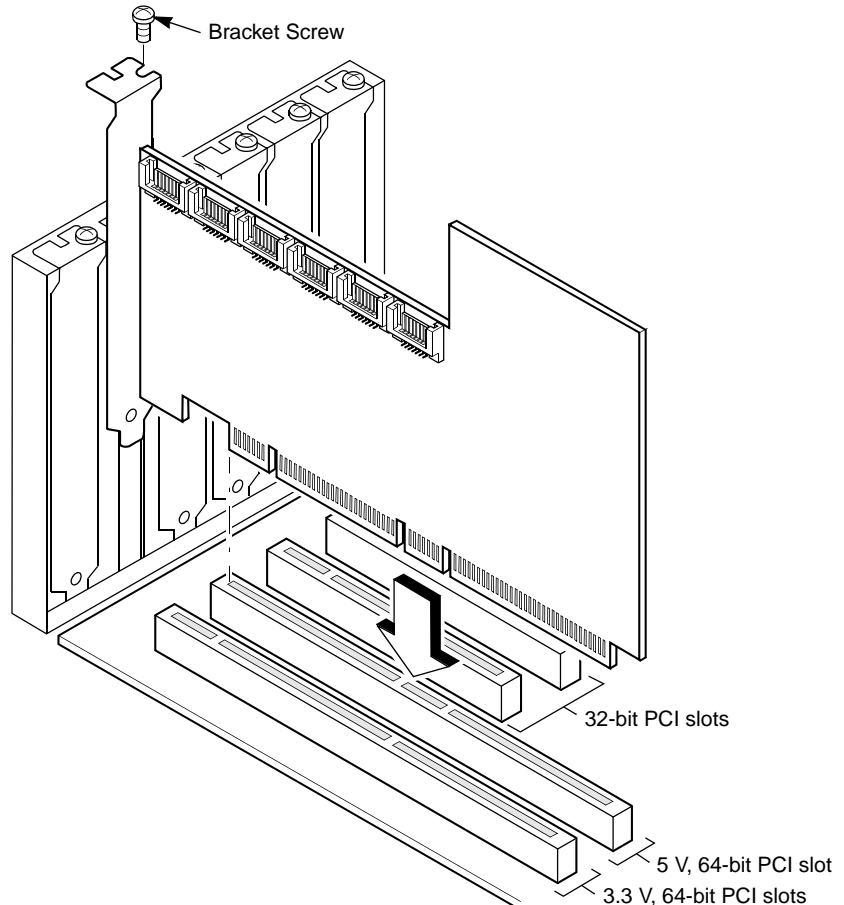

- 6) Screw the bracket to the computer frame.
- 7) Configure the Serial ATA devices and install them in the host system computer case.
See the documentation for the Serial ATA device for any pre-installation configuration requirements.
- 8) Connect the Serial ATA cables between the RAID Controller SRCS16 and the Serial ATA devices. Chapter 3, "Intel® RAID Controller SRCS16 Technical Reference," shows the connector locations on your RAID Controller SRCS16.

- 9) Replace the computer cover and power up the system.

Replace the computer cover and reconnect the power cords. Turn power on to the computer.

The BIOS Configuration utility prompt times out after several seconds. The second portion of the BIOS message displays the Intel® RAID Controller SRCS16 number, firmware version, and cache SDRAM size. The numbering of the controllers follows the PCI slot scanning order used by the host motherboard.

When you see the message:

Press <CTRL><G> to run BIOS Console

Press the <CTRL> and <G> keys at the same time. The firmware takes several seconds to initialize. During this time the adapter scans the Serial ATA ports.

2.3 After You Have Installed the RAID Controller

After installation, you must configure the RAID Controller SRCS16 and install the operating system driver. The *Intel RAID Software User's Guide* instructs you about the configuration options and how to set them on your RAID Controller SRCS16.

Chapter 3

Intel® RAID Controller SRCS16 Technical Reference

This chapter describes the characteristics of the Intel® RAID Controller SRCS16. This chapter contains the following sections:

- Section 3.1, “Overview,” page 21
- Section 3.3, “Technical Specifications,” page 23

3.1 Overview

The RAID Controller SRCS16 conforms to the PCI Local Bus Specification, Revision 2.2, and is backward-compatible with previous versions of the specification.

PCI is a high-speed standard local bus for interfacing I/O components to the processor and memory subsystems in a server. The component height on the top and bottom of the RAID Controller SRCS16 follow the *PCI Local Bus Specification, Revision 2.2*, and *PCI-X Addendum to the PCI Local Bus Specification, Revision 1.0a*. The RAID Controller SRCS16 is designed for use in a PCI computer system that has PCI standard bracket types.

The RAID Controller SRCS16 is an intelligent RAID controller that provides six Serial ATA ports and supports RAID 0, RAID 1, RAID 5, RAID 10, and RAID 50. The Web Console utility provides RAID management and configuration support both before and after the operating system boots.

Figure 3.1 provides a block diagram for the RAID Controller SRCS16.

Figure 3.1 Intel® RAID Controller SRCS16 Block Diagram

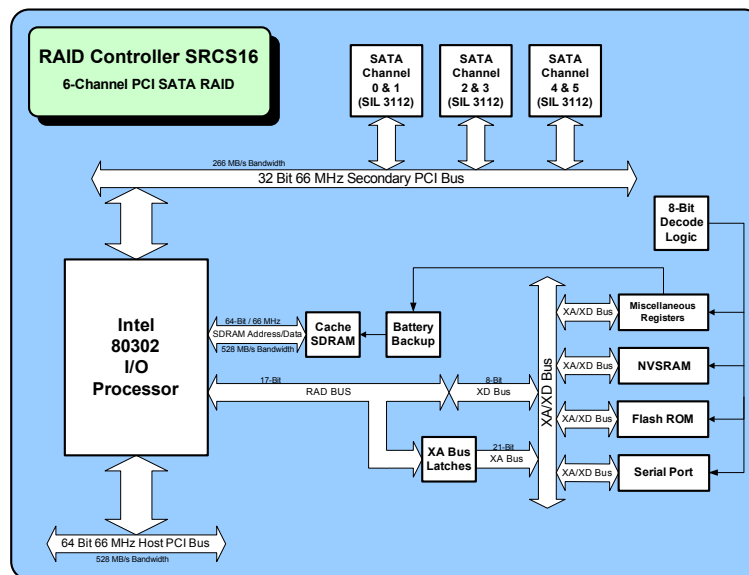
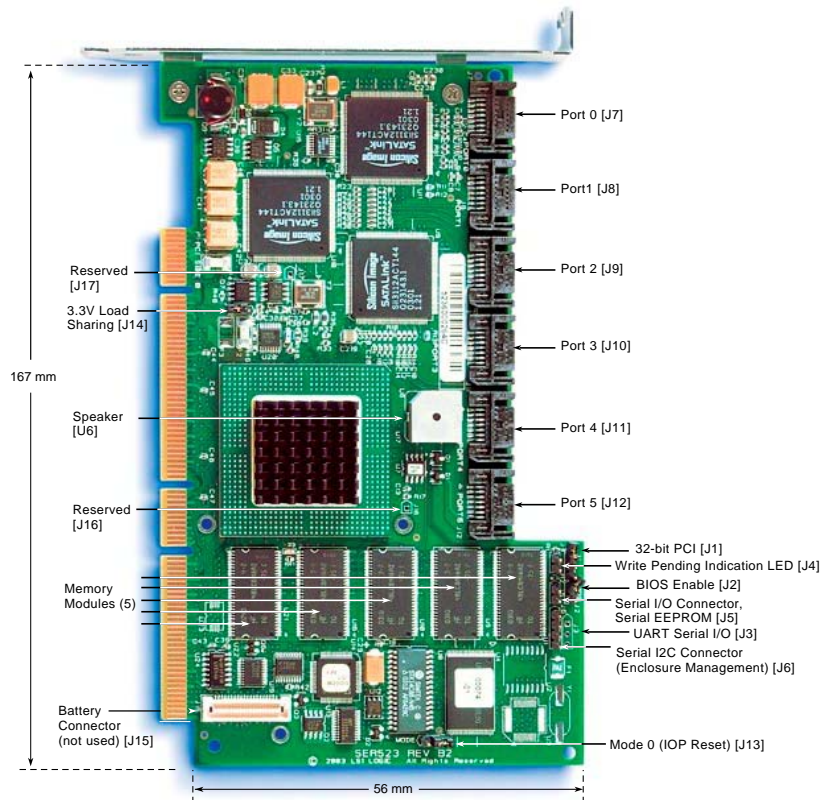

Table 3-1 defines the connectors on the RAID Controller SRCS16. Figure 3.1 provides the layout of the controller. The Write Pending connector (J4) provides a LED signal that indicates a write to disk has not been completed (dirty cache).

Table 3-1 Intel® RAID Controller SRCS16 Connector and Jumper Description

Jumpers and Connectors	Description	Default Setting
J1	32-bit PCI (open - 64-bit PCI)	Open
J2	BIOS enable; (installed - BIOS disabled)	Open
J3	UART serial I/O connector for test (not present)	Open
J4	Connector for Write Pending Indication LED	Open
J5	Serial I/O connector for Serial EPROM	Open
J6	I ² C connector, used as the interface for the controller to communicate with a storage enclosure processor in an enclosure arrangement	Open
J7-J12	Port connectors (see Figure 3.1 for details)	Open
J13	Mode 0 Select (closed - Mode 0)	Open
J14	3.3 V load sharing (open - disable)	Open
J15	Battery backup daughter card connector (not used)	Open
J16, J17, JP1	Reserved for factory use	—

Figure 3.2 RAID Controller SRCS16 Board Layout



3.2 Decoding the Audible Alarm

The following beep codes are used on Intel RAID controllers that use software stack 2. These codes usually indicate a drive has failed:

- Degraded Array: Short tone, one second on, one second off
- Failed Array: Long tone, three seconds on, one second off
- Hot Spare Commissioned: Short tone, one second on, three seconds off

These drive failure tones will repeat until the problem is corrected or until the alarm is silenced or disabled.

A tone alarm will also sound and will remain on during a rebuild. After the rebuild completes, an alarm with a different tone will sound, signaling the completion of the build. This is a one-time (non-repeating) tone.

The alarm can be disabled either in the BIOS Console or in the Web Console management utilities. When disabled, the alarm will not sound unless it is re-enabled in one of the utilities.

The alarm can be silenced either in the BIOS Console or in the Web Console management utilities. The default setting is enabled.

3.3 Technical Specifications

The design and implementation of the RAID Controller SRCS16 minimizes electromagnetic emissions, susceptibility to radio frequency energy, and the effects of electrostatic discharge. The RAID Controller SRCS16 carries the CE mark, C-Tick mark, FCC Self-Certification logo, Canadian Compliance Statement, Korean MIC, Taiwan BSMI, and Japan VCCI; they meet the requirements of CISPR Class B.

3.3.1 RAID Controller Specifications

Table 3-2 lists the specifications for the RAID Controller SRCS16.

Table 3-2 RAID Controller SRCS16 Specifications

Specification	Description
Processor (PCI Controller)	Intel GC80302 64-bit RISC processor @ 66 MHz
Operating Voltage	3.3 V, 5 V (universal)
Card Size	Half-length PCI Adapter card size (6.875" X 4.2")
Array Interface to Host	PCI Rev 2.2
PCI Bus Data Transfer Rate	Up to 528 Mbytes/s at 64-bit/66 MHz
Serial Port	3-pin RS232C-compatible connector (not present)
SATA Connectors	Six internal SATA ports

3.3.2 Electrical Characteristics

Table 3-3 lists the maximum power requirements for the RAID Controller SRCS16 under normal operation.

Table 3-3 RAID Controller SRCS16 Maximum Power Requirements

RAID Controller	PCI/PCI-X +5.0 V	PCI/PCI-X +3.3 V	Power	Over the Operating Range
SRCS16 ¹ (load sharing enabled)	0.85 A	1.29 A	11 W	0 °C to 45 °C
SRCS16 ¹ (load sharing disabled)	1.63 A	0 A		

1. The total power for the SRCS16 has taken into consideration the charging of the BBU from the +12 V and the on-board regulator efficiencies.

3.3.3 Thermal and Atmospheric Characteristics

The atmospheric characteristics for the RAID Controller SRCS16 are:

- Temperature range: 0 °C to 45 °C (dry bulb)
- Relative humidity range: 20% to 80% noncondensing
- Maximum dew point temperature: 32 °C

The following parameters define the storage and transit environment for the RAID Controller SRCS16:

- Temperature range: 40 °C to 105 °C (dry bulb)
- Relative humidity range: 20% to 80% noncondensing

3.3.4 Safety Characteristics

The RAID Controller SRCS16 meets or exceeds the requirements of UL flammability rating 94 V0. Each board is marked with the supplier's name or trademark, type, and UL flammability rating. Because these boards are installed in a PCI bus slot, all voltages are below the SELV 42.4 V limit.

Chapter A

Glossary of Terms and Abbreviations

BIOS	Basic Input/Output System. Software that provides basic read/write capability. Usually kept as firmware (ROM based). The system BIOS on the mainboard of a computer is used to boot and control the system. The SCSI BIOS on your host adapter acts as an extension of the system BIOS.
Configuration	Refers to the way a computer is setup; the combined hardware components (computer, monitor, keyboard, and peripheral devices) that make up a computer system; or the software settings that allow the hardware components to communicate with each other.
Device Driver	A program that allows a microprocessor (through the operating system) to direct the operation of a peripheral device.
Domain Validation	Domain Validation is a software procedure in which a host queries a device to determine its ability to communicate at the negotiated Ultra320 data rate.
EEPROM	Electrically Erasable Programmable Read Only Memory. A memory chip typically used to store configuration information. See NVRAM.
Fusion-MPT Architecture	Fusion-MPT (Message Passing Technology) architecture consists of several main elements: Fusion-MPT firmware, the Fibre Channel and SCSI hardware, and the operating system level drivers that support these architectures. Fusion-MPT architecture offers a single binary, operating system driver that supports both Fibre Channel and SCSI devices now.
Host	The computer system in which a RAID controller is installed. It uses the RAID controller to transfer information to and from devices attached to the SCSI bus.
Host Adapter Board (HAB)	A circuit board or integrated circuit that provides a device connection to the computer system.
Main Memory	The part of a computer's memory which is directly accessible by the CPU (usually synonymous with RAM).
NVRAM	NonVolatile Random Access Memory. Actually an EEPROM (Electrically Erasable Read Only Memory chip) used to store configuration information. See EEPROM.

PCI and PCI-X

Peripheral Component Interconnect. A high performance local bus specification that allows connection of devices directly to computer memory. The PCI Local Bus allows transparent upgrades from 32-bit data path at 33 MHz to 64-bit data path at 33 MHz, and from 32-bit data path at 66 MHz to 64-bit data path at 66 MHz.

Peripheral Devices

A piece of hardware (such as a video monitor, disk drive, printer, or CD-ROM) used with a computer and under the computer's control. SCSI peripherals are controlled through a SCSI SRCU42X controller (host adapter).