

True Scale Fabric Switches 12000 Series Hardware

Installation Guide

July 2015



INFORMATION IN THIS DOCUMENT IS PROVIDED IN CONNECTION WITH INTEL PRODUCTS. NO LICENSE, EXPRESS OR IMPLIED, BY ESTOPPEL OR OTHERWISE, TO ANY INTELLECTUAL PROPERTY RIGHTS IS GRANTED BY THIS DOCUMENT. EXCEPT AS PROVIDED IN INTEL'S TERMS AND CONDITIONS OF SALE FOR SUCH PRODUCTS, INTEL ASSUMES NO LIABILITY WHATSOEVER AND INTEL DISCLAIMS ANY EXPRESS OR IMPLIED WARRANTY, RELATING TO SALE AND/OR USE OF INTEL PRODUCTS INCLUDING LIABILITY OR WARRANTIES RELATING TO FITNESS FOR A PARTICULAR PURPOSE, MERCHANTABILITY, OR INFRINGEMENT OF ANY PATENT, COPYRIGHT OR OTHER INTELLECTUAL PROPERTY RIGHT.

A "Mission Critical Application" is any application in which failure of the Intel Product could result, directly or indirectly, in personal injury or death. SHOULD YOU PURCHASE OR USE INTEL'S PRODUCTS FOR ANY SUCH MISSION CRITICAL APPLICATION, YOU SHALL INDEMNIFY AND HOLD INTEL AND ITS SUBSIDIARIES, SUBCONTRACTORS AND AFFILIATES, AND THE DIRECTORS, OFFICERS, AND EMPLOYEES OF EACH, HARMLESS AGAINST ALL CLAIMS COSTS, DAMAGES, AND EXPENSES AND REASONABLE ATTORNEYS' FEES ARISING OUT OF, DIRECTLY OR INDIRECTLY, ANY CLAIM OF PRODUCT LIABILITY, PERSONAL INJURY, OR DEATH ARISING IN ANY WAY OUT OF SUCH MISSION CRITICAL APPLICATION, WHETHER OR NOT INTEL OR ITS SUBCONTRACTOR WAS NEGLIGENT IN THE DESIGN, MANUFACTURE, OR WARNING OF THE INTEL PRODUCT OR ANY OF ITS PARTS.

Intel may make changes to specifications and product descriptions at any time, without notice. Designers must not rely on the absence or characteristics of any features or instructions marked "reserved" or "undefined". Intel reserves these for future definition and shall have no responsibility whatsoever for conflicts or incompatibilities arising from future changes to them. The information here is subject to change without notice. Do not finalize a design with this information.

The products described in this document may contain design defects or errors known as errata which may cause the product to deviate from published specifications. Current characterized errata are available on request.

Contact your local Intel sales office or your distributor to obtain the latest specifications and before placing your product order.

Copies of documents which have an order number and are referenced in this document, or other Intel literature, may be obtained by calling 1-800-548-4725, or go to: <http://www.intel.com/design/literature.htm>

Intel and the Intel logo are trademarks of Intel Corporation in the U.S. and/or other countries.

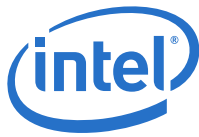
*Other names and brands may be claimed as the property of others.

Copyright © 2015, Intel Corporation. All rights reserved.



Contents

| | | |
|------------|---|----|
| 1.0 | Introduction | 9 |
| 1.1 | Intended Audience | 9 |
| 1.2 | Related Materials | 9 |
| 1.3 | Documentation Conventions | 9 |
| 1.4 | Laser Safety Information | 10 |
| 1.5 | Electrostatic Discharge Sensitivity (ESDS) Precautions | 11 |
| 1.6 | License Agreements | 11 |
| 1.7 | Technical Support | 11 |
| 2.0 | Installation | 13 |
| 2.1 | Planning the Installation | 13 |
| 2.1.1 | Cable Requirements | 13 |
| 2.1.2 | Uninterruptible Power Supply | 15 |
| 2.2 | Installation Tasks Checklist | 15 |
| 2.2.1 | Tools and Equipment Required | 16 |
| 2.2.2 | Check the Installation Site | 16 |
| 2.2.3 | Mark the Rack | 16 |
| 2.3 | 12200/12300 Installation | 16 |
| 2.3.1 | Four Post Standard-Depth Rack Installation | 17 |
| 2.3.2 | 12200 Four Post Shallow-Depth Rack Installation | 19 |
| 2.3.3 | 12200 Two Post Rack Installation | 20 |
| 2.4 | 12800-040 Installation | 21 |
| 2.4.1 | Mounting Hardware Kit Contents | 21 |
| 2.4.2 | Installation Tasks | 21 |
| 2.5 | 12800-120 Installation | 23 |
| 2.5.1 | Mounting Hardware Kit Contents | 23 |
| 2.5.2 | Installation Tasks | 24 |
| 2.6 | 12800-180 Installation | 30 |
| 2.6.1 | Mounting Hardware Kit Contents | 30 |
| 2.6.2 | Selecting a Rack | 31 |
| 2.6.3 | Installation Tasks | 31 |
| 2.7 | 12800-360 Installation | 36 |
| 2.7.1 | Mounting Hardware Kit Contents | 36 |
| 2.7.2 | Selecting a Rack | 36 |
| 2.7.3 | Installation Tasks | 38 |
| 2.8 | Connect Equipment to the Ports and Power On the System | 46 |
| 2.9 | Bringing Up the System For the First Time | 49 |
| 2.9.1 | 12800-Series Management Module Protective Label Guidelines | 49 |
| 2.9.2 | Start-up Procedures | 51 |
| 2.9.3 | Changing the Switch IP Address and Default Gateway through the CLI | 52 |
| 2.9.4 | Updating the Management Module IP Addresses in a Redundant Management Configuration (12800-040, 12800-120, 12800-180 and 12800-360) | 53 |
| 2.9.5 | Enabling 8X Ports | 54 |
| 2.10 | Component LEDs | 61 |
| 2.10.1 | Management Module | 61 |
| 2.10.2 | Leaf Module | 63 |
| 2.10.3 | Spine Module | 64 |
| 2.10.4 | SEEB Module | 65 |
| 2.10.5 | 12200 and 12300 | 66 |
| 2.10.6 | 12800 Fans and Power Supplies | 67 |
| A | Intel 12000 Series Product Specifications | 69 |



- A.1 Physical Specifications 69
- A.2 Environmental Specifications 69
- A.3 12200 and 12300 69
 - A.3.1 Cooling and Thermal Management: 69
 - A.3.2 Power 70
- A.4 12800 Series..... 70
 - A.4.1 Power Specifications..... 71
 - A.4.2 Power Distribution Guidelines 72
- B Safety and Regulatory Compliance Information 75**
 - B.1 Safety Information 75
 - B.1.1 Statement 1: 75
 - B.1.2 Statement 2: 76
 - B.1.3 Statement 3: 78
 - B.1.4 Statement 4: 80
 - B.1.5 Statement 5: 81
 - B.1.6 Statement 6: 83
 - B.1.7 Statement 7: 84
- C Serial Port Pinouts 87**
- D 12800 Leaf Module Guidelines..... 89**
 - D.1 12800-040..... 89
 - D.1.1 Single Management Module..... 89
 - D.1.2 Dual Management Modules..... 89
 - D.2 12800-120..... 89
 - D.2.1 Single Management Module..... 89
 - D.2.2 Dual Management Modules..... 89
 - D.3 12800-180..... 89
 - D.3.1 Single Management Module..... 89
 - D.3.2 Dual Management Modules..... 89
 - D.4 12800-360..... 90
 - D.4.1 Single Management Module..... 90
 - D.4.2 Dual Management Modules..... 90
- E FRU Replacement 91**
 - E.1 Intel 12200..... 91
 - E.1.1 Chassis Replacement..... 91
 - E.1.2 Management Card Installation or Replacement..... 91
 - E.2 Intel 12300..... 95
 - E.2.1 Chassis Replacement..... 95
 - E.2.2 Fan/Power Supply Replacement 96
 - E.3 Intel 12800 Series 97
 - E.3.1 Fan Replacement 97
 - E.3.2 Power Supply Replacement 98
 - E.3.3 Leaf Module Replacement 99
 - E.3.4 Spine Module Replacement 101
 - E.3.5 Management Module Replacement 102



Figures

| | | |
|----|---|----|
| 1 | Laser Safety Information..... | 10 |
| 2 | Copper Cable Bend Radius..... | 14 |
| 3 | Fiber Optic Bend Radius..... | 15 |
| 4 | 12200 and 12300 Hat Rails..... | 17 |
| 5 | Installing the Rack Rails..... | 18 |
| 6 | 12200 and 12300 Four Post Standard Rack Mounting..... | 18 |
| 7 | 12200 Hat Rails..... | 19 |
| 8 | 12200 Four Post Shallow Rack Mounting..... | 20 |
| 9 | 12200 Two Post Installation..... | 20 |
| 10 | Clip Nut Installation Locations..... | 21 |
| 11 | Clip Nut Orientation..... | 22 |
| 12 | Support Rail Installation..... | 22 |
| 13 | Rack Installation..... | 23 |
| 14 | Clip Nut Installation Locations..... | 24 |
| 15 | Clip Nut Orientation..... | 24 |
| 16 | Support Rail Installation..... | 25 |
| 17 | Hat Bracket Installation..... | 26 |
| 18 | Mounting Flange Installation..... | 27 |
| 19 | Chassis Installation..... | 28 |
| 20 | C Bracket Installation..... | 29 |
| 21 | Cable Management Installation..... | 30 |
| 22 | Clip Nut Locations..... | 31 |
| 23 | Clip Nut Orientation..... | 32 |
| 24 | Support Rail Installation..... | 32 |
| 25 | Flat Bracket Installation..... | 33 |
| 26 | Mounting Flange Installation..... | 34 |
| 27 | U Bracket Installation..... | 35 |
| 28 | Cable Management Guide Installation..... | 36 |
| 29 | 12800-360 Front and Rear Cabling..... | 37 |
| 30 | Locating Mounting Posts..... | 38 |
| 31 | Clip Nut Installation..... | 39 |
| 32 | Clip Nut Orientation..... | 39 |
| 33 | Support Shelf Assembly..... | 40 |
| 34 | Attaching the Support Shelf to the Rack..... | 41 |
| 35 | Loading from the Pallet..... | 42 |
| 36 | Positioning the Switch..... | 43 |
| 37 | Sliding the Switch off the Pallet..... | 43 |
| 38 | Fasten the Chassis to the Front of the Rack..... | 44 |
| 39 | Fasten the Chassis to the Back of the Rack..... | 45 |
| 40 | Attaching Cable Management Guides..... | 46 |
| 41 | 12200 and 12300 Serial and Ethernet Ports..... | 47 |
| 42 | 12800 Series Serial and Ethernet Ports (SEEB Module)..... | 47 |
| 43 | DC ON/OFF Switch..... | 49 |
| 44 | MRL Protective Label 1..... | 49 |
| 45 | MRL Protective Label 2..... | 50 |
| 46 | MRL Protective Label 3..... | 50 |
| 47 | MRL Protective Label 4..... | 50 |
| 48 | MRL Protective Label 5..... | 51 |
| 49 | MRL Protective Label 6..... | 51 |
| 50 | 12200/12300 8x DUOs..... | 55 |
| 51 | 8X Ports Enabled..... | 56 |
| 52 | 8X Port Statistics..... | 57 |
| 53 | 12800-180 Leaf Module 8x DUOs..... | 58 |



- 54 8X Ports Enabled 59
- 55 8X Port Statistics 60
- 56 Management Module LEDs 61
- 57 MRL Active LED 63
- 58 Leaf Module LEDs 63
- 59 Spine Module LEDs (Double Spine Shown) 64
- 60 SEEB Module LEDs 65
- 61 12200 and 12300 LEDs 66
- 62 12800 Fan LEDs 67
- 63 12800 Power Supply LEDs 68
- 64 12800-Series Power Distribution 73
- 65 Serial Port Pinouts 87
- 66 12200 Management Card Slot Cover 92
- 67 12200 Management Card Insertion 93
- 68 12200 Management Card Insertion (2) 94
- 69 12200 Management Card Insertion (3) 95
- 70 12300 Fan/Power Module Removal 96
- 71 12800 Fan Removal 97
- 72 12800 Intake and Exhaust Fans 98
- 73 12800 Power Removal 99
- 74 MRL 100
- 75 12800 Leaf Removal 101
- 76 12800 Spine Removal 101
- 77 12800 Management Module Removal 102

Tables

- 1 IB Copper Cable Guidelines 14
- 2 IB Fiber Optic Cable Guidelines 15
- 3 12000 Physical Attributes 69
- 4 12800 Product Configurations 70
- 5 System Power Attributes 71
- 6 AC Plug Types 73
- 7 Pinout Cross Reference 88



| Date | Revision | Description |
|--------------|----------|--|
| May 2013 | 001US | Initial release |
| January 2014 | 002US | Updated document File Info meta data |
| August 2014 | 003US | Update Support link in Section 1.7, "Technical Support" on page 11 |
| July 2015 | 004US | Document revision incremented for release 7.4 |

§ §





1.0 Introduction

This manual describes the hardware installation and initial configuration tasks for the Intel® True Scale Fabric Switches 12000 Series that includes:

- The Intel 12200 36-port fixed-configuration switch
- The Intel 12300 36-port configurable switch
- The Intel 12300 18-port configurable switch
- The Intel 12800 series:
 - 12800-040
 - 12800-120
 - 12800-180
 - 12800-360

This manual is organized as follows:

Preface describes the intended audience and technical support.

[Section 2.0](#) describes the hardware installation and initial configuration tasks.

[Appendix A](#) provides product specification information.

[Appendix B](#) provides product safety and regulatory information.

[Appendix C](#) provides serial port pinout information.

[Appendix E](#) provides FRU replacement information.

1.1 Intended Audience

This manual is intended to provide network administrators and other qualified personnel a reference for hardware installation and initial configuration for the switches.

1.2 Related Materials

- *Intel® True Scale 12000 Users Guide*
- *Intel® True Scale 12000 CLI Reference Guide*
- *Intel® True Scale 12000 Release Notes*
- *Intel® True Scale Fabric Switch 12200 Release Notes*

1.3 Documentation Conventions

This guide uses the following documentation conventions:

- *Note*: provides additional information.
- *Caution*: indicates the presence of a hazard that has the potential of causing damage to data or equipment.
- *Warning*: indicates the presence of a hazard that has the potential of causing personal injury.
- Text in **blue** font indicates a hyperlink (jump) to a figure, table, or section in this guide, and links to Web sites are also shown in **blue**. For example:

- Table 2 lists problems related to the user interface and remote agent.
- See “Installation Checklist” on page 6.
- For more information, visit www.intel.com.
- Text in **bold** font indicates user interface elements such as a menu items, buttons, check boxes, or column headings. For example:
 - Click the **Start** button, point to **Programs**, point to **Accessories**, and then click **Command Prompt**.
 - Under **Notification Options**, select the **Warning Alarms** check box.
- Text in *Courier* font indicates a file name, directory path, or command line text. For example:
 - To return to the root directory from anywhere in the file structure:
Type `cd /root` and press ENTER.
 - Enter the following command: `sh ./install.bin`
- Key names and key strokes are indicated with UPPERCASE:
 - Press CTRL+P.
 - Press the UP ARROW key.
- Text in *italics* indicates terms, emphasis, variables, or document titles. For example:
 - For a complete listing of license agreements, refer to the *Intel Software End User License Agreement*.
 - What are *shortcut keys*?
 - To enter the date type *mm/dd/yyyy* (where *mm* is the month, *dd* is the day, and *yyyy* is the year).
- Topic titles between quotation marks identify related topics either within this manual or in the online help throughout this document.

1.4 Laser Safety Information

This product may use Class 1 laser optical transceivers to communicate over the fiber optic conductors. The U.S. Department of Health and Human Services (DHHS) does not consider Class 1 lasers to be hazardous. The International Electrotechnical Commission (IEC) 825 Laser Safety Standard requires labeling in English, German, Finnish, and French stating that the product uses Class 1 lasers. Because it is impractical to label the transceivers, the following label is provided in this manual.

Figure 1. Laser Safety Information





1.5 Electrostatic Discharge Sensitivity (ESDS) Precautions

The assemblies used in the switch chassis are ESD sensitive. Observe ESD handling procedures when handling any assembly used in the switch chassis.

1.6 License Agreements

Refer to the *Intel Software End User License Agreement* for a complete listing of all license agreements affecting this product.

1.7 Technical Support

Intel True Scale Technical Support for products under warranty is available during local standard working hours excluding Intel Observed Holidays. For customers with extended service, consult your plan for available hours. For Support information, see the Support link at www.intel.com/truescale.







2.0 Installation

This section describes how to install and configure for first-time use:

- The Intel® 12000 Series switches in a network environment.

2.1 Planning the Installation

The 12000-series switches are designed for installation in standard 19-inch equipment racks.

Racks should conform to conventional standards. Use the American National Standards Institute (ANSI)/Electronic Industries Association (EIA) standard ANSI/EIA-310-D-92 and International Electrotechnical Commission (IEC) 297

Racks should meet the following mechanical recommendations:

- Four-post, 19" rack to facilitate easy maintenance
- Universal mounting rail hole pattern identified in IEC Standard 297
- Mounting holes flush with the rails to accommodate the chassis

Note: Operation is subject to the following conditions:

Note: Use a rack grounding kit and a ground conductor that is carried back to earth or to another suitable building ground. Ground the equipment rack to earth ground.

Note: Provide enough room to work on the equipment. Clear the work site of any unnecessary materials. Make sure the equipment will have enough clearance for front and rear access.

2.1.1 Cable Requirements

Note: For detailed information on all supported cables, please refer to the *InfiniBand Cable Matrix*, which can be found at www.intel.com/infiniband.

2.1.1.1 Cable Distances

When planning the location of the switches, consider the distance limitations for signaling, EMI, and connector compatibility. It is recommended that the user does not exceed specified transmission rate and distance limits.

2.1.1.2 Cable Guidelines

Note: Building and electrical codes vary depending on the location. Comply with all code specifications when planning the site and installing cable.

When running cable to the equipment, consider the following:

- Do not run cables where they can be stepped on or rolled over.
- Be sure cables are intact with no cuts, bends, or nicks.
- If the user is making a cable, ensure that the cable is properly crimped.
- Provide proper strain relief for IB cables.
- Support cables using a cable manager mounted above connectors to avoid unnecessary weight on the cable bundles.
- Bundle cable using velcro straps to avoid injuring cables.

- Keep all ports and connectors free of dust.
- Untwisted Pair (UTP) cables can build up Electrostatic Discharge (ESD) charges when being placed into a new installation. Before installing category 5 UTP cables, discharge ESD from the cable by plugging it into a port on a system that is not powered on.
- When required for safety and fire rating requirements, plenum-rated cable can be used. Check the local building codes to determine when it is appropriate to use plenum-rated cable, or refer to IEC standard 850.

2.1.1.3 Cable Handling and Bend Radius

Provide proper strain relief by adhering to the following guidelines:

Table 1. IB Copper Cable Guidelines

| InfiniBand Copper Cable Bend Radii | |
|--------------------------------------|-------------|
| American Wire Gauge (AWG) Size Cable | Bend Radius |
| 26 | 2.43 inches |
| 28 | 2.28 inches |
| 30 | 1.98 inches |

For copper cable, the temporary 90-degree bend can never be more than 0.5 inches tighter than the values listed above for any assembly. This is the absolute minimum sustained bend radius for each cable AWG size. This measurement is the distance from the switch panel to the point where the cable makes a 90-degree bend. In other words, this number includes the distance from the connector stand-off from the panel surface.

Figure 2. Copper Cable Bend Radius

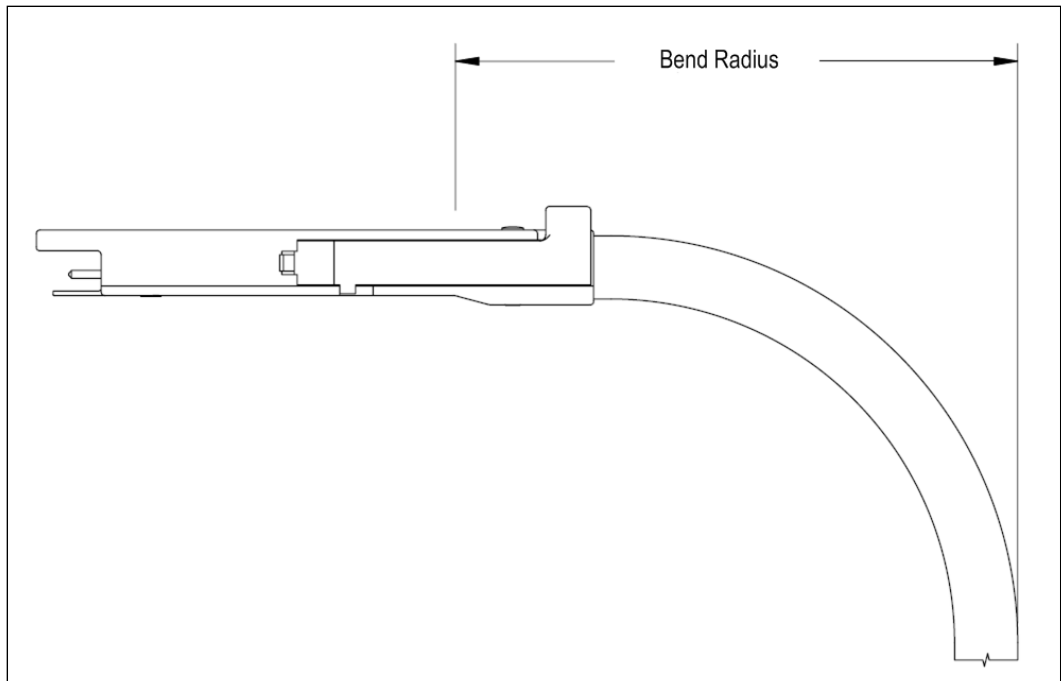
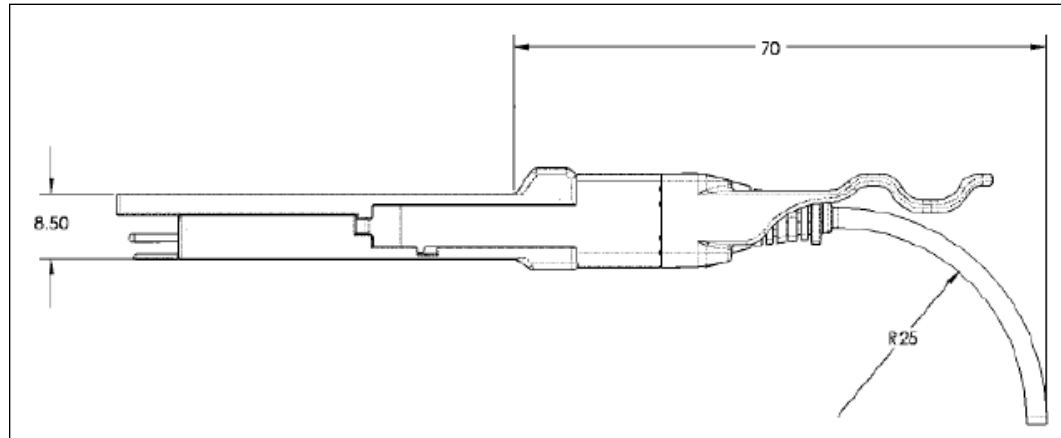




Table 2. IB Fiber Optic Cable Guidelines

| InfiniBand Fiber Optic Cable Bend Radii | |
|---|---|
| Cable Type | Bend Radius |
| Fiber Optic Standard Cable | 25 millimeters NOTE: A 50mm diameter is the smallest circle limit |

Figure 3. Fiber Optic Bend Radius



2.1.2 Uninterruptible Power Supply

Consider the following when selecting UPS equipment:

- The minimum amperage requirements for a UPS:
 - Calculate VA (volt-amps): Locate the voltage and amperage requirements for each piece of equipment (usually located on a sticker on the back or bottom of the equipment). Multiply the numbers together to get VA.
 - Add the VA from each piece of equipment together to find the total VA requirement. Then add 30% to determine the minimum amperage requirements for the UPS.
- Transition time (the time necessary for the UPS to transfer from utility power to full-load battery power).
- The longest potential time period the UPS might be required to supply backup power.
- Whether the UPS unit provides online protection.

2.2 Installation Tasks Checklist

To perform the actual switch installation, the site implementation engineer must perform the following tasks, which are detailed in this section.

Caution: Be sure to review the safety information before starting the installation and during the installation process (refer to <CR_CrossRef>Appendix E.

1. Check the installation site to verify the installation of cabinet power feeds, rails, and grounding.



2. Unpack the equipment and inspect for any shipping damage. Any shipping damage should be reported to the shipping company.
3. Verify that the equipment shipped matches the packing list.
4. Mark the rack and install the mounting rails.
5. Physically install the switch in the rack.

2.2.1 Tools and Equipment Required

- An ESD wrist strap
- A #2 Phillips screwdriver
- An M6 HEX nut wrench
- Pen (felt-tip) to mark the mounting holes
- Lifting device (e.g., pallet jack) for the 12800-360 and 12800-180

2.2.2 Check the Installation Site

The switches are designed to be installed in an existing server cabinet (not a telco cabinet), where it can be mounted in a standard equipment rack.

Be sure of the following:

- The cabinet has a full earth ground to provide reliable grounding.
- There is enough room to work on the equipment.
- The equipment will have enough clearance for front and rear access.
- The IB cables can be accessed easily.
- Water or moisture cannot enter the switch.
- The ambient temperature stays between 50°–113°F (5°–40° C).
- Cabinet doors do not interfere with front-to-back air flow.

The cabinet should have its own switchable power distribution. If the switch has two power supplies, it is suggested that a cabinet with dual power distribution units is used.

It is recommended that cabinet anti-tip devices are used. This is especially true if installing or removing a switch in the upper half of the cabinet when the lower half is empty.

2.2.3 Mark the Rack

Allow enough vertical space in the rack for each specific switch installation.

1. Determine the location in the rack of the bottom of the switch.
2. Mark the upper (if applicable) and lower mounting positions on the vertical rails on the front of the rack.
3. Mark the upper (if applicable) and lower mounting positions on the vertical rails on the back of the rack.

2.3 12200/12300 Installation

This section describes the rack mounting instructions for the 12200 and 12300:



2.3.1 Four Post Standard-Depth Rack Installation

In a standard-depth rack, the distance between the front and back mounting posts is ~28" (700mm). Mounting rails for the 12200 and 12300 are adjustable to accommodate racks with 26"– 33" between mounting posts.

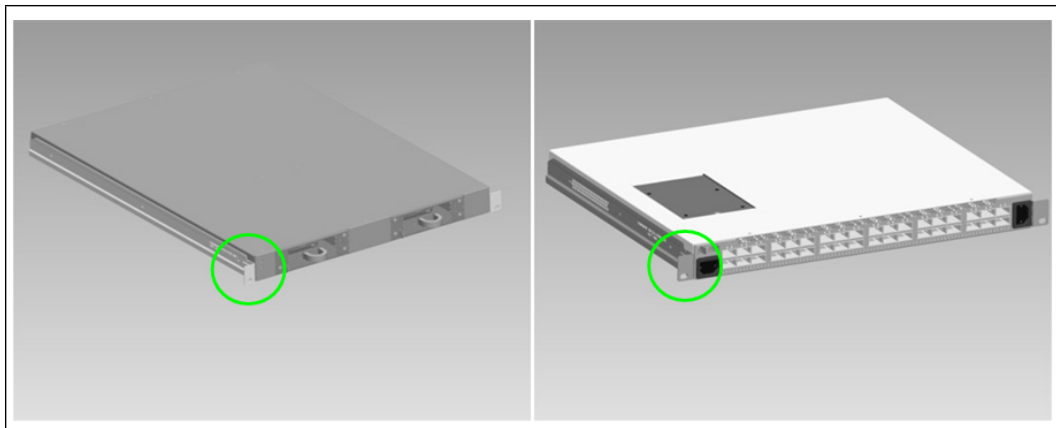
2.3.1.1 Mounting Hardware Kit Contents:

- One pair of mounting rails adjustable for 26"– 33" installation range
- One pair of hat rails, left and right
- #6-32 screws
- M6 cage nuts
- M6 screws

2.3.1.2 Installation

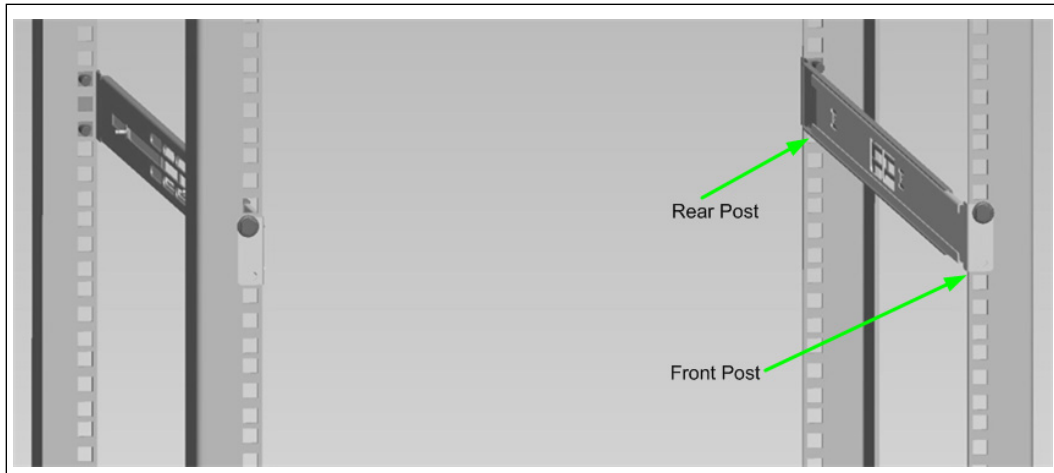
1. Install the hat rails on each side of the switch using three (3) #6-32 screws per rail. Torque screws to 8in-lb. A typical installation is shown in [Figure 4](#). On the 12300, hat rails are installed with mounting ears towards the power supply side of the switch. On the 12200, hat rails are installed with mounting ears towards the port side of the switch. Additionally, 12200 switches can be installed recessed within a rack. There are four sets of mounting holes on hat rails, for recess installations of 0, 2, 3 or 4 inches. Use the appropriate mounting holes to achieve the desired recess.

Figure 4. 12200 and 12300 Hat Rails



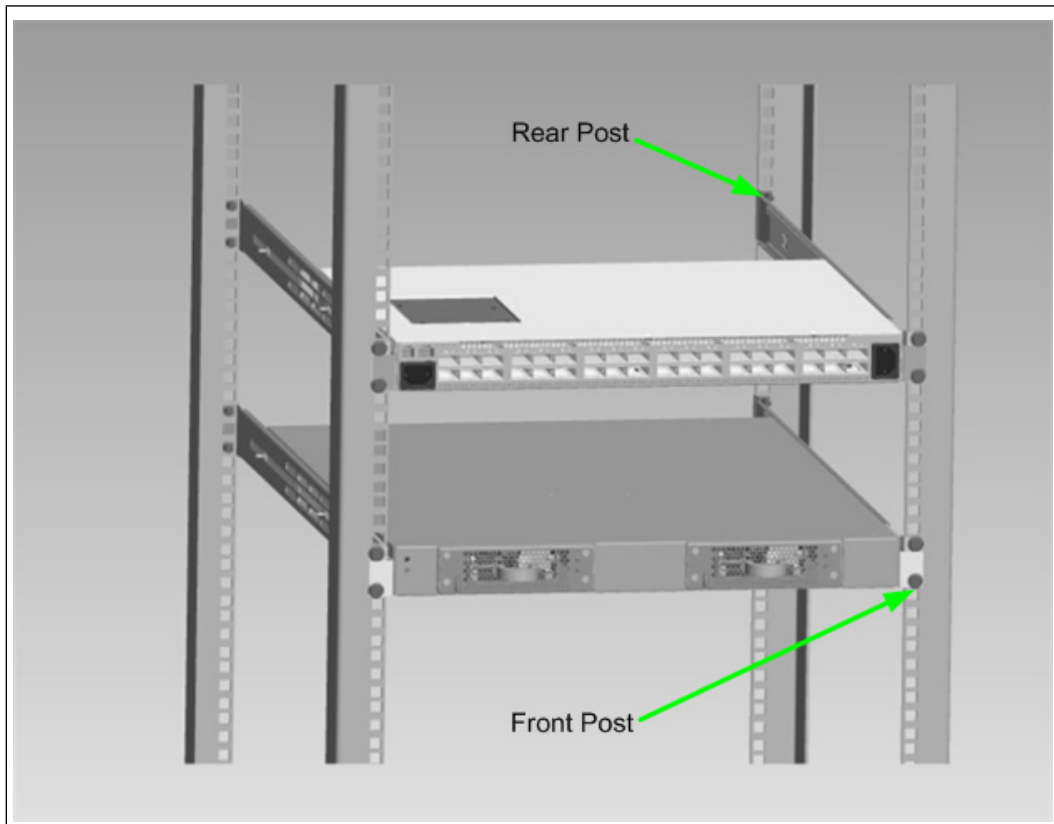
2. Install eight (8) cage nuts into rack posts, two (2) cage nuts per post. Install the mounting rails and fasten to cage nuts using six (6) M6 screws. Torque screws to 30in-lb. Do not install two (2) screws in lower locations on equipment installation side of the rack until the switch is installed in the rack. Note the orientation of mounting rails in [Figure 5](#). The rails are shown from the front side of the rack for 12300 or from the port side of the rack for 12200.

Figure 5. Installing the Rack Rails



3. Slide the switch into the mounting rails and fasten with M6 screws, one (1) per side. Torque screws to 30in-lb.

Figure 6. 12200 and 12300 Four Post Standard Rack Mounting





2.3.2 12200 Four Post Shallow-Depth Rack Installation

In a shallow-depth rack, the distance between the front and back mounting posts is ~16" (400mm). Mounting rails for the 12200 are adjustable to accommodate racks with 14"–20" between mounting posts.

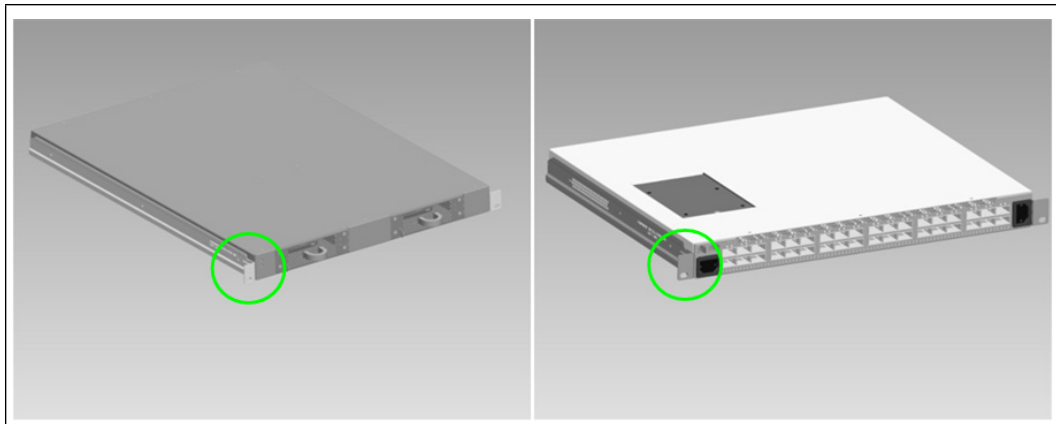
2.3.2.1 Mounting Hardware Kit Contents:

- One pair of C-brackets
- One pair of hat rails, left and right
- #6–32 screws
- M6 cage nuts
- M6 screws

2.3.2.2 Installation

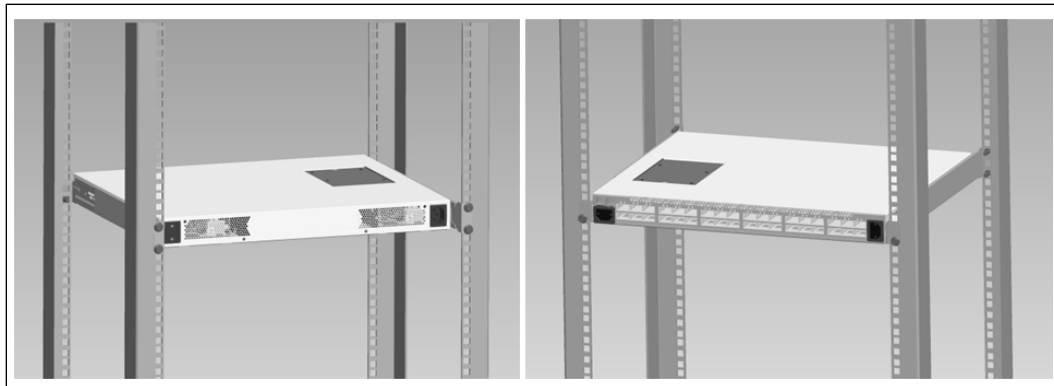
1. Install the hat rails with mounting ears towards the port side of the switch. Fasten with three (3) #6–32 screws per rail. Torque screws to 8in-lb.

Figure 7. 12200 Hat Rails



2. Install six (6) cage nuts into the rack posts. Two cage nuts into posts on the front side of the rack and four cage nuts into posts in the rear of the rack. Note that the front of the rack is where the switch is installed.
3. Install two C-brackets in the rear of the rack. Fasten to the rack posts with four (4) M6 screws. Slide the switch from the front of the rack into the C-brackets and fasten to the front posts with two (2) M6 screws. Torque to 30in-lb.

Figure 8. 12200 Four Post Shallow Rack Mounting



2.3.3 12200 Two Post Rack Installation

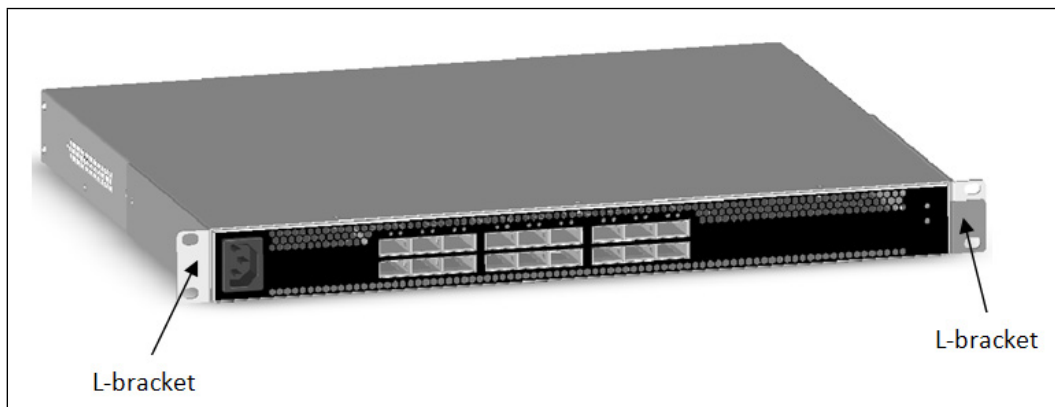
2.3.3.1 Mounting Hardware Kit Contents:

- One pair of mounting L-brackets, left and right.
- #6-32 screws
- M6 cage nuts
- M6 screws

2.3.3.2 Installation

1. Attach the L-brackets with mounting ears towards the port side of the switch. Fasten to the switch with three (3) #6-32 screws per L-bracket. Torque screws to 8in-lb.

Figure 9. 12200 Two Post Installation



2. Install four (4) cage nuts into the rack posts.
3. Install the switch in a rack and fasten to the cage nuts with four (4) M6 screws. Torque screws to 8in-lb.



2.4 12800-040 Installation

Note: The following procedures are for installing the switch using variable distances between the front and rear rack posts.

2.4.1 Mounting Hardware Kit Contents

Note: The mounting kit contains all of the necessary parts for installing and mounting the switch into a 19" 4-post server rack, with a distance between front and rear rack posts ranging from 28" - 33" (711mm - 838mm).

- Support Rails
- HAT Brackets
- C-Brackets
- #8-32 Flat Head Screws
- M6 Mounting Screws
- M6 Clip Nuts

2.4.2 Installation Tasks

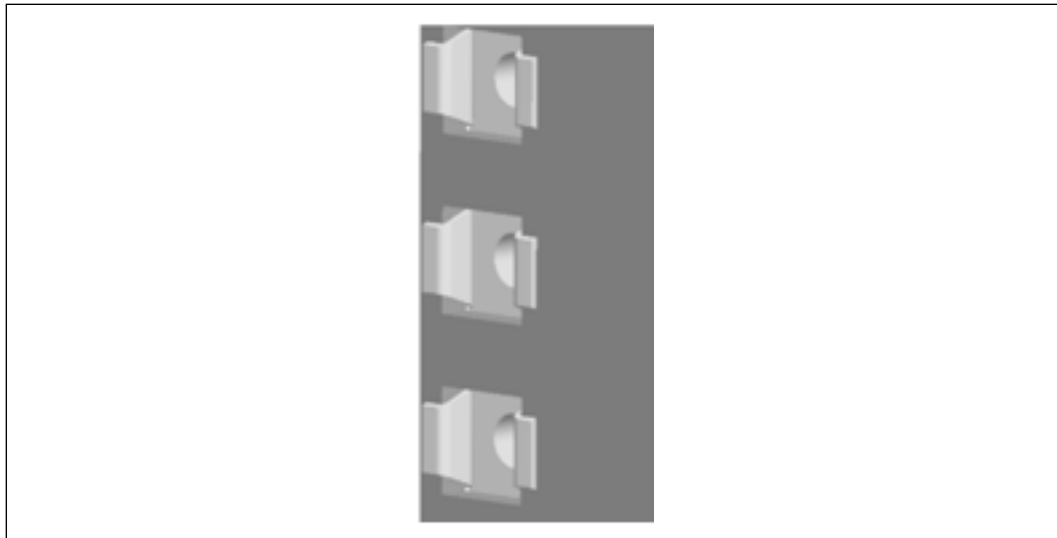
1. Install the clip nuts. Install M6 clip nuts in the following locations on EIA rails:

Figure 10. Clip Nut Installation Locations

| | Front of the Rack (left & right rail) | Rear of the Rack (left & right rail) | | | | | | | | | | | | | | | | |
|----------------|--|---|-----------|-------------|---|----------------|---|----------------|---|----------------|---|--|----|-----------|-------------|---|----------------|---|
| | <table border="1"> <thead> <tr> <th>U#</th> <th>Position#</th> </tr> </thead> <tbody> <tr> <td>Starting U#</td> <td>2</td> </tr> <tr> <td>Starting U# +1</td> <td>2</td> </tr> <tr> <td>Starting U# +2</td> <td>2</td> </tr> <tr> <td>Starting U# +4</td> <td>2</td> </tr> </tbody> </table> | U# | Position# | Starting U# | 2 | Starting U# +1 | 2 | Starting U# +2 | 2 | Starting U# +4 | 2 | <table border="1"> <thead> <tr> <th>U#</th> <th>Position#</th> </tr> </thead> <tbody> <tr> <td>Starting U#</td> <td>2</td> </tr> <tr> <td>Starting U# +1</td> <td>2</td> </tr> </tbody> </table> | U# | Position# | Starting U# | 2 | Starting U# +1 | 2 |
| | U# | Position# | | | | | | | | | | | | | | | | |
| | Starting U# | 2 | | | | | | | | | | | | | | | | |
| | Starting U# +1 | 2 | | | | | | | | | | | | | | | | |
| | Starting U# +2 | 2 | | | | | | | | | | | | | | | | |
| Starting U# +4 | 2 | | | | | | | | | | | | | | | | | |
| U# | Position# | | | | | | | | | | | | | | | | | |
| Starting U# | 2 | | | | | | | | | | | | | | | | | |
| Starting U# +1 | 2 | | | | | | | | | | | | | | | | | |
| | <p>Example:</p> <hr/> Starting at U10 Install clip nuts in U10 Pos 2 U11 Pos 2 U12 Pos 2 U14 Pos 2 | <hr/> U10 Pos 2 U11 Pos 2 | | | | | | | | | | | | | | | | |
| | | | | | | | | | | | | | | | | | | |
| | | | | | | | | | | | | | | | | | | |
| | | | | | | | | | | | | | | | | | | |

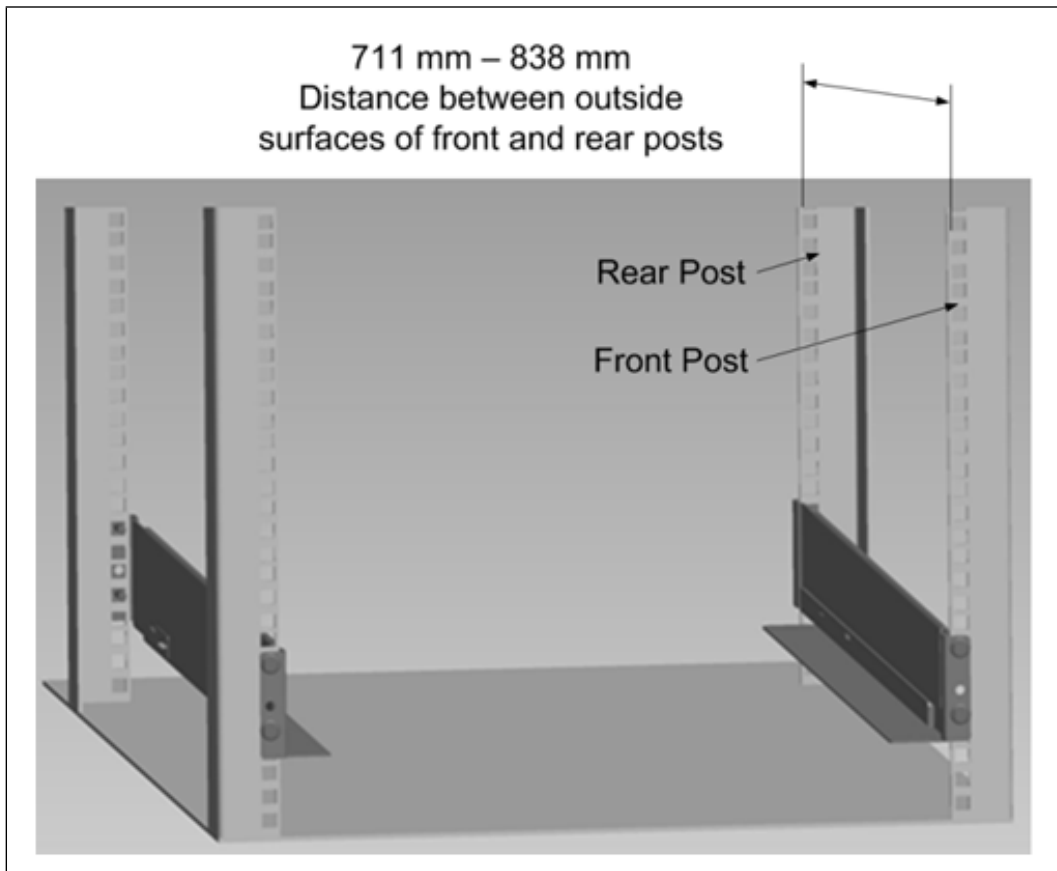
For improved stability, orient the clip nuts as shown (that is, orient the flanges horizontally):

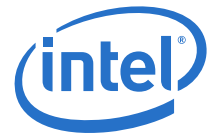
Figure 11. Clip Nut Orientation



2. Install support rails in the rack. Fasten with two (2) M6 screws per EIA rail to pre-installed clip nuts and torque to 30 in-lb.

Figure 12. Support Rail Installation





- Orient the chassis such that mounting flanges are in the front of the rack. Install the chassis in the rack. Fasten chassis to the rack with four (4) M6 screws. Torque to 30in-lb.

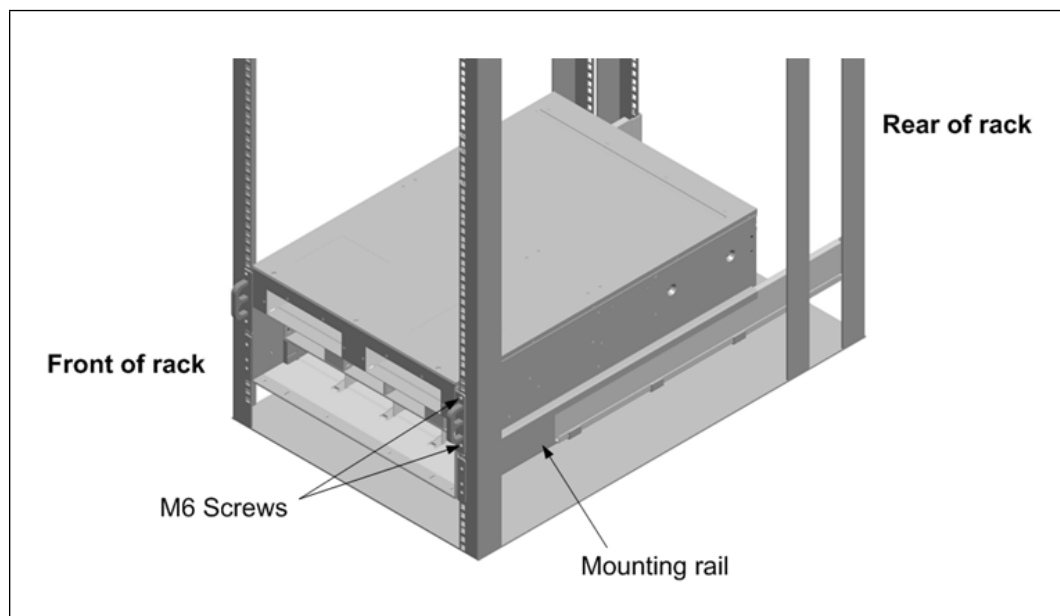
Warning: To avoid injury, use a team of people appropriate to the weight of the product and in conjunction with applicable laws and guidelines.



- 12800-040 weight:
- Fully-loaded: 43kg (95lbs)

- Fasten chassis to the rack with four (4) M6 screws. Torque to 30in-lb.

Figure 13. Rack Installation



- If applicable, replace the door(s) on the rack.

2.5 12800-120 Installation

Note: The mounting kit contains all of the necessary parts for installing and mounting the switch into a 19" 4-post server rack, with a distance between front and rear rack posts ranging from 28" - 33" (711mm - 838mm).

2.5.1 Mounting Hardware Kit Contents:

Note: The mounting kit contains all of the necessary parts for installing and mounting the switch into a 19" 4-post server rack, with a distance between front and rear rack posts ranging from 28" - 33" (711mm - 838mm).

- Support Rails
- HAT Brackets
- C-Brackets
- #8-32 Flat Head Screws

- M6 Mounting Screws
- M6 Clip Nuts

2.5.2 Installation Tasks

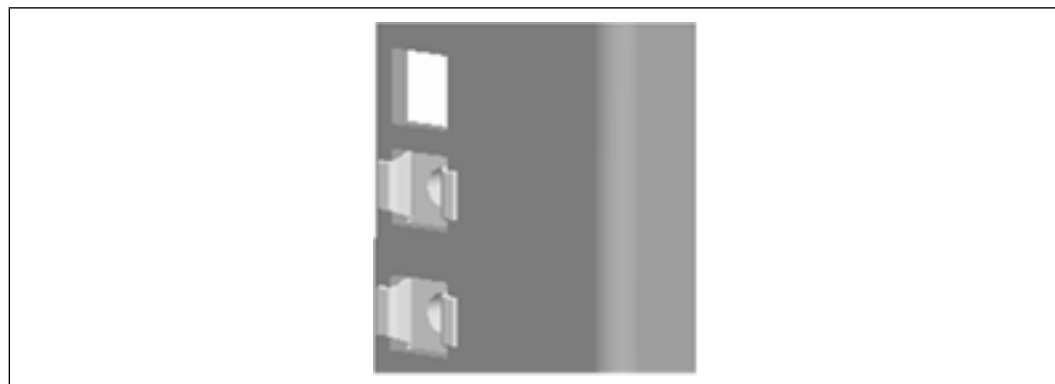
1. If applicable, remove the doors of the rack.
2. Install the clip nuts Install M6 clip nuts in the following locations on EIA rails:

Figure 14. Clip Nut Installation Locations

| | Front of the Rack (left & right rail) | | Rear of the Rack (left & right rail) | |
|--|--|-----------|---|-----------|
| | U# | Position# | U# | Position# |
| | Starting U# | 2 | Starting U# | 2 |
| | Starting U# +1 | 2 | Starting U# +1 | 2 |
| | Starting U# +3 | 2 | Starting U# +3 | 3 |
| | Starting U# +6 | 2 | Starting U# +5 | 1 |
| | | | Starting U# +9 | 1 |
| | | | | |
| | | | | |
| | | | | |
| | | | | |
| | | | | |

For improved stability, orient the clip nuts as shown (i.e., orient the flanges horizontally):

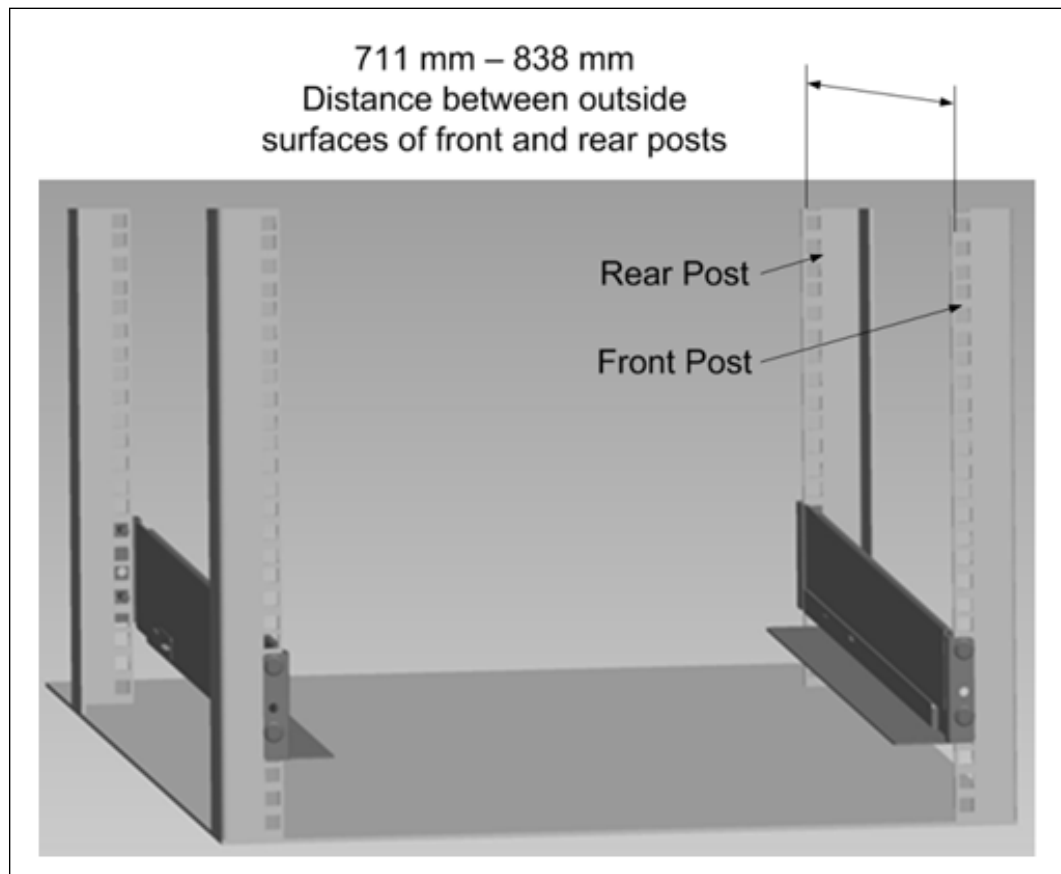
Figure 15. Clip Nut Orientation



Note: It is recommended that 12800-120 be installed into the rack at 5U or 6U location. This locates the chassis approximately 12" from the floor and allows the chassis to be moved onto the support rails by sliding off of the pallet.

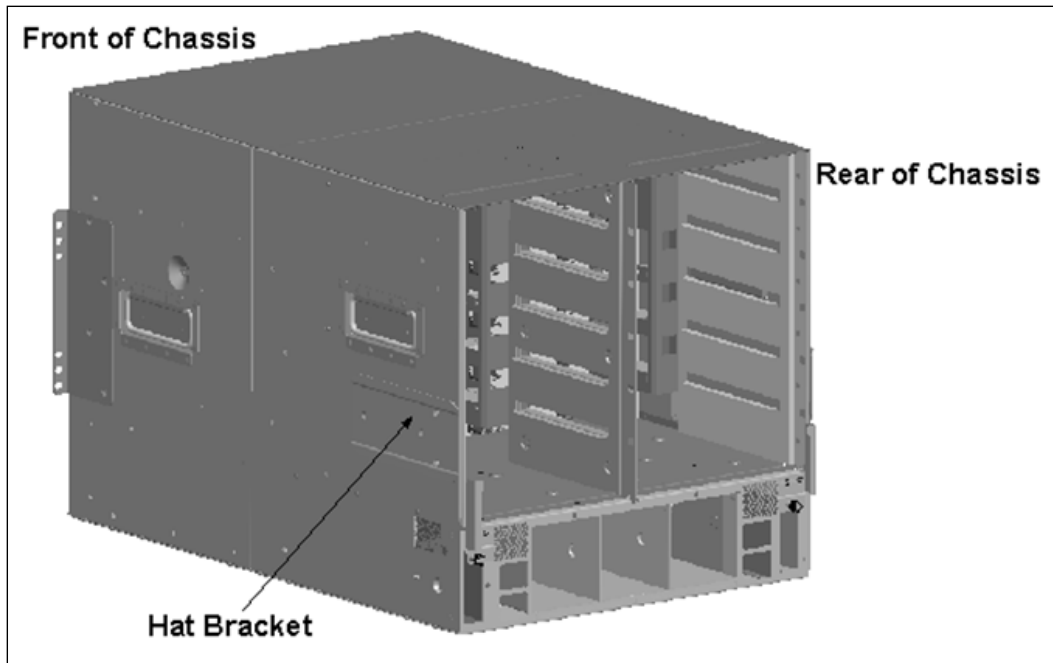
3. Install support rails in the rack. Fasten with two (2) M6 screws per EIA rail to pre-installed clip nuts and torque to 30 in-lb.

Figure 16. Support Rail Installation



4. Install two (2) rear mounting Hat Brackets on the chassis and fasten with #8-32 screws. There are four (4) screws per bracket. Torque to 30in-lb.

Figure 17. Hat Bracket Installation



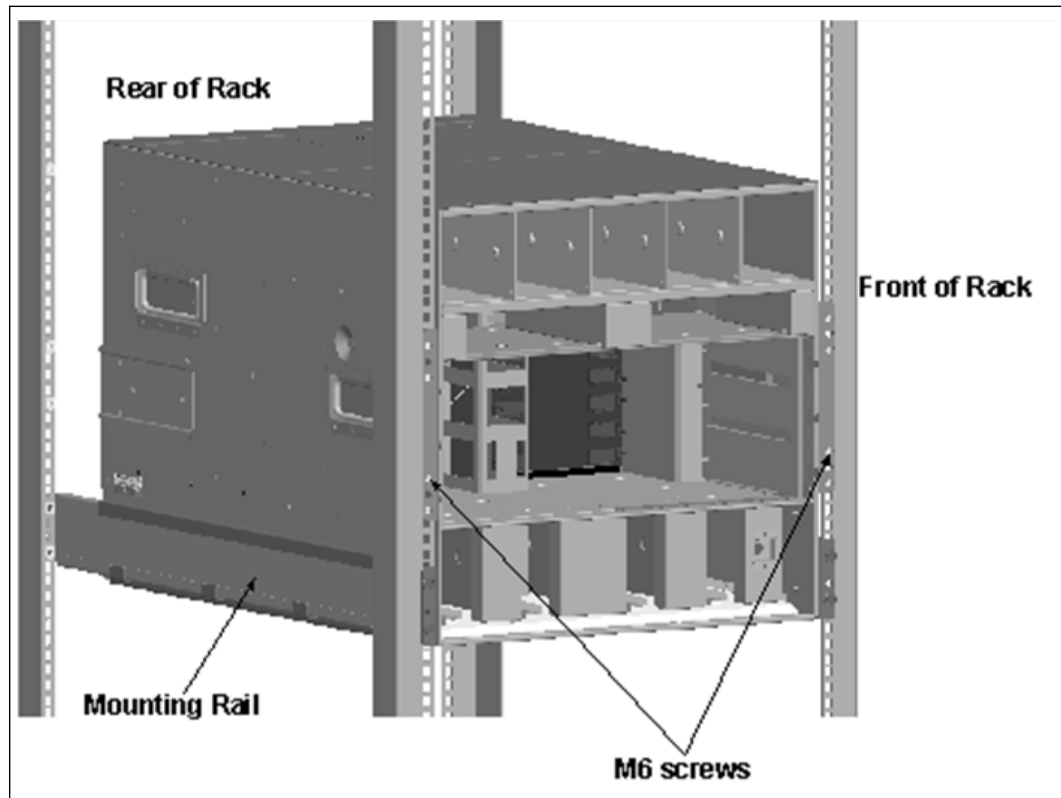
5. Orient the chassis such that mounting flanges are in the front of the rack. Install the chassis in the rack.

Warning: To avoid injury, do not manually lift the chassis when fully loaded. Use a mechanized lift whenever possible. For a manual lift, unload the product FRUs to minimize the weight. Use a team of people appropriate to the weight of the product, and in conjunction with applicable laws and guidelines.



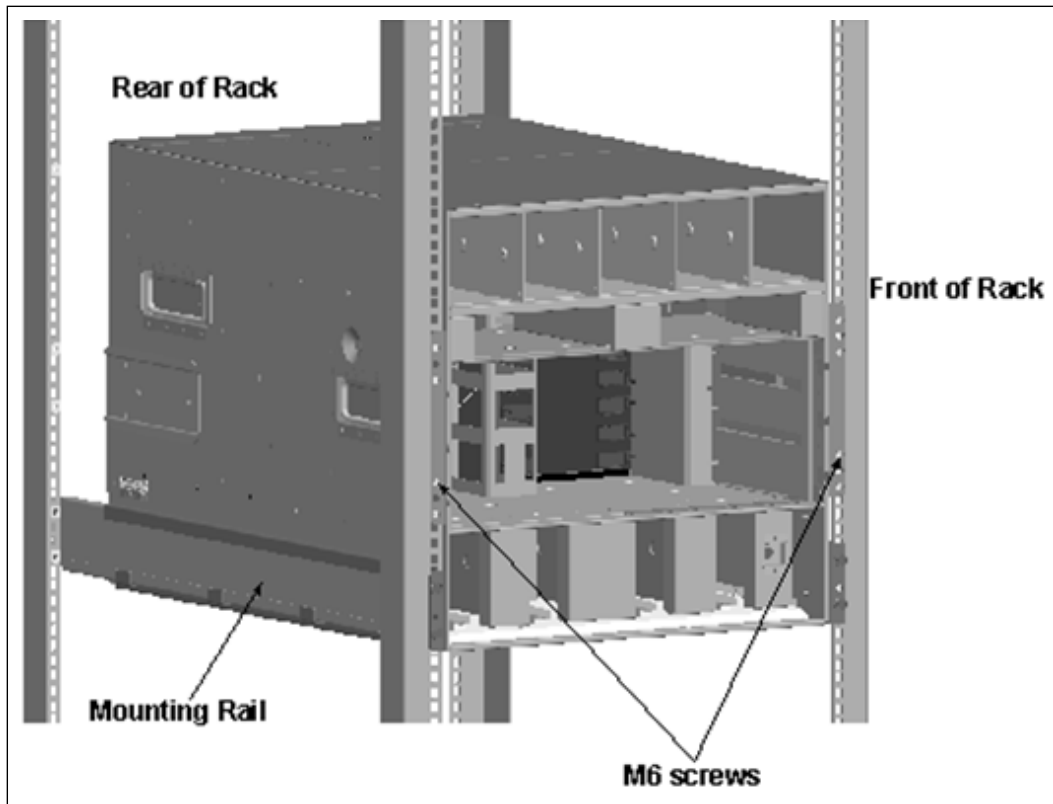
- 12800-120 weights:
- Chassis only: 34kg (74lbs)
 - Fully-loaded: 91kg (199lbs)

Figure 18. Mounting Flange Installation



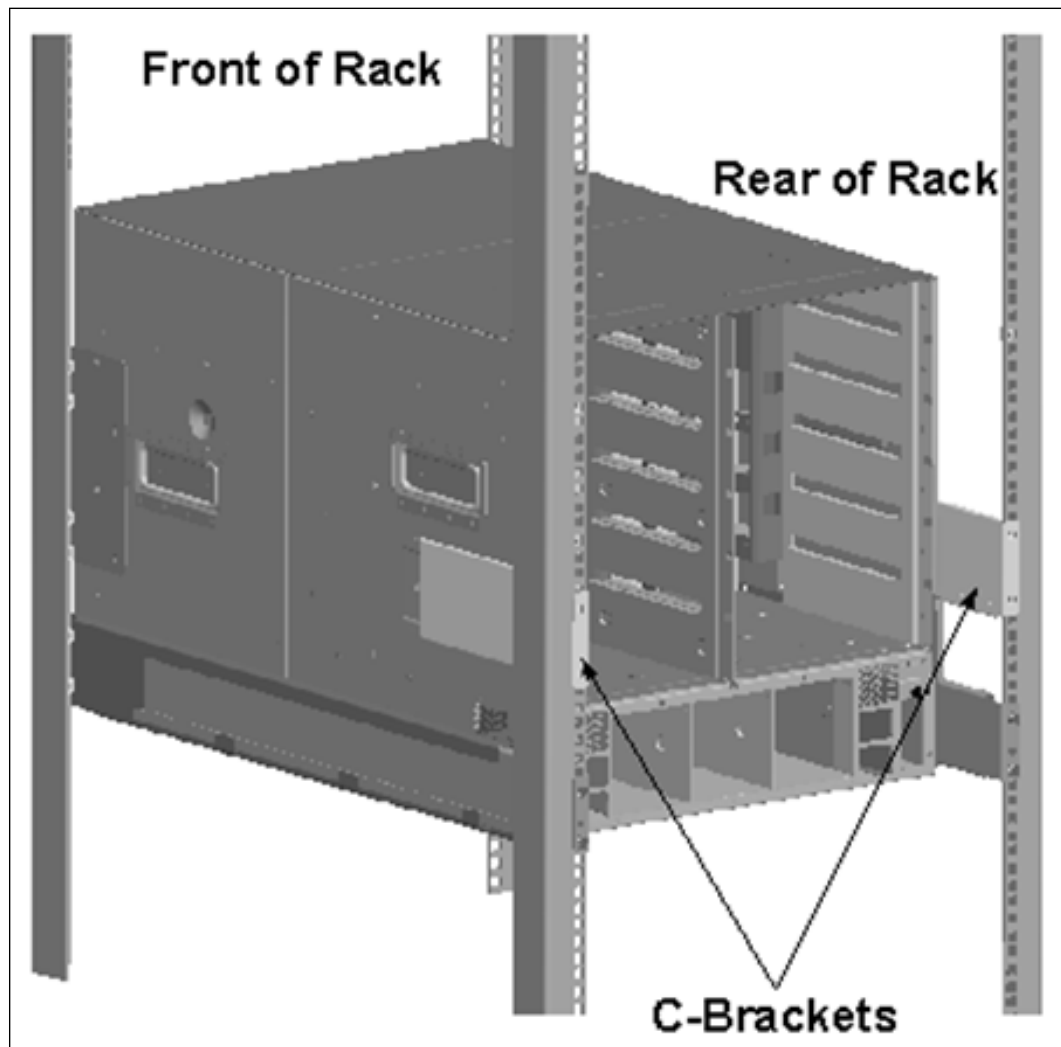
6. Fasten the chassis to the rack with eight (8) M6 screws. Torque to 30in-lb.

Figure 19. Chassis Installation



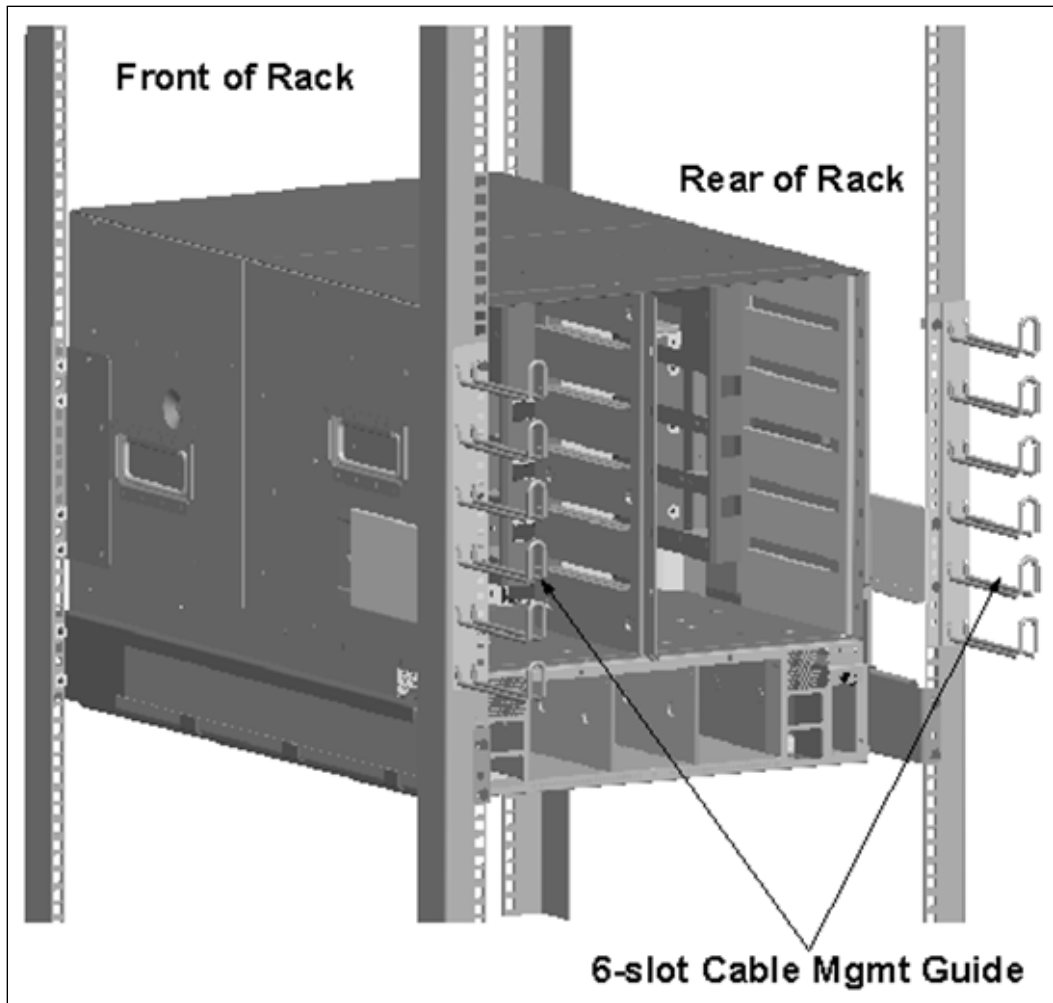
7. Slide two (2) C-brackets over the Hat brackets that are pre-installed on the chassis.

Figure 20. C Bracket Installation



8. If applicable, install the optional cable management guides. Fasten to the EIA rails with M6 screws. Torque all screws to 30in-lb.

Figure 21. Cable Management Installation



9. If applicable, replace the door(s) on the rack.

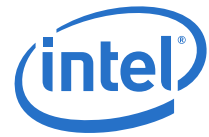
2.6 12800-180 Installation

2.6.1 Mounting Hardware Kit Contents:

Note:

The mounting kit contains all of the necessary parts for installing and mounting the switch into a 19" 4-post server rack, with a distance between front and rear rack posts ranging from 28" - 33" (711mm - 838mm).

- Support Rails
- HAT Brackets
- C-Brackets
- #8-32 Flat Head Screws
- M6 Mounting Screws
- M6 Clip Nuts



2.6.2 Selecting a Rack

The 12800-180 is a large IB switch capable of supporting up to 432 IB ports operating at QDR speed. It is designed for installations in standard-width, 19"-mount server racks (total width of a rack is typically 24"). However, to effectively route and manage such a large number of cables, it is recommended that a wide server rack is used for installation of 12800-180 switches. Wide 19"-mount server racks are typically 30-32" in total width.

2.6.3 Installation Tasks

Note: It is recommended that 12800-180 is installed into the rack at 5U or 6U location. This locates the chassis approximately 12" from the floor and allows the chassis to be moved onto the support rails by sliding off of the pallet.

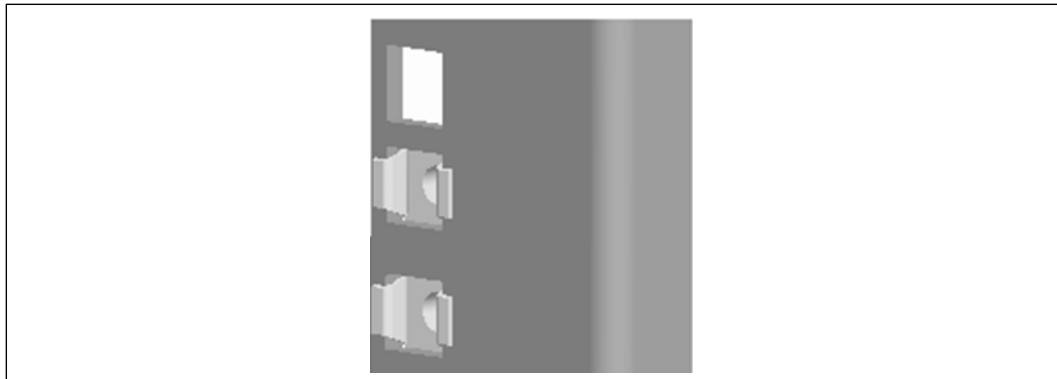
1. If applicable, remove the doors of the rack.
2. Install M6 clip nuts in the following locations on EIA rails for U5 installation. For U6 installation, increment clip nut locations by one U.

Figure 22. Clip Nut Locations

| | Front of the Rack (left & right rail) | | Rear of the Rack (left & right rail) | |
|--|--|-----------|---|-----------|
| | U# | Position# | U# | Position# |
| | U5 | 2 | U5 | 2 |
| | U6 | 2 | U6 | 2 |
| | U10 | 2 | U9 | 1,3 |
| | U12 | 2 | U14 | 2 |
| | U14 | 2 | U15 | 2 |
| | | | U17 | 1,3 |

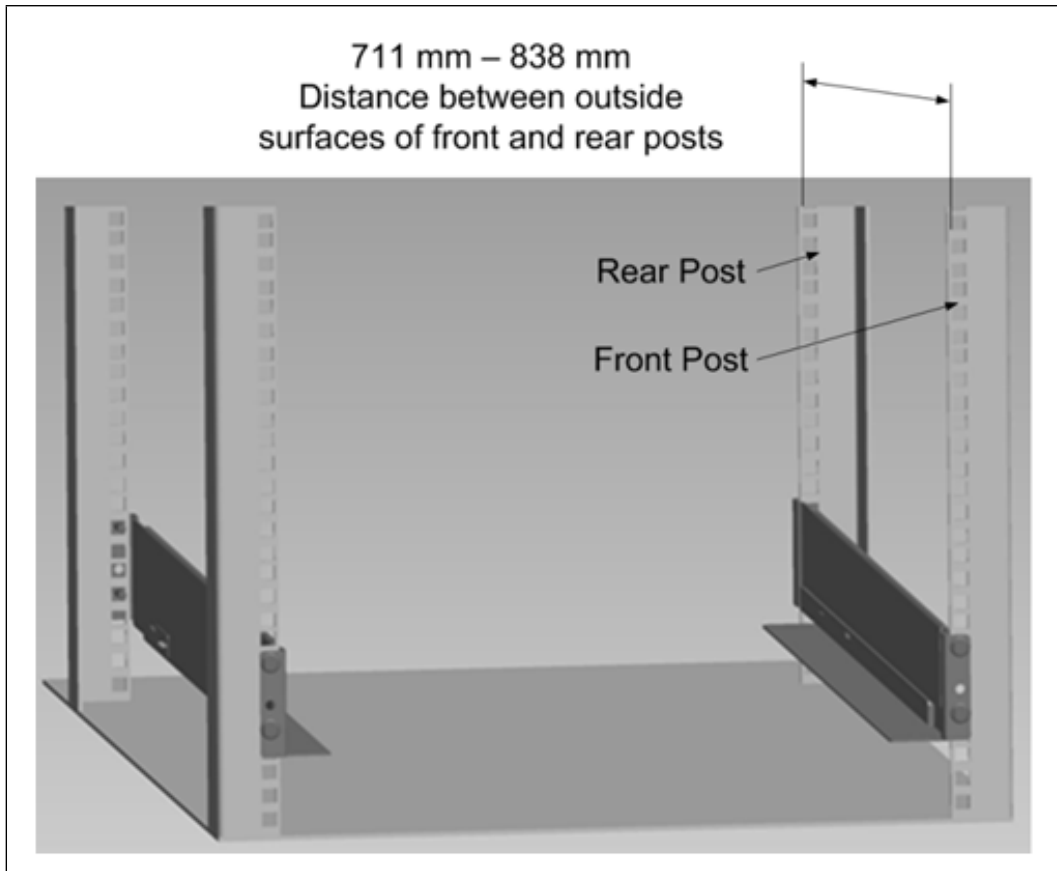
For improved stability, orient the clip nuts as shown (i.e., orient the flanges horizontally):

Figure 23. Clip Nut Orientation

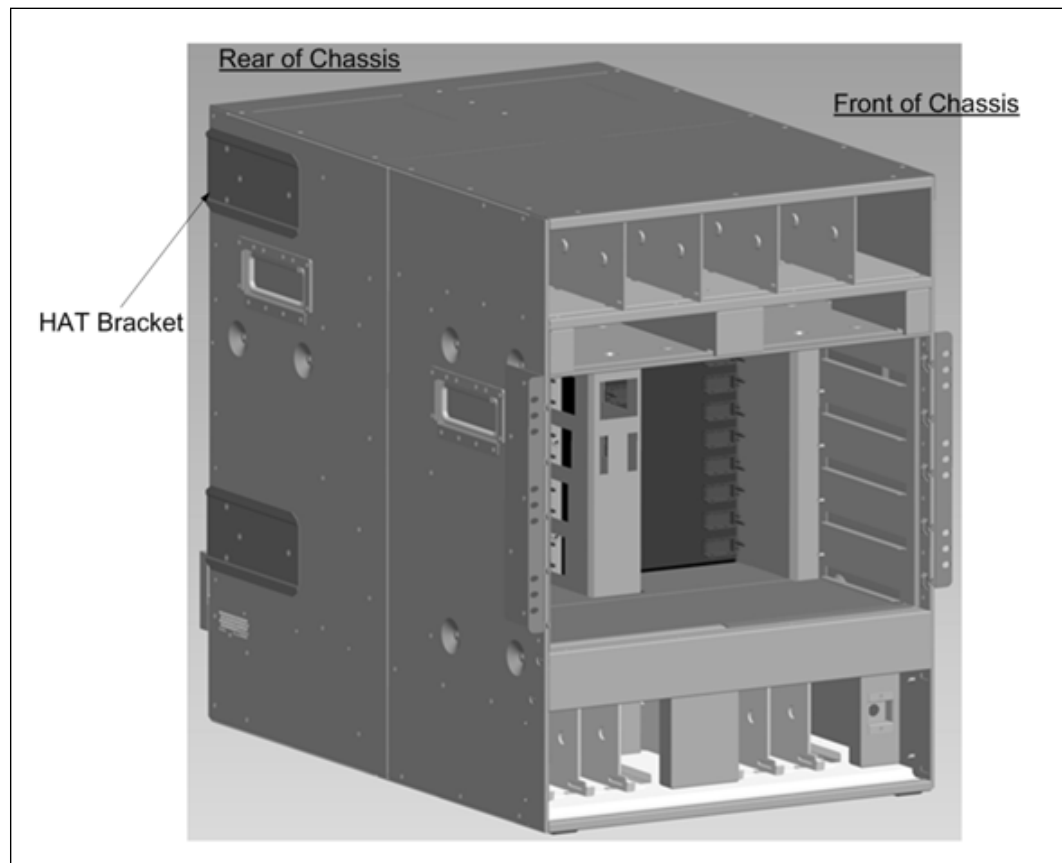


3. Install support rails in the rack. Fasten with two (2) M6 screws per EIA rail to pre-installed clip nuts and torque to 30 in-lb.

Figure 24. Support Rail Installation



4. Install four (4) rear mounting brackets to the chassis and fasten with #8-32 screws. There are four (4) screws per bracket. Torque to 30in-lb.

Figure 25. Flat Bracket Installation


5. Orient the chassis such that mounting flanges are in the front of the rack. Install the chassis in the rack.

Warning:

To avoid injury, when fully loaded do not lift manually. Use a mechanized lift only. If a manual lift is necessary, first unload all field replaceable units (FRUs) to minimize weight. Use a team of people appropriate to the weight of the product and in conjunction with applicable laws and guidelines.

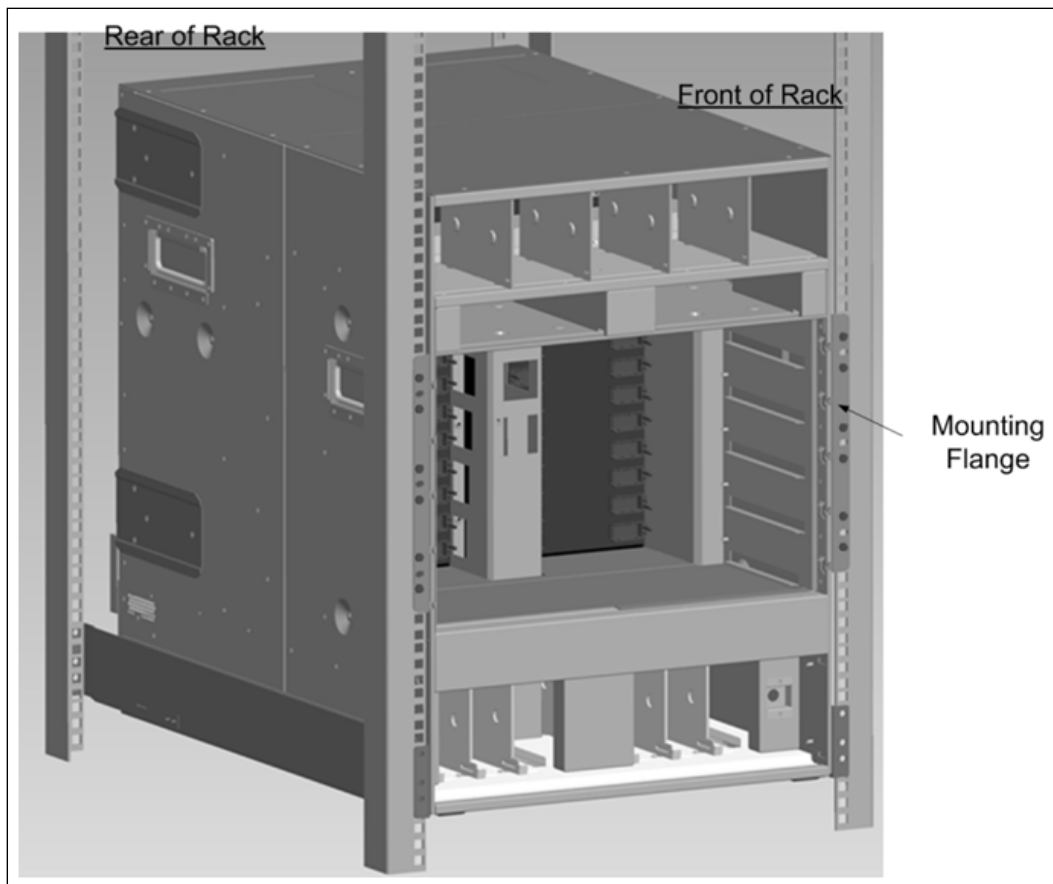


12800-180 weights:

- Chassis only: 45kg (100lbs)
- Fully-loaded: 125kg (270lbs)

6. Fasten the mounting flanges using M6 screws to the clip nuts that are pre-installed in the rack. There are six (6) screws per mounting flange. Torque to 30in-lb.

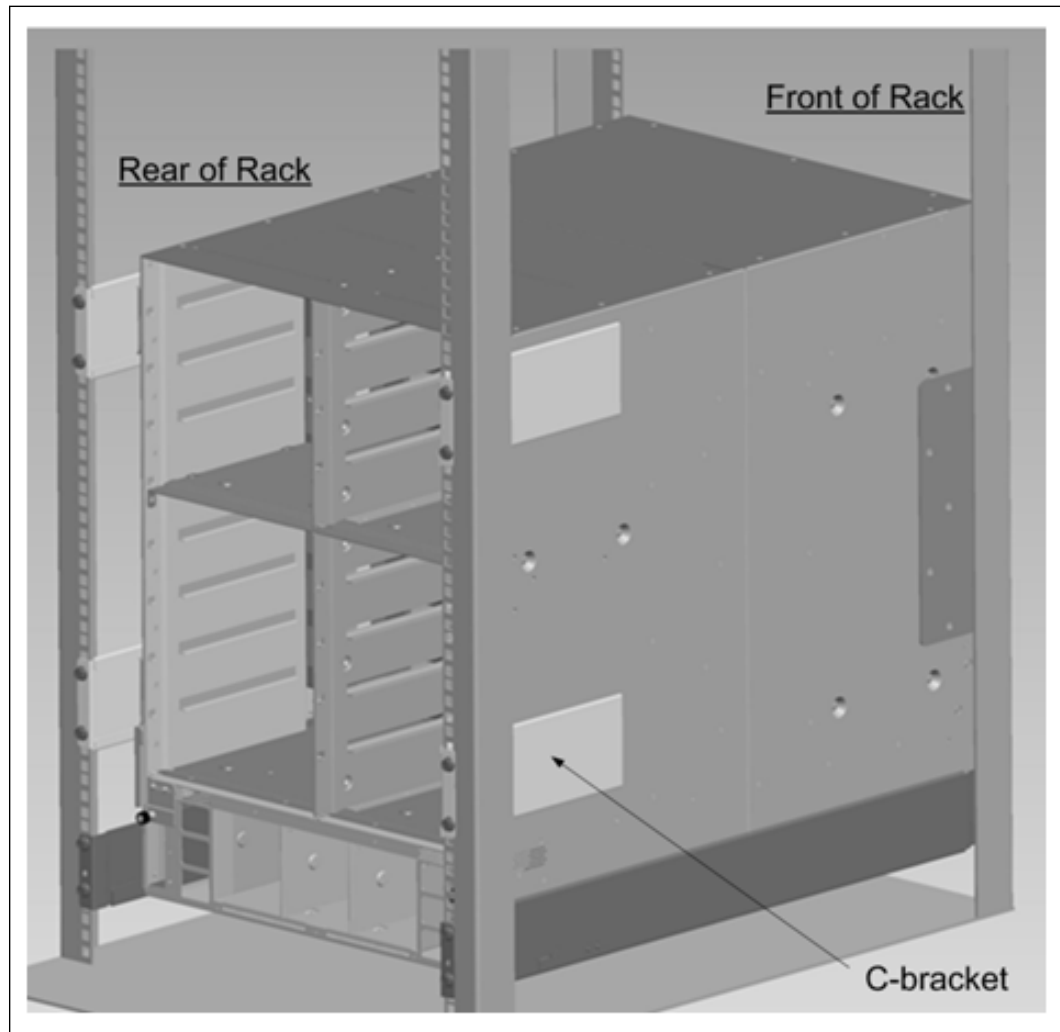
Figure 26. Mounting Flange Installation



7. Slide four (4) C-brackets over the HAT brackets that are pre-installed on the chassis.

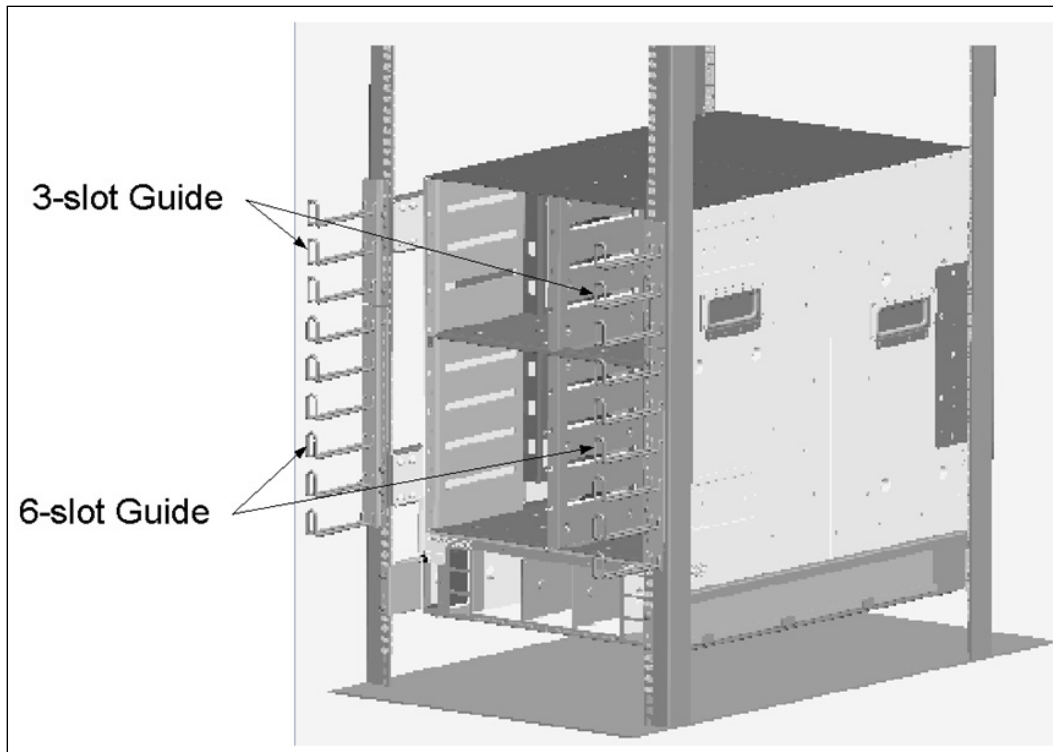


Figure 27. U Bracket Installation



8. If applicable, install the optional cable management guides. Fasten to the EIA rails with M6 screws. Torque all screws to 30in-lb.

Figure 28. Cable Management Guide Installation



9. If applicable, replace the door(s) on the rack.

2.7 12800-360 Installation

2.7.1 Mounting Hardware Kit Contents:

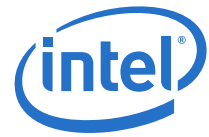
Note:

The following procedures are for installing the switch using variable distances between the front and rear rack posts.

- **Mounting Kit** containing:
 - Support Shelf
 - HAT Brackets
 - C-Brackets
 - #10 Mounting screws
 - M6 Mounting Screws
 - M6 Clip Nuts

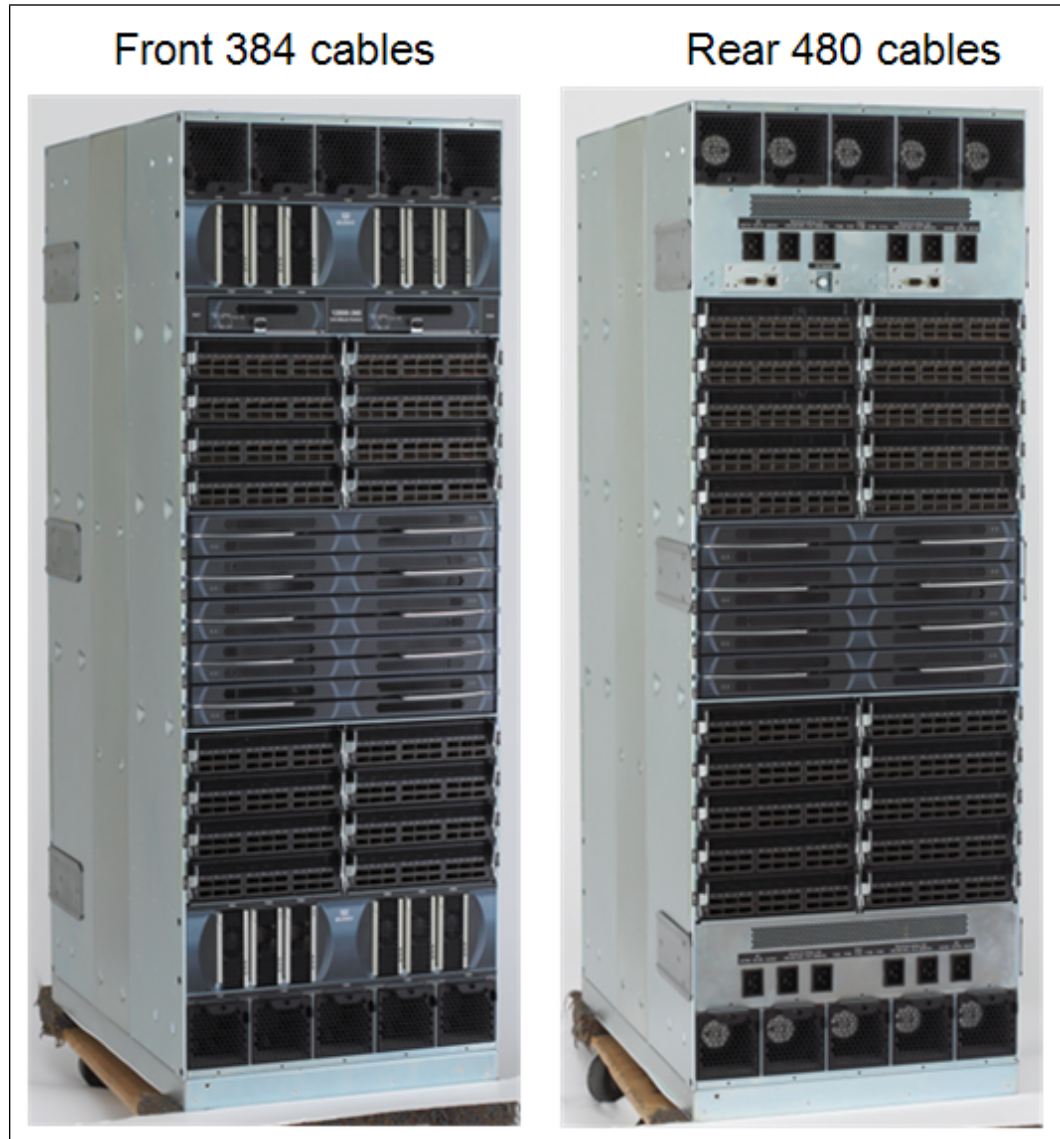
2.7.2 Selecting a Rack

12800-360 is the largest in the 12800-series of switches, capable of supporting up to 864 IB ports operating at QDR speed. To facilitate installation and management of such a large number of cables, the 12800-360 switch was designed with cables in the front and the rear of the chassis. This reduces cable density and improves cable management and accessibility.



To effectively route and manage cables, it is recommended that a wide server rack is used for installation of the 12800-360 switch. These instructions are for installation in a typical wide server rack 797mm wide x 1021mm deep, or similar, with adjustable vertical EIA rails.

Figure 29. 12800-360 Front and Rear Cabling

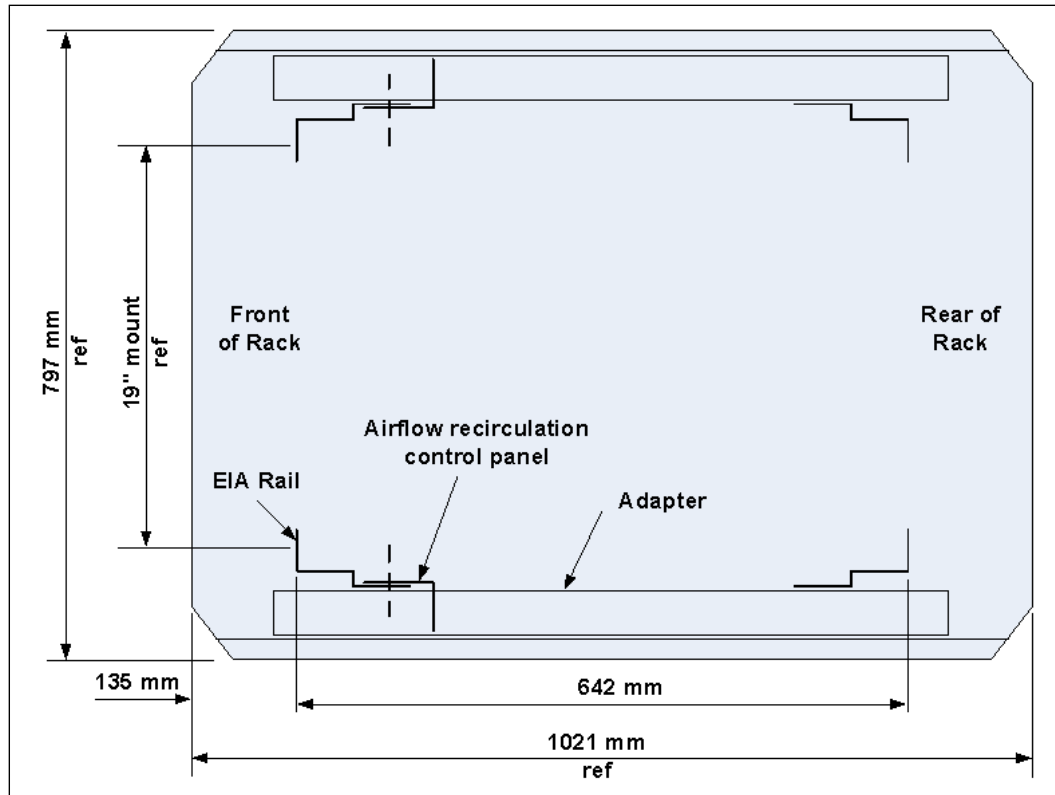


2.7.2.1 Locating Rack Mounting Posts for Front and Back Cable Routing

In a typical rack, front EIA rails are positioned approximately 50mm from the front face of a rack. With a chassis mounted flush with the front rails, space available in the front of the rack is insufficient for cable routing. To allocate enough space in the front of the rack to route 300+ cables, the two front rails should be recessed 135mm from the front of the rack. The rear EIA rails should be positioned such that the distance between mounting surfaces of front and rear EIA rails is 642mm. Additionally, airflow

recirculation control panels should be installed in a rack to minimize airflow recirculation between the hot and cold isles. Recirculation control panels for wide racks and installation instructions are available from rack suppliers.

Figure 30. Locating Mounting Posts



2.7.3 Installation Tasks

Note:

It is recommended that 12800-360 is installed into the rack at 5U or 6U location. This will locate the chassis approximately 12" from the floor and will allow the chassis to be moved onto the support rails by sliding off the pallet.

1. Install clip nuts: If applicable, remove the doors of the rack. Install M6 clip nuts in the following locations on EIA rails for U5 installation. For U6 installation, increment clip nut locations by one U (1.75").

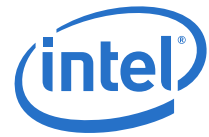
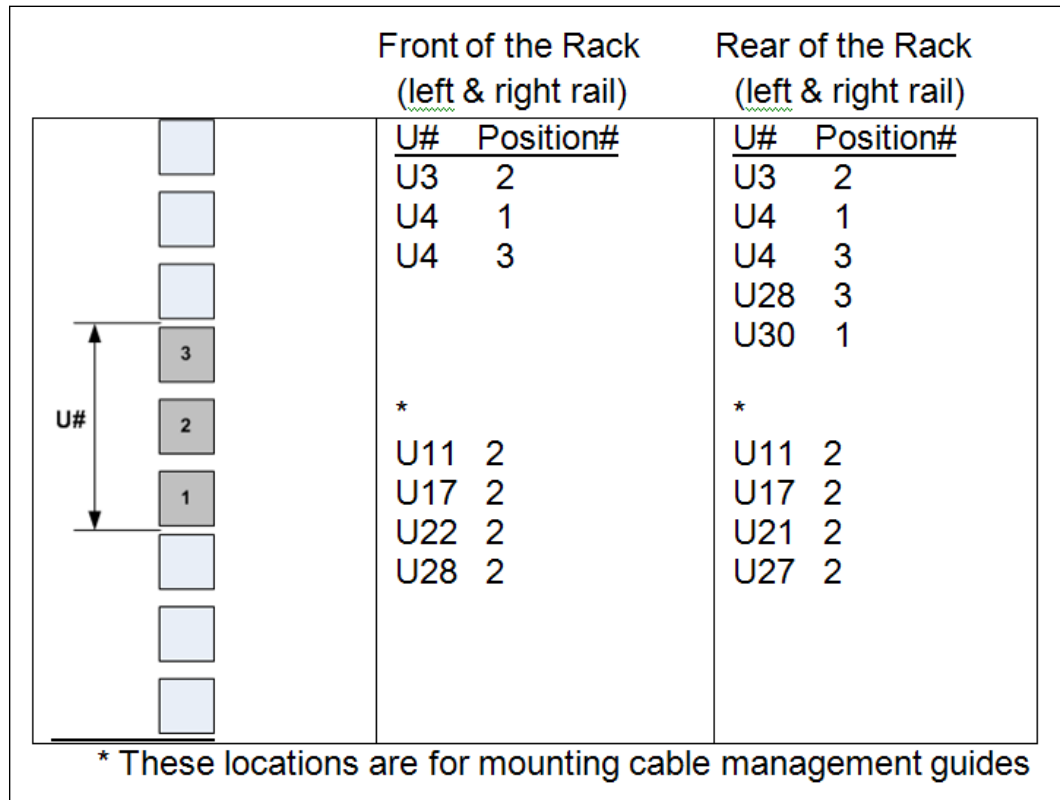
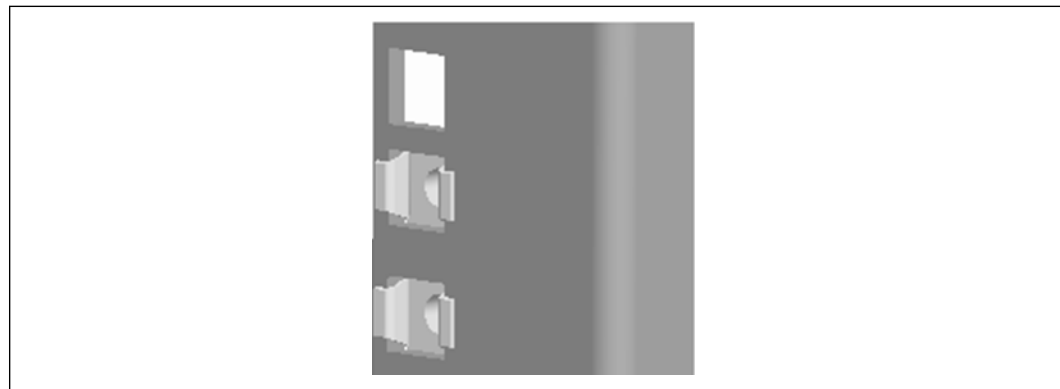


Figure 31. Clip Nut Installation



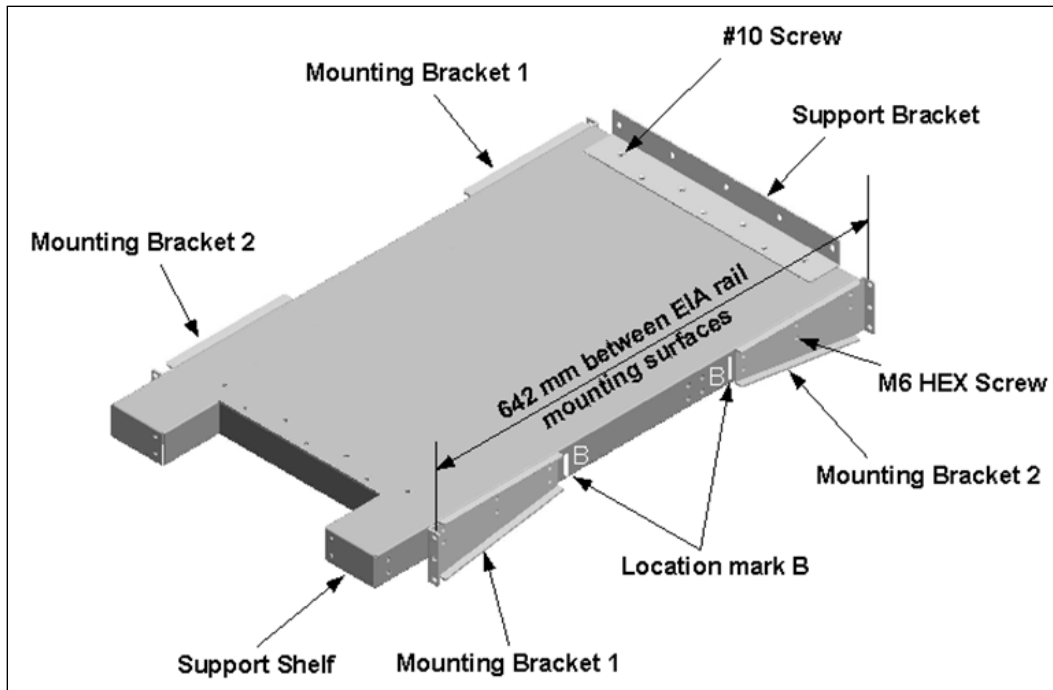
For improved stability, orient the clip nuts as shown (i.e., orient the flanges horizontally):

Figure 32. Clip Nut Orientation



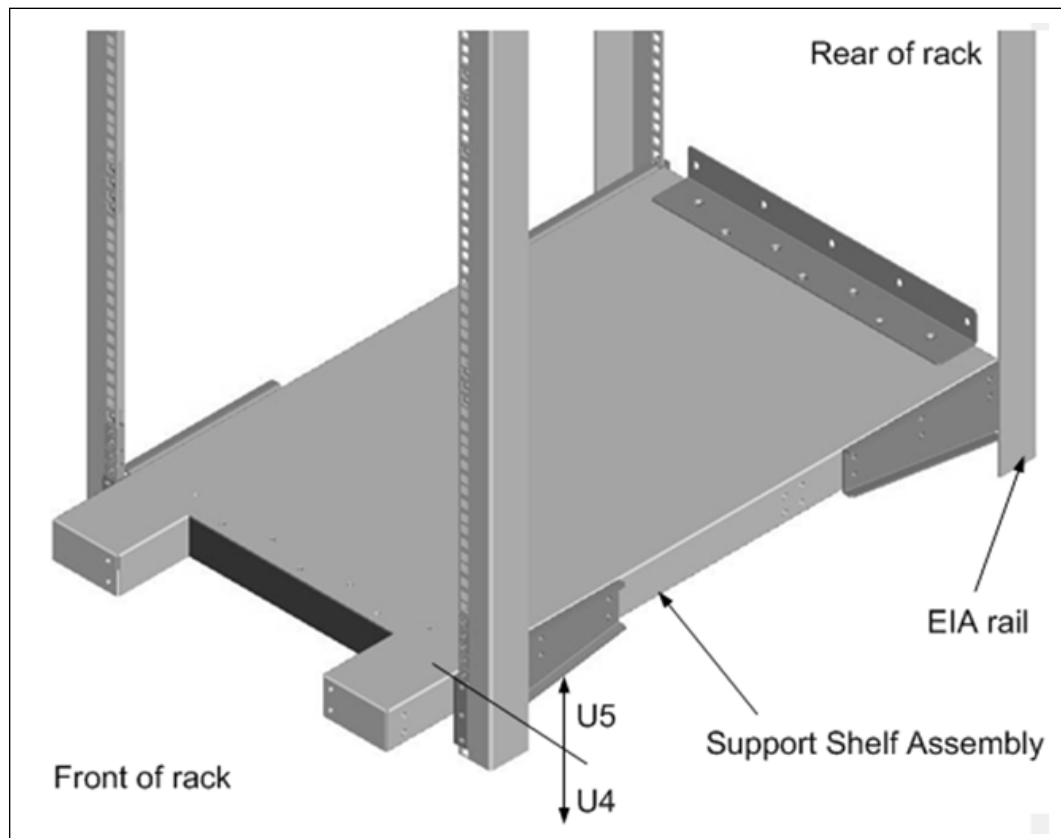
- Attach four (4) mounting brackets to the support shelf as shown in [Figure 33](#). Align the brackets with "B" marks on a support shelf and fasten with six (6) M6 HEX screws per bracket. Use a HEX socket wrench to tighten the screws. Torque the screws to 120in-lb.
- Attach the support bracket to the support shelf and fasten with seven (7) #10-32 flat head screws. Torque screws to 30in-lb.

Figure 33. Support Shelf Assembly



4. Install the support shelf into the rack. Fasten the M6 screws to pre-installed clip nuts and torque to 30 in-lb. There are three (3) screws per mounting bracket.

Figure 34. Attaching the Support Shelf to the Rack



5. Orient and position the chassis for installation in the rack.

Warning:

To avoid injury, when fully loaded do not lift the 12800-260 manually. Use a mechanized lift only. If a manual lift is necessary, first unload all field replaceable units (FRUs) to minimize weight. Use a team of people appropriate to the weight of the product and in conjunction with applicable laws and guidelines.

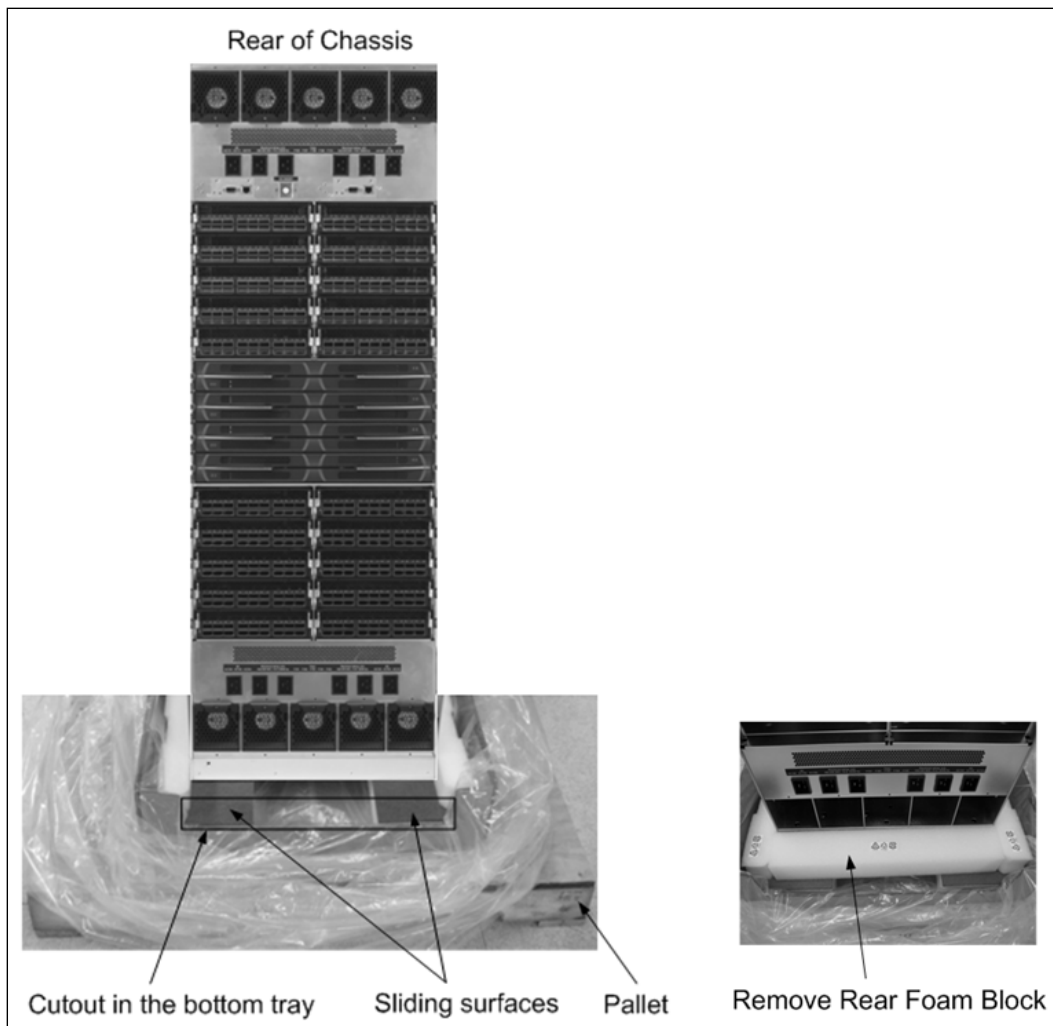


12800-360 weights:

- Chassis only: 90kg (197lbs)
- Fully-loaded: 244kg (535lbs)

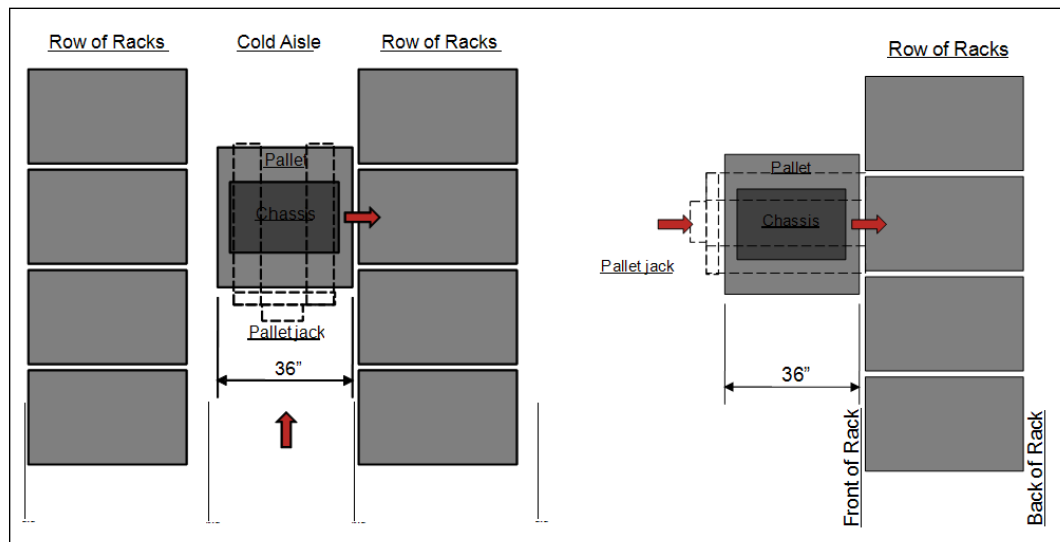
6. Orientation of the chassis on a pallet: The chassis has been packaged on sliding surfaces to facilitate installation in a rack by sliding off of the pallet and on the support shelf. Remove the rear foam block to expose sliding surfaces. The rear of the chassis is oriented towards a cutout in the bottom tray.

Figure 35. Loading from the Pallet



7. Position the chassis on front on the rack. Use pallet jack to move the chassis. Orient the chassis on a pallet in front of the rack as shown. Chassis rear should be facing front of the rack. For installations in racks arranged in rows, distance between adjacent rows of racks (width on a cold isle) should be greater than 36" to be able to move the chassis on a pallet through a cold isle.

Figure 36. Positioning the Switch



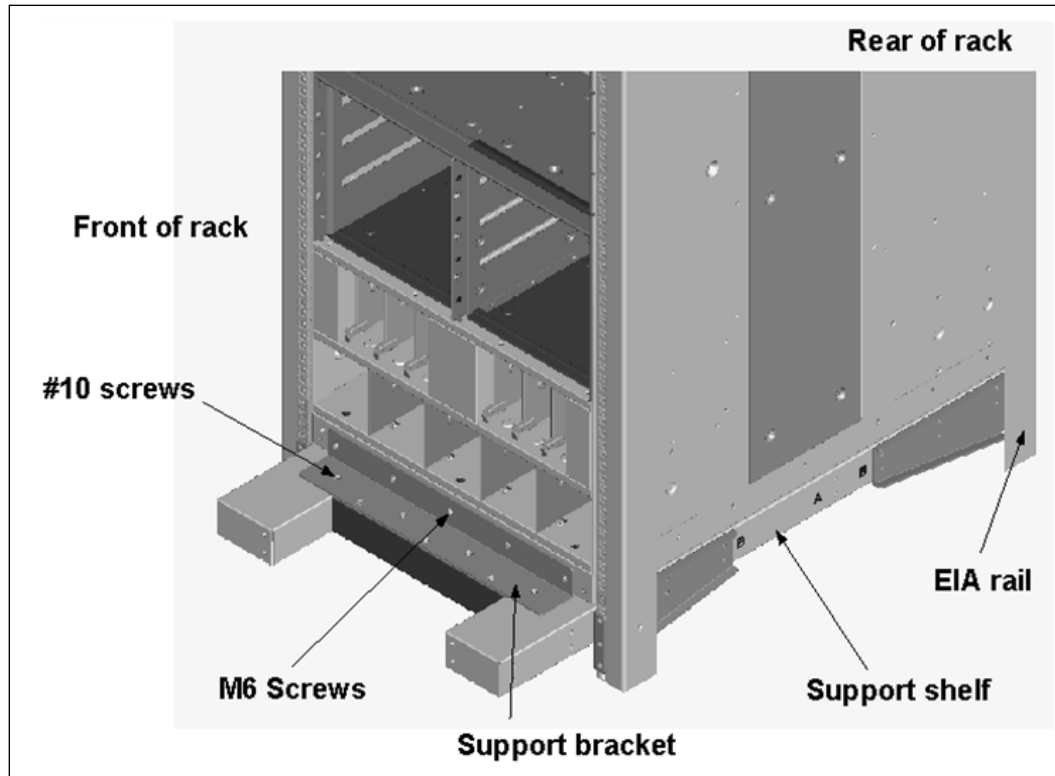
- Installing the chassis in the rack: Align the chassis with the rack. Raise the chassis using a pallet jack such that the bottom of the chassis is at or slightly higher than the top surface of the support shelf pre-installed in the rack. Lock the pallet jack wheels. Use a group of people to push the chassis from the front to slide it off the pallet and on the support shelf. The chassis should be inserted into the rack until the rear of the chassis base is against the rear support bracket.

Figure 37. Sliding the Switch off the Pallet



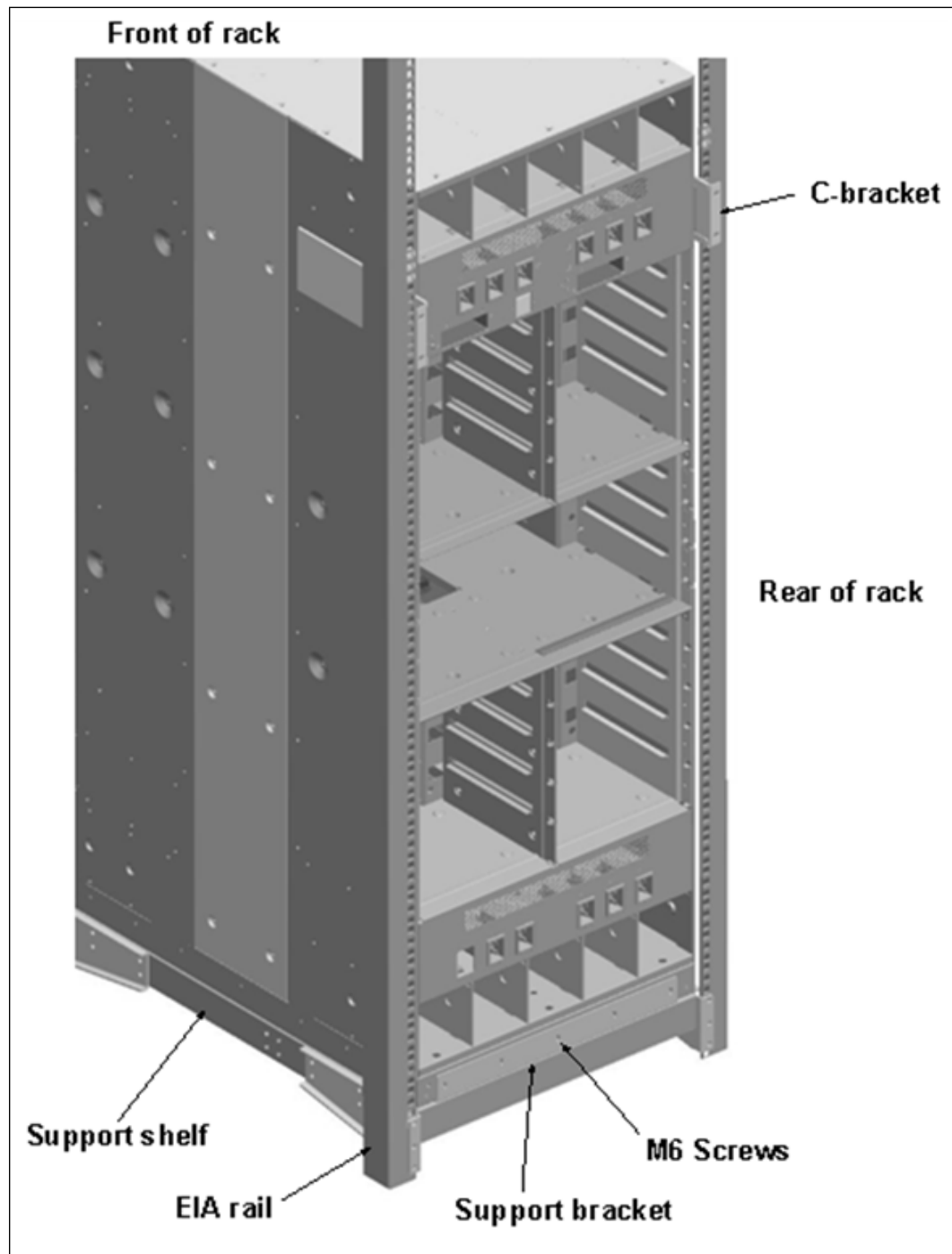
9. Fasten the front of the chassis to the rack by installing the front support bracket and fasten to the base of the chassis with five (5) M6 screws. Fasten to the support shelf with seven (7) #10-32 screws. Torque to 30 in-lb.

Figure 38. Fasten the Chassis to the Front of the Rack



10. Fasten the rear of the chassis to the rack: Fasten the rear support bracket to the base of the chassis with five (5) M6 screws. Torque to 30 in-lb.
11. Install two (2) C-brackets by sliding over the H-brackets that are pre-installed on the chassis.

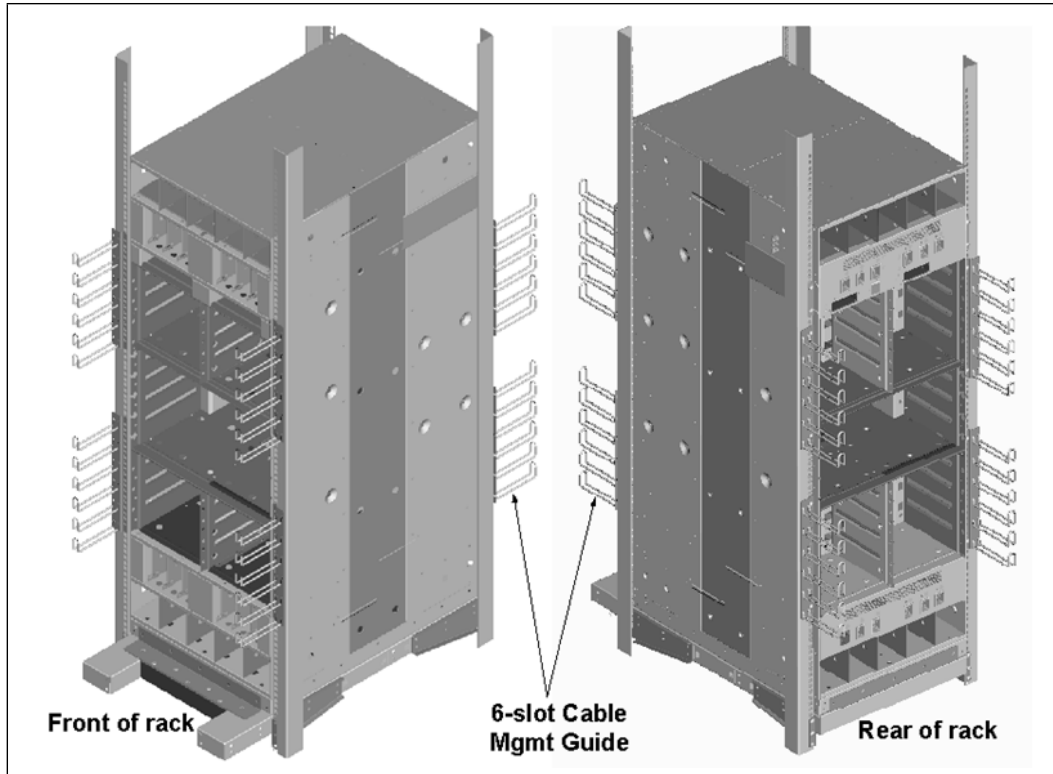
Figure 39. Fasten the Chassis to the Back of the Rack



12. Attach the cable management guides.
If applicable, attach the cable management guides to the front and rear EIA mounting rails, and fasten with M6 screws to the pre-installed clip nuts. The guides should be installed such that the wire frame supports line up with the chassis leaf

module slots. There are four (4) guides in the front of a rack and four (4) in the rear of a rack.

Figure 40. Attaching Cable Management Guides



13. If applicable, replace the door(s) on the rack.

2.8 Connect Equipment to the Ports and Power On the System

Note:

Before connecting equipment, it is important to understand the locations of the serial and Ethernet ports on the 12200, 12300 and 12800 series. For the 12200 and 12300, these are located on the switch 1B port side. For the 12800 series, these are located on the serial, Ethernet, Chassis EEPROM Board (SEEB). Each SEEB communicates with a Management Module (MM) on the opposite side of a 12800 chassis.

Figure 41. 12200 and 12300 Serial and Ethernet Ports

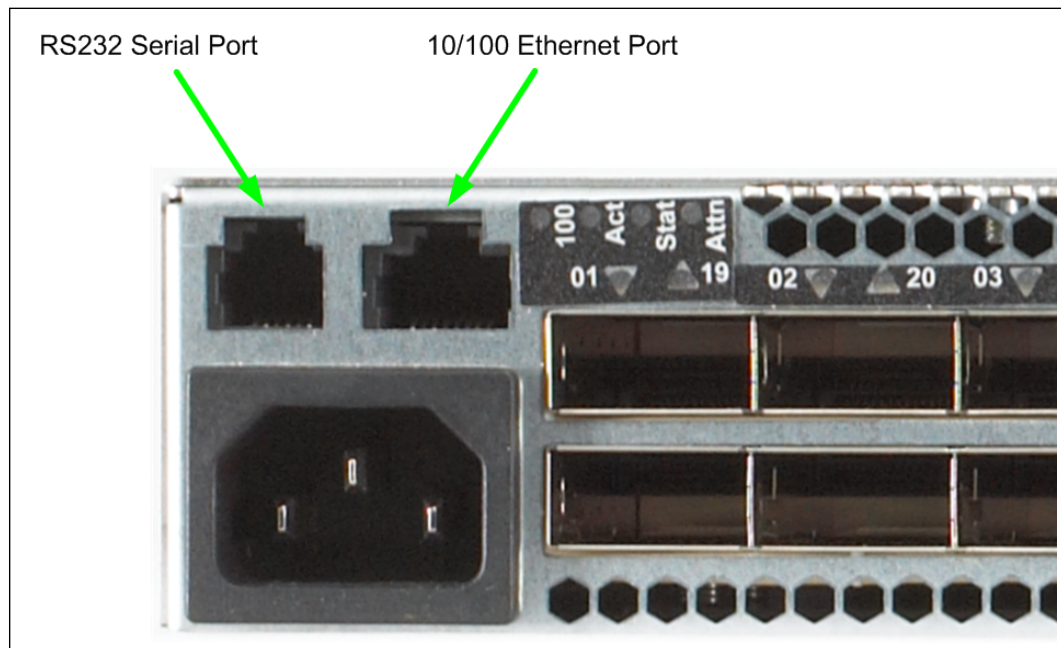
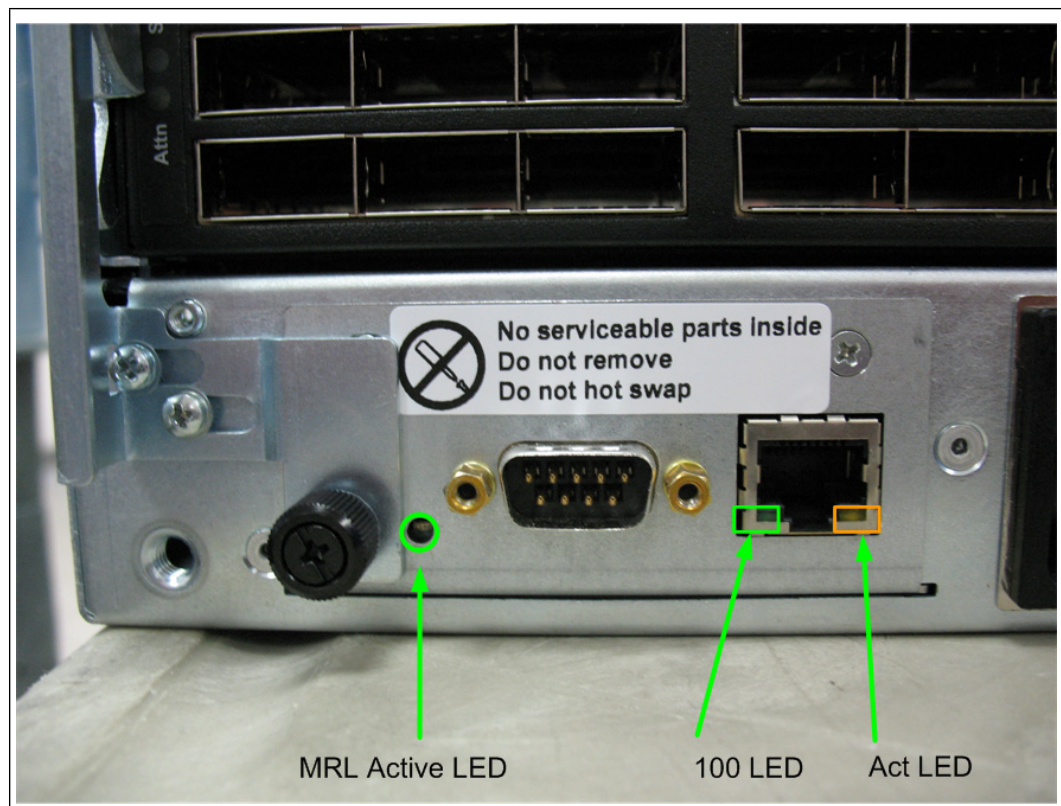


Figure 42. 12800 Series Serial and Ethernet Ports (SEEB Module)





1. Connect a Category 5 or 6 (Cat 5/6) Ethernet cable to the RJ-45 connector(s) on the switch. Connect the other end of the Cat 5/6 to an OOB LAN workstation, another switch or a hub.
2. Connect the switch to IB-enabled host(s)/switch(es) using QDR QSFP IB cables, or to DDR host(s)/switch(es) using a QSFP-CX4 cable.

Note: Make sure all cables latch securely into the corresponding port connectors. If the IB cable connector is not properly oriented to fit onto the port receptacle (i.e., while attempting to insert the cable in the port), do not twist the connector to achieve the correct orientation. Instead, reach back a few feet on the cable, and twist the bulk cable to allow the connector to rotate to the proper orientation. Doing this prevents all of the rotational forces from acting right at the connector terminations.

Caution: It is important to provide strain relief for the IB cable connector.

2.8.0.1 Connecting Power

Note: For each power supply installed, a power cord must be installed in corresponding power inlet.

1. Provide strain relief for the power cable(s).
2. If necessary, replace the fascia(s) over the switch fans.
3. Connect the power cables to a power distribution unit (PDU) or a proper AC power outlet.
4. When the switch is plugged into an AC power outlet:
 - a. The system powers up.
 - b. The fans start.
 - c. The system performs a power-on self test.

Note: For the 12800 switches, make certain the DC ON/OFF switch is illuminated. If it is not, press the button to supply power. The switch is located:

- 12800-360: Next to the AC power inlets on the top of the chassis.
- 12800-040: Next to the AC power inlets.
- 12800-180 and 12800-120: Next to the power supplies. If applicable, the user needs to remove the fascia covering the supplies to access the DC ON/OFF switch.

Figure 43. DC ON/OFF Switch



5. The switch, power supply, and fan LEDs light up.

2.9 Bringing Up the System For the First Time

2.9.1 12800-Series Management Module Protective Label Guidelines

A management module installed in a 12800 system may have a protective label installed, as shown in [Figure 44](#). This label protects the mechanical release latch (MRL) switch inside the management module from shock and vibration during shipping.

Figure 44. MRL Protective Label 1



2.9.1.1 Staging Area Testing

If a MM requires testing prior to final installation at an end-user site (for example, testing at a staging area), do the following:

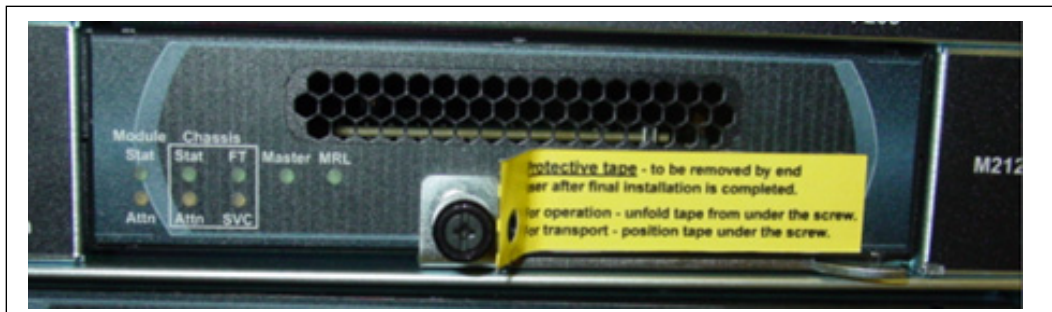
1. Disengage the thumb screw and partially rotate the lever as shown in [Figure 45](#).

Figure 45. MRL Protective Label 2



2. Fold back the label from the thumb screw hole. Re-engage the lever and tighten the thumb screw as shown in [Figure 46](#).

Figure 46. MRL Protective Label 3



3. After testing is complete at the staging area, reverse Steps 1 and 2 to prepare the system for shipment to the end-user site (see [Figure 47](#)).

Figure 47. MRL Protective Label 4



2.9.1.2 User Site Installation

After final installation of a 12800-series switch is completed at the end user site:

1. Disengage the thumb screw and partially rotate the lever as shown in [Figure 48](#).

Figure 48. MRL Protective Label 5



2. Peel off the protective label. Re-engage the lever and tighten the thumb screw as shown in [Figure 49](#).

Figure 49. MRL Protective Label 6



2.9.2 Start-up Procedures

1. Power up the switch.
2. From its flash image on the management module, the switch begins its boot process.

Note:

If the DB9 port of the SEEB or the RS232 port on the 12200/12300 is connected to a terminal emulation program, the user will be able to view the switch boot process. Be certain to use a null-modem/crossover serial cable for the console port. For users assembling their own cable, refer to Appendix C for serial port pinout information. The settings for the terminal emulation device should be:

- 8 data bits
- no parity bits
- 1 stop bit
- 57.6K baud
- Use VT100 emulation.



- Flow control = XON/XOFF
3. Verify the IP address with the CLI command `showChassisIpAddr` command. The system returns information similar to the following:
Chassis IP Address: 192.168.100.9 Net mask: 255.255.240.0

2.9.3 Changing the Switch IP Address and Default Gateway through the CLI

The CLI can be accessed two ways:

- using the switch serial port:
 - 12200 (with optional management module) and 12300: connects through the RS-232 serial port
 - 12800 series: connects through the SEEB DB-9 port
- through Ethernet, using Telnet or SSH

Note: If using a serial port with a 12800-series switch, make certain to connect to the SEEB serial port associated with the Management Module (MM) on the opposite side of the chassis.

2.9.3.1 Using the Serial Connection

1. When a serial port connection is established, the user will see a prompt. To change the chassis IP address type:
`setChassisIpAddr -h <ipaddress> -m <netMask>`
where `-h <ipaddress>` is the new IP address in dotted decimal format (that is, `xxx.xxx.xxx.xxx`), and `-m <netMask>` is the new subnet mask in dotted decimal format.
2. To change the switch default gateway IP address type:
`setDefaultRoute -h <ipaddress>`
where `-h <ipaddress>` is the new default gateway IP address in dotted decimal format.
3. The changes are effective immediately.

2.9.3.2 Using Ethernet

1. Access the switch with one of the following commands using the default IP address:
Telnet: `telnet 192.168.100.9`
SSH: `ssh 192.168.100.9`
2. The system prompts for a user name. In order to change the IP address and default gateway, the user must be logged in as the administrator. At the prompt type `admin` and press ENTER.
3. The system prompts for a password. At the prompt type `adminpass` and press ENTER. The system responds with:
Welcome to the <SWITCH> CLI. Type 'list' for the list of commands.
4. To change the switch IP address type:
`setChassisIpAddr -h <ipaddress> -m <netMask>`
where `-h <ipaddress>` is the new IP address in dotted decimal format (that is, `xxx.xxx.xxx.xxx`), and `-m <netMask>` is the new subnet mask in dotted decimal format.
5. To change the switch default gateway IP address type:



```
setDefaultRoute -h <ipaddress>
```

where `-h <ipaddress>` is the new default gateway IP address in dotted decimal format.

6. The changes are effective immediately.

2.9.4 Updating the Management Module IP Addresses in a Redundant Management Configuration (12800-040, 12800-120, 12800-180 and 12800-360)

Each management module must have a unique IP address that is different than the chassis IP address of the switch. A redundantly-managed switch will have multiple, unique IP addresses. The default IP addresses are:

12800-040:

- Chassis: 192.168.100.9
- Management Module 201: 192.168.100.10
- Management Module 202: 192.168.100.11

12800-120:

- Chassis: 192.168.100.9
- Management Module 207: 192.168.100.10
- Management Module 208: 192.168.100.11

12800-180:

- Chassis: 192.168.100.9
- Management Module 211: 192.168.100.10
- Management Module 212: 192.168.100.11

12800-360:

- Chassis: 192.168.100.9
- Management Module 227: 192.168.100.10
- Management Module 228: 192.168.100.11

It is necessary for each management module to have a unique IP address for the following reasons:

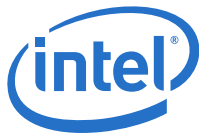
- Unique IP addresses are used when sending syslog messages from a management module to a syslog server.
- Gives the user the ability to ping each management module separately.
- If the IP addresses are not unique, collisions occur, causing IP operations to fail.

To update the IP address on a management module, do the following:

1. Ensure that the module is connected to a COM port on a serial terminal device through the RS-232 port (12200/12300) or DB-9 port (12800 series).
2. Get to a `[boot]` prompt by following either Step a or b.
 - a. If the management module is running and displays the `->` prompt, type the following command at the console:


```
reboot now
```

 and press ENTER.
 - b. If the module is not running, power on the switch.



3. When the system displays `image1` or `image2`, press the SPACEBAR to interrupt the auto load sequence before the counter expires (within 5 seconds).
4. At the `[boot]:` prompt type the following:
`moduleip <NEW IP ADDRESS>`
and press ENTER.

Note: For versions previous to 5.0.2, use the command `spineip`.

Note: The `moduleip` command changes the IP address for `image1` and `image2` on each module.

5. At the `[boot]:` prompt type `reboot`, and press ENTER. Following the reboot, the IP address is changed. Repeat these steps for the second management module.

2.9.5 Enabling 8X Ports

Users can enable 8X (10Gbps) ports by combining two (2) 4X ports together (also known as a "DUO"). The first port in a DUO is known as the master port; the second port is the partner or slave port. The following CLI commands can enable 8x ports:

- `ismPortSetWidth`: sets the supported link width for an individual IB port.
- `ismChassisSetWidth`: sets the supported link width for all chassis IB ports.
- `ismIslSetWidth`: sets the supported link width for all ISL IB ports. This command is only available 12800-series switches.

Note: This section focuses on enabling 8x external cable ports. For details on each command, refer the *Intel® True Scale 12000 CLI Reference Guide*.

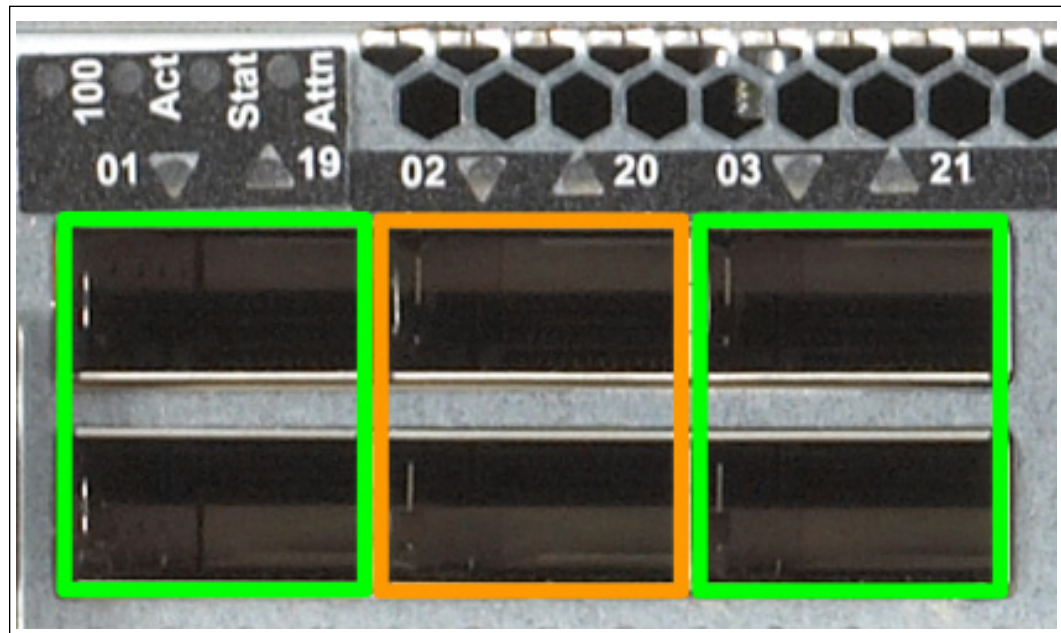
2.9.5.1 Creating an 8x Port: 12200/12300

Note: This section focuses on enabling 8x ports for 12200/12300 switches with an installed management card. For information on creating an 8x port on an externally-managed 12200, see ["Creating an 8x Port: Externally-managed 12200" on page 57](#)

For the 12200 and 12300 switches, 8x DUOs are set up by combining the 4X port on the bottom row with the 4X port directly above it (for example, port 1 with port 19, port 2, port 3 with port 21, etc.):



Figure 50. 12200/12300 8x DUOs



For example, to combine ports 2 and 20:

1. Log into the switch CLI with the login `admin` and password `adminpass`.
2. Enable port 2 with a command similar to:

```
ismPortSetWidth Cable02 7 -bounce
and press ENTER.
```

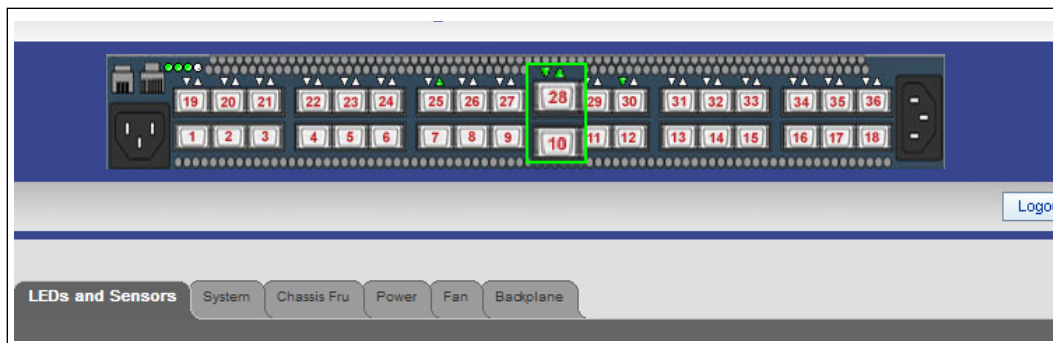
3. Enable port 20 using same command as above, changing the port number (that is, `ismPortSetWidth Cable20 7 -bounce`).
4. At the switch, unplug and reinsert the cables to the physical ports. After reinserting the first cable, the user has four (4) seconds to reinsert the second cable associated with the 8x connection before the link begins training.

Note:

For proper 8x functionality, it is required that both QSFP cables for a DUO are from the same manufacturer, and are the same length.

5. After reinserting the cables, bring up Chassis Viewer by entering the active IP address into your browser address box. The 8X ports are displayed as shown in [Figure 51](#) where both ports of the DUO have LEDs on (that is, they are green).

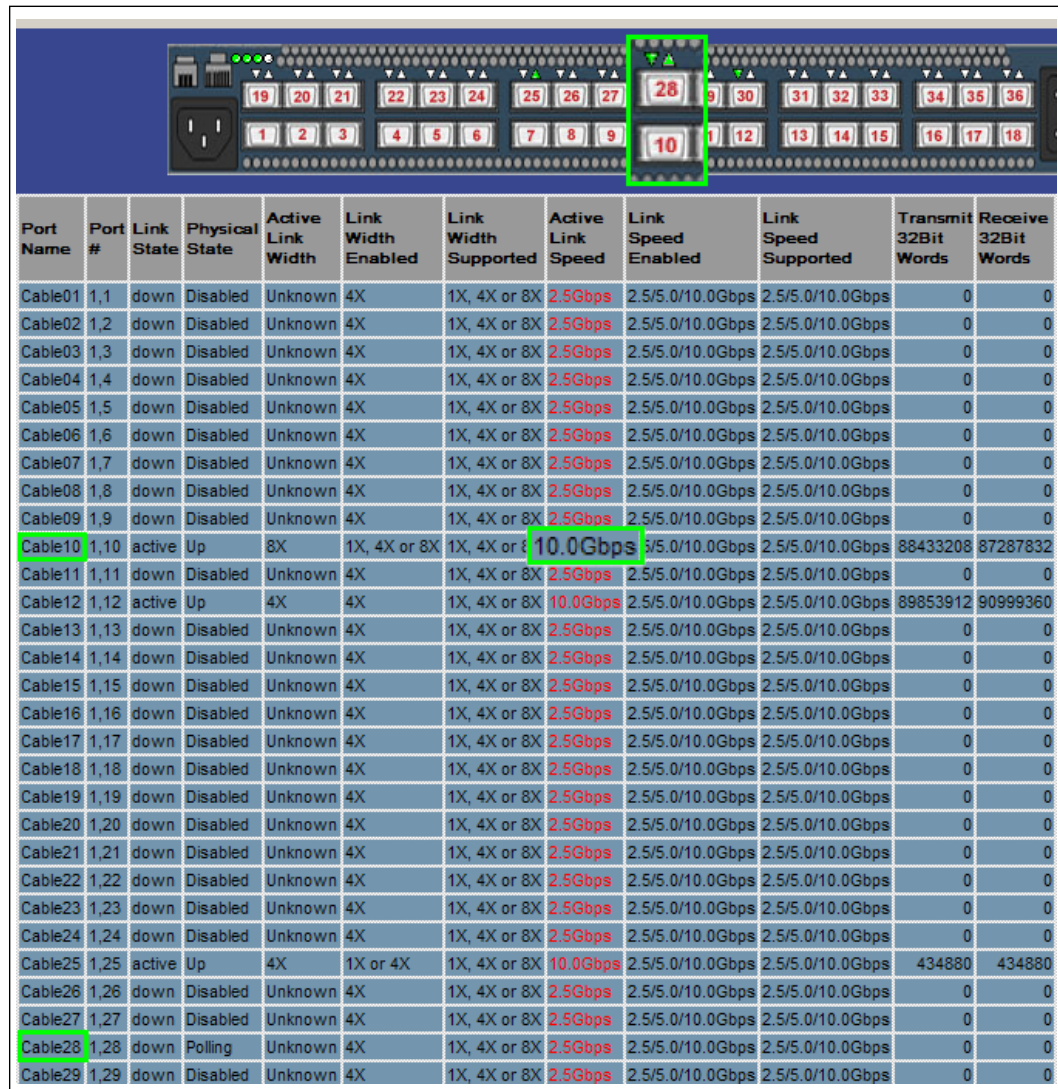
Figure 51. 8X Ports Enabled



6. From the Chassis Viewer main menu, click on **Port Stats** then **IB Port Stats** to display the IB Port Statistics screen. The 8X port (for DUO of cable ports 10 and 28) is displayed (see [Figure 52](#)).



Figure 52. 8X Port Statistics



The first port of the group (port 10) is shown as **active** and **Up**; the other port in the DUO (port 28) is displayed as **down** and **Disabled**.

2.9.5.2 Creating an 8x Port: Externally-managed 12200

Externally-managed 12200 switches are shipped with all ports having a port width of 1x/4x/8x. When connecting an externally-managed 12200 to another switch that has 8x ports defined (for example, another externally-managed 12200, or a 12800 switch leaf module), links come up automatically as 8x if the ports are cabled such that 8x DUOs are formed on both sides of the connection. For example, if ports 1 and 19 of an externally-managed 12200 is connected to ports 1 and 19 of another externally-managed 12200, an 8x link is created.

However, if the user wishes to connect two externally-managed 12200s together, but does not want to have 8x links, cable the ports such that 8x DUOs are not formed. For example, connect port 1 of the first externally-managed 12200 to port 1 of the second externally-managed switch, then connect port 19 of the first externally-managed switch to a port **other than** port 19 of the second externally-managed switch.

Note: If an externally-managed 12200 switch is connected to a port on another 12000-series switch that has 1x/4x/8x enabled (for example, another externally-managed 12200), but the cabling does not form an 8x DUO, the link will come up as a 4x link. Since both sides of the link have 8x enabled (and are capable of being an 8x connection), but the link is up at 4x, certain tools (for example, the Intel® FastFabric `iba_report -o slowlinks` command) may flag this connection as not being linked up at its optimum capability.

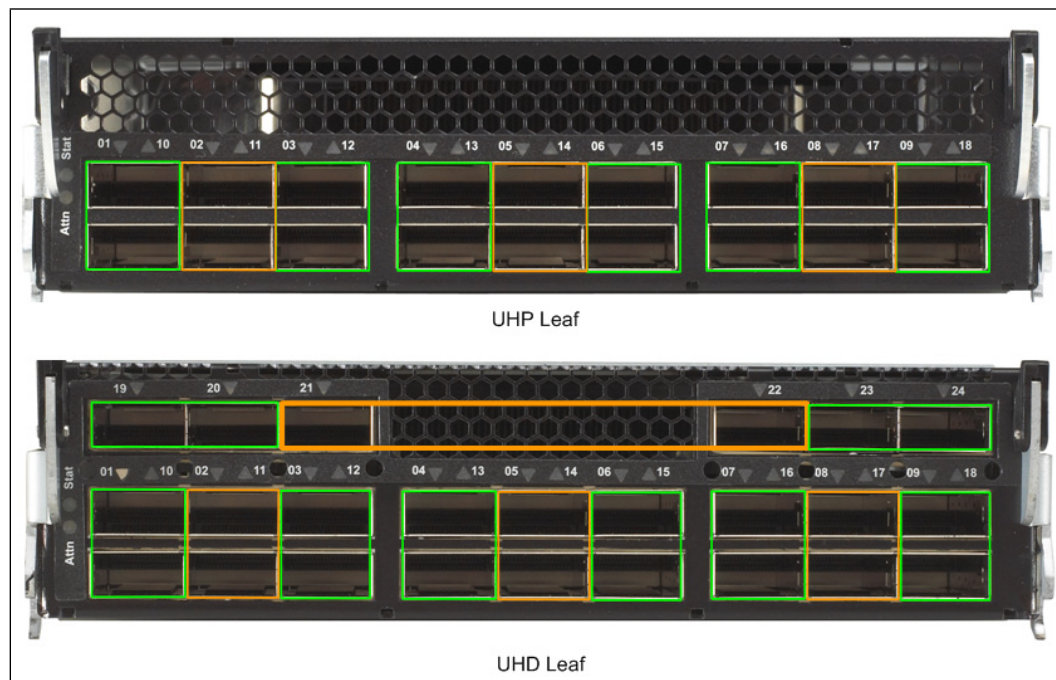
2.9.5.3 Creating an 8x Port: 12800-180

For the 12800-180, 8x DUOs are configured on the leaf modules as follows:

Ultra-high Performance (UHP) Leaf (18 4x QDR ports): combine the 4X port on the bottom row with the 4X port directly above it (for example, port 1 with port 10, port 2 with 11, port 3 with port 12, etc.).

Ultra-high Density (UHD) Leaf (24 4x QDR ports): for ports 1 through 18, combine the 4X port on the bottom row with the 4X port directly above it (for example, port 1 with port 10, port 2 with 11, port 3 with port 12, etc.). For ports 19 through 24 DUOs are made by combining the ports sequentially (that is, port 19 and port 20, port 21 and port 22, and port 23 and port 24).

Figure 53. 12800-180 Leaf Module 8x DUOs



For example, to combine ports 8 and 17 on UHP leaf 111 in a 12800-180 switch:

1. Log into the switch CLI with the login `admin` and password `adminpass`.



2. Enable port 8 with a command similar to:

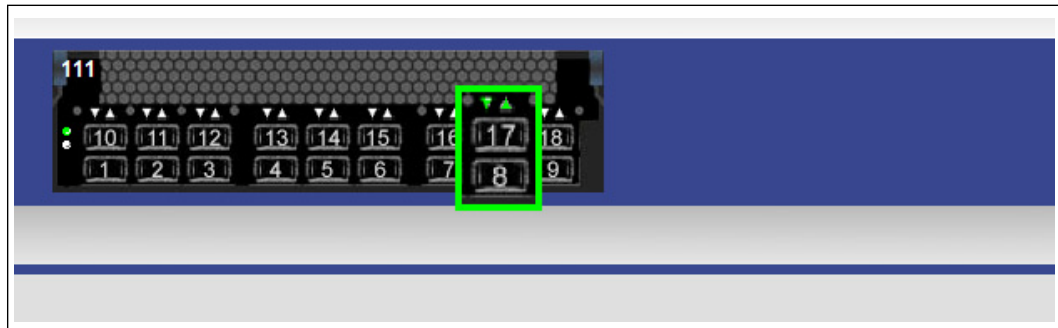
```
ismPortSetWidth L111P08 7 -bounce.  
and press ENTER.
```

3. Enable port 17 using same command as above, changing the port number (that is, L111P17).
4. At the switch, unplug and reinsert the cables to the physical ports. After reinserting the first cable, the user has four (4) seconds to reinsert the second cable associated with the 8x connection before the link begins training.

Note: For proper 8x functionality, it is required that both QSFP cables for a DUO are from the same manufacturer, and are the same length.

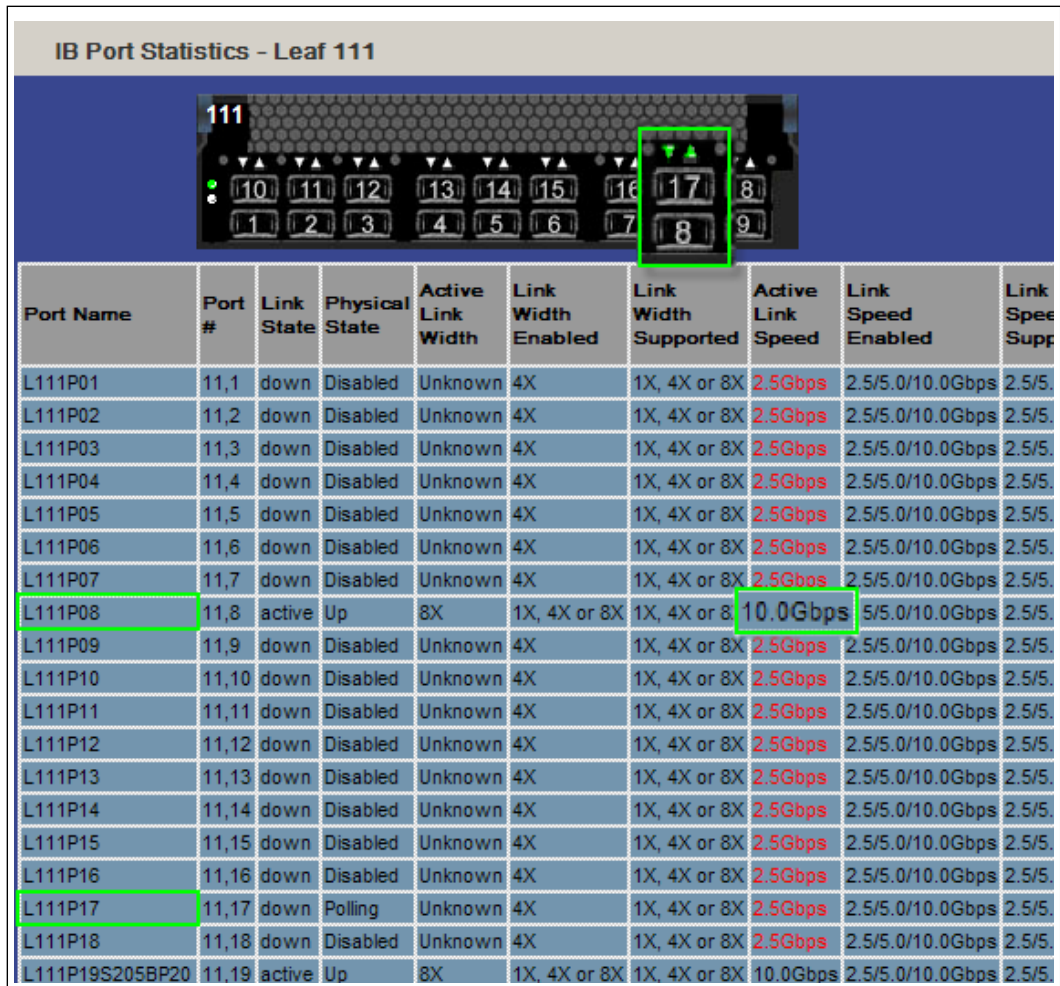
5. After reinserting the cables, bring up Chassis Viewer. The 8X ports are displayed as shown in [Figure 54](#) where both ports of the DUO have LEDs on.

Figure 54. 8X Ports Enabled



6. From the Chassis Viewer main menu, click on **Port Stats** then **IB Port Stats** to display the IB Port Statistics screen. The 8X port (for DUO of cable ports 8 and 17) is displayed (see [Figure 55](#)).

Figure 55. 8X Port Statistics



The first port of the group (port 8) is shown as **active** and **Up**, while the other port in the DUO (port 17) is displayed as **down** and **Disabled**.



2.10 Component LEDs

2.10.1 Management Module

Figure 56. Management Module LEDs



2.10.1.1 Module Status

The status LED indicates one of the following conditions:

- **Steady Green:** the module is operating normally.
- **Blinking Green:** LED test state.
- **Off:** module is in the removable state.

2.10.1.2 Module Attention

The Attention LED indicates one of the following conditions:

- **Off:** the system is functioning normally.
- **Steady Amber:** the system requires some attention, which could indicate one of the following conditions:
 - The switch temperature is at a warning level on the module.
 - The switch silicon temperature is at a warning level (approximately 90 degrees C).
 - DC voltages on the board are slightly out of tolerance (12V Bulk, 5V, 3.3V and 1.8V are all monitored).
 - The module can no longer function properly. The system will take the appropriate actions to ensure that no damage is done to its components.
- **Blinking Amber** (once every four seconds): LED test state, which could indicate one of the following conditions:
 - Bulk power is stable.
 - The module DC-to-DC converter is enabled.
 - The module is not removable.

2.10.1.3 Chassis Status and Attention

The chassis status LED is **Green** when the system is functioning normally.

The chassis status LED is **Amber** when one of the following conditions exists:

- Any Fan Alarm is amber.
- Any power supply AC OK LED is off.



- Any power supply DC OK LED is off
- Any spine module Attention LED is on, or it has been determined that a spine is not functioning (even if it is unable to turn on the LED).
- Any leaf module Attention LED is on, or it has been determined that a leaf is not functioning (even if it is unable to turn on the LED).

The chassis status LED is **Amber** when the system can no longer function properly and indicates one of the following conditions:

- No functional fan trays are present.
- No functional spines are present.
- No functional leaves are present.

The chassis status LED is **off** when:

- There are no functional power supplies present.
- There are no management cards in the system
- AC power has been removed from the system.

2.10.1.4 Fault Tolerant

The Chassis Fault Tolerant (FT) LED indicates the following condition:

- **Steady Green**: the chassis is populated with a full complement of fans as well as N+1 power.

2.10.1.5 Service Required

The chassis service required (SVC) LED is not currently implemented.

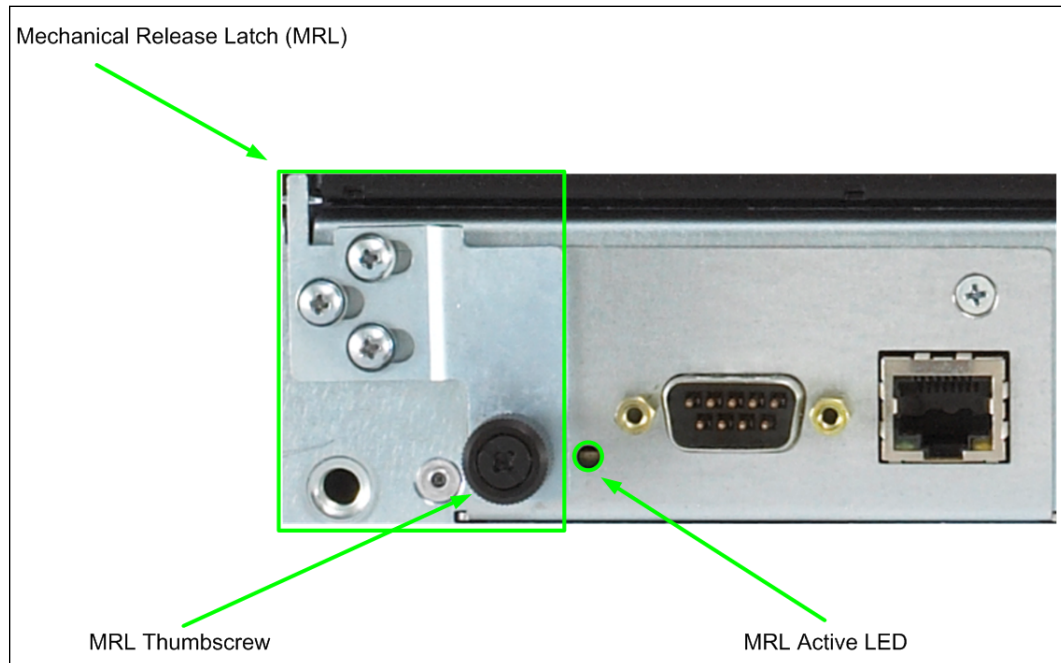
2.10.1.6 Master

The Master LED is **Green** when module is acting as the master Management Module (i.e., it is the master MM).

2.10.1.7 MRL Active

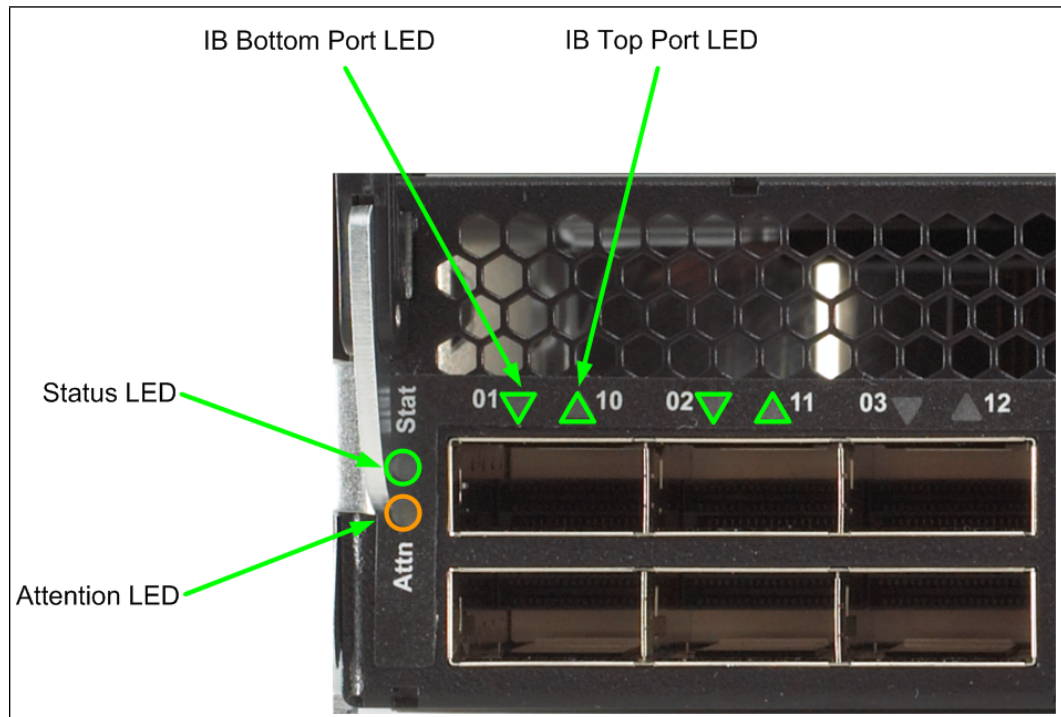
The mechanical release latch (MRL) Active LED is **Green** when the MRL thumbscrew is secured to the serial, Ethernet, chassis EEPROM board (SEEB).

Figure 57. MRL Active LED



2.10.2 Leaf Module

Figure 58. Leaf Module LEDs



2.10.2.1 InfiniBand Port LEDs

Each module IB port has a **Green** IB link status LED that provide the following indications:

- **On**: the logical link is up (port is in the Active state).
- **Off**: the physical link is down (port is in the Down state).

2.10.2.2 Module Status

The status LED indicates one of the following conditions:

- **Steady Green**: the module is operating normally.
- **Blinking Green**: LED test state.
- **Off**: module is in the removable state.

2.10.2.3 Module Attention

The Attention LED indicates one of the following conditions:

- **Off**: the system functioning normally.
- **Steady Amber**: the system requires some attention, which could indicate one of the following conditions:
 - The switch temperature is at a warning level on the module.
 - The switch silicon temperature is at a warning level (approximately 90 degrees C).
 - DC voltages on the board are slightly out of tolerance (12V Bulk, 5V, 3.3V and 1.8V are all monitored).
 - The module can no longer function properly. The system will take the appropriate actions to ensure that no damage is done to its components.
- **Blinking Amber** (once every four seconds): LED test state.

2.10.3 Spine Module

Figure 59. Spine Module LEDs (Double Spine Shown)



2.10.3.1 Module Status

The status LED indicates one of the following conditions:

- **Steady Green**: the module is operating normally.
- **Blinking Green**: LED test state.

- **Off**: module is in the removable state.

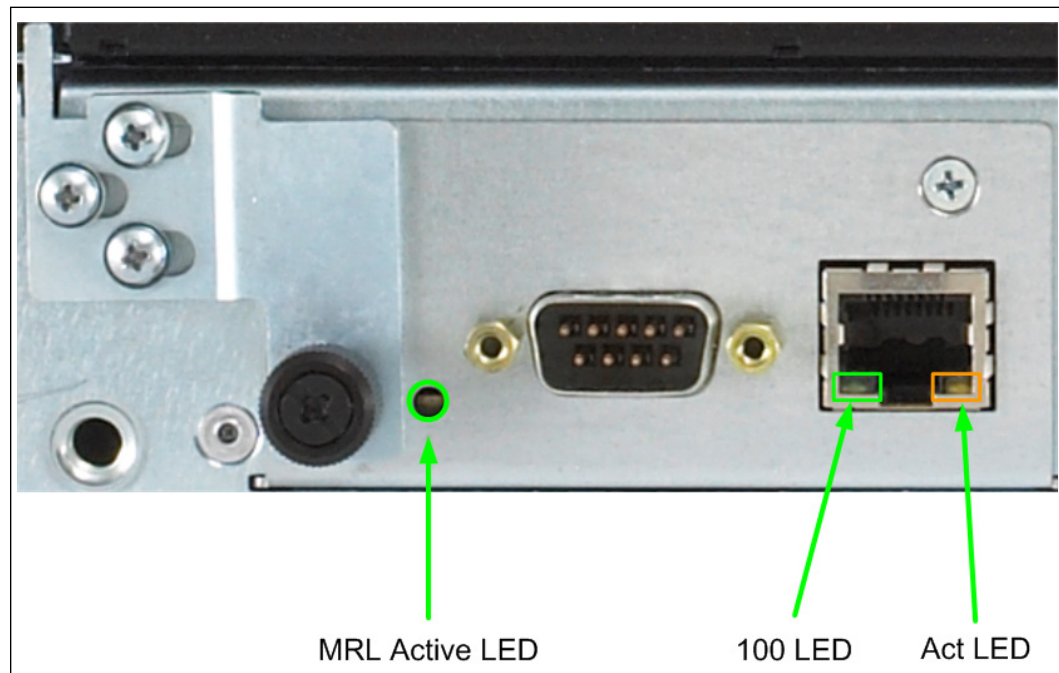
2.10.3.2 Module Attention

The Attention LED indicates one of the following conditions:

- **Off**: the system functioning normally.
- **Steady Amber**: the system requires some attention, which could indicate one of the following conditions:
 - The switch temperature is at a warning level on the module.
 - The switch silicon temperature is at a warning level (approximately 90 degrees C).
 - DC voltages on the board are slightly out of tolerance (12V Bulk, 5V, 3.3V and 1.8V are all monitored).
 - The module can no longer function properly. The system will take the appropriate actions to ensure that no damage is done to its components.
- **Blinking Amber** (once every four seconds): LED test state.

2.10.4 SEEB Module

Figure 60. SEEB Module LEDs



2.10.4.1 RJ45 LEDs

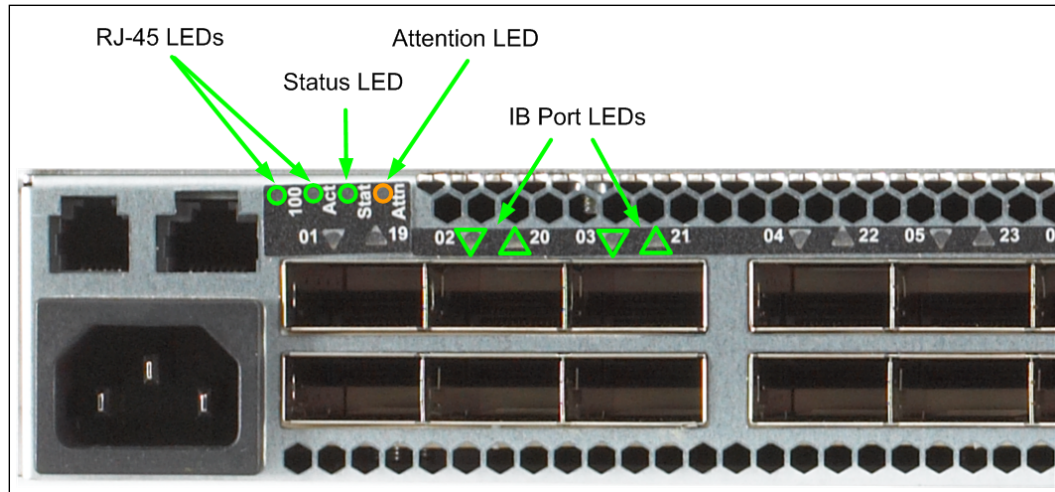
The RJ45 connectors have two LEDs, **Act** and **100**. The **100** LED is **Green** when a 100Mbps link is connected. The **Act** LED is **Amber** when an Ethernet link has been established, and blinking when the link is active.

2.10.4.2 MRL Active

The MRL Active LED is **Green** when the mechanical release latch (MRL) thumbscrew is secured to the serial, Ethernet, Chassis EEPROM Board (SEEB) and a Management Module is installed in the front of the chassis.

2.10.5 12200 and 12300

Figure 61. 12200 and 12300 LEDs



2.10.5.1 InfiniBand Port LEDs

Each module IB port has a **Green** IB link status LED that provide the following indications:

- **On**: the logical link is up (port is in the Active state).
- **Off**: the physical link is down (port is in the Down state).

2.10.5.2 Status

The status LED indicates one of the following conditions:

- **Steady Green**: the module is operating normally.
- **Blinking Green**: LED test state.
- **Off**: module is in the removable state.

2.10.5.3 Attention

The Attention LED indicates one of the following conditions:

- **Off**: the system functioning normally.
- **Steady Amber**: the system requires some attention, which could indicate one of the following conditions:
 - The switch temperature is at a warning level on the module.
 - The switch silicon temperature is at a warning level (approximately 90 degrees C).
 - DC voltages on the board are slightly out of tolerance (12V Bulk, 5V, 3.3V and 1.8V are all monitored).

— The module can no longer function properly. The system will take the appropriate actions to ensure that no damage is done to its components.

- **Blinking Amber** (once every four seconds): LED test state.

2.10.5.4 RJ45 LEDs

The RJ45 connectors have two LEDs, **Act** and **100**. The **100** LED is **Green** when a 100Mbps link is connected. The **Act** LED is **Green** when an Ethernet link has been established, and blinking when the link is active.

2.10.6 12800 Fans and Power Supplies

2.10.6.1 Fan LEDs

Figure 62. 12800 Fan LEDs



Status LED

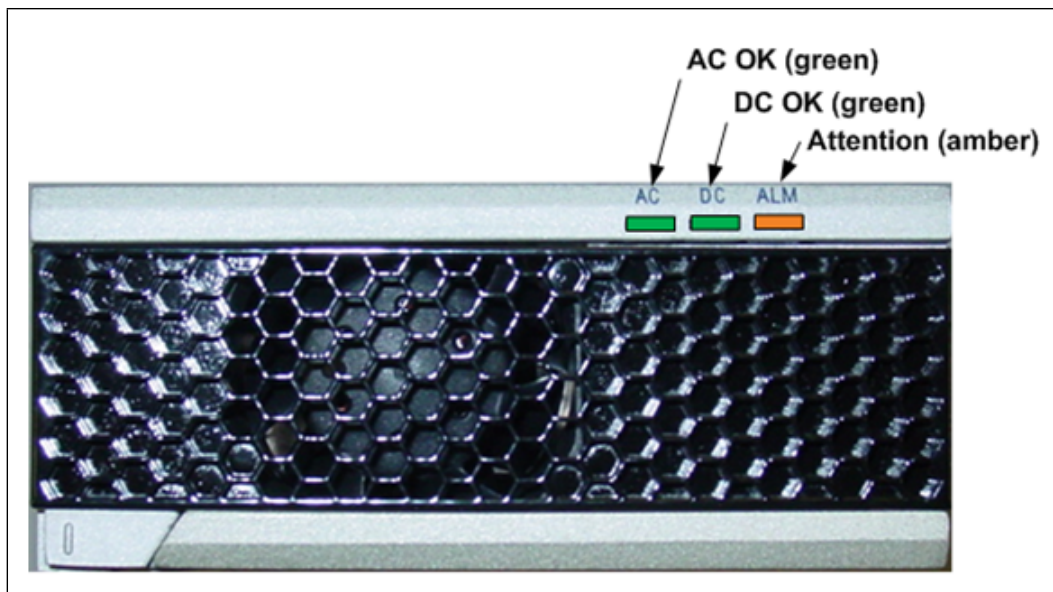
Attention LED

Fan LEDs indicate the following status(es):

- **Green** indicates that the fan is functioning properly.
- **Amber** indicates that the following warning condition exists:
 - A single fan failure when the rotation speed is less than 4000 RPM or greater than 10,950 RPM.
- **Green** and **Amber** on indicates a possible problem, including:
 - The fan tray is not responding to commands for configuration and temperature-related operations.
 - A fan is not responding to commands for temperature and speed related operations.
 - The fan speed has fallen below the minimum allowed RPM for a fan.

2.10.6.2 Power Supply LEDs

Figure 63. 12800 Power Supply LEDs



Each power supply has three LEDs: DC OK, AC OK and Alarm. Following are the status definitions for each.

AC OK:

- **Green** indicates that AC power is normal.
- **Off** indicates a AC power failure or no AC power is present.

DC OK:

- **Green** indicates that DC power is normal.
- **Off** indicates a DC power failure or no DC power is present.

Attention:

- **Amber** indicates a fault condition, failed fan, over temperature condition.



Appendix A Intel 12000 Series Product Specifications

A.1 Physical Specifications

All products within the 12200, 12300 and 12800 Director series are designed to be installed in industry-standard 19-inch four-post server racks.

Racks should conform to conventional standards. Use the American National Standards Institute (ANSI)/Electronic Industries Association (EIA) standard ANSI/EIA-310-D-92 and International Electrotechnical Commission (IEC) 297. These racks are commercially available in various depths. It is recommended to use rack with minimum of 36" depth to facilitate cable installation and routing. Other physical attributes are shown in the table below.

Note: The 12000-series products should not be installed in two-post telecommunication racks.

Table 3. 12000 Physical Attributes

| Model # | 12200 | 12300 | 12800-040 | 12800-120 | 12800-180 | 12800-360 |
|----------------------------|----------------|-----------------|-----------|-----------|-----------|-----------|
| Height (rack units/inches) | 1U/1.75" | 1U/1.75" | 5U/8.75" | 10U/17.5" | 14U/24.5" | 29U/50.7" |
| Depth (without cables) | 24" | 25 3/4" (654mm) | | | | |
| Width | 17.32" (440mm) | | | | | |
| Max weight (lb./kg.) | 15/6.8 | 26/11.8 | 100/45.5 | 155/70.5 | 285/129.3 | 536/243.1 |

A.2 Environmental Specifications

- Operating temperature:
 - 5°–40°C at sea level, altitude derating 1°C per 300m to 2,400m.
- Non-operating temperature:
 - -40°C to 65°C
- Relative humidity (non-condensing):
 - Operating 5%–85%; Non-operating 5%–90%

A.3 12200 and 12300

A.3.1 Cooling and Thermal Management:

- Cooling:
 - Air cooled with a hot plug fan/power tray, three fans per tray, 40mm, 12VDC (12300)
 - Four fans, no fan trays (12200)
 - Front-to-back airflow

Note: The 12200 also offers a reversed airflow model.



A.3.2 Power

- Power Supply:
 - Two redundant, hot plug fan/power supplies (12300)
 - 90/264 VAC operation
 - 275W max power per supply
 - Input: 90–264V AC, 47–63Hz, 1 Phase, 3.6A max current at 100VAC
 - Inrush Current: 13A @ 115VAC, 6.5A @ 230VAC
 - Power Factor: 95% @ 230VAC, 50% load
 - Power Inlet Plug: two IEC 320-c14 connectors for independent AC inputs (12300)

A.4 12800 Series

All 12800 series switches use the same fan tray modules -- intake and exhaust -- and share the same thermal management attributes listed below. The quantity of fan tray modules used in each system is defined in the following table:

Table 4. 12800 Product Configurations

| Maximum | 360 | 180 | 120 | 040 |
|----------------------------|----------|--------------------|--------------------|----------|
| Maximum IB Ports | 864 | 432 | 288 | 96 |
| Maximum Leaf Modules | 36 | 18 | 12 | 4 |
| Maximum Spine Modules | 9 double | 4 double, 1 single | 2 double, 1 single | 1 double |
| Management Modules | 2 | 2 | 2 | 2 |
| Fan Trays (Intake/Exhaust) | 10/10 | 5/3 | 5/3 | 4/0 |
| Power Supplies | 12 | 6 | 4 | 4 |

- Fan Tray:
 - Hot plug with one axial brushless, 12V fans per fan tray
- Chassis airflow:
 - Front-to-back
- Power supply airflow:
 - Front to back

Note: It is recommended that the 120, 180 and 360 be installed as follows:

- Intake fan side towards the cold aisle
- Exhaust fan side towards the hot aisle
- Thermal management:
 - Temperatures of all major heat-producing components are continuously monitored by system management modules. Fan speed is monitored and automatically adjusted by system management modules to maintain



appropriate temperatures of major heat-producing components. Monitoring is performed through a two-wire I2C interface to each fan tray.

A.4.1 Power Specifications

All products within the 12800 series use a common switching power supply. System power attributes are displayed in [Table 5](#). Power supplies are N+1 redundant and hot pluggable.

Note: An AC power cord is required for each power supply. Refer to [Table 5](#).

Table 5. System Power Attributes

| Model # | 12800-360 | 12800-180 | 12800-120 | 12800-040 |
|---|------------------------|-----------|-----------|-----------|
| Maximum # of Power Supplies | 12 | 6 | 4 | 4 |
| Maximum wattage, fully configured | 7,455 | 3,654 | 2,735 | 922 |
| Minimum required power supplies | 6 | 3 | 3 | 2 |
| Power supplies required for DC (N+1) redundancy | 7 | 4 | 3 | 2 |
| Power supplies required for AC redundancy | 12 | 6 | 4 | 2 |
| Maximum output per supply | 1200 Watts | | | |
| Input voltage | 90-264 VAC autoranging | | | |
| Input frequency and phase | 47-63 Hz | | | |
| Maximum current per supply | 100Amps | | | |

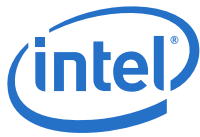


Table 5. System Power Attributes (Continued)

| Model # | 12800-360 | 12800-180 | 12800-120 | 12800-040 |
|-------------------------|-----------------------|-----------|-----------|-----------|
| Inrush Current | 30Amps Max | | | |
| Power Factor efficiency | 99% @ 230V, full load | | | |
| Power Inlet connector | IEC320-C20 | | | |
| # of Power Inlets | 12 | 6 | 4 | 4 |
| Power Cord connector | IEC320-C19 | | | |

A.4.2 Power Distribution Guidelines

The following section details power distribution guidelines and recommendations for the Intel® 12800 series.

- The power supplies for the 12800 series have a maximum inlet current of 15amps @ 110volts and 6amps @ 220volts. Please observe power outlet, power strip and extension cable ratings.
- Do not exceed 80% of the ampere rating limit of the power outlet, power strip, or extension cable that the equipment is plugged into. The power delivery system must be set up so the power supplies do not overpower the maximum amperage of any given system. For the 12800-360 and 12800-180 it is recommended to power the systems over 220 volts.

Caution: High-powered systems, such as the 12800-180 and 12800-360 can place significant loads on power distribution units (PDUs) and UPSs. It is recommended to measure the total amperage and power that a PDU or UPS can handle.

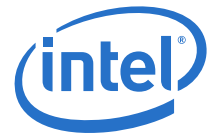


Figure 64. 12800-Series Power Distribution

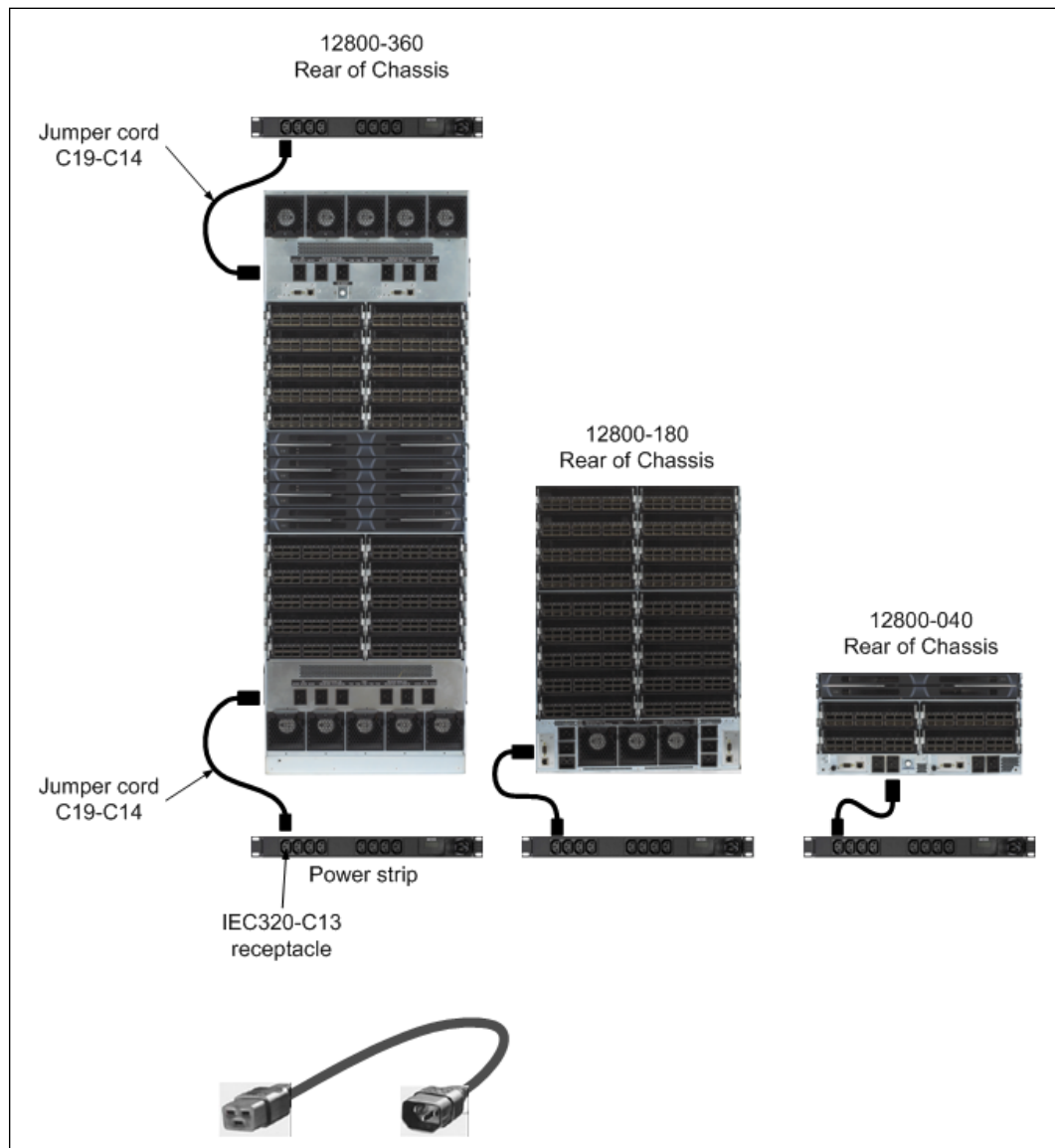


Table 6. AC Plug Types

| Region/Country | Voltage Rating | Plug Type | Misc./Notes |
|----------------|----------------|--------------|----------------|
| North America | 100–127 | NEMA 5–20P | |
| North America | 200–240 | NEMA L6–20P | |
| North America | 200–240 | NEMA L15–30P | Three phase AC |



Table 6. AC Plug Types (Continued)

| Region/Country | Voltage Rating | Plug Type | Misc./Notes |
|-----------------|----------------|-----------|---|
| Europe (Schuko) | 200–240 | CEE 7/7 | Used in Austria, Belgium, Finland, France, Germany, Greece, Hungary, Indonesia, The Netherlands, Norway, Poland, Portugal, Russia, Spain, Sweden. |
| International | 200–240 | IEC 309 | 3-wire (two-phase and earth). Connector size and color variations are used to indicate amperage rating. This is utilized in Switzerland for 16A applications. |
| International | 200–240 | IEC 309 | 4-wire (three-phase & earth). Connector size and color variations are used to indicate amperage rating. |
| International | 200–240 | IEC 309 | 5-wire (three-phase, earth & neutral). Connector size and color variations are used to indicate amperage rating. |

§ §



Appendix B Safety and Regulatory Compliance Information

This section provides regulatory compliance, safety and electromagnetic compatibility (EMC) information for the Intel® 12000 series products.

B.1 Safety Information

B.1.1 Statement 1:



Disconnect Device: This unit may have more than one power cord. To reduce the risk of electrical shock, disconnect all power cords before servicing unit.

B.1.1.1 Verklaring 1:

Apparaat loskoppelen: Deze eenheid heeft mogelijk meer dan een stroomkabel. Verminder het risico op een elektrische schok door alle stroomkabels los te koppelen voordat u onderhoud pleegt aan de eenheid.

B.1.1.2 Varoitus 1:

Irrota laite. Yksikössä saattaa olla useampia kuin yksi virtajohto. Irrota kaikki virtajohdot ennen yksikön huoltamista, niin sähköiskun vaara pienenee.

B.1.1.3 Déclaration 1 :

Déconnecter l'appareil: Cette unité peut disposer de plusieurs cordons d'alimentation. Déconnectez tous les cordons d'alimentation avant son entretien pour réduire le risque d'électrocution.

B.1.1.4 Anweisung 1:

Gerät trennen: Diese Komponente verfügt möglicherweise über mehrere Netzkabel. Trennen Sie alle Netzkabel bevor Sie die Komponente warten, um die Gefahr eines elektrischen Schlags zu vermeiden.

B.1.1.5 Dichiarazione 1:

Scollegare il dispositivo: L'unità potrebbe avere più di un cavo di alimentazione. Per ridurre il rischio di scosse elettriche, scollegare tutti i cavi di alimentazione prima di intervenire sull'unità.

B.1.1.6 Erklæring 1:

Frakobling av enheten: denne enheten kan ha mer enn én strømføring. For å redusere faren for elektrisk sjokk, må alle strømkablene trekkes ut før enheten vedlikeholdes.

B.1.1.7 Declaração 1:

Desligar dispositivo: Esta unidade pode ter mais de um cabo de alimentação. Para reduzir o risco de choque eléctrico, desligue todos os cabos de alimentação antes de fazer a manutenção da unidade.

B.1.1.8 Declaración 1:

Desconexión de dispositivo: Esta unidad puede tener más de un cable de alimentación eléctrica. Para reducir el riesgo de electrocución, desconecte todos los cables antes de realizar cualquier servicio técnico en la unidad.

B.1.1.9 Uttalande 1:

Koppla bort enhet. Den här enheten kan ha mer än en strömsladd. Reducera risken för elektrisk stöt genom att koppla bort alla strömsladdar innan enheten underhålls.

B.1.1.10 Kijelentés 1:

Szüntesse meg az eszköz tápellátását: Ez az egység egynél több tápvezetéssel rendelkezhet. Az áramütés kockázatának csökkentése érdekében minden tápvezetékot húzzon ki az egység szervizelése előtt.

B.1.1.11 Инструкция 1:

Отключите устройство: В данном устройстве может быть более одного сетевого шнура. Во избежание поражения электрическим током отсоедините все сетевые шнуры до проведения технического обслуживания устройства.

B.1.1.12 声明 1:

断开装置 - 此装置可能有一个以上电源电缆。为了减少电击风险，请在维修该装置前断开所有电源电缆。

B.1.1.13 ステートメント 1:

デバイスを外してください - このユニットには複数の電源ユニットが接続されている可能性があります。感電のリスクを軽減するため、ユニットを修理する前にすべての電源コードを外してください。

B.1.2 Statement 2:

Chassis Lifting: Use safe practices when lifting.

Note: Use a team of people appropriate to the weight of each specified product and in conjunction with applicable guidelines. Whenever possible, use a mechanical lift.

B.1.2.1 Verklaring 2:

Chassis optillen: Volg de veiligheidsinstructies bij het optillen.



ANMERKUNG: Gebruik genoeg mensen voor het gewicht van elk gespecificeerd product en hanteer de toepasselijke richtlijnen. Gebruik waar mogelijk een mechanisch tilapparaat.

B.1.2.2 Varoitus 2:

Kotelon nostaminen. Noudata nostaessasi turvaohjeita.

HUOMAUTUS: Varaa nostamista varten laitteen painoon nähden sopiva ja sovellettavien ohjeiden mukainen määrä henkilöitä. Käytä mekaanista nosturia aina, kun se on mahdollista.

B.1.2.3 Déclaration 2 :

Soulever le châssis: Employez des mesures de sécurité pour soulever.

REMARQUE : Faites appel au nombre de personnes approprié en fonction du poids de chaque produit spécifique et en conjonction avec les directives applicables. Utilisez un relevage mécanique, si possible.

B.1.2.4 Anweisung 2:

Anheben des Gehäuses: Lassen Sie Sicherheit beim Anheben des Gehäuses walten.

ANMERKUNG: Setzen Sie jeweils dem Gewicht jedes angegebenen Produkts und den Richtlinien entsprechend genügend Leute ein. Verwenden Sie, wenn möglich, einen mechanischen Aufzug.

B.1.2.5 Dichiarazione 2:

Sollevamento del telaio: Durante il sollevamento, seguire le procedure di sicurezza.

NOTA: utilizzare un gruppo di persone adeguato al peso di ogni prodotto specifico e insieme alle indicazioni applicabili. Se possibile, usare un sollevatore meccanico.

B.1.2.6 Erklæring 2:

Løfting av kabinettet: utvis varsomhet ved løfting.

MERK: Bruk flere personer til bæring, avhengig av vekten til hvert enkelt produkt og i samsvar med gjeldende retningslinjer. Bruk mekaniske løftemekanismer når mulig.

B.1.2.7 Declaração 2:

Levantar o chassi: Utilize práticas seguras ao levantar o chassi.

AVISO: Utilize um grupo de pessoas adequado ao peso de cada produto especificado, em conjunto com as diretivas aplicáveis. Sempre que possível, utilize um dispositivo mecânico de levantamento.

B.1.2.8 Declaración 2:

Elevación del chasis: Observe las prácticas de seguridad cuando quiera elevar el chasis.

NOTA: utilice un grupo de gente apropiado al peso de cada producto especificado junto con las pautas que correspondan. Siempre que sea posible, utilice un elevador mecánico.

B.1.2.9 Uttalande 2:

Løftning av chassi. Iakttag säkerhetsanvisningar vid lyft.

OBS! Använd ett team personer lämpade för vikten på varje specificerad produkt och i samband med gällande riktlinjer. Använd en mekanisk lyftanordning närhelst det är möjligt.

B.1.2.10 Kijelentés 2:

A burkolat emelése – Biztonságos eljárásokat alkalmazzon az emelés során.

MERK: Az egyes termékek súlyának megfelelő fobol álló csoportot alkalmazzon, a vonatkozó irányelvek betartása mellett. Lehetőség szerint mindig használjon mechanikus emeloszerkezetet.

B.1.2.11 Инструкция 2:

Подъем корпуса – Соблюдайте технику безопасности при подъеме.

ПРИМЕЧАНИЕ: Подъем каждого конкретного устройства исходя из его веса должен осуществляться несколькими лицами и в соответствии с надлежащим инструкциям. Везде, где это возможно, следует применять механические грузоподъемные устройства.

B.1.2.12 声明 2:

提起机箱 – 提起机箱时请采取安全措施。

注: 请按照每个具体产品的重量来使用一定的人数，并遵照适当的说明。可能的话，使用机械起重器。

B.1.2.13 ステートメント 2:

シャーシの持ち上げ – シャーシを持ち上げる際は安全に配慮してください。

メモ: 各製品の重量に見合った人数で、適切なガイドラインに従って持ち上げてください。可能な場合は、リフト機を使用してください。

B.1.3 Statement 3:



Energy Hazard: To reduce risk of electric shock, keep hands and fingers out of the power supply bays and backplane areas.

B.1.3.1 Verklaring 3:

Stroomgevaar: Reduceer het risico op een elektrische schok door handen en vingers weg te houden bij de voedingscompartimenten en de gebieden rond de centrale printplaat.

B.1.3.2 Varoitus 3:

Sähköiskun vaara. Voit vähentää sähköiskuille altistumista, kun vältät koskettamasta virtalähdepaikkoja ja keskuspiirilevyä.

**B.1.3.3 Déclaration 3 :**

Danger électrique: Pour réduire le risque d'électrocution, gardez vos mains hors des baies d'alimentation et des zones destinées aux cartes de circuits imprimés.

B.1.3.4 Anweisung 3:

Gefahr vor elektrischem Schock: Um der Gefahr vor elektrischem Schock vorzubeugen, halten Sie Hände und Finger den Netzteilgehäusen und der Rückwand fern.

B.1.3.5 Dichiarazione 3:

Pericolo di scosse: Per ridurre il rischio di scosse elettriche, allontanare le mani e le dita dagli alloggiamenti degli alimentatori e dalle aree della piastra base.

B.1.3.6 Erklæring 3:

Strømfare: hold fingre og hender unna strømforsyningsrom og kretskort for å unngå elektrisk sjokk.

B.1.3.7 Declaração 3:

Risco de choque eléctrico: Para reduzir o risco de choque eléctrico, mantenha as mãos e os dedos fora dos compartimentos da fonte de alimentação e das áreas de backplane.

B.1.3.8 Declaración 3:

Peligro de energía: Para reducir el riesgo de electrocución, mantenga las manos y los dedos alejados de los compartimentos de la fuente de alimentación eléctrica y del circuito impreso central.

B.1.3.9 Uttalande 3:

Risk för elektrisk stöt. Reducera risken för elektrisk stöt genom att hålla händer och fingrar borta från strömförsörjningsfack och bakpanelsområden.

B.1.3.10 Kijelentés 3:

Áramütés veszélye – Az áramütés kockázatának csökkentése érdekében kezeit és ujjait tartsa távol a tápcsatlakozóktól és a hátsó területektől.

B.1.3.11 Инструкция 3:

Опасное напряжение – Во избежание поражения электрическим током, не прикасайтесь к клеммам электропитания и к центральной электронной плате.

B.1.3.12 声明 3:

电能危害 – 为了减少电击风险，手和指应远离电源架和印刷电路板区域。

B.1.3.13 ステートメント 3 :

エネルギーの危険 – 感電のリスクを軽減するため、電源装置ベイおよびバックプレーン周辺に手や指を近づけないでください。

B.1.4 Statement 4:



Laser Radiation: certain optical products may emit laser radiation. Removing covers could result in exposure to hazardous laser radiation. Radiation may be emitted from connectors or fiber optic cables.

B.1.4.1 Verklaring 4:

Laserstraling: bepaalde optische producten kunnen laserstraling verspreiden. Het verwijderen van dekplaten kan resulteren in blootstelling aan schadelijke laserstraling. Straling kan worden afgegeven door connectoren of glasvezelkabels.

B.1.4.2 Varoitus 4:

Lasersäteily. Jotkut optiset laitteet saattavat päästää lasersäteilyä. Niiden suojusten poistaminen saattaa altistaa vaaralliselle lasersäteilylle. Säteily voi tulla liittimistä tai optisista kuitukaapeleista.

B.1.4.3 Déclaration 4:

Rayonnement laser: Certains produits optiques peuvent produire un rayonnement laser. Le retrait de capots peut engendrer une exposition à un rayonnement laser dangereux. Ce rayonnement peut provenir des connecteurs ou des câbles en fibre optique.

B.1.4.4 Anweisung 4:

Laserstrahlung: manche optischen Produkte geben Laserstrahlung ab. Beim Entfernen der Abdeckungen können Sie möglicherweise gefährlicher Laserstrahlung ausgesetzt werden. Laserstrahlung kann von Anschlüssen oder Faseroptikkabeln abgegeben werden.

B.1.4.5 Dichiarazione 4:

Radiazione laser: Alcuni prodotti ottici potrebbero emettere la radiazione laser. La rimozione delle coperture potrebbe causare l'esposizione alla radiazione laser pericolosa. I connettori o i cavi in fibra ottica potrebbero emettere radiazioni.

B.1.4.6 Erklæring 4:

Laserstråling: visse optiske produkter kan gi fra seg laserstråling. Dersom dekslene tas av, kan dette medføre utsettelse for farlig laserstråling. Strålingen kan komme fra kontakter eller fiberoptiske kabler.

B.1.4.7 Declaração 4:

Radiação laser: Certos produtos ópticos podem emitir radiação laser. A remoção de tampas pode resultar na exposição a níveis perigosos de radiação laser. A radiação pode ser emitida de conectores ou de cabos de fibra óptica.



B.1.4.8 Declaración 4:

Radiación de láser: Ciertos productos ópticos pueden emitir radiación de láser. Quitar las cubiertas podría resultar en la exposición peligrosa a radiación de láser. La radiación se puede emitir de conectores o cables de fibra óptica.

B.1.4.9 Uttalande 4:

Laserstrålning. Vissa optiska produkter kan utsända laserstrålning. Borttagning av skydd kan resultera i exponering för riskfylld laserstrålning. Strålning kan utsändas från kopplingsdetaljer eller fiberoptiska kablar.

B.1.4.10 Kijelentés 4:

Lézersugárzás – Bizonyos optikai termékek lézersugárzást bocsátanak ki. A burkolatok eltávolításával veszélyes lézersugárzásnak tehetik ki magukat. Sugárzást csatlakozók vagy üvegszálak optikai kábelek bocsáthatnak ki.

B.1.4.11 Инструкция 4:

Лазерное излучение! – некоторые оптические устройства являются источником лазерного излучения. При снятии крышки существует опасность воздействия лазерного излучения на персонал. Лазерное излучение может испускаться соединительными гнездами волоконно-оптических кабелей.

B.1.4.12 声明 4:

激光辐射 – 某些光学产品会发出激光辐射。移开盖板时会使人暴露于有害激光辐射。连接器或光纤电缆都可能发出辐射。

B.1.4.13 ステートメント 4:

レーザー光線 – 特定の光学製品からレーザー光線が放射される可能性があります。カバーを取り除くと、危険なレーザー光線を被爆する場合があります。光線はコネクタまたは光ファイバーケーブルから放射されることがあります。

B.1.5 Statement 5:



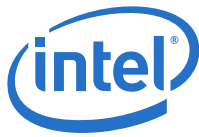
No user-serviceable parts: Hazardous energy levels may be present inside power supplies and circuit card modules. Do not remove covers.

B.1.5.1 Verklaring 5:

Onderdelen die niet door de gebruiker mogen worden onderhouden: Er kunnen gevaarlijke energieniveaus aanwezig zijn binnen voedingen en printplaten. Verwijder in geen geval dekplaten.

B.1.5.2 Varoitus 5:

Ei osia, jotka käyttäjä voisi vaihtaa. Virtalähteiden ja piirikorttimoduulien sisällä saattaa olla vaarallisen suuri virta tai jännite. Älä poista niiden suojuksia.



B.1.5.3 Déclaration 5 :

Pièces non entretenues par l'utilisateur: Des niveaux d'électricité dangereux peuvent résider à l'intérieur des sources d'alimentation et des modules de carte de circuits imprimés. Ne retirez pas les capots.

B.1.5.4 Anweisung 5:

Wartung nur durch Fachmann möglich: Gefährlich hohe Stromstärken sind in Netzteilen und in den Modulen der Busleiterplatte vorhanden. Entfernen Sie die Abdeckungen nicht.

B.1.5.5 Dichiarazione 5:

Non sono presenti componenti riparabili dall'utente: Livelli pericolosi di energia potrebbero essere presenti all'interno degli alimentatori e dei moduli delle schede dei circuiti. Non rimuovere le coperture.

B.1.5.6 Erklæring 5:

Ingen deler som kan vedlikeholdes av brukeren: farlig strømmengde kan finnes inni strømforsynings- og kretskortmoduler. Fjern ikke dekslene.

B.1.5.7 Declaração 5:

Não há peças a serem consertadas pelo utilizador: Níveis perigosos de energia podem estar presentes em fontes de alimentação e em módulos de placas de circuito. Não remova as tampas.

B.1.5.8 Declaración 5:

No hay piezas técnicas: Niveles peligrosos de energía pueden hacerse presentes en las fuentes de alimentación eléctrica. No quite las cubiertas.

B.1.5.9 Uttalande 5:

Inga delar kan underhållas av användaren. Farliga energinivåer kan finnas i strömförsörjningsenheter kretskortmoduler. Ta inte bort skydd.

B.1.5.10 Kijelentés 5:

A berendezés nem tartalmaz felhasználó által javítható alkatrészeket – Veszélyes energiaszint lehet a tápegységeken és az áramköri kártyamodulokon belül. Ne távolítsa el a burkolatokat.

B.1.5.11 Инструкция 5:

Устройство не содержит деталей, предназначенных для обслуживания пользователем – Блоки питания и электрические платы устройства являются источником опасного электрического напряжения. Снимать крышки запрещено.

B.1.5.12 声明 5:

禁止用户维修部件 – 电源和电路卡模块内部可能存在一定水平的有害能。切勿移除盖板。

**B.1.5.13** ステートメント 5 :

ユーザー修理可能部品なし - 電源装置および回路カードモジュール内のエネルギーが危険なレベルに達している場合があります。カバーを外さないでください。

B.1.6 **Statement 6:**

Equipment Installation: Only qualified personnel should be allowed to install, remove or replace chassis or modules.

B.1.6.1 **Verklaring 6:**

Installatie apparatuur: Voor het installeren, verwijderen of vervangen van chassis of modules mag alleen gekwalificeerd personeel worden gebruikt.

B.1.6.2 **Varoitus 6:**

Laitteiston asentaminen. Vain pätevä asentaja saa asentaa, poistaa ja vaihtaa kotelointa tai moduuleja.

B.1.6.3 **Déclaration 6 :**

Installation de l'équipement: Seul un personnel qualifié est autorisé à installer, retirer ou remplacer des châssis ou modules.

B.1.6.4 **Anweisung 6:**

Geräteinstallation: Die Installation, Entfernung oder Erneuerung von Gehäuse und Modulen sollte nur durch Fachpersonal erfolgen.

B.1.6.5 **Dichiarazione 6:**

Installazione dell'apparecchiatura: Solo il personale qualificato è autorizzato ad installare, rimuovere o ricollocare il telaio o i moduli.

B.1.6.6 **Erklæring 6:**

Utstyrsinstallasjon: kun kvalifisert personell kan installere, fjerne eller skifte ut kabinetter eller moduler.

B.1.6.7 **Declaração 6:**

Instalação do equipamento: A instalação, troca ou remoção de chassis ou módulos só deve ser feita por técnicos qualificados.

B.1.6.8 **Declaración 6:**

Instalación del equipo: Solamente se permite personal cualificado para realizar la instalación, quitar o sustituir módulos o chasis.

B.1.6.9 Uttalande 6:

Installation av utrustning. Enbart kvalificerad personal får installera, ta bort eller byta ut chassin eller moduler.

B.1.6.10 Kijelentés 6:

Berendezés telepítése – Kizárólag szakképzett személyzet számára megengedett a burkolat vagy a modulok telepítése, eltávolítása vagy cseréje.

B.1.6.11 Инструкция 6:

Установка оборудования – Установка, удаление и замена корпуса или модулей устройства должна производиться только квалифицированным техническим персоналом.

B.1.6.12 声明 6:

设备安装 – 只有有资格的技术人员才允许安装、卸下或装回机箱或模块。

B.1.6.13 ステートメント 6:

装置の取り付け – シャーシまたはモジュールの取り付け、取り外しまたは取替えは、有資格者のみが行うようにしてください。

B.1.7 Statement 7:

Adding or Replacing Modules: These modules are intended only for installation in Intel® 12000 base units. Always install blanks when removing an active module. They prevent exposure to energy hazards inside the unit, contain EMI, and maintain cooling air balance in the chassis.

B.1.7.1 Verklaring 7:

Toevoegen of vervangen van modules: deze modules zijn alleen bedoeld voor installatie in basiseenheden uit de Intel® 12000-reeks. Installeer altijd plaatshouders wanneer u een actieve module verwijdert. Deze voorkomen blootstelling aan energierisico's binnen de eenheid, bevatten EMI en handhaven de koelluchtbalans in het chassis.

B.1.7.2 Varoitus 7:

Moduulien lisääminen ja vaihtaminen. Moduulit on tarkoitettu asennettavaksi vain Intel® 12000 -sarjan perusyksikköihin. Kun olet poistanut aktiivisen moduulin, muista aina asentaa tyhjä kappale sen paikalle. Ne estävät sähköiskuille altistumista yksikön sisällä, hillitsevät sähkömagneettisia häiriöitä (EMI) ja pitävät yllä jäähdytysilman tasaista jakautumista koteloon.

**B.1.7.3 Déclaration 7 :**

Ajouter ou remplacer des modules: Ces modules sont conçus exclusivement pour une installation avec des unités de base Intel® 12000 series. Installez toujours des caches de protection lors du retrait d'un module actif. Ils protègent contre les dangers électriques à l'intérieur de l'unité, limitent l'interférence électromagnétique et maintiennent un volume d'air refroidissant approprié au sein du châssis.

B.1.7.4 Anweisung 7:

Hinzufügen oder Austauschen von Modulen: Diese Module sind für die Installation in Grundeinheiten der Intel® 12000 Serie vorgesehen. Installieren Sie stets leere Module, wenn Sie ein aktives Modul entfernen. Diese verhindern, dass Stromgefahr im Innern der Einheit entsteht, enthalten Störstrahlung und sorgen für den Kühlungsausgleich im Gehäuse.

B.1.7.5 Dichiarazione 7:

Aggiunta o sostituzione dei moduli: I moduli sono concepiti solo per l'installazione nelle unità di base Intel® 12000 Serie. Quando si rimuove un modulo attivo, installare sempre le protezioni, poiché impediscono l'esposizione ai pericoli di scosse all'interno dell'unità, contengono le IEM e mantengono un equilibrio dell'aria di raffreddamento nel telaio.

B.1.7.6 Erklæring 7:

Tillegging eller utskifting av moduler: disse modulene skal kun installeres i baseenheterne på Intel® 12000-serien. Installer alltid tomme enheter når en aktiv modul fjernes. De forhindrer utsettelse for strømfare inni enheten, inneholder EMI og opprettholder kjølebalansen i kabinettet.

B.1.7.7 Declaração 7:

Adição ou troca de módulos: Estes módulos foram projectados para serem instalados apenas nas unidades de base Intel® 12000 série. Instale sempre módulos de preenchimento ("blanks") ao remover módulos activos. Eles diminuem os riscos de choque eléctrico no interior da unidade, contêm dispositivos de protecção contra interferência eletromagnética e mantêm o equilíbrio de resfriamento por ar no interior do chassi.

B.1.7.8 Declaración 7:

Agregar o sustituir módulos: Estos módulos solamente se pueden instalar en unidades de base de la serie Intel® 12000. Siempre instale protectores al retirar un módulo activo. Los protectores previenen la exposición a peligros de energía dentro de la unidad, contienen EMI y mantienen el balance de enfriamiento de aire en el chasis.

B.1.7.9 Uttalande 7:

Lägga till eller byta ut moduler. De här modulerna är enbart avsedda för installation i Intel® 12000-seriens basenheter. Installera alltid tomenheter vid borttagning av en aktiv modul. De förhindrar exponering för energirisker på enhetens insida, hindrar EMI och upprätthåller kyluftbalansen i chassin.



B.1.7.10 Kijelentés 7:

Modulok hozzáadása vagy cseréje – Ezek a modulok kizárólag Intel® 12000-es sorozatú bázisegységekbe építhetőek be. Aktív modul cseréjekor mindig szereljen be üres helyeket. Ezek megakadályozzák az egységen belüli energiaveszélyek kialakulását, tartalmazznak EMI-t, és fenntartják a hűtőlevegő egyensúlyát a borításon belül.

B.1.7.11 Инструкция 7:

Установка и замена модулей – Модули предназначены только для установки внутрь базовых блоков Intel® серии 12000. После замены действующих модулей следует всегда устанавливать заглушки с крышками. Это обеспечивает защиту от опасного напряжения, электромагнитного излучения и надлежащий тепловой баланс внутри корпуса.

B.1.7.12 声明 7:

添加或装回模块 – 这些模块仅用于安装在 Intel® 12000 Series 基座装置。请在移除活动模块时安装空白的。它们能预防装置内部的有害能的暴露，包含 EMI，并在机箱内保持冷却空气平衡。

B.1.7.13 ステートメント 7:

モジュールの追加または取替え – これらのモジュールは Intel® 12000 シリーズ MPFD ベースユニットへの取り付け専用です。アクティブなモジュールを取り除く際は、常にダミーを取り付けてください。これはユニット内の危険なエネルギーの露出を防止し、EMI を阻止、およびシャーシ内の空冷バランスを維持します。



Appendix C Serial Port Pinouts

For those users making their own serial cables, follow the guidelines below.

Figure 65. Serial Port Pinouts

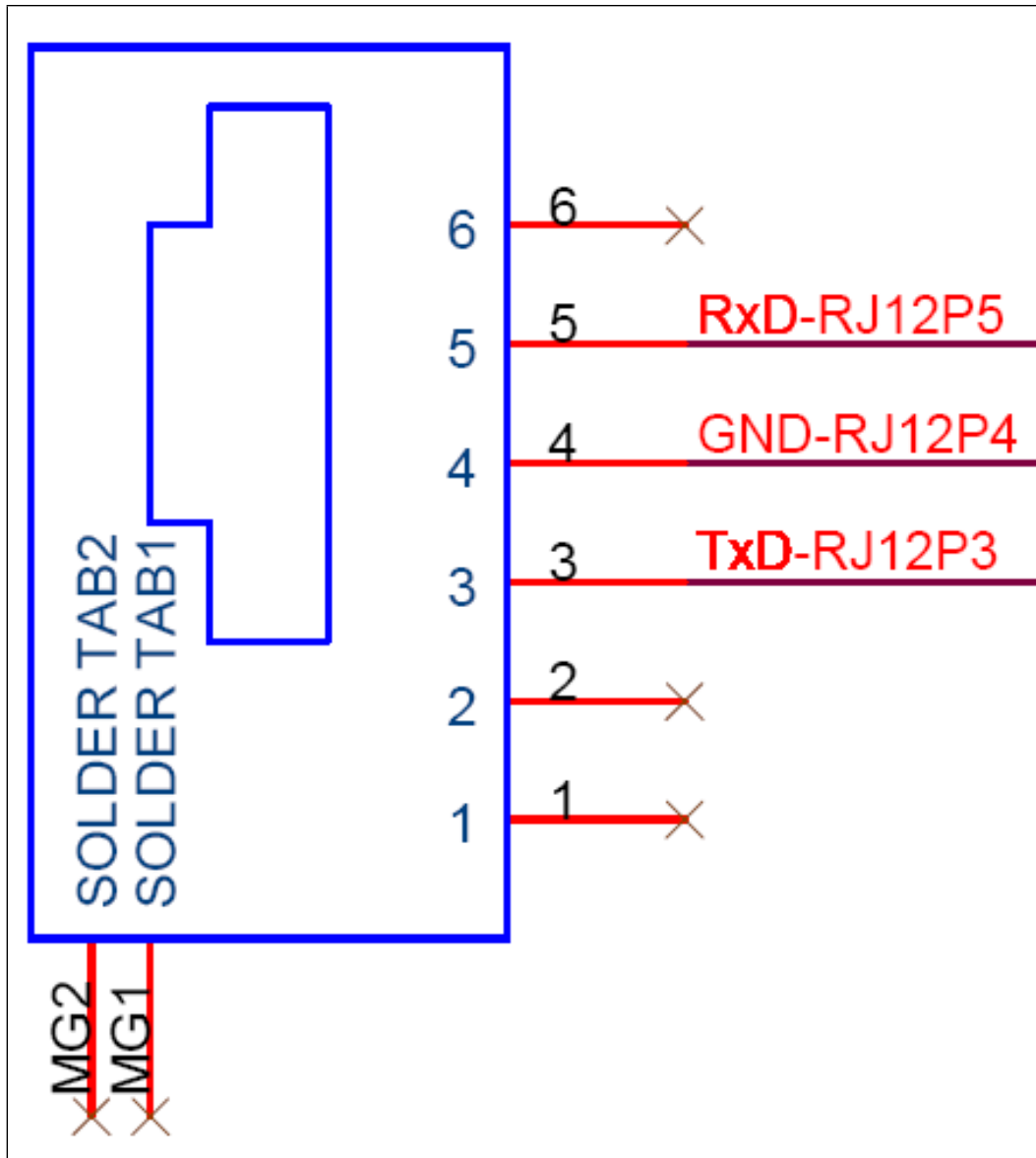


Figure 65 represents the RJ-11 connector located on the Intel® 12200 and 12300.

- The only serial port signals required are: **Tx**, **Rx** and **Ground**. All other serial port signals are NOT used.



See [Table 7](#) for a list of RJ45 (on Digi) to RJ11 cross references. The cable should connect the three RJ45 signals (on the Digi) to the RJ11 connector. The signals for the T3 card located inside the switch and spine are included for reference only.

Table 7. Pinout Cross Reference

| RJ45 (on Digi) | RJ11 | T3 RJ45 (reference only) |
|----------------|------|-----------------------------|
| P5-Rx | P5 | P6-Tx |
| P6-Gnd | P4 | P4-Gnd |
| P4-Tx | P3 | P5-Rx |

§ §



Appendix D 12800 Leaf Module Guidelines

This section details the general guidelines for populating each 12800-series switch.

Each switch has:

- Two Management Module (MM) slots with a corresponding management leaf slot.

The minimum requirement for each switch is one leaf module per management module. This leaf must be installed in the corresponding management leaf slot. If the management leaf slot(s) is not installed, then the MM cannot communicate or manage the chassis through the inband IB connection.

Note: The mechanical release latches (MRL) on the MM and the management leaf slots need to be secured and enabled to function properly.

After populating the management leaf slots, the user may install additional leaf modules in any of the leaf slot locations. Most users will generally install leaf modules in a left-to-right, bottom-to-top pattern. The details for each 12800-series switch are as follows:

D.1 12800-040

D.1.1 Single Management Module

- MM slot: M202/Leaf module management slot: L101.

D.1.2 Dual Management Modules

- MM slot: M202/Leaf module management slot: L101.
- MM slot: M201/Leaf module management slot: L102.

D.2 12800-120

D.2.1 Single Management Module

- MM slot: M208/Leaf module management slot: L101.

D.2.2 Dual Management Modules

- MM slot: M208/Leaf module management slot: L101.
- MM slot: M207/Leaf module management slot: L102.

D.3 12800-180

D.3.1 Single Management Module

- MM slot: M212/Leaf module management slot: L101.

D.3.2 Dual Management Modules

- MM slot: M212/Leaf module management slot: L101.
- MM slot: M211/Leaf module management slot: L102.



D.4 12800-360

D.4.1 Single Management Module

- MM slot: M228/Leaf module management slot: L127.

D.4.2 Dual Management Modules

- MM slot: M228/Leaf module management slot: L127.
- MM slot: M227/Leaf module management slot: L128.

§ §

Appendix E FRU Replacement

This section details replacement information for various Intel® 12000 FRUs. For replacement parts, contact Intel or an approved reseller.

Note: If it is part of a standard operating procedure, add replacement identification tags to both the rack and the FRU hardware to ensure that the warranty is transferred to the replacement part(s).

Note: If the FRU being replaced is in an active chassis (that is, hot swapping), please replace the FRU within 2 minutes to maintain thermal integrity.

E.1 Intel 12200

Note: For an externally-managed 12200, refer to the *Intel® True Scale Fabric Suite FastFabric User Guide* for update information.

E.1.1 Chassis Replacement

FRU part numbers:

- Standard chassis: 12200BS01
- Reversed airflow/AC power inlets: 12200BS02

E.1.1.1 Removal Procedures

1. Power down the switch by unplugging AC power.
2. Remove all applicable IB, Ethernet and serial cables. Set these aside for reinstalling the replacement switch.
3. Remove the switch from the rack. Keep all rail hardware installed in the rack.
4. Remove the hat rails from the switch. Set these aside for reinstalling the replacement switch.

E.1.1.2 Replacement Procedures

1. Install the hat rails to the switch.
2. Rack mount the switch in the existing rails on the rack.
3. Connect Ethernet and serial cables (managed 12200 only).
4. Connect AC power.
5. If applicable, change the switch, gateway and subnet mask addresses to a new network address.
6. Cable all applicable IB ports.

E.1.2 Management Card Installation or Replacement

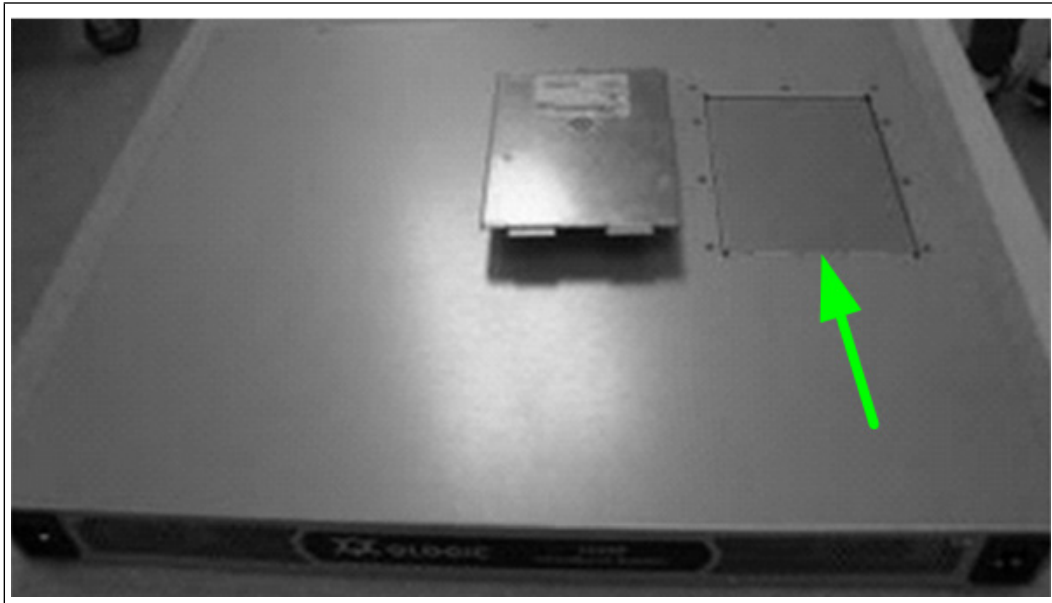
FRU part number:

- 12000MM01 installed in 12200BS01

E.1.2.1 Removal Procedures

1. Power down the switch by unplugging AC power.
2. Remove all applicable IB, Ethernet and Serial cables. Set these aside for reinstalling after replacing the management card.
3. Remove the switch from the rack. Keep all rail hardware installed in the rack.
4. Remove the management card slot cover and set aside the screw to use on the new management card.

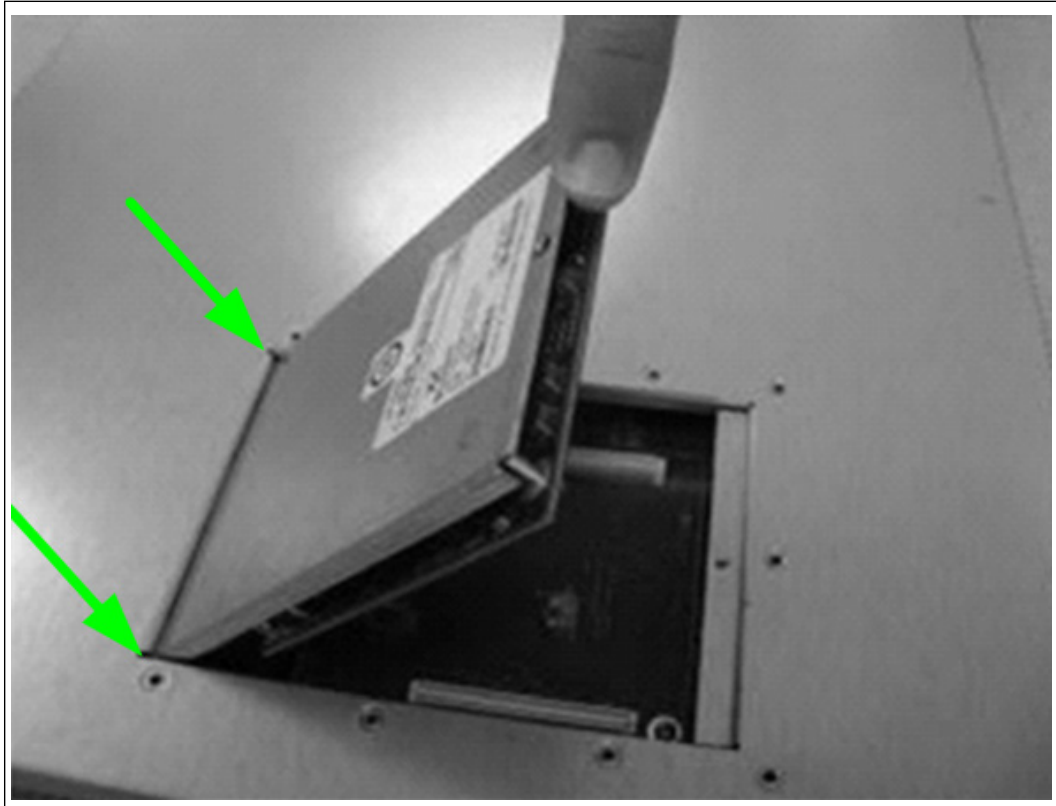
Figure 66. 12200 Management Card Slot Cover



E.1.2.2 Replacement Procedures

1. Insert the management card at the angle displayed in [Figure 67](#) to ensure proper contact with the connectors.

Figure 67. 12200 Management Card Insertion



2. Press down on the management card to ensure that is seated properly.

Figure 68. 12200 Management Card Insertion (2)



3. Complete the replacement by re-inserting the screw as displayed in [Figure 69](#).

Figure 69. 12200 Management Card Insertion (3)

4. Rack mount the switch in the existing rails on the rack.
5. Connect Ethernet and Serial cables.
6. Connect AC power.
7. If applicable, upgrade the switch firmware, and change the switch, gateway and subnet mask addresses to a new network address.
8. Cable all applicable IB ports.

E.2 Intel 12300

E.2.1 Chassis Replacement

FRU part numbers:

- Standard 36-port chassis: 12300BS01
- 12300 18-port chassis: 12300BS18

E.2.1.1 Removal Procedures

1. Power down the switch by unplugging AC power.
2. Remove all applicable IB, Ethernet and serial cables. Set these aside for reinstalling the replacement switch.
3. Remove the switch from the rack. Keep all rail hardware installed in the rack.
4. Remove the hat rails from the switch. Set these aside for reinstalling the replacement switch.

E.2.1.2 Replacement Procedures

1. Install the hat rails to the switch.
2. Rack mount the switch in the existing rails on the rack.
3. Connect Ethernet and serial cables.
4. Connect AC power.
5. Change the switch, gateway and subnet mask addresses to a new network address.
6. Cable all applicable IB ports.

E.2.2 Fan/Power Supply Replacement

FRU part number:

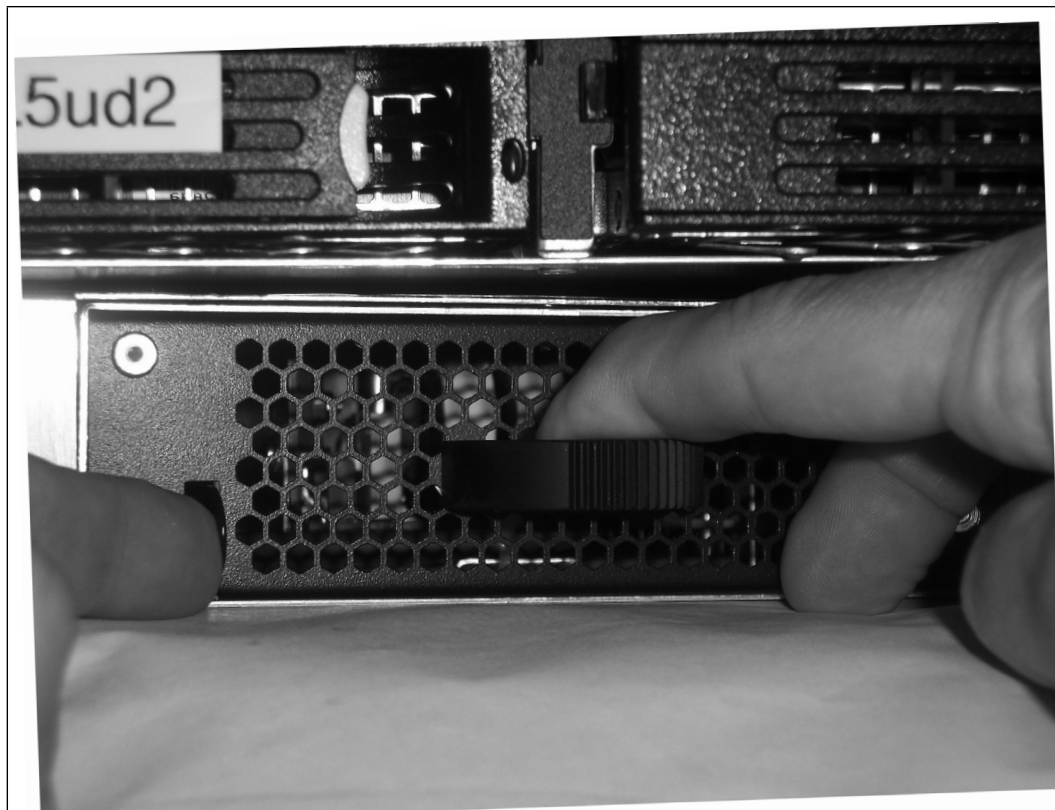
- 12300PS01

Note: These fan/power supplies are to be used exclusively with the Intel® 12300 QDR IB switch and are not intended to be sold separately.

E.2.2.1 Removal Procedures

1. Push the finger tab to the right.
2. While holding the finger tab, pull the module handle to disengage the unit from the switch.

Figure 70. 12300 Fan/Power Module Removal





E.2.2.2 Replacement Procedures

Hold the unit by the handle and slide into the applicable slot until the finger tab clicks into place.

E.3 Intel 12800 Series

E.3.1 Fan Replacement

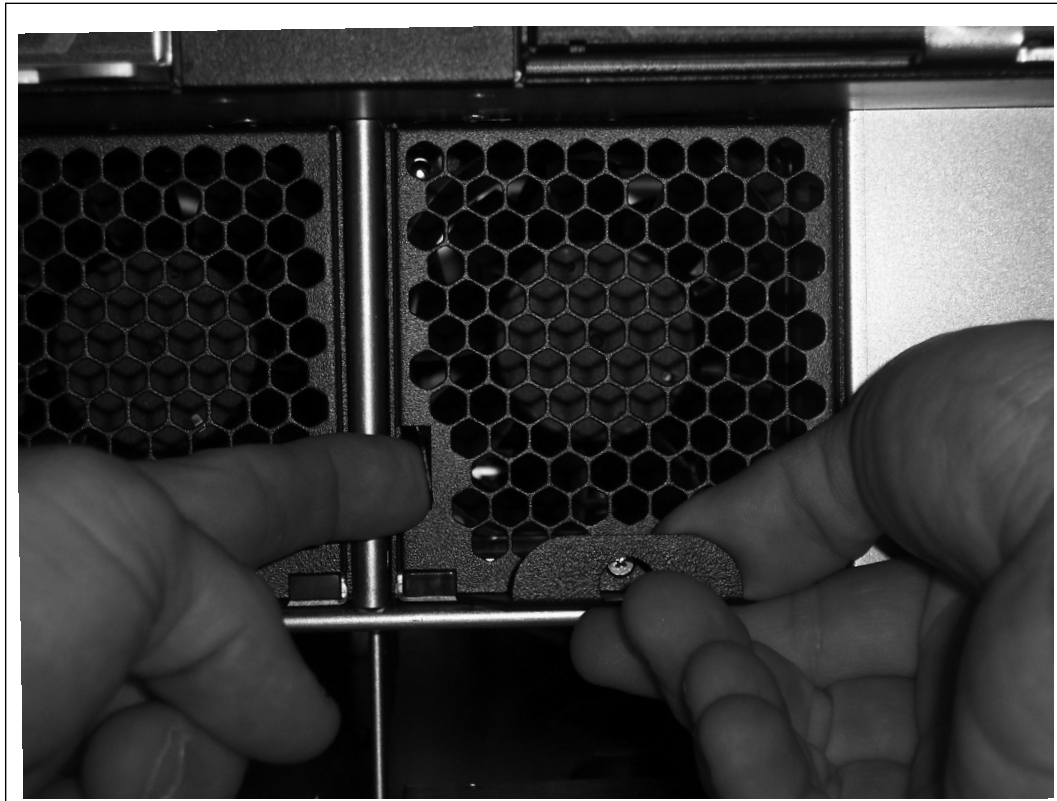
FRU part numbers:

- Intake Fan: 12800FITK
- Exhaust Fan: 12800FEXH

E.3.1.1 Removal Procedures

1. While holding the handle, push the release latch to the right

Figure 71. 12800 Fan Removal



2. Pull the fan by the handle until disengaged from the chassis.
3. Determine whether this is an intake or exhaust fan by checking the FRU label or noting the location of the open notch.

Figure 72. 12800 Intake and Exhaust Fans



E.3.1.2 Replacement Procedures

1. Slide the fan tray straight into the open slot until it engages with the backplane connector.
2. Make sure the fan is operating and the **Status** LED is green.

E.3.2 Power Supply Replacement

FRU part number:

- 12800PS01

Note: These power supplies are to be used exclusively with the Intel® 12800 series QDR IB switches and are not intended to be sold separately.

E.3.2.1 Removal Procedures

1. Push the release latch to release the arm.

**Figure 73. 12800 Power Removal**

2. Carefully pull the supply until it is disengaged from the chassis.

E.3.2.2 Replacement Procedures

1. Slide the power supply straight into the open slot until it engages with the backplane connector.
2. Make sure the supply is operating and the **AC OK** and **DC OK** LEDs are green.

E.3.3 Leaf Module Replacement

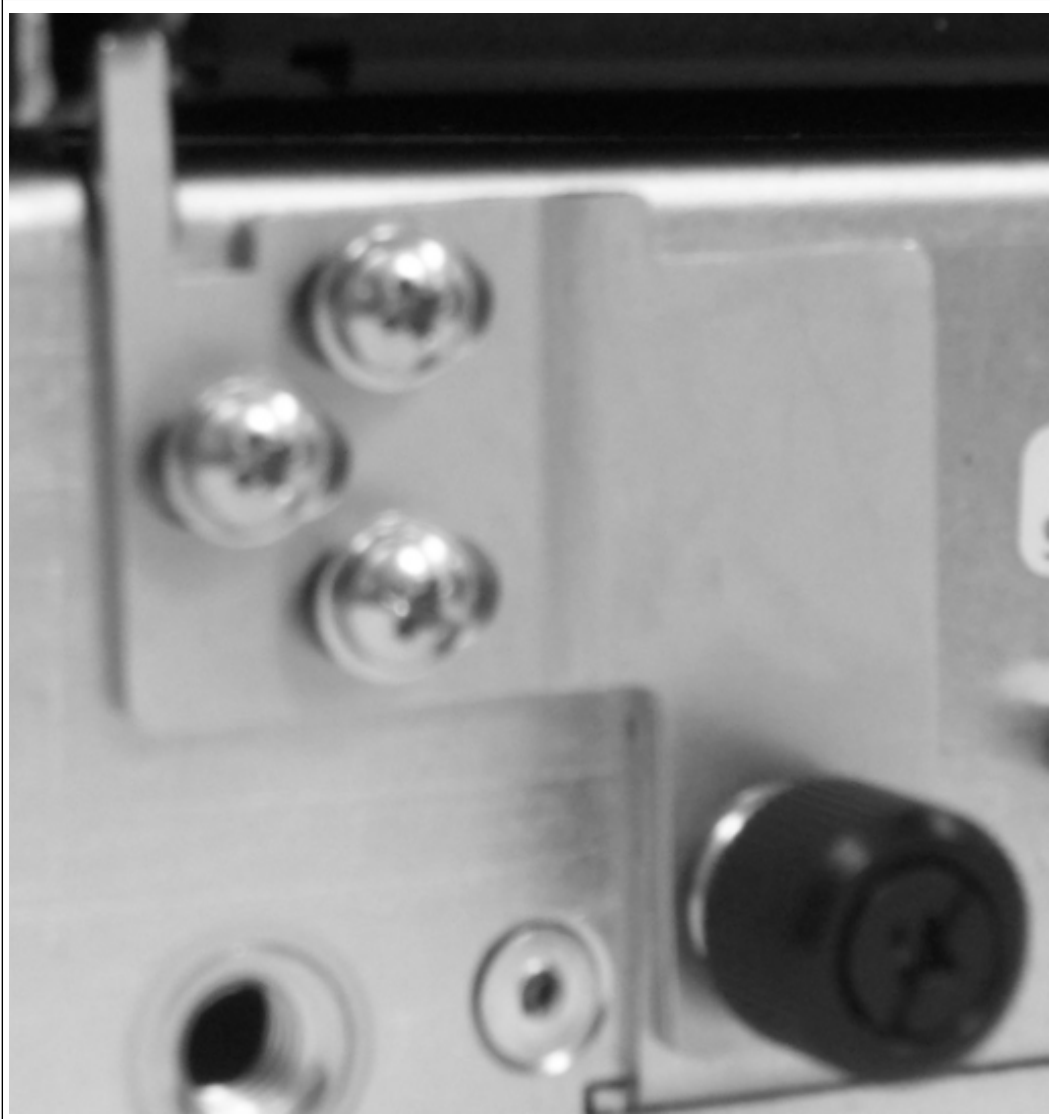
FRU part numbers:

- 18 Port Leaf: 12800LF18
- 24 Port Leaf: 12800LF24

E.3.3.1 Removal Procedures

Note: If the leaf module is in one of the chassis management slots, the mechanical release latch (MRL) must be moved in order to remove the leaf. To move the MRL, loosen the thumbscrew attached to the Serial, Ethernet, Chassis EEPROM Board (SEEB) module, then slide the MRL to the left. This allows enough clearance for leaf module release arm.

Figure 74. MRL



1. Pull each release arm down until the leaf module disengages from the backplane connector.

Figure 75. 12800 Leaf Removal

2. Carefully pull the module out of the chassis.

E.3.3.2 Replacement Procedures

1. Slide the module straight into the open slot until it engages with the backplane connector.
2. Push the arms up until they lock in place.
3. Make sure the module is operating and the **Status** LED is green.

E.3.4 Spine Module Replacement

FRU part numbers:

- Single Spine Module: 12800SPSG01
- Double Spine Module: 12800SPDB01

E.3.4.1 Removal Procedures

1. Pull the release arms out until the spine module disengages from the backplane connector.

Figure 76. 12800 Spine Removal

- Carefully pull the module out of the chassis.

E.3.4.2 Replacement Procedures

- Slide the module straight into the open slot until it engages with the backplane connector.
- Push the arms in until they lock in place.
- Make sure the module is operating and the **Status** LED(s) is green.

E.3.5 Management Module Replacement

FRU part number:

- 12800MM01

E.3.5.1 Removal Procedures

- Loosen the thumbscrew until it releases from the faceplate.
- Pull the release arm out until the management module disengages from the backplane connector.

Figure 77. 12800 Management Module Removal



- Carefully pull the module out of the chassis.

E.3.5.2 Replacement Procedures

- Slide the module straight into the open slot until it engages with the backplane connector.
- Move the release arm in until it locks in place.
- Tighten the thumbscrew.
- Make sure the module is operating and the **Module Status**, **Chassis Status** and **MRL Active** LEDs are green.



Note: The standard FRU replacement process for management modules is one at time. This allows the master module to move to a slave state, if necessary.

Note: Never replace multiple management modules at the same time.

