

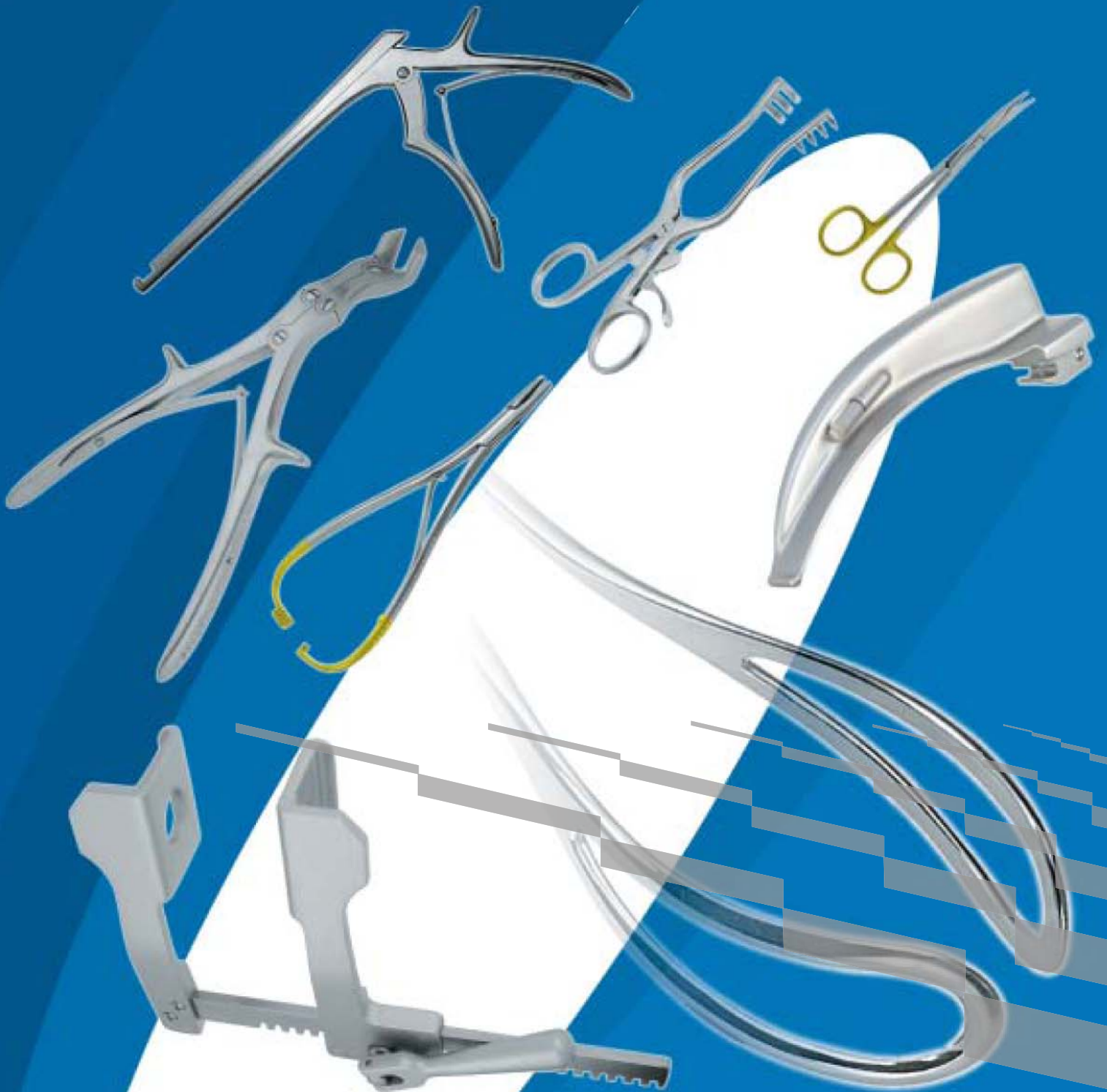

INSTRUMENTE

SURGICAL INSTRUMENTS

CHIRURGIE-INSTRUMENTE
INSTRUMENTS DE CHIRURGIE
INSTRUMENTOS QUIRÚRGICOS
STRUMENTI PER CHIRURGIA



Content

Inhalt
Contenu
Contenido
Contenuto



DIAGNOSTICS

DIAGNOSTIK / DIAGNOSTIC / DIAGNÓSTICO /
DIAGNOSTICA

ANESTHESIA

ANAESTHÉSIE / ANESTHÉSIE / ANESTESIA /
ANESTESIA

SCALPELS, KNIVES

SKALPELLE, MESSER / BISTOURIS, COUTEAUX /
BISTURIES, CUCHILLOS / BISTURI, COLTELLI

SCISSORS

SCHEREN / CISEAUX / TIJERAS / FORBICI

MICRO SCISSORS

MIKRO SCHEREN / MICRO CISEAUX / MICRO TIJERAS /
MICRO FORBICI

THUMB AND TISSUE FORCEPS

PINZETTEN / PINCES À DISECCION / PINZAS DE
DISECCION / PINZE PER DISSEZIONE

HEMOSTATIC FORCEPS

ARTERIENKLEMMEN / PINCES HÉMOSTATIQUES /
PINZAS HEMOSTÁTICAS / PINZE EMOSTATICHE

ATRAUMATIC FORCEPS

ATRAUMATISCHE KLEMMEN / PINCES ATRAUMATIQUE /
PINZAS ATRAUMATICAS / PINZE ATRAUMATICHE

POLYPUS & DRESSING FORCEPS

TUPFER-/KORNZANGEN / PINCES À PANSEMENTS & À
POLYPES / PINZAS PARA PÓLIPOS & ESPONJAS / PINZE
PER POLIPI & PER TAMPONI

RETRACTORS

WUNDHAKEN, / ECARTEURS / SEPARADORES /
DIVARICATORI

PROBES, SPATULAS, APPLICATORS

SONDEN, SPATEL, WATTETRÄGER / SONDAS, SPATULES,
PORTE-COTON / SONDAS, ESPÁTULAS, PORTA-
ALGODÓN / SONDE, SPATOLE, PORTACOTONE

TROCARS, PUNCTURE NEEDLES

TROKARE, PUNKTIONSNADLEN / TROCARTS
AIGUILLES À PONCTION / TRÓCARES, AGUJAS
PARA PUNCIÓN / TREQUARTI, AGHI DA PUNZIONE

NEEDLE HOLDERS

NADLHALTER / PORTE-AIGUILLES / PORTA-AGUJAS /
PORT'AGHI

SUTURE

NAHT / SUTURE / SUTURA / SUTURA

STERILIZING AIDS

STERILISIERHILFEN / INSTRUMENTS POUR
STÉRILISATION / AUXILIOS PARA LA ESTERILIZACIÓN
UTENSILI PER LA STERILIZZAZIONE

PLASTER OF PARIS

GIPSVERBAND / BANDAGES PLÂTRÉS / VENDAJES
ENYESADOS / BENDAGGI GESSATI

BONE SURGERY, OSTEOSYNTHESIS

ORTHOPÄDIE, OSTEOSYNTHESE / CHIRURGIE OSSEUSE,
OSTÉOSYNTHESE / CIRUGIA ÓSEA, OSTEOSINTESIS /
CHIRURGIA OSSEA, OSTEOSINTESI

AC NEUROSURGERY, LAMINECTOMY EA
NEUROCHIRURGIE, LAMINEKTOMIE / NEUROCHIRURGIE,
LAMINECTOMIE / NEUROCIURUGIA, LAMINECTOMIA /
NEUROCHIRURGIA, LAMINECTOMIA

AE OPHTHALMOLOGY EC - ED
OPHTHALMOLOGIE / OPHTALMOLOGIE /
OFTALMOLOGIA / OFTALMOLOGIA

AG OTOLOGY EE
OTOLOGIE / OTOLOGIE / OTOLOGIA / OTOLOGIA

AH - AI RHINOLOGY EG
RHINOLOGIE / RHINOLOGIE / RINOLOGIA / RINOLOGIA

AJ MOUTH & TONGUE EI
MUND & ZUNGE / BOUCHE & LANGUE /
BOCA & LENGUA / BOCCA & LINGUA

BA - BB TONSILS FA
TONSILLEN / AMYGDALES / AMIGDALAS / TONSILLE

BC LARYNX FC
KEHLKOPF / LARYNX / LARINGE / LARINGE

BD TRACHEOSTOMY, GOITRE FE
TACHEOTOMIE, KROPF / TRACHÉOTOMIE, GOITRE /
TRAQUEOTOMIA, BOCIO / TRACHEOTOMIA, GOZZO

BG THORAX FG
THORAX / THORAX / TÓRAX / TORACE

BH GALL BLADDER, KIDNEY GC
GALLE, NIERE / VESICULE BILIAIRE, REIN / VESICULA
BILIAR, RIÑÓN / VESICOLA BILIAIRE, RENE

BI INTESTINES, STOMACH GE
DARM, MAGEN / INTESTIN, ESTOMAC /
INTESTINES, ESTÓMAGO / INTESTINI, STOMACO

CA UROLOGY GG
UROLOGIE / UROLOGIE / UROLOGIA / UROLOGIA

CG RECTUM GI
MASTDARM / RECTUM / RECTO / RETTO

CC GYNECOLOGY HA
GYNÄKOLOGIE / GYNÉCOLOGIE / GINECOLOGIA /
GINECOLOGIA

CE OBSTETRICS HC
GEBURTSHILFE / OBSTÉTRIQUE / OBSTETRICIA /
OSTERICIA

CG DERMATOLOGY, HYGIENE HE
DERMATOLOGIE, HYGIENE / DERMATOLOGIE,
HYGIÈNE / DERMATOLOGIA, HIGIENE /
DERMATOLOGIA, IGIENE

CI DENTAL INSTRUMENTS IA-III
DENTAL INSTRUMENTE / INSTRUMENTS DENTAIRE /
INSTRUMENTOS DE ODONTOLOGIA / STRUMENTI
DENTALI

DA DIFFERENT CONTAINERS II
VERSCH. BEHÄLTER / BOÎTES DIVERSES / CONTENEDORES
VARIOS / VASSOI DIVERSI

DC - DG HIGH FREQUENCY SURGERY JA
HOCHFREQUENZ-CHIRURGIE / CHIRURGIE À HAUTE
FRÉQUENCE / ELECTROCIRUGIA/ ELETTRICIRURGIA

D - I INDEX D - I
INHALTSVERZEICHNIS / INDEX / INDICE / INDICE



Gerades Instrument
Straight Instrument
Instrument droit
Instrumento recto
Strumento retto



Gebogenes Instrument
Curved Instrument
Instrument courbe
Instrumento curvo
Strumento curvo



Scharfes Instrument
Sharp Instrument
Instrument pointu
Instrumento agudo
Strumento acuto



Stumpfes Instrument
Blunt Instrument
Instrument mousse
Instrumento romo
Strumento smusso

Mit TC-Einsätzen
TC Lined
A mors TC
Con bocas TC
Con morso TC

Mit TC-Schneiden
TC Cutting Edges
Tanchant TC
Filos de corte TC
Taglio TC

Instrument aus Titan
Instrument from Titanium
Instrument en Titane
Instrumento de Titanio
Strumento in Titanio



SuperCut Scheren
SuperCut Scissors
SuperCut Ciseaux
SuperCut Tijeras
SuperCut Forbici

AC

Diagnostik
Diagnostics
Diagnostic
Diagnóstico
Diagnostica



AC

AC

Blutdruckmessapparate
Blood Pressure Apparatus
Tensiometres
Esfigmomanómetros
Sfigmomanometri



AC-012-00
compl.



Econom
AC-110-00

AC-112-00
compl.



AC-212-00
compl.



AC-312-00
compl.



COLLIN
AC-410-01 Erwachsene • Adult
AC-410-02 Kinder • Child • enfant
niños • bambini



AC-417-00



VARIFOCAL
AC-610-00



MAY
AC-612-00



AC

Diagnostik-Bestecke
Diagnostic Sets
Trousse à diagnostic
Juegos para diagnóstico
Astucci per diagnostica



AC-710-00
Combination



AC-713-00
Econom Universal



AC-714-00
Otoskop • Otoposcope • Otoscopio

Stirnspiegel, Stirnlampen
 Head Mirrors, Head Lights
 Miroirs, lampes frontales
 Espejos, lámparas frontales
 Riflettori, lampade frontali

AC

Stirnlampen
 Head Lights
 Lampes frontales
 Lámparas frontales
 Lampade frontali



ZIEGLER
AC-810-90
 compl.



AC-810-91



AC-810-92

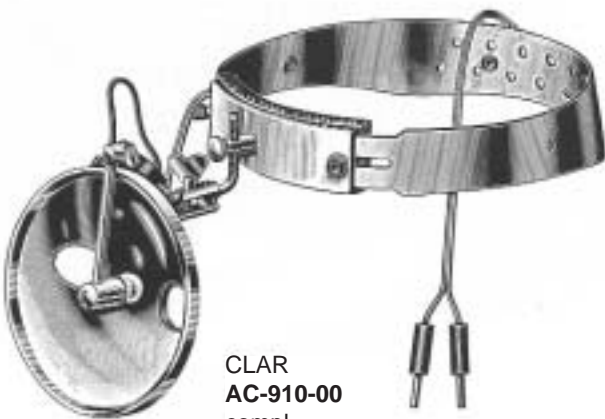

CLAR
AC-910-00
 compl.
 6 V.



AC-910-01



AC-915-00
 compl.
 6 V.

AC-020-00
 compl.
 Halogen



AC-915-01



6 Volt
AC-919-06

AC

Stethoskope
Stethoscopes
Stéthoscopes
Estetoscopios
Stetoscopi



**BOWLES
AC-420-00**



**FORD
AC-422-00**



**DUPLEX
AC-426-00**



**PINARD
AC-620-15
15 cm**



**PINARD
AC-622-18
18 cm**



cm TAYLOR
 17 AC-828-17
 20 AC-828-20



TRAUBE
 AC-920-16



BABINSKY
 AC-922-22
 22 cm



TROEMNER
 AC-924-24
 24 cm



DEJERINE
 AC-032-20



DEJERINE
 AC-034-20



BERLINER
 AC-036-17



BUCK
 AC-038-18

Schädel-Messzirkel
Cephalometer
Céphalomètre
Cefalómetro
Cefalometro



BERTILLON
AC-130-01

Winkelmesser
Goniometer
Goniomètre
Goniómetro
Goniometro



MOELTGEN
AC-132-01



Nadelrad
Pinwheel
Algesimetre
Rueda de espigas
Algesimetro

WARTENBERG
AC-230-19
19 cm

Metall Meßstäbe
Rulers, metal
Règles en métal
Reglas de metal
Regoli in acciaio



cm	inch.	
10	4	AC-430-10
20	8	AC-430-20
30	12	AC-430-30
50	20	AC-430-50



AC-434-15
15 cm

Maßband, Stahl
Tape measure, steel
Ruban métrique en acier
Cinta métrica de acero
Nastro metrico di acciaio



AC-530-15
1,5 m

AE

**Anaesthesia
Anesthesia
Anesthésie
Anestesia
Anestesia**



AE



POOLE
AE-310-10
ø 10 mm (30 Charr.)



POOLE
AE-410-06 ø 6 mm (18 Charr.)
AE-410-08 ø 8 mm (23 Charr.)

AE-510-98

Saugspitze
Suction Tip
Pointe de succion
Cabezal para aspiración
Punta per aspirazione

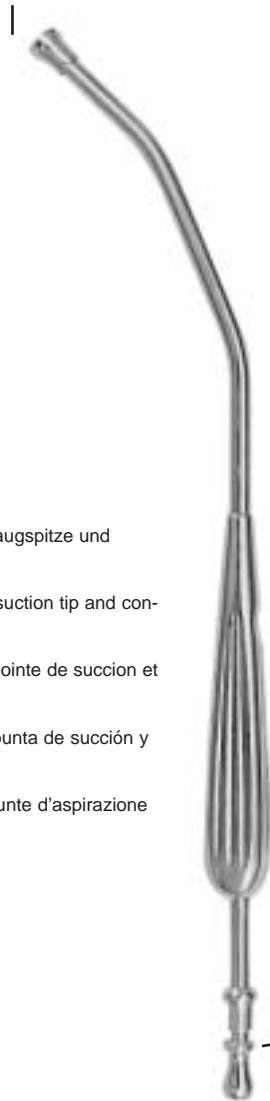

komplett mit Saugspitze und
Schlaucholive

complete with suction tip and con-
nector

complet avec pointe de succion et
raccord

completo con punta de succión y
conector

completi con punte d'aspirazione
e raccordo

AE-510-99

Schlaucholive
Olive
Olive
Oliva
Oliva

YANKAUER
AE-510-27
27 cm



ANDREW-PYNCHON
AE-511-24
ø 6 mm (18 Charr.)
23 cm



WALTON YANKAUER
AE-512-33
ø 10 mm (30 Charr.)
32 cm

mit Absperrventil und
abschraubbarem Rohr

with stopcock and tube
to be screwed off

avec robinet et canule
extérieure démontable

con interruptor y tubo
desenroscable

con interruttore e tubo
svitabile

Saugkanülen mit Unterbrecher und Mandrin
Suction Cannulae with finger cut-off and stylet
Canules d'aspiration avec interrupteur à doigt
Cánulas para aspiración con interruptor y estilete
Cannule per aspirazione con interruttore e stiletto

Saugspitze ø 5 mm
Suction Tip ø 5 mm
Pointe de succion ø 5 mm
Cabezal para aspiración ø 5 mm
Punta per aspirazione ø 5 mm



Schlaucholive ø 9 mm
Olive ø 9 mm
Olive ø 9 mm
Oliva ø 9 mm
Oliva ø 9 mm

cm	DE BAKEY
16	AE-514-16
26	AE-514-26



cm	DE BAKEY
28	AE-514-27



AE-515-99
Mandrin
Stylet
Doigt
Esfilete
Stiletto

cm	MAGILL	
24,5	AE-515-30	Fig. 1, ø 3,0 mm
24,5	AE-515-35	Fig. 2, ø 3,5 mm
24,5	AE-515-40	Fig. 3, ø 4,0 mm

Saug- und Spülkanüle
Suction and Irrigation Cannula
Canules d'aspiration et d'irrigation
Cánulas para aspiración e irrigación
Cannule per aspirazione e irrigazione



FINSTERER
AE-518-00
32 cm

runde Öffnung
round opening
ouverture ronde
abertura redonda
apertura retonda



ø 6 mm

NUBOER
AE-610-21
21 cm

ovale Öffnung
oval opening
ouverture ovale
abertura ovalada
apertura ovale



ø 6 mm

NUBOER
AE-611-21
21 cm

AE

Kathetereinführzangen
Catheter Introduction Forceps
Pinces pour introduire les sondes
Pinzas para catéteres
Pinze per introdurre le sonde



AE-910-17
für Kleinkinder
for babies
pour nourrissons
para neonatales
per neonati



AE-910-20
für Kinder
for children
pour enfants
para niños
per bambini



AE-910-25
für Erwachsene
for adults
pour adultes
para adultos
per adulti

cm	MAGILL
17	AE-910-17
20	AE-910-20
25	AE-910-25

Laryngoskope
Laryngoscope
Laryngoscope
Laringoscopio
Laringoscopio



Faseroptik-Laryngoskope **Sigma Lite**
Fiber Optic Laryngoscope **Sigma Lite**
Laryngoscope à fibres optiques **Sigma Lite**
Laringoscopio fibra optica **Sigma Lite**
Laringoscopio a fibre ottiche **Sigma Lite**

Sigma Lite ist unser Faseroptik- Laryngoskopsystem.

Die Spatel des Faseroptik-Laryngoskopsystems enthalten weder die Glühlampe noch die elektrischen Anschlüsse. Die Glühlampe befindet sich im Batteriegriff. Licht von der Glühlampe wird über Lichtwellenleiterbündel übertragen und tritt an der Spitze des Spatels nach außen.

Wir stellen die komplette Produktpalette faseroptischer MACINTOSH- und MILLER-Spatel her. Die Griffe sind je nach Kundenwunsch in kleineren und mittleren Größen erhältlich.

Sigma Lite Laryngoskopgriffe werden gemäß ISO 7376-3: 1996 hergestellt.

Sigma Lite Laryngoskopspatel

- mit 4 mm Faserbündel ausgestattet, um eine bessere Beleuchtung der Spatelspitze zu gewährleisten.
- sind mit polierten Faserenden für bestmögliche Beleuchtung versehen.
- werden aus nicht magnetischem rostfreien Stahl hergestellt.
- vollständig autoklavierbar.

Sigma Lite is our fiber optic laryngoscope system.

Blades in fiber optic laryngoscope system do not contain the bulb or electrical connections. The bulb is incorporated in the battery handle. Light from the bulb is transmitted through fiber optic bundles, and exits at the tip of the blade.

We manufacture complete range of fiber optic MACINTOSH and MILLER blades. Handles are available in small & medium sizes to suit customer requirements.

Sigma Lite laryngoscope handles are made according to ISO 7376-3: 1996.

Sigma Lite laryngoscope blades

- incorporate 4 mm fiber bundle for more light
- have polished fiber ends for maximum illumination
- are manufactured from non-magnetic stainless steel
- are fully autoclavable

Sigma Lite est notre système de laryngoscope à fibres optiques.

Les spatules du système de laryngoscope à fibres optiques ne contiennent ni l'ampoule, ni les connexions électriques. L'ampoule se trouve dans le manche de la batterie. La lumière de l'ampoule est transmise par les faisceaux des fibres optiques et ressort à l'avant de la spatule.

Nous produisons la palette complète des spatules à fibres optiques MACINTOSH et MILLER. Le client peut obtenir, selon souhait, des manches de petites ou grandes tailles.

Les manches du laryngoscope **Sigma Lite** sont fabriqués selon la norme ISO 7376-3: 1996.

Spatules du laryngoscope **Sigma Lite**

- sont équipées d'un faisceau optique de 4 mm afin d'assurer un meilleur éclairage de la pointe de la spatule
- sont pourvues de fibres polies au bout pour assurer un éclairage optimum
- sont fabriquées dans un acier inoxydable et non magnétique
- sont entièrement utilisables avec autoclave

Sigma Lite es nuestro sistema laringoscopio de fibra óptica.

Las espátulas del sistema laringoscopio de fibra óptica no contienen bombillas ni conexiones eléctricas. La bombilla está ubicada en el mango con baterías. La luz de la bombilla es transmitida a través del haz de fibras ópticas y sale por la punta de la espátula.

Producimos la gama completa de espátulas fibroópticas MACINTOSH y MILLER. Los mangos son disponibles en tamaños pequeños y medianos según el deseo del cliente.

Los mangos **Sigma Lite** para laringoscopios se producen conforme a la norma ISO 7376-3, 1996.

Las espátulas **Sigma Lite** para laringoscopios

- están equipadas con haces fibroópticas de 4 mm para asegurar una mejor iluminación de la punta de la espátula
- están provistas de fibras con extremos pulidos para lograr la mejor iluminación posible
- se hacen de acero inoxidable no magnético
- pueden ser tratados completamente en autoclave

Sigma Lite è il nostro sistema per laringoscopi a fibre ottiche.

Le spatole del sistema per laringoscopi a fibre ottiche non contengono né la lampadina a incandescenza, né i collegamenti elettrici. La lampadina si trova nel manico che contiene le batterie. La luce della lampadina a incandescenza viene trasmessa da un fascio di fibre ottiche e fuoriesce dalla punta della spatola.

Noi produciamo l'intera gamma di spatole a fibre ottiche MACINTOSH e MILLER. I manici sono disponibili in base ai desideri del cliente di dimensioni piccole o medie.

I manici dei laringoscopi **Sigma Lite** vengono prodotti in conformità alle norme ISO 7376-3: 1996.

Le spatole per laringoscopi **Sigma Lite**

- sono dotate di fasci di fibre da 4 mm, per garantire una migliore illuminazione della punta della spatola.
- sono dotate di estremità delle fibre lucidate per ottenere la migliore illuminazione possibile
- vengono prodotte in acciaio inossidabile non magnetico
- sono completamente trattabili con autoclave

Für Anästhesisten, die lieber das Standardsystem verwenden, bieten wir unser **Delta Lite** Laryngoskop an.
Die **Delta Lite** Produktreihe umfaßt alle Größen von MACINTOSH- und MILLER-Spateln mit Griffen in kleineren, mittleren, kurzen und großen Größen.

Delta Lite Laryngoskope und Griffe entsprechen EN 1819:1997.

Die Kontakte zu der Glühlampe in den **Delta Lite** Laryngoskopspateln sind mit Gold plattiert. Der federverspannte Kontakt zur Glühlampe sowie die Verdrahtung befinden sich in einer Röhre aus rostfreiem Stahl, die Teil des Spatels ist. Dadurch kann eine größtmögliche Zuverlässigkeit des elektrischen Kontakts garantiert werden.

For the anaesthetist who prefers using conventional system, we have our **Delta Lite** laryngoscope. **Delta Lite** range includes all sizes of MACINTOSH and MILLER blades along with handles in small, medium, large & stubby sizes.

Delta Lite laryngoscope handles conform to EN 1819:1997.

Delta Lite laryngoscope blades have gold plated contact to the bulb. The spring loaded contact to the bulb and wiring is incorporated in stainless steel tube, which forms part of the blade. This ensures maximum reliability of the electrical contact.

Pour les anesthésistes qui préfèrent se servir d'un système standard, nous proposons notre laryngoscope **Delta Lite**. La série de produits **Delta Lite** comprend toutes les tailles des spatules MACINTOSH et MILLER, avec des manches de petite, moyenne, courte et grande taille.

Les manches du laryngoscope **Delta Lite** correspondent à la norme EN 1819:1997.

Les contacts de l'ampoule dans les laryngoscopes **Delta Lite** sont plaqués avec de l'or. Le contact à ressort de l'ampoule, de même que le câblage, se trouvent dans un tube à acier inoxydable qui fait parti de la spatule. Ainsi, une fiabilité maximale du contact électrique peut être garantie.

Para los anestésistas que prefieren usar los sistemas convencionales tenemos el laringoscopio **Delta Lite**.

La gama de productos **Delta Lite** abarca todos los tamaños de espátulas MACINTOSH y MILLER con mangos en tamaños pequeños, medianos, cortos y grandes.

Los mangos **Delta Lite** para laringoscopios cumplen la norma EN 1819:1997.

Los contactos de las espátulas **Delta Lite** del laringoscopio para conectar la bombilla están recubiertos de oro. El contacto de muelle para conectar la bombilla así como el cableado están ubicados en un tubo de acero inoxidable que forma parte de la espátula. Así es posible garantizar la mayor fiabilidad posible del contacto eléctrico.

Per gli anestesisti che preferiscono utilizzare il sistema standard offriamo il nostro laringoscopio **Delta Lite**.

La serie **Delta Lite** comprende tutte le dimensioni di spatole MACINTOSH e MILLER con manici piccoli, medi, corti e grandi.

I manici dei laringoscopi **Delta Lite** sono conformi alle norme EN 1819:1997.

I contatti della lampadina a incandescenza nelle spatole dei laringoscopi **Delta Lite** sono placcati in oro. Il contatto con molla sotto carico della lampadine a incandescenza così come i cavi sono collocati in un condotto di acciaio inossidabile che è parte della spatola. Ciò consente di garantire la massima affidabilità del contatto elettrico.

Sigma Lite Faseroptik Spatel
 Sigma Lite fibreoptic blades

Größe Size Taille Tamaño Misura	Arbeitslänge (mm) Working Length (mm) Longueur de travail (mm) Largo de trabajo (mm) Lunghezza di lavoro (mm)	Seidenmatt Satin finish mat satinada opaca
0	55	AE-630-00S
1	70	AE-630-01S
2	78	AE-630-02S
2A	90	AE-631-02S
3	108	AE-630-03S
4	133	AE-630-04S
5	150	AE-631-05S



Sigma Lite Faseroptik Spatel mit auswechselbarem Lichtleiter
 Sigma Lite fibreoptic blades with interchangeable fibreoptic light guide

Größe Size Taille Tamaño Misura	Arbeitslänge (mm) Working Length (mm) Longueur de travail (mm) Largo de trabajo (mm) Lunghezza di lavoro (mm)	Glänzend Mirror finish brillant pulida lucida	Seidenmatt Satin finish mat satinada opaca
0	55	AE-030-00M	AE-030-00S
1	70	AE-030-01M	AE-030-01S
2	78	AE-030-02M	AE-030-02S
2A	90	AE-031-02M	AE-031-02S
3	108	AE-030-03M	AE-030-03S
4	133	AE-030-04M	AE-030-04S
5	150	AE-031-05M	AE-031-05S



Delta Lite Standard Spatel
 Sigma Lite conventional blades

Größe Size Taille Tamaño Misura	Arbeitslänge (mm) Working Length (mm) Longueur de travail (mm) Largo de trabajo (mm) Lunghezza di lavoro (mm)	Glänzend Mirror finish brillant pulida lucida	Seidenmatt Satin finish mat satinada opaca
0	55	AE-230-00M	AE-230-00S
1	70	AE-230-01M	AE-230-01S
2	78	AE-230-02M	AE-230-02S
2A	90	AE-231-02M	AE-231-02S
3	108	AE-230-03M	AE-230-03S
4	133	AE-230-04M	AE-230-04S
5	150	AE-231-05M	AE-231-05S



Sigma Lite Faseroptik Spatel
Sigma Lite fibreoptic blades

Größe	Arbeitslänge (mm)	Seidenmatt
Size	Working Length (mm)	Satin finish
Taille	Longueur de travail (mm)	mat
Tamaño	Largo de trabajo (mm)	satinada
Misura	Lunghezza di lavoro (mm)	opaca

0	65	AE-634-00S
1	66	AE-634-01S
2	86	AE-634-02S
3	107	AE-634-03S
3.5	123	AE-634-09S
4	134	AE-634-04S

Sigma Lite Faseroptik Spatel mit auswechselbarem Lichtleiter
Sigma Lite fibreoptic blades with interchangeable fibreoptic light guide

Größe	Arbeitslänge (mm)	Glänzend	Seidenmatt
Size	Working Length (mm)	Mirror finish	Satin finish
Taille	Longueur de travail (mm)	brillant	mat
Tamaño	Largo de trabajo (mm)	pulida	satinada
Misura	Lunghezza di lavoro (mm)	lucida	opaca

0	65	AE-034-00M	AE-034-00S
1	66	AE-034-01M	AE-034-01S
2	86	AE-034-02M	AE-034-02S
3	107	AE-034-03M	AE-034-03S
3.5	123	AE-034-09M	AE-034-09S
4	134	AE-034-04M	AE-034-04S

Delta Lite Standard Spatel
Sigma Lite conventional blades

Größe	Arbeitslänge (mm)	Glänzend	Seidenmatt
Size	Working Length (mm)	Mirror finish	Satin finish
Taille	Longueur de travail (mm)	brillant	mat
Tamaño	Largo de trabajo (mm)	pulida	satinada
Misura	Lunghezza di lavoro (mm)	lucida	opaca

0	65	AE-234-00M	AE-234-00S
1	66	AE-234-01M	AE-234-01S
2	86	AE-234-02M	AE-234-02S
3	107	AE-234-03M	AE-234-03S
3.5	123	AE-234-09M	AE-234-09S
4	134	AE-234-04M	AE-234-04S



Sigma Lite Faseroptik Spatel
 Sigma Lite fibreoptic blades

Größe Size Taille Tamaño Misura	Arbeitslänge (mm) Working Length (mm) Longueur de travail (mm) Largo de trabajo (mm) Lunghezza di lavoro (mm)	Seidenmatt Satin finish mat satinada opaca
3	133	AE-635-03S
4	150	AE-635-04S



Sigma Lite Faseroptik Spatel mit auswechselbarem Lichtleiter
 Sigma Lite fibreoptic blades with interchangeable fibreoptic light guide

Größe Size Taille Tamaño Misura	Arbeitslänge (mm) Working Length (mm) Longueur de travail (mm) Largo de trabajo (mm) Lunghezza di lavoro (mm)	Glänzend Mirror finish brillant pulida lucida	Seidenmatt Satin finish mat satinada opaca
3	133	AE-035-03M	AE-035-03S
4	150	AE-035-04M	AE-035-04S



Delta Lite Standard Spatel
 Sigma Lite conventional blades

Größe Size Taille Tamaño Misura	Arbeitslänge (mm) Working Length (mm) Longueur de travail (mm) Largo de trabajo (mm) Lunghezza di lavoro (mm)	Glänzend Mirror finish brillant pulida lucida	Seidenmatt Satin finish mat satinada opaca
3	133	AE-235-03M	AE-235-03S
4	150	AE-235-04M	AE-235-04S



Laryngoskope **MACINTOSH** Spatel mit integriertem Lichtleiteraustritt und mit flexibler Spitze
 Laryngoscope **MACINTOSH** Blades with integrated light guide and with flexible tip
 Laryngoscope **MACINTOSH**
 Laryngoscopio **MACINTOSH**
 Laringoscopio **MACINTOSH**

AE

Sigma Lite Faseroptik Spatel
 Sigma Lite fibreoptic blades

Größe Size Taille Tamaño Misura	Arbeitslänge (mm) Working Length (mm) Longueur de travail (mm) Largo de trabajo (mm) Lunghezza di lavoro (mm)	Seidenmatt Satin finish mat satinada opaca
0	58	AE-636-00S
1	72	AE-636-01S
2	88	AE-636-02S
3	112	AE-636-03S
4	131	AE-636-04S
5	148	AE-636-05S



MACINTOSH Spatel mit integriertem Lichtleiteraustritt
MACINTOSH Blades with integrated light guide

Sigma Lite Faseroptik Spatel
 Sigma Lite fibreoptic blades

Größe Size Taille Tamaño Misura	Arbeitslänge (mm) Working Length (mm) Longueur de travail (mm) Largo de trabajo (mm) Lunghezza di lavoro (mm)	Seidenmatt Satin finish mat satinada opaca
2	87	AE-034-02S
3	110	AE-034-03S
4	130	AE-034-04S
5	150	AE-034-05S



MACINTOSH Spatel mit flexibler Spitze
MACINTOSH Blades with flexible tip

AE

Laryngoskope **MACINTOSH** Spatel mit spezieller Biegung
Laryngoscope **MACINTOSH** Blades with special curvature
Laryngoscope **MACINTOSH**
Laryngoscopio **MACINTOSH**
Laringoscopio **MACINTOSH**

Delta Lite Standard Spatel
Sigma Lite conventional blades

Größe	Arbeitslänge (mm)	Seidenmatt
Size	Working Length (mm)	Satin finish
Taille	Longueur de travail (mm)	mat
Tamaño	Largo de trabajo (mm)	satinada
Misura	Lunghezza di lavoro (mm)	opaca
0	76	AE-340-00S
1	86	AE-340-01S
2	96	AE-340-02S
3	108	AE-340-03S
4	138	AE-340-04S



MACINTOSH Spatel mit spezieller Biegung
MACINTOSH Blades with special curvature

Sigma Lite Faseroptik Spatel
 Sigma Lite fibreoptic blades

Größe	Arbeitslänge (mm)	Seidenmatt
Size	Working Length (mm)	Satin finish
Taille	Longueur de travail (mm)	mat
Tamaño	Largo de trabajo (mm)	satinada
Misura	Lunghezza di lavoro (mm)	opaca

00	45	AE-730-09S
0	55	AE-730-00S
1	80	AE-730-01S
2	130	AE-730-02S
3	170	AE-730-03S
4	180	AE-730-04S



Sigma Lite Faseroptik Spatel mit auswechselbarem Lichtleiter
 Sigma Lite fibreoptic blades with interchangeable fibreoptic light guide

Größe	Arbeitslänge (mm)	Glänzend	Seidenmatt
Size	Working Length (mm)	Mirror finish	Satin finish
Taille	Longueur de travail (mm)	brillant	mat
Tamaño	Largo de trabajo (mm)	pulida	satinada
Misura	Lunghezza di lavoro (mm)	lucida	opaca

00	45	AE-130-09M	AE-130-09S
0	55	AE-130-00M	AE-130-00S
1	80	AE-130-01M	AE-130-01S
2	130	AE-130-02M	AE-130-02S
3	170	AE-130-03M	AE-130-03S
4	180	AE-130-04M	AE-130-04S



Delta Lite Standard Spatel
 Sigma Lite conventional blades

Größe	Arbeitslänge (mm)	Glänzend	Seidenmatt
Size	Working Length (mm)	Mirror finish	Satin finish
Taille	Longueur de travail (mm)	brillant	mat
Tamaño	Largo de trabajo (mm)	pulida	satinada
Misura	Lunghezza di lavoro (mm)	lucida	opaca

00	45	AE-330-09M	AE-330-09S
0	55	AE-330-00M	AE-330-00S
1	80	AE-330-01M	AE-330-01S
2	130	AE-330-02M	AE-330-02S
3	170	AE-330-03M	AE-330-03S
4	180	AE-330-04M	AE-330-04S



Sigma Lite Faseroptik Spatel
Sigma Lite fibreoptic blades

Größe	Arbeitslänge (mm)	Seidenmatt
Size	Working Length (mm)	Satin finish
Taille	Longueur de travail (mm)	mat
Tamaño	Largo de trabajo (mm)	satinada
Misura	Lunghezza di lavoro (mm)	opaca

0	55	AE-731-00S
1	80	AE-731-01S
2	132	AE-731-02S
3	172	AE-731-03S
4	182	AE-731-04S



Delta Lite Standard Spatel
Sigma Lite conventional blades

Größe	Arbeitslänge (mm)	Glänzend	Seidenmatt
Size	Working Length (mm)	Mirror finish	Satin finish
Taille	Longueur de travail (mm)	brillant	mat
Tamaño	Largo de trabajo (mm)	pulida	satinada
Misura	Lunghezza di lavoro (mm)	lucida	opaca

0	55	AE-331-00M	AE-331-00S
1	80	AE-331-01M	AE-331-01S
2	132	AE-331-02M	AE-331-02S
3	172	AE-331-03M	AE-331-03S
4	182	AE-331-04M	AE-331-04S



Sigma Lite Faseroptik Spatel
 Sigma Lite fibreoptic blades

Größe	Arbeitslänge (mm)	Seidenmatt
Size	Working Length (mm)	Satin finish
Taille	Longueur de travail (mm)	mat
Tamaño	Largo de trabajo (mm)	satinada
Misura	Lunghezza di lavoro (mm)	opaca
1	71	AE-732-01S
2	90	AE-732-02S
3	110	AE-732-03S
4	137	AE-732-04S



Sigma Lite Faseroptik Spatel mit auswechselbarem Lichtleiter
 Sigma Lite fibreoptic blades with interchangeable fibreoptic light guide

Größe	Arbeitslänge (mm)	Glänzend	Seidenmatt
Size	Working Length (mm)	Mirror finish	Satin finish
Taille	Longueur de travail (mm)	brillant	mat
Tamaño	Largo de trabajo (mm)	pulida	satinada
Misura	Lunghezza di lavoro (mm)	lucida	opaca
1	71	AE-132-01M	AE-132-01S
2	90	AE-132-02M	AE-132-02S
3	110	AE-132-03M	AE-132-03S
4	137	AE-132-04M	AE-132-04S



Delta Lite Standard Spatel
 Sigma Lite conventional blades

Größe	Arbeitslänge (mm)	Glänzend	Seidenmatt
Size	Working Length (mm)	Mirror finish	Satin finish
Taille	Longueur de travail (mm)	brillant	mat
Tamaño	Largo de trabajo (mm)	pulida	satinada
Misura	Lunghezza di lavoro (mm)	lucida	opaca
1	71	AE-332-01M	AE-332-01S
2	90	AE-332-02M	AE-332-02S
3	110	AE-332-03M	AE-332-03S
4	137	AE-332-04M	AE-332-04S



Sigma Lite Faseroptik Spatel mit auswechselbarem Lichtleiter
 Sigma Lite fiberoptic blades with interchangeable fiberoptic light guide

Größe Size Taille Tamaño Misura	Arbeitslänge (mm) Working Length (mm) Longueur de travail (mm) Largo de trabajo (mm) Lunghezza di lavoro (mm)	Glänzend Mirror finish brillant pulida lucida	Seidenmatt Satin finish mat satinada opaca
0	52	AE-133-00M	AE-133-00S
1	80	AE-133-01M	AE-133-01S
1.5	90	AE-133-09M	AE-133-09S



WISCONSIN-HIPPLE Spatel
WISCONSIN-HIPPLE Blades

Delta Lite Standard Spatel
 Sigma Lite conventional blades

Größe Size Taille Tamaño Misura	Arbeitslänge (mm) Working Length (mm) Longueur de travail (mm) Largo de trabajo (mm) Lunghezza di lavoro (mm)	Glänzend Mirror finish brillant pulida lucida	Seidenmatt Satin finish mat satinada opaca
0	52	AE-333-00M	AE-333-00S
1	80	AE-333-01M	AE-333-01S
1.5	90	AE-333-09M	AE-333-09S



WISCONSIN-HIPPLE Spatel
WISCONSIN-HIPPLE Blades

Delta Lite Standard Spatel
 Sigma Lite conventional blades

Größe Size Taille Tamaño Misura	Arbeitslänge (mm) Working Length (mm) Longueur de travail (mm) Largo de trabajo (mm) Lunghezza di lavoro (mm)	Glänzend Mirror finish brillant pulida lucida	Seidenmatt Satin finish mat satinada opaca
0	60	AE-238-00M	AE-238-00S
1	70	AE-238-01M	AE-238-01S



PEDIATRIC Spatel
PEDIATRIC Blades

Sigma Lite Faseroptik Spatel
 Sigma Lite fibreoptic blades

Größe	Arbeitslänge (mm)	Seidenmatt
Size	Working Length (mm)	Satin finish
Taille	Longueur de travail (mm)	mat
Tamaño	Largo de trabajo (mm)	satinada
Misura	Lunghezza di lavoro (mm)	opaca
1	72	AE-734-01S
2	95	AE-734-02S
3	111	AE-734-03S
4	135	AE-734-04S



Sigma Lite Faseroptik Spatel mit auswechselbarem Lichtleiter
 Sigma Lite fibreoptic blades with interchangeable fibreoptic light guide

Größe	Arbeitslänge (mm)	Glänzend	Seidenmatt
Size	Working Length (mm)	Mirror finish	Satin finish
Taille	Longueur de travail (mm)	brillant	mat
Tamaño	Largo de trabajo (mm)	pulida	satinada
Misura	Lunghezza di lavoro (mm)	lucida	opaca
1	72	AE-134-01M	AE-134-01S
2	95	AE-134-02M	AE-134-02S
3	111	AE-134-03M	AE-134-03S
4	135	AE-134-04M	AE-134-04S



Delta Lite Standard Spatel
 Sigma Lite conventional blades

Größe	Arbeitslänge (mm)	Glänzend	Seidenmatt
Size	Working Length (mm)	Mirror finish	Satin finish
Taille	Longueur de travail (mm)	brillant	mat
Tamaño	Largo de trabajo (mm)	pulida	satinada
Misura	Lunghezza di lavoro (mm)	lucida	opaca
1	72	AE-334-01M	AE-334-01S
2	95	AE-334-02M	AE-334-02S
3	111	AE-334-03M	AE-334-03S
4	135	AE-334-04M	AE-334-04S



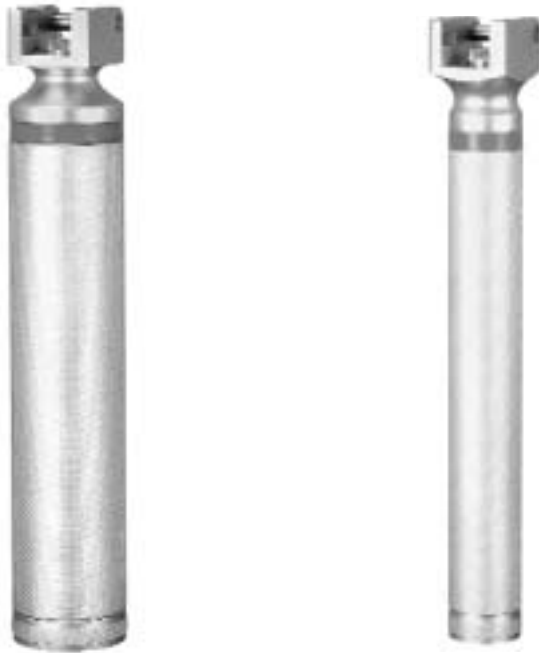

Alle Griffe sind in S = Seidenmatt oder
 M = glänzend erhältlich.
 All handles are available in S = Satin or
 M = Mirror finish.
 Toutes les poignées sont disponibles en S = mat ou en
 M = brillant.
 Todos los mangos disponibles en versión S = satinada o
 M = pulida.
 Tutti i manici sono disponibili nella versione S = opaca o
 M = lucida.

Größe Size Taille Tamaño Misura	Glänzend Mirror finish brillant pulida lucida	Seidenmatt Satin finish mat satinada opaca
Griff mittel, (Lieferung ohne Batterien)	AE-030-50M	AE-030-50S
Griff klein, (Lieferung ohne Batterien)	AE-030-51M	AE-030-51S
Kurzgriff, (Lieferung ohne Batterien)	AE-030-52M	AE-030-52S
Griff groß, (Lieferung ohne Batterien)	AE-030-53M	AE-030-53S
Medium Handle, (supplied without batteries)	AE-030-50M	AE-030-50S
Small Handle, (supplied without batteries)	AE-030-51M	AE-030-51S
Stubby Handle, (supplied without batteries)	AE-030-52M	AE-030-52S
Large Handle, (supplied without batteries)	AE-030-53M	AE-030-53S
Manche moyen, (livrée sans piles)	AE-030-50M	AE-030-50S
Manche petit, (livrée sans piles)	AE-030-51M	AE-030-51S
Manche court, (livrée sans piles)	AE-030-52M	AE-030-52S
Manche grand, (livrée sans piles)	AE-030-53M	AE-030-53S
Mango mediano, (suministro sin baterías)	AE-030-50M	AE-030-50S
Mango pequeño, (suministro sin baterías)	AE-030-51M	AE-030-51S
Mango corte, (suministro sin baterías)	AE-030-52M	AE-030-52S
Mango grande, (suministro sin baterías)	AE-030-53M	AE-030-53S
Manico medio, (consegna senza batterie)	AE-030-50M	AE-030-50S
Manico piccolo, (consegna senza batterie)	AE-030-51M	AE-030-51S
Manico corte, (consegna senza batterie)	AE-030-52M	AE-030-52S
Manico grande, (consegna senza batterie)	AE-030-53M	AE-030-53S

Standard-Laryngoskope **Delta Lite**
 Conventional Laryngoscope **Delta Lite**
 Laryngoscope standard **Delta Lite**
 Laryngoscopio convencional **Delta Lite**
 Laringoscopio standard **Delta Lite**

AE



Alle Griffe sind in S = Seidenmatt oder
 M = glänzend erhältlich.
 All handles are available in S = Satin or
 M = Mirror finish.
 Toutes les poignées sont disponibles en S = mat ou en
 M = brillant.
 Todos los mangos disponibles en versión S = satinada o
 M = pulida.
 Tutti i manici sono disponibili nella versione S = opaca o
 M = lucida.

Größe Size Taille Tamaño Misura	Glänzend Mirror finish brillant pulida lucida	Seidenmatt Satin finish mat satinada opaca
Griff mittel, (Lieferung ohne Batterien)	AE-230-50M	AE-230-50S
Griff klein, (Lieferung ohne Batterien)	AE-230-51M	AE-230-51S
Kurzgriff, (Lieferung ohne Batterien)	AE-230-52M	AE-230-52S
Griff groß, (Lieferung ohne Batterien)	AE-230-53M	AE-230-53S
Medium Handle, (supplied without batteries)	AE-230-50M	AE-230-50S
Small Handle, (supplied without batteries)	AE-230-51M	AE-230-51S
Stubby Handle, (supplied without batteries)	AE-230-52M	AE-230-52S
Large Handle, (supplied without batteries)	AE-230-53M	AE-230-53S
Manche moyen, (livrée sans piles)	AE-230-50M	AE-230-50S
Manche petit, (livrée sans piles)	AE-230-51M	AE-230-51S
Manche court, (livrée sans piles)	AE-230-52M	AE-230-52S
Manche grand, (livrée sans piles)	AE-230-53M	AE-230-53S
Mango mediano, (suministro sin baterías)	AE-230-50M	AE-230-50S
Mango pequeño, (suministro sin baterías)	AE-230-51M	AE-230-51S
Mango corte, (suministro sin baterías)	AE-230-52M	AE-230-52S
Mango grande, (suministro sin baterías)	AE-230-53M	AE-230-53S
Manico medio, (consegna senza batterie)	AE-230-50M	AE-230-50S
Manico piccolo, (consegna senza batterie)	AE-230-51M	AE-230-51S
Manico corte, (consegna senza batterie)	AE-230-52M	AE-230-52S
Manico grande, (consegna senza batterie)	AE-230-53M	AE-230-53S

AE

Standard-Laryngoskope **Delta Lite**
Conventional Laryngoscope **Delta Lite**
Laryngoscope standard **Delta Lite**
Laryngoscopio convencional **Delta Lite**
Laringoscopio standard **Delta Lite**



Delta Lite Standard Griffe für Spatel mit spezieller Biegung
Sigma Lite conventional handles for blades with special curvature

Größe Size Taille Tamaño Misura	Seidenmatt Satin finish mat satinada opaca
Griff mittel, (Lieferung ohne Batterien) Griff klein, (Lieferung ohne Batterien) Kurzgriff, (Lieferung ohne Batterien)	AE-240-50S AE-240-51S AE-240-52S
Medium Handle, (supplied without batteries) Small Handle, (supplied without batteries) Stubby Handle, (supplied without batteries)	AE-240-50S AE-240-51S AE-240-52S
Manche moyen, (livrée sans piles) Manche petit, (livrée sans piles) Manche court, (livrée sans piles)	AE-240-50S AE-240-51S AE-240-52S
Mango mediano, (suministro sin baterías) Mango pequeño, (suministro sin baterías) Mango corte, (suministro sin baterías)	AE-240-50S AE-240-51S AE-240-52S
Manico medio, (consegna senza batterie) Manico piccolo, (consegna senza batterie) Manico corte, (consegna senza batterie)	AE-240-50S AE-240-51S AE-240-52S

Kaltlicht / Cold light



AE-530-60

Halogenlampe, allein
Halogen lamp, only
Lampe halogène, seule
Lámpara halógeno, sola
Lampadina alogena, sola

Warmlicht / Krypton light



AE-530-71

Kryptonlampe, allein
Krypton lamp, only
Lampe krypton, seule
Lámpara criptón, sola
Lampadina alogena, sola

Warmlicht / Krypton light



AE-530-72

Kryptonlampe, allein
Krypton lamp, only
Lampe krypton, seule
Lámpara criptón, sola
Lampadina alogena, sola

Sicherheitshinweise

- **Delta Lite** und **Sigma Lite** Laryngoskope sind ausschließlich für endotracheale Intubation gedacht.
- Benutzen Sie mit **Sigma Lite** Spateln nur Griffe, die mit der grünen Markierung versehen sind.
- Versuchen Sie nicht, die faseroptische Röhre auszubauen.
- Zur Vorbeugung vor Mischinfektionen sollte das Laryngoskop nach jeder Intubation sorgfältig dekontaminiert werden. Reinigen Sie den Spatel direkt nach jedem Gebrauch mit einer weichen Bürste und Wasser oder einer Seifenlösung.
- Eine Dampfsterilisation kann bei 134°C vorgenommen werden. Standardspatel sollten mit montierter Glühlampe sterilisiert werden.

Benutzungshinweise

- Befestigen Sie den Spatel wie gewohnt am Griff und schwenken Sie ihn nach oben in Arbeitsposition.
- Überprüfen Sie, ob das Licht hell genug ist (Batterien!).
- Fassen Sie das Laryngoskop während der Intubation am Griff.

Instructions for use

Safety Information

- The **Delta Lite & Sigma Lite** laryngoscopes are used exclusively for endotracheal intubation.
- For **Sigma Lite** blades use only laryngoscope handles with the green identification mark.
- Do not attempt to dismantle the fiber optic tube.
- To avoid cross-infection, the laryngoscope must be decontaminated after each intubation. Use a soft brush with water or soap solution immediately after use to clean the blade.
- Steam sterilization can be done at 134°C. Conventional blades should be sterilized with bulb attached.

Using the instruments

- Attach the blade to the handle in the usual way and hinge upwards into the working position.
- Check that the light is bright enough (batteries!).
- During intubation hold the laryngoscope at the handle.

AE

Ersatzlampe für **Delta Lite** und **Sigma Lite**
Spare Lamps for both **Delta Lite** and **Sigma Lite**
Ampoule de rechange **Delta Lite** pour **Sigma Lite**
Bombilla de repuesto **Delta Lite Sigma Lite**
Lampada di ricambio **Delta Lite Sigma Lite**

Notice d'emploi

Consignes de sécurité

- Les laryngoscopes **Delta Lite** et **Sigma Lite** sont uniquement conçus pour les intubations endotracheales.
- Avec les spatules **Sigma Lite**, utilisez uniquement les manches qui sont marqués de vert.
- N'essayez pas de démonter les tubes des fibres optiques.
- Pour prévenir contre les infections mixtes, le laryngoscope devrait être soigneusement décontaminé après chaque intubation. Nettoyez la spatule immédiatement après chaque utilisation, à l'aide d'une brosse douce et d'eau, ou d'une solution savonneuse.
- Une stérilisation à la vapeur peut être envisagée à 134°C. Les spatules standards devraient être stérilisées, assemblées à l'ampoule.

Consignes d'utilisation

- Fixez comme d'usage la spatule au manche et faites la pivoter vers le haut dans la position de travail.
- Vérifiez que la lumière éclaire suffisamment (piles!).
- Durant l'intubation, saisissez le laryngoscope par le manche.

Indicaciones de uso

Indicaciones de seguridad

- Los laringoscopios **Delta Lite** y **Sigma Lite** sólo pueden ser usados para intubaciones endotraqueales.
- Los mangos de las espátulas **Sigma Lite** sólo deben ser usados con los mangos que llevan una marca verde.
- No intentar desmontar el tubo fibroóptico.
- Para prevenir infecciones mixtas el laringoscopio se debería descontaminar cuidadosamente después de cada intubación. Limpie la espátula inmediatamente después de usarla con un cepillo blando y agua o una jabonadura.
- Es posible efectuar una esterilización por vapor a 134°C. Las espátulas convencionales se deberían esterilizar con bombilla puesta.

Indicaciones para el uso del instrumento

- Sujete la espátula como de costumbre en el mango y gírelo hacia arriba a la posición de trabajo.
- Compruebe que la luz es lo suficientemente fuerte (baterías!).
- Agarre el laringoscopio por el mango durante la intubación.

Istruzioni per l'uso

Norme di sicurezza

- I laringoscopi **Delta Lite** e **Sigma Lite** sono concepiti esclusivamente per l'intubazione endotracheale.
- Con le spatole **Sigma Lite** utilizzare esclusivamente manici con il marchio verde.
- Non tentare di smontare il condotto a fibre ottiche.
- Per evitare infezioni miste il laringoscopio deve essere accuratamente decontaminato dopo ogni intubazione. Pulire la spatola subito dopo ogni uso con una spazzola morbida e dell'acqua o una soluzione saponata.
- La sterilizzazione a vapore può essere effettuata a 134°C.
Le spatole standard devono essere sterilizzate con la lampada montata.

Istruzioni per l'uso

- Fissare come di solito la spatola sul manico e orientarla verso l'alto in posizione pronta per l'uso.
- Verificare che la luce sia sufficientemente forte (batterie!).
- Durante l'intubazione tenere il laringoscopio per il manico.



Sigma Lite Faseroptik Spatel
 Sigma Lite fibreoptic blades

Größe
 Size
 Taille
 Tamaño
 Misura

Seidenmatt
 Satin finish
 mat
 satinada
 opaca

Griff mittel mit MACINTOSH-Spatel Größe 1, 2 (78 mm) und 3
 Griff mittel mit MACINTOSH-Spatel Größe 1, 2A (90 mm) und 3

AE-630-71S
AE-730-71S

Medium Handle with MACINTOSH Blade size 1, 2 (78 mm) and 3
 Medium Handle with MACINTOSH Blade size 1, 2A (90 mm) and 3

AE-630-71S
AE-730-71S

Manche moyen avec spatule MACINTOSH Taille 1, 2 (78 mm) et 3
 Manche moyen avec spatule MACINTOSH Taille 1, 2A (90 mm) et 3

AE-630-71S
AE-730-71S

Mango mediano con espátula MACINTOSH tamaño 1, 2 (78 mm) y 3
 Mango mediano con espátula MACINTOSH tamaño 1, 2 (90 mm) y 3

AE-630-71S
AE-730-71S

Manico medio con spatola MACINTOSH misura 1, 2 (78 mm) e 3
 Manico medio con spatola MACINTOSH misura 1, 2 (90 mm) e 3

AE-630-71S
AE-730-71S

Griff mittel mit MACINTOSH-Spatel Größe 2 (78 mm) 3 und 4
 Griff mittel mit MACINTOSH-Spatel Größe 2A (90 mm) 3 und 4

AE-630-72S
AE-730-72S

Medium Handle with MACINTOSH Blade size 2 (78 mm), 3 and 4
 Medium Handle with MACINTOSH Blade size 2A (90 mm), 3 and 4

AE-630-72S
AE-730-72S

Manche moyen avec spatule MACINTOSH Taille 2 (78 mm), 3 et 4
 Manche moyen avec spatule MACINTOSH Taille 2A (90 mm), 3 et 4

AE-630-72S
AE-730-72S

Mango mediano con espátula MACINTOSH tamaño 2 (78 mm), 3 y 4
 Mango mediano con espátula MACINTOSH tamaño 2A (90 mm), 3 y 4

AE-630-72S
AE-730-72S

Manico medio con spatola MACINTOSH misura 2 (78 mm), 3 e 4
 Manico medio con spatola MACINTOSH misura 2A (90 mm), 3 e 4

AE-630-72S
AE-730-72S



Sigma Lite Faseroptik Spatel
 Sigma Lite fibreoptic blades

Größe
 Size
 Taille
 Tamaño
 Misura

Seidenmatt
 Satin finish
 mat
 satinada
 opaca

Griff mittel mit MACINTOSH-Spatel Größe 1, 2 (78 mm), 3 und 4	AE-630-73S
Griff mittel mit MACINTOSH-Spatel Größe 1, 2A (90 mm), 3 und 4	AE-730-73S
Medium Handle with MACINTOSH Blade size 1, 2 (78 mm), 3 and 4	AE-630-73S
Medium Handle with MACINTOSH Blade size 1, 2A (90 mm), 3 and 4	AE-730-73S
Manche moyen avec spatule MACINTOSH Taille 1, 2 (78 mm), 3 et 4	AE-630-73S
Manche moyen avec spatule MACINTOSH Taille 1, 2A (90 mm), 3 et 4	AE-730-73S
Mango mediano con espátula MACINTOSH tamaño 1, 2 (78 mm), 3 y 4	AE-630-73S
Mango mediano con espátula MACINTOSH tamaño 1, 2 (90 mm), 3 y 4	AE-730-73S
Manico medio con spatola MACINTOSH misura 1, 2 (78 mm), 3 e 4	AE-630-73S
Manico medio con spatola MACINTOSH misura 1, 2 (90 mm), 3 e 4	AE-730-73S
Griff mittel mit MACINTOSH-Spatel Größe 0, 1, 2 (78 mm), 3 und 4	AE-630-77S
Griff mittel mit MACINTOSH-Spatel Größe 0, 1, 2A (90 mm), 3 und 4	AE-730-77S
Medium Handle with MACINTOSH Blade size 0, 1, 2 (78 mm), 3 and 4	AE-630-77S
Medium Handle with MACINTOSH Blade size 0, 1, 2A (90 mm), 3 and 4	AE-730-77S
Manche moyen avec spatule MACINTOSH Taille 0, 1, 2 (78 mm), 3 et 4	AE-630-77S
Manche moyen avec spatule MACINTOSH Taille 0, 1, 2A (90 mm), 3 et 4	AE-730-77S
Mango mediano con espátula MACINTOSH tamaño 0, 1, 2 (78 mm), 3 y 4	AE-630-77S
Mango mediano con espátula MACINTOSH tamaño 0, 1, 2 (90 mm), 3 y 4	AE-730-77S
Manico medio con spatola MACINTOSH misura 0, 1, 2 (78 mm), 3 e 4	AE-630-77S
Manico medio con spatola MACINTOSH misura 0, 1, 2 (90 mm), 3 e 4	AE-730-77S



Sigma Lite Faseroptik Spatel
 Sigma Lite fibreoptic blades

Größe
 Size
 Taille
 Tamaño
 Misura

Seidenmatt
 Satin finish
 mat
 satinada
 opaca

Griff mittel mit MACINTOSH-Spatel mit flexibler Spitze Größe 2	AE-630-82S
Griff mittel mit MACINTOSH-Spatel mit flexibler Spitze Größe 3	AE-630-83S
Griff mittel mit MACINTOSH-Spatel mit flexibler Spitze Größe 4	AE-630-84S
Griff mittel mit MACINTOSH-Spatel mit flexibler Spitze Größe 5	AE-630-85S

Medium Handle with MACINTOSH Blade with flexible tip size 2	AE-630-82S
Medium Handle with MACINTOSH Blade with flexible tip size 3	AE-630-83S
Medium Handle with MACINTOSH Blade with flexible tip size 4	AE-630-84S
Medium Handle with MACINTOSH Blade with flexible tip size 5	AE-630-85S

Manche moyen avec spatule MACINTOSH 2	AE-630-82S
Manche moyen avec spatule MACINTOSH 3	AE-630-83S
Manche moyen avec spatule MACINTOSH 4	AE-630-84S
Manche moyen avec spatule MACINTOSH 5	AE-630-85S

Mango mediano con espátula MACINTOSH con 2	AE-630-82S
Mango mediano con espátula MACINTOSH con 3	AE-630-83S
Mango mediano con espátula MACINTOSH con 4	AE-630-84S
Mango mediano con espátula MACINTOSH con 5	AE-630-85S

Manico medio con spatola MACINTOSH con 2	AE-630-82S
Manico medio con spatola MACINTOSH con 3	AE-630-83S
Manico medio con spatola MACINTOSH con 4	AE-630-84S
Manico medio con spatola MACINTOSH con 5	AE-630-85S



Sigma Lite Faseroptik Spatel
 Sigma Lite fibreoptic blades

Größe
 Size
 Taille
 Tamaño
 Misura

Seidenmatt
 Satin finish
 mat
 satinada
 opaca

Griff klein mit MILLER-Spatel Größe 0 und 1	AE-630-74S
Griff mittel mit MILLER-Spatel Größe 2, 3 und 4	AE-630-75S
Griff mittel mit MILLER-Spatel Größe 1, 2, 3 und 4	AE-630-76S
Small Handle with MILLER Blade size 0 & 1	AE-630-74S
Medium Handle with MILLER Blade size 2, 3 & 4	AE-630-75S
Medium Handle with MILLER Blade size 1, 2, 3 & 4	AE-630-76S
Manche petit avec spatule MILLER Taille 0 et 1	AE-630-74S
Manche moyen avec spatule MILLER Taille 2, 3 et 4	AE-630-75S
Manche moyen avec spatule MILLER Taille 1, 2, 3 et 4	AE-630-76S
Mango pequeño con espátula MILLER tamaño 0 y 1	AE-630-74S
Mango mediano con espátula MILLER tamaño 2, 3, y 4	AE-630-75S
Mango mediano con espátula MILLER tamaño 1, 2, 3 y 4	AE-630-76S
Manico piccolo con spatola MILLER misura 0 e 1	AE-630-74S
Manico medio con spatola MILLER misura 2, 3 e 4	AE-630-75S
Manico medio con spatola MILLER misura 1, 2, 3 e 4	AE-630-76S



Sigma Lite Faseroptik Spatel mit auswechselbarem Lichtleiter
 Sigma Lite fibreoptic blades with interchangeable fibreoptic light guide

Größe Size Taille Tamaño Misura	Glänzend Mirror finish brillant pulida lucida	Seidenmatt Satin finish mat satinada opaca
Griff mittel mit MACINTOSH-Spatel Größe 1, 2 (78 mm) und 3 Griff mittel mit MACINTOSH-Spatel Größe 1, 2A (90 mm) und 3	AE-030-71M AE-130-71M	AE-030-71S AE-130-71S
Medium Handle with MACINTOSH Blade size 1, 2 (78 mm) and 3 Medium Handle with MACINTOSH Blade size 1, 2A (90 mm) and 3	AE-030-71M AE-130-71M	AE-030-71S AE-130-71S
Manche moyen avec spatule MACINTOSH Taille 1, 2 (78 mm) et 3 Manche moyen avec spatule MACINTOSH Taille 1, 2A (90 mm) et 3	AE-030-71M AE-130-71M	AE-030-71S AE-130-71S
Mango mediano con espátula MACINTOSH tamaño 1, 2 (78 mm) y 3 Mango mediano con espátula MACINTOSH tamaño 1, 2 (90 mm) y 3	AE-030-71M AE-130-71M	AE-030-71S AE-130-71S
Manico medio con spatola MACINTOSH misura 1, 2 (78 mm) e 3 Manico medio con spatola MACINTOSH misura 1, 2 (90 mm) e 3	AE-030-71M AE-130-71M	AE-030-71S AE-130-71S
Griff mittel mit MACINTOSH-Spatel Größe 2 (78 mm) 3 und 4 Griff mittel mit MACINTOSH-Spatel Größe 2A (90 mm) 3 und 4	AE-030-72M AE-130-72M	AE-030-72S AE-130-72S
Medium Handle with MACINTOSH Blade size 2 (78 mm), 3 and 4 Medium Handle with MACINTOSH Blade size 2A (90 mm), 3 and 4	AE-030-72M AE-130-72M	AE-030-72S AE-130-72S
Manche moyen avec spatule MACINTOSH Taille 2 (78 mm), 3 et 4 Manche moyen avec spatule MACINTOSH Taille 2A (90 mm), 3 et 4	AE-030-72M AE-130-72M	AE-030-72S AE-130-72S
Mango mediano con espátula MACINTOSH tamaño 2 (78 mm), 3 y 4 Mango mediano con espátula MACINTOSH tamaño 2A (90 mm), 3 y 4	AE-030-72M AE-130-72M	AE-030-72S AE-130-72S
Manico medio con spatola MACINTOSH misura 2 (78 mm), 3 e 4 Manico medio con spatola MACINTOSH misura 2A (90 mm), 3 e 4	AE-030-72M AE-130-72M	AE-030-72S AE-130-72S



Sigma Lite Faseroptik Spatel mit auswechselbarem Lichtleiter
 Sigma Lite fibreoptic blades with interchangeable fibreoptic light guide

Größe Size Taille Tamaño Misura	Glänzend Mirror finish brillant pulida lucida	Seidenmatt Satin finish mat satinada opaca
Griff mittel mit MACINTOSH-Spatel Größe 1, 2 (78 mm), 3 und 4 Griff mittel mit MACINTOSH-Spatel Größe 1, 2A (90 mm), 3 und 4	AE-030-73M AE-130-73M	AE-030-73S AE-130-73S
Medium Handle with MACINTOSH Blade size 1, 2 (78 mm), 3 and 4 Medium Handle with MACINTOSH Blade size 1, 2A (90 mm), 3 and 4	AE-030-73M AE-130-73M	AE-030-73S AE-130-73S
Manche moyen avec spatule MACINTOSH Taille 1, 2 (78 mm), 3 et 4 Manche moyen avec spatule MACINTOSH Taille 1, 2A (90 mm), 3 et 4	AE-030-73M AE-130-73M	AE-030-73S AE-130-73S
Mango mediano con espátula MACINTOSH tamaño 1, 2 (78 mm), 3 y 4 Mango mediano con espátula MACINTOSH tamaño 1, 2 (90 mm), 3 y 4	AE-030-73M AE-130-73M	AE-030-73S AE-130-73S
Manico medio con spatola MACINTOSH misura 1, 2 (78 mm), 3 e 4 Manico medio con spatola MACINTOSH misura 1, 2 (90 mm), 3 e 4	AE-030-73M AE-130-73M	AE-030-73S AE-130-73S
Griff mittel mit MACINTOSH-Spatel Größe 0, 1, 2 (78 mm), 3 und 4 Griff mittel mit MACINTOSH-Spatel Größe 0, 1, 2A (90 mm), 3 und 4	AE-030-77M AE-130-77M	AE-030-77S AE-130-77S
Medium Handle with MACINTOSH Blade size 0, 1, 2 (78 mm), 3 and 4 Medium Handle with MACINTOSH Blade size 0, 1, 2A (90 mm), 3 and 4	AE-030-77M AE-130-77M	AE-030-77S AE-130-77S
Manche moyen avec spatule MACINTOSH Taille 0, 1, 2 (78 mm), 3 et 4 Manche moyen avec spatule MACINTOSH Taille 0, 1, 2A (90 mm), 3 et 4	AE-030-77M AE-130-77M	AE-030-77S AE-130-77S
Mango mediano con espátula MACINTOSH tamaño 0, 1, 2 (78 mm), 3 y 4 Mango mediano con espátula MACINTOSH tamaño 0, 1, 2 (90 mm), 3 y 4	AE-030-77M AE-130-77M	AE-030-77S AE-130-77S
Manico medio con spatola MACINTOSH misura 0, 1, 2 (78 mm), 3 e 4 Manico medio con spatola MACINTOSH misura 0, 1, 2 (90 mm), 3 e 4	AE-030-77M AE-130-77M	AE-030-77S AE-130-77S



Sigma Lite Faseroptik Spatel mit auswechselbarem Lichtleiter
 Sigma Lite fibreoptic blades with interchangeable fibreoptic light guide

Größe Size Taille Tamaño Misura	Seidenmatt Satin finish mat satinada opaca	Seidenmatt Satin finish mat satinada opaca
Griff klein mit MILLER-Spatel Größe 0 und 1	AE-030-74M	AE-030-74S
Griff mittel mit MILLER-Spatel Größe 2, 3 und 4	AE-030-75M	AE-030-75S
Griff mittel mit MILLER-Spatel Größe 1, 2, 3 und 4	AE-030-76M	AE-030-76S
Small Handle with MILLER Blade size 0 & 1	AE-030-74M	AE-030-74S
Medium Handle with MILLER Blade size 2, 3 & 4	AE-030-75M	AE-030-75S
Medium Handle with MILLER Blade size 1, 2, 3 & 4	AE-030-76M	AE-030-76S
Manche petit avec spatule MILLER Taille 0 et 1	AE-030-74M	AE-030-74S
Manche moyen avec spatule MILLER Taille 2, 3 et 4	AE-030-75M	AE-030-75S
Manche moyen avec spatule MILLER Taille 1, 2, 3 et 4	AE-030-76M	AE-030-76S
Mango pequeño con espátula MILLER tamaño 0 y 1	AE-030-74M	AE-030-74S
Mango mediano con espátula MILLER tamaño 2, 3, y 4	AE-030-75M	AE-030-75S
Mango mediano con espátula MILLER tamaño 1, 2, 3 y 4	AE-030-76M	AE-030-76S
Manico piccolo con spatola MILLER misura 0 e 1	AE-030-74M	AE-030-74S
Manico medio con spatola MILLER misura 2, 3 e 4	AE-030-75M	AE-030-75S
Manico medio con spatola MILLER misura 1, 2, 3 e 4	AE-030-76M	AE-030-76S



Delta Lite Standard Spatel
 Sigma Lite conventional blades

Größe Size Taille Tamaño Misura	Glänzend Mirror finish brillant pulida lucida	Seidenmatt Satin finish mat satinada opaca
Griff mittel mit MACINTOSH-Spatel Größe 1, 2 (78 mm) und 3 Griff mittel mit MACINTOSH-Spatel Größe 1, 2A (90 mm) und 3	AE-230-71M AE-330-71M	AE-230-71S AE-330-71S
Medium Handle with MACINTOSH Blade size 1, 2 (78 mm) and 3 Medium Handle with MACINTOSH Blade size 1, 2A (90 mm) and 3	AE-230-71M AE-330-71M	AE-230-71S AE-330-71S
Manche moyen avec spatule MACINTOSH Taille 1, 2 (78 mm) et 3 Manche moyen avec spatule MACINTOSH Taille 1, 2A (90 mm) et 3	AE-230-71M AE-330-71M	AE-230-71S AE-330-71S
Mango mediano con espátula MACINTOSH tamaño 1, 2 (78 mm) y 3 Mango mediano con espátula MACINTOSH tamaño 1, 2 (90 mm) y 3	AE-230-71M AE-330-71M	AE-230-71S AE-330-71S
Manico medio con spatola MACINTOSH misura 1, 2 (78 mm) e 3 Manico medio con spatola MACINTOSH misura 1, 2 (90 mm) e 3	AE-230-71M AE-330-71M	AE-230-71S AE-330-71S
Griff mittel mit MACINTOSH-Spatel Größe 2 (78 mm) 3 und 4 Griff mittel mit MACINTOSH-Spatel Größe 2A (90 mm) 3 und 4	AE-230-72M AE-330-72M	AE-230-72S AE-330-72S
Medium Handle with MACINTOSH Blade size 2 (78 mm), 3 and 4 Medium Handle with MACINTOSH Blade size 2A (90 mm), 3 and 4	AE-230-72M AE-330-72M	AE-230-72S AE-330-72S
Manche moyen avec spatule MACINTOSH Taille 2 (78 mm), 3 et 4 Manche moyen avec spatule MACINTOSH Taille 2A (90 mm), 3 et 4	AE-230-72M AE-330-72M	AE-230-72S AE-330-72S
Mango mediano con espátula MACINTOSH tamaño 2 (78 mm), 3 y 4 Mango mediano con espátula MACINTOSH tamaño 2A (90 mm), 3 y 4	AE-230-72M AE-330-72M	AE-230-72S AE-330-72S
Manico medio con spatola MACINTOSH misura 2 (78 mm), 3 e 4 Manico medio con spatola MACINTOSH misura 2A (90 mm), 3 e 4	AE-230-72M AE-330-72M	AE-230-72S AE-330-72S



Delta Lite Standard Spatel
 Sigma Lite conventional blades

Größe Size Taille Tamaño Misura	Glänzend Mirror finish brillant pulida lucida	Seidenmatt Satin finish mat satinada opaca
Griff mittel mit MACINTOSH-Spatel Größe 1, 2 (78 mm), 3 und 4	AE-230-73M	AE-230-73S
Griff mittel mit MACINTOSH-Spatel Größe 1, 2A (90 mm), 3 und 4	AE-330-73M	AE-330-73S
Medium Handle with MACINTOSH Blade size 1, 2 (78 mm), 3 and 4	AE-230-73M	AE-230-73S
Medium Handle with MACINTOSH Blade size 1, 2A (90 mm), 3 and 4	AE-330-73M	AE-330-73S
Manche moyen avec spatule MACINTOSH Taille 1, 2 (78 mm), 3 et 4	AE-230-73M	AE-230-73S
Manche moyen avec spatule MACINTOSH Taille 1, 2A (90 mm), 3 et 4	AE-330-73M	AE-330-73S
Mango mediano con espátula MACINTOSH tamaño 1, 2 (78 mm), 3 y 4	AE-230-73M	AE-230-73S
Mango mediano con espátula MACINTOSH tamaño 1, 2 (90 mm), 3 y 4	AE-330-73M	AE-330-73S
Manico medio con spatola MACINTOSH misura 1, 2 (78 mm), 3 e 4	AE-230-73M	AE-230-73S
Manico medio con spatola MACINTOSH misura 1, 2 (90 mm), 3 e 4	AE-330-73M	AE-330-73S
Griff mittel mit MACINTOSH-Spatel Größe 0, 1, 2 (78 mm), 3 und 4	AE-230-77M	AE-230-77S
Griff mittel mit MACINTOSH-Spatel Größe 0, 1, 2A (90 mm), 3 und 4	AE-330-77M	AE-330-77S
Medium Handle with MACINTOSH Blade size 0, 1, 2 (78 mm), 3 and 4	AE-230-77M	AE-230-77S
Medium Handle with MACINTOSH Blade size 0, 1, 2A (90 mm), 3 and 4	AE-330-77M	AE-330-77S
Manche moyen avec spatule MACINTOSH Taille 0, 1, 2 (78 mm), 3 et 4	AE-230-77M	AE-230-77S
Manche moyen avec spatule MACINTOSH Taille 0, 1, 2A (90 mm), 3 et 4	AE-330-77M	AE-330-77S
Mango mediano con espátula MACINTOSH tamaño 0, 1, 2 (78 mm), 3 y 4	AE-230-77M	AE-230-77S
Mango mediano con espátula MACINTOSH tamaño 0, 1, 2 (90 mm), 3 y 4	AE-330-77M	AE-330-77S
Manico medio con spatola MACINTOSH misura 0, 1, 2 (78 mm), 3 e 4	AE-230-77M	AE-230-77S
Manico medio con spatola MACINTOSH misura 0, 1, 2 (90 mm), 3 e 4	AE-330-77M	AE-330-77S



Delta Lite Standard Spatel
 Sigma Lite conventional blades

Größe Size Taille Tamaño Misura	Seidenmatt Satin finish mat satinada opaca	Seidenmatt Satin finish mat satinada opaca
Griff klein mit MILLER-Spatel Größe 0 und 1	AE-230-74M	AE-230-74S
Griff mittel mit MILLER-Spatel Größe 2, 3 und 4	AE-230-75M	AE-230-75S
Griff mittel mit MILLER-Spatel Größe 1, 2, 3 und 4	AE-230-76M	AE-230-76S
Small Handle with MILLER Blade size 0 & 1	AE-230-74M	AE-230-74S
Medium Handle with MILLER Blade size 2, 3 & 4	AE-230-75M	AE-230-75S
Medium Handle with MILLER Blade size 1, 2, 3 & 4	AE-230-76M	AE-230-76S
Manche petit avec spatule MILLER Taille 0 et 1	AE-230-74M	AE-230-74S
Manche moyen avec spatule MILLER Taille 2, 3 et 4	AE-230-75M	AE-230-75S
Manche moyen avec spatule MILLER Taille 1, 2, 3 et 4	AE-230-76M	AE-230-76S
Mango pequeño con espátula MILLER tamaño 0 y 1	AE-230-74M	AE-230-74S
Mango mediano con espátula MILLER tamaño 2, 3, y 4	AE-230-75M	AE-230-75S
Mango mediano con espátula MILLER tamaño 1, 2, 3 y 4	AE-230-76M	AE-230-76S
Manico piccolo con spatola MILLER misura 0 e 1	AE-230-74M	AE-230-74S
Manico medio con spatola MILLER misura 2, 3 e 4	AE-230-75M	AE-230-75S
Manico medio con spatola MILLER misura 1, 2, 3 e 4	AE-230-76M	AE-230-76S

AG

**Skalpelle, Messer
Scalpels, Knifes
Bistouris, Couteaux
Bisturías, Cuchillos
Bisturi, Coltelli**



AG

Skalpelli, passend für
auswechselbare Skalpellklingen
Fig. 10, 11, 12, 13, 15

Scalpel Handles for scalpel
blades fig. 10, 11, 12, 13, 15

Manches pour bistouris, allant
avec les lames de bistouris
interchangeables
fig. 10, 11, 12, 13, 15

Mangos de bisturi para
hojas intercambiables
fig. 10, 11, 12, 13, 15

Manici per bisturi, per fissare
le lame intercambiabili
fig. 10, 11, 12, 13, 15

abgewinkelt, lang
angled, long
coudé, long
angulado, largo
angolaro, lungo

lang
long
long
largo
lungo

Heftprofil wie Griff Fig. 4
handle style as fig. 4
manche selon fig. 4
mango como fig. 4
manico come fig. 4

mit Zentimeter-Graduierung
cm-graduation
gradué en cm
graduado en cm
graduato in cm



AG-013-00
Fig. 3
12 cm



AG-013-10
Fig. 3
12 cm



AG-013-01
Fig. 3
12 cm



AG-013-02
Fig. 3 L
21,5 cm



AG-013-06
Fig. 3 L
21 cm

**Fig.
3**

Skalpellgriffe
Scalpel Handles
Manches de bistouris
Mangos de bisturios
Manici per bisturi

AG

Skalpellgriffe, passend für
auswechselbare Skalpellschneiden
Fig. 10, 11, 12, 13, 15

Scalpel Handles for scalpel
blades fig. 10, 11, 12, 13, 15

Manches pour bistouris, allant
avec les lames de bistouris
interchangeables
fig. 10, 11, 12, 13, 15

Mangos de bisturi para
hojas intercambiables
fig. 10, 11, 12, 13, 15

Manici per bisturi, per fissare
la lama intercambiabile
fig. 10, 11, 12, 13, 15

rund
round
rond
redondo
rotondo

rund, abgewinkelt
round, angled
rond, coudé
redondo, angulado
rotondo, angolare

rund
round
rond
redondo
rotondo



AG-013-03
Fig. 3
14,5 cm



AG-013-33
Fig. 3
14 cm



AG-013-15
Fig. 3
15 cm

Skalpelli, passend für
 auswechselbare Skalpellklingen
 Fig. 10, 11, 12, 13, 15

Scalpel Handles for scalpel
 blades fig. 10, 11, 12, 13, 15

Manches pour bistouris, allant
 avec les lames de bistouris
 interchangeables
 fig. 10, 11, 12, 13, 15

Mangos de bisturi para
 hojas intercambiables
 fig. 10, 11, 12, 13, 15

Manici per bisturi, per fissare
 le lame intercambiabili
 fig. 10, 11, 12, 13, 15

mit rundem Hohlheft
 with round hollow handle
 avec manche creux rond
 con mango hueco redondo
 con manico vuoto, rotondo

mit Kunststoffheft
 with plastic handle
 avec manche en
 matière plastique
 con mango plástico
 con manico di materia
 plastica

lang
 long
 long
 long
 largo
 lungo

lang
 long
 long
 largo
 lungo

kurz
 short
 corto
 court
 corto

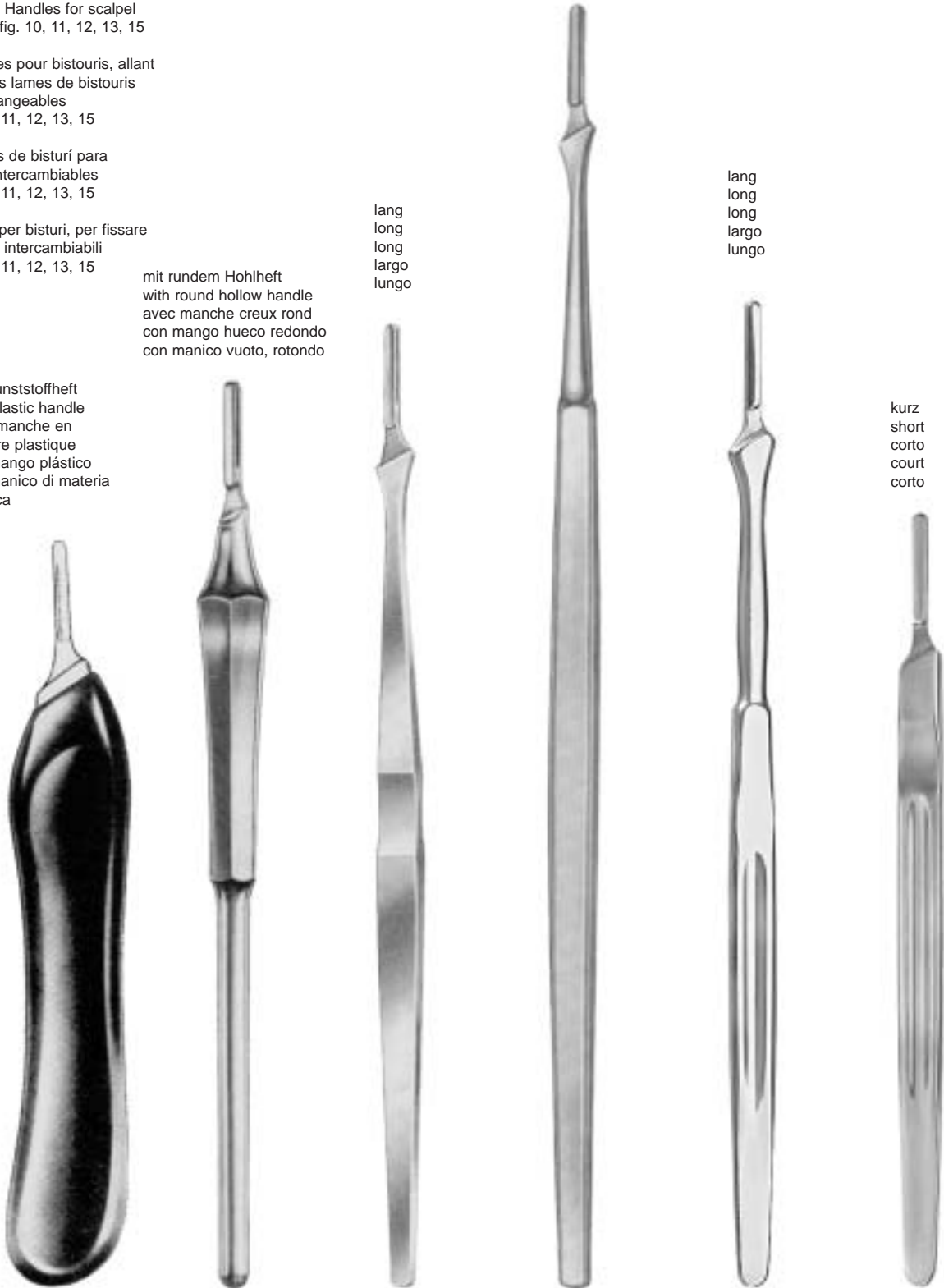

AG-013-08
 Fig. 3
 12,5 cm

AG-013-09
 Fig. 3
 15,5 cm

AG-015-00
 Fig. 5
 16 cm

AG-016-00
 Fig. 5
 21,5 cm

AG-017-00
 Fig. 7
 16 cm

AG-017-01
 Fig. 7 K
 12,5 cm

Fig.
3

Skalpelli
Scalpel Handles
Manches de bistouris
Mangos de bisturias
Manici per bisturi

AG

Skalpelli, passend für
auswechselbare Skalpellklingen
Fig. 10, 11, 12, 13, 15

Scalpel Handles for scalpel
blades fig. 10, 11, 12, 13, 15

Manches pour bistouris, allant
avec les lames de bistouris
interchangeables
fig. 10, 11, 12, 13, 15

Mangos de bisturi para
hojas intercambiables
fig. 10, 11, 12, 13, 15

Manici per bisturi, per fissare
le lame intercambiabili
fig. 10, 11, 12, 13, 15



AG-019-00
21 cm



AG-019-16
Fig. 3 + 4
16 cm

Skalpelli, passend für
auswechselbare Skalpellklingen
Fig. 10 - 36

Scalpel Handle for scalpel
blades fig. 10 - 36

Manche pour bistouri, allant
avec les lames de bistouris
interchangeables
fig. 10 - 36

Mango de bisturi para
hojas intercambiables
fig. 10 - 36

Manico per bisturi, per fissare
le lame intercambiabili
fig. 10 - 36

Doppelgriff Fig. 3 + 4
double handle fig. 3 + 4
manche double fig. 3 + 4
mango doble fig. 3 + 4
manico doppio fig. 3 + 4

AG

Skalpellklingen, steril
Scalpel Blades, sterile
Lames des bistouris, stériles
Hojas de bisturíes estériles
Lame da bisturi, sterili

Fig.
3



AG-110-00



AG-111-00



AG-112-00



AG-112-02



AG-115-00



AG-115-01



In Packungen à 100
in packages of 100 ea
en boîtes de 100 pieces
en cajas de 100 c/u
in scatole di 100 pezzi



AG-919-00
Skalpellklingen-Entferner
Scalpel Blade Remover
Enlève-lame
Quita hojas
Distributore lame

**Fig.
4**

Skalpelli
Scalpel Handles
Manches de bistouris
Mangos de bisturios
Manici per bisturi

AG

Skalpelli, passend für
auswechselbare Skalpellklingen
Fig. 18, 19, 20, 21, 22, 23, 24, 25, 36

Scalpel Handles for scalpel
blades fig. 18, 19, 20, 21, 22, 23, 24, 25, 36

Manches pour bistouris, allant
avec les lames de bistouris
interchangeables
fig. 18, 19, 20, 21, 22, 23, 24, 25, 36

Mangos de bisturi para
hojas intercambiables
fig. 18, 19, 20, 21, 22, 23, 24, 25, 36

Manici per bisturi, per fissare
le lame intercambiabili
fig. 18, 19, 20, 21, 22, 23, 24, 25, 36

lang
long
long
largo
lungo

abgewinkelt, lang
angled, long
coudé, long
angulado, largo
angolaro, lungo

mit Zentimeter-Graduierung
cm-graduation
gradué en cm
graduado en cm
graduato in cm



AG-014-00
Fig. 4
13,5 cm



AG-014-01
Fig. 4
13,5 cm



AG-014-03
21,5 cm



AG-014-02
Fig. 4 L
21 cm



AG-014-06
Fig. 4 L
21 cm

AG

Skalpelli
Scalpel Handles
Manches de bistouris
Mangos de bisturíes
Manici per bisturi

Fig.
4

Skalpelli, passend für
auswechselbare Skalpellklingen
Fig. 18, 19, 20, 21, 22, 23, 24, 25, 36

Scalpel Handles for scalpel
blades fig. 18, 19, 20, 21, 22, 23, 24, 25, 36

Manches pour bistouris, allant
avec les lames de bistouris
interchangeables
fig. 18, 19, 20, 21, 22, 23, 24, 25, 36

Mangos de bisturí para
hojas intercambiables
fig. 18, 19, 20, 21, 22, 23, 24, 25, 36

Manici per bisturi, per fissare
le lame intercambiabili
fig. 18, 19, 20, 21, 22, 23, 24, 25, 36

mit Kunststoffheft
with plastic handle
avec manche en matière plastique
con mango plástico
con manico di materia plastica



AG-014-08
Fig. 4
13,5 cm

mit Hohlheft
with hollow handle
avec manche creux
con mango hueco
con manico vuoto



COLLIN
AG-018-00
Fig. 8
13,5 cm

mit Hohlheft
with hollow handle
avec manche creux
con mango hueco
con manico vuoto



COLLIN
AG-018-09
Fig. 9
14,5 cm

Fig.
4

Skalpelliingen, steril
Scalpel Blades, sterile
Lames des bistouris, stériles
Hojas de bisturíes estériles
Lame da bisturi, sterili

AG



AG-118-00



AG-119-00



AG-210-00



AG-211-00



AG-212-00



AG-213-00



AG-214-00



AG-215-00



AG-316-00



In Packungen à 100
in packages of 100 ea
en boîtes de 100 pieces
en cajas de 100 c/u
in scatole di 100 pezzi



AG-919-00
Skalpelliingen-Entferner
Scalpel Blade Remover
Enlève-lame
Quita hojas
Distributore lame

AG

Einmalskalpelle, steril
Disposable Scalpels, sterile
Bistouris usage unique, stériles
Bisturías uso único, estériles
Bisturi monouso, sterili



AG-120-00
Fig. 10



AG-121-00
Fig. 10



AG-122-00
Fig. 12



AG-122-02
Fig. 12 d



AG-123-00
Fig. 13



AG-125-00
Fig. 15



AG-125-01
Fig. 15 c

In Packungen à 10 Stück
in packages of 10 ea
en boîtes de 10 pieces
en cajas de 10 c/u
in scatole di 10 pezzi



AG-128-00
Fig. 18

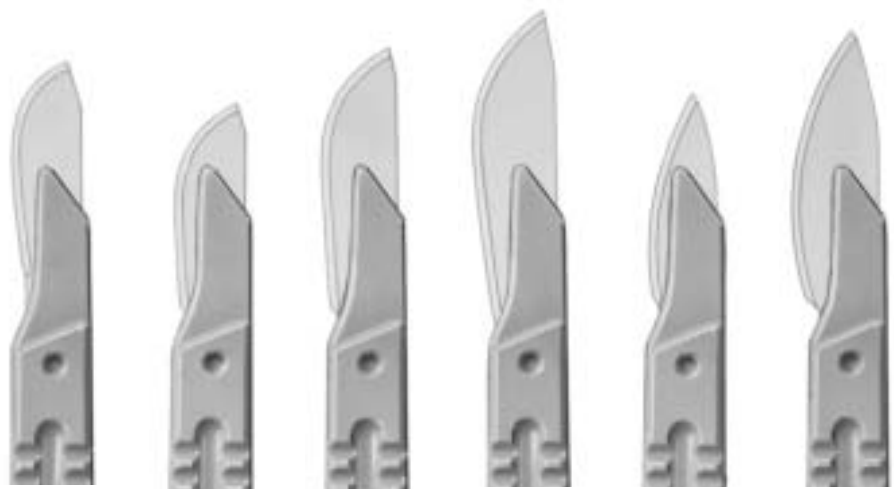

AG-129-00
Fig. 19

AG-220-00
Fig. 20

AG-221-00
Fig. 21

AG-222-00
Fig. 22

AG-223-00
Fig. 23

AG-224-00
Fig. 24

In Packungen à 10 Stück
in packages of 10 ea
en boîtes de 10 pieces
en cajas de 10 c/u
in scatole di 10 pezzi

AG

Skalpellgriffe, Mikro
Scalpel Handles, Micro
Manches pour bistouris, Micro
Mangos de bisturi, Micro
Manici per bisturi, Micro

für Mikro-Skalpellklingen
for micro scalpel blades
pour micro-lame de bisturis
para micro hojas
per micro lame



AG-032-13
13,5 cm



AG-034-15
15,5 cm



CASPAR
AG-036-18
18 cm



AG-038-20
20 cm

Skalpelli-griffe, Mikro-Skalpellklingen
 Scalpel Handles, Micro Scalpel Blades
 Manches pour bistouris, Micro lame de bistouris
 Mangos de bisturí, Micro hojas de bisturí
 Manici per bisturi, Micro lame per bisturi

AG

In Packungen à 10 Stück, steril
 in packages of 10 ea, sterile
 en boîtes de 10 pièces, stériles
 en cajas de 10 c/u, estériles
 in scatole di 10 pezzi, sterili



LANDOLT
EA-587-25
 25 cm

LANDOLT
EA-588-21
 21 cm



EA-589-01
 #61

EA-589-02
 #62

EA-589-04
 #64



EA-589-05
 #65

EA-589-07
 #67

EA-589-09
 #69



AG-925-00
 11 cm

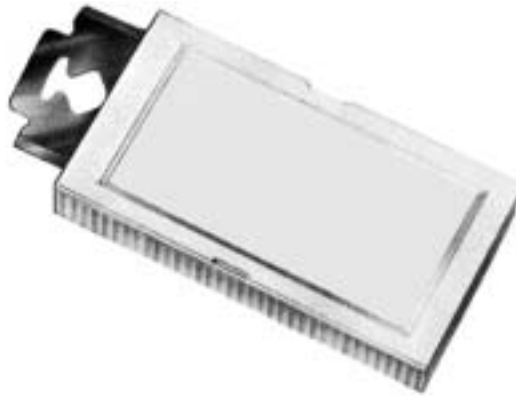

AG-926-00
 Packung = 10
 Package = 10 ea
 Boîte = 10
 Cajita = 10 c/u
 Scatola = 10



TROUTMAN-CHRIS
AG-920-09
 9 cm



DIMEDA
AG-921-09
 11 cm



CASTROVIEJO
AG-924-13
 13 cm

mit Metallheft
 with metal handle
 avec manche en métal
 con mango metálico
 con manico di metallo

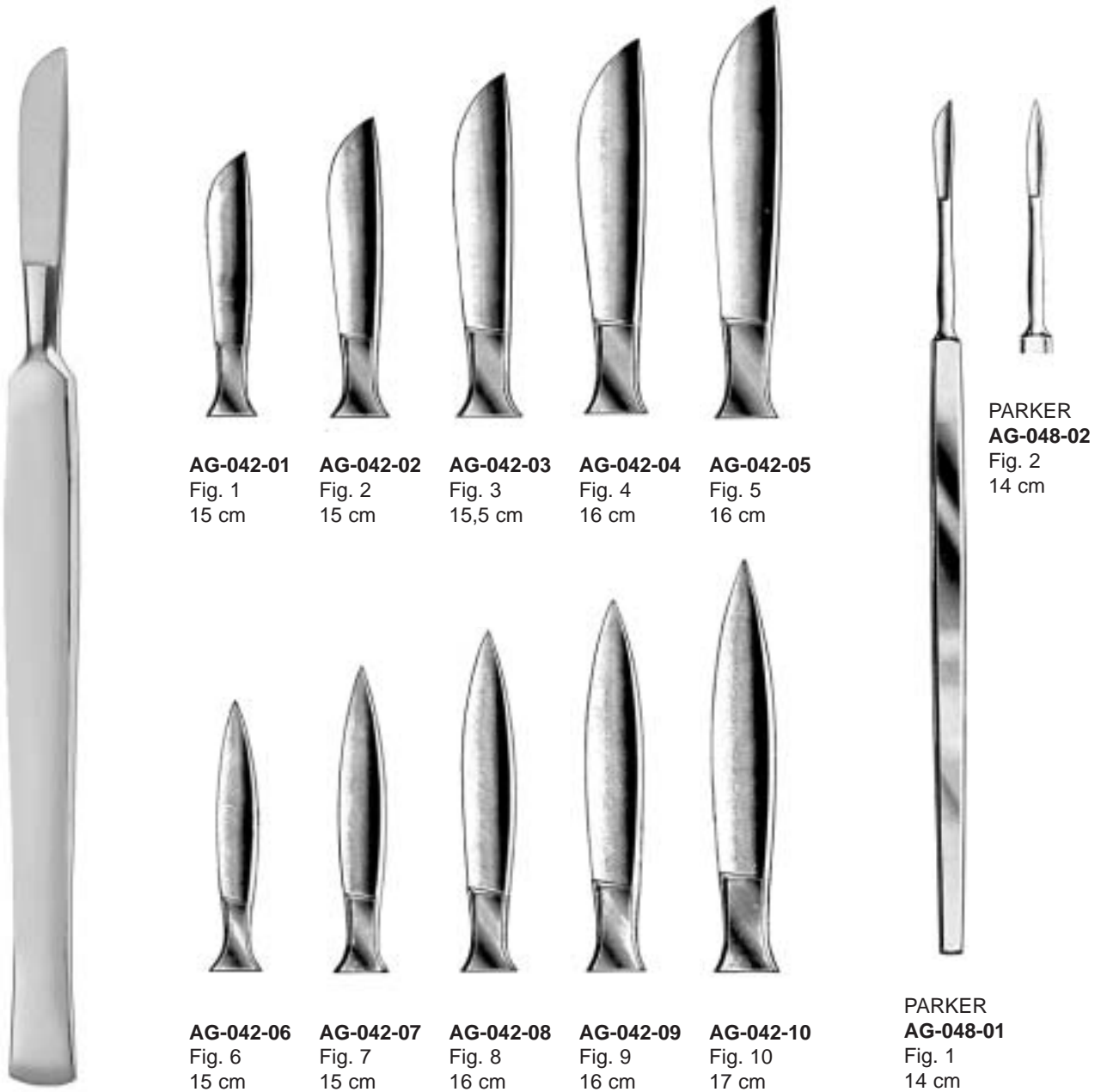

AG

Amputationsmesser
Amputating knives
Couteaux à amputation
Cuchillos para amputación
Coltelli per amputazione

mit Hohlheft
with hollow handle
con mango hueco
avec manche creux
con manico vuoto

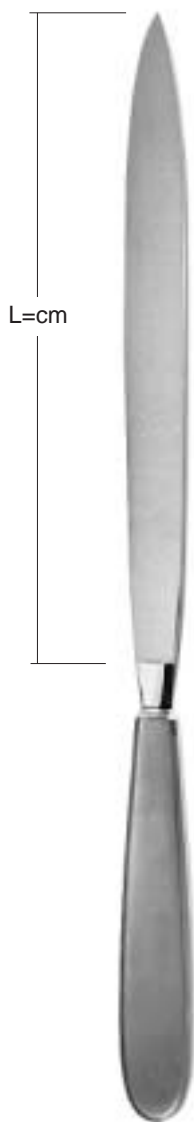

L = cm	
13	AG-240-13
16	AG-240-16
19	AG-240-19
22	AG-240-22
28	AG-240-28



L = cm	LISTON
17	AG-340-17
20	AG-340-20

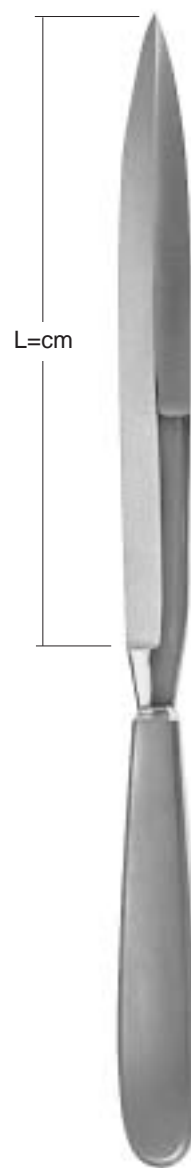

L = cm	CATLIN
16	AG-342-16
19	AG-342-19
22	AG-342-22

L = Klingenlänge/length
of blade/longueur tranchant/
largo de corte/lunghezza di taglio

massives Heft mit Schaber-Ende
solid handle, dissecting end
manche solide à rugine
mango macizo, con periostótomo
con manico pieno con raschino



LANGENBECK
AG-140-05
18 cm



LANGENBECK
AG-142-05
18 cm



LANGENBECK
AG-144-05
18 cm

AG

Knorpel-, Hirnmesser
Cartilage, brain knife
Couteaux à cartilage, à cerveau
Cuchillo para cartílagos y p. cerebro
Coltelli per cartilagini e per il cervello

mit Holzheft
with wooden handle
avec manche en bois
con mango de madera
con manico di legno

mit Schaber
with raspatory
avec râpe
con periostótomo
con raschiatoio

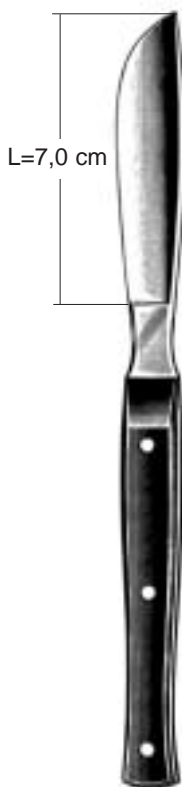

VIRCHOW
AG-690-25
25 cm



AG-790-55



AG-791-55



AG-792-70



L = cm	VIRCHOW
16	AG-890-15
20	AG-890-20
24	AG-890-24

In Packungen à 10 Stück, steril
in packages of 10 ea, sterile
en boîtes de 10 pièces, stériles
en cajas de 10 c/u, estériles
in scatole di 10 pezzi, sterili

Klinge flach/hohl
blade flat/hollow
lame à faces plane/ concave
hoja cóncava/convexa
lama piana/concava

Klinge beidseitig hohl
hollow blades on both sides
lame deux faces concaves
ambos lados cóncavos
lama concava/concava



Ag-944-01

AG-944-01



AG-946-00



AG-947-00

Abziehstein
Oil stone
Pierre à repasser
Piedra afiladora
Pietra per affilare



RECORD-ARKANSAS
AG-948-00

im Holzkasten
in wooden case
en boîte bois
en caja de madera
in astuccio di legno



ARKANSAS
AG-949-00

komplett mit Klinge
complete with blade
complet avec lame
completo con hoja
completo con lama



HUMBY
AG-840-00
32 cm

Ersatzklinge
Spare Blade
Lame de rechange, seule
Hoja de repuesto
Lama die ricambio sola



HUMBY
AG-840-01

für handelsübliche Rasierklingen
for usual razor blades
pour lames de rasoir modèle standard
para hojas de afeitar usuales
per lamette da barba normali



SILVER
AG-842-19
19 cm

einstellbar von 0,1 bis 2,0 mm
adjustable from 0,1 to 2,0 mm
réglable en épaisseur de 0,1 à 2,0 mm
ajustable de 0,1 hasta 2,0 mm
regolabile da 0,1 a 2,0 mm



komplett
mit 2 Spannplatten
und einer Klinge

complete
with 2 skin fixing
plates and one
blade

complet
avec deux plaque
pour tendre la peau
et lame

completo
con 2 placas para
extender la piel y
una hoja

completo
con 2 placche per
stendere la pelle es
una lama

SCHINK
AG-940-00
31 cm

Ersatzklinge
Spare Blade
Lame de rechange, seule
Hoja de repuesto
Lama di ricambio sola



AG-940-01

Spannplatte
Skin Fixing Plate
Plaque pour tendre la peau
Placa para extender la piel
Placca per stendere la pelle



AG-940-02

komplett mit Klinge
complete with blade
complet avec lame
completo con hoja
completo con lama

komplett mit Klinge
complete with blade
complet avec lame
completo con hoja
completo con lama



WATSON
AG-842-30
30 cm

AG-844-00

Ersatzklinge
Spare Blade
Lame de rechange, seule
Hoja de repuesto
Lama di ricambio sola



BRAITHWAITE
AG-844-00
31,5 cm

AH

SUPERCUT

**Scheren
Scissors
Ciseaux
Tijeras
Forbici**



AH

AH

Chirurgische Scheren
Operating Scissors
Ciseaux à chirurgie
Tijeras para cirugía
Forbici per chirurgia

SUPERCUT

TC-Schneiden
TC Cutting Edges
Tranchant TC
Filos de corte TC
Taglio TC



cm	Standard
10,5	AH-012-10
11,5	AH-012-11
13,0	AH-012-13
14,5	AH-012-14
15,5	AH-012-15
16,5	AH-012-16
18,5	AH-012-18
20,0	AH-012-20



cm	Standard
10,5	AH-013-10
11,5	AH-013-11
13,0	AH-013-13
14,5	AH-013-14
15,5	AH-013-15
16,5	AH-013-16
18,5	AH-013-18
20,0	AH-013-20



cm	Standard
14,5	AH-014-14
16,5	AH-014-16



cm	Standard
14,5	AH-015-14
16,5	AH-015-16

TC-Schneiden
 TC Cutting Edges
 Tranchant TC
 Filos de corte TC
 Taglio TC



cm	Standard
11,5	AH-110-11
13,0	AH-110-13
14,5	AH-110-14
15,5	AH-110-15
16,5	AH-110-16
18,5	AH-110-18
20,0	AH-110-20



cm	Standard
11,5	AH-111-11
13,0	AH-111-13
14,5	AH-111-14
15,5	AH-111-15
16,5	AH-111-16
18,5	AH-111-18
20,0	AH-111-20



cm	Standard
14,5	AH-114-14
16,5	AH-114-16



cm	Standard
14,5	AH-115-14
16,5	AH-115-16

AH

Chirurgische Scheren
Operating Scissors
Ciseaux à chirurgie
Tijeras para cirugía
Forbici per chirurgia

SUPERCUT

TC-Schneiden
TC Cutting Edges
Tranchant TC
Filos de corte TC
Taglio TC



cm	Standard
10,5	AH-210-10
11,5	AH-210-11
13,0	AH-210-13
14,5	AH-210-14
15,5	AH-210-15
16,5	AH-210-16
18,5	AH-210-18
20,0	AH-210-20



cm	Standard
10,5	AH-211-10
11,5	AH-211-11
13,0	AH-211-13
14,5	AH-211-14
15,5	AH-211-15
16,5	AH-211-16
18,5	AH-211-18
20,0	AH-211-20



cm	Standard
14,5	AH-214-14
16,5	AH-214-16



cm	Standard
14,5	AH-215-14
16,5	AH-215-16



cm DEAVER
 14,0 AH-310-14 AH-311-14

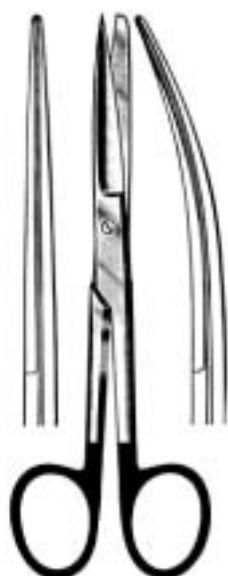

cm DEAVER
 14,0 AH-410-14 AH-411-14



cm DEAVER
 14,0 AH-510-14 AH-511-14

TC-Schneiden
 TC Cutting Edges
 Tranchant TC
 Filos de corte TC
 Taglio TC



cm DEAVER
 14,0 AH-314-14 AH-315-14

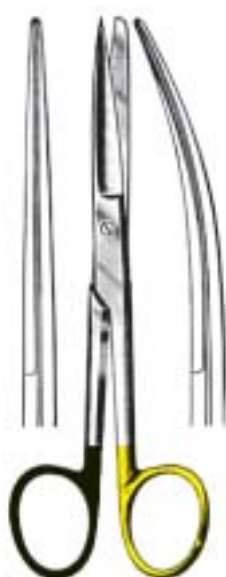

cm DEAVER
 14,0 AH-414-14 AH-415-14



cm DEAVER
 14,0 AH-514-14 AH-515-14

AH

Chirurgische Scheren
Operating Scissors
Ciseaux à chirurgie
Tijeras para cirugía
Forbici per chirurgia

SUPERCUT

TC-Schneiden
TC Cutting Edges
Tranchant TC
Filos de corte TC
Taglio TC



cm	MAYO
14,5	AH-610-14
17,0	AH-610-17
23,0	AH-610-23



cm	MAYO
14,5	AH-611-14
17,0	AH-611-17
23,0	AH-611-23



cm	MAYO
14,5	AH-614-14
17,0	AH-614-17
23,0	AH-614-23



cm	MAYO
14,5	AH-615-14
17,0	AH-615-17
23,0	AH-615-23

TC-Schneiden
 TC Cutting Edges
 Tranchant TC
 Filos de corte TC
 Taglio TC



cm MAYO-STILLE
 15,0 **AH-710-15**
 17,0 **AH-710-17**



cm MAYO-STILLE
 15,0 **AH-711-15**
 17,0 **AH-711-17**



cm MAYO-STILLE
 15,0 **AH-714-15**
 17,0 **AH-714-17**



cm MAYO-STILLE
 15,0 **AH-715-15**
 17,0 **AH-715-17**

AH

Chirurgische Scheren
Operating Scissors
Ciseaux à chirurgie
Tijeras para cirugía
Forbici per chirurgia

SUPERCUT

TC-Schneiden
TC Cutting Edges
Tranchant TC
Filos de corte TC
Taglio TC



cm MAYO-NOBLE
17,0 **AH-810-17**

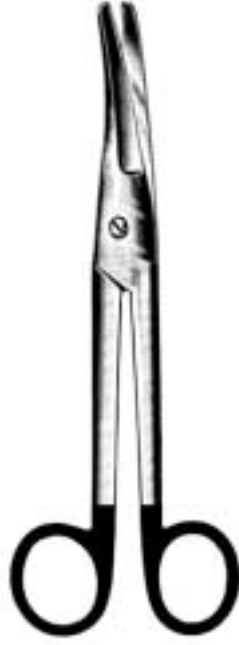

cm MAYO-NOBLE
17,0 **AH-811-17**



cm MAYO-NOBLE
17,0 **AH-814-17**

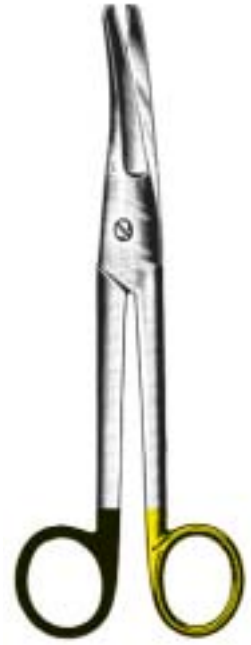

cm MAYO-NOBLE
17,0 **AH-815-17**

TC-Schneiden
 TC Cutting Edges
 Tranchant TC
 Filos de corte TC
 Taglio TC



cm LEXER
 16,0 **AH-910-16**
 21,0 **AH-910-21**



cm LEXER
 16,0 **AH-911-16**
 21,0 **AH-911-21**



cm LEXER
 16,0 **AH-914-16**
 21,0 **AH-914-21**



cm LEXER
 16,0 **AH-915-16**
 21,0 **AH-915-21**

AH

Präparierscheren
Dissecting Scissors
Ciseaux à dissection
Tijeras de disección
Forbici per dissezione

SUPERCUT

TC-Schneiden
TC Cutting Edges
Tranchant TC
Filos de corte TC
Taglio TC



cm LEXER-BABY
10,0 AH-022-10



cm LEXER-BABY
10,0 AH-023-10



cm LEXER-BABY
10,0 AH-026-10



cm LEXER-BABY
10,0 AH-027-10

TC-Schneiden
 TC Cutting Edges
 Tranchant TC
 Filos de corte TC
 Taglio TC



cm	METZENBAUM
11,5	AH-820-11
15,0	AH-820-15
18,0	AH-820-18
20,0	AH-820-20
23,0	AH-820-23
25,0	AH-820-25
28,0	AH-820-28
30,0	AH-820-30

cm	METZENBAUM
11,5	AH-821-11
15,0	AH-821-15
18,0	AH-821-18
20,0	AH-821-20
23,0	AH-821-23
25,0	AH-821-25
28,0	AH-821-28
30,0	AH-821-30

cm	METZENBAUM
11,5	AH-824-11
15,0	AH-824-15
18,0	AH-824-18
20,0	AH-824-20
23,0	AH-824-23
25,0	AH-824-25
28,0	AH-824-28
30,0	AH-824-30

cm	METZENBAUM
11,5	AH-825-11
15,0	AH-825-15
18,0	AH-825-18
20,0	AH-825-20
23,0	AH-825-23
25,0	AH-825-25
28,0	AH-825-28
30,0	AH-825-30

AH

Präparierscheren
Dissecting Scissors
Ciseaux à dissection
Tijeras de disección
Forbici per dissezione

SUPER CUT

TC-Schneiden
TC Cutting Edges
Tranchant TC
Filos de corte TC
Taglio TC



cm	METZENBAUM FINO
15,0	AH-822-15
18,0	AH-822-18
20,0	AH-822-20
23,0	AH-822-23
25,0	AH-822-25
28,0	AH-822-28

cm	METZENBAUM FINO
15,0	AH-823-15
18,0	AH-823-18
20,0	AH-823-20
23,0	AH-823-23
25,0	AH-823-25
28,0	AH-823-28

cm	METZENBAUM FINO
15,0	AH-826-15
18,0	AH-826-18
20,0	AH-826-20
23,0	AH-826-23
25,0	AH-826-25
28,0	AH-826-28

cm	METZENBAUM FINO
15,0	AH-827-15
18,0	AH-827-18
20,0	AH-827-20
23,0	AH-827-23
25,0	AH-827-25
28,0	AH-827-28



cm METZENBAUM "S"
 18,0 **AH-921-18**



cm SANVENERO
 14,0 **AH-032-14**



cm SANVENERO
 14,0 **AH-033-14**

TC-Schneiden
 TC Cutting Edges
 Tranchant TC
 Filos de corte TC
 Taglio TC



cm METZENBAUM "S"
 18,0 **AH-925-18**



cm SANVENERO
 14,0 **AH-036-14**



cm SANVENERO
 14,0 **AH-037-14**

Plastik - Plastic - Plastique - Plástica - Plastica



cm JOSEPH
 14,0 AH-034-14



cm JOSEPH
 14,0 AH-035-14



cm KILNER
 12,0 AH-130-12
 15,0 AH-130-15

TC-Schneiden
 TC Cutting Edges
 Tranchant TC
 Filos de corte TC
 Taglio TC



cm JOSEPH
 14,0 AH-038-14



cm JOSEPH
 14,0 AH-039-14



cm KILNER
 12,0 AH-134-12
 15,0 AH-134-14



cm REYNOLDS
15,0 AH-230-15



cm REYNOLDS
15,0 AH-231-15

TC-Schneiden
TC Cutting Edges
Tranchant TC
Filos de corte TC
Taglio TC



cm REYNOLDS
15,0 AH-234-15



cm REYNOLDS
15,0 AH-235-15

rund
 round
 rond
 redondo
 retondo



cm	IRIS-Standard
9,0	AH-430-09
10,5	AH-430-10
11,5	AH-430-11



cm	IRIS-Standard
9,0	AH-431-09
10,5	AH-431-10
11,5	AH-431-11



cm	IRIS-Standard
9,0	AH-432-09
10,5	AH-432-10
11,5	AH-432-11



cm	IRIS-Standard
9,0	AH-433-09
10,5	AH-433-10
11,5	AH-433-11

TC-Schneiden
 TC Cutting Edges
 Tranchant TC
 Filos de corte TC
 Taglio TC



cm	IRIS-Standard
9,0	AH-434-09
10,5	AH-434-10
11,5	AH-434-11



cm	IRIS-Standard
9,0	AH-435-09
10,5	AH-435-10
11,5	AH-435-11



cm STEVENS
 11,0 AH-632-11



cm STEVENS
 11,0 AH-633-11

TC-Schneiden
 TC Cutting Edges
 Tranchant TC
 Filos de corte TC
 Taglio TC

Strabismus Scheren
 Strabismus Scissors
 Ciseaux à strabisme
 Tijeras para estrabismo
 Forbici per strabismo



cm
 11,0 AH-730-11



cm
 11,0 AH-731-11



cm
 11,0 AH-734-11



cm
 11,0 AH-735-11

AH

Scheren, Ophthal., Nase
Scissors, Ophthal., Nasal
Ciseaux, ophtal., nasaux
Tijeras, oftalmología, nasales
Forbici, oftalmologia, nasali

SUPERCUT



cm HEYMANN
18,0 AH-041-18



cm FOMON
15,0 AH-043-15



cm COTTLE
16,0 AH-045-16



POTTS-SMITH

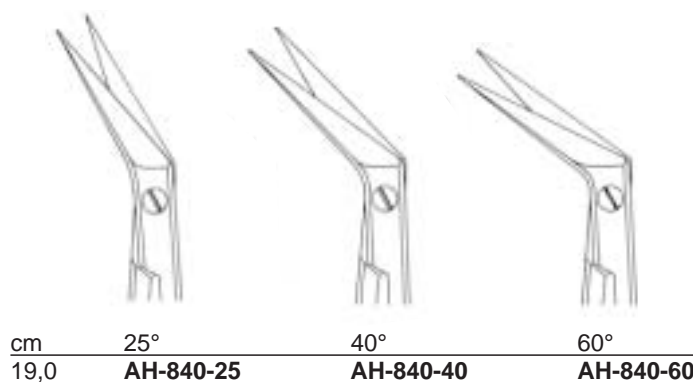

POTTS-SMITH

TC-Schneiden
 TC Cutting Edges
 Tranchant TC
 Filos de corte TC
 Taglio TC

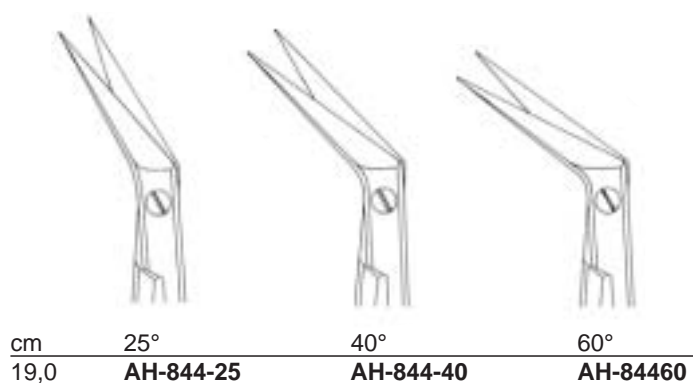

AH

Gefäß-Scheren
Vascular Scissors
Ciseaux vasculaires
Tijeras vasculares
Forbici vascolari

SUPER CUT

TC-Schneiden
TC Cutting Edges
Tranchant TC
Filos de corte TC
Taglio TC

Parametrium



cm
22,0 AH-055-22



cm
23,0 AH-055-23



cm	SIMS
20,0	AH-150-20
23,0	AH-150-23



cm	SIMS
20,0	AH-151-20
23,0	AH-151-23



cm	SIEBOLD
24,0	AH-253-24



cm	SIMS
20,0	AH-154-20
23,0	AH-154-23

TC-Schneiden
 TC Cutting Edges
 Tranchant TC
 Filos de corte TC
 Taglio TC



cm	SIMS
20,0	AH-155-20
23,0	AH-155-23

AH

Gynäkologische Scheren
Gynaecological Scissors
Ciseaux gynécologiques
Tijeras ginecológicas
Forbici ginecologiche

SUPERCUT



cm KELLY
16,0 AH-450-16
18,0 AH-450-18



cm KELLY
16,0 AH-451-16
18,0 AH-451-18



cm BRAUN-STADLER
14,5 AH-650-14
22,0 AH-650-22

Episiotomie
Episiotomy
Episiotomia



cm WAGNER
12,0 AH-284-12



cm WAGNER
20,0 AH-285-12

SUPERCUT

Gynäkologische Scheren
Gynaecological Scissors
Ciseaux gynécologiques
Tijeras ginecológicas
Forbici ginecologiche

AH

TC-Schneiden
TC Cutting Edges
Tranchant TC
Filos de corte TC
Taglio TC



cm	LISTER
14,0	AH-091-14
18,0	AH-091-18
20,0	AH-091-20



cm	LISTER
14,0	AH-095-14
18,0	AH-095-18
20,0	AH-095-20

AI

**Scheren
Scissors
Ciseaux
Tijeras
Forbici**



AI

AI

Chirurgische Scheren
Operating Scissors
Ciseaux à chirurgie
Tijeras para cirugía
Forbici per chirurgia

TC-Schneiden
TC Cutting Edges
Tranchant TC
Filos de corte TC
Taglio TC



cm	Standard
10,5	AI-012-10
11,5	AI-012-11
13,0	AI-012-13
14,5	AI-012-14
15,5	AI-012-15
16,5	AI-012-16
18,5	AI-012-18
20,0	AI-012-20

cm	Standard
10,5	AI-013-10
11,5	AI-013-11
13,0	AI-013-13
14,5	AI-013-14
15,5	AI-013-15
16,5	AI-013-16
18,5	AI-013-18
20,0	AI-013-20

cm	Standard TC
14,5	AI-014-14
16,5	AI-014-16
18,5	AI-014-18

cm	Standard TC
14,5	AI-015-14
16,5	AI-015-16
18,5	AI-015-18

TC-Schneiden
 TC Cutting Edges
 Tranchant TC
 Filos de corte TC
 Taglio TC

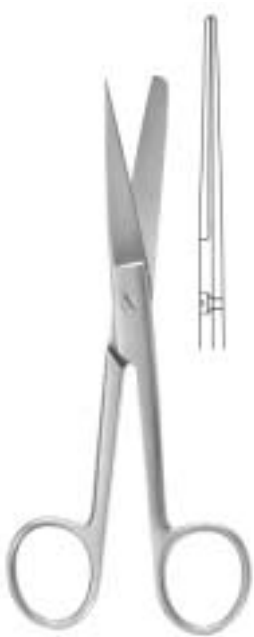

cm	Standard
10,5	AI-110-10
11,5	AI-110-11
13,0	AI-110-13
13,0	AI-110-13L
14,5	AI-110-14
14,5	AI-110-14L
15,5	AI-110-15
16,5	AI-110-16
18,5	AI-110-18
20,0	AI-110-20

cm	Standard
10,5	AI-111-10
11,5	AI-111-11
13,0	AI-111-13
13,0	AI-111-13L
14,5	AI-111-14
14,5	AI-111-14L
15,5	AI-111-15
16,5	AI-111-16
18,5	AI-111-18
20,0	AI-111-20

cm	Standard TC
14,5	AI-114-14
16,5	AI-114-16
18,5	AI-114-18

cm	Standard TC
14,5	AI-115-14
16,5	AI-115-16
18,5	AI-115-18

(L) = Für Linkshänder / For left-handed
 Pour la main gauche / Para zurdo / Per mancini

AI

Chirurgische Scheren
Operating Scissors
Ciseaux à chirurgie
Tijeras para cirugía
Forbici per chirurgia

TC-Schneiden
TC Cutting Edges
Tranchant TC
Filos de corte TC
Taglio TC



cm	Standard
10,5	AI-210-10
11,5	AI-210-11
13,0	AI-210-13
14,5	AI-210-14
15,5	AI-210-15
16,5	AI-210-16
18,5	AI-210-18
20,0	AI-210-20



cm	Standard
10,5	AI-211-10
11,5	AI-211-11
13,0	AI-211-13
14,5	AI-211-14
15,5	AI-211-15
16,5	AI-211-16
18,5	AI-211-18
20,0	AI-211-20



cm	Standard TC
14,5	AI-214-14
16,5	AI-214-16
18,5	AI-214-18



cm	Standard TC
14,5	AI-215-14
16,5	AI-215-16
18,5	AI-215-18

schlanke Modelle
slender patterns
modèles fins
modelos fins
modelli fini



cm
12,0 **AI-214-12**



cm
12,0 **AI-215-12**



cm
12,0 **AI-216-12**
13,0 **AI-216-13**



cm
12,0 **AI-217-12**
13,0 **AI-217-13**

Inzisionscheren
Incision scissors
Ciseaux à incision
Tijeras para incision
Forbici incisione



cm
14,0 **AI-218-14**

AI

Chirurgische Scheren
Operating Scissors
Ciseaux à chirurgie
Tijeras para cirugía
Forbici per chirurgia

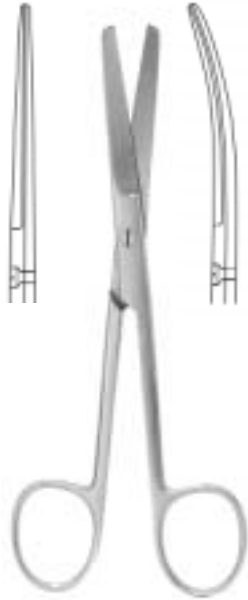

cm — DEAVER —
14,0 AI-310-14 AI-311-14

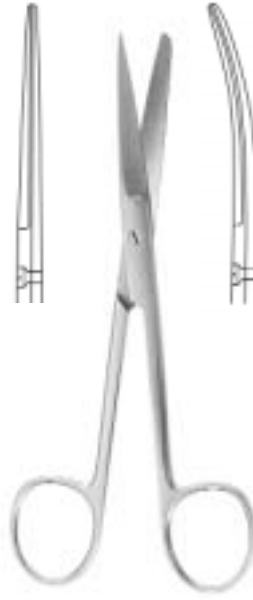

cm — DEAVER —
14,0 AI-410-14 AI-411-14

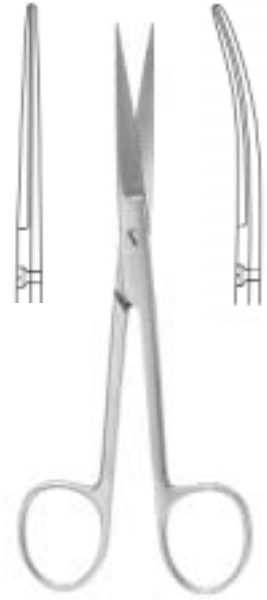

cm — DEAVER —
14,0 AI-510-14 AI-511-14

TC-Schneiden
TC Cutting Edges
Tranchant TC
Filos de corte TC
Taglio TC



cm — DEAVER —
14,0 AI-314-14 AI-315-14



cm — DEAVER —
14,0 AI-414-14 AI-415-14



cm — DEAVER —
14,0 AI-514-14 AI-515-14

TC-Schneiden
 TC Cutting Edges
 Tranchant TC
 Filos de corte TC
 Taglio TC



cm	MAYO
14,5	AI-610-14
14,5	AI-610-14L
17,0	AI-610-17
17,0	AI-610-17L
19,0	AI-610-19
23,0	AI-610-23
28,0	AI-610-28

cm	MAYO
14,5	AI-611-14
14,5	AI-611-14L
17,0	AI-611-17
17,0	AI-611-17L
19,0	AI-611-19
23,0	AI-611-23
28,0	AI-611-28

cm	MAYO
14,5	AI-614-14
17,0	AI-614-17
23,0	AI-614-23

cm	MAYO
14,5	AI-615-14
17,0	AI-615-17
23,0	AI-615-23

L = Für Linkshänder / For left-handed
 Pour la main gauche / Para zurdo / Per mancini

AI

Chirurgische Scheren
Operating Scissors
Ciseaux à chirurgie
Tijeras para cirugía
Forbici per chirurgia

schlanke Modelle
slender patterns
modèles fins
modelos finos
modelli fini



cm MAYO-STILLE
16,0 **AI-616-16**
19,0 **AI-616-19**
21,5 **AI-616-21**



cm MAYO-STILLE
16,0 **AI-617-16**
19,0 **AI-617-19**
21,5 **AI-617-21**

mit abgeschrägten Schneiden
with chamfered blades
avec tranchant biais
filos en declive
con lame inclinate



cm MAYO-STILLE
14,0 **AI-712-14**
17,0 **AI-712-17**



cm MAYO-STILLE
14,0 **AI-713-14**
17,0 **AI-713-17**

TC-Schneiden
 TC Cutting Edges
 Tranchant TC
 Filos de corte TC
 Taglio TC



cm MAYO-STILLE
 15,0 **AI-710-15**
 17,0 **AI-710-17**

cm MAYO-STILLE
 15,0 **AI-711-15**
 17,0 **AI-711-17**



cm MAYO-STILLE
 15,0 **AI-714-15**
 17,0 **AI-714-17**

cm MAYO-STILLE
 15,0 **AI-715-15**
 17,0 **AI-715-17**

AI

Chirurgische Scheren
Operating Scissors
Ciseaux à chirurgie
Tijeras para cirugía
Forbici per chirurgia

TC-Schneiden
TC Cutting Edges
Tranchant TC
Filos de corte TC
Taglio TC



cm MAYO-NOBLE
17,0 AI-810-17



cm MAYO-NOBLE
17,0 AI-811-17



cm MAYO-NOBLE
17,0 AI-814-17

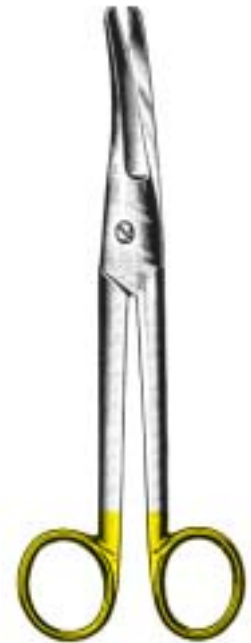

cm MAYO-NOBLE
17,0 AI-815-17

TC-Schneiden
 TC Cutting Edges
 Tranchant TC
 Filos de corte TC
 Taglio TC



cm LEXER
 16,0 **AI-910-16**
 21,0 **AI-910-21**

cm LEXER
 16,0 **AI-911-16**
 21,0 **AI-911-21**

cm LEXER
 16,0 **AI-914-16**
 21,0 **AI-914-21**

cm LEXER
 16,0 **AI-915-16**
 21,0 **AI-915-21**

AI

Präparierscheren
Dissecting Scissors
Ciseaux à dissection
Tijeras de disección
Forbici per dissezione



cm LEXER-FINO
16,0 AI-917-16



cm LEXER-BABY
10,0 AI-022-10



cm LEXER-BABY
10,0 AI-023-10



cm LEXER-BABY
10,0 AI-026-10



cm LEXER-BABY
10,0 AI-027-10

TC-Schneiden
TC Cutting Edges
Tranchant TC
Filos de corte TC
Taglio TC

Präparierschere mit Fadenbohrung in der Spitze
 Dissecting scissors, tips with eye for suture
 Ciseaux à dissection avec chas
 Tijera de disección, con ojal en las puntas
 Forbici per dissezione con foro per il filo alla punta



cm LITTLER
 12,0 **AI-025-12**
 14,0 **AI-025-14**



cm METZENBAUM
 11,5 **AI-120-11**
 15,5 **AI-120-15**



cm METZENBAUM
 11,5 **AI-121-11**
 15,5 **AI-121-15**



cm GORNEY
 12,0 **AI-122-12**
 19,0 **AI-122-19**



cm GORNEY
 19,0 **AI-123-19**

TC-Schneiden
TC Cutting Edges
Tranchant TC
Filos de corte TC
Taglio TC



cm	METZENBAUM
15,0	AI-820-15
15,0	AI-820-15L
18,0	AI-820-18
18,0	AI-820-18L
20,0	AI-820-20
23,0	AI-820-23
23,0	AI-820-23L
25,0	AI-820-25
28,0	AI-820-28
30,0	AI-820-30

cm	METZENBAUM
15,0	AI-821-15
15,0	AI-821-15L
18,0	AI-821-18
18,0	AI-821-18L
20,0	AI-821-20
23,0	AI-821-23
23,0	AI-821-23L
25,0	AI-821-25
28,0	AI-821-28
30,0	AI-821-30

cm	METZENBAUM
15,0	AI-824-15
18,0	AI-824-18
20,0	AI-824-20
23,0	AI-824-23
25,0	AI-824-25
28,0	AI-824-28
30,0	AI-824-30

cm	METZENBAUM
15,0	AI-825-15
18,0	AI-825-18
20,0	AI-825-20
23,0	AI-825-23
25,0	AI-825-25
28,0	AI-825-28
30,0	AI-825-30

L = Für Linkshänder / For left-handed
Pour la main gauche / Para zurdo / Per mancini

TC-Schneiden
 TC Cutting Edges
 Tranchant TC
 Filos de corte TC
 Taglio TC



cm	METZENBAUM FINO
15,0	AI-822-15
18,0	AI-822-18
20,0	AI-822-20
23,0	AI-822-23
25,0	AI-822-25
28,0	AI-822-28

cm	METZENBAUM FINO
15,0	AI-823-15
18,0	AI-823-18
20,0	AI-823-20
23,0	AI-823-23
25,0	AI-823-25
28,0	AI-823-28

cm	METZENBAUM FINO
15,0	AI-826-15
18,0	AI-826-18
20,0	AI-826-20
23,0	AI-826-23
25,0	AI-826-25
28,0	AI-826-28

cm	METZENBAUM FINO
15,0	AI-827-15
18,0	AI-827-18
20,0	AI-827-20
23,0	AI-827-23
25,0	AI-827-25
28,0	AI-827-28

AI

Präparierscheren
Dissecting Scissors
Ciseaux à dissection
Tijeras de disección
Forbici per dissezione

TC-Schneiden
TC Cutting Edges
Tranchant TC
Filos de corte TC
Taglio TC



cm METZENBAUM "S"
18,0 AI-921-18



cm METZENBAUM "S"
18,0 AI-925-18



cm SANVENERO
14,0 AI-032-14



cm SANVENERO
14,0 AI-033-14

Plastik
Plastic
Plastique
Plástica
Plastica



cm JOSEPH
14,0 AI-034-14



cm JOSEPH
14,0 AI-035-14

Plastik
 Plastic
 Plastique
 Plástica
 Plastica



gerade
 straight
 croits
 rectas
 rette

cm KILNER
 12,0 **AI-038-12**



cm KILNER
 12,0 **AI-130-12**
 15,0 **AI-130-15**

TC-Schneiden
 TC Cutting Edges
 Tranchant TC
 Filos de corte TC
 Taglio TC



cm KILNER
 12,0 **AI-134-12**
 15,0 **AI-134-15**

AI

Chirurgische Scheren
Operating Scissors
Ciseaux à chirurgie
Tijeras para cirugía
Forbici per chirurgia



cm LOCKLIN
16,0 AI-135-16

eine Schneide gezahnt
one toothed cutting edge
une lame dentelée
una hoja dentada
una lama dentata



cm LOCKLIN
16,0 AI-137-16

Plastik
Plastic
Plastique
Plástica
Plastica

TC-Schneiden
TC Cutting Edges
Tranchant TC
Filos de corte TC
Taglio TC



cm REYNOLDS
15,0 AI-230-15



cm REYNOLDS
15,0 AI-231-15
18,0 AI-231-18



cm REYNOLDS
15,0 AI-234-15



cm REYNOLDS
15,0 AI-235-15



cm IRIS
9,5 **AI-232-09**



cm IRIS
9,5 **AI-233-09**



cm IRIS
10,5 **AI-236-10**



cm IRIS
9,5 **AI-237-10**



cm IRIS
10,0 **AI-238-10**



cm IRIS
10,0 **AI-239-10**



cm IRIS
9,5 **AI-331-09**



cm IRIS
9,5 **AI-333-09**

AI

Chirurgische Scheren
Operating Scissors
Ciseaux à chirurgie
Tijeras para cirugía
Forbici per chirurgia



cm KNAPP
10,5 **AI-336-10**



cm KNAPP
10,5 **AI-337-10**



cm KNAPP
10,5 **AI-338-10**



cm KNAPP
10,5 **AI-339-10**

rund
 round
 rond
 redondo
 retondo



cm IRIS-Standard
 9,0 **AI-430-09**
 10,5 **AI-430-10**
 10,5 **AI-430-10L**
 11,5 **AI-430-11**
 12,5 **AI-430-12**

cm IRIS-Standard
 9,0 **AI-431-09**
 10,5 **AI-431-10**
 10,5 **AI-431-10L**
 11,5 **AI-431-11**
 12,5 **AI-431-12**

cm IRIS-Standard
 10,5 **AI-432-10**
 11,5 **AI-432-11**

cm IRIS-Standard
 10,5 **AI-433-10**
 11,5 **AI-433-11**

L = Für Linkshänder / For left-handed / Pour la main gauche / Para zurdo / Per mancini

TC-Schneiden
 TC Cutting Edges
 Tranchant TC
 Filos de corte TC
 Taglio TC



cm IRIS-Standard
 11,5 **AI-434-11**

cm IRIS-Standard
 11,5 **AI-435-11**

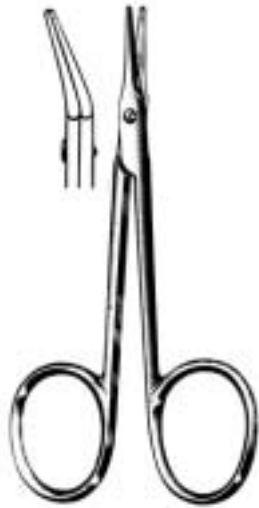

cm AEBLI
9,0 **AI-437-09**

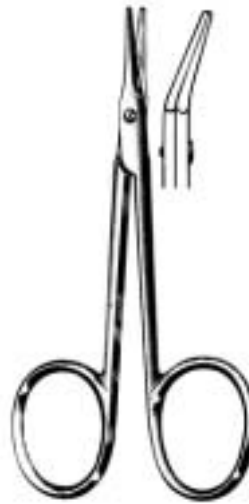

cm AEBLI
9,0 **AI-439-09**



cm IRIS
11,5 **AI-531-11**



cm IRIS
11,5 **AI-534-11**

Scheren, Ophthal., Nase
Scissors, Ophthal., Nasal
Ciseaux, ophtal., nasaux
Tijeras, oftalmología, nasales
Forbici, oftalmologia, nasali

AI



cm STEVENS
10,5 **AI-630-11**



cm STEVENS
10,5 **AI-631-11**



cm STEVENS
10,5 **AI-632-11**



cm STEVENS
10,5 **AI-633-11**



cm STEVENS
10,5 **AI-634-10**



cm STEVENS
10,5 **AI-635-10**



cm STEVENS
10,5 **AI-636-10**



cm STEVENS
10,5 **AI-637-10**

AI

Scheren, Ophthal., Nase
Scissors, Ophthal., Nasal
Ciseaux, ophtal., nasaux
Tijeras, oftalmología, nasales
Forbici, oftalmologia, nasali



cm
10,0 **AI-639-10**



cm
12,5 **AI-639-12**

Strabismusscheren
Strabismus scissors
Ciseaux à strabisme
Tijeras para estrabismo
Forbici per strabismo

TC-Schneiden
TC Cutting Edges
Tranchant TC
Filos de corte TC
Taglio TC



cm
11,0 **AI-730-11**



cm
11,0 **AI-731-11**



cm
11,0 **AI-734-11**



cm
11,0 **AI-735-11**

Enucleationsscheren
 Enucleation scissors
 Ciseaux à énucléation
 Tijeras para enucleación
 Forbici per enucleazione



cm LANDOLT
 11,0 **AI-831-11**
 13,0 **AI-831-13**



cm LANDOLT
 13,0 **AI-831-13**



cm HEYMANN
 18,0 **AI-041-18**



cm FOMON
 14,0 **AI-043-14**
 15,0 **AI-043-15**



cm COTTLE
 16,0 **AI-045-16**



cm COTTLE
 16,0 **AI-047-16**

TC-Schneiden
 TC Cutting Edges
 Tranchant TC
 Filos de corte TC
 Taglio TC

AI

Tonsillen-, Gefäß-Scheren
Tonsil, Vascular Scissors
Ciseaux amygdal., vasculaires
Tijeras, amígdal., vasculares
Forbici, tonsill., vascolari



cm BEUSE
14,0 **AI-240-14**
18,0 **AI-240-18**



cm BEUSE
14,0 **AI-241-14**
18,0 **AI-241-18**



aufgewinkelt
angled upwards
coudée en haut
angulada
angolari sul piatto

cm DEAN
17,0 **AI-245-17**



gezahnt, aufgewinkelt
toothed, angled upwards
dentelés, coudée en haut
dentada, angulada
dentate, angolari sul piatto

cm DEAN
17,0 **AI-247-17**

Tonsillen-, Gefäß-Scheren
 Tonsil, Vascular Scissors
 Ciseaux amygdal., vasculaires
 Tijeras, amígdal., vasculares
 Forbici, tonsill., vascolari

AI



cm BOETTCHE
 18,0 **AI-345-18**



cm GOOD
 14,0 **AI-347-19**

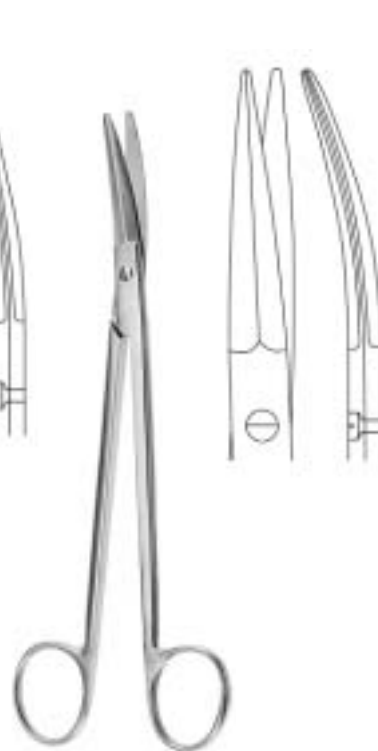

cm PRINCE
 17,0 **AI-349-17**



cm
 15,0 **AI-648-15**



cm
 11,0 **AI-740-11**



cm POTTS-DE MARTEL
 21,0 **AI-743-21**
 24,0 **AI-743-24**



cm MILLS
 22,0 **AI-745-22**

AI

Gefäß-Scheren
Vascular Scissors
Ciseaux vasculaires
Tijeras vasculares
Forbici vascolari



POTTS-SMITH

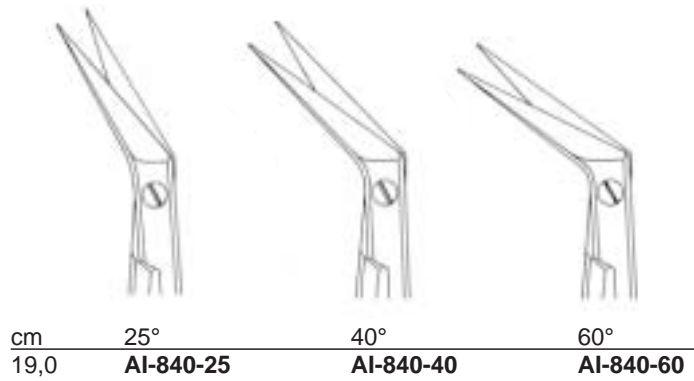

POTTS-SMITH

TC-Schneiden
TC Cutting Edges
Tranchant TC
Filos de corte TC
Taglio TC

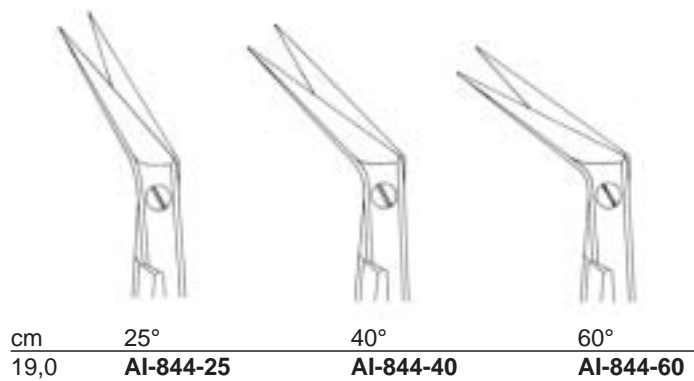



cm DIETHRICH
18,0 **AI-846-25**



cm DIETHRICH
18,0 **AI-846-45**



cm DIETHRICH
18,0 **AI-846-60**



cm DIETHRICH
18,0 **AI-846-90**



cm DIETHRICH
18,0 **AI-847-25**



cm DIETHRICH
18,0 **AI-848-25**

AI

Gefäß-Scheren
 Vascular Scissors
 Ciseaux vasculaires
 Tijeras vasculares
 Forbici vascolari



cm DE BAKEY
 16,0 **AI-940-16**
 23,0 **AI-940-23**
 28,0 **AI-940-28**



cm DE BAKEY
 16,0 **AI-941-16**
 23,0 **AI-941-23**
 28,0 **AI-941-28**



cm DE BAKEY
 16,0 **AI-942-16**
 23,0 **AI-942-23**
 28,0 **AI-942-28**

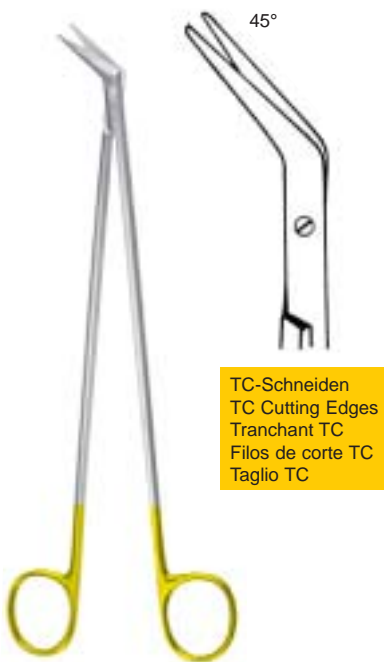

TC-Schneiden
 TC Cutting Edges
 Tranchant TC
 Filos de corte TC
 Taglio TC

cm DE BAKEY
 23,0 **AI-943-23**



cm DE BAKEY
 15,5 **AI-945-15**



cm DE BAKEY
 15,5 **AI-947-15**

Parametrium



cm
22,5 AI-051-22



cm
23,0 AI-051-23

TC-Schneiden
TC Cutting Edges
Tranchant TC
Filos de corte TC
Taglio TC



cm
22,5 AI-055-22



cm
23,0 AI-055-23

AI

Gynäkologische Scheren
 Gynaecological Scissors
 Ciseaux gynécologiques
 Tijeras ginecológicas
 Forbici ginecologiche



cm SIMS
 20,0 **AI-150-20**
 23,0 **AI-150-23**



cm SIMS
 20,0 **AI-151-20**
 23,0 **AI-151-23**



cm SIMS
 23,0 **AI-154-23**



cm SIMS
 23,0 **AI-155-23**

TC-Schneiden
 TC Cutting Edges
 Tranchant TC
 Filos de corte TC
 Taglio TC



cm SIEBOLD
 24,0 **AI-253-24**



cm WERTHEIM
 22,5 **AI-255-20**



cm WERTHEIM
 22,5 **AI-257-22**

TC-Schneiden
 TC Cutting Edges
 Tranchant TC
 Filos de corte TC
 Taglio TC



cm DOYEN
17,5 **AI-350-17**
18,5 **AI-350-18**



cm DOYEN
17,5 **AI-351-17**



cm DUBOIS
27,0 **AI-356-27**



cm DUBOIS
27,0 **AI-357-27**



cm KELLY
16,0 **AI-450-16**
18,0 **AI-450-18**



cm KELLY
16,0 **AI-451-16**
18,0 **AI-451-18**

Nabelschnur-Scheren
Umbilical Scissors
Ciseaux ombilicaux
Tijeras umbilicales
Forbici ombelicali



cm U.S.A Mod.
10,5 **AI-550-10**



cm BUSCH
16,0 **AI-551-16**



cm SCHUMACHER
14,0 **AI-553-16**



cm WALDMANN
18,0 **AI-555-18**

Episiotomie
Episiotomy
Episiotomia



cm BRAUN-STADLER
14,5 **AI-650-14**
20,0 **AI-650-20**
22,0 **AI-650-22**

Nerv-Präparierscheren
Nerve dissecting Scissors
Ciseaux pour nerfs
Tijeras para nervios
Forbici per nervi



cm
11,0 **AI-850-11**



cm
11,0 **AI-851-11**

Neurochirurgie
 Neurosurgery
 Neurocirurgia
 Neurochirurgia



cm
 15,0 **AI-852-15**



cm
 15,0 **AI-853-15**



cm **STRULLY**
 22,0 **AI-062-22**



cm **TOENNIS-ADSON**
 18,0 **AI-160-18**



cm **TOENNIS-ADSON**
 18,0 **AI-161-18**



cm **MC INDOE**
 19,0 **AI-164-19**

AI

Chirurgische Scheren
Operating Scissors
Ciseaux à chirurgie
Tijeras para cirugía
Forbici per chirurgia



cm DANDY
17,0 **AI-167-17**

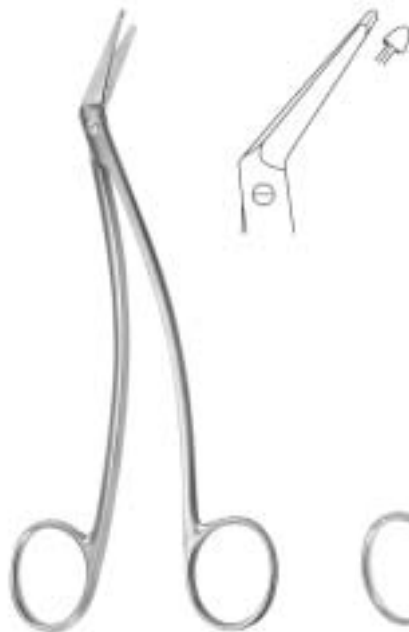

cm SCHMIEDEN-TAYLOR
17,0 **AI-169-17**



cm CRAFOORD
30,0 **AI-461-30**



cm THOREK
19,0 **AI-463-18**
25,0 **AI-463-25**



cm SATINSKY
21,0 **AI-560-21**



cm SATINSKY
24,5 **AI-561-24**



cm KLINKENBERG-LOTH
23,0 **AI-661-23**

AI

Chirurgische Scheren
Operating Scissors
Ciseaux à chirurgie
Tijeras para cirugía
Forbici per chirurgia

Lungenlappen- und Rektumscheren
Lobectomy and rectal scissors
Ciseaux à lobectomie et pour le rectum
Tijera para lobectomía y recto
Forbici per lobo polmonare e per il retto



cm FINOCHIETTO
27,0 **AI-663-27**



cm STELZNER
30,0 **AI-664-30**



cm STELZNER
30,0 **AI-665-30**

Darmscheren
Enterotomy Scissors
Ciseaux à entérotomie
Enterótomos
Forbici per enterotomia



cm
21,0 AI-770-21



cm
21,0 AI-772-21



cm
21,0 AI-774-21

Ligaturscheren
 Stitch Scissors
 Ciseaux à ligatures
 Tijeras para puntas
 Forbici per legature



cm SPENCER
 9,0 **AI-082-09**
 11,0 **AI-082-11**
 12,0 **AI-082-12**
 15,0 **AI-082-15**



cm SHORTBENT
 9,0 **AI-083-09**



cm NORTHBENT
 13,0 **AI-083-13**



cm LITTAUER
 14,0 **AI-084-14**



cm BUCK
 14,5 **AI-086-14**
 18,0 **AI-086-18**

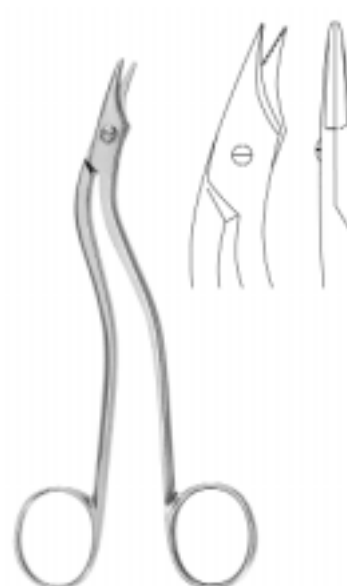

cm HEATH
 15,0 **AI-089-15**

Zahnfleischscheren
 Gum Scissors
 Ciseaux à gencives
 Tijeras para encías
 Forbici gengivali



cm
 11,5 **AI-185-11**



cm **LAGRANGE**
 11,5 **AI-187-11**



cm **LAGRANGE**
 11,5 **AI-189-11**

gezahnt
 serrated
 dentelé
 dentada
 dentellate



cm **GOLDMANN-FOX**
 13,0 **AI-280-13**



cm **GOLDMANN-FOX**
 13,0 **AI-281-13**

gezahnt
 serrated
 dentelé
 dentada
 dentellate



cm **GOLDMANN-FOX**
 13,0 **AI-282-13**

TC-Schneiden
 TC Cutting Edges
 Tranchant TC
 Filos de corte TC
 Taglio TC

gezahnt
 serrated
 dentelé
 dentada
 dentellate



cm **GOLDMANN-FOX**
 13,0 **AI-283-13**

Zahnfleischscheren
 Gum Scissors
 Ciseaux à gencives
 Tijeras para encías
 Forbici gengivali



cm WAGNER
 12,0 AI-284-12



cm WAGNER
 12,0 AI-285-12



cm QUINBY
 12,0 AI-287-12

Draht-, Blechscheren
 Wire and plate shears
 Ciseaux à fils et plaques métalliques
 Tijeras para alambre y chapas
 Forbice per filo metallo lamiera



cm UNIVERSAL
 12,0 AI-381-12



cm UNIVERSAL
 12,0 AI-385-12

TC-Schneiden
 TC Cutting Edges
 Tranchant TC
 Filos de corte TC
 Taglio TC

Draht-, Blechscheren
 Wire and plate shears
 Ciseaux à fils et plaques métalliques
 Tijeras para alambre y chapas
 Forbice per filo metallo lamiera

gerade
 straight
 droites
 rectas
 rette



cm BEEBE
 10,5 **AI-580-10**

spitz
 pointed
 pointus
 agudas
 acute



cm BEEBE
 10,5 **AI-581-10**

gebogen
 curved
 courbes
 curvas
 curve



cm BEEBE
 10,5 **AI-582-10**

stumpf
 blunt
 mousses
 romas
 smusse



cm BEEBE
 10,5 **AI-583-10**

gerade
 straight
 droites
 rectas
 rette



cm BEEBE
 12,0 **AI-584-12**

gezahnt
 serrated
 dentelé
 dentada
 dentellate



cm BEEBE
 12,0 **AI-585-12**

gebogen
 curved
 courbes
 curvas
 curve



cm LANGE
18,0 **AI-986-18**

Gaze
Gauze
Gaze
Gaza
Garza



cm SMITH US ARMY
15,0 **AI-988-15**
16,0 **AI-988-16**
18,0 **AI-988-18**
20,0 **AI-988-20**

TC-Schneiden
 TC Cutting Edges
 Tranchant TC
 Filos de corte TC
 Taglio TC



cm	LISTER
9,5	AI-091-09
11,0	AI-091-11
14,0	AI-091-14
14,0	AI-091-14L
16,0	AI-091-16
16,0	AI-091-16L
18,0	AI-091-18
18,0	AI-091-18L
20,0	AI-091-20

cm	LISTER
14,0	AI-092-14

cm	LISTER
18,0	AI-093-18
20,0	AI-093-20

cm	LISTER
14,0	AI-095-14
18,0	AI-095-18
20,0	AI-095-20

L = Für Linkshänder / For left-handed / Pour la main gauche / Para zurdo / Per mancini

AI

Verband-Scheren
Bandage Scissore
Ciseaux à bandages
Tijeras para vendajes
Forbici per bendaggi



cm BERGMANN
23,0 **AI-191-23**



cm ESMARCH
20,0 **AI-193-20**
22,0 **AI-193-22**



cm Excenter
16,0 **AI-291-16**
19,0 **AI-291-19**



cm ROTES KREUZ
17,0 AI-297-17



cm KNOWLES
14,0 AI-390-14



cm KNOWLES
14,0 AI-391-14



cm LORENZ
23,0 AI-393-23

AI

Verband-Scheren
Bandage Scissors
Ciseaux à bandages
Tijeras para vendajes
Forbici per bendaggi

eine Schneide gezahnt
one serrated cutting edge
une lame dentelé
una hoja cortante dentada
una lama dentada

TC-Schneiden
TC Cutting Edges
Tranchant TC
Filos de corte TC
Taglio TC



cm BRUNS
23,0 AI-395-23



cm BRUNS
23,0 AI-397-23



cm BRUNS
23,0 AI-399-23

Gipsschere
Plaster Shear
Ciseaux pour plâtre
Tijera para yeso
Forbice per gesso



cm
20,0 **AI-491-20**



cm **FERGUSON**
18,0 **AI-492-18**

AI

Verband-Scheren
Bandage Scissore
Ciseaux à bandages
Tijeras para vendajes
Forbici per bendaggi



cm
14,5 AI-592-14



cm UNIVERSAL

	Black	Blue	Green	Red	Yellow	White
15,0	AI-590-15	AI-590-15B	AI-590-15G	AI-590-15R	AI-590-15Y	AI-590-15W
18,0	AI-590-18	AI-590-18B	AI-590-18G	AI-590-18R	AI-590-18Y	AI-590-18W

AJ

**Mikro Scheren
Micro Scissors
Micro Ciseaux
Micro Tijeras
Micro Forbici**



AJ

AJ

Augen Scheren
Ophthalmic Scissors
Ciseaux oculaires
Tijeras oculares
Forbici oculistiche

Sehnen-Scheren
Tendon Scissors
Ciseaux tendons
Tijeras tendones
Forbici tendini

Iridectomiescheren
Iridectomy Scissors
Ciseaux à iridectomie
Tijeras para iridectomia
Forbici per iridectomia

spitz
sharp
pointu
agudo
appuntato

stumpf
blunt
mousse
romo
smusso

gerade
straight
droits
rectas
rette

gebogen
curved
courbes
curvas
curve



cm WESTCOTT
11,0 AJ-012-11

cm WESTCOTT
11,0 AJ-014-11

cm WESTCOTT
11,0 AJ-016-11

cm WESTCOTT
11,0 AJ-017-11

Sehnen-, Iris-Scheren
 Tendon, Iris Scissors
 Ciseaux à iris et tendons
 Tijeras iris y para tendones
 Forbici per iride e tendini



cm	NOYES
13,0	AJ-019-13
16,0	AJ-019-16



spitz/spitz
 sharp/sharp
 pointu/pointu
 agudo/agudo
 appuntato/appuntato

Fig. 1

cm	NOYES
12,0	AJ-110-12



spitz/stumpf
 sharp/blunt
 pointu/mousse
 agudo/romo
 appuntato/smusso

Fig. 2

cm	NOYES
12,0	AJ-111-12



stumpf/stumpf
 blunt/blunt
 mousse/mousse
 romo/romo
 smusso/smusso

Fig. 3

cm	NOYES
12,0	AJ-112-12

Sehnen-, Iris-Scheren
Tendon, Iris Scissors
Ciseaux à iris et tendons
Tijeras iris y para tendones
Forbici per iride e tendini



cm WECKER
11,0 AJ-113-11

spitz/spitz
sharp/sharp
pointu/pointu
agudo/agudo
appuntato/appuntato



cm NOYES
12,0 AJ-110-12

spitz/stumpf
sharp/blunt
pointu/mousse
agudo/romo
appuntato/smusso



cm NOYES
12,0 AJ-111-12

stumpf/stumpf
blunt/ blunt
mousse/ mousse
romo/ romo
smusso/ smusso



cm NOYES
12,0 AJ-112-12



cm McPherson-Westcott
10,0 AJ-118-01



spitz
sharp
pointu
agudo
appuntato



cm McPherson-Westcott
10,0 AJ-118-02



stumpf
blunt
mousse
romo
smusso

Blattlänge 10 mm
length of blades 10 mm
longeur des lames 10 mm
largo de hojas 10 mm
lunghezza della lama 10 mm



cm BARRAQUER
5,5 AJ-119-07

Iridektomie, Hornhaut
 Iridectomy, corneal
 Iridectomie, cornéens
 Iridectomía, corneal
 Iridectomia, corneale



cm McGUIRE
 10,0 **AJ-211-10**



spitz
 sharp
 pointu
 agudo
 appuntato

cm CASTROVIEJO
 10,0 **AJ-313-10**



stumpf
 blunt
 mousse
 romo
 smusso

cm CASTROVIEJO
 10,0 **AJ-315-10**



gerade
 straight
 droits
 rectas
 rette

cm VANNAS
 8,0 **AJ-410-08**



gebogen
 curved
 courbes
 curvas
 curve

cm VANNAS
 8,0 **AJ-411-08**



kniegebogen
 angular
 coudés
 acodadas
 angolate

cm VANNAS
 8,0 **AJ-413-08**

Iridektomie, Hornhaut
 Iridectomy, corneal
 Iridectomie, cornéens
 Iridectomía, corneal
 Iridectomia, corneale



links
 left
 gauche
 izquierda
 sinistra

cm CASTROVIEJO
 10,0 AJ-417-10



rechts
 right
 droite
 derecha
 destra

cm CASTROVIEJO
 10,0 AJ-419-10



stumpf
 blunt
 mousse
 romo
 smusso

cm CASTROVIEJO
 11,0 AJ-511-11



stumpf
 blunt
 mousse
 romo
 smusso

cm CASTROVIEJO
 11,0 AJ-513-11



stumpf
 blunt
 mousse
 romo
 smusso

cm CASTROVIEJO
 11,0 AJ-515-11

Mikrochirurgie
 Micro Surgery
 Microchirurgie
 Microcirugía
 Microchirurgia



cm
 10,0 AJ-517-10



rechts
 right
 droite
 derecha
 destra

cm TROUTMAN-CASTROVIEJO
 11,0 **AJ-611-11**



links
 left
 gauche
 izquierda
 sinistra

cm TROUTMAN-CASTROVIEJO
 11,0 **AJ-613-11**



gerade
 straight
 droits
 rectas
 rette

cm
 14,0 **AJ-022-14**
 18,0 **AJ-022-18**



gebogen
 curved
 courbes
 curvas
 curve

cm
 14,0 **AJ-023-14**
 18,0 **AJ-023-18**



gerade
 straight
 droits
 rectas
 rette

cm
 18,0 **AJ-024-18**



stumpf
 blunt
 mousse
 romo
 smusso

cm
 18,0 **AJ-025-18**

AJ

Augen-, Mikro-Scheren
Ophthalmic, Micro Scissors
Ciseaux oculaires, micro-ciseaux
Tijeras oculares, microquirúrgicas
Forbici oculistiche, micro-chirurg.



spitz
sharp
pointu
agudo
appuntato

cm
14,5 **AJ-220-14**
18,0 **AJ-220-18**
23,0 **AJ-220-23**



spitz
sharp
pointu
agudo
appuntato

cm
14,5 **AJ-221-14**
18,0 **AJ-221-18**
23,0 **AJ-221-23**



stumpf
blunt
mousse
romo
smusso

cm
14,5 **AJ-223-14**
18,0 **AJ-223-18**

Augen-, Mikro-Scheren
 Ophthalmic, Micro Scissors
 Ciseaux oculaires, micro-ciseaux
 Tijeras oculares, microquirúrgicas
 Forbici oculistiche, micro-chirurg.

AJ



AJ-224-25
 25°
 18 cm

spitz
 sharp
 pointu
 agudo
 appuntato



AJ-224-45
 45°
 18 cm



AJ-224-60
 60°
 18 cm



AJ-224-90
 90°
 18 cm



09.225.00
 125°
 18 cm



AJ-225-25
 25°
 18 cm

1 Blatt geknöpft
 1 probe-pointed blade
 1 lame boutonnée
 1 hoja botonada
 1 lama bottonnta



AJ-225-45
 45°
 18 cm



AJ-225-60
 60°
 18 cm



AJ-225-90
 90°
 18 cm



AJ-226-00
 125°
 18 cm



AJ

Augen-, Mikro-Scheren
Ophthalmic, Micro Scissors
Ciseaux oculaires, micro-ciseaux
Tijeras oculares, microquirúrgicas
Forbici oculistiche, micro-chirurg.

gerade
straight
droits
rectas
rette



cm YASARGIL
16,5 **AJ-520-16**
20,0 **AJ-520-20**
22,5 **AJ-520-22**

aufgebogen
upwards curved
courbe vers le haut
curvada hacia arriba
curvato verso l'alto



cm YASARGIL
16,5 **AJ-521-16**
20,0 **AJ-521-20**
22,5 **AJ-521-22**
24,5 **AJ-521-24**

abwärts gebogen
upwards curved
courbe en bas
curvada hacia abajo
curvato verso il basso



cm YASARGIL
20,0 **AJ-523-20**
22,5 **AJ-523-22**

stumpf
blunt
mousse
romo
smusso



cm YASARGIL
20,0 **AJ-524-20**
22,5 **AJ-524-22**

stumpf
 blunt
 mousse
 romo
 smusso



cm YASARGIL
 20,0 **AJ-525-20**
 22,5 **AJ-525-22**

gebogen
 curved
 courbes
 curvas
 curve



cm JACOBSON
 19,0 **AJ-527-19**

gerade
 straight
 droits
 rectas
 rette



cm YASARGIL
 12,0 **AJ-620-12**
 16,0 **AJ-620-16**
 18,0 **AJ-620-18**

gebogen
 curved
 courbes
 curvas
 curve



cm YASARGIL
 12,0 **AJ-621-12**
 16,0 **AJ-621-16**
 18,0 **AJ-621-18**

AJ

Augen-, Mikro-Scheren
Ophthalmic, Micro Scissors
Ciseaux oculaires, micro-ciseaux
Tijeras oculares, microquirúrgicas
Forbici oculistiche, micro-chirurg.

gerade
straight
droits
rectas
rette



cm VANNAS
12,0 AJ-622-12
16,0 AJ-622-16

gebogen
curved
courbes
curvas
curve



cm VANNAS
12,0 AJ-623-12
16,0 AJ-623-16

Augen-, Mikro-Scheren
 Ophthalmic, Micro Scissors
 Ciseaux oculaires, micro-ciseaux
 Tijeras oculares, microquirúrgicas
 Forbici oculistiche, micro-chirurg.

AJ

gerade
 straight
 droits
 rectas
 rette



cm
 18,5 AJ-626-16

gebogen
 curved
 courbes
 curvas
 curve



cm
 18,5 AJ-627-18

gerade
 straight
 droits
 rectas
 rette



cm VANNAS
 18,5 AJ-628-18

gebogen
 curved
 courbes
 curvas
 curve



cm VANNAS
 18,5 AJ-629-18

BA

BB

**Pinzetten
Forceps
Pinzes
Pinzas
Pinze**



BA-BB

BA

Pinzetten
Thumb and Tissue Forceps
Pincès à dissection
Pinzas de disección
Pinze per dissezione

	USA		STILLE		POTTS-SMITH	POTTS-SMITH
cm	11,5	12,0	13,0	14,5	15,0	15,5
	BA-012-11	BA-014-12	BA-016-13	BA-014-14	BA-110-11	BA-110-13
	BA-012-13	BA-014-13	BA-110-14	BA-114-14		
	BA-012-14	BA-014-14	BA-110-16	BA-114-16		
	BA-012-15	BA-014-15	BA-110-18	BA-110-18	BA-112-18	BA-116-18
	BA-012-16	BA-014-16	BA-110-20	BA-110-20	BA-112-21	BA-116-21
	BA-012-18	BA-014-18	BA-110-25	BA-110-25	BA-112-25	BA-116-25
	BA-012-20	BA-016-20	BA-110-30	BA-110-30	BA-112-30	BA-216-18
	BA-012-21	BA-014-21				BA-216-21
	BA-012-25	BA-014-25				BA-216-25
	BA-012-30					

schmal
narrow
étroite
estrecha
stretta

schmal
narrow
étroite
estrecha
stretta

	USA		STILLE				
cm	11,5	12,0	13,0	14,5	15,0	15,5	16,0
	BA-210-11	BA-212-12	BA-310-11	BA-410-11	BA-210-13	BA-212-13	BA-510-13
	BA-210-13	BA-212-13	BA-310-13	BA-410-13	BA-210-14	BA-212-14	BA-510-14
	BA-210-14	BA-212-14	BA-310-14	BA-410-14		BA-214-15	BA-610-13
							BA-610-14
		BA-212-15					
	BA-210-16	BA-212-16	BA-310-16	BA-410-16	BA-210-18	BA-212-18	BA-510-16
	BA-210-18	BA-212-18	BA-310-18	BA-410-18	BA-210-20	BA-212-20	BA-610-16
	BA-210-20	BA-212-20	BA-310-20	BA-410-20			BA-510-20
		BA-212-21	BA-214-21				BA-610-20
	BA-210-25	BA-212-25	BA-310-25	BA-410-25			
	BA-210-30		BA-310-30				

Pinzette
Thumb and Tissue Forceps
Pincas à dissection
Pinzas de disección
Pinze per dissezione

BA

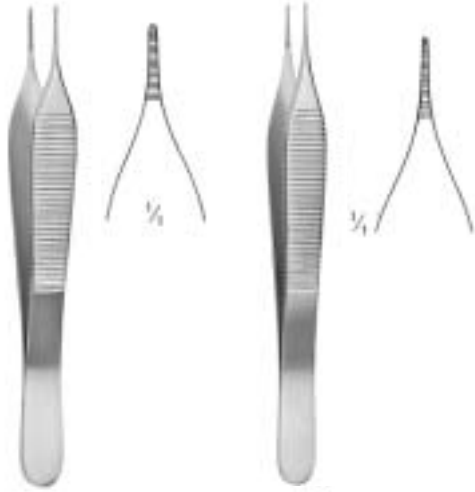

cm	ADSON	ADSON micro
12,0	BA-710-12	BA-716-12
12,0	BA-714-12	
15,0	BA-710-15	BA-716-15
15,0	BA-714-15	



CUSHING
BA-220-17
BA-224-17
17 cm

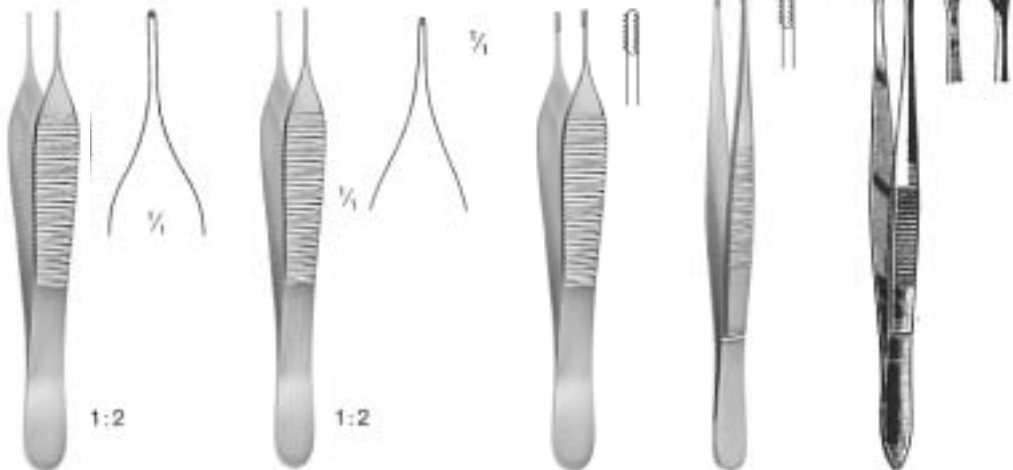

cm	ADSON	ADSON micro	ADSON-BROWN	BROWN	GRAEFE
10,5					BA910-10
12,0	BA-810-12	BA-816-12	BA-818-12	BA-819-12	
15,0	BA-810-15	BA-816-15			
16,0				BA-819-16	
20,0				BA-819-20	
25,0				BA-819-25	



CUSHING
BA-320-17
17 cm

BA

Pinzette
Thumb and Tissue Forceps
Pinces à dissection
Pinzas de disección
Pinze per dissezione

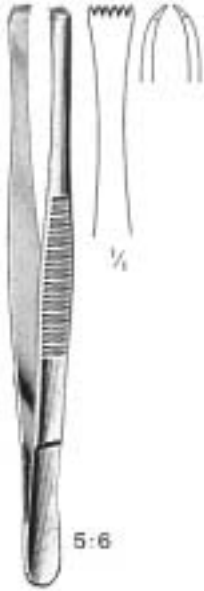

cm	LERICHE	ADLERKREUTZ	LANE	LANE	FERRIS-SMITH	FERRIS-SMITH
14,5	BA-322-15	BA-326-15	BA-420-14	BA-422-14		
15,0						
18,0			BA-420-18	BA-422-18	BA-426-18	BA-428-18
20,0		BA-326-20	BA-420-20			



cm	DUVAL	COLLIN-DUVAL	Russ. Mod.	McINDOE
14,5	BA-520-14			
15,0			BA-526-15	BA-528-15
20,0		BA-522-14	BA-526-18	
25,0			BA-526-25	

Pinzetten
 Thumb and Tissue Forceps
 Pincès à dissection
 Pinzas de disección
 Pinze per dissezione

BA

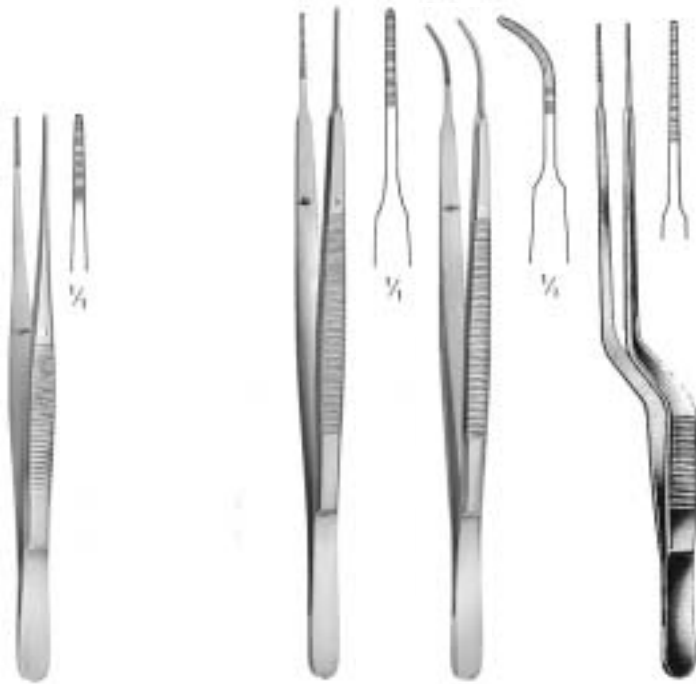

cm	SEMKEN	GERALD	GERALD	GERALD
12,5	BA-620-12			
15,5	BA-620-15			
18,0		BA-032-18	BA-033-18	BA-035-18

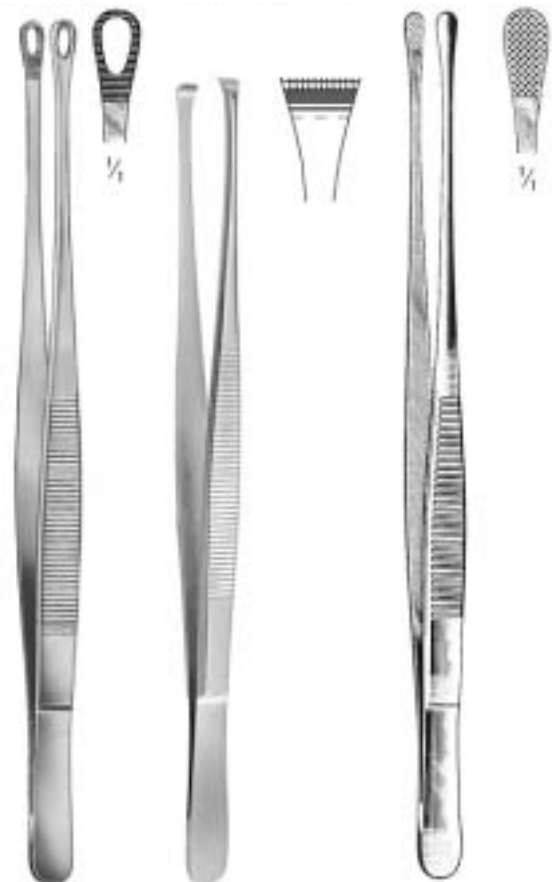

cm	SEMKEN	GILLIES	GERALD	GERALD	GERALD	SINGLEY	NELSON	WANGENSTEEN
12,5	BA-720-12							
15,5	BA-720-15	BA-722-15						
18,0			BA-130-18	BA-131-18	BA-133-18	BA-230-18	BA-232-15	
23,0			BA-130-23			BA-230-23	BA-232-18	BA-232-23
								BA-234-23

BA

Splitterpinzetten, -zangen
 Splinter Forceps
 Pincès à échardes
 Pinzas para espinas
 Pinze per schegge



BA-330-12
 12 cm
 Fig. 3

BA-331-12
 12 cm
 Fig. 7

cm		FEILCHENFELD	HUNTER	HUNTER		CARMALT	CARMALT
7,5		BA-180-07					
9,5	BA-082-09	BA-180-09					
10,5	BA-082-10		BA-182-10	BA-183-10		BA-186-10	BA-187-10
11,5	BA-082-11	BA-180-11					
12,5					BA-185-12		



PEET
BA-281-11
 11,5 cm



STIEGLITZ
BA-282-13 13,5 cm **BA-283-13**



ARCHER
BA-284-14 14 cm **BA-285-14**



VIRTUS (RALK)
BA-288-15
 15 cm

Mikrochirurgie-Pinzetten
Microsurgery Forceps
Pinces à microchirurgie
Pinzas para microcirugía
Pinze per microchirurgia

BB



BB-012-12 12 cm BB-013-12



BB-014-15 15 cm BB-015-15



BB-018-18 18 cm BB-019-18
BB-018-23 23 cm

BB

Atraumatische Pinzetten
 Atraumatic Tissue Forceps
 Pincès atraumàtiques
 Pinzas atraumáticas
 Pinze atraumatiche

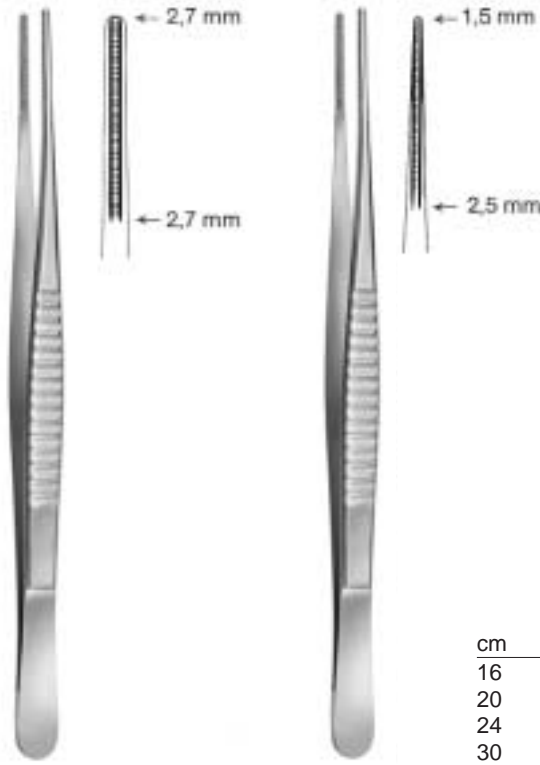

cm	DE BAKEY	DE BAKEY
16	BB-034-16	BB-036-16
20	BB-034-20	BB-036-20
24	BB-034-24	BB-036-24
30	BB-034-30	

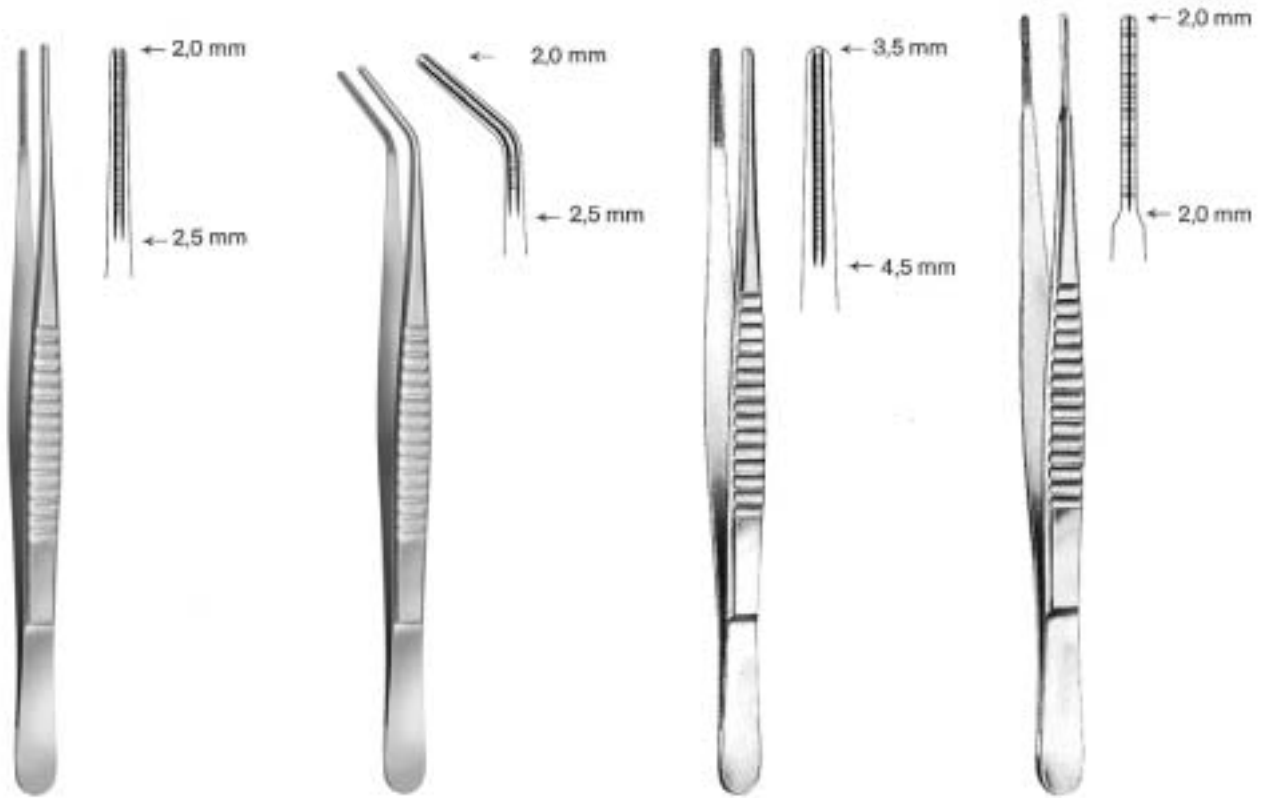

cm	DE BAKEY	DE BAKEY	DE BAKEY	COOLEY
16	BB-038-16	BB-039-16	BB-130-16	BB-134-16
20	BB-038-20	BB-039-20	BB-130-20	BB-134-20
24	BB-038-24	BB-039-24	BB-130-24	BB-134-24
30	BB-038-30	BB-039-30	BB-130-30	BB-134-30

BC

**Arterienklemmen
Hemostatic Forceps
Pinces hémostatiques
Pinzas hemostáticas
Pinze emostatiche**

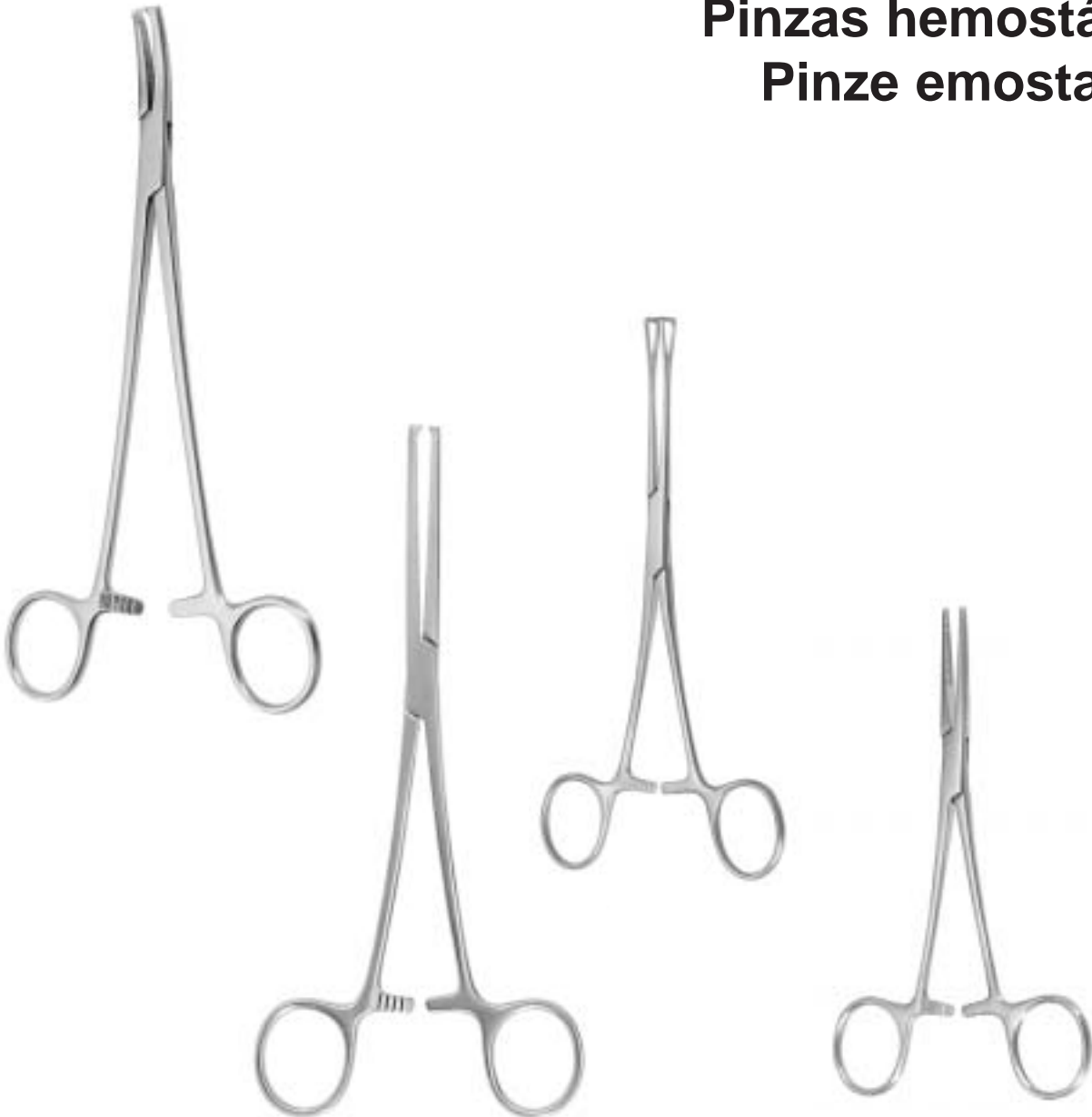

BC

BC

Atrauma-Bulldogklemmen
Atrauma Bulldog Clamps
Clamps Bulldog Atrauma
Clamps Atrauma Bulldog
Pinze Atrauma Bulldog



DE BAKEY
BC-902-07-BC-903-12

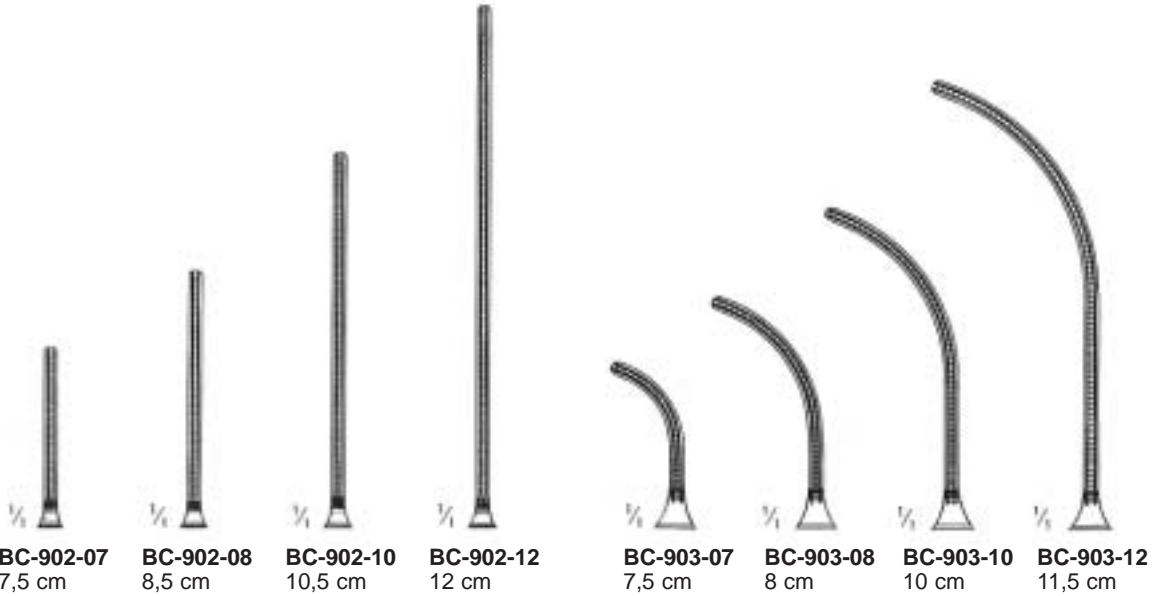

BC-902-07
7,5 cm

BC-902-08
8,5 cm

BC-902-10
10,5 cm

BC-902-12
12 cm

BC-903-07
7,5 cm

BC-903-08
8 cm

BC-903-10
10 cm

BC-903-12
11,5 cm



GLOVER
BC-906-06-BC-907-11

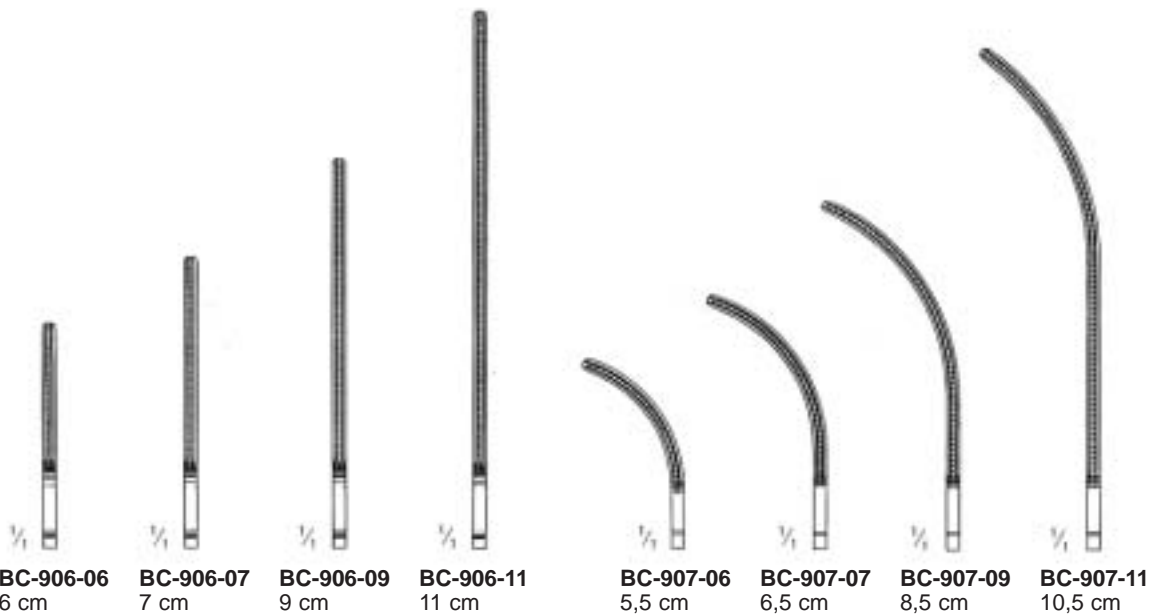

BC-906-06
6 cm

BC-906-07
7 cm

BC-906-09
9 cm

BC-906-11
11 cm



BC-907-06
5,5 cm







BC-907-07
6,5 cm

BC-907-09
8,5 cm

BC-907-11
10,5 cm

Gefäßklemmen
 Serrefines
 Serre-fines
 Serra-finas
 Serrefine

				
	DIEFFENBACH		JOHNS-HOPKINS	
cm	BC-012-04	BC-013-04	BC-110-50	BC-111-50
3,5	BC-012-05	BC-013-05	BC-110-55	BC-111-55
5,0			BC-110-65	BC-111-65
5,5			BC-110-70	BC-111-70
6,5			BC-110-75	BC-111-75
7,0			BC-110-90	BC-111-90
7,5				
9,0				

					
	HARTMANN		HARTMANN		
BC-120-10	10 cm	BC-121-10	BC-122-10	10 cm	BC-123-10

BC

Arterienklemmen
 Hemostatic Forceps
 Pinces hémostatiques
 Pinzas hemostáticas
 Pinze emostatiche

Titan
 Titanium
 Titane
 Titanio



— HALSTED-MOSQUITO —



— HALSTED-MOSQUITO micro —

cm	HALSTED-MOSQUITO		HALSTED-MOSQUITO micro	
12,5	BC-224-12	BC-220-12	BC-221-12	BC-225-12
14,0		BC-220-14	BC-221-14	
18,0		BC-220-18	BC-221-18	
21,0		BC-220-21	BC-221-21	

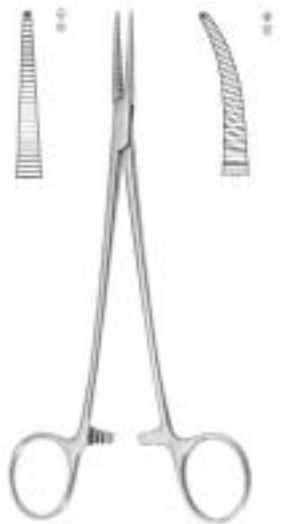

— HALSTED-MOSQUITO —



— HALSTED-MOSQUITO micro —

cm	HALSTED-MOSQUITO		HALSTED-MOSQUITO micro	
12,5	BC-324-12	BC-320-12	BC-321-12	BC-325-12
14,0		BC-320-14	BC-321-14	
18,0		BC-320-18	BC-321-18	
21,0		BC-320-21	BC-321-21	

Arterienklemmen
 Hemostatic Forceps
 Pinces hémostatiques
 Pinzas hemostáticas
 Pinze emostatiche

BC

Titan
 Titanium
 Titane
 Titanio



cm **KELLY**
 14,0 **BC-420-14** **BC-421-14**
 14,0 **BC-424-14** **BC-425-14**
 16,0



KELLY-RANKIN
BC-422-16 **BC-423-16**



PROVIDENCE-HOSPITAL
BC-720-14 **BC-721-14**



cm **CRILLE**
 14,0 **BC-520-14** **BC-521-14** **BC-620-14** **BC-621-14**
 14,0 **BC-524-14** **BC-525-14**
 16,0

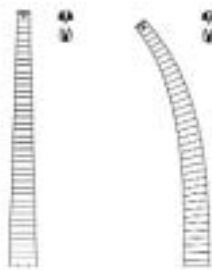

CRILE
BC-620-14 **BC-621-14**

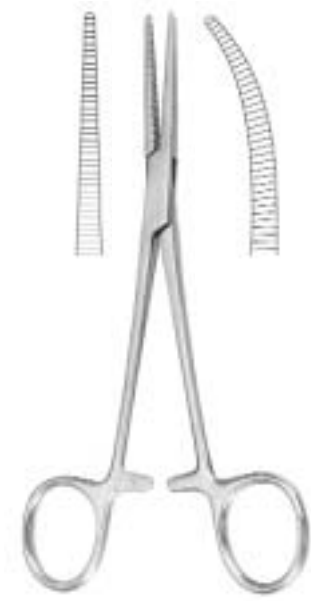

CRILE-RANKIN
BC-622-16 **BC-623-16**

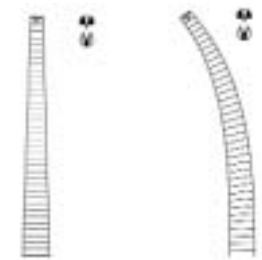

CRILE-RANKIN
BC-624-16 **BC-625-16**

BC

Arterienklemmen
Hemostatic Forceps
Pinces hémostatiques
Pinzas hemostáticas
Pinze emostatiche



ROCHESTER-PEAN



ROCHESTER-OCHSNER

cm	ROCHESTER-PEAN		ROCHESTER-OCHSNER	
13	BC-130-13	BC-131-13	BC-230-13	BC-231-13
14	BC-130-14	BC-131-14	BC-230-14	BC-231-14
16	BC-130-16	BC-131-16	BC-230-16	BC-231-16
18	BC-130-18	BC-131-18	BC-230-18	BC-231-18
20	BC-130-20	BC-131-20	BC-230-20	BC-231-20
22	BC-130-22	BC-131-22	BC-230-22	BC-231-22
24	BC-130-24	BC-131-24	BC-230-24	BC-231-24
26	BC-130-26	BC-131-26	BC-230-26	BC-231-26
30	BC-130-30	BC-131-30	BC-230-30	BC-231-30

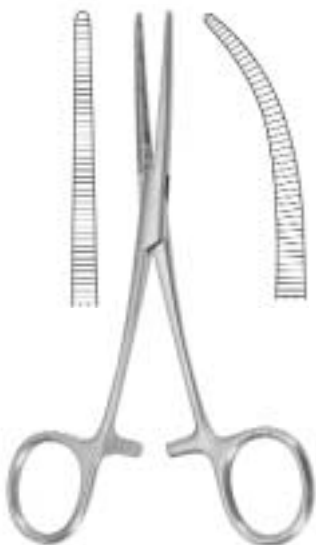

PEAN

BC-132-14	14 cm	BC-133-14
BC-132-16	16 cm	BC-133-16

Graziles Modell
Delicate Model
Modèle délicat
Modelo delgado
Modello delicato

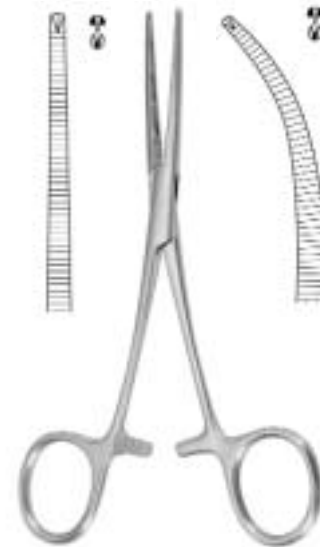

KOCHER

BC-232-14	14 cm	BC-233-14
BC-232-16	16 cm	BC-233-16

Graziles Modell
Delicate Model
Modèle délicat
Modelo delgado
Modello delicato



SPENCER-WELLS

BC-330-13	13 cm	BC-331-13
BC-330-15	15 cm	BC-331-15
BC-330-15	18 cm	BC-331-18
BC-330-15	20 cm	BC-331-20

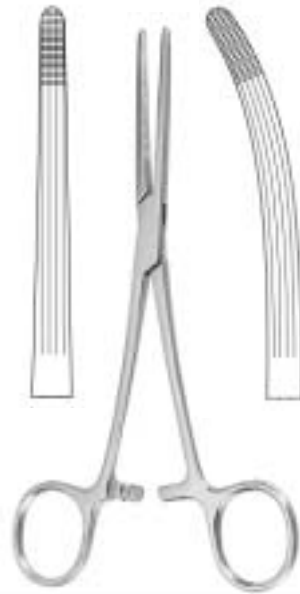

ROCHESTER-CARMALT

BC-430-16	16 cm	BC-431-16
BC-430-20	20 cm	BC-431-20



DANDY
 BC-435-14
 14 cm

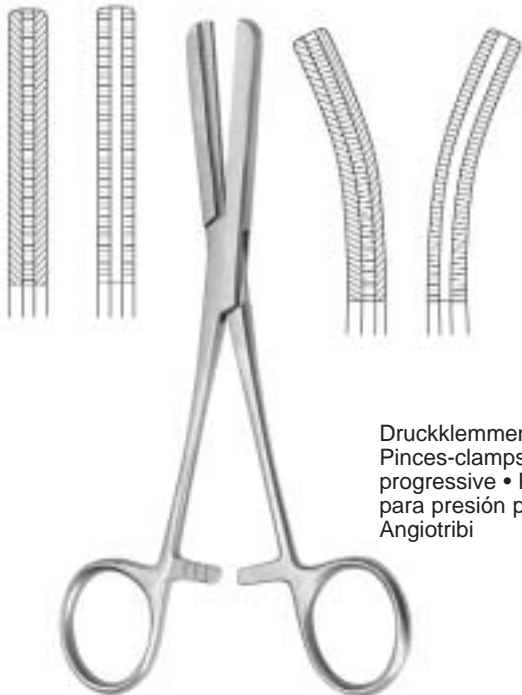

FERGUSSON

BC-530-16	16 cm	BC-531-16
BC-530-20	20 cm	BC-531-20

Druckklemmen • Angiotribes
 Pinces-clamps à pression
 progressive • Pinzas-clamps
 para presión progresiva •
 Angiotribi



LOVELACE
 BC-536-15
 15,5 cm



cm	PENNINGTON
15,5	BC-538-15
20,0	BC-538-20

BC

Arterienklemmen
Hemostatic Forceps
Pincès hémostatiques
Pinzas hemostáticas
Pinze emostatiche



PRATT
BC-630-15
15 cm



MARTEL
BC-634-14
14 cm



WILLET-MARTEL
BC-636-19
19 cm



cm	PEAN
14	BC-638-14
16	BC-638-16



CHAPUT
BC-730-13
13 cm



TUFFIER
BC-732-13
13 cm



COLLIN
BC-734-14
14 cm



COLLIN
BC-736-16
16 cm



LERICHE
BC-830-15 15 cm **BC-831-15**

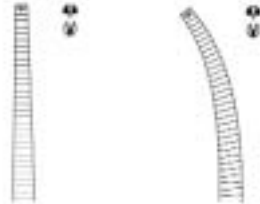

LERICHE
BC-832-15 15 cm **BC-833-15**

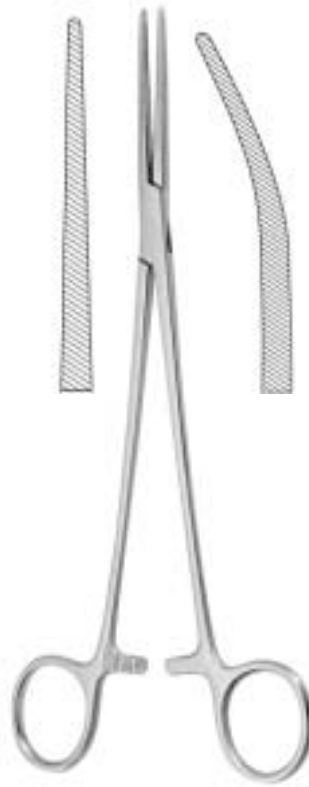

BENGOLEA
BC-834-20 20 cm **BC-835-20**
BC-834-26 26 cm **BC-835-26**

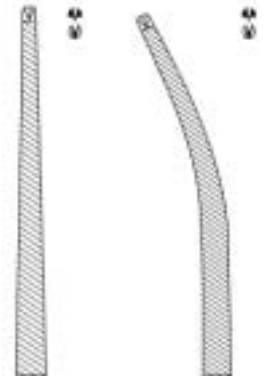

BENGOLEA
BC-836-20 20 cm **BC-837-20**
BC-836-26 26 cm **BC-837-26**

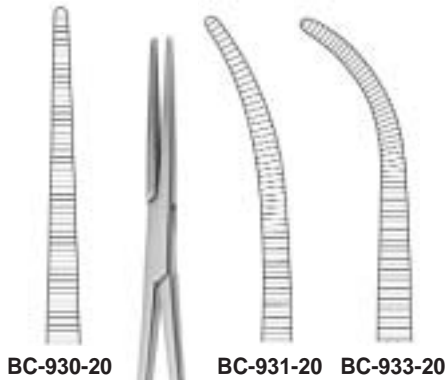

BC-930-20

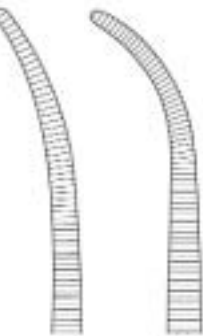

BC-931-20



BC-933-20

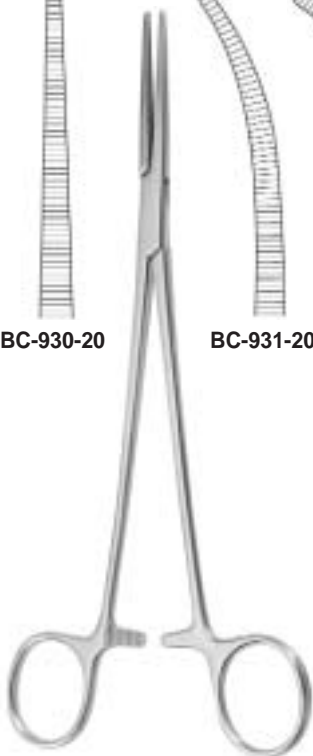

HEISS
 20 cm

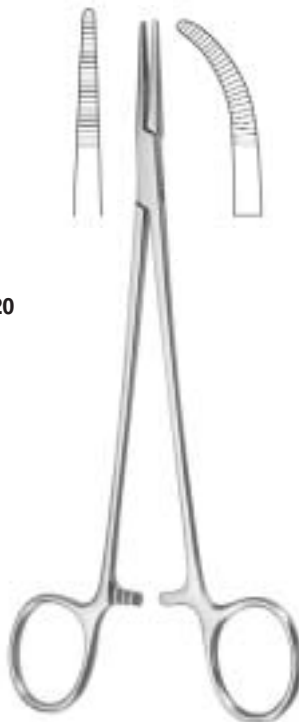

ADSON
BC-140-18 18,5 cm **BC-141-18**

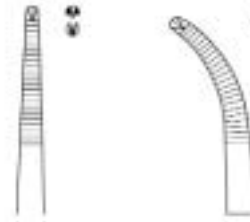

ADSON
BC-142-18 18,5 cm **BC-143-18**



ADSON Baby
BC-145-18
 18 cm

BC

Arterienklemmen
 Hemostatic Forceps
 Pincès hémostatiques
 Pinzas hemostáticas
 Pinze emostatiche

Präparier- und Ligaturklemmen
 Dissecting and Ligature Forceps
 Pincès à dissection et à ligatures
 Pinzas para disección y ligaduras
 Pinze per dissezione e per legature (Passafili)



OVERHOLT-GEISSENDOERFER
 BC-241-01 - BC-247-07

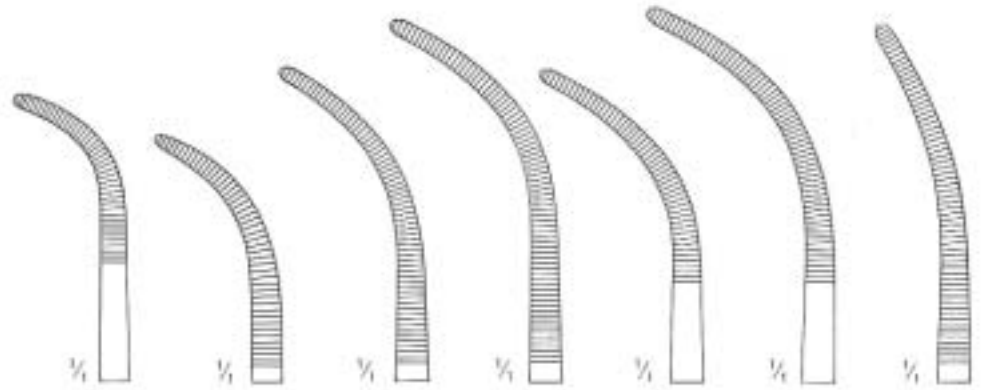

cm	Fig. 1	Fig. 2	Fig. 3	Fig. 4	Fig. 5	Fig. 6	Fig. 7
21	BC-241-01	BC-241-02	BC-241-03	BC-241-04	BC-241-05	BC-241-06	BC-241-07
27	BC-247-01	BC-247-02	BC-247-03	BC-247-04	BC-247-05	BC-247-06	BC-247-07



GEMINI
 GEMINI mini

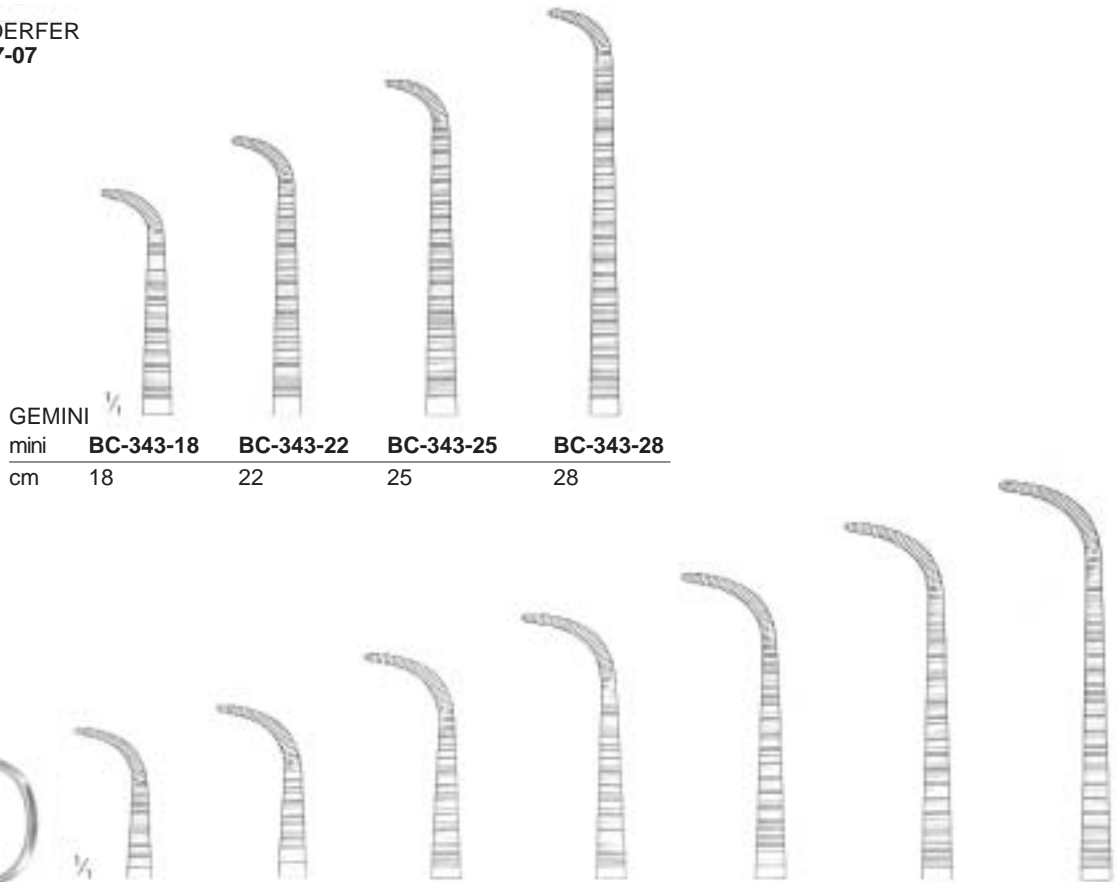

GEMINI	1/2	1/2	1/2	1/2
mini	BC-343-18	BC-343-22	BC-343-25	BC-343-28
cm	18	22	25	28

GEMINI	1/2	1/2	1/2	1/2	1/2	1/2	1/2
GEMINI mini	BC-341-13	BC-341-16	BC-341-18	BC-341-20	BC-341-23	BC-341-25	BC-341-28
cm	13	16	18	20	23	25	28



BC-441-01



BC-441-02



BC-441-03



BC-441-04



RUMEL
 BC-441-01-BC-441-04
 23 cm



BC-442-21 21 cm
 BC-442-26 26 cm



BC-443-21 21 cm
 BC-443-26 26 cm



BC-444-21 21 cm
 BC-444-26 26 cm



BC-445-21 21 cm
 BC-445-26 26 cm



TOENNIS
 BC-442-21-BC-445-26
 21 cm 26 cm

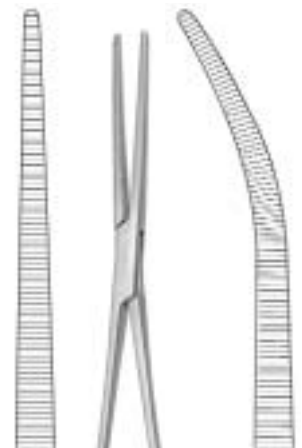

ROBERTS
 BC-448-22 18,5 cm BC-449-22

BC

Arterienklemmen
Hemostatic Forceps
Pinces hémostatiques
Pinzas hemostáticas
Pinze emostatiche

Bronchusklemmen
Bronchus Forceps
Pinces-Clamps à Bronches
Pinzas clamps bronquiales
Pinze per bronchi

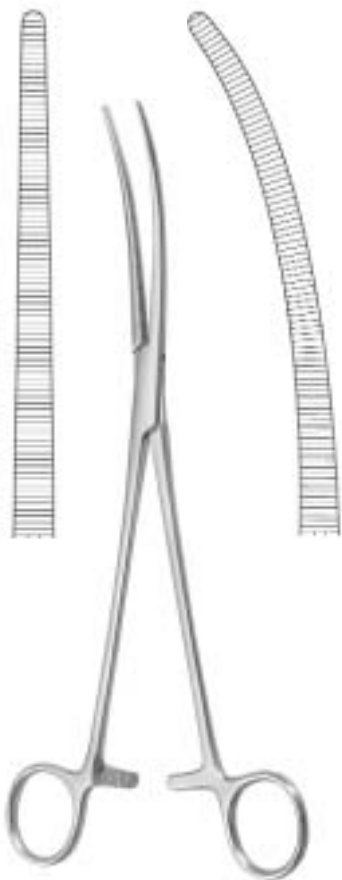

SAROT
BC-540-24 24 cm BC-541-24

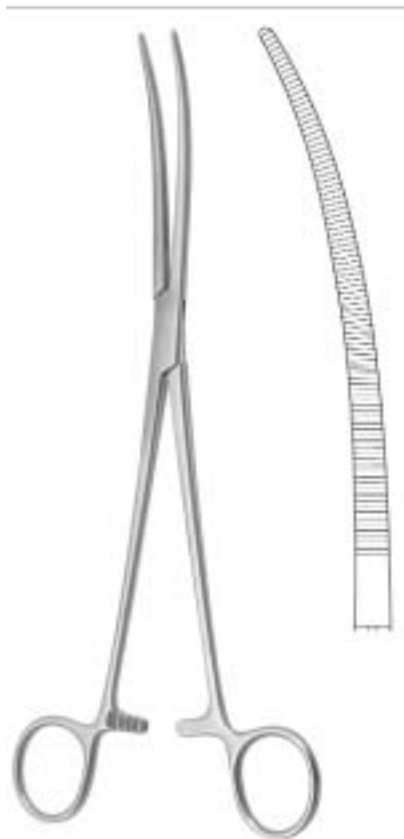

CRAFOORD
BC-543-24
24 cm

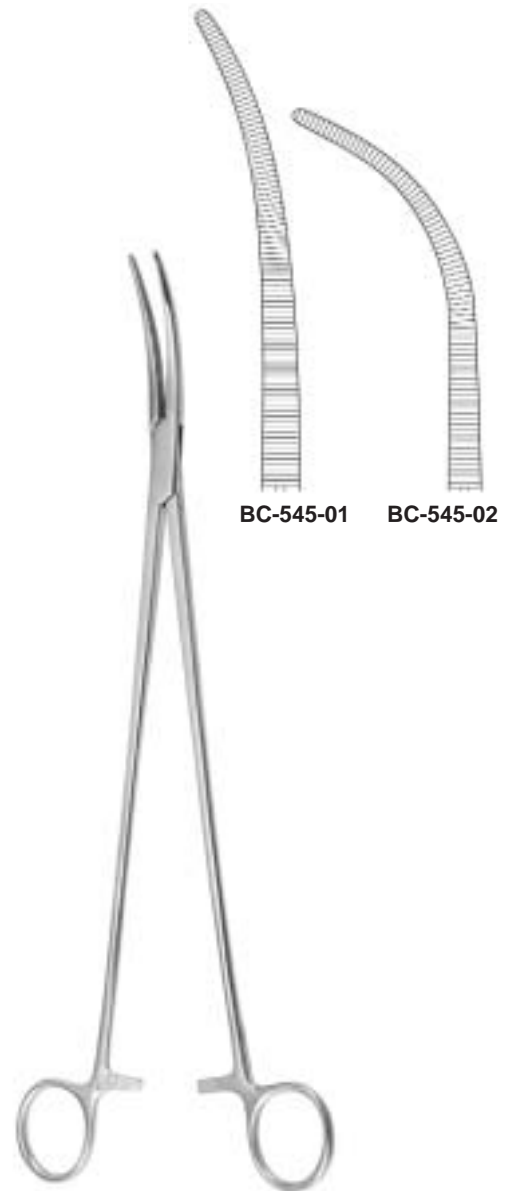

ZENKER
BC-545-01-BC-545-02
29,5 cm



LAWRENCE
BC-547-28
 28 cm



MEEKER
BC-549-28
 28 cm



cm	MIXTER
14	BC-741-14
16	BC-741-16
18	BC-741-18
23	BC-741-23



MIXTER
BC-743-22
 22 cm



MIXTER Baby
BC-745-14
 14 cm



MIXTER Baby
BC-745-18
 18 cm

Arterien, Gallenkanal, Nierenstiel
 Hemostatic, Gall Duct, and Kidney Pedicle
 Hémostatiques, pédicule rénal et voies biliaires
 Hemstáticas, pedículo renal y vías biliares
 Emostatiche, pedunculo renale e vie biliari



cm	MIXTER-O'SHAUGHNESSY
15,5	BC-747-15
19,0	BC-747-19

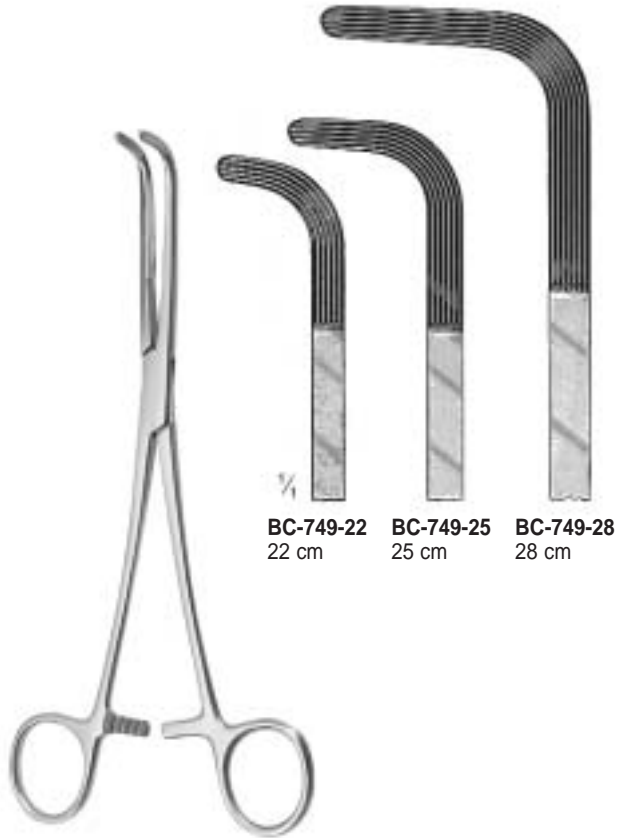

MIXTER
BC-749-22 - BC-749-28

BC-749-22 22 cm
BC-749-25 25 cm
BC-749-28 28 cm



BAINBRIDGE
BC-840-15 15,0 cm **BC-841-15**
BC-840-18 18,5 cm **BC-841-18**



LAHEY
BC-941-19
 19 cm



LAHEY
BC-943-23
 23 cm



LOWER
BC-945-18
 18 cm



JOHNS-HOPKINS
BC-947-20
 20 cm

Gallenkanal • Gall Duct •
 Voies biliaires • Vias
 biliares • Vie biliari



MIXTER
BC-949-16
 16,5 cm



MOYNIHAN
BC-051-23
 23 cm



DESJARDINS
BC-053-21
 21 cm
 (Cysticus)



DESJARDINS
BC-055-21
 21 cm



GRAY
 Cholecystectomie

BC-057-22 **BC-057-23**
 22 cm 23 cm

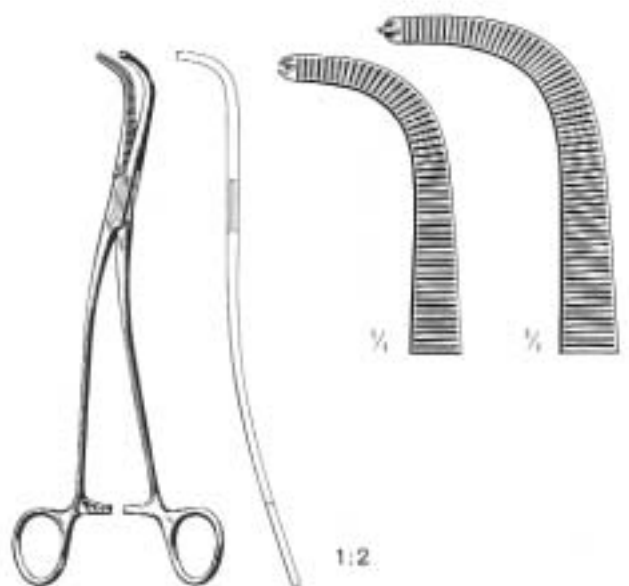

GRAY

BC-059-22 **BC-059-23**
 22 cm 23 cm

Nierenstiel, Gallenkanal
Kidney Pedicle, Gall Duct
Pédicule rénal, conduit biliare
Pediculo renal, vias biliare
Pedunculo renale, vie biliari



STILLE
BC-153-23
23 cm



MAYO-GUYON
BC-155-23
23 cm



GUYON
BC-157-23
23 cm

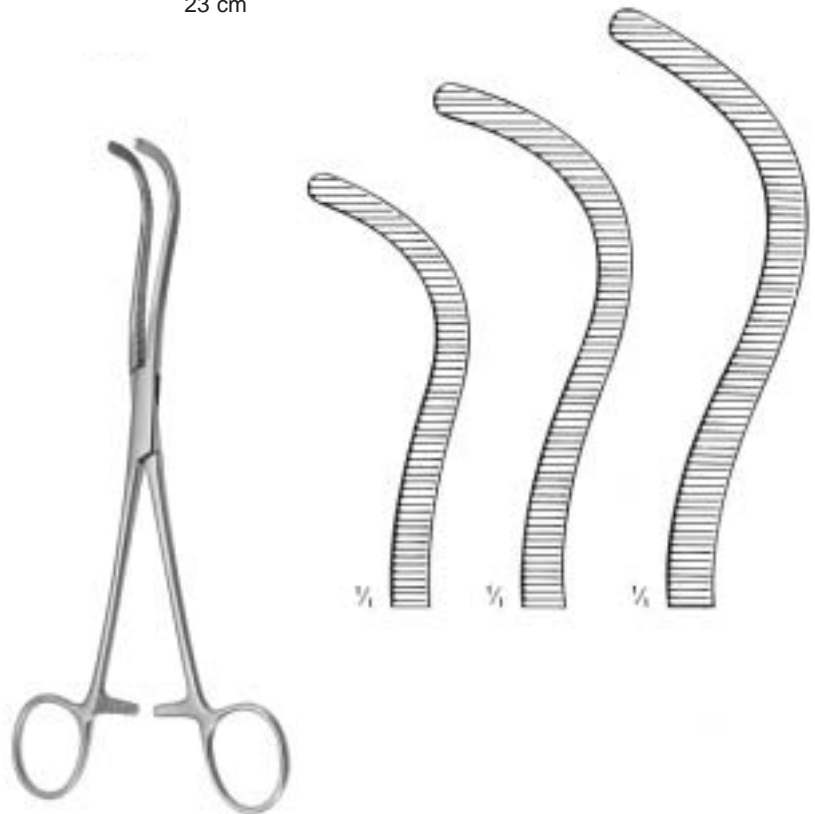

GUYON

BC-159-20
20 cm

BC-159-22
22 cm

BC-159-24
24 cm

Arterienklemmen
 Hemostatic Forceps
 Pinces hémostatiques
 Pinzas hemostáticas
 Pinze emostatiche

BC

Nierenstiel
 Kidney Pedicle
 Pédicule rénal
 Pediculo renal
 Pedunculo renale

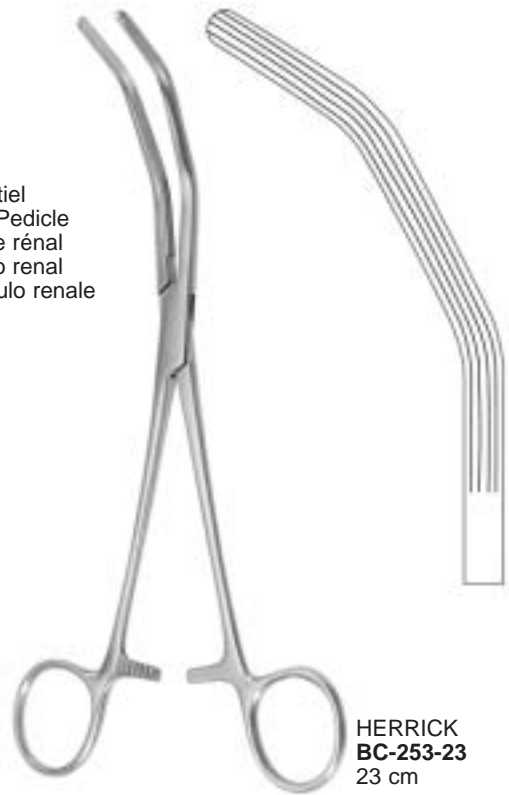

HERRICK
BC-253-23
 23 cm

Peritoneum-Klemmen
 Peritoneum Forceps
 Pinças à péritoine
 Pinzas para peritoneo
 Pinze peritoneali

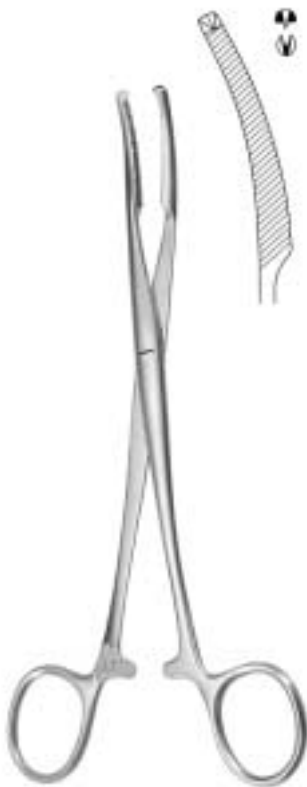

MIKULICZ
BC-551-20
 20 cm

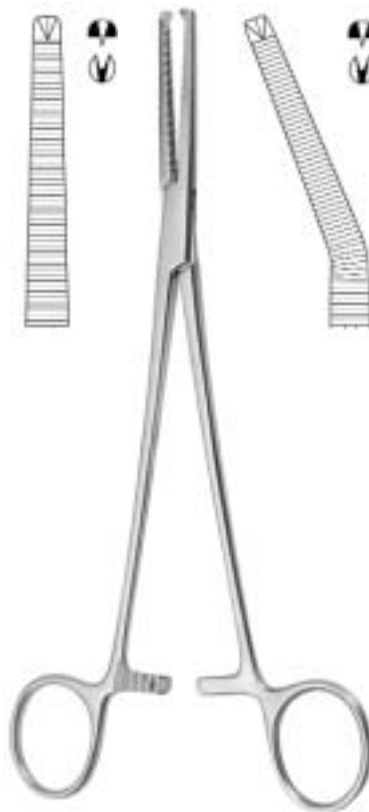

PHANEUF
BC-554-21 21 cm **BC-555-21**



FAURE
BC-651-20 20 cm **BC-653-20**



WERTHEIM
BC-751-25
 25 cm



WERTHEIM		
BC-753-22	22 cm	
	23 cm	BC-755-23



WERTHEIM-CULLEN
BC-759-21
 21,5 cm

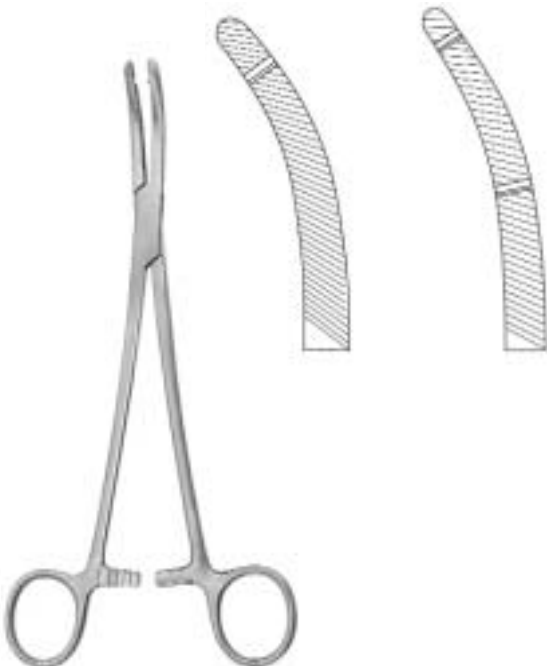

HEANEY		
21,5 cm	BC-951-22	BC-953-23

Schlauchklemmen
 Tubing Clamps
 Pinces serre-tubes
 Pinzas cierra-tubos
 Pinze serretubi

BC



WEISS
BC-072-14
 14,5 cm



MURPHY
BC-170-15 - BC-170-20



BC-170-15
 15 cm



BC-170-18
 18 cm



BC-170-20
 20 cm



PRESBYTERIAN HOSPITAL
BC-074-16 16 cm
BC-074-18 18 cm



BC-172-15 - BC-172-20



BC-172-15
 15 cm



BC-172-18
 18 cm



BC-172-20
 20 cm

BD

**Atraumatische Klemmen
Atraumatic Forceps
Pincès atraumatique
Pinzas atraumático
Pinze atraumatico**



BD

BD

Atraumatische Gefäßklemmen
Atraumatic Hemostatic Forceps
Pincés hémostatiques atraumáticos
Pinzas hemostáticas atraumáticas
Pinze emostatiche atraumatiche



cm — HALSTEAD-MOSQUITO —
12,0 **BD-800-12** **BD-801-12**
15,0 **BD-800-15** **BD-801-15**

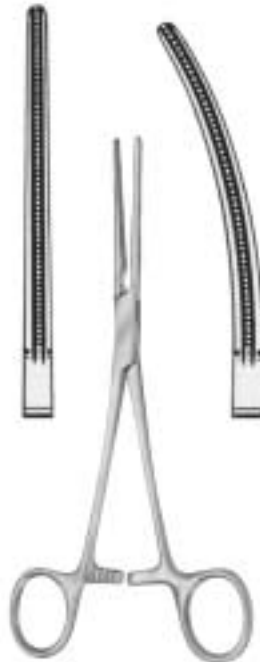

cm — PEAN —
14,0 **BD-802-14** **BD-803-14**
16,0 **BD-802-16** **BD-803-16**
18,0 **BD-802-18** **BD-803-18**
20,0 **BD-802-20** **BD-803-20**



cm — RANKIN —
16,0 **BD-804-16** **BD-805-16**



cm — DE BAKEY —
12,0 **BD-012-12** **BD-013-12**



DE BAKEY
BD-111-12
12,0 cm



DE BAKEY
BD-113-12
12,0 cm



DE BAKEY
BD-211-12
12,0 cm

Atraumatische Gefäßklemmen
Atraumatic Hemostatic Forceps
Pincès hémostatiques atraumatiques
Pinzas hemostáticas atraumáticas
Pinze emostatiche atraumatiche

BD



cm	LEES
23,0	BD-311-23
25,0	BD-311-25



BD-311-25

BD-311-23

Bronchusklemmen
Bronchus Forceps
Pincès-Clamps à Bronches
Pinzas clamps bronquiales
Pinze per bronchi



LEES
BD-313-25
25,0 cm

BD

Atraumatische Gefäßklemmen
Atraumatic Hemostatic Forceps
Pincès hémostatiques atraumatiques
Pinzas hemostáticas atraumáticas
Pinze emostatiche atraumatiche

Coarctationsklemmen
Coarction Clamps
Pincès à coarctacion
Pinzas para coarctación
Pinze per coartazione

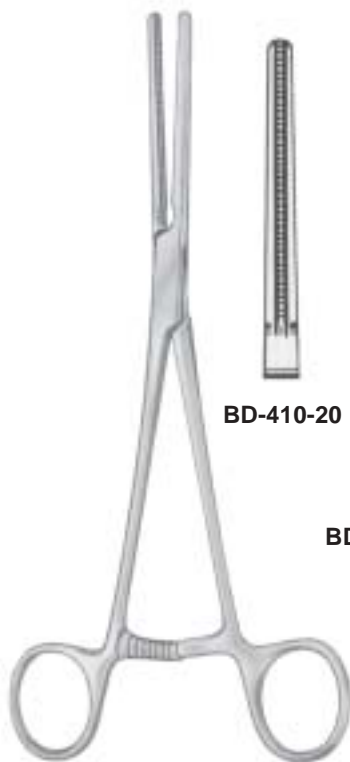

cm	POTTS
20,0	BD-410-20
22,5	BD-410-22
26,0	BD-410-26

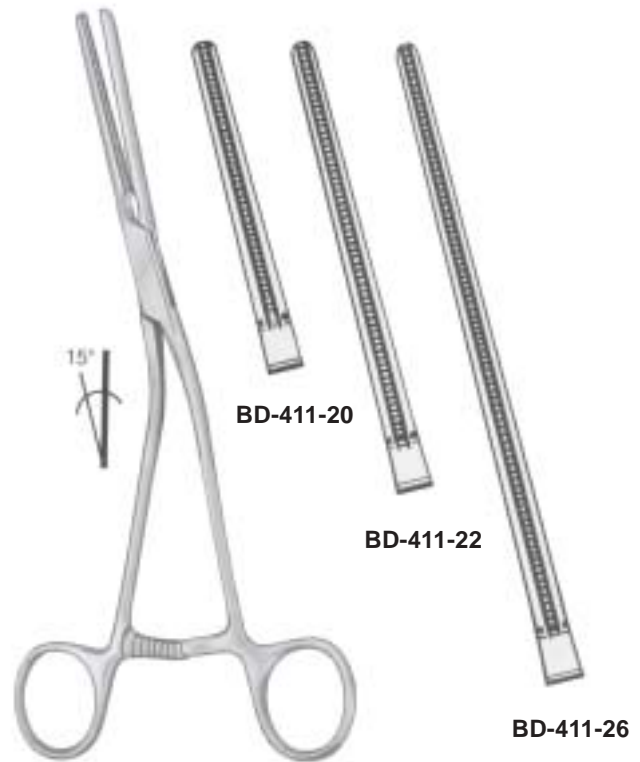

cm	GLOVER
20,0	BD-411-20
22,5	BD-411-22
26,0	BD-411-26

Anastomosenklemmen
 Anastomosis Clamps
 Pincès à anastomose
 Pinzas para anastomosis
 Pinze per anastomosi



cm POTT'S / GLOVER
 21,0 **BD-511-21**
 24,0 **BD-511-24**



BD-511-21



BD-511-24



cm GLOVER
 18,0 **BD-513-18**
 22,0 **BD-513-22**



BD-513-18



BD-513-22

BD

Atraumatische Gefäßklemmen
Atraumatic Hemostatic Forceps
Pincés hémostatiques atraumatiques
Pinzas hemostáticas atraumáticas
Pinze emostatiche atraumatiche

Vascularklemme löffelförmig
Vascular Clamps Spoon Shaped
Pince vasculaire forme cuiller
Pinza vascular forma cuchara
Pinza vascolare forma cucchiaio



BD-611-21



BD-611-26

Peripher-Vascularklemmen
Peripheral Vascular Forceps
Pincés vasculaires périph.
Pinzas vasculares perif.
Pinze vascolari perif.

cm	GLOVER
21,0	BD-611-21
26,0	BD-611-26



BD-710-19

BD-710-22

cm	DE BAKEY
18,0	BD-710-19
22,0	BD-710-22



BD-711-19

BD-711-22

cm	DE BAKEY
18,0	BD-711-19
22,0	BD-711-22

Atraumatische Mehrweckklemmen
 Atraumatic Multi-Purpose Clamps
 Pincès-clamps polyvalentes
 Pinzas clamps para usos varios
 Pinze atraumatiche per diversi usi



DARDIK



cm	0°	15°	30°	45°	90°
14,0	--	--	--	--	BD-712-90
15,0	BD-712-00	BD-712-15	BD-712-30	BD-712-45	--

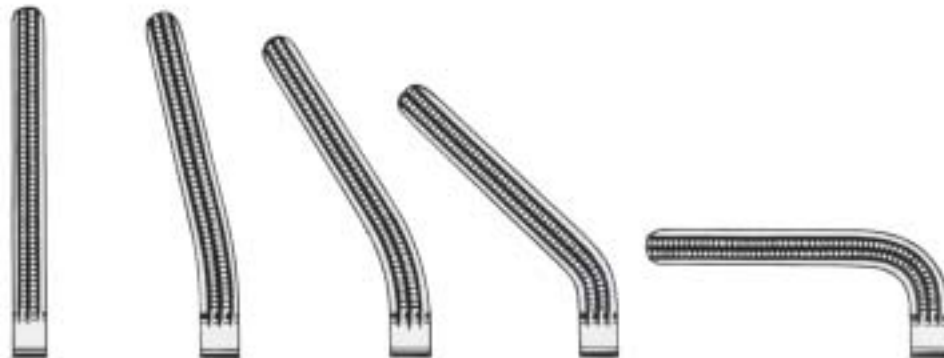

cm	0°	15°	30°	45°	90°
16,0	--	--	--	--	BD-714-90
17,0	BD-714-00	BD-714-15	BD-714-30	BD-714-45	--

BD

Atraumatische Gefäßklemmen
Atraumatic Hemostatic Forceps
Pincès hémostatiques atraumatiques
Pinzas hemostáticas atraumáticas
Pinze emostatiche atraumatiche



LELAND-JONES
BD-811-19
19,0 cm

Peripher-Vascularklemmen
Peripheral Vascular Forceps
Pincès vasculaires périph.
Pinzas vasculares perif.
Pinze vascolari perif.



DE BAKEY
BD-811-26
26,0 cm



cm DE BAKEY
19,0 **BD-813-19**
20,0 **BD-813-20**



BD-813-19

BD-813-20



DE BAKEY
BD-911-16
16,0 cm



BAINBRIDGE



BD-916-15
15,0 cm



BD-916-18
18,0 cm



BD-917-15
15,0 cm



BD-917-18
18,0 cm

Peripher-Vascularklemmen
 Peripheral Vascular Forceps
 Pincès vasculaires périph.
 Pinzas vasculares perif.
 Pinze vascolari perif.



LELAND JONES
BD-022-19
 19,0 cm



BD-023-19
19,0 cm

BD-025-19
19,0 cm

LELAND JONES

Aortaklemmen
Aortic Clamp
Pince-clamp à aorte
Pinza clamp para aorta
Pinza per aorta



LIDDLE
BD-029-27
27,0 cm

Aorta-Anastomosenklemmen
Aorta-Anastomosis Clamps
Pinces-clamps pour anastomoses d'aorte
Pinzas clamps para anastomosis de aorta
Pinze aortiche



LAMBERT KAY
BD-121-20
20,0 cm

Iliaca-Klemme
Iliac Clamp
Pince-clamp à iliaque
Pinza clamp para iliaca
Pinza per iliaca



LAMBERT KAY
BD-123-20
20,0 cm



DE BAKEY
BD-125-20
20,0 cm

BD

Atraumatische Gefäßklemmen
Atraumatic Hemostatic Forceps
Pinces hémostatiques atraumatiques
Pinzas hemostáticas atraumáticas
Pinze emostatiche atraumatiche



links gebogen
curved to left
courbe à gauche
curva a la izquierda
curva a sinistra



WEBER
BD-127-26
26,0 cm



rechts gebogen
curved to right
courbe à droite
curva a la derecha
curva a destra



WEBER
BD-129-26
26,0 cm

Aorta-Aneurysma-Klemmen
Aorta-Aneurysm Clamps
Pincés-clamps pour aneurysme d'aorte
Pinzas clamps para aneurisma de aorta
Pinze per aneurisma di aorta



DE BAKEY

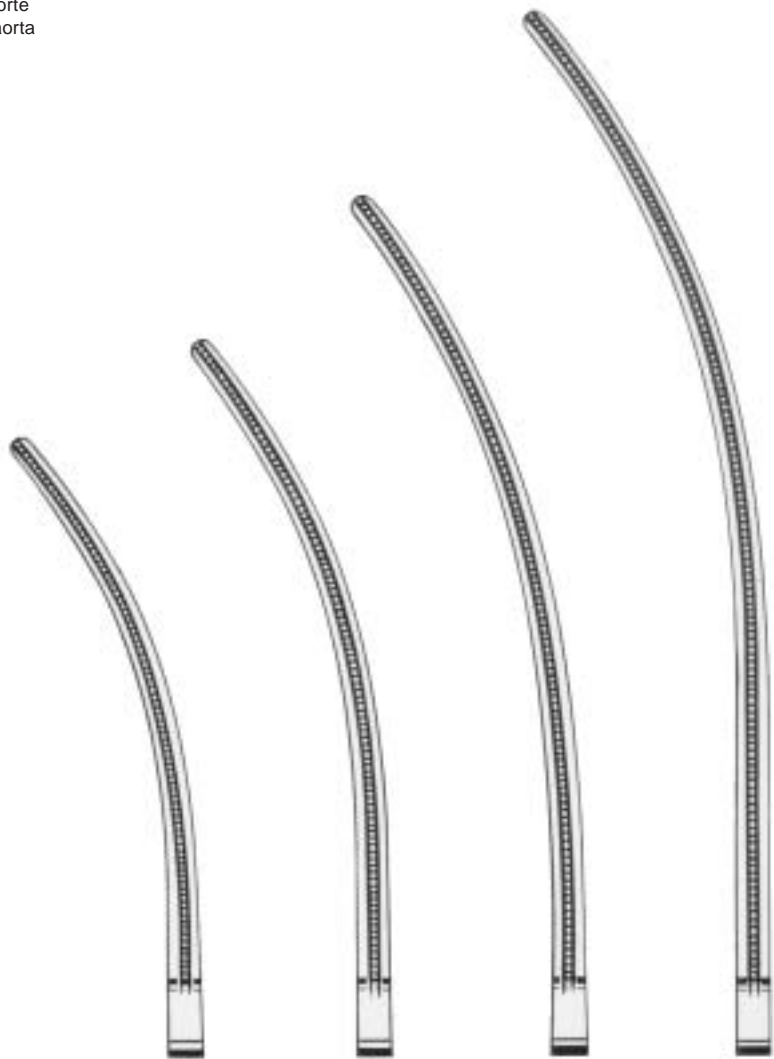

BD-221-24
24,0 cm

BD-221-27
27,0 cm

BD-221-31
31,0 cm

BD-221-35
35,0 cm

BD

Atraumatische Gefäßklemmen
Atraumatic Hemostatic Forceps
Pinces hémostatiques atraumatiques
Pinzas hemostáticas atraumáticas
Pinze emostatiche atraumatiche

Aorta-Aneurysma-Klemmen
Aorta-Aneurysm Clamps
Pinces-clamps pour aneurysme d'aorte
Pinzas clamps para aneurisma de aorta
Pinze per aneurisma di aorta



DE BAKEY BAHNSON



BD-223-24
24,0 cm

BD-223-25
25,0 cm

BD-223-26
26,0 cm

Aorta-Aneurysma-Klemmen
Aorta-Aneurysm Clamps
Pincés-clamps pour aneurysme d'aorte
Pinzas clamps para aneurisma de aorta
Pinze per aneurisma di aorta



DE BAKEY
BD-225-28
28,0 cm



DE BAKEY
BD-227-28
28,0 cm

BD

Atraumatische Gefäßklemmen
Atraumatic Hemostatic Forceps
Pinces hémostatiques atraumatiques
Pinzas hemostáticas atraumáticas
Pinze emostatiche atraumatiche

Atraumatische Mehrzweckklemmen
Atraumatic Multi-Purpose Clamps
Pinces-clamps polyvalentes
Pinzas clamps para usos varios
Pinze atraumatiche per diversi usi



DE BAKEY MORRIS

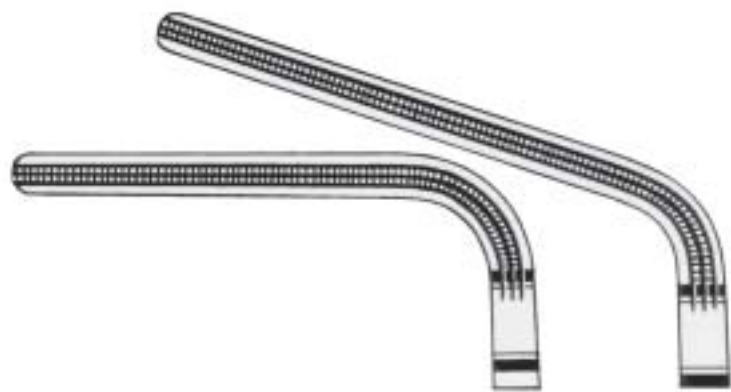

BD-229-18
18,0 cm

BD-229-20
20,0 cm



BD-229-23
23,0 cm

BD-229-25
25,0 cm

Atraumatische Gefäßklemmen
Atraumatic Hemostatic Forceps
Pincés hémostatiques atraumatiques
Pinzas hemostáticas atraumáticas
Pinze emostatiche atraumatiche

BD

Atraumatische Mehrzweckklemmen
Atraumatic Multi-Purpose Clamps
Pincés-clamps polyvalentes
Pinzas clamps para usos varios
Pinze atraumatiche per diversi usi



DE BAKEY



BD-231-18
18,0 cm

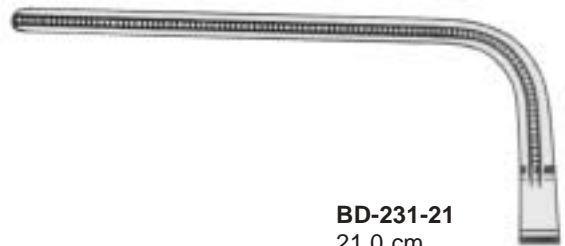

BD-231-21
21,0 cm



BD-231-23
23,0 cm

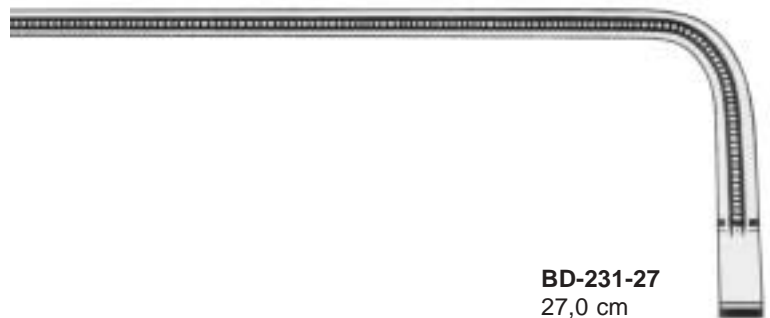

BD-231-27
27,0 cm

BD

Atraumatische Gefäßklemmen
Atraumatic Hemostatic Forceps
Pinces hémostatiques atraumatiques
Pinzas hemostáticas atraumáticas
Pinze emostatiche atraumatiche

Aorta-Aneurysma-Klemmen
Aorta-Aneurysm Clamps
Pinces-clamps pour aneurysme d'aorte
Pinzas clamps para aneurisma de aorta
Pinze per aneurisma di aorta



DE BAKKEY



BD-421-25
25,0 cm

BD-421-26
26,0 cm

Bronchus-Klemmen
Bronchus Clamps
Pincès pour les bronches
Pinzas bronquiales
Pinze per bronchi



DE BAKEY
BD-427-27
27,0 cm

BD

Atraumatische Gefäßklemmen
Atraumatic Hemostatic Forceps
Pincés hémostatiques atraumatiques
Pinzas hemostáticas atraumáticas
Pinze emostatiche atraumatiche



DE BAKEY

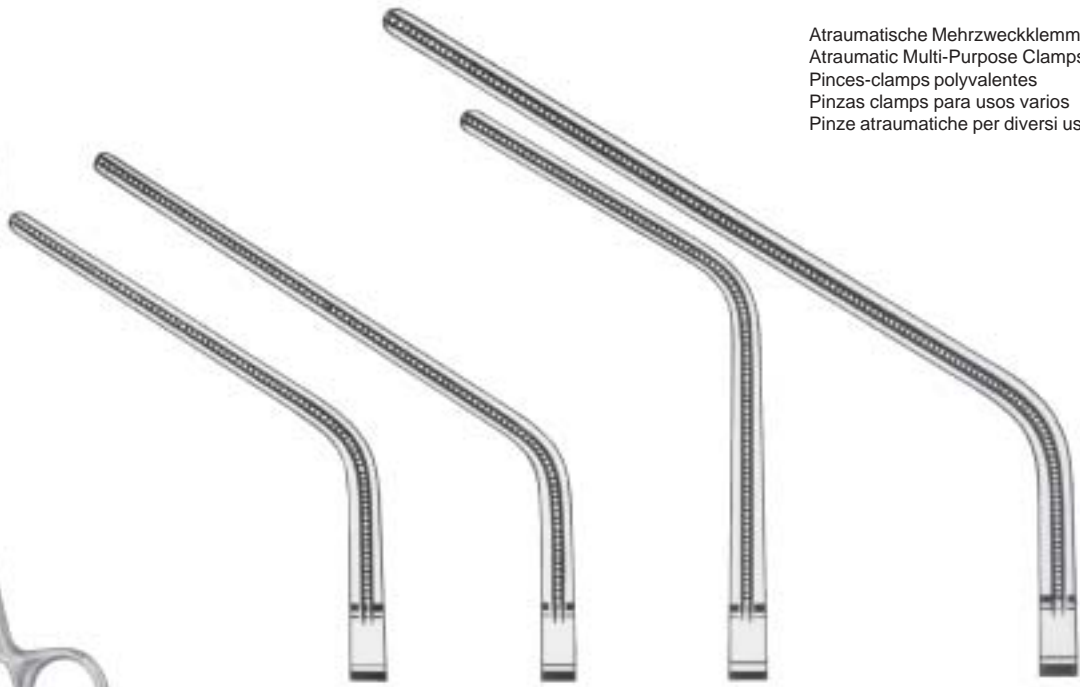

Atraumatische Mehrzweckklemmen
Atraumatic Multi-Purpose Clamps
Pincés-clamps polyvalentes
Pinzas clamps para usos varios
Pinze atraumatiche per diversi usi

BD-521-20
20,0 cm

BD-521-24
24,0 cm

BD-521-25
25,0 cm

BD-521-30
30,0 cm



SATINSKY

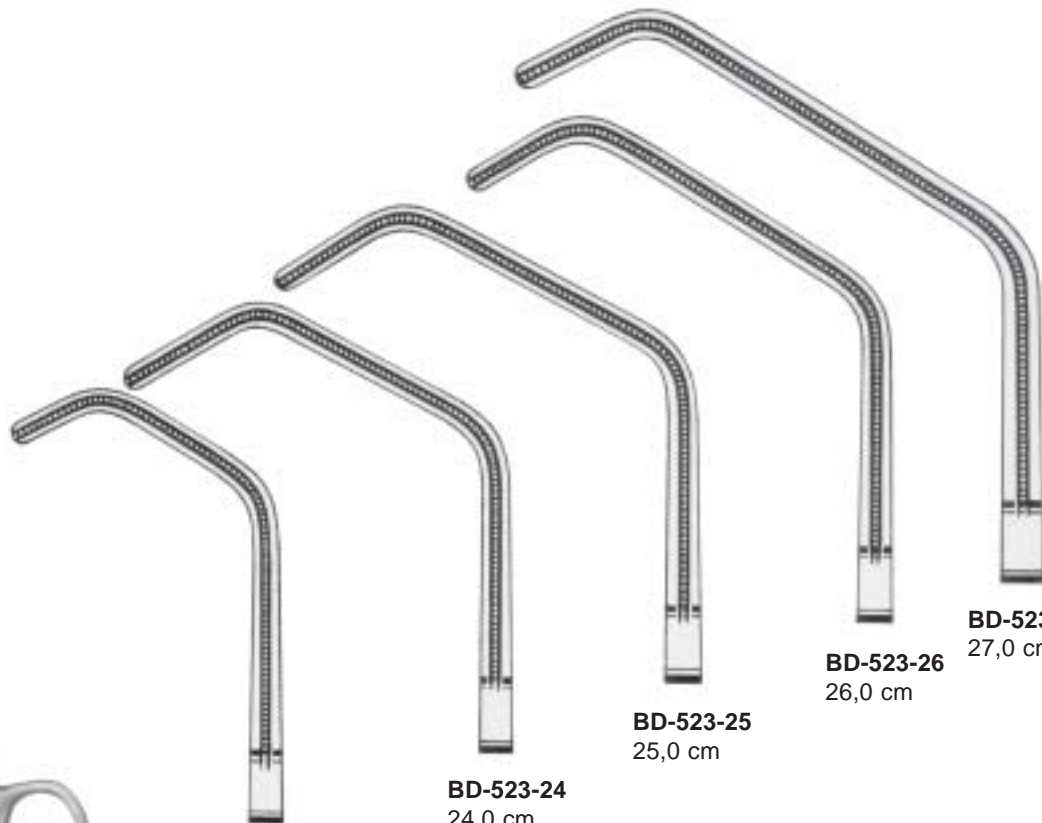

BD-523-20
20,0 cm

BD-523-24
24,0 cm

BD-523-25
25,0 cm

BD-523-26
26,0 cm

BD-523-27
27,0 cm

Anlegezange für Clips
 Applying for Clips
 Appicateur pour clips
 Pinza para aplicar clips
 Applicatore per clips



EDWARDS
BD-528-00

Clips
 Clips
 Clips
 Clips
 Clips



mm	EDWARDS
6	BD-528-06
12	BD-528-12



WYLIE



BD-529-01
 Fig. 1
 21,0 cm



BD-529-02
 Fig. 2
 22,0 cm

BD

Atraumatische Gefäßklemmen
Atraumatic Hemostatic Forceps
Pincès hémostatiques atraumatiques
Pinzas hemostáticas atraumáticas
Pinze emostatiche atraumatiche



DE BAKEY SATINSKY



BD-621-23
Fig. 1
23,0 cm

BD-621- 24
Fig. 2
24,0 cm

BD-621-25
Fig. 3
25,0 cm

Aurikelklemmen
Auricle Clamps
Pincès auriculaires
Pinzas para aurícula
Pinze ventricolari



HARKEN



BD-623-25
Fig. 1
25,0 cm



BD-625-24
Fig. 2
24,0 cm



BD-627-24
Fig. 3
24,0 cm



BD-629-24
Fig. 4
24,0 cm

BD

Atraumatische Gefäßklemmen
Atraumatic Hemostatic Forceps
Pincés hémostatiques atraumatiques
Pinzas hemostáticas atraumáticas
Pinze emostatiche atraumatiche

Peripheal-Gefäßklemmen
Peripheal Vascular Clamps
Pincés-clamps, vasculaires périphériques
Pinzas para vasos periféricos
Pinze vascolari periferali



DALE
BD-721-18
18,0 cm



DALE



BD-723-17
17,0 cm



BD-723-18
18,0 cm



BD-723-19
19,0 cm

Atraumatische Gefäßklemmen
Atraumatic Hemostatic Forceps
Pincas hémostatiques atraumatiques
Pinzas hemostáticas atraumáticas
Pinze emostatiche atraumatiche

BD



DE BAKEY
BD-821-17
17,0 cm



BECK
BD-823-17
17,0 cm

Präparier- und Ligaturklemmen
Dissecting and Ligature Clamps
Pincas à dissection et passe-fil
Pinzas de disección y para ligaduras
Pinze per dissezione e per legature



DE BAKEY
BD-825-24
24,0 cm



DE BAKEY
BD-827-24
24,0 cm

BD

Atraumatische Gefäßklemmen
Atraumatic Hemostatic Forceps
Pinces hémostatiques atraumatiques
Pinzas hemostáticas atraumáticas
Pinze emostatiche atraumatiche

Atraumatische Mehrzweckklemmen
Atraumatic Multi-Purpose Clamps
Pinces-clamps polyvalentes
Pinzas clamps para usos varios
Pinze atraumatiche per diversi usi



POTTS



BD-828-21
21,0 cm



BD-828-23
23,0 cm



BD-828-27
27,0 cm



BD-828-31
31,0 cm

Atraumatische Gefäßklemmen
Atraumatic Hemostatic Forceps
Pinces hémostatiques atraumatiques
Pinzas hemostáticas atraumáticas
Pinze emostatiche atraumatiche

BD

Atraumatische Mehrzweckklemmen
Atraumatic Multi-Purpose Clamps
Pinces-clamps polyvalentes
Pinzas clamps para usos varios
Pinze atraumatiche per diversi usi



POTTS

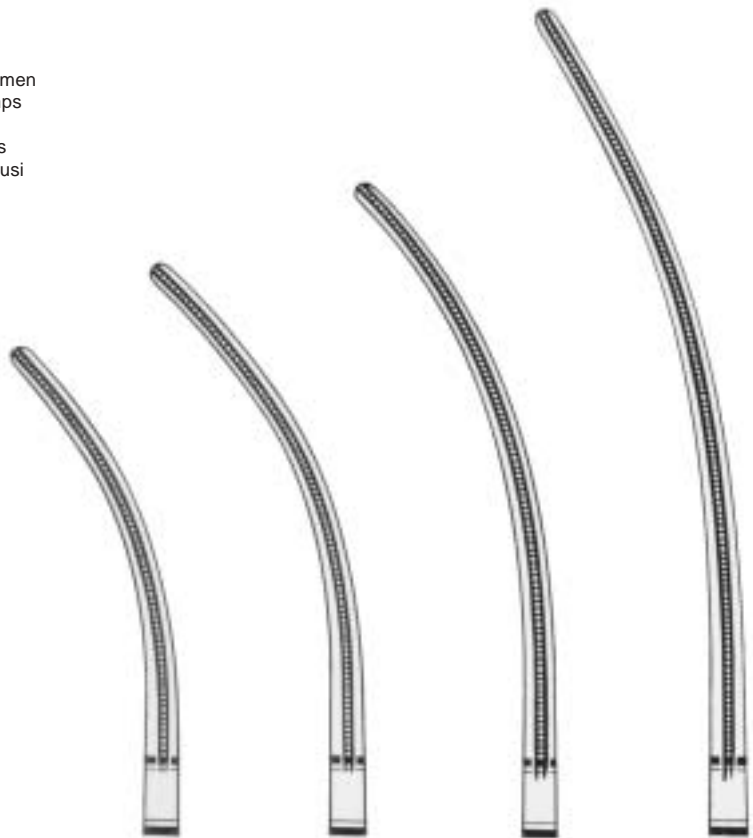

BD-829-21
21,0 cm

BD-829-23
23,0 cm

BD-829-27
27,0 cm

BD-829-31
31,0 cm

Anastomosenklemmen, Kindergrößen
Anastomosis Clamps, Pediatric
Pincès à anastomose, pédiatriques
Pinzas para anastomosis, pediátricas
Pinze per anastomosi, pediatriche



DERRA



BD-921-16
16,0 cm

BD-921-17
17,0 cm

BD-921-18
18,0 cm



DE BAKEY
BD-032-16
16,0 cm

Atraumatische Mehrzweckklemmen
Atraumatic Multi-Purpose Clamps
Pincès-clamps polyvalentes
Pinzas clamps para usos varios
Pinze atraumatiche per diversi usi



DE BAKEY
BD-032-17
17,0 cm



DE BAKEY
BD-033-15
15,0 cm



DE BAKEY
BD-037-17
17,0 cm



BD-039-16
16,0 cm

DE BAKEY

BD-039-17
17,0 cm

Atraumatische Gefäßklemmen
Atraumatic Hemostatic Forceps
Pincès hémostatiques atraumatiques
Pinzas hemostáticas atraumáticas
Pinze emostatiche atraumatiche

Atraumatische Mehrzweckklemmen
Atraumatic Multi-Purpose Clamps
Pincès-clamps polyvalentes
Pinzas clamps para usos varios
Pinze atraumatiche per diversi usi



DE BAKEY



BD-131-14
14,0 cm



BD-131-15
15,0 cm



BD-131-16
16,0 cm



GLOVER
BD-231-17
17,0 cm

Anastomosenklemmen
Anastomosis Clamps
Pincès à anastomose
Pinzas para anastomosis
Pinze per anastomosi



DE BAKEY REYNOLDS



BD-239-01
Fig. 1
17,5 cm



BD-239-02
Fig. 2
17,5 cm



BD-239-03
Fig. 3
16,5 cm



BD-239-04
Fig. 3
16,5 cm



SUBRAMANIAN
BD-331-15
15,0 cm



SUBRAMANIAN
BD-333-16
16,0 cm



SUBRAMANIAN
BD-335-16
16,0 cm



OCHSNER
BD-337-23
23,0 cm

Aortaklemmen
Aortic Clamp
Pince-clamp à aorte
Pinza clamp para aorta
Pinza per aorta



DIETRICH
BD-339-21
21,0 cm

Präparier- und Ligaturklemmen
Dissecting and Ligature Clamps
Pincés à dissection et passe-fil
Pinzas de dissección y para ligaduras
Pinze per dissezione e per legature



DE BAKEY



BD-431-19
19,0 cm



BD-431-20
20,0 cm



BD-431-23
23,0 cm

Carotis-Shuntklemmen
Carotid Shunt Clamps
Pincés pour carotide
Pinzas para shunt carótido
Pinze carotis



JAVID
BD-433-18
18,0 cm



JAVID
BD-433-19
19,0 cm

Profunda-Klemmen
 Profunda Clamps
 Pincès-clamps pour profunda
 Pinzas clamps para profunda
 Pinze per profunda



GREGORY

BD-439-14
14,0 cm



BD-439-16
16,0 cm



BD-439-18
18,0 cm

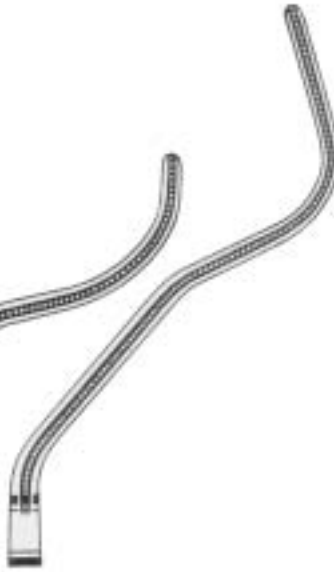

cm — COOLEY —
BD-530-13 **BD-531-13**



COOLEY
BD-533-13
 13,5 cm



COOLEY
BD-535-13
 13,0 cm



COOLEY
BD-537-12
12,5 cm



COOLEY
BD-539-10
10,5 cm



COOLEY
BD-631-12
12,0 cm



COOLEY
BD-633-13
13,5 cm

Atraumatische Gefäßklemmen
 Atraumatic Hemostatic Forceps
 Pincas hémostatiques atraumatiques
 Pinzas hemostáticas atraumáticas
 Pinze emostatiche atraumatiche

BD



Fr./Charrière	COOLEY
24	BD-731-24
26	BD-731-26
28	BD-731-28
30	BD-733-30
32	BD-733-32
36	BD-733-36



cm	— COOLEY —
14,0	BD-736-14 BD-737-14
16,0	BD-736-16 BD-737-16



COOLEY
BD-739-14
 14,0 cm



COOLEY
BD-830-14
 14,0 cm



COOLEY
BD-831-14
 14,0 cm

BD

Atraumatische Gefäßklemmen
Atraumatic Hemostatic Forceps
Pincès hémostatiques atraumatiques
Pinzas hemostáticas atraumáticas
Pinze emostatiche atraumatiche



COOLEY
BD-045-27
27,0 cm

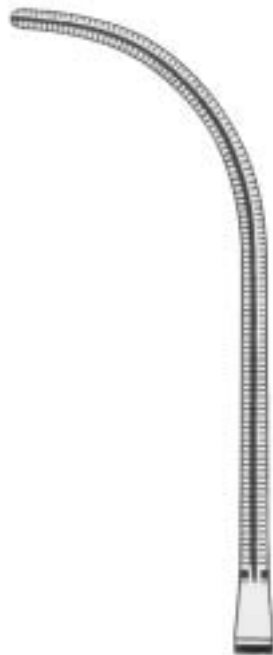

COOLEY
BD-140-17
17,0 cm

Atraumatische Gefäßklemmen
 Atraumatic Hemostatic Forceps
 Pincès hémostatiques atraumatiques
 Pinzas hemostáticas atraumáticas
 Pinze emostatiche atraumatiche

BD

Atraumatische Mehrzweckklemmen
 Atraumatic Multi-Purpose Clamps
 Pincès-clamps polyvalentes
 Pinzas clamps para usos varios
 Pinze atraumatiche per diversi usi



COOLEY

BD-141-17
17,0 cm

BD-143-17
17,0 cm

BD-146-17
17,0 cm

Iliaca-Klemmen
 Iliac Clamps
 Pincès-clamps à iliaque
 Pinzas clamps para iliaca
 Pinze per iliaca



COOLEY
BD-147-21
21,5 cm

Anastomosenklemmen
 Anastomosis Clamps
 Pincès à anastomose
 Pinzas para anastomosis
 Pinze per anastomosi



COOLEY
BD-149-17
17,0 cm



cm
14,0 **BD-240-14** **BD-241-14**



COOLEY
BD-243-14
14,0 cm



COOLEY
BD-245-14
14,0 cm

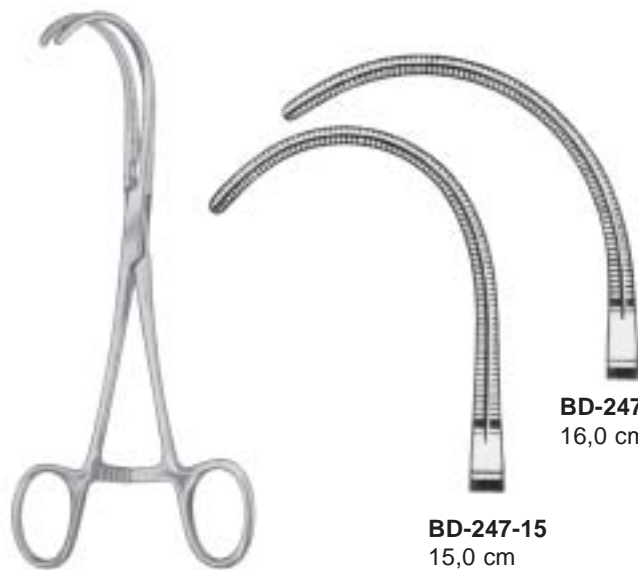

BD-247-15
15,0 cm

BD-247-16
16,0 cm

COOLEY

Atraumatische Mehrzweckklemmen
 Atraumatic Multi-Purpose Clamps
 Pincès-clamps polyvalentes
 Pinzas clamps para usos varios
 Pinze atraumatiche per diversi usi



COOLEY
BD-341-25
 16,5 cm



COOLEY
BD-341-45
 16,5 cm

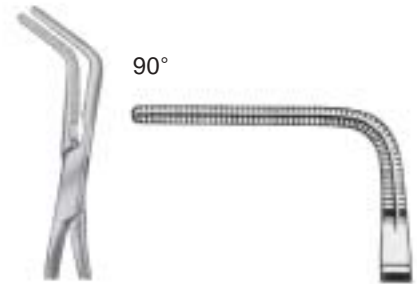

COOLEY
BD-341-90
 16,5 cm

Anastomosenklemmen
 Anastomosis Clamps
 Pincès à anastomose
 Pinzas para anastomosis
 Pinze per anastomosi



COOLEY
BD-343-14
 14,0 cm



COOLEY DERRA



BD-441-16
 16,0 cm



BD-441-17
 17,0 cm



BD-441-18
 18,0 cm

Anastomosenklemmen
Anastomosis Clamps
Pincès à anastomose
Pinzas para anastomosis
Pinze per anastomosi



COOLEY
17,0 cm



BD-447-17
Fig. 1

BD-449-17
Fig. 2



COOLEY

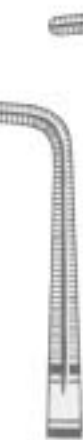

BD-541-16
16,0 cm

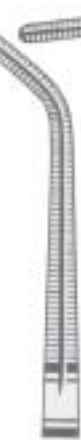

BD-543-16
17,5 cm

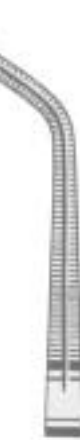

BD-545-17
17,5 cm



COOLEY
BD-547-17
17,0 cm



COOLEY
BD-641-17
17,0 cm



COOLEY
BD-645-18
18,0 cm



COOLEY
BD-645-19
19,0 cm



COOLEY
BD-645-26
26,0 cm



COOLEY
BD-647-27
27,0 cm

Neonatal- und Kinderklemmen, extra feine Modelle
Neonatal and Childrens Clamps, extra delicate patterns
Pincas-clamps pour des nouveaux-nés et des enfants, modèles très fins
Pinzas clamps para recién nacidos y niños, modelos muy finos
Pinze pediatriche, modelli molto fini



CASTAÑEDA
BD-841-13
13,0 cm



CASTAÑEDA
13,0 cm



BD-843-13
Fig. 1
13,0 cm



BD-845-13
Fig. 2
13,0 cm

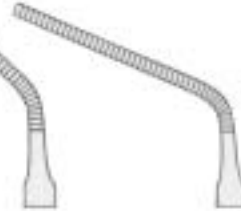

BD-847-13
Fig. 3
13,0 cm



BD-849-13
Fig. 4
13,0 cm



CASTAÑEDA
12,0 cm



BD-941-15
Fig. 1
12,0 cm

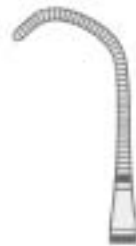

BD-943-15
Fig. 2
12,0 cm



BD-945-12
Fig. 3
12,0 cm



BD-945-15
Fig. 4
12,0 cm

Kinder-Gefäßklemmen
 Pediatric Vascular Clamp
 Pincas vasculaires pédiatriques
 Pinzas vasculares pediátricas
 Pinze vascolari pediatriche



gerade
 straight
 droites
 rectas
 rette

BD-052-01 - BD-052-09
 Fig. 1-9



abgewinkelt
 angled
 coudées
 acodadas
 angolari

BD-053-01 - BD-053-09
 Fig. 1-9



stark abgewinkelt
 strongly angled
 fortement coudées
 fuertemente acodadas
 fortemente angolari

BD-055-01 - BD-055-09
 Fig. 1-9



Fig. 1
BD-052-01
BD-053-01
BD-055-01



Fig. 2
BD-052-02
BD-053-02
BD-055-02



Fig. 3
BD-052-03
BD-053-03
BD-055-03



Fig. 4
BD-052-04
BD-053-04
BD-055-04



Fig. 5 Fig.
BD-052-05
BD-053-05
BD-055-05



Fig. 6
BD-052-06
BD-053-06
Bd-055-06



Fig. 7
BD-052-07
BD-053-07
BD-055-07



Fig. 8
BD-052-08
BD-053-08
BD-055-08



Fig. 9
BD-052-09
BD-053-09
BD-055-09

BD

Flexible Gefäßklemmen
Flexible Vessel Clamps
Pinces vasculaires flexibles
Pinzas vasculares flexibles
Pinze vascolari flessibili



BD-069-12 - BD-161-30
20,0 cm



BD-069-12
12 mm



BD-069-20
20 mm



BD-069-30
30 mm



BD-161-12
12 mm



BD-161-20
20 mm



BD-161-30
30 mm

Flexible Gefäßklemmen
Flexible Vessel Clamps
Pincas vasculaires flexibles
Pinzas vasculares flexibles
Pinze vascolari flessibili

BD



BD-165-03
ø 3 mm



BD-165-05
ø 5 mm



BD-165-07
ø 7 mm



BD-165-09
ø 9 mm



BD-165-03 - BD-165-09

BG

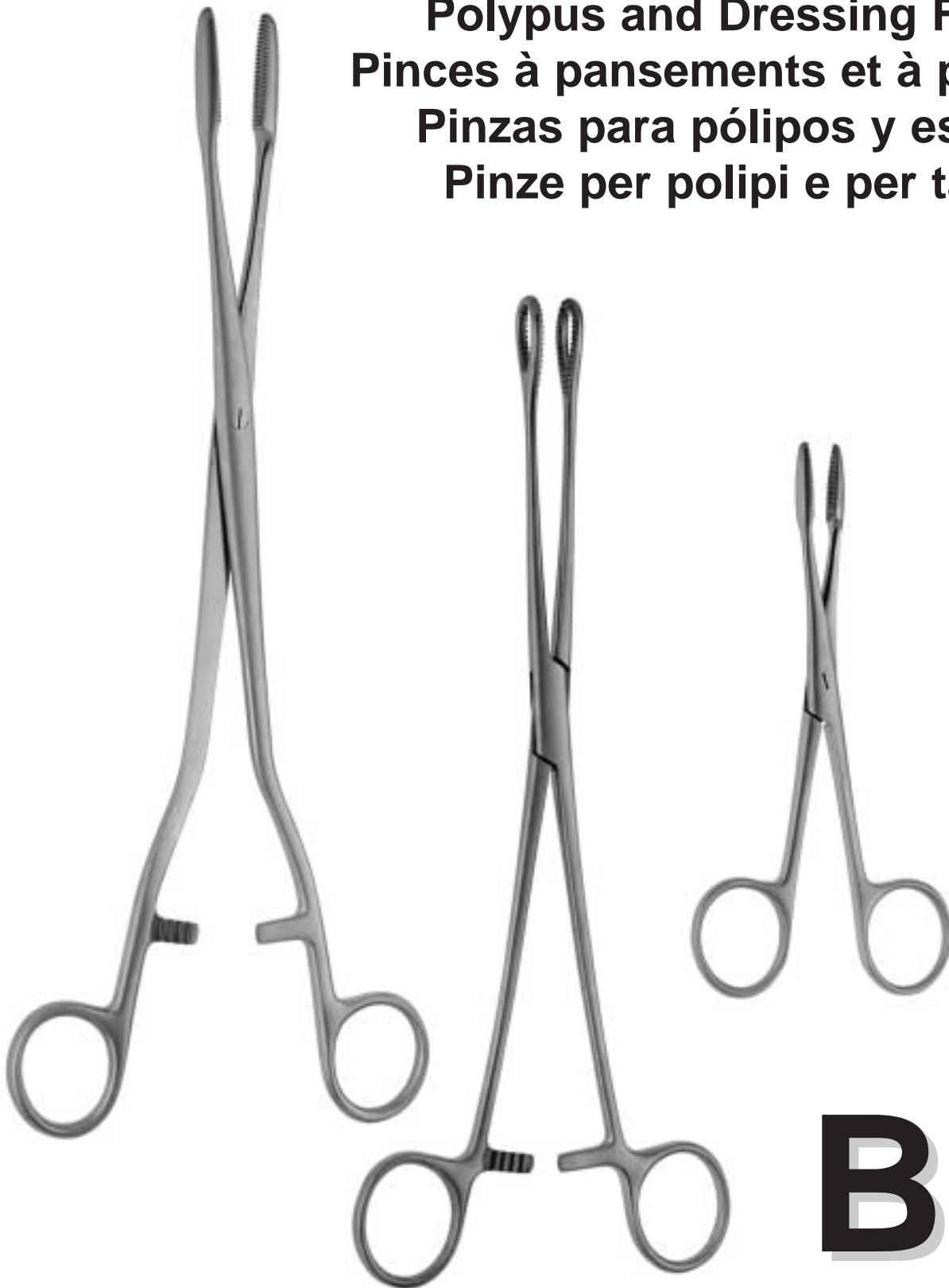
**Tupfer-/Kornzangen
Polypus and Dressing Forceps
Pinces à pansements et à polypes
Pinzas para pólipos y esponjas
Pinze per polipi e per tamponi**





BG

	
gerade	gebogen
straight	curved
droites	courbes
rectas	curvas
rette	curve





mit Sperre
with ratchet
avec crémaillère
con cremallera
con cremagliera

cm  MARTIN 
25,5 **BG-010-25** **BG-011-25**





ohne Sperre
without ratchet
sans crémaillère
sin cremallera
senza cremagliera

cm  GROSS-MAIER 
18 **BG-014-18** **BG-015-18**
20 **BG-014-20** **BG-015-20**
25 **BG-014-25** **BG-015-25**

Tupferzangen
 Dressing Forceps
 Pincès à pansements
 Pinzas para tapones
 Pinze per medicatura

BG



	
gerade	gebogen
straight	curved
droites	courbes
rectas	curvas
rette	curve







mit Sperre
 with ratchet
 avec crémaillère
 con cremallera
 con cremagliera



ohne Sperre
 without ratchet
 sans crémaillère
 sin cremallera
 senza cremagliera

cm		GROSS-MAIER	
18	BG-016-18		BG-017-18
20	BG-016-20		BG-017-20
25	BG-016-25		BG-017-25



cm		GROSS-MAIER	
13	BG-018-13		BG-019-13
14	BG-018-14		BG-019-14



	
gerade	gebogen
straight	curved
droites	courbes
rectas	curvas
rette	curve



ohne Sperre
without ratchet
sans crémaillère
sin cremallera
senza cremagliera

mit Sperre
with ratchet
avec crémaillère
con cremallera
con cremagliera





cm		GROSS-MAIER	
14	BG-110-14		BG-111-14
18	BG-110-18		BG-111-18
20	BG-110-20		BG-111-20
22	BG-110-22		BG-111-22
25	BG-110-25		BG-111-25
27	BG-110-27		BG-111-27
36	BG-110-36		BG-111-36
40	BG-110-40		BG-111-40

cm		GROSS-MAIER	
20	BG-112-20		BG-113-20
25	BG-112-25		BG-113-25

	
gerade	gebogen
straight	curved
droites	courbes
rectas	curvas
rette	curve





mit Sperre
with ratchet
avec crémaillère
con cremallera
con cremagliera

cm
18  GROSS 
BG-114-18 BG-115-18





mit Sperre
with ratchet
avec crémaillère
con cremallera
con cremagliera

cm
28  SIMS-MAIER 
BG-210-28 BG-211-28

BG

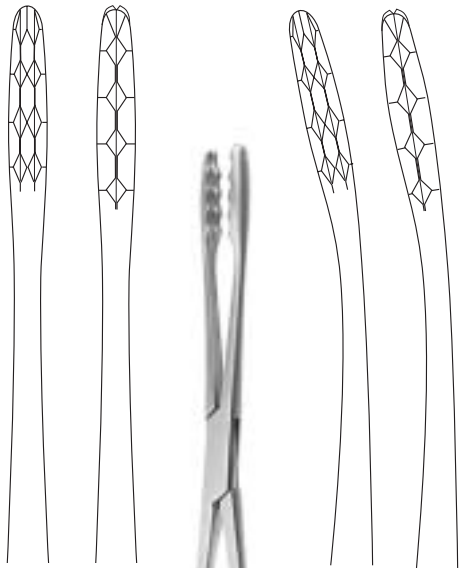

Schwammzangen
Sponge Holding Forceps
Pincès porte-éponges
Pinzas porta esponjas
Pinze per tamponi e spugne

	
gerade	gebogen
straight	curved
droites	courbes
rectas	curvas
rette	curve

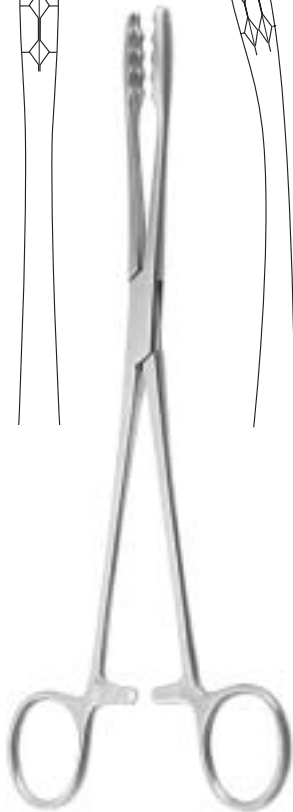

mit Sperre
with ratchet
avec crémaillère
con cremallera
con cremagliera





cm		ULRICH	
22	BG-610-22		BG-611-22
25	BG-610-25		BG-611-25
27	BG-610-27		BG-611-27



mit Sperre
with ratchet
avec crémaillère
con cremallera
con cremagliera

cm	FOERSTER
25	BG-618-25

	
gerade	gebogen
straight	curved
droites	courbes
rectas	curvas
rette	curve



mit Sperre
 with ratchet
 avec crémaillère
 con cremallera
 con cremagliera



mit Sperre
 with ratchet
 avec crémaillère
 con cremallera
 con cremagliera





cm		FOERSTER	
18	BG-710-18		BG-711-18
20	BG-710-20		BG-711-20
25	BG-710-25		BG-711-25
30	BG-710-30		BG-711-30

cm		FOERSTER	
18	BG-712-18		BG-713-18
20	BG-712-20		BG-713-20
25	BG-712-25		BG-713-25
30	BG-712-30		BG-713-30

BG

Schwammzangen
Sponge Holding Forceps
Pincès porte-éponges
Pinzas porta esponjas
Pinze per tamponi e spugne

	
gerade	gebogen
straight	curved
droites	courbes
rectas	curvas
rette	curve

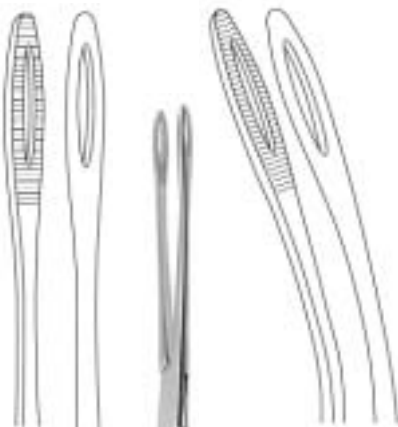

mit Sperre
with ratchet
avec crémaillère
con cremallera
con cremagliera





cm  FORESTER 
25 **BG-714-25** **BG-715-25**



mit Sperre
with ratchet
avec crémaillère
con cremallera
con cremagliera

cm **BONNEY**
24 **BG-716-24**

	
gerade	gebogen
straight	curved
droites	courbes
rectas	curvas
rette	curve



mit Sperre
 with ratchet
 avec crémaillère
 con cremallera
 con cremagliera

cm RAMPLEY
 18 **BG-718-18**
 25 **BG-718-25**





mit Sperre
 with ratchet
 avec crémaillère
 con cremallera
 con cremagliera

cm RAMPLEY
 25 **BG-810-25**

BG

Schwammzangen
Sponge Holding Forceps
Pinces porte-éponges
Pinzas porta esponjas
Pinze per tamponi e spugne

	
gerade	gebogen
straight	curved
droites	courbes
rectas	curvas
rette	curve



cm  FLETCHER JAVERS 
25 **BG-812-25** **BG-813-25**



cm  BERGMANN FOERSTER 
24 **BG-816-24** **BG-817-24**

ohne Sperre
without ratchet
sans crémaillère
sin cremallera
senza cremagliera



cm BRYANT
13 **BG-027-13**

Sinusklemme
Sinus forceps
Pincas à sinus
Pinzas para seno
Pinze sinus

ohne Sperre
without ratchet
sans crémaillère
sin cremallera
senza cremagliera



cm LISTER
13 **BG-120-13**
16 **BG-120-16**
18 **BG-120-18**



mit Sperre
with ratchet
avec crémaillère
con cremallera
con cremagliera



cm COLLIN
25 **BG-220-25**

BG

Tupferzangen
Dressing Forceps
Pincès à pansements
Pinzas para taponés
Pinze per medicatura

	
gerade	gebogen
straight	curved
droites	courbes
rectas	curvas
rette	curve



mit Sperre
with ratchet
avec crémaillère
con cremallera
con cremagliera



cm  PELKMANN 
25 **BG-226-25** **BG-227-25**



cm CHERON
25 **BG-229-25**





cm MAIER
25 **BG-320-25**

	
gerade	gebogen
straight	curved
droites	courbes
rectas	curvas
rette	curve





mit Sperre
with ratchet
avec crémaillère
con cremallera
con cremagliera

cm  BOZEMANN 
26 **BG-320-26** **BG-321-26**





mit Sperre
with ratchet
avec crémaillère
con cremallera
con cremagliera

cm **BOZEMANN-DOUGLAS**
26 **BG-323-26**

	
gerade	gebogen
straight	curved
droites	courbes
rectas	curvas
rette	curve





mit Sperre
with ratchet
avec crémaillère
con cremallera
con cremagliera

cm  MARTIN 
17 **BG-424-17** **BG-425-17**



mit Sperre
with ratchet
avec crémaillère
con cremallera
con cremagliera

cm  DUPLAY 
20 **BG-426-20** **BG-427-20**

BI

**Wundhaken
Retractors
Ecarteurs
Separadores
Divaricatori**



BI



FARABEUFB I-012-12
12 cm



FARABEUFB I-012-15
15 cm



PARKERBI-110-15
13,5 cm



PARKERBI-110-18
18 cm



ROUXBI-210-00

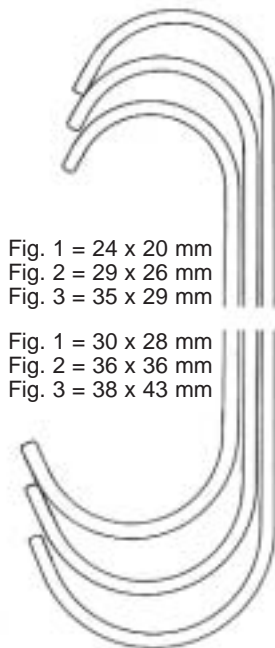

Fig. 1 = 24 x 20 mm
Fig. 2 = 29 x 26 mm
Fig. 3 = 35 x 29 mm

Fig. 1 = 30 x 28 mm
Fig. 2 = 36 x 36 mm
Fig. 3 = 38 x 43 mm



ROUX BabyBI-212-13
13cm



ROUX miniBI-214-13
15 cm



CRILEBI-217-11
11,5 cm

ROUXBI-210-00	Fig.	cm
BI-210-14	1	14
BI-210-15	2	15
BI-210-17	3	17



Fig. 1 = 40 x 15 mm
Fig. 2 = 45 x 15 mm

US Army (PARKER-LANGENBECK)
BI-311-21
21cm



Fig. 1 - 42 x 26 mm
Fig. 2 - 46 x 26 mm

MATHIEU
BI-314-20
20cm



GOELET
BI-315-19
19cm



COLLIN-HARTMANN
BI-317-16
16cm

BI

Wundhaken
Retractors
Ecarteurs
Separadores
Divaricatori



RICHARDSON-EASTMAN
BI-410-00



BI-510-01
28 x 20 mm



BI-150-02
36 x 28 mm



BI-510-03
44 x 38 mm



RICHARDSON



RICHARDSON Grip
BI-512-25 20 x 25 mm
BI-512-31 25 x 31 mm
BI-512-38 38 x 38 mm
BI-512-51 19 x 51 mm (Append.)
BI-512-64 41 x 64 mm



85 x 50 mm

KELLY
BI-516-26
26 cm



KELLY Grip
BI-518-51 38 x 51 mm
BI-518-64 51 x 64 mm
BI-518-76 64 x 76 mm
BI-518-82 70 x 82 mm

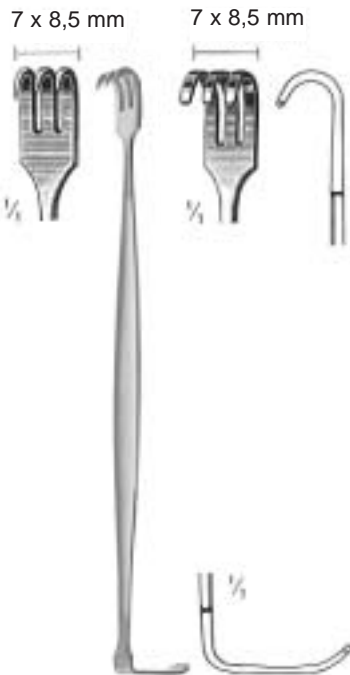

7 x 8,5 mm

7 x 8,5 mm

SENN
BI-610-17 17cm **BI-611-17**



RIBBON

BI-618-12 12 x 200 mm
BI-618-17 17 x 200 mm
BI-618-25 25 x 250 mm



RIBBON

BI-710-25 25 x 330 mm
BI-710-32 32 x 330 mm
BI-710-40 40 x 330 mm
BI-710-50 50 x 330 mm



Haberer

BI-714-17 17/25 x 200 mm
BI-714-25 25/30 x 250 mm
BI-714-37 37/45 x 300 mm



REVERDIN
BI-715-28
28 cm

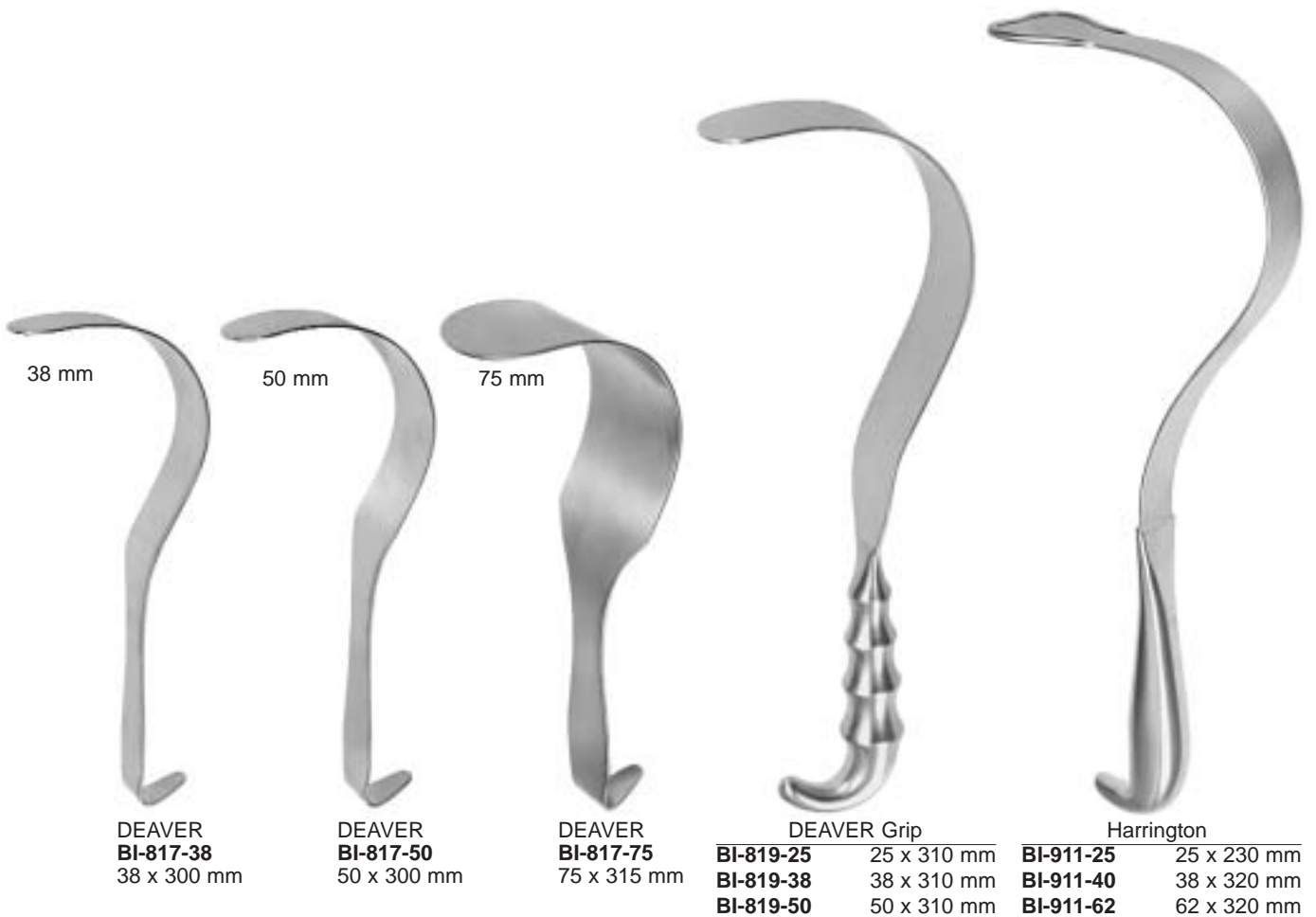
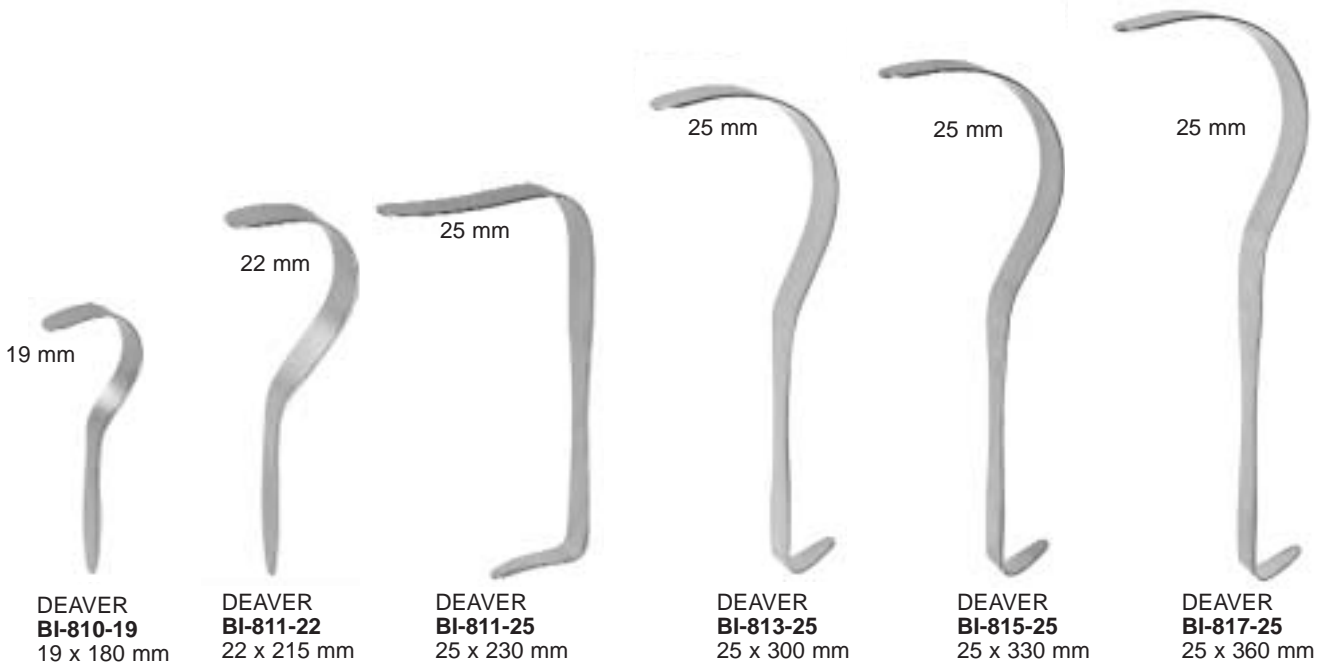

BI

Wundhaken
Retractors
Ecarteurs
Separadores
Divaricatori



GRAEFFE
BI-120-01



GRAEFFE
BI-121-12



GUTHRIE
BI-122-01



GUTHRIE
BI-122-02



cm	FRAZIER
13	BI-124-13
18	BI-124-18

BI-126-01

BI-126-02
2 mm

BI-126-05
5 mm

BI-126-07
7 mm

BI-126-10
10 mm

JOSEPH
16 cm

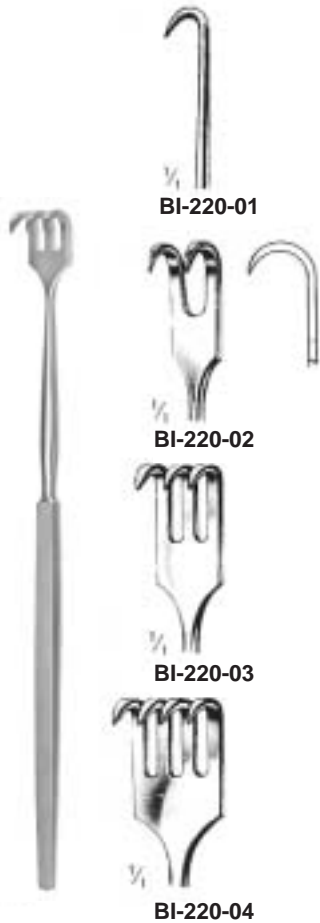

BI-220-01

BI-220-02

BI-220-03

BI-220-04

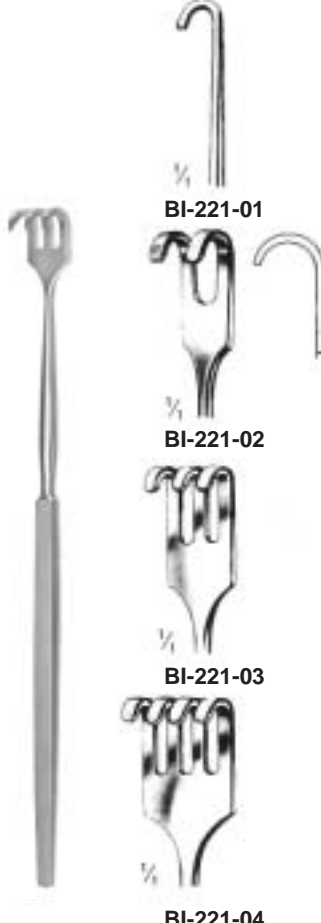

BI-221-01

BI-221-02

BI-221-03

BI-221-04

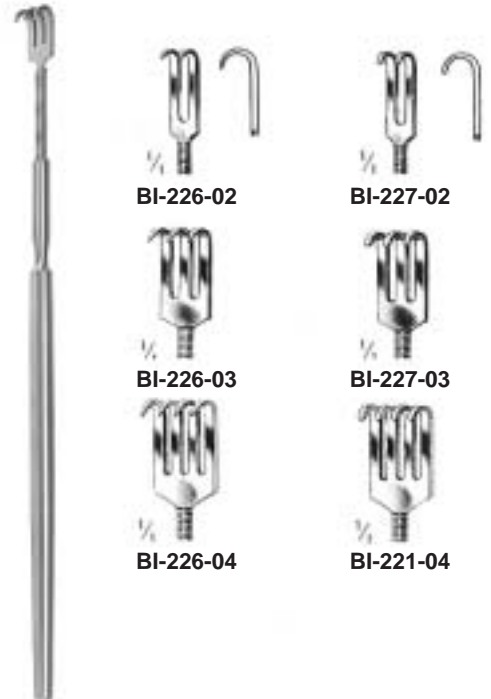

BI-226-02

BI-226-03

BI-226-04

BI-227-02

BI-227-03

BI-227-04



DESMARRES
16 cm



BI-320-12
12 mm

BI-320-14
14 mm

BI-320-16
16 mm

BI-320-18
18 mm



CUSHING
20 cm

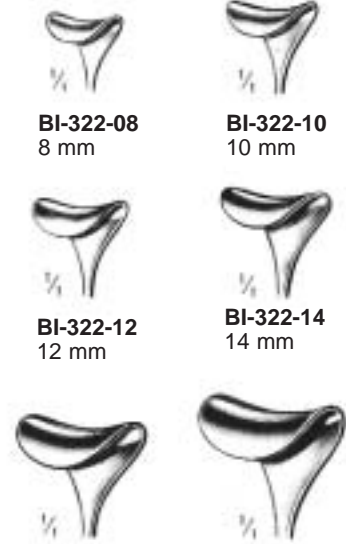

BI-322-08
8 mm

BI-322-10
10 mm

BI-322-12
12 mm

BI-322-14
14 mm

BI-322-16
16 mm

BI-322-18
18 mm



CUSCHING
BI-324-20
20 cm



CUSCHING
BI-324-21
21,5 cm



SENN-GREEN
BI-420-10 10 x 6 mm
BI-420-20 20 x 6 mm



10 x 5 mm

20 x 6 mm



VOLKMANN
11,5 cm

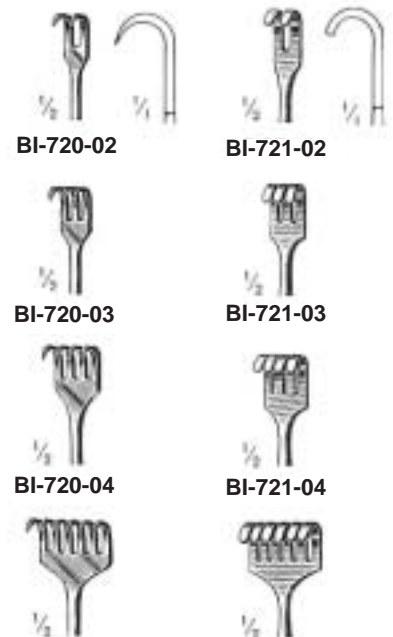

BI-720-02

BI-721-02

BI-720-03

BI-721-03

BI-720-04

BI-721-04

BI-720-06

BI-721-06



VOLKMANN
21,5 cm



BI-820-01



BI-820-02



BI-820-03



BI-820-04



BI-820-06



BI-821-01



BI-821-02



BI-821-03



BI-821-04



BI-821-06

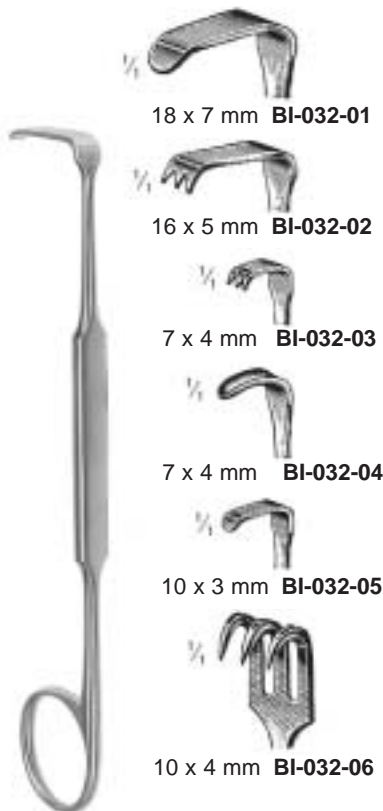

MEYERDING
18 cm



LAHEY
BI-034-19
19cm



LITTLE
BI-036-20
20cm



BI-130-01
- **BI-130-05**
22 cm

BI-132-01
- **BI-132-05**
21 cm

LANGENBECK

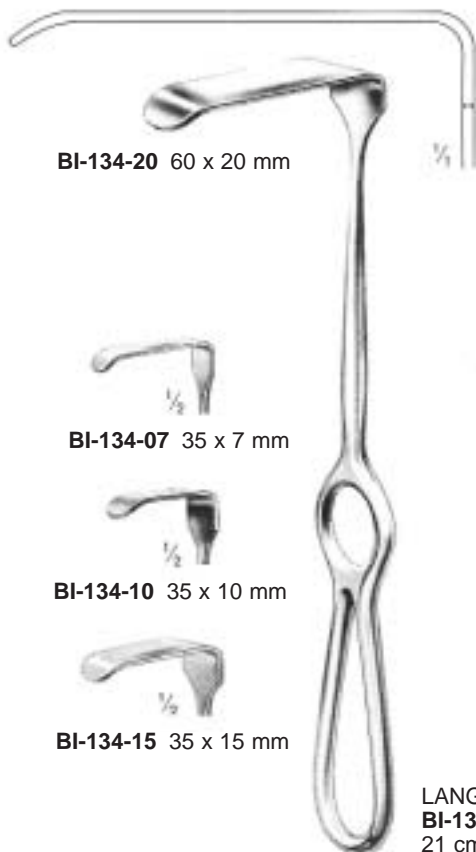
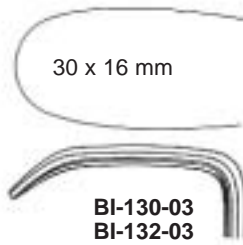
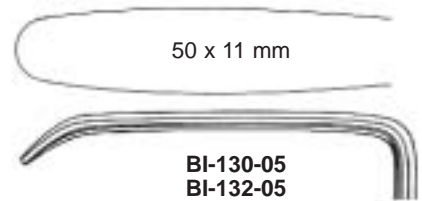
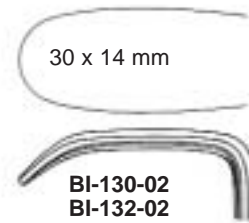
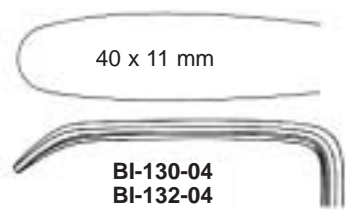
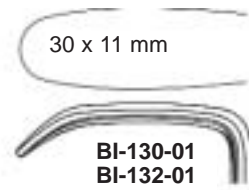

LANGENBECK
BI-134-07 - BI-134-21
21 cm



LANGENBECK
BI-135-21
21 cm

LANGENBECK
BI-137-21
21 cm

BI

Wundhaken
Retractors
Ecarteurs
Separadores
Divaricatori

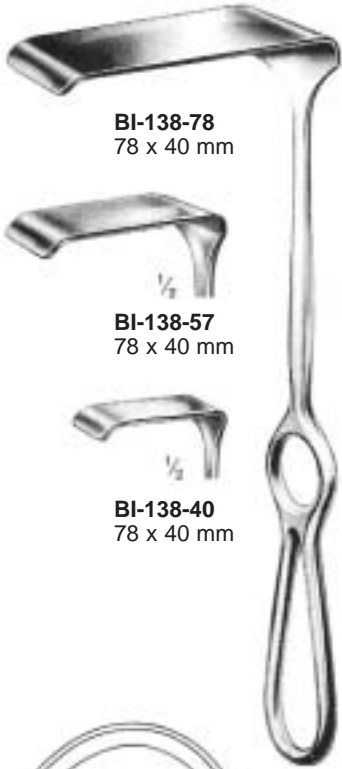

BI-138-78
78 x 40 mm

BI-138-57
78 x 40 mm

BI-138-40
78 x 40 mm

BI-138-40 - BI-138-78
23 cm



BI-330-40
40 x 12 mm

BI-330-50
55 x 11 mm

KOCHER
BI-330-40 - BI-330-55
19cm

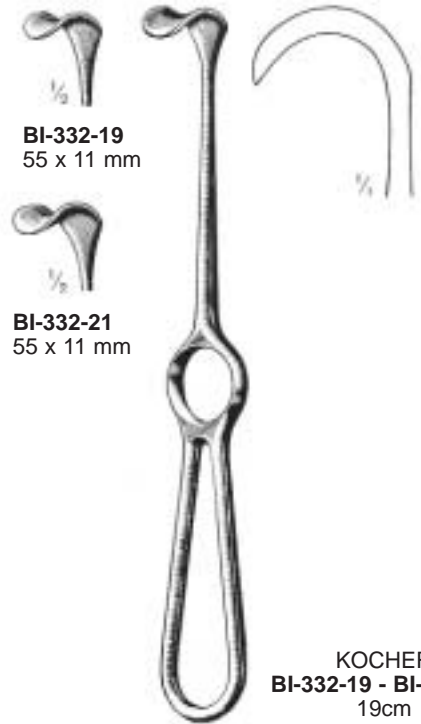

BI-332-19
55 x 11 mm

BI-332-21
55 x 11 mm

KOCHER
BI-332-19 - BI-332-21
19cm



KOCHER mm
BI-430-10 40 x 10
BI-430-15 40 x 15
BI-430-20 40 x 20
22 cm

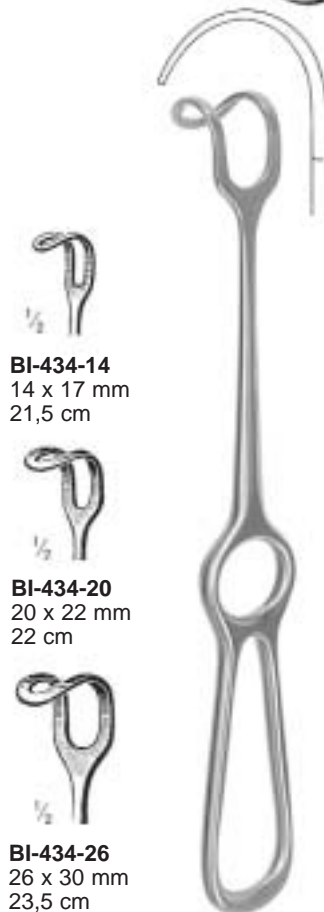

BI-434-14
14 x 17 mm
21,5 cm

BI-434-20
20 x 22 mm
22 cm

BI-434-26
26 x 30 mm
23,5 cm

MIDDELDORPF
BI-434-14 - BI-434-26



GREEN
BI-438-22
22 cm



OLLIER
BI-630-02
22,5 cm



BI-634-40 40 x 40 mm



BI-634-50 45 x 50 mm



BI-634-60 50 x 60 mm

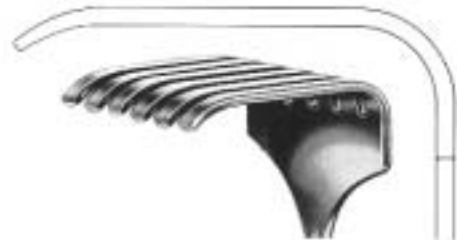

BI-634-70 70 x 70 mm

ISRAEL
25 cm



40 x 30 mm

KOERTE
BI-636-08 23,5cm BI-637-08



FRITSCH mm
BI-730-40 45 x 40
BI-730-50 45 x 50
BI-730-60 45 x 60
BI-730-75 45 x 75
24cm



70 x 25 mm

KOCHER
BI-732-22
22,5 cm



KOCHER mm
BI-734-45 80 x 45
BI-734-55 80 x 55
BI-734-65 80 x 65
25cm

BI

Wundhaken
Retractors
Ecarteurs
Separadores
Divaricatori



50 x 85 mm

DOYEN
BI-738-25
25 cm



90 x 50 mm

BI-830-35
95 x 35 mm

BI-830-55
120 x 50 mm

BI-831-50
150 x 50 mm

MIKULICZ
26 cm

MIKULICZ
26 cm

BI-842-82
82 x 28 mm

BI-842-73
73 x 28 mm

BI-842-45
45 x 25 mm

MIKULICZ
BI-832-50
26 cm

mm	KELLY
160 x 38	BI-835-38
160 x 57	BI-835-57
	27 cm

SIMON	mm
BI-840-22	115 x 22
BI-840-27	115 x 27
	28 cm

HEANEY
BI-842-45 -BI-842-82
27cm

BI-940-65
115 x 65 mm

BI-940-43
108 x 43 mm

BI-940-22
82 x 22 mm

125 x 37 mm

BI-944-45
45 x 15 mm

BI-944-60
60 x 23 mm

BI-944-75
75 x 20 mm

CORYLLOS (Thorax)
BI-940-22 - BI-940-65
24 cm

SAUERBRUCH
BI-944-45 - BI-944-75
22,5 cm

Sauerbruch
BI-942-25
25 cm

DAVIDSON (Scapula)
BI-946-50
75 x 50 mm

DAVIDSON (Scapula)
BI-946-90
75 x 90 mm

BI

Wundhaken
Retractors
Ecarteurs
Separadores
Divaricatori

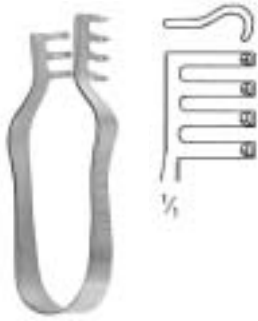

FINSEN
BI-160-07 7 cm BI-161-07



ALM
BI-260-07 7 cm BI-261-07
BI-260-10 10 cm BI-261-10



JANSEN
BI-360-10
10 cm



JANSEN
BI-361-10
10 cm



BI-364-10 10 cm **BI-365-10**



WEITLANER
BI-560-10 11,5 cm BI-365-10



WEITLANER-WULLSTEIN
BI-564-13 13 cm BI-565-13



PLESTER
BI-567-11
11 cm



PLESTER
BI-569-11
11 cm



WEITLANER
BI-760-14 14,0 cm BI-761-14
BI-760-16 16,5 cm BI-761-16
BI-760-20 20,0 cm BI-761-20



ADSON
BI-860-19 19 cm BI-861-19



ADSON
BI-862-26 - BI-863-26
26,5 cm

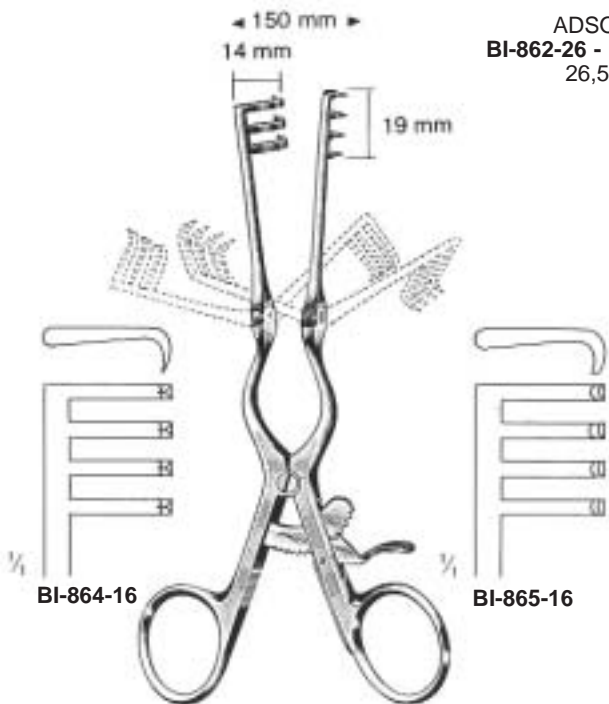
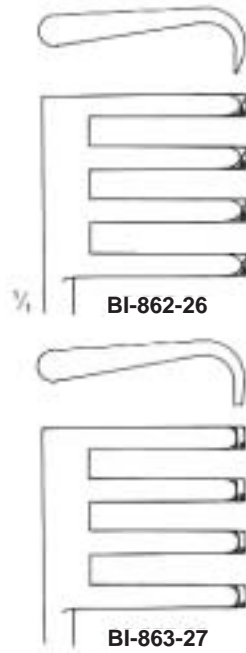

ADSON Baby
BI-864-16 - BI-865-16
16cm



BECKMANN-ADSON
BI-866-32
32 cm



BECKMANN
BI-960-31
31 cm



BECKMANN-EATON
BI-962-32
32 cm



MOLLISON
BI-963-15
15 cm



DARLING
BI-966-18
18 cm

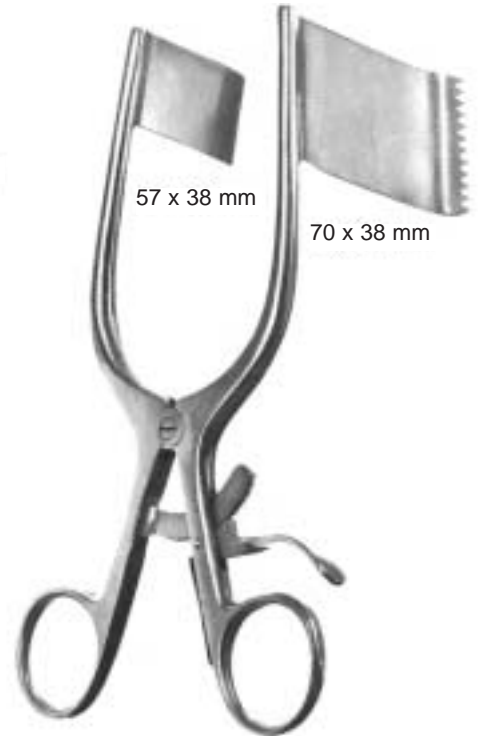

DARLING
BI-968-18
18 cm



CLOWARD
BI-170-00
BI-170-01

ohne Valven • without blades
sans valves • sin valves • senza valve

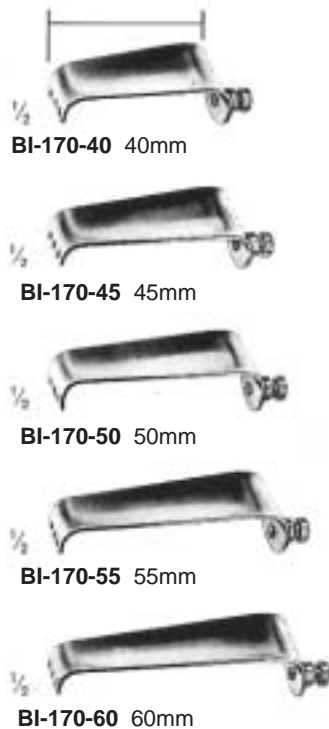

CLOWARD
BI-171-00
BI-171-01

ohne Valven • without blades
sans valves • sin valvas • senza valve

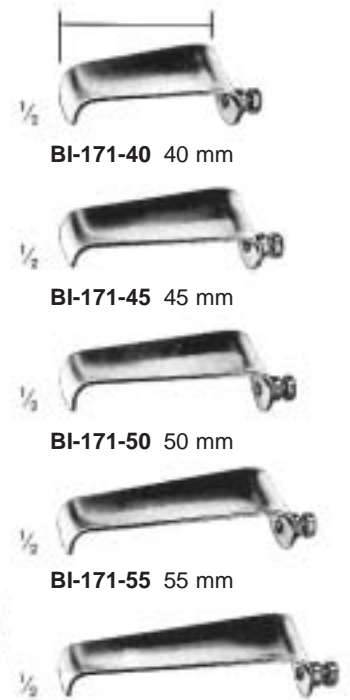



CASPAR
BI-270-00 compl.
BI-270-15 ohne Valven • without blades
sans valves • sin valvas • senza valve



CASPAR
BI-271-00 compl.
BI-271-15 ohne Valven • without blades • sans valves • sin valvas • senza valve



CASPAR
BI-274-00 compl.
BI-274-11



stumpf
blunt
mousse
roma
smussa

mm	CASPAR
45 x 23	BI-176-45
50 x 23	BI-176-50
55 x 23	BI-176-55
60 x 23	BI-176-60
65 x 23	BI-176-65



medial

mm	CASPAR
40 x 23	BI-178-40
45 x 23	BI-178-45
50 x 23	BI-178-50
55 x 23	BI-178-55
60 x 23	BI-178-60



lateral

mm	CASPAR
40 x 23	BI-179-40
45 x 23	BI-179-45
50 x 23	BI-179-50
55 x 23	BI-179-55
60 x 23	BI-179-60

BI-475-40
40 mm



BI-475-45
45 mm



BI-475-50
50 mm



BI-475-55
45 mm



BI-475-60
60 mm



BI-475-65
65 mm



BI-475-70
70 mm



CASPAR

BI-474-00 compl. incl. 5 Valven • blades

valves • valvas • valve

BI-474-17 ohne Valven • without blades • sans valves • sin valvas • senza valve



BI-477-45
45 mm

BI-477-50
50 mm

BI-477-55
55 mm

BI-477-60
60 mm

BI-477-65
65 mm



CASPAR
BI-477-45 - BI-477-65



O'SULLIVAN-O'CONNOR
BI-574-00

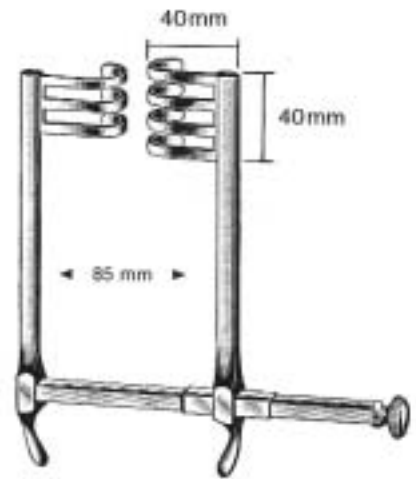

FRAZIER
BI-578-85



GOSSET
BI-670-14



GOSSET
BI-672-16



BALFOUR
BI-674-18
10 cm



BALFOUR
BI-674-20
20 cm

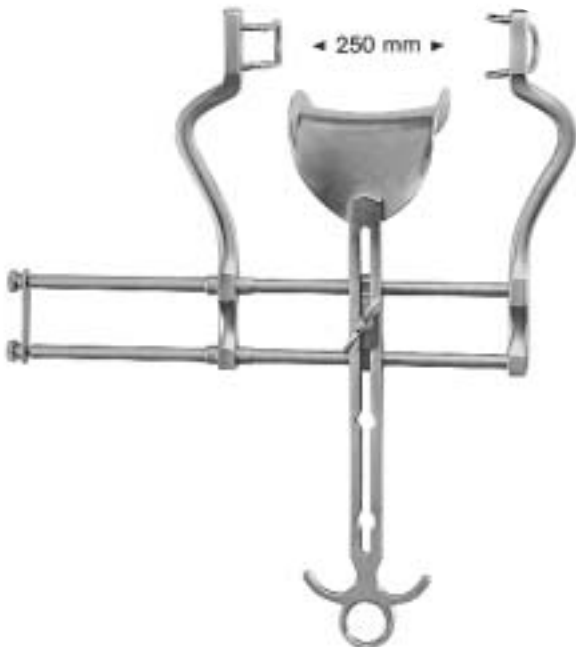

BALFOUR
BI-674-25
25 cm



mm	BALFOUR
45 x 80	BI-675-45
70 x 85	BI-675-70
80 x 90	BI-675-80



BALFOUR Baby
BI-676-90
9 cm

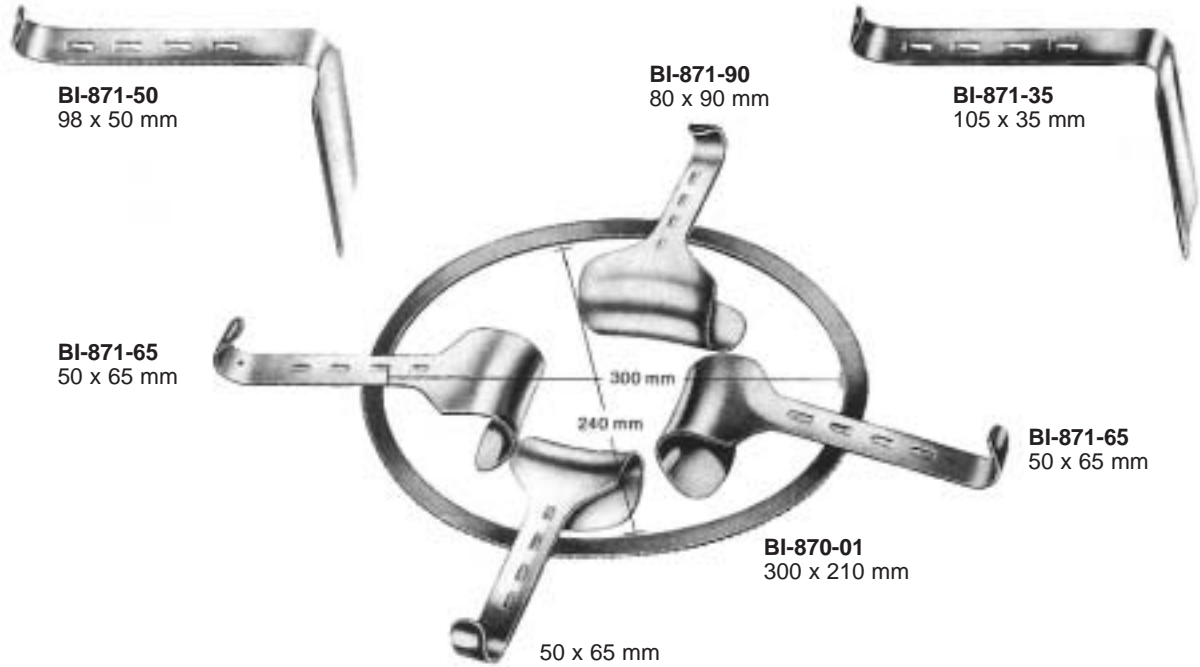

KIRSCHNER
BI-870-00 compl.

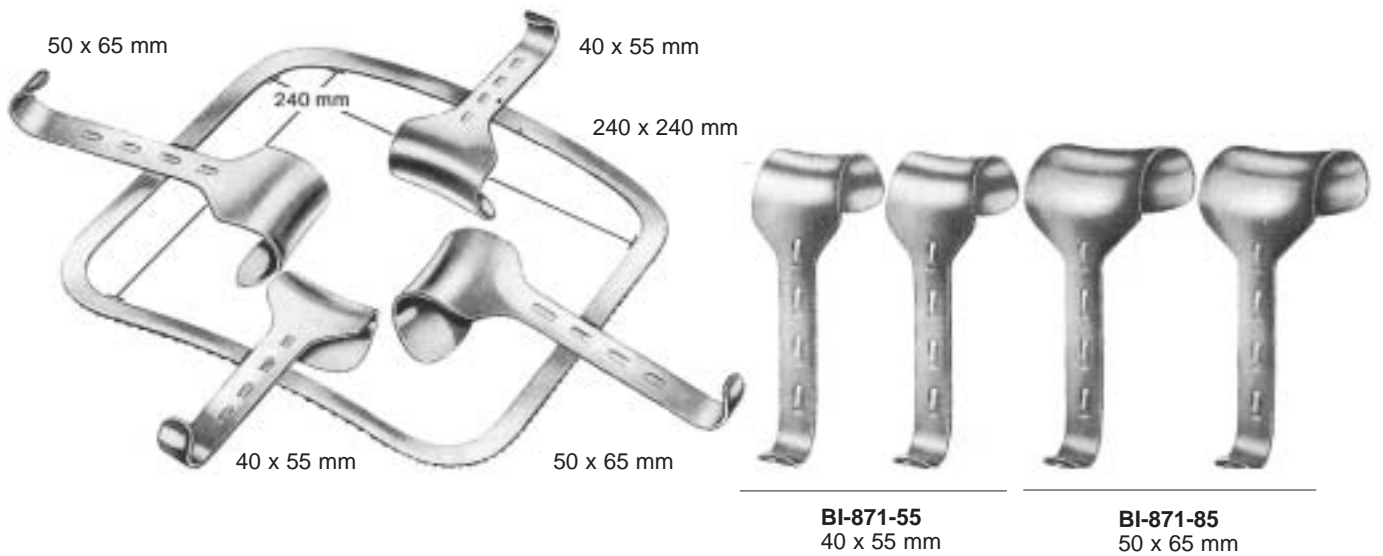

KIRSCHNER
BI-872-00 compl

BI

Wundhaken
Retractors
Ecarteurs
Separadores
Divaricatori



cm	GELPI
9	BI-082-09
14	BI-082-14
16	BI-082-16
18	BI-082-18



GELPI
BI-084-18
18 cm



RIGBY
BI-086-18
18 cm



COLLIN
BI-180-22



Central/mm	COLLIN
38 x 55	BI-182-60
50 x 75	BI-182-80

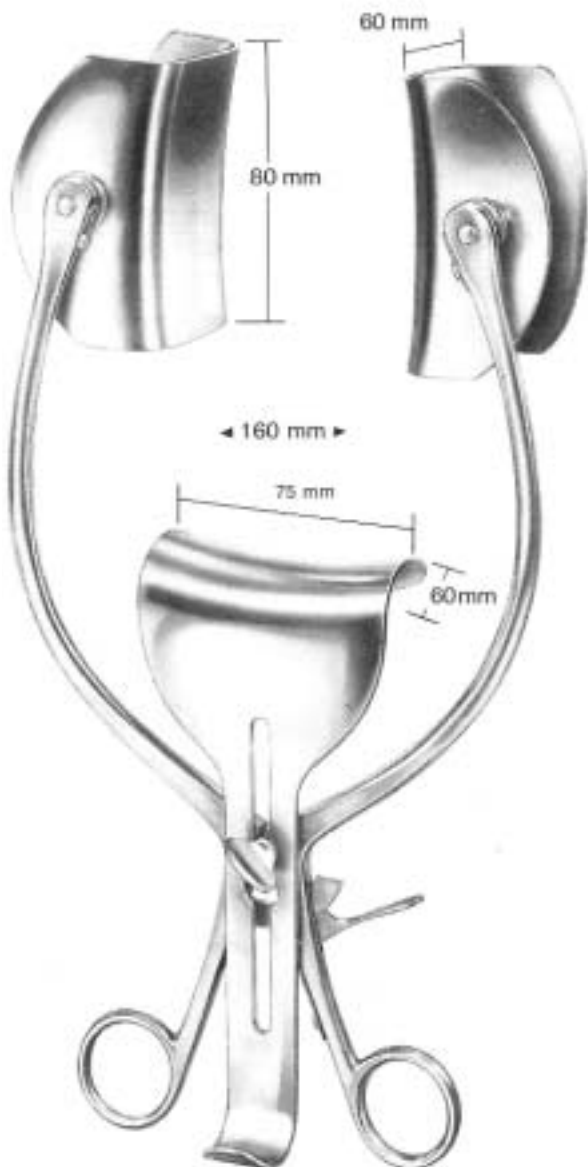

COLLIN Loktite
BI-186-00

Muskelhaken
Muscle Retractors (Hooks)
Ecarteurs musculaires
Separadores (ganchos) musculares
Divaricatori (uncini) muscolari



BI-092-10
10 cm



BI-093-00

CA

**Sonden, Spatel, Watteträger
Probes, Spatulas, Applicators
Sondes, Spatules, porte-coton
Sondas, Espátulas, porta-algodón
Sonde, Spatole, portacotone**

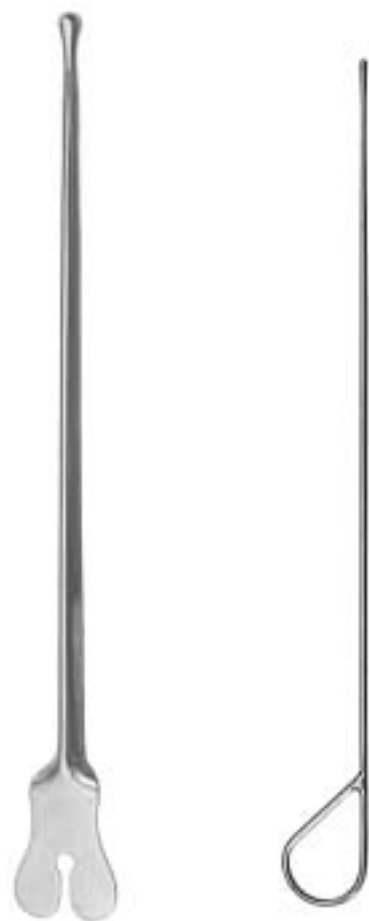

CA

CA

Sonden
Probes, Directors
Stylets, sondes
Sondas, estiletes
Sonde, specilli



cm	2 mm Ø	1 mm Ø	1,5 mm Ø	2 mm Ø		DOYEN		STACKE
10,5					CA-018-10			CA-115-10
11,5	CA-012-11	CA-014-11	CA-015-11	CA-016-11		CA-110-11		
13,0	CA-012-13	CA-014-13	CA-015-13	CA-016-13	CA-018-13	CA-110-13	CA-112-13	
14,0						CA-111-14		
14,5	CA-012-14	CA-014-14	CA-015-14	CA-016-14	CA-018-14	CA-110-14	CA-112-14	
16,0	CA-012-16	CA-014-16	CA-015-16	CA-016-16	CA-018-16	CA-110-16	CA-112-16	
18,0	CA-012-18	CA-014-18	CA-015-18	CA-016-18	CA-018-18	CA-110-18	CA-112-18	
20,0	CA-012-20	CA-014-20	CA-015-20	CA-016-20	CA-018-20	CA-110-20		
25,0	CA-012-25	CA-014-25	CA-015-25	CA-016-25				

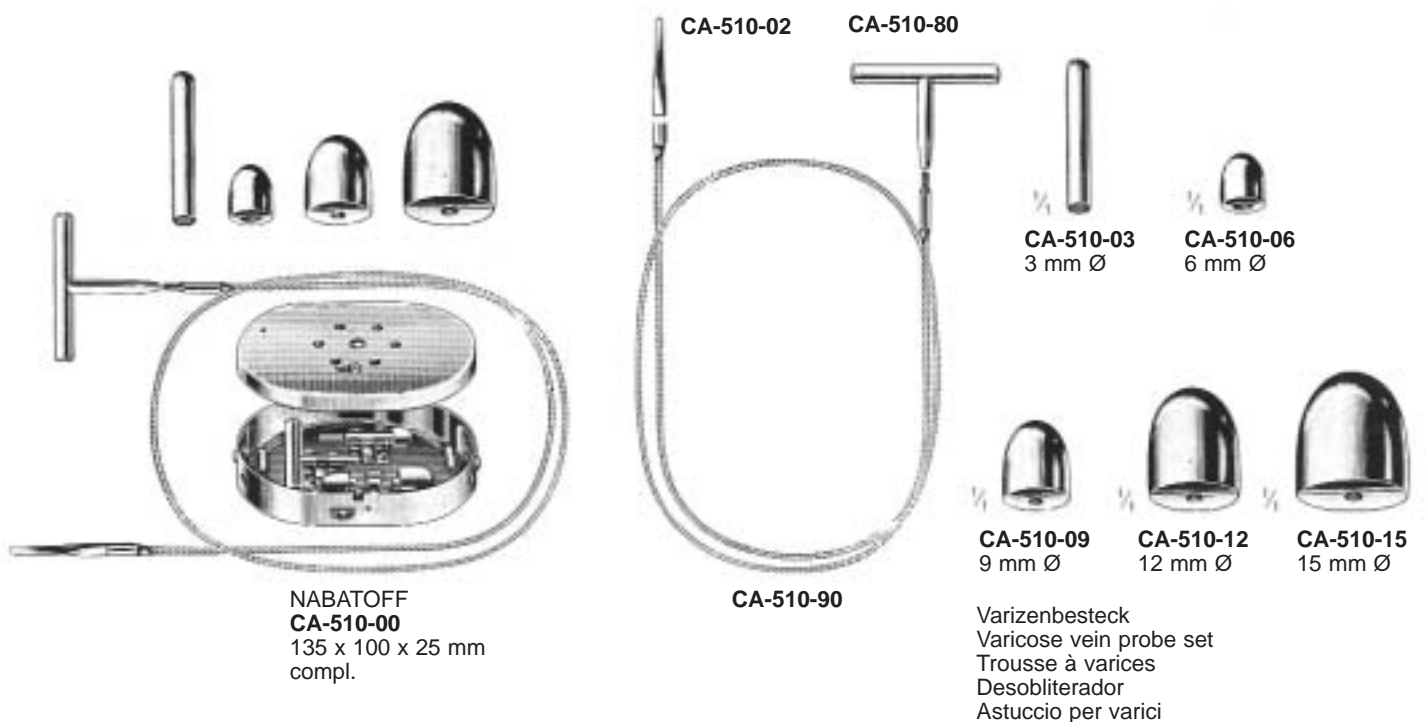

NABATOFF
CA-510-00
135 x 100 x 25 mm
compl.

CA-510-90

Varizenbesteck
Varicose vein probe set
Trousse à varices
Desobliterador
Astuccio per varici

Spatel, Watteträger
 Spatulas, Cotton-Applicators
 Spatules, porte-coton
 Espátulas, porta-algodón
 Spatole, portacotone

CA

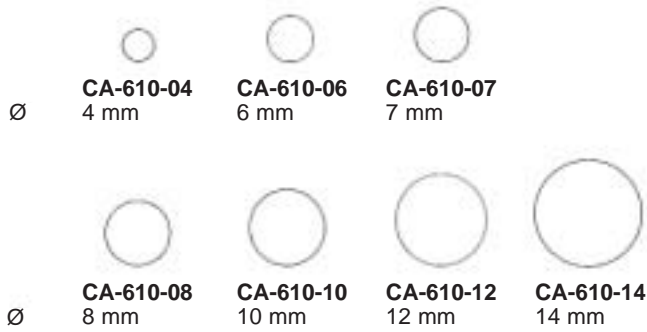

Pflasterspatel
 Plaster spatula
 Spatules
 Espátulas
 Spatole



cm	
13,0	CA-910-13
14,5	CA-910-14



cm	FARRELL	FARRELL			UCKERMANN	JOBSON-HORNE
12,0	CA-720-12	CA-722-12	CA-920-12	CA-922-12		CA-230-12
14,0	CA-720-14	CA-722-14	CA-920-14	CA-920-14		
15,0					CA-130-15	
16,0			CA-920-16	CA-920-16		
16,5	CA-720-16	CA-722-16				
18,0	CA-720-18	CA-722-18	CA-920-18	CA-920-18		CA-230-18
23,0	CA-720-23	CA-722-23				
25,0						
45,0						CA-430-45

**Trokare, Punktionsnadeln
Trocars, Puncture Needles
Trocarts, Aiguilles à ponction
Trócares, Agujas para punción
Trequarti, Aghi da punzione**



CC

CC

Trokare
Trocars
Trocarts
Trócares
Trequarti

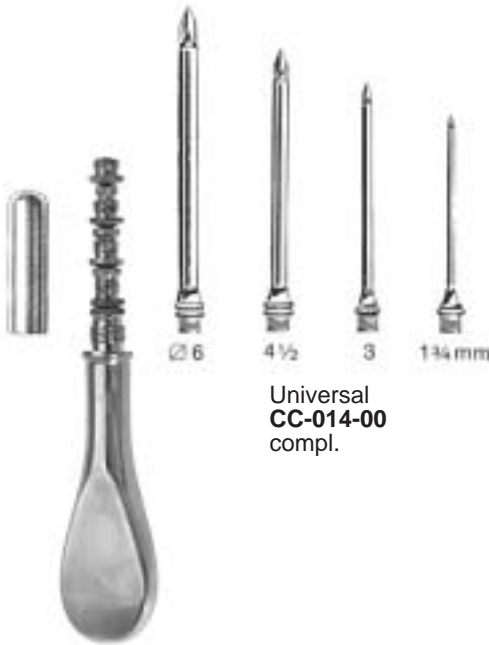

Universal
CC-014-00
compl.



mm	Standard	Standard	PIERCE
3,0	CC-110-30	CC-210-30	CC-213-30
3,5	CC-110-35	CC-210-35	
4,0	CC-110-40	CC-210-40	CC-213-40
4,5	CC-110-45	CC-210-45	
5,0	CC-110-50	CC-210-50	CC-213-50
5,5	CC-110-55	CC-210-55	
6,0	CC-110-60	CC-210-60	



DOUGLAS
CC-215-11
3 mm Ø

FLEURANT
CC-217-23
23 cm
5 mm Ø



LICHTWITZ
CC-218-20
1,70 mm Ø



COAKLEY
CC-410-02
2,25 mm Ø

Charr./ F.G.	OCHSNER
10	CC-510-10
12	CC-510-12
14	CC-510-14
16	CC-510-16
18	CC-510-18
20	CC-510-20

Charr./ F.G.	NELSON
25	CC-710-25
30	CC-710-30
33	CC-710-33
35	CC-710-35



Pneumoperitoneum
Pneumopéritoine
Neumoperitoneo
Pneumoperitoneo



CC-120-00 VERRES
compl. **CC-520-20**
2,0 x 100 mm

Pudendus Anesthesia
anesthesia

mm	QUINKE
1,2 x 76	CC-320-12
1,2 x 89	CC-322-12
1,0 x 76	CC-320-10
1,0 x 89	CC-322-10
0,7 x 76	CC-320-07
0,7 x 89	CC-322-07



mm	MENGHINI	mm	MENGHINI	MENGHINI
1,0 x 35	CC-032-01	1,4 x 168	CC-130-14	CC-132-14
1,0 x 70	CC-032-02	1,8 x 168	CC-130-18	CC-132-18
1,2 x 70	CC-032-03			
1,2 x 100	CC-032-04			
1,4 x 70	CC-032-05			
1,4 x 100	CC-032-06			
1,6 x 70	CC-032-07			
1,8 x 100	CC-032-08			

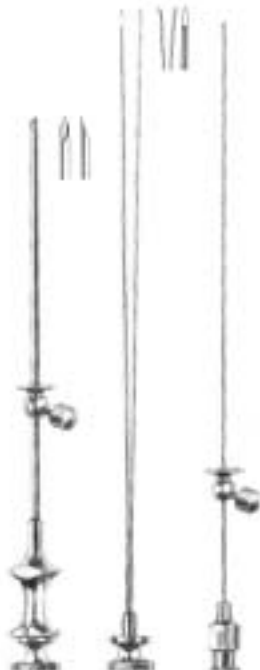

Ø ext. x L. mm	Ø int. x L. mm	FRANKLIN-SILVERMANN
2,0 x 105	1,5 x 155	CC-330-20
2,0 x 130	1,5 x 180	CC-330-14

compl.

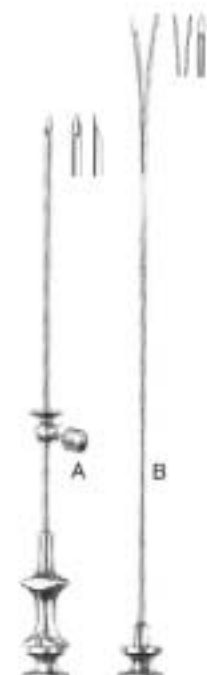

A Ø x L. mm	B Ø x L. mm	A + B FRANKLIN-SILVERMANN	B FRANKLIN-SILVERMANN
2,0 x 100	1,5 x 150	CC-530-20	CC-532-15
2,5 x 145	2,0 x 195	CC-530-30	CC-532-20
2,0 x 100	1,5 x 150	CC-534-20	CC-536-15
2,5 x 145	2,0 x 195	CC-534-25	CC-536-20

CE

**Nadelhalter
Needle Holders
Porte-aiguilles
Porta-agujas
Port'aghi**



CE

CE

Nadelhalter
Needle Holders
Porte-aiguilles
Porta-agujas
Port'aghi



DERF
CE-110-12 12 cm **CE-114-12**



DERF
CE-210-12
12,5 cm



NEIVERT
CE-416-13



BAUMGARTNER
CE-510-12 12,5 cm **CE-514-12**
CE-510-14 14,5 cm **CE-514-14**



COLLIER
CE-212-12
12,5 cm

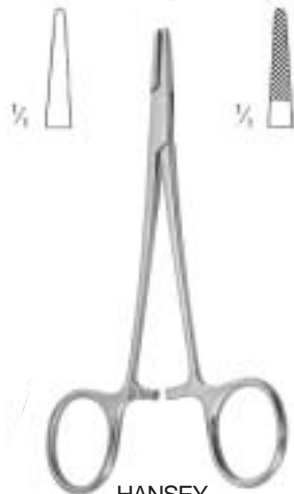

HANSEY
CE-310-13 13 cm **CE-410-13**
CE-314-13 13 cm **CE-414-13**

Mit TC-Einsätzen
TC-Lined
A mors TC
Con bocas TC
Con morso TC



CRILE-WOOD
CE-610-15 15 cm **CE-614-15**
CE-610-18 18 cm **CE-614-18**
CE-610-20 20 cm **CE-614-20**



CRILE-MURRAY
CE-710-15 15 cm **CE-714-15**



MAYO-HEGAR
CE-810-14 14 cm **CE-814-14**
CE-810-16 16 cm **CE-814-16**
CE-810-18 18 cm **CE-814-18**
CE-810-20 20 cm **CE-814-20**
CE-810-24 24 cm **CE-814-24**
CE-810-26 26 cm **CE-814-26**
CE-810-30 30 cm **CE-814-30**



MAYO-HEGAR
CE-910-16 16 cm **CE-914-16**
CE-910-18 18 cm **CE-914-18**
CE-910-20 20 cm **CE-914-20**



cm	DE BAKEY	RYDER
13		CE-224-13
15	CE-124-15	CE-224-15
18	CE-124-18	CE-224-18
20	CE-124-20	CE-224-20
23	CE-124-23	CE-224-23
26	CE-124-26	CE-224-26
31	CE-124-31	
37	CE-124-37	

	JAMISON	HEANEY
CE-320-23	23,5 cm	CE-324-23
CE-421-21	21 cm	CE-425-21



	MASSON	WANGENSTEEN	WANGENSTEEN	BOZEMANN
CE-520-27	27 cm	CE-524-27	CE-620-27	27 cm
		CE-624-27	CE-720-27	27 cm
			CE-724-27	
				cm
				20
				24
				26

CE

Nadelhalter
Needle Holders
Porte-aiguilles
Porta-agujas
Port'aghi



METZENBAUM
CE-920-18
18 cm



ADSON
CE-922-18
18 cm



JOHNSON
CE-923-27
27 cm

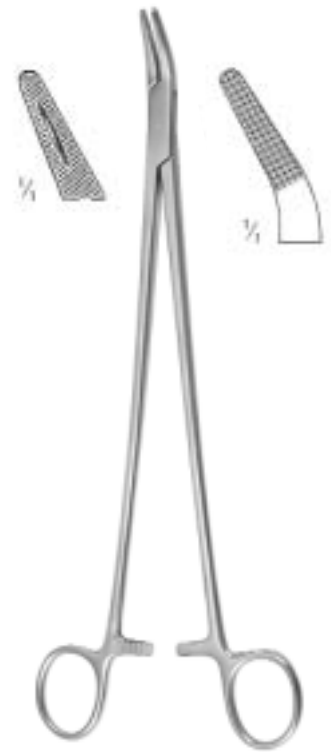

FINOCHIETTO
CE-131-20 20 cm **CE-135-20**
CE-131-27 27 cm **CE-135-27**

Mit TC-Einsätzen
TC-Lined
A mors TC
Con bocas TC
Con morso TC



SAROT
CE-230-18 18 cm **CE-234-18**
CE-230-26 26 cm **CE-234-26**



STRATTE
CE-330-23 23 cm **CE-334-23**



CRILE
CE-530-15
15 cm



TOENNIS
CE-630-18 18 cm **CE-634-18**



HOESEL
CE-636-25
25 cm



cm	MATHIEU		MATHIEU		MATHIEU	
14	CE-730-14	CE-734-14			CE-930-14	CE-934-14
17	CE-730-17	CE-734-17	CE-830-17	CE-834-17	CE-930-17	CE-934-17
20	CE-730-20	CE-734-20	CE-830-20	CE-834-20		
24	CE-730-24	CE-734-24				



OLSEN-HEGAR

CE-140-14 14 cm CE-144-14
CE-140-18 18 cm CE-144-18



OLSEN-HEGAR

CE-240-17 17 cm CE-244-17



GILLIES

CE-340-16 16 cm CE-344-16

Gefäß-Chirurgie
Vascular surgery
Chirurgie vasculaire
Chirurgia vascular
Chirurgia vascolare



Mit TC-Einsätzen
TC-Lined
A mors TC
Con bocas TC
Con morso TC

cm	DIETRICH
16	CE-444-16
18	CE-444-18
20	CE-444-20
23	CE-444-23
26	CE-444-26

Ophthalmologie
Ophthalmology
Ophtalmologie
Oftalmología
Oftalmologia



STEVENS
CE-160-11
11 cm



cm	STEVENS
13	CE-162-13
15	CE-162-15



BOYNTON
CE-164-12
12 cm



cm	ARRUGA
16 cm	CE-264-16



KALT-ARRUGA
CE-267-14
 14 cm



KALT
CE-268-14
CE-362-14
 14 cm



BARRAQUER
CE-560-10
 10 cm



BARRAQUER
CE-561-10
 10 cm



BARRAQUER
CE-661-13 13 cm **CE-665-13**



CASTROVIEJO
CE-760-14 14 cm **CE-761-14**
CE-764-14 14 cm **CE-765-14**



CASTROVIEJO
CE-860-13 13 cm **CE-864-13**

CG

**Naht
Suture
Suture
Sutura
Sutura**



CG



R	DESCHAMPS	L
CG-110-21	21 cm	CG-111-21
CG-110-24	24 cm	CG-111-24
CG-110-27	27 cm	CG-111-27

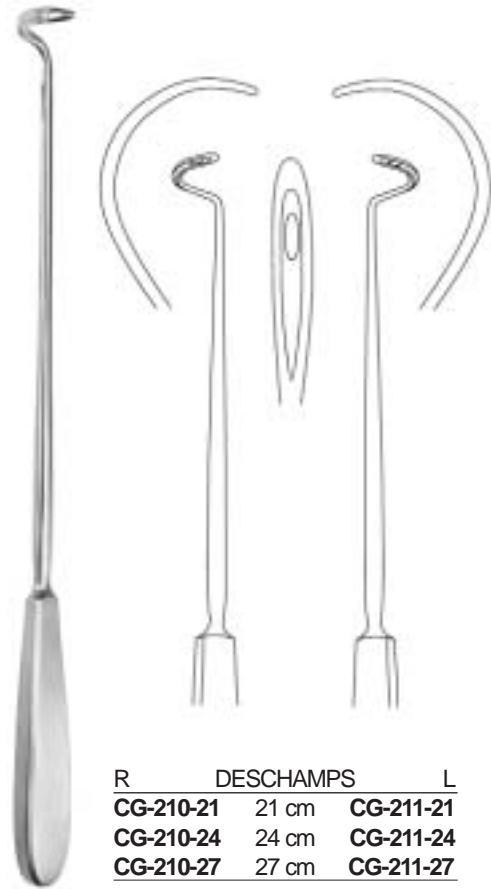

R	DESCHAMPS	L
CG-210-21	21 cm	CG-211-21
CG-210-24	24 cm	CG-211-24
CG-210-27	27 cm	CG-211-27

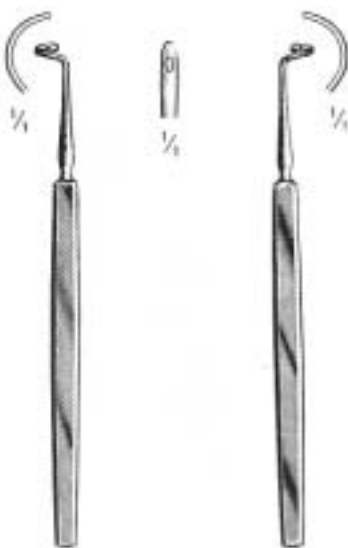

R	KRONECKER	L
CG-310-13	13 cm	CG-311-13



R	NELSON	L
CG-313-24	24,5 cm	CG-315-24



COOPER
CG-319-19
19 cm

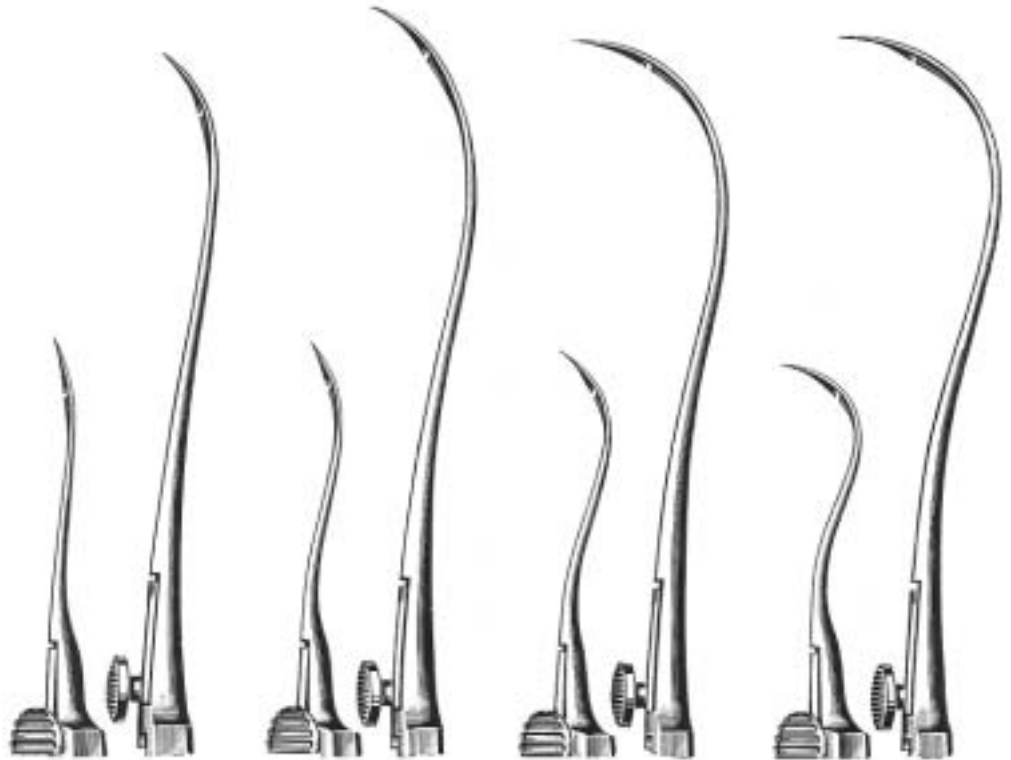

REVERDIN	cm	Fig. 1	Fig. 2	Fig. 3	Fig. 4
CG-021-15 - CG-024-23	15	CG-021-15	CG-022-15	CG-023-15	CG-024-15
	19	CG-021-19	CG-022-19	CG-023-19	CG-024-19
	21	CG-021-21	CG-022-21	CG-023-21	CG-024-21
	23	CG-021-23	CG-022-23	CG-023-23	CG-024-23



YOUNG Boomerang
CG-420-00
25 cm



Fig. 1
CG-420-01



Fig. 2
CG-420-02



Fig. 3
CG-420-03



SCHMIEDEN
CG-721-19
 19 cm



SCHMIEDEN-PAYR
CG-723-19
 19 cm



BRUNNER
CG-725-30
 30 cm



KIRSCHNER
CG-727-25
 25,5 cm



KOENIG
CG-825-20
 20 cm



PAYR
CG-828-22
 22 cm



PAYR
CG-829-22
 22 cm



cm	BRUNNER
18	CG-921-18
27	CG-921-27

Plastik
 from plastic material
 matière plastique
 de materia plástica
 in plastica

In Packungen zu 1 Dutzend
in packages of 1 dozen
en enveloppes de 1 douzaine
en sobres de 1 dozana
bustine di 1 dozzina

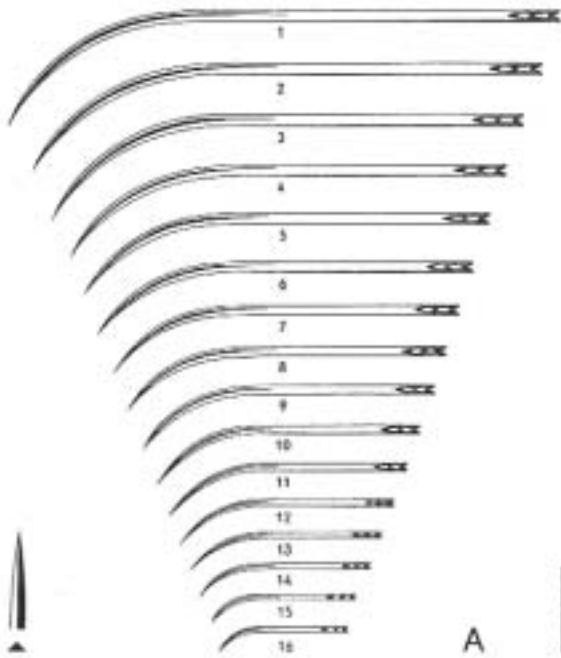

CG-043-01 - CG-043-16

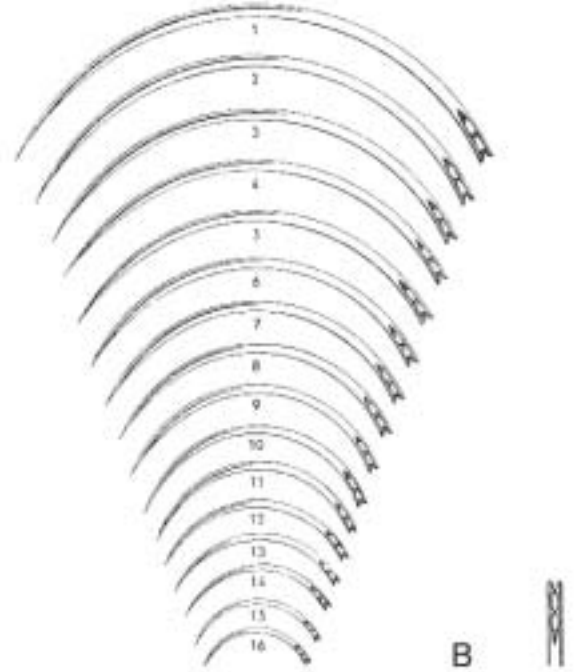

CG-143-01 - CG-143-16

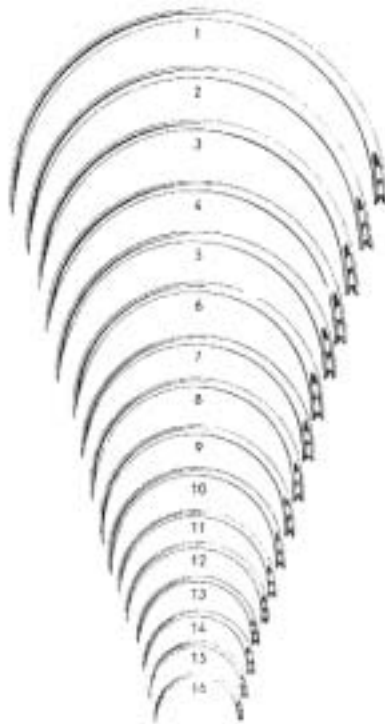

CG-243-01 - CG-243-16

Alle Nadeln mit Federöhr
all the needles with spring eye
toutes les aiguilles à chas à ressort
todas las agujas con ojo de resorte
tutti gli aghi con cruna aperta

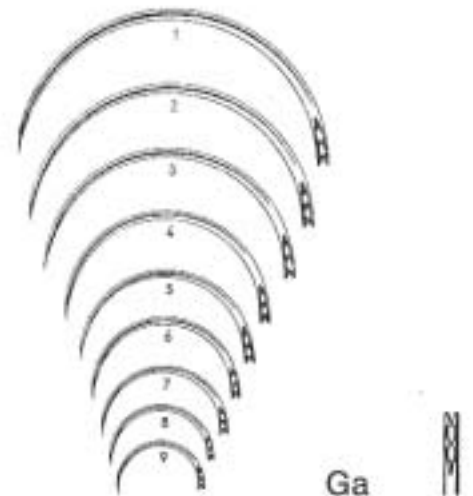

CG-343-01 - CG-343-09

Fig.	1	2	3	4	5	6	7	8	9	10	11	12	13	14	15	16
A	CG-043-01	CG-043-02	CG-043-03	CG-043-04	CG-043-05	CG-043-06	CG-043-07	CG-043-08	CG-043-09	CG-043-10	CG-043-11	CG-043-12	CG-043-13	CG-043-14	CG-043-15	CG-043-16
B	CG-143-01	CG-143-02	CG-143-03	CG-143-04	CG-143-05	CG-143-06	CG-143-07	CG-143-08	CG-143-09	CG-143-10	CG-143-11	CG-143-12	CG-143-13	CG-143-14	CG-143-15	CG-143-16
G	CG-243-01	CG-243-02	CG-243-03	CG-243-04	CG-243-05	CG-243-06	CG-243-07	CG-243-08	CG-243-09	CG-243-10	CG-243-11	CG-243-12	CG-243-13	CG-243-14	CG-243-15	CG-243-16
GA	CG-343-01	CG-343-02	CG-343-03	CG-343-04	CG-343-05	CG-343-06	CG-343-07	CG-343-08	CG-343-09							

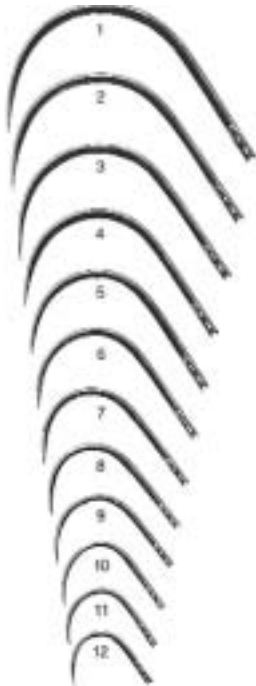

KOENIG
CG-441-01 - CG-441-12



CG-443-30 - CG-443-05

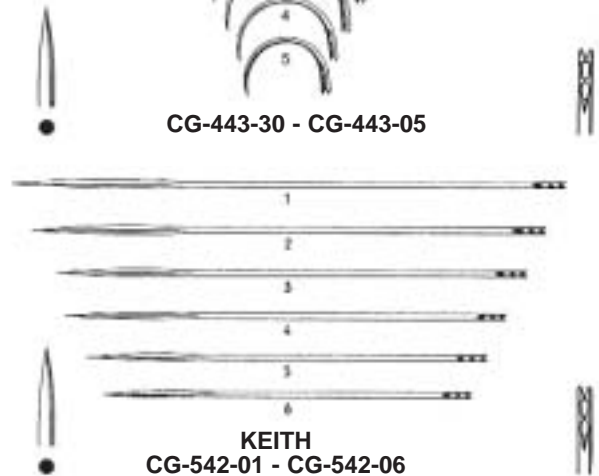

KEITH
CG-542-01 - CG-542-06

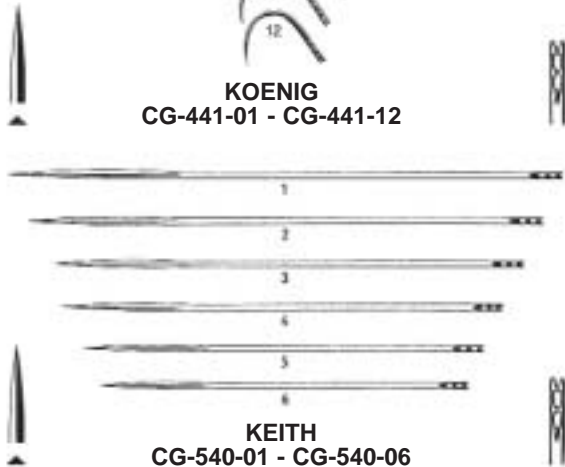

KEITH
CG-540-01 - CG-540-06

Alle Nadeln mit Federöhr
all the needles with spring eye
toutes les aiguilles à chas à ressort
todas las agujas con ojo de resorte
tutti gli aghi con cruna aperta

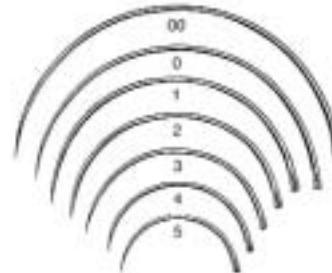

CG-645-20 - CG-647-05 Pb

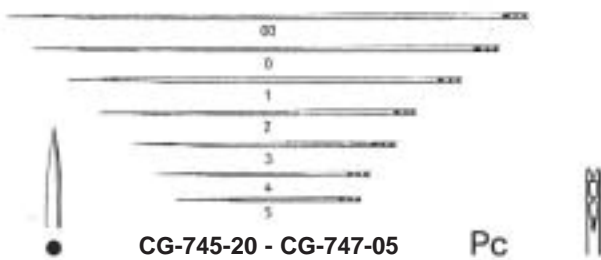

CG-745-20 - CG-747-05 Pc

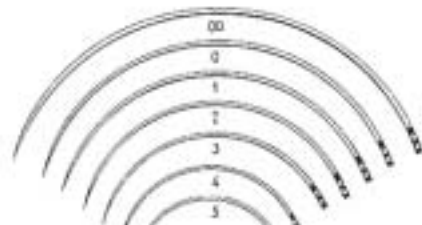

CG-845-20 - CG-847-05 Pd

Fig.	000	00	0	1	2	3	4	5	6	7	8	9	10	11	12
KOENIG				CG-441-01	CG-441-02	CG-441-03	CG-441-04	CG-441-05	CG-441-06	CG-441-07	CG-441-08	CG-441-09	CG-441-10	CG-441-11	CG-441-12
E	CG-443-30	CG-443-20	CG-443-10	CG-443-01	CG-443-02	CG-443-03	CG-443-04	CG-443-05							
KEITH				CG-540-01	CG-540-02	CG-540-03	CG-540-04	CG-540-05	CG-540-06						
KEITH				CG-542-01	CG-542-02	CG-542-03	CG-542-04	CG-542-05	CG-542-06						
Pb		CG-645-20	CG-645-10	CG-647-01	CG-647-02	CG-647-03	CG-647-04	CG-647-05	CG-647-06	CG-647-07	CG-647-08				
Pc		CG-745-20	CG-745-10	CG-747-01	CG-747-02	CG-747-03	CG-747-04	CG-747-05							
Pd		CG-845-20	CG-845-10	CG-847-01	CG-847-02	CG-847-03	CG-847-04	CG-847-05							



MICHEL
CG-160-12
12 cm



WACHENFELDT
CG-162-12
12,5 cm



WACHENFELDT
CG-164-12
12,5 cm



HEGENBARTH
CG-166-12
12,5 cm



CHILDE
CG-260-18
18 cm



MICHEL
CG-360-12
12 cm



MICHEL
CG-361-13
13 cm



COLLIN
CG-460-13
13 cm



RICHTER-HEATH
CG-462-14
14 cm



MICHEL

	mm
CG-660-07	7,5 x 1,75
CG-660-11	11 x 2
CG-660-12	12 x 3
CG-660-14	14 x 3
CG-660-16	16 x 3
CG-660-18	18 x 3
CG-660-20	20 x 3
CG-660-22	22 x 3

CG

Taschen-, Nahtbesteck
Pocket, Suturing Kits
Trousses à poche et à suture
Estuche de bolsillo y de sutura
Astucci tascabili e per sutura



Mini
CG-760-00
130 x 45 x 18 mm



Standard
CG-860-00
165 x 90 x 28 mm

CI

**Sterilisierhilfen
Sterilizing Aids
Instrumente pour Sterilisation
Auxilios para la esterilización
Utensili per las sterilizzazione**



CI

CI

Sterilisationsinstrumente
 Sterilization Instruments
 Instruments à stérilisation
 Instrumentos para esterilización
 Strumenti per la sterilizzazione

Sterilisationsinstrumente
 Sterilization Instruments
 Instruments à stérilisation
 Instrumentos para la esterilización
 Strumenti per la sterilizzazione



cm	DAVIS
16	CI-012-16
20	CI-012-20
24	CI-012-24



CHEATLE
 CI-110-27
 27 cm



Universal		
CI-210-20	20 cm	CI-211-20
CI-210-28	28 cm	CI-211-28



ROGGE
 CI-310-23
 23 cm



cm	
20	CI-410-20
30	CI-410-30



BUNT
 CI-510-12
 12 cm



MAYO
 CI-512-14
 14 cm



SAUERBRUCH
CI-610-55
55 cm



CM-Instrumente
CI-710-58
58 cm



- CI-135-13** 215x 60x13 mm
- CI-135-15** 215x 65x15 mm
- CI-135-20** 215x 95x20 mm
- CI-135-25** 215x 95x25 mm
- CI-135-28** 215x100x28 mm

CI-135-00
 Satz mit 5 Bürsten CI-135-13 - CI-135-28
 set of 5 brushes CI-135-13 - CI-135-28
 jeu de 5 brosses CI-135-13 - CI-135-28
 juego de 5 cepillos CI-135-13 - CI-135-28
 set a 5 spazzole CI-135-13 - CI-135-28



- CI-138-12** 275x65x12mm
- CI-138-15** 275x80x15mm
- CI-138-30** 300x120x30mm
- CI-138-50** 320x130x50mm
- CI-234-35** 360x140x35mm
- CI-236-40** 420x180x40mm
- CI-237-60** 500x180x60mm



CI-333-80
490x180x80 mm



CI-335-60
450x180x60 mm



CI-430-75
420x130x75 mm



CI-531-50
330x130x50 mm

konisch
conical
conical
conique
cónico
conico

konisch
conical
conical
conique
cónico
conico

konisch
conical
conical
conique
cónico
conico

konisch
conical
conical
conique
cónico
conico



CI-536-15
400x190x8/20 mm



CI-539-18
300x110x18/33 mm



CI-631-15
320x70x15/25 mm



CI-635-08
420x60x8/15 mm



CI-637-15
1000x180x16 mm



CI-730-95
210x95 mm

DA

**Gipsverband
Plaster of Paris
Bandages plâtrés
Vendajes enyesados
Bendaggi gessati**



DA

DA

Gipsverband
Plaster of Paris
Appareils plâtrés
Vendajes enyesados
Bendaggi gessati

Gipsscheren
Plaster Shears
Ciseaux pour plâtre
Cizallas para yeso
Forbici per gesso



STILLE
DA-011-24
24 cm



cm	STILLE
18,0	DA-013-18
20,0	DA-013-20
23,0	DA-013-23
26,0	DA-013-26
37,0	DA-013-37



SEUTIN
DA-014-23
23 cm



WIGMORE
DA-210-19
19 cm

Gipssägen
Plaster Saws
Scies pour plâtre
Sierra para yeso
Seghe per gesso



ENGEL
DA-310-14



BERGMANN
DA-314-18

Gipsspreizer
Plaster Spreaders
Pince pour plâtre
Separadores para yeso
Pinze per gesso



HENNIG
DA-530-28
28 cm



HERMANN
DA-530-48
48 cm



QUATTRO
DA-532-23
23 cm



BEESON
DA-630-30
30 cm



HAGLUND-STILLE
DA-632-28
28 cm



DA-636-23
23 cm

Gipsmesser
Plaster Knives
Couteaux pour plâtre
Cuchillos para yeso
Coltelli per gesso



HOPKINS
DA-730-20
20 cm



ESMARCH
DA-830-18
18 cm



REINER
DA-930-19
18 cm



DA-930-21
21 cm

Gipsabreißzangen
Plaster Breakers
Pince pour rompre plâtre
Pinzas para romper yeso
Pinze per rompere gesso



WOLFF
DA-935-18
18 cm



WOLFF
DA-937-24
24 cm

Oszillierende Gipssäge
Oscillating Plaster Saw
Scie oscillante
Sierra oscillante
Sega oscillante

DA



DA-120-21
110 Volt

DA-120-22
230 Volt

komplett mit 2 Sägeblättern und 2 Schraubenschlüsseln
complete with 2 saw blades and 2 wrenches
complet avec 2 lames de scie et clé à écrou
completo con 2 hojas de sierra y 2 llaves de tuercas
completa con lame e 2 chiavi



DA-122-02

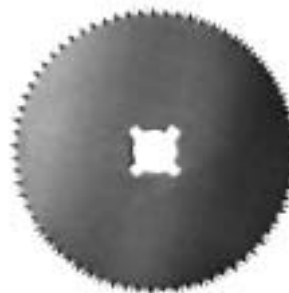

		Typ
50 mm Ø	DA-120-50	normal
65 mm Ø	DA-120-65	normal

DA

Oszillierende Gipssäge
Oscillating Plaster Saw
Scie oscillante
Sierra oscillante
Sega oscillante

Stufenlos regelbar
Fully adjustable
Réglable sans arrêt
Regulare con progresión
Regolabile con processione continua



DA-020-10
110 Volt

DA-020-20
230 Volt

komplett mit 2 Sägeblättern DA-120-50, DA-120-65 und 2 Schraubenschlüsseln DA-120-02
complete with 2 saw blades DA-120-50, DA-120-65 and 2 wrenches DA-120-02
complet avec 2 lames de scie DA-120-50, DA-120-65 et clé à écrou DA-120-02
completo con 2 hojas de sierra DA-120-50, DA-120-65 y 2 llaves de tuercas DA-120-02
completa con 2 lame DA-120-50, DA-120-65 e 2 chiavi DA-120-02



DA-120-02

Kreissägeblätter
Circular saw blades
Lames de scie circulaires
Hojas de sierra circular
Lame circolari per fasciature



		Typ
45 mm Ø	DA-120-45	normal
50 mm Ø	DA-120-50	normal
65 mm Ø	DA-120-65	normal
45 mm Ø	DA-121-45	hart
50 mm Ø	DA-121-50	hart
65 mm Ø	DA-121-65	hart
45 mm Ø	DA-122-45	Teflon
50 mm Ø	DA-122-50	Teflon
65 mm Ø	DA-122-65	Teflon

DC

**Orthopädie, Osteosynthese
Bone Surgery, Osteosynthesis
Chirurgie osseuse, Ostéosynthèse
Cirugía ósea, Osteosíntesis
Chirurgia ossea, Osteosintesi**



DC

DC

Hohlmeißelzangen
Bone Rongeurs
Pincas-gouges
Pinzas-gubias
Pinze sgorbie



FRIEDMAN Mini
DC-011-12
12 cm



FRIEDMAN
DC-011-14
14 cm



CLEVELAND
DC-015-17
17 cm Fig. 4 A



MEAD
DC-017-16
16 cm Fig. 1 A



FRIEDMAN
DC-012-14
14 cm



FRIEDMAN
DC-012-15
15 cm

CLEVELAND
DC-013-14
14 cm Fig. 4



MEAD
DC-019-16
16,5 cm



BLUMENTHAL
DC-115-15
15,5 cm



BLUMENTHAL
DC-117-15
15,5 cm



BLUMENTHAL
DC-119-15
15,5 cm



LUER
DC-311-15
 15 cm



LUER
DC-313-15
 15 cm



LUER
DC-316-17 17 cm **DC-317-17**



ADSON
DC-412-20 20 cm **DC-413-20**



OLIVECRONA
DC-417-20
 20 cm



LEMPERT
DC-510-16 16 cm **DC-511-16**



LEMPERT
DC-514-18 18,5 cm **DC-515-18**

DC

Hohlmeißelzangen
Bone Rongeurs
Pinces-gouges
Pinzas-gubias
Pinze sgorbie



BEYER
DC-021-18
18 cm



ZAUFAL-JANSEN
DC-025-18
18 cm



BÖHLER
DC-120-15 15 cm/2 mm DC-121-15
DC-122-15 15 cm/3 mm DC-123-15



RUSKIN
DC-126-18 18 cm DC-127-18



RUSKIN
DC-128-23 23 cm DC-129-23



STILLE-LUER
22 cm DC-321-22
DC-320-26 26 cm DC-321-26



STILLE-LUER
DC-325-23
23 cm



STILLE-RUSKIN
DC-327-23
 23 cm

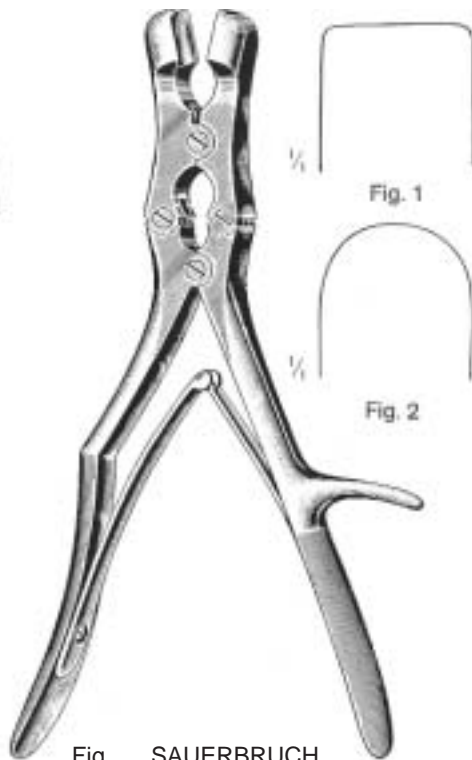

Fig. SAUERBRUCH
 1 **DC-421-30**
 2 **DC-423-30**
 30 cm



Fig. LEKSELL (STILLE)
 1 **DC-425-23** 8 mm
 2 **DC-427-23** 4 mm
 23 cm



R SCAGLIETTI L
DC-521-26 26 cm **DC-523-26**
 à droite à gauche
 derecha izquierda
 a destra a sinistra



FRYKHOLM
DC-525-24
 24 cm



mm ECHLIN
 2 **DC-529-02**
 3 **DC-529-03**
 4 **DC-529-23**
 23 cm

DC

Knochensplitterzangen
Bone Cutting Forceps
Pincès coupantes à os
Pinzas cortantes para huesos
Cesoie per ossa



cm	SEMB
22,5	DC-621-22
27,0	DC-621-27



LISTON

DC-724-14	14 cm	DC-725-14
DC-724-17	17 cm	DC-725-17
DC-724-19	19 cm	DC-725-19
DC-724-22	22 cm	DC-725-22



BÖHLER

DC-820-15	15 cm	DC-821-15
-----------	-------	-----------



COTTLE-KAZANJIAN
DC-822-19
19 cm



RUSKIN-LISTON

DC-826-18	18,5 cm	DC-829-18
-----------	---------	-----------



STILLE-LISTON

DC-920-27	27 cm	DC-921-27
-----------	-------	-----------

Knochensplitterzangen
 Bone Cutting Forceps
 Pinces coupantes à os
 Pinzas cortantes para huesos
 Cesioie per ossa

DC



STILLE-HORSLEY
DC-923-27
 27 cm

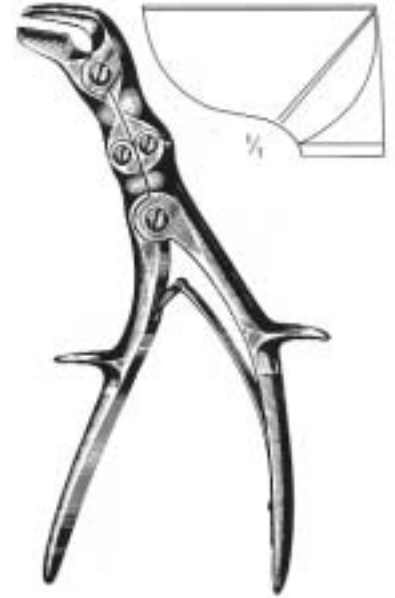

SEMB
DC-925-24
 24 cm

Knochenhalte­zangen
 Bone Holding Forceps
 Daviers porte-os
 Pinzas para huesos
 Tenaglie per ossa



FERGUSSON
DC-630-21
 21 cm



LANGENBECK
DC-632-21
 21 cm



SEMB
DC-635-19
 19 cm



cm	FARABEUF
23	DC-636-23
26	DC-636-26

DC

Knochenhalte­zangen
Bone Holding Forceps
Daviers porte os
Pinzas para huesos
Tenaglie per ossa



FARABEUF-LAMBOTTE
DC-638-26
26 cm



cm	LAMBOTTE
22	DC-730-22
27	DC-730-27
30	DC-730-30



cm	LAMBOTTE
22	DC-732-22
26	DC-732-26
33	DC-732-33



cm	LAMBOTTE
19	DC-733-19
23	DC-733-23
26	DC-733-26



cm	KERN	KERN
15	DC-738-15	DC-830-15
17	DC-738-17	DC-830-17
21	DC-738-21	DC-830-21



cm	LANE
33	DC-832-33
45	DC-832-45



cm	LANE
33	DC-834-33
45	DC-834-45



Selbstzentrierend
 self-centering
 autocentrant
 autocentrantes
 autocentranti



DC-931-15
 15 cm



DC-931-19
 19 cm



DC-931-24
 24 cm



DC-931-26
 26 cm



DC-931-28
 28 cm

DC-931-15 - DC-931-28



DC-935-17
 17,5 cm

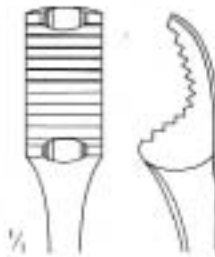

DC-935-25
 25 cm

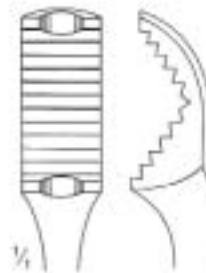

DC-935-26
 26 cm

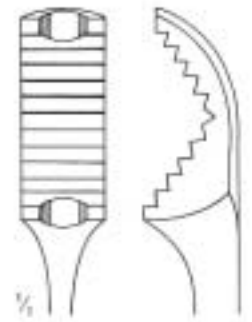

DC-935-27
 27 cm

VERBRUGGE
DC-935-17 - DC-935-27

DC

Knochenhalte-, Sequesterzangen
Bone Holding, Sequester Forceps
Pinces à os, à séquestres
Pinzas para huesos y secuestros
Pinze per ossa e sequestri



LEWIN
DC-042-17
17,5 cm

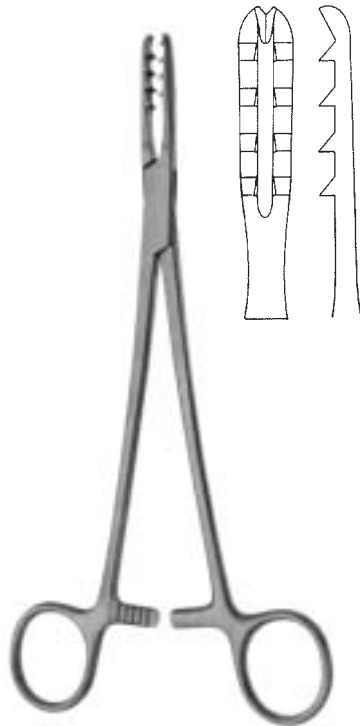

BIRCHER-GANSKE
DC-044-20 20 cm DC-045-20



DINGMANN
DC-047-19
19 cm



DC-049-13
13,5 cm



MARTIN
DC-140-19
19 cm

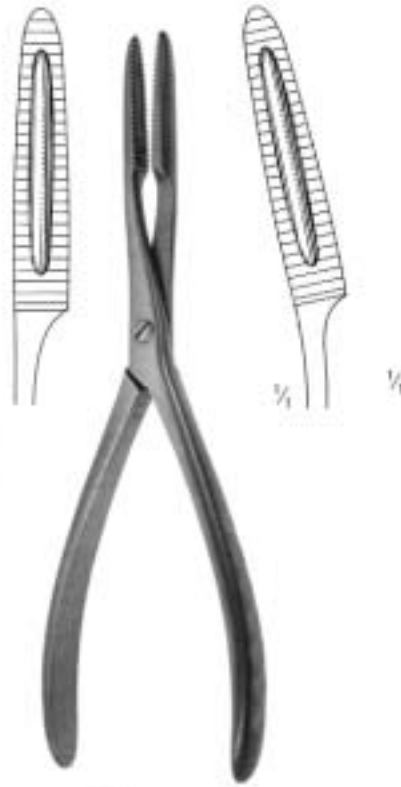

DC-240-20 20 cm DC-241-20



VAN BUREN
DC-243-23
23 cm



cm	LOWMAN
13	DC-441-13
18,5	DC-441-18
20	DC-441-20

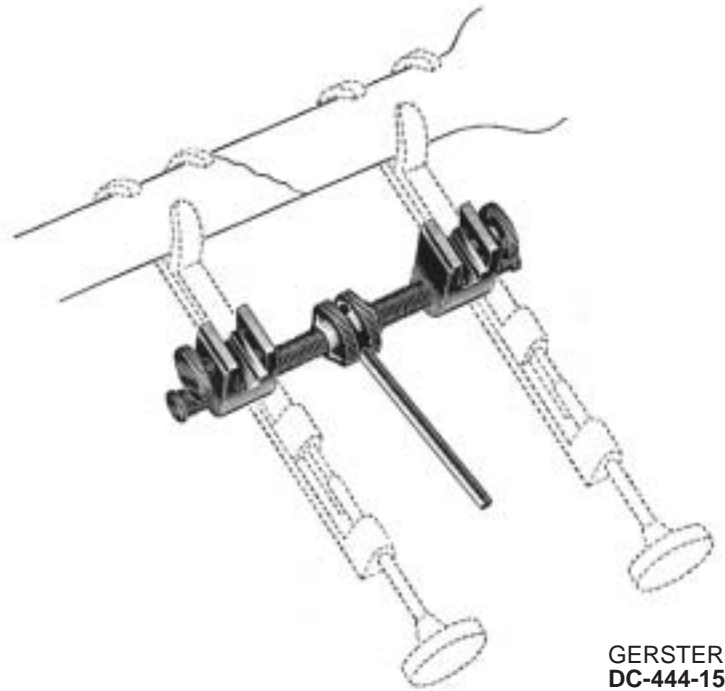

GERSTER
 DC-444-15



PARHAM
 DC-446-24



cm	PARHAM
18	DC-448-18
30	DC-448-30



DC-540-01 f. Erwachsene
 adult size
 p. adultes
 p. adultos
 p. adulti

DC-540-02 f. Kinder
 child size
 p. enfants
 p. niños
 p. bambini

DC

Scharfe Löffel
Bone Currettes
Curettes à os
Cucharillas cortantes
Curette taglienti



SCHÉDE
DC-647-97 - DC-648-04

SCHÉDE	Fig.	VOLKMANN
	0000	DC-649-96
DC-647-97	000	DC-649-97
DC-647-98	00	DC-649-98
DC-648-00	0	DC-740-00
DC-648-01	1	DC-740-01
DC-648-02	2	DC-740-02
DC-648-03	3	DC-740-03
DC-648-04	4	DC-740-04
	5	DC-740-05
	6	DC-740-06



VOLKMANN
DC-649-96 - DC-740-06



BRUNS
DC-741-96 - DC-742-06

BRUNS	Fig.	SPRATT
DC-741-96	0000	DC-744-96
DC-741-97	000	DC-744-97
DC-741-98	00	DC-744-98
DC-742-00	0	DC-745-00
DC-742-01	1	DC-745-01
DC-742-02	2	DC-745-02
DC-742-03	3	DC-745-03
DC-742-04	4	DC-745-04
DC-742-05	5	DC-745-05
DC-742-06	6	



SPRATT
DC-744-97 - DC-745-05



Fig.	HALLE 23 cm	SIMON 24 cm
000	DC-840-97	
00	DC-840-98	
0	DC-841-00	
1	DC-841-01	DC-845-01
2	DC-841-02	DC-845-02
3	DC-841-03	DC-845-03
4	DC-841-04	DC-845-04
5	DC-841-05	DC-845-05
6	DC-841-06	DC-845-06

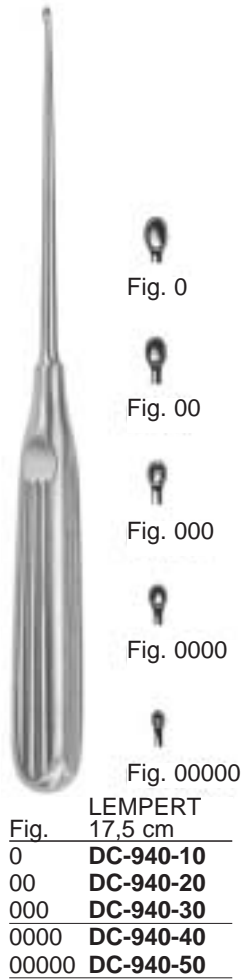

Fig.	LEMPERT 17,5 cm
0	DC-940-10
00	DC-940-20
000	DC-940-30
0000	DC-940-40
00000	DC-940-50

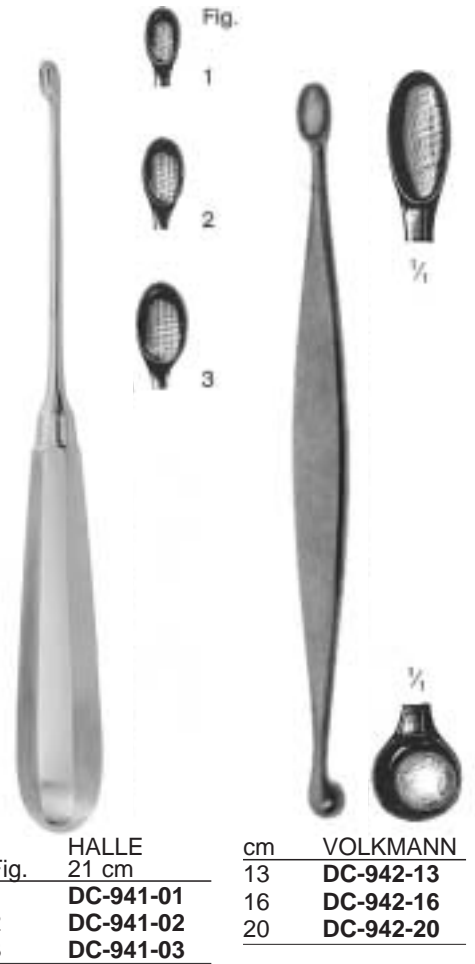

Fig.	HALLE 21 cm	cm	VOLKMANN
1	DC-941-01	13	DC-942-13
2	DC-941-02	16	DC-942-16
3	DC-941-03	20	DC-942-20



cm	VOLKMANN
13	DC-944-13
14	DC-944-14
17	DC-944-17

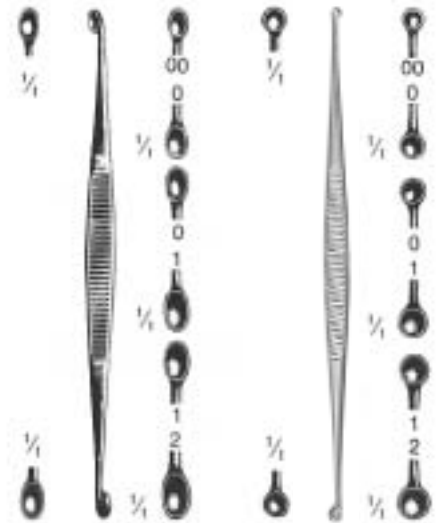

Fig.	WILLIGER 13,5 cm	MARTINI 13,5 cm
00/0	DC-946-00	DC-948-00
0/1	DC-946-01	DC-948-01
1/2	DC-946-12	DC-948-12

DC

Knochenmeißel
 Bone Chisels and Gouges
 Ciseaux-burins, gouges
 Cinceles, gubias
 Scalpelli, sgorbie



mm	13,5 cm	13,5 cm	13,5 cm	ALEXANDER 17 cm	ALEXANDER 17 cm
4	DC-062-04	DC-064-04	DC-065-04	DC-160-04	DC-161-04
6		DC-064-06		DC-160-06	DC-161-06
8	DC-062-08	DC-064-08	DC-065-08	DC-160-08	DC-161-08
10	DC-062-10	DC-064-10	DC-065-10	DC-160-10	DC-161-10
12	DC-062-12	DC-064-12	DC-065-12	DC-160-12	DC-161-12
14	DC-062-14	DC-064-14	DC-065-14	DC-160-14	DC-161-14
16	DC-062-16	DC-064-16	DC-065-16	DC-160-16	DC-161-16



mm	PARTSCH		PARTSCH	
	13,5 cm	17 cm	13,5 cm	17 cm
2	DC-260-02	DC-262-02	DC-263-02	DC-265-02
3	DC-260-03	DC-262-03	DC-263-03	DC-265-03
4	DC-260-04	DC-262-04	DC-263-04	DC-265-04
5	DC-260-05	DC-262-05	DC-263-05	DC-265-05
6	DC-260-06	DC-262-06	DC-263-06	DC-265-06
7	DC-260-07	DC-262-07	DC-263-07	DC-265-07
8	DC-260-08	DC-262-08	DC-263-08	DC-265-08

mm	STILLE		
	13,5 cm	17 cm	13,5 cm
10	DC-360-10	DC-362-10	DC-363-10
15	DC-360-15	DC-362-15	DC-363-15
20	DC-360-20	DC-362-20	DC-363-20
25	DC-360-25	DC-362-25	DC-363-25



mm	SMITH-PETERSEN				mm	LAMBOTTE		LAMBOTTE mini	
6	DC-364-06	DC-365-06	DC-367-06	DC-369-06	6,5	DC-560-06	DC-561-06	3	DC-564-03
9	DC-364-09	DC-365-09	DC-367-09	DC-369-09	15,0	DC-560-15	DC-561-15	4	DC-564-04
13	DC-364-13	DC-365-13	DC-367-13	DC-369-13	20,0	DC-560-20	DC-561-20	6	DC-564-06
16	DC-364-16	DC-365-16	DC-367-16	DC-369-16	25,0	DC-560-25	DC-561-25	8	DC-564-08
19	DC-364-19	DC-365-19	DC-367-19	DC-369-19	30,0	DC-560-30	DC-561-30	10	DC-564-10
25	DC-364-25	DC-365-25	DC-367-25	DC-369-25	38,0	DC-560-38	DC-561-38	12	DC-564-12
32	DC-364-32	DC-365-32	DC-367-32	DC-369-32	44,0	DC-560-44	DC-561-44	15	DC-564-15
	20 cm	20 cm	20 cm	20 cm		24 cm	23 cm		12,5 cm

DC

Knochenmeißel
 Bone Chisels and Gouges
 Ciseaux-burins, gouges
 Cinceles, gubias
 Scalpelli, sgorbie



mm	LEXER	LEXER
7	DC-660-07	DC-661-07
10	DC-660-10	DC-661-10
15	DC-660-15	DC-661-15
20	DC-660-20	DC-661-20
25	DC-660-25	DC-661-25
30	DC-660-30	DC-661-30
	22 cm	22 cm



mm	LEXER mini	LEXER mini
4	DC-664-04	DC-665-04
6	DC-664-06	DC-665-06
8	DC-664-08	DC-665-08
10	DC-664-10	DC-665-10
12	DC-664-12	DC-665-12



mm	HOKE
3	DC-668-03
5	DC-668-05
6	DC-668-06
8	DC-668-08
9	DC-668-09
	17 cm

mm	HIBBS					
6	DC-760-06	DC-762-06	DC-761-06	DC-763-06	DC-765-06	
13	DC-760-13	DC-762-13	DC-761-13	DC-763-13	DC-765-13	
19	DC-760-19	DC-762-19	DC-761-19	DC-763-19	DC-765-19	
25	DC-760-25	DC-762-25	DC-761-25	DC-763-25	DC-765-25	
32	DC-760-32	DC-762-32	DC-761-32	DC-763-32	DC-765-32	
	24 cm	24 cm	24 cm	24 cm	24 cm	



LEBSCHE
DC-768-24
24,5 cm



DC-769-22
22 cm



VIRCHOW
DC-860-12



BURNETTI
DC-861-28
28 cm



BURNETTI
DC-863-28
28 cm

Autopsie-Besteck
Post Mortem Set
Set à autopsie
Juego de autopsía
Set per autopsia



DC-864-00



GERZOG
DC-866-25
18 cm 250 g



KIRK
DC-868-75
19 cm 750 g



g
450 DC-960-45
900 DC-960-90
26,5 cm



COLLIN
DC-962-22
20 cm 220 g



WILLIGER
DC-964-34
24 cm 340 g

DC-967-02
Paar Ersatzbacken
Pair of Spare Faces
Paire de faces de rechange
Pareja de tapas intercambiables
Coppia di teste di ricambio



LUCAE
DC-966-26
19 cm 260 g



MEAD
DC-966-32
17 cm 320 g



g
250 DC-968-25
400 DC-968-40
26 cm



QUISLING
DC-968-75



DC-969-00
23,5 cm



FARABEU
DC-072-15
 15 cm

FARABEU
DC-073-15
 15 cm

mm	LAMBOTTE
10	DC-075-10
15	DC-075-15
20	DC-075-20
25	DC-075-25
	21 cm



SEDILLOT
DC-079-21
 21 cm

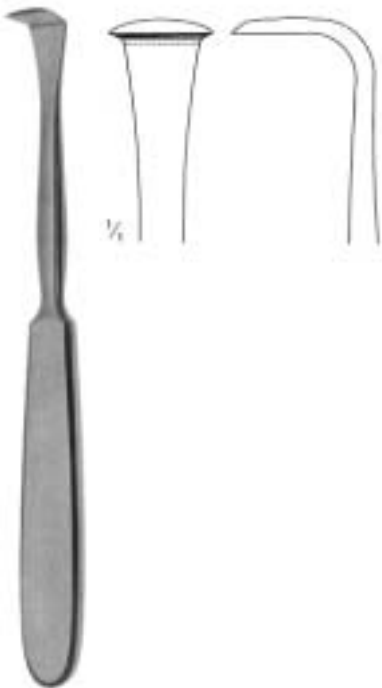

LANGENBECK
DC-171-18
 18 cm



WILLIGER
DC-173-16
 16 cm



cm	ALEXANDER
16	DC-175-16
20	DC-175-20

DC

Raspatorien
Periosteal Elevators
Rugines-raspatoires
Periostótomos
Periostotomi

Für Rippen
Rib
Pour les côtes
Para costillas
Costali



DOYEN DOYEN
DC-271-17 - DC-277-17
17 cm

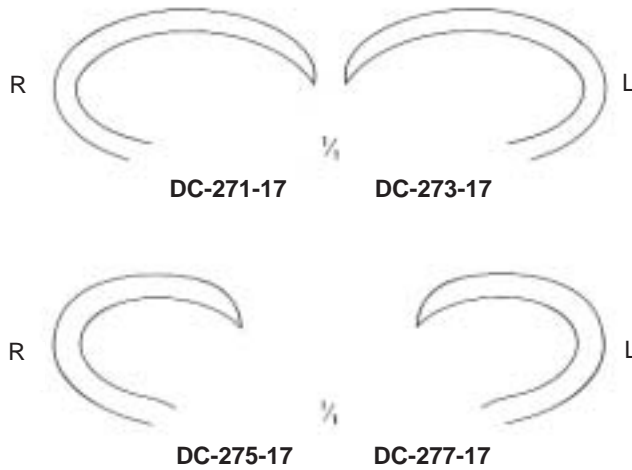

DC-279-01
17,5 cm



DC-279-02
21 cm



DC-279-03
17,5 cm



DC-279-04
21 cm



DC-279-05
20,5 cm



DC-279-06
20,5 cm



DC-279-07
22,5 cm

SEMB
DC-279-01 -
DC-297-07



**MATSON
DC-373-22**
22 cm



**OVERHOLT
DC-375-29**
29,5 cm



**OVERHOLT
DC-377-29**
29,5 cm



**OVERHOLT
DC-379-28**
28,5 cm



**LANGENBECK
DC-571-20**
20 cm



**LANGENBECK
DC-573-20**
20 cm



**ADSON
DC-574-17 -
DC-577-17**
17 cm



DC-574-17



DC-575-17



DC-576-17



DC-577-17



**KEY
DC-579-06 -
DC-579-25**
19 cm



mm	
6	DC-579-06
12	DC-579-12
19	DC-579-19
25	DC-579-25

DC

Elevatorii, Knochenhebel
Elevators, Bone Levers
Elévateurs, Leviers à os
Elevadores, E, para huesos
Elevatori, Elevatori per ossa



WATSON-CHEYNE
DC-675-17
17,5 cm



McDONALD
DC-677-19
19 cm



MURPHY-LANE
DC-679-30
30 cm



BENNETT
DC-771-71
65 x 260 mm



BENNETT
DC-771-73
45 x 260 mm



HOHMANN
DC-081-08
8 mm

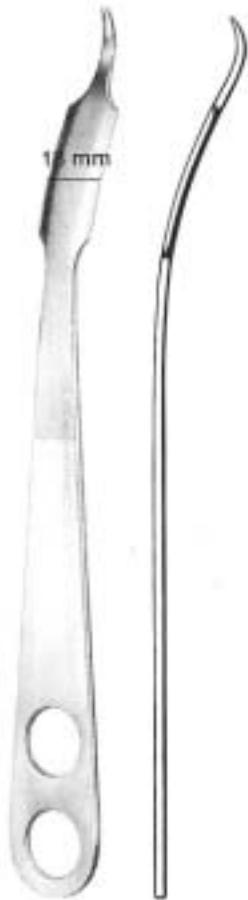

HOHMANN
DC-081-18
18 mm



HOHMANN
DC-081-43
43 mm



HOHMANN
DC-081-70
70 mm

Knochenhebel
 Bone Levers
 Leviers à os
 Elevadores para huesos
 Elevatori per ossa

DC

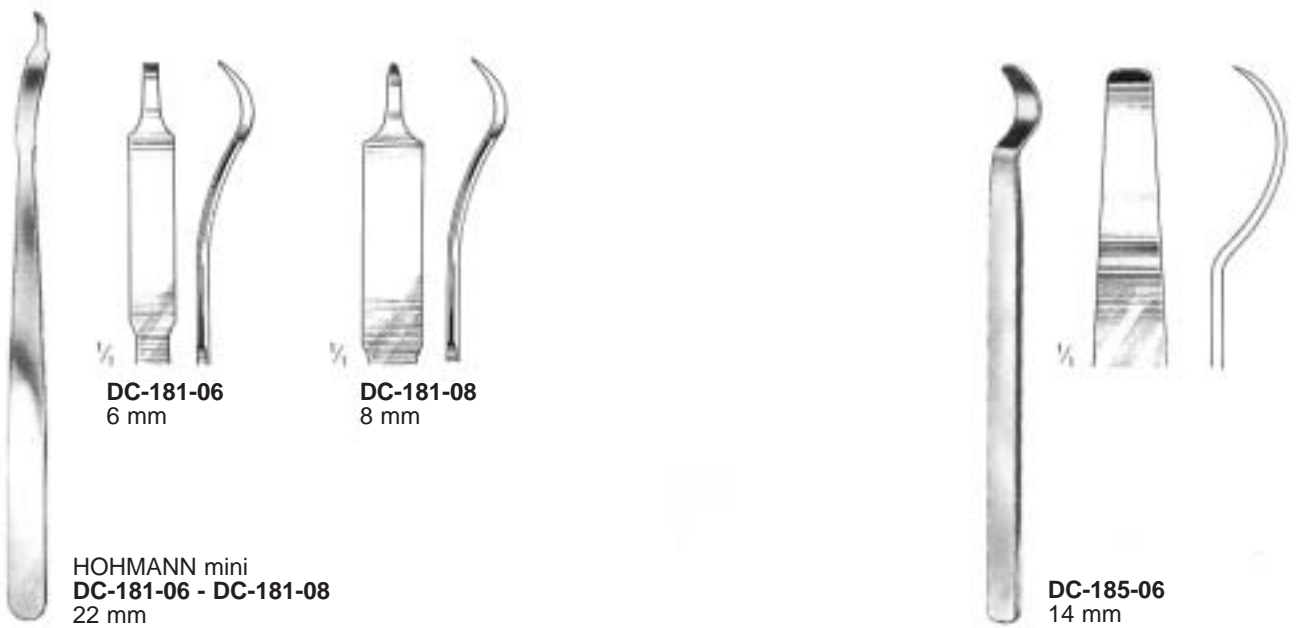
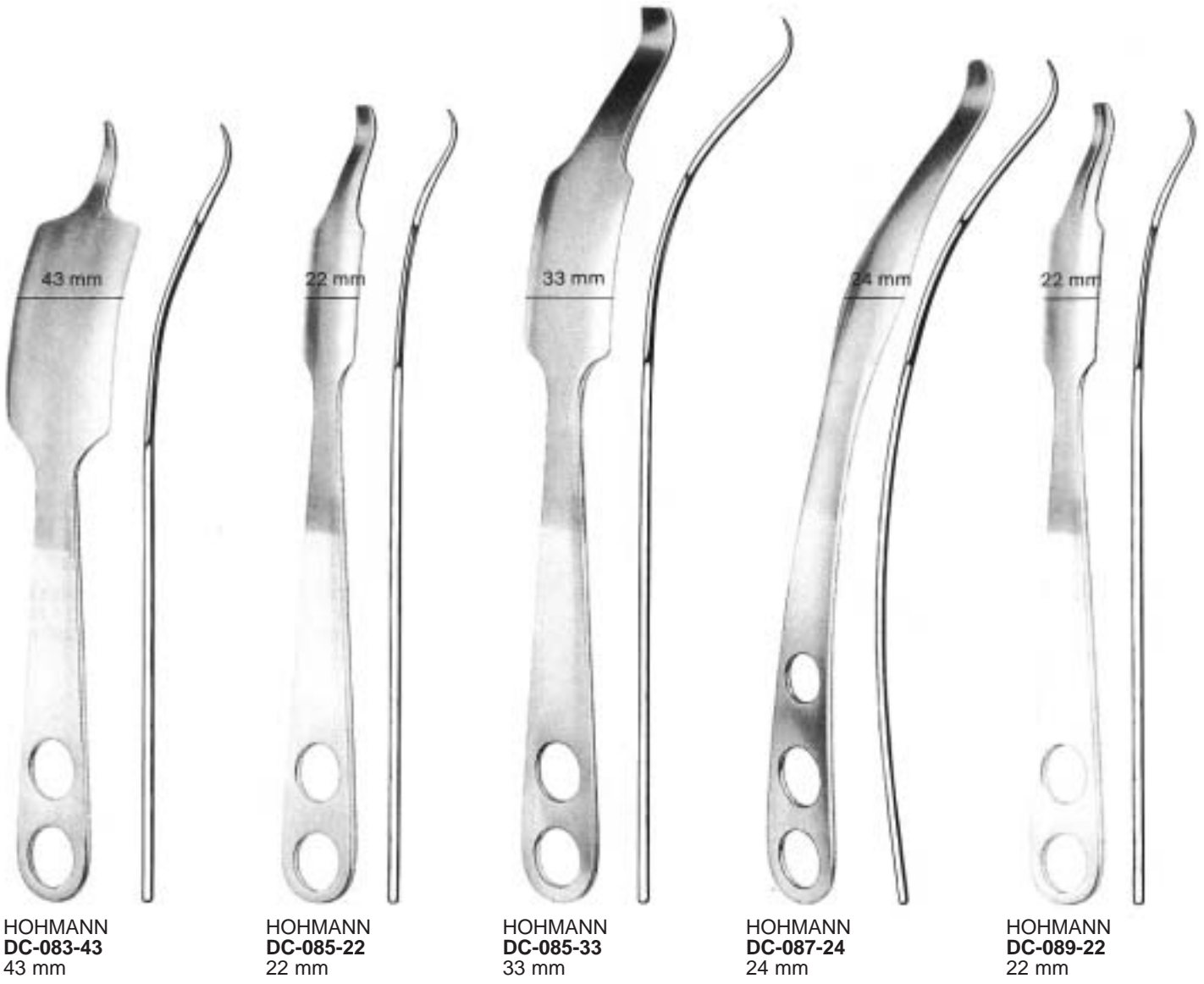

Knochenhebel
 Bone Levers
 Leviers à os
 Elevadores para huesos
 Elevatori per ossa



**BLOUNT
 DC-283-26**
 26 mm



**BLOUNT
 DC-285-26**
 26 mm

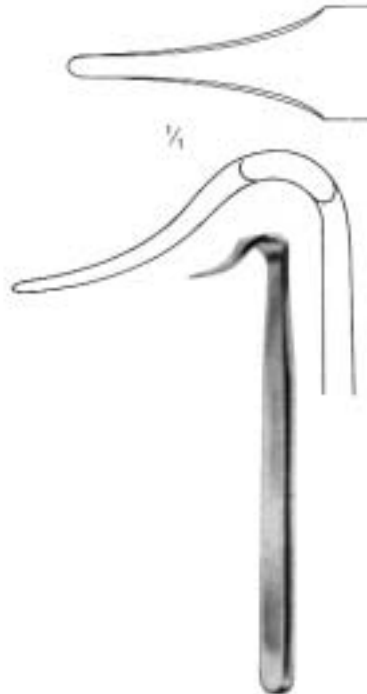

**BLOUNT
 DC-287-17**
 17,5 mm



mm x mm	TAYLOR
75 x 30	DC-381-16
100 x 30	DC-383-16
	16,5 cm

Meniskotome • Meniscotomes
 Meniscotomes • Meniscótomos
 Meniscotomi



**SMILLIE
 DC-190-17**
 17 mm



DC-191-17
 17 mm



DC-193-17
 17 mm



**BIRCHER
 DC-195-19**
 19 mm



**BIRCHER
 DC-197-19**
 19 mm



NEFF
DC-291-22 22 cm **DC-293-22**

Sehnenstripper, Knochenfeilen
Tendon Strippers, Bone Files
Instruments a écorcher les tendons, limes à os
Separadores para tendones, limas para huesos
Scollatendini, lime per ossa



- 
DC-590-01
- 
DC-590-02
- 
DC-590-03
- 
DC-590-04
- 
DC-590-05

BUNNELL
DC-590-01 - DC-590-05
15 mm



DC-791-24
24,5 mm



DC-792-22
22 mm



PUTTI
DC-793-27
27 mm



PUTTI
DC-795-30
30 mm

DD

**Orthopädie, Osteosynthese
Bone Surgery, Osteosynthesis
Chirurgie osseuse, Ostéosynthèse
Cirugía òsea, Osteosíntesis
Chirurgia ossea, Osteosintesi**



DD

DD

Komprimeter
Comprimeter
Comprimètre
Torniquete
Apparecchio per vuoto di sangue

Komprimeter zur Erzeugung von Blutleere in den Gliedern
Compression Apparatus for producing blood vacuum in limbs
Appareil compressif permettant d'obtenir un milieu exsangue des membres
Aparato de compresión para producir el vacío de sangre en los miembros
Vacumetro per determinare vuoti di sangue nelle membra



DD-011-01
compl.

Amputation, Finger
 Amputation, Fingers
 Amputation, doigts
 Amputación, dedos
 Amputazione, dita

DD

mm
 12 **DD-112-12**
 15 **DD-112-15**
 18 **DD-112-18**



PERCY
DD-110-00



CHARRIERE
DD-112-00

DD-116-99



CHARRIERE
DD-116-30
 30 cm

DD-118-99



SATTERLEE
DD-118-31
 31 cm



LANGENBECK
DD-210-23
 23 cm



DD-610-01



DD-610-00
 Compl. incl.
DD-610-01

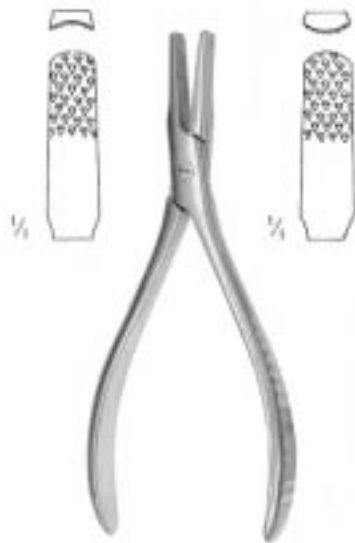

RADOLF
DD-612-13
 13,5 cm

DD-713-01



DD-713-00
 17 cm

DD-715-01









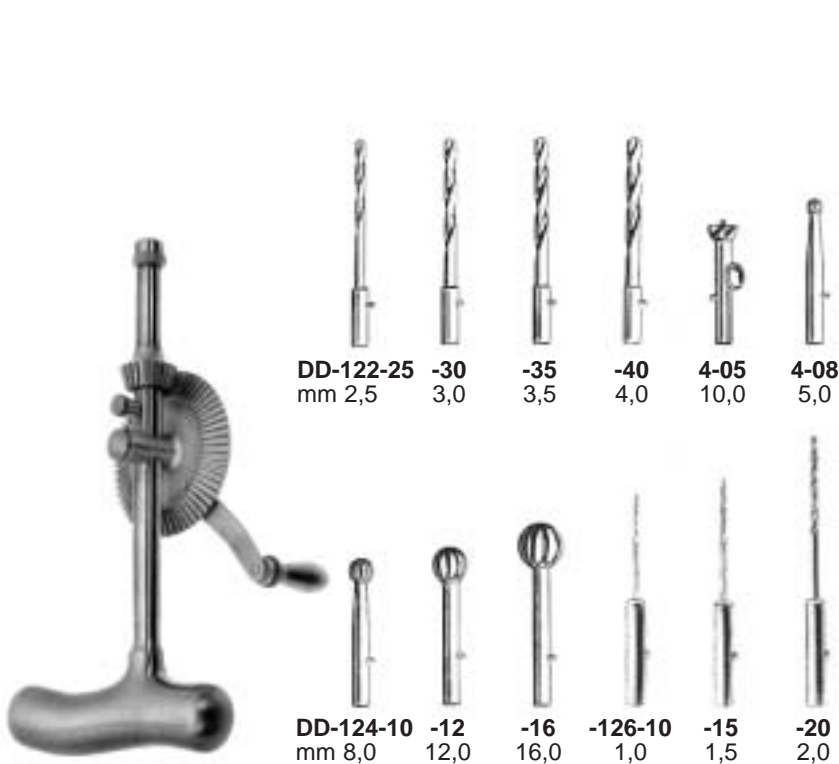





DD-715-00

DD

Handbohrapparate
 Bone Hand Drills
 Perforateurs à main
 Perforadores a mano
 Perforatori a mano





- 
DD-122-25
 mm 2,5
- 
-30
 3,0
- 
-35
 3,5
- 
-40
 4,0
- 
4-05
 10,0
- 
4-08
 5,0

- 
DD-124-10
 mm 8,0
- 
-12
 12,0
- 
-16
 16,0
- 
-126-10
 1,0
- 
-15
 1,5
- 
-20
 2,0

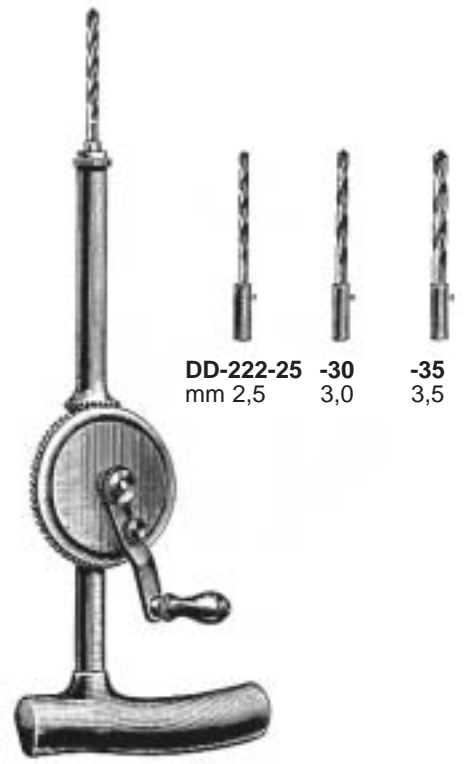
STILLE
DD-120-20
 Compl. 20 cm



- 
DD-222-25
 mm 2,5
- 
-30
 3,0
- 
-35
 3,5

STILLE-SHERMAN
DD-220-24
 Compl. 24 cm

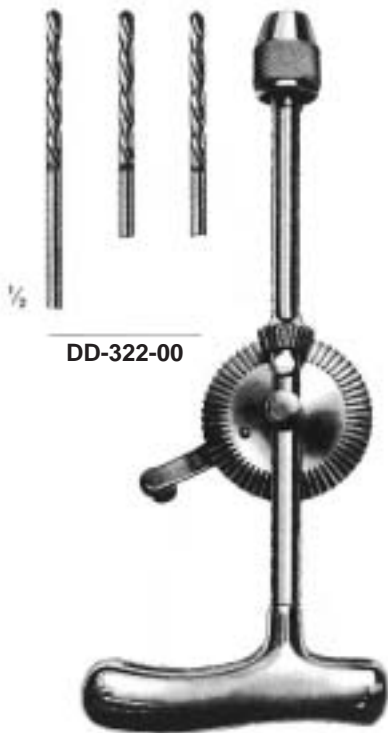

DD-322-00

MOORE
DD-320-28
 Compl. 28 cm



- 
DD-422-09
 9 mm
- 
DD-422-14
 14 mm
- 
DD-422-16
 16 mm
- 
DD-422-22
 22 mm

- 
CUSHING
DD-424-14
- 
DD-426-00
- 
McKINZIE
DD-428-00

HUDSON
DD-420-27
 Compl. incl. DD-422-09, -14, -16, -22, DD-426-00
 27 cm



KIRSCHNER
DD-520-00
Compl.



DD-522-00



DD-620-00
Compl.



DD-622-00



BUNNELL
DD-720-00
16 cm



RALK
DD-820-00

DD

Bohrapparate
Bone Drills
Perforateurs à os
Perforadores para huesos
Perforatori per ossa



Handbohrapparat
Bone Hand Drill
Perforateur à main
Perforador a mano
Perforatore a mano

DD-920-00



DD-926-00

Bohrer, Fräser, Trephinen
 Burrs, Drills, Trephines
 Mèches, fraises, trépan
 Taladros, fresas, trefinas
 Trapani, frese, trefine

DD



mm			
1,0		DD-532-10	DD-534-10
1,2		DD-532-12	
1,5		DD-532-15	DD-534-15
1,8		DD-532-18	
2,0	DD-530-20	DD-532-20	DD-534-20
2,2		DD-532-22	
2,5	DD-530-25	DD-532-25	DD-534-25
2,8		DD-532-28	DD-534-28
3,0	DD-530-30	DD-532-30	DD-534-30
3,2	DD-530-32	DD-532-32	DD-534-32
3,5	DD-530-35	DD-532-35	DD-534-35
4,0	DD-530-40	DD-532-40	DD-534-40
5,0	DD-530-50	DD-532-50	DD-534-50
6,0	DD-530-60		DD-534-60
7,0	DD-530-70		



mm Ø	DOYEN	DOYEN	DOYEN	DOYEN	ALBEE	ALBEE	BORCHARDT	TOTI
4	DD-632-04	DD-634-04						
6	DD-632-06	DD-634-06						
7							DD-734-07	
8	DD-632-08	DD-634-08		DD-638-08		DD-732-08		DD-738-08
10	DD-632-10	DD-634-10		DD-638-10		DD-732-10		
12	DD-632-12	DD-634-12	DD-636-12		DD-730-12	DD-732-12		
13							DD-736-13	
14	DD-632-14	DD-634-14						
15				DD-730-15				
16	DD-632-16	DD-634-16						
25								DD-737-25

DD

Bohrinstrumente, Pfrieme
Boring Instruments, Awls
Instruments à percer, poinçons
Instrumental para perforar, Escariadores
Strumenti per perforazione, Lesine

Reibahlen
Reamer
Pointes-carrées
Escariadores
Punteruoli



DD-932-14
14 cm



PERTHES
DD-935-21
21 cm

lieferbar in Packungen à 10 Stück
available in packages with 10 pieces
disponibles en paquets de 10 pièces
disponible en paquets de 10 unidades
disponibili in confezioni da pezzi



Trokarspitze
Trocar tip
Pointe trocart
Punta en forma de trócar
Punte a trequarti

mm Ø	L = 60 mm	L = 120 mm	L = 140 mm	L = 160 mm	L = 310 mm
1,0	DD-046-10	DD-142-10	DD-144-10	DD-146-10	DD-341-10
1,2	DD-046-12	DD-142-12	DD-144-12	DD-146-12	DD-341-12
1,4	DD-046-14	DD-142-14	DD-144-14	DD-146-14	DD-341-14
1,5	DD-046-15	DD-142-15	DD-144-15	DD-146-15	DD-341-15
1,6	DD-046-16	DD-142-16	DD-144-16	DD-146-16	DD-341-16
1,8	DD-046-18	DD-142-18	DD-144-18	DD-146-18	DD-341-18
2,0	DD-046-20	DD-142-20	DD-144-20	DD-146-20	DD-341-20
2,2	DD-046-22	DD-142-22	DD-144-22	DD-146-22	DD-341-22
2,5				DD-146-25	DD-341-25

KIRSCHNER
DD-046-10 - DD-341-16

lieferbar in Packungen à 10 Stück
available in packages with 10 pieces
disponibles en paquets de 10 pièces
disponible en paquets de 10 unidades
disponibili in confezioni da pezzi



Lanzenspitze
Lancet tip
Pointe lancéolaire
Punta lanceolar
Punte lanceolari

mm Ø	L = 310 mm
1,0	DD-342-10
1,2	DD-342-12
1,5	DD-342-15
1,6	DD-342-16
1,8	DD-342-18
2,0	DD-342-20
2,2	DD-342-22
2,5	DD-342-25

KIRSCHNER
DD-342-10 - DD-342-25



STEINMANN Nägel
STEINMANN Pins
STEINMANN clous à os
STEINMANN Clavos p. huesos
STEINMANN chiodi per ossa

L cm	
13	DD-940-13
14	DD-940-14
15	DD-940-15
16	DD-940-16
18	DD-940-18
20	DD-940-20
21	DD-940-21

STEINMANN
DD-940-13 - DD-940-21

DD

Exentionsbügel
Extension Bow
Etriers à exention
Estribos para extensión
Archi per estensione

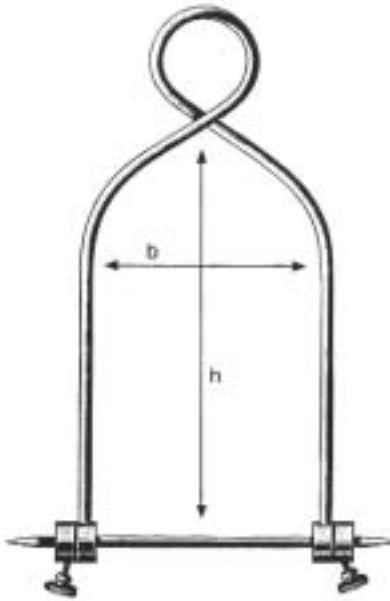

h x b cm	BOEHLER
16 x 9	DD-052-16
21 x 11	DD-052-21



h x b cm	BOEHLER
6,0 x 5,0	DD-152-06
9,5 x 7,0	DD-152-09
10,5 x 10,5	DD-152-10
9,5 x 11,0	DD-152-11
12,0 x 12,0	DD-152-12
13,5 x 13,0	DD-152-13
15,5 x 15,5	DD-152-15
20,0 x 15,5	DD-152-20



h x b cm	
18 x 10	DD-154-18
27 x 16	DD-154-27



DD-155-01



DD-155-02



KIRSCHNER U.S.
DD-158-01
klein • small • petit
pequeño • piccolo

DD-158-02
groß • large size
grand • grande

DD-158-03
extra groß • extra large size
extra grand • extra grande



DD-159-01



DD-159-02



10 m

weich
 soft
 souple
 blando
 morbido

mm Ø

0,2	DD-350-02
0,3	DD-350-03
0,4	DD-350-04
0,5	DD-350-05
0,6	DD-350-06
0,7	DD-350-07
0,8	DD-350-08
0,9	DD-350-09
1,0	DD-350-10
1,1	DD-350-11
1,2	DD-350-12
1,5	DD-350-15



LOUTE
DD-351-21
 21 cm



DD-352-17
 17 cm

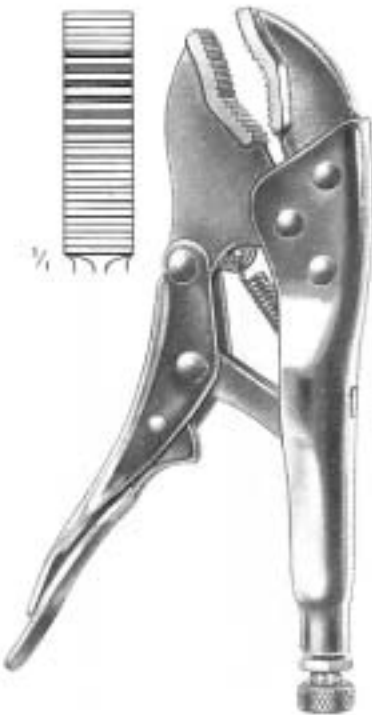

Grip
DD-353-18
 18 cm



DD-354-15
 15 cm



DD-356-14
 14 cm

DD

Knochenchirurgie
Bone Surgery
Chirurgie osseuse
Ciurgia ósea
Chirurgia ossea

Mit TC-Einsätzen
TC-Lined
A mors TC
Con bocas TC
Con morso TC



DD-450-16
16 cm



DD-452-15
15 cm



DD-455-22
22 cm



mm Ø	
2,4	DD-650-24
3,2	DD-650-32
4,8	DD-650-48
6,4	DD-650-64



	DD-652-24	DD-652-32	DD-652-48	DD-652-64
f./p. Ø	2,4 mm	3,2 mm	4,8 mm	6,4 mm



KUENTSCHER
 DD-751-26
 26 cm



KUENTSCHER
 DD-753-35
 35 cm



DD-851-35 -
 DD-855-60

mm Ø	L = 35 cm	L = 46 cm	L = 60 cm
2,5	DD-851-35	DD-851-46	
3,0	DD-852-35	DD-852-46	
3,5	DD-853-35		DD-853-60
4,0	DD-854-35	DD-854-46	DD-854-60
5,0	DD-855-35	DD-855-46	DD-855-60



KUENTSCHER
 DD-856-21
 21 cm



KUENTSCHER
 DD-858-21
 21 cm



DD-950-01



DD-950-02



DD-950-03



DD-950-04



KUENTSCHER
 DD-950-00
 63 cm



cm	
29	DD-956-29
37	DD-956-37
42	DD-956-42
49	DD-956-49



DD-958-30

DD

Instrumente zur Osteosynthese
Osteosynthesis Instruments
Instruments pour ostéosynthèse
Instrumentos para osteosíntesis
Strumenti per osteosintesi



LLOYD
DD-062-20
20 cm



LANE
DD-260-25
25 cm



WILLIAMS
DD-264-24
24 cm



mm
2,5
3,5

DD-268-25
DD-268-35



LANE
DD-362-25
25 cm



LANE
DD-365-18
18 cm



LANE
DD-367-23
23 cm

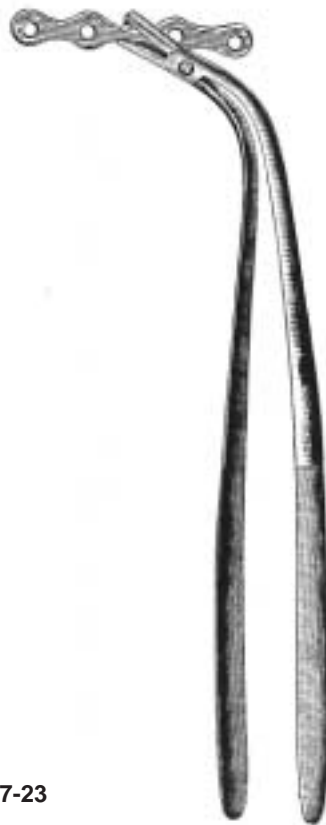

LANE
DD-369-22
22 cm



LANE
DD-460-18
18 cm

Instrumentarium zum Einbringen von Hohlschrauben
Instrument Set for Cannulated Screws
Instrumentation pour l'application des vis à perforation longitudinale
Instrumental para la aplicación de tornillos de perforación longitudinal
Strumentario per viti cannulate



Ø mm
4,5 **DD-082-45**
7,0 **DD-082-70**



DD-180-05
5 mm

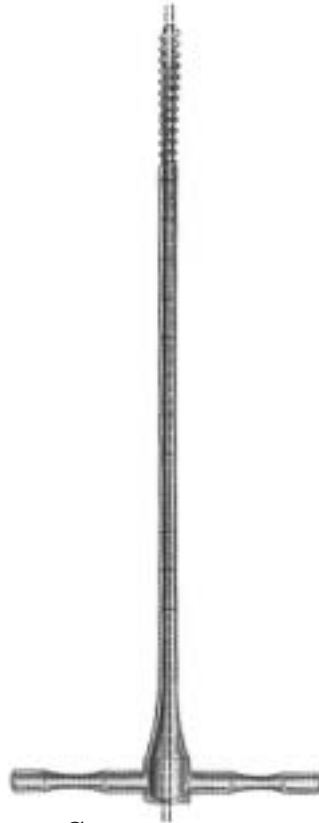

Ø mm
4,5 **DD-182-45**
7,0 **DD-182-70**



Ø mm
2,5 **DD-186-25**
3,5 **DD-186-35**
5,0 **DD-186-50**



DD-280-00

DG

**Osteosynthese
Osteosynthesis
Ostéosynthèse
Osteosíntesis
Osteosintesi**

**Verlangen Sie unseren Spezialkatalog für die Osteosynthese
Please ask for our special catalogue for osteosynthesis
Demandez notre catalogue spécial pour ostéosynthèse
Pidan nuestro catálogo especial para osteosíntesis
Chiedete il nostro catalogo speciale per osteosintesi**



DG

EA

**Neurochirurgie, Laminektomie
Neurosurgery, Laminectomy
Neurochirurgie, Laminektomie
Neurocirugía, Laminectomía
Neurochirurgia, Laminectomia**

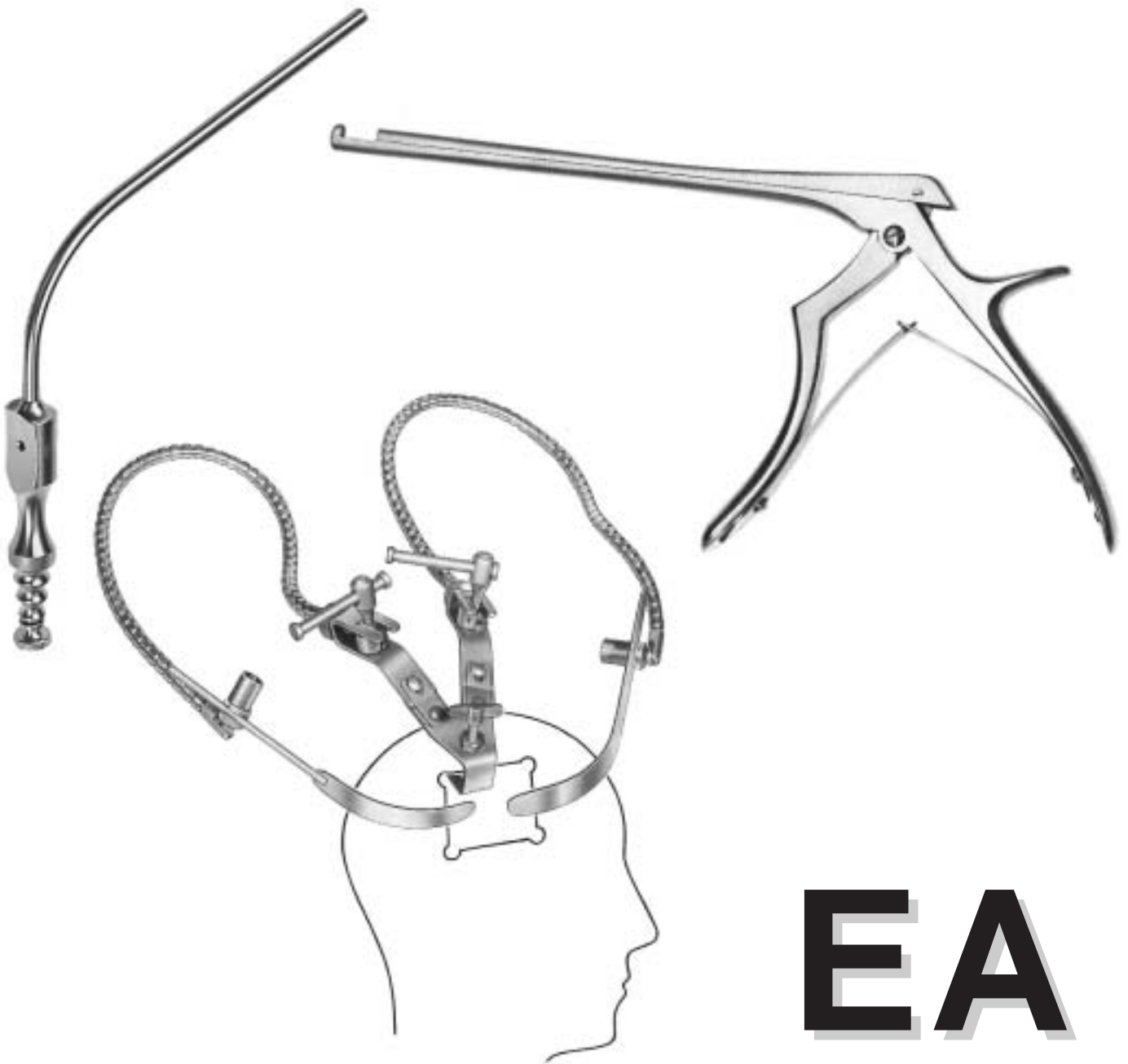

EA



cm McKenzie
15 EA-101-15
19 EA-101-19

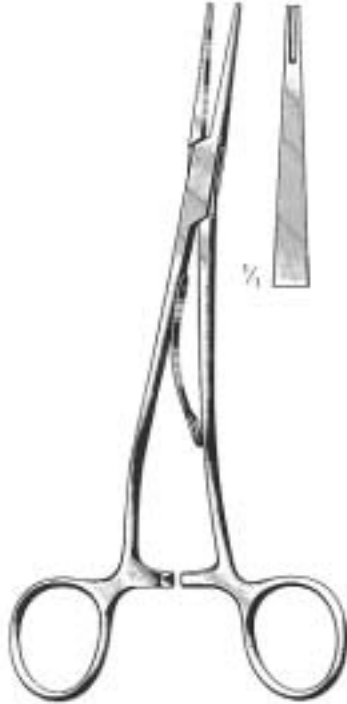

cm McKenzie
15 EA-103-15
19 EA-103-19



cm SMITHWICK
23 EA-105-23
26 EA-105-26

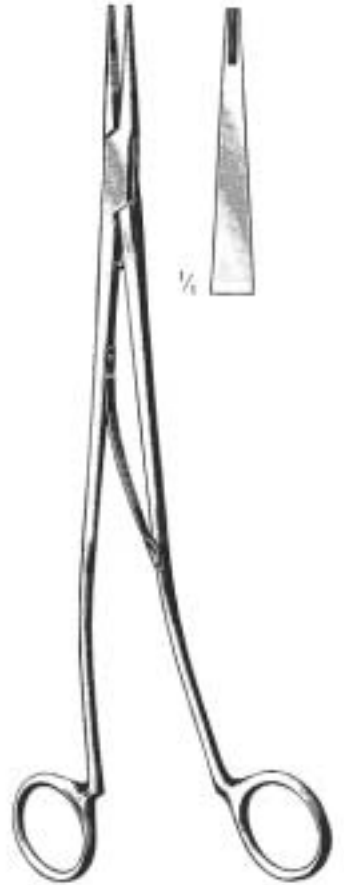

cm SWEET
23 EA-107-23
26 EA-107-26



OLIVECRONA-TOENNIS
EA-109-14



EA-200-00
148x40x6 mm



CRUTCHFIELD
EA-205-01



CRUTCHFIELD
EA-205-02



EA-206-35
3,5 mm ø



EA-206-50
5 mm ø

Kopfhautklammer, -anlegezange
Scalp Hemostasis Clip, Applying Forceps
Pince hémostatique pour le cuir chevelu, pince à poser
Pinza hermostática para cuero cabelludo, pinza para poner
Pinza emostatica per il cuoio capelluto, pinza per applicare e togliere



RANEY
EA-207-00



RANEY
EA-208-00



DANDY
EA-501-20
20 cm



DANDY
EA-502-20
20 cm



DANDY
EA-503-20
20 cm



CUSHING
EA-506-28
28 cm

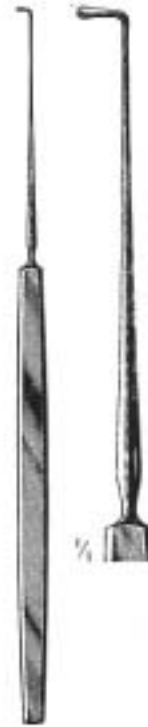

CUSHING
EA-508-28
28 cm



GRAHAM
EA-601-16
16,5 cm



SACHS
EA-604-18
18,5 cm



ADSON
EA-608-20
20 cm



ADSON
EA-609-20
20 cm

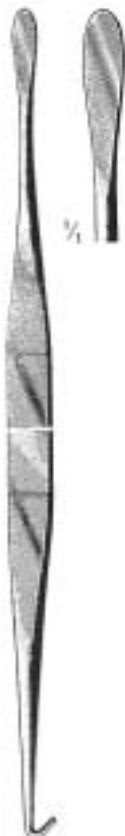

SMITHWICK
EA-700-29
29 cm



EA-800-19



LOVE

EA-801-19

EA-800-19 - EA-803-19



EA-803-19



De MARTEL
EA-900-33
33 cm

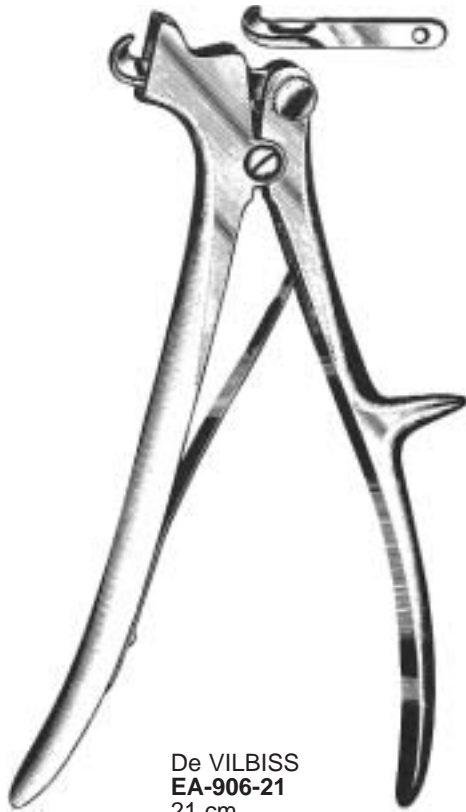

De VILBISS
EA-906-21
21 cm



cm	OLIVECRONA
30	EA-902-30
40	EA-902-40
50	EA-902-50
60	EA-902-60
70	EA-902-70



GIGLI
EA-904-00
1 Paar
1 pair
1 paire
1 par
1 paio

Dura-Dissektoren • Dura Dissectors • Dissecteurs à duremère
Descoladores para la duramadre • Scollatori per la duramadre



TOENNIS
EA-411-25
25 cm



SACHS
EA-413-21



SACHS
EA-415-21



MILLIGAN
EA-417-21

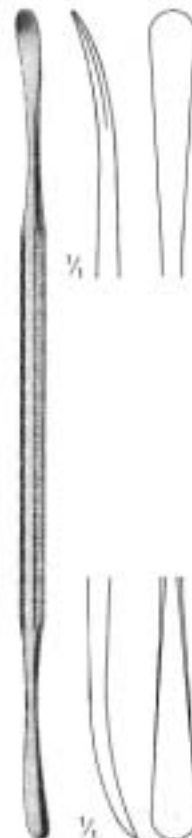

EA-419-22



DAVIS
EA-511-24

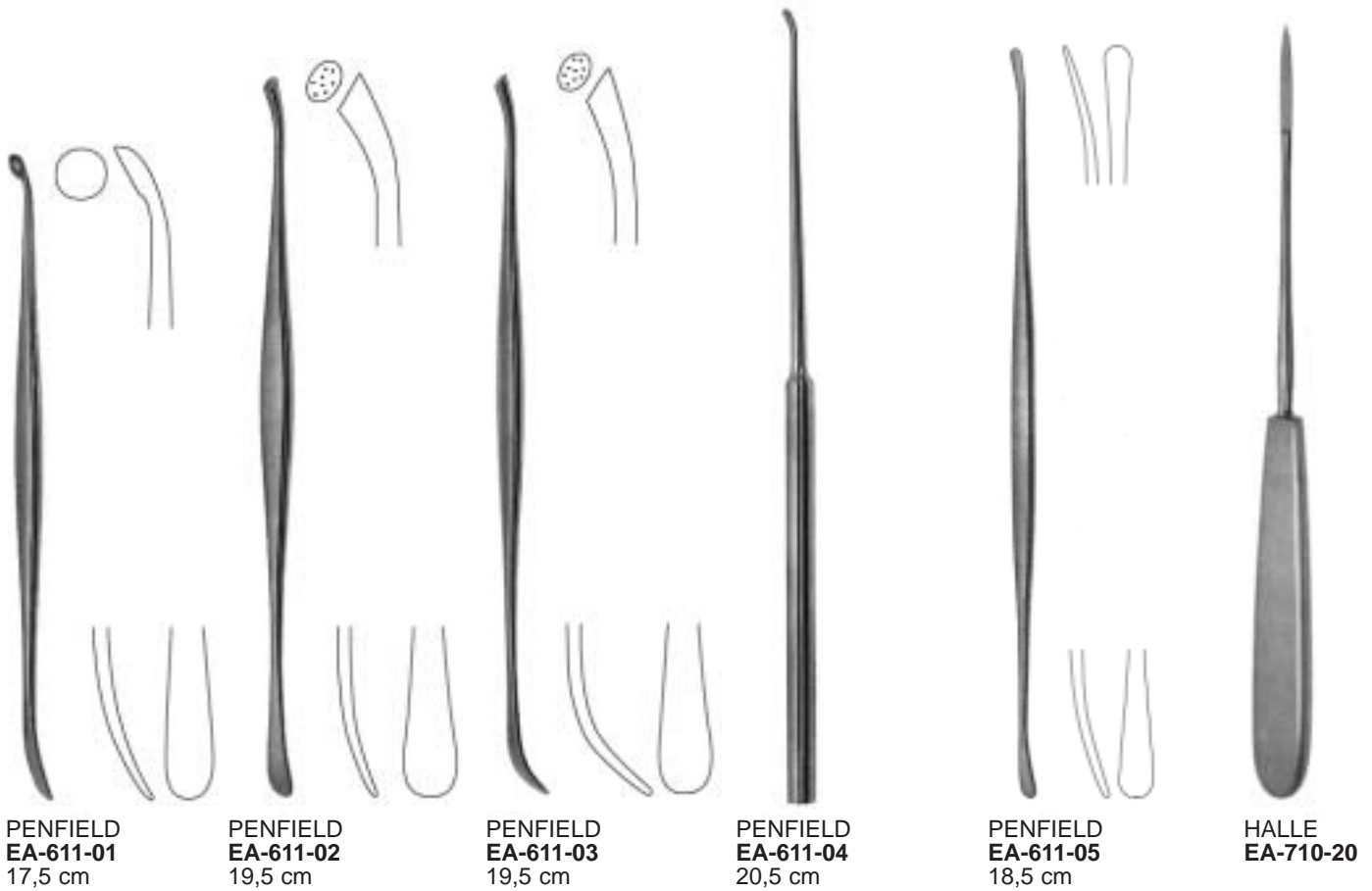

PENFIELD
EA-611-01
17,5 cm

PENFIELD
EA-611-02
19,5 cm

PENFIELD
EA-611-03
19,5 cm

PENFIELD
EA-611-04
20,5 cm

PENFIELD
EA-611-05
18,5 cm

HALLE
EA-710-20

Hypophysenpinzetten • Hypophyseal Forceps • Pincas á hypophyse • Pinzas para hipofisis • Pinze per ipofisi

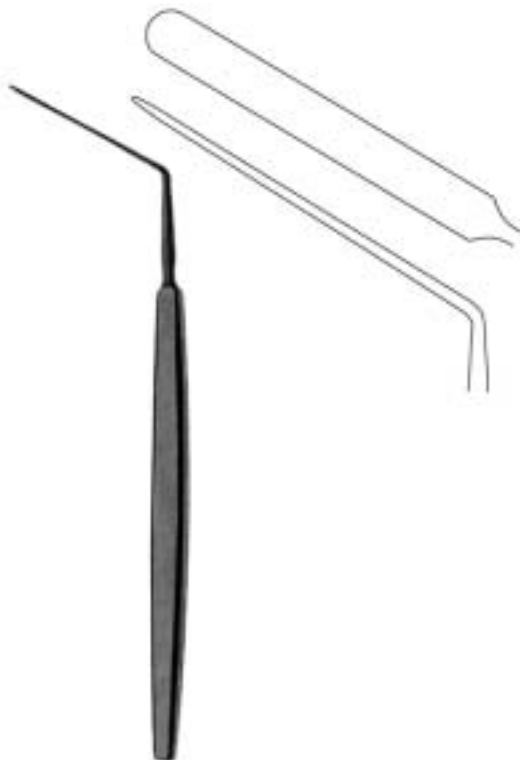

HORSLEY
EA-515-20



ADSON
EA-120-23



ADSON
EA-121-23



ADSON
EA-123-23

Hirnspatel, Saugrohre
Brain Spatulas, Aspiration Tubes
Spatules cérébr., tubes d'aspir.
Espátulas cerebr., tubos de aspir.
Spatole cerebr., tubi per aspiraz.

EA

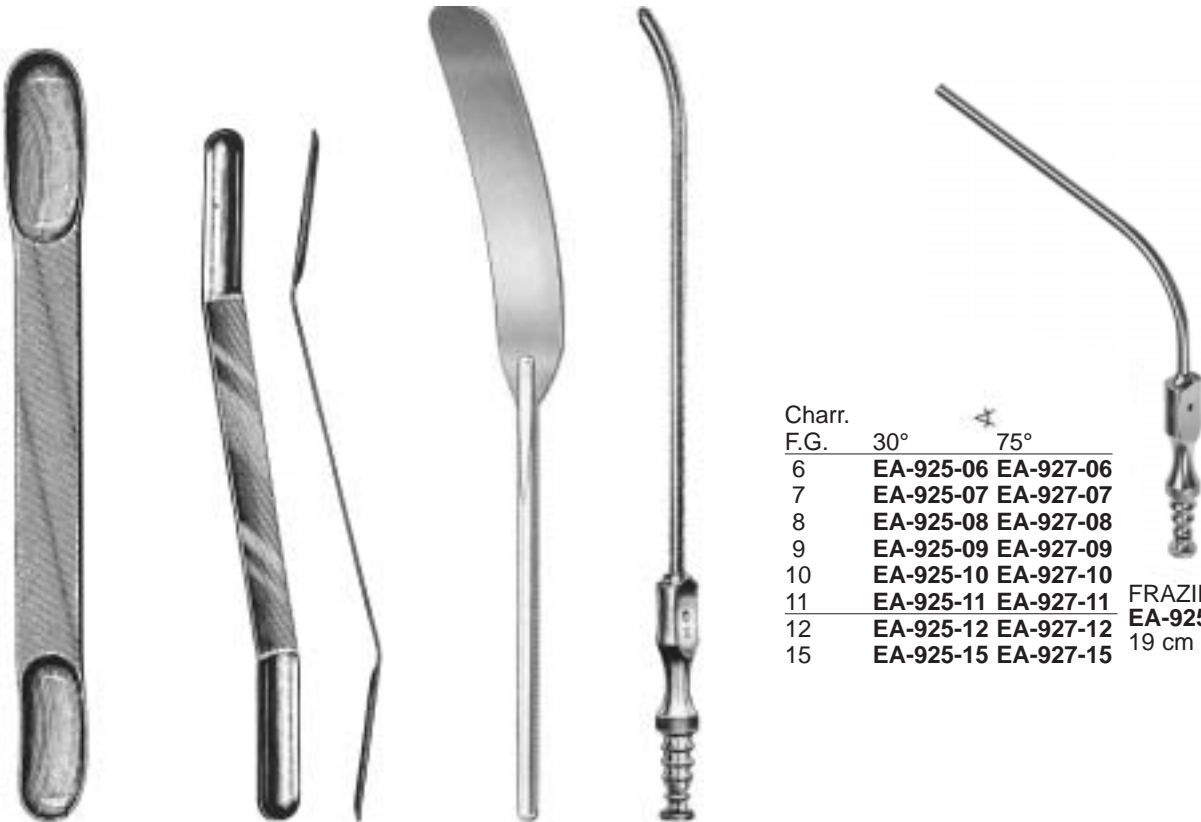

Charr.	30°	75°
6	EA-925-06	EA-927-06
7	EA-925-07	EA-927-07
8	EA-925-08	EA-927-08
9	EA-925-09	EA-927-09
10	EA-925-10	EA-927-10
11	EA-925-11	EA-927-11
12	EA-925-12	EA-927-12
15	EA-925-15	EA-927-15

FRAZIER
EA-925-06 - EA-927-12
19 cm

mm	CUSHING	mm	OLIVECRONA	mm	HEIFETZ	ADSON
7/9	EA-520-07	7/9	EA-523-07	8	EA-620-08	EA-920-21
11/13	EA-520-11	11/13	EA-523-11	11	EA-620-11	21cm/4 mm
15/18	EA-520-15	15/18	EA-523-15	14	EA-620-14	
18/22	EA-520-18	18/22	EA-523-18	17	EA-620-17	
	180 mm		180 mm			

Wirbelkörperspreizer • Lamina Spreaders •
Ecarteurs pour corps vertébraux •
Speradores para cuerpos vertebrales •
Divaricatori per corpi vertebrali



FRAZIER
EA-928-12
12 cm/3 mm



CLOWARD
EA-041-16



INGE
EA-045-17 - EA-045-27

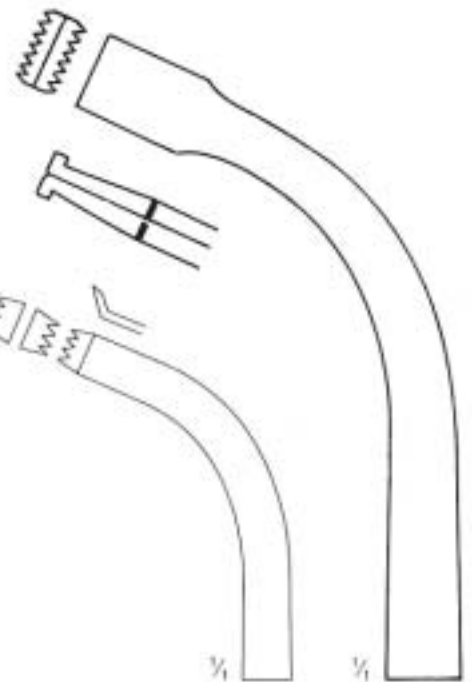

EA-045-17
17 cm

EA-045-27
27 cm

EA

Laminektomie
Laminectomy
Laminectomie
Laminectomía
Laminectomia

Laminektomie-Zangen
Laminectomy Rongeurs
Pinces emporte-pièce à laminectomie
Pinzas cortantes para laminectomia
Pinze taglianti per laminectomia



CUSHING
2 mm



2x10 mm	L
EA-240-01	12,5 cm
EA-242-01	18,0 cm



2x10 mm/45°	L
EA-240-01	12,5 cm
EA-242-01	18,0 cm

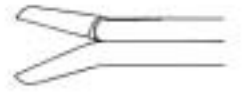

2x10 mm/45°	L
EA-240-03	12,5 cm
EA-242-03	18,0 cm

LOVE-GUENWALD
3 mm



3x10 mm	L
EA-340-01	12,5 cm
EA-342-01	18,0 cm



3x10 mm/45°	L
EA-340-01	12,5 cm
EA-342-01	18,0 cm



3x10 mm/45°	L
EA-340-03	12,5 cm
EA-342-03	18,0 cm

SPURLING
4 mm



4x10 mm	L
EA-440-01	12,5 cm
EA-442-01	18,0 cm



4x10 mm/45°	L
EA-440-01	12,5 cm
EA-442-01	18,0 cm

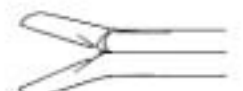

4x10 mm/45°	L
EA-440-03	12,5 cm
EA-442-03	18,0 cm

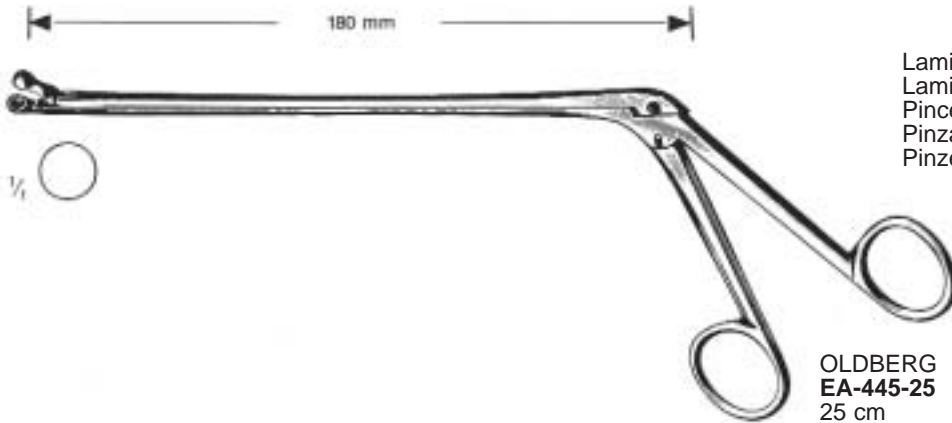

Laminektomie-Zangen
Laminectomy Rongeurs
Pinces emporte-pièce á laminectomie
Pinzas cortantes para laminectomia
Pinze taglianti per laminectomia

OLDBERG
EA-445-25
25 cm

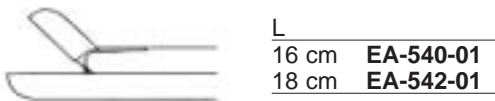

L
16 cm EA-540-01
18 cm EA-542-01



L
16 cm EA-540-02
18 cm EA-542-02



L
16 cm EA-540-03
18 cm EA-542-03



FERRIS-SMITH
EA-540-01 - EA-542-03
3 x 10 mm



WAGNER
EA-548-20
20 cm/ 4 mm

Bandscheiben-Stanzen
Intervertebral Disc, Rongeurs
Pincas emporte-pièce pour lames intervertébrales
Pinzas sacabocado para discos intervertebrales
Pinze taglienti per dischi intervertebrali

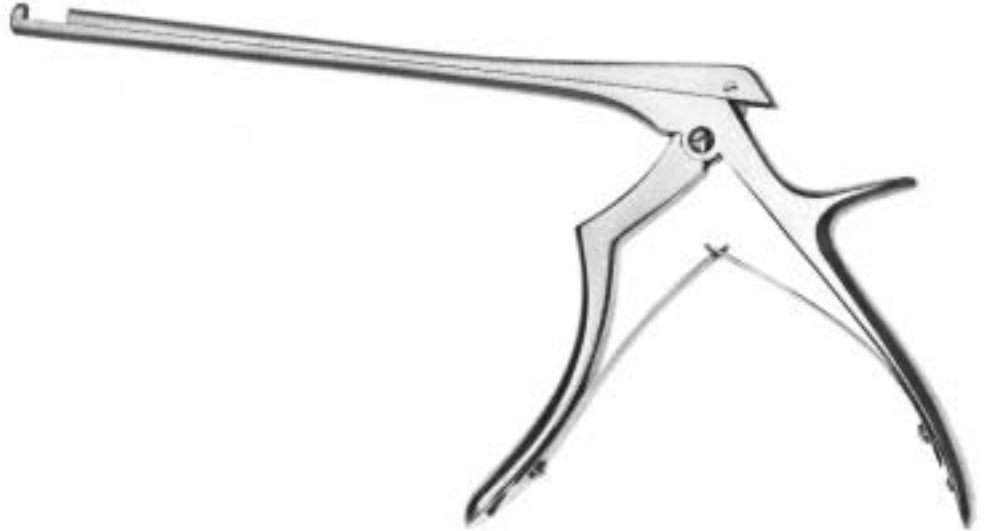

FERRIS-SMITH-Kerrison
EA-150-01 -EA-152-05
18 cm

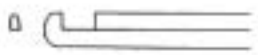

EA-150-01
1 mm

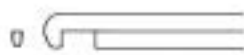

EA-151-01
1 mm



EA-150-02
2 mm

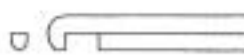

EA-151-02
2 mm

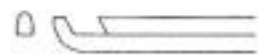

EA-152-02
2 mm

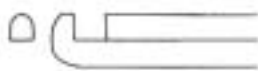

EA-150-03
3 mm

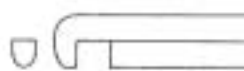

EA-151-03
3 mm



EA-152-03
3 mm



EA-150-04
4 mm

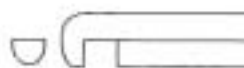

EA-151-04
4 mm

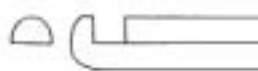

EA-150-05
5 mm



EA-151-05
5 mm



EA-152-05
5 mm

Bandscheiben-Stanzen
Intervertebral Disc, Rongeurs
Pinces emporte-pièce pour lames intervertébrales
Pinzas sacabocado para discos intervertebrales
Pinze taglianti per dischi intervertebrali



COLCLOUGH
EA-250-03 - EA-255-05

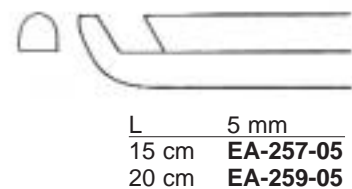
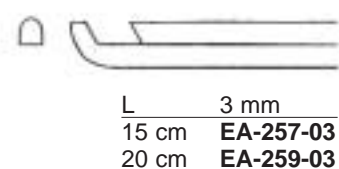
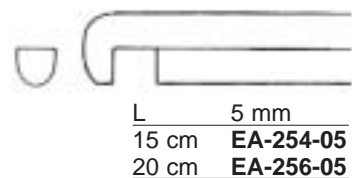
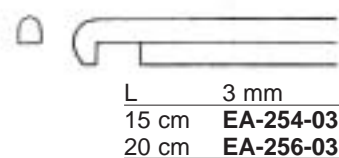
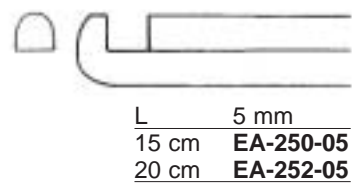
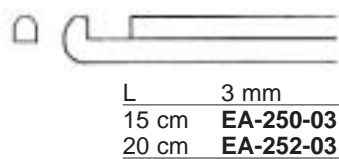

Verlangen Sie unseren Spezialkatalog für
Please ask for our special catalogue for
Demandez notre catalogue spécial pour
Pidan nuestro catálogo especial para
Chiedete il nostro catalogo speciale per

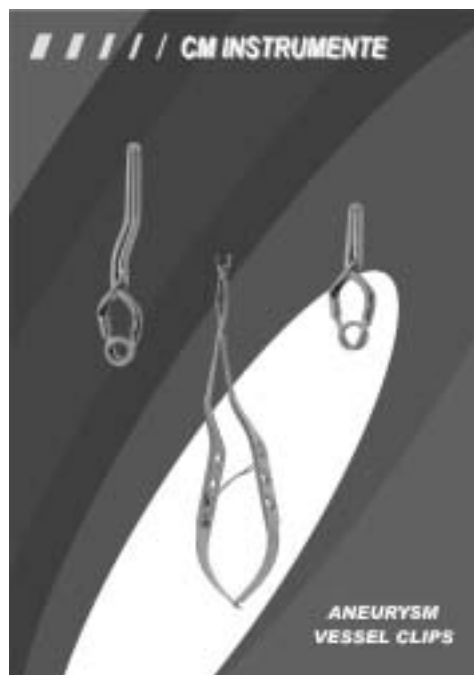

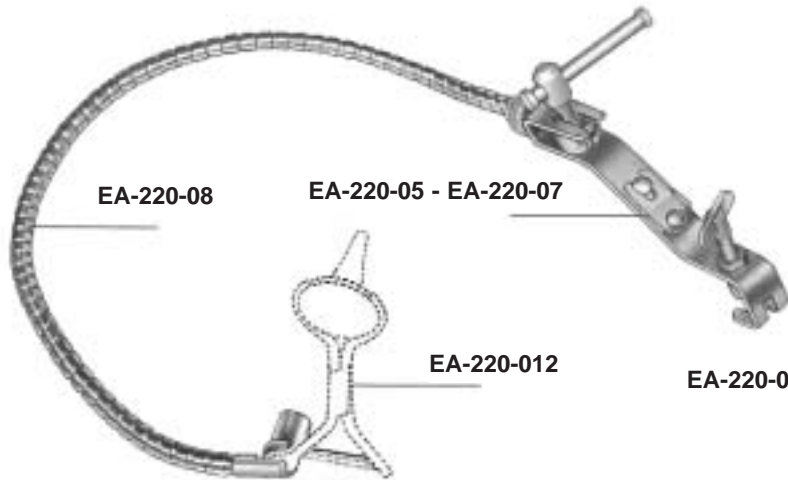

EA-220-08 Spannarm allein
 Flexible arm only
 Bras flexible seul
 Brazo flexible suelto
 Braccio flessibile solo

EA-220-12 Ohrtrichterhalter allein
 Ear specula holder only
 Support pour spéculum auriculaire
 Soporte para espejuelo de oídos
 Sostegno per specolo auricolare

EA-220-05 Fixiervorrichtungen für Schädel oder Starrarm
EA-220-06 Fixation bases for skull or rigid holding arm
EA-220-07 Bases pour fixation au crâne ou au bras rigide
 Fijadores para fijación al cráneo o al brazo rígido
 Fissatori per fissaggio al cranio o al braccio rigido



EA-220-05

EA-220-05 Fixiervorrichtung am Schädel für 1 Arm
 Fixation base for 1 arm at skull
 Base de fixation pour 1 bras au crâne
 Fijador para 1 brazo al cráneo
 Fissatore per 1 braccio al cranio



EA-220-06

EA-220-06 Fixiervorrichtung am Schädel für 2 Arme
 Fixation base for 2 arms at skull
 Base de fixation pour 2 bras au crâne
 Fijador para 2 brazos al cráneo
 Fissatore per 2 bracci al cranio



EA-220-07

EA-220-07 Fixiervorrichtung am Starrarm für 1 Arm
 Fixation base for 1 arm at rigid arm
 Base de fixation pour 1 bras au bras rigide
 Fijador para 1 brazo al brazo rígido
 Fissatore per 1 braccio al braccio rigido



EA-221-00

Hirnspatelhalter, selbsthaltend, flexibel,
für flache Spatel,
mit 1 Spannarm, komplett, bestehend aus:
EA-220-05, EA-220-08, EA-220-09

Brain retractor, self retaining, flexible,
for flat spatula
with 1 flexible arm, complete, consisting of:
EA-220-05, EA-220-08, EA-220-09

Ecarteur autostatique, flexible,
pour des spatules plates,
avec un bras flexible, complet, composé de:
EA-220-05, EA-220-08, EA-220-09

Separador autorretentivo, flexible
para espátulas llanas,
con 1 brazo flexible, completo, compuesto de:
EA-220-05, EA-220-08, EA-220-09

Divaricatore autostatico, flessibile,
per spatole piatte,
con 1 braccio flessibile, completo, composto da:
EA-220-05, EA-220-08, EA-220-09

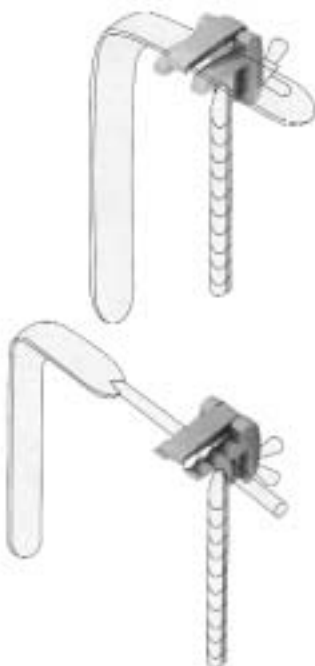

EA-220-09 Halter für flache Hirnspatel
Holder for flat brain spatula
Support pour des spatules plates
Soporte para espátulas llanas
Sostegno per spatole piatte

EA-220-10 Halter für Hirnspatel mit rundem Schaft
Holder for brain spatula with round stem
Support pour des spatules a tige ronde
Soporte para espátulas con vástago redondo
Sostegno per spatole con asta rotonda

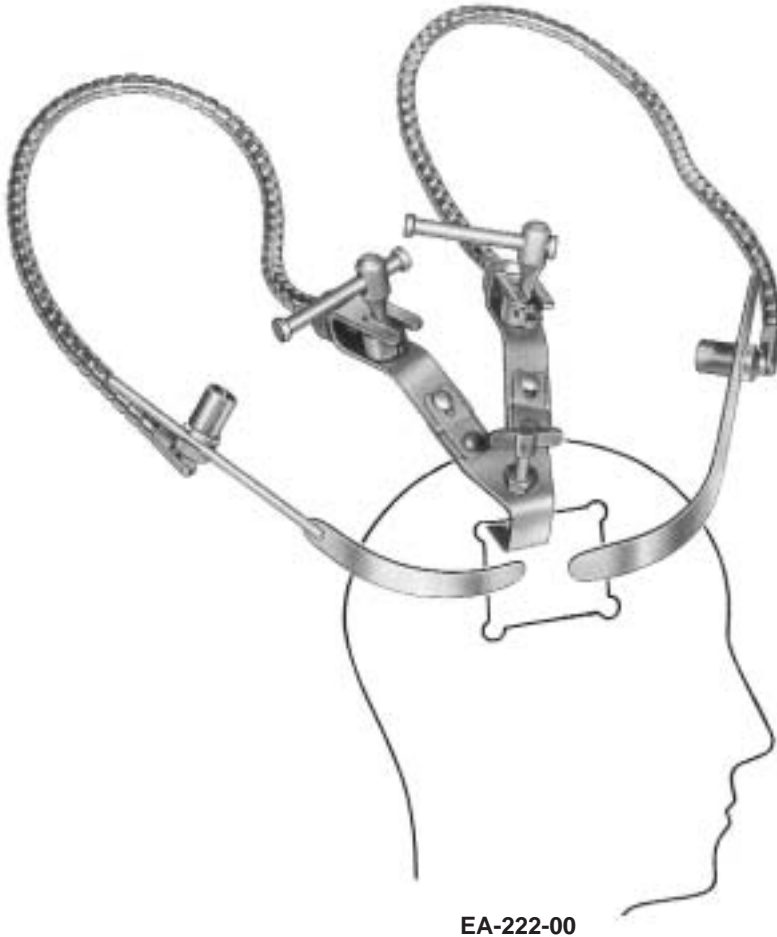

Hirnspatelhalter, selbsthaltend, flexibel,
für flache Spatel,
mit 2 Spannarmen, komplett, bestehend aus:
2 x EA-220-08, EA-220-06, 2 x EA-220-09

Brain retractor, self retaining, flexible,
for flat spatula,
with 2 flexible arms, complete, consisting of:
2 x EA-220.08, EA-220-06, 2 x EA-220-09

Ecarteur autostatique, flexible,
pour des spatules plates,
avec 2 bras flexibles, complet, composé de:
2 x EA-220-08, EA-220-06, 2 x EA-220-09

Separador autorretentivo, flexible,
para espátulas llanas,
con 2 brazos flexibles, completo, compuesto de
2 x EA-220-08, EA-220-06, 2 x EA-220-09

Divaricatore autostatico, flessibile,
per spatole piatte
con 2 bracci flessibili, completo, composto da:
2 x EA-220-08, EA-220-06, 2 x EA-220-09

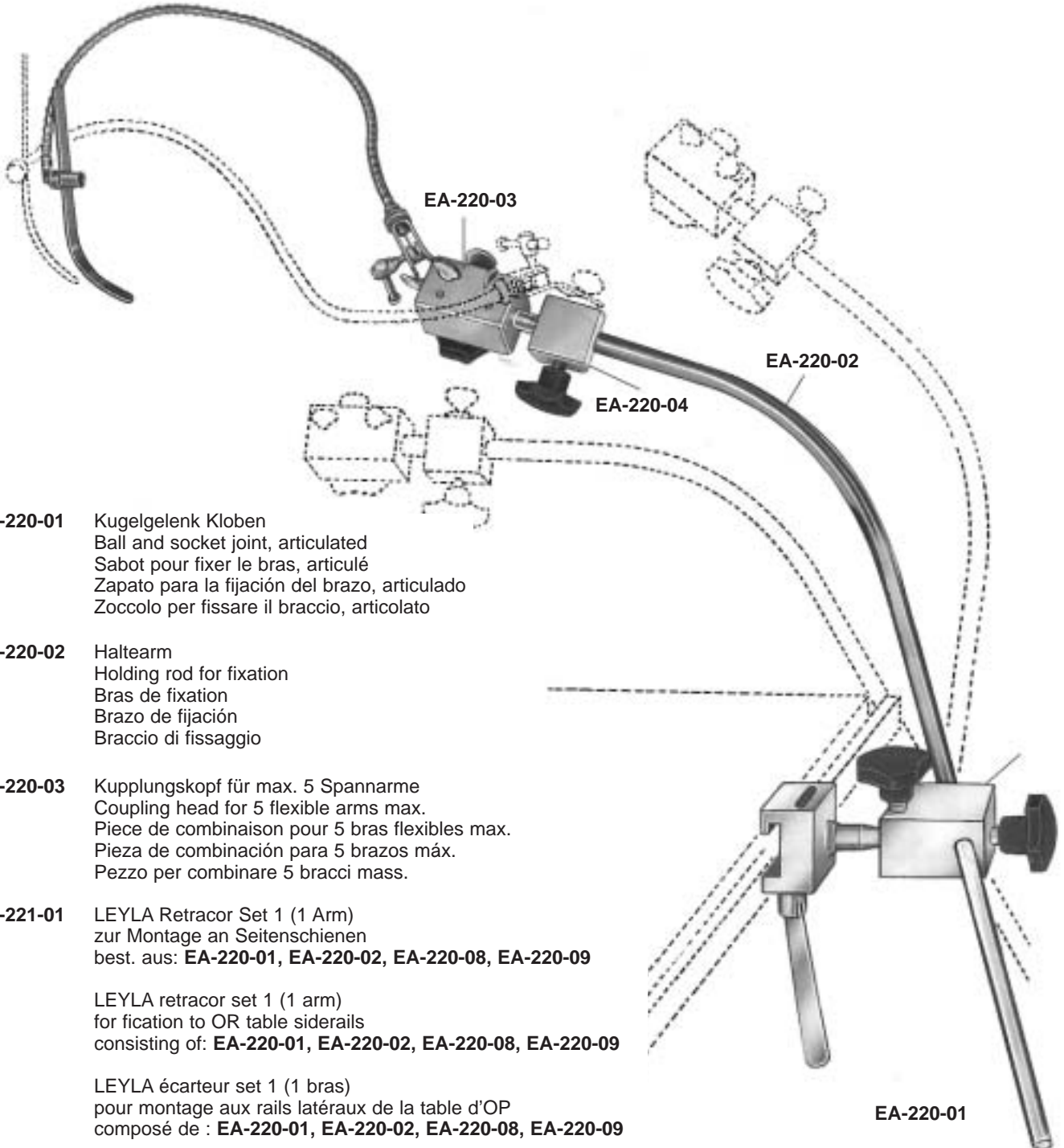

EA-220-01 Kugelgelenk Kloben
 Ball and socket joint, articulated
 Sabot pour fixer le bras, articulé
 Zapato para la fijación del brazo, articulado
 Zoccolo per fissare il braccio, articolato

EA-220-02 Haltearm
 Holding rod for fixation
 Bras de fixation
 Brazo de fijación
 Braccio di fissaggio

EA-220-03 Kupplungskopf für max. 5 Spannarme
 Coupling head for 5 flexible arms max.
 Piece de combinaison pour 5 bras flexibles max.
 Pieza de combinación para 5 brazos máx.
 Pezzo per combinare 5 bracci mass.

EA-221-01 LEYLA Retractor Set 1 (1 Arm)
 zur Montage an Seitenschienen
 best. aus: **EA-220-01, EA-220-02, EA-220-08, EA-220-09**

LEYLA retracor set 1 (1 arm)
 for fixation to OR table siderails
 consisting of: **EA-220-01, EA-220-02, EA-220-08, EA-220-09**

LEYLA écarteur set 1 (1 bras)
 pour montage aux rails latéraux de la table d'OP
 composé de : **EA-220-01, EA-220-02, EA-220-08, EA-220-09**

LEYLA separador set 1 (1 brazo)
 para montar al carril lateral de la mesa operatoria
 compuesto de: **EA- 220-01, EA-200-02, EA-220-08, EA-220-09**

LEYLA divaricatore set 1 (1 braccio)
 per montaggio al tavolo di operazione
 composto da: **EA-220-01, EA-220-02, EA-220-08, EA-220-09**

EA-220-01 Kugelgelenk Kloben
 Ball and socket joint, articulated
 Sabor pour fixer le bras, articulé
 Zapato para la fijación del brazo, articulado
 Zoccolo per fissare il braccio, articolato

EA-220-02 Haltearm
 Holding rod for fixation
 Bras de fixation
 Brazo de fijación
 Braccio di fissaggio

EA-220-03 Kupplungskopf für max. 5 Spannarme
 Coupling head for 5 flexible arms max.
 Pièce de combinaison pour 5 bras flexibles max.
 Pieza de combinación para 5 brazos máx.
 Pezzo per combinare 5 bracci mass.

EA-220-03 Kupplungskopf drehbar
 Coupling head rotatable
 Pièce de combinaison rotative
 Pieza de combinación giratoria
 Pezzo per combinare girevole

EA-222-02 LEYLA Retractor Set 2 (2 Arme) zur Montage an Seitenschiene
 best. aus: **EA-220-01, EA-220-02, EA-220-03, EA-220-04**
 2 x **EA-220-07, 2 x EA-220-08, 2 x EA-220-09**

LEYLA retractor set 2 (2 arms for fixation to OR table siderails
 consisting of: **EA-220-01, EA-220-02, EA-220-03, EA-220-04**
 2 x **EA-220-07, 2 x EA-220-08, 2 x EA-220-09**

LEYLA écarteur set 2 (2 bras) pour montage aux rails latéraux
 de la table d'OP
 composé de : **EA- 220-01, EA-220-02, EA-220-03, EA-220-04**
 2 x **EA-220-07, 2 x EA-220-08, 2 x EA-220-09**

LEYLA separado set 2 (2 brazos) para montar al carril lateral de la
 mesa operatoria
 compuesto de: **EA-220-01, EA-220-02, EA-220-03, EA-220-04**
 2 x **EA-220-07, 2 x EA-220-08, 2 x EA-220-09**

LEYLA divaricatore set 2 (2 bracci) per montaggio
 al tavolo di operazione
 composto da: **EA-220-01, EA-220-02, EA-220-03, EA-220-04**
 2 x **EA-220-07, 2 x EA-220-08, 2 x EA-220-09**

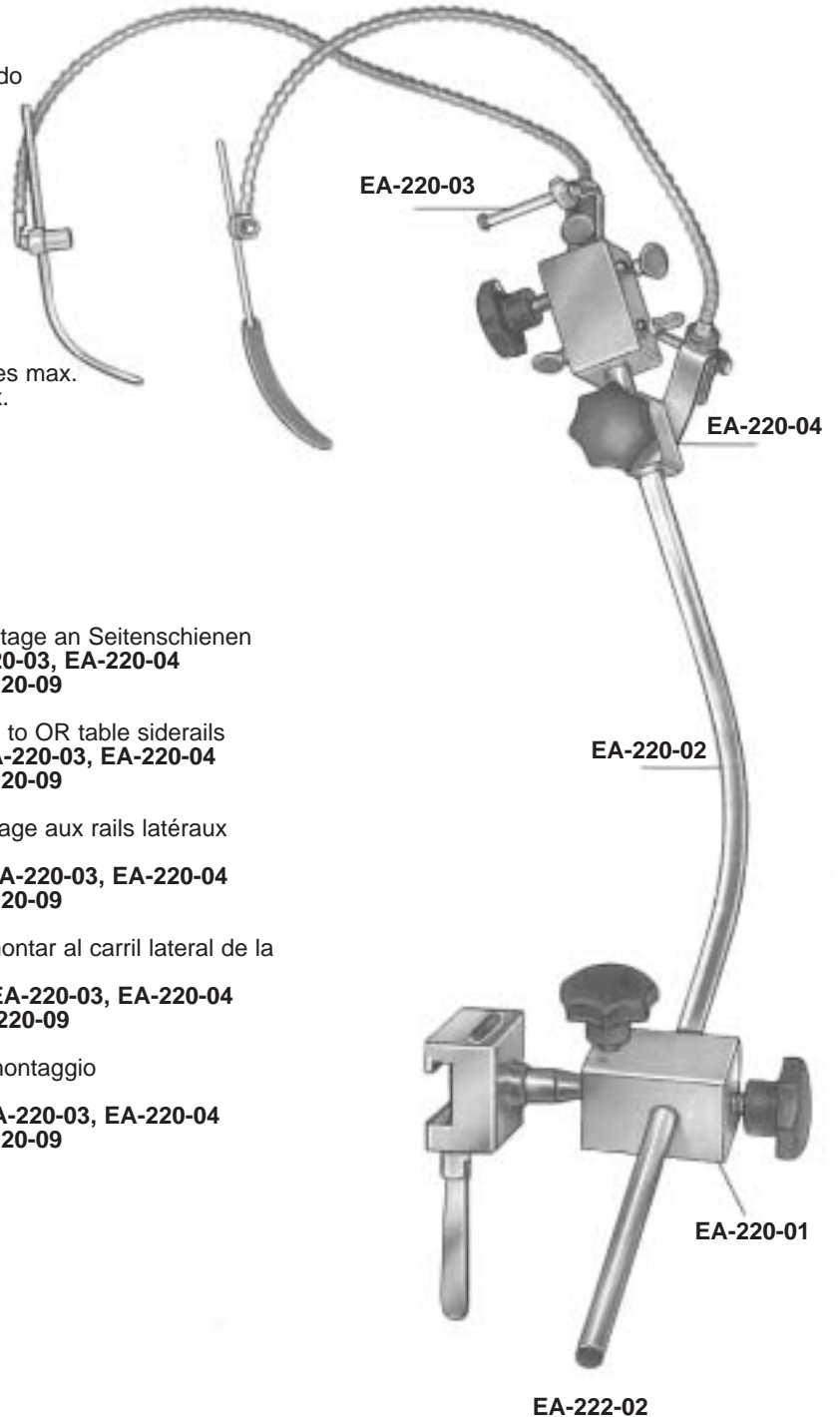

EC
ED

Ophthalmologie
Ophthalmology
Ophthalmologie
Oftalmología
Oftalmologia



EC-ED

Sperrelevatoren
Eye Specula
Blépharostats
Blefarostatos
Blefarostati

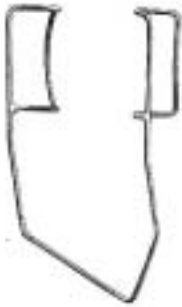

cm BARRAQUER(Colibri)
3 **EC-011-03**
4 **EC-011-04**



BOWMAN
EC-014-07
7 cm



CRITCHETT
EC-015-06
7 cm



SMITH
EC-016-05
5 cm



CLARK
EC-017-08
8 cm



cm GRAEFE
7 **EC-019-06**
9 **EC-019-07**



WEEK
EC-110-08
8 cm



ARRUGA
EC-111-07
7 cm • rechts •
right • à droite •
a la derecha •
destro

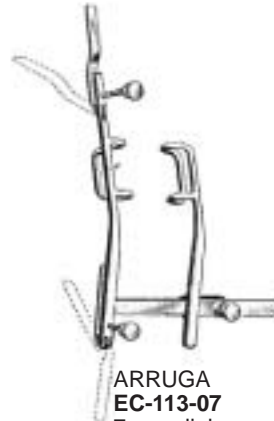

ARRUGA
EC-113-07
7 cm • links •
left • à gauche •
a la izquierda •
sinistro



MURDOCK
EC-115-05
5 cm



MELLINGER-AXENFELD
EC-211-07
7 cm



MELLINGER-AXENFELD
EC-213-07
7 cm



cm MELLINGER
5 **EC-215-05**
7 **EC-215-07**



LISTER-BURCH
EC-217-08
8 cm



WILLIAMS
EC-218-08
8 cm

Sperrelevatoren
 Eye Specula
 Blépharostats
 Blefarostatos
 Blefarostati



LANCASTER
 EC-219-07
 7 cm



ZIEGLER
 EC-310-07
 7 cm



CASTROVIEJO
 EC-312-08
 8 cm



PARK
 EC-313-08
 8 cm



MUELLER
 EC-315-07
 7 cm



GOLDSTEIN
 EC-317-07
 3 cm



STEVENSON
 EC-319-07
 7 cm



JAEGER
 EC-510-11
 11 cm

Lidplatte
 Lid Plate
 Plaque à paupières
 Placa para párpados
 Placca per palpebre

Starmesser
 Cataract Knives
 Couteaux à cataracte
 Cuchillos para cataratá
 Coltelli per cataratta



EC-710-00
 Fig. 0



EC-710-01
 Fig. 1



EC-710-02
 Fig. 2



EC-710-03
 Fig. 3

GRAEFE
 EC-710-00 - EC-710-03



DEUTSCHMANN
 EC-712-13
 13 cm



EC-128-12 - EC-810-01



JAEGER
EC-810-01 **EC-810-02** **EC-810-03**
 Fig. 1 Fig. 2 Fig. 3



JAEGER 45°
EC-811-01 **EC-811-02** **EC-811-03**
 Fig. 1 Fig. 2 Fig. 3

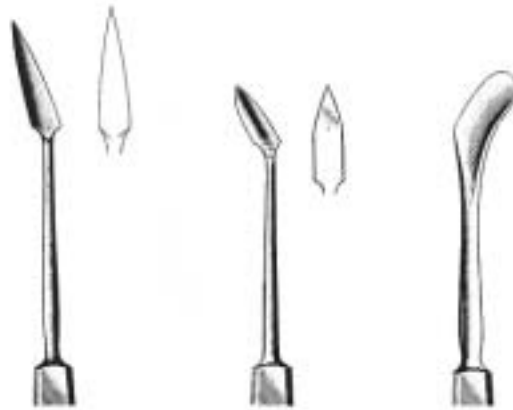

BERENS
EC-813-13
 13 cm

CASTROVIEJO
EC-815-13
 4 x 13 mm
 13 cm

GRAEFE
EC-817-13
 13 cm



KNAPP
EC-022-01 **EC-022-02** **EC-022-03**
 Fig. 1 Fig. 2 Fig. 3



ZIEGLER
EC-120-01 **EC-120-02** **EC-120-03**
 Fig. 1 Fig. 2 Fig. 3
 5 mm 6 mm 7 mm



DEAN
EC-123-12
 12,5 cm



BOWMAN
EC-124-04 **EC-124-08**
 0,4 mm 0,8 mm
 13 cm 13 cm



WHEELER
EC-128-12
 12 cm



ZIEGLER
 EC-221-11
 11 cm, 3,5 mm



SATO
 EC-226-12
 12,5 cm



TOOK
 EC-228-12
 12 cm



GILL
 EC-321-12
 12 cm



ELSCHNIG
 EC-323-13
 13 cm



KUHNT
 EC-420-01
 Fig. 1



KUHNT
 EC-420-02
 Fig. 2



KUHNT
 EC-420-03
 Fig. 3



KUHNT
 EC-420-04
 Fig. 4



PATON
 EC-425-12
 12 cm



LUNDSGAARD
 EC-521-12
 12 cm



GUYTON-
 LUNDSGAARD
 EC-523-12



BARRKAN
 EC-526-12



SCHEIE
 EC-528-12



BURCH
 EC-622-12



PAUFIQUE
 EC-721-11



BARRAQUER
 EC-723-13



EC-034-12



EC-035-12



BOWMAN
 EC-038-12



BOWMAN
 EC-039-12



EC-130-13



EC-131-13



LEVINSON
 EC-134-13



FRANCIS
 EC-231-12



DAVIS
 EC-235-13
 13 cm



LA FORCE
EC-237-12



DIX
EC-330-13



ELLIS
EC-331-11



WALTON
EC-332-12



WALTON
EC-334-12



ALVIS
EC-336-12



GREEN
EC-430-13



ROLLET
EC-432-12



GRAEFE
EC-531-01
Fig. 1



GRAEFE
EC-531-02
Fig. 2



GRAEFE
EC-531-03
Fig. 3



JAMESON
EC-533-13



GREEN
EC-535-13



STEVENS
EC-537-13



ARRUGA
EC-633-01
Fig. 1



ARRUGA
EC-633-02
Fig. 2



O'Connor
EC-730-12



WIENER
EC-732-13



WIENER
EC-733-13



ROLLET
EC-736-13



KNAPP
EC-737-13



GRAEFE
EC-830-13



GRAEFE
EC-831-13



GRAEFE
EC-833-13



BECKER
EC-836-13



MEYHOEFER

	EC-042-05	EC-042-10	EC-042-15	EC-042-18	EC-042-20	EC-042-25	EC-042-35	EC042-40	EC-042-45
Ø mm	0,5	1,0	1,5	1,8	2,0	2,5	3,5	4,0	4,5

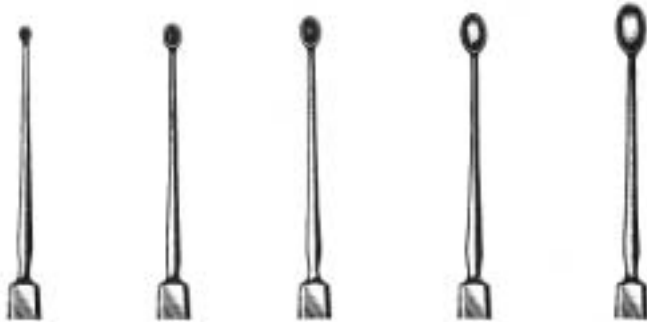

HEBRA

	EC-044-10	EC-044-20	EC-044-25	EC-044-30	EC-044-35
Ø mm	1,0	2,0	2,5	3,0	3,5



AXENFELD
 EC-047-13



GRAEFE
 EC-140-01 EC-140-02



DAVEL
 EC-142-01 EC-142-02



KNAPP
 EC-144-02



BUNGE
 EC-240-01 EC-240-02 EC-240-03



LANG
EC-244-13



WEBER
EC-441-01 Fig. 1 EC-441-02 Fig. 2



SNELLEN
EC-443-13



WILDER
EC-445-13 Fig. 1 EC-447-13 Fig. 2



ARLT
EC-449-01 EC-449-02

Iris • Iride



WECKER
EC-641-13 EC-642-13

CULLER
EC-647-13



WELLS
EC-842-20



Schützer
Protector
Protecteur
Protettore

ARRUGA
EC-845-13



Kauter • Cauter •
Cautère • Cauterio

WADSWORTH-TODD
EC-847-14

Zyklodialyse • Cyclodialysis • Cyclodialyse • Ciclodíalisis • Ciclodialisi

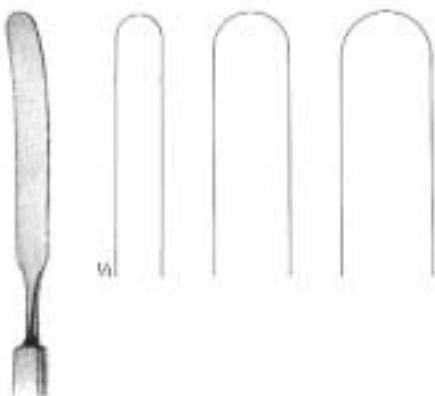

BANGERTER
EC-051-06 6 mm EC-051-10 10 mm EC-051-12 12 mm



EC-151-13 - EC-157-09



CASTROVIEJO
EC-151-13 1,2 x 10 mm EC-153-14 1,5 x 15 mm ELSCHNIG EC-155-14 1,2 x 12 mm CASTROVIEJO EC-157-09 0,8 x 15 mm



CASTROVIEJO
 EC-251-12



WHEELER
 EC-253-12



mm	CASTROVIEJO
0,5	EC-255-05
0,75	EC-255-07
1,0	EC-255-10



DIX
 EC-452-12



DIX
 EC-454-12



DIX
 EC-456-13

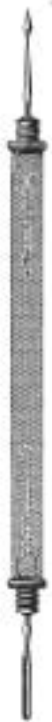

DIX
 EC-458-13

Markier-Instrumente
 Markers
 Marqueurs
 Marcadores
 Marcatori

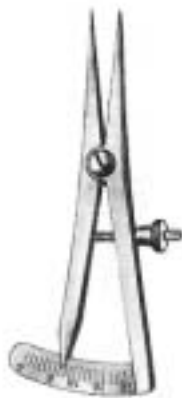

CASTROVIEJO
 EC-853-06
 0-20 mm



CONNIN-AMSLER
 EC-859-13



DASTOOR
 EC-950-06
 6 cm



HOLTH
 EC-953-09

Tränengang-Dilatatoren
Lachrymal Dilators
Dilatateurs pour canal lacrymal
Dilatadores para canal lacrimal
Dilatatori per canale lacrimale



WILDER
EC-062-01 EC-062-02 EC-06203



Fig. ZIEGLER
1/2 EC-065-12
3/4 EC-065-34
5/6 EC-065-56



CASTROVIEJO
EC-068-12

Tränenkanal-Sonden
Lachrymal Probes
Stylets pur le canal lacrymal
Estiletes para canal lacrimal
Specilli per canale lacrimale



BOWMAN	FIG.	BOWMAN
EC-164-00	00/0	EC-166-00
EC-164-01	0/1	EC-166-01
EC-164-12	1/2	EC-166-12
EC-164-23	2/3	EC-166-23
EC-164-34	3/4	EC-166-34
EC-164-45	4/5	EC-166-45
EC-164-56	5/6	EC-166-56
EC-164-67	6/7	EC-166-67
EC-164-78	7/8	EC-166-78

Iris Pinzetten • Iris Forceps •
Pincas à Iris • Pinzas para iris • Pinze per iride

Fig.	00	0	1	2	3	4	5	6	7	8
ø mm	0,7	0,8	0,9	1,1	1,3	1,4	1,5	1,6	1,8	1,9



GRAEFE
EC-082-07
7 cm/1 mm



GRAEFE
EC-083-07
7 cm/1 mm



GRAEFE
EC-084-07
7 cm/1 mm

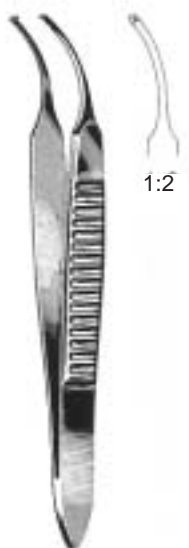

GRAEFE
EC-085-07
7 cm/1 mm



GRAEFE
EC-180-10
10 cm



GRAEFE
EC-181-10
10 cm



GRAEFE
EC-183-10
10 cm



GRAEFE
EC-280-10
10 cm



GRAEFE
EC-281-10
10 cm



GRAEFE
EC-283-10
10 cm



STEVENS
EC-380-10
10,5 cm



STEVENS
EC-381-10
10,5 cm



STEVENS
EC-383-10
10,5 cm



STEVENS
EC-480-10
10,5 cm



STEVENS
EC-481-10
10,5 cm



STEVENS
EC-483-10
10,5 cm



FOERSTER
EC-580-08
8,5 cm



FOERSTER
EC-581-08
8,5 cm



FOERSTER
EC-582-08
8,5 cm



FOERSTER
EC-583-08
8,5 cm



HESS
EC-585-07
7 cm/0,3 mm



HESS
EC-587-07
7 cm/0,3 mm



GILL
EC-681-07
7,5 cm/0,3 mm



GILL-HEISS
EC-683-07
7,5 cm/0,3 mm

Zähne unten
teeth below
dents en bas
dientes abajo
denti in basso



GILL-HEISS
EC-685-07
7,5 cm/0,3 mm

Zähne seitwärts
lateral teeth
dents latérales
dientes laterales
denti laterali

Iris-, Strabismus-Pinzetten
 Iris, Strabismus Forceps
 Pincas à iris et à strabisme
 Pinzas para iris y para estrabismo
 Pinze per iride e per strabismo

EC

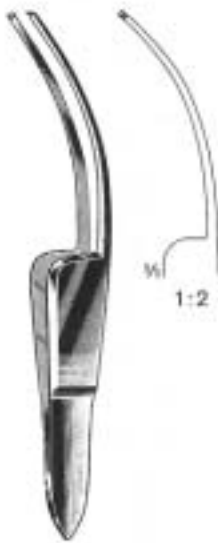

FISCHER
EC-689-07
 7 cm



BARRAQUER-KATZIN
EC-881-07
 7 cm/0,4 mm



TROUTMAN (Colibri)
EC-883-07
 7 cm/0,12 mm



BARRAQUER (Colibri)
EC-885-07
 7 cm/0,12 mm



BARRAQUER (Colibri)
EC-887-07
 7 cm/0,12 mm



KIRBY-ARTHUR
EC-981-09
 9 cm/0,2 mm



KIRBY-ARTHUR
EC-983-09
 9 cm/0,2 mm



McCULLOUGH
EC-092-09
 9,5 cm



McCULLOUGH
EC-094-09
 9,5 cm



JAMESON
EC-097-10
 L, 10 cm



JAMESON
EC-099-10
 R, 10 cm

EC

Strabismus-Pinzetten
Strabismus Forceps
Pinces à strabisme
Pinzas para estrabismo
Pinze per strabismo



BONACCOLTO
EC-194-10
10 cm



BONACCOLTO
EC-196-10
10 cm



BONACCOLTO
EC-290-11
11 cm



DASTOOR
EC-294-11
11 cm



DASTOOR
EC-296-11
11 cm



BISHOP-HARMAN
EC-490-05
8,5 cm, /0,5 mm



BISHOP-HARMAN
EC-490-08
8,5 cm, /0,8 mm



BISHOP-HARMAN
EC-492-05
8,5 cm, /0,5 mm



BISHOP-HARMAN
EC-492-08
8,5 cm, /0,8 mm



Iris-Pinzetten • Iris Forceps • Pinces à iris •
Pinzas para iris • Pinze per iride



Mod. Bonn
EC-494-07
7 cm, /0,12 mm



Mod. Bonn
EC-496-07
7 cm, /0,12 mm

Iris-, Muskel-Pinzetten • Iris,
Muscle Forceps • Pincés à iris, mus-
culaires • Pinzas para iris, muscu-
lares • Pinze per iride, muscolari



Mod. Bonn
EC-496-10
10 mm/0,12 mm



Mod. Tübingen
EC-590-10
EC-594-10
10 cm



Mod. Bonn
EC-592-10
EC-596-10
10 cm/0,12 mm



Mod. Tübingen
EC-593-10
EC-597-10
10 cm



PRINCE
ED-101-10
10 cm

PRINCE
ED-103-10
10 cm



BERKE
ED-105-20 - ED-105-27



ED-105-20



ED-105-27

RECTUS



TROUTMAN
ED-107-08
0,5 cm/0,8 mm

Vorderkammer-Pinzette
Anterior Chamber Forceps
Pince à chambre antérieure
Pinza para cámara anterior
Pinza per camera anteriore



BARRAQUER
ED-201-05
5,5 cm/7 mm

Fixierpinzetten, Kapsel-Pinzetten
 Fixation Forceps, Capsular Forceps
 Pincés à fixation, Pincés capsulaires
 Pinzas para fijación, Pinzas capsulares
 Pinza per fissaggio, Pinze capsulare

ED



ELSCHING
 ED-406-11
 10 cm



GRAEFE
 ED-500-11 - ED-502-11



ED-500-11



ED-502-11
 mit Schloß
 with catch
 à crémaillère
 con cierre
 c. cremagliera



LESTER
 ED-504-09
 9 cm



CASTROVIEJO
 ED-606-09

1:1



CASTROVIEJO
 ED-607-09

1:1



CASTROVIEJO
 ED-608-09

2:2



CASTROVIEJO
 ED-609-09

2:2



BARRAQUER
 ED-704-10
 10 cm



GREEN
 ED-706-05 - ED-708-10
 10 cm



ED-706-05 **ED-706-10**
 5 mm 10mm
 ohne/without/sans
 sin/senza



ED-708-05 **ED-708-10**
 5 mm 10mm
 mit/ with / avec / con

Schloß / catch /
 crémaillère /
 cierre / cremagliera



GILL-ARRUGA
 ED-011-07
 7,5 cm

ED

Kapsel-Pinzetten
Capsular Forceps
Pincas capsulaires
Pinzas capsulares
Pinze capsulare



TERSON
ED-013-09
9 cm



KALT
ED-016-10
10 cm



ELSCHING
ED-019-10
10 cm



ARRUGA
ED-111-10
10 cm



ARRUGA
ED-114-10
10 cm



CASTROVIEJO
ED-115-10
10 cm



SCHWEIGGER
ED-117-10
10 cm



SCHWEIGGER
ED-119-10
10 cm



SCHWEIGGER
ED-121-10
10 cm



HESS
ED-215-06
6 cm

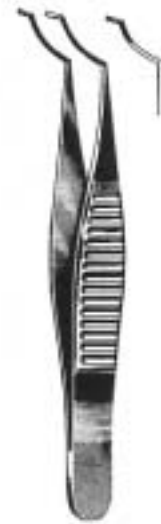

HESS
ED-217-06
6,5 cm



FUCHS
ED-219-07
7 cm

Naht-, Faden-Pinzetten
 Suturing, Ligature Forceps
 Pincas à suturas et à ligature
 Pinzas para suturas y para ligaduras
 Pinze per sutura e per legatura

ED

Zahn
 tooth
 dent
 diente
 dente



CASTROVIEJO

0,12 mm	ED-510-01	
0,3 mm	ED-510-03	
0,5 mm	ED-510-05	ED-511-05
1,0 mm	ED-510-10	ED-511-10
1,5 mm	ED-510-15	ED-511-15



MOORFIELD
ED-614-10
 10 cm



St. MARTIN
ED-616-07
 7 cm



Mod. Tübingen
ED-811-10
ED-815-10
 10 cm



PAUFIQUE
ED-910-08
ED-914-08
 8,5 cm



PAUFIQUE
ED-022-08
ED-026-08
 8,5 cm



McPHERSON
ED-120-10
ED-124-10
 10 cm



McPHERSON
ED-220-10
ED-224-10
 10 cm

ED

Pinzetten für Chalazion, Entropium, Trachom
Forceps for Chalazio, Entropium, Trachoma
Pincès à chalazion, à entropion, à granulations du trachome
Pinzas de chalazión, de entropión y para tracoma
Pinze per calazio, per entropio e per trichiasi



AYER
ED-420-09
9 cm



AYER
ED-422-09
9 cm



LAMBERT
ED-426-09
9 cm



DESMARRES
ED-524-09 - ED-528-09
9 cm



ED-524-09
Fig. 1



ED-526-09
Fig. 2



ED-528-09
Fig. 3



SNELLEN
ED-625-10
10 cm

SNELLEN
ED-627-10
10 cm



KNAPP-LUER
ED-724-11
11 cm



SCHEIE
 ED-032-28
 1,0 x 28 mm



SCHEIE
 ED-032-33
 1,5 x 33 mm



Mod. Tübingen
 ED-033-45



Mod. Hamburg
 ED-035-00



SIMCOE
 ED-036-00



Mod. Bonn
 ED-037-00



Mod. Bonn
 ED-039-00

Hornhaut-Trephinen • Corneal Trephines
 Trépan cornéens • Trépanos corneales
 Trefine corneali



CASTROVIEJO
 ED-130-50 - ED-131-01

ø mm	CASTROVIEJO
5,0	ED-130-50
5,5	ED-130-55
6,0	ED-130-60
6,5	ED-130-65
7,0	ED-130-70
8,0	ED-130-80
9,0	ED-130-90
10,0	ED-131-00
11,0	ED-131-01



FRANCESCETTI
 ED-230-50 - ED-231-01

ø mm	FRANCESCETTI
5,0	ED-230-50
5,1	ED-230-51
6,0	ED-230-60
6,1	ED-230-61
7,0	ED-230-70
7,1	ED-230-71
8,0	ED-230-80
8,1	ED-230-81
9,0	ED-230-90
9,1	ED-230-91
10,0	ED-231-00



ELLIOT
ED-430-00
compl. = 4

Tonometer • Tonometro
Tonométre



SCHIOETZ

ED-044-00

ED-046-00

Skala	gerade	schräg
scale	straight	oblique
échelle	droite	oblique
escala	recta	oblicua
scala	retta	obliqua

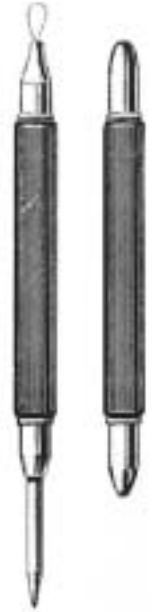

ED-048-00

Augen-Magnet
Eye Magnet
Aimant à corps étrangers
Imán para cuerpos extraños
Calamita per corpi estranei

Cilien-Pinzetten • Cilia Forceps
Pinces à épiler les cils • Pinzas
depilatorias • Pinze depilatorie



BEER
ED-240-09
9cm

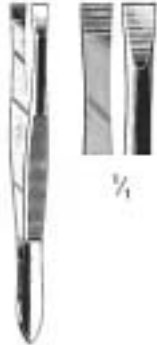

DOUGLAS
ED-242-09
9 cm



LITTAUER
ED-244-08
8,5 cm



DBARRAQUER
ED-245-10
10,5 cm

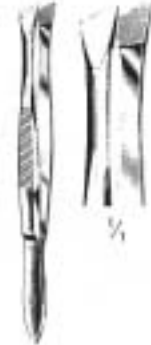

ED-246-09
9 cm



GRADLE
ED-248-09
9,5 cm

EE

**Otologie
Otology
Otologie
Otología
Otologia**



EE



mm Ø
 ③ = 3
EE-100-30
 ① = 4,5
EE-100-45
 ② = 5,5
EE-100-55
 ③ = 6,5
EE-100-65
 ④ = 7,5
EE-100-75

HARTMANN
EE-100-00
 Set = 4



mm Ø
 ② = 5,5
EE-102-55
 ③ = 6,5
EE-102-65
 ④ = 7,5
EE-102-75

TOYNBEE
EE-102-00
 Set = 3



mm Ø
 ① = 4,5
EE-104-45
 ② = 5,5
EE-104-55
 ③ = 6,5
EE-104-65
 ④ = 7,5
EE-104-75

GRUBER
EE-104-00
 Set = 4



mm Ø
 ① = 4,5
EE-105-45
 ② = 5,5
EE-105-55
 ③ = 6,5
EE-105-65
 ④ = 7,5
EE-105-75

GRUBER
EE-105-00
 Set = 3



EE-108-50
 5 mm
EE-108-60
 6 mm
EE-108-70
 7 mm
EE-108-80
 8 mm

BOUCHERON
EE-108-00
 Set = 4



① 6,5
 ② 7
 ③ 8 mm Ø



BRUENINGS
EE-300-04
 compl.



SIEGLE
EE-306-03
 compl.



EE-600-01
C 128

EE-600-02
C¹ 256

Alu
EE-600-03
C² 512

EE-600-04
C³ 1024

EE-600-05
C⁴ 2048

Alu
EE-601-00
compl.

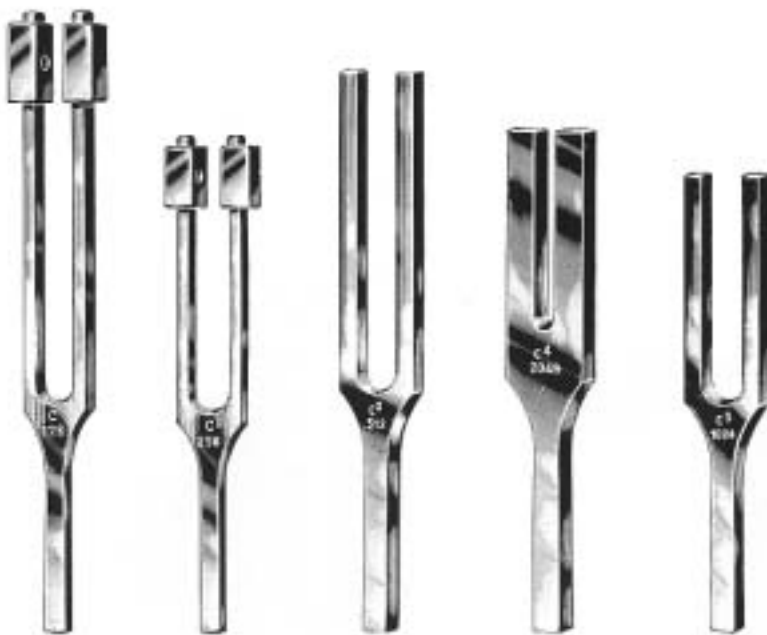

EE-700-01
C 128

EE-700-02
C¹ 256

HARTMANN
EE-700-03
C² 512

EE-700-04
C³ 1024

EE-700-05
C⁴ 2048

HARTMANN
EE-701-00
compl.



LUCAE
EE-704-01
C 128



EE-705-00
neurolog.



RYDEL-SEIFFER
EE-706-01
C 64 / c 128

Lärmapparat
Noise Apparatus
Assourdisseur
Ensordecedor
Assordatore



BARANY
EE-800-00

Pulverbläser
Powder Blowers
Lance-Poudre
Lanzapolvero
Insuffiadori per polvere

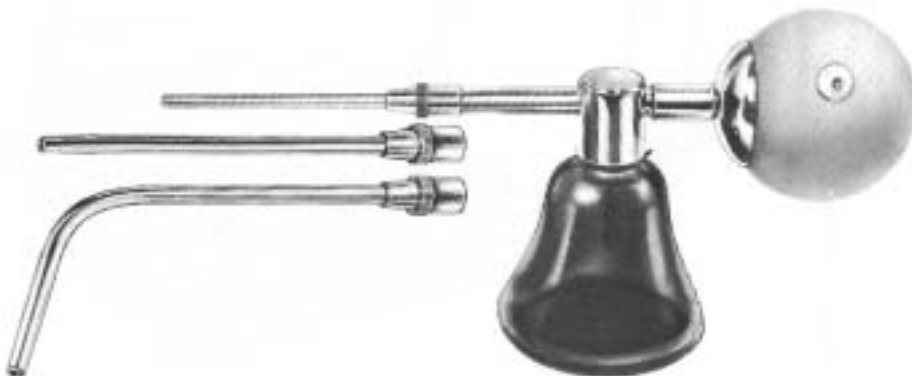

KABIERSKE
EE-900-00
30 cc

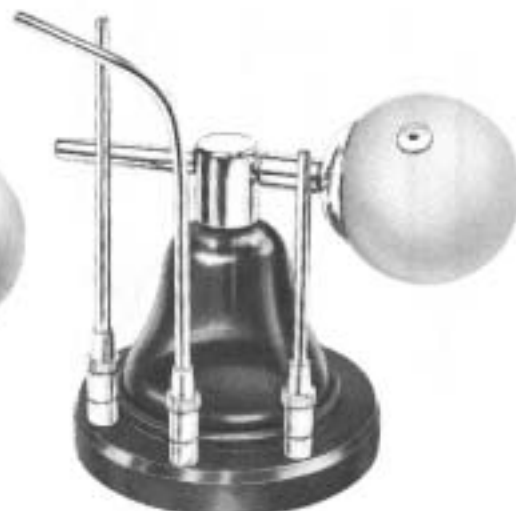

KABIERSKE
EE-900-01
30 cc



EE-901-03



EE-901-04
4 mm Ø



EE-901-15
15 mm Ø



EE-901-17
17 mm Ø



EE-901-22
22 mm Ø

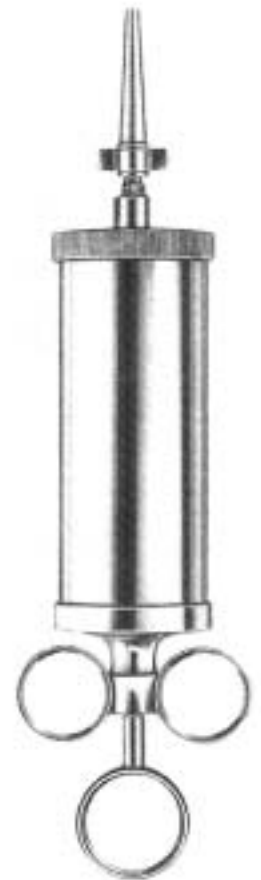

POLITZER

EE-901-00 = EE-901-15, EE-901-17, EE-901-22, EE-901-03

EE-901-01 = EE-901-15, EE-901-17, EE-901-22, EE-901-03, EE-901-04

ml	REINER
50	EE-906-50
75	EE-906-75
100	EE-907-10
150	EE-907-15



Küretten • Currettes •
 Curettes • Curetas •
 Curette



Fig. 00



0



1



2



3



4



5

stumpf • blunt
 mousses
 romas
 smusse

EE-019-00

EE-110-00

EE-110-01

EE-110-02

EE-110-03

EE-110-04

EE-110-05

scharf • sharp
 tranchantes
 cortantes
 taglienti

EE-111-00

EE-112-00

EE-112-01

EE-112-02

EE-112-03

EE-112-04

EE-112-05

stumpf • blunt
 mousses
 romas
 smusse

EE-114-00

EE-115-00

EE-115-01

EE-115-02

EE-115-03

EE-115-04

EE-115-05

scharf • sharp
 tranchantes
 cortantes
 taglienti

EE-116-00

EE-117-00

EE-117-01

EE-117-02

EE-117-03

EE-117-04

EE-117-05



Fig.	HARTMANN	ITARD
0	EE-311-00	
1	EE-311-01	EE-313-01
2	EE-311-02	EE-313-02
3	EE-311-03	EE-313-03
4	EE-311-04	EE-313-04
5	EE-311-05	EE-313-05

POLITZER
EE-510-18
 18 cm

POLITZER
EE-511-16
 16,5 cm

POLITZER
EE-513-16



POLITZER
EE-610-15
 15 cm

SEXTON
EE-612-18
 18 cm

SEXTON
EE-614-17
 17 cm

SEXTON
EE-615-17
 17 cm

GROSS
EE-710-12
 12 cm

GROSS
EE-711-12
 12 cm

Schlingen, Hakchen, Pinzetten, Schnurer
 Loops, Hooklets, Dressing Forceps, Snares
 Anses, Crochets, Pincas, Serrenoed
 Asas, Granchitos, Pinzas, Cierranudos
 Anse, Uncinetti, Pinze, Serranodi

EE

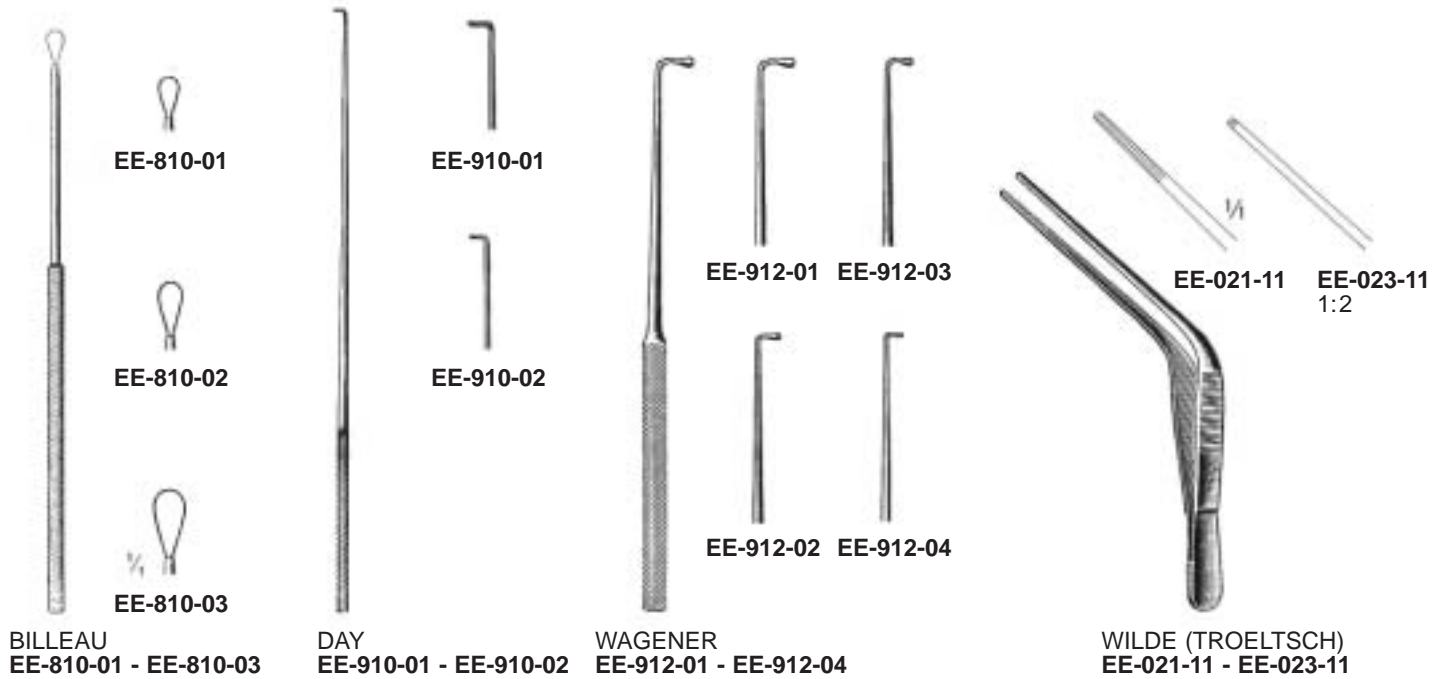

BILLEAU
 EE-810-01 - EE-810-03

DAY
 EE-910-01 - EE-910-02

WAGENER
 EE-912-01 - EE-912-04

WILDE (TROELTSCH)
 EE-021-11 - EE-023-11

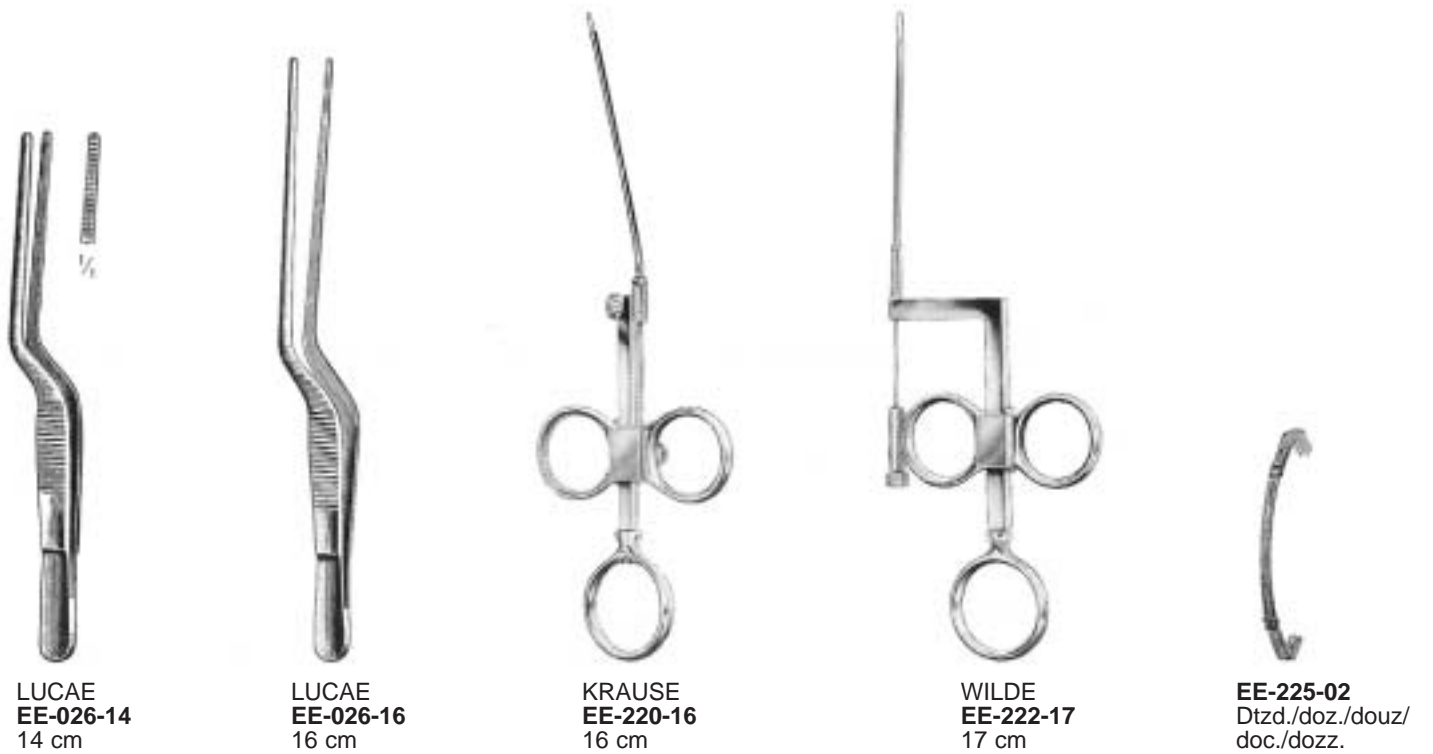

LUCAE
 EE-026-14
 14 cm

LUCAE
 EE-026-16
 16 cm

KRAUSE
 EE-220-16
 16 cm

WILDE
 EE-222-17
 17 cm

EE-225-02
 Dtzd./doz./douz/
 doc./dozz.

EE

Ohrzangchen
Ear Forceps
Pincas auriculaires
Pinzas auriculares
Pinze auricolari



TILLEY
EE-423-14
14 cm



LITTAUER
EE-425-12
12 cm



HARTMANN
EE-421-12
12 cm



HARTMANN
EE-421-14
14 cm



QUIRE
EE-521-10
10 cm

Fremdkorperhebel
Foreign Body Levers
Leviers pour corps etrangers
Elevadores para cuerpos extranjeros
Leve per corpi estranei



BUCK
EE-523-11
11 cm



EE-525-08 - EE-725-08



HARTMANN-WULLSTEIN
EE-525-08
8,5 cm



HARTMANN-WULLSTEIN
EE-527-08
8,5 cm



cm	HARTMANN
8,5	EE-621-08
14,0	EE-621-14
16,0	EE-621-16



cm	HARTMANN
8,5	EE-623-08
14,0	EE-623-14



cm	HARTMANN
8,5	EE-625-08



cm	HARTMANN
2,0	EE-627-20
2,5	EE-627-25
3,0	EE-627-30
8,5	

3 mm



HARTMANN
EE-629-30
8,5 cm



STRUEMPEL
EE-721-08
8,5 cm



HARTMANN
EE-723-08
8,5 cm

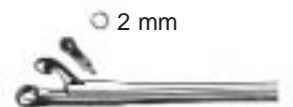

HARTMANN-HOFFMANN
EE-725-08
8,5 cm

2 mm

Mikro-Ohrscherchen
 Micro Ear Scissors
 Ciseaux auriculaires micro
 Tijeras auriculares micro
 Forbici auricolari micro



EE-130-40 - EE-232-70

gerade
 straight
 droite
 recta
 retta



**BELLUCCI
 EE-130-40**
 micro mini
 4 mm

links
 left
 gauche
 izquierda
 sinistra



**BELLUCCI
 EE-135-55**
 micro standard
 5,5 mm

gerade
 straight
 droite
 recta
 retta



**SHEA
 EE-230-70**
 7,0 mm

gerade
 straight
 droite
 recta
 retta



**BELLUCCI
 EE-132-55**
 micro standard
 5,5 mm

rechts
 right
 droite
 derecha
 retta



**BELLUCCI
 EE-137-55**
 micro standard
 5,5 mm

links
 left
 gauche
 izquierda
 sinistra



**SHEA
 EE-231-70**
 7,0 mm

aufgebogen
 bent upwards
 courbée vers le haut
 curva por arriba
 curva in alto



**BELLUCCI
 EE-133-55**
 micro standard
 5,5 mm

rechts
 right
 droite
 derecha
 retta



**SHEA
 EE-232-70**
 7,0 mm

Mikro-Ohrzängchen
 Micro Ear Forceps
 Pincés auriculaires micro
 Pinzas auriculares micro
 Pinze auricolari micro



EE-530-40 - EE-630-35

gerieft, gerade
 serrated, straight
 striée, droite
 estriada, recta
 con scanalatura, retta



EE-530-40
 4 mm

links, gerieft
 left, serrated
 gauche, striée
 izquierda, estriada
 sinistra, con scanalatura



EE-533-60
 6 mm

abwärts gebogen, gerieft
 downwards, serrated
 courbée en bas, striée
 curva hacia abajo, estriada
 curva in basso, con scanalatura



EE-534-40
 4 mm

gerieft, gerade
 serrated, straight
 striée, droite
 estriada, recta
 con scanalatura, retta



EE-530-70
 7 mm

rechts, gerieft
 right, serrated
 droite, striée
 derecha, estriada
 retta, con scanalatura



EE-535-60
 6 mm

gerieft, gerade
 serrated, straight
 striée, droite
 estriada, recta
 con scanalatura, retta



EE-630-35
 3,5 mm

glatt, gerade
 smooth, straight
 lisse, droite
 lisa, recta
 liscia, retta



EE-532-40
 4 mm

aufgebogen, gerieft
 bent upwards, serrated
 courbée vers le haut, striée
 curva por arriba, estriada
 curva in alto, con scanalatura



EE-537-40
 4 mm

Mikro-Ohrzängchen
 Micro Ear Forceps
 Pincés auriculaires micro
 Pinzas auriculares micro
 Pinze auricolari micro

rechts
 right
 droite
 derecha
 retta



EE-632-45
 4,5 mm

links
 left
 gauche
 izquierda
 sinistra



EE-633-45
 4,5 mm

gerade
 straight
 droite
 recta
 retta



EE-635-45
 4,5 mm



EE-637-50
 5,0 mm



EE-639-50
 5,0 mm

abgebogen
 bent downwards
 courbée vers le bas
 curva por abajo
 curva in baso



GREVEN
EE-730-50
 5,0 mm

abgebogen
 bent downwards
 courbée vers le bas
 curva por abajo
 curva in baso

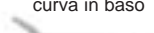

GREVEN
EE-731-40
 0,8 x 4,0 mm



EE-632-45 - EE-731-40

Hammerkopf-Zwickzängchen
 Malleus Nippers
 Pincés pour la tête du marteau
 Pinzas para la cabeza del martillo
 Pinze per la testa del martello

micro



EE-835-01

aufwärts
 upward
 en haut
 arriba
 in alto

mini



EE-837-01



EE-835-02

abwärts
 downward
 en bas
 abajo
 in basso



EE-837-02

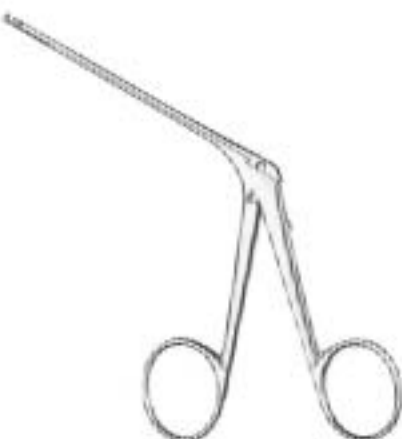

DIETER
EE-835-01 - EE-837-02

Modelle mit Ringgriff
 Ring Handle Patterns
 Modèles manches à anneaux
 Modelos mangos con anillos
 Modelli manici con anelli

Modelle mit Bleistiftgriff
 Pencil Handle Patterns
 Modèles manches crayon
 Modelos mango en forma de lapiz
 Modelli manico forma matita



EE-140-00 - EE-149-00
 micro
 RG

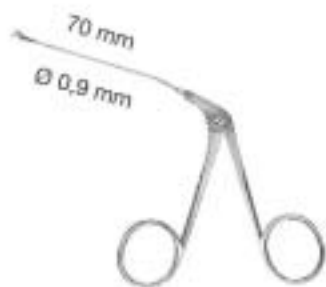

EE-240-00 - EE-249-00
 micro-mini
 RG

EE-140-00  **EE-340-00**

EE-142-00  **EE-342-00**

EE-143-00  **EE-343-00**

EE-145-00  **EE-345-00**

EE-147-00  **EE-347-00**

EE-149-00  **EE-349-00**

 **EE-349-08**

EE-240-00  **EE-440-00**

EE-242-00  **EE-442-00**

EE-243-00  **EE-443-00**

EE-245-00  **EE-445-00**

EE-247-00  **EE-447-00**

EE-249-00  **EE-449-00**



EE-340-00 - EE-349-08
 micro
 BG

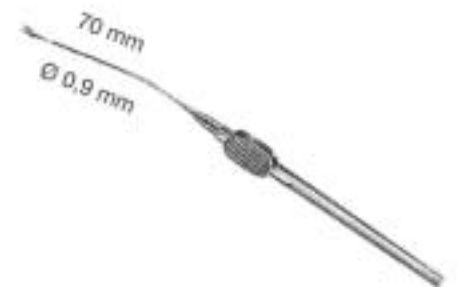

EE-440-00 - EE-449-00
 micro-mini
 BG



Modelle mit Ringgriff
 Ring Handle Patterns
 Modèles manches à anneaux
 Modelos mangos con anillos
 Modelli manici con anelli

EE-150-00 - EE-459-00
 micro
 RG

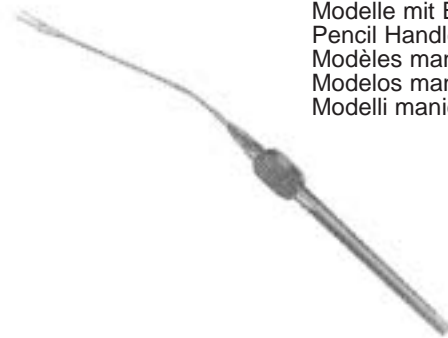

Modelle mit Bleistiftgriff
 Pencil Handle Patterns
 Modèles manches crayon
 Modelos mango en forma de lapiz
 Modelli manico forma matita

EE-160-00 - EE-469-00
 micro
 BG

EE-150-00		EE-160-00
EE-151-00		EE-161-00
EE-153-00		EE-163-00
EE-154-00		EE-164-00
EE-155-00		EE-165-00
EE-156-00		EE-166-00
EE-157-00		EE-167-00
EE-159-00		EE-169-00
EE-250-00		EE-260-00
EE-251-00		

Ø 1 mm Ø 1,5 mm Ø 2 mm Ø 2,5 mm

Ø 1 mm Ø 1,5 mm Ø 2 mm Ø 2,5 mm

EE-252-00	EE-258-00	EE-354-00	EE-450-00		EE-262-00	EE-268-00	EE-364-00	EE-460-00
EE-253-00	EE-259-00	EE-355-00	EE-451-00		EE-263-00	EE-269-00	EE-365-00	EE-461-00
EE-255-00	EE-351-00	EE-357-00	EE-453-00		EE-265-00	EE-361-00	EE-367-00	EE-463-00
EE-257-00	EE-353-00	EE-359-00	EE-455-00		EE-267-00	EE-363-00	EE-399-00	EE-465-00
			EE-456-00					EE-466-00
			EE-457-00					EE-467-00
			EE-458-00					EE-468-00
			EE-459-00					EE-469-00

Modelle mit Ringgriff
 Ring Handle Patterns
 Modèles manches à anneaux
 Modelos mangos con anillos
 Modelli manici con anelli

Modelle mit Bleistiftgriff
 Pencil Handle Patterns
 Modèles manches crayon
 Modelos mango en forma de lapiz
 Modelli manico forma matita



EE-550-00 - EE-859-00
 micro-mini
 RG



EE-560-00 - EE-869-00
 micro-mini
 BG

EE-550-00		EE-560-00
EE-551-00		EE-561-00
EE-553-00		EE-563-00
EE-554-00		EE-564-00
EE-555-00		EE-565-00
EE-556-00		
EE-557-00		EE-567-00
EE-559-00		EE-569-00
EE-650-00		EE-660-00
EE-651-00		
EE-652-00		EE-662-00
EE-653-00		EE-663-00
EE-655-00		EE-665-00
EE-657-00		EE-667-00
EE-856-00		EE-866-00
EE-857-00		EE-867-00
EE-858-00		EE-868-00
EE-859-00		EE-869-00



SCHUKNECHT
 EE-071-01



SCHUKNECHT
 EE-071-02



SCHUKNECHT
 EE-073-15
 15,5 cm



WULLSTEIN
 EE-074-15
 15,5 cm



TABB
 EE-075-15
 15,5 cm



PLESTER
 EE-076-35
 15,5 cm / 3,5 mm Ø



EE-079-10 1,0 mm
 EE-079-14 1,4 mm
 EE-079-16 1,6 mm
 EE-079-20 2,0 mm



EE-079-26 2,6 mm
 EE-079-28 2,8 mm
 EE-079-30 3,0 mm

ROSEN
 EE-079-10 - EE-079-30



BARBARA
 EE-170-15



BARBARA
 EE-171-15



BARBARA
 EE-173-15



ROSEN
 EE-175-15



	25°	45°	90°	
mm	BARBARA	BARBARA	BARBARA	BARBARA
0,3	EE-270-03	EE-272-03	EE-274-03	EE-275-05 = 0,5 mm
0,6	EE-270-06	EE-272-06	EE-274-06	EE-275-10 = 0,5 mm
1,0	EE-270-10	EE-272-10	EE-274-10	
1,2		EE-272-12	EE-274-12	
1,5		EE-272-15	EE-274-15	
2,0		EE-272-20	EE-274-20	
2,5		EE-272-25	EE-274-25	

EE-170-15 - EE-275-10

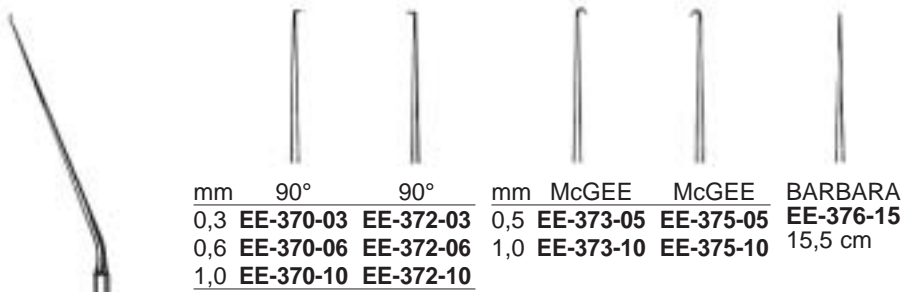

mm	90°	90°	mm	McGEE	McGEE	BARBARA
0,3	EE-370-03	EE-372-03	0,5	EE-373-05	EE-375-05	EE-376-15
0,6	EE-370-06	EE-372-06	1,0	EE-373-10	EE-375-10	15,5 cm
1,0	EE-370-10	EE-372-10				



EE-571-16 EE-573-16
 EE-575-16 EE-577-16

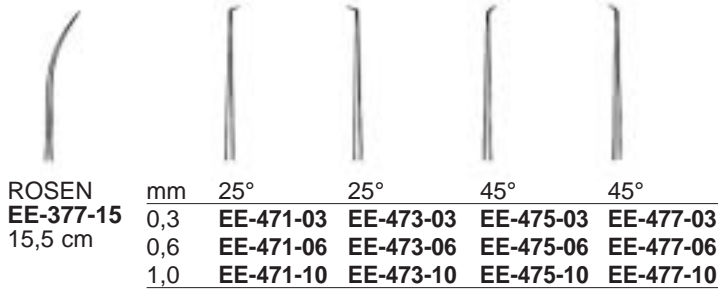

ROSEN	mm	25°	25°	45°	45°
EE-377-15	0,3	EE-471-03	EE-473-03	EE-475-03	EE-477-03
15,5 cm	0,6	EE-471-06	EE-473-06	EE-475-06	EE-477-06
	1,0	EE-471-10	EE-473-10	EE-475-10	EE-477-10

FISCH
 EE-571-16 - EE-577-16

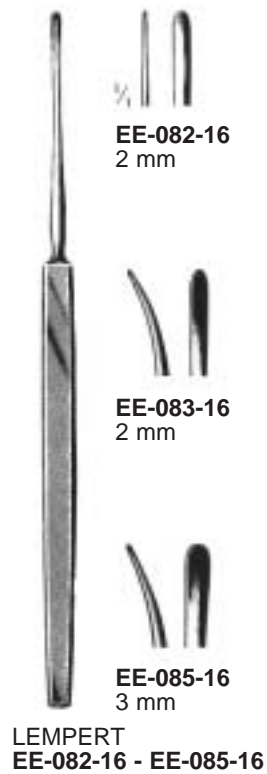

EE-082-16
 2 mm

EE-083-16
 2 mm

EE-085-16
 3 mm

LEMPERT
 EE-082-16 - EE-085-16

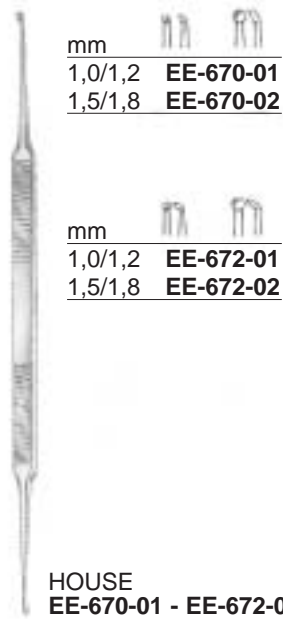

mm	
1,0/1,2	EE-670-01
1,5/1,8	EE-670-02

mm	
1,0/1,2	EE-672-01
1,5/1,8	EE-672-02

HOUSE
 EE-670-01 - EE-672-02

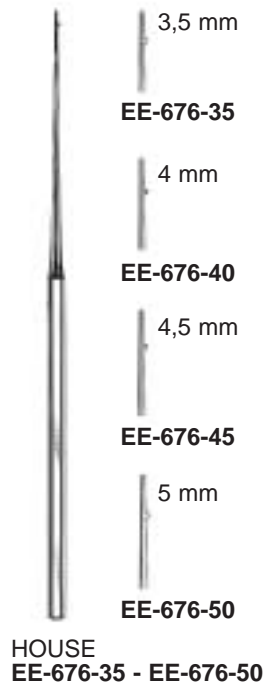

3,5 mm

EE-676-35

4 mm

EE-676-40

4,5 mm

EE-676-45

5 mm

EE-676-50

HOUSE
 EE-676-35 - EE-676-50



LEMPERT
 EE-087-20
 20,5 cm



mm	PASSOW
2 x 2	EE-180-01
3 x 3	EE-180-02

MUCK
 EE-182-13
 13 cm

EG

Rhinologie
Rhinology
Rhinologie
Rinología
Rinologia



EG

EG

Nasenspekula
Nasal Specula
Spéculums nasaux
Espéculos nasales
Specoli nasali



EG-500-01 Fig. 1
EG-500-02 Fig. 2
EG-500-03 Fig. 3
EG-500-04 Fig. 4



EG-500-05 Fig. 5
EG-500-06 Fig. 6
EG-500-07 Fig. 7

THUDICHUM
EA-500-01 - EA-500-07



EG-600-01
Fig. 1



EG-600-02
Fig. 2



EG-600-03
Fig. 2



VOLTOLINI
EG-600-01 - EG-600-03



EG-012-01
Fig. 1



EG-012-02
Fig. 2



EG-012-03
Fig. 3



HARTMANN-HALLE
EG-012-01 - EG-012-03
15 cm



Mod. Wien • Vienna •
Vienne • Viena

Baby • Bébé **EG-112-01**
Kind • child • enf. • niño • bamb. **EG-112-02**
Erw. • Adult. **EG-112-03**



Mod. Wien • Vienna
Vienne • Viena
EG-113-03
leichtes Modell
lightweight
mod. léger
mod. ligero
mod. leggero



TIECK-HALLE
EG-116-13
 13,5 cm



KILLIAN
EG-210-35 - EG-210-90
 13,5 cm

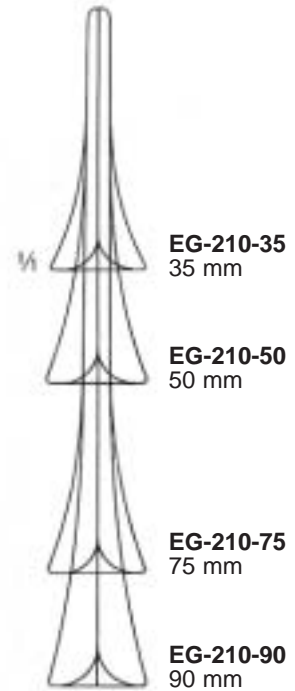

EG-210-35
 35 mm

EG-210-50
 50 mm

EG-210-75
 75 mm

EG-210-90
 90 mm



COTTLE
EG-214-35 - EG-214-90
 14 cm



COTTLE
EG-216-35 - EG-216-90
 schwarz • black • noirs
 negros • neri
 14 cm

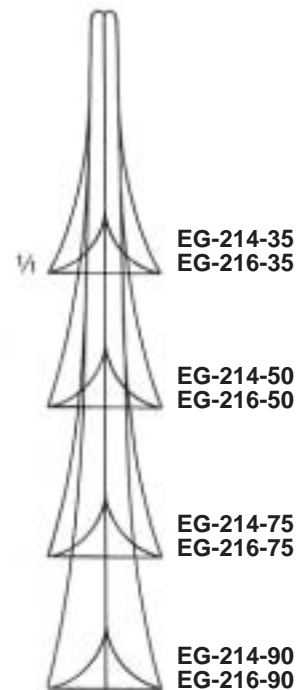

EG-214-35
EG-216-35

EG-214-50
EG-216-50

EG-214-75
EG-216-75

EG-214-90
EG-216-90



YANKAUER
EG-311-19
19 cm



MICHEL
EG-319-12 - EG-319-18
25 cm



EG-319-12
12 mm



EG-319-14
14 mm



EG-319-16
16 mm



EG-319-18
18 mm



TROELTSCH
EG-511-15
15 cm

TROELTSCH
EG-511-18
18 cm



JANSEN
EG-514-20
20 cm



HARTMANN
EG-611-16
16 cm



HARTMANN
EG-611-20
20 cm

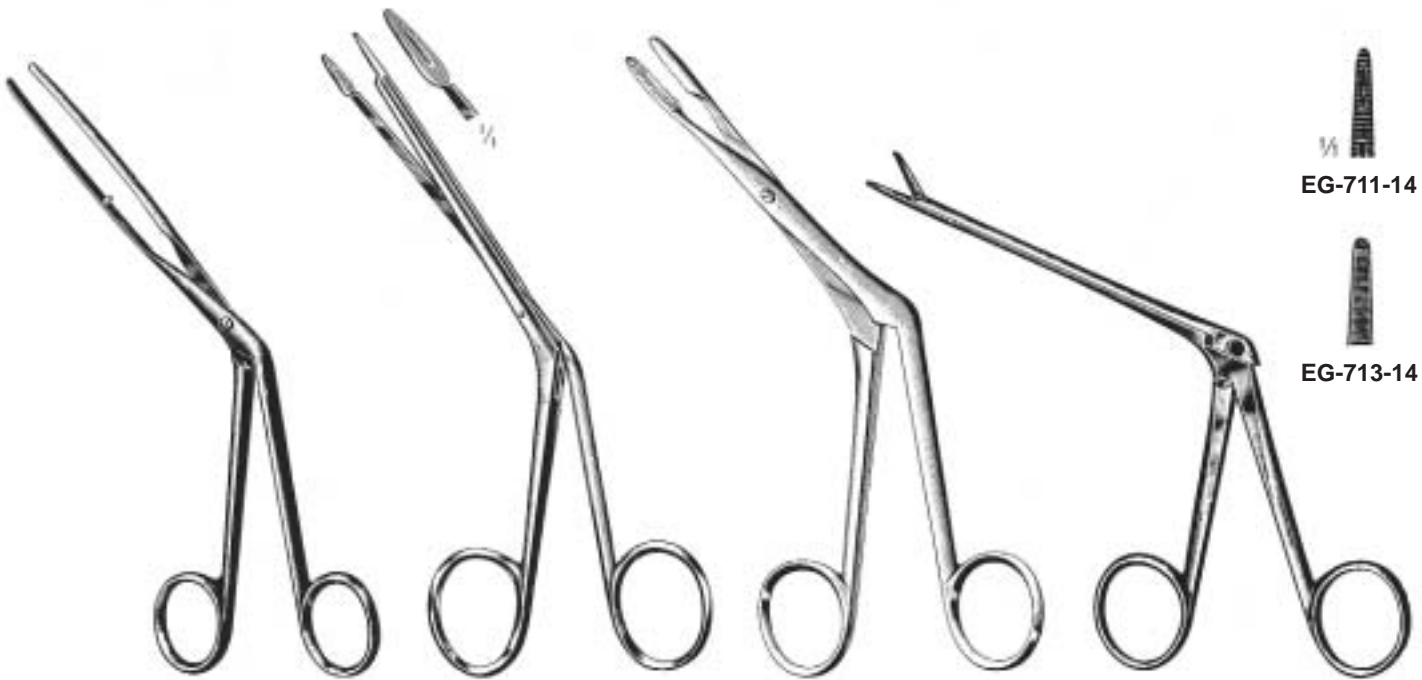

LUBET-BARBON
EG-615-20
 20 cm

LITTAUER
EG-617-18
 18 cm

HEYMANN-KNIGHT
EG-619-18
 18 cm

NOYES
EG-711-14 - EG-713-14
 14,5 cm



EG-811-01

EG-811-02

EG-811-03

HEYMANN
EG-811-01 - EG-811-03
 18 cm

KNIGHT
EG-815-18
 18 cm

BRUENINGS
EG-911-01 - EG-911-04
 19 cm

EG-911-01

EG-911-02

EG-911-03

EG-911-04



EG-915-01 Fig. 1
EG-915-02 Fig. 2



LUC
EG-915-01 - EG-915-02
 19 cm



EG-917-01 Fig. 1
EG-917-02 Fig. 2



LUC
EG-917-01 - EG-917-02
 19 cm

ohne Hals
 without neck
 sans cou
 sin cuello
 senza collo



mit Hals
 with neck
 avec cou
 con cuello
 con collo

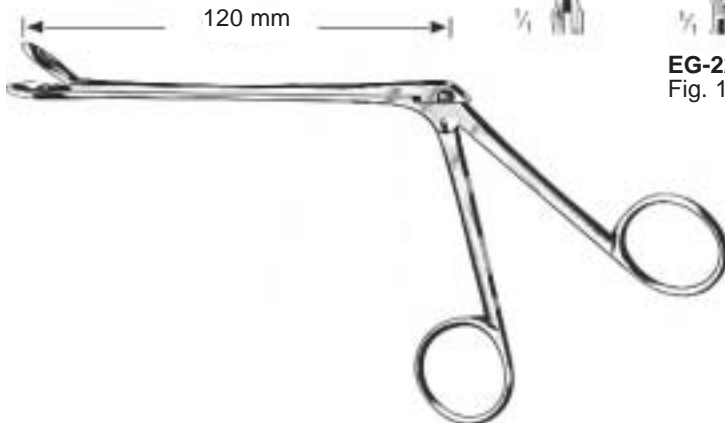

WEIL-BLAKESLEY
EG-221-01 - EG-223-05

Scharfe Nasenzangen
 Nasal Cutting Forceps
 Pincès coupantes nasales
 Pinzas cortantes nasales
 Pinze taglienti nasali



EG-321-01-EG-327-03
 19 cm



STRUYCKEN
EG-321-01
 Fig. 1



STRUYCKEN
EG-321-02
 Fig. 2

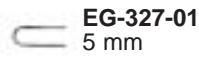

EG-327-01
 5 mm

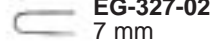

EG-327-02
 7 mm



EG-327-03
 9 mm



MYLES



EG-325-05



EG-325-07



EG-325-09



EG-325-11



HARTMANN



Septum- Quetschzange
 Septum Crushing Forceps
 Pince à éraiser la cloison
 Pinza para magullar tabique
 Pinza per ammaccare il setto

RUBIN
EG-521-21
 21 cm



mm x mm	KERRISON
3 x 3	EG-033-03
4 x 4	EG-033-04
5 x 5	EG-033-05
6 x 6	EG-033-06

17 cm

 **EG-035-01**
3, 5 mm

 **EG-035-02**
3, 5 mm



HAJEK-KOFLER
EG-035-01 - EG-035-02



mm	CITELLI
1,0	EG-131-10
2,5	EG-131-25
4,0	EG-131-40



BEYER
EG-135-20
2,0 mm



HAJEK-CLAUS
EG-230-20
20 mm



MIDDLETON-JANSEN
EG-233-19
 19 cm



MIDDLETON-JANSEN
EG-235-19
 19 cm



ø mm	LICHTWITZ
1,5	EG-430-15
1,8	EG-430-18
2,0	EG-430-20

Luer-Lock
 10 cm



KILLIAN
EG-431-03
 14 cm/3 mm ø



KRAUSE
EG-531-26
 26 cm



WILDE
EG-532-24
 24 cm



WILDE
EG-535-03
 0,3 mm



JOSEPF
 EG-730-16 - EG-733-16



EG-730-16
 stumpf • blunt • mousses
 romos • smussi



EG-731-16



EG-732-16
 spitz • pinted • pointus
 puntiagudos • acuti



EG-733-16



FREER
 EG-734-15
 15 cm



FREER
 EG-735-19
 19cm



JOSEPH
 EG-736-16
 16 cm



CONVERSE
 EG-739-16
 16 cm



CONVERSE
 EG-830-15
 15 cm



EG-832-15



COTTLE
 EG-834-15



EG-835-15

Septum-Messer
 Septum Knives
 Couteaux pour la cloison
 Cuchillos para tabique
 Coltelli per setto

EG

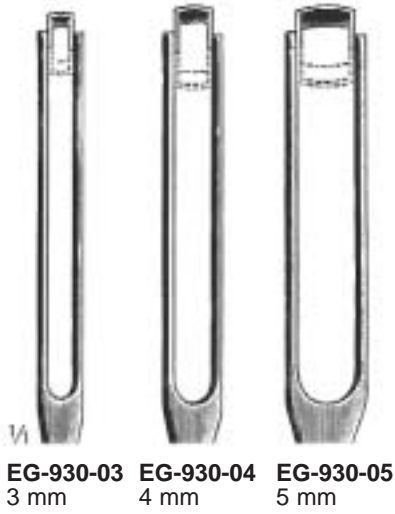

EG-930-03 3 mm
EG-930-04 4 mm
EG-930-05 5 mm

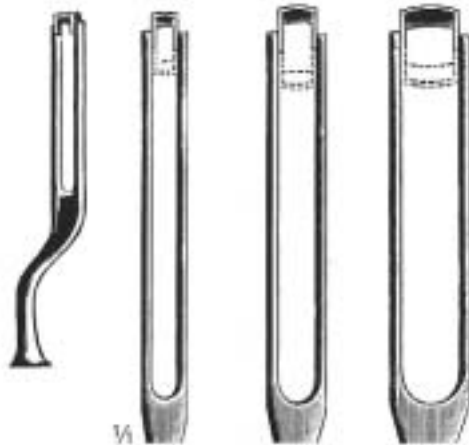

EG-932-03 3 mm
EG-932-04 4 mm
EG-932-05 5 mm



BRUENINGS
EG-938-16
 16,5 cm

BALLENGER
EG-930-03 - EG-932-05
 20 cm

Septum-Elevatorien
 Septum Elevators
 Élévateurs pour la cloison nasale
 Elevadores para tabique
 Elevatori per setto

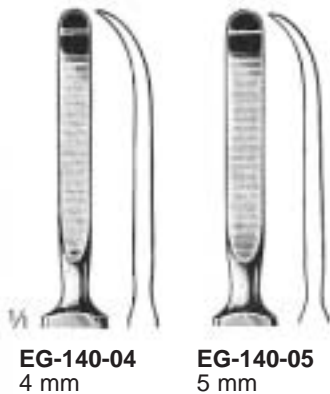

EG-140-04 4 mm
EG-140-05 5 mm

McKENTY
EG-140-04 - EG-140-05
 15 cm



ROGER
EG-143-19
 19 cm



FREER
EG-145-18
 18 cm



FREER
EG-147-19
 19 cm



FREER
EG-149-19
 19 cm



**COTTLE
EG-241-23**
23 cm



**COTTLE
EG-243-22**
22 cm



**JOSEPH
EG-245-16**
16 cm



**COTTLE
EG-245-19**
19cm



**KILLIAN
EG-246-22**
19cm

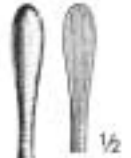

**HAJEK-BALLENGER
EG-248-21**
22 cm



**BALLENGER
EG-340-22**
2 cm



**FREER
EG-540-04**
4 mm



**FREER
EG-541-04**
4 mm



EG-544-04
4 mm

EG-544-07
7 mm

EG-544-09
9 mm

EG-544-12
12 mm

COTTLE
EG-544-04 - EG-544-12
 18 cm



COTTLE
EG-545-06
 18 cm/6 mm

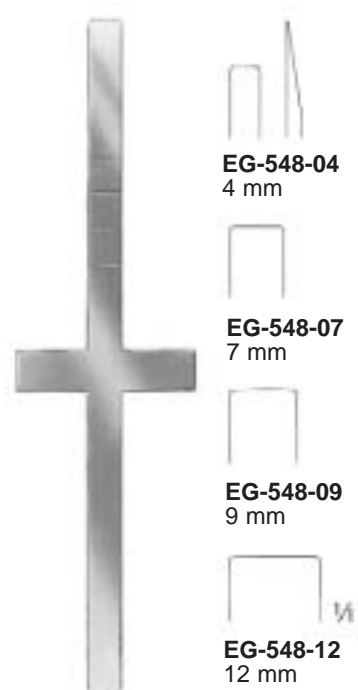

EG-548-04
4 mm

EG-548-07
7 mm

EG-548-09
9 mm

EG-548-12
12 mm

COTTLE
EG-548-04 - EG-548-12

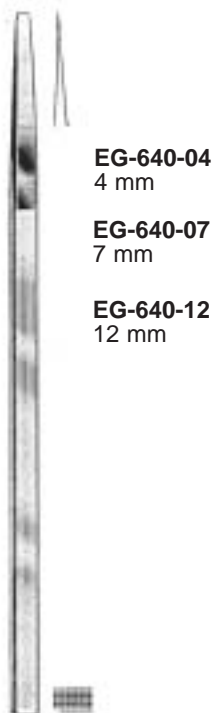

EG-640-04
4 mm

EG-640-07
7 mm

EG-640-12
12 mm

COTTLE
EG-640-04 - EG-640-12
 18 cm

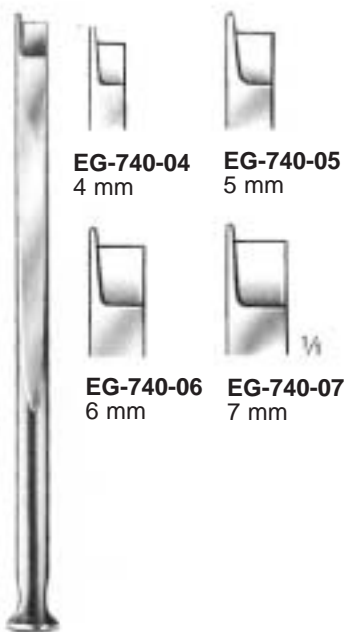

EG-740-04
4 mm

EG-740-05
5 mm

EG-740-06
6 mm

EG-740-07
7 mm

FOMON
EG-740-04 - EG-740-07
 17 cm

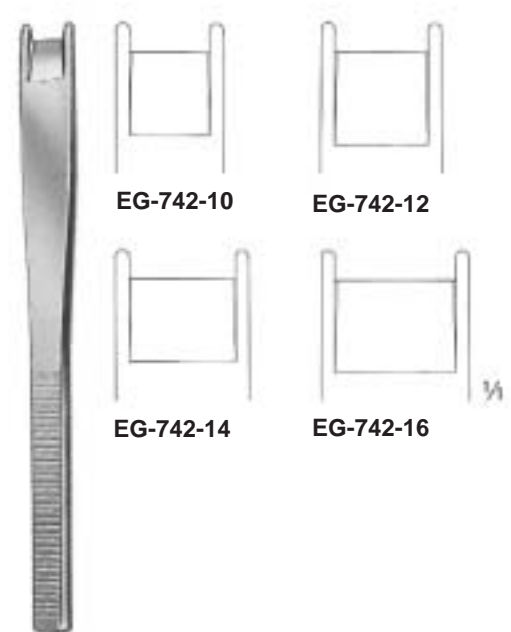

EG-742-10

EG-742-12

EG-742-14

EG-742-16

FOMON
EG-742-10 - EG-742-16

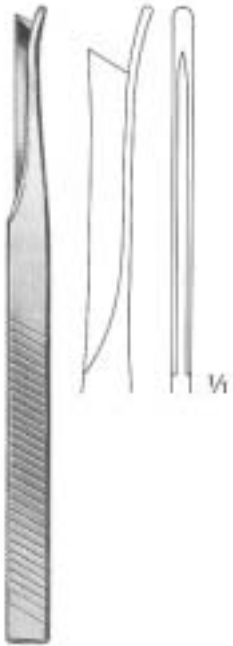

SILVER
EG-743-01
18 cm

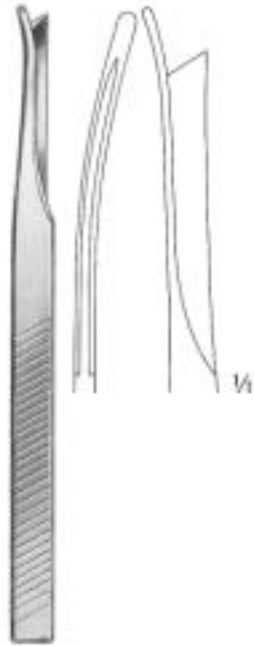

SILVER
EG-743-02
18 cm



SILVER
EG-743-03
18 cm



KILLIAN-CLAUS
EG-842-05
17 cm/5 mm



mm	HAJEK
4	EG-844-04
6	EG-844-06
8	EG-844-08



WEST
EG-846-16
16 cm



WEST
EG-847-16
16 cm



FREER
EG-849-16
6 mm

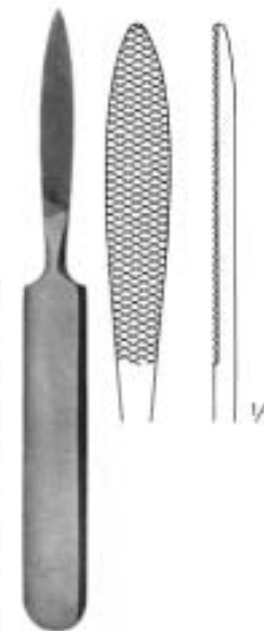

JOSEPH
EG-052-16
16 cm

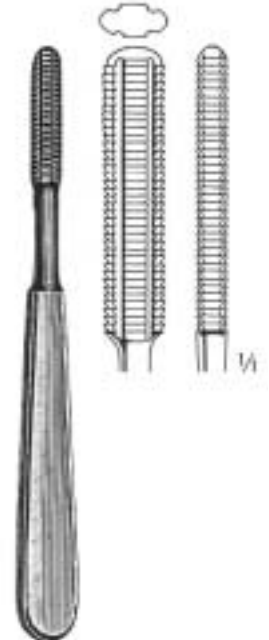

MALTZ
EG-054-18
18 cm



EG-057-18

EG-057-19

WIENER
 EG-057-18 - EG-057-19
 18 cm



EG-151-21

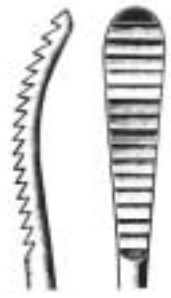

EG-153-21

WIENER (AUFRICHT)
 EG-151-21 - EG-153-21
 21 cm



EG-154-16
 fein • fine
 fina



EG-156-16
 grob • coarse • gruesa
 entellure grosse
 dentellatura grossa

JOSEPH (LEWIS)
 EG-154-16 - EG-156-16
 18 cm

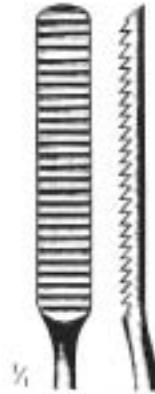

MALTZ (COTTLE)
 EG-158-21
 21 cm

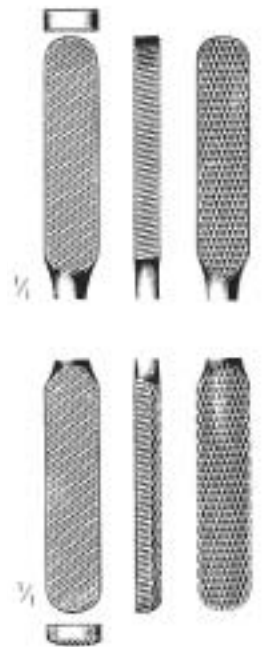

FOMON
 EG-250-21
 21 cm



FOMON
20 cm TC

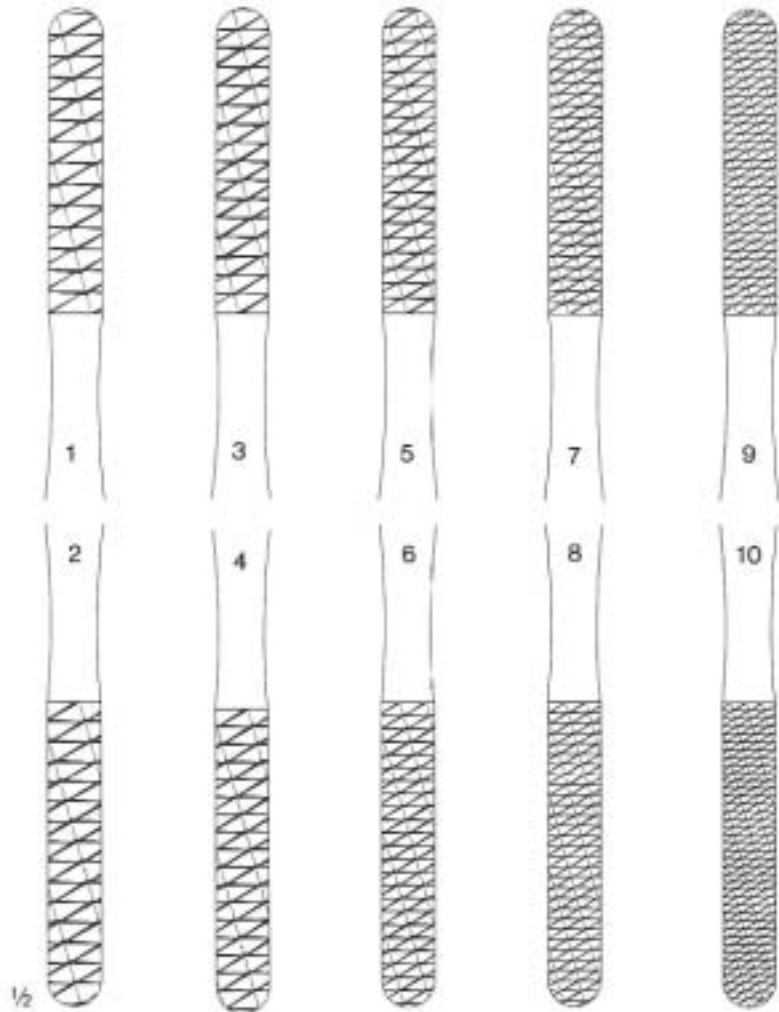

Fig. 1/2

EG-252-01

Fig. 3/4

EG-252-03

Fig. 5/6

EG-252-05

Fig. 7/8

EG-252-07

Fig. 9/10

EG-252-09

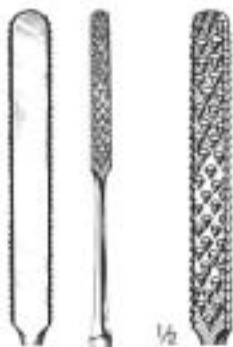

Fig. 1

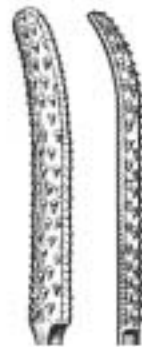

Fig. 2

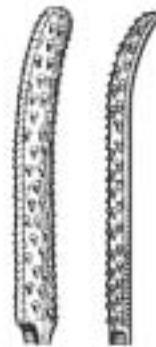

Fig. 3



GALLAHER

EG-256-16

EG-257-16

EG-259-16

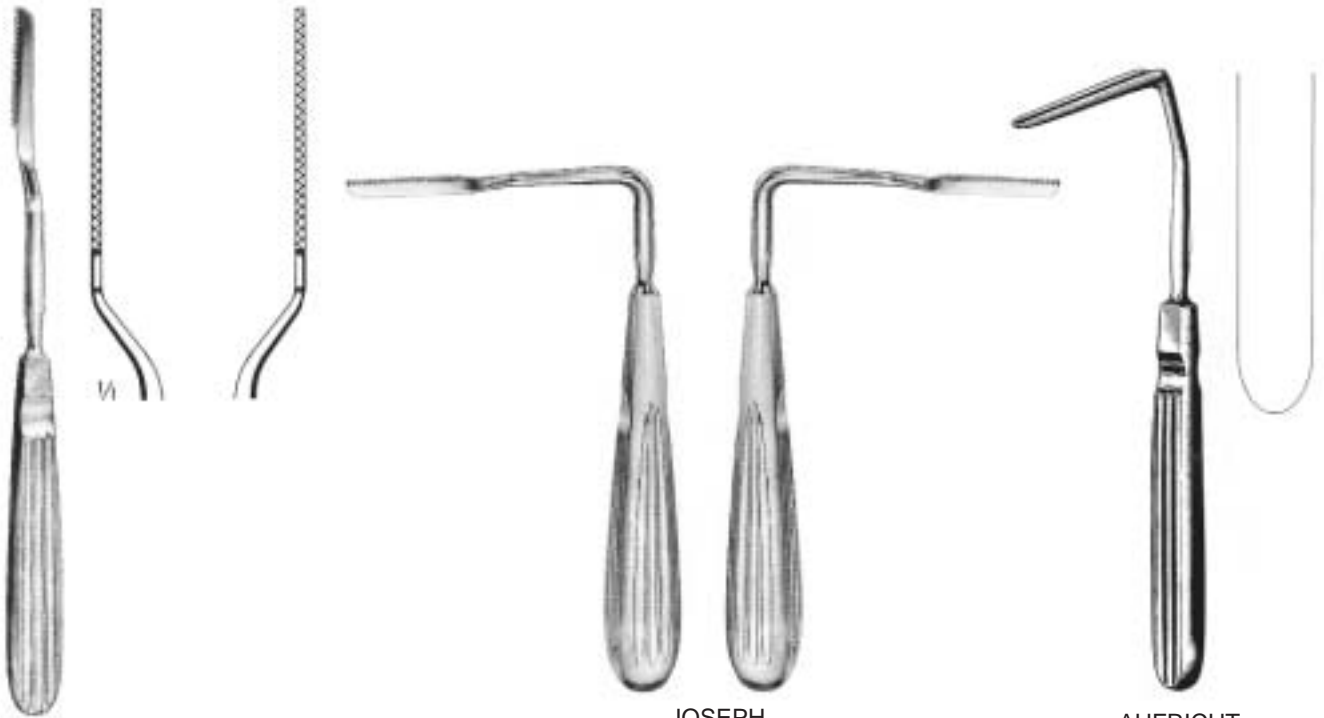

JOSEPH
EG-355-01 17 cm EG-355-01

AUFRICHT
EG-551-16
19 cm

JOSEPH
19 cm
EG-352-19 links • left
à gauche
izquierda
a sinistra
EG-354-19 rechts • right •
á droite
derecha
a destra



COTTLE
EG-556-14

FOMON
EG-556-16

FOMON
EG-557-17

COTTLE-NEIVERT
EG-559-20

Fig. 1 GILLIES
EG-650-18
Fig. 2 EG-652-18
18 cm



ASCH
EG-751-23
23 cm



WALSHAM
EG-752-23 - EG-755-23
23 cm



EG-752-23
gerade
straight
droite
recta
retta



EG-753-23
links
left
à gauche
izquierda
a sinistra



EG-755-23
rechts
right
à droite
derecha
a destra



JATHO
EG-955-15



FAULKNER
EG-061-21
21 cm



EG-067-01
Fig. 1



EG-067-02
Fig. 2



EG-067-02
Fig. 3



EG-067-04
Fig. 4



EG-067-05
Fig. 5



EG-067-06
Fig. 6



COAKLEY
EG-067-01 - EG-067-06
17 cm



EG-260-01
Fig. 1



EG-260-02
Fig. 2



BECKMANN
EG-260-01 - EG-260-06
22 cm



EG-260-03
Fig. 3



EG-260-04
Fig. 4



EG-260-05
Fig. 5



EG-260-06
Fig. 6



BARNHILL
EG-360-01 - EG-360-04
21 cm



EG-360-01
Fig. 1



EG-360-02
Fig. 2



EG-360-03
Fig. 3



EG-360-04
Fig. 4



EG-461-01
Fig. 1



EG-461-02
Fig. 2



EG-461-03
Fig. 3

Ersatzklingen, gelocht
Spare blades, perforated
Lames de rechange, perforées
Hojas de repuesto, perforadas
Lame di ricambio, forate

Fig.

- | | |
|---|------------------|
| 1 | EG-462-01 |
| 2 | EG-462-02 |
| 3 | EG-462-03 |



St. CLAIR-THOMSON
EG-366-01 - EG-366-04
21 cm



EG-366-01
Fig. 1



EG-366-03
Fig. 3



EG-366-02
Fig. 2



EG-366-04
Fig. 4



LAFORCE
EG-461-01 - EG-641-03
25 cm

EI

**Mund und Zunge
Mouth and Tongue
Bouche et langue
Boca y lengua
Bocca e lingua**



EI



EI-012-16
 16 cm
 Holz • wood •
 bois • madera • legno



FRENZEL
EI-015-16
 16,5 cm



BRUENINGS
EI-017-19
 19 cm



BUCHWALD
EI-019-19
 19 cm



HARTMANN
EI-111-15
 15 cm



EI-115-01 **EI-115-02**
 Fig. 1, 14 cm Fig. 2, 15 cm

WIEDER
EI-115-01 - EI-115-02



ANDREW
EI-117-11
 11 cm



TOBOLD
EI-119-14
 14,5 cm



cm	STERNBERG
14	EI-227-14
16	EI-227-16
18	EI-227-18



cm	STERNBERG
12	EI-229-12
14	EI-229-14
16	EI-229-16

Zungenzangen • Tongue Holding Forceps
 Pincas tire-langue • Pinzas tiralengua
 Pinze tiralingua



EI-320-11
 11 cm



EI-325-19
 19 cm



cm	Collin
16	EI-520-16
18	EI-520-18



YOUNG
EI-525-16
 16 cm



EI-525-99
 Ersatz (Paar)
 Spare (Pair)
 Rechange (paire)
 Repuesto (pareja)
 Ricambio (coppia)

Mundsperrer • Mouth Gags
 Ouvre-bouche • Abrebocas
 Apribocca



DOYEN-JANSEN (MOLT)
EI-625-12
 12 cm



DOYEN-JANSEN (MOLT)
EI-625-14
 14 cm



DENHART	cm
EI-627-12	16
12 cm	19



ROSER-KOENIG
EI-720-16
EI-720-19



HEISTER
EI-722-13
 13 cm



cm	JENNINGS
9	EI-724-09
11	EI-724-11
13	EI-724-13
15	EI-724-15



cm	WHITEHEAD
11	EI-820-11
13	EI-820-13
15	EI-820-15



cm	WHITEHEAD
11	EI-821-11
13	EI-821-13
15	EI-821-15



cm	SEEMANN-SEIFFERT
9	EI-825-09
11	EI-825-11
13	EI-825-13
15	EI-825-15



EI-130-10

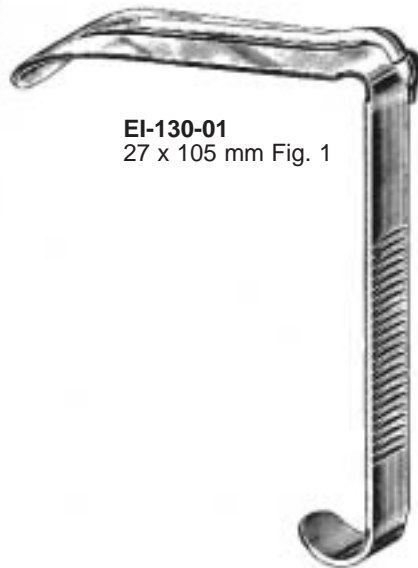

EI-130-01
 27 x 105 mm Fig. 1

DAVIS-BOYLE
 EI-130-00
 compl.



EI-130-02
 25 x 90 mm Fig. 2



EI-130-03
 25 x 75 mm Fig. 3



EI-130-04
 22 x 60 mm Fig. 4



EI-130-05
 20 x 25 mm Fig. 5



EI-135-10



EI-135-01
28 x 65 mm
Fig. 1



EI-135-02
32 x 75 mm
Fig. 2



EI-135-03
37 x 80 mm
Fig. 3



EI-135-99

KILNER-DOUGHTY
EI-135-00
compl.



EI-230-10



EI-230-01
27 x 95 mm
Fig. 1



EI-230-02
22 x 85 mm
Fig. 2



EI-230-03
22 x 70 mm
Fig. 3

McIVOR
EI-230-00
compl.



MAUNDER
EI-630-10



PITHA
EI-635-10



LANGENBECK
EI-731-01 Fig. 1 EI-731-02 Fig. 2 EI-731-03 Fig. 3

links
left side
côté gauche
izquierda
lato sinistro



rechts
right side
côté droit
derecha
lato destro

cm	ROWE	ROWE	
22,5	EI-051-22	EI-053-22	Säugling • baby • bébé • bebé • lattante
23,5	EI-051-23	EI-053-23	Kinder • child • enfant • niño • bambino
24	EI-051-24	EI-053-24	Erwachsene • adult

FA

**Tonsillen
Tonsils
Amygdales
Amígdalas
Tonsille**



FA

FA

Tonsillen
Tonsils
Amygdales
Amígdalas
Tonsille



mm	LOVE
18	FA-013-18
20	FA-013-20
22	FA-013-22



HOFER
FA-019-24
24 cm



NAGER
FA-111-23
23 cm



HURD
FA-311-22
glatt • smooth
liso • liscio
22 cm

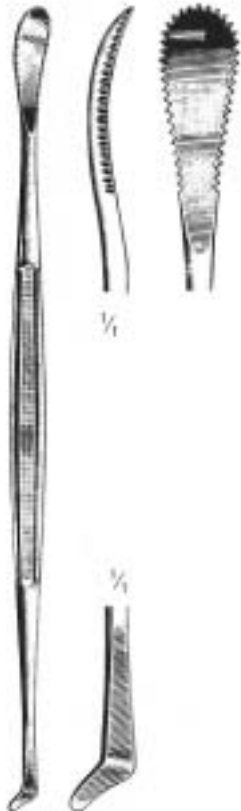

HENKE
FA-315-23
23 cm

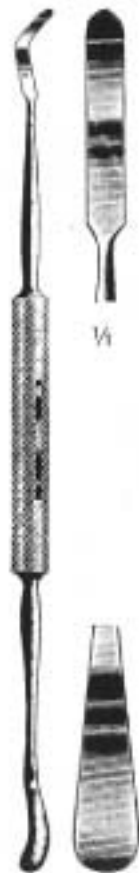

CARPENTER
FA-319-25
25 cm



CARPENTER
FA-413-24
24 cm



LUNIATSCHEK
FA-511-19
19 cm

FA-313-22
gezahnt • serrated
dentelé • dentado
dentellato
22 cm

Tonsillen
Tonsils
Amygdales
Amígdalas
Tonsille

FA



DUPUY-WEISS
FA-615-22 FA-617-22
22 cm

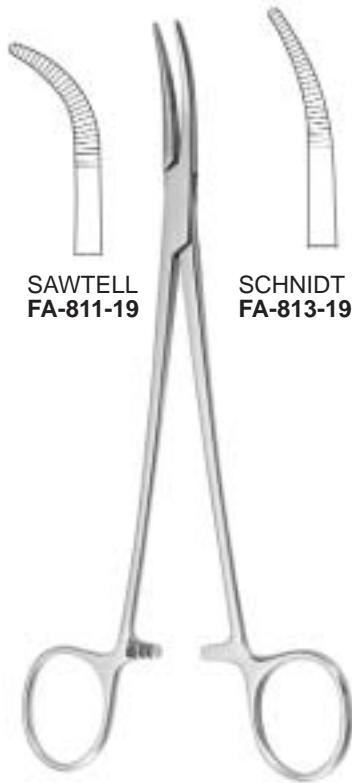

SAWTELL
FA-811-19

SCHNIDT
FA-813-19

FA-811-19 - FA-813-19
19 cm

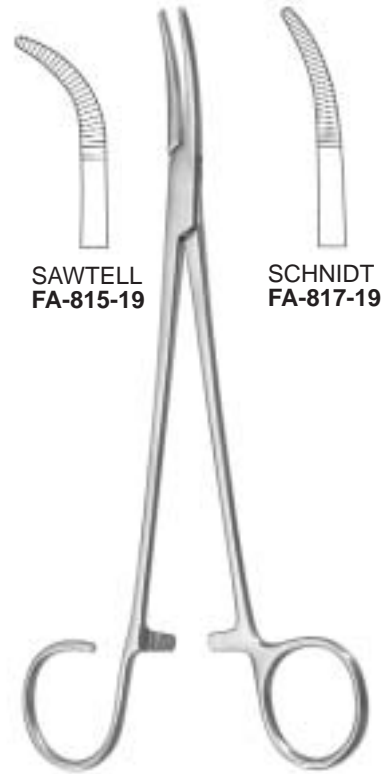

SAWTELL
FA-815-19

SCHNIDT
FA-817-19

FA-815-19 - FA-817-19
19 cm

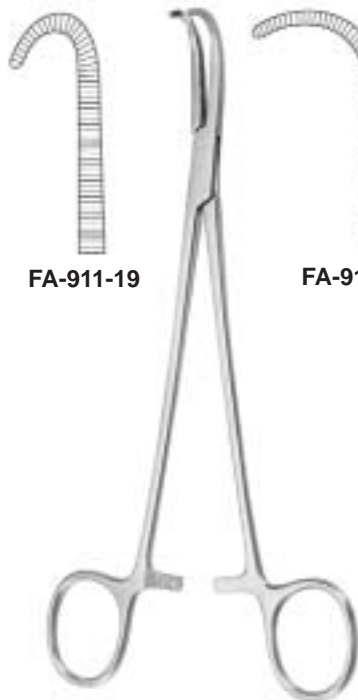

FA-911-19

FA-913-19

NEGUS
FA-911-19 - FA-913-19
19 cm

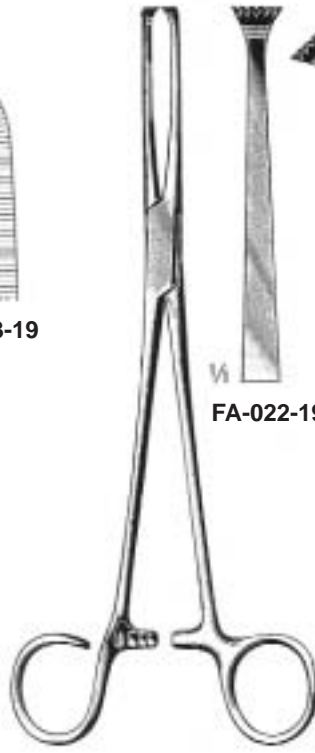

FA-022-19

FA-023-19

COLVER
FA-022-19 - FA-023-19
19 cm



cm WHITE
18 FA-025-18
23 FA-025-23

FA

Tonsillen
Tonsils
Amygdales
Amígdalas
Tonsille



BALLENGER
FA-027-21
21,5 cm



BLOHMKE
FA-029-20
20 cm

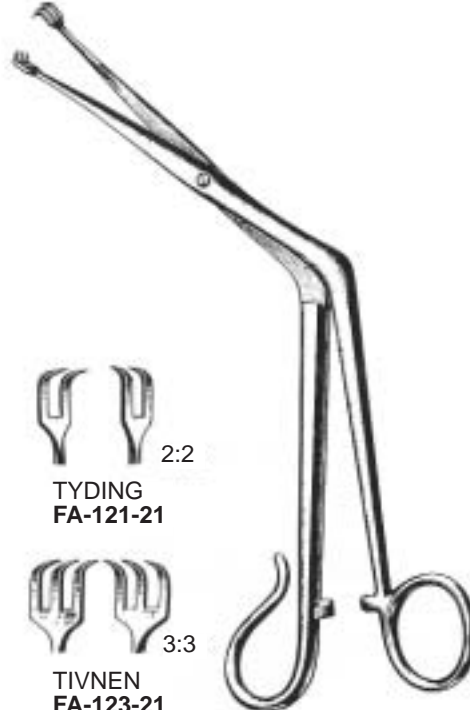

TYDING
FA-121-21



TIVNEN
FA-123-21

FA-121-21 - FA-123-21
21 cm



MARSCHIK
FA-129-20
22cm



CORWIN
FA-321-14
14 cm



EVES
FA-520-28
28 cm



EVES
FA-522-28
28 cm



BRUENINGS
FA-526-28
28 cm



mm		FA-529-03
40	FA-527-40	0,3 mm
50	FA-527-50	12 x
	100 x	



Tonsillen
Tonsils
Amygdales
Amígdalas
Tonsille

FA

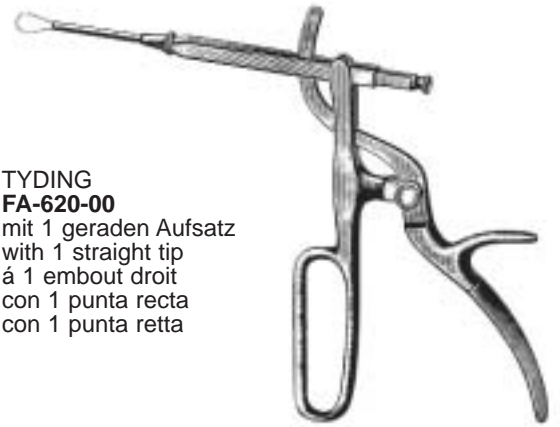

TYDING
FA-620-00
mit 1 geraden Aufsatz
with 1 straight tip
à 1 embout droit
con 1 punta recta
con 1 punta retta

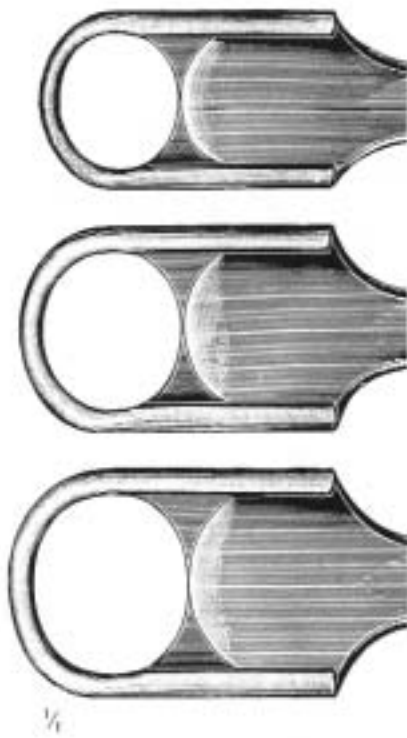

SLUDER-BALLENGER
FA-720-00
mit 3 Aufsätzen
with 3 blades
avec 3 lames
con 3 hojas
con 3 lame



FA-922-00



FA-923-45
45°

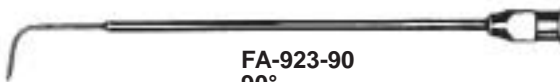

FA-923-90
90°



ml
2 **FA-920-02**
5 **FA-920-05**
10 **FA-920-10**

FC

**Kehlkopf
Larynx
Larynx
Laringe
Laringe**



FC

FC

Kehlkopf
Larynx
Larynx
Larynx
Larynx



JACKSON
FC-011-22 - FC-013-22
22 cm



FC-011-22



FC-013-22



FRAENKEL
FC-111-18
18 cm

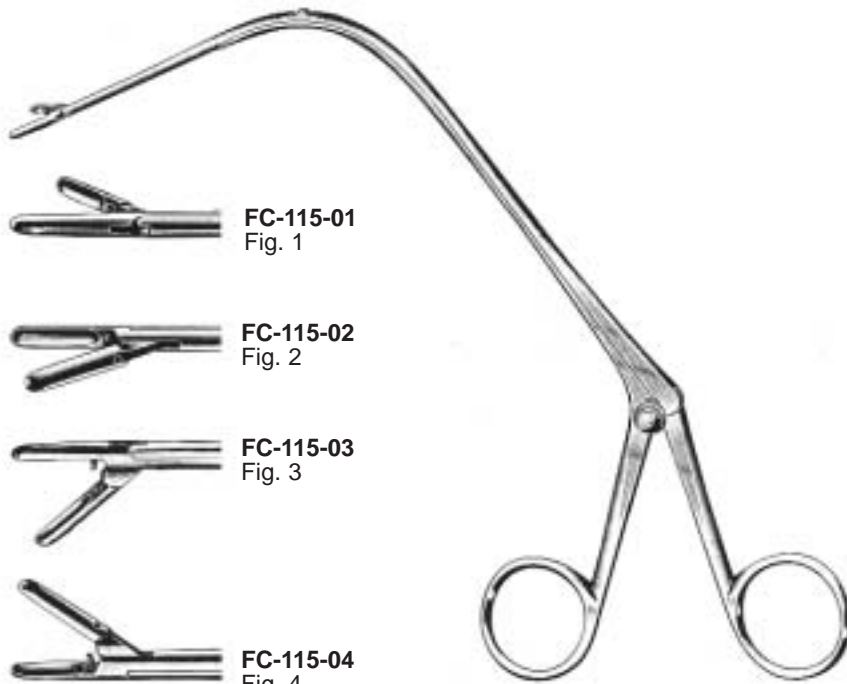

FC-115-01
Fig. 1



FC-115-02
Fig. 2



FC-115-03
Fig. 3



FC-115-04
Fig. 4

JURASZ
FC-115-01 - FC-115-04
23 cm



REICHERT
FC-211-24
24 cm



HUBER
FC-310-00



cm	BRUENINGS
20	FC-312-20
30	FC-312-30
40	FC-312-40
50	FC-312-50
60	FC-312-60



BRUENINGS
FC-311-20
20 cm



FRAENKEL
FC-510-00



SEIFFERT
FC-512-00



FRAENKEL
FC-514-00



SCHEINMANN
FC-515-00



SCHEINMANN
FC-517-00

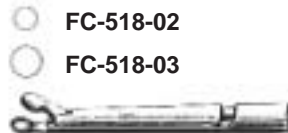

BRUENINGS
FC-518-02 - FC-518-03

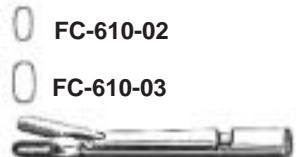

BRUENINGS
FC-610-02 - FC-610-03



LANGE
FC-612-00

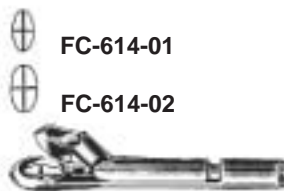

FC-614-01

FC-614-02

KRAUSE
FC-614-01 - FC-614-02



KRAUSE
FC-616-00

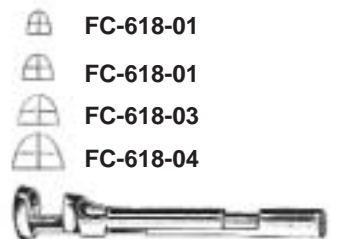

FC-618-01

FC-618-01

FC-618-03

FC-618-04

CORDES
FC-618-01 - FC-618-04



SCHUMACHER
FC-710-00

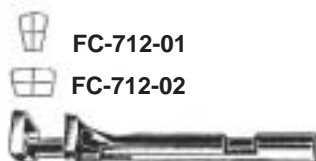

FC-712-01

FC-712-02

GORDES
FC-712-01 - FC-712-02



GORDES
FC-714-00



ROSENBERG
FC-716-00



CHEVALIER-JACKSON
FC-320-01 - FC-620-07



cm	Fig. 1	Fig. 2	Fig. 3	Fig. 4	Fig. 5	Fig. 6	Fig. 7
30	FC-320-01	FC-320-02	FC-320-03	FC-320-04	FC-320-05	FC-320-06	FC-320-07
40	FC-420-01	FC-420-02	FC-420-03	FC-420-04	FC-420-05	FC-420-06	FC-420-07
50	FC-520-01	FC-520-02	FC-520-03	FC-520-04	FC-520-05	FC-520-06	FC-520-07
60	FC-620-01	FC-620-02	FC-620-03	FC-620-04	FC-620-05	FC-620-06	FC-620-07

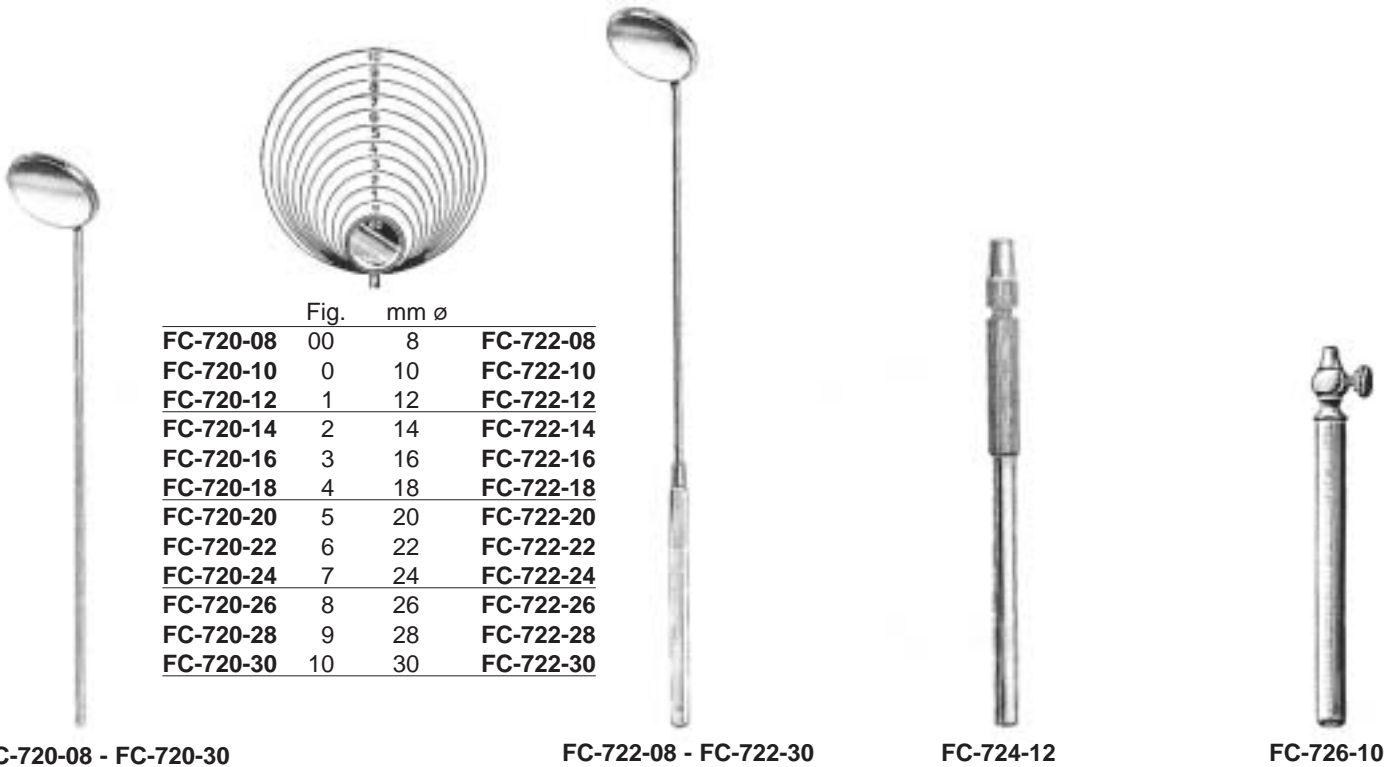

	Fig.	mm ø	
FC-720-08	00	8	FC-722-08
FC-720-10	0	10	FC-722-10
FC-720-12	1	12	FC-722-12
FC-720-14	2	14	FC-722-14
FC-720-16	3	16	FC-722-16
FC-720-18	4	18	FC-722-18
FC-720-20	5	20	FC-722-20
FC-720-22	6	22	FC-722-22
FC-720-24	7	24	FC-722-24
FC-720-26	8	26	FC-722-26
FC-720-28	9	28	FC-722-28
FC-720-30	10	30	FC-722-30

FC-720-08 - FC-720-30

FC-722-08 - FC-722-30

FC-724-12

FC-726-10

FE

**Tracheotomie, Kropf
Tracheostomy, Goitre
Trachéotomie, Goitre
Traqueotomía, Bocio
Tracheotomia, Gozzo**

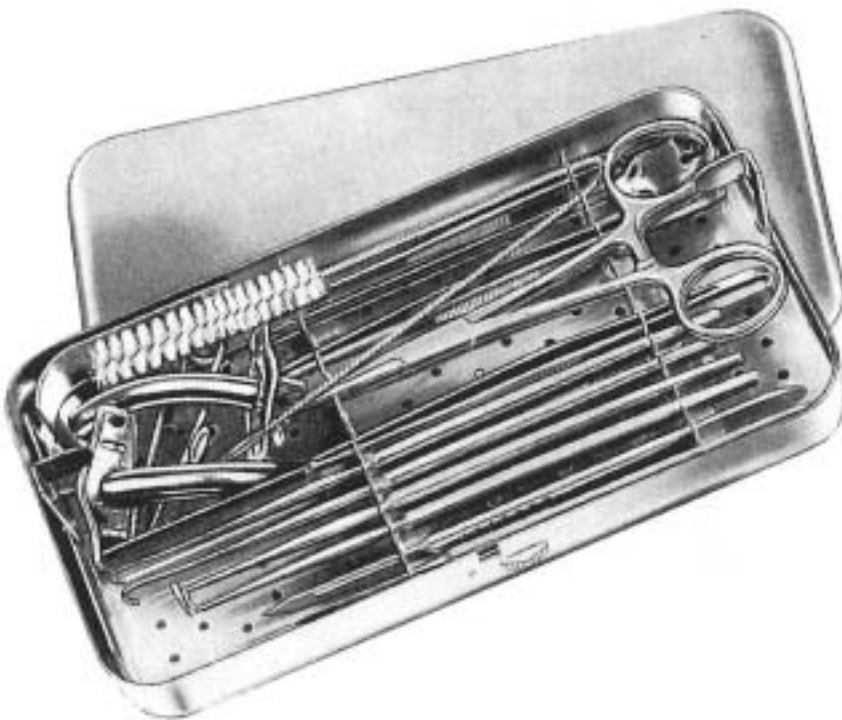

FE

FE

Tracheotomie
Tracheostomy
Trachéotomie
Traqueotomía
Tracheotomia

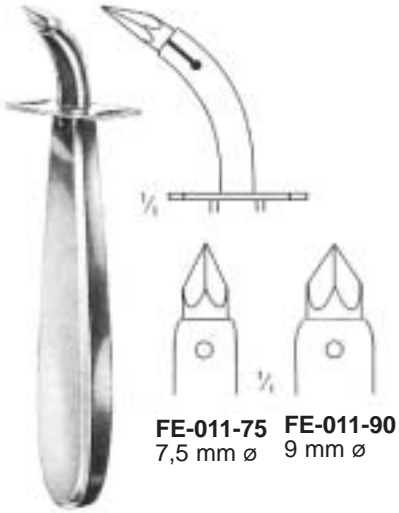

FE-011-75 7,5 mm ø
FE-011-90 9 mm ø

UCKERMANN
FE-011-75 - FE-011-90
13 cm



TROUSSEAU
FE-111-14
14 cm



LABORDE
FE-113-14
14 cm



BOSE
FE-115-07
7 cm



JACKSON
FE-116-15
15 cm



JACKSON
FE-117-17
17 cm



ITERSON
FE-118-16 - FE-119-16
16 cm



BOSE
FE-212-16
16 cm



BOSE
FE-214-16
16 cm



ROSE
FE-310-13
13 cm



mm	WAGENER-MOSHER
5	FE-511-05
7	FE-511-07
9	FE-511-09



FE-720-00



Fig.	mm	LUER
0	4	FE-220-04
1	5	FE-220-05
2	6	FE-220-06
3	7	FE-220-07
4	8	FE-220-08
5	9	FE-220-09
6	10	FE-220-10
7	11	FE-220-11
8	12	FE-220-12
9	13	FE-220-13



Fig.	mm	JACKSON
0	4	FE-420-04
1	5	FE-420-05
2	6	FE-420-06
3	7	FE-420-07
4	8	FE-420-08
5	9	FE-420-09
6	10	FE-420-10
7	11	FE-420-11
8	12	FE-420-12
9	13	FE-420-13



FE-051-15 **FE-053-15**

KOCHER
FE-051-15 - FE-053-15
15 cm



SCHOENBORN
FE-151-21
21 cm



cm	LAHEY
15	FE-250-15
20	FE-250-20



MASTIN
FE-253-17
17 cm

FG

**Thorax
Thorax
Thorax
Tórax
Torace**

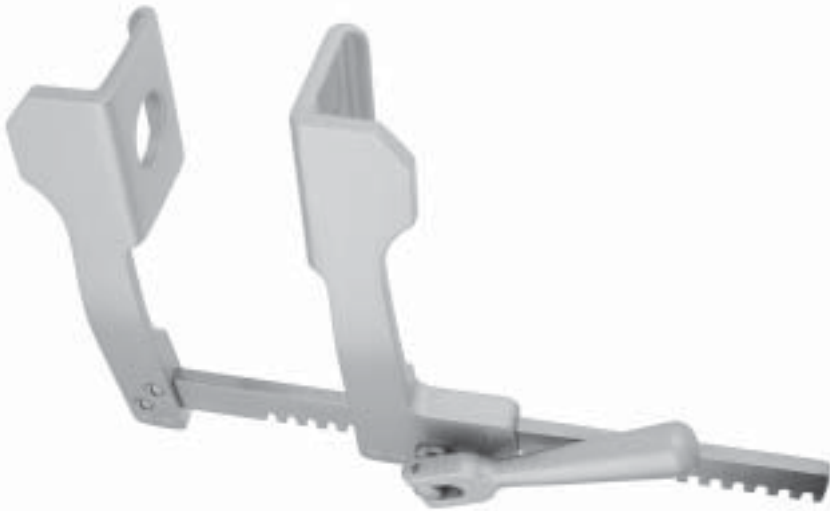

FG

FG

Rippenscheren
Rib Shears
Costotomes
Costótomos
Costotomi



Rippenschere mit ziehendem Schnitt
Rib shears with drawing cut
Costotome avec lame excentrée
Costótomo con hoja de retroacción
Costotomo con lama eccentrica a scorrimento



GLUCK
FG-017-22
22,0 cm



STILLE
FG-111-21
21,0 cm

FG

Rippenscheren
Rib Shears
Costotomes
Costótomos
Costotomi

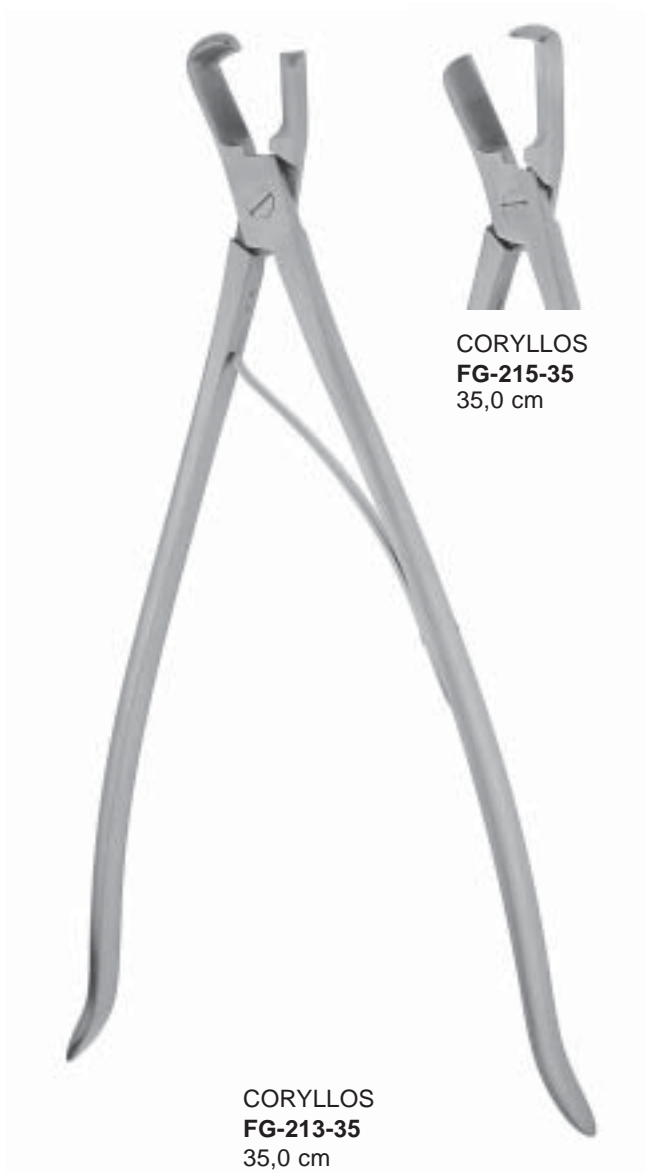



COOLEY
FG-218-35
35,0 cm



SAUERBRUCH
FG-311-26
26,0 cm

FG

Rippenscheren
Rib Shears
Costotomes
Costótomos
Costotomi

für die erste Rippe
for the first rib
pour la première côte
para la primera costilla
per la prima costola



GIERTZ-STILLE
FG-317-27
27,0 cm



SAUERBRUCH-FREY
FG-411-36
36,0 cm



BRUNNER
FG-417-28
32,0 cm

für die rechte Hand
for right hand
pour la main droite
para la mano derecha
per la mano destra

BRUNNER
FG-419-28
32,0 cm

für die linke Hand
for left hand
pour la main gauche
para la mano
izquierda
per la mano sinistra

Sternum Schere
Sternum scissors
Ciseaux a sternum
Tijera de esternón
Forbici per sterno



SCHUMACHER
FG-418-21
21,0 cm

FG

Rippensperrer
Rib Spreaders
Ecarteurs des côtes
Separadores costales
Divaricatori costali

Blatt • Blade • valve • hoja • valva		
Spreizung Spread Ecartement Abertura Apertura	Tiefe Depth profondité profundidad profondità	Breite Width largeur ancho larghezza
A	B	C

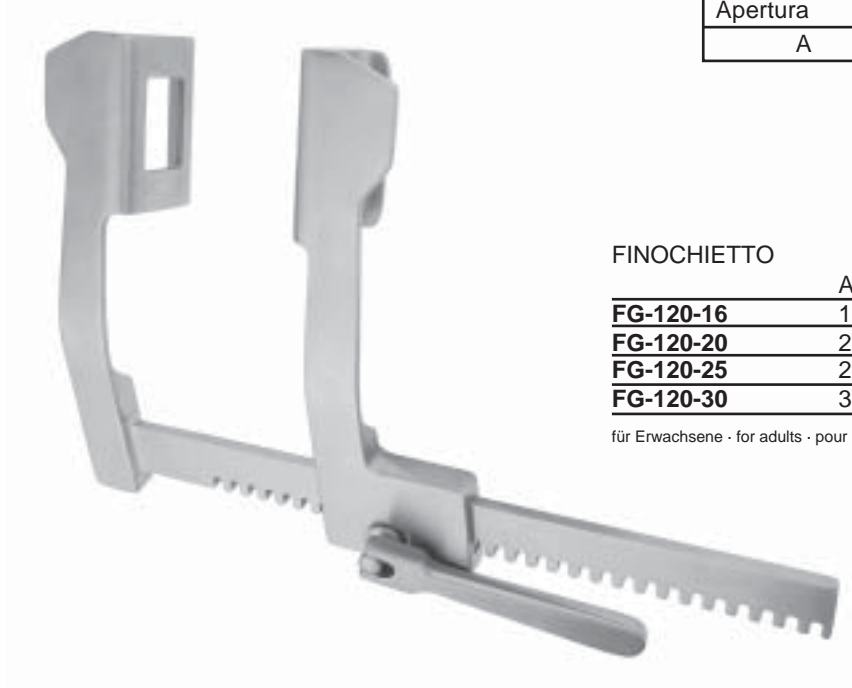

FINOCHIETTO

	A = mm	B = mm	C = mm
FG-120-16	165 mm	40 mm	40 mm
FG-120-20	200 mm	45 mm	65 mm
FG-120-25	250 mm	70 mm	65 mm
FG-120-30	300 mm	70 mm	65 mm

für Erwachsene · for adults · pour adultes · para adultos · per adulti

ALUMINIUM



FINOCHIETTO (modif.)

	A = mm	B = mm	C = mm
FG-122-12	120 mm	14 mm	15 mm

für Kinder · for children · pour enfants · para niños · per bambini

Blatt • Blade • valve • hoja • valva		
Spreizung Spread Ecartement Abertura Apertura	Tiefe Depth profondité profundidad profondità	Breite Width largeur ancho larghezza
A	B	C



FINOCHIETTO-BABY

	A = mm	B = mm	C = mm
FG-124-75	75 mm	18 mm	20 mm

für Säuglinge · for babies · pour bébé · para bebés · per neonati

ALUMINIUM



COOLEY

	A = mm	B = mm	C = mm
FG-220-01	95 mm	12 mm	13 mm

für Säuglinge · for babies · pour bébé · para bebés · per neonati

COOLEY

	A = mm	B = mm	C = mm
FG-220-02	140 mm	15 mm	30 mm
FG-220-03	150 mm	21 mm	44 mm

für Kinder · for children · pour enfants · para niños · per bambini

COOLEY

	A = mm	B = mm	C = mm
FG-220-04	200 mm	35 mm	50 mm

für Erwachsene · for adults · pour adultes · para adultos · per adulti

FG

Rippensperrer
Rib Spreaders
Ecarteurs des côtes
Separadores costales
Divaricatori costali

Blatt • Blade • valve • hoja • valva		
Spreizung Spread Ecartement Abertura Apertura	Tiefe Depth profondité profundidad profondità	Breite Width largeur ancho larghezza
A	B	C

ALUMINIUM

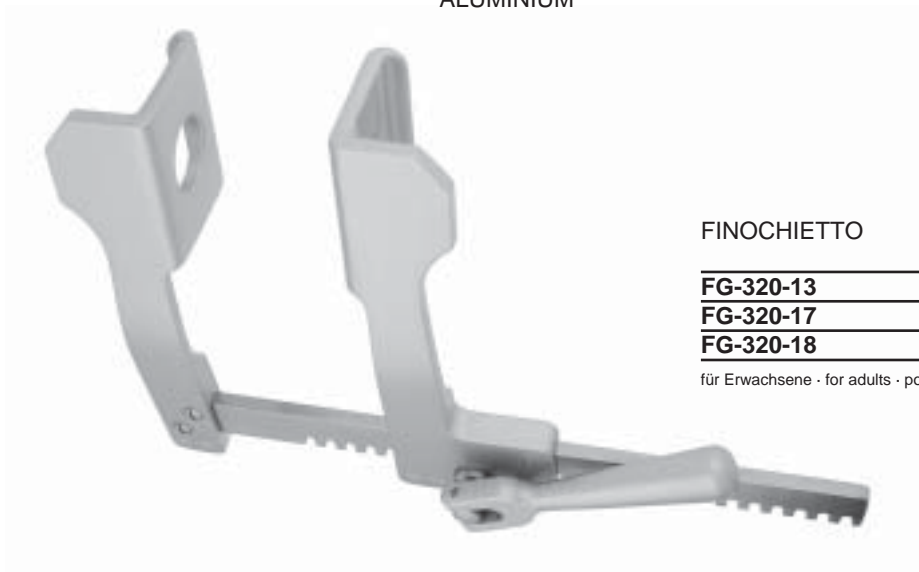

FINOCHIETTO

	A = mm	B = mm	C = mm
FG-320-13	135 mm	38 mm	44 mm
FG-320-17	175 mm	52 mm	62 mm
FG-320-18	175 mm	85 mm	65 mm

für Erwachsene · for adults · pour adultes · para adultos · per adulti

ALUMINIUM



FINOCHIETTO HAIGHT Baby

	A = mm	B = mm	C = mm
FG-322-10	100 mm	31 mm	31 mm

für Kinder · for children · pour enfants · para niños · per bambini

Blatt • Blade • valve • hoja • valva		
Spreizung Spread Ecartement Abertura Apertura	Tiefe Depth profondité profundidad profondità	Breite Width largeur ancho larghezza
A	B	C

ALUMINIUM



FINOCHIETTO

	A = mm	B = mm	C = mm
FG-324-40	100 mm	12 mm	15 mm
FG-324-41	143 mm	28 mm	30 mm
FG-324-42	210 mm	31 mm	45 mm
FG-324-43	245 mm	42 mm	61 mm
FG-324-44	245 mm	74 mm	64 mm

für Erwachsene · for adults · pour adultes · para adultos · per adulti

Blatt • Blade • valve • hoja • valva		
Spreizung Spread Ecartement Abertura Apertura	Tiefe Depth profondité profundidad profondità	Breite Width largeur ancho larghezza
A	B	C

ALUMINIUM



FINOCHIETTO Infant

	A = mm	B = mm	C = mm
FG-324-75	75 mm	15 mm	15 mm

für Säuglinge · for babies · pour bébé · para bebés · per neonati



mit 2 Paar Valven
 with 2 pairs of blades
 avec 2 paires de valves
 con 2 pares de valvas
 con 2 paia di valve

FINOCHIETTO BURFORD

	A = mm	B = mm	C = mm
FG-326-21	210 mm	48/77 mm	64 mm
FG-326-25	260 mm	48/77 mm	64 mm
FG-326-30	300 mm	48/77 mm	64 mm

für Erwachsene · for adults · pour adultes · para adultos · per adulti

Blatt • Blade • valve • hoja • valva		
Spreizung Spread Ecartement Abertura Apertura	Tiefe Depth profondité profundidad profondità	Breite Width largeur ancho larghezza
A	B	C



mit 2 Paar Valven
 with 2 pairs of blades
 avec 2 paires de valves
 con 2 pares de valvas
 con 2 paia di valve

FINOCHIETTO BURFORD

	A = mm	B = mm	C = mm
FG-422-18	180 mm	47/65 mm	62 mm
FG-422-26	260 mm	47/65 mm	62 mm
FG-422-30	300 mm	47/65 mm	62 mm

für Erwachsene · for adults · pour adultes · para adultos · per adulti



ALUMINIUM

Blatt • Blade • valve • hoja • valva		
Spreizung Spread Ecartement Abertura Apertura	Tiefe Depth profondité profundidad profondità	Breite Width largeur ancho larghezza
A	B	C

mit 2 Paar Valven
with 2 pairs of blades
avec 2 paires de valves
con 2 pares de valvas
con 2 paia di valve

FINOCHIETTO BURFORD

	A = mm	B = mm	C = mm
FG-424-13	135 mm	34/48 mm	42 mm

für Kinder · for children · pour enfants · para niños · per bambini



ALUMINIUM

CASTAÑEDA

	A = mm	B = mm	C = mm
FG-520-06	65 mm	10,5 mm	32 mm

für Säuglinge · for babies · pour bébé · para bebés · per neonati

CASTAÑEDA

	A = mm	B = mm	C = mm
FG-520-07	70 mm	12 mm	45 mm

für Kinder · for children · pour enfants · para niños · per bambini

CASTAÑEDA

	A = mm	B = mm	C = mm
FG-520-12	120 mm	15 mm	60 mm

für Kinder · for children · pour enfants · para niños · per bambini

Blatt • Blade • valve • hoja • valva		
Spreizung Spread Ecartement Abertura Apertura	Tiefe Depth profondité profundidad profondità	Breite Width largeur ancho larghezza
A	B	C



CHEVALIER

	A = mm	B = mm	C = mm
FG-529-19	190 mm	27 mm	100 mm



HAIGHT

	A = mm	B = mm	C = mm
FG-620-09	90 mm	30 mm	30 mm
FG-620-15	115 mm	30 mm	30 mm

FG

Rippensperrer
Rib Spreaders
Ecarteurs des côtes
Separadores costales
Divaricatori costali



Blatt • Blade • valve • hoja • valva		
Spreizung Spread Ecartement Abertura Apertura	Tiefe Depth profundité profundidad profondità	Breite Width largeur ancho larghezza
A	B	C

TUFFIER

	A = mm	B = mm	C = mm
FG-624-16	165 mm	50 mm	45 mm



Thoraxsperrer
Thoracic retractor
Ecarteur thoracique
Separador torácico
Divaricatore per il torace



MERCEDES
FG-720-00

Thoraxsperrer, komplett, bestehend aus:
FG-720-10 1 Sperrer
FG-720-48 2 Seitenvalven 42 x 65 mm
FG-720-70 2 Seitenvalven 75 x 75 mm

Thoracic retractor, complete, consisting of:
FG-720-10 1 Spreader
FG-720-48 2 Lateral blades 42 x 65 mm
FG-720-70 2 Lateral blades 75 x 75 mm

Ecarteur thoracique, complet, composé de:
FG-720-10 1 Ecarteur
FG-720-48 2 Valves latérales 42 x 65 mm
FG-720-70 2 Valves latérales 75 x 75 mm

Separador torácico, completo, compuesto de:
FG-720-10 1 Separador
FG-720-48 2 Valvas laterales 42 x 65 mm
FG-720-70 2 Valvas laterales 75 x 75 mm

Divaricatore per il torace, completo, composto da:
FG-720-10 1 Divaricatore
FG-720-48 2 Valve laterali 42 x 65 mm
FG-720-70 2 Valve laterali 75 x 75 mm

Blatt • Blade • valve • hoja • valva		
Spreizung Spread Ecartement Abertura Apertura	Tiefe Depth profondité profundidad profondità	Breite Width largeur ancho larghezza
A	B	C

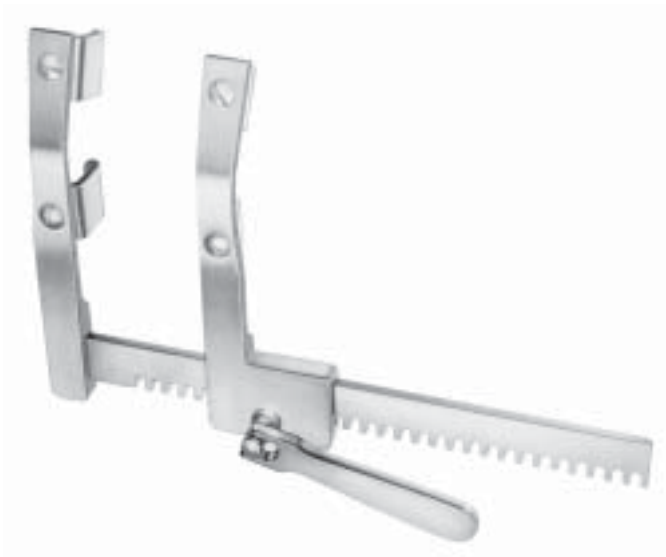

MORSE-FAVOLORO

	A = mm	B = mm	C = mm
FG-723-16	160 mm	17 mm	22 mm

für Kinder · for children · pour enfants · para niños · per bambini

MORSE-FAVOLORO

	A = mm	B = mm	C = mm
FG-723-19	200 mm	22 mm	27 mm

für Erwachsene · for adults · pour adultes · para adultos · per adulti



HERTZLER

	A = mm	B = mm	C = mm
FG-728-00	105 mm	25 mm	25 mm

Rippensperrer und -Kontraktor
 mit drehbaren Klauen

Rib spreader and contractor
 with swivel blades

Ecarteur et rapprocheur des côtes
 avec valves orientables

Separador y contractor costal
 con garras girables

Divaricatore ed approssimatore costale
 con valve orientabili

für Kinder
 for children
 pour enfants;
 para niños
 per bambini

für Erwachsene
 for adults
 pour adultes
 para adultos
 per adulti



SELLORS
FG-820-19
 19,0 cm



BAILEY-BABY
FG-822-14
 15,5 cm



BAILEY
FG-824-16
 20,0 cm



BAILEY-GIBBON
FG-826-16
 20,0 cm

Lungenspatel
Lung Spatulas
Spatule pulmonaire
Espátula para el pulmón
Spatole per polmone



cm ALLISON
25,5 **FG-829-30**
32,0 **FG-829-32**

Lungenfaßzangen
Lung Grasping Forceps
Pincés à saisir le poumon
Pinzas para coger el pulmón
Pinze per afferrare il polmone



LOVELACE
FG-920-20
20,0 cm



LOVELACE
FG-921-20
20,0 cm

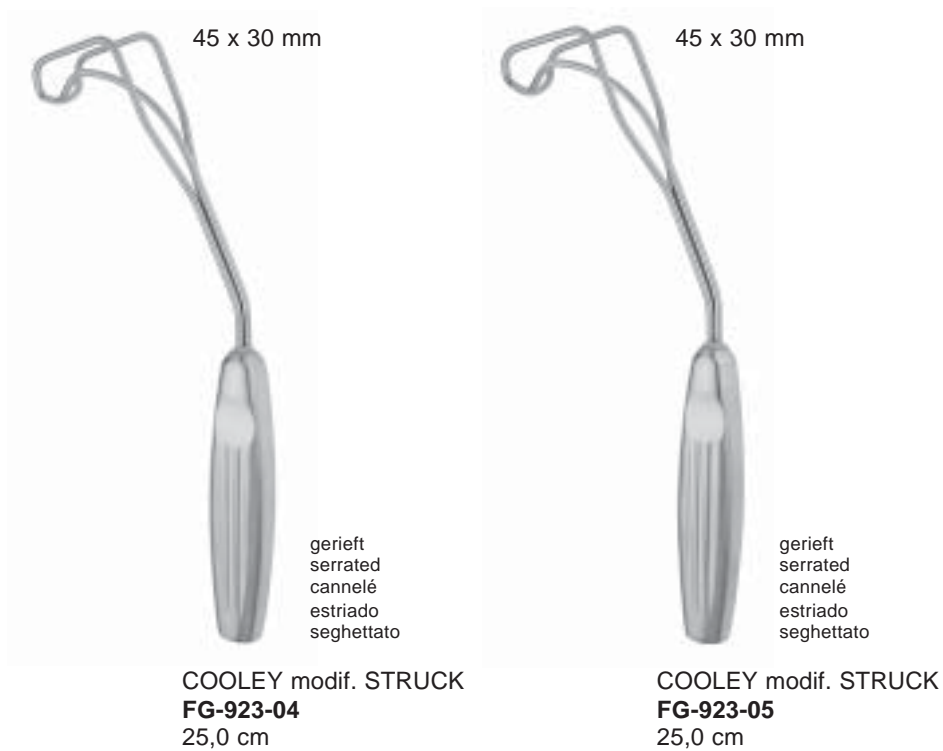
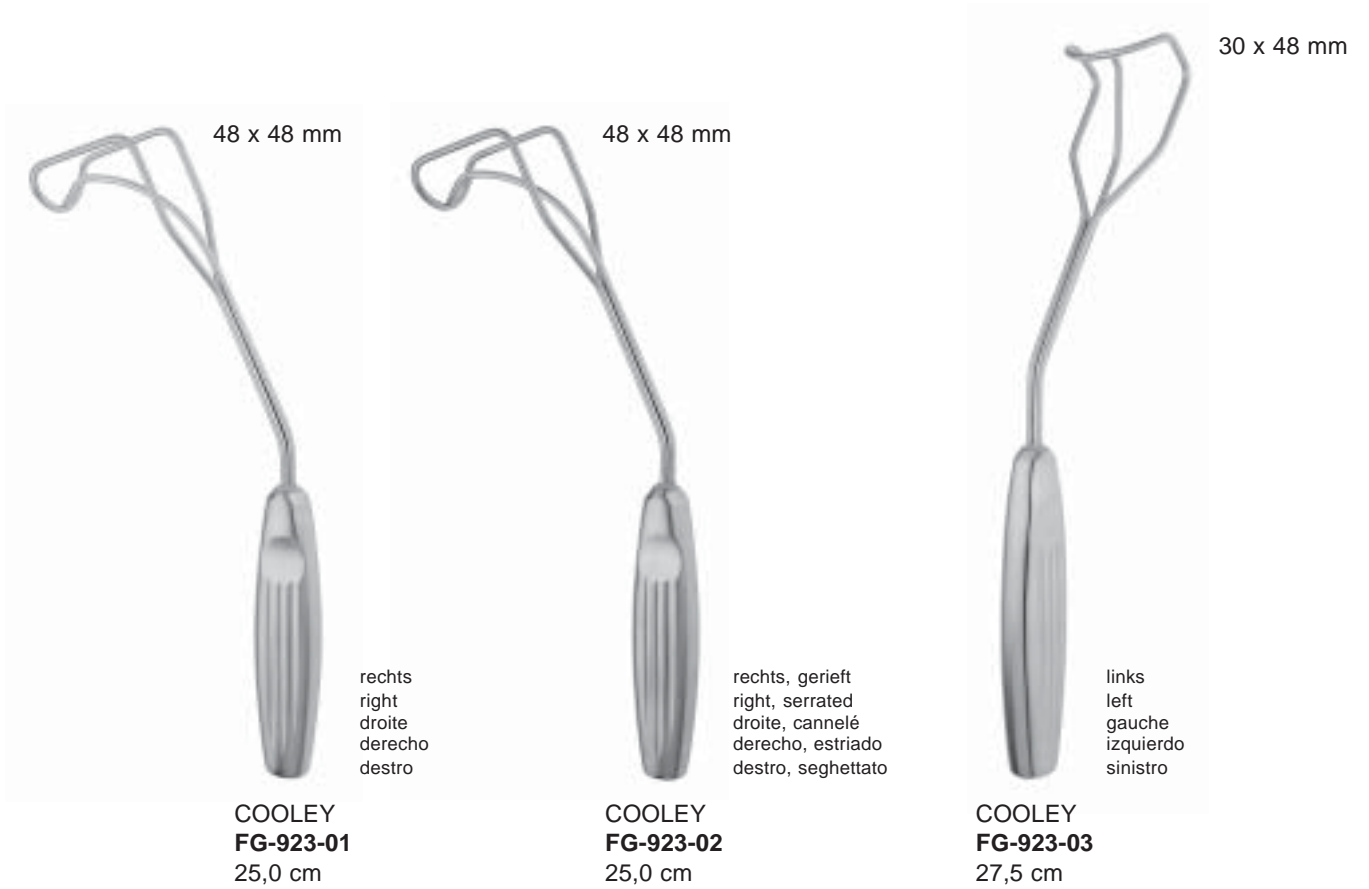

Bronchusklemmen
Bronchus Forceps
Pincés-Clamps à Bronches
Pinzas clamps bronquiales
Pinze per bronchi



HARRINGTON
FG-031-30
30,5 cm



cm HARRINGTON
29,0 **FG-033-29**
31,0 **FG-033-31**



FINOCHIETTO
FG-037-24
24,0 cm

FG

Lunge
Lung
Poumon
Pulmón
Polmone

Bronchusklemmen
Bronchus Forceps
Pinces-Clamps à Bronches
Pinzas clamps bronquiales
Pinze per bronchi



PRICE-THOMAS
FG-039-22
22,0 cm



links
left
à gauche
izquierda
sinistra

PRICE-THOMAS
FG-131-22
22,0 cm



rechts
right
à droite
derecha
destra

PRICE-THOMAS
FG-133-22
22,0 cm

Bronchusklemmen
Bronchus Forceps
Pincas-Clamps à Bronches
Pinzas clamps bronquiales
Pinze per bronchi



SAROT
FG-137-23
23,0 cm



SAROT
FG-139-23
23,0 cm



SAROT



SEMB
FG-231-23
23,0 cm



SEMB
FG-233-23
23,0 cm



SEMB

Anastomosen- (Vena cava) Klemmen
Anastomosis (Vena Cava) Clamps
Pinces-clamps à anastomose (veine cave)
Pinzas clamps para anastomosis (vena cava)
Pinze per anastomosi (vena cava)



SATINSKY
FG-235-15
15,0 cm



SATINSKY

FG-237-26
Fig. 1
26,5 cm

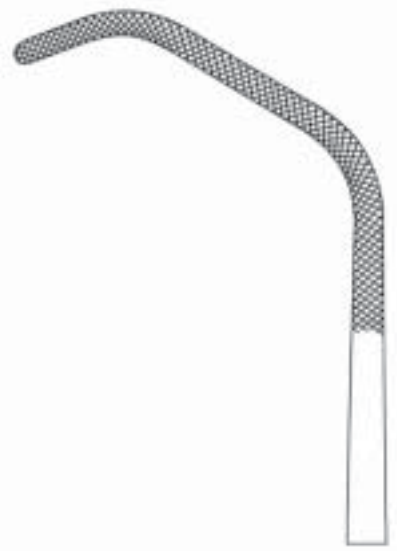

FG-239-26
Fig. 2
26,5 cm

Anastomosen- (Vena cava) Klemmen
Anastomosis (Vena Cava) Clamps
Pinces-clamps à anastomose (veine cave)
Pinzas clamps para anastomosis (vena cava)
Pinze per anastomosi (vena cava)



FG-331-26
Fig. 1
26,5 cm

FG-333-26
Fig. 2
26,5 cm



BROCK
FG-140-00

Griff allein
 Handle only
 Manche seul
 Mango suelto
 Manico solo



BROCK
FG-142-00

Dilatator Spreizweite 8 - 20 mm
 Dilator Opening 8 to 20 mm
 Dilatateur ouverture 8 à 20 mm
 Dilatador abertura 8 a 20 mm
 Dilattatore apertura 8 a 20 mm

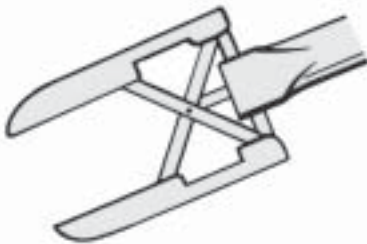

ø mm	BROCK
4,0	FG-144-04
7,5	FG-144-07
10,0	FG-144-10
12,0	FG-144-12

Stanzen
 Punches
 Pincas coupantes
 Pinzas cortantes
 Pinze taglienti

Herz-Dilatatoren
Mitral Valve Dilators
Dilatateurs pour valve mitrale
Dilatadores para válvula mitral
Dilatatori per valvole mitrali

FG

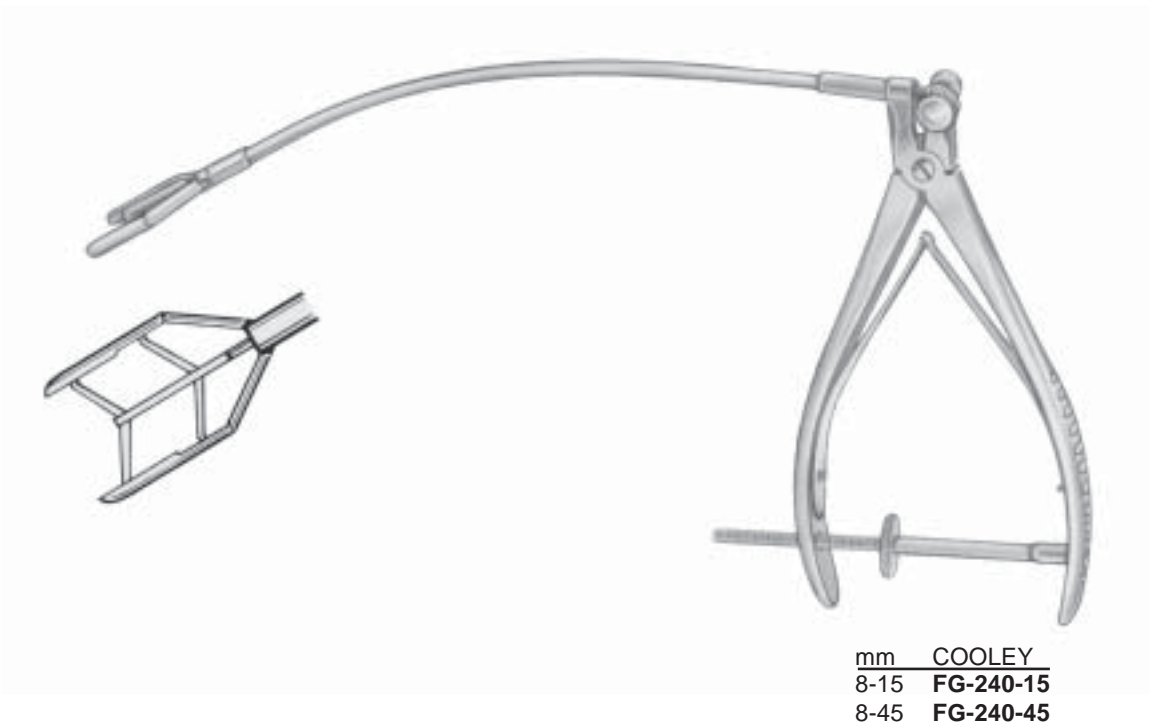
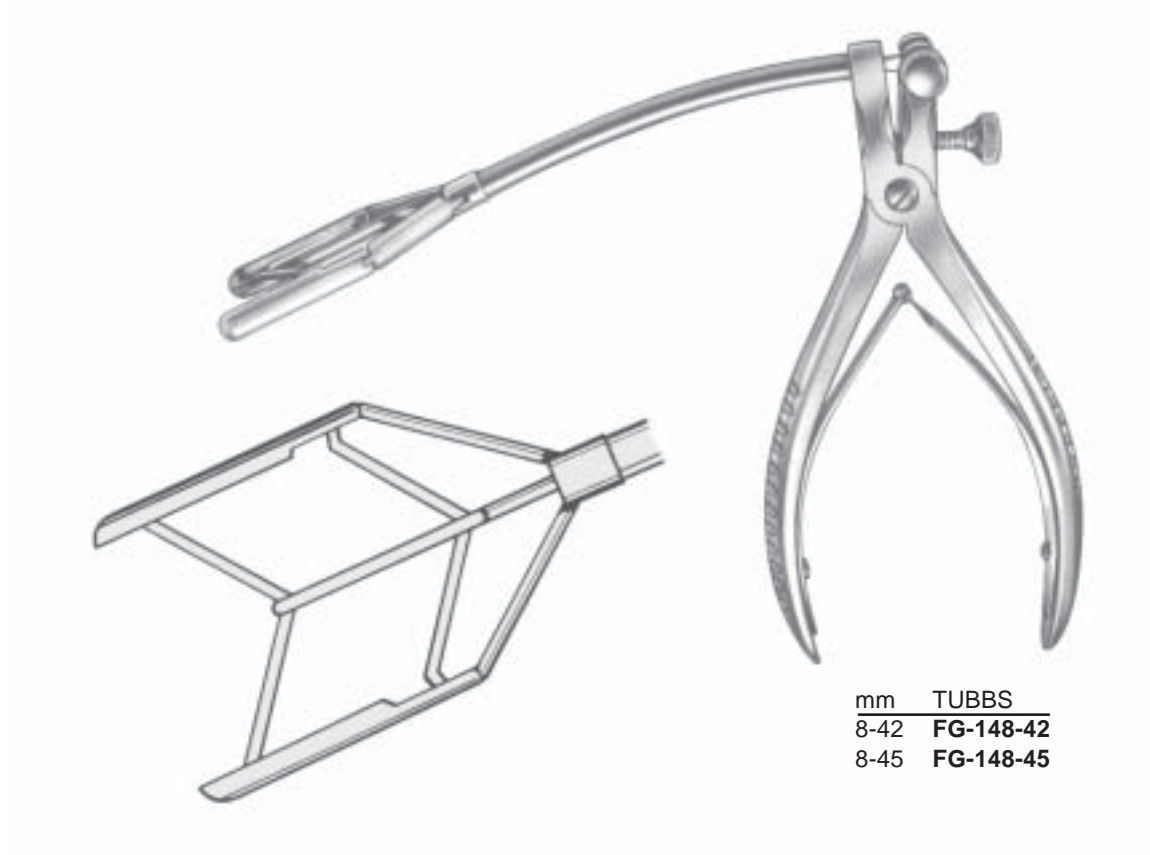

FG

Herz-Dilatatoren
Mitral Valve Dilators
Dilatateurs pour valve mitrale
Dilatadores para válvula mitral
Dilatatori per valvole mitrali

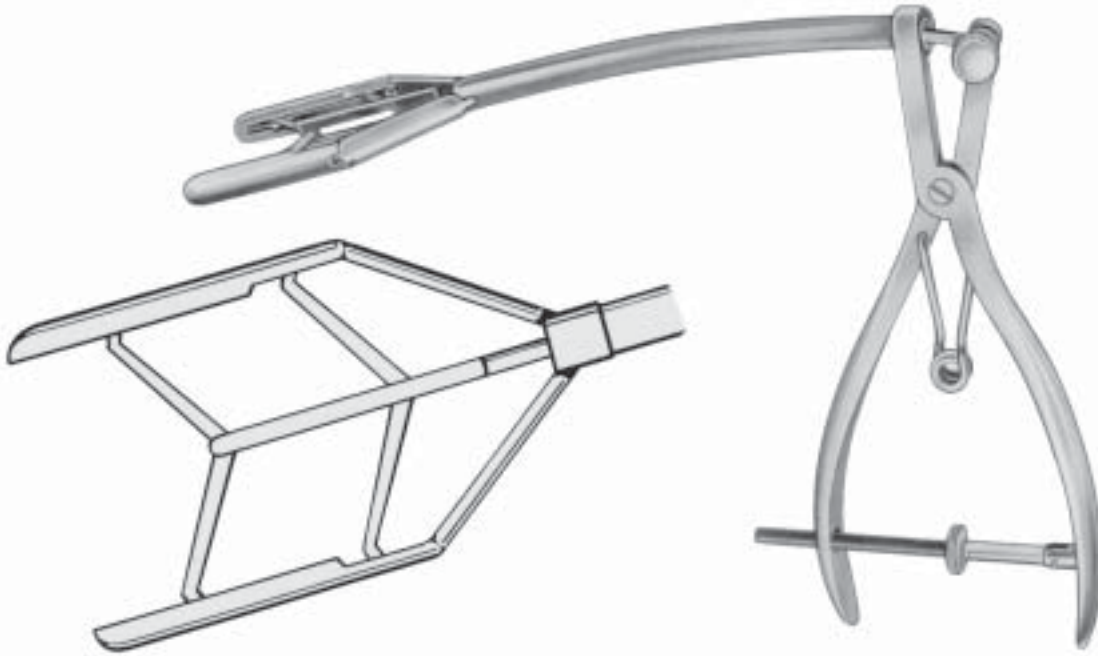

mm GERBODE
9-45 FG-242-45

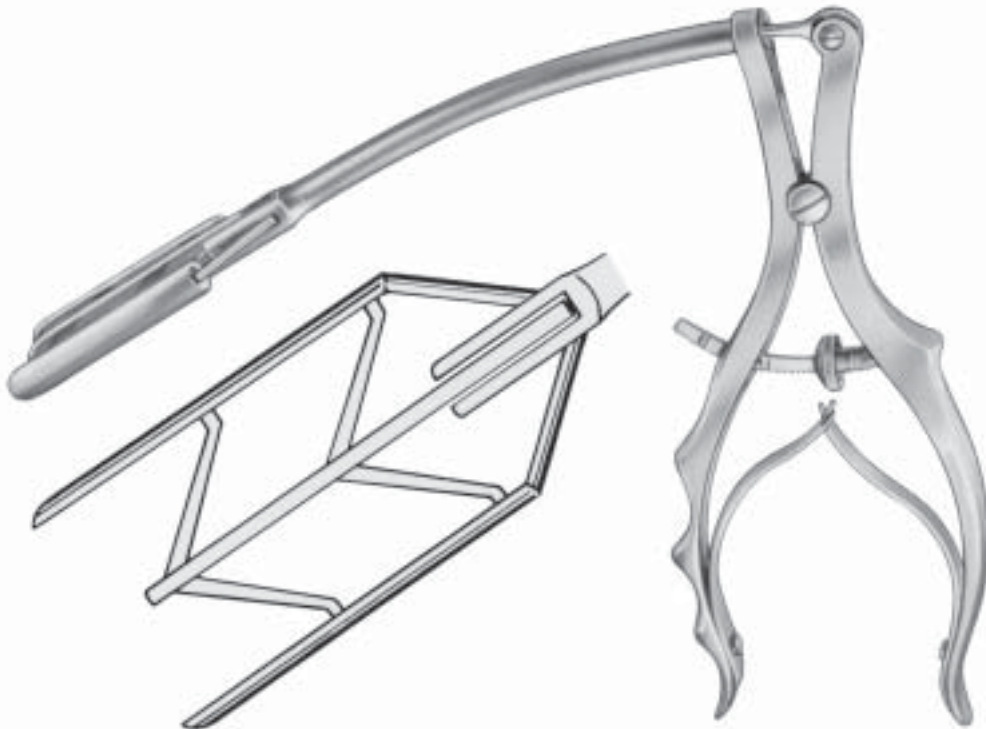

mm COOLEY
7-30 FG-243-30
9-40 FG-243-40

Herz-Dilatatoren
Mitral Valve Dilators
Dilatateurs pour valve mitrale
Dilatadores para válvula mitral
Dilatatori per valvole mitrali

FG



mm COOLEY
5-18 **FG-245-18**
6-20 **FG-245-20**



mm HETZER
4-10 **FG-246-10**

FG

Gefäßdilatoren
Vascular Dilators
Dilatateurs vasculaires
Dilatadores vasculares
Dilatatori vascolari

biegsam, Silber
malleable, silver
malléables, argent
maleables, silver
maleabili, argento



COOLEY	
ø mm	13,0 cm
0,5	FG-740-05
1,0	FG-740-10
1,5	FG-740-15
2,0	FG-740-20
2,5	FG-740-25
3,0	FG-740-30
4,0	FG-740-40
5,0	FG-740-50



FG-740-05



FG-740-10



FG-740-15



FG-740-20



FG-740-25



FG-740-30



FG-740-40



FG-740-50

biegsam
 malleable
 malléables
 maleables
 maleabili

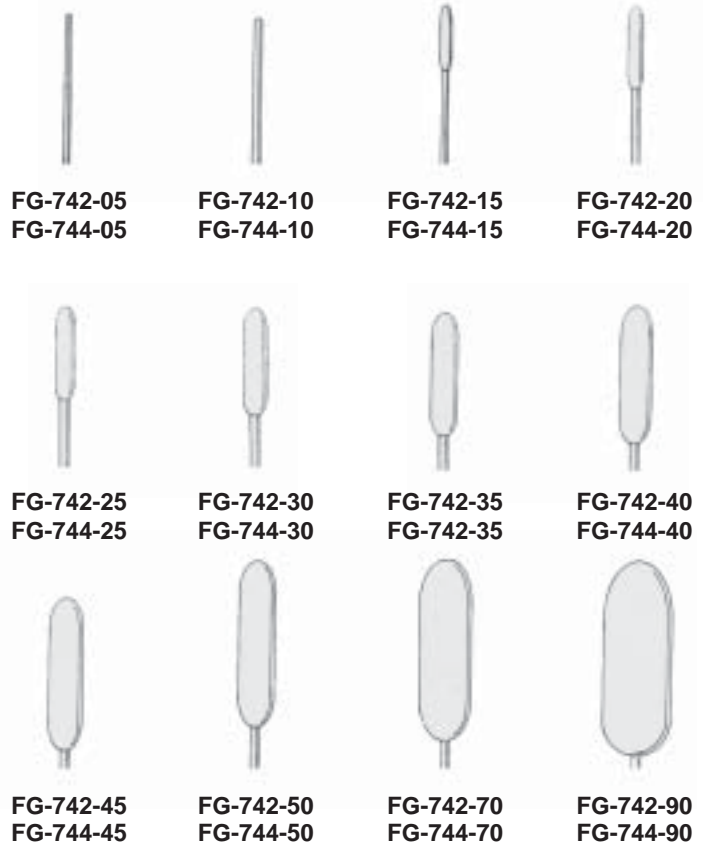

DEBAKEY

ø mm	19,0 cm	35,0 cm
0,5	FG-742-05	FG-744-05
1,0	FG-742-10	FG-744-10
1,5	FG-742-15	FG-744-15
2,0	FG-742-20	FG-744-20
2,5	FG-742-25	FG-744-25
3,0	FG-742-30	FG-744-30
3,5	FG-742-35	FG-744-35
4,0	FG-742-40	FG-744-40
4,5	FG-742-45	FG-744-45
5,0	FG-742-50	FG-744-50
7,0	FG-742-70	FG-744-70
9,0	FG-742-90	FG-744-90

FG

Intima-Spatel
Intima spatula
Spatule pour la tunique interne
Espátula para la íntima
Spatola per intima



cm
18,0 **FG-055-18**
21,0 **FG-055-21**

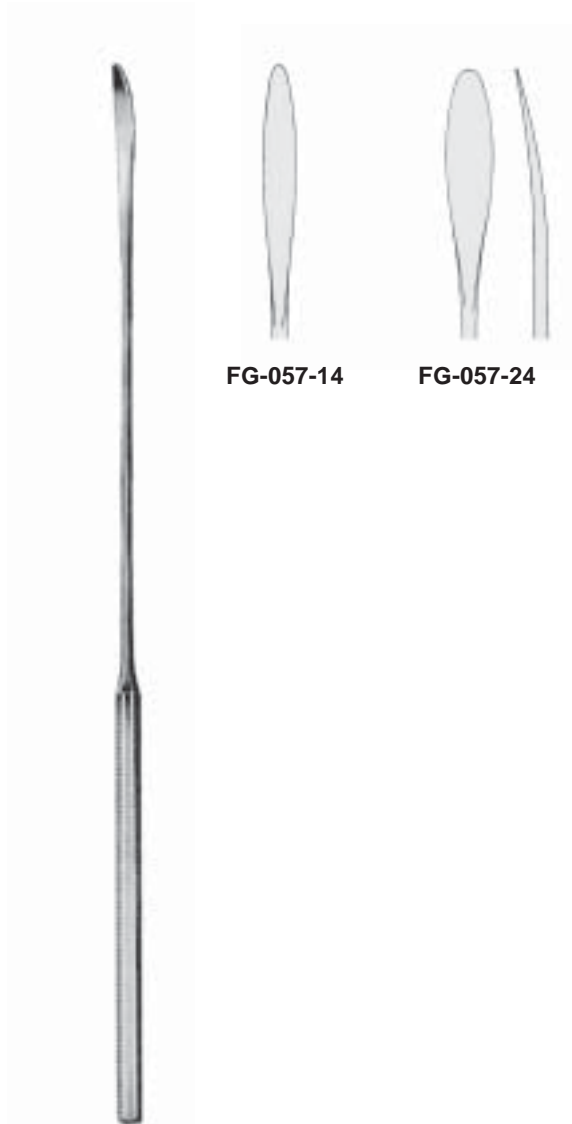

cm 3 mm
14,0 **FG-057-14**
24,0 **FG-057-24**



ROBB
FG-059-01
Fig. 1
24,0 cm



ROBB
FG-059-02
Fig. 2
24,0 cm



ROBB
FG-059-03
Fig. 3
24,0 cm



ROBB
FG-059-04
Fig. 4
24,0 cm

GC

**Galle, Niere
Gall Bladder, Kidney
Vesicule biliaire, Rein
Vesicula biliar, Riñón
Vesicola biliare, Rene**



GC

GC

Gallensteinzangen
Gall Stone Forceps
Pinces pour calculs biliaires
Pinzas para cálculos biliares
Pinze per calcoli biliari



cm DESJARDINS
23,0 **GC-011-23**
23,0 **GC-013-23**

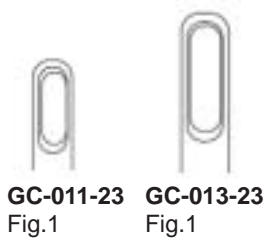

GC-011-23
Fig.1

GC-013-23
Fig.1



cm DESJARDINS
24,0 **GC-013-24**
22,5 **GC-013-25**



GC-013-24

GC-013-25

sehr schlankes Modell
very slender pattern
modèle très fin
modelo muy delgado
modello molto delicato



cm CZERNY
25,0 GC-015-25



cm BLAKE
21,0 GC-017-20
23,0 GC-017-23

cm BLAKE
21,0 GC-016-20

GC

Gallensteinzangen
Gall Stone Forceps
Pincès pour calculs biliaires
Pinzas para cálculos biliares
Pinze per calcoli biliari



cm MAYO BLAKE
20,0 GC-110-20



cm MAYO BLAKE
20,0 GC-111-20



cm MIXTER
22,0 GC-117-22

Gallensteinlöffel
 Gall Stone Scoops
 Curettes pour calculs biliaires
 Cucharillas para coger cálculos biliares
 Cuchhiai per calcoli biliari



cm MOORE
 28,0 **GC-215-28**

federnd
 elastic
 élastiques
 elásticas
 elastiche



GC-310-13

GC-310-18

GC-310-21

cm DESJARDINS
 28,0 **GC-310-13**
 28,0 **GC-310-18**
 28,0 **GC-310-21**

Gallensteinsonde
 Gall Stone Probes
 Sondes à calculs biliaires
 Sondas-exploradoras para cálculos biliares
 Sonde per calcoli biliari

biegsam
 malleable
 souples
 maleables
 malleabili



cm MOYNIHAN
 34,0 **GC-412-34**

biegsamer Schaft
 malleable shaft
 tige malléable
 vástago maleable
 gambo flessibile

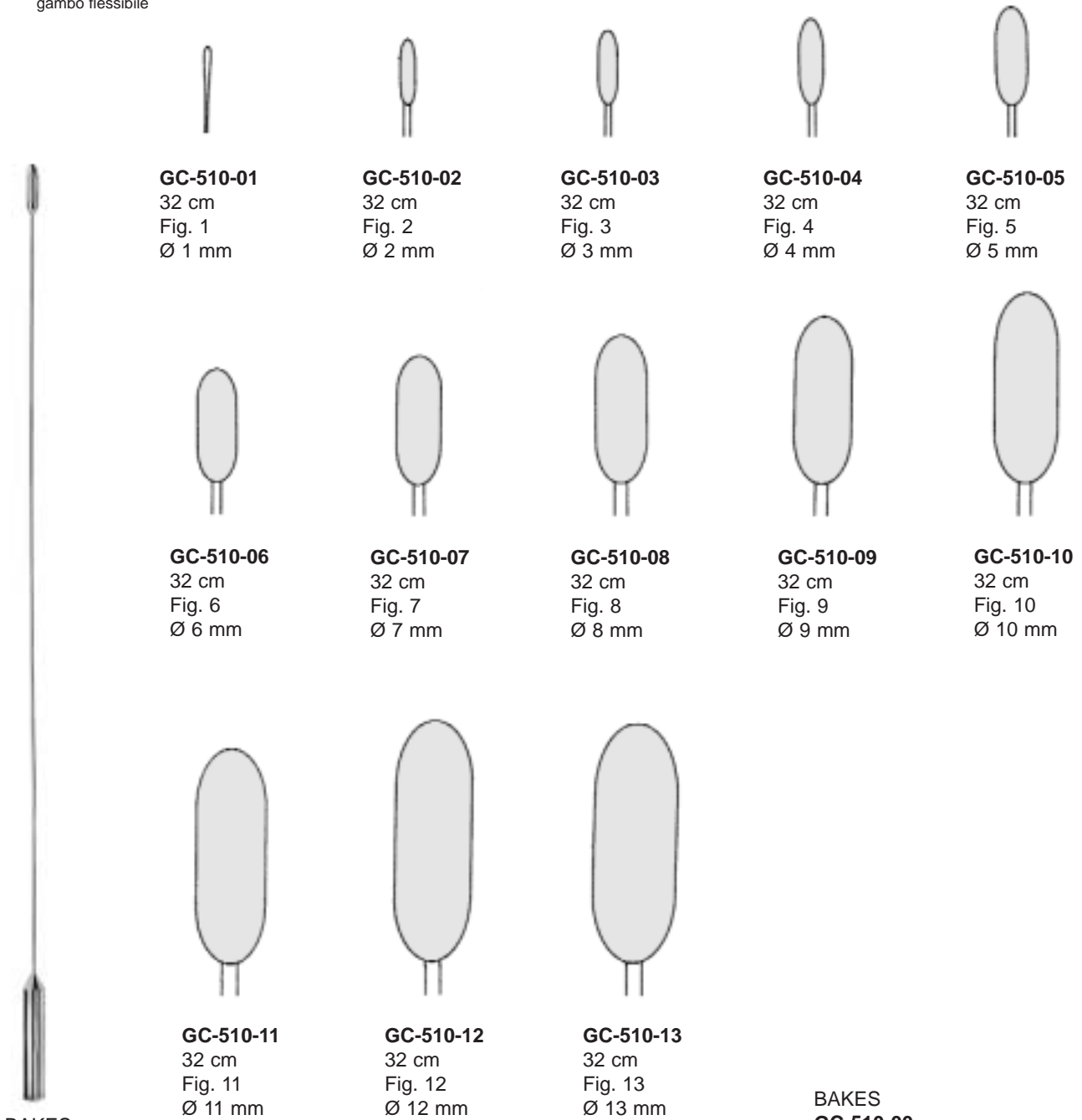

BAKES

GC-510-00

Satz à 9 Stück in Leinentuchtaschen
 set of 9 pieces in canvas pocket
 jeu de 9 pièces dans une poche en toile
 juego de 9 unidades en bolsa de tela
 set di 9 pezzi

GC-510-03 - GC-510-11

Gallensteinlöffel
Gall Stone Scoops
Curettes pour calculs biliars
Cucharas para cálculos biliars
Pinze per calcoli biliari

GC



cm FERGUSSON
21,5 **GC-710-21**



cm MAYO
28,0 **GC-715-27**



cm MAYO
27,0 **GC-718-01**
27,0 **GC-718-02**
27,0 **GC-718-03**

GC

Gallensteinlöffel
Gall Stone Scoops
Curettes pour calculs biliaires
Cucharas para cálculos biliares
Pinze per calcoli biliari



federnd
elastic
élastiques
elásticas
elastiche



GC-810-17



GC-810-21



GC-810-24



GC-810-27

cm	DESJARDINS
30,0	GC-810-17
30,0	GC-810-21
30,0	GC-810-24
30,0	GC-810-27

biegsam
 malleable
 souples
 maleables
 malleabili

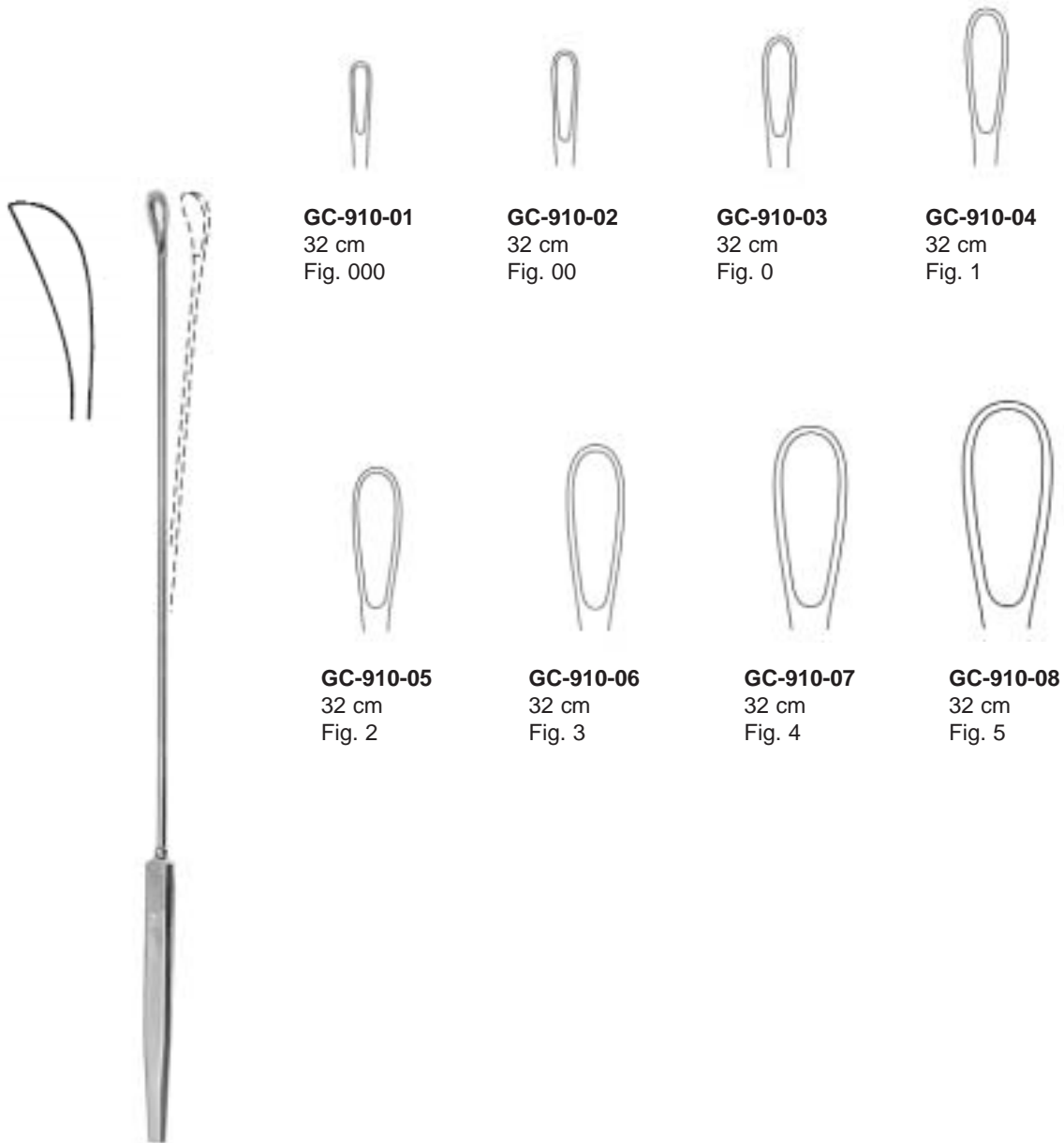

GC-910-01
 32 cm
 Fig. 000

GC-910-02
 32 cm
 Fig. 00

GC-910-03
 32 cm
 Fig. 0

GC-910-04
 32 cm
 Fig. 1

GC-910-05
 32 cm
 Fig. 2

GC-910-06
 32 cm
 Fig. 3

GC-910-07
 32 cm
 Fig. 4

GC-910-08
 32 cm
 Fig. 5

Fig	mm	LUER-KOERTE
000	Ø 2,5	GC-910-01
00	Ø 3,2	GC-910-02
0	Ø 4,2	GC-910-03
1	Ø 5,5	GC-910-04
2	Ø 6,7	GC-910-05
3	Ø 8,0	GC-910-06
4	Ø 11,0	GC-910-07
5	Ø 15,0	GC-910-08

GC

Ureterklemmen
Ureter Clamps
Pinces-clapms uretère
Pinzas clamps para ureter
Pinze per uretere



cm MAYO
32,0 GC-120-32



cm LURZ
21,0 GC-221-21



cm LURZ
21,0 GC-223-21



GC-321-01
23 cm
Fig. 1



GC-321-02
21 cm
Fig. 2



GC-321-03
19 cm
Fig. 3



GC-321-04
18,5 cm
Fig. 4

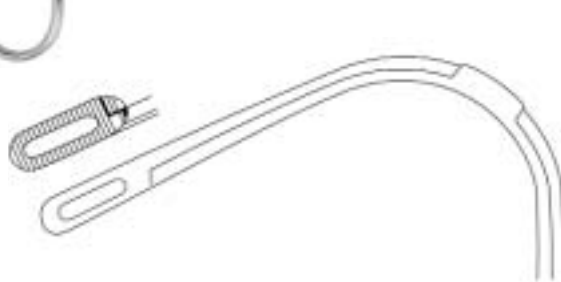

GC-321-05
19 cm
Fig. 5

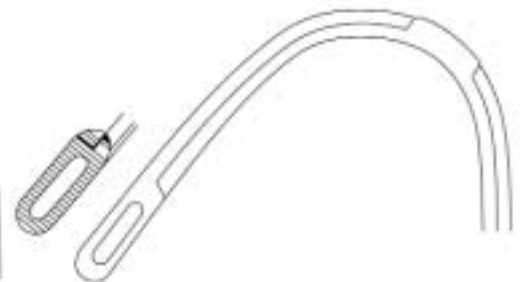

GC-321-06
19 cm
Fig. 6

Fig.	RANDALL
1	GC-321-01
2	GC-321-02
3	GC-321-03
4	GC-321-04
5	GC-321-05
6	GC-321-06

feines Modell
delicate pattern
modèle délicat
modelo fino
modello delicato

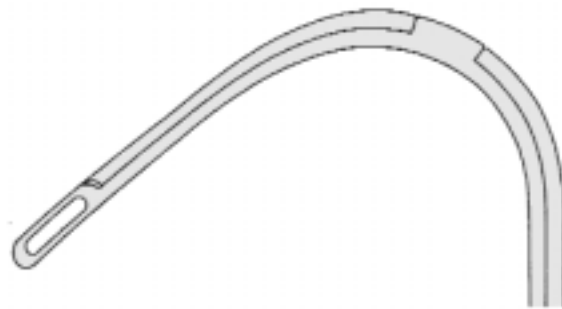

GC-321-23
23 cm
Fig. 1

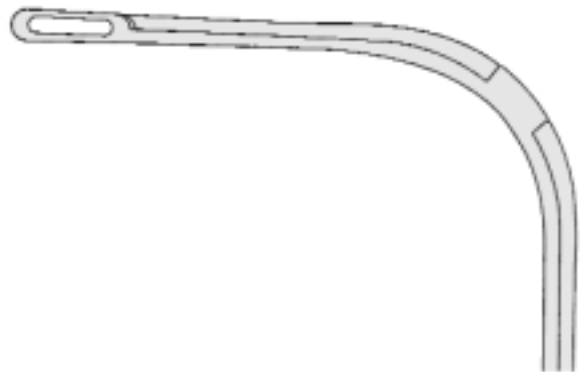

GC-321-24
24,5 cm
Fig. 2

Fig.	RANDALL
1	GC-321-23
2	GC-321-24

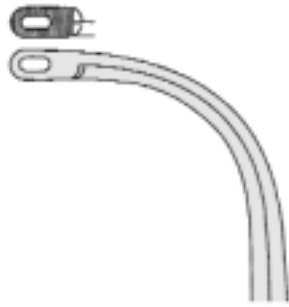

GC-323-16
16 cm
Fig. 1

Nierenfistelzangen
Nephrostomy Forceps
Pinces à néphrostomie
Pinzas para nephrostomie
Pinze per nefrostomia

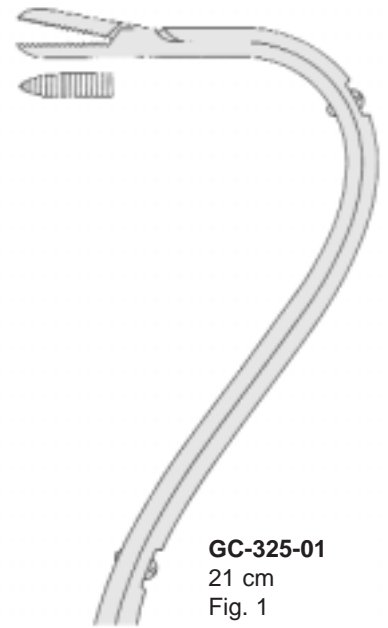

GC-325-01
21 cm
Fig. 1

für Kinder
for children
pour enfants
para niños
per bambini

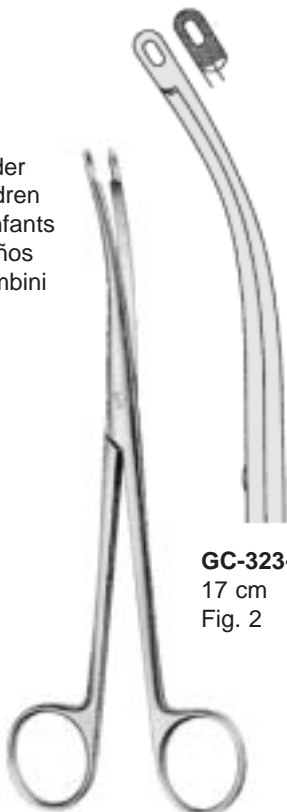

GC-323-17
17 cm
Fig. 2



GC-325-02
21 cm
Fig. 2

Fig. HEIMING
1 **GC-323-16**
2 **GC-323-17**

Fig. ELSAESSER
1 **GC-325-01**
2 **GC-325-02**

GE

**Darm, Magen
Intestines and Stomach
Intestin, Estomac
Intestines, Estómago
Intestini, Stomaco**



GE



ALLIS-Baby
 GE-012-14
 14 cm



4:5	ALLIS	5:6
GE-110-15	15 cm	GE-210-15
	19 cm	GE-210-19
	22 cm	GE-210-22
	24 cm	GE-210-24

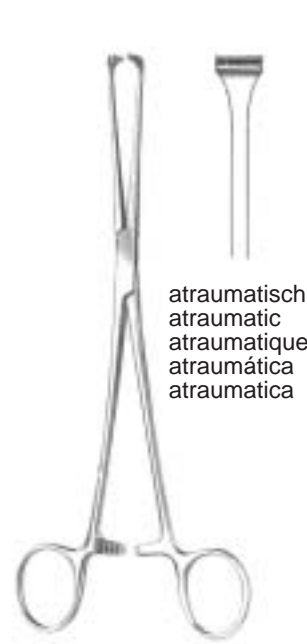

cm	ALLIS
16	GE-214-16
20	GE-214-20
25	GE-214-25

atraumatisch
 atraumatic
 atraumatique
 atraumática
 atraumatica



ALLIS-ADAIR
 GE-310-15
 15,5 cm



cm	JUDD-ALLIS
15	GE-410-15
19	GE-410-19



THOMS-ALLIS
 GE-510-20
 20 cm

Mit TC-Einsätzen
 TC Lined
 A mors TC
 Con bocas TC
 Con morso TC



cm	BABCOCK	TC	
16	GE-610-16	GE-614-16	GE-618-16
18	GE-610-18		
20	GE-610-20	GE-614-20	GE-618-20
24	GE-610-24		

atraumatisch
 atraumatic
 atraumatique
 atraumática
 atraumatica

Darm, Magen
Intestines and Stomach
Intestin, Estomac
Intestines, Estómago
Intestini, Stomaco

GE

Mit TC-Einsätzen
TC- Lined
A mors TC
Con bocas TC
Con morso TC



DUVAL
13 mm
GE-710-18
GE-710-20
GE-714-20



DUVAL
25 mm
GE-712-20
GE-712-23



DUVAL
GE-710-18 - GE-714-20



WILLIAMS
GE-810-16
16,5 cm



SCHOENBURG
GE-812-22
22 cm

cm
18
20
20
23

Darmklemmen
Intestinal Forceps
Pinzas intestinales
Pinzas intestinales
Pinze intestinali



DOYEN
DOYEN-Baby
GE-120-18-GE-127-23

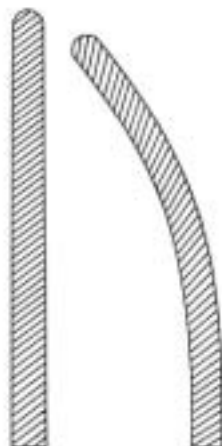

cm DOYEN-Baby
16
18 GE-120-18 GE-121-18
21
23 GE-120-21 GE-121-23

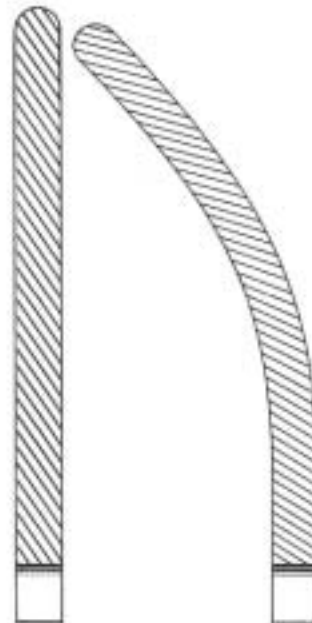

DOYEN
GE-120-21 GE-121-21
GE-120-23 GE-121-23

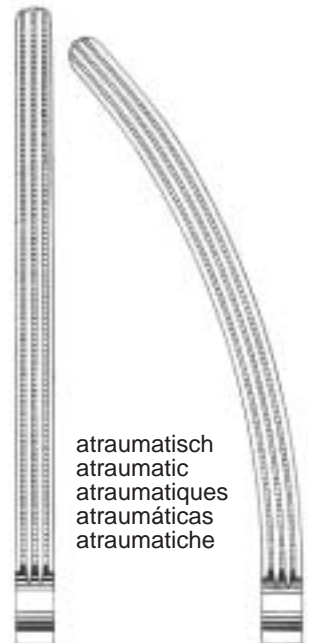

atraumatisch
atraumatic
atraumatiques
atraumáticas
atraumatiche

DOYEN
GE-126-16 GE-127-16
GE-126-18 GE-127-18
GE-126-21 GE-127-21
GE-126-23 GE-127-23

Darmklemmen
 Intestinal Forceps
 Pincas intestinales
 Pinzas intestinales
 Pinze intestinali

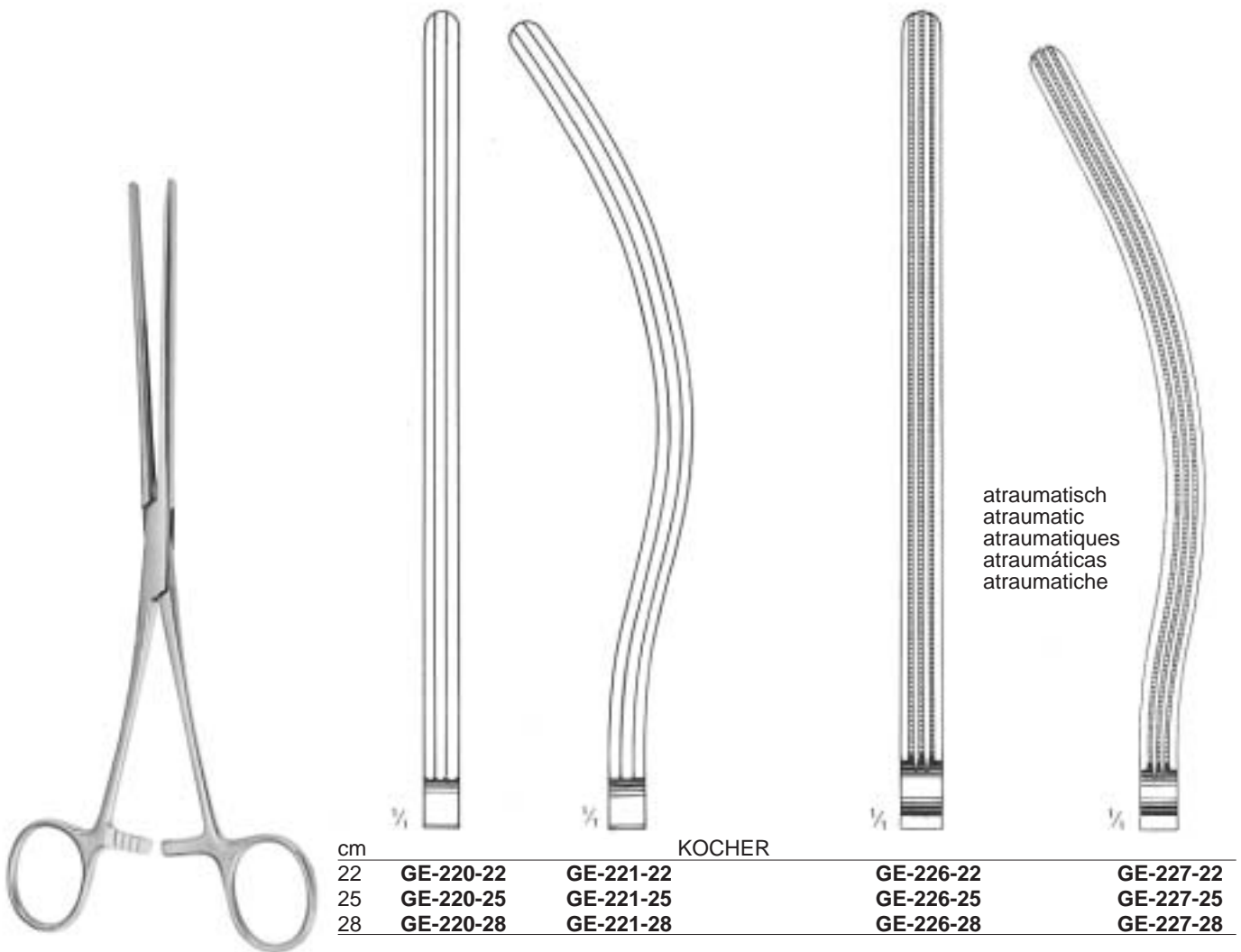

atraumatisch
 atraumatic
 atraumatiques
 atraumáticas
 atraumatiche

cm	KOCHER			
22	GE-220-22	GE-221-22	GE-226-22	GE-227-22
25	GE-220-25	GE-221-25	GE-226-25	GE-227-25
28	GE-220-28	GE-221-28	GE-226-28	GE-227-28

KOCHER
 GE-220-22 - GE-227-22

Darm, Magen
Intestines and Stomach
Intestin, Estomac
Intestines, Estómago
Intestini, Stomaco

GE

Darmklemmen
Intestinal Forceps
Pinças intestinales
Pinzas intestinales
Pinze intestinali

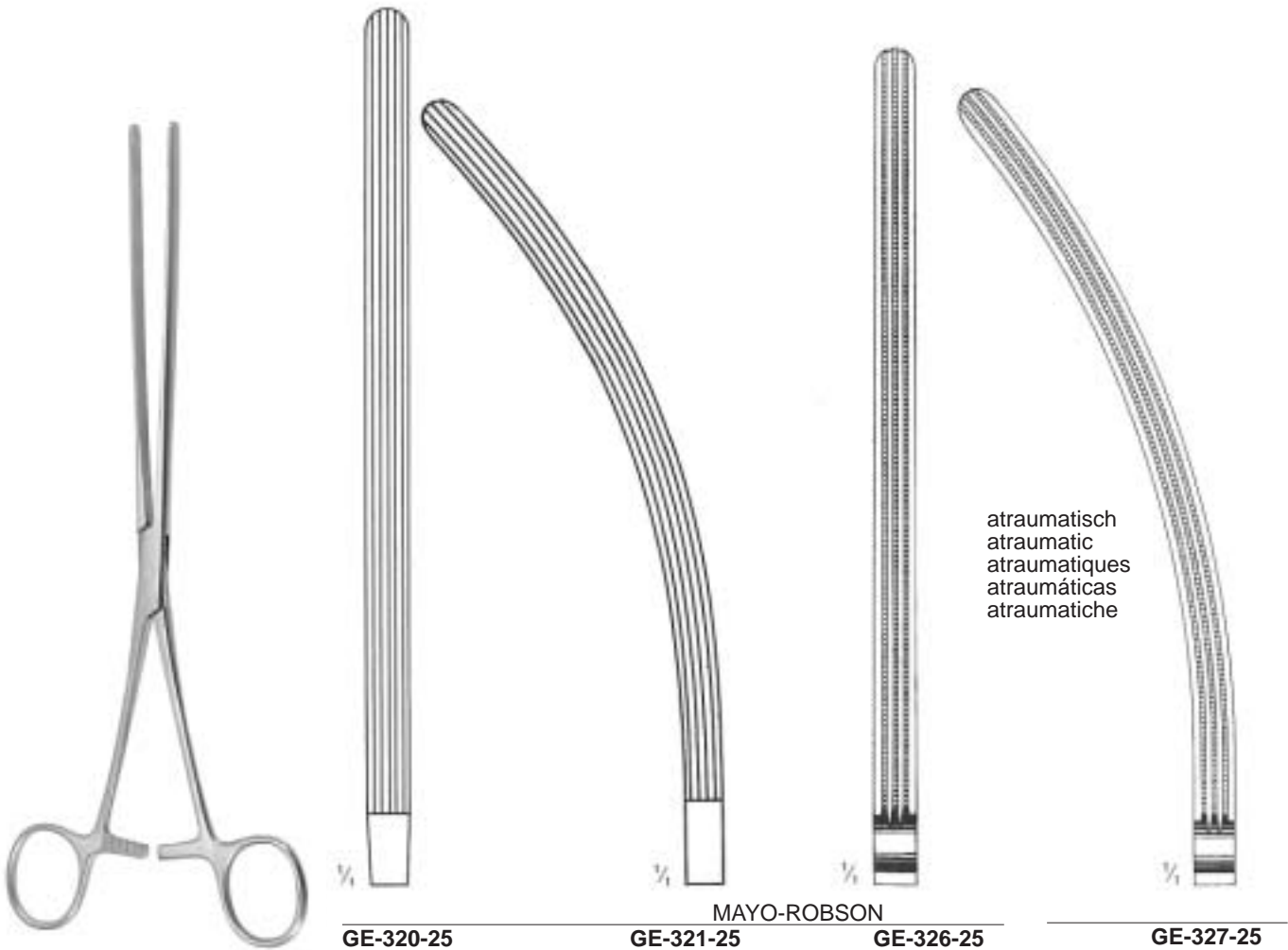

atraumatisch
atraumatic
atraumatiques
atraumáticas
atraumatiche

MAYO-ROBSON
GE-320-25 - GE-327-25
25 cm

GE-320-25

GE-321-25

GE-326-25

GE-327-25

GE

Darm, Magen
Intestines and Stomach
Intestin, Estomac
Intestines, Estómago
Intestini, Stomaco



normal FEHLAND atraum.
GE-421-23 23,5 cm **GE-427-23**

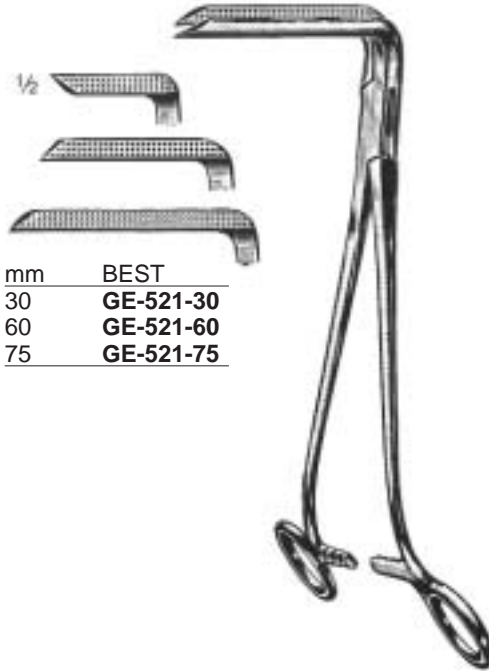

mm	BEST
30	GE-521-30
60	GE-521-60
75	GE-521-75

BEST
GE-521-30 - GE-521-75
26,5 cm

Darm- und Magenklappen
Intestinal and Stomach Clamps
Pinces-clamps intestinales
Pinzas-clamps intestinales y estomacales
Pinze intestinali e stomacali



BRUNNER
GE-620-24 - GE-626-24
24 cm

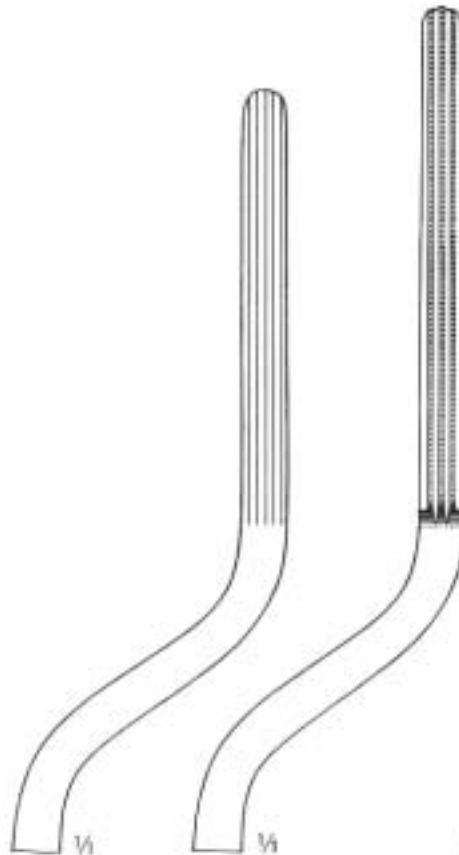

BRUNNER
GE-620-24 GE-626-24

atraumatisch
atraumatic
atraumatique
atraumática
atraumatica



STONE
GE-720-15
15,5 cm



STONE-WATT
GE-724-00



cm STONE-WATT
7,5 **GE-722-07**
10 **GE-722-10**

Anastomosenklemmen und Zubehör
 Anastomosis Clamps and Accessories
 Clamps á anastomose et accessoires
 Clamps para anastomosis y accesorios
 Pinze per anastomosi e accessori

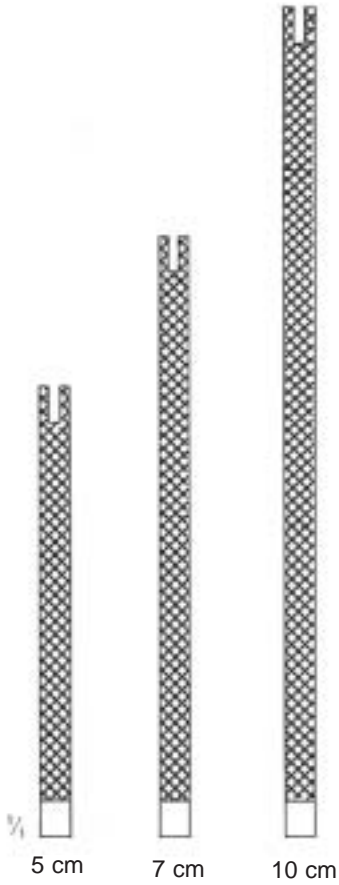

5 cm 7 cm 10 cm



cm	DE MARTEL-WOLFSON
5	GE-820-05
7	GE-820-07
10	GE-820-10
	Set/3



DE MARTEL-WOLFSON
GE-822-26
 26 cm



DE MARTEL-WOLFSON	
GE-824-08	GE-824-23
8,5 cm	23 cm

GE

Darm, Magen
Intestines and Stomach
Intestin, Estomac
Intestines, Estómago
Intestini, Stomaco

Magenklemmen
Stomach Clamps
Pinces-clamps stomacales
Pinzas-clamps estomacales
Pinze stomacali

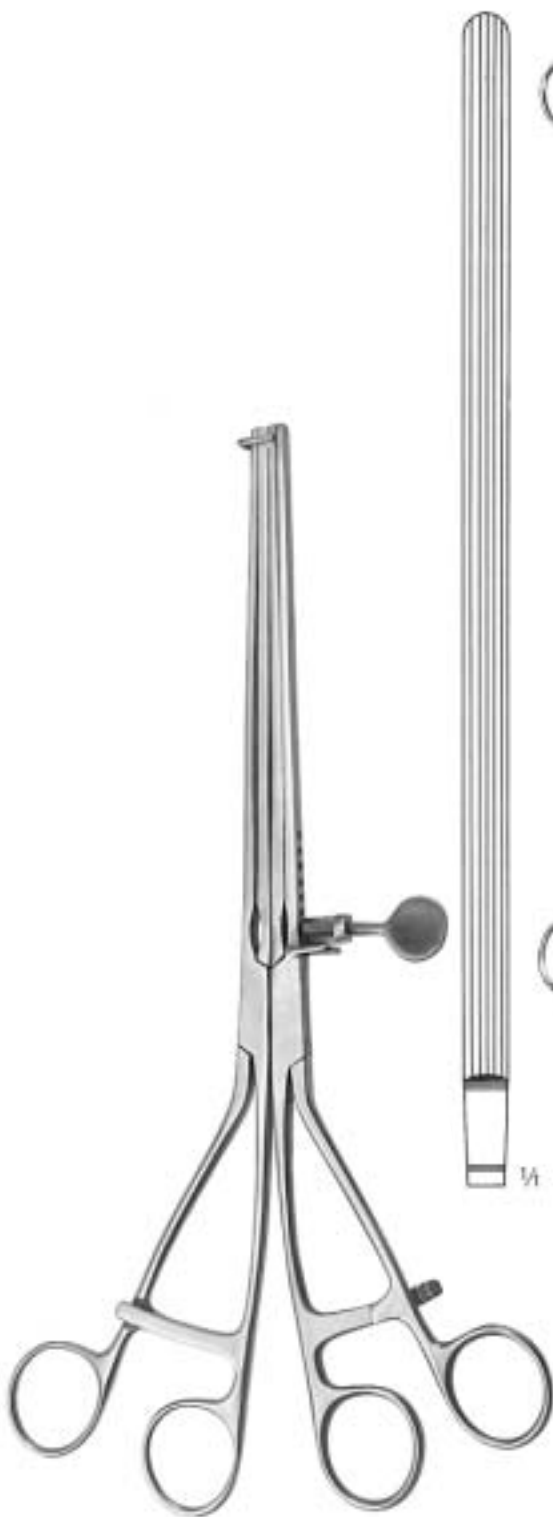

LANE
GE-920-30
30 cm

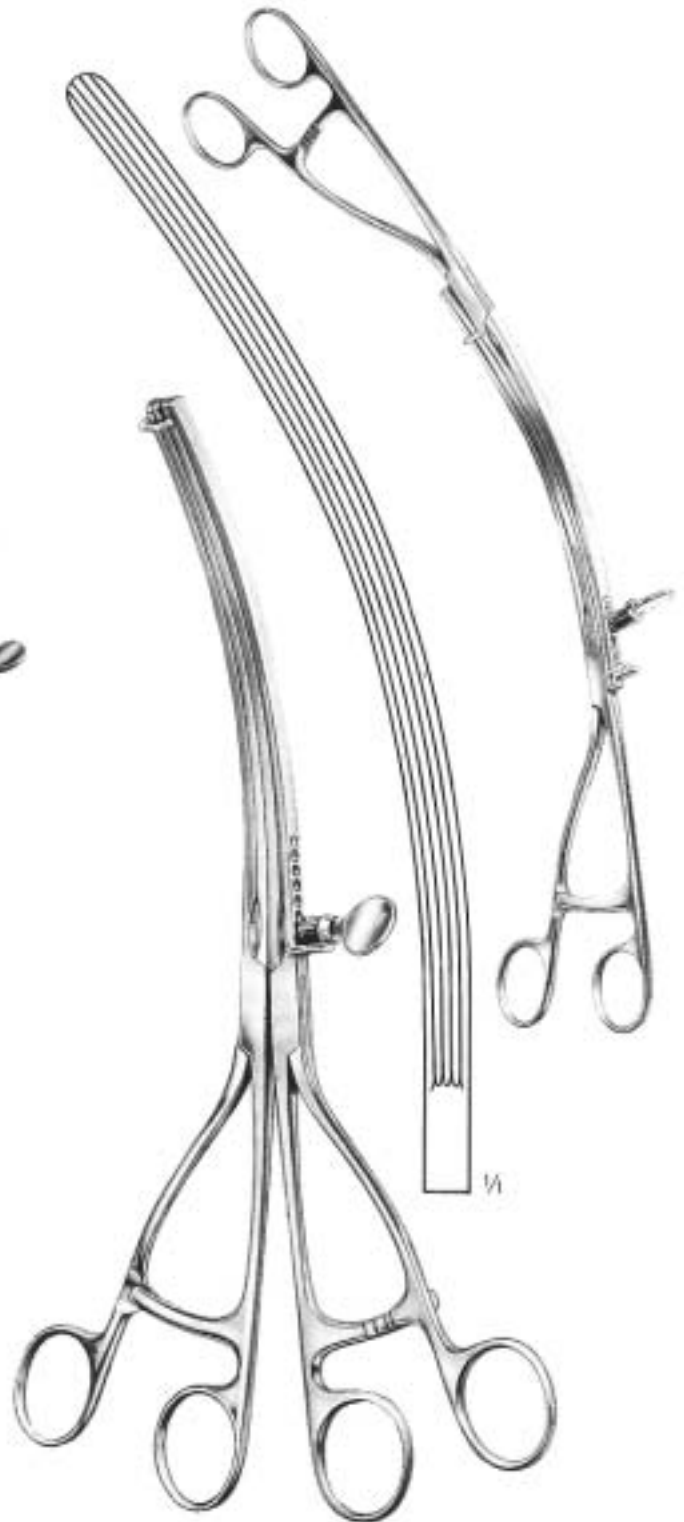

LANE
GE-921-30
30 cm

Darm, Magen
 Intestines and Stomach
 Intestin, Estomac
 Intestines, Estómago
 Intestini, Stomaco

GE

Magenklemmen
 Stomach Clamps
 Pincés-clamps stomacales
 pinzas-clamps estomacales
 Pinze stomacali

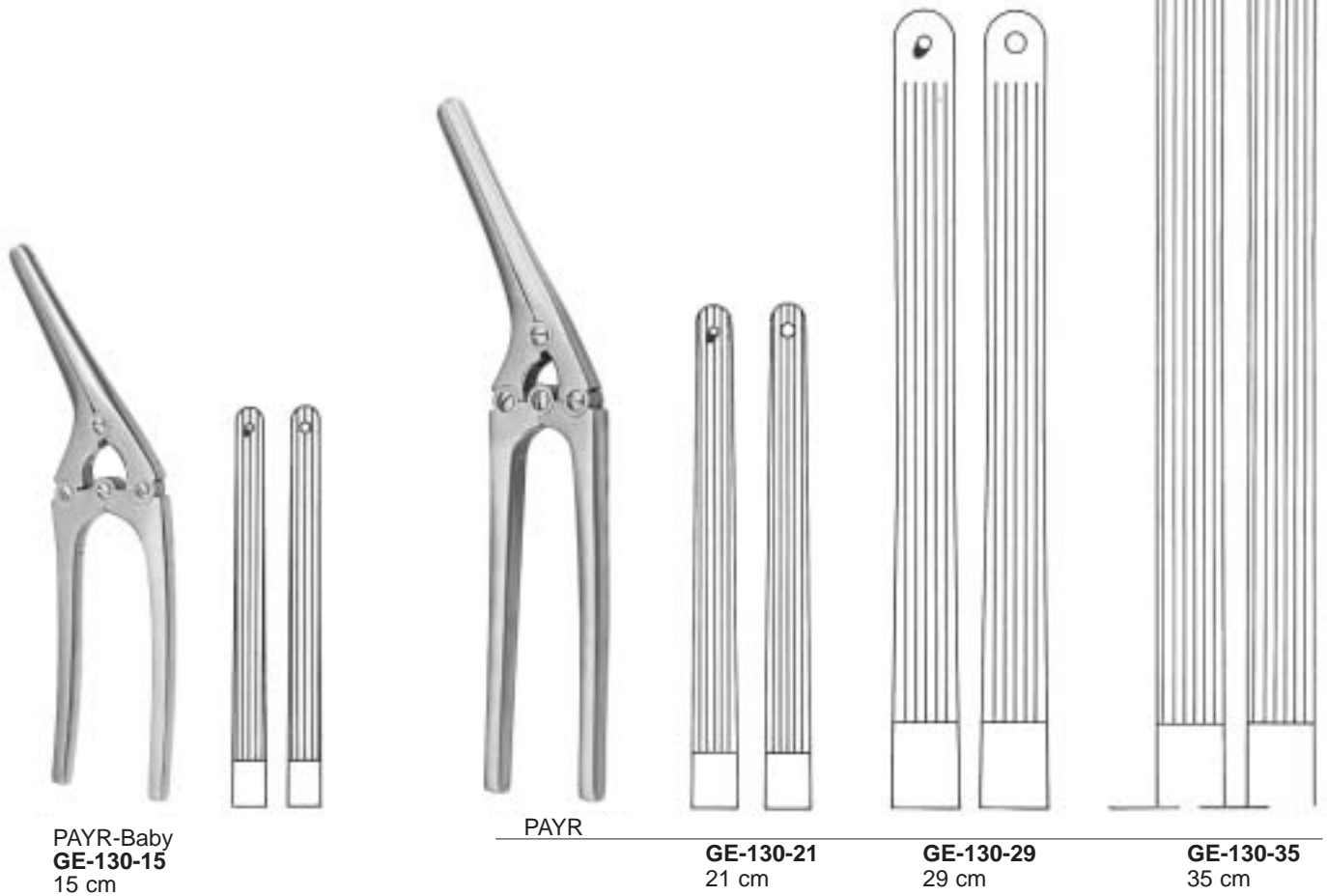

Magen- und Darmnähapparat • Stomach and Intestinal Suturing Apparatus • Appareil á sutures stomacales et intestinales • Aparato para suturas estomacales e intestinales • Apparecchio per suture stomacali e intestinali

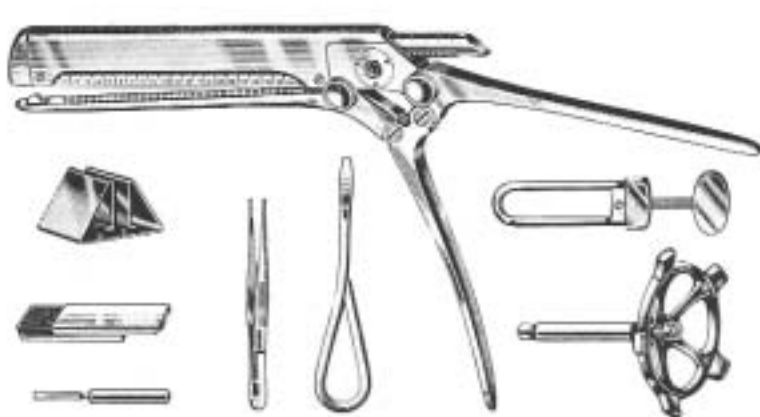

v. PETZ
GE-230-00
 compl.



300 Stück
 300 ea.
 300 pièces
 300 c/u
 300 pezzi

GE-231-00

GG

**Urologie
Urology
Urologie
Urología
Urologia**



GG

GG

Prostata Haken, -Faßzange
Prostatic Retractors, Grasping Forceps
Ecarteurs à prostate, Pince à saisir la prostate
Separadores, Pinza para coger prostata
Divaricatori, Pinza per afferrare la prostata



YOUNG
GG-011-21
21,5 cm



YOUNG
GG-012-22
21,5 cm



YOUNG
GG-013-22
20,5 cm



YOUNG
GG-015-21
22 cm



YOUNG
GG-016-20
20 cm

Kapselfasszangen, Fadenführungszange
 Capsule Forceps, Ligature Carrying Forceps
 Pincés pour saisir les capsules. Pince porte-fil
 Pinzas capsulares, Pinze porta ligaduras
 Pinze per afferrare capsule, Pinza porta-filo

GG



MILLIN
GG-111-23
 24,5 cm



MILLIN
GG-115-24
 24,5 cm



MILLIN
GG-117-23
 22 cm



MILLIN
GG-213-23
 22 cm

Fasszange für vordere Lappen
 Lobe Holding Forceps
 Pince pour saisir les lombeaux
 Pinza para lóbulos anteriores
 Pinza per lobuli anteriori



MILLIN
GG-215-24
 24,5 cm

Fadenführungszange
 Ligature Carrying Forceps
 Pince porte-fil
 Pinze porta ligaduras
 Pinza porta-filo



35 mm

LEGUEU
GG-417-27
27 cm



67 mm

KOCHER
GG-419-27
26 cm



JUDD-MASSON
GG-510-00



MILLIN

MILLIN

GG-511-00

komplett mit je 2 Seitenvalven
57 x 25 mm und 80 x 25 mm,
sowie 1 Mittelvalve 120 x 45 mm
ohne Kaltlichtaufsatz

complete with 2 pairs of lateral
blades 57 x 25 mm and 80 x 25 mm
and 1 central blade 120 x 45 mm
without F.O. Carrier

complet, avec 2 paires de valves laterales,
57 x 25 mm et 80 x 25 mm,
ainsi qu'une valve centrale 120 x 45 mm
sans support lumière froide

completo, con 2 pares de valvas laterales
57 x 25 mm y 80 x 25 mm
y una valva central 120 x 45 mm
sin portador de luz fria

completo, con 2 paia di valve laterali
57 x 25 mm e 80 x 25 mm
in piú 1 valva centrale 120 x 45 mm
senza supporto per luce fredda

MILLIN

GG-511-50

komplett mit je 2 Seitenvalven
57 x 25 mm und 80 x 25 mm,
sowie 1 Mittelvalve 120 x 45 mm
mit Kaltlichtaufsatz

complete with 2 pairs of lateral
blades 57 x 25 mm and 80 x 25 mm
and 1 central blade 120 x 45 mm
with F.O. Carrier

complet, avec 2 paires de valves laterales,
57 x 25 mm et 80 x 25 mm,
ainsi qu'une valve centrale 120 x 45 mm
avec support lumière froide

completo, con 2 pares de valvas laterales
57 x 25 mm y 80 x 25 mm
y una valva central 120 x 45 mm
con portador de luz fria

completo, con 2 paia di valve laterali
57 x 25 mm e 80 x 25 mm
in piú 1 valva centrale 120 x 45 mm
con supporto per luce fredda

MILLIN

GG-511-51

Kaltlichtaufsatz
F.O. Light Carrier
Supporto lumière froide
Portador de luz fria
Supporto per luce fredda

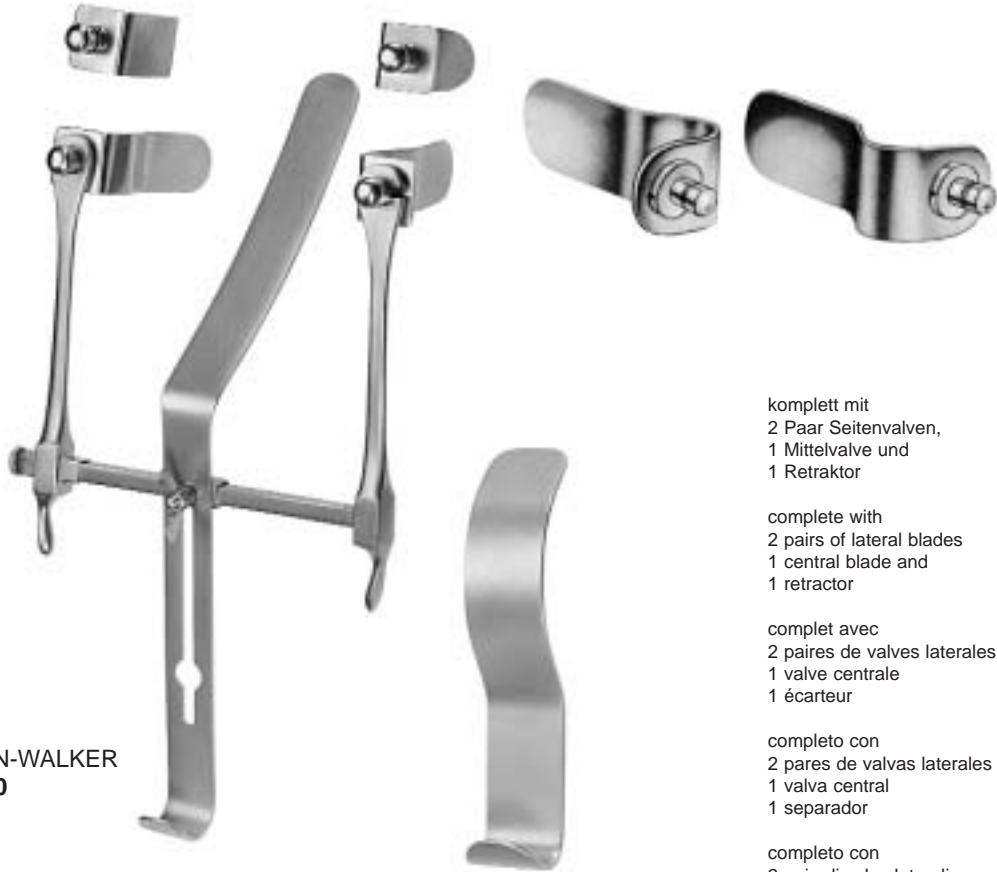

THOMSON-WALKER
GG-610-00

komplett mit
2 Paar Seitenvalven,
1 Mittelvalve und
1 Retraktor

complete with
2 pairs of lateral blades
1 central blade and
1 retractor

complet avec
2 paires de valves laterales
1 valve centrale
1 écarteur

completo con
2 pares de valvas laterales
1 valva central
1 separador

completo con
2 paia di valve laterali
1 valva centrale e
1 retrattore



LEGUEU
GG-613-00



MILLIN
GG-615-00
29 cm

Fremdkörperzangen
Foreign Body Forceps
Pinceps à corps étrangers
Pinzas para cuerpos extranjerios
Pinze per corpi estranei



MATHIEU
GG-618-20
Schaftlänge 20 cm
length of shaft 20 cm
longueur du tige 20 cm
longitud del vástago 20 cm
lunghezza del gambo 20 cm

MATHIEU
GG-618-28
Schaftlänge 28 cm
length of shaft 28 cm
longueur du tige 28 cm
longitud del vástago 28 cm
lunghezza del gambo 28 cm

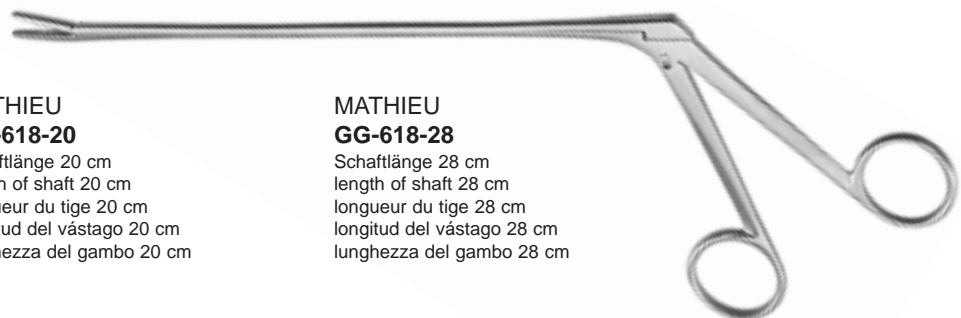

GG

Urethrotom
Urethrotome
Urétrótome
Uretrótomo
Uretrotomi

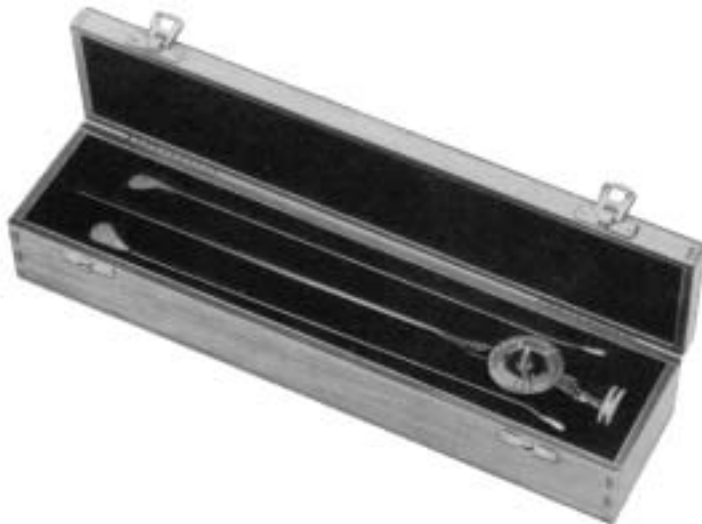

OTIS
GG-619-00

komplett mit Holzetui
mit Dilatator, 2 Messern und 3 Ansätzen

complete in wooden case
with dilator, 2 knives and 3 tips

complet, en boîte métal
avec dilataleur, 2 lames et 3 embouts

completo an caja de madera
con dilatador, 2 cuchillos y 3 puntas

completo, in contenitore di legno
con dilatatore, 2 bisturi e 3 punte



OTIS
GG-619-01
Ersatzmesser
Spare Blade
Couteau de rechange
Cuchillo de repuesto
Lama die ricambio

Circumcisionsgerät
 Circumcision Instrument
 Instrument de circoncision
 Instrumento para circuncisión
 Strumento per circoncisione



GG-711-08 Ø 8 mm
GG-711-11 Ø 11 mm
GG-711-13 Ø 13 mm
GG-711-16 Ø 16 mm
GG-711-21 Ø 21 mm
GG-711-26 Ø 26 mm
GG-711-32 Ø 32 mm

Urethrographieinstrument
 Urethrography Instrument
 Instrument pour urétrographie
 Instrumento para uretrografia
 Strumento per uretrografia



GG-712-01

KNUTSON-KOCH
GG-712-01

Konus
 Cone
 Cône
 Cono
 Cono

KNUTSON
GG-712-00

Beschneidungsinstrument
 Circumcision Instrument
 Instrument de circoncision
 Instrumento para circuncisión
 Strumento per circoncisione



MOGAN
GG-714-01
 für Erwachsene
 for adults
 pour adultes
 para adultos
 per adulti

MOGAN
GG-714-02
 für Kinder
 for children
 pour enfants
 para niños
 per bambini



WINKELMANN

GG-714-12 Ø 12 mm
GG-714-16 Ø 16 mm
GG-714-20 Ø 20 mm

Penisklemmen
 Meatus Clamps
 Compresseurs de l'urètre
 Compresores uretrales
 Serrapene



STOCKMANN
GG-715-08
 8 cm



STRAUSS
GG-717-11
 11 cm

Zange zum Erfassen der Glans und der Vorhaut
 Forceps for grasping the glans and the foreskin



GG-719-12
 12,5 cm

Klemme zum Fixieren des Samenstranges
 Fixation clamp for the spermatic cord
 Pince pour fixer le cordon
 Pinza para fijar el cordón espermático
 Pinza per fissare il tronco spermatico



GG-719-15
 14,5 cm

Sekretlöffel, Katheterspanner
Secretions Scoops, Catheter Introducer
Cuiller à sécrétions, Introducteur de sondes
Cucharillas p. secreciones, Introducer de catéres
Cucchia per secrezioni, mandrini per sonde uretrali

GG



GUTTMANN
GG-810-26
26,5 cm



DITTEL
GG-812-46
46 cm



GUYON
GG-813-46
46 cm



GUYON
GG-814-39
39 cm



GUYON
GG-815-35
35 cm

GG

Gleitsonde, Harnröhrenbougies
Filiform Bougiem Urethral Sounds
Bougie conductrice, Bougies urétrales
Sonda filiforme, Bujias uretrales
Candeletta filiforme, Candelette dilatatrice

mit Schraubgewinde-Ansatz
with screw thread
avec ambout fileté
con rosca de tornillo
con attacco filettato

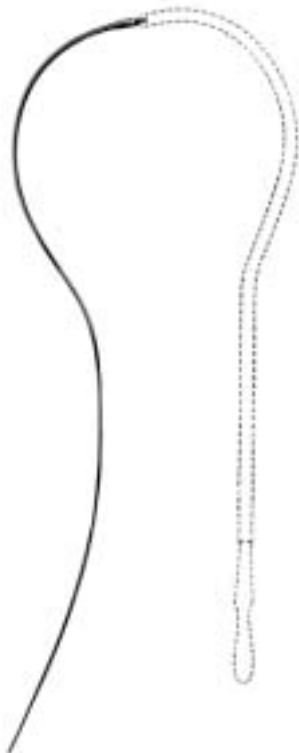

FILIFORM

GG-919-03	3 Ch.
GG-919-04	4 Ch.
GG-919-05	5 Ch.
GG-919-06	6 Ch.

Satz mit 21 Bougies, Charr. 10 bis 30
mit 4 Gleitsonden
im Metalletui 42 x 17,5 x 4 cm

set with 21 bougies, Charr. 10 to 30
with 4 filiform bougies
in metal case 42 x 17,5 x 4 cm

jeu avec 21 bougies, Charr. 10 jusqu' à 30
avec 4 bougies conductrices
en boîte métal 42 x 17,5 x 4 cm

juego de 21 bujias, Charr. 10 a 30
con 4 bujias filiformes
en caja metálica 42 x 17,5 x 4 cm

set di 21 dilatatori, Charr. 10 fino a 30
con 4 candelette dilatatrici
in contenitore metallico 42 x 17,5 x 4 cm



GUYON
GG-020-00
compl.



VAN BUREN
GG-021-00
Set compl.
8-36 Charr.

van BUREN	mm Ø	Charrière (French)
GG-021-06	2	6
GG-021-08	2 ² / ₃	8
GG-021-10	3 ¹ / ₃	10
GG-021-12	4	12
GG-021-14	4 ² / ₃	14
GG-021-16	5 ¹ / ₃	16
GG-021-18	6	18
GG-021-20	6 ² / ₃	20
GG-021-22	7 ¹ / ₃	22
GG-021-24	8	24
GG-021-26	8 ² / ₃	26
GG-021-28	9 ¹ / ₃	28
GG-021-30	10	30
GG-021-32	10 ² / ₃	32
GG-021-34	11 ¹ / ₃	34
GG-021-36	12	36
GG-021-38	12 ² / ₃	38

mit Schraubgewinde-Ansatz
 with screw thread
 avec ambout fileté
 con rosca de tornillo
 con attacco filettato



GUYON
GG-023-00
 Set compl.
 10-30 Charr.

GUYON	mm Ø	Charrière (French)
GG-023-10	3 ¹ / ₃	10
GG-023-11	3 ² / ₃	11
GG-023-12	4	12
GG-023-13	4 ¹ / ₃	13
GG-023-14	4 ² / ₃	14
GG-023-15	5	15
GG-023-16	5 ¹ / ₃	16
GG-023-17	5 ² / ₃	17
GG-023-18	6	18
GG-023-19	6 ¹ / ₃	19
GG-023-20	6 ² / ₃	20
GG-023-21	7	21
GG-023-22	7 ¹ / ₃	22
GG-023-23	7 ² / ₃	23
GG-023-24	8	24
GG-023-25	8 ¹ / ₃	25
GG-023-26	8 ² / ₃	26
GG-023-27	9	27
GG-023-28	9 ¹ / ₃	28
GG-023-29	9 ² / ₃	29
GG-023-30	10	30



GUYON

GUYON	mm Ø	Charrière (French)
GG-025-08	2 ² / ₃	8
GG-025-09	3	9
GG-025-10	3 ¹ / ₃	10
GG-025-11	3 ² / ₃	11
GG-025-12	4	12
GG-025-13	4 ¹ / ₃	13
GG-025-14	4 ² / ₃	14
GG-025-15	5	15
GG-025-16	5 ¹ / ₃	16
GG-025-17	5 ² / ₃	17
GG-025-18	6	18
GG-025-19	6 ¹ / ₃	19
GG-025-20	6 ² / ₃	20
GG-025-21	7	21
GG-025-22	7 ¹ / ₃	22
GG-025-23	7 ² / ₃	23
GG-025-24	8	24
GG-025-25	8 ¹ / ₃	25
GG-025-26	8 ² / ₃	26
GG-025-27	9	27
GG-025-28	9 ¹ / ₃	28
GG-025-29	9 ² / ₃	29
GG-025-30	10	30
GG-025-31	10 ¹ / ₃	31
GG-025-32	10 ² / ₃	32
GG-025-33	11	33
GG-025-34	11 ¹ / ₃	34
GG-025-35	11 ² / ₃	35
GG-025-36	12	36
GG-025-37	12 ¹ / ₃	37
GG-025-38	12 ² / ₃	38
GG-025-39	13	39
GG-025-40	13 ¹ / ₃	40
GG-025-50	16 ² / ₃	50

für Männer
 for men
 pour hommes
 para hombres
 per uomini



	mm Ø	Charrière (French)
GG-121-08	2 ² / ₃	8
GG-121-10	3 ¹ / ₃	10
GG-121-12	4	12
GG-121-14	4 ² / ₃	14
GG-121-16	5 ¹ / ₃	16
GG-121-18	6	18
GG-121-20	6 ² / ₃	20
GG-121-22	7 ¹ / ₃	22
GG-121-24	8	24

für Frauen
 for women
 pour femmes
 para mujeres
 per donne



	mm Ø	Charrière (French)
GG-123-08	2 ² / ₃	8
GG-123-10	3 ¹ / ₃	10
GG-123-12	4	12
GG-123-14	4 ² / ₃	14
GG-123-16	5 ¹ / ₃	16
GG-123-18	6	18
GG-123-20	6 ² / ₃	20
GG-123-22	7 ¹ / ₃	22
GG-123-24	8	24



COXETER	mm Ø	Charrière (French)
GG-129-08	2 ² / ₃	8
GG-129-10	3 ¹ / ₃	10
GG-129-12	4	12
GG-129-14	4 ² / ₃	14
GG-129-16	5 ¹ / ₃	16
GG-129-18	6	18
GG-129-20	6 ² / ₃	20
GG-129-22	7 ¹ / ₃	22
GG-129-24	8	24



WALTHER	mm Ø	Charrière (French)
GG-221-12	4	12
GG-221-14	4 ² / ₃	14
GG-221-16	5 ¹ / ₃	16
GG-221-18	6	18
GG-221-20	6 ² / ₃	20
GG-221-22	7 ¹ / ₃	22
GG-221-24	8	24
GG-221-26	8 ² / ₃	26
GG-221-28	9 ¹ / ₃	28
GG-221-30	10	30
GG-221-32	10 ² / ₃	32
GG-221-34	10 ¹ / ₃	34
GG-221-36	12	36
GG-221-38	12 ² / ₃	38

WALTHER
GG-221-00
 34,5 cm

Satz komplett
 complete set
 jeu complet
 juego completo
 set completo
GG-221-12 - GG-221-38



DITTEL	mm Ø	Charrière (French)
GG-225-08	2 ² / ₃	8
GG-225-09	3	9
GG-225-10	3 ¹ / ₃	10
GG-225-11	3 ² / ₃	11
GG-225-12	4	12
GG-225-13	4 ¹ / ₃	13
GG-225-14	4 ² / ₃	14
GG-225-15	5	15
GG-225-16	5 ¹ / ₃	16
GG-225-17	5 ² / ₃	17
GG-225-18	6	18
GG-225-19	6 ¹ / ₃	19
GG-225-20	6 ² / ₃	20
GG-225-21	7	21
GG-225-22	7 ¹ / ₃	22
GG-225-23	7 ² / ₃	23
GG-225-24	8	24
GG-225-25	8 ¹ / ₃	25
GG-225-26	8 ² / ₃	26
GG-225-27	9	27
GG-225-28	9 ¹ / ₃	28
GG-225-29	9 ² / ₃	29
GG-225-30	10	30
GG-225-32	10 ² / ₃	32

DITTEL
GG-225-00

Satz komplett (23)
complet set (23)
jeu complet (23)
juego completo (23)
set completo (23)
GG-225-08 - GG-225-30

DITTEL
GG-225-98

Satz komplett (6)
complet set (6)
jeu complet (6)
juego completo (6)
set completo (6)
GG-225-08/12/16/20/24/30



DITTEL
 34,5 cm

DITTEL	mm Ø	Charrière (French)
GG-227-08	2 ² / ₃	8
GG-227-09	3	9
GG-227-10	3 ¹ / ₃	10
GG-227-11	3 ² / ₃	11
GG-227-12	4	12
GG-227-13	4 ¹ / ₃	13
GG-227-14	4 ² / ₃	14
GG-227-15	5	15
GG-227-16	5 ¹ / ₃	16
GG-227-17	5 ² / ₃	17
GG-227-18	6	18
GG-227-19	6 ¹ / ₃	19
GG-227-20	6 ² / ₃	20
GG-227-21	7	21
GG-227-22	7 ¹ / ₃	22
GG-227-23	7 ² / ₃	23
GG-227-24	8	24
GG-227-25	8 ¹ / ₃	25
GG-227-26	8 ² / ₃	26
GG-227-27	9	27
GG-227-28	9 ¹ / ₃	28
GG-227-29	9 ² / ₃	29
GG-227-30	10	30

GI

**Mastdarm
Rectum
Rectum
Recto
Retto**



GI

Mastdarm-Spekula
Rectal Specula
Spéculums rectaux
Espéculos rectales
Specoli rettali



CZERNY
GI-015-22
22 cm



SIMS
GI-110-15
15 cm



BODENHAMMER
GI-115-15
GI-117-15 = Kaltlicht • Cold Light
15 cm
Lumière froide
Luz fria • Luce fredda



PRATT
GI-211-00



BARR
GI-215-17
70 x 22 mm
17 cm



MATHIEU
GI-310-19
17 cm

Mastdarm-Spreizer
Anal Retractors
Dilatateurs p. anus et rectum
Speculadores rectales
Dilatatori per l'ano retto



ALAN-PARKS
GI-417-00
compl.
13,5 cm

SMITH-BUIE
GI-510-15
75 x 23 mm
15 cm

GI-418-00
Kaltlicht-Adapter für **GI-417-00**
Cold Light Attachment for **GI-417-00**
Adaptateur lumière froide pour **GI-417-00**
Adaptador luz fría para **GI-417-00**
Adattatore luce fredda per **GI-417-00**

Rektoskop
Rectoscope
Rectoscope
Rectoscopio
Rettoscopio

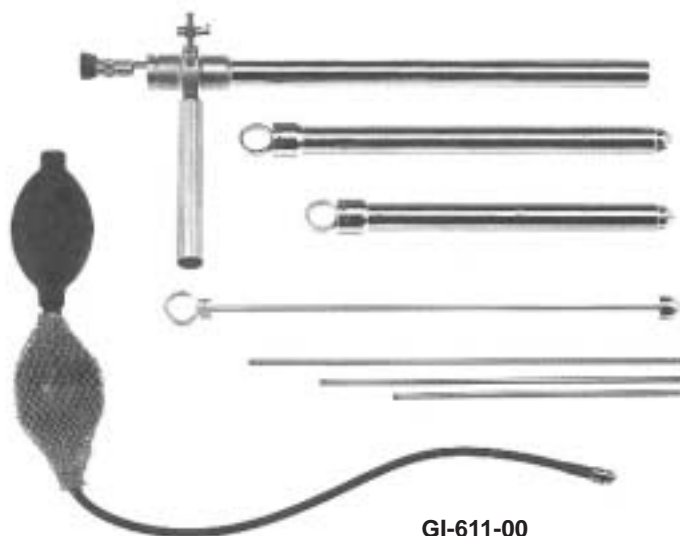

GI-611-00
compl.

Kaltlicht • Cold Light • Lumière froide
Luz fría • Luce fredda

GI

Mastdarm
Rectum
Rectum
Recto
Retto

Anoskope, Proktoskope
Anoscopes, Proctoscopes
Anuscopes, Proctoscopes
Anoscopios, Proctoscopios
Anoscopi, Proctoscopi



IVES-FANSLER
GI-120-22
22 mm Ø
L = 80 mm



Ø mm	HIRSCHMANN
16	GI-122-16
19	GI-122-19
22	GI-122-22
L = 65 mm	



mm Ø x L	KELLY
22 x 50	GI-220-05
22 x 100	GI-220-10
22 x 140	GI-220-14
22 x 200	GI-220-20

Cystikus-Haken
Cystic Hooks
Ecarteurs rectaux
Ganchos rectales
Unicini rettali



Ø mm	KELLY
21	GI-224-21
27	GI-224-27
L = 50 mm	



GI-521-01
Fig. 1

GI-521-02
Fig. 2

GI-521-03
Fig. 3

PRATT
GI-521-01 - GI-521-03



Biopsie-Zangen
Biopsy Specimen Forceps
Pinces emporte-pièce à biopsie
Pinzas sacabocado para biopsia
Pinze per biopsia

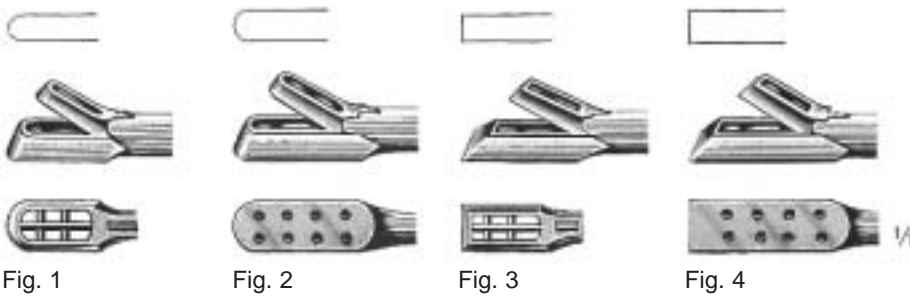
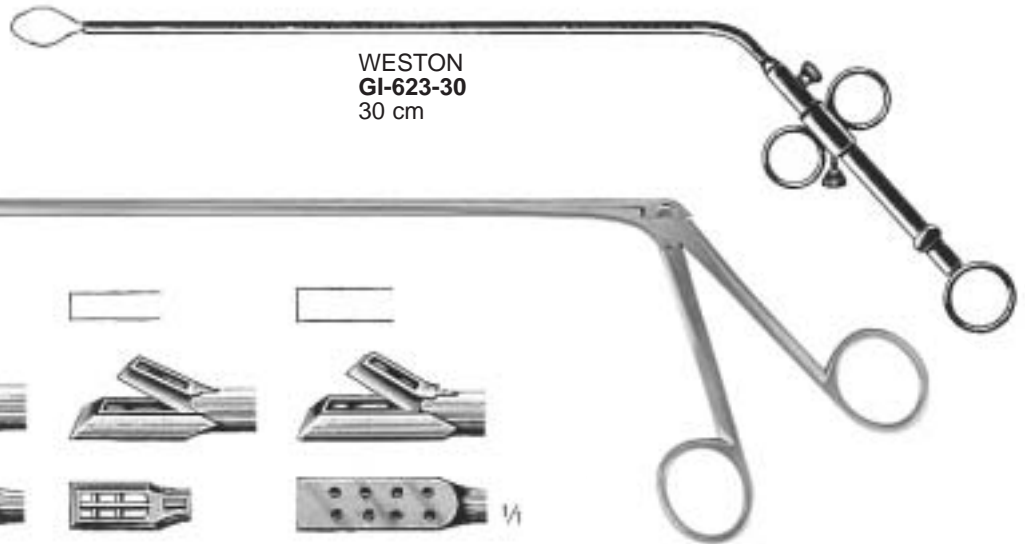

				cm	YEOMAN
GI-031-28	GI-032-28	GI-033-28	GI-034-28	28	
GI-031-35	GI-032-35	GI-033-35	GI-034-35	35	
GI-031-42	GI-032-42	GI-033-42	GI-034-42	42	



cm	YEOMAN
23	GI-131-23
33	GI-131-33
40	GI-131-40



cm	TURREL
23	GI-231-23
33	GI-231-33
40	GI-231-40

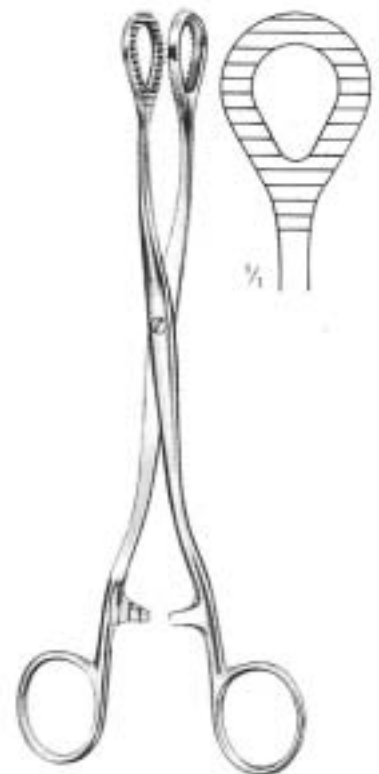

HA

**Gynäkologie
Gynecology
Gynécologie
Ginecología
Ginecologia**



HA



GRAVE			
Fig.	mm	Standard	Laser Mod.
1	75x20	HA-110-01	HA-114-01
2	95x35	HA-110-02	HA-114-02
3	115x35	HA-110-03	HA-114-03



GRAVE		
Fig.	mm	Standard
2	95x35	HA-111-02

mit Absaugung
 with suction
 avec aspiration
 con aspiradoras
 con aspirazione



extra klein
 extra small
 extra petit
 extra pequeno
 extra piccolo

GRAVE
HA-112-01
 76 x 12 mm



extra groß
 extra large
 extra grande
 extra grande
 extra grande

GRAVE
HA-112-02
 120 x 38 mm



PEDERSON

Fig. mm

1	75x13	HA-210-01
2	100x22	HA-210-02
3	120x25	HA-210-03



PEDERSON
HA-212-10
100 x 31 mm



COLLIN
 Fig. mm
 1 85x30 **HA-310-01**
 2 100x35 **HA-310-02**
 3 110x40 **HA-310-03**



COLLIN
HA-311-00
 65x20 mm



COLLIN
HA-312-00
 65x10 mm



Seitl. Schraube
 Lateral Screw
 Vis latérale
 Tornillo lateral
 Vite laterale

CUSCO
 Fig. mm Standard Laser Mod.
 0 80x24 **HA-410-00**
 1 75x32 **HA-410-01**
 2 85x35 **HA-410-02** **HA-414-02**
 3 100x35 **HA-410-03** **HA-414-03**

Mittelschraube
Central Screw
Vis centrale
Tornillo central
Vite centrale



CUSCO
HA-412-00
65x20 mm



CUSCO	mm
HA-510-00	80x24
HA-510-01	75x32
HA-510-02	85x36
HA-510-03	95x37
HA-510-04	110x37
HA-511-00	75x17

flache Entenschnabelform
 flat duck beak



CUSCO	mm
HA-512-01	80x32
HA-512-02	90x37
HA-512-03	115x37

Schweizer Modell
 Swiss Pattern
 Modèle suisse
 Modelo suizo
 Modello svizzero



Fig.	mm	CUSCO
1	90x23-25	HA-610-01
2	100x25-27	HA-610-02
3	110x27-30	HA-610-03



FREEWAY GRAVE
HA-612-01
 100 x 32 mm



FREEWAY GRAVE
HA-612-02
 45°

Vaginalspekula
Vaginal Specula
Speculums vaginaux
Espécules vaginales
Specoli vaginali

HA



mm	TRELAT
85x33	HA-810-01
95x35	HA-810-02
115x43	HA-810-03



mm	SEMM
90x14-18	HA-910-00
100x17-20	HA-910-01
100x25-30	HA-910-02



O`SULLIVAN O`CONNOR
HA-916-00
komplett
complete
complet
completo
completo



HA-916-01
Fig. 1
45x17 mm

HA-916-02
Fig. 2
90x37 mm

HA-916-03
Fig. 3
90x45mm

Vaginalspekula, Scheidenhalter
 Vaginal Specula, Vaginal Retractors
 Speculums vaginaux, Velves vaginales
 Espécules vaginales, Valvas vaginales
 Specoli vaginali, Valve vaginali

HA



Satz Fig.
 set no.
 jeu no.
 juego no.
 serie no.

bestehend aus
 consisting of
 se compositant de
 consiste de
 composto da

KRISTELLER

HA-120-01	0	HA-121-00 + HA-122-00
HA-120-02	1	HA-121-01 + HA-122-01
HA-120-03	2	HA-121-02 + HA-122-02
HA-120-04	3	HA-121-03 + HA-122-03



Fig.	mm	KRISTELLER
0	70x15	HA-121-00
1	70x27	HA-121-01
2	80x30	HA-121-02
3	90x36	HA-121-03

Spekulum
 Speculum
 Spéculum
 Espéculo
 Specolo

Fig.	mm	KRISTELLER
0	75x10	HA-122-00
1	75x23	HA-122-01
2	85x26	HA-122-02
3	100x32	HA-122-03

Halter
 Retractor
 Valve
 Valva

HA

Vaginalspekula, Scheidenhalter
Vaginal Specula, Vaginal Retractors
Speculums vaginaux, Velves vaginales
Espécules vaginales, Valvas vaginales
Specoli vaginali, Valve vaginali



Mit konischen Blättern, für Jungfrauen
With taper blades, for virgins
A valves coniques, pour vierges
Con hojas cónicas, para vírgenes
Con valve coniche, per vergini

Satz Fig.
set no.
jeu no.
juego no.
serie no.

bestehend aus
consisting of
se compostant de
consiste de
composto da

KRISTELLER

HA-220-01
HA-220-02

1
2

HA-221-01 + HA-222-01
HA-221-02 + HA-222-02



mm KRISTELLER
105x18 HA-221-01
105x21 HA-221-02

Spekulum
Speculum
Spéculum
Espéculo
Specolo



mm KRISTELLER
110x14 HA-222-01
115x17 HA-222-02

Halter
Retractor
Valve
Valva



Satz Fig.
 set no.
 jeu no.
 juego no.
 serie no.

bestehend aus
 consisting of
 se composant de
 consiste de
 composto da

KRISTELLER

HA-320-01	1	HA-321-01 + HA-322-01
HA-320-02	2	HA-321-02 + HA-322-02
HA-320-03	3	HA-321-03 + HA-322-03

Flache Specula
 Specula Flat Hollow
 Spéculums plats
 Espéculos con huecos planos
 Specoli piatti



KRISTELLER	Fig.	mm
HA-321-01	1	105 x 26
HA-321-02	2	105 x 25
HA-321-03	3	105 x 33

Spekulum
 Speculum
 Spéculum
 Espéculo
 Specolo

KRISTELLER	Fig.	mm
HA-322-01	1	115 x 22
HA-322-02	2	115 x 24
HA-322-03	3	115 x 29

Halter
 Retractor
 Valve
 Valva



Satz Fig.
 set no.
 jeu no.
 juego no.
 serie no.

bestehend aus
 consisting of
 se compositant de
 consiste de
 composto da

KRISTELLER

HA-329-99	00	HA-329-97 + HA-329-98
HA-420-00	0	HA-421-00 + HA-422-00
HA-420-01	1	HA-421-01 + HA-422-01
HA-420-02	2	HA-421-02 + HA-422-02
HA-420-03	3	HA-421-03 + HA-422-03



Fig.	mm	KRISTELLER
00	110x18	HA-329-97
0	110x20	HA-421-00
1	110x27	HA-421-01
2	110x30	HA-421-02
3	110x36	HA-421-03

Spekulum
 Speculum
 Spéculum
 Espéculo
 Specolo

Fig.	mm	KRISTELLER
00	115x14	HA-329-98
0	115x17	HA-422-00
1	115x23	HA-422-01
2	115x26	HA-422-02
3	115x32	HA-422-03

Halter
 Retractor
 Valve
 Valva



Für Kinder
 For children
 Pour enfants
 Para niños
 Per bambini

Satz Fig.
 set no.
 jeu no.
 juego no.
 serie no.

bestehend aus
 consisting of
 se compositant de
 consiste de
 composto da

KRISTELLER
HA-424-00

0 **HA-425-00 + HA-426-00**



KRISTELLER
mm
 70x15 **HA-425-00**

Spekulum
 Speculum
 Spéculum
 Espéculo
 Specolo



KRISTELLER
mm
 75x10 **HA-426-00**

Halter
 Retractor
 Valve
 Valva

HA

Vaginalspekula, Scheidenhalter
Vaginal Specula, Vaginal Retractors
Speculums vaginaux, Velves vaginales
Espéculos vaginales, Valvas vaginales
Specoli vaginali, Valve vaginali



Satz Fig.
set no.
jeu no.
juego no.
serie no.

bestehend aus
consisting of
se compositant de
consiste de
composto da

KRISTELLER
HA-520-00

0 KRISTELLER
HA-521-01 + HA-522-00



mm KRISTELLER
135x36 HA-521-00

Spekulum
Speculum
Spéculum
Espéculo
Specolo



mm KRISTELLER
140x30 HA-522-00

Halter
Retractor
Valve
Valva

Vaginalspekula, Scheidenhalter
 Vaginal Specula, Vaginal Retractors
 Speculums vaginaux, Velves vaginales
 Espécules vaginales, Valvas vaginales
 Specoli vaginali, Valve vaginali

HA



Satz Fig.
 set no.
 jeu no.
 juego no.
 serie no.

bestehend aus
 consisting of
 se compostant de
 consiste de
 composto da

KALLMORGEN

HA-620-01	1	HA-621-01	HA-622-01
HA-620-02	2	HA-621-01	HA-622-02



mm **KALLMORGEN**
 70x40 **HA-621-01**
 90x40 **HA-621-02**
 Spekulum
 Speculum
 Spéculum
 Espéculo
 Specolo

mm **KALLMORGEN**
 70x33 **HA-622-01**
 90x33 **HA-622-02**
 Halter
 Retractor
 Valve
 Valva

HA

Vaginalspekula
Vaginal Specula
Speculums vaginaux
Espéculos vaginales
Specoli vaginali

56 x 13 mm



mm BRAUN
56x13 **HA-623-01**

60 x 10 mm



mm BRAUN
60x10 **HA-624-01**

flaches Spekulum
flat speculum
spéculum plat
espéculo plano
specolo piatto

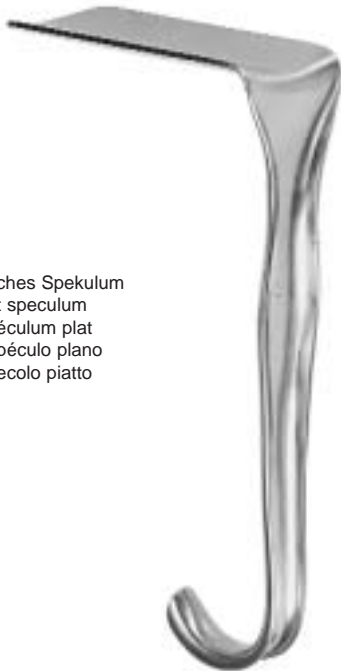

JACKSON



HA-721-01
75 x 40 mm



HA-721-02
90 x 40 mm



HA-721-03
100 x 40 mm



Fig. 1 = klein/small/petit/pequeno/piccolo
 Fig. 2 = mittel/medium/moyen/mediano/medio
 Fig. 3 = groß/large/grand/grande

SIMS		
Fig.	mm	
1	70x25	HA-821-01
2	85x30	HA-821-02
3	100x40	HA-821-03

Scheidenspekula, doppelendig
 Vaginal specula, double-ended
 Spéculums vaginaux, doubles
 Espéculos vaginales, dobles
 Speculi vaginali, doppi

HA-921-00 = Set

bestehend aus
 consisting of
 consiste de
 se composant de
 composto da

HA-921-01/HA-921-02/HA-921-03



Fig.	mm	SIMS
1	65x25, 70x30	HA-921-01
2	70x30, 70x35	HA-921-02
3	85x35, 90x40	HA-921-03



leicht hohl
 slightly concave
 légèrement concave
 ligeramente cóncavo
 leggermente concavo

Fig.	mm	DOYEN
1	75x45	HA-030-01
2	90x45	HA-030-02
3	110x45	HA-030-03

Fig.	mm	DOYEN
1	55x35	HA-031-01
2	75x35	HA-031-02
3	115x35	HA-032-03
1	55x45	HA-033-01
2	75x45	HA-033-02
3	115x35	HA-033-03
4	160x45	HA-033-04
1	55x60	HA-035-01
2	75x60	HA-035-02
3	115x60	HA-035-03
4	160x60	HA-035-04



AUVARD
HA-037-00
83x38 mm
Loses Gewicht
Detachable Weight
Poids démontable
Pessa desmontable
Peso smontabile

AUVARD
HA-039-00
83 x 38 mm
Festes Gewicht
Fixed Weight
Poids fixe
Pessa fija
Peso fissa

HA

Vaginalspekula
Vaginal Specula
Speculums vaginaux
Espécules vaginales
Specoli vaginali



mm	BREISKY
100x20	HA-130-20
100x25	HA-130-25
100x30	HA-130-30
100x35	HA-130-35
100x40	HA-130-40
130x20	HA-133-20
130x25	HA-133-25
130x30	HA-133-30
130x35	HA-133-35
130x40	HA-133-40
155x40	HA-135-40

70 x 30 mm



DOYEN
HA-137-24
25,0 cm

SCHERBAK

HA-138-00

Satz komplett mit Griff,
 Gewicht (400 g) und 5 Blättern
 complete Set with handle,
 weight (400 g) and 5 blades
 jeu complet avec manche,
 poids (400 g) et 5 valves
 juego completo con mango,
 peso (400 g) y 5 valvas
 Set completo con manico,
 peso (400 g) e 5 valve

Blatt allein
 Specula Blade only
 Valve vaginale, seule
 Valva vaginal, suelta
 Valve vaginale, sola



SCHERBAK

HA-138-01	80x30 mm
HA-138-02	85x35 mm
HA-138-03	90x40 mm

SCHERBAK

HA-138-04	62x40-60 mm
HA-138-05	81x45-70 mm

Gewicht zum Vaginalspekulum
 Weight for Vaginal Speculum
 Poids pour spéculum vaginal
 Peso para especulo vaginal
 Peso per specolo vaginale



SCHERBAK
HA-138-10
 10,5 cm
 400 g

SCHERBAK
HA-138-12
 13,0 cm
 800 g

Griff zum Vaginalspekulum
 Handle for Vaginal Speculum
 Manche pour spéculum vaginal
 Mango para especulo vaginal
 Manico per specolo vaginale



SCHERBAK
HA-138-14
 20,0 cm



LANDAU

HA-139-28 100x28 mm
HA-139-38 100x38 mm



HA-230-99

Auffangsieb
 Strainer for Vaginal Speculum
 Tarnis pour spéculum vaginal
 Tamiz para especulo vaginal
 Crivello per specolo vaginale

WEISSBARTH

HA-230-24
 80x42 mm

komplett, mit abnehmbarem Auffangkorb
 complete, with detachable strainer
 complet avec tamis demontable
 completo, con tamiz desmontable
 completo con crivello smontabile



FRIEDMANN

HA-531-10	10,0 cm
HA-531-15	15,0 cm

mit skaliertem Sperre und Fixierschraube
 with graduated ratchet and fixing screw
 avec crémaillère à échelle et vis à fixation
 con cremallera graduada y tornillo de fijacion
 con cremagliera con scala e vite di fissaggio



KOGAN
HA-539-24
 24,5 cm



Standard
HA-630-24

KOGAN
 24,0 cm

Laser
HA-634-24

**HEGAR
 HA-044-14**

Satz mit 14 Stück (ganze Größen)
 von 4,0 - 17,0 mm ohne Etui

set of 14 pieces (full sizes)
 from 4,0 - 17,0 mm without case

jeu de 14 pièces (taille entière)
 de 4,0 - 17,0 mm sans boîte

juego de 14 piezas (tamaños enteros)
 de 4,0 - 17,0 mm sin caja

serie di 14 pezzi (grandezza intera)
 da 4,0 - 17,0 mm senza scatola



**HEGAR
 HA-044-26**

Satz mit 26 Stück (ganze Größen)
 von 1,0 - 26,0 mm ohne Etui

set of 26 pieces (full sizes)
 from 1,0 - 26,0 mm without case

jeu de 26 pièces (taille entière)
 de 1,0 - 26,0 mm sans boîte

juego de 26 piezas (tamaños enteros)
 de 1,0 - 26,0 mm sin caja

serie di 26 pezzi (grandezza intera)
 da 1,0 - 26,0 mm senza scatola

HEGAR	mm	HEGAR	mm
HA-140-01	1	HA-145-01	1,5
HA-140-02	2	HA-145-02	2,5
HA-140-03	3	HA-145-03	3,5
HA-140-04	4	HA-145-04	4,5
HA-140-05	5	HA-145-05	5,5
HA-140-06	6	HA-145-06	6,5
HA-140-07	7	HA-145-07	7,5
HA-140-08	8	HA-145-08	8,5
HA-140-09	9	HA-145-09	9,5
HA-140-10	10	HA-145-10	10,5
HA-140-11	11	HA-145-11	11,5
HA-140-12	12	HA-145-12	12,5
HA-140-13	13	HA-145-13	13,5
HA-140-14	14	HA-145-14	14,5
HA-140-15	15	HA-145-15	15,5
HA-140-16	16	HA-145-16	16,5
HA-140-17	17	HA-145-17	17,5
HA-140-18	18	HA-145-18	18,5
HA-140-19	19	HA-145-19	19,5
HA-140-20	20		
HA-140-21	21		
HA-140-22	22		
HA-140-23	23		
HA-140-24	24		
HA-140-25	25		
HA-140-26	26		
HA-140-27	27		
HA-140-28	28		
HA-140-29	29		
HA-140-30	30		



HEGAR
HA-045-14
4-17 mm
14 Stück/ea./pces./c./u./pezzi



in Metalletui
in metal case
en boîte metal
en caja metalica
in scatola metallica

HEGAR	mm	
HA-046-14	4-17	14 Stück/ea./pces./c./u./pezzi
HA-046-26	1-26	26 Stück/ea./pces./c./u./pezzi

HA

Uterusdilatoren
Uterine Dilators
Dilatateurs du col de l'utérus
Dilataores uterios
Dilatatori uterini

HEGAR
HA-244-08

Satz mit 8 Stück von 3,0 / 4,0 - 17,0 / 18,0 mm
ohne Etui

set of 8 pieces from 3,0 / 4,0 - 17,0 / 18,0 mm
without case

jeu de 8 pièces de 3,0 / 4,0 - 17,0 / 18,0 mm
sans boîte

juego de 8 piezas de 3,0 / 4,0 - 17,0 / 18,0 mm
sin caja

serie di 8 pezzi da 3,0 / 4,0 - 17,0 / 18,0 mm
senza scatola



HEGAR
HA-244-13

Satz mit 13 Stück von 1,0 / 2,0 - 25,0 / 26,0 mm
ohne Etui

set of 13 pieces from 1,0 / 2,0 - 25,0 / 26,0 mm
without case

jeu de 13 pièces de 1,0 / 2,0 - 25,0 / 26,0 mm
sans boîte

juego de 13 piezas de 1,0 / 2,0 - 25,0 / 26,0 mm
sin caja

serie di 13 pezzi da 1,0 / 2,0 - 25,0 / 26,0 mm
senza scatola

HEGAR	mm
HA-240-01	1/ 2
HA-240-03	3/ 4
HA-240-05	5/ 6
HA-240-07	7/ 8
HA-240-09	9/10
HA-240-11	11/12
HA-240-13	13/14
HA-240-15	15/16
HA-240-17	17/18
HA-240-19	19/20
HA-240-21	21/22
HA-240-23	23/24
HA-240-25	25/26

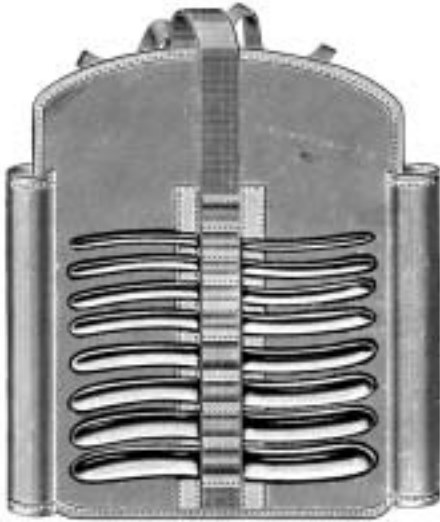

HEGAR
HA-245-08

Satz mit 8 Stück von 3,0 / 4,0 - 17,0 / 18,0 mm
in auskochbarer Stoffrolltasche

set of 8 pieces from 3,0 / 4,0 - 17,0 / 18,0 mm
in boilable canvas roll

jeu de 8 pièces de 3,0 / 4,0 - 17,0 / 18,0 mm
en pochette en treillis stérilisable par ébullition

juego de 8 piezas de 3,0 / 4,0 - 17,0 / 18,0 mm
en bolsa de tela esterilizable por ebullicion

serie di 8 pezzi da 3,0 / 4,0 - 17,0 / 18,0 mm
in busta di tela sterilizzabile

HEGAR
HA-246-08

Satz mit 8 Stück von 3,0 / 4,0 - 17,0 / 18,0 mm
im Metalletui mit Scharnierdeckel

set of 8 pieces from 3,0 / 4,0 - 17,0 / 18,0 mm
in metal case with hinged lid

jeu de 8 pièces de 3,0 / 4,0 - 17,0 / 18,0 mm
en boîte métal à charnière

juego de 8 piezas de 3,0 / 4,0 - 17,0 / 18,0 mm
en caja metálica con tapa de bisagra

serie di 8 pezzi da 3,0 / 4,0 - 17,0 / 18,0 mm
in scatola metallica con coperchio a cerniera



HEGAR
HA-246-13

Satz mit 13 Stück von 1,0 / 2,0 - 25,0 / 26,0 mm
im Metalletui mit Scharnierdeckel

set of 13 pieces from 1,0 / 2,0 - 25,0 / 26,0 mm
in metal case with hinged lid

jeu de 13 pièces de 1,0 / 2,0 - 25,0 / 26,0 mm
en boîte métal à charnière

juego de 13 piezas de 1,0 / 2,0 - 25,0 / 26,0 mm
en caja metálica con tapa de bisagra

serie di 13 pezzi da 1,0 / 2,0 - 25,0 / 26,0 mm
in scatola metallica con coperchio a cerniera



amerikanische Skala
 American scala
 échelle américaine
 escala americana
 scala americana

HANK
HA-345-06

Satz mit 6 Stück
 von 4,5 - 10,0 mm ohne Etui

set of 6 pieces
 from 4,5 - 10,0 mm without case

jeu de 6 pièces
 de 4,5 - 10,0 mm sans boîte

juego de 6 piezas
 de 4,5 - 10,0 mm sin caja

serie di 6 pezzi
 da 4,5 - 10,0 mm senza scatola

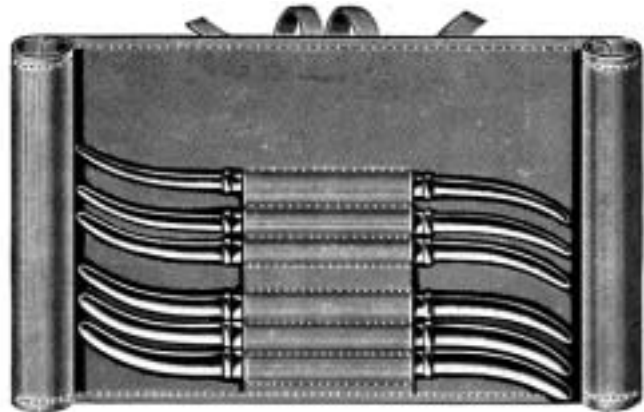

HANK
HA-346-08

Satz mit 6 Stück von 4,5 - 10,0 mm
 in auskochbarer Stoffrolltasche

set of 6 pieces from 4,5 - 10,0 mm
 in boilable canvas roll

jeu de 6 pièces de 4,5 - 10,0 mm
 en pochette en treillis stérilisable par ébullition

juego de 6 piezas de 4,5 - 10,0 mm
 en bolsa de tela esterilizable por ebullicion

serie di 6 pezzi da 4,5 - 10,0 mm
 in busta di tela sterilizzabile

HANK	mm	Fig. US.
HA-340-08	3,5/ 4	7/ 8
HA-340-10	4,5/ 5	9/10
HA-340-12	5,5/ 6	11/12
HA-340-14	6,5/ 7	13/14
HA-340-16	7,5/ 8	15/16
HA-340-18	8,5/ 9	17/18
HA-340-20	9,5/10	19/20
HA-340-22	10,5/11	21/22
HA-340-24	11,5/12	23/24
HA-340-26	12,5/13	25/26



**PRATT
 HA-447-08**

Satz mit 8 Stück von 4,5 / 5,0 - 13,6 / 14,3 mm
 in auskochbarer Stoffrolltasche

set of 8 pieces from 4,5 / 5,0 - 13,6 / 14,3 mm
 in boilable canvas roll

jeu de 8 pièces de 4,5 / 5,0 - 13,6 / 14,3 mm
 en pochette en treillis stérilisable par ébullition

juego de 8 piezas de 4,5 / 5,0 - 13,6 / 14,3 mm
 en bolsa de tela esterilizable por ebullicion

serie di 8 pezzi da 4,5 / 5,0 - 13,6 / 14,3 mm
 in busta di tela sterilizzabile

PRATT	Charr.	mm
HA-447-13	13/15	4,5/ 5,0
HA-447-17	17/19	5,6/ 6,3
HA-447-21	21/23	7,0/ 7,6
HA-447-25	25/27	8,3/ 9,0
HA-447-29	29/31	9,6/10,3
HA-447-33	33/35	11,0/11,6
HA-447-37	37/39	12,3/13,0
HA-447-41	41/43	13,6/14,3
HA-447-45	45/47	14,9/15,6
HA-447-49	49/51	16,3/16,9
HA-447-53	53/55	17,6/18,3
HA-447-57	57/59	19,9/19,6



GOODELL
HA-441-34
34,0 cm



WYLIE
HA-443-29
29,0 cm



SIMS
HA-445-29
29,0 cm

Hakenzangen
Tenaculum Forceps
Pinces pour abaissement du col de l'utérus
Pinzas para coger el cuello del útero
Pinze per abbassare il collo dell'utero

HA



SCHROEDER
HA-052-23 23,0 cm
HA-052-25 25,0 cm



BRAUN
HA-054-25
25,0 cm



SKENE
HA-055-24
24,0 cm



POZZI
HA-056-25
25,0 cm



DUPLAY
HA-057-28
28,0 cm



STAUDE-MOORE
HA-058-17
17,0 cm

Hakenzangen
 Tenaculum Forceps
 Pincés pour abaissement du col de l'uterus
 Pinzas para coger el cuello del útero
 Pinze per abbassare il collo dell'utero



COLLIN-POZZI
HA-059-25
 25,0 cm



BARRETT
HA-150-18
 18,0 cm



JARCHO
HA-152-20
 20,0 cm



2x2 Zähne
 2x2 teeth
 2x2 dents
 2x2 dientes
 2x2 denti

cm **SCHROEDER**
 20,0 **HA-154-20**
 24,0 **HA-154-24**



2x2 Zähne
 2x2 teeth
 2x2 dents
 2x2 dientes
 2x2 denti

SCHROEDER
HA-155-24
 24,0 cm



TIEMANN
HA-158-22
 22,0 cm

Hakenzangen
 Tenaculum Forceps
 Pinces pour abaissement du col de l'utérus
 Pinzas para coger el cuello del útero
 Pinze per abbassare il collo dell'utero

HA

2x2 Zähne
 2x2 teeth
 2x2 dents
 2x2 dientes
 2x2 denti



MUSEUX



MUSEUX
HA-254-06
 6 mm
 24,0 cm



MUSEUX
HA-254-08
 8 mm
 24,0 cm



MUSEUX
HA-254-10
 10 mm
 24,0 cm



MUSEUX
HA-255-06
 6 mm
 24,0 cm



MUSEUX
HA-255-08
 8 mm
 24,0 cm



MUSEUX
HA-255-10
 10 mm
 24,0 cm



MUSEUX

2x2 Zähne
 2x2 teeth
 2x2 dents
 2x2 dientes
 2x2 denti



MUSEUX
HA-256-20
 20,0 cm

3x4 Zähne
 3x4 teeth
 3x4 dents
 3x4 dientes
 3x4 denti



cm	TEALE
18,0	HA-351-18
23,0	HA-351-23
26,5	HA-351-26

Hakenzangen
 Tenaculum Forceps
 Pinces pour abaissement du col de l'uterus
 Pinzas para coger el cuello del útero
 Pinze per abbassare il collo dell'utero



2x2 Zähne
 2x2 teeth
 2x2 dents
 2x2 dientes
 2x2 denti

JAKOBS
HA-352-21
 21,0 cm



2x2 Zähne
 2x2 teeth
 2x2 dents
 2x2 dientes
 2x2 denti

JAKOBS
HA-353-21
 21,0 cm



2x3 Zähne
 2x3 teeth
 2x3 dents
 2x3 dientes
 2x3 denti

HENROTIN
HA-354-20
 20,5 cm



4x4 Zähne
 4x4 teeth
 4x4 dents
 4x4 dientes
 4x4 denti

PRATT
HA-356-28
 28,0 cm



4x4 Zähne
 4x4 teeth
 4x4 dents
 4x4 dientes
 4x4 denti

CZERNY
HA-357-21
 21,0 cm

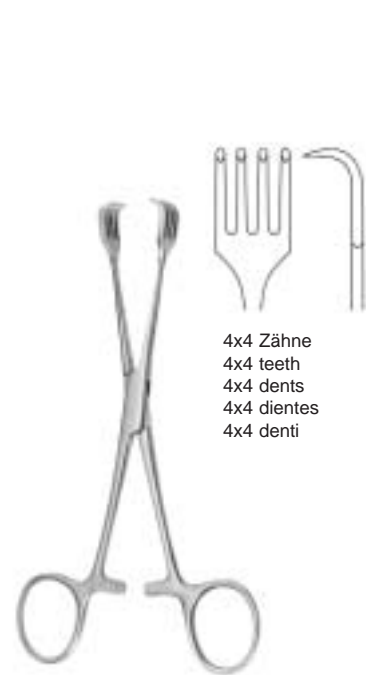

4x4 Zähne
 4x4 teeth
 4x4 dents
 4x4 dientes
 4x4 denti

BRAUN
HA-358-15
 15,5 cm

Hakenzangen
Tenaculum Forceps
Pinces pour abaissement du col de l'utérus
Pinzas para coger el cuello del útero
Pinze per abbassare il collo dell'utero

HA



4x4 Zähne
4x4 teeth
4x4 dents
4x4 dientes
4x4 denti

PRATT
HA-358-26
26,0 cm



5x6 Zähne
5x6 teeth
5x6 dents
5x6 dientes
5x6 denti

IOWA
HA-359-26
26,0 cm

HA

Uterus-Polypenzangen
Uterine Polypus Forceps
Pinces à polypes uterins
Pinzas per polipi uterine

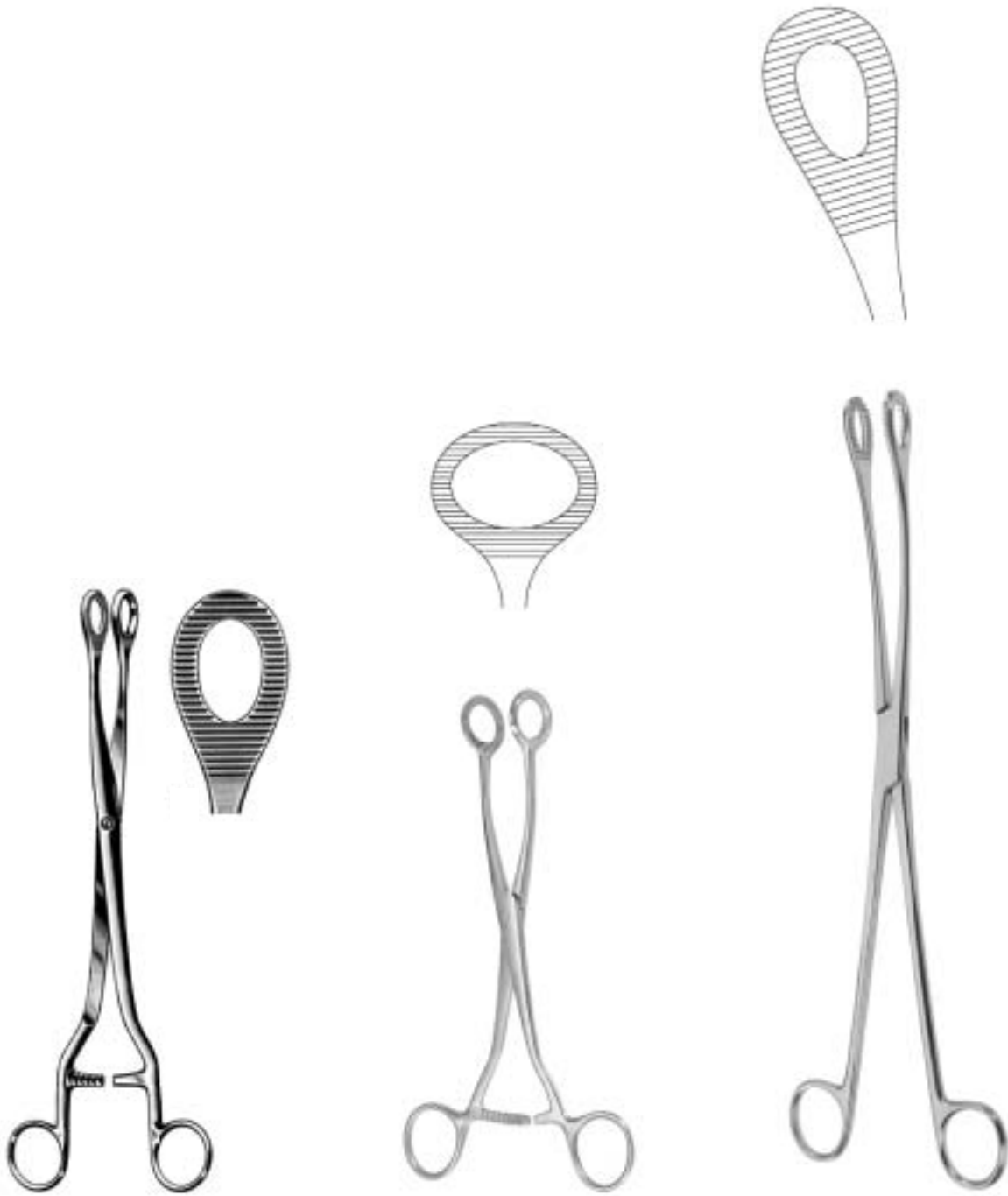

NOTO
HA-450-27
27,0 cm

DOYEN
HA-452-20
20,0 cm

KELLY
HA-453-32
32,0 cm

Uterus-Faßzangen
Uterine Elevating Forceps
Pincès hystérolabes
Pinzas para el útero
Pinzas per afferrare l'utero

HA



DARTIGUES
HA-455-27
27,0 cm



SOMER
HA-457-23
23,0 cm



COLLIN
HA-459-25
25,0 cm



COLLIN
HA-550-28
28,0 cm

HA

Uterus-Faßzangen
Uterine Elevating Forceps
Pincès hystérolabes
Pinzas para el útero
Pinzas per afferrare l'utero



COLLIN
HA-551-25
25,0 cm



BUMM
HA-552-28
28,0 cm



SIEGLER HELLMANN
HA-553-24
24,0 cm

Uterussonden, Uterusdepressor
 Uterine Sounds, Uterine Depressor
 Hystéromètres, Dépresseur utérin
 Histerómetros, Depresor uterino
 Isterometri, Depressore uterino

HA



Anniotom
 Anniotome
 Anniotome
 Anniótomo
 Anniotomo

BEACHMANN
HA-559-26
 26 cm



BRAUN
HA-655-28
 28 cm



SIMS
HA-657-26
 26 cm

Uterus-Depressoren
 Uterine Depressors
 Dépresseurs utérins
 Depressores uterinos
 Depressori uterini



starr
 rigid
 rigide
 rigida
 rigida

SIMS
HA-850-32 32 cm

Uterus-Sonden
 Uterine Sounds
 Hystéromètres
 Histerómetros
 Isterometri



starr
 rigid
 rigide
 rigida
 rigida

MARTIN
HA-852-32 32 cm



biegsam
 malleable
 malléable
 maleable
 malleabile

COLLIN
HA-854-28
 28 cm



VALLEIX
HA-855-25
 29,5 cm

HA

Uterus-Biopsie-Saugküretten
Uterine Biopsy Aspirating Curettes
Curettes aspirantes à biopsie de l'utérus
Curetas aspiradoras p. la biopsia uterina
Curette di aspirazione per biopsia



RANDALL
HA-950-04
24 cm/4 mm



mm	NOVAK
1	HA-952-01
2	HA-952-02
3	HA-952-03
4	HA-952-04



mit Korb
with basket
avec grille
con cesto
con cestino

KEVORKIAN	
HA-954-12	1,2 mm
HA-954-40	4,0 mm
	30 cm

Probeexcisionszangen
Biopsy Specimen Forceps
Pincès amporte-pièce pour le col de l'utérus
Pinzas sacabocado para el cuello del útero
Pinze taglienti per biopsia

HA



FAURE
HA-061-21
21 cm



cm SCHUBERT
21 HA-064-21
28 HA-064-28



SCHUBERT
HA-065-26
26 cm

HA

Biopsiezangen
Biopsy Specimen Forceps
Pinces à biopsie
Pinzas sacabocado p. biopsia
Pinze per biopsia



THOMS-GAYLOR
HA-066-21 23,5 cm
HA-066-24 21,0 cm



GELLHORN
HA-069-23
23 cm



van DOREN
HA-161-24
25 cm

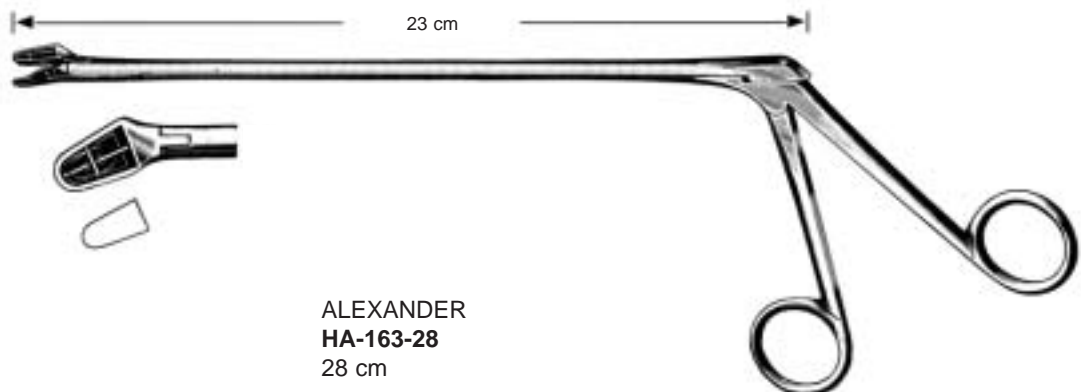

ALEXANDER
HA-163-28
28 cm



HA-165-01

HA-165-02

24 cm

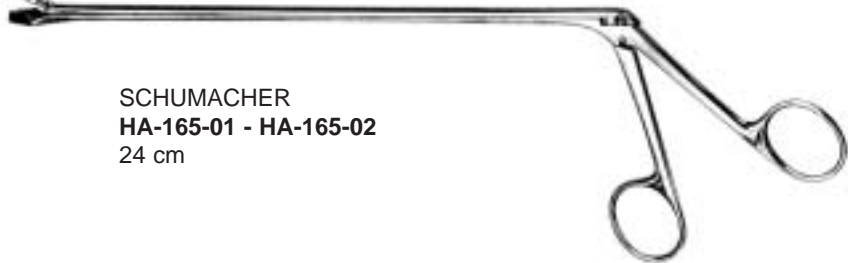

SCHUMACHER
HA-165-01 - HA-165-02
24 cm

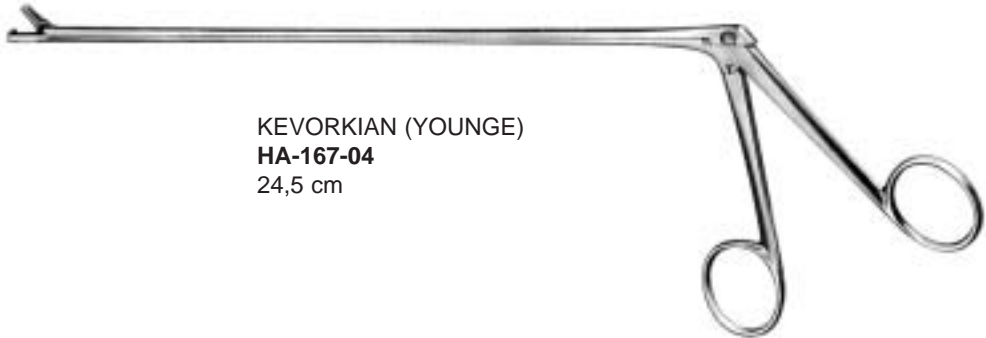

KEVORKIAN (YOUNGE)
HA-167-04
24,5 cm

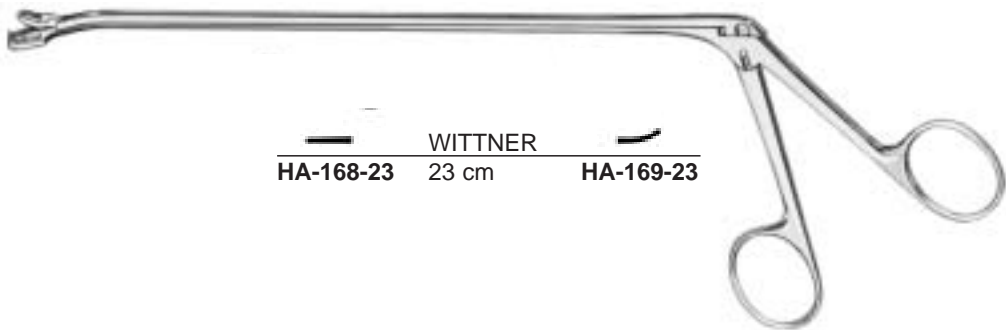

WITTNER
HA-168-23 23 cm HA-169-23



TISCHLER-MORGAN
HA-261-01
20 cm

HA

Biopsiezangen
 Biopsy Specimen Forceps
 Pinces à biopsie
 Pinzas sacabocado p. biopsia
 Pinze per biopsia



oval
7 x 5 mm



BURKE
HA-262-00



TISCHLER Morgan

Fig. 1



	Instr. kompl.	Aufsatz allein
	compl. instr.	Tip only
	Instrum. compl.	Embout seul
	Strumento completo	Punta sola

Fig. **TOWNSEND**

Fig.	HA-264-01	HA-264-11
1	HA-264-01	HA-264-11
3	HA-264-03	HA-264-13
4	HA-264-04	HA-264-14
5	HA-264-05	HA-264-15

HA-264-99
 Griff allein
 handle only
 manche seul
 manico solo
 mango suelto



Fig. 3

oval ● 3,7 x 5 mm



Fig. 5

mini

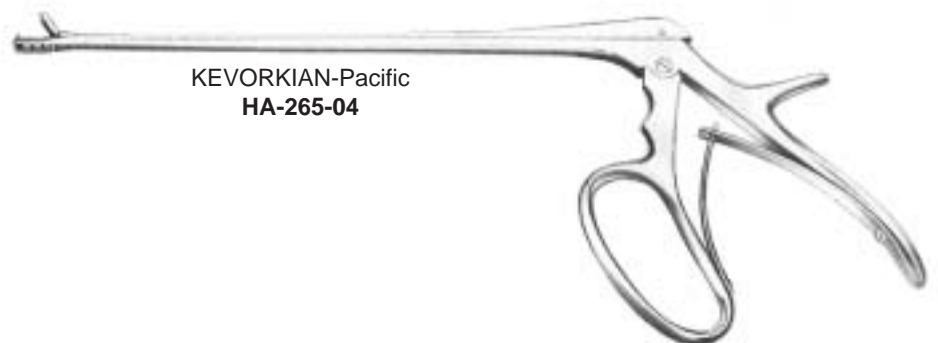

Fig. 4

KEVORKAN



■ 3 x 8 mm



KEVORKIAN-Pacific
HA-265-04



■ 2,3 x 4,2 mm



TOWNSEND-MINI (BABY TISCHLER)
HA-266-00



■ 3,0 x 9,5 mm



TISCHLER-KEVORKIAN
HA-267-00



● 4,0 x 6,5 mm



BAGGISH
HA-268-00



■ 4,5 x 8 mm

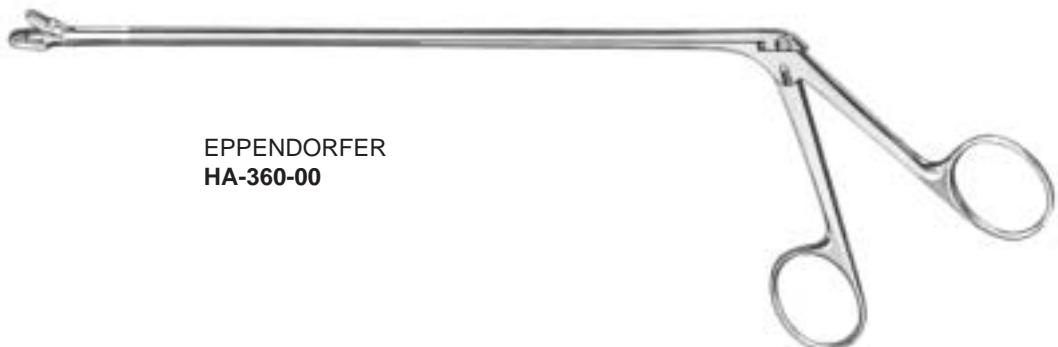

EPPENDORFER
HA-360-00

Biopsiezangen
 Biopsy Specimen Forceps
 Pincas à biopsie
 Pinzas sacabocado p. biopsia
 Pinze per biopsia

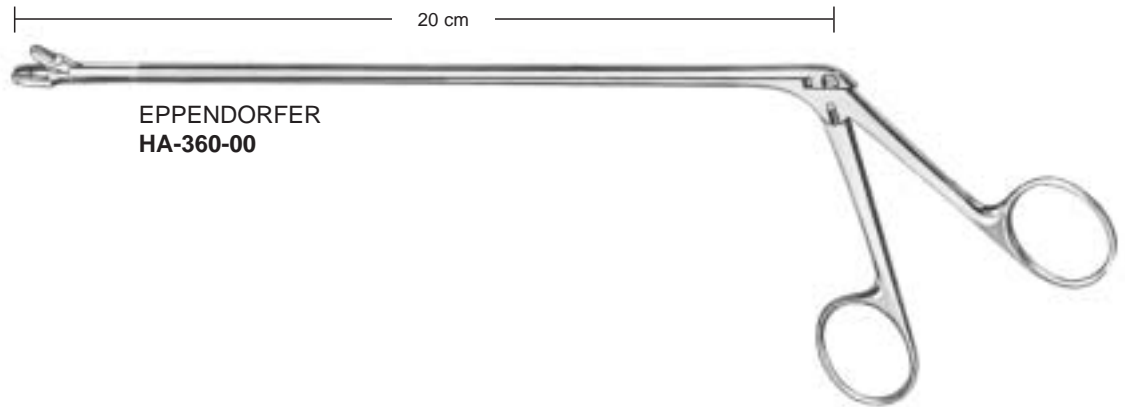

EPPENDORFER
 HA-360-00

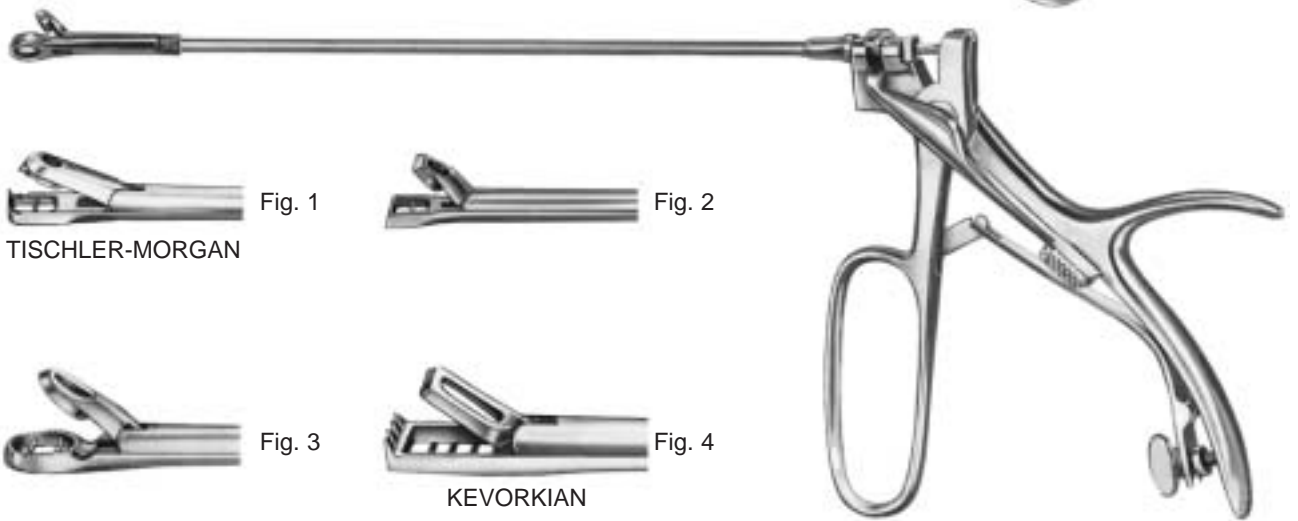

Fig. 1
 TISCHLER-MORGAN

Fig. 2

Fig. 3

Fig. 4
 KEVORKIAN

Fig.	Instr. kompl. compl. instr. Instrum. compl. Strumento completo	Aufsatz allein Tip only Embout seul Punta sola
1	HA-362-01	HA-362-11
2	HA-362-02	HA-362-12
3	HA-362-03	HA-362-13
4	HA-362-04	HA-362-14

Myomesser
 Myoma knives
 Evidens pour fibromes
 Cuchillo para fibromas
 Bisturi per fibromi

Myom-Heber
 Myoma Screw
 Tracteur pour fibromes
 Tirabuzón para fibromas
 Tiramiomi



DOYEN
 HA-461-17
 15 cm



SEGOND
 HA-463-27
 27 cm



EMMET
 22 cm



HA-465-01 Fig. 1
 HA-465-02 Fig. 2
 HA-465-03 Fig. 3



HA-465-04 Fig. 4
 HA-465-05 Fig. 5

Fistelhaken
 Fistula Hooks
 Crochets pour fistules
 Ganchos para fistulas
 Uncini per fistole

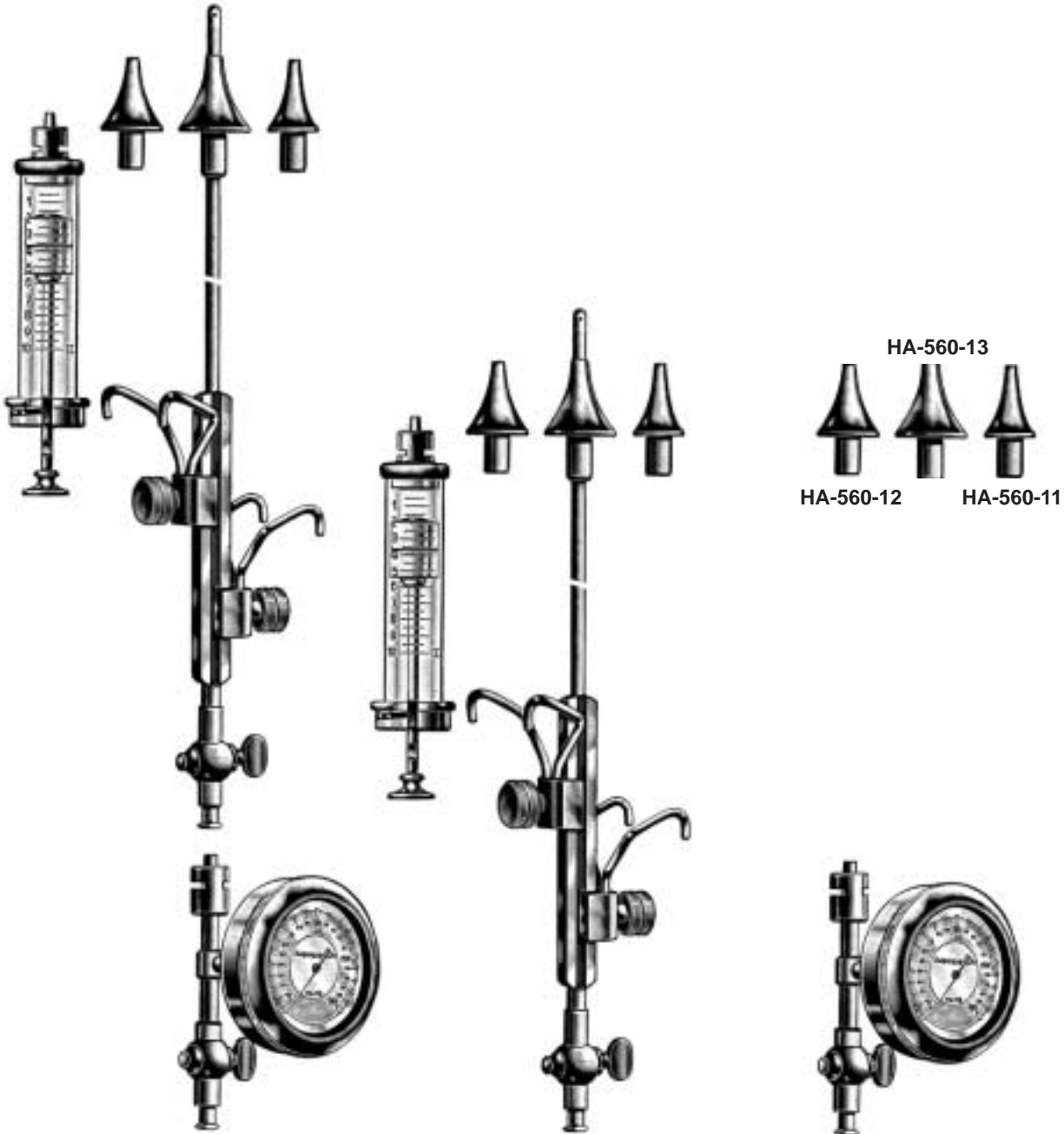

SCHULTZE
HA-560-00
compl.

im Holzetui
in wooden case
en boîte de bois
en estuche de madera
in scatola di legno

SCHULTZE
HA-560-01

ohne Manometer
without manometer
sans manomètre
sin manómetro
senza manometro

SCHULTZE
HA-560-10

Manometer zum Salpingograph
Manometer for Salpingograph
Manomètre pour salpingographe
Manómetro para salpingógrafo
Manometro per salpingografo

scharf
 sharp
 tranchant
 cortante
 tagliente

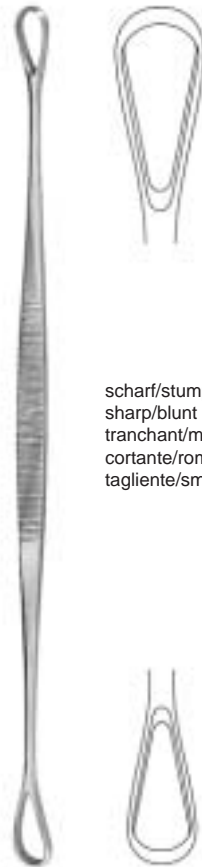

scharf/stumpf
 sharp/blunt
 tranchant/mousse
 cortante/roma
 tagliente/smussa

Fig.	SIMON
1	HA-072-01
2	HA-072-02
3	HA-072-03
4	HA-072-04
5	HA-072-05
6	HA-072-06

25 cm

Fig.	SCHROEDER
1	HA-073-01
2	HA-073-02
3	HA-073-03
4	HA-073-04
5	HA-073-05
6	HA-073-06

31 cm

BLAKE
 HA-074-27
 27 cm

Fig.	GOURDET
1	HA-076-01
2	HA-076-02
3	HA-076-03
4	HA-076-04
5	HA-073-05

28 cm



SIMS = 31 cm
 RECAIMER = 31 cm

Fig.	00	0	1	2	3	4	5	6
mm	5	6	7	8	9	11	12	14



SIMS = 31 cm
 RECAIMER = 31 cm

Fig.	7	8	9	10
mm	15	16	19	20



SIMS
 RECAIMER
 BUMM = 34 cm
HA-170-05-HA-377-40

Fig.	14	15	16
mm	30	35	40



SIMS
HA-170-05-HA-177-14
 31 cm



RECAMIER
HA-270-07-HA-277-25
 31 cm



BUMM
HA-370-30-HA-377-40
 34 cm

Ausführung	scharf	stumpf
Features	sharp	blunt
Exécution	tranch.	mousse
Ejecución	cort.	roma
Esecuzione	tagl.	smussa
fest/rig.	A	B
flex./fless.	C	D

Fig.	A	B	C	D	A	B	C	D	A	B	C	D
00	HA-170-05	HA-172-05	HA-175-05	HA-177-05	HA-270-05	HA-272-05	HA-275-05	HA-277-05				
0	HA-170-06	HA-172-06	HA-175-06	HA-177-06	HA-270-06	HA-272-06	HA-275-06	HA-277-06				
1	HA-170-07	HA-172-07	HA-175-07	HA-177-07	HA-270-07	HA-272-07	HA-275-07	HA-277-07				
2	HA-170-08	HA-172-08	HA-175-08	HA-177-08	HA-270-08	HA-272-08	HA-275-08	HA-277-08				
3	HA-170-09	HA-172-09	HA-175-09	HA-177-09	HA-270-09	HA-272-09	HA-275-09	HA-277-09				
4	HA-170-11	HA-172-11	HA-175-11	HA-177-11	HA-270-11	HA-272-11	HA-275-11	HA-277-11				
5	HA-170-12	HA-172-12	HA-175-12	HA-177-12	HA-270-12	HA-272-12	HA-275-12	HA-277-12				
6	HA-170-14	HA-172-14	HA-175-14	HA-177-14	HA-270-14	HA-272-14	HA-275-14	HA-277-14				
7					HA-270-15	HA-272-15	HA-275-15	HA-277-15				
8					HA-270-16	HA-272-16	HA-275-16	HA-277-16				
9					HA-270-19	HA-272-19	HA-275-19	HA-277-19				
10					HA-270-20	HA-272-20	HA-275-20	HA-277-20				HA-377-28
14									HA-370-30	HA-372-30	HA-375-30	HA-377-30
15									HA-370-35	HA-372-35	HA-375-35	HA-377-35
16									HA-370-40	HA-372-40	HA-375-40	HA-377-40



29 cm

HA-180-03	Ø 3,0 mm
HA-180-04	Ø 4,0 mm
HA-180-06	Ø 6,0 mm
HA-180-08	Ø 8,0 mm
HA-180-10	Ø 10,0 mm
HA-180-12	Ø 12,0 mm
HA-180-14	Ø 14,0 mm



HA-180-50

Kupplungsstück
Coupling Piece
Pièce de raccordement
Pieza de acoplamiento
Pezzo di collegamento



Tubenfaßpinzette
Tubal seizing forceps
Pince a saisir les trompes
Pinza para sostener trompas
Pinze per afferare trompe

NEUBÜSSER

20 cm

HA-580-06	Ø 6,0 mm
HA-580-08	Ø 8,0 mm
HA-580-10	Ø 10,0 mm

HC

**Geburtshilfe
Obstetrics
Obstétrique
Obstetricia
Ostetricia**



HC

Geburtszangen für section caesares (Schnittentbindung)
 Forceps for caesarean section
 Forceps pour césarienne
 Fórceps para operación cesárea
 Forcipi per tagli cesarei



cm WRIGLEY
 23 HC-011-23
 28 HC-011-28



SIMPSON
 HC-012-30
 30 cm



SIMPSON
 HC-013-23
 23 cm



cm SIMPSON-BRAUN
 33 HC-015-33
 36 HC-015-36



De LEE
 HC-017-30
 30 cm



cm De LEE
 36 HC-018-36
 39 HC-018-39



KIELLAND
 HC-110-41
 41 cm



cm ELLIOT
 32 HC-115-32
 38 HC-115-38



cm NAEGELE
36 **HC-119-36**
40 **HC-119-40**



LUIKART
HC-215-40
40 cm



KIELLAND-LUIKART
HC-217-40
40 cm



SIMPSON-LUIKART
HC-315-36
36 cm



McLEAN-TUCKER-LUIKART
HC-319-40
40 cm



McLEAN-TUCKER
HC-411-39
39 cm



McLEAN-LUIKART
HC-413-39
39 cm



McLEAN
HC-415-36
36 cm



BARTON
HC-417-36
36 cm



BARTON
HC-418-17
17 cm



BOERMA
HC-511-29
29 cm



PIPER
HC-515-44
44 cm

für nachkommenden Kopf bei Steisslagen
for delivery of the after coming head in breech presentation
Spatules pour dégager la tête
Especialmente para partos en presentación de nalgas
Speciale in parti con predentazione di podice



PIPER
HC-517-40
40 cm



DEWEY
HC-610-37
 37 cm



TARNIER
HC-612-40
 40 cm

Geburtszange mit Achsenzugvorrichtung
 Forceps with traction rod
 Forceps avec dispositif de traction
 Fórceps con dispositivo de tracción
 Forcipi con dispositivo di trazione

Kopfhobel für unteres Segment bei Kaiserschnitt
 Head extractor for use in lower segment in caesarean operation
 Levier à tête utilisé en cas de césarienne
 Elevador para cabeza usándose en el segmento inferior del útero
 en casos de operaciones cesáreas
 Elevatore per testa in interventi con taglio cesareo



MURLESS
HC-614-26



BILL
HC-710-00

Zughebel, passend für alle Geburtszangen mit
 gehorntem Standard-Griff
 Traction handle to be used with all forceps
 with standard type handle
 Tracteurs pour tous les forceps avec manches
 ordinaires
 Tractor adecuado para todas las fórceps con
 mango standard
 Manico a trazione adatto a tutte le forcipi con
 manico standard



LUIKART-BILL
HC-711-21
 21 cm

Uterusklemmzange zur Blutstillung
Caesarean section haemostatic forceps
Pince-clamp utérine pour hémostase
Pinza-clamp uterina para hemostasis
Pinza emostatiche per tagli cesarei



SMELLIE
HC-811-33
33 cm



GAUSS
HC-813-27
27 cm



GREEN-ARMYTAGE
HC-814-21
21 cm

Nabelschnurklemmen
Umbilical Cord Clamps
Clamps p. cordon ombilical
Clamps umbilicales
Pinze ombelicali



COLLIN
HC-817-09
9 cm



KANE
HC-819-09
8,5 cm



MARTIN
HC-911-34
34 cm



COLLIER
HC-913-30
30 cm



COLLIN
HC-915-35
35 cm

mit Sperre
 with ratchet
 avec crémaillère
 con cremallera
 con cremagliera



SAENGER
 HC-422-27 HC-423-27



WINTER
 28 cm
 Fig.
 HC-424-01 1 HC-425-01
 HC-424-02 2 HC-425-02
 HC-424-03 3 HC-425-03



WINTER Fig.
 HC-427-02 2
 HC-427-03 3



LEWKOWITZ
 HC-428-24 HC-429-24



McCLINTOCK
 HC-520-24
 24 cm

HC

Plazentar- und Abortuslöffel
Placenta and ovum scoops
Curettes à avortement et placenta
Cucharillas para aborto y placenta
Cucchiai per placenta e ovaie



PESTALOZZA
HC-522-30
30 cm



HC-524-14 HC-524-18 HC-524-21
14,5 mm 18 mm 21 mm



WALLICH
HC-526-42
42 cm



SELLHEIM
HC-529-28
28 cm



BRAUN
HC-032-42
42 cm

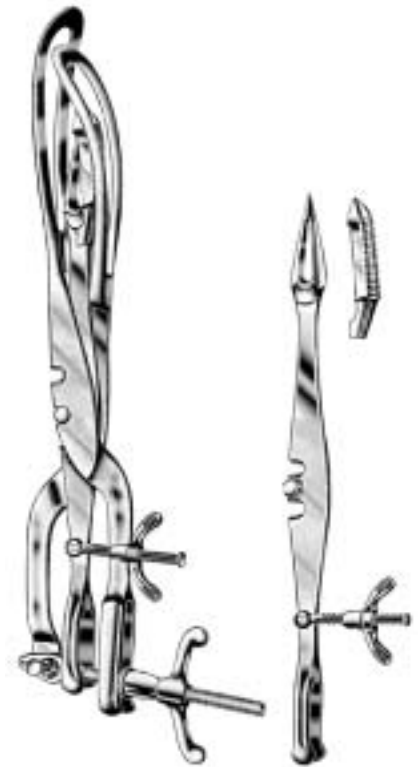

TARNIER
HC-034-46
46 cm



Perforatorium
Perforator
Perce-crâne
Perfora-crâneos
Spezzacrano

SMELLIE
HC-036-25
25 cm



NÄGELE
HC-038-25
25 cm

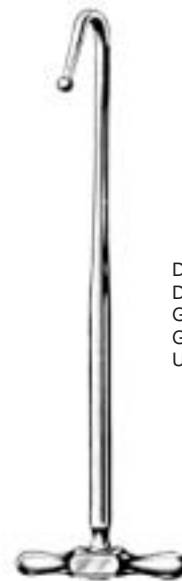

Dekapitationshaken
Decapitating hook
Grochet pour décapitation
Gancho para decapitación
Uncino per detroncazione

BRAUN
HC-039-30
30 cm

HE

**Dermatologie, Hygiene
Dermatology, Hygiene
Dermatologie, Hygiène
Dermatología, Higiene
Dermatologia, Igiene**



HE



KILNER
HE-013-15
15 cm



SCHRAMBERG
HE-111-10
10 cm



UNNA
HE-113-14
14 cm

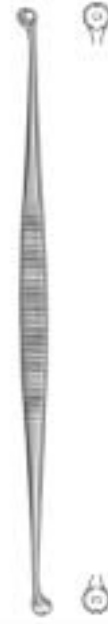

UNNA
HE-115-14
14 cm



WALTON
HE-118-14
14 cm



SAALFELD
HE-211-10
10 cm



mm	FOX
3	HE-218-03
4	HE-218-04
5	HE-218-05
6	HE-218-06



Fig.	PIFFARD
1	HE-310-01
2	HE-310-02
3	HE-310-03



Fig. 1



Fig. 2



Fig. 3



KEYES
HE-318-00
compl.

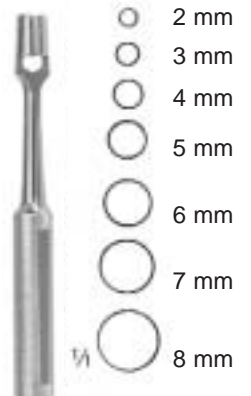

mm	KEYES
2	HE-410-02
3	HE-410-03
4	HE-410-04
5	HE-410-05
6	HE-410-06
7	HE-410-07
8	HE-410-08



HE-031-10



HE-034-10 10 cm HE-035-10



HE-331-14
14 cm



HE-336-14
14 cm



cm TURNBULL
11,5 HE-431-11
13,5 HE-431-13



HE-630-13
13 cm



HE-635-11
11 cm



HE-733-10
10 cm



HE-738-10
10 cm



HE-739-10
10 cm

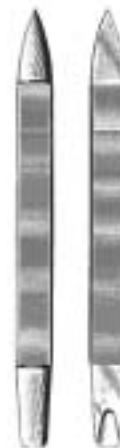

cm
10 HE-836-10
12 HE-836-12



CREDO
HE-935-14
14,5 cm

HE-936-00
10 Ersatzklingen
10 Spare Blades
10 lames de rechange
10 hojas de repuesto
10 lame di ricambio

IA

IH

**Dental Instrumente
Dental Instruments
Instruments dentaires
Instrumentos de odontología
Strumenti dentali**

**Verlangen Sie unseren Dental Spezialkatalog
Please ask for our special catalogue for Dental Instruments
Demandez notre catalogue spécial pour Instruments dentaires
Pidan nuestro catálogo especial para Instrumentos odontología
Chiedete il nostro catalogo speciale per Strumenti dentali**

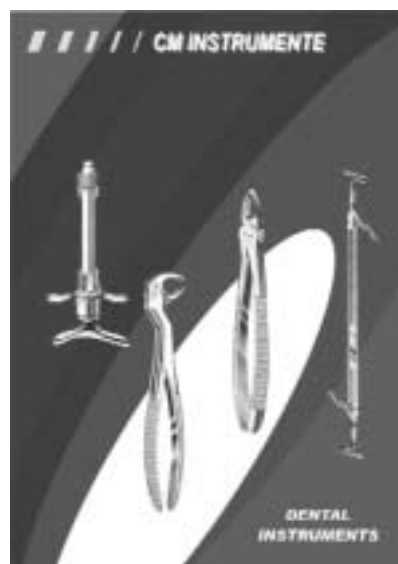

IA-IH



**Verschiedene Behälter
Different Containers
Boîtes diverses
Contenedores varios
vassoi diversi**





Nadeldosen
Needle Cases
Boîtes pour aiguilles
Estuches para agujas
Scatole per aghi

18/10
Edelstahl rostfrei
Stainless Steel
Acier inoxydable
Acero inoxidable
Acciaio inossidabile

komplett mit perforierter Innendose
complete with perforated interior box
complet avec boîte intérieure perforée
completo con caja interior perforada
completo con scatola interiore perforata



II-112-65
65x15 mm

Innendose
Deckel und Boden perforiert
Interior Box
perforated lid and bottom
Boîte intérieure
couverture et fond perforé
Caja interior
tapa y fondo perforado
Scatola interiore
coperchio e fondo perforati



II-113-65

Nadelkassetten
Needle Cases
Boîtes pour aiguilles
Estuches para agujas
Scatole per aghi

Deckel und Boden perforiert
perforated lid and bottom
couverture et fond perforé
tapa y fondo perforado
coperchio e fondo perforati



SAUERBRUCH
II-110-21
210x125x17 mm

Deckel und Boden perforiert
perforated lid and bottom
couverture et fond perforé
tapa y fondo perforado
coperchio e fondo perforati



II-114-00
150x95x13 mm



	L x B x H
II-210-16	165x 85x 35 mm
II-210-20	200x100x 60 mm
II-210-22	220x120x 60 mm
II-210-23	230x130x 50 mm
II-210-26	260x150x 50 mm
II-210-30	280x140x 60 mm
II-210-50	500x200x120 mm



	L x B x H
II-213-32	320x100x50 mm
II-213-43	430x100x35 mm



	L x B x H
II-214-17	170x120x60 mm
II-214-20	200x 60x40 mm
II-214-22	220x100x50 mm
II-214-23	220x140x60 mm
II-214-27	270x170x60 mm
II-214-30	300x180x65 mm



Verschiedene Behälter
Different Containers
Boîtes diverses
Contenedores varios
Vassoi diversi



	Ø x H
II-217-10	75x 60 mm
II-217-11	75x 75 mm
II-217-20	100x 60 mm
II-217-21	100x100 mm
II-217-30	125x 80 mm
II-217-31	125x125 mm
II-217-40	150x150 mm



	Ø x H	
II-310-04	40x 19 mm	(0.05 Liter)
II-310-06	61x 30 mm	(0.07 Liter)
II-310-08	80x 40 mm	(0.14 Liter)
II-310-12	116x50 mm	(0.35 Liter)
II-310-13	128x55 mm	(0.45 Liter)
II-310-15	147x65 mm	(0.70 Liter)
II-310-16	157x75 mm	(1.10 Liter)
II-310-19	187x85 mm	(1.60 Liter)



	Ø x H
II-311-01	42x 30 mm
II-311-02	53x 34 mm
II-311-03	58x 40 mm
II-311-04	64x 48 mm
II-311-05	68x 47 mm
II-311-06	71x 46 mm
II-311-07	71x 50 mm
II-311-08	81x 51 mm
II-311-09	81x 54 mm
II-311-10	89x 47 mm
II-311-11	100x48 mm
II-311-12	100x53 mm



	Ø x H
II-312-01	300x100 mm
II-312-02	350x100 mm
II-312-03	400x100 mm
II-312-04	330x 90 mm
II-312-05	330x115 mm



	Ø x H	
II-313-16	150x 74 mm	(0.75 Liter)
II-313-17	160x 65 mm	(1.00 Liter)
II-313-22	220x 70 mm	(2.00 Liter)
II-313-23	230x 80 mm	(2.50 Liter)
II-313-24	260x130 mm	(4.50 Liter)
II-313-25	255x115 mm	(3.50 Liter)
II-313-27	275x115 mm	(5.00 Liter)
II-313-29	300x105 mm	(6.00 Liter)
II-313-38	400x150 mm	(14.00 Liter)



	Ø x H
II-313-31	300x120 mm
II-313-34	350x130 mm
II-313-41	400x140 mm



II-314-10	1.00 Liter
II-314-15	1.50 Liter
II-314-20	2.00 Liter



Verschiedene Behälter
Different Containers
Boîtes diverses
Contenedores varios
Vassoi diversi



	L x B x H
II-316-23	380x230x95 mm
II-316-27	350x270x100 mm



II-317-23	235 mm
II-317-30	310 mm



	L x B x H	
II-317-40	300x200x 75 mm	Small (with handle)
II-317-41	300x200x 75 mm	Small (without handle)
II-317-43	350x230x100 mm	Large (with handle)



	Ø x H
II-318-70	100x50 mm



	L x B x H
II-319-17	170x100x30 mm
II-319-20	200x120x35 mm
II-319-25	250x140x40 mm
II-319-27	275x150x50 mm
II-319-30	300x160x50 mm
II-319-40	400x200x60 mm



	Ø x H
II-319-91	100x100 mm
II-319-92	150x150 mm



	Ø x H	
II-410-00	58x30 mm	25ml
II-410-01	52x50 mm	50ml
II-410-03	65x55 mm	100ml



II-410-02	0.25 Liter
II-410-05	0.50 Liter
II-410-10	1.00 Liter
II-410-20	2.00 Liter



Verschiedene Behälter
Different Containers
Boîtes diverses
Contenedores varios
Vassoi diversi



	\varnothing x H
II-411-06	60x20 mm
II-411-09	90x15 mm
II-411-10	100x20 mm
II-411-12	120x20 mm



	\varnothing x H
II-412-01	30x 90 mm
II-412-02	50x100 mm
II-412-03	50x130 mm
II-412-04	50x175 mm
II-412-05	75x100 mm
II-412-06	75x130 mm
II-412-07	75x175 mm
II-412-08	100x175 mm
II-412-09	100x200 mm



	L x B x H
II-412-19	190x100x13 mm
II-412-20	200x100x13 mm



	L x B x H
II-413-19	190x100x13 mm
II-413-20	200x100x13 mm
II-413-45	450x300x32 mm

Verschiedene Behälter
 Different Containers
 Boîtes diverses
 Contenedores varios
 Vassoi diversi



L x B x H

II-414-20	200x150x25 mm
II-414-22	230x155x30 mm
II-414-28	300x175x30 mm
II-414-31	300x175x40 mm
II-414-32	300x200x50 mm
II-414-35	350x220x40 mm
II-414-37	400x300x50 mm
II-414-42	450x350x50 mm



L x B x H

II-415-21	210x160x10 mm
II-415-24	240x180x10 mm
II-415-29	290x190x10 mm
II-415-30	310x150x10 mm
II-415-32	300x200x20 mm
II-415-33	300x245x16 mm
II-415-35	350x240x10 mm
II-415-38	385x265x16 mm
II-415-39	385x210x10 mm
II-415-40	400x270x20 mm
II-415-42	420x280x10 mm
II-415-43	430x295x16 mm
II-415-49	485x320x16 mm
II-415-51	510x380x30 mm
II-415-59	590x380x30 mm



L x B x H

II-416-22	220x170x50 mm
II-416-28	300x175x30 mm
II-416-30	300x175x40 mm
II-416-32	300x200x50 mm
II-416-35	350x240x36 mm
II-416-37	400x300x50 mm
II-416-42	450x350x50 mm



Verschiedene Behälter
Different Containers
Boîtes diverses
Contenedores varios
Vassoi diversi



	L x B x H
II-417-31	230x150x85 mm



	L x B x H
II-417-32	230x150x85 mm



	Ø x H
II-417-33	230x115 mm



	Ø x H	
II-510-02	75x 75 mm	0.25 Liter
II-510-05	100x 85 mm	0.50 Liter
II-510-07	115x100 mm	0.75 Liter
II-510-10	125x125 mm	1.00 Liter



II-574-10	10.00 Liter
II-574-13	13.00 Liter
II-574-15	15.00 Liter
II-574-18	18.00 Liter



II-575-21	210 mm
II-575-24	240 mm
II-575-27	270 mm
II-575-30	300 mm



Sterilisiertrommeln
Sterilizing Drums
Tambours à stérilisation
Tambores p. esterilización
Tambori p. sterilizzazione

18/10

Edelstahl rostfrei
Stainless Steel
Acier inoxydable
Acero inoxidable
Acciaio inossidabile



SCHIMMELBUSCH	Ø x H	KONRICH
II-512-08	125x 80 mm	II-812-08
II-512-10	125x100 mm	II-812-10
II-512-12	125x125 mm	II-812-12
II-515-08	150x 80 mm	
II-515-10	150x100 mm	II-815-10
II-515-13	150x130 mm	II-815-13
II-515-15	150x150 mm	II-815-15
II-515-19	150x190 mm	II-815-19
II-519-14	190x145 mm	II-819-14
II-519-16	190x165 mm	II-819-16
II-519-19	190x190 mm	II-819-19
II-519-24	190x240 mm	II-819-24
II-614-14	240x145 mm	
II-614-16	240x165 mm	II-914-16
II-614-19	240x190 mm	II-914-19
II-614-24	240x240 mm	II-914-24
II-614-29	240x290 mm	II-914-29
II-614-34	240x340 mm	
II-614-39	240x390 mm	
II-619-14	290x145 mm	II-919-14
II-619-16	290x165 mm	II-919-16
II-619-19	290x190 mm	II-919-19
II-619-24	290x240 mm	II-919-24
II-619-29	290x290 mm	II-919-29
II-619-34	290x340 mm	
II-619-39	290x390 mm	
II-714-14	340x145 mm	II-024-14
II-714-16	340x165 mm	II-024-16
II-714-19	340x190 mm	II-024-19
II-714-24	340x240 mm	II-024-24
II-714-29	340x290 mm	II-024-29
II-714-34	340x340 mm	
II-714-39	340x390 mm	
II-714-14	390x145 mm	II-029-14
II-714-16	390x165 mm	II-029-16
II-714-19	390x190 mm	II-029-19
II-719-24	390x240 mm	II-029-24
II-719-29	390x290 mm	II-029-29
II-719-34	390x340 mm	II-029-34
II-719-39	390x390 mm	II-029-39
II-719-49	390x490 mm	
II-719-59	390x590 mm	



18/10
Edelstahl rostfrei
Stainless Steel
Acier inoxydable
Acero inoxidable
Acciaio inossidabile

Aus Drahtgeflecht
Wire Mesh
En fil inox
De alambre
In rete metallica



Aus perforiertem Blech
From Perforated Sheet Metal
En tôle perforée
De chapa de acero perforada
In acciaio perforato



	L x B x H
II-420-24	240x250x 5 mm
II-420-48	480x250x 5 mm
II-420-55	550x250x 5 mm
II-421-24	240x250x 7 mm
II-421-48	480x250x 7 mm
II-422-24	240x250x10 mm
II-422-48	480x250x10 mm

	L x B x H
II-520-26	260x260x 5 mm
II-520-48	480x260x 5 mm
II-520-53	505x305x 4 mm



Container aus Aluminium
Aluminium Containers
Containers en aluminium
Contenedores de aluminio
Container in alluminio



Deckelfarbe
Colour of Lid
Couleur du couvercle
Color de la tapa
Colore del coperchio

A = Silber, silver, argent, plata, argento
B = Gold, gold, or, oro, oro
C = Rot, red, rouge, rojo, rosso
D = Blau, blue, bleu, azul, blu
E = Grün, green, vert, verde, verde
F = Schwarz, black, noir, negro, nero

Bezeichnung
Description
Designation
Descripción
Descrizione



Große Container und Zubehör
 Large Containers and Accessories
 Grands container et accessoires
 Contenedores grandes y accesoris
 Grossi container e accessori

4 - 7



3/4 Container und Zubehör
 3/4 Containers and Accessories
 3/4 Container et accessoires
 3/4 Contenedores y accesorios
 3/4 Container e accessori

8 - 11



Halb-Container und Zubehör
 Half-Size-Containers and Accessories
 Semi-Container et accessoires
 Contenedores medianos y accesorios
 Mezzi container e accessori

12 - 15



Flach-, Halb-, Container und Zubehör
 Flat Half-Size-Containers and Accessories
 Plat-, Semi-, Container et accessoires
 Contenedores medianos y planos y accesorios
 Piatti, Mezzi-, Container e accessori

16 - 17



Kleine Container und Zubehör
 Small Containers and Accessories
 Petit-Container et accessoires
 Contenedores pequeños y accesorios
 Piccoli container e accessori

18 - 19



Spezial Container Set und Zubehör
 Special Container Set and Accessories
 Spécial Container Set et accessoires
 Contenedores especiales y accesorios
 Container speciale e accessori

20



Spezial Container Set und Zubehör
 Special Container Set and Accessories
 Spécial Container Set et accessoires
 Contenedores especiales y accesorios
 Container speciale e accessori

21 - 23



Zubehör
 Accessories
 Accessoires
 Accesorios
 Accessori

24 - 27



Große Container und Zubehör
Large Containers and Accessories
Grands container et accessoires
Contenedores grandes y accesorios
Grossi container e accessori

Deckel gelocht - Boden ungelocht
Lid perforated - Bottom non perforated
Courvercle perforé - Fond non perforé
Tapa perforada - Fondo no perforada
Coperchio forato - Fondo non forato

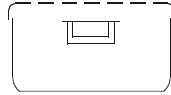

Deckel gelocht - Boden gelocht
Lid perforated - Bottom perforated
Courvercle perforé - Fond perforé
Tapa perforada - Fondo perforada
Coperchio forato - Fondo forato

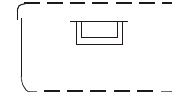

580 x 280 x 100 mm



II-060-01 A
II-060-02 B
II-060-03 C
II-060-04 D
II-060-05 E
II-060-06 F

II-061-01 A
II-061-02 B
II-061-03 C
II-061-04 D
II-061-05 E
II-061-06 F

580 x 280 x 135 mm



II-060-11 A
II-060-12 B
II-060-13 C
II-060-14 D
II-060-15 E
II-060-16 F

II-061-11 A
II-061-12 B
II-061-13 C
II-061-14 D
II-061-15 E
II-061-16 F

580 x 280 x 150 mm



II-060-21 A
II-060-22 B
II-060-23 C
II-060-24 D
II-060-25 E
II-060-26 F

II-061-21 A
II-061-22 B
II-061-23 C
II-061-24 D
II-061-25 E
II-061-26 F

580 x 280 x 200 mm



II-060-31 A
II-060-32 B
II-060-33 C
II-060-34 D
II-060-35 E
ii-060-36 F

II-061-31 A
II-061-32 B
II-061-33 C
II-061-34 D
II-061-35 E
II-061-36 F

580 x 280 x 260 mm



II-060-41 A
II-060-42 B
II-060-43 C
II-060-44 D
II-060-45 E
II-060-46 F

II-061-41 A
II-061-42 B
II-061-43 C
II-061-44 D
II-061-45 E
II-061-46 F



Sicherheitsdeckel - Boden ungelocht
 Safety Lid - Bottom non-perforated
 Courvercle de sécurité - Fond non perforé
 Tapa de seguridad - Fondo no perforada
 Coperchio di Protezione - Fondo non forato

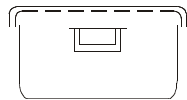

Sicherheitsdeckel - Boden gelocht
 Safety Lid - Bottom perforated
 Courvercle de sécurité - Fond perforé
 Tapa de seguridad - Fondo perforada
 Coperchio di Protezione - Fondo forato

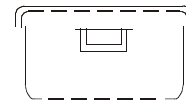

580 x 280 x 100 mm



II-062-01 A
 II-062-02 B
 II-062-03 C
 II-062-04 D
 II-062-05 E
 II-062-06 F

II-063-01 A
 II-063-02 B
 II-063-03 C
 II-063-04 D
 II-063-05 E
 II-063-06 F

580 x 280 x 135 mm



II-062-11 A
 II-062-12 B
 II-062-13 C
 II-062-14 D
 II-062-15 E
 II-062-16 F

II-063-11 A
 II-063-12 B
 II-063-13 C
 II-063-14 D
 II-063-15 E
 II-063-16 F

580 x 280 x 150 mm



II-062-21 A
 II-062-22 B
 II-062-23 C
 II-062-24 D
 II-062-25 E
 II-062-26 F

II-063-21 A
 II-063-22 B
 II-063-23 C
 II-063-24 D
 II-063-25 E
 II-063-26 F

580 x 280 x 200 mm



II-062-31 A
 II-062-32 B
 II-062-33 C
 II-062-34 D
 II-062-35 E
 II-062-36 F

II-063-31 A
 II-063-32 B
 II-063-33 C
 II-063-34 D
 II-063-35 E
 II-063-36 F

580 x 280 x 260 mm



II-062-41 A
 II-062-42 B
 II-062-43 C
 II-062-44 D
 II-062-45 E
 II-062-46 F

II-063-41 A
 II-063-42 B
 II-063-43 C
 II-063-44 D
 II-063-45 E
 II-063-46 F



Große Container und Zubehör
Large Containers and Accessories
Grands container et accessoires
Contenedores grandes y accesorios
Grossi container e accessori

Boden ungelocht
Bottom non-perforated
Fond non perforé
Fondo no perforada
Fondo non forato

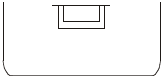

II-064-10	580 x 280 x 100 mm
II-064-20	580 x 280 x 135 mm
II-064-30	580 x 280 x 150 mm
II-064-40	580 x 280 x 200 mm
II-064-50	580 x 280 x 260 mm

Boden gelocht
Bottom perforated
Fond perforé
Fondo perforada
Fondo forato

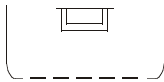

II-065-10	580 x 280 x 100 mm
II-065-20	580 x 280 x 135 mm
II-065-30	580 x 280 x 150 mm
II-065-40	580 x 280 x 200 mm
II-065-50	580 x 280 x 260 mm

Deckel gelocht
Lid perforated
Courvercle perforé
Tapa perforada
Coperchio forato

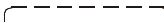

580 x 280 mm



II-066-01	A
II-066-02	B
II-066-03	C
II-066-04	D
II-066-05	E
II-066-06	F

Sicherheitsdeckel
Safety Lid
Courvercle de sécurité
Tapa de seguridad
Coperchio di Protezione

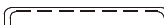

580 x 280 mm



II-067-01	A
II-067-02	B
II-067-03	C
II-067-04	D
II-067-05	E
II-067-06	F



Siebkörbe Edelstahl
 Wire baskets, special steel
 Paniers grillagés en acier de haute qualité
 Cestillos de acero fino
 Cestelli in acciaio fino



II-069-11 540 x 255 x 30 mm
II-069-12 540 x 255 x 50 mm
II-069-13 540 x 255 x 70 mm
II-069-14 540 x 255 x 100 mm

Siebkörbe Edelstahl
 Wire baskets, special steel
 Paniers grillagés en acier de haute qualité
 Cestillos de acero fino
 Cestelli in acciaio fino



II-069-01 485 x 255 x 30 mm
II-069-02 485 x 255 x 50 mm
II-069-03 485 x 255 x 70 mm
II-069-04 485 x 255 x 100 mm

Siebboden
 Separate floors
 Fond du crible
 Cestas-cuerpos
 Fondo di Cestello



II-069-21 545 x 255 x 30 mm

Spannrahmen für Einschlagtücher
 Tension Clips for Towels
 Cadre tendeur à champs
 Marcos tensores para paños
 Telaio di fissaggio



II-956-12 545 x 255 mm

Einschlagtücher aus Baumwolle
 Wrapping drapes, cotton
 Champs, coton
 Paños de embalaje de algodón
 Telo, cotone



II-965-07 130 x 60 cm
II-965-08 140 x 100 cm
II-965-09 185 x 45 cm
II-965-10 185 x 60 cm



3/4 Container und Zubehör
3/4 Containers and Accessories
3/4 Container et accessoires
3/4 Contenedores y accesorios
3/4 Container e accessori

Deckel gelocht - Boden ungelocht
Lid perforated - Bottom non perforated
Couvercle perforé - Fond non perforé
Tapa perforada - Fondo no perforada
Coperchio forato - Fondo non forato

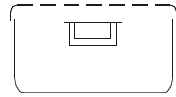

Deckel gelocht - Boden gelocht
Lid perforated - Bottom perforated
Couvercle perforé - Fond perforé
Tapa perforada - Fondo perforada
Coperchio forato - Fondo forato

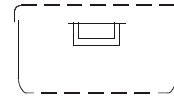

465 x 280 x 100 mm



II-160-01 A
II-160-02 B
II-160-03 C
II-160-04 D
II-160-05 E
II-160-06 F

II-161-01 A
II-161-02 B
II-161-03 C
II-161-04 D
II-161-05 E
II-161-06 F

465 x 280 x 135 mm



II-160-11 A
II-160-12 B
II-160-13 C
II-160-14 D
II-160-15 E
II-160-16 F

II-161-11 A
II-161-12 B
II-161-13 C
II-161-14 D
II-161-15 E
II-161-16 F

465 x 280 x 150 mm



II-160-21 A
II-160-22 B
II-160-23 C
II-160-24 D
II-160-25 E
II-160-26 F

II-161-21 A
II-161-22 B
II-161-23 C
II-161-24 D
II-161-25 E
II-161-26 F



Sicherheitsdeckel - Boden ungelocht
 Safety Lid - Bottom non-perforated
 Courvercle de securité - Fond non perforé
 Tapa de seguridad - Fondo no perforada
 Coperchio di Protezione - Fondo non forato

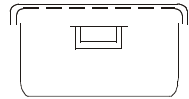

Sicherheitsdeckel - Boden gelocht
 Safety Lid - Bottom perforated
 Courvercle de securité - Fond perforé
 Tapa de seguridad - Fondo no perforada
 Coperchio di Protezione - Fondo forato

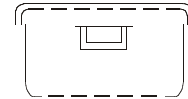

465 x 280 x 100 mm



II-162-01 A
 II-162-02 B
 II-162-03 C
 II-162-04 D
 II-162-05 E
 II-162-06 F

II-163-01 A
 II-163-02 B
 II-163-03 C
 II-163-04 D
 II-163-05 E
 II-163-06 F

465 x 280 x 135 mm



II-162-11 A
 II-162-12 B
 II-162-13 C
 II-162-14 D
 II-162-15 E
 II-162-16 F

II-163-11 A
 II-163-12 B
 II-163-13 C
 II-163-14 D
 II-163-15 E
 II-163-16 F

465 x 280 x 150 mm



II-162-21 A
 II-162-22 B
 II-162-23 C
 II-162-24 D
 II-162-25 E
 II-162-26 F

II-163-21 A
 II-163-22 B
 II-163-23 C
 II-163-24 D
 II-163-25 E
 II-163-26 F



3/4 Container und Zubehör
3/4 Containers and Accessories
3/4 Container et accessoires
3/4 Contenedores y accesorios
3/4 Container e accessori

Boden ungelocht
Bottom non-perforated
Fond non perforé
Fondo no perforada
Fondo non forato

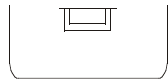

II-164-01 465 x 280 x 100 mm
II-164-02 465 x 280 x 135 mm
II-164-03 465 x 280 x 150 mm

Boden gelocht
Bottom perforated
Fond perforé
Fondo perforada
Fondo forato

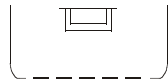

II-165-01 465 x 280 x 100 mm
II-165-02 465 x 280 x 135 mm
II-165-03 465 x 280 x 150 mm

Deckel gelocht
Lid perforated
Courvercle perforé
Tapa perforada
Coperchio forato

465 x 280 mm

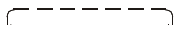

II-166-01 A
II-166-02 B
II-166-03 C
II-166-04 D
II-166-05 E
II-166-06 F

Sicherheitsdeckel
Saftey Lid
Courvercle de securité
Tapa de seguridad
Coperchio di Protezione

465 x 280 mm

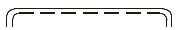

II-167-01 A
II-167-02 B
II-167-03 C
II-167-04 D
II-167-05 E
II-167-06 F



Siebkörbe Edelstahl
Wire baskets, special steel
Paniers grillagés en acier de haute qualité
Cestillos de acero fino
Cestelli in acciaio fino



II-169-01 405 x 255 x 30 mm
II-169-02 405 x 255 x 50 mm
II-169-03 405 x 255 x 70 mm
II-169-04 405 x 255 x 100 mm

Siebboden
Separate floors
Fond du crible
Cestas-cuerpos
Fondo di Cestello



II-169-11 405 x 255 x 30 mm

Spannrahmen für Einschlagtücher
Tension Clips for Towels
Cadre tendeur à champs
Marcos tensores para paños
Telaio di fissaggio



II-965-13 405 x 255 mm

Einschlagtücher aus Baumwolle
Wrapping drapes, cotton
Champs, coton
Paños de embalaje de algodón
Telo, cotone



II-965-08 140 x 100 cm



Halb-Container und Zubehör
Half-Size-Containers and Accessories
Semi-Container et accessoires
Contenedores medianos y accesorios
Mezzi container e accessori

Deckel gelocht - Boden ungelocht
Lid perforated - Bottom non perforated
Courvercle perforé - Fond non perforé
Tapa perforada - Fondo no perforada
Coperchio forato - Fondo non forato

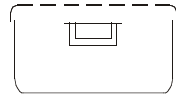

Deckel gelocht - Boden gelocht
Lid perforated - Bottom perforated
Courvercle perforé - Fond perforé
Tapa perforada - Fondo perforada
Coperchio forato - Fondo forato

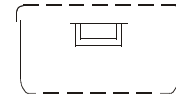

285 x 280 x 100 mm



II-260-01 A
II-260-02 B
II-260-03 C
II-260-04 D
II-260-05 E
II-260-06 F

II-261-01 A
II-261-02 B
II-261-03 C
II-261-04 D
II-261-05 E
II-261-06 F

285 x 280 x 135 mm



II-260-11 A
II-260-12 B
II-260-13 C
II-260-14 D
II-260-15 E
II-260-16 F

II-261-11 A
II-261-12 B
II-261-13 C
II-261-14 D
II-261-15 E
II-261-16 F

285 x 280 x 150 mm



II-260-21 A
II-260-22 B
II-260-23 C
II-260-24 D
II-260-25 E
II-260-26 F

II-261-21 A
II-261-22 B
II-261-23 C
II-261-24 D
II-261-25 E
II-261-26 F

285 x 280 x 200 mm



II-260-31 A
II-260-32 B
II-260-33 C
II-260-34 D
II-260-35 E
II-260-36 F

II-261-31 A
II-261-32 B
II-261-33 C
II-261-34 D
II-261-35 E
II-261-36 F

285 x 280 x 260 mm



II-260-41 A
II-260-42 B
II-260-43 C
II-260-44 D
II-260-45 E
II-260-46 F

II-261-41 A
II-261-42 B
II-261-43 C
II-261-44 D
II-261-45 E
II-261-46 F



Sicherheitsdeckel - Boden ungelocht
 Saftey Lid - Bottom non-perforated
 Courvercle de sécurité - Fond non perforé
 Tapa de seguridad - Fondo no perforada
 Coperchio di Protezione - Fondo non forato

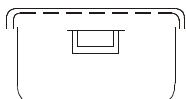

Sicherheitsdeckel - Boden gelocht
 Saftey Lid - Bottom perforated
 Courvercle de sécurité - Fond perforé
 Tapa de seguridad - Fondo no perforada
 Coperchio di Protezione - Fondo forato

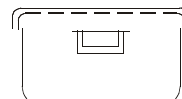

285 x 280 x 100 mm



II-262-01 A
 II-262-02 B
 II-262-03 C
 II-262-04 D
 II-262-05 E
 II-262-06 F

II-263-01 A
 II-263-02 B
 II-263-03 C
 II-263-04 D
 II-263-05 E
 II-263-06 F

285 x 280 x 135 mm



II-262-11 A
 II-262-12 B
 II-262-13 C
 II-262-14 D
 II-262-15 E
 II-262-16 F

II-263-11 A
 II-263-12 B
 II-263-13 C
 II-263-14 D
 II-263-15 E
 II-263-16 F

285 x 280 x 150 mm



II-262-21 A
 II-262-22 B
 II-262-23 C
 II-262-24 D
 II-262-25 E
 II-262-26 F

II-263-21 A
 II-263-22 B
 II-263-23 C
 II-263-24 D
 II-263-25 E
 II-263-26 F

285 x 280 x 200 mm



II-262-31 A
 II-262-32 B
 II-262-33 C
 II-262-34 D
 II-262-35 E
 II-262-36 F

II-263-31 A
 II-263-32 B
 II-263-33 C
 II-263-34 D
 II-263-35 E
 II-263-36 F

285 x 280 x 260 mm



II-262-41 A
 II-262-42 B
 II-262-43 C
 II-262-44 D
 II-262-45 E
 II-262-46 F

II-263-41 A
 II-263-42 B
 II-263-43 C
 II-263-44 D
 II-263-45 E
 II-263-46 F



Halb-Container und Zubehör
Half-Size-Containers and Accessories
Semi-Container et accessoires
Contenedores medianos y accesorios
Mezzi container e accessori

Boden ungelocht
Bottom non-perforated
Fond non perforé
Fondo no perforada
Fondo non forato

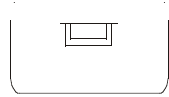

II-264-01	285 x 280 x 100 mm
II-264-02	285 x 280 x 135 mm
II-264-03	285 x 280 x 150 mm
II-264-04	285 x 280 x 200 mm
II-264-05	285 x 280 x 260 mm

Boden gelocht
Bottom perforated
Fond perforé
Fondo perforada
Fondo forato

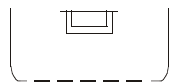

II-265-01	285 x 280 x 100 mm
II-265-02	285 x 280 x 135 mm
II-265-03	285 x 280 x 150 mm
II-265-04	285 x 280 x 200 mm
II-265-05	285 x 280 x 260 mm

Deckel gelocht
Lid perforated
Courvercle perforé
Tapa perforada
Coperchio forato

285 x 280 mm

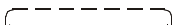

II-262-01	A
II-262-02	B
II-262-03	C
II-262-04	D
II-262-05	E
II-262-06	F

Sicherheitsdeckel
Safety Lid
Courvercle de sécurité
Tapa de seguridad
Coperchio di Protezione

285 x 280 mm

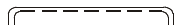

II-267-01	A
II-267-02	B
II-267-03	C
II-267-04	D
II-267-05	E
II-267-06	F



Siebkörbe Edelstahl
Wire baskets, special steel
Paniers grillagés en acier de haute qualité
Cestillos de acero fino
Cestelli in acciaio fino



II-269-01 255 x 245 x 30 mm
II-269-02 255 x 245 x 50 mm
II-269-03 255 x 245 x 70 mm
II-269-04 255 x 245 x 100 mm

Siebboden
Separate floors
Fond du crible
Cestas-cuerpos
Fondo di Cestello



II-269-11 255 x 245 x 30 mm

Spannrahmen für Einschlagtücher
Tension Clips for Towels
Cadre tendeur à champs
Marcos tensores para paños
Telaio di fissaggio



II-965-17 255 x 255 mm

Einschlagtücher aus Baumwolle
Wrapping drapes, cotton
Champs, coton
Paños de embalaje de algodón
Telo, cotone



II-965-04 90 x 60 cm
II-965-05 90 x 80 cm
II-965-06 130 x 45 cm
II-965-07 130 x 60 cm



Halb-Container und Zubehör
 Half-Size-Containers and Accessories
 Semi-Container et accessoires
 Contenedores medianos y accesorios
 Mezzi container e accessori

Deckel gelocht - Boden ungelocht
 Lid perforated - Bottom non-perforated
 Courvercle perforé - Fond non perforé
 Tapa perforada - Fondo no perforada
 Coperchio forato - Fondo non forato

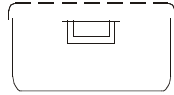

Deckel gelocht - Boden gelocht
 Lid perforated - Bottom perforated
 Courvercle perforé - Fond perforé
 Tapa perforada - Fondo no perforada
 Coperchio forato - Fondo forato

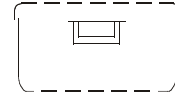

285 x 280 x 55 mm



II-360-01 **A**
II-360-02 **B**
II-360-03 **C**
II-360-04 **D**
II-360-05 **E**
II-360-06 **F**

285 x 280 x 85 mm



II-360-11 **A**
II-360-12 **B**
II-360-13 **C**
II-360-14 **D**
II-360-15 **E**
II-360-16 **F**

II-361-11 **A**
II-361-12 **B**
II-361-13 **C**
II-361-14 **D**
II-361-15 **E**
II-361-16 **F**

Boden ungelocht
 Bottom non-perforated
 Fond non perforé
 Fondo no perforada
 Fondo non forato

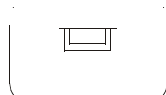

II-362-01 285 x 280 x 55 mm
II-362-02 285 x 280 x 85 mm

Boden gelocht
 Bottom perforated
 Fond perforé
 Fondo perforada
 Fondo forato

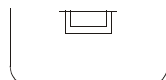

II-362-03 285 x 280 x 85 mm

Deckel gelocht
 Lid perforated
 Courvercle perforé
 Tapa perforada
 Coperchio forato

285 x 280 mm

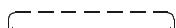

II-362-11 **A**
II-362-12 **B**
II-362-13 **C**
II-362-14 **D**
II-362-15 **E**
II-362-10 **F**



Siebkörbe Edelstahl
 Wire baskets, special steel
 Paniers grillagés en acier de haute qualité
 Cestillos de acero fino
 Cestelli in acciaio fino



II-269-01 255 x 245 x 30 mm
II-269-02 255 x 245 x 50 mm

Siebboden
 Separate floors
 Fond du crible
 Cestas-cuerpos
 Fondo di Cestello



II-269-11 255 x 245 x 30 mm

Silikon-Noppenmatte
 Silicone Mats
 Tapis silicone
 Planchas granuladas de silicona
 Stuoia di silicone



II-965-21 245 x 245 mm

Spannrahmen für Einschlagtücher
 Tension Clips for Towels
 Cadre tendeur à champs
 Marcos tensores para paños
 Telaio di fissaggio



II-965-17 255 x 255 mm

Einschlagtücher aus Baumwolle
 Wrapping drapes, cotton
 Champs, coton
 Paños de embalaje de algodón
 Telo, cotone



II-965-04 90 x 60 cm
II-965-05 90 x 80 cm



Kleine Container und Zubehör
 Small Containers and Accessories
 Petit-Container et accessoires
 Contenedores pequeños y accesorios
 Piccoli container e accessori

Deckel gelocht - Boden ungelocht
 Lid perforated - Bottom non perforated
 Courvercle perforé - Fond non perforé
 Tapa perforada - Fondo no perforada
 Coperchio forato - Fondo non forato

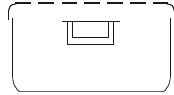

Deckel gelocht - Boden gelocht
 Lid perforated - Bottom perforated
 Courvercle perforé - Fond perforé
 Tapa perforada - Fondo perforada
 Coperchio forato - Fondo forato

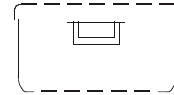

300 x 140 x 40 mm



II-460-01 **A**
II-460-02 **B**
II-460-03 **C**
II-460-04 **D**
II-460-05 **E**
II-460-06 **F**

II-461-01 **A**
II-461-02 **B**
II-461-03 **C**
II-461-04 **D**
II-461-05 **E**
II-461-06 **F**

300 x 140 x 70 mm



II-460-11 **A**
II-460-12 **B**
II-460-13 **C**
II-460-14 **D**
II-460-15 **E**
II-460-16 **F**

II-461-11 **A**
II-461-12 **B**
II-461-13 **C**
II-461-14 **D**
II-461-15 **E**
II-461-16 **F**

300 x 140 x 100 mm



II-460-21 **A**
II-460-22 **B**
II-460-23 **C**
II-460-24 **D**
II-460-25 **E**
II-460-26 **F**

II-461-21 **A**
II-461-22 **B**
II-461-23 **C**
II-461-24 **D**
II-461-25 **E**
II-461-26 **F**

Boden ungelocht
 Bottom non-perforated
 Fond non perforé
 Fondo no perforada
 Fondo non forato

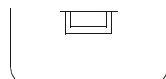

II-462-01 300 x 140 x 40 mm
II-462-02 300 x 140 x 70 mm
II-462-03 300 x 140 x 100 mm

Boden gelocht
 Bottom perforated
 Fond perforé
 Fondo perforada
 Fondo forato

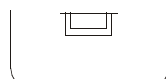

II-462-11 300 x 140 x 40 mm
II-462-12 300 x 140 x 70 mm
II-462-13 300 x 140 x 100 mm



Deckel gelocht
 Lid perforated
 Courvercle perforé
 Tapa perforada
 Coperchio forato

300 x 140 mm



II-462-21
II-462-22
II-462-23
II-462-24
II-462-25
II-462-26

A
B
C
D
E
F

Silikon-Noppenmatte
 Silicone Mats
 Tapis silicone
 Planchas granuladas de silicona
 Stuoia di silicone



II-965-20

270 x 125 mm

Spannrahmen für Einschlagtücher
 Tension Clips for Towels
 Cadre tendeur à champs
 Marcos tensores para paños
 Telaio di fissaggio



II-965-18

280 x 125 mm

Einschlagtücher aus Baumwolle
 Wrapping drapes, cotton
 Champs, coton
 Paños de embalaje de algodón
 Telo, cotone



II-965-01

60 x 40 cm



Spezial Container Set und Zubehör
Special Container Set and Accessories
Spécial Container Set et accessoires
Contenedores especiales y accesorios
Container speciale e accessori

Deckel gelocht - Boden gelocht
Lid perforated - Bottom perforated
Couvercle perforé - Fond perforé
Tapa perforada - Fondo perforada
Coperchio forato - Fondo forato

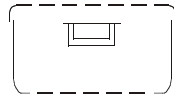

310 x 190 x 40 mm



II-560-01 A

Boden gelocht
Bottom perforated
Fond perforé
Fondo perforada
Fondo forato

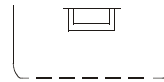

A

II-560-11 310 x 190 x 40 mm
II-560-12 310 x 190 x 65 mm
II-560-13 310 x 190 x 130 mm

310 x 190 x 65 mm



II-560-02 A

Deckel gelocht
Lid perforated
Couvercle perforé
Tapa perforada
Coperchio forato

310 x 190 x 130 mm



II-560-03 A



A

II-560-21 310 x 190 mm

Spannrahmen für Einschlagtücher
Tension Clips for Towels
Cadre tendeur à champs
Marcos tensores para paños
Telaio di fissaggio



II-965-19 310 x 190 mm

Einschlagtücher aus Baumwolle
Wrapping drapes, cotton
Champs, coton
Paños de embalaje de algodón
Telo, cotone



II-965-01 60 x 40 cm
II-965-02 65 x 65 cm
II-965-03 85 x 85 cm



Deckel gelocht - Boden gelocht
 Lid perforated - Bottom perforated
 Courvercle perforé - Fond perforé
 Tapa perforada - Fondo perforada
 Coperchio forato - Fondo forato

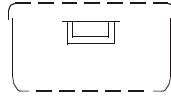

300 x 138 x 65 mm



II-660-01	A
II-660-02	B
II-660-03	C
II-660-04	D
II-660-05	E
II-660-06	F

500 x 155 x 75 mm



II-660-11	A
II-660-12	B
II-660-13	C
II-660-14	D
II-660-15	E
II-660-16	F

Deckel gelocht - Boden gelocht
 Lid perforated - Bottom perforated
 Courvercle perforé - Fond perforé
 Tapa perforada - Fondo perforada
 Coperchio forato - Fondo forato

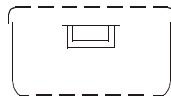

250 x 60 x 50 mm



II-660-21	A
------------------	----------

450 x 70 x 70 mm



II-660-22	A
------------------	----------



Spezial Container Set und Zubehör
Special Container Set and Accessories
Spécial Container Set et accessoires
Contenedores especiales y accesorios
Container speciale e accessori

Deckel ungelocht - Boden ungelocht
Lid non perforated - Bottom non perforated
Courvercle non perforé - Fond non perforé
Tapa no perforada - Fondo no perforada
Coperchio non-forato - Fondo non forato

285 x 280 x 100 mm



II-760-01
II-760-02
II-760-03
II-760-04
II-760-05
II-760-06

A
B
C
D
E
F

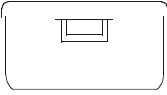

Deckel ungelocht - Boden ungelocht
Lid non perforated - Bottom non perforated
Courvercle non perforé - Fond non perforé
Tapa no perforada - Fondo no perforada
Coperchio non-forato - Fondo non forato

285 x 280 x 150 mm



II-760-11
II-760-12
II-760-13
II-760-14
II-760-15
II-760-16

A
B
C
D
E
F

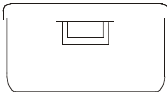

Boden ungelocht
Bottom non-perforated
Fond non perforé
Fondo no perforada
Fondo non forato



II-264-01
II-264-03

285 x 280 x 100 mm
285 x 280 x 150 mm

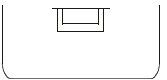

Deckel ungelocht
Lid non perforated
Courvercle non perforé
Tapa no perforada
Coperchio non-forato

285 x 280 mm



II-760-51
II-760-52
II-760-53
II-760-54
II-760-55
II-760-56

A
B
C
D
E
F

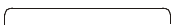



Deckel ungelocht - Boden ungelocht
 Lid non perforated - Bottom non perforated
 Courvercle non perforé - Fond non perforé
 Tapa no perforada - Fondo no perforada
 Coperchio non-forato - Fondo non forato

580 x 280 x 150 mm



II-760-21	A
II-760-22	B
II-760-23	C
II-760-24	D
II-760-25	E
II-760-26	F

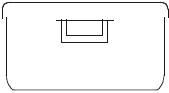

Boden ungelocht
 Bottom non-perforated
 Fond non perforé
 Fondo no perforada
 Fondo non forato



II-064-30 580 x 280 x 150 mm

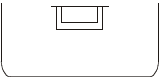

Deckel ungelocht
 Lid non perforated
 Courvercle non perforé
 Tapa no perforada
 Coperchio non-forato

580 x 280 mm



II-760-41	A
II-760-42	B
II-760-43	C
II-760-44	D
II-760-45	E
II-760-46	F

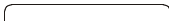



Zubehör
Accessories
Accessoires
Accesorios
Accessori

Bürstenspender
für 20 Bürsten (ohne Bürsten),
mit Aufhängevorrichtung

285 x 280 x 85 mm

Brush dispenser
for 20 Brushes (without brushes)
with suspension hook

Distruteur
pour 20 brosses (sans brosses),
avec crochet de suspension

Distribuidor de cepillos
para 20 cepillos (sin cepillos),
completo con gancho de suspensión

Distributore
per 20 spazzole (spazzole escluse),
con gancio di sospensione



II-860-01
II-860-02
II-860-03
II-860-04
II-860-05
II-860-06

A
B
C
D
E
F

Handwaschbürste,
über 400 Mal im Autoklaven
sterilisierbar

Nailbrush, more than
400 times autoclavable

Brosse à de ongles,
stérilisable à l'autoclave 400 fois ou plus

Cepillo de uñas,
esterilizable más de 400 veces en autoclave

Spazzola per unghie,
sterilizzabile più di 400 volte in
autoclave



HE-938-00



Einmal-Papierfilter
Single use paper filters
Filtres papiers à usage unique
Filtros de papel de un solo uso
Filtri di carta monouso

Verpackungseinheit 100 Stück
Packing unit 100 pieces
Boîtes de 100 pièces
Cajas con 100 piezas
Unità di 100 pezzi



II-960-01

Für 1/1, 3/4 und halbe Container
For 1/1, 3/4 and Half-Size Containers
Pour 1/1, 3/4 et Semi-Container
Para contenedores grandes y medianos
Per grossi container e mezzo container

Langzeit-Textilfilter
Long-term textile filters
Filtres textiles longue
Filtros de tejido de larga duración
Filtri tessili a lunga durata

Verpackungseinheit 1 Stück
Packing unit 1 pieces
Boîtes de 1 pièces
Cajas con 1 piezas
Unità di 1 pezzi



II-960-02

Für 1/1, 3/4 und halbe Container
For 1/1, 3/4 and Half-Size Containers
Pour 1/1, 3/4 et Semi-Container
Para contenedores grandes y medianos
Per grossi container e mezzo container



II-960-03

Für Klein-Set Container (Mini)
For small Container Sets (Mini)
Pour petit-Set Container (Mini)
Para contenedores pequeños (Mini)
Per piccoli container (Mini)



II-960-04

Für Klein-Set Container (Mini)
For small Container Sets (Mini)
Pour petit-Set Container (Mini)
Para contenedores pequeños (Mini)
Per piccoli container (Mini)



II-960-05

Für Klein-Set Container (Dental)
For small Container Sets (Dental)
Pour petit-Set Container (Dental)
Para contenedores pequeños (Dental)
Per piccoli container (Dental)



II-960-06

Für Klein-Set Container (Dental)
For small Container Sets (Dental)
Pour petit-Set Container (Dental)
Para contenedores pequeños (Dental)
Per piccoli container (Dental)

Filterspender
Filter Dispenser
Pièce à rangement
Contenedor de filtros
Distributore filtri



II-960-07



Zubehör
Accessories
Accessoires
Accesorios
Accessori

Filterblech
Filter sheet
Dispositif d'arrêt filtre
Dispositivo de sujetar filtro
Fermafilro



II-960-08

Für Einmal-Papierfilter
For single use paper filters
Pour filtres papiers à usage unique
Para filtros de papel de un solo uso
Per filtri di carta per un solo uso

II-960-09

Für Langzeit-Textilfilter
For long-term textile filters
Pour filtres textiles longue durée
Para filtros de tejido de larga duración
Per filtri tessili a lunga durata

Indikatoretiketten aus Papier
Indications labels, made of paper
Etiquettes-témions, en papier
Etiquetas indicadoras de papel
Etichette di identificazione in carta

Verpackungseinheit 100 Stück
Packing unit 100 pieces
Boîtes de 100 pièces
Cajas con 100 piezas
Unità di 100 pezzi

II-960-10

Für 1/1, 3/4 und halbe Container
For 1/1, 3/4 and Half-Size Containers
Pour 1/1, 3/4 et Semi-Container
Para contenedores grandes y medianos
Per grossi container e mezzo container

II-960-11

Für Klein-Set Container (Mini und Dental)
For small Container Sets (Mini and Dental)
Pour petit-Set Container (Mini et Dental)
Para contenedores pequeños (Mini de Dental)
Per piccoli container (Mini e Dental)

Verschlußblomben aus Kunststoff
Plastic Security Seals
Plombs de verrouillage en matière plastique
Precintos de plastico
Piombi in materia plastica

Verpackungseinheit 100 Stück
Packing unit 100 pieces
Boîtes de 100 pièces
Cajas con 100 piezas
Unità di 100 pezzi



II-960-12

Farbige Kennzeichnungsschilder (ohne Gravur)
Coloured identification labels (without engraving)
Etiquettes d'identification en couleur (sans gravure)
Placas de identificación de color (sin grabación)
Targhette di identificazione colorate (senza incisione)

Gravur auf Anfrage
Engraving as per request
Gravure par demande
Grabación según su deseo
Incisione su richiesta

II-960-21

A

II-960-22

B

II-960-23

C

II-960-24

D

II-960-25

E

II-960-26

F

Sortiermagazin für Kennzeichnungsschilder
Dispenser for identification labels
Magasin à étiquettes pour d'identification
Cajetín clasificador de identificación
Cassetta da selezione targhette di identificazione



II-960-29



Trennblechhaltestift zur Aufnahme von Trennblechen
Fixing bolt for divisions
Plot de cloisonnement pour maintenir les cloisonnements
Piñon para separadores
Perno di fissaggio per separatori



II-960-31



Sortierspieß zur Fixierung von Instrumenten
Fixation shaft for instruments
Attache de fixation pour la fixation d'instruments
Piñon para fijar instrumental
Perno di fissaggio per strumenti



II-960-32

Trennbleche
Divisions
Séparateurs
Separadores
Dvisorii per cesti in rete



II-960-33

50 x 20 mm

II-860-34

130 x 20 mm

II-960-35

225 x 20 mm

II-960-36

460 x 20 mm

Gleitschieber
Sliders
Curseur
Corredor
Cursore



II-960-41



Schiene für
Gleitschieber
Rail for Sliders
Éclisse pour le curseur
Riel para corredor
Sbarra per cursore



II-960-42

232 mm

II-960-43

471 mm

Winkelblech (Anschlagrahmen)
Angled stopper
Separateur en angle
Separador ángulado
Sbarra angolata



II-960-44

232 mm

II-860-45

471 mm

Spiralfeder mit Halterung
Spiral holding support
Support à ressorts spiraux
Apoyo con resorte espiral
Supporto a molle



II-960-46



Doppelte-Spiralfeder mit Halterung
Spiral holding support double
Support à ressorts spiraux double
Apoyo don resorte espiral doble
Supporto doppio a molle



II-960-47

Fixierklammern für Tücher
Fixation clamps for drapes
Clips à champs
Clip de fijación para paños
Clips di fissaggio per teli



II-960-48



JA

**Hochfrequenz-Chirurgie
High Frequency Surgery
Chirurgie à haute fréquence
Electrocirugía
Elettrochirurgia**



JA

Elektroden zum Schneiden und Koagulieren
 Cutting and Coagulation Electrodes
 Electrodes pour la coupe et la coagulation
 Electrodo para cortar y para la coagulación
 Elettrodi di taglio e di coagulazione

Serie MICRO + DENTAL



JA-100-01
Fig. 1

JA-100-02
Fig. 2
45°

JA-100-03
Fig. 3
120°

JA-100-11
Fig. 11
Ø 3 mm

JA-100-12
Fig. 12
Ø 5 mm

JA-100-13
Fig. 13
Ø 8 mm

JA-100-14
Fig. 14

JA-100-15
Fig. 15
7,0 x 1,5 mm
45°

JA-100-16
Fig. 16
7 mm
45°

JA-100-17
Fig. 17
6,0 x 1,3 mm

JA-100-18
Fig. 18
7,0 x 1,7 mm
30°

JA-100-21
Fig. 21
7,0 x 1,7 mm

JA-100-31
Fig. 31
Ø 0,6 mm
45°

JA-100-33
Fig. 33
Ø 1,7 mm
45°

JA-100-34
Fig. 34
Ø 3,0 mm
45°

JA-100-35
Fig. 35

JA-100-36
Fig. 36
90°

Schaft • shaft • tige
 vástago • asta
 Ø 1,6 mm

Elektroden zum Schneiden und Koagulieren
 Cutting and Coagulation Electrodes
 Electrodes pour la coupe et la coagulation
 Electrodo para cortar y para la coagulación
 Elettrodi di taglio e di coagulazione

Serie MICRO + DENTAL



JA-101-51
 Fig. 51
 Ø 3 mm
 45°

JA-101-52
 Fig. 52
 7,0 x 1,7 mm
 45°

JA-101-53
 Fig. 53
 45°

JA-101-54
 Fig. 54

JA-101-55
 Fig. 55

JA-101-56
 Fig. 56
 Ø 5 mm
 45°



JA-101-61
 Fig. 61
 45°

JA-101-62
 Fig. 62
 90°

Schaft • shaft • tige
 vástago • asta
 Ø 4 mm

Serie STANDARD



JA-200-01

JA-200-02

JA-200-03

JA-200-04

Ø mm
 5
 10
 20

JA-202-05
JA-202-10
JA-202-20

Ø mm
 5
 10
 20

JA-204-05
JA-204-10
JA-204-20

Ø mm
 2
 4
 6

JA-300-02
JA-300-04
JA-300-06

Schaft • shaft • tige
 vástago • asta
 Ø 4 mm

JA

Bipolare Koagulation
Bipolar Coagulation
Coagulation bipolaire
Coagulación bipolar
Coagulazione bipolare

Handchirurgie, Ophthalmologie, Plastische Chirurgie, Experimentelle Chirurgie
Hand Surgery, Ophthalmology, Plastic Surgery, Experimental Surgery
Chirurgie de la main, Ophtalmologie, Chirurgie plastique, Chirurgie experimentale
Cirugía de la mano, Oftalmología, Cirugía plástica, Cirugía experimental
Chirurgia della mano, Oftalmologia Chirurgia plastica, Chirurgia esperimentale



JA-012-11
11 cm



JA-014-11
11 cm



JA-015-11
11 cm



JA-019-11
11 cm
45°



JA-113-11
11 cm
45°



JA-115-11
11 cm
45°

Mikrochirurgie, HNO • Microsurgery, ENT • Microchirurgie, ORL • Microcirugía, ORL • Microchirurgia, ORL



JA-212-16
16,5 cm



JA-213-16
16,5 cm



JA-214-16
16,5 cm
1 mm



JA-215-16
16,5 cm



JA-217-16
16,5 cm
1 mm

Bipolare Koagulation
Bipolar Coagulation
Coagulation bipolaire
Coagulación bipolar
Coagulazione bipolare

JA

Mikrochirurgie, HNO • Microsurgery, ENT • Microchirurgie, ORL • Microcirugía, ORL • Microchirurgia, ORL



JA-315-16
16,5 cm



JA-319-16
16,5 cm



JA-412-16
16,5 cm



JA-414-16
16,5 cm



JA-416-16
16,5 cm
1 mm

Gynäkologie, HNO, Tonsillen Chirurgie • Gynaecology, ENT, Tonsil Surgery • Gynécologie, ORL, Chirurgie des amygdales
Ginecología, ORL, Cirugía de amígdalas • Ginecologia, ORL, Chirurgia tonsillare



JA-512-19
19,5 cm



JA-514-19
19,5 cm
1 mm



JA-517-19
19,5 cm
1 mm



JA-519-19
19,5 cm
2 mm

JA

Bipolare Koagulation
Bipolar Coagulation
Coagulation bipolaire
Coagulación bipolar
Coagulazione bipolare

Neurochirurgie • Neurosurgery • Neurochirurgie • Neurocirugía • Neurochirurgia



JA-612-19
19,5 cm



JA-614-19
19,5 cm
1 mm



JA-616-19
19,5 cm
2 mm



JA-617-19
19,5 cm
1 mm



JA-619-19
19,5 cm
1 mm



JA-712-03
0,3 mm

JA-712-07
0,7 mm

JA-712-12
1,2 mm

JA-712-03 - JA-712-12
22,5 cm
0,3 - 1,2 mm

Anschlußkabel
Connection Cords
Cordons d'alimentation
Cables de conexión
Cavi da connessione



m
3
5

JA-910-30
JA-910-50
ERBE
SELECT

JA-911-30
AESCULAP

JA-912-30
JA-912-50
USA Mod.

JA-913-30
JA-913-50
MARTIN

HF-Chirurgie-Geräte
Electrosurgery Equipment
Electrobistouris
Electrobisturries
Elettrobisturi

D

Inhaltsverzeichnis Deutsch

D

D

Inhaltsverzeichnis Deutsch

A

Abziehstein ARKANSAS	AG-19
Adenotom LAFORCE	EG-19
ADLERKREUTZ Pinzette	BA-04
ADSON Arterien Klemme	BC-09
ADSON BABY	
Arterien Klemme	BC-09
ADSON BABY	
Wund Sperrer	BI-15
ADSON-BROWN Pinzette	BA-03
ADSON	
Elevatoren	DC-21
Hohlmeißel Zange	DC-03
Hypophysen Pinzette	EA-06
Mikro Pinzette	BA-03
Nadelhalter	CE-04
Nerv Haken	EA-04
Pinzette	BA-03
Wund Sperrer	BI-15
AEBLI Hornhaut Schere	AI-22
AESCLAP HF Chirurgie Geräte Kabel	JA-07
ALAN-PARKS Mastdarm Spreizer	GI-03
ALBEE Fräser	DD-07
ALEXANDER	
Flachmeißel	DC-14
Hohlmeißel	DC-14
Probeexcisions Zange	HA-42
Raspatorien	DC-19
ALLIS-ADAIR Darmfaß Zange	GE-02
ALLIS-Baby Darmfaß Zange	GE-02
ALLIS Darmfaß Zange	GE-02
ALLISON Lungen Spatel	FG-19
ALM Wund Sperrer	BI-14
ALVIS Fremdkörper Kürette	EC-06
Amniotom BEACHAM	HA-39
Amputations Messer	AG-16
Anatomische Skalpell	AG-15
ANDREWS-PINCHON Sauger	AE-03
ANDREW Zungen Spatel	EI-02
Anoskop	
HIRSCHMANN Anoskop	GI-04
IVES-FANSLER Anoskop	GI-04
Apparat	
BUNNELL Handbohr Apparat	DD-05
Handbohr Apparat	DD-05
Handbohr Apparat mit Jacobs-Futter	DD-06
HUDSON Handbohr Apparat	DD-04
KIRSCHNER Handbohr Apparat	DD-05
MOORE Handbohr Apparat	DD-04
PETZ Magen- und Darmnääh Apparat	GE-09
RALK Handbohr Apparat	DD-05
STILLE Handbohr Apparat	DD-04
STILLE-SHERMAN Handbohr Apparat	DD-04
ARCHER Splitter Pinzette	BA-06
ARKANSAS Abziehstein	AG-19
ARLT Draht Schlinge	EC-08
ARRUGA	
Extraktion Haken	EC-06
Kapsel Pinzette	ED-04
Nadelhalter	CE-06
Netzhaut Ablös Schützer	EC-08
Sperr Elevator	EC-02
ASCH Septum Zange	EG-18
Atraumatische Klemmen	BD-02 bis BD-43
Atraumatische Kinder-Gefäß Klemme	BD-43
AUFRICHT Nasenrücken Haken	EG-17
Aufsatz MILLIN Kaltlicht	GG-05
AUVARD Vaginal Spekulum	HA-19
AXENFELD Chalazion Löffel	EC-07
AYER Chalazion Pinzette	ED-06

B

BABCOCK Darmfaß Zange	GE-02
BABINSKY Perkussions Hammer	AC-07
BACKHAUS-CLIP Schlauchhalter Tuch Klemme	BE-03
BACKHAUS KOCHER Tuch Klemme	BE-02
BACKHAUS Tuch Klemme	BE-02
BAGGISH Probeexcisions Zange	HA-45
BAILEY-BABY Rippen Kontraktor	FG-18
BAILEY-GIBBON Rippen Kontraktor	FG-18
BAILEY Rippen Kontraktor	FG-18
BAINBRIDGE	
Arterien Klemme	BC-14
Atraumatische Klemme	BD-09
BAKES Gallenkanal Dilatatoren	GC-06
BALFOUR Baby Bauch Deckenhalter	BI-22
BALFOUR	
Bauch Deckenhalter	BI-22
Valve	BI-22
BALL AND SOCKET Tuch Klemme	BE-04
BALLENGER	
Schwing Messer	EG-11
Septum Elevatorium	EG-12
Tonsillen Fass Zange	FA-04
Bandmass	AC-08
Band PARHAM	DC-11
Bandschlinge Elektrode	JA-03
BANGERTER Cyclodialyse Spatel	EC-08
BARANY Lärmtrommel	EE-04
BARBARA	
Häkchen	EE-14
Nadel	EE-14
Pick	EE-14 bis EE-15
BARKAN Goniotomie Messer	EC-05
BARNHILL Ring Messer	EG-19
BARRAQUER KATZIN	
Iris Pinzette	EC-13
BARRAQUER Colibri Iris Pinzette	EC-13
BARRAQUER	
Cilien Pinzette	ED-08
Colibri Schere	AJ-04
BARRAQUER Colibri Sperr Elevator	EC-02
BARRAQUER	
Fixier Pinzette	ED-03
Keratoplastik Messer	EC-05
Nadelhalter	CE-07
Vorderkammer Pinzette	ED-02
BARRETT Haken Zange	HA-32
BARR Rektal Spekulum	GI-02
BARTON	
Geburts Zange	HC-04
Zug Hebel	HC-04
BAUMGARTNER Nadelhalter	CE-02
BEACHAM Amniotom	HA-39
Becher	HE-10
Medizin Becher	HE-07
Meß Becher	HE-07
Sputum Becher	HE-06
BECK Atraumatische Peripher-Vascular Klemme	BD-25
Becken	
Plazenta Becken	HE-06
Stech Becken	HE-06
Becken Zirkel	
COLLIN Becken Zirkel	HC-06
COLLYER Becken Zirkel	HC-06
MARTIN Becken Zirkel	HC-06
BECKER Cystotom	EC-06
BECKMANN-ADSON Wund Sperrer	BI-15
BECKMANN-EATON Wund Sperrer	BI-16
BECKMANN	
Ring Messer	EG-19

BECKMANN	
Wund Sperrer	BI-16
BEEBEE Draht und Blech Schere	AI-43
BEER Cilien Pinzette	ED-08
BEESON Gips Spreizer	DA-03
BELLUCCI Ohr Mikro Schere	EE-09
BENGOLEA Arterien Klemme	BC-09
BENNETT Knochen Hebel.....	DC-22
BERENS Lanzen Messer.....	EC-04
BERGMANN FOERSTER Schwamm Zange	BG-10
BERGMANN	
Gips Säge	DA-02
Verband Schere	AI-46
BERKE Muskel Pinzette.....	ED-02
BERLIND-AUVARD Vaginal Spekulum	HA-19
BERLINER Perkussions Hammer.....	AC-07
BERNHARD Tuch Klemme	BE-05
BERTILLON Schädel Messzirkel	AC-08
BEST Darm Klemme.....	GE-06
Besteck	
Autopsie Besteck	DC-17
Mini Naht Besteck.....	CG-08
Standard Naht Besteck.....	CG-08
BETHUNE Rippen Schere	FG-04
BEUSE Schere	AI-26
BEYER	
Hohlmeißel Zange	DC-04
Stanze.....	EG-08
BILLEAU Ohr Schlinge.....	EE-07
BILL Zug Hebel	HC-05
BIRCHER-GANSKE Knochenhalte Zange	DC-10
BIRCHER Meniskotom	DC-24
BISHOP-HARMAN Iris Pinzette.....	EC-14
BLAKE	
Gallenstein Zange	GC-03
Uterus Kürette	HA-48
Bleihand	DC-11
BLOHMKE Tonsillen Fass Zange	FA-04
BLOUNT	
Knie Haken	DC-24
Knochen Hebel	DC-24
BLUMENTHAL Hohlmeißel Zange	DC-02
Blutdruckmesser.....	AC-02
BODENHAMMER Rektal Spekulum	GI-02
BOEHLER Extension Bügel.....	DD-10
BOERMA Geburts Zange.....	HC-04
BOETTCHER Tonsillen Schere	AI-27
BÖHLER	
Hohlmeißel Zange	DC-04
Knochensplitter Zange	DC-06
Bohrdrähte KIRSCHNER	DD-09
Bohrer	
Gewinde Bohrer	DD-15
McKENZIE Bohrer	DD-04
BONACCOLTO Strabismus Pinzette	EC-14
BONNEY Schwamm Zange.....	BG-08
BONN	
Iris Pinzette	EC-15
Spül Kanüle.....	ED-07
BONN TITAN Iris Pinzette.....	EC-15
BORCHARDT Fräser.....	DD-07
BOSE	
Tracheal Häkchen	FE-02
Tracheal Sperre.....	FE-02
BOUCHERON Ohr Spekula	EE-02
Bougie	
COXETER Harnröhren Bougie.....	GG-17
DITTEL Harnröhren Bougie	GG-18 bis GG-19
FILIFORM Harnröhren Bougie	GG-12
GUYON Harnröhren Bougie	GG-14 bis GG-15
VAN BUREN Harnröhren Bougie	GG-13
Bougie	
WALTHER Harnröhren Bougie.....	GG-17
BOWLES Stethoskop	AC-06
BOWMAN	
Discisions Messer	EC-04
Discisions Nadel	EC-05
Sperr Elevator	EC-02
Tränenkanal Sonde.....	EC-10
BOYNTON Nadelhalter	CE-06
BOZEMANN-DOUGLAS Tupfer Zange	BG-13
BOZEMANN	
Nadelhalter.....	CE-03
Tupfer Zange	BG-13
BRAITHWAITE Dermatom.....	AG-22
BRAUN	
Dekapitations Haken.....	HC-09
Haken Zange	HA-31, HA-34
Kranioklast	HC-09
BRAUN-STADLER Episiotomie Schere.....	AH-22, AI-34
BRAUN	
Uterus Depressor	HA-39
Vaginal Spekulum	HA-16
BREISKY Vaginal Spekulum	HA-20
BROCK	
Griff für Herz-Dilatatoren	FG-26
Spreizweite für Herz-Dilatatoren	FG-26
Stanze für Herz-Dilatatoren	FG-26
BROWN Pinzette.....	BA-03
BRUENINGS	
Kehlkopf Zange	FC-03
Nasen scharfe Zange	EG-05
Ohr Spekula	EE-02
Septatom	EG-11
Tonsillen Schnürer	FA-04
Verlängerung Rohr	FC-03
Zungen Spatel	EI-02
BRUNETTI Wirbelsäulenmeißel	DC-17
BRUNNER	
Darm Klemme	GE-06
Fuehrungshohl Sonde	CG-04
Rippen Schere	FG-07
BRUNS	
Gips Schere	AI-48
Scharfe Löffel.....	DC-12 bis DC-13
BRYANT Schwamm Zange.....	BG-11
BUCHWALD	
Zungen Spatel	EI-02
BUCK	
Fremdkörper Hebel	EE-08
Ligatur Schere	AI-40
Ohr Kürette.....	EE-05
Perkussions Hammer.....	AC-07
Bügel	
BOEHLER Extension Bügel.....	DD-10
Extension Bügel.....	DD-10
KIRSCHNER Extension Bügel.....	DD-10
BUIE Saug Kanüle	GI-05
BUMM	
Uterus-Faß Zange.....	HA-38
Uterus Kürette	HA-49 bis HA-50
BUNGE Exenterations Löffel.....	EC-07
BUNNELL	
Handbohr Apparat.....	DD-05
Sehnen Stripper	DC-25
BUNT	
Sterilisier Klammer	CI-02
BURCH Fixier Gabel.....	EC-05
BURKE-Baby	
Probeexcisions Zange.....	HA-44
BURKE Probeexcisions Zange	HA-44
BUSCH Nabelschnur Schere.....	AI-34

D

Inhaltsverzeichnis Deutsch

C

CARMALT Splitter Pinzette	BA-06
CARPENTER Tonsillen Messer	FA-02
CASPAR	
Cervical Wirbelsäule Wund Spreizer	BI-18
ges. Wirbelsäule Valve	BI-19
ges. Wirbelsäule Wund Sperrer	BI-19
Mikro Skalpellgriff	AG-12
Muskelab Spreizer	BI-20
Valve	BI-20
Wund Sperrer	BI-20
CASTAÑEDA	
Atraumatische Neonatal und Kinder Klemme	BD-42
Rippen Sperrer	FG-14
CASTROVIEJO	
Cyclodialyse Spatel	EC-08 bis EC-09
Fixier Pinzette	ED-03
Hornhaut Schere	AJ-06
Hornhaut Trepheine	ED-07
Iridectomie Schere	AJ-05
Kapsel Pinzette	ED-04
Klingenbrecher	AG-14
Kompass Markier	EC-09
Lanzen Messer	EC-04
Nadelhalter	CE-07
Naht Pinzette	ED-05
Sperr Elevatorium	EC-03
Tränenkanal Dilator	EC-10
CATLIN Amputations Messer	AG-16
CHAPUT Arterien Klemme	BC-08
CHARRIERE	
Amputations Säge	DD-03
Sägeblatt	DD-03
CHEATLE Sterilisier Zange	CI-02
CHERON Tupfer Zange	BG-12
CHEVALIER-JACKSON Kehlkopf Zange	FC-04
CHEVALLIER Rippen Sperrer	FG-15
CHILDE Wundklammer Zange	CG-07
CINELLI Nasenplastik Meißel	EG-13
CITELLI Stanze	EG-08
CLARK	
Sperr Elevator	EC-02
CLAR	
Mini Stirnlampe	AC-05
Stirnlampe	AC-05
CLEVELAND Hohlmeißel Zange	DC-02
Clip	
EDWARDS Clips	BD-21
YASARGIL Standard Clips	EA-13
YASARGIL Temporäre Clips	EA-12
CLOWARD	
Wirbelkoerper Spreizer	EA-07
Wund Sperrer	BI-17
CM Abfall Zange	CI-03
CM Alu Stimmgabel	EE-03
CM-Instrumente	
Augen Magnet	ED-08
Fingerring Säge	DD-03
CM-Instrumente	
Klingenbrecher	AG-14
Verbands Schere	AI-46
Watteträger	CA-03
Wund Sperrer	BI-14
COAKLEY	
Antrum Kürette	EG-18
Trokar	CC-02
COLCLOUGH Bandscheiben Stanze	EA-11
COLLIER Nadelhalter	CE-02
COLLIN	
Arterien Klemme	BC-08
Bauch Deckenhalter	BI-24 bis BI-25
Becken Zirkel	HC-06
COLLIN-DUVAL Pinzette	BA-04
COLLIN	
Dynamometer	AC-03
Hammer	DC-18
COLLIN-HARTMANN Wund Haken	BI-03
COLLIN	
Nabelschnur Klemme	HC-06
COLLIN-POZZI Haken Zange	HA-32
COLLIN	
Skalpell Griff	AG-08
Tupfer Zange	BG-11
Uterus-Faß Zange	HA-37
Uterus Sonde	HA-39
Vaginal Spekulum	HA-04
Wundklammer Zange	CG-07
Zungen Zange	EI-03
COLLYER Becken Zirkel	HC-06
COLVER Tonsillen Fass Zange	FA-03
CONNIN-AMSLER Markier Instrument	EC-09
CONVERSE Nasen Messer	EG-10
COOLEY	
Atraumatische Anastomosen Klemme	BD-37, BD-40
Atraumatische Bulldog Klemme	BD-33 bis BD-34
Atraumatische Iliaca Klemme	BD-37
Atraumatische Kindergrößen Klemme	BD-38 bis BD-39
Atraumatische Klemme	BD-35 bis BD-37, BD-39, BD-41
Atraumatische Pinzette	BB-03
Atrium Haken	FG-20
COOLEY DERRA	
Atraumatische Anastomosen Klemme	BD-39
COOLEY	
Gefäß Dilator	FG-30
Gefäß Klemme	BD-40
Herz Dilator	FG-27 bis FG-29
COOLEY modif. STRUCK Atrium Haken	FG-20
COOLEY	
Rippen Schere	FG-05
Rippen Sperrer	FG-09
COOPER Unterbindungs Nadel	CG-02
CORDES Kehlkopf Zange	FC-03
CORWIN Tonsillen Kompressorium	FA-04
CORYLLOS Rippen Schere	FG-04
CORYLLOS (Thorax) Wund Haken	BI-13
COTTLE-KAZANJIAN Knochensplitter Zange	DC-06
COTTLE	
Nasen Messer	EG-10
Nasenplastik Meißel	EG-13
Nasenrücken Haken	EG-17
Nasen Schere	AH-18, AI-25
Nasen Spekulum	EG-03
COTTLE-NEIVERT Nasenrücken Haken	EG-17
COTTLE	
Periost Elevatorium	EG-12
Septum Elevatorium	EG-12
COXETER Harnröhren Bougie	GG-17
CRAFOORD	
Arterien Bronchus Klemme	BC-12
Lungen und Thorax Schere	AI-36
CREDO Hornhaut Hobel	HE-03
CRILE Arterien Klemme	BC-05
CRILE-MURRAY Nadelhalter	CE-02
CRILE Nadelhalter	CE-04
CRILE-RANKIN Arterien Klemme	BC-05
CRILE TITAN Arterien Klemme	BC-05
CRILE-WOOD Nadelhalter	CE-02
CRILE Wund Haken	BI-02
CRITCHETT Sperr Elevator	EC-02
CRUTCHFIELD Schädelhalter	EA-03
Vorböhrer	EA-03

CULLER Iris Spatel	EC-08
CUSCO Vaginal Spekulum	HA-04 bis HA-06
CUSHING	
Flachbohrer	DD-04
Hirn Spatel	EA-07
Laminektomie Zange	EA-08
CUSHING	
Nerv Haken	EA-04
Pinzette	BA-03
Wund Haken	BI-07
CUZZI Plazentar und Abortus Löffel	HC-08
Cystotom	
BECKER	EC-06
GRAEFE	EC-06
CZERNY	
Gallenstein Zange	GC-03
Haken Zange	HA-34
Rektal Spekulum	GI-02

D

DALE Atraumatische Peripher-Vascular Klemme	BD-24
DANDY	
Arterien Klemme	BC-07
Nerv Haken	EA-04
Neurochirurgische Schere	AI-36
DARDIK Atraumatische Klemme	BD-07
DARLING Wund Sperrer	BI-17
Darm Schere	AI-39
DARTIGUES Uterus-Faß Zange	HA-37
DASTOOR	
Kapsel Sauger	EC-09
Strabismus Pinzette	EC-14
DAVIDSON (Scapula) Wund Haken	BI-13
DAVIEL Star Löffel	EC-07
DAVIS-BOYLE Mund Sperrer	EI-04
DAVIS	
Dura Dissektor	EA-05
Fremdkörper Nadel	EC-05
Sterilisier Zange	CI-02
DAY Ohr Häkchen	EE-07
DEAN	
Iris Messer	EC-04
Tonsillen Schere	AI-26
DEAVER Grip Wund Haken	BI-05
DEAVER	
Schere	AH-05, AI-06
Wund Haken	BI-05
DE BAKEY	
Atraumatische Anastomosen Klemme	BD-25
Atraumatische Aorta-Aneurysma	
Klemme	BD-13, BD-15, BD-18
Atraumatische Bronchus Klemme	BD-19
Atraumatische Bulldog Klemme	BC-02
Atraumatische Iliaca Klemme	BD-11
DE BAKEY Atraumatische Klemme	BD-02, BD-08
DE BAKEY Atraumatische Klemme	BD-16 bis BD-17
DE BAKEY Atraumatische Klemme	BD-20
DE BAKEY	
Atraumatische Klemme	BD-28 bis BD-30
Atraumatische Peripher-Vascular Klemme	BD-06
Atraumatische Pinzette	BB-03
Atraumatische Präparier und Ligatur Klemme	BD-25, BD-32
DE BAKEY BAHNSON	
Atraumatische Aorta-Aneurysma Klemme	BD-14
DE BAKEY	
Gefäß Dilatator	FG-31
Gefäß Schere	AI-30
DE BAKEY MORRIS	
Atraumatische Klemme	BD-16
DE BAKEY Nadelhalter	CE-03
DE BAKEY REYNOLDS	
Atraumatische Anastomosen Klemme	BD-30
DE BAKEY SATINSKY	
Atraumatische Klemme	BD-22
DE BAKEY	
Sauger	AE-04
Deckenhalter (Bauch)	
BALFOUR Baby Bauch Deckenhalter	BI-22
BALFOUR Bauch Deckenhalter	BI-22
COLLIN Bauch Deckenhalter	BI-24 bis BI-25
Deckenhalter (Bauch)	
GELPI Bauch Deckenhalter	BI-24
GOSSET Bauch Deckenhalter	BI-21
KIRSCHNER Bauch Deckenhalter	BI-23
O'SULLIVAN-O'CONNOR Bauch Deckenhalter	BI-21
RIGBY Bauch Deckenhalter	BI-24
DEJERINE Perkussions Hammer	AC-07
De LEE Geburts Zange	HC-02
De MARTEL Umfuehr Instrument	EA-05
De MARTEL-WOLFSON Anastomosen Klemme	GE-07
DENHART Mund Sperrer	EI-03
Depressor	
BRAUN Uterus	HA-39
SIMS Uterus	HA-39
DERF Nadelhalter	CE-02
Dermatom	
BRAITHWAITE Dermatom	AG-22
Ersatz Klinge	AG-21
HUMBY Dermatom	AG-20
SCHINK Dermatom	AG-21
SILVER Dermatom	AG-20
WATSON Dermatom	AG-22
DERRA	
Atraumatische, Anastomosen, Kinder Klemme	BD-28
DESCHAMPS	
Unterbindungs Nadel	CG-02
DESJARDINS	
Gallenkanal Klemme	BC-15
Gallenstein Löffel	GC-08
Gallenstein Sonde	GC-05
Gallenstein Zange	GC-02
DESMARRES	
Chalazion Pinzette	ED-06
Wund Haken	BI-07
DEUTSCHMANN Star Messer	EC-03
DeVILBISS Schädelzange	EA-05
DEWEY	
Geburts Zange, mit Achsenzugvorrichtung	HC-05
Diagnostik Besteck	AC-04
DIAMANT Draht Schneider	DD-12
DIEFFENBACH	
Gefäß Bulldog Klemme	BC-03
DIETER Hammerkopf Stanze	EE-10
DIETHRICH	
Atraumatische Klemme	BD-31
Gefäß Nadelhalter	CE-06
Gefäß Schere	AI-29
Dilatator	
BAKES Gallenkanal Dilatoren	GC-06
CASTROVIEJO Tränenkanal Dilator	EC-10
COOLEY Gefäß Dilator	FG-30
COOLEY Herz Dilator	FG-27 bis FG-29
DE BAKEY Gefäß Dilator	FG-31
GERBODE Herz Dilator	FG-28
GOODELL Uterus Dilator	HA-30
HANK Uterus Dilator	HA-28
HEGAR Uterus Dilator	HA-24 bis HA-27
HETZER Herz Dilator	FG-29
LABORDE Tracheal Dilator	FE-02
PRATT Uterus Dilator	HA-29
SIMS Uterus Dilator	HA-30

D

Inhaltsverzeichnis Deutsch

TROUSSEAU Tracheal Dilator	FE-02
TUBBS Herz Dilator	FG-27
WILDER Tränenkanal Dilator	EC-10
WYLIE Uterus Dilator	HA-30
ZIEGLER Tränenkanal Dilator	EC-10
DINGMANN Knochenhalte Zange	DC-10
Dissektor	
DAVIS Dura Dissektor	EA-05
Dura Dissektor	EA-05
FISCH Dissektor	EE-15
GREEN Hornhaut Dissektor	EC-06
HORSLEY Dura Dissektor	EA-06
HURD Tonsillen Dissektor	FA-02
MILLIGAN Dura Dissektor	EA-05
PATON Hornhaut Dissektor	EC-05
PENFIELD Dura Dissektor	EA-06
ROBB Gefäß Dissektor	FG-33
SACHS Dura Dissektor	EA-05
TOENNIS Dura Dissektor	EA-05
DITTEL	
Harnröhren Bougie	GG-18 bis GG-19
Katheter Spanner	GG-11
DIX	
Flachmeißel Nadel	EC-09
Fremdkörper Flachmeißel	EC-06
Dose	
Nadel Dose	HE-02
SAUERBRUCH Nadel Dose	HE-02
DOUGLAS	
Cilien Pinzette	ED-08
Trokar	CC-02
DOYEN-Baby Darm Klemme	GE-03
DOYEN	
Darm Klemme	GE-03
Fräser	DD-07
Gynäkologische Schere	AI-33
DOYEN-JANSEN Mund Sperrer	EI-03
DOYEN	
Myom Heber	HA-46
Rippen Raspatorien	DC-20
Sonde	CA-02
Tuch Klemme	BE-05
Uterus-Polypen Zange	HA-36
Vaginal Spekulum	HA-18, HA-20
Wund Haken	BI-12
Drahtschlinge Elektrode	JA-03
Dreher	
LANE Schrauben Dreher	DD-14
Schrauben Dreher	DD-14 bis DD-15
WILLIAMS Schrauben Dreher	DD-14
DUBOIS Gynäkologische Schere	AI-33
DUPLAY	
Haken Zange	HA-31
Tupfer Zange	BG-14
Duplex Stethoskop	AC-06
DUPUY-WEISS	
Tonsillen Nadel	FA-03
DUVAL	
Darmfaß Zange	GE-03
Pinzette	BA-04
Dynamometer COLLIN	AC-03
E	
ECHLIN Hohlmeißel Zange	DC-05
EDWARDS	
Clip	BD-21
Clip Anlegezange Klemme	BD-21
Eimer Abfall	HE-11
Einschläger	DD-12
Elektrode Koagulieren Mini	JA-02 bis JA-03

Elevator	
ARRUGA Sperr Elevator	EC-02
BARRAQUER Colibri Sperr Elevator	EC-02
BOWMAN Sperr Elevator	EC-02
CASTROVIEJO Sperr Elevator	EC-03
CLARK Sperr Elevator	EC-02
CRITCHETT Sperr Elevator	EC-02
GOLDSTEIN Sperr Elevator	EC-03
GRAEFE Sperr Elevator	EC-02
HENKE Tonsillen Elevator	FA-02
Elevatoren	
ADSON Elevatoren	DC-21
KEY Elevatoren	DC-21
LANGENBECK Elevatoren	DC-21
McDONALD Elevatoren	DC-22
MURPHY-LANE Elevatoren	DC-22
WATSON-CHEYNE Elevatoren	DC-22
Elevatorium	
BALLENGER Septum Elevatorium	EG-12
COTTLE Periost Elevatorium	EG-12
COTTLE Septum Elevatorium	EG-12
FREER Septum Elevatorium	EG-11
HAJEK-BALLENGER Septum Elevatorium	EG-12
JOSEPH Periost Elevatorium	EG-12
KILLIAN Septum Elevatorium	EG-12
LEMPERT Elevatorium	EE-15
McKENTY Septum Elevatorium	EG-11
ROGER Septum Elevatorium	EG-11
Elevator	
LANCASTER Sperr Elevator	EC-03
LISTER-BURCH Sperr Elevator	EC-02
MELLINGER-AXENFELD Sperr Elevator	EC-02
MELLINGER Sperr Elevator	EC-02
MUELLER Sperr Elevator	EC-03
MURDOCK Sperr Elevator	EC-02
PARK Sperr Elevator	EC-03
SMITH Sperr Elevator	EC-02
STEVENSON Sperr Elevator	EC-03
WEEK Sperr Elevator	EC-02
WILLIAMS Sperr Elevator	EC-02
ZIEGLER Sperr Elevator	EC-03
ELLIOT	
Geburts Zange	HC-02
Hornhaut Trepheine	ED-08
ELLIS Fremdkörper Hohlmeißel	EC-06
ELSAESSER	
Nieren Fistel Zange	GC-13
ELSCHNIG	
Cyclodialyse Spatel	EC-08
Fixier Pinzette	ED-03
Hornhaut Messer	EC-05
Kapsel Pinzette	ED-04
EMMET	
Fistel Haken	HA-46
ENGEL Gips Säge	DA-02
EPENDORFER-KEVORKIAN	
Probeexcisions Zange	HA-46
EPENDORFER	
Probeexcisions Zange	HA-45 bis HA-46
EPENDORFER TISCHLER-MORGAN	
Probeexcisions Zange	HA-46
ERBE SELECT HF	
Chirurgie Geräte Kabel	JA-07
ESMARCH	
Gips Messer	DA-04
Verband Schere	AI-46
Etui Edelstahl rostfrei	HE-03
EVES	
Tonsillen Schnürer	FA-04
Extraktor KUENTSCHER	DD-13

F

FARABEUF	
Knochenhalte Zange.....	DC-07
FARABEUF-LAMBOTTE Knochenhalte Zange	DC-08
FARABEUF	
Raspatorien.....	DC-19
Wund Haken.....	BI-02
FARREL Watteträger.....	CA-03
Faseroptik Laryngoskopegriff	AE-11
FAULKNER Kürette	EG-18
FAURE	
Peritoneum Klemme	BC-17
Probeexcisions Zange	HA-41
FEHLAND Darm Klemme	GE-06
FEILCHENFELD Splitter Pinzette	BA-06
Feile	
JOSEPH Knochen Feile	EG-14
Nagel Feile.....	HE-03
Feine Scheren.....	AI-19, AI-24
FERGUSSON	
Arterien Klemme	BC-07
Gallenstein Löffel.....	GC-07
Knochenhalte Zange.....	DC-07
Schere	AI-49
FERRIS Pinzette	BA-04
FERRIS-SMITH-KERRISON Bandscheiben Stanze.....	EA-10
FERRIS-SMITH Laminektomie Zange	EA-09
Fertigschläger KUENTSCHER	DD-13
FILIFORM Harnröhren Bougie	GG-12
Fingerschutz LANGENBECK.....	EI-06
FINOCHIETTO-BABY Rippen Sperrer.....	FG-09
FINOCHIETTO	
Bronchus Klemme.....	FG-21
FINOCHIETTO BURFORD	
Rippen Sperrer.....	FG-12 bis FG-14
FINOCHIETTO-HAIGTH BABY Rippen Sperrer.....	FG-10
FINOCHIETTO INFANT Rippen Sperrer.....	FG-12
FINOCHIETTO (modif) Rippen Sperrer	FG-08
FINOCHIETTO	
Nadelhalter.....	CE-04
Rektum Schere	AI-38
Rippen Sperrer.....	FG-08, FG-10 bis FG-11
FINSEN Wund Sperrer	BI-14
FINSTERER Saug- und Spül Kanüle.....	AE-05
FISCH Dissektor.....	EE-15
FISCHER Iris Pinzette.....	EC-13
Fixations-System LEYLA.....	EA-14 bis EA-18
Flachbohrer CUSHING	DD-04
Flachmeißel.....	DC-14
ALEXANDER Flachmeißel	DC-14
DIX Fremdkörper Flachmeißel.....	EC-06
HIBBS Flachmeißel	DC-16
HOKE Flachmeißel	DC-16
LEXER Flachmeißel	DC-16
LEXER Mini Flachmeißel.....	DC-16
PARTSCH Flachmeißel	DC-14
SMITH-PETERSEN Flachmeißel	DC-15
STILLE Flachmeißel	DC-14
FLETCHER JAVERTS Schwamm Zange.....	BG-10
FLEURANT Trokar.....	CC-02
FOERSTER	
Iris Pinzette	EC-12
Schwamm Zange.....	BG-06 bis BG-08
FOMON	
Nasenplastik Meißel	EG-13
Nasen Raspel	EG-15 bis EG-16
Nasenrücken Haken	EG-17
Nasen Schere.....	AH-18, AI-25
FORD BOWLES Stethoskop.....	AC-06
FORD Stethoskop.....	AC-06

FOX Lupus Kürette	HE-02
FRAENKEL	
Kehlkopf Polypus Zange	FC-02
Kehlkopf Zange	FC-03
FRANCESCHETTI Hornhaut Trephine	ED-07
FRANCIS Fremdkörper Nadel	EC-05
FRANKLIN-SILVERMANN Punktions Nadel.....	CC-03
Fräser.....	DD-07
ALBEE Fräser.....	DD-07
BORCHARDT Fräser.....	DD-07
DOYEN Fräser.....	DD-07
HUDSON Kegel Fräser.....	DD-04
Kegel Fräser	DD-04
Kortikalis Fräser.....	DD-15
TOTI Fräser	DD-07
FRAZIER	
Häkchen.....	BI-06
Sauger.....	EA-07
Wund Spreizer	BI-21
FREER	
Mukosa Messer	EG-10
Nasen Hohl Meißel	EG-14
Septum Elevatorium.....	EG-11
Septum Meißel.....	EG-12
Septum Messer.....	EG-10
FREEWAY-GRAVE	
Vaginal Spekulum	HA-06
FRENZEL Zungen Spatel.....	EI-02
FRIEDMAN	
Hohlmeißel Zange	DC-02
Mini Hohlmeißel Zange.....	DC-02
Perineorrhaph Sperrer	HA-23
FRITSCH Wund Haken.....	BI-11
FRYKHOLM Hohlmeißel Zange.....	DC-05
FUCHS Kapsel Pinzette.....	ED-04
Für Faseroptik Laryngoskope Ersatzlampe	AE-20
Für Standard Laryngoskope Ersatzlampe.....	AE-20

G

Gabel BURCH Fixier	EC-05
GALLAHER Antrum Raspel	EG-16
GAUSS Kopfschwarten Zange	HC-06
Gefäß Klemme, flexibel.....	BD-44 bis BD-45
Gefäß Schere	AI-27
Gefäß Schere Mikro.....	AJ-09
GELLHORN Probeexcisions Zange.....	HA-42
GELPI Bauch Deckenhalter.....	BI-24
GEMINI MINI Präparier und Ligatur Klemme	BC-10
GEMINI Präparier und Ligatur Klemme	BC-10
GERALD Pinzette.....	BA-05
GERBODE Herz Dilator	FG-28
GERSTER Distractions Klammer.....	DC-11
GERZOG Hammer.....	DC-18
GIERTZ-STILLE Rippen Schere	FG-06
GIGLI für Drahtsäge Griff	EA-05
GILL-ARRUGA Kapsel Pinzette	ED-03
GILL-HESS Iris Pinzette.....	EC-12
GILL	
Hornhaut Messer	EC-05
GILLIES	
Häkchen.....	EG-17
Nadelhalter.....	CE-05
Pinzette	BA-05
GILL	
Iris Pinzette	EC-12
Gips Messer.....	DA-04
Gipssäge Sägeblatt.....	DA-05 bis DA-06
Gips Schere	AI-49
Gips Spreizer	DA-03
Glasschale.....	HE-03

D

Inhaltsverzeichnis Deutsch

GLOVER

Atraumatische Anastomosen Klemme	BD-05
Atraumatische Bulldog Klemme	BC-02
Atraumatische Coarctation Klemme	BD-04
Atraumatische Klemme	BD-06, BD-30
GLUCK Rippen Schere	FG-03
GOELET Wund Haken	BI-03
GOLDMAN-FOX Zahnfleisch Schere	AI-41
GOLDSTEIN Sperr Elevator	EC-03
GOODSELL Uterus Dilator	HA-30
GOOD Tonsillen Schere	AI-27
GORNEY Präparier Schere	AI-13
GOSSET Bauch Deckenhalter	BI-21
GOURDET Uterus Kürette	HA-48
GRADLE Cilien Pinzette	ED-08
GRAEFE	
Cystotom	EC-06
Fixier Pinzette	ED-03
Häkchen	BI-06
Iris Pinzette	EC-11
Pinzette	BA-03
Schiel Haken	EC-06
Skarifikateur	EC-04
Sperr Elevator	EC-02
Star Löffel	EC-07
Star Messer	EC-03
GRAEFE-TITAN Schiel Haken	EC-06
GRAHAM Nerv Haken	EA-04
GRAVE Vaginal Spekulum	HA-02
GRAY Gallenkanal Klemme	BC-15
Graziles Modell Tuch Klemme	BE-02
GREEN-ARMYTAGE	
Uterus zur Blutstillung Klemme	HC-06
GREEN	
Fixier Pinzette	ED-03
Hornhaut Dissektor	EC-06
Muskel Haken	EC-06
Wund Haken	BI-10
GREGORY Atraumatische Profunda Klemme	BD-33
GREVEN Ohr Mikro Zängchen	EE-10
Griff	
BROCK Griff für Herz-Dilatatoren	FG-26
COLLIN Skalpell Griff	AG-08
GIGLI Griff für Drahtsäge	EA-05
HUBER Universal Griff	FC-03
Kehlkopf Spiegel Griff	FC-04
GRIP Zange	DD-11
Große Ringe Präparier Schere	AI-19
GROSS-MAIER Tupfer Zange	BG-02 bis BG-04
GROSS	
Ohr Löffel	EE-06
Tupfer Zange	BG-05
GRUBER Ohr Spekula	EE-02
GUTHRIE Häkchen	BI-06
GUTMANN Sekret Löffel	GG-11
GUYON	
Gleit Sonde	GG-12
Harnröhren Bougie	GG-14 bis GG-15
Katheter Spanner	GG-11
Nierenstiel Klemme	BC-16
GUYTON-LUNDSGAARD Sklerotom	EC-05
Gynäkologische Mikro Schere	AJ-07 bis AJ-08

H

HABERER Wund Haken	BI-04
HAGLUND-STILLE Gips Spreizer	DA-03
HAIGHT Rippen Sperrer	FG-15
HAJEK-BALLENGER Septum Elevatorium	EG-12
HAJEK-CLAUS Stanze	EG-08
HAJEK-KOFLER Stanze	EG-08

HAJEK Nasen Hohl Meißel	EG-14
Häkchen	EE-15
BARBARA Häkchen	EE-14
BOSE Tracheal Häkchen	FE-02
DAY Ohr Häkchen	EE-07
FRAZIER Häkchen	BI-06
GILLIES Häkchen	EG-17
GRAEFE Häkchen	BI-06
GUTHRIE Häkchen	BI-06
ITERSON Tracheal Häkchen	FE-02
JACKSON Tracheal Häkchen	FE-02
JOSEPH Häkchen	BI-06
KILNER Haut Häkchen	HE-02
KNAPP Häkchen	EC-06
ROLLET Häkchen	EC-06
ROSE Tracheal Häkchen	FE-03
WAGENER Ohr Häkchen	EE-07
Haken	
ADSON Nerv Haken	EA-04
ARRUGA Extraktion Haken	EC-06
AUFRICHT Nasenrücken Haken	EG-17
BLOUNT Knie Haken	DC-24
BRAUN Dekapitations Haken	HC-09
COLLIN-HARTMANN Wund Haken	BI-03
COOLEY Atrium Haken	FG-20
COOLEY modif. STRUCK Atrium Haken	FG-20
CORYLLOS (Thorax) Wund Haken	BI-13
COTTLE Nasenrücken Haken	EG-17
COTTLE-NEIVERT Nasenrücken Haken	EG-17
CRILE Wund Haken	BI-02
CUSHING Nerv Haken	EA-04
CUSHING Wund Haken	BI-07
DANDY Nerv Haken	EA-04
DAVIDSON (Scapula) Wund Haken	BI-13
DEAVER Grip Wund Haken	BI-05
DEAVER Wund Haken	BI-05
DESMARRES Wund Haken	BI-07
DOYEN Wund Haken	BI-12
Elektrode mini	JA-02
EMMET Fistel Haken	HA-46
Extraktion Haken	DD-13
FARABEUF Wund Haken	BI-02
FOMON Nasenrücken Haken	EG-17
FRITSCH Wund Haken	BI-11
für Extensionbügel	DD-10
GOELET Wund Haken	BI-03
GRAEFE Schiel Haken	EC-06
GRAEFE-TITAN Schiel Haken	EC-06
GRAHAM Nerv Haken	EA-04
GREEN Muskel Haken	EC-06
GREEN Wund Haken	BI-10
HABERER Wund Haken	BI-04
HARRINGTON Wund Haken	BI-05
HEANEY Wund Haken	BI-12
HOFER Gaumenbogen Haken	FA-02
ISRAEL Wund Haken	BI-11
JAMESON Schiel Haken	EC-06
KELLY Grip Wund Haken	BI-04
KELLY Wund Haken	BI-04, BI-12
KOCHER Wund Haken	BI-10 bis BI-11
KOERTE Wund Haken	BI-11
LAHEY Wund Haken	BI-08
LANGENBECK Wund Haken	BI-09
LITTLE Wund Haken	BI-08
LOVE Nerv Haken	EA-04
LOVE Zäpfchen Haken	FA-02
MATHIEU Wund Haken	BI-03
MEYERDING Wund Haken	BI-08
MIDDELDORPF Wund Haken	BI-10
MIKULICZ Wund Haken	BI-12
NAGER Gaumensegel Haken	FA-02

Haken		HARTMANN	
O' CONNOR Iris Haken	EC-06	Nasen Polypus Zange	EG-04
OLLIER Wund Haken	BI-10	Nasen scharfe Zange	EG-07
PARKER Wund Haken	BI-02	Ohr Katheter	EE-06
PRATT Cystikus Haken	GI-04	Ohr Spekula	EE-02
REVERDIN Wund Haken	BI-04	Ohr Zängchen	EE-08
RIBBON Wund Haken	BI-04	Stimmgabel	EE-03
RICHARDSON-EASTMAN Wund Haken	BI-04	HARTMANN-WULLSTEIN Ohr Zängchen	EE-08
RICHARDSON Grip Wund Haken	BI-04	HARTMANN	
RICHARDSON Wund Haken	BI-04	Zungen Spatel	EI-02
ROUX Baby Wund Haken	BI-02	HEANEY	
ROUX mini Wund Haken	BI-02	Hysterektomie Klemme	BC-18
ROUX Wund Haken	BI-02	Nadelhalter	CE-03
SACHS Nerv Haken	EA-04	Wund Haken	BI-12
SAUERBRUCH Wund Haken	BI-13	HEATH Ligatur Schere	AI-40
SCHOENBORN Schilddrüsen Haken	FE-04	Hebel	
SENN-GREEN Wund Haken	BI-07	BARTON Zug Hebel	HC-04
SENN Wund Haken	BI-04	BENNETT Knochen Hebel	DC-22
SIMON Wund Haken	BI-12	BILL Zug Hebel	HC-05
SMELLIE Geburts Haken	HC-06	BLOUNT Knochen Hebel	DC-24
SMITHWICK Nerv Haken	EA-04	BUCK Fremdkörper Hebel	EE-08
STEVENS Linsen Haken	EC-06	HOHMANN Knochen Hebel	DC-22 bis DC-23
TAYLOR Spinal Haken	DC-24	HOHMANN Mini Knochen Hebel	DC-23
US Army (PARKER-LANGENBECK)		Knochen Hebel	DC-23
Wund Haken	BI-03	LUIKART-BILL Zug Hebel	HC-05
VOLKMANN Wund Haken	BI-07 bis BI-08	MURLESS Kopf Hebel	HC-05
WIENER Iris Haken	EC-06	QUIRE Fremdkörper Hebel	EE-08
YOUNG Prostata Haken	GG-02	Heber DOYEN Myom	HA-46
HALLE		HEBRA Chalazion Löffel	EC-07
Dura Messer	EA-06	HEGAR Uterus Dilatator	HA-24 bis HA-27
Scharf Löffel	DC-13	HEGENBARTH Wundklammer Zange	CG-07
HALSEY Nadelhalter	CE-02	HEIFETZ Hirn Spatel	EA-07
HALSTED-MOSQUITO		HEIMING Nierenstein Zange	GC-13
Arterien Klemme	BC-04	HEISS Arterien Klemme	BC-09
Atraumatische Klemme	BD-02	HEISTER Mund Sperrer	EI-03
HALSTED-MOSQUITO Micro Arterien Klemme	BC-04	HENKE Tonsillen Elevator	FA-02
HALSTED-MOSQUITO TITAN Arterien Klemme	BC-04	HENNIG Gips Spreizer	DA-03
Halter		HENROTIN Haken Zange	HA-34
KALLMORGEN Schneiden Halter	HA-15	HERMANN Gips Spreizer	DA-03
KRISTELLER Schneiden Halter	HA-09 bis HA-14	HERRICK Peritoneum Klemme	BC-17
Lippen und Wangen Halter	EI-03	HERTZLER Rippen Sperrer	FG-17
PITHA Lippen Halter	EI-06	HESS	
REICHERT Kehlkopfpolypendeckel Halter	FC-02	Iris Pinzette	EC-12
STERNBERG Lippen Halter	EI-02	Kapsel Pinzette	ED-04
Wangen Halter	EI-03	HETZER Herz Dilatator	FG-29
Hamburg Knopf Kanüle	ED-07	HEYMANN-KNIGHT Nasen Polypus Zange	EG-05
Hammer	DC-18	HEYMANN	
BABINSKY Perkussions Hammer	AC-07	Nasen scharfe Zange	EG-05
BERLINER Perkussions Hammer	AC-07	Nasen Schere	AH-18, AI-25
BUCK Perkussions Hammer	AC-07	HEYWOOD-SMITH Hämorrhoid Zange	GI-05
COLLIN Hammer	DC-18	HIBBS	
DEJERINE Perkussions Hammer	AC-07	Flachmeißel	DC-16
GERZOG Hammer	DC-18	Hohlmeißel	DC-16
KIRK Hammer	DC-18	Osteotom	DC-16
LUCAE Hammer	DC-18	HIRSCHMANN Anoskop	GI-04
MEAD Hammer	DC-18	Hobel CREDO Hornhaut	HE-03
QUISLING Hammer	DC-18	HOESEL Nadelhalter	CE-05
Schlitz Hammer	DD-13	HOFFER Gaumenbogen Haken	FA-02
TAYLOR Perkussions Hammer	AC-07	HOFF Tuch Klemme	BE-03
TRAUBE Perkussions Hammer	AC-07	Hohlmeißel	DC-14
TROEMNER Perkussions Hammer	AC-07	ALEXANDER Hohlmeißel	DC-14
WILLIGER Hammer	DC-18	ELLIS Fremdkörper Hohlmeißel	EC-06
HANK Uterus Dilatator	HA-28	HIBBS Hohlmeißel	DC-16
HARKEN Atraumatische Aurikel Klemme	BD-23	LEXER Hohlmeißel	DC-16
HARRINGTON		LEXER Mini Hohlmeißel	DC-16
Bronchus Klemme	FG-21	PARTSCH Hohlmeißel	DC-14
Wund Haken	BI-05	SMITH-PETERSEN Hohlmeißel	DC-15
HARTMANN		STILLE Hohlmeißel	DC-14
Arterien Klemme	BC-03	WALTON Fremdkörper Hohlmeißel	EC-06
HARTMANN-HALLE Nasen Spekulum	EG-02	HOHMANN Knochen Hebel	DC-22 bis DC-23
HARTMANN-HOFFMANN Ohr Zängchen	EE-08	HOHMANN Mini Knochen Hebel	DC-23

D

Inhaltsverzeichnis Deutsch

HOKE Flachmeißel	DC-16
HOLTH Kapsel Stanze	EC-09
HOPKINS Gips Messer	DA-04
HORSLEY Dura Dissektor	EA-06
HOUSE Kürette	EE-15
HRyntSCHAK Prostata Wundsperrer	GG-06
HUBER Universal Griff	FC-03
HUDSON	
Handbohrapparat Apparat	DD-04
Kegel Fräser	DD-04
HUMBY	
Dermatom	AG-20
Dermatom Ersatz Klinge	AG-20
HUNTER Splitter Pinzette	BA-06
HURD Tonsillen Dissektor	FA-02

I

INGE Wirbelkoerper Spreizer	EA-07
Instrument	
Beschneidungs Instrument	GG-09
KNUTSON Urethrographie Instrument	GG-09
LAFORCE Fremdkörper Instrument	EC-06
MOGAN Beschneidungs Instrument	GG-09
Inzisions Schere	AI-05
IOWA Haken Zange	HA-35
IRIS	
Augen Schere	AI-22
Schere	AH-16, AI-21
Schere, mit großen Ringen	AI-19
Irrigator	HE-05
ISRAEL Wund Haken	BI-11
ITARD Ohr Katheter	EE-06
ITERSON Tracheal Häkchen	FE-02
IVES-FANSLER Anoskop	GI-04

J

JACKSON	
Tampon Pinzette	FC-02
Tracheal Häkchen	FE-02
Tracheal Kannule	FE-03
Vaginal Spekulum	HA-16
JACOBS Haken Zange	HA-34
JACOBSON Mikro Schere	AJ-11
JAEGER	
Lanzen Messer	EC-04
Lid Platte	EC-03
JAMESON	
Schiel Haken	EC-06
Strabismus Pinzette	EC-13
JAMISON Nadelhalter	CE-03
JANSEN	
Nasen Zange	EG-04
Wund Sperrer	BI-14
JARCHO Haken Zange	HA-32
JATHO Nasenrachen Zange	EG-18
JAVID Atraumatische Carotis Klemme	BD-32
JENNINGS Mund Sperrer	EI-04
JOBSON-HORNE Watteträger	CA-03
JOHNS-HOPKINS	
Gallenkanal Klemme	BC-14
Gefäß Bulldog Klemme	BC-03
JOHNSON Nadelhalter	CE-04
JONES Schlauchhalter Tuch Klemme	BE-02
JOSEPH	
Häkchen	BI-06
Knochen Feile	EG-14
JOSEPH (LEWIS) Nasen Raspel	EG-15
JOSEPH	
Nasen Messer	EG-10

JOSEPH

Nasen Säge	EG-17
Nasen Skalpell	EG-10
Periost Elevatorium	EG-12
Schere	AH-14, AI-16
JUDD-ALLIS Darmfaß Zange	GE-02
JUDD-MASSON Blasen Wundsperrer	GG-04
JURASZ Kehlkopf Polypus Zange	FC-02

K

Kabel

AESCULAP HF Chirurgie Geräte Kabel	JA-07
ERBE SELECT HF Chirurgie Geräte Kabel	JA-07
MARTIN HF Chirurgie Geräte Kabel	JA-07
USA HF Chirurgie Geräte Kabel	JA-07
KABIERSKE Pulverbläser	EE-04

KALLMORGEN

Schneiden Halter	HA-15
Vaginal Spekulum	HA-15
KALT-ARRUGA Nadelhalter	CE-07

KALT

Kapsel Pinzette	ED-04
Kaltlicht Rectoskop	GI-03

KALT

Nadelhalter	CE-07
-------------------	-------

KANE Nabelschnur Klemme	HC-06
-------------------------------	-------

Kanüle

JACKSON Tracheal Kanüle	FE-03
LUER Tracheal Kanüle	FE-03
WAGENER-MOSHER Tracheal Kanüle	FE-03

Kanüle

Bonn Spül Kanüle	ED-07
BUIE Saug Kanüle	GI-05
FINSTERER Saug- und Spül Kanüle	AE-05
Hamburg Knopf Kanüle	ED-07
KILLIAN Spül Kanüle	EG-09
SCHEIE Augen Kanüle	ED-07
SIMCOE Naht Kanüle	ED-07
Tonsillen Kanüle	FA-05
Tübingen Luft Kanüle	ED-07

Katheter

HARTMANN Ohr Katheter	EE-06
ITARD Ohr Katheter	EE-06
Metall, Katheter Frauen	GG-16
Metall, Katheter Männer	GG-16

Katheter Spanner

DITTEL Katheter Spanner	GG-11
GUYON Katheter Spanner	GG-11
Kauter WADSWORTH-TODD	EC-08

Kegel Verschluss	HA-47
------------------------	-------

KEITH Naeh Nadel	CG-06
------------------------	-------

KELLY

Arterien Klemme	BC-05
-----------------------	-------

KELLY Grip Wund Haken	BI-04
-----------------------------	-------

KELLY

Gynäkologische Schere	AI-33
Gynäkologische Schere	AH-22
Proktoskop	GI-04

KELLY-RANKIN Arterien Klemme	BC-05
------------------------------------	-------

KELLY TITAN Arterien Klemme	BC-05
-----------------------------------	-------

KELLY

Uterus-Polypen Zange	HA-36
----------------------------	-------

Wund Haken	BI-04, BI-12
------------------	--------------

KERN Knochenhalte Zange	DC-08
-------------------------------	-------

KERRISON Stanze	EG-08
-----------------------	-------

KEVORKIAN-Pacific Probeexcisions Zange	HA-44
--	-------

KEVORKIAN	
-----------	--

Probeexcisions Zange	HA-43, HA-46
----------------------------	--------------

Uterus Biopsie Saug Kürette	HA-40
-----------------------------------	-------

KEY Elevatorien	DC-21
KEYES Haut Stanzbesteck	HE-02
Kieferhöhlenpunktionskanülen LICHTWITZ	EG-09
KIELLAND Geburts Zange	HC-02
KIELLAND-LUIKART Geburts Zange	HC-03
KILLIAN-CLAUS Nasen Hohl Meißel	EG-14
KILLIAN	
Septum Elevatorium	EG-12
Septum Spekulum	EG-03
Spül Kanüle	EG-09
KILNER-DOUGHTY Mund Sperrer	EI-05
KILNER	
Haut Häkchen	HE-02
Schere	AH-14, AI-17
KIRBY-ARTHUR Iris Pinzette	EC-13
KIRK Hammer	DC-18
KIRSCHNER	
Bauch Deckenhalter	BI-23
Bohrdrähte	DD-09
Extension Bügel	DD-10
Fuehrungshohl Sonde	CG-04
Handbohr Apparat	DD-05
Rahmen	BI-23
Valve	BI-23
Klammer LOWMAN Knochenhalte	DC-11
Klammerblock	EA-02
Klammer	
BUNT Sterilisier Klammer	CI-02
GERSTER Distraktions Klammer	DC-11
MAYO Sterilisier Klammer	CI-02
MICHEL Wund Klammer	CG-07
RANEY Kopfhaut Klammer	EA-03
Klemme	
ADSON Arterien Klemme	BC-09
ADSON BABY Arterien Klemme	BC-09
BACKHAUS-CLIP Schlauchhalter Tuch Klemme	BE-03
BACKHAUS KOCHER Tuch Klemme	BE-02
BACKHAUS Tuch Klemme	BE-02
BAINBRIDGE Arterien Klemme	BC-14
BAINBRIDGE Atraumatische Klemme	BD-09
BALL AND SOCKET Tuch Klemme	BE-04
BECK Atraumatische Peripher-Vascular Klemme	BD-25
BENGOLEA Arterien Klemme	BC-09
BERNHARD Tuch Klemme	BE-05
BEST Darm Klemme	GE-06
BRUNNER Darm Klemme	GE-06
CASTAÑEDA Atraumatische Neonatal und Kinder	BD-42
CHAPUT Arterien Klemme	BC-08
COLLIN Arterien Klemme	BC-08
COLLIN Nabelschnur Klemme	HC-06
COOLEY Atraumatische	BD-35 bis BD-37, BD-39, BD-41
COOLEY Atraumatische Anastomosen	BD-37, BD-40
COOLEY Atraumatische Bulldog Klemme	BD-33 bis BD-34
COOLEY Atraumatische Iliaca Klemme	BD-37
COOLEY Atraumatische Kindergrößen	BD-38 bis BD-39
COOLEY DERRA Atraumatische Anastomosen	BD-39
COOLEY Gefäß Klemme	BD-40
CRAFOORD Arterien Bronchus Klemme	BC-12
CRILE Arterien Klemme	BC-05
CRILE-RANKIN Arterien Klemme	BC-05
CRILE TITAN Arterien Klemme	BC-05
DALE Atraumatische Peripher-Vascular Klemme	BD-24
DANDY Arterien Klemme	BC-07
DARDIK Atraumatische Klemme	BD-07
DE BAKEY Atraumatische Klemme	BD-02, BD-08
DE BAKEY Atraumatische Klemme	BD-16 bis BD-17
DE BAKEY Atraumatische Klemme	BD-20
DE BAKEY Atraumatische Klemme	BD-28 bis BD-30
DE BAKEY Atraumatische Anastomosen	BD-25
DE BAKEY Atrauma. Aorta-Aneurys..	BD-13, BD-15, BD-18
DE BAKEY Atraumatische Bronchus Klemme	BD-19

DE BAKEY Atraumatische Bulldog Klemme	BC-02
Kemme	
DE BAKEY Atraumatische Iliaca Klemme	BD-11
DE BAKEY Atraumatische Peripher-Vascular	BD-06
DE BAKEY Atrauma. Präparier und Ligatur ..	BD-25, BD-32
DEBAKEY BAHNSON	
Atraumatische Aorta-Aneurysma Klemme	BD-14
DE BAKEY MORRIS Atraumatische Klemme	BD-16
DE BAKEY REYNOLDS Atrauma. Anastomosen	BD-30
DEBAKEY SATINSKY Atraumatische Klemme	BD-22
DeMARTEL-WOLFSON Anastomosen Klemme	GE-07
DERRA Atrauma. Anastomosen, Kindergrößen	BD-28
DESJARDINS Gallenkanal Klemme	BC-15
DIEFFENBACH Gefäß Bulldog Klemme	BC-03
DIETHRICH Atraumatische Klemme	BD-31
DOYEN-Baby Darm Klemme	GE-03
DOYEN Darm Klemme	GE-03
DOYEN Tuch Klemme	BE-05
EDWARDS Clip Anlegezange	BD-21
FAURE Peritoneum Klemme	BC-17
FEHLAND Darm Klemme	GE-06
FERGUSSON Arterien Klemme	BC-07
FINOCHIETTO Bronchus Klemme	FG-21
GEMINI MINI Präparier und Ligatur Klemme	BC-10
GEMINI Präparier und Ligatur Klemme	BC-10
GLOVER Atraumatische Klemme	BD-06, BD-30
GLOVER Atraumatische Anastomosen Klemme	BD-05
GLOVER Atraumatische Bulldog Klemme	BC-02
GLOVER Atraumatische Coarctation Klemme	BD-04
GRAY Gallenkanal Klemme	BC-15
GREEN-ARMYTAGE Uterus zur Blutstillung	HC-06
GREGORY Atraumatische Profunda Klemme	BD-33
GUYON Nierenstiel Klemme	BC-16
HALSTED-MOSQUITO Arterien Klemme	BC-04
HALSTED-MOSQUITO Atraumatische Klemme	BD-02
HALSTED-MOSQUITO Micro Arterien Klemme	BC-04
HALSTED-MOSQUITO TITAN Arterien Klemme	BC-04
HARKEN Atraumatische Aurikel Klemme	BD-23
HARRINGTON Bronchus Klemme	FG-21
HARTMANN Arterien Klemme	BC-03
HEANEY Hysterektomie Klemme	BC-18
HEISS Arterien Klemme	BC-09
HERRICK Peritoneum Klemme	BC-17
HOFF Tuch Klemme	BE-03
JAVID Atraumatische Carotis Klemme	BD-32
JOHNS-HOPKINS Gallenkanal Klemme	BC-14
JOHNS-HOPKINS Gefäß Bulldog Klemme	BC-03
JONES Schlauchhalter Tuch Klemme	BE-02
KANE Nabelschnur Klemme	HC-06
KELLY Arterien Klemme	BC-05
KELLY-RANKIN Arterien Klemme	BC-05
KELLY TITAN Arterien Klemme	BC-05
KOCHER Arterien Klemme, grazil	BC-06
KOCHER Darm Klemme	GE-04
LAHEY Gallenkanal Klemme	BC-14
LAMBERT KAY Atraumatische Aorta-Anastomos.	BD-10
LAMBERT KAY Atraumatische Iliaca Klemme	BD-11
LANE Magen Klemme	GE-08
LANE Tuch Klemme	BE-05
LAWRENCE Präparier und Ligatur Klemme	BC-13
LEES Atraumatische Bronchus Klemme	BD-03
LELAND JONES	
Atrauma. Peripher-Vascular Klemme	BD-08 bis BD-09
LERICHE Arterien Klemme	BC-09
LIDDLE Atraumatische Aorta Klemme	BD-10
LORNA Tuch Klemme	BE-04
LOVELACE Arterien Klemme	BC-07
LOWER Gallenkanal Klemme	BC-14
LURZ Ureter Klemme	GC-10
MARTEL Kopfhaut Klemme	BC-08
MASTIN Muskel Klemme	FE-04

D

Inhaltsverzeichnis Deutsch

MAYO-GUYON Nierenstiel Klemme.....	BC-16	TROUTMAN-CHRIS Klängenbrecher.....	AG-14
Klemme		Klinge	
MAYO-ROBSON Darm Klemme.....	GE-05	Skalpell Steril, Mikro Klinge.....	AG-13
MEEKER Präparier und Ligatur Klemme.....	BC-13	KLINKENBERGH-LOTH Lungen und Thorax Schere.....	AI-37
MIKULICZ Peritoneum Klemme.....	BC-17	KNAPP	
MIXTER Arterien Klemme.....	BC-14	Häkchen.....	EC-06
MIXTER Arterien Bronchus Klemme.....	BC-13	Iris Messer.....	EC-04
MIXTER BABY Arterien Bronchus Klemme.....	BC-13	KNAPP-LUER Trachom Pinzette.....	ED-06
MIXTER Gallenkanal Klemme.....	BC-15	KNAPP	
MIXTER O'SHAUGNESSY Arterien Klemme.....	BC-14	Schere.....	AI-20
MOYNIHAN Gallenkanal Klemme.....	BC-15	Star Löffel.....	EC-07
MOYNIHAN Tuch Klemme.....	BE-05	KNIGHT Nasen scharfe Zange.....	EG-05
MURPHY Schlauch Klemme.....	BC-19	Knochendraht.....	DD-11
NEGUS Tonsillen Klemme.....	FA-03	Knochenhalte Zange.....	DC-09 bis DC-10
OCHSNER Atraumatische Aorta Klemme.....	BD-31	Knorpel Messer.....	AG-18
OVERHOLT-GEISSENDOERFER		KNOWLES Verband Schere.....	AI-47
Präparier und Ligatur Klemme.....	BC-10	KNUTSON-KOCH Urethrographie Konus.....	GG-09
PAYR-Baby Magen Klemme.....	GE-09	KNUTSON Urethrographie Instrument.....	GG-09
PAYR Magen Klemme.....	GE-09	KOCHER	
PEAN Arterien Klemme.....	BC-08	Arterien Klemme, grazil.....	BC-06
PEAN Arterien Klemme, grazil.....	BC-06	Blasen Spatel.....	GG-04
PEAN Atraumatische Klemme.....	BD-02	Darm Klemme.....	GE-04
PEERS BERTRAM Tuch Klemme.....	BE-03	Kropf Sonde.....	FE-04
PENNINGTON Arterien Klemme.....	BC-07	Wund Haken.....	BI-10 bis BI-11
PHANEUF Peritoneum Klemme.....	BC-17	KOENIG	
POTTS Atraumatische Klemme.....	BD-26 bis BD-27	Fuehrungshohl Sonde.....	CG-04
POTTS Atraumatische Anastomosen Klemme.....	BD-05	Naeh Nadel.....	CG-06
POTTS Atraumatische Coarctation Klemme.....	BD-04	KOERTE Wund Haken.....	BI-11
PRATT Arterien Klemme.....	BC-08	KOGAN Endo Spekulum.....	HA-23
PRESBYTERIAN HOSPITAL Schlauch Klemme.....	BC-19	Kompressorium CORWIN Tonsillen.....	FA-04
PRICE-THOMAS Bronchus Klemme.....	FG-22	Komprimeter.....	DD-02
PROVIDENCE-HOSPITAL Arterien Klemme.....	BC-05	KONRICH Sterilisier Trommel.....	HE-12
RANKIN Atraumatische Klemme.....	BD-02	Kontraktor	
ROBERTS Arterien Klemme.....	BC-11	BAILEY-BABY Rippen Kontraktor.....	FG-18
ROCHESTER-CARMALT Arterien Klemme.....	BC-07	BAILEY-GIBBON Rippen Kontraktor.....	FG-18
ROCHESTER-OCHSNER Arterien Klemme.....	BC-06	BAILEY Rippen Kontraktor.....	FG-18
ROCHESTER-PEAN Arterien Klemme.....	BC-06	SELLORS Rippen Kontraktor.....	FG-18
ROEDER Tuch Klemme.....	BE-03	Konus KNUTSON-KOCH Urethrographie.....	GG-09
RUMEL Thorax Klemme.....	BC-11	Kranioklast	
SAROT Arterien Bronchus Klemme.....	BC-12	BRAUN Kranioklast.....	HC-09
SAROT Bronchus Klemme.....	FG-23	TARNIER Kranioklast.....	HC-09
SATINSKY Anastomosen (Vena Cava).....	FG-24 bis FG-25	KRAUSE	
SATINSKY Atraumatische Klemme.....	BD-20	Kehlkopf Zange.....	FC-03
SAWTELL Tonsillen Klemme.....	FA-03	Nasen Schnürer.....	EG-09
SCHNIDT Tonsillen Klemme.....	FA-03	Ohrpolypen Schnürer.....	EE-07
SEMB Bronchus Klemme.....	FG-23	KRISTELLER	
SPENCER-WELLS Arterien Klemme.....	BC-07	Schneiden Halter.....	HA-09 bis HA-14
STILLE Nierenstiel Klemme.....	BC-16	Vaginal Spekulum.....	HA-09 bis HA-14
STOCKMANN Penis Klemme.....	GG-10	KRONECKER Unterbindungs Nadel.....	CG-02
STONE Verschluss Klemme.....	GE-06	KUENTSCHER	
STONE-WATT Darm Klemme.....	GE-06	Extraktor.....	DD-13
STRAUSS Penis Klemme.....	GG-10	Fertigschläger.....	DD-13
SUBRAMANIAN Atraumatische Klemme.....	BD-31	Vorböhrer.....	DD-13
TOENNIS Arterien Klemme.....	BC-11	Kugel Koagulieren Elektrode.....	JA-03
TOHOKU Tuch Klemme.....	BE-04	KUHNT Hornhaut Schaber.....	EC-05
TUFFIER Arterien Klemme.....	BC-08	Kürette	
WEBER Atraumatische Klemme.....	BD-12	Absaug Kürette.....	HA-51
WEISS Schlauch Klemme.....	BC-19	ALVIS Fremdkörper Kürette.....	EC-06
WERTHEIM-CULLEN Hysterektomie Klemme.....	BC-18	BLAKE Uterus Kürette.....	HA-48
WERTHEIM Hysterektomie Klemme.....	BC-18	BUCK Ohr Kürette.....	EE-05
WILLET-MARTELL Kopfhaut Klemme.....	BC-08	BUMM Uterus Kürette.....	HA-49 bis HA-50
WINKELMANN Beschneidungs Klemme.....	GG-09	COAKLEY Antrum Kürette.....	EG-18
WYLIE Atraumatische Klemme.....	BD-21	FAULKNER Kürette.....	EG-18
ZENKER Präparier und Ligatur Klemme.....	BC-12	FOX Lupus Kürette.....	HE-02
zum Erfassen der Glans und der Vorhaut.....	GG-10	GOURDET Uterus Kürette.....	HA-48
zum Fixieren des Samenstranges.....	GG-10	HOUSE Kürette.....	EE-15
Klinge Dermatol Ersatz Klinge.....	AG-21	KEVORKIAN Uterus Biopsie Saug Kürette.....	HA-40
HUMBY Dermatol Ersatz Klinge.....	AG-20	NOVAK Uterus Biopsie Saug Kürette.....	HA-40
Klängenbrecher		PIFFARD Lupus Kürette.....	HE-02
CASTROVIEJO Klängenbrecher.....	AG-14	RANDALL Uterus Biopsie Saug Kürette.....	HA-40
DIMEDA Klängenbrecher.....	AG-14	RECAIMER Uterus Kürette.....	HA-49 bis HA-50

SCHROEDER Uterus Kürette	HA-48
Kürette	
SIMON Uterus Kürette	HA-48
SIMS Uterus Kürette	HA-49 bis HA-50

L

LABORDE Tracheal Dilatator	FE-02
LAFORCE	
Adenotom	EG-19
Fremdkörper Instrument	EC-06
LAGRANGE Zahnfleisch Schere	AI-41
LAHEY	
Gallenkanal Klemme	BC-14
Kropf Fass Zange	FE-04
Wund Haken	BI-08
LAMBERT Chalazion Pinzette	ED-06
LAMBERT KAY	
Atraumatische Aorta-Anastomosen Klemme	BD-10
Atraumatische Iliaca Klemme	BD-11
LAMBOTTE	
Knochenhalte Zange	DC-08
LAMBOTTE Mini Osteotom	DC-15
LAMBOTTE	
Osteotom	DC-15
Raspatorien	DC-19
LANCASTER Sperr Elevator	EC-03
LANDAU Vaginal Spekulum	HA-22
LANDOLT	
Enukleations Schere	AI-25
Mikro Skalpellgriff	AG-13
LANE	
Knochenhalte Zange	DC-08
Knochenschraub Halte Zange	DD-14
Magen Klemme	GE-08
Pinzette	BA-04
Schrauben Dreher	DD-14
Tuch Klemme	BE-05
LANGE	
Kehlkopf Zange	FC-03
LANGENBECK	
Elevatoren	DC-21
Finger Säge	DD-03
Fingerschutz	EI-06
Knochenhalte Zange	DC-07
Raspatorien	DC-19
resektions Messer	AG-17
Wund Haken	BI-09
LANGE	
Verband Schere	AI-44
LANG Tränens Löffel	EC-08
Lanzette Elektrode	JA-03
Lärmtrommel BARANY	EE-04
Laryngoskopset	
MACINTOSH Faseroptik	AE-12 bis AE-13
MACINTOSH Standard	AE-18 bis AE-19
MILLER Faseroptik	AE-12 bis AE-13
MILLER Standard	AE-18 bis AE-19
Laryngoskopspatel	
MACINTOSH Faseroptik	AE-10
MACINTOSH Standard	AE-15
MILLER Faseroptik	AE-10
MILLER Standard	AE-16
LAWRENCE Präparier und Ligatur Klemme	BC-13
LEBSCHKE Sternummeißel	DC-17
LEES Atraumatische Bronchus Klemme	BD-03
LEGUEU	
Blasen Spatel	GG-04
Blasen Wundsperrer	GG-06
LEKSELL STILLE Hohlmeißel Zange	DC-05
LELAND JONES Atraumatische	
Peripher-Vascular Klemme	BD-08 bis BD-09
LEMPERT	
Elevatorium	EE-15
Hohlmeißel Zange	DC-03
Scharf Löffel	DC-13
LERCHE Pinzette	BA-04
LERICHE Arterien Klemme	BC-09
LESTER Fixier Pinzette	ED-03
LEVINSON Fremdkörper Nadel	EC-05
LEWIN Knochenhalte Zange	DC-10
LEWKOWITZ Plazentar und Abortus Zange	HC-07
LEXER-BABY	
Präparier Schere	AI-12
Schere	AH-10
LEXER-FINO Präparier Schere	AI-12
LEXER	
Flachmeißel	DC-16
Hohlmeißel	DC-16
LEXER Mini	
Flachmeißel	DC-16
Hohlmeißel	DC-16
LEXER	
Präparier Schere	AI-11
Schere	AH-09
LEYLA Fixations-System	EA-14 bis EA-18
LICHTWITZ	
Kieferhöhlenpunktionskanülen	EG-09
Trokar	CC-02
LIDDLE Atraumatische Aorta Klemme	BD-10
LISTER-BURCH Sperr Elevator	EC-02
LISTER	
Sinus Schwamm Zange	BG-11
Verband Schere	AH-23, AI-45
LISTON	
amputations Messer	AG-16
Knochensplitter Zange	DC-06
LITTAUER	
Cilien Pinzette	ED-08
Ligatur Schere	AI-40
Nasen Polypus Zange	EG-05
Ohr Zängchen	EE-08
LITTLER Präparier Schere	AI-13
LITTLE Wund Haken	BI-08
LOCKLIN Schere	AI-18
Löffel	
AXENFELD Chalazion Löffel	EC-07
BRUNS Scharfe Löffel	DC-12 bis DC-13
BUNGE Exenterations Löffel	EC-07
CUZZI Plazentar und Abortus Löffel	HC-08
DAVIEL Star Löffel	EC-07
DESJARDINS Gallenstein Löffel	GC-08
FERGUSSON Gallenstein Löffel	GC-07
GRAEFE Star Löffel	EC-07
GROSS Ohr Löffel	EE-06
GUTMANN Sekret Löffel	GG-11
HALLE Löffel, Scharf	DC-13
HEBRA Chalazion Löffel	EC-07
KNAPP Star Löffel	EC-07
LANG Tränensack Dissektor- Löffel	EC-08
LEMPERT Scharfer Löffel	DC-13
LUER-KOERTE Gallenstein Löffel	GC-09
MARTINI Scharfer Löffel	DC-13
MAYO Gallenstein Löffel	GC-07
MEYHOEFER Chalazion Löffel	EC-07
MOORE Gallenstein Löffel	GC-05
PESTALOZZA Plazentar und Abortus Löffel	HC-08
SCHEDE Löffel, Scharf	DC-12
SELLHEIM Geburts Löffel	HC-09
SIMON Löffel, Scharf	DC-13
SPRATT Löffel, Scharf	DC-12
VOLKMANN Löffel, Scharf	DC-12 bis DC-13

D

Inhaltsverzeichnis Deutsch

WALLICH Plazentar und Abortus Löffel.....	HC-08
Löffel	
WELLS Eukleation Löffel	EC-08
WILLIGER Löffel, Scharf	DC-13
LORENZ Verband Schere	AI-47
LORNA Tuch Klemme	BE-04
LOUTE Draht Spanner.....	DD-11
LOVE-GRUENWALD Laminektomie Zange.....	EA-08
LOVELACE	
Arterien Klemme	BC-07
Lungenfaß Zange.....	FG-19
LOVE	
Nerv Haken	EA-04
Zäpfchen Haken	FA-02
LOWER Gallenkanal Klemme.....	BC-14
LOWMAN Knochenhalte Klamme.....	DC-11
LUBET-BARBON Nasen Polypus Zange.....	EG-05
LUCAE	
Hammer	DC-18
Ohr Pinzette	EE-07
Stimmgabel	EE-04
LUC Nasen scharfe Zange	EG-06
LUER	
Hohlmeißel Zange	DC-03
LUER-KOERTE Gallenstein Löffel	GC-09
LUER Tracheal Kannule	FE-03
Luftdusche POLITZER	EE-05
LUIKART-BILL Zug Hebel.....	HC-05
LUIKART Geburts Zange.....	HC-03
LUNDSGAARD Sklerotom	EC-05
LUNIATSCHEK Tampon Stopfer	FA-02
LURZ Ureter Klemme	GC-10

M

MACINTOSH	
Faseroptik Laryngoskopeset	AE-12 bis AE-13
Faseroptik Laryngoskopespatel	AE-10
Standard Laryngoskopeset.....	AE-18 bis AE-19
Standard Laryngoskopespatel	AE-15
MAGILL	
Kathetereinführ Zange	AE-06
Mandrin	AE-04
Sauger.....	AE-04
Magnet DIMEDA Augen	ED-08
MAIER Tupfer Zange	BG-12
MALTZ (COTTLE) Nasen Raspel	EG-15
MALTZ	
Knorpel Messer.....	EG-11
Nasen Raspel	EG-14
Mandrin MAGILL	AE-04
Manometer zum Salpingograph.....	HA-47
Markier	
CASTROVIEJO Kompass.....	EC-09
CONNIN-AMSLER Markier Instrument.....	EC-09
MARSCHIK Tonsillen Pinzette.....	FA-04
MARTEL Kopfhaut Klemme	BC-08
MARTIN	
Becken Zirkel	HC-06
HF Chirurgie Geräte Kabel	JA-07
MARTINI Löffel, Scharf	DC-13
MARTIN	
Sequester Zange	DC-10
Tupfer Zange.....	BG-02, BG-14
Uterus Sonde	HA-39
MASSON Nadelhalter	CE-03
MASTIN Muskel Klemme	FE-04
MATHIEU	
Fremdkörper Zange.....	GG-07
Nadelhalter.....	CE-05
Rektal Spekulum	GI-02

Wund Haken	BI-03
MATSON Raspatorien.....	DC-21
MAUNDER Holz Mundkeil	EI-06
MAYO BLAKE Gallenstein Zange	GC-04
MAYO	
Gallenstein Löffel.....	GC-07
MAYO-GUYON Nierenstiel Klemme	BC-16
MAYO-HEGAR Nadelhalter.....	CE-02
MAYO	
Linkshänder Schere.....	AI-07
Nierenstein Sonde	GC-10
MAYO-NOBLE Schere.....	AH-08, AI-10
MAY Ophthalmoskop.....	AC-03
MAYO-ROBSON Darm Klemme.....	GE-05
MAYO	
Schere	AH-06, AI-07
Sterilisier Klammer	CI-02
MAYO-STILLE Schere.....	AH-07, AI-08 bis AI-09
McCLINTOCK Plazentar und Abortus Zange	HC-07
McCULLOUGH Strabismus Pinzette	EC-13
McDONALD Elevatorien	DC-22
McGEE Ohr Mikro Zängchen	EE-10
McGUIRE Hornhaut Schere.....	AJ-05
McINDOE	
Knorpel Schere.....	AI-35
Pinzette	BA-04
McIVOR	
Mund Sperrer.....	EI-05
Zungen Spatel	EI-05
McKENTY Septum Elevatorium	EG-11
McKENZIE	
Bohrer	DD-04
Clip-Anlege Zange	EA-02
McLEAN Geburts Zange.....	HC-04
McLEAN-LUIKART Geburts Zange	HC-03
McLEAN-TUCKER-LUIKART Geburts Zange	HC-03
McPHERSON Faden Pinzette	ED-05
McPHERSON TITAN Faden Pinzette	ED-05
McPHERSON WESTCOTT Sehnen Schere	AJ-04
MEAD	
Hammer	DC-18
Hohlmeißel Zange	DC-02
MEEKER Präparier und Ligatur Klemme.....	BC-13
Meißel	
CINELLI Nasenplastik Meißel.....	EG-13
COTTLE Nasenplastik Meißel	EG-13
FOMON Nasenplastik Meißel	EG-13
FREER Nasen Hohl Meißel	EG-14
FREER Septum Meißel	EG-12
HAJEK Nasen Hohl Meißel	EG-14
KILLIAN-CLAUS Nasen Hohl Meißel	EG-14
PASSOW Meißel.....	EE-15
ROLLET Extirpations Meißel	EC-06
SILVER Nasenplastik Meißel.....	EG-14
WEST Nasen Hohl Meißel.....	EG-14
MELLINGER-AXENFELD Sperr Elevator	EC-02
MELLINGER Sperr Elevator	EC-02
MENGHINI Trokar	CC-03
Meniskotom	
BIRCHER Meniskotom	DC-24
NEFF Meniskotom	DC-24
SMILLIE Meniskotom.....	DC-24
MERCEDES Thorax Sperrer.....	FG-16
Messer	
BALLENGER Schwing Messer	EG-11
BARKAN Goniotomie Messer	EC-05
BARNHILL Ring Messer	EG-19
BARRAQUER Keratoplastik Messer.....	EC-05
BECKMANN Ring Messer	EG-19
BERENS Lanzen Messer.....	EC-04
BOWMAN Discisions Messer	EC-04

CARPENTER Tonsillen Messer.....	FA-02
Messer	
CASTROVIEJO Lanzen Messer.....	EC-04
CATLIN Amputations Messer.....	AG-16
CONVERSE Nasen Messer.....	EG-10
COTTLE Nasen Messer.....	EG-10
DEAN Iris Messer.....	EC-04
DEUTSCHMANN Star Messer.....	EC-03
Elektrode Messer.....	JA-03
ELSCHNIG Hornhaut Messer.....	EC-05
ESMARCH Gips Messer.....	DA-04
FREER Mukosa Messer.....	EG-10
FREER Septum Messer.....	EG-10
GILL Hornhaut Messer.....	EC-05
GRAEFE Star Messer.....	EC-03
HALLE Dura Messer.....	EA-06
HOPKINS Gips Messer.....	DA-04
JAEGER Lanzen Messer.....	EC-04
JOSEPH Nasen Messer.....	EG-10
KNAPP Iris Messer.....	EC-04
LANGENBECK Resektions Messer.....	AG-17
LISTON Amputations Messer.....	AG-16
MALTZ Knorpel Messer.....	EG-11
MOELTGEN Winkel Messer.....	AC-08
MUCK Periost Messer.....	EE-15
OTIS Ersatz Messer.....	GG-08
PAUFIQUE Keratoplastik Messer.....	EC-05
PLESTER Lappen Messer.....	EE-14
POLITZER Ohr Messer.....	EE-06
REINER Gips Messer.....	DA-04
ROSEN Rundschnitt Messer.....	EE-14
SATO Hornhaut Messer.....	EC-05
SCHEIE Goniotomie Messer.....	EC-05
SCHUKNECHT Roll Messer.....	EE-14
SCHUKNECHT Sichel Messer.....	EE-14
SEGOND Myom Messer.....	HA-46
SEXTON Ohr Messer.....	EE-06
St. CLAIR-THOMSON Ring Messer.....	EG-19
TABB Sichel Messer.....	EE-14
TOOK Hornhaut Messer.....	EC-05
VIRCHOW Hirn Messer.....	AG-18
VIRCHOW Knorpel Messer.....	AG-18
WHEELER Diszisions Messer.....	EC-04
WULLSTEIN Sichel Messer.....	EE-14
ZIEGLER Iris Messer.....	EC-04
ZIEGLER Kapsulotomie Messer.....	EC-05
Messzirkel BERTILLON Schädel.....	AC-08
Metall MassStäbe.....	AC-08
METZENBAUM FINO	
Präparier Schere.....	AI-15
Schere.....	AH-12
METZENBAUM	
Nadelhalter.....	CE-04
Präparier Schere.....	AI-13 bis AI-14
Schere.....	AH-11
METZENBAUM "S" Schere.....	AH-13, AI-16
MEYERDING Wund Haken.....	BI-08
MEYHOEFER Chalazion Löffel.....	EC-07
MICHEL	
Spiegel.....	EG-04
Wund Klammer.....	CG-07
Wundklammer Zange.....	CG-07
MIDDELDORPF Wund Haken.....	BI-10
MIDDLETON-JANSEN Nasen scharfe Zange.....	EG-09
Mikro Pinzette.....	BB-02
Mikro Schere.....	AJ-06, AJ-13
Mikro Skalpell Griff.....	AG-12
MIKULICZ	
Peritoneum Klemme.....	BC-17
Wund Haken.....	BI-12

MILLER	
Faseroptik Laryngoskopset.....	AE-12 bis AE-13
MILLER	
Faseroptik Laryngoskopspatel.....	AE-10
Standard Laryngoskopset.....	AE-18 bis AE-19
Standard Laryngoskopspatel.....	AE-16
MILLIGAN Dura Dissektor.....	EA-05
MILLIN	
Blasenhals Sperrer.....	GG-07
Blasen Wundsperrer.....	GG-05
Fadenführungs Zange.....	GG-03
Faß vordere Lappen Zange.....	GG-03
Kaltlicht Aufsatz.....	GG-05
Kapsel Faß Zange.....	GG-03
MILLS Gefäß Schere.....	AI-27
Mini Naht Besteck.....	CG-08
Mini Stirnlampe CLAR.....	AC-05
MIXTER	
Arterien Bronchus Klemme.....	BC-13
Arterien Klemme.....	BC-14
MIXTER BABY Arterien Bronchus Klemme.....	BC-13
MIXTER	
Gallenkanal Klemme.....	BC-15
Gallenstein Zange.....	GC-04
MIXTER O'SHAUGNESSY Arterien Klemme.....	BC-14
MOELTGEN Winkel Messer.....	AC-08
MOGAN Beschneidungs Instrument.....	GG-09
MOLLISON Wund Sperrer.....	BI-17
MOORE	
Gallenstein Löffel.....	GC-05
Handbohr Apparat.....	DD-04
MOORFIELD Naht Pinzette.....	ED-05
MORSE-FAVOLORO Rippen Sperrer.....	FG-17
MOYNIHAN	
Gallenkanal Klemme.....	BC-15
Gallenstein Sonde.....	GC-05
Tuch Klemme.....	BE-05
MUCK Periost Messer.....	EE-15
MUELLER Sperr Elevator.....	EC-03
Mundkeil MAUNDER Holz.....	EI-06
MURDOCK Sperr Elevator.....	EC-02
MURLESS Kopf Hebel.....	HC-05
MURPHY-LANE Elevatorien.....	DC-22
MURPHY Schlauch Klemme.....	BC-19
MUSEUX Haken Zange.....	HA-33
Muskel Haken.....	BI-25
Mutterschlüssel für Extensionbügel.....	DD-10
MYLES Nasen scharfe Zange.....	EG-07

N

NABATOFF Varicen Besteck Ohr Sonde.....	CA-02
Nadel	
BARBARA Nadel.....	EE-14
BOWMAN Diszisions Nadel.....	EC-05
COOPER Unterbindungs Nadel.....	CG-02
DAVIS Fremdkörper Nadel.....	EC-05
DESCHAMPS Unterbindungs Nadel.....	CG-02
DIX Flachmeißel.....	EC-09
DUPUY-WEISS Tonsillen Nadel-, Nadel.....	FA-03
Elektrode.....	JA-03
Elektrode mini.....	JA-02
FRANCIS Fremdkörper Nadel.....	EC-05
FRANKLIN-SILVERMANN Punktions Nadel.....	CC-03
Fremdkörper Nadel.....	EC-05
Nadelhalter	
ADSON Nadelhalter.....	CE-04
ARRUGA Nadelhalter.....	CE-06
BARRAQUER Nadelhalter.....	CE-07
BAUMGARTNER Nadelhalter.....	CE-02
BOYNTON Nadelhalter.....	CE-06
BOZEMANN Nadelhalter.....	CE-03

D

Inhaltsverzeichnis Deutsch

CASTROVIEJO Nadelhalter	CE-07
Nadelhalter	
COLLIER Nadelhalter	CE-02
CRILE Nadelhalter	CE-04
CRILE-MURRAY Nadelhalter	CE-02
CRILE-WOOD Nadelhalter	CE-02
DE BAKEY Nadelhalter	CE-03
DERF Nadelhalter	CE-02
DIETHRICH Nadelhalter	CE-06
FINOCHIETTO Nadelhalter	CE-04
GILLIES Nadelhalter	CE-05
HALSEY Nadelhalter	CE-02
HEANEY Nadelhalter	CE-03
HOESEL Nadelhalter	CE-05
JAMISON Nadelhalter	CE-03
JOHNSON Nadelhalter	CE-04
KALT Nadelhalter	CE-07
KALT-ARRUGA Nadelhalter	CE-07
MASSON Nadelhalter	CE-03
MATHIEU Nadelhalter	CE-05
MAYO-HEGAR Nadelhalter	CE-02
METZENBAUM Nadelhalter	CE-04
NEIVERT Nadelhalter	CE-02
OLSEN-HEGAR Nadelhalter	CE-05
RYDER Nadelhalter	CE-03
SAROT Nadelhalter	CE-04
STEVENS Nadelhalter	CE-06
STRATTE Nadelhalter	CE-04
TOENNIS Nadelhalter	CE-04
WANGENSTEEN Nadelhalter	CE-03
Nadel	
KEITH Naeh Nadel	CG-06
KOENIG Naeh Nadel	CG-06
KRONECKER Unterbindungs Nadel	CG-02
LEVINSON Fremdkörper Nadel	EC-05
NELSON Unterbindungs Nadel	CG-02
POLITZER Parazentese Nadeln	EE-06
QUINKE Punktions Nadel	CC-03
Nadelrad WARTENBERG	AC-08
Nadel	
REVERDIN Unterbindungs Nadel	CG-03
ROSEN Nadel	EE-14 bis EE-15
Star Nadel	EC-05
VERRES Pneumoperitoneum Punktions Nadel	CC-03
YOUNG Boomerang Unterbindungs Nadel	CG-03
NAEGELE Geburts Zange	HC-03
Naeh Nadel	CG-05 bis CG-06
NÄGELE Perforatorium	HC-09
Nagel STEINMANN Knochen	DD-09
NAGER Gaumensegel Haken	FA-02
NEFF Meniskotom	DC-24
NEGUS Tonsillen Klemme	FA-03
NEIVERT Nadelhalter	CE-02
NELSON	
Pinzette	BA-05
Trokar	CC-02
Unterbindungs Nadel	CG-02
NEUBÜSER Tuben Faß Pinzette	HA-51
Neurochirurgische Schere	AI-35
NORTHBENT Ligatur Schere	AI-40
NOTO Uterus-Polypen Zange	HA-36
NOVAK Uterus Biopsie Saug Kürette	HA-40
NOYES	
Iris Schere	AJ-03 bis AJ-04
Nasen Polypus Zange	EG-05
Sehnen Schere	AJ-03
NUBOER Sauger	AE-05
O	
OCHSNER	
Atraumatische Aorta Klemme	BD-31

OCHSNER	
Trokar	CC-02
O' CONNOR Iris Haken	EC-06
OLDBERG Laminektomie Zange	EA-09
OLIVECRONA	
Draht Säge	EA-05
Hirn Spatel	EA-07
Hohlmeißel Zange	DC-03
OLIVECRONA-TOENNIS Clip-Anlege Zange	EA-02
OLLIER Wund Haken	BI-10
OLSEN-HEGAR Nadelhalter	CE-05
Ophthalmoskop	
MAY Ophthalmoskop	AC-03
VARIFOCAL Ophthalmoskop	AC-03
Osteotom	DC-14
HIBBS Osteotom	DC-16
LAMBOTTE Osteotom	DC-15
LAMBOTTE Mini Osteotom	DC-15
STILLE Osteotom	DC-14
O'SULLIVAN-O'CONNOR	
Bauch Deckenhalter	BI-21
Vaginal Spekulum	HA-08
Oszillierende Gips Säge	DA-05 bis DA-06
OTIS	
Ersatz Messer	GG-08
Urethrotom	GG-08
Otoskop	AC-04
OVERHOLT-GEISSENDOERFER	
Präparier und Ligatur Klemme	BC-10
OVERHOLT Raspatorien	DC-21
P	
Parametrien Gefäß Schere	AI-31
Parametrium Gefäß Schere	AH-20
PARHAM Band	DC-11
PARKER	
anatomische Skalpell	AG-15
Wund Haken	BI-02
PARK Sperr Elevator	EC-03
PARTSCH	
Flachmeißel	DC-14
Hohlmeißel	DC-14
PASSOW Meißel	EE-15
PATON Hornhaut Dissektor	EC-05
PAUFIQUE	
Faden Pinzette	ED-05
Keratoplastik Messer	EC-05
PAUFIQUE TITAN Faden Pinzette	ED-05
PAYR-Baby Magen Klemme	GE-09
PAYR	
Fuehrungshohl Sonde	CG-04
Magen Klemme	GE-09
PEAN	
Arterien Graziilles Klemme	BC-06
Arterien Klemme	BC-08
Atraumatische Klemme	BD-02
PEDERSON Vaginal Spekulum	HA-03
PEERS BERTRAM Tuch Klemme	BE-03
PEET Splitter Pinzette	BA-06
PELKMANN Tupfer Zange	BG-12
PENFIELD Dura Dissektor	EA-06
PENNINGTON Arterien Klemme	BC-07
PERCY Amputation Retraktor	DD-03
Perforatorium	
NÄGELE Perforatorium	HC-09
SMELLIE Perforatorium	HC-09
PERTHES Reibhalen	DD-08
PESTALOZZA Plazentar und Abortus Löffel	HC-08
PETRI Schale	HE-08

PETZ Magen- und Darmnäh Apparat	GE-09
Pflaster Spatel	CA-03
PHANEUF Peritoneum Klemme	BC-17
Pick	EE-15
BARBARA	EE-14 bis EE-15
PIERCE Trokar	CC-02
PIFFARD Lupus Kürette	HE-02
PINARD Stethoskop	AC-06
Pinzette	BA-02
ADLERKREUTZ Pinzette	BA-04
ADSON Pinzette	BA-03
ADSON-BROWN Pinzette	BA-03
ADSON Hypophysen Pinzette	EA-06
ADSON Mikro Pinzette	BA-03
ARCHER Splitter Pinzette	BA-06
ARRUGA Kapsel Pinzette	ED-04
AYER Chalazion Pinzette	ED-06
BARRAQUER KATZIN Iris Pinzette	EC-13
BARRAQUER Colibri Iris Pinzette	EC-13
BARRAQUER Cilien Pinzette	ED-08
BARRAQUER Fixier Pinzette	ED-03
BARRAQUER Vorderkammer Pinzette	ED-02
BEER Cilien Pinzette	ED-08
BERKE Muskel Pinzette	ED-02
Bipolare Koagulation Pinzette	JA-04 bis JA-06
BISHOP-HARMAN Iris Pinzette	EC-14
BONACCOLTO Strabismus Pinzette	EC-14
Bonn Iris Pinzette	EC-15
Bonn TITAN Iris Pinzette	EC-15
BROWN Pinzette	BA-03
CARMALT Splitter Pinzette	BA-06
CASTROVIEJO Fixier Pinzette	ED-03
CASTROVIEJO Kapsel Pinzette	ED-04
CASTROVIEJO Naht Pinzette	ED-05
Cilien Pinzette	ED-08
COLLIN-DUVAL Pinzette	BA-04
COOLEY Atraumatische Pinzette	BB-03
CUSHING Pinzette	BA-03
DASTOOR Strabismus Pinzette	EC-14
DE BAKEY Atraumatische Pinzette	BB-03
DESMARRES Chalazion Pinzette	ED-06
DOUGLAS Cilien Pinzette	ED-08
DUVAL Pinzette	BA-04
ELSCHNIG Fixier Pinzette	ED-03
ELSCHNIG Kapsel Pinzette	ED-04
FEILCHENFELD Splitter Pinzette	BA-06
FERRIS Pinzette	BA-04
FISCHER Iris Pinzette	EC-13
FOERSTER Iris Pinzette	EC-12
FUCHS Kapsel Pinzette	ED-04
GERALD Pinzette	BA-05
GILL-ARRUGA Kapsel Pinzette	ED-03
GILL-HESS Iris Pinzette	EC-12
GILLIES Pinzette	BA-05
GILL Iris Pinzette	EC-12
GRADLE Cilien Pinzette	ED-08
GRAEFE Pinzette	BA-03
GRAEFE Fixier Pinzette	ED-03
GRAEFE Iris Pinzette	EC-11
GREEN Fixier Pinzette	ED-03
HESS Iris Pinzette	EC-12
HESS Kapsel Pinzette	ED-04
HUNTER Splitter Pinzette	BA-06
JACKSON Tampon Pinzette	FC-02
JAMESON Strabismus Pinzette	EC-13
KALT Kapsel Pinzette	ED-04
KIRBY-ARTHUR Iris Pinzette	EC-13
KNAPP-LUER Tracho. Pinzette	ED-06
LAMBERT Chalazion Pinzette	ED-06
LANE Pinzette	BA-04
LERCHE Pinzette	BA-04

LESTER Fixier Pinzette	ED-03
Pinzette	
LITTAUER Cilien Pinzette	ED-08
LUCAE Ohr Pinzette	EE-07
MARSCHIK Tonsillen Pinzette	FA-04
McCULLOUGH Strabismus Pinzette	EC-13
McINDOE Pinzette	BA-04
McPHERSON Faden Pinzette	ED-05
McPHERSON TITAN Faden Pinzette	ED-05
MOORFIELD Naht Pinzette	ED-05
NELSON Pinzette	BA-05
NEUBÜSER Tuben Faß Pinzette	HA-51
PAUFIQUE Faden	ED-05
PAUFIQUE TITAN Faden Pinzette	ED-05
PEET Splitter Pinzette	BA-06
POTTS-SMITH Pinzette	BA-02
PRINCE Muskel Pinzette	ED-02
RUSSIAN Pinzette	BA-04
SCHWEIGGER Kapsel Pinzette	ED-04
SEMKEN Pinzette	BA-05
SINGLEY Pinzette	BA-05
SNELLEN Entropium Pinzette	ED-06
STEVENS Iris Pinzette	EC-11
STIEGLITZ Splitter Pinzette	BA-06
STILLE Pinzette	BA-02
St. MARTIN Naht Pinzette	ED-05
TERSON Kapsel Pinzette	ED-04
TROUTMAN Colibri Iris Pinzette	EC-13
TROUTMAN Rectus Pinzette	ED-02
Tübingen Faden Pinzette	ED-05
Tübingen Iris Pinzette	EC-15
Tübingen TITAN Faden Pinzette	ED-05
Tübingen TITAN Iris Pinzette	EC-15
USA Pinzette	BA-02
VIRTUS (RALK) Splitter Pinzette	BA-06
WANGENSTEEN Pinzette	BA-05
WILDE (TROELTSCH) Ohr Pinzette	EE-07
PIPER	
Geburts Zange, mit Achsenzugvorrichtung	HC-04
Geburts Zange	HC-04
Platte JAEGER Lid	EC-03
PLESTER	
Lappen Messer	EE-14
Wund Sperrer	BI-14
POLITZER	
Luftdusche	EE-05
Ohr Messer	EE-06
Parazentesenadeln Nadel	EE-06
POOLE Sauger	AE-02
POTTS	
Atraumatische Anastomosen Klemme	BD-05
Atraumatische Coarctation Klemme	BD-04
Atraumatische Klemme	BD-26 bis BD-27
POTTS DE MARTEL	
Gefäß Schere	AI-27
POTTS-SMITH	
Gefäß Schere	AH-19
Gefäß Schere	AI-28
Pinzette	BA-02
POZZI Haken Zange	HA-31
Präparier Schere	AI-34
PRATT	
Arterien Klemme	BC-08
Cystikus Haken	GI-04
Haken Zange	HA-34 bis HA-35
Rektal Spekulum	GI-02
Uterus Dilatator	HA-29
PRESBYTERIAN HOSPITAL Schlauch Klemme	BC-19
PRICE-THOMAS Bronchus Klemme	FG-22
PRINCE	
Muskel Pinzette	ED-02

D

Inhaltsverzeichnis Deutsch

Tonsillen Schere	AI-27
Proktoskop KELLY	GI-04
PROVIDENCE-HOSPITAL Arterien Klemme	BC-05
Pulverbläser KABIERSKE	EE-04
PUTTI Knochen Raspel	DC-25

Q

QUATTRO Gips Spreizer	DA-03
Quetscher	
SAALFELD Komedonen Quetscher	HE-02
SCHAMBERG Komedonen Quetscher	HE-02
UNNA Komedonen Quetscher	HE-02
WALTON Komedonen Quetscher	HE-02
QUINBY Zahnfleisch Schere	AI-42
QUINKE Punktions Nadel	CC-03
QUIRE Fremdkörper Hebel	EE-08
QUISLING Hammer	DC-18

R

RADOLF Nagelausreiss Zange	DD-03
Rahmen KIRSCHNER	BI-23
RALK Handbohr Apparat	DD-05
RAMPLEY Schwamm Zange	BG-09
RANDALL	
Nierenstein Zange	GC-11 bis GC-12
Uterus Biopsie Saug Kürette	HA-40
RANEY	
Anlege- und Abnahme Zange	EA-03
Kopfhaut Klammer	EA-03
RANKIN Atraumatische Klemme	BD-02
Rasierer	AG-14
Rasierer Klinge	AG-14
Rasier Messer	AG-19
Rasiermesser Ersatz Klängen	AG-19
Raspatorien	
ALEXANDER Raspatorien	DC-19
DOYEN Rippen Raspatorien	DC-20
FARABEUF Raspatorien	DC-19
LAMBOTTE Raspatorien	DC-19
LANGENBECK Raspatorien	DC-19
MATSON Raspatorien	DC-21
OVERHOLT Raspatorien	DC-21
SADILLOT Raspatorien	DC-19
SEMB Raspatorien	DC-20
WILLIGER Raspatorien	DC-19
Raspel	
FOMON Nasen Raspel	EG-15 bis EG-16
GALLAHER Antrum Raspel	EG-16
JOSEPH (LEWIS) Nasen Raspel	EG-15
Knochen Raspel	DC-25
MALTZ (COTTLE) Nasen Raspel	EG-15
MALTZ Nasen Raspel	EG-14
PUTTI Knochen Raspel	DC-25
WIENER (AUFRICHT) Nasen Raspel	EG-15
WIENER Nasen Raspel	EG-15
RECAIMER Uterus Kürette	HA-49 bis HA-50
Reibhalen	DD-08
PERTHES Reibhalen	DD-08
REICHERT Kehldedeckel Halter	FC-02
REINER	
Gips Messer	DA-04
Ohr Spritze	EE-05
Reinigungs Bürste	CI-04 bis CI-05
Retraktor PERCY Amputation	DD-03
REVERDIN	
Unterbindungs Nadel	CG-03
Wund Haken	BI-04
REYNOLDS Schere	AH-15, AI-18
Rhachiotom	DC-17

RIBBON Wund Haken	BI-04
RICHARDSON-EASTMAN Wund Haken	BI-04
RICHARDSON Grip Wund Haken	BI-04
RICHARDSON Wund Haken	BI-04
RICHTER-HEATH Wundklammer Zange	CG-07
RIGBY Bauch Deckenhalter	BI-24
Ringstripper	CA-03
ROBB Gefäß Dissektor	FG-33
ROBERTS Arterien Klemme	BC-11
ROCHESTER-CARMALT Arterien Klemme	BC-07
ROCHESTER-OCHSNER Arterien Klemme	BC-06
ROCHESTER-PEAN Arterien Klemme	BC-06
ROEDER Tuch Klemme	BE-03
ROGER Septum Elevatorium	EG-11
ROGGE Sterilisier Zange	CI-02
Rohr BRUENINGS Verlängerung	FC-03
ROLLET	
Extirpations Meißel	EC-06
Häkchen	EC-06
ROSENBERG Kehlkopf Zange	FC-03
ROSEN	
Nadel	EE-14 bis EE-15
Rundschnitt Messer	EE-14
ROSER-KOENIG Mund Sperrer	EI-03
ROSE Tracheal Häkchen	FE-03
ROTES KREUZ Verband Schere	AI-47
ROUX Baby Wund Haken	BI-02
ROUX mini Wund Haken	BI-02
ROUX Wund Haken	BI-02
ROWE Mund Zange	EI-06
RUBIN Septum Quetsch Zange	EG-07
RUMEL Thorax Klemme	BC-11
RUSKIN Hohlmeißel Zange	DC-04
RUSKIN-LISTON Knochensplitter Zange	DC-06
RUSSIAN Pinzette	BA-04
RYDEL-SEIFFER Stimmgabel	EE-04
RYDER Nadelhalter	CE-03

S

SAALFELD Komedonen Quetscher	HE-02
SACHS	
Dura Dissektor	EA-05
Nerv Haken	EA-04
SADILLOT Raspatorien	DC-19
SAENGER Plazentar und Abortus Zange	HC-07
Säge	
BERGMANN Gips Säge	DA-02
Sägeblatt CHARRIERE	DD-03
Säge	
CHARRIERE Amputations Säge	DD-03
DIMEDA Fingerring Säge	DD-03
ENGEL Gips Säge	DA-02
Fingerring Säge	DD-03
JOSEPH Nasen Säge	EG-17
LANGENBECK Finger Säge	DD-03
OLIVECRONA Draht Säge	EA-05
WIGMORE Gips Säge	DA-02
SAIRGES Haken Zange	HA-32
Salpingograph SCHULTZE	HA-47
SANVENERO Schere	AH-13, AI-16
SAROT	
Arterien Bronchus Klemme	BC-12
Bronchus Klemme	FG-23
Nadelhalter	CE-04
SATINSKY	
Anastomosen (Vena Cava) Klemme	FG-24 bis FG-25
Atraumatische Klemme	BD-20
Lungen und Thorax Schere	AI-37
SATO Hornhaut Messer	EC-05
SAUERBRUCH	
Abfall Zange	CI-03

SAUERBRUCH-FREY Rippen Schere	FG-06
SAUERBRUCH	
Hohlmeißel Zange	DC-05
Nadel Dose	HE-02
Rippen Schere	FG-05
Wund Haken	BI-13
Sauger	
ANDREWS-PINCHON Sauger	AE-03
DASTOOR Kapsel Sauger	EC-09
DE BAKEY Sauger	AE-04
FRAZIER Sauger	EA-07
MAGILL Sauger	AE-04
NUBOER Sauger	AE-05
POOLE Sauger	AE-02
WALTON YANKAUER Sauger	AE-03
YANKAUER Sauger	AE-02
SAWTELL Tonsillen Klemme	FA-03
SCAGLIETTI Hohlmeißel Zange	DC-05
Schaber KUHNT Hornhaut	EC-05
Schädelhalter CRUTCHFIELD	EA-03
Schädelzange De VILBISS	EA-05
Schale	
Instrumenten Schale	HE-08 bis HE-09
Lösungs Schale	HE-04
Nieren Schale	HE-07
PETRI Schale	HE-08
Spül- Schale	HE-05
SCHAMBERG Komedonen Quetscher	HE-02
SCHEDE Scharf Löffel	DC-12
SCHEIE	
Augen Kanüle	ED-07
Goniotomie Messer	EC-05
SCHEINMANN Kehlkopf Zange	FC-03
SCHERBAK Vaginal Spekulum	HA-21
Schere	AH-02 bis AH-04, AI-02 bis AI-04
AEBLI Hornhaut Schere	AI-22
BARRAQUER Colibri Schere	AJ-04
BEEBEE Draht und Blech Schere	AI-43
BELLUCCI Ohr Mikro Schere	EE-09
BERGMANN Verband Schere	AI-46
BETHUNE Rippen Schere	FG-04
BEUSE Schere	AI-26
BOETTCHER Tonsillen Schere	AI-27
BRAUN-STADLER Episiotomie Schere	AH-22, AI-34
BRUNNER Rippen Schere	FG-07
BRUNS Gips Schere	AI-48
BUCK Ligatur Schere	AI-40
BUSCH Nabelschnur Schere	AI-34
CASTROVIEJO Hornhaut Schere	AJ-06
CASTROVIEJO Iridectomie Schere	AJ-05
COOLEY Rippen Schere	FG-05
CORYLLOS Rippen Schere	FG-04
COTTLE Nasen Schere	AH-18, AI-25
CRAFOORD Lungen und Thorax Schere	AI-36
DANDY Neurochirurgische Schere	AI-36
DEAN Tonsillen Schere	AI-26
DEAVER Schere	AH-05, AI-06
DE BAKEY Gefäß Schere	AI-30
DIETHRICH Gefäß Schere	AI-29
DIMEDA Verband Schere	AI-46
DOYEN Gynäkologische Schere	AI-33
DUBOIS Gynäkologische Schere	AI-33
ESMARCH Verband Schere	AI-46
FERGUSON Schere	AI-49
FINOCHIETTO Rektum Schere	AI-38
FOMON Nasen Schere	AH-18, AI-25
GIERTZ-STILLE Rippen Schere	FG-06
GLUCK Rippen Schere	FG-03
GOLDMAN-FOX Zahnfleisch Schere	AI-41
GOOD Tonsillen Schere	AI-27

GORNEY Präparier Schere	AI-13
Haut Schere	HE-03
Schere	
HEATH Ligatur Schere	AI-40
HEYMANN Nasen Schere	AH-18, AI-25
IRIS Schere	AH-16, AI-21
IRIS Augen Schere	AI-22
IRIS Schere, große Ringe	AI-19
JACOBSON Mikro Schere	AJ-11
JOSEPH Schere	AH-14, AI-16
KELLY Gynaekologische Schere	AI-33
KELLY Gynäkologische Schere	AH-22
KILNER Schere	AH-14, AI-17
KLINKENBERGH-LOTH Lungen- Thorax Schere	AI-37
KNAPP Schere	AI-20
KNOWLES Verband Schere	AI-47
LAGRANGE Zahnfleisch Schere	AI-41
LANDOLT Enukeleations Schere	AI-25
LANGE Verband Schere	AI-44
LEXER Schere	AH-09
LEXER-BABY Schere	AH-10
LEXER-BABY Präparier Schere	AI-12
LEXER-FINO Präparier Schere	AI-12
LEXER Präparier Schere	AI-11
LISTER Verband Schere	AH-23, AI-45
LITTAUER Ligatur Schere	AI-40
LITTLER Präparier Schere	AI-13
LOCKLIN Schere	AI-18
LORENZ Verband Schere	AI-47
MAYO Schere	AH-06, AI-07
MAYO Linkshänder Schere	AI-07
MAYO-NOBLE Schere	AH-08, AI-10
MAYO-STILLE Schere	AH-07, AI-08 bis AI-09
McGUIRE Hornhaut Schere	AJ-05
McINDOE Knorpel Schere	AI-35
McPHERSON WESTCOTT Sehnen Schere	AJ-04
METZENBAUM Schere	AH-11
METZENBAUM FINO Schere	AH-12
METZENBAUM FINO Präparier Schere	AI-15
METZENBAUM Präparier Schere	AI-13 bis AI-14
METZENBAUM "S" Schere	AH-13, AI-16
MILLS Gefäß Schere	AI-27
Nagel Schere	HE-03
NORTHBENT Ligatur Schere	AI-40
NOYES Iris Schere	AJ-03 bis AJ-04
NOYES Sehnen Schere	AJ-03
Ohr Mikro Schere	EE-11
Ohr Mikro Mini Schere	EE-11
Parametrium Gefäß Schere	AH-20
POTTS DE MARTEL Gefäß Schere	AI-27
POTTS-SMITH Gefäß Schere	AH-19
POTTS-SMITH Gefäß Schere	AI-28
PRINCE Tonsillen Schere	AI-27
QUINBY Zahnfleisch Schere	AI-42
REYNOLDS Schere	AH-15, AI-18
Rippen Schere	FG-02
ROTES KREUZ Verband Schere	AI-47
SANVENERO Schere	AH-13, AI-16
SATINSKY Lungen und Thorax Schere	AI-37
SAUERBRUCH-FREY Rippen Schere	FG-06
SAUERBRUCH Rippen Schere	FG-05
SCHMIEDEN-TAYLOR Schere	AI-36
SCHUMACHER Nabelschnur Schere	AI-34
SCHUMACHER Sternum Schere	FG-07
SEUTIN Gips Schere	DA-02
SHEA Ohr Mikro Schere	EE-09
SHORTBENT Ligatur Schere	AI-40
SIEBOLD Gynäkologische Schere	AI-32
SIEBOLD Gynäkologische Schere	AH-21
SIMS Gynäkologische Schere	AI-32
SIMS Gynäkologische Schere	AH-21

D

Inhaltsverzeichnis Deutsch

SMITH US ARMY Verband Schere	AI-44	Nabelschnur Schere	AI-34
SPENCER Ligatur Schere	AI-40	SCHUMACHER	
Schere		Probeexcisions Zange	HA-43
STELZNER Rektum Schere	AI-38	Sternum Schere	FG-07
STEVENS Tenotomie Schere	AH-17, AI-23	Schützer ARRUGA Netzhaut Ablös.	EC-08
STILLE Gips Schere	DA-02	Schutzhülse Gewebe	DD-15
STILLE Rippen Schere	FG-03	SCHWEIGGER Kapsel Pinzette	ED-04
Strabismus Schere	AH-17	Schwestern Garnitur	HE-03
STRULLY Neurochirurgische Schere	AI-35	SEEMANN-SEIFFERT Mund Sperrer	EI-04
THOREK Lungen und Thorax Schere	AI-36	SEGOND Myom Messer	HA-46
TOENNIS-ADSON Neurochirurgische Schere	AI-35	SEIFFERT Kehlkopf Zange	FC-03
TROUTMAN-CASTROVIEJO Mikro Schere	AJ-07	SELLHEIM Geburts Löffel	HC-09
UNIVERSAL Draht und Blech Schere	AI-42	SELLORS Rippen Kontraktor	FG-18
UNIVERSAL Verband Schere	AI-50	SEMB	
USA MODEL Nabelschnur Schere	AI-34	Bronchus Klemme	FG-23
VANNAS Iridectomie Schere	AJ-05	Hohlmeißel Zange	DC-06
VANNAS Mikro Schere	AJ-12 bis AJ-13	Knochenhalte Zange	DC-07
WAGNER Schere	AH-22	Knochensplitter Zange	DC-07
WAGNER Zahnfleisch Schere	AI-42	Raspatorien	DC-20
WALDMANN Episiotomie Schere	AI-34	SEMKEN Pinzette	BA-05
WECKER Iris Schere	AJ-04	SEMM Vaginal Spekulum	HA-07
WERTHEIM Praeparier Schere	AI-32	SENN-GREEN Wund Haken	BI-07
WESTCOTT Iridectomie Schere	AJ-02	SENN Wund Haken	BI-04
WESTCOTT Sehnen Schere	AJ-02	Septatom BRUENINGS	EG-11
WULLSTEIN Ohr Mikro Schere	EE-11	Sequester Zange	DC-10
WULLSTEIN Ohr Mikro Mini Schere	EE-11	SEUTIN Gips Schere	DA-02
YASARGIL Mikro Schere	AJ-10 bis AJ-11	SEXTON Ohr Messer	EE-06
SCHIMMELBUSCH Sterilisier Trommel	HE-12	SHEA Ohr Mikro Schere	EE-09
SCHINK Dermatome	AG-21	SHORTBENT Ligatur Schere	AI-40
SCHIOETZ Tonometer	ED-08	Sieb Auffang	HA-22
Schlanke Schere	AI-05	SIEBOLD	
Schlauch Klemme	BC-19	Gynäkologische Schere	AI-32
Schlinge		Gynäkologische Schere	AH-21
ARLT Draht Schlinge	EC-08	Siebschale	
BILLEAU Ohr Schlinge	EE-07	aus Drahtgeflecht	HE-13
Elektrode Mini Schlinge	JA-02 bis JA-03	aus perforiertem Blech	HE-13
Schlingen		SIEGLE Ohr Spekula	EE-02
Nasen Schlingen	EG-09	SIEGLER HELLMANN Uterus-Faß Zange	HA-38
Tonsillen Schlingen	FA-04	SILVER	
Schlinge		Dermatom	AG-20
Ohr Schlinge	EE-07	Nasenplastik Meißel	EG-14
SNELLEN Draht Schlinge	EC-08	SIMCOE Naht Kanüle	ED-07
WEBER Draht Schlinge	EC-08	SIMON	
WILDER Draht Schlinge	EC-08	Scharf Löffel	DC-13
SCHMIEDEN Führungshohl Sonde	CG-04	Uterus Kürette	HA-48
SCHMIEDEN-PAYR Führungshohl Sonde	CG-04	Wund Haken	BI-12
SCHMIEDEN-TAYLOR Schere	AI-36	SIMPSON-BRAUN Geburts Zange	HC-02
Schneider		SIMPSON Geburts Zange	HC-02
DIAMANT Draht Schneider	DD-12	SIMPSON-LUIKART Geburts Zange	HC-03
Draht Schneider	DD-12	SIMS	
SCHNIDT Tonsillen Klemme	FA-03	Gynäkologische Schere	AI-32
Schnürer		Gynäkologische Schere	AH-21
BRUENINGS Tonsillen Schnürer	FA-04	SIMS-MAIER Tupfer Zange	BG-05
EVES Tonsillen Schnürer	FA-04	SIMS	
KRAUSE Nasen Schnürer	EG-09	Rektal Spekulum	GI-02
KRAUSE Ohrpolypen Schnürer	EE-07	Uterus Depressor	HA-39
TYDING Tonsillen Schnürer	FA-05	Uterus Dilatator	HA-30
WESTON Rektal Polypen Schnürer	GI-05	Uterus Kürette	HA-49 bis HA-50
WILDE Nasen Schnürer	EG-09	Uterus Sonde	HA-39
WILDE Ohrpolypen Schnürer	EE-07	Vaginal Spekulum	HA-17
SCHOENBORN Schilddrüsen Haken	FE-04	SINGLEY Pinzette	BA-05
SCHOENBURG Darmfaß Zange	GE-03	Skalpell Abnehmer	AG-06, AG-10
SCHROEDER		Skalpell Griff	AG-02 bis AG-05, AG-07 bis AG-08
Haken Zange	HA-31 bis HA-32	Skalpellgriff	
Uterus Kürette	HA-48	CASPAR Mikro Skalpellgriff	AG-12
SCHUBERT Probeexcisions Zange	HA-41	LANDOLT Mikro Skalpellgriff	AG-13
SCHUKNECHT		Skalpell	
Roll Messer	EE-14	JOSEPH Nasen	EG-10
Sichel Messer	EE-14	Skalpell Klinge	AG-06
SCHULTZE Salpingograph	HA-47	Skalpell	
SCHUMACHER		PARKER anatomische Skalpell	AG-15
Kehlkopf Zange	FC-03		

Steril, Mikro Klinge	AG-13
Skarifrikateur GRAEFE	EC-04
SKENE Haken Zange	HA-31
Sklerotom	
GUYTON-LUNDSGAARD Sklerotom	EC-05
LUNDSGAARD Sklerotom	EC-05
SLUDER-BALLENGER Tonsillotom	FA-05
SMELLIE	
Geburts Haken	HC-06
Perforatorium	HC-09
SMILLIE Meniskotom	DC-24
SMITH-BUIE Mastdarm Spreizer	GI-03
SMITH-PETERSEN	
Flachmeißel	DC-15
Hohlmeißel	DC-15
SMITH Sperr Elevator	EC-02
SMITH US ARMY Verband Schere	AI-44
SMITHWICK	
Clip-Anlege Zange	EA-02
Nerv Haken	EA-04
SNELLEN	
Draht Schlinge	EC-08
Entropium Pinzette	ED-06
SOMER Uterus-Faß Zange	HA-37
Sonde	CA-02
BOWMAN Tränenkanal Sonde	EC-10
BRUNNER Fuehrungshohl Sonde	CG-04
COLLIN Uterus Sonde	HA-39
DESJARDINS Gallenstein Sonde	GC-05
DOYEN Sonde	CA-02
GUYON Gleit Sonde	GG-12
KIRSCHNER Fuehrungshohl Sonde	CG-04
KOCHER Kropf	FE-04
KOENIG Fuehrungshohl Sonde	CG-04
Markierung Sonde	EE-15
MARTIN Uterus Sonde	HA-39
MAYO Nierenstein Sonde	GC-10
MOYNIHAN Gallenstein Sonde	GC-05
NABATOFF Varicen Besteck Ohr Sonde	CA-02
PAYR Fuehrungshohl Sonde	CG-04
SCHMIEDEN Fuehrungshohl Sonde	CG-04
SCHMIEDEN-PAYR Fuehrungshohl Sonde	CG-04
SIMS Uterus Sonde	HA-39
STACKE Ohr Sonde	CA-02
VALLEIX Uterus Sonde	HA-39
Spalter VIRCHOW Schaedel	DC-17
Spanner LOUTE Draht	DD-11
Spannplatte	AG-21
Spannschluessel für Extensionbügel	DD-10
Spatel	
ALLISON Lungen Spatel	FG-19
ANDREW Zungen Spatel	EI-02
BANGERTER Cyclodialyse Spatel	EC-08
BRUENINGS Zungen Spatel	EI-02
BUCHWALD Zungen Spatel	EI-02
CASTROVIEJO Cyclodialyse Spatel	EC-08 bis EC-09
CULLER Iris Spatel	EC-08
CUSHING Hirn Spatel	EA-07
ELSCHNIG Cyclodialyse Spatel	EC-08
FRENZEL Zungen Spatel	EI-02
HARTMANN Zungen Spatel	EI-02
HEIFETZ Hirn Spatel	EA-07
Holz Zungen Spatel	EI-02
Intima Spatel	FG-32
KOCHER Blasen Spatel	GG-04
LEGUEU Blasen Spatel	GG-04
McIVOR Zungen Spatel	EI-05
OLIVECRONA Hirn Spatel	EA-07
TOBOLD Zungen Spatel	EI-02
WECKER Iris Spatel	EC-08

WHEELER Cyclodialyse Spatel	EC-09
WIEDER Zungen Spatel	EI-02
Spekula	
BOUCHERON Ohr Spekula	EE-02
BRUENINGS Ohr Spekula	EE-02
GRUBER Ohr Spekula	EE-02
HARTMANN Ohr Spekula	EE-02
SIEGLE Ohr Spekula	EE-02
TOYNBEE Ohr Spekula	EE-02
Spekulum	
AUVARD Vaginal Spekulum	HA-19
BARR Rektal Spekulum	GI-02
BERLIND-AUVARD Vaginal Spekulum	HA-19
BODENHAMMER Rektal Spekulum	GI-02
BRAUN Vaginal Spekulum	HA-16
BREISKY Vaginal Spekulum	HA-20
COLLIN Vaginal Spekulum	HA-04
COTTLE Nasen Spekulum	EG-03
CUSCO Vaginal Spekulum	HA-04 bis HA-06
CZERNY Rektal Spekulum	GI-02
DOYEN Vaginal Spekulum	HA-18, HA-20
FREEWAY-GRAVE Vaginal Spekulum	HA-06
GRAVE Vaginal Spekulum	HA-02
HARTMANN-HALLE Nasen Spekulum	EG-02
JACKSON Vaginal Spekulum	HA-16
KALLMORGEN Vagina Spekulum	HA-15
KILLIAN Septum Spekulum	EG-03
KOGAN Endo Spekulum	HA-23
KRISTELLER Vaginal Spekulum	HA-09 bis HA-14
LANDAU Vaginal Spekulum	HA-22
MATHIEU Rektal Spekulum	GI-02
O'SULLIVAN-O'CONNOR Vaginal Spekulum	HA-08
PEDERSON Vaginal Spekulum	HA-03
PRATT Rektal Spekulum	GI-02
SCHERBAK Vaginal Spekulum	HA-21
SEMM Vaginal Spekulum	HA-07
SIMS Rektal Spekulum	GI-02
SIMS Vaginal Spekulum	HA-17
STEINER-AUVARD Vaginal Spekulum	HA-19
THUDICHUM Nasen Spekulum	EG-02
TIECK-HALLE Nasen Spekulum	EG-03
TRELAT Vaginal Spekulum	HA-07
Vienna Nasen Spekulum	EG-02
VOLTOLINI Nasen Spekulum	EG-02
WEISSBARTH Vaginal Spekulum	HA-22
YANKAUER Nasenrachen Spekulum	EG-04
SPENCER Ligatur Schere	AI-40
SPENCER-WELLS Arterien Klemme	BC-07
Sperre BOSE Tracheal	FE-02
Sperrer	
ADSON Baby Wund Sperrer	BI-15
ADSON Wund Sperrer	BI-15
ALM Wund Sperrer	BI-14
BECKMANN-ADSON Wund Sperrer	BI-15
BECKMANN-EATON Wund Sperrer	BI-16
BECKMANN Wund Sperrer	BI-16
CASPAR ges. Wirbelsäule Wund Sperrer	BI-19
CASPAR Wund Sperrer	BI-20
CASTAÑEDA Rippen Sperrer	FG-14
CHEVALLIER Rippen Sperrer	FG-15
CLOWARD Wund Sperrer	BI-17
COOLEY Rippen Sperrer	FG-09
DARLING Wund Sperrer	BI-17
DAVIS-BOYLE Mund Sperrer	EI-04
DENHART Mund Sperrer	EI-03
DIMEDA Wund Sperrer	BI-14
DOYEN-JANSEN Mund Sperrer	EI-03
FINOCHIETTO-BABY Rippen Sperrer	FG-09
FINOCHIETTO BURFORD Rippen	FG-12 bis FG-14
FINOCHIETTO-HAIGHT BABY Rippen Sperrer	FG-10
FINOCHIETTO INFANT Rippen Sperrer	FG-12

D

Inhaltsverzeichnis Deutsch

FINOCHIETTO (modif) Rippen Sperrer	FG-08	Flach Halb	HE-30 bis HE-31
FINOCHIETTO Rippen Sperrer	FG-08, FG-10 bis FG-11	Große	HE-18 bis HE-20
Sperrer		Sterilisier Container	
FINSEN Wund Sperrer	BI-14	Halb	HE-26 bis HE-29
FRIEDMAN Perineorrhaph Sperrer	HA-23	Kleine	HE-32 bis HE-33
HAIGHT Rippen Sperrer	FG-15	Spezial	HE-34 bis HE-37
HEISTER Mund Sperrer	EI-03	Sterilisier Zange	CI-02
HERTZLER Rippen Sperrer	FG-17	Steril Skalpell Klinge	AG-09
JANSEN Wund Sperrer	BI-14	STERNBERG Lippen Halter	EI-02
JENNINGS Mund Sperrer	EI-04	Sternummeißel LEBSCHKE	DC-17
KILNER-DOUGHTY Mund Sperrer	EI-05	Stethoskop	
McIVOR Mund Sperrer	EI-05	BOWLES Stethoskop	AC-06
MERCEDES Thorax Sperrer	FG-16	FORD Stethoskop	AC-06
MILLIN Blasenhalshals Sperrer	GG-07	FORD BOWLES Stethoskop	AC-06
MOLLISON Wund Sperrer	BI-17	PINARD Stethoskop	AC-06
MORSE-FAVOLORO Rippen Sperrer	FG-17	STEVENS	
PLESTER Wund Sperrer	BI-14	Iris Pinzette	EC-11
ROSER-KOENIG Mund Sperrer	EI-03	Linsen Haken	EC-06
SEEMANN-SEIFFERT Mund Sperrer	EI-04	Nadelhalter	CE-06
TUFFIER Rippen Sperrer	FG-16	STEVENS Sperr Elevator	EC-03
WEITLANER-WULLSTEIN Wund Sperrer	BI-14	STEVENS	
WEITLANER Wund Sperrer	BI-14	Tenotomie Schere	AH-17, AI-23
WHITEHEAD Mund Sperrer	EI-04	STIEGLITZ Splitter Pinzette	BA-06
Spiegel		STILLE	
Kehlkopf Spiegel	FC-04	Flachmeißel	DC-14
MICHEL Spiegel	EG-04	Gips Schere	DA-02
Spiralbohrer	DD-04	Handbohr Apparat	DD-04
Splitter Pinzette	BA-06	Hohlmeißel	DC-14
SPRATT Scharf Löffel	DC-12	STILLE-HORSLEY Knochensplitter Zange	DC-07
Spreizer		STILLE-LISTON Knochensplitter Zange	DC-06
ALAN-PARKS Mastdarm Spreizer	GI-03	STILLE-LUER Hohlmeißel Zange	DC-04
BEESON Gips Spreizer	DA-03	STILLE	
CASPAR Cervical Wirbelsäule Wund Spreizer	BI-18	Nierenstiel Klemme	BC-16
CASPAR Muskelab Spreizer	BI-20	Osteotom	DC-14
CLOWARD Wirbelkörper Spreizer	EA-07	Pinzette	BA-02
FRAZIER Wund Spreizer	BI-21	Rippen Schere	FG-03
HAGLUND-STILLE Gips Spreizer	DA-03	STILLE-RUSKIN Hohlmeißel Zange	DC-05
HENNIG Gips Spreizer	DA-03	STILLE-SHERMAN Handbohr Apparat	DD-04
HERMANN Gips Spreizer	DA-03	Stimmgabel	EE-04
INGE Wirbelkörper Spreizer	EA-07	DIMEDA Alu	EE-03
QUATTRO Gips Spreizer	DA-03	HARTMANN	EE-03
SMITH-BUIE Mastdarm Spreizer	GI-03	LUCAE	EE-04
Spreizweite BROCK für Herz-Dilatatoren	FG-26	RYDEL-SEIFFER	EE-04
Spritze		Stirnlampe CLAR	AC-05
REINER Ohr Spritze	EE-05	Stirnspiegel ZIEGLER	AC-05
Tonsillen Spritze	FA-05	St. MARTIN Naht Pinzette	ED-05
SPURLING Laminektomie Zange	EA-08	STOCKMANN Penis Klemme	GG-10
STACKE Ohr Sonde	CA-02	STONE Verschluss Klemme	GE-06
Standard Laryngoskopgriff	AE-17	STONE-WATT Darm Klemme	GE-06
Standard Naht Besteck	CG-08	Strabismus Schere	AH-17, AI-24
Standgefäß	HE-08	STRATTE Nadelhalter	CE-04
Stanzbesteck KEYES Haut	HE-02	STRAUSS Penis Klemme	GG-10
Stanze		Stripper BUNNELL Sehnen	DC-25
BEYER Stanze	EG-08	STRUEMPEL Ohr Zängchen	EE-08
BROCK für Herz-Dilatatoren	FG-26	STRULLY Neurochirurgische Schere	AI-35
CITELLI Stanze	EG-08	STRUYCKEN Nasen scharfe Zange	EG-07
COLCLOUGH Bandscheiben Stanze	EA-11	SUBRAMANIAN Atraumatische Klemme	BD-31
DIETER Hammerkopf Stanze	EE-10	SWEET Clip-Anlege Zange	EA-02
FERRIS-SMITH-KERRISON Bandscheiben Stanze	EA-10		
HAJEK-CLAUS Stanze	EG-08	T	
HAJEK-KOFLER Stanze	EG-08	TABB Sichel Messer	EE-14
HOLTH Kapsel Stanze	EC-09	Tampon Stopfer LUNIATSCHEK	FA-02
KERRISON Stanze	EG-08	TARNIER	
STAUDE-MOORE Haken Zange	HA-31	Geburts, mit Achsenzugvorrichtung Zange	HC-05
St. CLAIR-THOMSON Ring Messer	EG-19	Kranioklast	HC-09
STEINER-AUVARD Vaginal Spekulum	HA-19	TAYLOR	
STEINMANN Knochen Nagel	DD-09	Perkussions Hammer	AC-07
STELZNER Rektum Schere	AI-38	Spinal Haken	DC-24
Steril Einmalskalpell	AG-10 bis AG-11	TEALE Haken Zange	HA-33
Sterilisier Container		TERSON Kapsel Pinzette	ED-04
3/4	HE-22 bis HE-24		

THOMS-ALLIS Darmfaß Zange.....	GE-02	TURNBULL Nagel Zange.....	HE-03
THOMS-GAYLOR Probeexcisions Zange.....	HA-42	TURREL Biopsie Zange.....	GI-05
THOMSON-WALKER Blasen Wundsperrer.....	GG-06	TYDING	
THOREK Lungen und Thorax Schere.....	AI-36	Tonsillen Fass Zange.....	FA-04
THUDICHUM Nasen Spekulum.....	EG-02	Tonsillen Schnürer.....	FA-05
TIECK-HALLE Nasen Spekulum.....	EG-03		
TIEMANN Haken Zange.....	HA-32	U	
TILLEY Ohr Zängchen.....	EE-08	UCKERMANN	
TISCHLER-KEVORKIAN		Tracheal Trokar.....	FE-02
Probeexcisions Zange.....	HA-44 bis HA-45	Watteträger.....	CA-03
TISCHLER-MORGAN		Uhrmacher Pinzette.....	BA-06
Probeexcisions Zange.....	HA-43 bis HA-44, HA-46	ULRICH Schwamm Zange.....	BG-06
TIVNEN Tonsillen Fass Zange.....	FA-04	Umfuehr De MARTEL.....	EA-05
TOBOLD		UNIVERSAL	
Watteträger.....	CA-03	Draht und Blech Schere.....	AI-42
Zungen Spatel.....	EI-02	Sterilisiert Zange.....	CI-02
TOENNIS-ADSON Neurochirurgische Schere.....	AI-35	Trokar.....	CC-02
TOENNIS		Verband Schere.....	AI-50
Arterien Klemme.....	BC-11	UNNA Komedonen Quetscher.....	HE-02
Dura Dissektor.....	EA-05	Urethrotom OTIS.....	GG-08
Nadelhalter.....	CE-04	Urinal.....	HE-10
TOHOKU Tuch Klemme.....	BE-04	USA	
Tonometer SCHIOETZ.....	ED-08	HF Chirurgie Geräte Kabel.....	JA-07
Tonsillotom SLUDER-BALLENGER.....	FA-05	USA MODEL Nabelschnur Schere.....	AI-34
TOOK Hornhaut Messer.....	EC-05	USA	
TOTI Fräser.....	DD-07	Pinzette.....	BA-02
TOWNSEND-KEVORKIAN Probeexcisions Zange.....	HA-44	US Army (PARKER-LANGENBECK) Wund Haken.....	BI-03
TOWNSEND-MINI (BABY TISCHLER) Probeexcisions Zange.....	HA-44		
TOWNSEND-mini Probeexcisions Zange.....	HA-44	V	
TOWNSEND Probeexcisions Zange.....	HA-44	VALLEIX Uterus Sonde.....	HA-39
TOWNSEND-TISCHLER Probeexcisions Zange.....	HA-44	Valve	
TOYNBEE Ohr Spekula.....	EE-02	BALFOUR Valve.....	BI-22
TRAUBE Perkussions Hammer.....	AC-07	CASPAR Valve.....	BI-20
TRELAT Vaginal Spekulum.....	HA-07	CASPAR Valve ges. Wirbelsäule.....	BI-19
Trephine.....	DD-04	KIRSCHNER Valve.....	BI-23
CASTROVIEJO Hornhaut Trephine.....	ED-07	VAN BUREN	
ELLIOT Hornhaut Trephine.....	ED-08	Harnröhren Bougie.....	GG-13
FRANCESCETTI Hornhaut Trephine.....	ED-07	Sequester Zange.....	DC-10
Trichter.....	HE-07	Van DOREN Probeexcisions Zange.....	HA-42
TROELTSCH Nasen Zange.....	EG-04	VANNAS	
TROEMNER Perkussions Hammer.....	AC-07	Iridectomie Schere.....	AJ-05
Trokar.....	CC-02	Mikro Schere.....	AJ-12 bis AJ-13
COAKLEY Trokar.....	CC-02	VARIFOCAL Ophthalmoskop.....	AC-03
DOUGLAS Trokar.....	CC-02	Venenstauer.....	AC-03
FLEURANT Trokar.....	CC-02	VERBRUGGE Knochenhalte Zange.....	DC-09
LICHTWITZ Trokar.....	CC-02	VERRES Pneumoperitoneum Punktions Nadel.....	CC-03
MENGHINI Trokar.....	CC-03	Vienna Nasen Spekulum.....	EG-02
NELSON Trokar.....	CC-02	VIRCHOW	
OCHSNER Trokar.....	CC-02	Hirn Messer.....	AG-18
PIERCE Trokar.....	CC-02	Knorpel Messer.....	AG-18
UCKERMANN Tracheal Trokar.....	FE-02	Schaedel Spalter.....	DC-17
UNIVERSAL Trokar.....	CC-02	VIRTUS (RALK) Splitter Pinzette.....	BA-06
Trommel		VOLKMANN	
KONRICH Sterilisier Trommel.....	HE-12	Scharf Löffel.....	DC-12 bis DC-13
SCHIMMELBUSCH Sterilisier Trommel.....	HE-12	Wund Haken.....	BI-07 bis BI-08
TROUSSEAU Tracheal Dilatator.....	FE-02	VOLTOLINI Nasen Spekulum.....	EG-02
TROUTMAN-CASTROVIEJO Mikro Schere.....	AJ-07	Vorböhrer.....	DD-12
TROUTMAN-CHRIS Klingenbrecher.....	AG-14	CRUTCHFIELD Vorböhrer.....	EA-03
TROUTMAN Colibri Iris Pinzette.....	EC-13	KUENTSCHER Vorböhrer.....	DD-13
TROUTMAN Rectus Pinzette.....	ED-02		
TUBBS Herz Dilatator.....	FG-27	W	
Tübingen		WACHENFELDT Wundklammer Zange.....	CG-07
Faden Pinzette.....	ED-05	WADSWORTH-TODD Kauter.....	EC-08
Iris Pinzette.....	EC-15	WAGENER-MOSHER Tracheal Kannule.....	FE-03
Luft Kanüle.....	ED-07	WAGENER Ohr Häkchen.....	EE-07
Tübingen TITAN		WAGNER	
Faden Pinzette.....	ED-05	Laminektomie Zange.....	EA-09
Iris Pinzette.....	EC-15	Schere.....	AH-22
TUFFIER			
Arterien Klemme.....	BC-08		
Rippen Sperrer.....	FG-16		

D

Inhaltsverzeichnis Deutsch

Zahnfleisch Schere	AI-42	WINKELMANN Beschneidungs Klemme	GG-09
WALDMANN Episiotomie Schere	AI-34	WINTER Plazentar und Abortus Zange	HC-07
WALLICH Plazentar und Abortus Löffel	HC-08	Wirbelsmeißel BRUNETTI	DC-17
WALSHAM Septum Zange	EG-18	WITTNER Probeexcisions Zange	HA-43
WALTHER Harnröhren Bougie	GG-17	WOLFF Gipsabreiss Zange	DA-04
WALTON		WRIGLEY Geburts Zange	HC-02
Fremdkörper Hohlmeißel	EC-06	WULLSTEIN	
Komedonen Quetscher	HE-02	Ohr Mikro mini Schere	EE-11
WALTON YANKAUER Sauger	AE-03	Ohr Mikro Schere	EE-11
WANGENSTEEN		Sichel Messer	EE-14
Nadelhalter	CE-03	Wund Haken	BI-06, BI-10
Pinzette	BA-05	Wundsperrerr	
WARTENBERG Nadelrad	AC-08	HRYNTSCHAK Prostata Wundsperrerr	GG-06
Waschschüssel	HE-05	JUDD-MASSON Blasen Wundsperrerr	GG-04
WATSON-CHEYNE Elevatorien	DC-22	LEGUEU Blasen Wundsperrerr	GG-06
WATSON Dermatome	AG-22	MILLIN Blasen Wundsperrerr	GG-05
Watteträger	CA-03	THOMSON-WALKER Blasen Wundsperrerr	GG-06
DIMEDA Watteträger	CA-03	WYLIE	
FARREL Watteträger	CA-03	Atraumatische Klemme	BD-21
JOBSON-HORNE Watteträger	CA-03	Uterus Dilatator	HA-30
TOBOLD Watteträger	CA-03		
UCKERMANN Watteträger	CA-03	Y	
WEBER		YANKAUER	
Atraumatische Klemme	BD-12	Nasenrachen Spekulum	EG-04
Draht Schlinge	EC-08	Sauger	AE-02
WECKER		YASARGIL	
Iris Schere	AJ-04	MINI Clip-Anlege Zange	EA-12
Iris Spatel	EC-08	Mikro Schere	AJ-10 bis AJ-11
WEEK Sperr Elevator	EC-02	STANDARD Clip-Anlege Zange	EA-12
WEIL-BLAKESLEY Nasen scharfe Zange	EG-06	Standard Clips	EA-13
WEISSBARTH Vaginal Spekulum	HA-22	Temporäre Clips	EA-12
WEISS Schlauch Klemme	BC-19	YEOMAN Biopsie Zange	GI-05
WEITLANER-WULLSTEIN Wund Sperrerr	BI-14	YOUNG Boomerang Unterbindungs Nadel	CG-03
WEITLANER Wund Sperrerr	BI-14	YOUNG	
WELLS Enukektion Löffel	EC-08	Prostata Faß Zange	GG-02
WERTHEIM-CULLEN Hysterektomie Klemme	BC-18	Prostata Haken	GG-02
WERTHEIM		Zungen Zange	EI-03
Hysterektomie Klemme	BC-18		
Praeparier Schere	AI-32	Z	
WESTCOTT		Zahnfleisch Schere	AI-41
Iridektomie Schere	AJ-02	Zängchen	
Sehnen Schere	AJ-02	GREVEN Ohr Mikro Zängchen	EE-10
WEST Nasen Hohl Meißel	EG-14	HARTMANN-HOFFMANN Ohr Zängchen	EE-08
WESTON Rektal Polypen Schnürer	GI-05	HARTMANN Ohr Zängchen	EE-08
WHEELER		HARTMANN-WULLSTEIN Ohr Zängchen	EE-08
Cyclodialyse Spatel	EC-09	LITTAUER Ohr Zängchen	EE-08
Diszisions Messer	EC-04	McGEE Ohr Mikro Zängchen	EE-10
WHITEHEAD Mund Sperrerr	EI-04	Ohr Mikro Zängchen	EE-09 bis EE-10, EE-12
WHITE Tonsillen Fass Zange	FA-03	Ohr Mikro Mini Zängchen	EE-13
WIEDER Zungen Spatel	EI-02	STRUEMPEL Ohr Zängchen	EE-08
WIENER (AUFRICHT) Nasen Raspel	EG-15	TILLEY Ohr Zängchen	EE-08
WIENER		Zange	
Iris Haken	EC-06	ADSON Hohlmeißel Zange	DC-03
Nasen Raspel	EG-15	ALEXANDER Probeexcisions Zange	HA-42
WIGMORE Gips Sage	DA-02	ALLIS-ADAIR Darmfaß Zange	GE-02
WILDE		ALLIS-BABY Darmfaß Zange	GE-02
Nasen Schnürer	EG-09	ALLIS Darmfaß Zange	GE-02
Ohrpolypen Schnürer	EE-07	ASCH Septum Zange	EG-18
WILDER		BABCOCK Darmfaß Zange	GE-02
Draht Schlinge	EC-08	BAGGISH Probeexcisions Zange	HA-45
Tränenkanal Dilatatoren	EC-10	BALLENGER Tonsillen Fass Zange	FA-04
WILDE (TROELTSCH) Ohr Pinzette	EE-07	BARRETT Haken Zange	HA-32
WILLET-MARTELL Kopfhaut Klemme	BC-08	BARTON Geburts Zange	HC-04
WILLIAMS		BERGMANN FOERSTER Schwamm Zange	BG-10
Darmfaß Zange	GE-03	BEYER Hohlmeißel Zange	DC-04
Schrauben Dreher	DD-14	BIRCHER-GANSKE Knochenhalte Zange	DC-10
Sperr Elevator	EC-02	BLAKE Gallenstein Zange	GC-03
WILLIGER		BLOHMKE Tonsillen Fass Zange	FA-04
Hammer	DC-18	BLUMENTHAL Hohlmeißel Zange	DC-02
Raspatorien	DC-19		
Scharf Löffel	DC-13		

BOERMA Geburts Zange	HC-04
BÖHLER Hohlmeißel Zange.....	DC-04
BÖHLER Knochensplitter Zange.....	DC-06
Zange	
BONNEY Schwamm Zange.....	BG-08
BOZEMANN-DOUGLAS Tupfer Zange	BG-13
BOZEMANN Tupfer Zange.....	BG-13
BRAUN Haken Zange	HA-31, HA-34
BRUENINGS Kehlkopf Zange.....	FC-03
BRUENINGS Nasen Zange, scharf.....	EG-05
BRYANT Schwamm Zange.....	BG-11
BUMM Uterus-Faß Zange.....	HA-38
BURKE-Baby Probeexcisions Zange.....	HA-44
BURKE Probeexcisions Zange	HA-44
CHEATLE Sterilisier Zange.....	CI-02
CHERON Tupfer Zange.....	BG-12
CHEVALIER-JACKSON Kehlkopf Zange.....	FC-04
CHILDE Wundklammer Zange	CG-07
CLEVELAND Hohlmeißel Zange	DC-02
COLLIN-POZZI Haken Zange.....	HA-32
COLLIN Tupfer Zange.....	BG-11
COLLIN Uterus-Faß Zange.....	HA-37
COLLIN Wundklammer Zange	CG-07
COLLIN Zungen Zange	EI-03
COLVER Tonsillen Faß Zange	FA-03
CORDES Kehlkopf Zange.....	FC-03
COTTLE-KAZANJIAN Knochensplitter Zange.....	DC-06
CUSHING Laminektomie Zange	EA-08
CZERNY Gallenstein Zange.....	GC-03
CZERNY Haken Zange.....	HA-34
DARTIGUES Uterus-Faß Zange.....	HA-37
DAVIS Sterilisier Zange.....	CI-02
De LEE Geburts Zange	HC-02
DESJARDINS Gallenstein Zange.....	GC-02
DEWEY Geburtszange, mit Achsenzugvorrichtung.....	HC-05
DIMEDA Abfall Zange.....	CI-03
DINGMANN Knochenhalte Zange	DC-10
DOYEN Uterus-Polypen Zange	HA-36
DUPLAY Haken Zange	HA-31
DUPLAY Tupfer Zange	BG-14
DUVAL Darmfaß Zange	GE-03
ECHLIN Hohlmeißel Zange	DC-05
ELLIOT Geburts Zange	HC-02
ELSAESSER Nieren Fistel Zange.....	GC-13
EPPENDORFER-KEVORKIAN	
Probeexcisions Zange	HA-46
EPPENDORFER Probeexcisions Zange.....	HA-45 bis HA-46
EPPENDORFER TISCHLER-MORGAN	
Probeexcisions Zange	HA-46
FARABEUF Knochenhalte Zange.....	DC-07
FARABEUF-LAMBOTTE Knochenhalte Zange	DC-08
FAURE Probeexcisions Zange	HA-41
FERGUSSON Knochenhalte Zange	DC-07
FERRIS-SMITH Laminektomie Zange	EA-09
Flach Zange	DD-11
FLETCHER JAVERTS Schwamm Zange.....	BG-10
FOERSTER Schwamm Zange.....	BG-06 bis BG-08
FRAENKEL Kehlkopf Polypus Zange	FC-02
FRAENKEL Kehlkopf Zange	FC-03
FRIEDMAN Hohlmeißel Zange.....	DC-02
FRIEDMAN Mini Hohlmeißel Zange	DC-02
FRYKHOLM Hohlmeißel Zange	DC-05
GAUSS Kopfschwarten Zange	HC-06
GELLHORN Probeexcisions Zange.....	HA-42
GRIP Zange	DD-11
GROSS-MAIER Tupfer Zange.....	BG-02 bis BG-04
GROSS Tupfer Zange	BG-05
HARTMANN Nasen Polypus Zange	EG-04
HARTMANN Nasen Zange, scharf.....	EG-07
HEGENBARTH Wundklammer Zange	CG-07
HEIMING Nierenstein Zange.....	GC-13

HENROTIN Haken v	HA-34
HEYMANN-KNIGHT Nasen Polypus Zange.....	EG-05
HEYMANN Nasen Zange, scharf	EG-05
Zange	
HEYWOOD-SMITH Hämorrhoid. Zange.....	GI-05
IOWA Haken Zange	HA-35
JACOBS Haken Zange	HA-34
JANSEN Nasen Zange	EG-04
JARCHO Haken Zange.....	HA-32
JATHO Nasenrachen Zange.....	EG-18
JUDD-ALLIS Darmfaß Zange	GE-02
JURASZ Kehlkopf Polypus Zange	FC-02
KELLY Uterus-Polypen Zange	HA-36
KERN Knochenhalte Zange.....	DC-08
KEVORKIAN-Pacific Probeexcisions Zange.....	HA-44
KEVORKIAN Probeexcisions Zange	HA-43, HA-46
KIELLAND Geburts Zange	HC-02
KIELLAND-LUIKART Geburts Zange	HC-03
KNIGHT Nasen Zange, scharf.....	EG-05
KRAUSE Kehlkopf Zange	FC-03
LAHEY Kropf Fass Zange	FE-04
LAMBOTTE Knochenhalte Zange	DC-08
LANE Knochenhalte Zange	DC-08
LANE Knochenschraub. Halte Zange.....	DD-14
LANGE Kehlkopf Zange.....	FC-03
LANGENBECK Knochenhalte Zange	DC-07
LEKSELL STILLE Hohlmeißel Zange.....	DC-05
LEMPERT Hohlmeißel Zange.....	DC-03
LEWIN Knochenhalte Zange	DC-10
LEWKOWITZ Plazentar und Abortus Zange	HC-07
LISTER Sinus Schwamm Zange	BG-11
LISTON Knochensplitter Zange.....	DC-06
LITTAUER Nasen Polypus Zange	EG-05
LOVE-GRUENWALD Laminektomie Zange.....	EA-08
LOVELACE Lungenfaß Zange.....	FG-19
LUBET-BARBON Nasen Polypus Zange	EG-05
LUC Nasen Zange, scharf	EG-06
LUER Hohlmeißel Zange	DC-03
LUIKART Geburts Zange.....	HC-03
MAGILL Kathetereinführ Zange	AE-06
MAIER Tupfer Zange	BG-12
MARTIN Sequester Zange	DC-10
MARTIN Tupfer Zange	BG-02, BG-14
MATHIEU Fremdkörper Zange.....	GG-07
MAYO BLAKE Gallenstein Zange	GC-04
McCLINTOCK Plazentar und Abortus Zange	HC-07
McKENZIE Clip-Anlege Zange.....	EA-02
McLEAN Geburts Zange.....	HC-04
McLEAN-LUIKART Geburts Zange	HC-03
McLEAN-TUCKER-LUIKART Geburts Zange	HC-03
MEAD Hohlmeißel Zange	DC-02
MICHEL Wundklammer Zange.....	CG-07
MIDDLETON-JANSEN Nasen Zange, scharf.....	EG-09
MILLIN Fadenführungs Zange	GG-03
MILLIN Faß vordere Lappen Zange.....	GG-03
MILLIN Kapsel Faß Zange	GG-03
MIXTER Gallenstein Zange.....	GC-04
MUSEUX Haken Zange.....	HA-33
MYLES Nasen Zange, scharf	EG-07
NAEGELE Geburts Zange.....	HC-03
Nagel Zange	HE-03
Nagelhaut Zange	HE-03
NOTO Uterus-Polypen Zange.....	HA-36
NOYES Nasen Polypus Zange.....	EG-05
OLDBERG Laminektomie Zange	EA-09
OLIVECRONA Hohlmeißel Zange	DC-03
OLIVECRONA-TOENNIS Clip-Anlege Zange.....	EA-02
PELMANN Tupfer Zange.....	BG-12
PIPER Geburts Zange	HC-04
PIPER Geburtszange, mit Achsenzugvorrichtung.....	HC-04
POZZI Haken Zange.....	HA-31

D

Inhaltsverzeichnis Deutsch

PRATT Haken Zange	HA-34 bis HA-35	VERBRUGGE Knochenhalte Zange.....	DC-09
RADOLF Nagelausreiss Zange	DD-03	WACHENFELDT Wundklammer Zange	CG-07
RAMPLEY Schwamm Zange.....	BG-09	WAGNER Laminektomie Zange.....	EA-09
Zange		Zange	
RANDALL Nierenstein Zange.....	GC-11 bis GC-12	WALSHAM Septum Zange	EG-18
RANEY Anlege- und Abnahme Zange	EA-03	WEIL-BLAKESLEY Nasen Zange, scharf.....	EG-06
RICHTER-HEATH Wundklammer Zange	CG-07	WHITE Tonsillen Fass Zange	FA-03
ROGGE Sterilisier Zange	CI-02	WILLIAMS Darmfaß Zange	GE-03
ROSENBERG Kehlkopf Zange	FC-03	WINTER Plazentar und Abortus Zange.....	HC-07
ROWE Mund Zange	EI-06	WITTNER Probeexcisions Zange	HA-43
RUBIN Septum Quetsch Zange	EG-07	WOLFF Gipsabreiss Zange	DA-04
RUSKIN Hohlmeißel Zange.....	DC-04	WRIGLEY Geburts Zange	HC-02
RUSKIN-LISTON Knochensplitter Zange	DC-06	YASARGIL MINI Clip-Anlege Zange	EA-12
SAENGER Plazentar und Abortus Zange	HC-07	YASARGIL STANDARD Clip-Anlege Zange	EA-12
SAIRGES Haken Zange	HA-32	YEOMAN Biopsie Zange.....	GI-05
SAUERBRUCH Abfall Zange	CI-03	YOUNG Prostata Faß Zange	GG-02
SAUERBRUCH Hohlmeißel Zange	DC-05	YOUNG Zungen Zange.....	EI-03
SCAGLIETTI Hohlmeißel Zange	DC-05	ZAUFAL-JANSEN Hohlmeißel Zange	DC-04
Schneide- und Biege Zange	DD-11	ZAUFAL-JANSEN Hohlmeißel Zange.....	DC-04
SCHEINMANN Kehlkopf Zange.....	FC-03	ZENKER Präparier und Ligatur Klemme	BC-12
SCHOENBURG Darmfaß Zange.....	GE-03	ZIEGLER	
SCHROEDER Haken Zange	HA-31 bis HA-32	Iris Messer	EC-04
SCHUBERT Probeexcisions Zange.....	HA-41	Kapsulotomie Messer	EC-05
SCHUMACHER Kehlkopf Zange	FC-03	Sperr Elevator	EC-03
SCHUMACHER Probeexcisions Zange.....	HA-43	Stirnspiegel	AC-05
SEIFFERT Kehlkopf Zange.....	FC-03	Tränenkanal Dilatatore.....	EC-10
SEMB Hohlmeißel Zange	DC-06	Zubehör für Sterilisier Container	HE-38 bis HE-41
SEMB Knochenhalte Zange	DC-07		
SEMB Knochensplitter Zange.....	DC-07		
SIEGLER HELLMANN Uterus-Faß Zange	HA-38		
SIMPSON-BRAUN Geburts Zange	HC-02		
SIMPSON Geburts Zange	HC-02		
SIMPSON-LUIKART Geburts Zange	HC-03		
SIMS-MAIER Tupfer Zange	BG-05		
SKENE Haken Zange	HA-31		
SMITHWICK Clip-Anlege Zange.....	EA-02		
SOMER Uterus-Faß Zange	HA-37		
SPURLING Laminektomie Zange	EA-08		
STAUDE-MOORE Haken Zange	HA-31		
STILLE-HORSLEY Knochensplitter Zange	DC-07		
STILLE-LISTON Knochensplitter Zange.....	DC-06		
STILLE-LUER Hohlmeißel Zange.....	DC-04		
STILLE-RUSKIN Hohlmeißel Zange.....	DC-05		
STRUYCKEN Nasen Zange, scharf	EG-07		
SWEET Clip-Anlege Zange.....	EA-02		
TARNIER			
Geburtszange, mit Achsenzugvorrichtung.....	HC-05		
TEALE Haken Zange	HA-33		
THOMS-ALLIS Darmfaß Zange.....	GE-02		
THOMS-GAYLOR Probeexcisions Zange	HA-42		
TIEMANN Haken Zange	HA-32		
TISCHLER-KEVORKIAN			
Probeexcisions Zange	HA-44 bis HA-45		
TISCHLER-MORGAN			
Probeexcisions Zange.....	HA-43 bis HA-44, HA-46		
TIVNEN Tonsillen Fass Zange	FA-04		
TOWNSEND-KEVORKIAN			
Probeexcisions Zange	HA-44		
TOWNSEND-MINI (BABY TISCHLER)			
Probeexcisions Zange	HA-45		
TOWNSEND-Mini Probeexcisions Zange.....	HA-44		
TOWNSEND Probeexcisions Zange	HA-44		
TOWNSEND-TISCHLER Probeexcisions Zange	HA-44		
TROELTSCH Nasen Zange.....	EG-04		
TURNBULL Nagel Zange.....	HE-03		
TURREL Biopsie Zange	GI-05		
TYDING Tonsillen Fass Zange	FA-04		
ULRICH Schwamm Zange	BG-06		
UNIVERSAL Sterilisier Zange	CI-02		
VAN BUREN Sequester Zange	DC-10		
VAN DOREN Probeexcisions Zange	HA-42		

E

**Index
English**

E

A

- Accessories for sterilization containerHE-38 to HE-41
 Adenotome LAFORCEEG-19
 ADLERKREUTZ thumb and tissue forcepsBA-04
 ADSON BABY hemostatic forcepsBC-09
 ADSON-Baby retractorBI-15
 ADSON
 bone rongeurDC-03
 ADSON-BROWN thumb and tissue forcepsBA-03
 ADSON
 elevatorDC-21
 hemostatic forcepsBC-09
 hypophyseal forcepsEA-06
 needle holderCE-04
 nerve hookEA-04
 retractorBI-15
 thumb and tissue forcepsBA-03
 thumb and tissue, micro forcepsBA-03
 AEBLI corneal scissorsAI-22
 AESCULAP electrosurgery equipment cableJA-07
 Air bag POLITZEREE-05
 ALAN-PARKS anal retractorGI-03
 ALBEE drill burrDD-07
 ALEXANDER
 bone chiselDC-14
 bone gougeDC-14
 periosteal elevatorDC-19
 uterine biopsy specimen forcepsHA-42
 ALLIS-ADAIR tissue forcepsGE-02
 ALLIS-Baby tissue forcepsGE-02
 ALLISON lung spatulaFG-19
 ALLIS tissue forcepsGE-02
 ALM retractorBI-14
 ALVIS foreign body curetteEC-06
 Amniotome BEACHAMHA-39
 Amputation knifeAG-16
 ANDREWS-PINCHON suction tubeAE-03
 ANDREW tongue depressorEI-02
 Anoscope
 HIRSCHMANNGI-04
 IVES-FANSLERGI-04
 Apparatus
 BARANY noiseEE-04
 PETZ stomach and intestinal suturingGE-09
 ARCHER splinter forcepsBA-06
 ARKANSAS grinding stoneAG-19
 ARLT wire loopEC-08
 ARRUGA
 capsular forcepsED-04
 extracting hookEC-06
 eye speculumEC-02
 ophthalmological needle holderCE-06
 protectorEC-08
 ASCH septum forcepsEG-18
 Atraumatic pediatric vascular forcepsBD-43
 AUFRICHT nasal retractorEG-17
 AUVARD vaginal speculumHA-19
 AXENFELD chalazion curetteEC-07
 AYER chalazion forcepsED-06
- B**
- BABCOCK seizing forcepsGE-02
 BABINSKY percussion hammerAC-07
 BACKHAUS-CLIP tube holder towel clampBE-03
 BACKHAUS KOCHER towel clampBE-02
 BACKHAUS towel clampBE-02
 BAGGISH uterine biopsy specimen forcepsHA-45
 BAILEY-BABY rib contractorFG-18
 BAILEY-GIBBON rib contractorFG-18
 BAILEY rib contractorFG-18
 BAINBRIDGE
 atraumatic forcepsBD-09
 hemostatic forcepsBC-14
 BAKES gall duct dilatorGC-06
 BALFOUR
 abdominal retractorBI-22
 BALFOUR Baby abdominal retractorBI-22
 BALFOUR
 bladeBI-22
 BALL AND SOCKET towel clampBE-04
 Ball coagulation electrodeJA-03
 BALLENGER
 septum elevatorEG-12
 swivel knifeEG-11
 tonsil seizing forcepsFA-04
 Band PARHAMDC-11
 BANGERTER cycloidalysis spatulaEC-08
 BARANY noise apparatusEE-04
 BARBARA
 hookletEE-14
 needleEE-14
 pickEE-14 to EE-15
 BARKAN goniotomy knifeEC-05
 BARNHILL adenoid curetteEG-19
 BARRAQUER-KATZIN iris forcepsEC-13
 BARRAQUER Colibri iris forcepsEC-13
 BARRAQUER
 anterior chamber forcepsED-02
 cilia forcepsED-08
 BARRAQUER Colibri eye speculumEC-02
 BARRAQUER
 colibri scissorsAJ-04
 fixation forcepsED-03
 keratoplasty knifeEC-05
 needle holderCE-07
 BARRETT tenaculum forcepsHA-32
 BARR rectal speculumGI-02
 BARTON
 obstetrical forcepsHC-04
 traction handleHC-04
 BAUMGARTNER needle holderCE-02
 BEACHAM amniotomeHA-39
 BeakerHE-10
 BECK atraumatic peripheral vascular forcepsBD-25
 BECKER cystotomeEC-06
 BECKMANN
 adenoid curetteEG-19
 BECKMANN-ADSON retractorBI-15
 BECKMANN-EATON retractorBI-16
 BECKMANN
 retractorBI-16
 BEEBEE wire and plate scissorsAI-43
 BEER cilia forcepsED-08
 BEESON plaster spreaderDA-03
 BELLUCCI ear micro scissorsEE-09
 BENGOLEA hemostatic forcepsBC-09
 BENNETT bone leverDC-22
 BERENS keratomeEC-04
 BERGMANN bandage scissorsAI-46
 BERGMANN FOERSTER sponge holding forcepsBG-10
 BERGMANN plaster sawDA-02
 BERKE muscular forcepsED-02
 BERLIND-AUVARD vaginal speculumHA-19
 BERLINER percussion hammerAC-07
 BERNHARD towel clampBE-05
 BERTILLON cephalometerAC-08
 BEST intestinal forcepsGE-06
 BETHUNE rib shearFG-04
 BEUSE scissors toothedAI-26

- BEYER
bone rongeurDC-04
punchEG-08
- BILLEAU ear loopEE-07
- BILL traction handleHC-05
- BIRCHER-GANSKE bone holding forcepsDC-10
- BIRCHER meniscotomeDC-24
- BISHOP-HARMAN iris forcepsEC-14
- Blade
BALFOURBI-22
- Blade breaker
CASTROVIEJOAG-14
DIMEDAAG-14
TROUTMAN-CHRISAG-14
- Blade
CASPARBI-20
CASPAR vertebral columnBI-19
HUMBY dermatomeAG-20
KIRSCHNER abdominal retractorBI-23
OTIS spareGG-08
- BLAKE
gall stone forcepsGC-03
uterine curetteHA-48
- BLOHMKE tonsil seizing forcepsFA-04
- Blood pressure apparatusAC-02
- BLOUNT
bone leverDC-24
knee retractorDC-24
- BLUMENTHAL bone rongeurDC-02
- BODENHAMMER rectal speculumGI-02
- BOEHLER 16x9 cm extension bowDD-10
- BOERMA obstetrical forcepsHC-04
- BOETTCHER tonsil scissorsAI-27
- BOEHLER
bone cutting forcepsDC-06
bone rongeurDC-04
- BONACCOLTO strabismus forcepsEC-14
- Bone holding forcepsDC-09 to DC-10
- Bone wireDD-11
- BONNEY sponge holding forcepsBG-08
- Bonn
iris forcepsEC-15
irrigating cannulaED-07
- Bonn TITAN iris forcepsEC-15
- BORCHARDT drill burrDD-07
- BOSE
tracheal hookFE-02
tracheal spreaderFE-02
- BOUCHERON ear speculaEE-02
- Bougiem FILIFORMGG-12
- BowlHE-04
- BOWLES stethoscopeAC-06
- Bowl
kidneyHE-07
solutionHE-05
- BOWMAN
discision knifeEC-04
discision needleEC-05
eye speculumEC-02
lachrymal probeEC-10
- BOYNTON ophthalmological needle holderCE-06
- BOZEMANN-DOUGLAS swab forcepsBG-13
- BOZEMANN
swab forcepsBG-13
needle holderCE-03
- BRAIN MINI clip applying forcepsEA-12
- BRAIN
standard clipEA-13
- BRAIN STANDARD clip applying forcepsEA-12
- BRAIN
temporary clipEA-12
- BRAITHWAITE dermatomeAG-22
- BRAUN
cranioclastHC-09
decapitating hookHC-09
- BRAUN-STADLER episiotomy scissorsAH-22, AI-34
- BRAUN
tenaculum forcepsHA-31, HA-34
uterine depressorHA-39
vaginal speculumHA-16
- Breaker WOLFF plasterDA-04
- BREISKY vaginal speculumHA-20
- BROCK
mitral valve dilator handleFG-26
mitral valve dilator openingFG-26
mitral valve dilator punchFG-26
- BROWN thumb and tissue forcepsBA-03
- BRUENINGS
ear speculaEE-02
extension tubeFC-03
larynx forcepsFC-03
nasal cutting forcepsEG-05
septatomeEG-11
tongue depressorEI-02
tonsil snareFA-04
- BRUNETTI spine chiselDC-17
- BRUNNER
intestinal forcepsGE-06
ligature conductorCG-04
rib shearFG-07
- BRUNS
bone curetteDC-12 to DC-13
plaster scissorsAI-48
- BRYANT sponge holding forcepsBG-11
- BUCHWALD tongue depressorEI-02
- BUCK
ear curetteEE-05
foreign body leverEE-08
ligature scissorsAI-40
percussion hammerAC-07
- BUIE aspirating cannulaGI-05
- BUMM
uterine curetteHA-49 to HA-50
uterine elevating forcepsHA-38
- BUNGE exenteration scoopEC-07
- BUNNELL
bone hand drillDD-05
tendon stripperDC-25
- BUNT safety needleCI-02
- BURCH fixation forkEC-05
- BURKE Baby uterine biopsy specimen forcepsHA-44
- BURKE uterine biopsy specimen forcepsHA-44
- BUSCH umbilical scissorsAI-34
- C**
- Cable
AESCULAP electro-surgery equipmentJA-07
ERBE SELECT electro-surgery equipmentJA-07
MARTIN electro-surgery equipmentJA-07
USA electro-surgery equipmentJA-07
- Cannula
Bonn irrigatingED-07
BUIE aspiratingGI-05
FINSTERER suction and irrigationAE-05
HamburgED-07
KILLIAN washEG-09
SCHEIE eyeED-07
SIMCOE suturingED-07
Tübingen airED-07
- CARMALT splinter forcepsBA-06
- CARPENTER tonsil knife and dissectorFA-02

E

Index English

- Cartilage knifeAG-18
- Case
- glassHE-03
 - stainless steelHE-03
- CASPAR
- bladeBI-20
 - cervical spine retractorBI-18
 - micro surgical scalpel handleAG-12
 - retractorBI-20
 - vertebral column bladeBI-19
 - vertebral column retractorBI-19
 - vertebral lumbar retractorBI-20
- CASTAÑEDA
- atraumatic neonatal and children forcepsBD-42
 - rib spreaderFG-14
- CASTROVIEJO
- blade breakerAG-14
 - capsular forcepsED-04
 - compass markerEC-09
 - corneal scissorsAJ-06
 - corneal trephineED-07
 - cyclodialysis spatulaEC-08 to EC-09
 - eye speculumEC-03
 - fixation forcepsED-03
 - iridectomy scissorsAJ-05
 - keratomeEC-04
 - lachrymal dilatorEC-10
 - needle holderCE-07
 - suture forcepsED-05
- Catheter
- HARTMANN earEE-06
- Catheter introducer
- DITTELGG-11
 - GUYONGG-11
- Catheter
- ITARD earEE-06
 - metal, femaleGG-16
 - metal, maleGG-16
- CATLIN amputation knifeAG-16
- Cauter WADSWORTH-TODDEC-08
- Cephalometer BERTILLONAC-08
- CHAPUT hemostatic forcepsBC-08
- CHARRIERE
- amputation sawDD-03
 - blade sawDD-03
- CHEATLE sterilizing forcepsCI-02
- CHERON dressing forcepsBG-12
- CHEVALIER-JACKSON larynx forcepsFC-04
- CHEVALLIER rib spreaderFG-15
- CHILDE clip applying forcepsCG-07
- Chisel
- ALEXANDER boneDC-14
 - boneDC-14
 - BRUNETTI spineDC-17
 - CINELLI rhinoplasticEG-13
 - COTTLE rhinoplasticEG-13
 - FOMON rhinoplasticEG-13
 - FREER septumEG-12
 - HIBBS boneDC-16
 - HOKE boneDC-16
 - LEBSCHE sternumDC-17
 - LEXER boneDC-16
 - LEXER mini boneDC-16
 - PARTSCH boneDC-14
 - ROLLET extirpationEC-06
 - SILVER rhinoplasticEG-14
 - SMITH-PETERSEN boneDC-15
 - STILLE boneDC-14
 - WEST nasalEG-14
- CINELLI rhinoplastic chiselEG-13
 - CITELLI punchEG-08
- Clamp
- DeMARTEL-WOLFSON anastomosisGE-07
 - LANE stomachGE-08
 - LOWMAN bone holdingDC-11
 - LURZ ureterGC-10
 - PAYR-Baby stomachGE-09
 - PAYR stomachGE-09
 - SATINSKY anastomosis (vena cava)FG-24 to FG-25
- Clamps
- COLLIN umbilical cordHC-06
 - COOLEY atraumatic bulldogBD-33 to BD-34
 - DE BAKEY atraumatic bulldogBC-02
 - DIEFFENBACH serrefine bulldogBC-03
 - GLOVER atraumatic bulldogBC-02
 - JOHNS-HOPKINS serrefine bulldogBC-03
- Clamp
- spermatic cord fixationGG-10
 - STOCKMANN PenileGG-10
 - STRAUSS PenileGG-10
 - WINKELMANN circumcisionGG-09
- CLAR
- head lampAC-05
- CLARK eye speculumEC-02
- CLAR
- mini head lightAC-05
- Cleaning brushCI-04 to CI-05
- CLEVELAND bone rongeurDC-02
- Clip
- BRAIN standardEA-13
 - BRAIN temporaryEA-12
- Clip carrierEA-02
- Clip
- EDWARDSBD-21
 - MICHELCG-07
 - RANEY scalp hemostasisEA-03
- CLOWARD
- lamina spreaderEA-07
 - retractorBI-17
- COAKLEY
- antrum curetteEG-18
 - trocárCC-02
- COLCLOUGH intervertebral disc rongeurEA-11
- COLLIER needle holderCE-02
- COLLIN
- abdominal retractorBI-24 to BI-25
 - clip applying forcepsCG-07
 - dressing forcepsBG-11
 - COLLIN-DUVAL thumb and tissue forcepsBA-04
- COLLIN
- dynamometerAC-03
 - hammerDC-18
- COLLIN-HARTMANN retractorBI-03
- COLLIN
- hemostatic forcepsBC-08
 - pelvimeterHC-06
- COLLIN-POZZI tenaculum forcepsHA-32
- COLLIN
- scalpel handleAG-08
 - tongue holding forcepsEI-03
 - umbilical cord clampsHC-06
 - uterine elevating forcepsHA-37
 - uterine soundHA-39
 - vaginal speculumHA-04
- COLLYER pelvimeterHC-06
- COLVER tonsil seizing forcepsFA-03
- ComprimeterDD-02
- Conductor
- BRUNNER ligatureCG-04
 - KIRSCHNER ligatureCG-04
 - KOENIG ligatureCG-04
 - PAYR ligatureCG-04

SCHMIEDEN ligatureCG-04
 SCHMIEDEN-PAYR ligatureCG-04
 Cone
 KNUTSON-KOCH urethrographyGG-09
 occlusionHA-47
 CONNIN-AMSLER markerEC-09
 Contractor
 BAILEY-BABY ribFG-18
 BAILEY-GIBBON ribFG-18
 BAILEY ribFG-18
 SELLORS ribFG-18
 Conventional laryngoscope handleAE-17
 CONVERSE nasal knifeEG-10
 COOLEY
 atraumatic anastomosis forcepsBD-37, BD-40
 atraumatic bulldog clampsBD-33 to BD-34
 atraumatic forcepsBB-03, BD-35 to BD-37, BD-39, BD-41
 atraumatic iliac forcepsBD-37
 atraumatic pediatric forcepsBD-38 to BD-39
 atrium retractorFG-20
 COOLEY DERRA atraumatic anastomosis forcepsBD-39
 COOLEY
 mitral valve dilatorFG-27 to FG-29
 COOLEY modif- STRUCK atrium retractorFG-20
 COOLEY
 rib first shearFG-05
 rib spreaderFG-09
 vascular dilatorFG-30
 vascular forcepsBD-40
 COOPER ligature needleCG-02
 CORDES larynx forcepsFC-03
 Corn cutter CREDOHE-03
 CORWIN tonsil hemostatFA-04
 CORYLLOS rib shearFG-04
 CORYLLOS (Thorax) retractorBI-13
 COTTLE-KAZANJIAN bone cutting forcepsDC-06
 COTTLE
 nasal knifeEG-10
 nasal retractorEG-17
 nasal scissorsAH-18, AI-25
 nasal speculaEG-03
 COTTLE-NEIVERT nasal retractorEG-17
 COTTLE
 periosteal elevatorEG-12
 rhinoplastic chiselEG-13
 septum elevatorEG-12
 Cotton applicatorCA-03
 DIMEDACA-03
 FARRELCA-03
 JOBSON-HORNECA-03
 TOBOLDCA-03
 UCKERMANNCA-03
 COXETER urethral soundGG-17
 CRAFOORD
 hemostatic bronchus forcepsBC-12
 lung and thorax scissorsAI-36
 Cranioclast
 BRAUNHC-09
 TARNIERHC-09
 CREDO corn cutterHE-03
 CRILE
 hemostatic forcepsBC-05
 CRILE-MURRAY needle holderCE-02
 CRILE
 needle holderCE-04
 CRILE-RANKIN hemostatic forcepsBC-05
 CRILE
 retractorBI-02
 CRILE TITAN hemostatic forcepsBC-05
 CRILE-WOOD needle holderCE-02
 CRITCHETT eye speculumEC-02

CRUTCHFIELD
 cervical traction tongEA-03
 drill bitEA-03
 CULLER iris spatulaEC-08
 Cup
 medicineHE-07
 sputumHE-06
 Curette
 ALVIS foreign bodyEC-06
 AXENFELD chalazionEC-07
 BARNHILL adenoidEG-19
 BECKMANN adenoidEG-19
 BLAKE uterineHA-48
 BRUNS boneDC-12 to DC-13
 BUMM uterineHA-49 to HA-50
 COAKLEY antrumEG-18
 FAULKNEREG-18
 FOX lupusHE-02
 GOURDET uterineHA-48
 HALLE boneDC-13
 HEBRA chalazionEC-07
 HOUSEEE-15
 KEVORKIAN uterine biopsy aspiratingHA-40
 LEMPERT boneDC-13
 MARTINI boneDC-13
 MEYHOEFER chalazionEC-07
 NOVAK uterine biopsy aspiratingHA-40
 PIFFARD lupusHE-02
 RANDALL uterine biopsy aspiratingHA-40
 RECAIMER uterineHA-49 to HA-50
 SCHEDE boneDC-12
 SCHROEDER uterineHA-48
 SIMON boneDC-13
 SIMON uterineHA-48
 SIMS uterineHA-49 to HA-50
 SPRATT boneDC-12
 St- CLAIR-THOMSON adenoidEG-19
 suctionHA-51
 VOLKMANN boneDC-12 to DC-13
 WILLIGER boneDC-13
 Curette BUCK earEE-05
 CUSCO vaginal speculumHA-04 to HA-06
 CUSHING
 brain spatulaEA-07
 drill burrDD-04
 laminectomy rongerEA-08
 nerve hookEA-04
 retractorBI-07
 thumb and tissue forcepsBA-03
 Cutter MCKENZIEDD-04
 CUZZI placenta and ovum scoopHC-08
 Cystotome
 BECKEREC-06
 GRAEFEEC-06
 CZERNY
 gall stone forcepsGC-03
 rectal speculumGI-02
 tenaculum forcepsHA-34
 D
 DALE atraumatic peripheral vascular forcepsBD-24
 DANDY
 hemostatic forcepsBC-07
 nerve hookEA-04
 neurosurgical scissorsAI-36
 DARDIK atraumatic forcepsBD-07
 DARLING retractorBI-17
 DARTIGUES uterine elevating forcepsHA-37
 DASTOOR
 erisophakeEC-09

- strabismus forcepsEC-14
- DAVIDSON (Scapula) retractorBI-13
- DAVIEL cataract spoonEC-07
- DAVIS-BOYLE mouth gagEI-04
- DAVIS
- dura dissectorEA-05
 - foreign body needleEC-05
 - sterilizing forcepsCI-02
- DAY ear hookletEE-07
- DEAN
- iris knifeEC-04
 - tonsil scissorsAI-26
- DEAVER Grip retractorBI-05
- DEAVER
- retractorBI-05
 - scissorsAH-05, AI-06
- DE BAKEY
- atraumatic anastomosis forcepsBD-25
 - atraumatic aortic-aneurysm forceps . .BD-13, BD-15, BD-18
 - atraumatic bronchus forcepsBD-19
 - atraumatic bulldog clampsBC-02
 - atraumatic dissecting and ligature forceps . .BD-25, BD-32
 - atraumatic forceps
.....BB-03, BD-02, BD-08, BD-16 to BD-17,
BD-20, BD-28 to BD-30
 - atraumatic iliac forcepsBD-11
 - atraumatic peripheral vascular forcepsBD-06
- DE BAKEY BAHNSON atraumatic
aortic-aneurysm forcepsBD-14
- DE BAKEY MORRIS atraumatic forcepsBD-16
- DE BAKEY
- needle holderCE-03
- DE BAKEY REYNOLDS atraumatic
anastomosis forcepsBD-30
- DE BAKEY SATINSKY atraumatic forcepsBD-22
- DE BAKEY
- suction tubeAE-04
 - vascular dilatorFG-31
 - vascular scissorsAI-30
- DEJERINE percussion hammerAC-07
- De LEE obstetrical forcepsHC-02
- Delicate model towel clampBE-02
- Delicate scissorsAI-05, AI-24
- De MARTEL saw conductorEA-05
- DeMARTTEL-WOLFSON anastomosis clampGE-07
- DENHART mouth gagEI-03
- Depressor
- BRAUN uterineHA-39
 - SIMS uterineHA-39
- DERF needle holderCE-02
- Dermatome bladeAG-21
- Dermatome
- BRAITHWAITEAG-22
 - HUMBYAG-20
 - SCHINKAG-21
 - SILVERAG-20
 - WATSONAG-22
- DERRA atraumatic anastomosis, pediatric forcepsBD-28
- DESCHAMPS ligature needleCG-02
- DESJARDINS
- gall duct forcepsBC-15
 - gall stone forcepsGC-02
 - gall stone probeGC-05
 - gall stone scoopGC-08
- DESMARRES
- Chalazion forcepsED-06
 - retractorBI-07
- DEUTSCHMANN cataract knifeEC-03
- DeVILBISS skull forcepsEA-05
- DEWEY obstetrical, with traction rod forcepsHC-05
- Diagnostic setAC-04
- DIAMANT wire cutterDD-12
- DIEFFENBACH serrefine bulldog clampsBC-03
- DIETER malleus nipperEE-10
- DIETHRICH
- atraumatic forcepsBD-31
 - vascular needle holderCE-06
 - vascular scissorsAI-29
- Dilator
- BAKES gall ductGC-06
 - CASTROVIEJO lachrymalEC-10
 - COOLEY mitral valveFG-27 to FG-29
 - COOLEY vascularFG-30
 - DE BAKEY vascularFG-31
 - GERBODE mitral valveFG-28
 - GOODELL uterineHA-30
 - HANK uterineHA-28
 - HEGAR uterineHA-24 to HA-27
 - HETZER mitral valveFG-29
 - LABORDE trachealFE-02
 - PRATT uterineHA-29
 - SIMS uterineHA-30
 - TROUSSEAU trachealFE-02
 - TUBBS mitral valveFG-27
 - WILDER lachrymalEC-10
 - WYLIE uterineHA-30
 - ZIEGLER lachrymalEC-10
- DIMEDA Alu tuning forkEE-03
- DIMEDA
- bandage scissorsAI-46
 - blade breakerAG-14
 - cotton applicatorCA-03
 - eye magnetED-08
 - finger ring cutterDD-03
 - retractorBI-14
 - waste pickup forcepsCI-03
- DINGMANN bone holding forcepsDC-10
- DirectorCA-02
- DOYENCA-02
 - KOCHER goitreFE-04
- Dish PETRIHE-08
- Dissecting knifeAG-15
- Dissecting large rings scissorsAI-19
- Dissecting scissorsAI-34
- Dissector
- DAVIS duraEA-05
 - duraEA-05
 - FISCHEE-15
 - GREEN cornealEC-06
 - HORSLEY duraEA-06
 - HURD tonsilFA-02
 - LANG lachrymalEC-08
 - MILLIGAN duraEA-05
 - PATON cornealEC-05
 - PENFIELD duraEA-06
 - ROBB vascularFG-33
 - SACHS duraEA-05
 - TOENNIS duraEA-05
- DITTEL
- catheter introducerGG-11
 - urethral soundGG-18 to GG-19
- DIX
- foreign body needleEC-09
 - foreign body spudEC-06
- DOUGLAS
- cilia forcepsED-08
 - trocaxCC-02
- DOYEN-Baby intestinal forcepsGE-03
- DOYEN
- directorCA-02
 - drill burrDD-07
 - gynecological scissorsAI-33

intestinal forceps	.GE-03
DOYEN-JANSEN mouth gag	.EI-03
DOYEN	
myoma screw	.HA-46
periosteal, rib elevator	.DC-20
retractor	.BI-12
towel clamp	.BE-05
uterine polypus forceps	.HA-36
vaginal speculum	.HA-18, HA-20
Dressing thumb and tissue forceps	.BA-02
Drill bit CRUTCHFIELD	.EA-03
Drill burr	.DD-04, DD-07
ALBEE	.DD-07
BORCHARDT	.DD-07
CUSHING	.DD-04
DOYEN	.DD-07
HUDSON	.DD-04
TOTI	.DD-07
twist	.DD-04
Drums	
KONRICH sterilizing	.HE-12
SCHIMMELBUSCH sterilizing	.HE-12
DUBOIS gynecological scissors	.AI-33
DUPLAY	
dressing forceps	.BG-14
tenaculum forceps	.HA-31
Duplex stethoscope	.AC-06
DUPUY-WEISS tonsil needle	.FA-03
DUVAL	
grasping forceps	.GE-03
thumb and tissue forceps	.BA-04
Dynamometer COLLIN	.AC-03

E

ECHLIN bone rongeur	.DC-05
EDWARDS	
clip	.BD-21
clip applying forceps	.BD-21
Electrical plaster saw	.DA-05 to DA-06
Electrode coagulation mini	.JA-02 to JA-03
Elevator	
ADSON	.DC-21
ALEXANDER periosteal	.DC-19
BALLENGER septum	.EG-12
COTTLE periosteal	.EG-12
COTTLE septum	.EG-12
DOYEN periosteal, rib	.DC-20
FARABEUF periosteal	.DC-19
FREER septum	.EG-11
HAJEK-BALLENGER septum	.EG-12
HENKE tonsil	.FA-02
JOSEPH periosteal	.EG-12
KEY	.DC-21
KILLIAN septum	.EG-12
LAMBOTTE periosteal	.DC-19
LANGENBECK	.DC-21
LANGENBECK periosteal	.DC-19
LEMPERT	.EE-15
MATSON periosteal	.DC-21
McDONALD	.DC-22
McKENTY septum	.EG-11
MURLESS head	.HC-05
MURPHY-LANE	.DC-22
OVERHOLT periosteal	.DC-21
ROGER septum	.EG-11
SADILLOT periosteal	.DC-19
SEMB periosteal	.DC-20
WATSON-CHEYNE	.DC-22
WILLIGER periosteal	.DC-19
ELLIOT	
corneal trephine	.ED-08

obstetrical forceps	.HC-02
ELLIS foreign body gouge	.EC-06
ELSAESSER nephrostomy forceps	.GC-13
ELSCHNIG	
capsular forceps	.ED-04
corneal knife	.EC-05
cyclodialysis spatula	.EC-08
fixation forceps	.ED-03
EMMET fistula hook	.HA-46
ENGEL plaster saw	.DA-02
Enterotomy scissors	.AI-39
EPPENDORFER-KEVORKIAN	
uterine biopsy specimen forceps	.HA-46
EPPENDORFER TISCHLER-MORGAN	
uterine biopsy specimen forceps	.HA-46
EPPENDORFER	
uterine biopsy specimen forceps	.HA-45 to HA-46
ERBE SELECT electrosurgery equipment cable	.JA-07
Erisophake DASTOOR	.EC-09
ESMARCH	
bandage scissors	.AI-46
plaster knife	.DA-04
EVES tonsil snare	.FA-04
Extension bow	.DD-10
BOEHLER 16x9 cm	.DD-10
KIRSCHNER	.DD-10
tightener	.DD-10
wrench	.DD-10
Extractor	
KUENTSCHER	.DD-13
SAALFELD comedo	.HE-02
SCHAMBERG comedo	.HE-02
UNNA comedo	.HE-02
WALTON comedo	.HE-02

F

FARABEUF	
bone holding forceps	.DC-07
FARABEUF-LAMBOTTE bone holding forceps	.DC-08
FARABEUF	
periosteal elevator	.DC-19
retractor	.BI-02
FARREL cotton applicator	.CA-03
FAULKNER curette	.EG-18
FAURE	
peritoneum forceps	.BC-17
uterine biopsy specimen forceps	.HA-41
FEHLAND intestinal forceps	.GE-06
FEILCHENFELD splinter forceps	.BA-06
FERGUSSON	
angiotribe forceps	.BC-07
bone holding forceps	.DC-07
gall stone scoop	.GC-07
scissors	.AI-49
FERRIS-SMITH-KERRISON intervertebral disc rongeur	.EA-10
FERRIS-SMITH laminectomy rongeur	.EA-09
FERRIS thumb and tissue forceps	.BA-04
Fiber optic laryngoscope handle	.AE-11
File	
JOSEPH file	.EG-14
nail	.HE-03
FILIFORM bougiem	.GG-12
Fine scissors	.AI-19
Finger protector LANGENBECK	.EI-06
FINOCHIETTO-BABY rib spreader	.FG-09
FINOCHIETTO	
bronchus forceps	.FG-21
FINOCHIETTO BURFORD rib spreader	.FG-12 to FG-14
FINOCHIETTO-HAIGHT BABY rib spreader	.FG-10

E

Index English

- FINOCHIETTO INFANT rib spreaderFG-12
 FINOCHIETTO (modif) rib spreaderFG-08
 FINOCHIETTO
 needle holderCE-04
 rectal scissorsAI-38
 rib spreaderFG-08, FG-10 to FG-11
 FINSEN retractorBI-14
 FINSTERER suction and irrigation cannulaAE-05
 FISCH dissectorEE-15
 FISCHER iris forcepsEC-13
 Fixation system LEYLAEA-14 to EA-18
 FLETCHER JAVERTS sponge holding forcepsBG-10
 FLEURANT trocarCC-02
 FOERSTER
 iris forcepsEC-12
 sponge holding forcepsBG-06 to BG-08
 FOMON
 nasal raspEG-15 to EG-16
 nasal retractorEG-17
 nasal scissorsAH-18, AI-25
 rhinoplastic chiselEG-13
 Forceps
 ADLERKREUTZ thumb and tissueBA-04
 ADSON BABY hemostaticBC-09
 ADSON-BROWN thumb and tissueBA-03
 ADSON hemostaticBC-09
 ADSON hypophysealEA-06
 ADSON thumb and tissueBA-03
 ADSON thumb and tissue, microBA-03
 ALEXANDER uterine biopsy specimenHA-42
 ALLIS-ADAIR tissueGE-02
 ALLIS-Baby tissueGE-02
 ALLIS tissueGE-02
 ARCHER splinterBA-06
 ARRUGA capsularED-04
 ASCH septumEG-18
 AYER chalazionED-06
 BABCOCK seizingGE-02
 BAGGISH uterine biopsy specimenHA-45
 BAINBRIDGE atraumaticBD-09
 BAINBRIDGE hemostaticBC-14
 BALLENGER tonsil seizingFA-04
 BARRAQ-KATZIN irisEC-13
 BARRAQU Colibri irisEC-13
 BARRAQUER anterior chamberED-02
 BARRAQUER ciliaED-08
 BARRAQUER fixationED-03
 BARRETT tenaculumHA-32
 BARTON obstetricalHC-04
 BECK atraumatic peripheral vascularBD-25
 BEER ciliaED-08
 BENGOLEA hemostaticBC-09
 BERGMANN FOERSTER sponge holdingBG-10
 BERKE muscularED-02
 BEST intestinalGE-06
 bipolar coagulationJA-04 to JA-06
 BIRCHER-GANSKE bone holdingDC-10
 BISHOP-HARMAN irisEC-14
 BLAKE gall stoneGC-03
 BLOHMKE tonsil seizingFA-04
 BOERMA obstetricalHC-04
 BÖHLER bone cuttingDC-06
 BONACCOLTO strabismusEC-14
 BONNEY sponge holdingBG-08
 Bonn irisEC-15
 Bonn TITAN irisEC-15
 BOZEMANN-DOUGLAS dressingBG-13
 BOZEMANN dressingBG-13
 BRAIN MINI clip applyingEA-12
 BRAIN STANDARD clip applyingEA-12
 BRAUN tenaculumHA-31, HA-34
 BROWN thumb and tissueBA-03
 BRUENINGS larynxFC-03
 BRUENINGS nasal cuttingEG-05
 BRUNNER intestinalGE-06
 BRYANT sponge holdingBG-11
 BUMM uterine elevatingHA-38
 BURKE-Baby uterine biopsy specimenHA-44
 BURKE uterine biopsy specimenHA-44
 CARMALT splinterBA-06
 CASTAÑEDA atraumatic neonatal and childrenBD-42
 CASTROVIEJO capsularED-04
 CASTROVIEJO fixationED-03
 CASTROVIEJO sutureED-05
 CHAPUT hemostaticBC-08
 CHEATLE sterilizingCI-02
 CHERON dressingBG-12
 CHEVALIER-JACKSON larynxFC-04
 CHILDE clip applyingCG-07
 ciliaED-08
 COLLIN clip applyingCG-07
 COLLIN dressingBG-11
 COLLIN-DUVAL thumb and tissueBA-04
 COLLIN hemostaticBC-08
 COLLIN-POZZI tenaculumHA-32
 COLLIN tongue holdingEI-03
 COLLIN uterine elevatingHA-37
 COLVER tonsil seizingFA-03
 COOLEY
 atraumaticBB-03, BD-35 to BD-37, BD-39, BD-41
 atraumatic anastomosisBD-37, BD-40
 atraumatic iliacBD-37
 atraumatic pediatricBD-38 to BD-39
 COOLEY DERRA atraumatic anastomosisBD-39
 COOLEY vascularBD-40
 CORDES larynxFC-03
 COTTLE-KAZANJIAN bone cuttingDC-06
 CRAFOORD hemostatic bronchusBC-12
 CRILE hemostaticBC-05
 CRILE-RANKIN hemostaticBC-05
 CRILE TITAN hemostaticBC-05
 CUSHING thumb and tissueBA-03
 CZERNY gall stoneGC-03
 CZERNY tenaculumHA-34
 DALE atraumatic peripheral vascularBD-24
 DANDY hemostaticBC-07
 DARDIK atraumaticBD-07
 DARTIGUES uterine elevatingHA-37
 DASTOOR strabismusEC-14
 DAVIS sterilizingCI-02
 DE BAKEY atraumatic
 BB-03, BD-02, BD-08, BD-16 to BD-17, BD-20, BD-28 to BD-30
 DE BAKEY atraumatic anastomosisBD-25
 DE BAKEY atraumatic
 aortic-aneurysmBD-13, BD-15, BD-18
 DE BAKEY atraumatic bronchusBD-19
 DE BAKEY atraumatic
 dissecting and ligatureBD-25, BD-32
 DE BAKEY atraumatic iliacBD-11
 DE BAKEY atraumatic peripheral vascularBD-06
 DE BAKEY BAHNSON atraumatic
 aortic-aneurysmBD-14
 DE BAKEY MORRIS atraumaticBD-16
 DE BAKEY REYNOLDS atraumatic anastomosisBD-30
 DE BAKEY SATINSKY atraumaticBD-22
 De LEE obstetricalHC-02
 DERRA atraumatic anastomosis, pediatricBD-28
 DESJARDINS gall ductBC-15
 DESJARDINS gall stoneGC-02
 DESMARRES chalazionED-06
 DeVILBISS skullEA-05

DEWEY obstetrical, with traction rod	.HC-05	HALSTED-MOSQUITO micro hemostatic	.BC-04
DIETHRICH atraumatic	.BD-31	HALSTED-MOSQUITO TITAN hemostatic	.BC-04
DIMEDA waste pickup	.CI-03	HARKEN atraumatic auricle	.BD-23
DINGMANN bone holding	.DC-10	HARRINGTON bronchus	.FG-21
DOUGLAS cilia	.ED-08	HARTMANN ear	.EE-08
DOYEN-Baby intestinal	.GE-03	HARTMANN hemostatic	.BC-03
DOYEN intestinal	.GE-03	HARTMANN-HOFFMANN ear	.EE-08
DOYEN uterine polypus	.HA-36	HARTMANN nasal cutting	.EG-07
DUPLAY dressing	.BG-14	HARTMANN nasal polypus	.EG-04
DUPLAY tenaculum	.HA-31	HARTMANN-WULLSTEIN ear	.EE-08
DUVAL grasping	.GE-03	HEANEY hysterectomy	.BC-18
DUVAL thumb and tissue	.BA-04	HEGENBARTH clip applying	.CG-07
ear micro	.EE-09 to EE-10, EE-12	HEIMING kidney stone	.GC-13
ear micro mini	.EE-13	HEISS hemostatic	.BC-09
EDWARDS clip applying	.BD-21	HENROTIN tenaculum	.HA-34
ELLIOT obstetrical	.HC-02	HERRICK kidney pedicle	.BC-17
ELSAESSER nephrostomy	.GC-13	HESS capsular	.ED-04
ELSCHNIG capsular	.ED-04	HESS iris	.EC-12
ELSCHNIG fixation	.ED-03	HEYMANN-KNIGHT nasal polypus	.EG-05
EPPENDORFER-KEVORKIAN		HEYMANN nasal cutting	.EG-05
uterine biopsy specimen	.HA-46	HEYWOOD-SMITH pile	.GI-05
EPPENDORFER TISCHLER-MORGAN		HUNTER splinter	.BA-06
uterine biopsy specimen	.HA-46	IOWA tenaculum	.HA-35
EPPENDORFER		JACKSON tampon	.FC-02
uterine biopsy specimen	.HA-45 to HA-46	JACOBS tenaculum	.HA-34
FARABEUF bone holding	.DC-07	JAMESON strabismus	.EC-13
FARABEUF-LAMBOTTE bone holding	.DC-08	JANSEN nasal	.EG-04
FAURE peritoneum	.BC-17	JARCHO tenaculum	.HA-32
FAURE uterine biopsy specimen	.HA-41	JATHO nasopharynx	.EG-18
FEHLAND intestinal	.GE-06	JAVID atraumatic carotid	.BD-32
FEILCHENFELD splinter	.BA-06	JOHNS-HOPKINS gall duct	.BC-14
FERGUSSON angiotribe	.BC-07	JUDD-ALLIS tissue	.GE-02
FERGUSSON bone holding	.DC-07	JURASZ larynx polypus	.FC-02
FERRIS thumb and tissue	.BA-04	KALT capsular	.ED-04
FINOCHIETTO bronchus	.FG-21	KELLY hemostatic	.BC-05
FISCHER iris	.EC-13	KELLY-RANKIN hemostatic	.BC-05
FLETCHER JAVERTS sponge holding	.BG-10	KELLY TITAN hemostatic	.BC-05
FOERSTER iris	.EC-12	KELLY uterine polypus	.HA-36
FOERSTER sponge holding	.BG-06 to BG-08	KERN bone holding	.DC-08
FRAENKEL larynx	.FC-03	KEVORKIAN-Pacific uterine biopsy specimen	.HA-44
FRAENKEL larynx polypus	.FC-02	KEVORKIAN uterine biopsy specimen	.HA-43, HA-46
FUCHS capsular	.ED-04	KIELLAND-LUIKART obstetrical	.HC-03
GAUSS scalp flap	.HC-06	KIELLAND obstetrical	.HC-02
GELLHORN uterine biopsy specimen	.HA-42	KIRBY-ARTHUR iris	.EC-13
GEMINI dissecting and ligature	.BC-10	KNAPP-LUER trachoma	.ED-06
GEMINI MINI dissecting and ligature	.BC-10	KNIGHT nasal cutting	.EG-05
GERALD thumb and tissue	.BA-05	KOCHER hemostatic delicate	.BC-06
GILL-ARRUGA capsular	.ED-03	KOCHER intestinal	.GE-04
GILL-HESS iris	.EC-12	KRAUSE larynx	.FC-03
GILLIES thumb and tissue	.BA-05	LAHEY gall duct	.BC-14
GILL iris	.EC-12	LAHEY goitre seizing	.FE-04
glans and the foreskin grasping	.GG-10	LAMBERT chalazion	.ED-06
GLOVER atraumatic	.BD-06, BD-30	LAMBERT KAY atraumatic aortic-anastomosis	.BD-10
GLOVER atraumatic anastomosis	.BD-05	LAMBERT KAY atraumatic iliac	.BD-11
GLOVER atraumatic coarction	.BD-04	LAMBOTTE bone holding	.DC-08
GRADLE cilia	.ED-08	LANE bone holding	.DC-08
GRAEFE fixation	.ED-03	LANE for bone plates	.DD-14
GRAEFE iris	.EC-11	LANE for bone screws	.DD-14
GRAEFE thumb and tissue	.BA-03	LANE thumb and tissue	.BA-04
GRAY gall duct	.BC-15	LANGE larynx	.FC-03
GREEN-ARMYTAGE		LANGENBECK bone holding	.DC-07
caesarean section haemostatic	.HC-06	LAWRENCE hemostatic	.BC-13
GREEN fixation	.ED-03	LEES atraumatic bronchus	.BD-03
GREGORY atraumatic profunda	.BD-33	LELAND JONES atraumatic	
GREVEN ear micro	.EE-10	peripheral vascular	.BD-08 to BD-09
GRIP seizing	.DD-11	LERCHE thumb and tissue	.BA-04
GROSS dressing	.BG-05	LERICHE hemostatic	.BC-09
GROSS-MAIER dressing	.BG-02 to BG-04	LESTER fixation	.ED-03
GUYON kidney pedicle	.BC-16	LEWIN bone holding	.DC-10
HALSTED-MOSQUITO atraumatic	.BD-02	LEWKOWITZ placenta and ovum	.HC-07
HALSTED-MOSQUITO hemostatic	.BC-04	LIDDLE atraumatic aortic	.BD-10

E

Index English

LISTER sponge holding sinus	.BG-11	PIPER obstetrical, with traction rod	.HC-04
LISTON bone cutting	.DC-06	POTTS atraumatic	.BD-26 to BD-27
LITTAUER cilia	.ED-08	POTTS atraumatic anastomosis	.BD-05
LITTAUER ear	.EE-08	POTTS atraumatic coarctation	.BD-04
LITTAUER nasal polypus	.EG-05	POTTS-SMITH thumb and tissue	.BA-02
LOVELACE hemostatic	.BC-07	POZZI tenaculum	.HA-31
LOVELACE lung grasping	.FG-19	PRATT hemostatic	.BC-08
LOWER gall duct	.BC-14	PRATT tenaculum	.HA-34 to HA-35
LUBET-BARBON nasal polypus	.EG-05	PRESBYTERIAN HOSPITAL tubing clamp	.BC-19
LUCAE ear	.EE-07	PRICE-THOMAS bronchus	.FG-22
LUC nasal cutting	.EG-06	PRINCE muscular	.ED-02
LUIKART obstetrical	.HC-03	PROVIDENCE-HOSPITAL hemostatic	.BC-05
MAGILL catheter introducing	.AE-06	RADOLF nail extracting	.DD-03
MAIER dressing	.BG-12	RAMPLEY sponge holding	.BG-09
MARSHNIK tonsil	.FA-04	RANDALL kidney stone	.GC-11 to GC-12
MARTEL scalp flap	.BC-08	RANEY clip applying	.EA-03
MARTIN dressing	.BG-02, BG-14	RANKIN atraumatic	.BD-02
MARTIN sequester	.DC-10	RICHTER-HEATH clip applying	.CG-07
MASTIN muscular	.FE-04	ROBERTS hemostatic	.BC-11
MATHIEU foreign body	.GG-07	ROCHESTER-CARMALT hemostatic	.BC-07
MAYO BLAKE gall stone	.GC-04	ROCHESTER-OCHSNER hemostatic	.BC-06
MAYO-GUYON kidney pedicle	.BC-16	ROCHESTER-PEAN hemostatic	.BC-06
MAYO-ROBSON intestinal	.GE-05	ROGGE sterilizing	.CI-02
McCLINTOCK placenta and ovum	.HC-07	ROSENBERG larynx	.FC-03
McCULLOUGH strabismus	.EC-13	ROWE mouth	.EI-06
McGEE ear micro	.EE-10	RUBIN septum crushing	.EG-07
McINDOE thumb and tissue	.BA-04	RUMEL thorax	.BC-11
McKENZIE clip applying	.EA-02	RUSKIN-LISTON bone cutting	.DC-06
McLEAN-LUIKART obstetrical	.HC-03	RUSSIAN thumb and tissue	.BA-04
McLEAN obstetrical	.HC-04	SAENGER placenta and ovum	.HC-07
McLEAN-TUCKER-LUIKART obstetrical	.HC-03	SAIRGES tenaculum	.HA-32
McPHERSON TITAN tying	.ED-05	SAROT bronchus	.FG-23
McPHERSON tying	.ED-05	SAROT hemostatic bronchus	.BC-12
MEEKER hemostatic	.BC-13	SATINSKY atraumatic	.BD-20
MICHEL clip applying	.CG-07	SAUERBRUCH waste pickup	.CI-03
MIDDLETON-JANSEN nasal cutting	.EG-09	SAWTELL tonsil	.FA-03
MIKULICZ peritoneum	.BC-17	SCHEINMANN larynx	.FC-03
MILLIN capsule forceps	.GG-03	SCHNIDT tonsil	.FA-03
MILLIN ligature carrying	.GG-03	SCHOENBURG grasping	.GE-03
MILLIN lobe holding	.GG-03	SCHROEDER tenaculum	.HA-31 to HA-32
MIXTER BABY hemostatic bronchus	.BC-13	SCHUBERT uterine biopsy specimen	.HA-41
MIXTER gall duct	.BC-15	SCHUMACHER larynx	.FC-03
MIXTER gall stone	.GC-04	SCHUMACHER uterine biopsy specimen	.HA-43
MIXTER hemostatic	.BC-14	SCHWEIGGER capsular	.ED-04
MIXTER hemostatic bronchus	.BC-13	SEIFFERT larynx	.FC-03
MIXTER O'SHAUGNESSY hemostatic	.BC-14	SEMB bone cutting	.DC-07
MOORFIELD suture	.ED-05	SEMB bone holding	.DC-07
MOYNIHAN gall duct	.BC-15	SEMB bronchus	.FG-23
MURPHY tubing clamp	.BC-19	SEMKEN thumb and tissue	.BA-05
MUSEUX tenaculum	.HA-33	SIEGLER HELLMANN uterine elevating	.HA-38
MYLES nasal cutting	.EG-07	SIMPSON-BRAUN obstetrical	.HC-02
NAEGELE obstetrical	.HC-03	SIMPSON-LUIKART obstetrical	.HC-03
NEGUS tonsil	.FA-03	SIMPSON obstetrical	.HC-02
NELSON thumb and tissue	.BA-05	SIMS-MAIER dressing	.BG-05
NEUBÜSER tubal seizing	.HA-51	SINGLEY thumb and tissue	.BA-05
NOTO uterine polypus	.HA-36	SKENE tenaculum	.HA-31
NOYES nasal polypus	.EG-05	SMITHWICK clip applying	.EA-02
OCHSNER atraumatic aortic	.BD-31	SNELLEN entropium	.ED-06
OLIVECRONA-TOENNIS clip applying	.EA-02	SOMER uterine elevating	.HA-37
OVERHOLT-GEISSENDOERFER		SPENCER-WELLS hemostatic	.BC-07
dissecting and ligature	.BC-10	STAUDE-MOORE tenaculum	.HA-31
PAUFIQUE TITAN tying	.ED-05	STEVENS iris	.EC-11
PAUFIQUE tying	.ED-05	STIEGLITZ splinter	.BA-06
PEAN atraumatic	.BD-02	STILLE-HORSLEY bone cutting	.DC-07
PEAN hemostatic	.BC-08	STILLE kidney pedicle	.BC-16
PEAN hemostatic delicate	.BC-06	STILLE-LISTON bone cutting	.DC-06
PEET splinter	.BA-06	STILLE thumb and tissue	.BA-02
PELKMANN dressing	.BG-12	St- MARTIN suture	.ED-05
PENNINGTON hemostatic	.BC-07	STONE closing	.GE-06
PHANEUF peritoneum	.BC-17	STONE-WATT intestinal	.GE-06
PIPER obstetrical	.HC-04	STRUEMPPEL ear	.EE-08

STRUYCKEN nasal cutting	EG-07	FRANCIS foreign body needle	EC-05
SUBRAMANIAN atraumatic	BD-31	FRANKLIN-SILVERMANN puncture needle	CC-03
SWEET clip applying	EA-02	FRAZIER	
TARNIER obstetrical, with traction rod	HC-05	hooklet	BI-06
TEALE tenaculum	HA-33	retractor	BI-21
TERSON capsular	ED-04	suction tube	EA-07
THOMS-ALLIS tissue	GE-02	FREER	
THOMS-GAYLOR uterine biopsy specimen	HA-42	mucosa knife	EG-10
TIEMANN tenaculum	HA-32	nasal gouge	EG-14
TILLEY ear	EE-08	septum chisel	EG-12
TISCHLER-KEVORKIAN		septum elevator	EG-11
uterine biopsy specimen	HA-44 to HA-45	septum knife	EG-10
TISCHLER-MORGAN		FREEWAY-GRAVE vaginal speculum	HA-06
uterine biopsy specimen	HA-43 to HA-44, HA-46	FRENZEL tongue depressor	EI-02
TIVNEN tonsil seizing	FA-04	FRIEDMAN	
TOENNIS hemostatic	BC-11	bone rongeur	DC-02
TOWNSEND-KEVORKIAN		FRIEDMAN Mini bone rongeur	DC-02
uterine biopsy specimen	HA-44	FRIEDMAN	
TOWNSEND-MINI (BABY TISCHLER)		perineorr retractor	HA-23
uterine biopsy specimen	HA-45	FRITSCH retractor	BI-11
TOWNSEND-mini uterine biopsy specimen	HA-44	FRYKHOLM bone rongeur	DC-05
TOWNSEND-TISCHLER		FUCHS capsular forceps	ED-04
uterine biopsy specimen	HA-44	Funnel	HE-07
TOWNSEND uterine biopsy specimen	HA-44		
TROELTSCH nasal	EG-04	G	
TROUTMAN Colibri iris	EC-13	GALLAHER antrum rasp	EG-16
TROUTMAN rectus	ED-02	GAUSS scalp flap forceps	HC-06
Tübingen iris	EC-15	Gauze packer LUNIATSCHEK	FA-02
Tübingen TITAN iris	EC-15	GELLHORN uterine biopsy specimen forceps	HA-42
Tübingen TITAN tying	ED-05	GELPI abdominal retractor	BI-24
Tübingen tying	ED-05	GEMINI dissecting and ligature forceps	BC-10
TUFFIER hemostatic	BC-08	GEMINI MINI dissecting and ligature forceps	BC-10
TURREL biopsy specimen	GI-05	GERALD thumb and tissue forceps	BA-05
TYDING tonsil seizing	FA-04	GERBODE mitral valve dilator	FG-28
ULRICH sponge holding	BG-06	GERSTER traction bar	DC-11
UNIVERSAL sterilizing	CI-02	GERZOG hammer	DC-18
USA thumb and tissue	BA-02	GIERTZ-STILLE rib shear	FG-06
VAN BUREN sequester	DC-10	GIGLI for wire saw handle	EA-05
van DOREN uterine biopsy specimen	HA-42	GILL-ARRUGA capsular forceps	ED-03
VERBRUGGE bone holding	DC-09	GILL	
VIRTUS (RALK) splinter	BA-06	corneal knife	EC-05
WACHENFELDT clip applying	CG-07	GILL-HESS iris forceps	EC-12
WALSHAM septum	EG-18	GILLIES	
WANGENSTEEN thumb and tissue	BA-05	hooklet	EG-17
WEBER atraumatic	BD-12	needle holder	CE-05
WEIL-BLAKESLEY nasal cutting	EG-06	thumb and tissue forceps	BA-05
WEISS tubing clamp	BC-19	GILL	
WERTHEIM-CULLEN hysterectomy	BC-18	iris forceps	EC-12
WERTHEIM hysterectomy	BC-18	GLOVER	
WHITE tonsil seizing	FA-03	atraumatic anastomosis forceps	BD-05
WILDE (TROELTSCH) ear	EE-07	atraumatic bulldog clamps	BC-02
WILLET-MARTELL scalp flap	BC-08	atraumatic coarctation forceps	BD-04
WILLIAMS grasping	GE-03	atraumatic forceps	BD-06, BD-30
WINTER placenta and ovum	HC-07	GLUCK rib shear	FG-03
wire cutting and bending	DD-11	GOELET retractor	BI-03
WITTNER uterine biopsy specimen	HA-43	GOLDMAN-FOX gum scissors	AI-41
WRIGLEY obstetrical	HC-02	GOLDSTEIN eye speculum	EC-03
WYLIE atraumatic	BD-21	Goniometer MOELTGEN	AC-08
YEOMAN biopsy specimen	GI-05	GOODELL uterine dilator	HA-30
YOUNG prostatic grasping	GG-02	GOOD tonsil scissors	AI-27
YOUNG tongue holding	EI-03	GORNEY dissecting scissors	AI-13
ZENKER hemostatic	BC-12	GOSSET abdominal retractor	BI-21
FORD BOWLES stethoscope	AC-06	Gouge	
FORD stethoscope	AC-06	ALEXANDER bone	DC-14
Fork BURCH fixation	EC-05	bone	DC-14
FOX lupus curette	HE-02	ELLIS foreign body	EC-06
FRAENKEL		FREER nasal	EG-14
larynx forceps	FC-03	HAJEK nasal	EG-14
larynx polypus forceps	FC-02	HIBBS bone	DC-16
Frame KIRSCHNER abdominal retractor	BI-23	KILLIAN-CLAUS nasal	EG-14
FRANCESCHETTI corneal trephine	ED-07		

E

Index English

- LEXER boneDC-16
 LEXER mini boneDC-16
 PARTSCH boneDC-14
 SMITH-PETERSEN boneDC-15
 STILLE boneDC-14
 WALTON foreign bodyEC-06
 WEST nasalEG-14
 GOURDET uterine curetteHA-48
 GRADLE cilia forcepsED-08
GRAEFE
 cataract knifeEC-03
 cataract spoonEC-07
 cystotomeEC-06
 eye speculumEC-02
 fixation forcepsED-03
 hookletBI-06
 iris forcepsEC-11
 scarifierEC-04
 strabismus hookEC-06
 thumb and tissue forcepsBA-03
 GRAEFE-TITAN strabismus hookEC-06
 GRAHAM nerve hookEA-04
 GRAVE vaginal speculumHA-02
 GRAY gall duct forcepsBC-15
GREEN-ARMYTAGE
 caesarean section haemostatic forcepsHC-06
GREEN
 corneal dissectorEC-06
 fixation forcepsED-03
 muscular hookEC-06
 retractorBI-10
 GREGORY atraumatic profunda forcepsBD-33
 GREVEN ear micro forcepsEE-10
 Grinding stone ARKANSASAG-19
 GRIP seizing forcepsDD-11
GROSS
 dressing forcepsBG-05
 ear spoonEE-06
 GROSS-MAIER dressing forcepsBG-02 to BG-04
 GRUBER ear speculaEE-02
 Gum scissorsAI-41
 GUTHRIE hookletBI-06
 GUTMANN secretions scoopGG-11
GUYON
 catheter introducerGG-11
 kidney pedicle forcepsBC-16
 urethral soundGG-12, GG-14 to GG-15
 GUYTON-LUNDSGAARD sclerotomeEC-05
 Gynecological micro scissorsAJ-07 to AJ-08
- H**
 HABERER retractorBI-04
 HAGLUND-STILLE plaster spreaderDA-03
 HAIGHT rib spreaderFG-15
 HAJEK-BALLENGER septum elevatorEG-12
 HAJEK-CLAUS punchEG-08
 HAJEK-KOFLER punchEG-08
 HAJEK nasal gougeEG-14
HALLE
 bone curetteDC-13
 dura knifeEA-06
 HALSEY needle holderCE-02
HALSTED-MOSQUITO
 atraumatic forcepsBD-02
 hemostatic forcepsBC-04
 HALSTED-MOSQUITO micro hemostatic forcepsBC-04
 HALSTED-MOSQUITO TITAN hemostatic forcepsBC-04
 Hamburg cannulaED-07
 HammerDC-18
 COLLINDC-18
- GERZOGDC-18
 KIRKDC-18
 LUCAEDC-18
 MEADDC-18
 QUISLINGDC-18
 slottedDD-13
 WILLIGERDC-18
Hand drill
 boneDD-05
 BUNNELL boneDD-05
 HUDSON braceDD-04
 KIRSCHNER boneDD-05
 MOORE boneDD-04
 RALK boneDD-05
 STILLE boneDD-04
 STILLE-SHERMAN boneDD-04
Hand drill with jacobs chuck boneDD-06
Handle
 BARTON tractionHC-04
 BILL tractionHC-05
 BROCK mitral valve dilatorFG-26
 COLLIN scalpelAG-08
 GIGLI for wire sawEA-05
 HUBER universalFC-03
 laryngeal mirrorFC-04
 LUIKART-BILL tractionHC-05
 HANK uterine dilatorHA-28
 HARKEN atraumatic auricle forcepsBD-23
HARRINGTON
 bronchus forcepsFG-21
 retractorBI-05
HARTMANN
 ear catheterEE-06
 ear forcepsEE-08
 ear speculaEE-02
 HARTMANN-HALLE nasal speculaEG-02
HARTMANN
 hemostatic forcepsBC-03
 HARTMANN-HOFFMANN ear forcepsEE-08
HARTMANN
 nasal cutting forcepsEG-07
 nasal polypus forcepsEG-04
 tongue depressorEI-02
 tuning forkEE-03
 HARTMANN-WULLSTEIN ear forcepsEE-08
Head lamp CLARAC-05
Head light CLAR miniAC-05
Head mirror ZIEGLERAC-05
HEANEY
 hysterectomy forcepsBC-18
 needle holderCE-03
 retractorBI-12
HEATH ligature scissorsAI-40
HEBRA chalazion curetteEC-07
HEGAR uterine dilatorHA-24 to HA-27
HEGENBARTH clip applying forcepsCG-07
HEIFETZ brain spatulaEA-07
HEIMING kidney stone forcepsGC-13
HEISS hemostatic forcepsBC-09
HEISTER mouth gagEI-03
Hemostat
 CORWIN tonsilFA-04
 PASSOWEE-15
HENKE tonsil elevatorFA-02
HENNIG plaster spreaderDA-03
HENROTIN tenaculum forcepsHA-34
HERMANN plaster spreaderDA-03
HERRICK kidney pedicle forcepsBC-17
HERTZLER rib spreaderFG-17
HESS
 capsular forcepsED-04

iris forcepsEC-12
HETZER mitral valve dilatorFG-29
HEYMANN-KNIGHT nasal polypus forcepsEG-05
HEYMANN
nasal cutting forcepsEG-05
nasal scissorsAH-18, AI-25
HEYWOOD-SMITH pile forcepsGI-05
HIBBS
bone chiselDC-16
bone gougeDC-16
osteotomeDC-16
HIRSCHMANN anoscopeGI-04
HOESEL needle holderCE-05
HOFER pillar retractorFA-02
HOFF towel clampBE-03
HOHMANN bone leverDC-22 to DC-23
HOHMANN mini bone leverDC-23
HOKE bone chiselDC-16
HOLTH corneoscleral punchEC-09
Hook
ADSON nerveEA-04
ARRUGA extractingEC-06
BOSE trachealFE-02
BRAUN decapitatingHC-09
CUSHING nerveEA-04
DANDY nerveEA-04
EMMET fistulaHA-46
extensionDD-10
extractionDD-13
GRAEFE strabismusEC-06
GRAEFE-TITAN strabismusEC-06
GRAHAM nerveEA-04
GREEN muscularEC-06
ITERSON trachealFE-02
JACKSON trachealFE-02
JAMESON strabismusEC-06
HookletEE-15
BARBARAEE-14
DAY earEE-07
FRAZIERBI-06
GILLIESEG-17
GRAEFEBI-06
GUTHRIEBI-06
JOSEPHBI-06
WAGENER earEE-07
Hook
LOVE nerveEA-04
mini electrodeJA-02
O'CONNOR irisEC-06
PRATT cysticGI-04
ROSE trachealFE-03
SACHS nerveEA-04
SMELLIE obstetricalHC-06
SMITHWICK nerveEA-04
STEVENS lensEC-06
WIENER irisEC-06
HOPKINS plaster knifeDA-04
HORSLEY dura dissectorEA-06
HOUSE curetteEE-15
HRYNTSCHAK prostatic retractorGG-06
HUBER universal handleFC-03
HUDSON
brace hand drillDD-04
drill burrDD-04
HUMBY
dermatomeAG-20
dermatome bladeAG-20
HUNTER splinter forcepsBA-06
HURD tonsil dissectorFA-02

I

Impactor
KUENTSCHER nailDD-13
nailDD-12
Incision scissorsAI-05
INGE lamina spreaderEA-07
Instrument
circumcisionGG-09
KNUTSON urethrographyGG-09
LAFORCE foreign bodyEC-06
MOGAN circumcisionGG-09
IOWA tenaculum forcepsHA-35
IRIS
eye scissorsAI-22
large rings scissorsAI-19
scissorsAH-16, AI-21
IrrigatorHE-05
ISRAEL retractorBI-11
ITARD ear catheterEE-06
ITERSON tracheal hookFE-02
IVES-FANSLER anoscopeGI-04

J

JACKSON
tampon forcepsFC-02
tracheal hookFE-02
tracheal tubeFE-03
vaginal speculumHA-16
JACOBSON micro scissorsAJ-11
JACOBS tenaculum forcepsHA-34
JAEGER
keratomeEC-04
lid plateEC-03
JAMESON
strabismus forcepsEC-13
strabismus hookEC-06
JAMISON needle holderCE-03
JANSEN
nasal forcepsEG-04
retractorBI-14
JarHE-08
JARCHO tenaculum forcepsHA-32
JATHO nasopharynx forcepsEG-18
JAVID atraumatic carotid forcepsBD-32
JENNINGS mouth gagEI-04
JOBSON-HORNE cotton applicatorCA-03
JOHNS-HOPKINS
gall duct forcepsBC-14
serrefine bulldog clampsBC-03
JOHNSON needle holderCE-04
JONES tube holder towel clampBE-02
JOSEPH
file fileEG-14
hookletBI-06
JOSEPH (LEWIS) nasal raspEG-15
JOSEPH
nasal knifeEG-10
nasal sawEG-17
nasel knifeEG-10
periosteal elevatorEG-12
scissorsAH-14, AI-16
JUDD-ALLIS tissue forcepsGE-02
JUDD-MASSON bladder retractorGG-04
JURASZ larynx polypus forcepsFC-02

K
KABIERSKE powder blowerEE-04

E

Index
English

- KALLMORGEN
vaginal retractorHA-15
vaginal speculumHA-15
- KALT-ARRUGA needle holderCE-07
- KALT
capsular forcepsED-04
needle holderCE-07
- KANE umbilical cord umbilic-cordHC-06
- KEITH suturing needleCG-06
- KELLY Grip retractorBI-04
- KELLY
gynecological scissorsAH-22, AI-33
hemostatic forcepsBC-05
proctoscopeGI-04
- KELLY-RANKIN hemostatic forcepsBC-05
- KELLY
retractorBI-04, BI-12
- KELLY TITAN hemostatic forcepsBC-05
- KELLY
uterine polypus forcepsHA-36
- Keratome
BERENSEC-04
CASTROVIEJOEC-04
JAEGEREC-04
- KERN bone holding forcepsDC-08
- KERRISON punchEG-08
- KEVORKIAN-Pacific uterine biopsy specimen forcepsHA-44
- KEVORKIAN
uterine biopsy aspirating curetteHA-40
uterine biopsy specimen forcepsHA-43, HA-46
- KEY elevatorDC-21
- KEYES cutaneous punchHE-02
- KIELLAND-LUIKART obstetrical forcepsHC-03
- KIELLAND obstetrical forcepsHC-02
- KILLIAN-CLAUS nasal gougeEG-14
- KILLIAN
septum elevatorEG-12
septum speculaEG-03
wash cannulaEG-09
- KILNER-DOUGHTY mouth gagEI-05
- KILNER
scissorsAH-14, AI-17
skin retractorHE-02
- KIRBY-ARTHUR iris forcepsEC-13
- KIRK hammerDC-18
- KIRSCHNER
abdominal retractorBI-23
abdominal retractor bladeBI-23
abdominal retractor frameBI-23
bone hand drillDD-05
extension bowDD-10
ligature conductorCG-04
wiredrillDD-09
- KLINKENBERGH-LOTH lung and thorax scissorsAI-37
- KNAPP
cataract spoonEC-07
iris knifeEC-04
- KNAPP-LUER tracheoma forcepsED-06
- KNAPP
retractorEC-06
scissorsAI-20
- Knife and dissector CARPENTER tonsilFA-02
- Knife
BALLENGER swivelEG-11
BARKAN goniotomyEC-05
BARRAQUER keratoplastyEC-05
BOWMAN discisionEC-04
cartilageAG-18
CATLIN amputationAG-16
CONVERSE nasalEG-10
COTTLE nasalEG-10
- DEAN irisEC-04
- DEUTSCHMANN cataractEC-03
dissectingAG-15
electrodeJA-03
- ELSCHNIG cornealEC-05
- ESMARCH plasterDA-04
- FREER mucosaEG-10
FREER septumEG-10
- GILL cornealEC-05
- GRAEFE cataractEC-03
- HALLE duraEA-06
- HOPKINS plasterDA-04
- JOSEPH nasalEG-10
JOSEPH naselEG-10
- KNAPP irisEC-04
- LANGENBECK resectionAG-17
- LISTON amputationAG-16
- MALTZ cartilageEG-11
- MUCK periostalEE-15
- PARKER dissectingAG-15
- PAUFIQUE keratoplastyEC-05
- PLESTER flapEE-14
- POLITZER earEE-06
- REINER plasterDA-04
- ROSEN circularEE-14
- SATO cornealEC-05
- SCHEIE goniotomyEC-05
- SCHUKNECHT rollerEE-14
SCHUKNECHT sickleEE-14
- SEGOND myomaHA-46
- SEXTON earEE-06
- TABB sickleEE-14
- TOOK cornealEC-05
- VIRCHOW brainAG-18
VIRCHOW cartilageAG-18
- WHEELER discisionEC-04
- WULLSTEIN sickleEE-14
- ZIEGLER capsulotomyEC-05
ZIEGLER irisEC-04
- KNIGHT nasal cutting forcepsEG-05
- KNOWLES bandage scissorsAI-47
- KNUTSON-KOCH urethrography coneGG-09
- KNUTSON urethrography instrumentGG-09
- KOCHER
bladder spatulaGG-04
goitre directorFE-04
hemostatic delicate forcepsBC-06
intestinal forcepsGE-04
retractorBI-10 to BI-11
- KOENIG
ligature conductorCG-04
suturing needleCG-06
- KOERTE retractorBI-11
- KOGAN endo speculumHA-23
- KONRICH sterilizing drumsHE-12
- KRAUSE
ear polypus snareEE-07
larynx forcepsFC-03
nasal snareEG-09
- KRISTELLER
vaginal retractorHA-09 to HA-14
vaginal speculumHA-09 to HA-14
- KRONECKER ligature needleCG-02
- KUENTSCHER
extractorDD-13
nail impactorDD-13
reamerDD-13
- KUHNT corneal scarifierEC-05
- L
LABORDE tracheal dilatorFE-02

- LAFORCE
adenotomeEG-19
foreign body instrumentEC-06
- LAGRANGE gum scissorsAI-41
- LAHEY
gall duct forcepsBC-14
goitre seizing forcepsFE-04
retractorBI-08
- LAMBERT chalazion forcepsED-06
- LAMBERT KAY
atraumatic aortic-anastomosis forcepsBD-10
atraumatic iliac forcepsBD-11
- LAMBOTTE
bone holding forcepsDC-08
- LAMBOTTE mini osteotomeDC-15
- LAMBOTTE
osteotomeDC-15
periosteal elevatorDC-19
- LANCASTER eye speculumEC-03
- Lancet electrodeJA-03
- LANDAU vaginal speculumHA-22
- LANDOLT
enucleation scissorsAI-25
micro surgical scalpel handleAG-13
- LANE
bone holding forcepsDC-08
for bone plates forcepsDD-14
for bone screws forcepsDD-14
screw driverDD-14
stomach clampGE-08
thumb and tissue forcepsBA-04
towel clampBE-05
- LANGE
bandage scissorsAI-44
larynx forcepsFC-03
- LANGENBECK
bone holding forcepsDC-07
elevatorDC-21
finger protectorEI-06
finger sawDD-03
periosteal elevatorDC-19
resection knifeAG-17
retractorBI-09
- LANG lachrymal dissectorEC-08
- Laryngoscope blade
MACINTOSH conventionalAE-15
MACINTOSH fiber opticAE-10
MILLER conventionalAE-16
MILLER fiber opticAE-10
- Laryngoscope set
MACINTOSH conventionalAE-18 to AE-19
MACINTOSH fiber opticAE-12 to AE-13
MILLER conventionalAE-18 to AE-19
MILLER fiber opticAE-12 to AE-13
- Laryngoscope
Spare lamp conventionalAE-20
Spare lamp fiber opticAE-20
- LAWRENCE hemostatic forcepsBC-13
- Lead hand splintDC-11
- LEBSCHKE sternum chiselDC-17
- LEES atraumatic bronchus forcepsBD-03
- LEGUEU
bladder retractorGG-06
bladder spatulaGG-04
- LEKSELL STILLE bone rongeurDC-05
- LELAND JONES atraumatic
peripheral vascular forcepsBD-08 to BD-09
- LEMPERT
bone curetteDC-13
bone rongeurDC-03
elevatorEE-15
- LERCHE thumb and tissue forcepsBA-04
- LERICHE hemostatic forcepsBC-09
- LESTER fixation forcepsED-03
- Lever
BENNETT boneDC-22
BLOUNT boneDC-24
boneDC-23
BUCK foreign bodyEE-08
HOHMANN boneDC-22 to DC-23
HOHMANN mini boneDC-23
QUIRE foreign bodyEE-08
- LEVINSON foreign body needleEC-05
- LEWIN bone holding forcepsDC-10
- LEWKOWITZ placenta and ovum forcepsHC-07
- LEXER-BABY scissorsAH-10
- LEXER
bone chiselDC-16
bone gougeDC-16
dissecting scissorsAI-11 to AI-12
- LEXER mini
bone chiselDC-16
bone gougeDC-16
- LEXER
scissorsAH-09
- LEYLA fixation systemEA-14 to EA-18
- LICHTWITZ trocarCC-02, EG-09
- LIDDLE atraumatic aortic forcepsBD-10
- Light carrier MILLIN fiber opticGG-05
- LISTER
bandage scissorsAH-23, AI-45
- LISTER-BURCH eye speculumEC-02
- LISTER
sponge holding sinus forcepsBG-11
- LISTON
amputation knifeAG-16
bone cutting forcepsDC-06
- LITTAUER
cilia forcepsED-08
ear forcepsEE-08
ligature scissorsAI-40
nasal polypus forcepsEG-05
- LITTLER dissecting scissorsAI-13
- LITTLE retractorBI-08
- LOCKLIN scissorsAI-18
- Loop
ARLT wireEC-08
BILLEAU earEE-07
earEE-07
mini electrodeJA-02 to JA-03
nasalEG-09
SNELLEN wireEC-08
tonsilFA-04
WEBER wireEC-08
WILDER wireEC-08
- LORENZ bandage scissorsAI-47
- LORNA towel clampBE-04
- LOUTE wire twisterDD-11
- LOVE-GRUENWALD laminectomy rongeurEA-08
- LOVELACE
hemostatic forcepsBC-07
lung grasping forcepsFG-19
- LOVE
nerve hookEA-04
uvula retractorFA-02
- LOWER gall duct forcepsBC-14
- LOWMAN bone holding clampDC-11
- LUBET-BARBON nasal polypus forcepsEG-05
- LUCAE
ear forcepsEE-07
hammerDC-18
tuning forkEE-04

E

Index
English

LUC nasal cutting forcepsEG-06
 LUER
 bone rongeurDC-03
 LUER-KOERTE gall stone scoopGC-09
 LUER
 tracheal tubeFE-03
 LUIKART-BILL traction handleHC-05
 LUIKART obstetrical forcepsHC-03
 LUNDGAARD sclerotomeEC-05
 LUNIATSCHEK gauze packerFA-02
 LURZ ureter clampGC-10

M

MACINTOSH
 conventional laryngoscope bladeAE-15
 conventional laryngoscope setAE-18 to AE-19
 fiber optic laryngoscope bladeAE-10
 fiber optic laryngoscope setAE-12 to AE-13
 MAGILL
 catheter introducing forcepsAE-06
 styletAE-04
 suction tubeAE-04
 Magnet DIMEDA eyeED-08
 MAIER dressing forcepsBG-12
 MALTZ
 cartilage knifeEG-11
 MALTZ (COTTLE) nasal raspEG-15
 MALTZ
 nasal raspEG-14
 Manometer for salpingographeHA-47
 Marker
 CASTROVIEJO compassEC-09
 CONNIN-AMSLEREC-09
 MARSCHIK tonsil forcepsFA-04
 MARTEL scalp flap forcepsBC-08
 MARTIN
 dressing forcepsBG-02, BG-14
 electrosurgery equipment cableJA-07
 MARTINI bone curetteDC-13
 MARTIN
 pelvimeterHC-06
 sequester forcepsDC-10
 uterine soundHA-39
 MASSON needle holderCE-03
 MASTIN muscular forcepsFE-04
 MATHIEU
 foreign body forcepsGG-07
 needle holderCE-05
 rectal speculumGI-02
 retractorBI-03
 MATSON periosteal elevatorDC-21
 MAUNDER wooden oral screwEI-06
 MAYO BLAKE gall stone forcepsGC-04
 MAYO
 gall stone scoopGC-07
 MAYO-GUYON kidney pedicle forcepsBC-16
 MAYO-HEGAR needle holderCE-02
 MAYO
 kidney stone probeGC-10
 left handed scissorsAI-07
 MAYO-NOBLE scissorsAH-08, AI-10
 MAY ophthalmoscopeAC-03
 MAYO-ROBSON intestinal forcepsGE-05
 MAYO
 safety needleCI-02
 scissorsAH-06, AI-07
 MAYO-STILLE scissorsAH-07, AI-08 to AI-09
 McClINTOCK placenta and ovum forcepsHC-07
 McCULLOUGH strabismus forcepsEC-13
 McDONALD elevatorDC-22

McGEE ear micro forcepsEE-10
 McGUIRE corneal scissorsAJ-05
 McINDOE
 cartilage scissorsAI-35
 thumb and tissue forcepsBA-04
 McIVOR
 mouth gagEI-05
 tongue depressorEI-05
 McKENTY septum elevatorEG-11
 McKENZIE
 clip applying forcepsEA-02
 cutterDD-04
 McLEAN-LUIKART obstetrical forcepsHC-03
 McLEAN obstetrical forcepsHC-04
 McLEAN-TUCKER-LUIKART obstetrical forcepsHC-03
 McPHERSON TITAN tying forcepsED-05
 McPHERSON tying forcepsED-05
 McPHERSON WESTCOTT tenotomy scissorsAJ-04
 MEAD
 bone rongeurDC-02
 hammerDC-18
 Measure graduatedHE-07
 Measuring tapeAC-08
 MEEKER hemostatic forcepsBC-13
 MELLINGER-AXENFELD eye speculumEC-02
 MELLINGER eye speculumEC-02
 MENGHINI trocarCC-03
 Meniscotome
 BIRCHERDC-24
 NEFFDC-24
 SMILLIEDC-24
 MERCEDES thoracic spreaderFG-16
 Metal rulerAC-08
 METZENBAUM
 dissecting scissorsAI-13 to AI-14
 METZENBAUM FINO
 dissecting scissorsAI-15
 scissorsAH-12
 METZENBAUM
 needle holderCE-04
 scissorsAH-11
 METZENBAUM "S" scissorsAH-13, AI-16
 MEYERDING retractorBI-08
 MEYHOEFER chalazion curetteEC-07
 MICHEL
 clipCG-07
 clip applying forcepsCG-07
 mirrorEG-04
 Micro forcepsBB-02
 Micro scissorsAJ-06, AJ-13
 Micro surgical scalpel handleAG-12
 MIDDELDORPF retractorBI-10
 MIDDLETON-JANSEN nasal cutting forcepsEG-09
 MIKULICZ
 peritoneum forcepsBC-17
 retractorBI-12
 MILLER
 conventional laryngoscope bladeAE-16
 conventional laryngoscope setAE-18 to AE-19
 fiber optic laryngoscope bladeAE-10
 fiber optic laryngoscope setAE-12 to AE-13
 MILLIGAN dura dissectorEA-05
 MILLIN
 bladder neck spreaderGG-07
 bladder retractorGG-05
 capsule forceps forcepsGG-03
 fiber optic light carrierGG-05
 ligature carrying forcepsGG-03
 lobe holding forcepsGG-03
 MILLS vascular scissorsAI-27
 Mini suturing kitCG-08

- Mirror
laryngealFC-04
MICHELEG-04
MIXTER BABY hemostatic bronchus forcepsBC-13
MIXTER
gall duct forcepsBC-15
gall stone forcepsGC-04
hemostatic bronchus forcepsBC-13
hemostatic forcepsBC-14
MIXTER O'SHAUGNESSY hemostatic forcepsBC-14
MOELTGEN goniometerAC-08
MOGAN circumcison instrumentGG-09
MOLLISON retractorBI-17
MOORE
bone hand drillDD-04
gall stone scoopGC-05
MOORFIELD suture forcepsED-05
MORSE-FAVOLORO rib spreaderFG-17
Mouth gag
DAVIS-BOYLEEI-04
DENHARTEI-03
DOYEN-JANSENEI-03
HEISTEREI-03
JENNINGSEI-04
KILNER-DOUGHTYEI-05
McIVOREI-05
ROSER-KOENIGEI-03
SEEMANN-SEIFFERTEI-04
WHITEHEADEI-04
MOYNIHAN
gall duct forcepsBC-15
gall stone probeGC-05
towel clampBE-05
MUCK periostal knifeEE-15
MUELLER eye speculumEC-03
MURDOCK eye speculumEC-02
MURLESS head elevatorHC-05
MURPHY-LANE elevatorDC-22
MURPHY tubing clamp forcepsBC-19
Muscle hook retractorBI-25
MUSEUX tenaculum forcepsHA-33
MYLES nasal cutting forcepsEG-07
- N**
NABATOFF probeCA-02
NAEGELE obstetrical forcepsHC-03
NÁGELE perforatorHC-09
NAGER palate retractorFA-02
Needle
BARBARAEE-14
BOWMAN discisionEC-05
BUNT safetyCI-02
Needle caseHE-02
SAUERBRUCHHE-02
Needle
cataractEC-05
COOPER ligatureCG-02
DAVIS foreign bodyEC-05
DESCHAMPS ligatureCG-02
DIX foreign bodyEC-09
DUPUY-WEISS tonsilFA-03
electrodeJA-03
foreign bodyEC-05
FRANCIS foreign bodyEC-05
FRANKLIN-SILVERMANN punctureCC-03
Needle holder
ADSONCE-04
ARRUGA ophthalmologicCE-06
BARRAQUERCE-07
BAUMGARTNERCE-02
BOYNTON ophthalmologicCE-06
BOZEMANNCE-03
CASTROVIEJOCE-07
COLLIERCE-02
CRILECE-04
CRILE-MURRAYCE-02
CRILE-WOODCE-02
DE BAKEYCE-03
DERFCE-02
DIETHRICH vascularCE-06
FINOCHIETTOCE-04
GILLIESCE-05
HALSEYCE-02
HEANEYCE-03
HOESELCE-05
JAMISONCE-03
JOHNSONCE-04
KALTCE-07
KALT-ARRUGACE-07
MASSONCE-03
MATHIEUCE-05
MAYO-HEGARCE-02
METZENBAUMCE-04
NEIVERTCE-02
OLSEN-HEGARCE-05
RYDERCE-03
SAROTCE-04
STEVENS ophthalmologicalCE-06
STRATTECE-04
TOENNISCE-04
WANGENSTEENCE-03
Needle
KEITH suturingCG-06
KOENIG suturingCG-06
KRONECKER ligatureCG-02
LEVINSON foreign bodyEC-05
MAYO safetyCI-02
mini electrodeJA-02
NELSON ligatureCG-02
POLITZER paracentesisEE-06
QUINKE punctureCC-03
REVERDIN ligatureCG-03
ROSENEE-14 to EE-15
tonsilFA-05
VERRES pneumoperitoneum punctureCC-03
YOUNG Boomerang ligatureCG-03
NEFF meniscotomeDC-24
NEGUS tonsil forcepsFA-03
NEIVERT needle holderCE-02
NELSON
ligature needleCG-02
thumb and tissue forcepsBA-05
trocarCC-02
NEUBÜSER tubal seizing forcepsHA-51
Neurosurgical scissorsAI-35
Nipper
cuticleHE-03
DIETER malleusEE-10
nailHE-03
TURNBULL nailHE-03
NORTHBENT ligature scissorsAI-40
NOTO uterine polypus forcepsHA-36
NOVAK uterine biopsy aspirating curetteHA-40
NOYES
iris scissorsAJ-03 to AJ-04
nasal polypus forcepsEG-05
tendon scissorsAJ-03
NUBOER suction tubeAE-05
Nurse set hospitalHE-03

O

OCHSNER	
atraumatic aortic forceps	.BD-31
trocar	.CC-02
O'CONNOR iris hook	.EC-06
OLDBERG laminectomy rongeur	.EA-09
OLIVECRONA	
bone rongeur	.DC-03
brain spatula	.EA-07
OLIVECRONA-TOENNIS clip applying forceps	.EA-02
OLIVECRONA	
wire saw	.EA-05
OLLIER retractor	.BI-10
OLSEN-HEGAR needle holder	.CE-05
Opening BROCK mitral valve dilator	.FG-26
Ophthalmoscope	
MAY	.AC-03
VARIFOCAL	.AC-03
Oral screw MAUNDER wooden	.EI-06
Osteotome	.DC-14
HIBBS	.DC-16
LAMBOTTE	.DC-15
LAMBOTTE mini	.DC-15
STILLE	.DC-14
O'SULLIVAN-O'CONNOR	
abdominal retractor	.BI-21
vaginal speculum	.HA-08
OTIS	
spare blade	.GG-08
urethrotome	.GG-08
Otoscope	.AC-04
OVERHOLT-GEISSENDOERFER dissecting and ligature forceps	.BC-10
OVERHOLT periosteal elevator	.DC-21

P

Pan	
bed	.HE-06
plazenta	.HE-06
PARHAM band	.DC-11
PARKER	
dissecting knife	.AG-15
retractor	.BI-02
PARK eye speculum	.EC-03
PARTSCH	
bone chisel	.DC-14
bone gouge	.DC-14
PASSOW hemostat	.EE-15
PATON corneal dissector	.EC-05
PAUFIQUE	
keratoplasty knife	.EC-05
PAUFIQUE TITAN tying forceps	.ED-05
PAUFIQUE	
tying forceps	.ED-05
PAYR-Baby stomach clamp	.GE-09
PAYR	
ligature conductor	.CG-04
stomach clamp	.GE-09
PEAN	
atraumatic forceps	.BD-02
hemostatic delicate forceps	.BC-06
hemostatic forceps	.BC-08
PEDERSON vaginal speculum	.HA-03
PEERS BERTRAM towel clamp	.BE-03
PEET splinter forceps	.BA-06
PELKMANN dressing forceps	.BG-12
Pelvimeter	
COLLIN	.HC-06
COLLYER	.HC-06

MARTIN	.HC-06
PENFIELD dura dissector	.EA-06
PENNINGTON hemostatic forceps	.BC-07
Percussion hammer	
BABINSKY	.AC-07
BERLINER	.AC-07
BUCK	.AC-07
DEJERINE	.AC-07
TAYLOR	.AC-07
TRAUBE	.AC-07
TROEMNER	.AC-07
PERCY amputation retractor	.DD-03
Perforator	
NÄGELE	.HC-09
SMELLIE	.HC-09
PERTHES reamer	.DD-08
PESTALOZZA placenta and ovum scoop	.HC-08
PETRI dish	.HE-08
PETZ stomach and intestinal suturing apparatus	.GE-09
PHANEUF peritoneum forceps	.BC-17
Pick	.EE-15
BARBARA	.EE-14 to EE-15
PIERCE trocar	.CC-02
PIFFARD lupus curette	.HE-02
PINARD stethoscope	.AC-06
Pin STEINMANN	.DD-09
Pin-wheel WARTENBERG	.AC-08
PIPER	
obstetrical forceps	.HC-04
obstetrical, with traction rod forceps	.HC-04
Plaster knife	.DA-04
Plaster saw blade	.DA-05 to DA-06
Plaster scissors	.AI-49
Plaster spatula	.CA-03
Plaster spreader	.DA-03
Plate JAEGER lid	.EC-03
PLESTER	
flap knife	.EE-14
retractor	.BI-14
Pliers flat nose	.DD-11
POLITZER	
air bag	.EE-05
ear knife	.EE-06
paracentesis needle	.EE-06
POOLE suction tube	.AE-02
Post mortem set	.DC-17
POTTS	
atraumatic anastomosis forceps	.BD-05
atraumatic coarctation forceps	.BD-04
atraumatic forceps	.BD-26 to BD-27
POTTS DE MARTEL vascular scissors	.AI-27
POTTS-SMITH	
thumb and tissue forceps	.BA-02
vascular scissors	.AH-19, AI-28
Powder blower KABIERISKE	.EE-04
POZZI tenaculum forceps	.HA-31
PRATT	
cystic hook	.GI-04
hemostatic forceps	.BC-08
rectal speculum	.GI-02
tenaculum forceps	.HA-34 to HA-35
uterine dilator	.HA-29
PRESBYTERIAN HOSPITAL tubing clamp forceps	.BC-19
PRICE-THOMAS bronchus forceps	.FG-22
PRINCE	
muscular forceps	.ED-02
tonsil scissors	.AI-27
Probe	.CA-02
BOWMAN lachrymal	.EC-10
DESJARDINS gall stone	.GC-05
MAYO kidney stone	.GC-10

measuringEE-15
 MOYNIHAN gall stoneGC-05
 NABATOFFCA-02
 STACKECA-02
 Proctoscope KELLYGI-04
 Protector
 ARRUGAEC-08
 tissueDD-15
 PROVIDENCE-HOSPITAL hemostatic forcepsBC-05
 Punch
 BEYEREG-08
 BROCK mitral valve dilatorFG-26
 CITELLIEG-08
 HAJEK-CLAUSEG-08
 HAJEK-KOFLEREG-08
 HOLTH corneoscleralEC-09
 KERRISONEG-08
 KEYES cutaneousHE-02
 PUTTI bone raspDC-25

Q

QUATTRO plaster spreaderDA-03
 QUINBY gum scissorsAI-42
 QUINKE puncture needleCC-03
 QUIRE foreign body leverEE-08
 QUISLING hammerDC-18

R

RADOLF nail extracting forcepsDD-03
 RALK bone hand drillDD-05
 RAMPLEY sponge holding forcepsBG-09
 RANDALL
 kidney stone forcepsGC-11 to GC-12
 uterine biopsy aspirating curetteHA-40
 RANEY
 clip applying forcepsEA-03
 scalp hemostasis clipEA-03
 RANKIN atraumatic forcepsBD-02
 Rasp
 boneDC-25
 FOMON nasalEG-15 to EG-16
 GALLAHER antrumEG-16
 JOSEPH (LEWIS) nasalEG-15
 MALTZ (COTTLE) nasalEG-15
 MALTZ nasalEG-14
 PUTTI boneDC-25
 WIENER antrumEG-15
 WIENER (AUFRIEHT) nasalEG-15
 Razor
 Razor bladeAG-14, AG-19
 Razor knifeAG-19
 ReamerDD-08, DD-12
 KUENTSCHERDD-13
 PERTHESDD-08
 RECAMIER uterine curetteHA-49 to HA-50
 Rectoscope cold lightGI-03
 Retractor SCHOENBORN thyroidFE-04
 REICHERT epiglottis retractorFC-02
 REINER
 ear syringeEE-05
 plaster knifeDA-04
 RetractorBI-06, BI-10
 ADSONBI-15
 ADSON-BabyBI-15
 ALAN-PARKS analGI-03
 ALMBI-14
 AUFRIEHT nasalEG-17
 BALFOUR abdominalBI-22
 BALFOUR Baby abdominalBI-22

BECKMANNBI-16
 BECKMANN-ADSONBI-15
 BECKMANN-EATONBI-16
 BLOUNT kneeDC-24
 CASPARBI-20
 CASPAR cervical spineBI-18
 CASPAR vertebral columnBI-19
 CASPAR vertebral lumbarBI-20
 cheekEI-03
 CLOWARDBI-17
 COLLIN abdominalBI-24 to BI-25
 COLLIN-HARTMANNBI-03
 COOLEY atriumFG-20
 COOLEY modif- STRUCK atriumFG-20
 CORYLLOS (Thorax)BI-13
 COTTLE nasalEG-17
 COTTLE-NEIVERT nasalEG-17
 CRILEBI-02
 CUSHINGBI-07
 DARLINGBI-17
 DAVIDSON (Scapula)BI-13
 DEAVERBI-05
 DEAVER GripBI-05
 DESMARRSBI-07
 DIMEDABI-14
 DOYENBI-12
 FARABEUFBI-02
 FINSENBI-14
 FOMON nasalEG-17
 FRAZIERBI-21
 FRIEDMAN perineorrHA-23
 FRITSCHBI-11
 GELPI abdominalBI-24
 GOELETBI-03
 GOSSET abdominalBI-21
 GREENBI-10
 HABERERBI-04
 HARRINGTONBI-05
 HEANEYBI-12
 HOFER pillarFA-02
 HRYNTSCHAK prostaticGG-06
 ISRAELBI-11
 JANSENBI-14
 JUDD-MASSON bladderGG-04
 KALLMORGEN vaginalHA-15
 KELLYBI-04, BI-12
 KELLY GripBI-04
 KILNER skinHE-02
 KIRSCHNER abdominalBI-23
 KNAPPEC-06
 KOCHERBI-10 to BI-11
 KOERTEBI-11
 KRISTELLER vaginalHA-09 to HA-14
 LAHEYBI-08
 LANGENBECKBI-09
 LEGUEU bladderGG-06
 lip and cheekEI-03
 LITTLEBI-08
 LOVE uvulaFA-02
 MATHIEUBI-03
 MEYERDINGBI-08
 MIDDELDORPFBI-10
 MIKULICZBI-12
 MILLIN bladderGG-05
 MOLLISONBI-17
 NAGER palateFA-02
 OLLIERBI-10
 O'SULLIVAN-O'CONNOR abdominalBI-21
 PARKERBI-02
 PERCY amputationDD-03
 PLESTERBI-14

- REICHERT epiglottisFC-02
 REVERDINBI-04
 RIBBONBI-04
 RICHARDSONBI-04
 RICHARDSON-EASTMANBI-04
 RICHARDSON GripBI-04
 RIGBY abdominalBI-24
 ROLLETEC-06
 ROUXBI-02
 ROUX BabyBI-02
 ROUX miniBI-02
 SAUERBRUCHBI-13
 SENNBI-04
 SENN-GREENBI-07
 SIMONBI-12
 SMITH-BUIE analGI-03
 STERNBERG lipEI-02
 TAYLOR spinalDC-24
 THOMSON-WALKER bladderGG-06
 US Army (PARKER-LANGENBECK)BI-03
 VOLKMANNBI-07 to BI-08
 WEITLANERBI-14
 WEITLANER-WULLSTEINBI-14
 YOUNG prostaticGG-02
- REVERDIN
 ligature needleCG-03
 retractorBI-04
- REYNOLDS scissorsAH-15, AI-18
 RhachiotomeDC-17
 Ribbon loop electrodeJA-03
 RIBBON retractorBI-04
 RICHARDSON-EASTMAN retractorBI-04
 RICHARDSON Grip retractorBI-04
 RICHARDSON retractorBI-04
 RICHTER-HEATH clip applying forcepsCG-07
 RIGBY abdominal retractorBI-24
- Ring cutter
 DIMEDA fingerDD-03
 fingerDD-03
- Ring stripperCA-03
- ROBB vascular dissectorFG-33
 ROBERTS hemostatic forcepsBC-11
 ROCHESTER-CARMALT hemostatic forcepsBC-07
 ROCHESTER-OCHSNER hemostatic forcepsBC-06
 ROCHESTER-PEAN hemostatic forcepsBC-06
 ROEDER towel clampBE-03
 ROGER septum elevatorEG-11
 ROGGE sterilizing forcepsCI-02
- ROLLET
 extirpation chiselEC-06
 retractorEC-06
- Rongeur
 ADSON boneDC-03
 BEYER boneDC-04
 BLUMENTHAL boneDC-02
 BÖHLER boneDC-04
 CLEVELAND boneDC-02
 ECHLIN boneDC-05
 FRIEDMAN boneDC-02
 FRIEDMAN Mini boneDC-02
 FRYKHOLM boneDC-05
 LEKSELL STILLE boneDC-05
 LEMPERT boneDC-03
 LUER boneDC-03
 MEAD boneDC-02
 OLIVECRONA boneDC-03
 RUSKIN boneDC-04
 SAUERBRUCH boneDC-05
 SCAGLIETTI boneDC-05
 SEMB boneDC-06
 STILLE-LUER boneDC-04
- STILLE-RUSKIN boneDC-05
 ZAUFAL-JANSEN boneDC-04
- ROSENBERG larynx forcepsFC-03
- ROSEN
 circular knifeEE-14
 needleEE-14 to EE-15
- ROSER-KOENIG mouth gagEI-03
 ROSE tracheal hookFE-03
 ROTES KREUZ bandage scissorsAI-47
- Rounger
 COLCLOUGH intervertebral discEA-11
 CUSHING laminectomyEA-08
 FERRIS-SMITH-KERRISON intervertebral discEA-10
 FERRIS-SMITH laminectomyEA-09
 LOVE-GRUENWALD laminectomyEA-08
 OLDBERG laminectomyEA-09
 SPURLING laminectomyEA-08
 WAGNER laminectomyEA-09
- ROUX Baby retractorBI-02
 ROUX mini retractorBI-02
 ROUX retractorBI-02
 ROWE mouth forcepsEI-06
 RUBIN septum crushing forcepsEG-07
 RUMEL thorax forcepsBC-11
 RUSKIN bone rongeurDC-04
 RUSKIN-LISTON bone cutting forcepsDC-06
 RUSSIAN thumb and tissue forcepsBA-04
 RYDEL-SEIFFER tuning forkEE-04
 RYDER needle holderCE-03
- ## S
- SAALFELD comedo extractorHE-02
- SACHS
 dura dissectorEA-05
 nerve hookEA-04
- SADILLOT periosteal elevatorDC-19
 SAENGER placenta and ovum forcepsHC-07
 SAIRGES tenaculum forcepsHA-32
 Salpingograph SCHULTZEHA-47
 SANVENERO scissorsAH-13, AI-16
- SAROT
 bronchus forcepsFG-23
 hemostatic bronchus forcepsBC-12
 needle holderCE-04
- SATINSKY
 anastomosis (vena cava) clampFG-24 to FG-25
 atraumatic forcepsBD-20
 lung and thorax scissorsAI-37
- SATO corneal knifeEC-05
- SAUERBRUCH
 bone rongeurDC-05
 SAUERBRUCH-FREY rib shearFG-06
- SAUERBRUCH
 needle caseHE-02
 retractorBI-13
 rib shearFG-05
 waste pick-up forcepsCI-03
- Saw
 BERGMANN plasterDA-02
 CHARRIERE amputationDD-03
 CHARRIERE bladeDD-03
- Saw conductor De MARTELEA-05
- Saw
 ENGEL plasterDA-02
 JOSEPH nasalEG-17
 LANGENBECK fingerDD-03
 OLIVECRONA wireEA-05
- SAWTELL tonsil forcepsFA-03
- Saw
 WIGMORE plasterDA-02

SCAGLIETTI bone rongeurDC-05
 Scalpel handleAG-02 to AG-05, AG-07 to AG-08
 CASPAR micro surgicalAG-12
 LANDOLT micro surgicalAG-13
 Scalpel removerAG-06, AG-10
 Scalpel, sterile bladeAG-06, AG-09
 Scarifier
 GRAEFEEC-04
 KUHNT cornealEC-05
 SCHAMBERG comedo extractorHE-02
 SCHEDE bone curetteDC-12
 SCHEIE
 eye cannulaED-07
 goniotomy knifeEC-05
 SCHEINMANN larynx forcepsFC-03
 SCHERBAK vaginal speculumHA-21
 SCHIMMELBUSCH sterilizing drumsHE-12
 SCHINK dermatomeAG-21
 SCHIOETZ tonometerED-08
 SCHMIEDEN ligature conductorCG-04
 SCHMIEDEN-PAYR ligature conductorCG-04
 SCHMIEDEN-TAYLOR scissorsAI-36
 SCHNIDT tonsil forcepsFA-03
 SCHOENBORN thyroid retractorFE-04
 SCHOENBURG grasping forcepsGE-03
 SCHROEDER
 tenaculum forcepsHA-31 to HA-32
 uterine curetteHA-48
 SCHUBERT uterine biopsy specimen forcepsHA-41
 SCHUKNECHT
 roller knifeEE-14
 sickle knifeEE-14
 SCHULTZE salpingographHA-47
 SCHUMACHER
 larynx forcepsFC-03
 sternum shearFG-07
 umbilical scissorsAI-34
 uterine biopsy specimen forcepsHA-43
 SCHWEIGGER capsular forcepsED-04
 ScissorsAH-02 to AH-04, AI-02 to AI-04
 AEBLI cornealAI-22
 BARRAQUER colibriAJ-04
 BEEBEE wire and plateAI-43
 BELLUCCI ear microEE-09
 BERGMANN bandageAI-46
 BEUSE scissors toothedAI-26
 BOETTCHER tonsilAI-27
 BRAUN-STADLER episiotomyAH-22, AI-34
 BRUNS plasterAI-48
 BUCK ligatureAI-40
 BUSCH umbilicalAI-34
 CASTROVIEJO cornealAJ-06
 CASTROVIEJO iridectomyAJ-05
 COTTLE nasalAH-18, AI-25
 CRAFOORD lung and thoraxAI-36
 cuticleHE-03
 DANDY neurosurgicalAI-36
 DEAN tonsilAI-26
 DEAVERAH-05, AI-06
 DE BAKEY vascularAI-30
 DIETHRICH vascularAI-29
 DIMEDA bandageAI-46
 DOYEN gynecologicalAI-33
 DUBOIS gynecologicalAI-33
 ear microEE-11
 ear micro-miniEE-11
 ESMARCH bandageAI-46
 FERGUSONAI-49
 FINOCHIETTO rectalAI-38
 FOMON nasalAH-18, AI-25
 GOLDMAN-FOX gumAI-41

GOOD tonsilAI-27
 GORNEY dissectingAI-13
 HEATH ligatureAI-40
 HEYMANN nasalAH-18, AI-25
 IRISAH-16, AI-21
 IRIS eyeAI-22
 IRIS large ringsAI-19
 JACOBSON microAJ-11
 JOSEPHAH-14, AI-16
 KELLY gynecologicalAH-22, AI-33
 KILNERAH-14, AI-17
 KLINKENBERGH-LOTH lung and thoraxAI-37
 KNAPPAI-20
 KNOWLES bandageAI-47
 LAGRANGE gumAI-41
 LANDOLT enucleationAI-25
 LANGE bandageAI-44
 LEXERAH-09
 LEXER-BABYAH-10
 LEXER dissectingAI-11 to AI-12
 LISTER bandageAH-23, AI-45
 LITTAUER ligatureAI-40
 LITTLER dissectingAI-13
 LOCKLINAI-18
 LORENZ bandageAI-47
 MAYOAH-06, AI-07
 MAYO left handedAI-07
 MAYO-NOBLEAH-08, AI-10
 MAYO-STILLEAH-07, AI-08 to AI-09
 McGUIRE cornealAJ-05
 McINDOE cartilageAI-35
 McPHERSON WESTCOTT tenotomyAJ-04
 METZENBAUMAH-11
 METZENBAUM dissectingAI-13 to AI-14
 METZENBAUM FINOAH-12
 METZENBAUM FINO dissectingAI-15
 METZENBAUM "S"AH-13, AI-16
 MILLS vascularAI-27
 nailHE-03
 NORTHBENT ligatureAI-40
 NOYES irisAJ-03 to AJ-04
 NOYES tendonAJ-03
 POTTS DE MARTEL vascularAI-27
 POTTS-SMITH vascularAH-19, AI-28
 PRINCE tonsilAI-27
 QUINBY gumAI-42
 REYNOLDSAH-15, AI-18
 ROTES KREUZ bandageAI-47
 SANVENEROAH-13, AI-16
 SATINSKY lung and thoraxAI-37
 SCHMIEDEN-TAYLORAI-36
 SCHUMACHER umbilicalAI-34
 SHEA ear microEE-09
 SHORTBENT ligatureAI-40
 SIEBOLD gynecologicalAH-21, AI-32
 SIMS gynecologicalAH-21, AI-32
 SMITH US ARMY bandageAI-44
 SPENCER ligatureAI-40
 STELZNER rectalAI-38
 STEVENS tenotomyAH-17, AI-23
 STRULLY neurosurgicalAI-35
 THOREK lung and thoraxAI-36
 TOENNIS-ADSON neurosurgicalAI-35
 TROUTMAN-CASTROVIEJO microAJ-07
 UNIVERSAL bandageAI-50
 UNIVERSAL wire and plateAI-42
 USA MODEL umbilicalAI-34
 VANNAS iridectomyAJ-05
 VANNAS microAJ-12 to AJ-13
 WAGNERAH-22
 WAGNER gumAI-42

- WALDMANN episiotomyAI-34
 WECKER irisAJ-04
 WERTHEIM preparationAI-32
 WESTCOTT iridectomyAJ-02
 WESTCOTT tendonAJ-02
 WULLSTEIN ear microEE-11
 WULLSTEIN ear micro-miniEE-11
 YASARGIL microAJ-10 to AJ-11
- Sclerotome**
- GUYTON-LUNDSGAARDEC-05
 LUNDSGAARDEC-05
- Scoop**
- BUNGE exenterationEC-07
 CUZZI placenta and ovumHC-08
 DESJARDINS gall stoneGC-08
 FERGUSON gall stoneGC-07
 GUTMANN secretionsGG-11
 LUER-KOERTE gall stoneGC-09
 MAYO gall stoneGC-07
 MOORE gall stoneGC-05
 PESTALOZZA placenta and ovumHC-08
 WALLICH placenta and ovumHC-08
 WELLS enucleationEC-08
- Screw driver**
- DOYEN myomaHA-46
 driverDD-14 to DD-15
- LANEDD-14
 WILLIAMSDD-14
- SEEMANN-SEIFFERT mouth gagEI-04
 SEGOND myoma knifeHA-46
 SEIFFERT larynx forcepsFC-03
 SELLHEIM elevating spoonHC-09
 SELLORS rib contractorFG-18
- SEMB**
- bone cutting forcepsDC-07
 bone holding forcepsDC-07
 bone rongeurDC-06
 bronchus forcepsFG-23
 periosteal elevatorDC-20
- SEMKEN thumb and tissue forcepsBA-05
 SEMM vaginal speculumHA-07
 SENN-GREEN retractorBI-07
 SENN retractorBI-04
 Septatome BRUENINGSEG-11
 Sequester forcepsDC-10
 SEUTIN plaster shearDA-02
 SEXTON ear knifeEE-06
 SHEA ear micro scissorsEE-09
- Shear**
- BETHUNE ribFG-04
 BRUNNER ribFG-07
 COOLEY rib firstFG-05
 CORYLLOS ribFG-04
 GIERTZ-STILLE ribFG-06
 GLUCK ribFG-03
 ribFG-02
 SAUERBRUCH-FREY ribFG-06
 SAUERBRUCH ribFG-05
 SCHUMACHER sternumFG-07
 SEUTIN plasterDA-02
 STILLE plasterDA-02
 STILLE ribFG-03
- SHORTBENT ligature scissorsAI-40
 SIEBOLD gynecological scissorsAH-21, AI-32
 SIEGLE ear speculaEE-02
 SIEGLER HELLMANN uterine elevating forcepsHA-38
- SILVER**
- dermatomeAG-20
 rhinoplastic chiselEG-14
- SIMCOE suturing cannulaED-07
 SIMON
- bone curetteDC-13
 retractorBI-12
 uterine curetteHA-48
- SIMPSON-BRAUN obstetrical forcepsHC-02
 SIMPSON-LUIKART obstetrical forcepsHC-03
 SIMPSON obstetrical forcepsHC-02
- SIMS**
- gynecological scissorsAH-21, AI-32
 SIMS-MAIER dressing forcepsBG-05
- SIMS**
- rectal speculumGI-02
 uterine curetteHA-49 to HA-50
 uterine depressorHA-39
 uterine dilatorHA-30
 uterine soundHA-39
 vaginal speculumHA-17
- SINGLEY thumb and tissue forcepsBA-05
 Sinker corticalisDD-15
 SKENE tenaculum forcepsHA-31
 Skin fixing plateAG-21
 Skull breaker VIRCHOWDC-17
 SLUDER-BALLENGER tonsillectomeFA-05
- SMELLIE**
- obstetrical hookHC-06
 perforatorHC-09
- SMILLIE meniscotomeDC-24
 SMITH-BUIE anal retractorGI-03
 SMITH eye speculumEC-02
 SMITH-PETERSEN
- bone chiselDC-15
 bone gougeDC-15
- SMITH US ARMY bandage scissorsAI-44
 SMITHWICK
- clip applying forcepsEA-02
 nerve hookEA-04
- Snare**
- BRUENINGS tonsilFA-04
 EVES tonsilFA-04
 KRAUSE ear polypusEE-07
 KRAUSE nasalEG-09
 TYDING tonsilFA-05
 WESTON rectal polypusGI-05
 WILDE ear polypusEE-07
 WILDE nasalEG-09
- SNELLEN**
- entropium forcepsED-06
 wire loopEC-08
- SOMER uterine elevating forcepsHA-37
- Sound**
- COLLIN uterineHA-39
 COXETER urethralGG-17
 DITTEL urethralGG-18 to GG-19
 GUYON urethralGG-12, GG-14 to GG-15
 MARTIN uterineHA-39
 SIMS uterineHA-39
 VALLEIX uterineHA-39
 VAN BUREN urethralGG-13
 WALTHER urethralGG-17
- Spare lamp**
- conventional laryngoscopeAE-20
 fiber optic laryngoscopeAE-20
- Spatula**
- ALLISON lungFG-19
 BANGERTER cyclodialysisEC-08
 CASTROVIEJO cyclodialysisEC-08 to EC-09
 CULLER irisEC-08
 CUSHING brainEA-07
 ELSCHNIG cyclodialysisEC-08
 HEIFETZ brainEA-07
 intimaFG-32
 KOCHER bladderGG-04
 LEGUEU bladderGG-04

- OLIVECRONA brainEA-07
 WECKER irisEC-08
 WHEELER cyclodialysisEC-09
- Specula
- BOUCHERON earEE-02
 BRUENINGS earEE-02
 COTTLE nasalEG-03
 GRUBER earEE-02
 HARTMANN earEE-02
 HARTMANN-HALLE nasalEG-02
 KILLIAN septumEG-03
 SIEGLE earEE-02
 THUDICHUM nasalEG-02
 TIECK-HALLE nasalEG-03
 TOYNBEE earEE-02
 Vienna nasalEG-02
 VOLTOLINI nasalEG-02
 YANKAUER postnasalEG-04
- Speculum
- ARRUGA eyeEC-02
 AUVARD vaginalHA-19
 BARRAQUER Colibri eyeEC-02
 BARR rectalGI-02
 BERLIND-AUVARD vaginalHA-19
 BODENHAMMER rectalGI-02
 BOWMAN eyeEC-02
 BRAUN vaginalHA-16
 BREISKY vaginalHA-20
 CASTROVIEJO eyeEC-03
 CLARK eyeEC-02
 COLLIN vaginalHA-04
 CRITCHETT eyeEC-02
 CUSCO vaginalHA-04 to HA-06
 CZERNY rectalGI-02
 DOYEN vaginalHA-18, HA-20
 FREEWAY-GRAVE vaginalHA-06
 GOLDSTEIN eyeEC-03
 GRAEFE eyeEC-02
 GRAVE vaginalHA-02
 JACKSON vaginalHA-16
 KALLMORGEN vaginalHA-15
 KOGAN endoHA-23
 KRISTELLER vaginalHA-09 to HA-14
 LANCASTER eyeEC-03
 LANDAU vaginalHA-22
 LISTER-BURCH eyeEC-02
 MATHIEU rectalGI-02
 MELLINGER-AXENFELD eyeEC-02
 MELLINGER eyeEC-02
 MUELLER eyeEC-03
 MURDOCK eyeEC-02
 O'SULLIVAN-O'CONNOR vaginalHA-08
 PARK eyeEC-03
 PEDERSON vaginalHA-03
 PRATT rectalGI-02
 SCHERBAK vaginalHA-21
 SEMM vaginalHA-07
 SIMS rectalGI-02
 SIMS vaginalHA-17
 SMITH eyeEC-02
 STEINER-AUVARD vaginalHA-19
 STEVENSON eyeEC-03
 TRELAT vaginalHA-07
 WEEK eyeEC-02
 WEISSBARTH vaginalHA-22
 WILLIAMS eyeEC-02
 ZIEGLER eyeEC-03
- SPENCER ligature scissorsAI-40
 SPENCER-WELLS hemostatic forcepsBC-07
 Splinter forcepsBA-06
 Spoon
- DAVIEL cataractEC-07
 GRAEFE cataractEC-07
 GROSS earEE-06
 KNAPP cataractEC-07
 SELLHEIM elevatingHC-09
 SPRATT bone curetteDC-12
- Spreader
- BEESON plasterDA-03
 BOSE trachealFE-02
 CASTAÑEDA ribFG-14
 CHEVALLIER ribFG-15
 CLOWARD laminaEA-07
 COOLEY ribFG-09
 FINOCHIETTO-BABY ribFG-09
 FINOCHIETTO BURFORD ribFG-12 to FG-14
 FINOCHIETTO-HAIGHT BABY ribFG-10
 FINOCHIETTO INFANT ribFG-12
 FINOCHIETTO (modif) ribFG-08
 FINOCHIETTO ribFG-08, FG-10 to FG-11
 HAGLUND-STILLE plasterDA-03
 HAIGHT ribFG-15
 HENNIG plasterDA-03
 HERMANN plasterDA-03
 HERTZLER ribFG-17
 INGE laminaEA-07
 MERCEDES thoracicFG-16
 MILLIN bladder neckGG-07
 MORSE-FAVOLORO ribFG-17
 QUATTRO plasterDA-03
 TUFFIER ribFG-16
- Spud DIX foreign bodyEC-06
 SPURLING laminectomy rongerEA-08
 STACHE probeCA-02
 Stainer vaginal speculumHA-22
 Standard suturing kitCG-08
 STAUDE-MOORE tenaculum forcepsHA-31
 St- CLAIR-THOMSON adenoid curetteEG-19
 STEINER-AUVARD vaginal speculumHA-19
 STEINMANN pinDD-09
 STELZNER rectal scissorsAI-38
 Sterile disposable scalpelAG-10 to AG-11
 Sterile, micro surgical scalpel bladeAG-13
- Sterilization container
- 3/4HE-22 to HE-24
 flat half sizeHE-30 to HE-31
 half sizeHE-26 to HE-29
 largeHE-18 to HE-20
 smallHE-32 to HE-33
 specialHE-34 to HE-37
- Sterilizing forcepsCI-02
 STERNBERG lip retractorEI-02
- Stethoscope
- BOWLESAC-06
 FORDAC-06
 FORD BOWLESAC-06
 PINARDAC-06
- STEVENS
- iris forcepsEC-11
 lens hookEC-06
- STEVENSON eye speculumEC-03
- STEVENS
- ophthalmologic needle holderCE-06
 tenotomy scissorsAH-17, AI-23
- STIEGLITZ splinter forcepsBA-06
- STILLE
- bone chiselDC-14
 bone gougeDC-14
 bone hand drillDD-04
- STILLE-HORSLEY bone cutting forcepsDC-07
- STILLE
- kidney pedicle forcepsBC-16

E

Index
English

STILLE-LISTON bone cutting forceps	DC-06	dura dissector	EA-05
STILLE-LUER bone rongeur	DC-04	hemostatic forceps	BC-11
STILLE		needle holder	CE-04
osteotome	DC-14	TOHOKU towel clamp	BE-04
plaster shear	DA-02	Tong CRUTCHFIELD cervical traction	EA-03
rib shear	FG-03	Tongue depressor	
STILLE-RUSKIN bone rongeur	DC-05	ANDREW	EI-02
STILLE-SHERMAN bone hand drill	DD-04	BRUENINGS	EI-02
STILLE		BUCHWALD	EI-02
thumb and tissue forceps	BA-02	FRENZEL	EI-02
St- MARTIN suture forceps	ED-05	HARTMANN	EI-02
STOCKMANN Penile clamp	GG-10	McIVOR	EI-05
STONE closing forceps	GE-06	TOBOLD	EI-02
STONE-WATT intestinal forceps	GE-06	WIEDER	EI-02
Strabismus scissors	AH-17, AI-24	wooden	EI-02
STRATTE needle holder	CE-04	Tonometer SCHIOETZ	ED-08
STRAUSS Penile clamp	GG-10	Tonsillectome SLUDER-BALLENGER	FA-05
STRUEMPPEL ear forceps	EE-08	TOOK corneal knife	EC-05
STRULLY neurosurgical scissors	AI-35	TOTI drill burr	DD-07
STRUYCKEN nasal cutting forceps	EG-07	Tourniquet	AC-03
Stylet MAGILL	AE-04	Towel clamp	
SUBRAMANIAN atraumatic forceps	BD-31	BACKHAUS	BE-02
Suction tube		BACKHAUS-CLIP tube holder	BE-03
ANDREWS-PINCHON	AE-03	BACKHAUS KOCHER	BE-02
DE BAKEY	AE-04	BALL AND SOCKET	BE-04
FRAZIER	EA-07	BERNHARD	BE-05
MAGILL	AE-04	DOYEN	BE-05
NUBOER	AE-05	HOFF	BE-03
POOLE	AE-02	JONES tube holder	BE-02
WALTON YANKAUER	AE-03	LANE	BE-05
YANKAUER	AE-02	LORNA	BE-04
Suturing kit		MOYNIHAN	BE-05
mini	CG-08	PEERS BERTRAM	BE-03
standard	CG-08	ROEDER	BE-03
Suturing needle	CG-05 to CG-06	TOHOKU	BE-04
SWEET clip applying forceps	EA-02	TOWNSEND-KEVORKIAN	
Syringe		uterine biopsy specimen forceps	HA-44
REINER ear	EE-05	TOWNSEND-MINI (BABY TISCHLER)	
tonsil	FA-05	uterine biopsy specimen forceps	HA-45
		TOWNSEND-mini uterine biopsy specimen forceps	HA-44
T		TOWNSEND-TISCHLER	
TABB sickle knife	EE-14	uterine biopsy specimen forceps	HA-44
Tap screw	DD-15	TOWNSEND uterine biopsy specimen forceps	HA-44
TARNIER		TOYNBEE ear specula	EE-02
cranioclast	HC-09	Traction bar GERSTER	DC-11
obstetrical, with traction rod forceps	HC-05	TRAUBE percussion hammer	AC-07
TAYLOR		Tray	
percussion hammer	AC-07	instrument	HE-08 to HE-09
spinal retractor	DC-24	sterilization , sheet metal	HE-13
TEALE tenaculum forceps	HA-33	sterilization , wire mesh	HE-13
Tendon stripper BUNNELL	DC-25	TRELAT vaginal speculum	HA-07
TERSON capsular forceps	ED-04	Trephine	DD-04
THOMS-ALLIS tissue forceps	GE-02	CASTROVIEJO corneal	ED-07
THOMS-GAYLOR uterine biopsy specimen forceps	HA-42	ELLIOT corneal	ED-08
THOMSON-WALKER bladder retractor	GG-06	FRANCESCHETTI corneal	ED-07
THOREK lung and thorax scissors	AI-36	Trocar	CC-02
THUDICHUM nasal specula	EG-02	COAKLEY	CC-02
TIECK-HALLE nasal specula	EG-03	DOUGLAS	CC-02
TIEMANN tenaculum forceps	HA-32	FLEURANT	CC-02
TILLEY ear forceps	EE-08	LICHTWITZ	CC-02, EG-09
TISCHLER-KEVORKIAN		MENGHINI	CC-03
uterine biopsy specimen forceps	HA-44 to HA-45	NELSON	CC-02
TISCHLER-MORGAN		OCHSNER	CC-02
uterine biopsy specimen forceps	HA-43 to HA-44, HA-46	PIERCE	CC-02
TIVNEN tonsil seizing forceps	FA-04	UCKERMANN tracheal	FE-02
TOBOLD		UNIVERSAL	CC-02
cotton applicator	CA-03	TROELTSCH nasal forceps	EG-04
tongue depressor	EI-02	TROEMNER percussion hammer	AC-07
TOENNIS-ADSON neurosurgical scissors	AI-35	TROUSSEAU tracheal dilator	FE-02
TOENNIS		TROUTMAN-CASTROVIEJO micro scissors	AJ-07
		TROUTMAN-CHRIS blade breaker	AG-14

TROUTMAN Colibri iris forcepsEC-13
 TROUTMAN rectus forcepsED-02
 TUBBS mitral valve dilatorFG-27
 Tube
 BRUENINGS extensionFC-03
 JACKSON trachealFE-03
 LUER trachealFE-03
 WAGENER-MOSHER trachealFE-03
 Tubing clamp forcepsBC-19
 Tübingen
 air cannulaED-07
 iris forcepsEC-15
 Tübingen TITAN
 iris forcepsEC-15
 tying forcepsED-05
 Tübingen
 tying forcepsED-05
 TUFFIER
 hemostatic forcepsBC-08
 rib spreaderFG-16
 Tuning forkEE-04
 DIMEDA AluEE-03
 HARTMANNEE-03
 LUCAEEE-04
 RYDEL-SEIFFEREE-04
 TURNBULL nail nipperHE-03
 TURREL biopsy specimen forcepsGI-05
 TYDING
 tonsil seizing forcepsFA-04
 tonsil snareFA-05

U

UCKERMANN
 cotton applicatorCA-03
 tracheal trocarFE-02
 ULRICH sponge holding forcepsBG-06
 Umbilic-cord KANE umbilical cordHC-06
 UNIVERSAL
 bandage scissorsAI-50
 sterilizing forcepsCI-02
 trocarCC-02
 wire and plate scissorsAI-42
 UNNA comedo extractorHE-02
 Urethrotome OTISGG-08
 UrinalHE-10
 USA
 electrosurgery equipment cableJA-07
 USA MODEL umbilical scissorsAI-34
 US Army (PARKER-LANGENBECK) retractorBI-03
 USA
 thumb and tissue forcepsBA-02

V

VALLEIX uterine soundHA-39
 VAN BUREN
 sequester forcepsDC-10
 urethral soundGG-13
 Van DOREN uterine biopsy specimen forcepsHA-42
 VANNAS
 iridectomy scissorsAJ-05
 micro scissorsAJ-12 to AJ-13
 VARIFOCAL ophthalmoscopeAC-03
 Vascular micro scissorsAJ-09
 Vascular, parametrium scissorsAH-20, AI-31
 Vascular scissorsAI-27
 VERBRUGGE bone holding forcepsDC-09
 VERRES pneumoperitoneum puncture needleCC-03
 Vessel flexible clampBD-44 to BD-45
 Vienna nasal speculaEG-02

VIRCHOW
 brain knifeAG-18
 cartilage knifeAG-18
 skull breakerDC-17
 VIRTUS (RALK) splinter forcepsBA-06
 VOLKMANN
 bone curetteDC-12 to DC-13
 retractorBI-07 to BI-08
 VOLTOLINI nasal speculaEG-02

W

WACHENFELDT clip applying forcepsCG-07
 WADSWORTH-TODD cauterEC-08
 WAGENER ear hookletEE-07
 WAGENER-MOSHER tracheal tubeFE-03
 WAGNER
 gum scissorsAI-42
 laminectomy rongeurEA-09
 scissorsAH-22
 WALDMANN episiotomy scissorsAI-34
 WALLICH placenta and ovum scoopHC-08
 WALSHAM septum forcepsEG-18
 WALTHER urethral soundGG-17
 WALTON
 comedo extractorHE-02
 foreign body gougeEC-06
 WALTON YANKAUER suction tubeAE-03
 WANGENSTEEN
 needle holderCE-03
 thumb and tissue forcepsBA-05
 WARTENBERG pin-wheelAC-08
 Wash basinHE-05
 Waste bucketHE-11
 Watchmaker forcepsBA-06
 WATSON-CHEYNE elevatorDC-22
 WATSON dermatomeAG-22
 WEBER
 atraumatic forcepsBD-12
 wire loopEC-08
 WECKER
 iris scissorsAJ-04
 iris spatulaEC-08
 WEEK eye speculumEC-02
 WEIL-BLAKESLEY nasal cutting forcepsEG-06
 WEISSBARTH vaginal speculumHA-22
 WEISS tubing clamp forcepsBC-19
 WEITLANER retractorBI-14
 WEITLANER-WULLSTEIN retractorBI-14
 WELLS enucleation scoopEC-08
 WERTHEIM-CULLEN hysterectomy forcepsBC-18
 WERTHEIM
 hysterectomy forcepsBC-18
 preparation scissorsAI-32
 WESTCOTT
 iridectomy scissorsAJ-02
 tendon scissorsAJ-02
 WEST
 nasal chiselEG-14
 nasal gougeEG-14
 WESTON rectal polypus snareGI-05
 WHEELER
 cycloclialysis spatulaEC-09
 discision knifeEC-04
 WHITEHEAD mouth gagEI-04
 WHITE tonsil seizing forcepsFA-03
 WIEDER tongue depressorEI-02
 WIENER
 antrum raspEG-15
 WIENER (AUFRICHT) nasal raspEG-15
 WIENER

E

Index English

iris hook	.EC-06
WIGMORE plaster saw	.DA-02
WILDE	
ear polypus snare	.EE-07
nasal snare	.EG-09
WILDER	
lachrymal dilator	.EC-10
wire loop	.EC-08
WILDE (TROELTSCH) ear forceps	.EE-07
WILLET-MARTELL scalp flap forceps	.BC-08
WILLIAMS	
eye speculum	.EC-02
grasping forceps	.GE-03
screw driver	.DD-14
WILLIGER	
bone curette	.DC-13
hammer	.DC-18
periosteal elevator	.DC-19
WINKELMANN circumcision clamp	.GG-09
WINTER placenta and ovum forceps	.HC-07
Wire cutter	.DD-12
DIAMANT	.DD-12
Wiredrill KIRSCHNER	.DD-09
Wire loop electrode	.JA-03
Wire twister LOUTE	.DD-11
WITTNER uterine biopsy specimen forceps	.HA-43
WOLFF plaster breaker	.DA-04
WRIGLEY obstetrical forceps	.HC-02
WULLSTEIN	
ear micro-mini scissors	.EE-11
ear micro scissors	.EE-11
sickle knife	.EE-14
WYLIE	
atraumatic forceps	.BD-21
uterine dilator	.HA-30

Y

YANKAUER	
postnasal specula	.EG-04
suction tube	.AE-02
YASARGIL micro scissors	.AJ-10 to AJ-11
YEOMAN biopsy specimen forceps	.GI-05
YOUNG Boomerang ligature needle	.CG-03
YOUNG	
prostatic grasping forceps	.GG-02
prostatic retractor	.GG-02
tongue holding forceps	.EI-03

Z

ZAUFAL-JANSEN bone rongeur	.DC-04
ZENKER hemostatic forceps	.BC-12
ZIEGLER	
capsulotomy knife	.EC-05
eye speculum	.EC-03
head mirror	.AC-05
iris knife	.EC-04
lachrymal dilator	.EC-10

F

Index Français

F

A

- Abaisse-langue
 ANDREWEI-02
 boisEI-02
 BRUENINGSEI-02
 BUCHWALDEI-02
 FRENZELEI-02
 HARTMANNEI-02
 McIVOREI-05
 TOBOLDEI-02
 WIEDEREI-02
- Accessoires pour containers
 pour la stérilisationHE-38 jusque HE-41
- Adenotome LAFORCEEG-19
- ADLERKREUTZ pince à dissectionBA-04
- ADSON Baby
 écarteurBI-15
- ADSON BABY
 pince hémostatiqueBC-09
- ADSON-BROWN pince à dissectionBA-03
- ADSON
 écarteurBI-15
 écarteur à nerfsEA-04
 élévateurDC-21
 pince à dissectionBA-03
 pince à dissection, microBA-03
 pince à hypophyseEA-06
 pince gougeDC-03
 pince hémostatiqueBC-09
 porte-aiguilleCE-04
- AEBLI ciseaux cornéensAI-22
- AESCULAP cordon électrobistourisJA-07
- Aesthésiomètre WARTENBERGAC-08
- Agrafe MICHELCG-07
- Aiguille
 à amygdalesFA-05
 à cataracteEC-05
- Aiguille à suturesCG-05 jusque CG-06
- Aiguille
 BARBARAEE-14
 BOWMAN à dissectionsEC-05
 COOPER à ligaturesCG-02
 DAVIS pour corps étrangersEC-05
 DESCHAMPS à ligaturesCG-02
 DUPUY-WEISS pour les amygdalesFA-03
 électrodeJA-03
 électrode miniJA-02
 FRANCIS pour corps étrangersEC-05
 FRANKLIN-SILVERMANN à ponctionCC-03
 KEITH à suturesCG-06
 KOENIG à suturesCG-06
 KRONECKER à ligaturesCG-02
 LEVINSON pour corps étrangersEC-05
 LICHTWITZEG-09
 NELSON à ligaturesCG-02
 POLITZER paracentèseEE-06
 pour corps étrangersEC-05
 QUINKE à ponctionCC-03
 REVERDIN à ligaturesCG-03
 ROSENEE-14 jusque EE-15
 VERRES à ponction pneumopéritoineCC-03
 YOUNG Boomerang à ligaturesCG-03
- Aimant DIMEDA oculaireED-08
- ALAN-PARKS dilateur pour anus et rectumGI-03
- ALBEE fraiseDD-07
- Alésior
 CRUTCHFIELDEA-03
 KUENTSCHERDD-13
 pour clousDD-12
- ALEXANDER
 ciseaux-burinDC-14
 gougeDC-14
 pince emporte-pièce pour le col de l'utérusHA-42
 rugine raspatoireDC-19
- ALLIS-ADAIR pince pour saisir les tissusGE-02
- ALLIS-Baby pince pour saisir les tissusGE-02
- ALLISON spatule pulmonaireFG-19
- ALLIS pince pour saisir les tissusGE-02
- ALM écarteurBI-14
- ALVIS curette pour corps étrangersEC-06
- Amniotome BEACHAMHA-39
- Ampoule de rechange laryngoscope, fibres optiquesAE-20
- Ampoule de rechange laryngoscope, standardAE-20
- Amygdalotome SLUDER-BALLENGERFA-05
- ANDREW abaisse-langueEI-02
- ANDREWS-PINCHON tube d'aspirationAE-03
- Anse
 ARLTEC-08
 auriculaireEE-07
 BILLEAU auriculaireEE-07
 électrode miniJA-02 jusque JA-03
- Anse en bande électrodeJA-03
- Anse en fil électrodeJA-03
- Anse
 à amygdalesFA-04
- Anse
 nasaleEG-09
- Anse
 SNELLENEC-08
 WEBEREC-08
 WILDEREC-08
- Anuscope
 HIRSCHMANNGI-04
 IVES-FANSLERGI-04
- Appareil PETZ à sutures stomacales et intestinalesGE-09
- ARCHER pince à échardesBA-06
- ARKANSAS pierre à repasserAG-19
- ARLT anseEC-08
- ARRUGA
 blépharostatEC-02
 crochet à extractionEC-06
 pince capsulaireED-04
 porte-aiguille pour l'ophtalmologieCE-06
 protecteurEC-08
- ASCH pince à redresser la cloisonEG-18
- Assourdisseur BARANYEE-04
- AUFRIEHT écarteur nasalEG-17
- AUVARD spéculum vaginalHA-19
- AXENFELD curette à chalazionEC-07
- AYER pince à chalazionED-06

B

- BABCOCK pince pour saisir les tissusGE-02
- BABINSKY marteau percuteurAC-07
- BACKHAUS-CLIP pince à champs clamp porte-tubeBE-03
- BACKHAUS KOCHER pince à champsBE-02
- BACKHAUS pince à champsBE-02
- BAGGISH pince emporte-pièce
 pour le col de l'utérusHA-45
- BAILEY-BABY Rapprocheur pour les côtesFG-18
- BAILEY-GIBBON Rapprocheur pour les côtesFG-18
- BAILEY Rapprocheur pour les côtesFG-18
- Baillon MAUNDER boisEI-06
- BAINBRIDGE
 pince atraumatiqueBD-09
 pince hémostatiqueBC-14
- BAKES dilateur pour les voies biliairesGC-06
- BALFOUR Baby écarteur abdominalBI-22
- BALFOUR
 écarteur abdominalBI-22

valve	.BI-22	BISHOP-HARMAN pince à iris	.EC-14
BALL AND SOCKET pince à champs	.BE-04	Bistouri	
BALLENGER		CARPENTER à amygdales	.FA-02
couteau mobile	.EG-11	CONVERSE nasal	.EG-10
élevateur pour la cloison nasale	.EG-12	électrode	.JA-03
pince à préhension amygdalienne	.FA-04	FREER à muqueuses	.EG-10
BANGERTER spatule cyclodialyse	.EC-08	HALLE à duremère	.EA-06
BARANY assourdisseur	.EE-04	JOSEPH mousse	.EG-10
BARBARA		JOSEPH nasal	.EG-10
aiguille	.EE-14	MALTZ à cartilage coude	.EG-11
crochet	.EE-14	Bistouris à dissection	.AG-15
pick	.EE-14 jusque EE-15	Bistouris PARKER à dissection	.AG-15
BARKAN couteau à goniotomie	.EC-05	Bistouri stérile à usage unique	.AG-10 jusque AG-11
BARNHILL couteau	.EG-19	BLAKE	
BARRAQ.KATZIN pince à iris	.EC-13	curette utérine	.HA-48
BARRAQU Colibri pince à iris	.EC-13	pince pour calculs biliaires	.GC-03
BARRAQUER		Blépharostat	
ciseaux colibri	.AJ-04	ARRUGA	.EC-02
BARRAQUER Colibri blépharostat	.EC-02	BARRAQUER Colibri	.EC-02
BARRAQUER		BOWMAN	.EC-02
couteau pour la kératoplastie	.EC-05	CASTROVIEJO	.EC-03
pince chambre antérieure	.ED-02	CLARK	.EC-02
pince à épiler	.ED-08	CRITCHETT	.EC-02
pince à fixation	.ED-03	GOLDSTEIN	.EC-03
porte-aiguille	.CE-07	GRAEFE	.EC-02
BARRETT pince pour abaissement du col de l'utérus	.HA-32	LANCASTER	.EC-03
BARR spéculum rectal	.GI-02	LISTER-BURCH	.EC-02
BARTON		MELLINGER	.EC-02
forceps obstétrique	.HC-04	MELLINGER-AXENFELD	.EC-02
tracteur pour manches ordinaires	.HC-04	MUELLER	.EC-03
Bassin		MURDOCK	.EC-02
de lit	.HE-06	PARK	.EC-03
pour placenta	.HE-06	SMITH	.EC-02
BAUMGARTNER porte-aiguille	.CE-02	STEVENSON	.EC-03
BEACHAM amniotome	.HA-39	WEEK	.EC-02
Becher	.HE-10	WILLIAMS	.EC-02
BECKER cystotome	.EC-06	ZIEGLER	.EC-03
BECKMANN-ADSON écarteur	.BI-15	BLOHMKE pince à préhension amygdalienne	.FA-04
BECKMANN		BLOUNT	
couteau	.EG-19	écarteur à genou	.DC-24
BECKMANN-EATON écarteur	.BI-16	levier à os	.DC-24
BECKMANN		BLUMENTHAL pince gouge	.DC-02
écarteur	.BI-16	BODENHAMMER spéculum rectal	.GI-02
BECK pince atraumatique vasculaire périph	.BD-25	BOEHLER étrier à extension	.DD-10
BEEBEE ciseaux à fils et à plaques	.AI-43	BOERMA forceps obstétrique	.HC-04
BEER pince à épiler	.ED-08	BOETTCHER ciseaux à amygdales	.AI-27
BEESON écarteur pour plâtre	.DA-03	BÖHLER	
BELLUCCI ciseaux auriculaires micro	.EE-09	pince coupante à os	.DC-06
BENGOLEA pince hémostatique	.BC-09	pince gouge	.DC-04
BENNETT levier à os	.DC-22	Boîte	
BERENS kératome	.EC-04	acier inoxydable	.HE-03
BERGMANN		PETRI	.HE-08
ciseaux à bandages	.AI-46	pour aiguille	.HE-02
BERGMANN FOERSTER pince porte-éponges	.BG-10	SAUERBRUCH pour aiguille	.HE-02
BERGMANN		verre	.HE-03
scie pour plâtre	.DA-02	BONACCOLTO pince à strabisme	.EC-14
BERKE pince musculaire	.ED-02	Bonn	
BERLIND-AUVARD spéculum vaginal	.HA-19	Canule à irrigation	.ED-07
BERLINER marteau percuteur	.AC-07	BONNEY pince porte-éponges	.BG-08
BERNHARD pince à champs	.BE-05	Bonn	
BERTILLON céphalomètre	.AC-08	pince à iris	.EC-15
BEST pince intestinale	.GE-06	Bonn TITAN pince à iris	.EC-15
BETHUNE costotome	.FG-04	BORCHARDT fraise	.DD-07
BEUSE ciseaux	.AI-26	BOSE écarteur trachéal	.FE-02
BEYER		BOUCHERON spéculum auriculaire	.EE-02
pince coupante nasale	.EG-08	Bougie	
pince gouge	.DC-04	COXETER urétrale	.GG-17
BILLEAU anse auriculaire	.EE-07	DITTEL urétrale	.GG-18 jusque GG-19
BILL tracteur pour manches ordinaires	.HC-05	FILIFORM conductrice	.GG-12
BIRCHER-GANSKE davier porte-os	.DC-10	GUYON urétrale	.GG-12, GG-14 jusque GG-15
BIRCHER méniscotome	.DC-24	VAN BUREN urétrale	.GG-13

F

Index Français

WALTHER urétrale	GG-17
BOWLES stéthoscope	AC-06
BOWMAN	
aiguille à discision	EC-05
blépharostat	EC-02
couteau à discision	EC-04
stylet pour canal lacrymal	EC-10
BOYNTON porte-aiguille pour l' ophtalmologie	CE-06
BOZEMANN-DOUGLAS pince à pansements	BG-13
BOZEMANN	
pince à pansements	BG-13
porte-aiguille	CE-03
BRAIN	
clip standard	EA-13
clip temporaire	EA-12
BRAIN MINI pince pour poser les clips	EA-12
BRAIN STANDARD pince pour poser les clips	EA-12
BRAITHWAITE dermatome	AG-22
BRAUN	
cranioclaste	HC-09
crochet pour décapitation	HC-09
dépresseur utérin	HA-39
pince pour abaissement du col de l'utérus	HA-31, HA-34
spéculum vaginal	HA-16
BRAUN-STADLER ciseaux pour l'épisiotomie	AH-22, AI-34
BREISKY spéculum vaginal	HA-20
Broche KIRSCHNER	DD-09
BROCK	
dilateur coupant pour valve mitrale	FG-26
manche dilateur pour valve mitrale	FG-26
ouverture dilateur pour valve mitrale	FG-26
Brosse à lavement	CI-04 jusque CI-05
BROWN pince à dissection	BA-03
BRUENINGS	
abaisse-langue	EI-02
couteau pour la cloison nasale	EG-11
pince coupante nasale	EG-05
pince laryngienne	FC-03
rallonge courbée	FC-03
serre-noeud	FA-04
spéculum auriculaire	EE-02
BRUNETTI burin à spinal	DC-17
BRUNNER	
costotome	FG-07
pince intestinale	GE-06
sonde conductrice	CG-04
BRUNS	
ciseaux à plâtre	AI-48
curette	DC-12 jusque DC-13
BRYANT pince porte-éponges	BG-11
BUCHWALD abaisse-langue	EI-02
BUCK	
ciseaux à ligatures	AI-40
curette auriculaire	EE-05
levier pour corps étrangers	EE-08
marteau percuteur	AC-07
BUIE tube d'aspiration	GI-05
BUMM	
curette utérine	HA-49 jusque HA-50
pince hystérolabe	HA-38
BUNGE curette pour exentération	EC-07
BUNNELL	
écorcheur à tendons	DC-25
perforateur à main	DD-05
BUNT épingle de sécurité	CI-02
BURCH fourchette à fixation	EC-05
Burin à spinal BRUNETTI	DC-17
Burin pour crâne VIRCHOW	DC-17
BURKE-Baby pince emporte-pièce pour le col de l'utérus	HA-44
BURKE pince emporte-pièce pour le col de l'utérus	HA-44
BUSCH ciseaux pour le cordon ombilical	AI-34

C

Cadre KIRSCHNER	BI-23
Canule	
Bonn à irrigation	ED-07
Hamburg	ED-07
JACKSON trachéale	FE-03
LUER trachéale	FE-03
SCHEIE oculaire	ED-07
Canules FINSTERER d'aspiration et d'irrigation	AE-05
Canule	
SIMCOE suture	ED-07
Tübingen air	ED-07
WAGENER-MOSHER trachéale	FE-03
Capsula DASTOOR aspirateur	EC-09
CARMALT pince à échardes	BA-06
CARPENTER bistouri à amygdales	FA-02
CASPAR	
écarteur	BI-20
écarteur pour colonne cervicale	BI-18
écarteur pour colonne vertébrale	BI-19
écarteur pour lombo vertébrale	BI-20
manche de bistouris, micro	AG-12
valve	BI-20
valve pour colonne vertébrale	BI-19
Casse-lames	
CASTROVIEJO	AG-14
DIMEDA	AG-14
TROUTMAN-CHRIS	AG-14
CASTANEDA	
écarteur pour les côtes	FG-14
pince atraumatique p. nouveaux-nés et enfants	BD-42
CASTROVIEJO	
blépharostat	EC-03
casse-lames	AG-14
ciseaux à iridectomie	AJ-05
ciseaux cornéens	AJ-06
dilateur pour canal lacrymal	EC-10
kératome	EC-04
marqueur compass	EC-09
pince capsulaire	ED-04
pince à fixation	ED-03
pince à suture	ED-05
porte-aiguille	CE-07
spatule à cyclodialyse	EC-08 jusque EC-09
trépan cornéen	ED-07
CATLIN couteaux à amputation	AG-16
Cautère WADSWORTH-TODD	EC-08
Céphalomètre BERTILLON	AC-08
CHAPUT pince hémostatique	BC-08
CHARRIERE	
lame	DD-03
scie à amputation	DD-03
CHEATLE pince à stérilisation	CI-02
CHERON pince à pansements	BG-12
CHEVALIER-JACKSON pince laryngienne	FC-04
CHEVALLIER écarteur pour les côtes	EC-08 jusque EC-09
CHILDE pince pour agrafes	CG-07
CINELLI ciseau-burin pour plastique nasale	EG-13
Cisaille SCHUMACHER pour le sternum	FG-07
Ciseau-burin	DC-14
ALEXANDER	DC-14
CINELLI pour plastique nasale	EG-13
COTTLE pour plastique nasale	EG-13
FOMON pour plastique nasale	EG-13
FREER pour la cloison nasale	EG-12
HIBBS	DC-16
HOKE	DC-16
LEXER	DC-16
LEXER mini	DC-16

- PARTSCHDC-14
 SILVER pour plastique nasaleEG-14
 SMITH-PETERSENDC-15
 STILLEDC-14
 WEST nasalEG-14
- Ciseaux
 DIX pour corps étrangersEC-06
 ROLLET à extirpationEC-06
- Ciseaux sternaux LEBSCHÉDC-17
- CiseauxAH-02 jusque AH-04, AI-02 jusque AI-04
- Ciseaux à dissectionAI-19
- Ciseaux
 AEBLI cornéensAI-22
- Ciseaux pour l'entérotomieAI-39
- Ciseaux
 à enviesHE-03
- Ciseaux à gencivesAI-41
- Ciseaux
 à onglesHE-03
- Ciseaux à plâtreAI-49
- Ciseaux
 auriculaires microEE-11
 auriculaires micro miniEE-11
 BARRAQUER colibriAJ-04
 BEEBEE à fils et à plaquesAI-43
 BELLUCCI auriculaires microEE-09
 BERGMANN à bandagesAI-46
 BEUSEAI-26
 BOETTCHER à amygdalesAI-27
 BRAUN-STADLER pour l'épisiotomieAH-22, AI-34
 BRUNS à plâtreAI-48
 BUCK à ligaturesAI-40
- Ciseaux-burin DIXEC-09
- Ciseaux
 BUSCH pour le cordon ombilicalAI-34
 CASTROVIEJO à iridectomieAJ-05
 CASTROVIEJO cornéensAJ-06
- Ciseaux
 ciseaux microAJ-06
- Ciseaux
 Ciseaux microAJ-06
 COTTLE nasauxAH-18, AI-25
 CRAFOORD pulmonairesAI-36
 CROIX ROUGE à bandagesAI-47
 DANDY neurochirurgicauxAI-36
 DEAN à amygdalesAI-26
 DEAVERAH-05, AI-06
 DE BAKEY vasculairesAI-30
 DIETHRICH vasculairesAI-29
 DIMEDA à bandagesAI-46
 DOYEN gynécologiquesAI-33
 DUBOIS gynécologiquesAI-33
 ESMARCH à bandagesAI-46
 FERGUSSONAI-49
 FINOCHIETTO à rectumAI-38
- Ciseaux finsAI-05, AI-19, AI-24
- Ciseaux
 FOMON nasauxAH-18, AI-25
 GOLDMAN-FOX à gencivesAI-41
 GOOD à amygdalesAI-27
 GORNEY à dissectionAI-13
 HEATH à ligaturesAI-40
 HEYMANN nasauxAH-18, AI-25
- Ciseaux incisionsAI-05
- Ciseaux
 IRISAH-16, AI-19, AI-21
 IRIS ophtalmologiquesAI-22
 JACOBSON microAJ-11
 JOSEPHAH-14, AI-16
 KELLY gynécologiquesAH-22, AI-33
 KILNERAH-14, AI-17
- KLINKENBERGH-LOTH thoraciquesAI-37
- KNAPPAI-20
- KNOWLES à bandagesAI-47
- LAGRANGE à gencivesAI-41
- LANDOLT à énucléationAI-25
- LANGE à bandagesAI-44
- LEXERAH-09
- LEXER à dissectionAI-11
- LEXER-BABYAH-10
- LEXER-BABY à dissectionAI-12
- LEXER-FINO à dissectionAI-12
- LISTER à bandagesAH-23, AI-45
- LITTAUER à ligaturesAI-40
- LITTLER à dissectionAI-13
- LOCKLINAI-18
- LORENZ à bandagesAI-47
- MAYOAH-06, AI-07
- MAYO main gaucheAI-07
- MAYO-NOBLEAH-08, AI-10
- MAYO-STILLEAH-07, AI-08 jusque AI-09
- McGUIRE cornéensAJ-05
- McINDOE à cartilageAI-35
- McPHERSON WESTCOTT ténatomieAJ-04
- METZENBAUMAH-11
- METZENBAUM à dissectionAI-13 jusque AI-14
- METZENBAUM FINOAH-12
- METZENBAUM FINO à dissectionAI-15
- METZENBAUM "S"AH-13, AI-16
- Ciseaux microAJ-13
- Ciseaux micro gynécologiquesAJ-07 jusque AJ-08
- Ciseaux
 MILLS vasculairesAI-27
- Ciseaux neurochirurgicauxAI-35
- Ciseaux
 NORTHBENT à ligaturesAI-40
- NOYES à irisAJ-03 jusque AJ-04
- NOYES à tendonsAJ-03
- POTTS DE MARTEL vasculairesAI-27
- POTTS-SMITH vasculairesAH-19, AI-28
- Ciseaux pour strabismeAH-17, AI-24
- Ciseaux préparationAI-34
- Ciseaux
 PRINCE à amygdalesAI-27
 QUINBY à gencivesAI-42
 REYNOLDSAH-15, AI-18
 SANVENEROAH-13, AI-16
 SATINSKY thoraciquesAI-37
 SCHMIEDEN-TAYLORAI-36
 SCHUMACHER pour cordon ombilicalAI-34
 SEUTIN pour plâtreDA-02
 SHEA auriculaire microEE-09
 SHORTBENT à ligaturesAI-40
 SIEBOLD gynécologiquesAH-21, AI-32
 SIMS gynécologiquesAH-21, AI-32
 SMITH US ARMY à bandagesAI-44
 SPENCER à ligaturesAI-40
 STELZNER pour le rectumAI-38
 STEVENS pour la ténatomieAH-17, AI-23
 STILLE pour plâtreDA-02
 STRULLY neurochirurgicauxAI-35
 THOREK pulmonairesAI-36
 TOENNIS-ADSON neurochirurgicauxAI-35
 TROUTMAN-CASTROVIEJO microAJ-07
 UNIVERSAL à bandagesAI-50
 UNIVERSAL à fils et plaquesAI-42
 USA MODEL pour le cordon ombilicalAI-34
 VANNAS à iridectomieAJ-05
 VANNAS microAJ-12 jusque AJ-13
- Ciseaux vasculairesAI-27
- Ciseaux vasculaires iris microAJ-09
- Ciseaux vasculaires paramétriumAH-20, AI-31

- Ciseaux
WAGNERAH-22
WAGNER à gencivesAI-42
WALDMANN pour l'épisiotomieAI-34
WECKER à irisAJ-04
WERTHEIM préparationAI-32
WESTCOTT à iridectomieAJ-02
WESTCOTT à tendonsAJ-02
WULLSTEIN auriculaires microEE-11
WULLSTEIN auriculaires micro miniEE-11
YASARGIL microAJ-10 jusque AJ-11
- CITELLI pince coupante nasaleEG-08
- Clamp
COLLIN pour cordon ombilicalHC-06
KANE pour cordon ombilicalHC-06
- Clamps
COOLEY bulldog atraumaBD-33 jusque BD-34
DE BAKEY bulldog atraumaBC-02
DIEFFENBACH bulldog serre-fineBC-03
GLOVER bulldog atraumaBC-02
JOHNS-HOPKINS bulldog serre-fineBC-03
- CLARK blépharostatEC-02
- CLAR
lampe frontaleAC-05
miniAC-05
- Clé à écrousDD-10
- CLEVELAND pince gougeDC-02
- Clip
BRAIN standardEA-13
BRAIN temporaireEA-12
EDWARDSBD-21
- Clou STEINMANN à osDD-09
- CLOWARD
écarteurBI-17
écarteur pour corps vertébrauxEA-07
- COAKLEY
curette pour sinusEG-18
trocartCC-02
- COLCLOUGH pince emporte-pièce pour lames intervertébralesEA-11
- COLLIER porte-aiguilleCE-02
- COLLIN
clamp pour cordon ombilicalHC-06
compas pelvimètreHC-06
- COLLIN-DUVAL pince à dissectionBA-04
- COLLIN
dynamomètreAC-03
écarteur abdominalBI-24 jusque BI-25
- COLLIN-HARTMANN écarteurBI-03
- COLLIN
hystéromètreHA-39
mailletDC-18
manche de bistourisAG-08
pince à pansementsBG-11
pince hystérolabeHA-37
pince pour agrafesCG-07
pince hémostatiqueBC-08
pince tire-langueEI-03
- COLLIN-POZZI pince pour abaissement du col de l'utérusHA-32
- COLLYER
spéculum vaginalHA-04
- COLLYER compas pelvimètreHC-06
- COLVER pince à préhension amygdalienneFA-03
- Compas pelvimètre
COLLINHC-06
COLLYERHC-06
MARTINHC-06
- Compresseur
CORWIN à amygdalesFA-04
STOCKMANN de l'urètreGG-10
STRAUSS de l'urètreGG-10
- ComprimètreDD-02
- Cône KNUTSON-KOCH pour urétrographieGG-09
- Cone occluseurHA-47
- CONNIN-AMSLER marqueurEC-09
- Containers pour la stérilisation
3/4HE-22 jusque HE-24
grandsHE-18 jusque HE-20
petitsHE-32 jusque HE-33
plats semiHE-30 jusque HE-31
semiHE-26 jusque HE-29
spéciauxHE-34 jusque HE-37
- CONVERSE bistouri nasalEG-10
- COOLEY
clamps bulldog atraumaBD-33 jusque BD-34
costotome premièreFG-05
- COOLEY DERRA pince atraumatique p. anastomoseBD-39
- COOLEY
dilatateur pour valve mitraleFG-27 jusque FG-29
dilatateur vasculaireFG-30
écarteur atriumFG-20
écarteur pour les côtesFG-09
- COOLEY modif. STRUCK écarteur atriumFG-20
- COOLAR
pince atraumatique BB-03, BD-35 jusque BD-37, BD-39, BD-41
pince atraumatique pour l'anastomoseBD-37, BD-40
pince atraumatique iliaqueBD-37
pince atraumatique pédiatriqueBD-38 jusque BD-39
pince vasculaireBD-40
- COOPER aiguille à ligaturesCG-02
- CORDES pince laryngienneFC-03
- Cordon
AESCULAP électrobistourisJA-07
ERBE SELECT électrobistourisJA-07
MARTIN électrobistourisJA-07
USA électrobistourisJA-07
- Corte-agravesEA-02
- CORWIN compresseur à amygdalesFA-04
- CORYLLOS costotomeFG-04
- CORYLLOS (Thorax) écarteurBI-13
- CostotomeFG-02
BETHUNEFG-04
BRUNNERFG-07
COOLEY premièreFG-05
CORYLLOSFG-04
GIERTZ-STILLEFG-06
GLUCKFG-03
SAUERBRUCHFG-05
SAUERBRUCH-FREYFG-06
STILLEFG-03
- COTTLE
ciseaux-burin pour plastique nasaleEG-13
ciseaux nasauxAH-18, AI-25
couteau nasalEG-10
écarteur nasalEG-17
élévateur pour la cloison nasaleEG-12
- COTTLE-KAZANJIAN pince coupante à osDC-06
- COTTLE-NEIVERT écarteur nasalEG-17
- COTTLE
spéculum nasalEG-03
- Coupante BROCK dilatateur pour valve mitraleFG-26
- Coupe-bagueDD-03
DIMEDADD-03
- Coupe-cors CREDOHE-03
- Couteau à cartilageAG-18
- Couteau
BALLENGER mobileEG-11
BARKAN à goniectomieEC-05
BARNHILLEG-19
BARRAQUER pour la kératoplastieEC-05
BECKMANNEG-19
BOWMAN à discisionEC-04

BRUENINGS pour la cloison nasale	EG-11	GRAEFE à strabisme	EC-06
COTTLE nasal	EG-10	GRAEFE-TITAN à strabisme	EC-06
DEAN à iridectomie	EC-04	GREEN musculaire	EC-06
DEUTSCHMANN à cataracte	EC-03	GUTHRIE	BI-06
ELSCHNIG cornéen	EC-05	JAMESON à strabisme	EC-06
ESMARCH pour plâtre	DA-04	JOSEPH	BI-06
FREER pour la cloison nasale	EG-10	KILNER à peau	HE-02
GILL cornéen	EC-05	O' CONNOR à iris	EC-06
GRAEFE à cataracte	EC-03	SMELLIE pour les accouchements	HC-06
HOPKINS pour plâtre	DA-04	STEVENS	EC-06
KNAPP à iridectomie	EC-04	WAGENER auriculaire	EE-07
LANGENBECK à résection	AG-17	WIENER à iris	EC-06
MUCK à périoste	EE-15	CROIX ROUGE ciseaux à bandages	AI-47
OTIS de rechange	GG-08	CRUTCHFIELD	
PAUFIQUE pour la kératoplastie	EC-05	alésoir	EA-03
PLESTER lobaire	EE-14	traction crânienne	EA-03
POLITZER auriculaire	EE-06	Cuiller GUTMANN à sécrétion	GG-11
Couteau pour plâtre	DA-04	CULLER spatule à iris	EC-08
Couteau		Curette	
REINER pour plâtre	DA-04	ALVIS pour corps étrangers	EC-06
ROSEN circulaire	EE-14	AXENFELD à chalazion	EC-07
SATO cornéen	EC-05	BLAKE utérine	HA-48
SCHEIE à goniotomie	EC-05	BRUNS	DC-12 jusque DC-13
SCHUKNECHT circulaire	EE-14	BUCK auriculaire	EE-05
SCHUKNECHT serpette	EE-14	BUMM utérine	HA-49 jusque HA-50
SEXTON auriculaire	EE-06	BUNGE pour exentération	EC-07
St. CLAIR-THOMSON	EG-19	COAKLEY pour sinus	EG-18
TABB serpette	EE-14	CUZZI placentaire et pour post-abortionum	HC-08
TOOK cornéen	EC-05	d'aspiration	HA-51
VIRCHOW à cartilages	AG-18	DAVIEL à cataracte	EC-07
VIRCHOW pour le cerveau	AG-18	DESJARDINS pour calculs biliaires	GC-08
WHEELER à dissection	EC-04	FAULKNER	EG-18
WULLSTEIN serpette	EE-14	FERGUSON pour calculs biliaires	GC-07
Couteaux à amputation	AG-16	FOX pour lupus	HE-02
Couteaux		GOURDET utérine	HA-48
CATLIN à amputation	AG-16	GRAEFE à cataracte	EC-07
LISTON à amputation	AG-16	GROSS auriculaire	EE-06
Couteau		HALLE	DC-13
ZIEGLER à capsulotomie	EC-05	HEBRA à chalazion	EC-07
ZIEGLER à iridectomie	EC-04	HOUSE	EE-15
COXETER bougie urétrale	GG-17	KEVORKIAN aspirante pour biopsie de l'utérus	HA-40
Crachoir	HE-06	KNAPP à cataracte	EC-07
CRAFOORD		LANG	EC-08
ciseaux pulmonaires	AI-36	LEMPERT	DC-13
pince hémostatique pour les bronches	BC-12	LUER-KOERTE pour calculs biliaires	GC-09
Cranioclaste		MARTINI	DC-13
BRAUN	HC-09	MAYO pour calculs biliaires	GC-07
TARNIER	HC-09	MEYHOEFER à chalazion	EC-07
CREDO coupe-cors	HE-03	MOORE pour calculs biliaires	GC-05
CRILE		NOVAK aspirante pour biopsie de l'utérus	HA-40
écarteur	BI-02	PESTALOZZA placentaire et pour post-abortionum	HC-08
CRILE-MURRAY porte-aiguille	CE-02	PIFFARD pour lupus	HE-02
CRILE		RANDALL aspirante pour biopsie de l'utérus	HA-40
pince hémostatique	BC-05	RECAIMER utérine	HA-49 jusque HA-50
porte-aiguille	CE-04	SCHEDE	DC-12
CRILE-RANKIN pince hémostatique	BC-05	SCHROEDER utérine	HA-48
CRILE TITAN pince hémostatique	BC-05	SIMON	DC-13
CRILE-WOOD porte-aiguille	CE-02	SIMON utérine	HA-48
CRITCHETT blépharostat	EC-02	SIMS utérine	HA-49 jusque HA-50
Crochet	EE-15	SPRATT	DC-12
à extension	DD-10	VOLKMANN	DC-12 jusque DC-13
à extraction	DD-13	WALLICH placentaire et pour post-abortionum	HC-08
ARRUGA à extraction	EC-06	WILLIGER	DC-13
BARBARA	EE-14	CUSCO spéculum vaginal	HA-04 jusque HA-06
BRAUN pour décapitation	HC-09	CUSHING	
DAY auriculaire	EE-07	écarteur	BI-07
électrode mini	JA-02	écarteur à nerfs	EA-04
EMMET pour fistules	HA-46	perforateur plat	DD-04
FRAZIER	BI-06	pince à dissection	BA-03
GILLIES	EG-17	pince emporte-pièce pour laminectomie	EA-08
GRAEFE	BI-06	spatule cérébrale	EA-07

F

Index Français

- Cuvette rondeHE-04 jusque HE-05
 CUZZI curette placentaire et pour post-abortumHC-08
 CZERNY
 pince pour abaissement du col de l'utérusHA-34
 pince pour calculs biliairesGC-03
 spéculum rectalGI-02
- D**
- DALE pince atraumatique vasculaire périphBD-24
 DANDY
 ciseaux neurochirurgicauxAI-36
 écarteur à nerfsEA-04
 pince hémostatiqueBC-07
 DARDIK pince atraumatiqueBD-07
 DARLING écarteurBI-17
 DARTIGUES pince hystérolabeHA-37
 DASTOOR
 Aspirateur capsulaireEC-09
 pince à strabismeEC-14
 DAVIDSON (Scapula) écarteurBI-13
 DAVIEL curette à cataracteEC-07
 Davier
 BIRCHER-GANSKE porte-osDC-10
 DINGMANN porte-osDC-10
 FARABEU-F-LAMBOTTE porte-osDC-08
 FARABEU-F porte-osDC-07
 FERGUSSON porte-osDC-07
 KERN porte-osDC-08
 LAMBOTTE porte-osDC-08
 LANE porte-osDC-08
 LANGENBECK porte-osDC-07
 LEWIN porte-osDC-10
 LOWMAN à osDC-11
 Davier porte-osDC-09 jusque DC-10
 Davier
 SEMB porte-osDC-07
 VERBRUGGE porte-osDC-09
 DAVIS
 aiguille pour corps étrangersEC-05
 DAVIS-BOYLE ouvre-boucheEI-04
 DAVIS
 dissecteur duremètreEA-05
 pince à stérilisationCI-02
 DAY crochet auriculaireEE-07
 DEAN
 ciseaux à amygdalesAI-26
 couteau à iridectomieEC-04
 DEEVER
 ciseauxAH-05, AI-06
 écarteurBI-05
 DEEVER Grip écarteurBI-05
 DEBAKEY BAHNSON pince atraumatique pour aneurisme d'aorte
 BD-14
 DE BAKEY
 ciseaux vasculairesAI-30
 clamps bulldog atraumaBC-02
 dilateur vasculaireFG-31
 DE BAKEY MORRIS pince atraumatiqueBD-16
 DE BAKEY
 pince atraumatiqueBB-03
 DEBAKEY pince atraumatiqueBD-02, BD-08, BD-12
 DE BAKEY
 pince atraumatiqueBD-16 jusque BD-17
 DEBAKEY pince atraumatiqueBD-20
 DE BAKEY
 pince atraumatiqueBD-28 jusque BD-30
 pince atraumatique à dissection et à ligatureBD-25, BD-32
 pince atraumatique pour anastomoseBD-25
 pince atraumatique p. aneurisme d'aorteBD-13, BD-15, BD-18
 pince atraumatique pour les bronchesBD-19
 pince atraumatique iliaqueBD-11
 pince atraumatique vasculaire périphBD-06
 porte-aiguilleCE-03
 DE BAKEY REYNOLDS pince atraumatique pour anastomoseBD-30
 DEBAKEY SATINSKY pince atraumatiqueBD-22
 DE BAKEY
 tube d'aspirationAE-04
 Décolleur
 FISCHEE-15
 HURD à amygdalesFA-02
 DEJERINE marteau percuteurAC-07
 De LEE forceps obstétriqueHC-02
 De MARTEL guide-scieEA-05
 DeMARTEL-WOLFSON pince à anastomoseGE-07
 DENHART ouvre-boucheEI-03
 Dépresseur BRAUN utérinHA-39
 Dépresseur
 REICHERT pour l'épiglottisFC-02
 SIMS utérinHA-39
 DERF porte-aiguilleCE-02
 Dermatome
 BRAITHWAITEAG-22
 HUMBYAG-20
 SCHINKAG-21
 SILVERAG-20
 WATSONAG-22
 DERRA pince atraumatique p. anastomose et pédiatrie BD-28
 DESCHAMPS aiguille à ligaturesCG-02
 DESJARDINS
 curette pour calculs biliairesGC-08
 pince pour calculs biliairesGC-02
 pince pour voies biliairesBC-15
 sonde pour calculs biliairesGC-05
 DESMARRES
 écarteurBI-07
 pince à chalazionED-06
 DEUTSCHMANN couteau à cataracteEC-03
 DeVILBISS pince crânienneEA-05
 DEWEY forceps obstétrique avec dispositif de tractionHC-05
 DIAMANT pince coupe-filDD-12
 DiapasonEE-04
 DIMEDA AluEE-03
 HARTMANNEE-03
 LUCAEEE-04
 RYDEL-SEIFFEREE-04
 DIEFFENBACH clamps bulldog serre-fineBC-03
 DIETER pince pour la tête du marteauEE-10
 DIETHRICH
 ciseaux vasculairesAI-29
 pince atraumatiqueBD-31
 porte-aiguille vasculaireCE-06
 Dilatateur
 ALAN-PARKS pour anus et rectumGI-03
 BAKES pour les voies biliairesGC-06
 CASTROVIEJO pour le canal lacrymalEC-10
 COOLEY pour valve mitraleFG-27 jusque FG-29
 COOLEY vasculaireFG-30
 DE BAKEY vasculaireFG-31
 GERBODE pour valve mitraleFG-28
 GOODELL pour col de l'utérusHA-30
 HANK pour col de l'utérusHA-28
 HEGAR pour col de l'utérusHA-24 jusque HA-27
 HETZER pour valve mitraleFG-29
 LABORDE trachéalFE-02
 PRATT pour col de l'utérusHA-29
 SIMS pour col de l'utérusHA-30
 SMITH-BUIE pour anus et rectumGI-03
 TROUSSEAU trachéalFE-02
 TUBBS pour valve mitraleFG-27
 WILDER pour canal lacrymalEC-10

WYLIE pour col de l'utérusHA-30
 ZIEGLER pour canal lacrymalEC-10
 DIMEDA
 aimant oculaireED-08
 DIMEDA Alu diapasonEE-03
 DIMEDA
 casse-lamesAG-14
 ciseaux à bandagesAI-46
 coupe-bagueDD-03
 écarteurBI-14
 pince pour déchetsCI-03
 styletCA-03
 DINGMANN davier porte-osDC-10
 Dissecteur
 DAVIS duremèreEA-05
 duremèreEA-05
 GREEN cornéenEC-06
 HORSLEY duremèreEA-06
 MILLIGAN duremèreEA-05
 PATON cornéenEC-05
 PENFIELD duremèreEA-06
 ROBB vasculaireFG-33
 SACHS duremèreEA-05
 TOENNIS duremèreEA-05
 DITTEL
 bougie urétraleGG-18 jusque GG-19
 introducteur de sondesGG-11
 DIX
 ciseaux pour corps étrangersEC-06
 ciseaux-burinEC-09
 Doigtier LANGENBECKEI-06
 Doigt MAGILLAE-04
 DOUGLAS
 Pince à épilerED-08
 trocartCC-02
 DOYEN-Baby pince intestinaleGE-03
 DOYEN
 ciseaux gynécologiquesAI-33
 écarteurBI-12
 fraiseDD-07
 DOYEN-JANSEN ouvre-boucheEI-03
 DOYEN
 pince à champsBE-05
 pince à polypes utérinsHA-36
 pince intestinaleGE-03
 rugine raspatoire pour les côtesDC-20
 sondeCA-02
 spéculum vaginalHA-18, HA-20
 tracteur pour fibromesHA-46
 DUBOIS ciseaux gynécologiquesAI-33
 DUPLAY
 pince à pansementsBG-14
 pince pour abaissement du col de l'utérusHA-31
 DUPUY-WEISS aiguille à amygdalesFA-03
 DUVAL
 pince à dissectionBA-04
 pince à saisir les tissusGE-03
 Dynamomètre COLLINAC-03
 écarteurBI-06, BI-10
 ADSONBI-15
 ADSON à nerfsEA-04
 ADSON BabyBI-15
 ALMBI-14
 AUFRICHT nasalEG-17
 BECKMANNBI-16
 BECKMANN-ADSONBI-15
 BECKMANN-EATONBI-16
 BEESON pour plâtreDA-03
 BLOUNT pour le genouDC-24
 BOSE trachéalFE-02
 CASPARBI-20

CASPAR pour colonne cervicaleBI-18
 CASPAR pour colonne vertébraleBI-19
 CASPAR pour lombar vertébraleBI-20
 CASTAÑEDA pour les côtesFG-14
 CHEVALLIER pour les côtesFG-15
 CLOWARDBI-17
 CLOWARD pour corps vertébrauxEA-07
 COLLIN-HARTMANNBI-03
 COOLEY atriumFG-20
 COOLEY pour les côtesFG-09
 COOLEY modif. STRUCK pour l'atriumFG-20
 CORYLLOS (Thorax)BI-13
 COTTLE nasalEG-17
 COTTLE-NEIVERT nasalEG-17
 CRILEBI-02
 CUSHINGBI-07
 CUSHING à nerfsEA-04
 DANDY à nerfsEA-04
 DARLINGBI-17
 DAVIDSON (Scapula)BI-13
 DEEVERBI-05
 DEEVER GripBI-05
 DESMARRSBI-07
 DIMEDABI-14
 DOYENBI-12
 FARABEUFBI-02
 FINOCHIETTO-BABY pour les côtesFG-09
 FINOCHIETTO BURFORD p. les côtes FG-12 jusque FG-14
 FINOCHIETTO p. les côtesFG-08, FG-10 jusque FG-11
 FINOCHIETTO-HAIGHT BABY p. les côtesFG-10
 FINOCHIETTO INFANT pour les côtesFG-12
 FINOCHIETTO (modif) pour les côtesFG-08
 FINSENBI-14
 FOMON nasalEG-17
 FRAZIERBI-21
 FRIEDMAN à périnéorrhapieHA-23
 FRITSCHBI-11
 GERSTER pour daviersDC-11
 GOELETBI-03
 GRAHAM à nerfsEA-04
 GREENBI-10
 HABERERBI-04
 HAGLUND-STILLE pour plâtreDA-03
 HAIGHT pour les côtesFG-15
 HARRINGTONBI-05
 HEANEYBI-12
 HENNIG pour plâtreDA-03
 HERMANN pour plâtreDA-03
 HERTZLER pour les côtesFG-17
 HOFER piliaireFA-02
 HRYNTSCHAK pour saisir la prostateGG-06
 INGE pour corps vertébrauxEA-07
 ISRAELBI-11
 ITERSON trachéalFE-02
 JACKSON trachéalFE-02
 JANSENBI-14
 JUDD-MASSON vésicalGG-04
 KELLYBI-04, BI-12
 KELLY GripBI-04
 KNAPPEC-06
 KOCHERBI-10 jusque BI-11
 KOERTEBI-11
 LAHEYBI-08
 LANGENBECKBI-09
 LEGUEU vésicalGG-06
 lèvres et jouesEI-03
 LITTLEBI-08
 LOVE à nerfsEA-04
 LOVE ovulaireFA-02
 MATHIEUBI-03
 MERCEDES thoraciqueFG-16

F

Index Français

MEYERDING	.BI-08
MIDDELDORPF	.BI-10
MIKULICZ	.BI-12
MILLIN pour le col de la vessie	.GG-07
MILLIN vésical	.GG-05
MOLLISON	.BI-17
MORSE-FAVOLORO pour les côtes	.FG-17
écarteur Musculaire	.BI-25
écarteur	
NAGER pour le palais	.FA-02
OLLIER	.BI-10
PARKER	.BI-02
PITHA pour les lèvres et joues	.EI-06
PLESTER	.BI-14
écarteur Pour plâtre	.DA-03
écarteur	
PRATT cystique	.GI-04
QUATTRO pour plâtre	.DA-03
REVERDIN	.BI-04
RIBBON	.BI-04
RICHARDSON	.BI-04
RICHARDSON-EASTMAN	.BI-04
RICHARDSON Grip	.BI-04
ROLLET	.EC-06
ROSE trachéal	.FE-03
ROUX	.BI-02
ROUX Baby	.BI-02
ROUX mini	.BI-02
SACHS à nerfs	.EA-04
SAUERBRUCH	.BI-13
écarteur	
BALFOUR abdominal	.BI-22
BALFOUR Baby abdominal	.BI-22
écarteur	
SCHOENBORN pour la thyroïde	.FE-04
écarteur	
COLLIN abdominal	.BI-24 jusque BI-25
écarteur	
SENN	.BI-04
SENN-GREEN	.BI-07
écarteur	
GELPI abdominal	.BI-24
GOSSET abdominal	.BI-21
écarteur	
SIMON	.BI-12
écarteur	
KIRSCHNER abdominal	.BI-23
écarteur	
SMITHWICK à nerfs	.EA-04
écarteur	
O'SULLIVAN-O'CONNOR abdominal	.BI-21
RIGBY abdominal	.BI-24
écarteur	
STERNBERG pour lèvres et joues	.EI-02
TAYLOR spinal	.DC-24
THOMSON-WALKER vésical	.GG-06
TUFFIER pour les côtes	.FG-16
US Army (PARKER-LANGENBECK)	.BI-03
VOLKMANN	.BI-07 jusque BI-08
WEITLANER	.BI-14
WEITLANER-WULLSTEIN	.BI-14
YOUNG pour la prostate	.GG-02

E

ECHLIN pince gouge	.DC-05
Ecorcheur BUNNELL à tendons	.DC-25
EDWARDS	
clip	.BD-21
pince à poser clips	.BD-21
Électrode mini pour la coagulation	.JA-02 jusque JA-03

Elévateur

ADSON	.DC-21
BALLENGER pour la cloison nasale	.EG-12
COTTLE pour la cloison nasale	.EG-12
FREER pour la cloison nasale	.EG-11
HAJEK-BALLENGER pour la cloison nasale	.EG-12
HENKE à amygdales	.FA-02
JOSEPH pour la cloison nasale	.EG-12
KEY	.DC-21
KILLIAN pour la cloison nasale	.EG-12
LANGENBECK	.DC-21
LEMPERT	.EE-15
McDONALD	.DC-22
McKENTY pour la cloison nasale	.EG-11
MURPHY-LANE	.DC-22
ROGER pour la cloison nasale	.EG-11
WATSON-CHEYNE	.DC-22
ELLIOT	
forceps obstétrique	.HC-02
trépan cornéen	.ED-08
ELLIS gouge pour corps étrangers	.EC-06
ELSAESSER pince à néphrostomie	.GC-13
ELSCHNIG	
couteau cornéen	.EC-05
pince capsulaire	.ED-04
pince fixation	.ED-03
spatule cyclodialyse	.EC-08
EMMET crochet pour fistules	.HA-46
ENGEL scie pour plâtre	.DA-02
Enlève-lame	.AG-06, AG-10
Entonnoir	.HE-07
Épingle	
BUNT de sécurité	.CI-02
MAYO de sécurité	.CI-02
EPENDORFER-KEVORKIAN pince emporte-pièce pour le col de l'utérus	.HA-46
EPENDORFER pince emporte-pièce pour le col de l'utérus	HA-45 jusque HA-46
EPENDORFER TISCHLER-MORGAN pince emporte-pièce pour le col de l'utérus	.HA-46
ERBE SELECT cordon électrobistouris	.JA-07
ESMARCH	
ciseaux à bandages	.AI-46
couteau pour plâtre	.DA-04
Etrier	
à extension	.DD-10
BOEHLER à extension	.DD-10
KIRSCHNER à extension	.DD-10
EVES serre-noeud	.FA-04
Evideur SEGOND pour fibromes	.HA-46
Extractor KUENTSCHER	.DD-13

F

FARABEUF	
davier porte-os	.DC-07
écarteur	.BI-02
FARABEUF-LAMBOTTE davier porte-os	.DC-08
FARABEUF	
rugine raspatoire	.DC-19
FARREL stylet	.CA-03
FAULKNER curette	.EG-18
FAURE	
pince emporte-pièce pour le col de l'utérus	.HA-41
pince à péritoine	.BC-17
FEHLAND pince intestinale	.GE-06
FEILCHENFELD pince à échardes	.BA-06
FERGUSSON	
ciseaux	.AI-49
curette pour calculs biliaires	.GC-07
davier porte-os	.DC-07

- pince hémostatiqueBC-07
- FERRIS pince à dissectionBA-04
- FERRIS-SMITH-KERRISON pince emporte-pièce pour lames inter-
vertébralesEA-10
- FERRIS-SMITH pince emporte-pièce à laminectomieEA-09
- FILIFORM bougie conductriceGG-12
- Fil pour cerclageDD-11
- FINOCHIETTO-BABY écarteur pour les côtesFG-09
- FINOCHIETTO BURFORD écarteur pour les côtesFG-12 jusque
FG-14
- FINOCHIETTO
ciseaux pour le rectumAI-38
écarteur pour les côtesFG-08, FG-10 jusque FG-11
- FINOCHIETTO-HAIGTH BABY écarteur p. les côtesFG-10
- FINOCHIETTO INFANT écarteur p. les côtesFG-12
- FINOCHIETTO (modif) écarteur p. les côtesFG-08
- FINOCHIETTO
pince pour les bronchesFG-21
porte-aiguilleCE-04
- FINSEN écarteurBI-14
- FINSTERER canules d'aspiration et d'irrigationAE-05
- FISCH décolleurEE-15
- FISCHER pince à irisEC-13
- FLETCHER JAVERTS pince porte-épongesBG-10
- FLEURANT trocartCC-02
- FOERSTER
pince à irisEC-12
pince porte-épongesBG-06 jusque BG-08
- FOMON
ciseaux-burin pour plastique nasaleEG-13
ciseaux nasauxAH-18, AI-25
écarteur nasalEG-17
rape nasaleEG-15 jusque EG-16
- Forceps
- BARTON obstétriqueHC-04
- BOERMA obstétriqueHC-04
- De LEE obstétriqueHC-02
- DEWEY obstétrique avec dispositif de tractionHC-05
- ELLIOT obstétriqueHC-02
- KIELLAND-LUIKART obstétriqueHC-03
- KIELLAND obstétriqueHC-02
- LUIKART obstétriqueHC-03
- McLEAN-LUIKART obstétriqueHC-03
- McLEAN obstétriqueHC-04
- McLEAN-TUCKER-LUIKART obstétriqueHC-03
- NAEGELE obstétriqueHC-03
- PIPER obstétriqueHC-04
- PIPER obstétrique avec dispositif de tractionHC-04
- SIMPSON-BRAUN obstétriqueHC-02
- SIMPSON-LUIKART obstétriqueHC-03
- SIMPSON obstétriqueHC-02
- TARNIER obstétrique avec dispositif de tractionHC-05
- WRIGLEY obstétriqueHC-02
- FORD BOWLES stéthoscopeAC-06
- FORD stéthoscopeAC-06
- Fourchette BURCH à fixationEC-05
- FOX curette lupusHE-02
- FRAENKEL
pince à polypes laryngiensFC-02
pince laryngienneFC-03
- FraiseDD-07
- ALBEEDD-07
- BORCHARDTDD-07
- coniqueDD-04
- Fraise conique HUDSONDD-04
- Fraise
DOYENDD-07
pour corticalisDD-15
- TOTIDD-07
- FRANCESCHETTI trépan cornéenED-07
- FRANCIS aiguille pour corps étrangersEC-05
- FRANKLIN-SILVERMANN aiguille à ponctionCC-03
- FRAZIER
crochetBI-06
écarteurBI-21
tube d'aspirationEA-07
- FREER
bistouri à muqueusesEG-10
ciseaux-burin pour cloison nasaleEG-12
couteau pour la cloison nasaleEG-10
élévateur pour la cloison nasaleEG-11
gouge nasaleEG-14
- FREEWAY-GRAVE spéculum vaginalHA-06
- FRENZEL abaisse-langueEI-02
- FRIEDMAN
écarteur pour la perinéorrhapieHA-23
pince gougeDC-02
pince gouge, miniDC-02
- FRITSCH écarteurBI-11
- FRYKHOLM pince gougeDC-05
- FUCHS pince capsulaireED-04
- G**
- GALLAHER rape pour le sinusEG-16
- GAUSS pince péri crânienneHC-06
- GELLHORN pince emporte-pièce pour le col de l'utérusHA-42
- GELPI écarteur abdominalBI-24
- GEMINI MINI pince à dissection et à ligatureBC-10
- GEMINI pince à dissection et à ligatureBC-10
- GERALD pince à dissectionBA-05
- GERBODE dilateur valve mitraleFG-28
- GERSTER écarteur pour daviersDC-11
- GERZOG mailletDC-18
- GIERTZ-STILLE costotomeFG-06
- GIGLI manche pour scieEA-05
- GILL-ARRUGA pince capsulaireED-03
- GILL
couteau cornéenEC-05
- GILL-HESS pince à irisEC-12
- GILLIES
crochetEG-17
pince à dissectionBA-05
porte-aiguilleCE-05
- GILL
pince à irisEC-12
- GLOVER
clamps bulldog atraumaBC-02
pince atraumatiqueBD-06, BD-30
pince atraumatique à coarctationBD-04
pince atraumatique pour l'anastomoseBD-05
- GLUCK costotomeFG-03
- GOLET écarteurBI-03
- GOLDMAN-FOX ciseaux à gencivesAI-41
- GOLDSTEIN blépharostatEC-03
- Goniomètre MOELTGENAC-08
- GOOD ciseaux à amygdalesAI-27
- GOODELL dilateur du col de l'utérusHA-30
- GORNEY ciseaux à dissectionAI-13
- GOSSET écarteur abdominalBI-21
- GougeDC-14
- ALEXANDERDC-14
- ELLIS pour corps étrangersEC-06
- FREER nasaleEG-14
- HAJEK nasaleEG-14
- HIBBSDC-16
- KILLIAN-CLAUS nasaleEG-14
- LEXERDC-16
- LEXER miniDC-16
- PARTSCHDC-14
- SMITH-PETERSENDC-15
- STILLEDC-14

WALTON pour corps étrangers	EC-06
WEST nasale	EG-14
GOURDET curette utérine	HA-48
GRADLE pince à épiler	ED-08
GRAEFE	
blépharostat	EC-02
couteau à cataracte	EC-03
crochet	BI-06
crochet à strabisme	EC-06
curette à cataracte	EC-07
kistitome	EC-06
pince à dissection	BA-03
pince à iris	EC-11
pince fixation	ED-03
scarificateur	EC-04
GRAEFE-TITAN crochet à strabisme	EC-06
GRAHAM écarteur à nerfs	EA-04
GRAVE spéculum vaginal	HA-02
GRAY pince pour voies biliaires	BC-15
GREEN-ARMYTAGE pince-clamp utérine pour hémostase	HC-06
GREEN	
crochet musculaire	EC-06
dissecteur cornéen	EC-06
écarteur	BI-10
pince fixation	ED-03
GREGORY pince atraumatique pour profunda	BD-33
GREVEN pince auriculaire micro	EE-10
GRIP pince à saisir	DD-11
GROSS	
curette auriculaire	EE-06
GROSS-MAIER pince à pansements	BG-02 jusqu'à BG-04
GROSS	
pince à pansements	BG-05
GRUBER spéculum auriculaire	EE-02
Guide-scie De MARTEL	EA-05
GUTHRIE crochet	BI-06
GUTMANN cuillère à sécrétion	GG-11
GUYON	
bougie urétrale	GG-12, GG-14 jusqu'à GG-15
introduceur de sondes	GG-11
pince à pédicule rénal	BC-16
GUYTON-LUNDSGAARD sclérotome	EC-05
H	
HABERER écarteur	BI-04
HAGLUND-STILLE écarteur pour plâtre	DA-03
HAIGHT écarteur pour les côtes	FG-15
HAJEK-BALLENGER élévateur pour la cloison nasale	EG-12
HAJEK-CLAUS pince coupante nasale	EG-08
HAJEK gouge nasale	EG-14
HAJEK-KOFLER pince coupante nasale	EG-08
HALLE	
bistouri à duremère	EA-06
curette	DC-13
HALSEY porte-aiguille	CE-02
HALSTED-MOSQUITO micro pince hémostatique	BC-04
HALSTED-MOSQUITO	
pince atraumatique	BD-02
pince hémostatique	BC-04
HALSTED-MOSQUITO TITAN pince hémostatique	BC-04
Hamburg canule	ED-07
HANK dilateur pour col de l'utérus	HA-28
Haricot	HE-07
HARKEN pince atraumatique auriculaire	BD-23
HARRINGTON	
écarteur	BI-05
pince pour les bronches	FG-21
HARTMANN	
abaisse-langue	EI-02
diapason	EE-03
HARTMANN-HALLE spéculum nasal	EG-02
HARTMANN-HOFFMANN pince auriculaire	EE-08
HARTMANN	
pince auriculaire	EE-08
pince coupante nasale	EG-07
pince nasale à polypes	EG-04
pince hémostatique	BC-03
sonde auriculaire	EE-06
spéculum auriculaire	EE-02
HARTMANN-WULLSTEIN pince auriculaire	EE-08
HEANEY	
écarteur	BI-12
pince à hystérectomie	BC-18
porte-aiguille	CE-03
HEATH ciseaux à ligatures	AI-40
HEBRA curette à chalazion	EC-07
HEGAR dilateur pour col de l'utérus	HA-24 jusqu'à HA-27
HEGENBARTH pince pour agrafes	CG-07
HEIFETZ spatule cérébrale	EA-07
HEIMING pince pour les calculs du bassin	GC-13
HEISS pince hémostatique	BC-09
HEISTER ouvre-bouche	EI-03
Hémostate PASSOW	EE-15
HENKE élévateur à amygdales	FA-02
HENNIG écarteur pour plâtre	DA-03
HENROTIN pince pour abaissement du col de l'utérus	HA-34
HERMANN écarteur pour plâtre	DA-03
HERRICK pince à péritoine	BC-17
HERTZLER écarteur pour les côtes	FG-17
HESS	
pince à iris	EC-12
pince capsulaire	ED-04
HETZER dilateur pour valve mitrale	FG-29
HEYMANN	
ciseaux nasaux	AH-18, AI-25
HEYMANN-KNIGHT pince nasale à polypes	EG-05
HEYMANN	
pince coupante nasale	EG-05
HEYWOOD-SMITH pince à hémorroïdes	GI-05
HIBBS	
ciseau-burin	DC-16
gouge	DC-16
ostéome	DC-16
HIRSCHMANN anoscope	GI-04
HOESEL porte-aiguille	CE-05
HOFER écarteur pileaire	FA-02
HOFF pince à champs	BE-03
HOHMANN levier à os	DC-22 jusqu'à DC-23
HOHMANN mini levier à os	DC-23
HOKE ciseau-burin	DC-16
HOLTH pince pour capsulotomie	EC-09
HOPKINS couteau pour plâtre	DA-04
HORSLEY dissecteur duremère	EA-06
HOUSE curette	EE-15
HRYNTSCHAK écarteur pour saisir la prostate	GG-06
HUBER manche universel	FC-03
HUDSON	
fraise conique	DD-04
perforateur à main	DD-04
HUMBY	
dermatome	AG-20
lame dermatome de rechange	AG-20
HUNTER pince à échardes	BA-06
HURD décolleur à amygdales	FA-02
Hystéromètre	
COLLIN	HA-39
MARTIN	HA-39
SIMS	HA-39
VALLEIX	HA-39

I

Impactor	.DD-12
KUENTSCHER	.DD-13
INGE écarteur vertébral	.EA-07
Instrument	
de circoncision	.GG-09
KNUTSON pour urétrographie	.GG-09
Instrument	
LAFORCE pour corps étrangers	.EC-06
Instrument	
MOGAN de circoncision	.GG-09
WINKELMANN de circoncision	.GG-09
Insufflateur POLITZER d'air	.EE-05
Introduceur de sondes	
DITTEL	.GG-11
GUYON	.GG-11
IOWA pince pour abaissement du col de l'utérus	.HA-35
IRIS	
ciseaux	.AH-16, AI-19, AI-21
ciseaux ophtalmologiques	.AI-22
Irrigateur	.HE-05
ISRAEL écarteur	.BI-11
ITARD sonde auriculaire	.EE-06
ITERSON écarteur trachéal	.FE-02
IVES-FANSLER anoscope	.GI-04

J

JACKSON	
canule trachéale	.FE-03
écarteur trachéal	.FE-02
pince porte tampons	.FC-02
spéculum vaginal	.HA-16
JACOBSON ciseaux micro	.AJ-11
JACOBS pince pour abaissement du col de l'utérus	.HA-34
JAEGER	
kératome	.EC-04
plaque pour paupières	.EC-03
JAMESON	
crochet à strabisme	.EC-06
pince à strabisme	.EC-13
JAMISON porte-aiguille	.CE-03
JANSEN	
écarteur	.BI-14
pince nasale	.EG-04
JARCHO pince pour abaissement du col de l'utérus	.HA-32
JATHO pince nasopharyngienne	.EG-18
JAVID pince atraumatique carotis	.BD-32
JENNINGS ouvre-bouche	.EI-04
JOBSON-HORNE stylet	.CA-03
JOHNS-HOPKINS	
clamps bulldog serre-fine	.BC-03
pince pour voies biliaires	.BC-14
JOHNSON porte-aiguille	.CE-04
JONES pince à champs clamp porte tube	.BE-02
JOSEPH	
bistouri mousse	.EG-10
bistouri nasal	.EG-10
ciseaux	.AH-14, AI-16
crochet	.BI-06
élévateur pour la cloison nasale	.EG-12
JOSEPH (LEWIS) rape nasale	.EG-15
JOSEPH	
lime à os	.EG-14
scie nasale	.EG-17
JUDD-ALLIS pince pour saisir les tissus	.GE-02
JUDD-MASSON écarteur vésical	.GG-04
JURASZ pince à polypes laryngiens	.FC-02

K

KABIERSKE lance-poudre	.EE-04
KALLMORGEN	
spéculum vaginal	.HA-15
valve vaginale	.HA-15
KALT-ARRUGA porte-aiguille	.CE-07
KALT	
pince capsulaire	.ED-04
porte-aiguille	.CE-07
KANE clamp pour cordon ombilical	.HC-06
KEITH aiguille à sutures	.CG-06
KELLY	
ciseaux gynécologiques	.AH-22, AI-33
écarteur	.BI-04, BI-12
KELLY Grip écarteur	.BI-04
KELLY	
pince à polypes utérins	.HA-36
pince hémostatique	.BC-05
proctoscope	.GI-04
KELLY-RANKIN pince hémostatique	.BC-05
KELLY TITAN pince hémostatique	.BC-05
Kératome	
BERENS	.EC-04
CASTROVIEJO	.EC-04
JAEGER	.EC-04
KERN davier porte-os	.DC-08
KERRISON pince coupante nasale	.EG-08
KEVORKIAN	
curette aspirante pour biopsie de l'utérus	.HA-40
KEVORKIAN-Pacific pince emporte-pièce pour le col de l'utérus	.HA-44
KEVORKIAN	
pince emporte-pièce pour le col de l'utérus	.HA-43, HA-46
KEY élévateur	.DC-21
KEYES trépan cutané	.HE-02
KIELLAND forceps obstétrique	.HC-02
KIELLAND-LUIKART forceps obstétrique	.HC-03
KILLIAN-CLAUS gouge nasale	.EG-14
KILLIAN	
Élévateur pour la cloison nasale	.EG-12
sonde	.EG-09
spéculum pour cloison nasale	.EG-03
KILNER	
ciseaux	.AH-14, AI-17
crochet à peau	.HE-02
KILNER-DOUGHTY ouvre-bouche	.EI-05
KIRBY-ARTHUR pince à iris	.EC-13
KIRK maillets	.DC-18
KIRSCHNER	
broche	.DD-09
cadre	.BI-23
écarteur abdominal	.BI-23
étrier à extension	.DD-10
perforateur à main	.DD-05
sonde conductrice	.CG-04
valve	.BI-23
Kistitome	
BECKER	.EC-06
GRAEFE	.EC-06
KLINKENBERGH-LOTH ciseaux thoraciques	.AI-37
KNAPP	
ciseaux	.AI-20
couteau à iridectomie	.EC-04
curette à cataracte	.EC-07
écarteur	.EC-06
KNAPP-LUER pince trachome	.ED-06
KNIGHT pince coupante nasale	.EG-05
KNOWLES ciseaux à bandages	.AI-47
KNUTSON Instrument pour l'urétrographie	.GG-09
KNUTSON-KOCH cône pour l'urétrographie	.GG-09

KOCHER	
écarteur	.BI-10 jusque BI-11
pince intestinale	.GE-04
pince hémostatique délicate	.FE-06
spatule à goitre	.FE-04
spatule vésicale	.GG-04
KOENIG	
aiguille à sutures	.CG-06
sonde conductrice	.CG-04
KOERTE écarteur	.BI-11
KOGAN endospéculum	.HA-23
KONRICH tambours à stérilisation	.HE-12
KRAUSE	
pince laryngienne	.FC-03
serre-noeud auriculaire	.EE-07
serre-noeud nasal	.EG-09
KRISTELLER	
spéculum vaginal	.HA-09 jusque HA-14
valve vaginale	.HA-09 jusque HA-14
KRONECKER aiguille à ligatures	.CG-02
KUENTSCHER	
alésoir	.DD-13
extracteur	.DD-13
impacteur	.DD-13
KUHNT rugine cornéenne	.EC-05
L	
LABORDE dilateur trachéal	.FE-02
LAFORCE	
adénotome	.EG-19
instrument pour corps étrangers	.EC-06
LAGRANGE ciseaux à gencives	.AI-41
LAHEY	
écarteur	.BI-08
pince à saisir le goitre	.FE-04
pince pour voies biliaires	.BC-14
LAMBERT KAY	
pince atraumatique pour l'anastomoses d'aorte	.BD-10
pince atraumatique iliaque	.BD-11
LAMBERT pince à chalazion	.ED-06
LAMBOTTE	
davier porte-os	.DC-08
LAMBOTTE mini ostéotome	.DC-15
LAMBOTTE	
ostéotome	.DC-15
rugine raspatoire	.DC-19
Lame	
CHARRIERE	.DD-03
Lame dermatome de rechange	.AG-21
Lame	
HUMBY dermatome de rechange	.AG-20
Lame rasoir	.AG-19
Lame scie pour plâtre	.DA-05 jusque DA-06
Lame de bistouris, stérile	.AG-06, AG-09
Lame de bistouris stérile, micro	.AG-13
Lame pour rasoir	.AG-14
Lampe frontale CLAR	.AC-05
LANCASTER blépharostat	.EC-03
Lance-poudre KABIERSKE	.EE-04
Lancette électrode	.JA-03
LANDAU spéculum vaginal	.HA-22
LANDOLT	
ciseaux à énucléation	.AI-25
manche de bistouris, micro	.AG-13
LANE	
davier porte-os	.DC-08
pince à champs	.BE-05
pince à dissection	.BA-04
pince pour saisir les attelles	.DD-14
pince pour saisir les vis	.DD-14
pince clamp stomacale	.GE-08
tourne-vis	.DD-14
LANG curette	.EC-08
LANGÉ	
ciseaux à bandages	.AI-44
LANGENBECK	
couteau à resection	.AG-17
davier porte-os	.DC-07
doigtier	.EI-06
écarteur	.BI-09
élévateur	.DC-21
rugine raspatoire	.DC-19
scie à doigts	.DD-03
LANGÉ	
pince laryngienne	.FC-03
Laryngoscope set	
MACINTOSH fibres optiques	.AE-12 jusque AE-13
MACINTOSH standard	.AE-18 jusque AE-19
MILLER fibres optiques	.AE-12 jusque AE-13
MILLER standard	.AE-18 jusque AE-19
Laryngoscope spatule	
MACINTOSH fibres optiques	.AE-10
MACINTOSH standard	.AE-15
MILLER fibres optiques	.AE-10
MILLER standard	.AE-16
Lavier MURLESS à tête	.HC-05
LAWRENCE pince à dissection et à ligature	.BC-13
LEBSCHÉ ciseaux sternaux	.DC-17
LEES pince atraumatique pour les bronches	.BD-03
LEGUEU	
écarteur vésical	.GG-06
spatule vésicale	.GG-04
LEKSELL STILLE pince gouge	.DC-05
LELAND JONES pince atraumatique vasculaire périphérique BD-09	.BD-08 jusque BD-09
LEMPERT	
curette	.DC-13
élévateur	.EE-15
pince gouge	.DC-03
LERCHE pince à dissection	.BA-04
LERICHE pince hémostatique	.BC-09
LESTER pince à fixation	.ED-03
Levier	
à os	.DC-23
BENNETT à os	.DC-22
BLOUNT à os	.DC-24
BUCK pour corps étrangers	.EE-08
HOHMANN à os	.DC-22 jusque DC-23
HOHMANN mini à os	.DC-23
QUIRE pour corps étrangers	.EE-08
SELLHEIM pour abaissement de la tête	.HC-09
LEVINSON aiguille pour corps étrangers	.EC-05
LEWIN davier porte-os	.DC-10
LEWKOWITZ pince placentaire et pour post-abortum	.HC-07
LEXER-BABY	
ciseaux	.AH-10
ciseaux à dissection	.AI-12
LEXER	
ciseau-burin	.DC-16
ciseaux	.AH-09
ciseaux à dissection	.AI-11
LEXER-FINO ciseaux à dissection	.AI-12
LEXER	
gouge	.DC-16
LEXER mini	
ciseau-burin	.DC-16
gouge	.DC-16
LEYLA système de fixation	.EA-14 jusque EA-18
LICHTWITZ	
aiguille	.EG-09
trocart	.CC-02

- LIDDLE pince atraumatique pour l'aorteBD-10
Lien PARHAMDC-11
Lime
à onglesHE-03
JOSEPH à osEG-14
LISTER-BURCH blépharostatEC-02
LISTER
ciseaux à bandagesAH-23, AI-45
pince porte-éponges, sinusBG-11
LISTON
couteaux à amputationAG-16
pince coupante à osDC-06
LITTAUER
ciseaux à ligaturesAI-40
pince auriculaireEE-08
pince à épilerED-08
pince nasale à polypesEG-05
LITTLE écarteurBI-08
LITTLER ciseaux à dissectionAI-13
LOCKLIN ciseauxAI-18
LORENZ ciseaux à bandagesAI-47
LORNA pince à champsBE-04
LOUTE tendeur serre-filDD-11
LOVE
écarteur à nerfsEA-04
écarteur ovulaireFA-02
LOVE-GRUENWALD pince emporte-pièce pour laminectomieEA-08
LOVELACE
pince pulmonaireFG-19
pince hémostatiqueBC-07
LOWER pince pour voies biliairesBC-14
LOWMAN davier à osDC-11
LUBET-BARBON pince nasale à polypesEG-05
LUCAE
diapasonEE-04
mailletDC-18
pince auriculaireEE-07
LUC pince coupante nasaleEG-06
LUER
canule trachéaleFE-03
LUER-KOERTE curette pour calculs biliairesGC-09
LUER
pince gougeDC-03
LUIKART-BILL tracteur pour manches ordinairesHC-05
LUIKART forceps obstétriqueHC-03
LUNDGAARD sclérotomeEC-05
LUNIATSCHEK obturateur à gazeFA-02
LURZ pince urétraleGC-10
- M**
- MACINTOSH
laryngoscope set fibres optiquesAE-12 jusque AE-13
laryngoscope set standardAE-18 jusque AE-19
laryngoscope spatules fibres optiquesAE-10
laryngoscope spatules standardAE-15
MAGILL
doigtAE-04
pince pour introduire les sondesAE-06
tube d'aspirationAE-04
MAIER pince à pansementsBG-12
MailletsDC-18
COLLINDC-18
GERZOGDC-18
KIRKDC-18
LUCAEDC-18
MEADDC-18
QUISLINGDC-18
WILLIGERDC-18
Main en plombDC-11
MALTZ
bistouri à cartilage coudeEG-11
MALTZ (COTTLE) rape nasaleEG-15
MALTZ
rape nasaleEG-14
Manche
BROCK dilateur pour valve mitraleFG-26
CASPAR de bistouris, microAG-12
COLLIN de bistourisAG-08
Manche de bistouris AG-02 jusque AG-05, AG-07 jusque AG-08
Manche de bistouris, microAG-12
Manche
GIGLI pour scieEA-05
HUBER universelFC-03
LANDOLT de bistouris, microAG-13
miroirs laryngiensFC-04
Manomètre pour salpingographeHA-47
Marqueur
CASTROVIEJO compassEC-09
CONNIN-AMSLEREC-09
MARSCHIK pince à amygdalesFA-04
Marteau à fenteDD-13
Marteau
BABINSKY percuteurAC-07
BERLINER percuteurAC-07
BUCK percuteurAC-07
DEJERINE percuteurAC-07
TAYLOR percuteurAC-07
TRAUBE percuteurAC-07
TROEMNER percuteurAC-07
MARTEL pince pour cuir cheveluBC-08
MARTIN
compas pelvimètreHC-06
cordon électrobistourisJA-07
hystéromètreHA-39
MARTINI curetteDC-13
MARTIN
pince à pansementsBG-02, BG-14
pince à sequestresDC-10
MASSON porte-aiguilleCE-03
MASTIN pince musculaireFE-04
MATHIEU
écarteurBI-03
pince pour corps étrangersGG-07
porte-aiguilleCE-05
spéculum rectalGI-02
MATSON rugine raspatoireDC-21
MAUNDER baillon boisEI-06
MAYO BLAKE pince pour calculs biliairesGC-04
MAYO
ciseauxAH-06, AI-07
ciseaux pour main gaucheAI-07
curette pour calculs biliairesGC-07
épingle de sécuritéCI-02
MAYO-GUYON pince pédicule rénalBC-16
MAYO-HEGAR porte-aiguilleCE-02
MAYO-NOBLE ciseauxAH-08, AI-10
MAY ophtalmoscopeAC-03
MAYO-ROBSON pince intestinaleGE-05
MAYO
sonde pour les calculs du bassinGC-10
MAYO-STILLE ciseauxAH-07, AI-08 jusque AI-09
McCLINTOCK pince placentaire et pour post-abortionumHC-07
McCULLOUGH pince à strabismeEC-13
McDONALD élévateurDC-22
McGEE pince auriculaire microEE-10
McGUIRE ciseaux cornéensAJ-05
McINDOE
ciseaux à cartilageAI-35
pince à dissectionBA-04
McIVOR
abaisse-langueEI-05

ouvre-bouche	.EI-05
McKENZY élévateur pour la cloison nasale	.EG-11
McKENZIE	
perforateur plat	.DD-04
pince pour poser clips	.EA-02
McLEAN forceps obstétrique	.HC-04
McLEAN-LUIKART forceps obstétrique	.HC-03
McLEAN-TUCKER-LUIKART forceps obstétrique	.HC-03
McPHERSON pince à ligatures	.ED-05
McPHERSON TITAN pince à ligatures	.ED-05
McPHERSON WESTCOTT ciseaux à ténotomie	.AJ-04
MEAD	
maillet	.DC-18
pince gouge	.DC-02
Mèche	.DD-04
MEEKER pince à dissection et à ligature	.BC-13
MELLINGER-AXENFELD blépharostat	.EC-02
MELLINGER blépharostat	.EC-02
MENGHINI trocart	.CC-03
Méniscotome	
BIRCHER	.DC-24
NEFF	.DC-24
SMILLIE	.DC-24
MERCEDES écarteur thoracique	.FG-16
Mesure graduée	.HE-07
METZENBAUM	
ciseaux	.AH-11
ciseaux à dissection	.AI-13 jusque AI-14
METZENBAUM FINO	
ciseaux	.AH-12
ciseaux à dissection	.AI-15
METZENBAUM	
porte-aiguille	.CE-04
METZENBAUM "S" ciseaux	.AH-13, AI-16
MEYERDING écarteur	.BI-08
MEYHOEFER curette à chalazion	.EC-07
MICHEL	
agrafes	.CG-07
miroir	.EG-04
pince pour agrafes	.CG-07
MIDDELDORPF écarteur	.BI-10
MIDDLETON-JANSEN pince coupante nasale	.EG-09
MIKULICZ	
écarteur	.BI-12
pince à péritoine	.BC-17
MILLER	
laryngoscope set fibres optiques	.AE-12 jusque AE-13
laryngoscope set standard	.AE-18 jusque AE-19
laryngoscope spatules fibres optiques	.AE-10
laryngoscope spatules standard	.AE-16
MILLIGAN dissecteur duremère	.EA-05
MILLIN	
écarteur pour le col de la vessie	.GG-07
écarteur vésical	.GG-05
pince porte-fil	.GG-03
pince capsulaire	.GG-03
pince pour saisir lombeaux	.GG-03
support lumière froide	.GG-05
MILLS ciseaux vasculaires	.AI-27
Mini CLAR	.AC-05
Miroir frontal ZIEGLER	.AC-05
Miroir	
laryngien	.FC-04
MICHEL	.EG-04
MIXTER BABY pince hémostatique p. les bronches	BC-13
MIXTER O'SHAUGNESSY pince hémostatique	.BC-14
MIXTER	
pince pour calculs biliaires	.GC-04
pincettes hémostatique	.BC-14
pince hémostatique pour les bronches	.BC-13
pince pour voies biliaires	.BC-15

MOELTGEN goniomètre	.AC-08
MOGAN Instrument de circoncision	.GG-09
MOLLISON écarteur	.BI-17
Monde mesurer	.EE-15
MOORE	
curette pour calculs biliaires	.GC-05
perforateur à main	.DD-04
MOORFIELD pince à suture	.ED-05
MORSE-FAVOLORO écarteur pour les côtes	.FG-17
MOYNIHAN	
pince à champs	.BE-05
pince pour voies biliaires	.BC-15
sonde pour calculs biliaires	.GC-05
MUCK couteau périoste	.EE-15
MUELLER blépharostat	.EC-03
MURDOCK blépharostat	.EC-02
MURLESS lavier à tête	.HC-05
MURPHY-LANE élévateur	.DC-22
MURPHY pince serre-tubes	.BC-19
MUSEUX pince pour abaissement du col de l'utérus	.HA-33
MYLES pince coupante nasale	.EG-07

N

NABATOFF sonde auriculaire en argent	.CA-02
NAEGELE forceps obstétrique	.HC-03
NÄGELE perce crâne	.HC-09
NAGER écarteur pour le palais	.FA-02
NEFF méniscotome	.DC-24
NEGUS pince à amygdales	.FA-03
NEIVERT porte-aiguille	.CE-02
NELSON	
aiguille à ligatures	.CG-02
pince à dissection	.BA-05
trocart	.CC-02
NEUBÜSER pince à saisir les trompes	.HA-51
NORTHBENT ciseaux à ligatures	.AI-40
NOTO pince à polypes utérins	.HA-36
NOVAK curette aspirante pour biopsie de l'utérus	.HA-40
NOYES	
ciseaux à iris	.AJ-03 jusque AJ-04
ciseaux à tendons	.AJ-03
pince nasale à polypes	.EG-05
NUBOER tube d'aspiration	.AE-05

O

Obturbateur à gaze LUNIATSCHEK	.FA-02
OCHSNER	
pince atraumatique pour l'aorte	.BD-31
trocart	.CC-02
O'CONNOR crochet à iris	.EC-06
OLDBERG pince emporte-pièce pour laminectomie	.EA-09
OLIVECRONA	
pince gouge	.DC-03
scie	.EA-05
spatule cérébrale	.EA-07
OLIVECRONA-TOENNIS pince à poser clips	.EA-02
OLLIER écarteur	.BI-10
OLSEN-HEGAR porte-aiguille	.CE-05
Ophthalmoscope	
MAY	.AC-03
VARIFOCAL	.AC-03
Ostéotome	.DC-14
HIBBS	.DC-16
LAMBOTTE	.DC-15
LAMBOTTE mini	.DC-15
STILLE	.DC-14
O'SULLIVAN-O'CONNOR	
écarteur abdominal	.BI-21
spéculum vaginal	.HA-08

- OTIS
 couteau de rechange .GG-08
 uréthrotome .GG-08
 Otoscope .AC-04
 Ouverture BROCK dilateur pour valve mitrale .FG-26
 Ouvre-bouche
 DAVIS-BOYLE .EI-04
 DENHART .EI-03
 DOYEN-JANSEN .EI-03
 HEISTER .EI-03
 JENNINGS .EI-04
 KILNER-DOUGHTY .EI-05
 McIVOR .EI-05
 ROSER-KOENIG .EI-03
 SEEMANN-SEIFFERT .EI-04
 WHITEHEAD .EI-04
 OVERHOLT-GEISSENDOERFER pince à dissection et à ligature
 BC-10
 OVERHOLT rugine raspatoire .DC-21
- P**
 PARHAM lien .DC-11
 PARK blépharostat .EC-03
 PARKER
 bistouri à dissection .AG-15
 écarteur .BI-02
 PARTSCH
 ciseaux-burin .DC-14
 gouge .DC-14
 PASSOW hémostat .EE-15
 PATON dissecteur cornéen .EC-05
 PAUFIQUE
 couteau pour la kératoplastie .EC-05
 pince à ligatures .ED-05
 PAUFIQUE TITAN pince à ligatures .ED-05
 PAYR-Baby pince clamp stomacale .GE-09
 PAYR
 pince clamp stomacale .GE-09
 sonde conductrice .CG-04
 PEAN
 pince atraumatique .BD-02
 pince hémostatique .BC-08
 pince hémostatique délicate .BC-06
 PEDERSON spéculum vaginal .HA-03
 PEERS BERTRAM pince à champs .BE-03
 PEET pince à échardes .BA-06
 PELKMANN pince à pansements .BG-12
 PENFIELD dissecteur duremère .EA-06
 PENNINGTON pince hémostatique .BC-07
 Perce-crâne
 NÄGELE .HC-09
 SMELLIE .HC-09
 PERCY retracteur à amputation .DD-03
 Perforateur
 à main .DD-05
 à mandrin Jacobs .DD-06
 BUNNELL à main .DD-05
 CUSHING plat .DD-04
 HUDSON à main .DD-04
 KIRSCHNER à main .DD-05
 McKENZIE plat .DD-04
 MOORE à main .DD-04
 RALK à main .DD-05
 STILLE à main .DD-04
 STILLE-SHERMAN à main .DD-04
 PERTHES pointes-carrées .DD-08
 PESTALOZZA curette placentaire et pour post-abortum .HC-08
 PETRI boîte .HE-08
 PETZ appareil à sutures stomacales et intestinales .GE-09
 PHANEUF pince à péritoine .BC-17
- Pick .EE-15
 BARBARA .EE-14 jusque EE-15
 PIERCE trocart .CC-02
 Pierre ARKANSAS à repasser .AG-19
 PIFFARD curette à lupus .HE-02
 PINARD stéthoscope .AC-06
 Pince à champs modèle gracille .BE-02
 Pince
 à couper et à plier le fil .DD-11
 Pince à dissection .BA-02
 Pince
 ADLERKREUTZ à dissection .BA-04
 ADSON à dissection .BA-03
 ADSON à dissection, micro .BA-03
 ADSON à hypophyse .EA-06
 ADSON-BROWN à dissection .BA-03
 ADSON gouge .DC-03
 Pince à échardes .BA-06
 Pince
 à envies .HE-03
 ALEXANDER emporte-pièce pour le col de l'utérus .HA-42
 ALLIS-ADAIR à saisir les tissus .GE-02
 ALLIS à saisir les tissus .GE-02
 ALLIS-Baby à saisir les tissus .GE-02
 à ongles .HE-03
 ARCHER à échardes .BA-06
 ARRUGA capsulaire .ED-04
 ASCH pour redresser cloison .EG-18
 Pince à sequestres .DC-10
 Pince à stérilisation .CI-02
 Pince
 auriculaire micro .EE-09 jusque EE-10, EE-12
 auriculaire micro mini .EE-13
 AYER à chalazion .ED-06
 BABCOCK pour saisir les tissus .GE-02
 BACKHAUS à champs .BE-02
 BACKHAUS-CLIP à champs clamp porte-tube .BE-03
 BACKHAUS KOCHER à champs .BE-02
 BAGGISH emporte-pièce pour le col de l'utérus .HA-45
 BALL AND SOCKET à champs .BE-04
 BALLENGER à préhension amygdalienne .FA-04
 BARRAQ.KATZIN à iris .EC-13
 BARRAQU Colibri à iris .EC-13
 BARRAQUER chambre antérieure .ED-02
 BARRAQUER à épiler .ED-08
 BARRAQUER à fixation .ED-03
 BARRETT pour abaissement du col de l'utérus .HA-32
 BEER à épiler .ED-08
 BERGMANN FOERSTER porte-éponges .BG-10
 BERKE musculaire .ED-02
 BERNHARD à champs .BE-05
 BEST intestinale .GE-06
 BEYER coupante nasale .EG-08
 BEYER gouge .DC-04
 BISHOP-HARMAN à iris .EC-14
 BLAKE pour calculs biliaires .GC-03
 BLOHMKE à préhension amygdalienne .FA-04
 BLUMENTHAL gouge .DC-02
 BÖHLER coupante à os .DC-06
 BÖHLER gouge .DC-04
 BONACCOLTO à strabisme .EC-14
 Bonn à iris .EC-15
 BONNEY porte-éponges .BG-08
 Bonn TITAN à iris .EC-15
 BOZEMANN à pansements .BG-13
 BOZEMANN-DOUGLAS à pansements .BG-13
 BRAIN MINI de pose clip .EA-12
 BRAIN STANDARD de pose clip .EA-12
 BRAUN pour abaissement du col de l'utérus .HA-31, HA-34
 BROWN à dissection .BA-03
 BRUENINGS coupante nasale .EG-05

BRUENINGS laryngienne	.FC-03
BRUNNER intestinale	.GE-06
BRYANT porte-éponges	.BG-11
BUMM hystérolabe	.HA-38
BURKE emporte-pièce pour le col de l'utérus	.HA-44
BURKE-Baby emporte-pièce pour le col de l'utérus	.HA-44
CARMALT à échardes	.BA-06
CASTROVIEJO capsulaire	.ED-04
CASTROVIEJO fixation	.ED-03
CASTROVIEJO suture	.ED-05
CHEATLE à stérilisation	.CI-02
CHERON à pansements	.BG-12
CHEVALIER-JACKSON laryngienne	.FC-04
CHILDE pour agrafes	.CG-07
CITELLI coupante nasale	.EG-08
Pince-clamp GREEN-ARMYTAGE utérine pour hémostase	HC-06
Pince	
CLEVELAND gouge	.DC-02
coagulation bipolaire	.JA-04 jusque JA-06
COLCLOUGH emporte-pièce pour lames intervertébrales	EA-11
COLLIN à pansements	.BG-11
COLLIN-DUVAL à dissection	.BA-04
COLLIN hystérolabe	.HA-37
COLLIN pour agrafes	.CG-07
COLLIN-POZZI pour abaissement du col de l'utérus	.HA-32
COLLIN tire-langue	.EI-03
COLVER à préhension amygdalienne	.FA-03
CORDES laryngienne	.FC-03
COTTLE-KAZANJIAN coupante à os	.DC-06
coupe-fil	.DD-12
CUSHING à dissection	.BA-03
CUSHING emporte-pièce pour laminectomie	.EA-08
CZERNY pour abaissement du col de l'utérus	.HA-34
CZERNY pour calculs biliaires	.GC-03
DARTIGUES hystérolabe	.HA-37
DASTOOR à strabisme	.EC-14
DAVIS à stérilisation	.CI-02
DeMARTEL-WOLFSON pour anastomose	.GE-07
DESJARDINS pour calculs biliaires	.GC-02
DESJARDINS pour voies biliaires	.BC-15
DESMARRES à chalazion	.ED-06
DeVILBISS crânienne	.EA-05
Pince d'horloger	.BA-06
Pince	
DIAMANT coupe-fil	.DD-12
DIETER pour la tête du marteau	.EE-10
DIMEDA pour déchets	.CI-03
DOUGLAS à épiler	.ED-08
DOYEN à champs	.BE-05
DOYEN à polypes utérins	.HA-36
DOYEN-Baby intestinale	.GE-03
DOYEN intestinale	.GE-03
DUPLAY à pansements	.BG-14
DUPLAY pour abaissement du col de l'utérus	.HA-31
DUVAL à dissection	.BA-04
DUVAL à saisir les tissus	.GE-03
ECHLIN gouge	.DC-05
EDWARDS pour poser clips	.BD-21
ELSAESSER à néphrostomie	.GC-13
ELSCHNIG capsulaire	.ED-04
ELSCHNIG à fixation	.ED-03
épiler	.ED-08
EPPENDORFER emporte-pièce pour le col de l'utérus	HA-45 jusque HA-46
EPPENDORFER-KEVORKIAN emporte-pièce pour le col de l'utérus	.HA-46
EPPENDORFER TISCHLER-MORGAN emporte-pièce pour le col de l'utérus	.HA-46
FAURE emporte-pièce pour le col de l'utérus	.HA-41
FAURE à péritoine	.BC-17
FEHLAND intestinale	.GE-06
FEILCHENFELD à échardes	.BA-06
FERRIS à dissection	.BA-04
FERRIS-SMITH emporte-pièce pour laminectomie	.EA-09
FERRIS-SMITH-KERRISON emporte-pièce pour lames intervertébrales	.EA-10
FINOCHIETTO pour les bronches	.FG-21
FISCHER à iris	.EC-13
FLETCHER JAVERTS porte-éponges	.BG-10
FOERSTER à iris	.EC-12
FOERSTER porte-éponges	.BG-06 jusque BG-08
FRAENKEL à polypes laryngiens	.FC-02
FRAENKEL laryngienne	.FC-03
FRIEDMAN gouge	.DC-02
FRIEDMAN gouge, mini	.DC-02
FRYKHOLM gouge	.DC-05
FUCHS capsulaire	.ED-04
GAUSS péri crânienne	.HC-06
GELLHORN emporte-pièce pour le col de l'utérus	.HA-42
GEMINI à dissection et à ligature	.BC-10
GEMINI MINI à dissection et à ligature	.BC-10
GERALD à dissection	.BA-05
GILL à iris	.EC-12
GILL-ARRUGA capsulaire	.ED-03
GILL-HESS à iris	.EC-12
GILLIES à dissection	.BA-05
GRADLE à épiler	.ED-08
GRAEFE à dissection	.BA-03
GRAEFE à iris	.EC-11
GRAEFE à fixation	.ED-03
GRAY pour les voies biliaires	.BC-15
GREEN à fixation	.ED-03
GREVEN auriculaire micro	.EE-10
GRIP à saisir	.DD-11
GROSS à pansements	.BG-05
GROSS-MAIER à pansements	.BG-02 jusque BG-04
GUYON pédicule rénal	.BC-16
HAJEK-CLAUS coupante nasale	.EG-08
HAJEK-KOFLER coupante nasale	.EG-08
HARRINGTON pour les bronches	.FG-21
HARTMANN auriculaire	.EE-08
HARTMANN coupante nasale	.EG-07
HARTMANN-HOFFMANN auriculaire	.EE-08
HARTMANN à polypes nasaux	.EG-04
HARTMANN-WULLSTEIN auriculaire	.EE-08
HEANEY pour l'hystérectomie	.BC-18
HEGENBARTH pour agrafes	.CG-07
HEIMING pour les calculs du bassin	.GC-13
HENROTIN pour abaissement du col de l'utérus	.HA-34
HERRICK à péritoine	.BC-17
HESS à iris	.EC-12
HESS capsulaire	.ED-04
HEYMANN coupante nasale	.EG-05
HEYMANN-KNIGHT à polypes nasaux	.EG-05
HEYWOOD-SMITH pour hémorroïdes	.GI-05
HOFF à champs	.BE-03
HOLTH capsulaire	.EC-09
HUNTER à échardes	.BA-06
IOWA pour abaissement du col de l'utérus	.HA-35
JACKSON porte-tampons	.FC-02
JACOBS pour abaissement du col de l'utérus	.HA-34
JAMESON à strabisme	.EC-13
JANSEN nasale	.EG-04
JARCHO pour abaissement du col de l'utérus	.HA-32
JATHO nasopharyngienne	.EG-18
JOHNS-HOPKINS pour voies biliaires	.BC-14
JONES à champs clamp porte-tube	.BE-02
JUDD-ALLIS pour saisir les tissus	.GE-02
JURASZ à polypes laryngiens	.FC-02
KALT capsulaire	.ED-04
KELLY à polypes utérins	.HA-36
KERRISON coupante nasale	.EG-08

KEVORKIAN emporte-pièce pour le col de l'utérus	HA-43, HA-46	MYLES coupante nasale	EG-07
KEVORKIAN-Pacific emporte-pièce pour le col de l'utérusHA-44		NEGUS à amygdales	FA-03
KIRBY-ARTHUR à iris	EC-13	NELSON à dissection	BA-05
KNAPP-LUER trachome	ED-06	NEUBÜSER pour saisir les trompes	HA-51
KNIGHT coupante nasale	EG-05	NOTO à polypes utérins	HA-36
KOCHER intestinale	GE-04	NOYES à polypes nasaux	EG-05
KRAUSE laryngienne	FC-03	OLDBERG emporte-pièce pour laminectomie	EA-09
LAHEY pour saisir le goitre	FE-04	OLIVECRONA gouge	DC-03
LAHEY pour les voies biliaires	BC-14	OLIVECRONA-TOENNIS pour poser clips	EA-02
LAMBERT à chalazion	ED-06	OVERHOLT-GEISSENDOERFER à dissection et à ligatureBC-10	
LANE à champs	BE-05	PAUFIQUE à ligatures	ED-05
LANE à dissection	BA-04	PAUFIQUE TITAN à ligatures	ED-05
LANE pour saisir les attelles	DD-14	PAYR-Baby clamp stomacale	GE-09
LANE pour saisir les vis	DD-14	PAYR clamp stomacale	GE-09
LANE clamp stomacale	GE-08	PEERS BERTRAM à champs	BE-03
LANGE laryngienne	FC-03	PEET à échardes	BA-06
LAWRENCE à dissection et à ligature	BC-13	PELKMANN à pansements	BG-12
LEKSELL STILLE gouge	DC-05	PHANEUF à péritoine	BC-17
LEMPERT gouge	DC-03	plate	DD-11
LERCHE à dissection	BA-04	POTTS-SMITH à dissection	BA-02
LESTER à fixation	ED-03	pour fixer	GG-10
LEWKOWITZ placentaire et pour post-abortum	HC-07	pour fixer le cordon	GG-10
LISTER porte-éponges, sinus	BG-11	POZZI pour l'abaissement du col de l'utérus	HA-31
LISTON coupante à os	DC-06	PRATT pour l'abaissement du col de l'utérus.....HA-34	
LITTAUER auriculaire	EE-08	jusque HA-35	
LITTAUER à épiler	ED-08	PRESBYTERIAN HOSPITAL serre-tubes	BC-19
LITTAUER à polypes nasaux	EG-05	PRICE-THOMAS pour les bronches	FG-22
LORNA à champs	BE-04	PRINCE musculaire	ED-02
LOVE-GRUENWALD emporte-pièce p. laminectomie .EA-08		RADOLF pour extraire les ongles	DD-03
LOVELACE pulmonaire	FG-19	RAMPLEY porte-éponges	BG-09
LOWER pour les voies biliaires	BC-14	RANDALL pour les calculs du bassin GC-11 jusque GC-12	
LUBET-BARBON à polypes nasaux	EG-05	RANEY pour poser et enlever	EA-03
LUCAE auriculaire	EE-07	RICHTER-HEATH pour agrafes	CG-07
LUC coupante nasale	EG-06	ROEDER à champs	BE-03
LUER gouge	DC-03	ROGGE à stérilisation	CI-02
LURZ urètre	GC-10	ROSENBERG laryngienne	FC-03
MAIER à pansements	BG-12	ROWE pour la bouche	EI-06
MARSCHIK à amygdales	FA-04	RUBIN pour écraser la cloison	EG-07
MARTEL pour cuir chevelu	BC-08	RUMEL thoracique	BC-11
MARTIN à pansements	BG-02, BG-14	RUSKIN gouge	DC-04
MARTIN à sequestres	DC-10	RUSKIN-LISTON coupante à os	DC-06
MASTIN musculaire	FE-04	RUSSIAN à dissection	BA-04
MATHIEU pour corps étrangers	GG-07	Pince	
MAYO BLAKE pour calculs biliaires	GC-04	ADSON BABY hémostatique	BC-09
MAYO-GUYON pédicule rénal	BC-16	ADSON hémostatique	BC-09
MAYO-ROBSON intestinale	GE-05	Pince	
McCLINTOCK placentaire et pour post-abortum	HC-07	SAENGER placentaire et pour post-abortum	HC-07
McCULLOUGH à strabisme	EC-13	SAIRGES pour l'abaissement du col de l'utérus	HA-32
McGEE auriculaire micro	EE-10	SAROT pour les bronches	FG-23
McINDOE à dissection	BA-04	SATINSKY pour anastomose(veina cava).....FG-24	
McKENZIE à poser clips	EA-02	jusque FG-25	
McPHERSON à ligatures	ED-05	Pince atraumatique pédiatrique vasculaire	BD-43
McPHERSON TITAN à ligatures	ED-05	Pince	
MEAD gouge	DC-02	SAUERBRUCH gouge	DC-05
MEEKER à dissection et à ligature	BC-13	SAUERBRUCH pour déchets	CI-03
MICHEL pour agrafes	CG-07	SAWTELL à amygdales	FA-03
Pince micro	BB-02	Pince	
Pince		BAINBRIDGE atraumatique	BD-09
MIDDLETON-JANSEN coupante nasale	EG-09	BAINBRIDGE hémostatique	BC-14
MIKULICZ à péritoine	BC-17	BECK atraumatique vasculaire périph	BD-25
MILLIN porte-fil	GG-03	BENGOLEA hémostatique	BC-09
MILLIN capsulaire	GG-03	Pince	
MILLIN pour saisir lombeaux	GG-03	SCAGLIETTI gouge	DC-05
MIXTER pour calculs biliaires	GC-04	Pince	
MIXTER pour voies biliaires	BC-15	CASTANEDA atraumatique pour nouveaux-nés et enfantsBD-42	
MOORFIELD suture	ED-05	CHAPUT hémostatique	BC-08
MOYNIHAN à champs	BE-05	Pince	
MOYNIHAN pour voies biliaires	BC-15	SCHNEIMANN laryngienne	FC-03
MURPHY serre-tubes	BC-19	SCHNIDT à amygdales	FA-03
MUSEUX pour abaissement du col de l'utérus	HA-33	SCHOENBURG à saisir les tissus	GE-03

- SCHROEDER pour abaissement du col de l'utérus HA-31 jusque HA-32
- SCHUBERT emporte-pièce pour le col de l'utérus ... HA-41
- SCHUMACHER emporte-pièce p. le col de l'utérus ... HA-43
- SCHUMACHER laryngienne FC-03
- SCHWEIGGER capsulaire ED-04
- Pince
- COLLIN hémostatique BC-08
- COOLEY atraumatique BB-03, BD-35 jusque BD-37, BD-39, BD-41
- COOLEY atraumatique pour anastomose ... BD-37, BD-40
- COOLEY atraumatique iliaque BD-37
- COOLEY atraumatique pédiatrique ... BD-38 jusque BD-39
- COOLEY DERRA atraumatique p. anastomose ... BD-39
- COOLEY vasculaire BD-40
- CRAFOORD hémostatique pour bronches BC-12
- CRILE hémostatique BC-05
- CRILE-RANKIN hémostatique BC-05
- CRILE TITAN hémostatique BC-05
- DALE atraumatique vasculaire périph ... BD-24
- DANDY hémostatique BC-07
- DARDIK atraumatique BD-07
- DE BAKEY atraumatique BB-03
- DEBAKEY atraumatique BD-02, BD-08, BD-12
- DE BAKEY atraumatique BD-16 jusque BD-17
- DEBAKEY atraumatique BD-20
- DE BAKEY atraumatique BD-28 jusque BD-30
- DE BAKEY atraumatique à dissection et à ligature BD-25, BD-32
- DE BAKEY atraumatique pour l'anastomose BD-25
- DE BAKEY atraumatique pour aneurisme d'aorte BD-13, BD-15, BD-18
- DE BAKEY atraumatique pour les bronches BD-19
- DE BAKEY atraumatique iliaque BD-11
- DE BAKEY atraumatique vasculaire périph ... BD-06
- DEBAKEY BAHNSON atraumatique pour l'anéurisme d'aorte BD-14
- DE BAKEY MORRIS atraumatique BD-16
- DE BAKEY REYNOLDS atraumatique p. anastomose BD-30
- DEBAKEY SATINSKY atraumatique BD-22
- DERRA atraumatique pour anastomose et pédiatrie BD-28
- DIETHRICH atraumatique BD-31
- Pince
- SEIFFERT laryngienne FC-03
- SEMB pour les bronches FG-23
- SEMB coupante à os DC-07
- SEMB gouge DC-06
- SEMKEN à dissection BA-05
- Pince serre-tubes BC-19
- Pince
- FERGUSON hémostatique BC-07
- GLOVER atraumatique BD-06, BD-30
- GLOVER atraumatique à coarctacion BD-04
- GLOVER atraumatique pour anastomose BD-05
- GREGORY atraumatique pour profunda BD-33
- HALSTED-MOSQUITO atraumatique BD-02
- HALSTED-MOSQUITO hémostatique BC-04
- HALSTED-MOSQUITO micro hémostatique BC-04
- HALSTED-MOSQUITO TITAN hémostatique BC-04
- HARKEN atraumatique auriculaire BD-23
- HARTMANN hémostatique BC-03
- HEISS hémostatique BC-09
- Pince
- SIEGLER HELLMANN hystérolabes HA-38
- SIMS-MAIER à pansements BG-05
- SINGLEY à dissection BA-05
- Pince
- JAVID atraumatique pour carotis BD-32
- KELLY hémostatique BC-05
- KELLY-RANKIN hémostatique BC-05
- KELLY TITAN hémostatique BC-05
- Pince
- SKENE pour l'abaissement du col de l'utérus HA-31
- Pince
- KOCHER hémostatique délicate BC-06
- LAMBERT KAY atraumatique p. anastomose d'aorte BD-10
- LAMBERT KAY atraumatique iliaque BD-11
- LEES atraumatique pour les bronches BD-03
- LELAND JONES atraumatique vasculaire périph BD-08 jusque BD-09
- LERICHE hémostatique BC-09
- LIDDLE atraumatique pour l'aorte BD-10
- LOVELACE hémostatique BC-07
- MAGILL pour introduire les sondes AE-06
- Pince
- SMITHWICK à poser clips EA-02
- Pince
- MIXTER BABY hémostatique pour les bronches ... BC-13
- MIXTER hémostatique BC-14
- MIXTER hémostatique pour les bronches BC-13
- MIXTER O'SHAUGNESSY hémostatique BC-14
- Pince
- SNELLEN entropion ED-06
- Pinces
- OCHSNER atraumatique pour l'aorte BD-31
- Pince
- SOMER hystérolabes HA-37
- Pince
- PEAN atraumatique BD-02
- PEAN hémostatique BC-08
- PEAN hémostatique délicate BC-06
- PENNINGTON hémostatique BC-07
- POTTS atraumatique BD-26 jusque BD-27
- POTTS atraumatique à coarctacion BD-04
- POTTS atraumatique pour anastomose BD-05
- PRATT hémostatique BC-08
- PROVIDENCE-HOSPITAL hémostatique BC-05
- Pince
- SPURLING emporte-pièce pour laminectomie EA-08
- Pince
- RANEY hémostatique pour le cuir chevelu EA-03
- RANKIN atraumatique BD-02
- ROBERTS hémostatique BC-11
- ROCHESTER-CARMALT hémostatique BC-07
- ROCHESTER-OCHSNER hémostatique BC-06
- ROCHESTER-PEAN hémostatique BC-06
- SAROT hémostatique pour les bronches BC-12
- SATINSKY atraumatique BD-20
- SPENCER-WELLS hémostatique BC-07
- SUBRAMANIAN atraumatique BD-31
- Pince
- STAUDE-MOORE pour l'abaissement du col de l'utérus.... HA-31
- STEVENS à iris EC-11
- STIEGLITZ à échardes BA-06
- STILLE à dissection BA-02
- STILLE-HORSLEY coupante à os DC-07
- STILLE-LISTON coupante à os DC-06
- STILLE-LUER gouge DC-04
- STILLE pédicule rénal BC-16
- STILLE-RUSKIN gouge DC-05
- St. MARTIN suture ED-05
- Pince
- TOENNIS hémostatique BC-11
- Pince
- STONE à fermer GE-06
- STONE-WATT intestinale GE-06
- STRUEMPPEL auriculaire EE-08
- STRUYCKEN coupante nasale EG-07
- Pince
- TUFFIER hémostatique BC-08
- Pince vasculaire flexible BD-44 jusque BD-45
- Pince

SWEET pour poser clips	EA-02	écarteur	BI-14
Pince		Poignée laryngoscope, fibres optiques	AE-11
WYLIE atraumatique	BD-21	Poignée laryngoscope, standard	AE-17
Pince		Pointes carrées	DD-08
TEALE pour l'abaissement du col de l'utérus	HA-33	PERTHES	DD-08
TERSON capsulaire	ED-04	POLITZER	
THOMS-ALLIS pour saisir les tissus	GE-02	aiguille paracentèse	EE-06
THOMS-GAYLOR emporte-pièce pour le col de l'utérus	HA-42	couteau auriculaire	EE-06
TIEMANN pour l'abaissement du col de l'utérus	HA-32	insufflateur d'air	EE-05
TILLEY auriculaire	EE-08	POOLE tube d'aspiration	AE-02
TISCHLER-KEVORKIAN emporte-pièce pour le col de l'utérus		Porte-aiguille	
HA-44 jusque HA-45		ADSON	CE-04
TISCHLER-MORGAN emporte-pièce pour le col de l'utérus	HA-43 jusque HA-44, HA-46	ARRUGA pour l'ophtalmologie	CE-06
TIVNEN à préhension amygdalienne	FA-04	BARRAQUER	CE-07
TOHOKU à champs	BE-04	BAUMGARTNER	CE-02
TOWNSEND emporte-pièce pour le col de l'utérus	HA-44	BOYNTON pour l'ophtalmologie	CE-06
TOWNSEND-KEVORKIAN emporte-pièce pour le col de l'utérus	HA-44	BOZEMANN	CE-03
TOWNSEND-mini emporte-pièce pour le col de l'utérus	HA-44	CASTROVIEJO	CE-07
TOWNSEND-MINI (BABY TISCHLER) emporte-pièce pour le col de l'utérus	HA-45	COLLIER	CE-02
TOWNSEND-TISCHLER emporte-pièce pour le col de l'utérus	HA-44	CRILE	CE-04
TROELTSCH nasale	EG-04	CRILE-MURRAY	CE-02
TROUTMAN Colibri à iris	EC-13	CRILE-WOOD	CE-02
TROUTMAN rectus	ED-02	DE BAKEY	CE-03
Tübingen à iris	EC-15	DERF	CE-02
Tübingen à ligatures	ED-05	DIETHRICH vasculaire	CE-06
Tübingen TITAN à iris	EC-15	FINOCHIETTO	CE-04
Tübingen TITAN à ligatures	ED-05	GILLIES	CE-05
TURNBULL pour les ongles	HE-03	HALSEY	CE-02
TURREL emporte-pièce pour biopsie	GI-05	HEANEY	CE-03
TYDING à préhension amygdalienne	FA-04	HOESEL	CE-05
ULRICH porte-éponges	BG-06	JAMISON	CE-03
UNIVERSAL à stérilisation	CI-02	JOHNSON	CE-04
USA à dissection	BA-02	KALT	CE-07
VAN BUREN à sequestres	DC-10	KALT-ARRUGA	CE-07
van DOREN emporte-pièce pour le col de l'utérus	HA-42	MASSON	CE-03
VIRTUS (RALK) à échardes	BA-06	MATHIEU	CE-05
WACHENFELDT pour agrafes	CG-07	MAYO-HEGAR	CE-02
WAGNER emporte-pièce pour laminectomie	EA-09	METZENBAUM	CE-04
WALSHAM pour redresser cloison	EG-18	NEIVERT	CE-02
WANGENSTEEN à dissection	BA-05	OLSEN-HEGAR	CE-05
WEIL-BLAKESLEY coupante nasale	EG-06	RYDER	CE-03
WEISS serre-tubes	BC-19	SAROT	CE-04
WERTHEIM-CULLEN pour hystérectomie	BC-18	STEVENS pour ophtalmologie	CE-06
WERTHEIM pour hystérectomie	BC-18	STRATTE	CE-04
WHITE à préhension amygdalienne	FA-03	TOENNIS	CE-04
WILDE (TROELTSCH) auriculaire	EE-07	WANGENSTEEN	CE-03
WILLET-MARTELL pour cuir chevelu	BC-08	POTTS DE MARTEL ciseaux vasculaires	AI-27
WILLIAMS pour saisir les tissus	GE-03	POTTS	
WINTER placentaire et pour post-abortum	HC-07	pince atraumatique	BD-26 jusque BD-27
WITTNER emporte-pièce pour le col de l'utérus	HA-43	pince atraumatique à coarctation	BD-04
WOLFF pour rompre plâtre	DA-04	pince atraumatique pour anastomose	BD-05
YEOMAN emporte-pièce pour biopsie	GI-05	POTTS-SMITH	
YOUNG pour saisir la prostate	GG-02	ciseaux vasculaires	AH-19, AI-28
YOUNG tire-langue	EI-03	pince à dissection	BA-02
ZAUFAL-JANSEN gouge	DC-04	POZZI pince pour abaissement du col de l'utérus	HA-31
ZENKER à dissection et à ligature	BC-12	PRATT	
PIPER		dilatateur pour col de l'utérus	HA-29
forceps obstétrique	HC-04	écarteur cystique	GI-04
forceps obstétrique avec dispositif de traction	HC-04	pince pour abaissement du col de l'utérus	HA-34 jusque HA-35
Plaque JAEGER à paupières	EC-03	pince hémostatique	BC-08
Plaque pour tendre la peau	AG-21	spéculum rectal	GI-02
Plateau		PRESBYTERIAN HOSPITAL pince serre-tubes	BC-19
en fil inox	HE-13	PRICE-THOMAS pince pour bronches	FG-22
en tôle perforée	HE-13	PRINCE	
pour instruments	HE-08 jusque HE-09	ciseaux à amygdales	AI-27
PLESTER		pince musculaire	ED-02
couteau lobaire	EE-14	Proctoscope KELLY	GI-04
		Protecteur	
		ARRUGA	EC-08
		de tissu p.vis cann	DD-15
		PROVIDENCE-HOSPITAL pince hémostatique	BC-05

PUTTI rape à osDC-25

Q

QUATTRO écarteur pour plâtreDA-03
 QUINBY ciseaux à gencivesAI-42
 QUINKE aiguille à ponctionCC-03
 QUIRE levier pour corps étrangersEE-08
 QUISLING mailletDC-18

R

RADOLF pince pour extraire les onglesDD-03
 RALK perforateur à mainDD-05
 Rallonge BRUENINGS courbeFC-03
 RAMPLEY pince porte-épongesBG-09
 RANDALL
 curette aspirante pour biopsie de l'utérusHA-40
 pince pour les calculs du bassinGC-11 jusqu'à GC-12
 RANEY
 pince pour poser et enleverEA-03
 pince hémostatique pour le cuir cheveluEA-03
 RANKIN pince atraumatiqueBD-02
 Rape
 à osDC-25
 FOMON nasaleEG-15 jusqu'à EG-16
 GALLAHER pour le sinusEG-16
 JOSEPH (LEWIS) nasaleEG-15
 MALTZ (COTTLE) nasaleEG-15
 MALTZ nasaleEG-14
 PUTTI à osDC-25
 WIENER (AUFRIEHT) nasaleEG-15
 WIENER nasaleEG-15
 Rapprocheur
 BAILEY-BABY pour les côtesFG-18
 BAILEY pour les côtesFG-18
 BAILEY-GIBBON pour les côtesFG-18
 SELLORS pour les côtesFG-18
 RasoirAG-14, AG-19
 RECAIMER curette utérineHA-49 jusqu'à HA-50
 Récipient cylindriqueHE-08
 Rectoscope lumière froideGI-03
 Règle en métalAC-08
 REICHERT dépresseur pour épiglottisFC-02
 REINER
 couteau pour plâtreDA-04
 seringue auriculaireEE-05
 Rétracteur PERCY à amputationDD-03
 REVERDIN
 aiguille à ligaturesCG-03
 écarteurBI-04
 REYNOLDS ciseauxAH-15, AI-18
 RachiotomeDC-17
 RIBBON écarteurBI-04
 RICHARDSON-EASTMAN écarteurBI-04
 RICHARDSON écarteurBI-04
 RICHARDSON Grip écarteurBI-04
 RICHTER-HEATH pince pour agrafesCG-07
 RIGBY écarteur abdominalBI-24
 ROBB dissecteur vasculaireFG-33
 ROBERTS pince hémostatiqueBC-11
 ROCHESTER-CARMALT pince hémostatiqueBC-07
 ROCHESTER-OCHSNER pince hémostatiqueBC-06
 ROCHESTER-PEAN pince hémostatiqueBC-06
 ROEDER pince à champsBE-03
 ROGER élévateur pour la cloison nasaleEG-11
 ROGGE pince à stérilisationCI-02
 ROLLET
 ciseaux à extirpationEC-06
 écarteurEC-06
 ROSE écarteur trachéalFE-03

ROSEN

aiguilleEE-14 jusqu'à EE-15
 ROSENBERG pince laryngienneFC-03
 ROSEN
 couteau circulaireEE-14
 ROSER-KOENIG ouvre-boucheEI-03
 ROUX Baby écarteurBI-02
 ROUX écarteurBI-02
 ROUX mini écarteurBI-02
 ROWE pince pour la boucheEI-06
 Ruban métriqueAC-08
 RUBIN pince pour écraser la cloisonEG-07
 Rugine
 ALEXANDER raspatoireDC-19
 DOYEN raspatoire pour les côtesDC-20
 FARABEUF raspatoireDC-19
 KUHN cornéenEC-05
 LAMBOTTE raspatoireDC-19
 LANGENBECK raspatoireDC-19
 MATSON raspatoireDC-21
 OVERHOLT raspatoireDC-21
 SADILLOT raspatoireDC-19
 SEMB raspatoireDC-20
 WILLIGER raspatoireDC-19
 RUMEL pince thoraciqueBC-11
 RUSKIN-LISTON pince coupante à osDC-06
 RUSKIN pince gougeDC-04
 RUSSIAN pince à dissectionBA-04
 RYDEL-SEIFFER diapasonEE-04
 RYDER porte-aiguilleCE-03

S

SAALFELD tire comédonsHE-02
 SACHS
 dissecteur duremèreEA-05
 écarteur à nerfsEA-04
 SADILLOT rugine raspatoireDC-19
 SAENGER pince placentaire et pour post-abortumHC-07
 SAIRGES pince pour l'abaissement du col de l'utérusHA-32
 Salpingographe SCHULTZEHA-47
 SANVENERO ciseauxAH-13, AI-16
 SAROT
 pince pour les bronchesFG-23
 pince hémostatique pour les bronchesBC-12
 porte-aiguilleCE-04
 SATINSKY
 ciseaux thoraciquesAI-37
 pince pour l'anastomose (veina cava)FG-24 jusqu'à FG-25
 pince atraumatiqueBD-20
 SATO couteau cornéenEC-05
 SAUERBRUCH
 boîte pour aiguilleHE-02
 costotomeFG-05
 écarteurBI-13
 SAUERBRUCH-FREY costotomeFG-06
 SAUERBRUCH
 pince gougeDC-05
 pince pour déchetsCI-03
 SAWTELL pince à amygdalesFA-03
 SCAGLIETTI pince gougeDC-05
 Scarificateur GRAEFEEC-04
 SCHAMBERG tire comédonsHE-02
 SCHEDE curetteDC-12
 SCHEIE
 canule oculaireED-07
 couteau à goniectomieEC-05
 SCHEINMANN pince laryngienneFC-03
 SCHERBAK spéculum vaginalHA-21
 SCHIMMELBUSCH tambours à stérilisationHE-12
 SCHINK dermatomeAG-21

SCHIOETZ tonomètre tonomet.echell.obli.	ED-08	SIEBOLD ciseaux gynécologiques	AH-21, AI-32
SCHMIEDEN-PAYR sonde conductrice	CG-04	SIEGLER HELLMANN pince hystérolabe	HA-38
SCHMIEDEN sonde conductrice	CG-04	SIEGLE spéculum auriculaire	EE-02
SCHMIEDEN-TAYLOR ciseaux	AI-36	SILVER	
SCHNIDT pince à amygdales	FA-03	ciseau-burin pour la plastique nasale	EG-14
SCHOENBORN écarteur pour la thyroïde	FE-04	dermatome	AG-20
SCHOENBURG pince pour saisir les tissus	GE-03	SIMCOE canule à suture	ED-07
SCHROEDER		SIMON	
curette utérine	HA-48	curette	DC-13
pince pour abaissement du col de l'utérus	HA-31 jusqu'à HA-32	curette utérine	HA-48
SCHUBERT pince emporte-pièce pour le col de l'utérus	HA-41	écarteur	BI-12
SCHUKNECHT		SIMPSON-BRAUN forceps obstétrique	HC-02
couteau circulaire	EE-14	SIMPSON forceps obstétrique	HC-02
couteau serpette	EE-14	SIMPSON-LUIKART forceps obstétrique	HC-03
SCHULTZE salpingographe	HA-47	SIMS	
SCHUMACHER		ciseaux gynécologiques	AH-21, AI-32
cisaille à sternum	FG-07	curette utérine	HA-49 jusqu'à HA-50
ciseaux pour cordon ombilical	AI-34	dépresseur utérin	HA-39
pince emporte-pièce pour le col de l'utérus	HA-43	dilatateur pour le col de l'utérus	HA-30
pince laryngienne	FC-03	hystéromètre	HA-39
SCHWEIGGER pince capsulaire	ED-04	SIMS-MAIER pince à pansements	BG-05
Scie		SIMS	
BERGMANN pour plâtre	DA-02	spéculum rectal	GI-02
CHARRIERE à amputation	DD-03	spéculum vaginal	HA-17
ENGEL pour plâtre	DA-02	SINGLEY pince à dissection	BA-05
JOSEPH nasale	EG-17	SKENE pince pour l'abaissement du col de l'utérus	HA-31
LANGENBECK à doigts	DD-03	SLUDER-BALLENGER amygdalotome	FA-05
OLIVECRONA	EA-05	SMELLIE	
Scie oscillante pour plâtre	DA-05 jusqu'à DA-06	Crochet pour les accouchements	HC-06
Scie		perce-crâne	HC-09
WIGMORE pour plâtre	DA-02	SMILLIE méniscotome	DC-24
Sclerotome		SMITH blépharostat	EC-02
GUYTON-LUNDGAARD	EC-05	SMITH-BUIE dilatateur pour anus et rectum	GI-03
LUNDGAARD	EC-05	SMITH-PETERSEN	
Seaux pour déchets	HE-11	ciseaux-burin	DC-15
SEEMANN-SEIFFERT ouvre-bouche	EI-04	gouge	DC-15
SEGOND évideur pour fibromes	HA-46	SMITH US ARMY ciseaux à bandages	AI-44
SEIFFERT pince laryngienne	FC-03	SMITHWICK	
SELLHEIM levier pour abaisser la tête	HC-09	écarteur à nerfs	EA-04
SELLORS Rapprocheur des côtes	FG-18	pince pour poser clips	EA-02
SEMB		SNELLEN	
davier porte-os	DC-07	anse	EC-08
pince pour bronches	FG-23	pince entropion	ED-06
pince coupante à os	DC-07	SOMER pince hystérolabe	HA-37
pince gouge	DC-06	Sonde	CA-02
rugine raspatoire	DC-20	BRUNNER conductrice	CG-04
SEMKEN pince à dissection	BA-05	DESJARDINS pour calculs biliaires	GC-05
SEMM spéculum vaginal	HA-07	DOYEN	CA-02
SENN écarteur	BI-04	HARTMANN auriculaire	EE-06
SENN-GREEN écarteur	BI-07	ITARD auriculaire	EE-06
Seringue		KILLIAN	EG-09
à amygdales	FA-05	KIRSCHNER conductrice	CG-04
REINER auriculaire	EE-05	KOENIG conductrice	CG-04
Serre-noeud		MAYO pour les calculs du bassin	GC-10
BRUENINGS	FA-04	métallique pour femmes	GG-16
EVES	FA-04	métallique pour hommes	GG-16
Serre-noeud		MOYNIHAN pour calculs biliaires	GC-05
KRAUSE auriculaire	EE-07	NABATOFF auriculaire en argent	CA-02
Serre-noeud		PAYR conductrice	CG-04
KRAUSE nasal	EG-09	SCHMIEDEN conductrice	CG-04
TYDING	FA-05	SCHMIEDEN-PAYR conductrice	CG-04
Serre-noeud		STACKE auriculaire en argent	CA-02
WESTON à polypes rectaux	GI-05	Spatule	CA-03
WILDE auriculaire	EE-07	ALLISON pulmonaire	FG-19
Serre-noeud		BANGERTER cyclodialyse	EC-08
WILDE nasal	EG-09	CASTROVIEJO cyclodialyse	EC-08 jusqu'à EC-09
Set à autopsie	DC-17	CULLER à iris	EC-08
SEUTIN ciseaux pour plâtre	DA-02	ELSCHNIG cyclodialyse	EC-08
SEXTON couteau auriculaire	EE-06	KOCHER à goitre	FE-04
SHEA ciseaux auriculaires micro	EE-09	KOCHER vésicale	GG-04
SHORTBENT ciseaux à ligatures	AI-40	LEGUEU vésicale	GG-04

pour la tunique interne	FG-32	VIENNA nasal	EG-02
Spatule		VOLTOLINI nasal	EG-02
CUSHING cérébrale	EA-07	Spéculum	
HEIFETZ cérébrale	EA-07	WEISSBARTH vaginal	HA-22
OLIVECRONA cérébrale	EA-07	Spéculum	
Spatule		YANKAUER nasopharyngien	EG-04
WECKER à iris	EC-08	SPENCER ciseaux à ligatures	AI-40
WELLS à énucléation	EC-08	SPENCER-WELLS pince hémostatique	BC-07
WHEELER cyclodialyse	EC-09	Sphérique électrode pour la coagulation	JA-03
Spéculum		SPRATT curette	DC-12
AUVARD vaginal	HA-19	SPURLING pince emporte-pièce pour laminectomie	EA-08
Spéculum		STACKE sonde auriculaire en argent	CA-02
BARR rectal	GI-02	STAUDE-MOORE pince pour l'abaissement du col de l'utérus	HA-31
Spéculum		St. CLAIR-THOMSON couteau	EG-19
BERLIND-AUVARD vaginal	HA-19	STEINER-AUVARD spéculum vaginal	HA-19
Spéculum		STEINMANN clou à os	DD-09
BODENHAMMER rectal	GI-02	STELZNER ciseaux à rectum	AI-38
BOUCHERON auriculaire	EE-02	STERNBERG écarteur pour lèvres et joues	EI-02
Spéculum		Stéthoscope	
BRAUN vaginal	HA-16	BOWLES	AC-06
BREISKY vaginal	HA-20	Stéthoscope duplex	AC-06
Spéculum		Stéthoscope	
BRUENINGS auriculaire	EE-02	FORD	AC-06
Spéculum		FORD BOWLES	AC-06
COLLIN vaginal	HA-04	PINARD	AC-06
Spéculum		STEVENS	
COTTLE nasal	EG-03	ciseaux à ténotomie	AH-17, AI-23
Spéculum		crochet	EC-06
CUSCO vaginal	HA-04 jusqu'à HA-06	STEVENSON blépharostat	EC-03
Spéculum		STEVENS	
CZERNY rectal	GI-02	pince à iris	EC-11
Spéculum		porte-aiguille pour l'ophtalmologie	CE-06
DOYEN vaginal	HA-18, HA-20	STIEGLITZ pince à échardes	BA-06
FREEWAY-GRAVE vaginal	HA-06	STILLE	
GRAVE vaginal	HA-02	ciseau-burin	DC-14
Spéculum		ciseaux pour plâtre	DA-02
GRUBER auriculaire	EE-02	costotome	FG-03
HARTMANN auriculaire	EE-02	gouge	DC-14
HARTMANN-HALLE nasal	EG-02	STILLE-HORSLEY pince coupante à os	DC-07
Spéculum		STILLE-LISTON pince coupante à os	DC-06
JACKSON vaginal	HA-16	STILLE-LUER pince gouge	DC-04
KALLMORGEN vaginal	HA-15	STILLE	
Spéculum		ostéotome	DC-14
KILLIAN cloison	EG-03	perforateur à main	DD-04
KOGAN endos	HA-23	pince à dissection	BA-02
Spéculum		pince pédicule rénal	BC-16
KRISTELLER vaginal	HA-09 jusqu'à HA-14	STILLE-RUSKIN pince gouge	DC-05
LANDAU vaginal	HA-22	STILLE-SHERMAN perforateur à main	DD-04
Spéculum		St. MARTIN pince à suture	ED-05
MATHIEU rectal	GI-02	STOCKMANN compresseur de l'urètre	GG-10
Spéculum		STONE pince pour fermer	GE-06
O'SULLIVAN-O'CONNOR vaginal	HA-08	STONE-WATT pince intestinale	GE-06
PEDERSON vaginal	HA-03	STRATTE porte-aiguille	CE-04
Spéculum		STRAUSS compresseur de l'urètre	GG-10
PRATT rectal	GI-02	Strippers	CA-03
Spéculum		STRUEMPPEL pince auriculaire	EE-08
SCHERBAK vaginal	HA-21	STRULLY ciseaux neurochirurgicaux	AI-35
SEMM vaginal	HA-07	STRUYCKEN pince coupante nasale	EG-07
Spéculum		Styilet	CA-03
SIEGLE auriculaire	EE-02	BOWMAN pour canal lacrymal	EC-10
SIMS rectal	GI-02	DIMEDA	CA-03
Spéculum		FARREL	CA-03
SIMS vaginal	HA-17	JOBSON-HORNE	CA-03
STEINER-AUVARD vaginal	HA-19	TOBOLD	CA-03
Spéculum		UCKERMANN	CA-03
THUDICHUM nasal	EG-02	SUBRAMANIAN pince atraumatique	BD-31
TIECK-HALLE nasal	EG-03	Support MILLIN lumière froide	GG-05
TOYNBEE auriculaire	EE-02	SWEET pince pour poser clips	EA-02
Spéculum		Système de fixation LEYLA	EA-14 jusqu'à EA-18
TRELAT vaginal	HA-07		
Spéculum			

T

TABB couteau serpente	EE-14
Tambour	
KONRICH à stérilisation	HE-12
SCHIMMELBUSCH à stérilisation	HE-12
Taraud pour vis canulées	DD-15
Tarmis pour spéculum vaginal	HA-22
TARNIER	
cranioclaste	HC-09
forceps obstétrique avec dispositif de traction	HC-05
TAYLOR	
écarteur spinal	DC-24
marteau perceur	AC-07
TEALE pince pour abaissement du col de l'utérus	HA-33
Tendeur	
à broches	DD-10
LOUTE serre-fil	DD-11
Tensiomètre	AC-02
TERSON pince capsulaire	ED-04
THOMS-ALLIS pince pour saisir les tissus	GE-02
THOMS-GAYLOR pince emporte-pièce pour le col de l'utérus	HA-42
THOMSON-WALKER écarteur vésical	GG-06
THOREK ciseaux pulmonaires	AI-36
THUDICHUM spéculum nasal	EG-02
TIECK-HALLE spéculum nasal	EG-03
TIEMANN pince pour abaissement du col de l'utérus	HA-32
TILLEY pince auriculaire	EE-08
Tire	
SAALFELD comédons	HE-02
SCHAMBERG comédons	HE-02
UNNA comédons	HE-02
WALTON comédons	HE-02
TISCHLER-KEVORKIAN pince emporte-pièce pour le col de l'utérus	HA-44 jusqu'à HA-45
TISCHLER-MORGAN pince emporte-pièce pour le col de l'utérus	HA-43 jusqu'à HA-44, HA-46
TIVNEN pince à préhension amygdalienne	FA-04
TOBOLD	
abaisse-langue	EI-02
stylet	CA-03
TOENNIS-ADSON ciseaux neurochirurgicaux	AI-35
TOENNIS	
dissecteur duremère	EA-05
pince hémostatique	BC-11
porte-aiguille	CE-04
TOHOKU pince à champs	BE-04
Tonomètre SCHIOETZ tonomet.echell.obli.	ED-08
TOOK couteau cornéen	EC-05
TOTI fraise	DD-07
Tourne-vis	
hexagonal	DD-14
LANE	DD-14
Tournevis pour vis canulées	DD-15
Tourne-vis	
WILLIAMS	DD-14
Tourniquet	AC-03
TOWNSEND-KEVORKIAN pince emporte-pièce pour le col de l'utérus	HA-44
TOWNSEND-MINI (BABY TISCHLER) pince emporte-pièce pour le col de l'utérus	HA-45
TOWNSEND-mini pince emporte-pièce pour le col de l'utérus	HA-44
TOWNSEND pince emporte-pièce pour le col de l'utérus	HA-44
TOWNSEND-TISCHLER pince emporte-pièce pour le col de l'utérus	HA-44
TOYNBEE spéculum auriculaire	EE-02
Tracteur	
BARTON pour manches ordinaires	HC-04
BILL pour manches ordinaires	HC-05
DOYEN pour fibromes	HA-46
LUIKART-BILL pour manches ordinaires	HC-05
Traction CRUTCHFIELD crânienne	EA-03
TRAUBE marteau perceur	AC-07
TRELAT spéculum vaginal	HA-07
Trépan	DD-04
CASTROVIEJO cornéen	ED-07
ELLIOT cornéen	ED-08
FRANCESCHETTI cornéen	ED-07
Trépan KEYES cutanéen	HE-02
Trocart	CC-02
COAKLEY	CC-02
DOUGLAS	CC-02
FLEURANT	CC-02
LICHTWITZ	CC-02
MENGHINI	CC-03
NELSON	CC-02
OCHSNER	CC-02
PIERCE	CC-02
UCKERMANN trachéal	FE-02
UNIVERSAL	CC-02
TROELTSCH pince nasale	EG-04
TROEMNER marteau perceur	AC-07
Trousse à manucure pour les infirmières	HE-03
TROUSSEAU dilateur trachéal	FE-02
Trousse de diagnostic	AC-04
Trousse mini à poche et à suture	CG-08
Trousses standard à poche et à suture	CG-08
TROUTMAN-CASTROVIEJO ciseaux micro	AJ-07
TROUTMAN-CHRIS casse-lames	AG-14
TROUTMAN Colibri pince à iris	EC-13
TROUTMAN pince rectus	ED-02
TUBBS dilateur valve mitrale	FG-27
Tube	
ANDREWS-PINCHON d'aspiration	AE-03
BUIE d'aspiration	GI-05
DE BAKEY d'aspiration	AE-04
FRAZIER d'aspiration	EA-07
MAGILL d'aspiration	AE-04
NUBOER d'aspiration	AE-05
POOLE d'aspiration	AE-02
WALTON YANKAUER d'aspiration	AE-03
YANKAUER d'aspiration	AE-02
Tübingen	
canule air	ED-07
pince à iris	EC-15
pince à ligatures	ED-05
Tübingen TITAN	
pince à iris	EC-15
pince à ligatures	ED-05
TUFFIER	
écarteur pour les côtes	FG-16
pince hémostatique	BC-08
TURNBULL pince à ongles	HE-03
TURREL pince emporte-pièce pour biopsie	GI-05
TYDING	
pince à préhension amygdalienne	FA-04
serre-noeud	FA-05
U	
UCKERMANN	
stylet	CA-03
trocart trachéal	FE-02
ULRICH pince porte-éponges	BG-06
UNIVERSAL	
ciseaux à bandages	AI-50
ciseaux à fils et à plaques	AI-42
pince à stérilisation	CI-02
trocart	CC-02
UNNA tire comédons	HE-02
Uréthrotome OTIS	GG-08
Urinal	HE-10

- USA
cordon électrobistourisJA-07
USA MODEL ciseaux pour le cordon ombilicalAI-34
USA
pince à dissectionBA-02
US Army (PARKER-LANGENBECK) écarteurBI-03
- V**
- VALLEIX hystéromètreHA-39
Valve
BALFOURBI-22
CASPARBI-20
CASPAR pour colonne vertébraleBI-19
KIRSCHNERBI-23
VAN BUREN
bougie urétraleGG-13
pince à sequestresDC-10
Van DOREN pince emporte-pièce pour le col de l'utérus HA-42
VANNAS
ciseaux à iridectomieAJ-05
ciseaux microAJ-12 jusqu'à AJ-13
VARIFOCAL ophtalmoscopeAC-03
Vase à médicamentsHE-07
Valve
KALLMORGEN vaginaleHA-15
KRISTELLER vaginaleHA-09 jusqu'à HA-14
VERBRUGGE davier porte-osDC-09
VERRES aiguille à ponction pneumopéritoineCC-03
VIENNA spéculum nasalEG-02
VIRCHOW
burin pour le crâneDC-17
couteau à cartilageAG-18
couteau pour le cerveauAG-18
VIRTUS (RALK) pince à échardesBA-06
VOLKMANN
curetteDC-12 jusqu'à DC-13
écarteurBI-07 jusqu'à BI-08
VOLTOLINI spéculum nasalEG-02
- W**
- WACHENFELDT pince pour agrafesCG-07
WADSWORTH-TODD cautèreEC-08
WAGENER crochet auriculaireEE-07
WAGENER-MOSHER canule trachéaleFE-03
WAGNER
ciseauxAH-22
ciseaux à gencivesAI-42
pince emporte-pièce pour laminectomieEA-09
WALDMANN ciseaux à épisiotomieAI-34
WALLICH curette placentaire et pour post-abortumHC-08
WALSHAM pince pour redresser cloisonEG-18
WALTHER bougie urétraleGG-17
WALTON
gouge pour corps étrangersEC-06
tire comédonsHE-02
WALTON YANKAUER tube d'aspirationAE-03
WANGENSTEEN
pince à dissectionBA-05
porte-aiguilleCE-03
WARTENBERG aesthésiomètreAC-08
WATSON-CHEYNE élévateurDC-22
WATSON dermatomeAG-22
WEBER anseEC-08
WECKER
ciseaux à irisAJ-04
spatule à irisEC-08
WEEK blépharostatEC-02
WEIL-BLAKESLEY pince coupante nasaleEG-06
WEISSBARTH spéculum vaginalHA-22
- WEISS pince serre-tubesBC-19
WEITLANER écarteurBI-14
WEITLANER-WULLSTEIN écarteurBI-14
WELLS spatule à énucléationEC-08
WERTHEIM
ciseaux préparationAI-32
WERTHEIM-CULLEN pince pour hystérectomieBC-18
WERTHEIM
Pince pour hystérectomieBC-18
WEST
ciseaux-burin nasalEG-14
WESTCOTT
ciseaux à iridectomieAJ-02
ciseaux à tendonsAJ-02
WEST
gouge nasaleEG-14
WESTON serre noeud à polypes rectauxGI-05
WHEELER
couteau à discisionEC-04
spatule à cyclodialyseEC-09
WHITEHEAD ouvre-boucheEI-04
WHITE pince à préhension amygdalienneFA-03
WIEDER abaisse-langueEI-02
WIENER (AUFRIECHT) rape nasaleEG-15
WIENER
crochet à irisEC-06
rape nasaleEG-15
WIGMORE scie pour plâtreDA-02
WILDER
anseEC-08
dilatateur pour canal lacrymalEC-10
WILDE
Serre-noeud auriculaireEE-07
serre-noeud nasalEG-09
WILDE (TROELTSCH) pince auriculaireEE-07
WILLET-MARTELL pince cuir cheveluBC-08
WILLIAMS
blépharostatEC-02
pince pour saisir les tissusGE-03
tourne-visDD-14
WILLIGER
curetteDC-13
mailletDC-18
rugine raspatoireDC-19
WINKELMANN Instrument de circoncisionGG-09
WINTER pince placentaire et pour post-abortumHC-07
WITTNER pince emporte-pièce pour le col de l'utérusHA-43
WOLFF pince pour rompre plâtreDA-04
WRIGLEY forceps obstétriqueHC-02
WULLSTEIN
ciseaux auriculaires microEE-11
ciseaux auriculaires micro miniEE-11
couteau serpetteEE-14
WYLIE
dilatateur pour col de l'utérusHA-30
pince atraumatiqueBD-21
- Y**
- YANKAUER
spéculum nasopharyngienEG-04
tube d'aspirationAE-02
YASARGIL ciseaux microAJ-10 jusqu'à AJ-11
YEOMAN pince emporte-pièce pour biopsieGI-05
YOUNG Boomerang aiguille à ligaturesCG-03
YOUNG
écarteur pour la prostateGG-02
pince pour saisir la prostateGG-02
pince tire-langueEI-03

Z

ZAUFAL-JANSEN pince gougeDC-04
ZENKER pince à dissection et à ligatureBC-12
ZIEGLER	
blépharostatEC-03
couteau à capsulotomieEC-05
couteau à iridectomieEC-04
dilatateur pour canal lacrymalEC-10
miroir frontalAC-05

S

Índice alfabético Español

S

S

Índice alfabético
Español

A

Abajalengua	
ANDREW	EI-02
BRUENINGS	EI-02
BUCHWALD	EI-02
FRENZEL	EI-02
HARTMANN	EI-02
madera	EI-02
McIVOR	EI-05
TOBOLD	EI-02
WIEDER	EI-02
Abertura BROCK dilatador para válvula mitral	FG-26
Abreboca	
DAVIS-BOYLE	EI-04
DENHART	EI-03
DOYEN-JANSEN	EI-03
HEISTER	EI-03
JENNINGS	EI-04
KILNER-DOUGHTY	EI-05
McIVOR	EI-05
ROSER-KOENIG	EI-03
SEEMANN-SEIFFERT	EI-04
WHITEHEAD	EI-04
Accesorios para contenedores	
para esterilización	HE-38 hasta HE-41
Adenotomo LAFORCE	EG-19
ADLERKREUTZ pinza de disección	BA-04
ADSON BABY	
pinza hemostática	BC-09
ADSON Baby	
separador	BI-15
ADSON-BROWN pinza de disección	BA-03
ADSON	
elevador	DC-21
gancho para nervios	EA-04
pinza de disección	BA-03
pinza gubia	DC-03
pinza hemostática	BC-09
pinza micro de disección	BA-03
pinza para hipófisis	EA-06
porta-aguja	CE-04
separador	BI-15
AEBLI tijera para corneal	AI-22
AESCULAP cable electrobisturías	JA-07
Aguja	
amígdalas	FA-05
BARBARA	EE-14
BOWMAN para discision	EC-05
COOPER para ligaduras	CG-02
DAVIS para cuerpos extraños	EC-05
DESCHAMPS para ligaduras	CG-02
DIX	EC-09
electrodo	JA-03
electrodo mini	JA-02
FRANCIS para cuerpos extraños	EC-05
FRANKLIN-SILVERMANN para punción	CC-03
KEITH para sutura	CG-06
KOENIG para sutura	CG-06
KRONECKER para ligaduras	CG-02
LEVINSON para cuerpos extranj	EC-05
LICHTWITZ	EG-09
NELSON para ligaduras	CG-02
para catarata	EC-05
para cuerpos extraños	EC-05
Aguja para sutura	CG-05 hasta CG-06
Aguja	
POLITZER paracentesis	EE-06
QUINKE para punción	CC-03
REVERDIN para ligaduras	CG-03
ROSEN	EE-14 hasta EE-15

VERRES para punción, neumoperitoneo	CC-03
YOUNG Boomerang para ligaduras	CG-03
ALAN-PARKS separadore rectales	GI-03
ALBEE fresa	DD-07
ALEXANDER	
cincel	DC-14
gubia	DC-14
periostótomo	DC-19
pinza sacabocado para el cuello del útero	HA-42
ALLIS-ADAIR pinza para tejidos	GE-02
ALLIS-Baby pinza para tejidos	GE-02
ALLISON espátula pulmón	FG-19
ALLIS pinza para tejidos	GE-02
ALM separador	BI-14
ALVIS cureta para cuerpos extraños	EC-06
Amigdalotomo SLUDER-BALLENGER	FA-05
Amniótomo BEACHAM	HA-39
ANDREW abajalengua	EI-02
ANDREWS-PINCHON tubo de aspiración	AE-03
Anoscopio	
HIRSCHMANN	GI-04
IVES-FANSLER	GI-04
Aparato PETZ para suturar	
estomacales e intestinales	GE-09
Aproximador	
BAILEY-BABY para costillas	FG-18
BAILEY-GIBBON para costillas	FG-18
BAILEY para costillas	FG-18
SELLORS para costillas	FG-18
ARCHER pinza para espinas	BA-06
ARKANSAS Piedra afiladora	AG-19
ARLT asa	EC-08
ARRUGA	
blefarostato	EC-02
gancho para extracion	EC-06
pinza capsulares	ED-04
porta-aguja de oftalmología	CE-06
protector	EC-08
Asa	
amígdalas	FA-04
ARLT	EC-08
auriculares	EE-07
BILLEAU auriculares	EE-07
Asa de alambre electrodo	JA-03
Asa de cinta electrodo	JA-03
Asa	
electrodo mini	JA-02 hasta JA-03
para nasales	EG-09
SNELLEN	EC-08
WEBER	EC-08
WILDER	EC-08
ASCH pinza enderezar tabique	EG-18
AUFRIEHT separador para nasales	EG-17
AUVARD espéculo vaginales	HA-19
AXENFELD cucharilla para chalazion	EC-07
AYER pinza chalazión	ED-06

B

BABCOCK pinza para tejidos	GE-02
BABINSKY martillos de percusión	AC-07
BACKHAUS-CLIP pinza para campos	
con porta-tubo	BE-03
BACKHAUS KOCHER pinza para campos	BE-02
BACKHAUS pinza para campos	BE-02
BAGGISH pinza sacabocado	
para el cuello del útero	HA-45
BAILEY aproximador para costillas	FG-18
BAILEY-BABY aproximador para costillas	FG-18
BAILEY-GIBBON aproximador para costillas	FG-18
BAINBRIDGE	

pinza atraumatica.....	BD-09
pinza hemostática.....	BC-14
BAKES dilatador para conducto biliar.....	GC-06
BALFOUR Baby separador abdominales.....	BI-22
BALFOUR	
separador abdominales.....	BI-22
valva.....	BI-22
BALL AND SOCKET pinza para campos.....	BE-04
BALLENGER	
cuchillo.....	EG-11
elevadores tabique.....	EG-12
pinza coger amígdalas.....	FA-04
Bandeja	
de alambre.....	HE-13
de chapa de acero perforada.....	HE-13
para instrumento.....	HE-08 hasta HE-09
BANGERTER espátula ciclodialálisis.....	EC-08
BARANY ensordecedor.....	EE-04
BARBARA	
aguja.....	EE-14
ganchito.....	EE-14
pick.....	EE-14 hasta EE-15
BARKAN cuchillo para goniometría.....	EC-05
BARNHILL cuchillo.....	EG-19
Barra GERSTER de tracción.....	DC-11
BARRAQ.KATZIN pinza para iris.....	EC-13
BARRAQU Colibri pinza para iris.....	EC-13
BARRAQUER Colibri blefarostato.....	EC-02
BARRAQUER	
cuchillo para queratoplastico.....	EC-05
pinza cámara anterior.....	ED-02
pinza depilatorias.....	ED-08
pinza fijación.....	ED-03
porta-aguja.....	CE-07
tijeras de colibri.....	AJ-04
BARR espéculo rectales.....	GI-02
BARRETT pinza pra coger el cuello de útero.....	HA-32
BARTON	
pinza obstétricas.....	HC-04
tractor adecuada para todas las pinzas con mango.....	HC-04
BAUMGARTNER porta-aguja.....	CE-02
BEACHAM amniótomo.....	HA-39
Vaso.....	HE-10
BECKER quistotomo.....	EC-06
BECKMANN-ADSON separador.....	BI-15
BECKMANN	
cuchillo.....	EG-19
BECKMANN-EATON separador.....	BI-16
BECKMANN	
separador.....	BI-16
BECK pinza atraumatica para vasculares perif.....	BD-25
BEEBEE tijeras para alambre y chapas.....	AI-43
BEER pinza depilatorias.....	ED-08
BEESON separador para yesos.....	DA-03
BELLUCCI tijeras auriculares micro.....	EE-09
BENGOLEA pinza hemostática.....	BC-09
BENNETT elevador para huesos.....	DC-22
BERENS queratomo.....	EC-04
BERGMANN FOERSTER pinza porta esponjas.....	BG-10
BERGMANN	
sierra para yesos.....	DA-02
tijeras de vendajes.....	AI-46
BERKE pinza musculares.....	ED-02
BERLIND-AUVARD espéculo vaginales.....	HA-19
BERLINER martillos de percusión.....	AC-07
BERNHARD pinza para campos.....	BE-05
BERTILLON cefalómetro.....	AC-08
BEST pinza intestinales.....	GE-06
BETHUNE costotomo.....	FG-04
BEUSE tijeras.....	AI-26
BEYER	

pinza gubia.....	DC-04
pinza sacabocado.....	EG-08
BILLEAU asa auriculares.....	EE-07
BILL tractor adecuada	
para todas las pinzas con mango.....	HC-05
BIRCHER-GANSKE pinza para huesos.....	DC-10
BIRCHER meniscotomo.....	DC-24
BISHOP-HARMAN pinza para iris.....	EC-14
Bisturi	
CONVERSE para nasales.....	EG-10
electrodo.....	JA-03
Bisturías para disección.....	AG-15
Bisturías PARKER para disección.....	AG-15
Bisturi	
FREER mucosa.....	EG-10
HALLE para duramadre.....	EA-06
JOSEPH para nasales.....	EG-10
JOSEPH romo.....	EG-10
MALTZ cartilage acodado.....	EG-11
SEGOND para fibroma.....	HA-46
BLAKE	
cureta uterinas.....	HA-48
pinza para cálculos biliares.....	GC-03
Blefarostato	
ARRUGA.....	EC-02
BARRAQUER Colibri.....	EC-02
BOWMAN.....	EC-02
CASTROVIEJO.....	EC-03
CLARK.....	EC-02
CRITCHETT.....	EC-02
GOLDSTEIN.....	EC-03
GRAEFE.....	EC-02
LANCASTER.....	EC-03
LISTER-BURCH.....	EC-02
MELLINGER.....	EC-02
MELLINGER-AXENFELD.....	EC-02
MUELLER.....	EC-03
MURDOCK.....	EC-02
PARK.....	EC-03
SMITH.....	EC-02
STEVENSON.....	EC-03
WEEK.....	EC-02
WILLIAMS.....	EC-02
ZIEGLER.....	EC-03
BLOHMKE pinza coger amígdalas.....	FA-04
BLOUNT	
elevador para huesos.....	DC-24
separador para rodilla.....	DC-24
BLUMENTHAL pinza gubia.....	DC-02
BODENHAMMER espéculo rectales.....	GI-02
BOEHLER estribo para extensión.....	DD-10
BOERMA pinzas obstétricas.....	HC-04
BOETTCHER tijeras para amígdalas.....	AI-27
BÖHLER	
pinza cortante para huesos.....	DC-06
pinza gubia.....	DC-04
Bola electrodo para coagulación.....	JA-03
Bombilla de repuesto	
para laringoscopia convencional.....	AE-20
Bombilla de repuesto	
para laringoscopia de fibra optica.....	AE-20
BONACCOLTO pinza para estrabismo.....	EC-14
Bonn	
canula irrigacion.....	ED-07
BONNEY pinza porta esponjas.....	BG-08
Bonn	
pinza para iris.....	EC-15
Bonn TITAN pinza para iris.....	EC-15
BORCHARDT fresa.....	DD-07
BOSE	
gancho traqueal.....	FE-02

S

Índice alfabético Español

separador traqueal	FE-02
BOUCHERON espéculos auriculares	EE-02
BOWLES estetoscopio	AC-06
BOWMAN	
aguja para discision	EC-05
blefarostato	EC-02
cuchillo para discision	EC-04
sonda canal lacrimonal	EC-10
BOYNTON porta-aguja de oftalmología	CE-06
BOZEMANN-DOUGLAS pinza para tapones	BG-13
BOZEMANN	
pinza para tapones	BG-13
porta-aguja	CE-03
BRAIN	
clip standard	EA-13
clip temporarios	EA-12
BRAIN MINI pinza de aplicación clip	EA-12
BRAIN STANDARD pinza de aplicación clip	EA-12
BRAITHWAITE dermatomo	AG-22
BRAUN	
cranioclasto	HC-09
depresor uterino	HA-39
espéculo vaginales	HA-16
gancho de decapitación	HC-09
pinza pra coger el cuello de útero	HA-31, HA-34
BRAUN-STADLER tijeras para episiotomía	AH-22, AI-34
BREISKY espéculo vaginales	HA-20
BROCK	
abertura dilatador para válvula mitral	FG-26
cortante dilatador para válvula mitral	FG-26
mango dilatador para válvula mitral	FG-26
BROWN pinza de disección	BA-03
BRUENINGS	
abajalengua	EI-02
cierranudos amígdalas	FA-04
cuchillo tabique	EG-11
espéculos auriculares	EE-02
pinza cortantes para nasales	EG-05
pinza laringe	FC-03
tubo alarmiento	FC-03
BRUNETTI cincel espinal	DC-17
BRUNNER	
costotomo	FG-07
pinza intestinales	GE-06
sonda conductora	CG-04
BRUNS	
cucharilla cortante	DC-12 hasta DC-13
tijeras para yeso	AI-48
BRYANT pinza porta esponjas	BG-11
BUCHWALD abajalengua	EI-02
BUCK	
cureta auriculares	EE-05
elevadores cuerpos extraños	EE-08
martillos de percusión	AC-07
tijeras para puntas	AI-40
BUIE tubo de aspiracion	GI-05
Bujía	
COXETER uretrales	GG-17
DITTEL uretrales	GG-18 hasta GG-19
GUYON uretrales	GG-12, GG-14 hasta GG-15
VAN BUREN uretrales	GG-13
WALTHER uretrales	GG-17
BUMM	
cureta uterinas	HA-49 hasta HA-50
pinza para el útero	HA-38
BUNGE cucharilla para exentracion	EC-07
BUNNELL	
perforador a mano	DD-05
separador tendones	DC-25
BUNT clip para esterilización	CI-02
BURCH horquilla fijadora	EC-05

BURKE-Baby pinza sacabocado	
para el cuello del útero	HA-44
BURKE pinza sacabocado para el cuello del útero	HA-44
BUSCH tijeras para umbilicales	AI-34

C

Cable	
AESCULAP electrobisturías	JA-07
ERBE SELECT electrobisturías	JA-07
MARTIN electrobisturías	JA-07
USA electrobisturías	JA-07
Caja	
para agujas	HE-02
SAUERBRUCH para agujas	HE-02
Canula	
Bonn irrigacion	ED-07
Hamburg canula abotonada	ED-07
KILLIAN	EG-09
SCHEIE oculares	ED-07
Cánulas FINSTERER para aspiración e irrigación	AE-05
Canula	
SIMCOE sutura	ED-07
Tübingen aire	ED-07
Capsular DASTOOR aspirador	EC-09
CARMALT pinza para espinas	BA-06
CARPENTER cuchillo para amígdalas	FA-02
CASPAR	
especulo para lumbar vertebral	BI-20
mango de bisturías micro	AG-12
separador	BI-20
separador para columna espinal	BI-18
separador para columna vertebral	BI-19
valva	BI-20
valva para columna vertebral	BI-19
CASTAÑEDA	
pinza atraumatica para nacidos y niños	BD-42
separador costales	FG-14
CASTROVIEJO	
blefarostato	EC-03
dilatador canal lacrimonal	EC-10
espatula ciclodialálisis	EC-08 hasta EC-09
marcador compas	EC-09
pinza capsulares	ED-04
pinza fijación	ED-03
pinza sutura	ED-05
porta-aguja	CE-07
queratomo	EC-04
rompe hojas	AG-14
tijeras para corneal	AJ-06
tijeras para iridectomía	AJ-05
trépano para corneal	ED-07
Cateter	
HARTMANN auriculares	EE-06
ITARD auriculares	EE-06
merálicas para hombre	GG-16
merálicas para mujer	GG-16
CATLIN cuchillo para amputación	AG-16
Cauterio WADSWORTH-TODD	EC-08
Cefalómetro BERTILLON	AC-08
Cepillo de limpieza	CI-04 hasta CI-05
CHAPUT pinza hemostática	BC-08
CHARRIERE	
hoja de recambio	DD-03
sierra para amputacion	DD-03
CHEATLE pinza para esterilización	CI-02
CHERON pinza para tapones	BG-12
CHEVALIER-JACKSON pinza laringe	FC-04
CHEVALLIER separador costales	FG-15
CHILDE pinza para grapas	CG-07
Cierranudo	

KRAUSE auriculares.....	EE-07
Cierranudos	
BRUENINGS amígdalas.....	FA-04
EVES amígdalas.....	FA-04
KRAUSE para nasales.....	EG-09
TYDING amígdalas.....	FA-05
WILDE para nasales.....	EG-09
Cierranudo	
WESTON polipus rectal.....	GI-05
WILDE auriculares.....	EE-07
Cinzel.....	DC-14
ALEXANDER.....	DC-14
CINELLI plástica para nasales.....	EG-13
COTTLE plástica para nasales.....	EG-13
DIX para cuerpos extraños.....	EC-06
Cinzel espinal BRUNETTI.....	DC-17
Cinzel esternon LEBSCHÉ.....	DC-17
Cinzel	
FOMON plástica para nasales.....	EG-13
FREER tabique.....	EG-12
HIBBS.....	DC-16
HOKE.....	DC-16
LEXER.....	DC-16
LEXER mini.....	DC-16
PARTSCH.....	DC-14
ROLLET para extirpación.....	EC-06
SILVER plástica para nasales.....	EG-14
SMITH-PETERSEN.....	DC-15
STILLE.....	DC-14
WEST para nasales.....	EG-14
CINELLI cinzel plástica para nasales.....	EG-13
Cinta de métrica.....	AC-08
Cinta sola PARHAM.....	DC-11
CITELLI pinza sacabocado.....	EG-08
Cizalla	
SEUTIN para yeso.....	DA-02
STILLE para yeso.....	DA-02
Clamp	
COLLIN para umbilicales.....	HC-06
COOLEY de bulldog atraumática.....	BD-33 hasta BD-34
DE BAKEY de bulldog atraumática.....	BC-02
DIEFFENBACH de bulldog para sierra-fina.....	BC-03
GLOVER de bulldog atraumática.....	BC-02
JOHNS-HOPKINS de bulldog para sierra-fina.....	BC-03
KANE para umbilicales.....	HC-06
LOWMAN para huesos.....	DC-11
CLARK blefarostato.....	EC-02
CLAR	
lámpara frontal.....	AC-05
mini.....	AC-05
Clavo para huesos STEINMANN.....	DD-09
CLEVELAND pinza gubia.....	DC-02
Clip	
BRAIN standard.....	EA-13
BRAIN temporarios.....	EA-12
BUNT para esterilización.....	CI-02
EDWARDS.....	BD-21
MAYO para esterilización.....	CI-02
CLOWARD	
separador.....	BI-17
separador para cuerpos vertebrales.....	EA-07
COAKLEY	
cureta para seno.....	EG-18
trócar.....	CC-02
Cobo para desechos.....	HE-11
COLCLOUGH pinza sacabocado	
para discos intervertebrales.....	EA-11
COLLIER porta-aguja.....	CE-02
COLLIN	
clamp para umbilicales.....	HC-06
dinamómetro.....	AC-03

COLLIN-DUVAL pinza de disección.....	BA-04
COLLIN	
especulo vaginales.....	HA-04
COLLIN-HARTMANN separador.....	BI-03
COLLIN	
histerómetro.....	HA-39
mango de bisturíes.....	AG-08
martillo.....	DC-18
pelvómetro.....	HC-06
pinza hemostática.....	BC-08
pinza para el útero.....	HA-37
pinza para grapas.....	CG-07
pinza para tapones.....	BG-11
pinza tiralengua.....	EI-03
COLLIN-POZZI pinza para coger el cuello de útero.....	HA-32
COLLIN	
separador abdominales.....	BI-24 hasta BI-25
COLLYER pelvómetro.....	HC-06
COLVER pinza coger amígdalas.....	FA-03
Compresor CORWIN amígdalas.....	FA-04
Compresor	
STOCKMANN uretrales.....	GG-10
STRAUSS uretrales.....	GG-10
CONNIN-AMSLER marcador.....	EC-09
Cono	
de oclusión.....	HA-47
KNUTSON-KOCH para uretrografía.....	GG-09
Contenedores para esterilización	
3/4.....	HE-22 hasta HE-24
especiales.....	HE-34 hasta HE-37
grandes.....	HE-18 hasta HE-20
medianos.....	HE-26 hasta HE-29
medianos y planos.....	HE-30 hasta HE-31
pequeños.....	HE-32 hasta HE-33
CONVERSE bisturí para nasales.....	EG-10
COOLEY	
clamp de bulldog atraumática.....	BD-33 hasta BD-34
costotomo primera.....	FG-05
COOLEY DERRA pinza atraumática anastomosis.....	BD-39
COOLEY	
dilatador para válvula mitral.....	FG-27 hasta FG-29
dilatador para vasculares.....	FG-30
COOLEY modif. STRUCK separador atrium.....	FG-20
COOLEY	
pinza atraumática BB-03, BD-35 hasta BD-37, BD-39, BD-41	
pinza atraumática anastomosis.....	BD-37, BD-40
pinza atraumática iliaca.....	BD-37
pinza atraumática pediátricas.....	BD-38 hasta BD-39
pinza para vascular.....	BD-40
separador atrium.....	FG-20
separador costales.....	FG-09
COOPER aguja para ligaduras.....	CG-02
Copa graduada.....	HE-07
CORDES pinza laringe.....	FC-03
Corta-anillos.....	DD-03
DIMEDA.....	DD-03
Corta-callos CREDO.....	HE-03
Corta-grapas.....	EA-02
Cortante BROCK dilatador para válvula mitral.....	FG-26
CORWIN compresor amígdalas.....	FA-04
CORYLLOS costotomo.....	FG-04
CORYLLOS (Thorax) separador.....	BI-13
Costotomo.....	FG-02
Costotomo	
BETHUNE.....	FG-04
BRUNNER.....	FG-07
COOLEY primera.....	FG-05
CORYLLOS.....	FG-04
GIERTZ-STILLE.....	FG-06
Costotomo	
GLUCK.....	FG-03

S

Índice alfabético Español

Costotomo			
SAUERBRUCH	FG-05	
SAUERBRUCH-FREY	FG-06	
Costótomo			
STILLE	FG-03	
COTTLE			
cincel plástica para nasales	EG-13	
cuchillo para nasales	EG-10	
elevadores periostotomo	EG-12	
elevadores tabique	EG-12	
espéculo para nasales	EG-03	
COTTLE-KAZANJIAN pinza cortante para huesos	DC-06	
COTTLE-NEIVERT separador para nasales	EG-17	
COTTLE			
separador para nasales	EG-17	
tijeras para nasales	AH-18, AI-25	
COXETER bujía uretrales	GG-17	
CRAFOORD			
pinza hemostática bronquial	BC-12	
tijeras para pulmonares	AI-36	
Cranioclasto			
BRAUN	HC-09	
TARNIER	HC-09	
CREDO corta-callos	HE-03	
CRILE-MURRAY porta-aguja	CE-02	
CRILE			
pinza hemostática	BC-05	
porta-aguja	CE-04	
CRILE-RANKIN pinza hemostática	BC-05	
CRILE			
separador	BI-02	
CRILE TITAN pinza hemostática	BC-05	
CRILE-WOOD porta-aguja	CE-02	
CRITCHETT blefarostato	EC-02	
CRUTCHFIELD			
perforador para inicial	EA-03	
pinza de tracción craneal	EA-03	
CRUZ ROJA tijeras de vendajes	AI-47	
Cuadro KIRSCHNER	BI-23	
Cubeta			
para placenta	HE-06	
PETRI	HE-08	
redonda	HE-04 hasta HE-05	
Cuchara			
DESJARDINS para cálculos biliares	GC-08	
FERGUSON para cálculos biliares	GC-07	
LUER-KOERTE para cálculos biliares	GC-09	
MAYO para cálculos biliares	GC-07	
MOORE para cálculos biliares	GC-05	
Cucharilla			
AXENFELD para chalazion	EC-07	
BRUNS cortante	DC-12 hasta DC-13	
BUNGE para exentracion	EC-07	
DAVIEL para cataratas	EC-07	
GRAEFE para cataratas	EC-07	
GUTMANN para secreciones	GG-11	
HALLE cortante	DC-13	
HEBRA para chalazion	EC-07	
KNAPP para cataratas	EC-07	
LEMPERT cortante	DC-13	
MARTINI cortante	DC-13	
MEYHOEFER para chalazion	EC-07	
SCHEDE cortante	DC-12	
SIMON cortante	DC-13	
SPRATT cortante	DC-12	
VOLKMANN cortante	DC-12 hasta DC-13	
WILLIGER cortante	DC-13	
Cuchillo			
BALLENGER	EG-11	
BARKAN para goniotomía	EC-05	
BARNHILL	EG-19	
BARRAQUER para queratoplastico	EC-05	
BECKMANN	EG-19	
BOWMAN para discision	EC-04	
BRUENINGS tabique	EG-11	
CARPENTER para amigdalas	FA-02	
CATLIN para amputación	AG-16	
COTTLE para nasales	EG-10	
DEAN para iris	EC-04	
DEUTSCHMANN para catarata	EC-03	
ELSCHNIG para corneal	EC-05	
ESMARCH para yesos	DA-04	
FREER tabique	EG-10	
GILL para corneal	EC-05	
GRAEFE para catarata	EC-03	
HOPKINS para yesos	DA-04	
KNAPP para iris	EC-04	
LANGENBECK para resección	AG-17	
LISTON para amputación	AG-16	
MUCK periostio	EE-15	
OTIS de repuesto	GG-08	
Cuchillo para amputación	AG-16	
Cuchillo para cartílagos	AG-18	
Cuchillo para yesos	DA-04	
Cuchillo			
PAUFIQUE para queratoplastico	EC-05	
PLESTER lobar	EE-14	
POLITZER auriculares	EE-06	
REINER para yesos	DA-04	
ROSEN circular	EE-14	
SATO para corneal	EC-05	
SCHEIE para goniotomía	EC-05	
SCHUKNECHT circular	EE-14	
SCHUKNECHT forma hoz	EE-14	
SEXTON auriculares	EE-06	
St. CLAIR-THOMSON	EG-19	
TABB forma hoz	EE-14	
TOOK para corneal	EC-05	
VIRCHOW para cartílagos	AG-18	
VIRCHOW para cerebro	AG-18	
WHEELER para discision	EC-04	
WULLSTEIN forma hoz	EE-14	
ZIEGLER capsulotomía	EC-05	
ZIEGLER para iridectomía	EC-04	
CULLER espátula para iris	EC-08	
Cuna	HE-06	
Cureta			
ALVIS para cuerpos extraños	EC-06	
aspiradora	HA-51	
BLAKE uterinas	HA-48	
BUCK auriculares	EE-05	
BUMM uterinas	HA-49 hasta HA-50	
COAKLEY para seno	EG-18	
CUZZI para aborto y placenta	HC-08	
FAULKNER	EG-18	
FOX para lupus	HE-02	
GOURDET uterinas	HA-48	
GROSS auriculares	EE-06	
HOUSE	EE-15	
KEVORKIAN aspiradoras			
para la biopsia uterina	HA-40	
LANG	EC-08	
NOVAK aspiradoras para la biopsia uterina	HA-40	
PESTALOZZA para aborto y placenta	HC-08	
PIFFARD para lupus	HE-02	
RANDALL aspiradoras para la biopsia uterina	HA-40	
RECAIMER uterinas	HA-49 hasta HA-50	
SCHROEDER uterinas	HA-48	
SIMON uterinas	HA-48	
SIMS uterinas	HA-49 hasta HA-50	
WALLICH para aborto y placenta	HC-08	
CUSCO espéculo vaginales	HA-04 hasta HA-06	

CUSHING	
espátulas cerebral.....	EA-07
gancho para nervios.....	EA-04
perforadores plano.....	DD-04
pinza cortantes para laminectomía.....	EA-08
pinza de disección.....	BA-03
separador.....	BI-07
Cuticular.....	HE-03
CUZZI cureta para aborto y placenta.....	HC-08
CZERNY	
espéculo rectales.....	GI-02
pinza para cálculos biliares.....	GC-03
pinza para coger el cuello de útero.....	HA-34

D

DALE pinza atraumatica para vasculares perif.....	BD-24
DANDY	
gancho para nervios.....	EA-04
pinza hemostática.....	BC-07
tijeras para neuroquirurgicas.....	AI-36
DARDIK pinza atraumatica.....	BD-07
DARLING separador.....	BI-17
DARTIGUES pinza para el útero.....	HA-37
DASTOOR	
capsular aspirador.....	EC-09
pinza para estrabismo.....	EC-14
DAVIDSON (Scapula) separador.....	BI-13
DAVIEL cucharilla para cataratas.....	EC-07
DAVIS	
aguja para cuerpos extraños.....	EC-05
DAVIS-BOYLE abreboca.....	EI-04
DAVIS	
descolador duramadre.....	EA-05
pinza para esterilización.....	CI-02
DAY ganchito auriculares.....	EE-07
DEAN	
cuchillo para iris.....	EC-04
tijeras para amígdalas.....	AI-26
DEAVER Grip separador.....	BI-05
DEAVER	
separador.....	BI-05
tijeras.....	AH-05, AI-06
DEBAKEY BAHNSON	
pinza atraumatica aneurisma de aorta.....	BD-14
DE BAKEY	
clamp de bulldog atraumatica.....	BC-02
dilatador para vasculares.....	FG-31
DE BAKEY MORRIS pinza atraumatica.....	BD-16
DE BAKEY	
pinza atraumatica.....	BB-03
DEBAKEY pinza atraumatica.....	BD-02, BD-08
DE BAKEY	
pinza atraumatica.....	BD-16 hasta BD-17
DEBAKEY pinza atraumatica.....	BD-20
DE BAKEY	
pinza atraumatica.....	BD-28 hasta BD-30
pinza atraumatica anastomosis.....	BD-25
pinza atraumatica aneurisma	
de aorta.....	BD-13, BD-15, BD-18
pinza atraumatica bronquiales.....	BD-19
pinza atraumatica de disección y ligadura.....	BD-25, BD-32
pinza atraumatica iliaca.....	BD-11
pinza atraumatica para vasculares perif.....	BD-06
porta-aguja.....	CE-03
DE BAKEY REYNOLDS	
pinza atraumatica anastomosis.....	BD-30
DEBAKEY SATINSKY pinza atraumatica.....	BD-22
DE BAKEY	
tijeras para vasculares.....	AI-30
tubo de aspiración.....	AE-04
Dedal LANGENBECK.....	EI-06
DEJERINE martillos de percusión.....	AC-07
De LEE pinza obstétricas.....	HC-02
De MARTEL guía-sierra.....	EA-05
DeMARTEL-WOLFSON pinza para anastomosis.....	GE-07
DENHART abreboca.....	EI-03
Depresor	
BRAUN uterino.....	HA-39
REICHERT epiglotis.....	FC-02
SIMS uterino.....	HA-39
DERF porta-aguja.....	CE-02
Dermátomo	
BRAITHWAITE.....	AG-22
hoja.....	AG-21
HUMBY.....	AG-20
SCHINK.....	AG-21
SILVER.....	AG-20
WATSON.....	AG-22
DERRA pinza atraumatica anastomosis, pediátricas.....	BD-28
DESCHAMPS aguja para ligaduras.....	CG-02
Descolador	
DAVIS duramadre.....	EA-05
duramadre.....	EA-05
FISCH.....	EE-15
HORSLEY duramadre.....	EA-06
MILLIGAN duramadre.....	EA-05
PENFIELD duramadre.....	EA-06
SACHS duramadre.....	EA-05
TOENNIS duramadre.....	EA-05
DESJARDINS	
cuchara para cálculos biliares.....	GC-08
pinza para cálculos biliares.....	GC-02
pinza via billar.....	BC-15
sonda para cálculos biliares.....	GC-05
DESMARRES	
pinza chalazión.....	ED-06
separador.....	BI-07
Destornillador.....	DD-14 hasta DD-15
LANE.....	DD-14
WILLIAMS.....	DD-14
DEUTSCHMANN cuchillo para catarata.....	EC-03
DeVILBISS pinza craneanea.....	EA-05
DEWEY pinzas obstétricas	
con dispositivo de tracción.....	HC-05
Diagnóstico Juego para.....	AC-04
DIAMANT pinza corta-hilo.....	DD-12
Diapasones.....	EE-04
DIMEDA Alu.....	EE-03
HARTMANN.....	EE-03
LUCAE.....	EE-04
RYDEL-SEIFFER.....	EE-04
DIEFFENBACH clamp de bulldog para serra-fina.....	BC-03
DIETER pinza la cabeza del martillo.....	EE-10
DIETHRICH	
pinza atraumatica.....	BD-31
porta-aguja para vascular.....	CE-06
tijeras para vasculares.....	AI-29
Dilatador	
BAKES para conducto biliar.....	GC-06
CASTROVIEJO canal lacrimal.....	EC-10
COOLEY para válvula mitral.....	FG-27 hasta FG-29
COOLEY para vasculares.....	FG-30
DE BAKEY para vasculares.....	FG-31
GERBODE para válvula mitral.....	FG-28
GOODELL uterinos.....	HA-30
HANK uterinos.....	HA-28
HEGAR uterinos.....	HA-24 hasta HA-27
HETZER para válvula mitral.....	FG-29
KUENTSCHER.....	DD-13
LABORDE traqueal.....	FE-02
MILLIN para el cuello vesical.....	GG-07

S

Índice alfabético Español

PRATT uterinos.....	HA-29
SIMS uterinos.....	HA-30
TROUSSEAU traqueal.....	FE-02
TUBBS para válvula mitral.....	FG-27
WILDER canal lacrimonal.....	EC-10
WYLIE uterinos.....	HA-30
ZIEGLER canal lacrimonal.....	EC-10
DIMEDA Alu diapasones.....	EE-03
DIMEDA	
corta-anillos.....	DD-03
estilete.....	CA-03
iman oculístico.....	ED-08
pinza para desechos.....	CI-03
rompe hojas.....	AG-14
separador.....	BI-14
tijeras de vendajes.....	AI-46
Dinamometro COLLIN.....	AC-03
DINGMANN pinza para huesos.....	DC-10
Disecador	
GREEN para corneal.....	EC-06
HURD para amígdalas.....	FA-02
PATON para la cornea.....	EC-05
Disector ROBB para vasculares.....	FG-33
DITTEL	
bujía uretrales.....	GG-18 hasta GG-19
introdutor de catéter.....	GG-11
DIX	
aguja.....	EC-09
cincel para cuerpos extraños.....	EC-06
DOUGLAS	
pinza depilatorias.....	ED-08
trócar.....	CC-02
DOYEN-Baby pinza intestinales.....	GE-03
DOYEN	
especulo vaginales.....	HA-18, HA-20
fresa.....	DD-07
DOYEN-JANSEN abreboca.....	EI-03
DOYEN	
periotótomos para costillas.....	DC-20
pinza intestinales.....	GE-03
pinza para campos.....	BE-05
pinza para polipe uterino.....	HA-36
separador.....	BI-12
sonda.....	CA-02
tijeras para ginecológicas.....	AI-33
tirabuzón para fibroma.....	HA-46
DUBOIS tijeras para ginecológicas.....	AI-33
DUPLAY	
pinza para tapones.....	BG-14
pinza para coger el cuello de útero.....	HA-31
DUPUY-WEISS pinza aguja.....	FA-03
DUVAL	
pinza de disección.....	BA-04
pinza para tejidos.....	GE-03

E

ECHLIN pinza gubia.....	DC-05
EDWARDS	
clip.....	BD-21
pinza para aplicar clips.....	BD-21
Electrodo para coagulación mini.....	JA-02 hasta JA-03
Elevador	
ADSON.....	DC-21
BENNETT para huesos.....	DC-22
BLOUNT para huesos.....	DC-24
Elevadores	
BALLENGER tabique.....	EG-12
BUCK cuerpos extraños.....	EE-08
COTTLE periototomo.....	EG-12
COTTLE tabique.....	EG-12

FREER tabique.....	EG-11
HAJEK-BALLENGER tabique.....	EG-12
JOSEPH periototomo.....	EG-12
KILLIAN tabique.....	EG-12
McKENTY tabique.....	EG-11
QUIRE cuerpos extraños.....	EE-08
ROGER tabique.....	EG-11
Elevador	
HENKE para amígdalas.....	FA-02
HOHMANN mini para huesos.....	DC-23
HOHMANN para huesos.....	DC-22 hasta DC-23
KEY.....	DC-21
LANGENBECK.....	DC-21
LEMPERT.....	EE-15
McDONALD.....	DC-22
MURLESS para cabeza.....	HC-05
MURPHY-LANE.....	DC-22
para huesos.....	DC-23
WATSON-CHEYNE.....	DC-22
ELLIOT	
pinza obstétricas.....	HC-02
trépano para corneal.....	ED-08
ELLIS gubia para cuerpos extraños.....	EC-06
ELSAESSER pinza para nephrostomía.....	GC-13
ELSCHNIG	
cuchillo para corneal.....	EC-05
espatula ciclodialísis.....	EC-08
pinza capsulares.....	ED-04
pinza fijación.....	ED-03
Embudos	HE-07
EMMET gancho para fistula.....	HA-46
ENGEL sierra para yesos.....	DA-02
Ensordecidor BARANY.....	EE-04
EPPENDORFER-KEVORKIAN	
pinza sacabocado para el cuello del útero.....	HA-46
EPPENDORFER pinza sacabocado	
para el cuello del útero.....	HA-45 hasta HA-46
EPPENDORFER TISCHLER-MORGAN	
pinza sacabocado para el cuello del útero.....	HA-46
ERBE SELECT cable electrobisturías.....	JA-07
Escariadores	DD-08
PERTHES.....	DD-08
Escarificador GRAEFE.....	EC-04
Esclerotomo	
GUYTON-LUNDSGAARD.....	EC-05
LUNDSGAARD.....	EC-05
Escupideras	HE-06
Esférica	DD-04
Esfigmomanómetros	AC-02
ESMARCH	
cuchillo para yesos.....	DA-04
tijeras de vendajes.....	AI-46
Espátula	CA-03
ALLISON pulmón.....	FG-19
Espátula	
BANGERTER ciclodialísis.....	EC-08
CASTROVIEJO ciclodialísis.....	EC-08 hasta EC-09
CULLER para iris.....	EC-08
ELSCHNIG ciclodialísis.....	EC-08
KOCHER vesical.....	GG-04
LEGUEU vesical.....	GG-04
Espátula	
para la íntima.....	FG-32
Espátulas	
CUSHING cerebral.....	EA-07
HEIFETZ cerebral.....	EA-07
OLIVECRONA cerebral.....	EA-07
Espatula	
WECKER para iris.....	EC-08
WELLS enucleación.....	EC-08
WHEELER ciclodialísis.....	EC-09

Espéculo	
AUVARD vaginales	HA-19
BARR rectales	GI-02
BERLIND-AUVARD vaginales	HA-19
BODENHAMMER rectales	GI-02
BRAUN vaginales	HA-16
BREISKY vaginales	HA-20
Especulo CASPAR para lumbar vertebral	BI-20
Espéculo	
COLLIN vaginales	HA-04
COTTLE para nasales	EG-03
CUSCO vaginales	HA-04 hasta HA-06
CZERNY rectales	GI-02
DOYEN vaginales	HA-18, HA-20
FREEWAY-GRAVE vaginales	HA-06
GRAVE vaginales	HA-02
HARTMANN-HALLE para nasales	EG-02
JACKSON vaginales	HA-16
KALLMORGEN vaginales	HA-15
KILLIAN tabique	EG-03
KOGAN endocervicales	HA-23
KRISTELLER vaginales	HA-09 hasta HA-14
LANDAU vaginales	HA-22
MATHIEU rectales	GI-02
O'SULLIVAN-O'CONNOR vaginales	HA-08
PEDERSON vaginales	HA-03
PRATT rectales	GI-02
Espéculos	
BOUCHERON auriculares	EE-02
BRUENINGS auriculares	EE-02
Espéculo	
SCHERBAK vaginales	HA-21
SEMM vaginales	HA-07
Espéculos	
GRUBER auriculares	EE-02
HARTMANN auriculares	EE-02
Espéculo	
SIMS rectales	GI-02
SIMS vaginales	HA-17
Espéculos	
SIEGLE auriculares	EE-02
Espéculo	
STEINER-AUVARD vaginales	HA-19
Espéculos	
TOYNBEE auriculares	EE-02
Espéculo	
THUDICHUM para nasales	EG-02
TIECK-HALLE para nasales	EG-03
TRELAT vaginales	HA-07
Vienna para nasales	EG-02
VOLTOLINI para nasales	EG-02
WEISSBARTH vaginales	HA-22
YANKAUER nasofaringe	EG-04
Espejo frontal ZIEGLER	AC-05
Espejo	
laringeos	FC-04
MICHEL	EG-04
Estetoscopio	
BOWLES	AC-06
Estetoscopio duplex	AC-06
Estetoscopio	
FORD	AC-06
FORD BOWLES	AC-06
PINARD	AC-06
Estilete	CA-03
DIMEDA	CA-03
FARREL	CA-03
JOBSON-HORNE	CA-03
MAGILL para tubo	AE-04
TOBOLD	CA-03
UCKERMANN	CA-03

Estríbo	
BOEHLER para extensión	DD-10
KIRSCHNER para extensión	DD-10
para extensión	DD-10
Estuche	
acero inoxidable	HE-03
caja	HE-03
Estuche de bolsillo y de sutura	
mini	CG-08
standard	CG-08
EVES cierranudos amigdalas	FA-04
Extractor KUENTSCHER	DD-13

F

FARABEU-F-LAMBOTTE pinza para huesos	DC-08
FARABEU	
periostótomo	DC-19
pinza para huesos	DC-07
separador	BI-02
FARREL estilete	CA-03
FAULKNER cureta	EG-18
FAURE	
pinza para peritoneo	BC-17
pinza sacabocado para el cuello del útero	HA-41
FEHLAND pinza intestinales	GE-06
FEILCHENFELD pinza para espinas	BA-06
FERGUSON	
cuchara para cálculos biliares	GC-07
pinza hemostática	BC-07
pinza para huesos	DC-07
tijeras	AI-49
FERRIS pinza de disección	BA-04
FERRIS-SMITH-KERRISON	
pinza sacabocado para discos intervertebrales	EA-10
FERRIS-SMITH pinza cortantes para laminectomía	EA-09
FILIFORM sonda	GG-12
FINOCHIETTO-BABY separador costales	FG-09
FINOCHIETTO BURFORD	
separador costales	FG-12 hasta FG-14
FINOCHIETTO-HAIGTH BABY separador costales	FG-10
FINOCHIETTO INFANT separador costales	FG-12
FINOCHIETTO (modif) separador costales	FG-08
FINOCHIETTO	
pinza bronquiales	FG-21
porta-aguja	CE-04
separador costales	FG-08, FG-10 hasta FG-11
tijera para recto	AI-38
FINSEN separador	BI-14
FINSTERER cánulas para aspiración e irrigación	AE-05
FISCH descolador	EE-15
FISCHER pinza para iris	EC-13
Fleboextractores	CA-03
FLETCHER JAVERTS pinza porta esponjas	BG-10
FLEURANT trócar	CC-02
FOERSTER	
pinza para iris	EC-12
pinza porta esponjas	BG-06 hasta BG-08
FOMON	
cíncel plástica para nasales	EG-13
lima para nasales	EG-15 hasta EG-16
separador para nasales	EG-17
tijeras para nasales	AH-18, AI-25
Fórceps	
BARTON obstétricos	HC-04
BOERMA obstétricos	HC-04
De LEE obstétricos	HC-02
DEWEY obstétricos con dispositivo de tracción	HC-05
ELLIOT obstétricos	HC-02
KIELLAND-LUIKART obstétricos	HC-03
KIELLAND obstétricos	HC-02

S

Índice alfabético Español

LUIKART obstétricos	HC-03
McLEAN-LUIKART obstétricos	HC-03
McLEAN obstétricos	HC-04
McLEAN-TUCKER-LUIKART obstétricos	HC-03
NAEGELE obstétricos	HC-03
PIPER obstétricos	HC-04
PIPER obstétricos con dispositivo de tracción	HC-04
SIMPSON-BRAUN obstétricos	HC-02
SIMPSON-LUIKART obstétricos	HC-03
SIMPSON obstétricos	HC-02
TARNIER obstétricos con dispositivo de tracción	HC-05
WRIGLEY obstétricos	HC-02
FORD BOWLES estetoscopio	AC-06
FORD estetoscopio	AC-06
FOX cureta para lupus	HE-02
FRAENKEL	
pinza laringe	FC-03
pinza polipus laringe	FC-02
FRANCESCHETTI trépano para corneal	ED-07
FRANCIS aguja para cuerpos extraños	EC-05
FRANKLIN-SILVERMANN aguja para punción	CC-03
FRAZIER	
ganchito	BI-06
separador	BI-21
tubo de aspiración	EA-07
FREER	
bisturi mucosa	EG-10
cincel tabique	EG-12
cuchillo tabique	EG-10
elevadores tabique	EG-11
gubia	EG-14
FREEWAY-GRAVE espéculo vaginales	HA-06
FRENZEL abajalengua	EI-02
Fresa	DD-07
ALBEE	DD-07
BORCHARDT	DD-07
Fresa cónica HUDSON	DD-04
Fresa	
DOYEN	DD-07
para corticalis	DD-15
TOTI	DD-07
FRIEDMAN MINI pinza gubia, mini	DC-02
FRIEDMAN	
pinza gubia	DC-02
separador perineorraf	HA-23
FRITSCH separador	BI-11
FRYKHOLM pinza gubia	DC-05
FUCHS pinza capsulares	ED-04

G

GALLAHER lima para seno	EG-16
Ganchito	EE-15
BARBARA	EE-14
DAY auriculares	EE-07
FRAZIER	BI-06
GILLIES	EG-17
GRAEFE	BI-06
GUTHRIE	BI-06
JOSEPH	BI-06
KILNER para la piel	HE-02
WAGENER auriculares	EE-07
Gancho	
ADSON para nervios	EA-04
ARRUGA para extracción	EC-06
BOSE traqueal	FE-02
BRAUN de decapitación	HC-09
CUSHING para nervios	EA-04
DANDY para nervios	EA-04
de extracción	DD-13
electrodo mini	JA-02

EMMET para fístula	HA-46
GRAEFE para estrabismo	EC-06
GRAEFE-TITAN para estrabismo	EC-06
GRAHAM para nervios	EA-04
GREEN muscular	EC-06
ITERSON traqueal	FE-02
JAMESON para estrabismo	EC-06
LOVE para nervios	EA-04
O' CONNOR para iris	EC-06
para extensión	DD-10
PRATT cístico	GI-04
ROSE traqueal	FE-03
SACHS para nervios	EA-04
SMELLIE obstetrico	HC-06
SMITHWICK para nervios	EA-04
STEVENS para cristalino	EC-06
WIENER para iris	EC-06
Garrote MAUNDER madera	EI-06
GAUSS pinza para pericraneos	HC-06
GELLHORN pinza sacabocado	
para el cuello del útero	HA-42
GELPI separador abdominales	BI-24
GEMINI MINI pinza de disección y ligadura	BC-10
GEMINI pinza de disección y ligadura	BC-10
GERALD pinza de disección	BA-05
GERBODE dilatador para válvula mitral	FG-28
GERSTER barra de tracción	DC-11
GERZOG martillo	DC-18
GIERTZ-STILLE costotomo	FG-06
GIGLI mango para sierra	EA-05
GILL-ARRUGA pinza capsular	ED-03
GILL	
cuchillo para corneal	EC-05
GILL-HESS pinza para iris	EC-12
GILLIES	
ganchito	EG-17
pinza de disección	BA-05
porta-aguja	CE-05
GILL	
pinza para iris	EC-12
GLOVER	
clamp de bulldog atraumática	BC-02
pinza atraumática	BD-06, BD-30
pinza atraumática anastomosis	BD-05
pinza para coacción atraumática	BD-04
GLUCK costotomo	FG-03
GOELET separador	BI-03
GOLDMAN-FOX tijeras para encías	AI-41
GOLDSTEIN blefarostato	EC-03
Goniómetro MOELTGEN	AC-08
GOODELL dilatador uterinos	HA-30
GOOD tijeras para amígdalas	AI-27
GORNEY tijera de disección	AI-13
GOSSET separador abdominales	BI-21
GOURDET cureta uterinas	HA-48
GRADLE pinza depilatorias	ED-08
GRAEFE	
blefarostato	EC-02
cucharilla para cataratas	EC-07
cuchillo para catarata	EC-03
escarificador	EC-04
ganchito	BI-06
gancho para estrabismo	EC-06
pinza de disección	BA-03
pinza fijación	ED-03
pinza para iris	EC-11
quistotomo	EC-06
GRAEFE-TITAN gancho para estrabismo	EC-06
GRAHAM gancho para nervios	EA-04
Grapas MICHEL	CG-07
GRAVE espéculo vaginales	HA-02

GRAY pinza via billar	BC-15
GREEN-ARMYTAGE pinza-clamp uterina para hemostasis	HC-06
GREEN	
disecador para corneal	EC-06
gancho muscular	EC-06
pinza fijación	ED-03
separador	BI-10
GREGORY pinza atraumatica profunda	BD-33
GREVEN pinza auriculares micro	EE-10
GRIP pinza para agarrar	DD-11
GROSS	
cureta auriculares	EE-06
GROSS-MAIER pinza para tapones	BG-02 hasta BG-04
GROSS	
pinza para tapones	BG-05
GRUBER espéculos auriculares	EE-02
Gubia	DC-14
ALEXANDER	DC-14
ELLIS para cuerpos extraños	EC-06
FREER gubia	EG-14
HAJEK para nasales	EG-14
HIBBS	DC-16
KILLIAN-CLAUS para nasales	EG-14
LEXER	DC-16
LEXER mini	DC-16
PARTSCH	DC-14
SMITH-PETERSEN	DC-15
STILLE	DC-14
WALTON para cuerpos extraños	EC-06
WEST para nasales	EG-14
Guia-sierra De MARTEL	EA-05
GUTHRIE ganchito	BI-06
GUTMANN cucharilla para secreciones	GG-11
GUYON	
bujia uretrales	GG-12, GG-14 hasta GG-15
introdutor de catere	GG-11
pinza para pedícula renal	BC-16
GUYTON-LUNDSGAARD esclerotomo	EC-05

H

HABERER separador	BI-04
HAGLUND-STILLE separador para yesos	DA-03
HAIGHT separador costales	FG-15
HAJEK-BALLENGER elevadores tabique	EG-12
HAJEK-CLAUS pinza seno maxil	EG-08
HAJEK gubia para nasales	EG-14
HAJEK-KOFLER pinza sacabocado	EG-08
HALLE	
bisturi para duramadre	EA-06
cucharilla cortante	DC-13
HALSEY porta-aguja	CE-02
HALSTED-MOSQUITO micro pinza hemostática	BC-04
HALSTED-MOSQUITO	
pinza atraumatica	BD-02
pinza hemostática	BC-04
HALSTED-MOSQUITO TITAN pinza hemostática	BC-04
Hamburg canula abotonada	ED-07
HANK dilatador uterinos	HA-28
HARKEN pinza atraumatica auricula	BD-23
HARRINGTON	
pinza bronquiales	FG-21
separador	BI-05
HARTMANN	
abajalengua	EI-02
cateter auriculares	EE-06
diapasones	EE-03
espéculos auriculares	EE-02
HARTMANN-HALLE espéculo para nasales	EG-02
HARTMANN-HOFFMANN pinza auriculares	EE-08

HARTMANN	
pinza auriculares	EE-08
pinza cortantes para nasales	EG-07
pinza hemostática	BC-03
pinza polipus para nasales	EG-04
HARTMANN-WULLSTEIN pinza auriculares	EE-08
HEANEY	
pinza histerectomía	BC-18
porta-aguja	CE-03
separador	BI-12
HEATH tijeras para puntas	AI-40
HEBRA cucharilla para chalazion	EC-07
HEGAR dilatador uterinos	HA-24 hasta HA-27
HEGENBARTH pinza para grapas	CG-07
HEIFETZ espátulas cerebral	EA-07
HEIMING pinza para cálculos renales	GC-13
HEISS pinza hemostática	BC-09
HEISTER abreboca	EI-03
Hemostata PASSOW	EE-15
HENKE elevador para amígdalas	FA-02
HENNIG separador para yesos	DA-03
HENROTIN pinza para coger el cuello de útero	HA-34
HERMANN separador para yesos	DA-03
HERRICK pinza para peritoneo	BC-17
HERTZLER separador costales	FG-17
HESS	
pinza capsulares	ED-04
pinza para iris	EC-12
HETZER dilatador para válvula mitral	FG-29
HEYMANN-KNIGHT pinza polipus para nasales	EG-05
HEYMANN	
pinza cortantes para nasales	EG-05
tijeras para nasales	AH-18, AI-25
HEYWOOD-SMITH pinza emorroidal	GI-05
HIBBS	
cincel	DC-16
gubia	DC-16
osteotomo	DC-16
Hilo para huesos	DD-11
HIRSCHMANN anoscopio	GI-04
Histerómetro	
COLLIN	HA-39
MARTIN	HA-39
SIMS	HA-39
VALLEIX	HA-39
HOESEL porta-aguja	CE-05
HOFER separador bilar	FA-02
HOFF pinza para campos	BE-03
HOHMANN elevador para huesos	DC-22 hasta DC-23
HOHMANN mini elevador para huesos	DC-23
Hoja	
CHARRIERE de recambio	DD-03
Hoja de bisturíes estériles	AG-06, AG-09
Hoja de bisturíes estériles micro	AG-13
Hoja	
dermatomo	AG-21
HUMBY de repuesto para dermatomo	AG-20
Hoja para navaja	AG-14, AG-19
Hoja sierra para yesos	DA-05 hasta DA-06
HOKE cincel	DC-16
HOLTH pinza para capsuloiridectomía	EC-09
HOPKINS cuchillo para yesos	DA-04
Horquilla BURCH fijadora	EC-05
HORSLEY descolador duramadre	EA-06
HOUSE cureta	EE-15
HRYNTSCHAK separador para prostata	GG-06
HUBER mango universal	FC-03
HUDSON	
fresa cónica	DD-04
perforador a mano	DD-04
HUMBY	

S

Índice alfabético Español

dermatómo	AG-20
hoja de repuesto para dermatómo	AG-20
HUNTER pinza para espinas	BA-06
HURD disecador para amígdalas	FA-02

I

Iman DIMEDA oculístico	ED-08
Impactor	DD-12
KUENTSCHER	DD-13
INGE separador para cuerpos vertebrales	EA-07
Instrument LAFORCE para cuerpos extraños	EC-06
Instrumento	
KNUTSON para uretrografía	GG-09
MOGAN para circuncisión	GG-09
para circuncisión	GG-09
WINKELMANN para circuncisión	GG-09
Insuflador POLITZER de aire	EE-05
Introduccion de catéte	
DITTEL	GG-11
GUYON	GG-11
IOWA pinza para coger el cuello de útero	HA-35
IRIS	
tijera	AI-19
tijera de oftalmología	AI-22
tijeras	AH-16, AI-21
Irrigador	HE-05
ISRAEL separador	BI-11
ITARD cateter auriculares	EE-06
ITERSON gancho traqueal	FE-02
IVES-FANSLER anoscopio	GI-04

J

JACKSON	
espéculo vaginales	HA-16
pinza tapones	FC-02
separador traqueal	FE-02
tubo traqueal	FE-03
JACOBSON tijeras micro	AJ-11
JACOBS pinza pra coger el cuello de útero	HA-34
JAEGER	
placa para párpados	EC-03
queratomo	EC-04
JAMESON	
gancho para estrabismo	EC-06
pinza para estrabismo	EC-13
JAMISON porta-aguja	CE-03
JANSEN	
pinza para nasales	EG-04
separador	BI-14
JARCHO pinza pra coger el cuello de útero	HA-32
JATHO pinza nasofaringe	EG-18
JAVID pinza atraumatica carotis	BD-32
JENNINGS abrebooca	EI-04
Jeringa	
amígdalas	FA-05
REINER auriculares	EE-05
JOBSON-HORNE estilete	CA-03
JOHNS-HOPKINS	
clamp de bulldog para sierra-fina	BC-03
pinza via billar	BC-14
JOHNSON porta-aguja	CE-04
JONES pinza para campos con porta-tubo	BE-02
JOSEPH	
bisturi para nasales	EG-10
bisturi romo	EG-10
elevadores periostotomo	EG-12
ganchito	BI-06
JOSEPH (LEWIS) lima para nasales	EG-15
JOSEPH	

lima para huesos	EG-14
sierra para nasales	EG-17
tijera	AI-16
tijeras	AH-14
JUDD-ALLIS pinza para tejidos	GE-02
JUDD-MASSON separador vesicales	GG-04
Juego	
de autopsia	DC-17
de manicura para enfermeras	HE-03
KEYES de trefinas cutaneous	HE-02
Juego para	
diagnóstico	AC-04
otoscopia	AC-04
JURASZ pinza polipus laringe	FC-02

K

KABIERSKE lanzapolvo	EE-04
KALLMORGEN	
espéculo vaginales	HA-15
valva vaginales	HA-15
KALT-ARRUGA porta-aguja	CE-07
KALT	
pinza capsulares	ED-04
porta-aguja	CE-07
KANE clamp para umbilicales	HC-06
KEITH aguja para sutura	CG-06
KELLY Grip separador	BI-04
KELLY	
pinza hemostática	BC-05
pinza para polipe uterino	HA-36
proctoscopio	GI-04
KELLY-RANKIN pinza hemostática	BC-05
KELLY	
separador	BI-04, BI-12
tijeras para ginecológicas	AH-22, AI-33
KELLY TITAN pinza hemostática	BC-05
KERN pinza para huesos	DC-08
KERRISON pinza sacabocado	EG-08
KEVORKIAN	
cureta aspiradoras para la biopsia uterina	HA-40
KEVORKIAN-Pacific pinza sacabocado	
para el cuello del útero	HA-44
KEVORKIAN	
pinza sacabocado para el cuello del útero	HA-43, HA-46
KEY elevador	DC-21
KEYES juego de trefinas cutaneos	HE-02
KIELLAND pinza obstétricas	HC-02
KIELLAND-LUIKART pinzas obstétricas	HC-03
KILLIAN	
canula	EG-09
KILLIAN-CLAUS gubia para nasales	EG-14
KILLIAN	
elevadores tabique	EG-12
espéculo tabique	EG-03
KILNER-DOUGHTY abrebooca	EI-05
KILNER	
ganchito para la piel	HE-02
tijera	AI-17
tijeras	AH-14
KIRBY-ARTHUR pinza para iris	EC-13
KIRK martillo	DC-18
KIRSCHNER	
cuadro	BI-23
estribo para extensión	DD-10
perforador a mano	DD-05
separador abdominales	BI-23
sonda conductora	CG-04
taladros filiformes	DD-09
valva	BI-23
KLINKENBERGH-LOTH tijeras para toracica	AI-37

KNAPP	
cucharilla para cataratas	EC-07
cuchillo para iris	EC-04
KNAPP-LUER pinza tracoma	ED-06
KNAPP	
separador	EC-06
tijeras	AI-20
KNIGHT pinza cortantes para nasales	EG-05
KNOWLES tijeras de vendajes	AI-47
KNUTSON instrumento para uretrografía	GG-09
KNUTSON-KOCH cono para uretrografía	GG-09
KOCHER	
espatula vesical	GG-04
pinza hemostática delgada	BC-06
pinza intestinales	GE-04
separador	BI-10 hasta BI-11
sonda bocio	FE-04
KOENIG	
aguja para sutura	CG-06
sonda conductora	CG-04
KOERTE separador	BI-11
KOGAN espéculo endocervicales	HA-23
KONRICH tambor para esterilización	HE-12
KRAUSE	
cierranudo auriculares	EE-07
cierranudos para nasales	EG-09
pinza laringe	FC-03
KRISTELLER	
espéculo vaginales	HA-09 hasta HA-14
valva vaginales	HA-09 hasta HA-14
KRONECKER aguja para ligaduras	CG-02
KUENTSCHER	
dilatador	DD-13
extractador	DD-13
impactor	DD-13
KUHNT legra para la cornea	EC-05
L	
LABORDE dilatador traqueal	FE-02
LAFORCE	
adenotomo	EG-19
instrument para cuerpos extraños	EC-06
LAGRANGE tijeras para encías	AI-41
LAHEY	
pinza agarrar bocio	FE-04
pinza via billar	BC-14
separador	BI-08
LAMBERT KAY	
pinza atraumatica anastomosis de aorta	BD-10
pinza atraumatica iliaca	BD-11
LAMBERT pinza chalazión	ED-06
LAMBOTTE mini osteotomo	DC-15
LAMBOTTE	
osteotomo	DC-15
periostótomo	DC-19
pinza para huesos	DC-08
Lámpara frontal CLAR	AC-05
LANCASTER blefarostato	EC-03
Lanceta electrodo	JA-03
LANDAU espéculo vaginales	HA-22
LANDOLT	
mango de bisturíes micro	AG-13
tijeras enucleación	AI-25
LANE	
destornillador	DD-14
pinza clamp estomacales	GE-08
pinza de disección	BA-04
pinza para campos	BE-05
pinza para huesos	DC-08
pinza para sostener placas	DD-14
pinza para sostener tornillo	DD-14
LANG cureta	EC-08
LANGENBECK	
cuchillo para resección	AG-17
dedal	EI-06
elevador	DC-21
periostótomo	DC-19
pinza para huesos	DC-07
separador	BI-09
sierra a dedo	DD-03
LANGE	
pinza laringe	FC-03
tijeras de vendajes	AI-44
Lanzapolvo KABIERSKE	EE-04
Laringoscopia conjuntos	
MACINTOSH convencional	AE-18 hasta AE-19
MACINTOSH de fibra optica	AE-12 hasta AE-13
MILLER convencional	AE-18 hasta AE-19
MILLER de fibra optica	AE-12 hasta AE-13
Laringoscopia espátulas	
MACINTOSH convencional	AE-15
MACINTOSH de fibra optica	AE-10
MILLER convencional	AE-16
MILLER de fibra optica	AE-10
Laringoscopia mango convencional	AE-17
Laringoscopia mango de fibra optica	AE-11
LAWRENCE pinza de disección y ligadura	BC-13
LEBSCHKE cincel esternon	DC-17
LEES pinza atraumatica bronquiales	BD-03
Legra KUHNT para la cornea	EC-05
LEGUEU	
espatula vesical	GG-04
separador vesicales	GG-06
LEKSELL STILLE pinza gubia	DC-05
LELAND JONES pinza atraumatica para vasculares perif	BD-08 hasta BD-09
LEMPERT	
cucharilla cortante	DC-13
elevador	EE-15
pinza gubia	DC-03
LERCHE pinza de disección	BA-04
LERICHE pinza hemostática	BC-09
LESTER pinza fijación	ED-03
LEVINSON aguja para cuerpos extraños	EC-05
LEWIN pinza para huesos	DC-10
LEWKOWITZ pinza para aborto y placenta	HC-07
LEXER-BABY	
tijera de disección	AI-12
tijeras	AH-10
LEXER	
cincel	DC-16
LEXER-FINO tijera de disección	AI-12
LEXER	
gubia	DC-16
LEXER mini	
cincel	DC-16
gubia	DC-16
LEXER	
tijeras	AH-09
tijeras de disección	AI-11
LEYLA sistema de fijación	EA-14 hasta EA-18
LICHTWITZ	
aguja	EG-09
trócar	CC-02
LIDDLE pinza atraumatica aorta	BD-10
Lima	
FOMON para nasales	EG-15 hasta EG-16
GALLAHER para seno	EG-16
JOSEPH (LEWIS) para nasales	EG-15
JOSEPH para huesos	EG-14
MALTZ (COTTLE) para nasales	EG-15

S

Índice alfabético Español

MALTZ para nasales.....	EG-14
para huesos.....	DC-25
para unas 10 cm.....	HE-03
PUTTI para huesos.....	DC-25
WIENER (AUFRIKHT) para nasales.....	EG-15
WIENER para el seno.....	EG-15
LISTER-BURCH blefarostato.....	EC-02
LISTER	
pinza para seno, porta esponjas.....	BG-11
tijeras de vendajes.....	AH-23, AI-45
LISTON	
cuchillo para amputación.....	AG-16
pinza cortante para huesos.....	DC-06
LITTAUER	
pinza auriculares.....	EE-08
pinza depilatorias.....	ED-08
pinza polipus para nasales.....	EG-05
tijeras para puntas.....	AI-40
LITTLER tijera de disección.....	AI-13
LITTLE separador.....	BI-08
Llave.....	DD-10
LOCKLIN tijera.....	AI-18
LORENZ tijeras de vendajes.....	AI-47
LORNA pinza para campos.....	BE-04
LOUTE tensor tierra-hilo.....	DD-11
LOVE	
gancho para nervios.....	EA-04
LOVE-GRUENWALD pinza cortantes para laminectomía.....	EA-08
LOVELACE	
pinza hemostática.....	BC-07
pinza para coger el pulmón.....	FG-19
LOVE	
separador uvula.....	FA-02
LOWER pinza via billar.....	BC-14
LOWMAN clamp para huesos.....	DC-11
LUBET-BARBON pinza polipus para nasales.....	EG-05
LUCAE	
diapasones.....	EE-04
martillo.....	DC-18
pinza auriculares.....	EE-07
LUC pinza cortantes para nasales.....	EG-06
LUER-KOERTE cuchara para cálculos biliares.....	GC-09
LUER	
pinza gubia.....	DC-03
tubo traqueal.....	FE-03
LUIKART-BILL tractor adecuada para todas las pinzas con mango HC-05	HC-05
LUIKART pinza obstétricas.....	HC-03
LUNDSGAARD esclerotomo.....	EC-05
LUNIATSCHEK obturador a gaza.....	FA-02
LURZ pinza para ureter.....	GC-10
M	
MACINTOSH	
laringoscopio conjuntos convencional.....	AE-18 hasta AE-19
laringoscopio conjuntos de fibra optica.....	AE-12 hasta AE-13
laringoscopio espátulas convencional.....	AE-15
laringoscopio espátulas de fibra optica.....	AE-10
MAGILL	
estilete para tubo.....	AE-04
tubo de aspiración.....	AE-04, AE-06
MAIER pinza para tapones.....	BG-12
MALTZ	
bisturi cartilage acodado.....	EG-11
MALTZ (COTTLE) lima para nasales.....	EG-15
MALTZ	
lima para nasales.....	EG-14

Mango	
BROCK dilatador para válvula mitral.....	FG-26
CASPAR de bisturíes micro.....	AG-12
COLLIN de bisturíes.....	AG-08
Mango de bisturíes.....	AG-02 hasta AG-05, AG-07 hasta AG-08
Mango de bisturíes micro.....	AG-12
Mango	
espejos laringeos.....	FC-04
GIGLI para sierra.....	EA-05
HUBER universal.....	FC-03
LANDOLT de bisturíes micro.....	AG-13
Mano de plomo.....	DC-11
Manómetro para salpingógrafo.....	HA-47
Marcador	
CASTROVIEJO compas.....	EC-09
CONNIN-AMSLER.....	EC-09
MARSCHIK pinza amigdalas.....	FA-04
MARTEL pinza para pericraneos.....	BC-08
Martillo.....	DC-18
COLLIN.....	DC-18
con ranura.....	DD-13
GERZOG.....	DC-18
KIRK.....	DC-18
LUCAE.....	DC-18
MEAD.....	DC-18
QUISLING.....	DC-18
Martillos	
BABINSKY de percusión.....	AC-07
BERLINER de percusión.....	AC-07
BUCK de percusión.....	AC-07
DEJERINE de percusión.....	AC-07
TAYLOR de percusión.....	AC-07
TRAUBE de percusión.....	AC-07
TROMNER de percusión.....	AC-07
Martillo	
WILLIGER.....	DC-18
MARTIN	
cable electrobisturíes.....	JA-07
histerómetro.....	HA-39
MARTINI cucharilla cortante.....	DC-13
MARTIN	
pelvimetro.....	HC-06
pinza para secuestros.....	DC-10
pinza para tapones.....	BG-02, BG-14
MASSON porta-aguja.....	CE-03
MASTIN pinza muscular.....	FE-04
MATHIEU	
espéculo rectales.....	GI-02
pinza para cuerpos extraños.....	GG-07
porta-aguja.....	CE-05
separador.....	BI-03
MATSON periostótomo.....	DC-21
MAUNDER garrote madera.....	EI-06
MAYO BLAKE pinza para cálculos biliares.....	GC-04
MAYO	
clip para esterilización.....	CI-02
cuchara para cálculos biliares.....	GC-07
MAY oftalmoscopio.....	AC-03
MAYO-GUYON pinza para pedícula renal.....	BC-16
MAYO-HEGAR porta-aguja.....	CE-02
MAYO-NOBLE tijeras.....	AH-08, AI-10
MAYO-ROBSON pinza intestinales.....	GE-05
MAYO	
sonda para cálculos renales.....	GC-10
MAYO-STILLE tijeras.....	AH-07, AI-08 hasta AI-09
MAYO	
tijeras.....	AH-06, AI-07
tijeras zurdo.....	AI-07
McCLINTOCK pinza para aborto y placenta.....	HC-07
McCULLOUGH pinza para estrabismo.....	EC-13

McDONALD elevador	DC-22
McGEE pinza auriculares micro	EE-10
McGUIRE tijeras para corneal	AJ-05
McINDOE	
pinza de disección	BA-04
tijeras para cartilago	AI-35
McIVOR	
abajalengua	EI-05
abreboca	EI-05
McKENTY elevadores tabique	EG-11
McKENZIE	
perforadores plano	DD-04
pinza para poner grapas	EA-02
McLEAN pinza obstétricas	HC-04
McLEAN-LUIKART pinza obstétricas	HC-03
McLEAN-TUCKER-LUIKART pinza obstétricas	HC-03
McPHERSON pinza ligaduras	ED-05
McPHERSON TITAN pinza ligaduras	ED-05
McPHERSON WESTCOTT tijeras para tenotomía	AJ-04
MEAD	
martillo	DC-18
pinza gubia	DC-02
MEEKER pinza de disección y ligadura	BC-13
MELLINGER-AXENFELD blefarostato	EC-02
MELLINGER blefarostato	EC-02
MENGHINI trócar	CC-03
Meniscotomo	
BIRCHER	DC-24
NEFF	DC-24
SMILLIE	DC-24
MERCEDES separador torácico	FG-16
METZENBAUM FINO	
tijera de disección	AI-15
tijeras	AH-12
METZENBAUM	
porta-aguja	CE-04
METZENBAUM "S"	
tijera	AI-16
tijeras	AH-13
METZENBAUM	
tijera de disección	AI-13 hasta AI-14
tijeras	AH-11
MEYERDING separador	BI-08
MEYHOEFER cucharilla para chalazion	EC-07
MICHEL	
espejo	EG-04
grapas	CG-07
pinza para grapas	CG-07
MIDDELDORPF separador	BI-10
MIDDLETON-JANSEN pinza cortantes para nasales	EG-09
MIKULICZ	
pinza para peritoneo	BC-17
separador	BI-12
MILLER	
laringoscopia	
conjuntos convencional	AE-18 hasta AE-19
laringoscopia	
conjuntos de fibra optica	AE-12 hasta AE-13
laringoscopia espátulas convencional	AE-16
laringoscopia espátulas de fibra optica	AE-10
MILLIGAN descolador duramadre	EA-05
MILLIN	
dilatador para el cuello vesical	GG-07
pinza capsulares	GG-03
pinza para lóbulos anteriores	GG-03
pinza porta ligaduras	GG-03
Portador de luz fría	GG-05
separador vesicales	GG-05
MILLS tijeras para vasculares	AI-27
Mini	
CLAR	AC-05

estuche de bolsillo y de sutura	CG-08
MIXTER BABY pinza hemostática bronquial	BC-13
MIXTER O'SHAUGNESSY pinza hemostática	BC-14
MIXTER	
pinza hemostática	BC-14
pinza hemostática bronquial	BC-13
pinza para cálculos biliares	GC-04
pinza via billar	BC-15
MOELTGEN goniómetro	AC-08
MOGAN instrumento para circuncisión	GG-09
MOLLISON separador	BI-17
MOORE	
cuchara para cálculos biliares	GC-05
perforador a mano	DD-04
MOORFIELD pinza sutura	ED-05
MORSE-FAVOLORO separador costales	FG-17
MOYNIHAN	
pinza para campos	BE-05
pinza via billar	BC-15
sonda para cálculos biliares	GC-05
MUCK cuchillo periostio	EE-15
MUELLER blefarostato	EC-03
MURDOCK blefarostato	EC-02
MURLESS elevador para cabeza	HC-05
MURPHY-LANE elevador	DC-22
MURPHY pinza para cierra-tubo	BC-19
MUSEUX pinza para coger el cuello de útero	HA-33
MYLES pinza cortantes para nasales	EG-07

N

NABATOFF sonda de plata auricular	CA-02
NAEGELE pinza obstétricas	HC-03
NÁGELE perfora-cráneo	HC-09
NAGER separador paladar	FA-02
Navaja	AG-14, AG-19
NEFF meniscotomo	DC-24
NEGUS pinza para amígdalas	FA-03
NEIVERT porta-aguja	CE-02
NELSON	
aguja para ligaduras	CG-02
pinza de disección	BA-05
trócar	CC-02
NEUBÜSER pinza para sostener trompas	HA-51
NORTHBENT tijeras para puntas	AI-40
NOTO pinza para polipe uterino	HA-36
NOVAK cureta aspiradoras para la biopsia uterina	HA-40
NOYES	
pinza polipus para nasales	EG-05
tijeras para iris	AJ-03 hasta AJ-04
tijeras para tendones	AJ-03
NUBOER tubo de aspiración	AE-05

O

Obturador a gaza LUNIATSCHEK	FA-02
OCHSNER	
pinza atraumatica aorta	BD-31
trócar	CC-02
O' CONNOR gancho para iris	EC-06
Oftalmoscopio	
MAY	AC-03
VARIFOCAL	AC-03
OLDBERG pinza cortantes para laminectomía	EA-09
OLIVECRONA	
espátulas cerebral	EA-07
pinza gubia	DC-03
sierra	EA-05
OLIVECRONA-TOENNIS pinza para poner grapas	EA-02
OLLIER separador	BI-10
OLSEN-HEGAR porta-aguja	CE-05

S

Índice alfabético Español

Osteotomo.....	DC-14
HIBBS.....	DC-16
LAMBOTTE.....	DC-15
LAMBOTTE mini.....	DC-15
STILLE.....	DC-14
O'SULLIVAN-O'CONNOR	
espéculo vaginales.....	HA-08
separador abdominales.....	BI-21
OTIS	
cuchillo de repuesto.....	GG-08
uretrotomo.....	GG-08
Otoscopia Juego para.....	AC-04
OVERHOLT-GEISSENDOERFER	
pinza de disección y ligadura.....	BC-10
OVERHOLT periostótomo.....	DC-21

P

Parametrio curvado fuerte.....	AI-31
PARHAM cinta sola.....	DC-11
PARK blefarostato.....	EC-03
PARKER	
bisturíes para disección.....	AG-15
separador.....	BI-02
PARTSCH	
cincel.....	DC-14
gubia.....	DC-14
PASSOW hemostata.....	EE-15
PATON diseccador para la cornea.....	EC-05
PAUFIQUE	
cuchillo para queratoplastico.....	EC-05
pinza ligaduras.....	ED-05
PAUFIQUE TITAN pinza ligaduras.....	ED-05
PAYR-Baby pinza clamp estomacales.....	GE-09
PAYR	
pinza clamp estomacales.....	GE-09
sonda conductora.....	CG-04
PEAN	
pinza atraumatica.....	BD-02
pinza hemostática.....	BC-08
pinza hemostática delgada.....	BC-06
PEDERSON espéculo vaginales.....	HA-03
PEERS BERTRAM pinza para campos.....	BE-03
PEET pinza para espinas.....	BA-06
PELKMANN pinza para tapones.....	BG-12
Pelvimetro	
COLLIN.....	HC-06
COLLYER.....	HC-06
MARTIN.....	HC-06
PENFIELD descolador duramadre.....	EA-06
PENNINGTON pinza hemostática.....	BC-07
PERCY retractor para amputacion.....	DD-03
Perfora-cráneo	
NÄGELE.....	HC-09
SMELLIE.....	HC-09
Perforador	
a mano.....	DD-05
BUNNELL a mano.....	DD-05
con mandril Jacobs.....	DD-06
CRUTCHFIELD para inicial.....	EA-03
Perforadores	
CUSHING plano.....	DD-04
McKENZIE plano.....	DD-04
Perforador	
HUDSON a mano.....	DD-04
KIRSCHNER a mano.....	DD-05
MOORE a mano.....	DD-04
para clavos.....	DD-12
RALK a mano.....	DD-05
STILLE a mano.....	DD-04
STILLE-SHERMAN a mano.....	DD-04
Periostótomo	
ALEXANDER.....	DC-19
DOYEN para costillas.....	DC-20
FARABEUF.....	DC-19
LAMBOTTE.....	DC-19
LANGENBECK.....	DC-19
MATSON.....	DC-21
OVERHOLT.....	DC-21
SADILLOT.....	DC-19
SEMB.....	DC-20
WILLIGER.....	DC-19
PERTHES escariadores.....	DD-08
PESTALOZZA cureta para aborto y placenta.....	HC-08
PETRI cubeta.....	HE-08
PETZ aparato	
para suturar estomacales e intestinales.....	GE-09
PHANEUF pinza para peritoneo.....	BC-17
Pick.....	EE-15
BARBARA.....	EE-14 hasta EE-15
Piedra afiladora ARKANSAS.....	AG-19
PIERCE trócar.....	CC-02
PIFFARD cureta para lupus.....	HE-02
PINARD estetoscopio.....	AC-06
Pinza	
ADLERKREUTZ de disección.....	BA-04
ADSON BABY hemostática.....	BC-09
ADSON-BROWN de disección.....	BA-03
ADSON de disección.....	BA-03
ADSON gubia.....	DC-03
ADSON hemostática.....	BC-09
ADSON micro de disección.....	BA-03
ADSON para hipófisis.....	EA-06
ALEXANDER sacabocado para el cuello del útero.....	HA-42
ALLIS-ADAIR para tejidos.....	GE-02
ALLIS-Baby para tejidos.....	GE-02
ALLIS para tejidos.....	GE-02
ARCHER para espinas.....	BA-06
ARRUGA capsulares.....	ED-04
ASCH enderezar tabique.....	EG-18
auriculares micro.....	EE-09 hasta EE-10, EE-12
auriculares micro mini.....	EE-13
AYER chalazión.....	ED-06
BABCOCK para tejidos.....	GE-02
BACKHAUS-CLIP para campos con porta-tubo.....	BE-03
BACKHAUS KOCHER para campos.....	BE-02
BACKHAUS para campos.....	BE-02
BAGGISH sacabocado para el cuello del útero.....	HA-45
BAINBRIDGE atraumatica.....	BD-09
BAINBRIDGE hemostática.....	BC-14
BALL AND SOCKET para campos.....	BE-04
BALLENGER coger amígdalas.....	FA-04
BARRAQ.KATZIN para iris.....	EC-13
BARRAQU Colibri para iris.....	EC-13
BARRAQUER cámara anterior.....	ED-02
BARRAQUER depilatorias.....	ED-08
BARRAQUER fijación.....	ED-03
BARRETT pra coger el cuello de útero.....	HA-32
BECK atraumatica para vasculares perif.....	BD-25
BEER depilatorias.....	ED-08
BENGOLEA hemostática.....	BC-09
BERGMANN FOERSTER porta esponjas.....	BG-10
BERKE muscular.....	ED-02
BERNHARD para campos.....	BE-05
BEST intestinales.....	GE-06
BEYER gubia.....	DC-04
BEYER sacabocado.....	EG-08
BIRCHER-GANSKE para huesos.....	DC-10
BISHOP-HARMAN para iris.....	EC-14
BLAKE para cálculos biliares.....	GC-03
BLOHMKE coger amígdalas.....	FA-04
BLUMENTHAL gubia.....	DC-02

BÖHLER cortante para huesos	DC-06
BÖHLER gubia	DC-04
BONACCOLTO para estrabismo	EC-14
BONNEY porta esponjas	BG-08
Bonn para iris	EC-15
Bonn TITAN para iris	EC-15
BOZEMANN-DOUGLAS para tapones	BG-13
BOZEMANN para tapones	BG-13
BRAIN MINI de aplicación clip	EA-12
BRAIN STANDARD de aplicación clip	EA-12
BRAUN para coger el cuello de útero	HA-31, HA-34
BROWN de disección	BA-03
BRUENINGS cortantes para nasales	EG-05
BRUENINGS laringe	FC-03
BRUNNER intestinales	GE-06
BRYANT porta esponjas	BG-11
BUMM para el útero	HA-38
BURKE-Baby sacabocado para el cuello del útero	HA-44
BURKE sacabocado para el cuello del útero	HA-44
CARMALT para espinas	BA-06
CASTAÑEDA atraumatica para nacidos y niños	BD-42
CASTROVIEJO capsulares	ED-04
CASTROVIEJO fijación	ED-03
CASTROVIEJO sutura	ED-05
CHAPUT hemostática	BC-08
CHEATLE para esterilización	CI-02
CHERON para tapones	BG-12
CHEVALIER-JACKSON laringe	FC-04
CHILDE para grapas	CG-07
CITELLI sacabocado	EG-08
Pinza-clamp GREEN-ARMYTAGE uterina para hemostasis	HC-06
Pinza	
CLEVELAND gubia	DC-02
coagulación bipolar	JA-04 hasta JA-06
COLCLOUGH sacabocado para discos intervertebrales	EA-11
COLLIN-DUVAL de disección	BA-04
COLLIN hemostática	BC-08
COLLIN para el útero	HA-37
COLLIN para grapas	CG-07
COLLIN para tapones	BG-11
COLLIN-POZZI para coger el cuello de útero	HA-32
COLLIN tiralengua	EI-03
COLVER coger amígdalas	FA-03
COOLEY atraumatica	BB-03, BD-35 hasta BD-37, BD-39, BD-41
COOLEY atraumatica anastomosis	BD-37, BD-40
COOLEY atraumatica iliaca	BD-37
COOLEY atraumatica pediátricas	BD-38 hasta BD-39
COOLEY DERRA atraumatica anastomosis	BD-39
COOLEY para vascular	BD-40
CORDES laringe	FC-03
corta-hilo	DD-12
COTTLE-KAZANJIAN cortante para huesos	DC-06
CRAFOORD hemostática bronquial	BC-12
CRILE hemostática	BC-05
CRILE-RANKIN hemostática	BC-05
CRILE TITAN hemostática	BC-05
CRUTCHFIELD de tracción craneal	EA-03
CUSHING cortantes para laminectomía	EA-08
CUSHING de disección	BA-03
CZERNY para cálculos biliares	GC-03
CZERNY pra coger el cuello de útero	HA-34
DALE atraumatica para vasculares perif	BD-24
DANDY hemostática	BC-07
DARDIK atraumatica	BD-07
DARTIGUES para el útero	HA-37
DASTOOR para estrabismo	EC-14
DAVIS para esterilización	CI-02
DE BAKEY atraumatica	BB-03

DEBAKEY atraumatica	BD-02, BD-08
DE BAKEY atraumatica	BD-16 hasta BD-17
DEBAKEY atraumatica	BD-20
DE BAKEY atraumatica	BD-28 hasta BD-30
DE BAKEY atraumatica anastomosis	BD-25
DE BAKEY atraumatica aneurisma de aorta	BD-13, BD-15, BD-18
DE BAKEY atraumatica bronquiales	BD-19
DE BAKEY atraumatica de disección y ligadura	BD-25, BD-32
DE BAKEY atraumatica iliaca	BD-11
DE BAKEY atraumatica para vasculares perif	BD-06
DEBAKEY BAHNSON atraumatica aneurisma de aorta	BD-14
DE BAKEY MORRIS atraumatica	BD-16
DE BAKEY REYNOLDS atraumatica anastomosis	BD-30
DEBAKEY SATINSKY atraumatica	BD-22
Pinza de disección	BA-02
Pinza DeMARTEL-WOLFSON para anastomosis	GE-07
depilatorias	ED-08
Pinza de relojero	BA-06
Pinza DERRA atraumatica anastomosis, pediátricas	BD-28
DESJARDINS para cálculos biliares	GC-02
DESJARDINS via billar	BC-15
DESMARRES chalazión	ED-06
DeVILBISS cranea	EA-05
DIAMANT corta-hilo	DD-12
DIETER la cabeza del martillo	EE-10
DIETHRICH atraumatica	BD-31
DIMEDA para desechos	CI-03
DINGMANN para huesos	DC-10
DOUGLAS depilatorias	ED-08
DOYEN-Baby intestinales	GE-03
DOYEN intestinales	GE-03
DOYEN para campos	BE-05
DOYEN para polipe uterino	HA-36
DUPLAY para tapones	BG-14
DUPLAY pra coger el cuello de útero	HA-31
DUPUY-WEISS aguja	FA-03
DUVAL de disección	BA-04
DUVAL para tejidos	GE-03
ECHLIN gubia	DC-05
EDWARDS para applicar clips	BD-21
ELSAESSER para nephrostomie	GC-13
ELSCHNIG capsulares	ED-04
ELSCHNIG fijación	ED-03
EPPENDORFER-KEVORKIAN sacabocado para el cuello del útero	HA-46
EPPENDORFER sacabocado para el cuello del útero	HA-45 hasta HA-46
EPPENDORFER TISCHLER-MORGAN sacabocado para el cuello del útero	HA-46
FARABEUF-LAMBOTTE para huesos	DC-08
FARABEUF para huesos	DC-07
FAURE para peritoneo	BC-17
FAURE sacabocado para el cuello del útero	HA-41
FEHLAND intestinales	GE-06
FEILCHENFELD para espinas	BA-06
FERGUSSON hemostática	BC-07
FERGUSSON para huesos	DC-07
FERRIS de disección	BA-04
FERRIS-SMITH cortantes para laminectomía	EA-09
FERRIS-SMITH-KERRISON sacabocado para discos intervertebrales	EA-10
FINOCHIETTO bronquiales	FG-21
FISCHER para iris	EC-13
FLETCHER JAVERTS porta esponjas	BG-10
Pinza flexibles para vasculares	BD-44 hasta BD-45
Pinza	

FOERSTER para iris.....	EC-12	JURASZ polipus laringe.....	FC-02
FOERSTER porta esponjas.....	BG-06 hasta BG-08	KALT capsulares.....	ED-04
FRAENKEL laringe.....	FC-03	KELLY hemostática.....	BC-05
FRAENKEL polipus laringe.....	FC-02	KELLY para polipe uterino.....	HA-36
FRIEDMAN gubia.....	DC-02	KELLY-RANKIN hemostática.....	BC-05
FRIEDMAN MINI gubia, mini.....	DC-02	KELLY TITAN hemostática.....	BC-05
FRYKHOLM gubia.....	DC-05	KERN para huesos.....	DC-08
FUCHS capsulares.....	ED-04	KERRISON sacabocado.....	EG-08
GAUSS para pericraneos.....	HC-06	KEVORKIAN-Pacific	
GELLHORN sacabocado para el cuello del útero.....	HA-42	sacabocado para el cuello del útero.....	HA-44
GEMINI de disección y ligadura.....	BC-10	KEVORKIAN	
GEMINI MINI de disección y ligadura.....	BC-10	sacabocado para el cuello del útero.....	HA-43, HA-46
GERALD de disección.....	BA-05	KIRBY-ARTHUR para iris.....	EC-13
GILL-ARRUGA capsular.....	ED-03	KNAPP-LUER tracoma.....	ED-06
GILL-HESS para iris.....	EC-12	KNIGHT cortantes para nasales.....	EG-05
GILLIES de disección.....	BA-05	KOCHER hemostática delgada.....	BC-06
GILL para iris.....	EC-12	KOCHER intestinales.....	GE-04
GLOVER atraumática.....	BD-06, BD-30	KRAUSE laringe.....	FC-03
GLOVER atraumática anastomosis.....	BD-05	LAHEY agarrar bocio.....	FE-04
GLOVER para coarctación atraumática.....	BD-04	LAHEY via billar.....	BC-14
GRADLE depilatorias.....	ED-08	LAMBERT chalazión.....	ED-06
GRAEFE de disección.....	BA-03	LAMBERT KAY atraumática anastomosis de aorta.....	BD-10
GRAEFE fijación.....	ED-03	LAMBERT KAY atraumática iliaca.....	BD-11
GRAEFE para iris.....	EC-11	LAMBOTTE para huesos.....	DC-08
GRAY via billar.....	BC-15	LANE clamp estomacales.....	GE-08
GREEN fijación.....	ED-03	LANE de disección.....	BA-04
GREGORY atraumática profunda.....	BD-33	LANE para campos.....	BE-05
GREVEN auriculares micro.....	EE-10	LANE para huesos.....	DC-08
GRIP para agarrar.....	DD-11	LANE para sostener placas.....	DD-14
GROSS-MAIER para tapones.....	BG-02 hasta BG-04	LANE para sostener tornillo.....	DD-14
GROSS para tapones.....	BG-05	LANGE laringe.....	FC-03
GUYON para pedícula renal.....	BC-16	LANGENBECK para huesos.....	DC-07
HAJEK-CLAUS seno maxil.....	EG-08	LAWRENCE de disección y ligadura.....	BC-13
HAJEK-KOFLER sacabocado.....	EG-08	LEES atraumática bronquiales.....	BD-03
HALSTED-MOSQUITO atraumática.....	BD-02	LEKSELL STILLE gubia.....	DC-05
HALSTED-MOSQUITO hemostática.....	BC-04	LELAND JONES	
HALSTED-MOSQUITO micro hemostática.....	BC-04	atraumática para vasculares.....	BD-08 hasta BD-09
HALSTED-MOSQUITO TITAN hemostática.....	BC-04	LEMPERT gubia.....	DC-03
HARKEN atraumática aurícula.....	BD-23	LERCHE de disección.....	BA-04
HARRINGTON bronquiales.....	FG-21	LERICHE hemostática.....	BC-09
HARTMANN auriculares.....	EE-08	LESTER fijación.....	ED-03
HARTMANN cortantes para nasales.....	EG-07	LEWIN para huesos.....	DC-10
HARTMANN hemostática.....	BC-03	LEWKOWITZ para aborto y placenta.....	HC-07
HARTMANN-HOFFMANN auriculares.....	EE-08	LIDDLE atraumática aorta.....	BD-10
HARTMANN polipus para nasales.....	EG-04	LISTER para seno, porta esponjas.....	BG-11
HARTMANN-WULLSTEIN auriculares.....	EE-08	LITTON cortante para huesos.....	DC-06
HEANEY histerectomía.....	BC-18	LITTAUER auriculares.....	EE-08
HEGENBARTH para grapas.....	CG-07	LITTAUER depilatorias.....	ED-08
HEIMING para cálculos renales.....	GC-13	LITTAUER polipus para nasales.....	EG-05
HEISS hemostática.....	BC-09	LORNA para campos.....	BE-04
HENROTIN pra coger el cuello de útero.....	HA-34	LOVE-GRUENWALD cortantes para laminectomía.....	EA-08
HERRICK para peritoneo.....	BC-17	LOVELACE hemostática.....	BC-07
HESS capsulares.....	ED-04	LOVELACE para coger el pulmón.....	FG-19
HESS para iris.....	EC-12	LOWER via billar.....	BC-14
HEYMANN cortantes para nasales.....	EG-05	LUBET-BARBON polipus para nasales.....	EG-05
HEYMANN-KNIGHT polipus para nasales.....	EG-05	LUCAE auriculares.....	EE-07
HEYWOOD-SMITH emorroidal.....	GI-05	LUC cortantes para nasales.....	EG-06
HOFF para campos.....	BE-03	LUER gubia.....	DC-03
HOLTH para capsuloiridectomía.....	EC-09	LURZ para ureter.....	GC-10
HUNTER para espinas.....	BA-06	MAIER para tapones.....	BG-12
IOWA pra coger el cuello de útero.....	HA-35	MARSCHIK amigdalas.....	FA-04
JACKSON tapones.....	FC-02	MARTEL para pericraneos.....	BC-08
JACOBS pra coger el cuello de útero.....	HA-34	MARTIN para secuestros.....	DC-10
JAMESON para estrabismo.....	EC-13	MARTIN para tapones.....	BG-02, BG-14
JANSEN para nasales.....	EG-04	MASTIN muscular.....	FE-04
JARCHO pra coger el cuello de útero.....	HA-32	MATHIEU para cuerpos extraños.....	GG-07
JATHO nasofaringe.....	EG-18	MAYO BLAKE para cálculos biliares.....	GC-04
JAVID atraumática carotis.....	BD-32	MAYO-GUYON para pedícula renal.....	BC-16
JOHNS-HOPKINS via billar.....	BC-14	MAYO-ROBSON intestinales.....	GE-05
JONES para campos con porta-tubo.....	BE-02	McCLINTOCK para aborto y placenta.....	HC-07
JUDD-ALLIS para tejidos.....	GE-02	McCULLOUGH para estrabismo.....	EC-13

McGEE auriculares micro	EE-10
McINDOE de disección	BA-04
McKENZIE para poner grapas	EA-02
McPHERSON ligaduras	ED-05
McPHERSON TITAN ligaduras	ED-05
MEAD gubia	DC-02
MEEKER de disección y ligadura	BC-13
MICHEL para grapas	CG-07
Pinza micro	BB-02
Pinza	
MIDDLETON-JANSEN cortantes para nasales	EG-09
MIKULICZ para peritoneo	BC-17
MILLIN capsulares	GG-03
MILLIN para lóbulos anteriores	GG-03
MILLIN porta ligaduras	GG-03
MIXTER BABY hemostática bronquial	BC-13
MIXTER hemostática	BC-14
MIXTER hemostática bronquial	BC-13
MIXTER O'SHAUGNESSY hemostática	BC-14
MIXTER para cálculos biliares	GC-04
MIXTER vía billar	BC-15
MOORFIELD sutura	ED-05
MOYNIHAN para campos	BE-05
MOYNIHAN vía billar	BC-15
MURPHY para cierra-tubo	BC-19
MUSEUX pra coger el cuello de útero	HA-33
MYLES cortantes para nasales	EG-07
NEGUS para amígdalas	FA-03
NELSON de disección	BA-05
NEUBÜSER para sostener trompas	HA-51
NOTO para polipe uterino	HA-36
NOYES polipus para nasales	EG-05
OCHSNER atraumatica aorta	BD-31
OLDBERG cortantes para laminectomía	EA-09
OLIVECRONA gubia	DC-03
OLIVECRONA-TOENNIS para poner grapas	EA-02
OVERHOLT-GEISSENDOERFER	
de disección y ligadura	BC-10
Pinza para campos modelo delicato	BE-02
Pinza para cierra-tubo	BC-19
Pinza	
para cortar y alambre	DD-11
Pinza para espinas	BA-06
Pinza para esterilización	CI-02
Pinza	
para fijar	GG-10
para fijar el cordón espermatoc	GG-10
Pinza para huesos	DC-09 hasta DC-10
Pinza para secuestros	DC-10
Pinza	
para unas 11,5 cm	HE-03
PAUFIQUE ligaduras	ED-05
PAUFIQUE TITAN ligaduras	ED-05
PAYR-Baby clamp estomacales	GE-09
PAYR clamp estomacales	GE-09
PEAN atraumatica	BD-02
PEAN hemostática	BC-08
PEAN hemostática delgada	BC-06
PEERS BERTRAM para campos	BE-03
PEET para espinas	BA-06
PELKMANN para tapones	BG-12
PENNINGTON hemostática	BC-07
PHANEUF para peritoneo	BC-17
picos planos	DD-11
POTTS atraumatica	BD-26 hasta BD-27
POTTS atraumatica anastomosis	BD-05
POTTS para coarctación atraumatica	BD-04
POTTS-SMITH de disección	BA-02
POZZI para coger el cuello de útero	HA-31
PRATT hemostática	BC-08
PRATT para coger el cuello de útero	HA-34 hasta HA-35

PRESBYTERIAN HOSPITAL para cierra-tubo	BC-19
PRICE-THOMAS bronquiales	FG-22
PRINCE muscular	ED-02
PROVIDENCE-HOSPITAL hemostática	BC-05
RADOLF para unas	DD-03
RAMPLEY porta esponjas	BG-09
RANDALL para cálculos renales	GC-11 hasta GC-12
RANEY hemostática para cuero cabell	EA-03
RANEY para poner y quitar	EA-03
RANKIN atraumatica	BD-02
RICHTER-HEATH para grapas	CG-07
ROBERTS hemostática	BC-11
ROCHESTER-CARMALT hemostática	BC-07
ROCHESTER-OCHSNER hemostática	BC-06
ROCHESTER-PEAN hemostática	BC-06
ROEDER para campos	BE-03
ROGGE para esterilización	CI-02
ROSENBERG laringe	FC-03
ROWE boca	EI-06
RUBIN para magullar tabique	EG-07
RUMEL para toracica	BC-11
RUSKIN gubia	DC-04
RUSKIN-LISTON cortante para huesos	DC-06
RUSSIAN de disección	BA-04
SAENGER para aborto y placenta	HC-07
SAIRGES pra coger el cuello de útero	HA-32
SAROT bronquiales	FG-23
SAROT hemostática bronquial	BC-12
SATINSKI atraumatica	BD-20
SATINSKY	
para anastomosis (vena cava)	FG-24 hasta FG-25
Pinzas atraumaticas, pediátricas, vasculares	BD-43
Pinza	
SAUERBRUCH gubia	DC-05
SAUERBRUCH para desechos	CI-03
SAWTELL para amígdalas	FA-03
SCAGLIETTI gubia	DC-05
SCHEINMANN laringe	FC-03
SCHNIDT para amígdalas	FA-03
SCHOENBURG para tejidos	GE-03
SCHROEDER	
para coger el cuello de útero	HA-31 hasta HA-32
SCHUBERT sacabocado para el cuello del útero	HA-41
SCHUMACHER laringe	FC-03
SCHUMACHER sacabocado	
para el cuello del útero	HA-43
SCHWEIGGER capsulares	ED-04
SEIFFERT laringe	FC-03
SEMB bronquiales	FG-23
SEMB cortante para huesos	DC-07
SEMB gubia	DC-06
SEMB para huesos	DC-07
SEMKEN de disección	BA-05
SIEGLER HELLMANN para el útero	HA-38
SIMS-MAIER para tapones	BG-05
SINGLEY de disección	BA-05
SKENE para coger el cuello de útero	HA-31
SMITHWICK para poner grapas	EA-02
SNELLEN entropión	ED-06
SOMER para el útero	HA-37
SPENCER-WELLS hemostática	BC-07
SPURLING cortantes para laminectomía	EA-08
STAUDE-MOORE para coger el cuello de útero	HA-31
STEVENS para iris	EC-11
STIEGLITZ para espinas	BA-06
STILLE de disección	BA-02
STILLE-HORSLEY cortante para huesos	DC-07
STILLE-LISTON cortante para huesos	DC-06
STILLE-LUER gubia	DC-04
STILLE para pedícula renal	BC-16
STILLE-RUSKIN gubia	DC-05

St. MARTIN sutura.....	ED-05	pinza obstétricas.....	HC-04
STONE para cerrar.....	GE-06	pinza obstétricas con dispositivo de tracción.....	HC-04
STONE-WATT intestinales.....	GE-06	Placa JAEGER para párpados.....	EC-03
STRUEMPEL auriculares.....	EE-08	Placa para extender la piel.....	AG-21
STRUYCKEN cortantes para nasales.....	EG-07	PLESTER	
SUBRAMANIAN atraumatica.....	BD-31	cuchillo lobar.....	EE-14
SWEET para poner grapas.....	EA-02	separador.....	BI-14
TEALE para coger el cuello del útero.....	HA-33	POLITZER	
TERSON capsulares.....	ED-04	aguja paracentesis.....	EE-06
THOMS-ALLIS para tejidos.....	GE-02	cuchillo auriculares.....	EE-06
THOMS-GAYLOR sacabocado		insuflador de aire.....	EE-05
para el cuello del útero.....	HA-42	POOLE tubo de aspiración.....	AE-02
TIEMANN para coger el cuello del útero.....	HA-32	Porta-aguja	
TILLEY auriculares.....	EE-08	ADSON.....	CE-04
TISCHLER-KEVORKIAN sacabocado		ARRUGA de oftalmología.....	CE-06
para el cuello del útero.....	HA-44 hasta HA-45	BARRAQUER.....	CE-07
TISCHLER-MORGAN sacabocado		BAUMGARTNER.....	CE-02
para el cuello del útero.....	HA-43 hasta HA-44, HA-46	BOYNTON de oftalmología.....	CE-06
TIVNEN coger amígdalas.....	FA-04	BOZEMANN.....	CE-03
TOENNIS hemostática.....	BC-11	CASTROVIEJO.....	CE-07
TOHOKU para campos.....	BE-04	COLLIER.....	CE-02
TOWNSEND-KEVORKIAN sacabocado		CRILE.....	CE-04
para el cuello del útero.....	HA-44	CRILE-MURRAY.....	CE-02
TOWNSEND-MINI (BABY TISCHLER)		CRILE-WOOD.....	CE-02
sacabocado para el cuello del útero.....	HA-45	DE BAKEY.....	CE-03
TOWNSEND-mini sacabocado		DERF.....	CE-02
para el cuello del útero.....	HA-44	DIETHRICH para vascular.....	CE-06
TOWNSEND sacabocado para el cuello del útero.....	HA-44	FINOCHIETTO.....	CE-04
TOWNSEND-TISCHLER sacabocado		GILLIES.....	CE-05
para el cuello del útero.....	HA-44	HALSEY.....	CE-02
TROELTSCH para nasales.....	EG-04	HEANEY.....	CE-03
TROUTMAN Colibri para iris.....	EC-13	HOESEL.....	CE-05
TROUTMAN rectus.....	ED-02	JAMISON.....	CE-03
Tübingen ligaduras.....	ED-05	JOHNSON.....	CE-04
Tübingen para iris.....	EC-15	KALT.....	CE-07
Tübingen TITAN ligaduras.....	ED-05	KALT-ARRUGA.....	CE-07
Tübingen TITAN para iris.....	EC-15	MASSON.....	CE-03
TUFFIER hemostática.....	BC-08	MATHIEU.....	CE-05
TURNBULL para unas 11,5 cm.....	HE-03	MAYO-HEGAR.....	CE-02
TURREL sacabocado para biopsia.....	GI-05	METZENBAUM.....	CE-04
TYDING coger amígdalas.....	FA-04	NEIVERT.....	CE-02
ULRICH porta esponjas.....	BG-06	OLSEN-HEGAR.....	CE-05
UNIVERSAL para esterilización.....	CI-02	RYDER.....	CE-03
USA de disección.....	BA-02	SAROT.....	CE-04
VAN BUREN para secuestros.....	DC-10	STEVENS de oftalmología.....	CE-06
van DOREN sacabocado para el cuello del útero.....	HA-42	STRATTE.....	CE-04
VERBRUGGE para huesos.....	DC-09	TOENNIS.....	CE-04
VIRTUS (RALK) para espinas.....	BA-06	WANGENSTEEN.....	CE-03
WACHENFELDT para grapas.....	CG-07	Portador MILLIN de luz fria.....	GG-05
WAGNER cortantes para laminectomía.....	EA-09	POTTS DE MARTEL tijeras para vasculares.....	AI-27
WALSHAM enderezar tabique.....	EG-18	POTTS	
WANGENSTEEN de disección.....	BA-05	pinza atraumatica.....	BD-26 hasta BD-27
WEBER atraumatica.....	BD-12	pinza atraumatica anastomosis.....	BD-05
WEIL-BLAKESELEY cortantes para nasales.....	EG-06	pinza para coarctación atraumatica.....	BD-04
WEISS para cierra-tubo.....	BC-19	POTTS-SMITH	
WERTHEIM-CULLEN histerectomía.....	BC-18	pinza de disección.....	BA-02
WERTHEIM histerectomía.....	BC-18	tijeras para vasculares.....	AH-19, AI-28
WHITE coger amígdalas.....	FA-03	POZZI pinza pra coger el cuello de útero.....	HA-31
WILDE (TROELTSCH) auriculares.....	EE-07	P. para unas 11,5 cm.....	HE-03
WILLET-MARTELL para pericraneio.....	BC-08	PRATT	
WILLIAMS para tejidos.....	GE-03	dilatador uterinos.....	HA-29
WINTER para aborto y placenta.....	HC-07	espéculo rectales.....	GI-02
WITTNER sacabocado para el cuello del útero.....	HA-43	gancho cistico.....	GI-04
WOLFF para romper yesos.....	DA-04	pinza hemostática.....	BC-08
WYLIE atraumatica.....	BD-21	pinza pra coger el cuello del útero.....	HA-34 hasta HA-35
YEOMAN sacabocado para biopsia.....	GI-05	PRESBYTERIAN HOSPITAL pinza	
YOUNG para coger prostata.....	GG-02	para cierra-tubo.....	BC-19
YOUNG tiralengua.....	EI-03	PRICE-THOMAS pinza bronquiales.....	FG-22
ZAUFAL-JANSEN gubia.....	DC-04	PRINCE	
ZENKER de disección y ligadura.....	BC-12	pinza musculares.....	ED-02
PIPER		tijeras para amígdalas.....	AI-27

Proctoscopio KELLY.....	GI-04
Protector	
ARRUGA.....	EC-08
de tejido.....	DD-15
PROVIDENCE-HOSPITAL pinza hemostática.....	BC-05
PUTTI lima para huesos.....	DC-25

Q

QUATTRO separador para yesos.....	DA-03
Queratomo	
BERENS.....	EC-04
CASTROVIEJO.....	EC-04
JAEGER.....	EC-04
QUINBY tijeras para encías.....	AI-42
QUINKE aguja para punción.....	CC-03
QUIRE elevadores cuerpos extraños.....	EE-08
QUISLING martillo.....	DC-18
Quistotomo	
BECKER.....	EC-06
GRAEFE.....	EC-06
Quita hojas.....	AG-06, AG-10

R

RADOLF pinza para unas.....	DD-03
RALK perforador a mano.....	DD-05
RAMPLEY pinza porta esponjas.....	BG-09
RANDALL	
cureta aspiradoras para la biopsia uterina.....	HA-40
pinza para cálculos renales.....	GC-11 hasta GC-12
RANEY	
pinza hemostática para cuero cabell.....	EA-03
pinza para poner y quitar.....	EA-03
RANKIN pinza atraumática.....	BD-02
Raquiótomo.....	DC-17
RECAIMER cureta uterinas.....	HA-49 hasta HA-50
Rectoscopio luz fría.....	GI-03
Regla de metal.....	AC-08
REICHERT depresor epiglotis.....	FC-02
REINER	
cuchillo para yesos.....	DA-04
jeringa auriculares.....	EE-05
Retractor PERCY para amputación.....	DD-03
REVERDIN	
aguja para ligaduras.....	CG-03
separador.....	BI-04
REYNOLDS	
tijera.....	AI-18
tijeras.....	AH-15
RIBBON separador.....	BI-04
RICHARDSON-EASTMAN separador.....	BI-04
RICHARDSON Grip separador.....	BI-04
RICHARDSON separador.....	BI-04
RICHTER-HEATH pinza para grapas.....	CG-07
RIGBY separador abdominales.....	BI-24
Riñonera.....	HE-07
ROBB disector para vasculares.....	FG-33
ROBERTS pinza hemostática.....	BC-11
ROCHESTER-CARMALT pinza hemostática.....	BC-07
ROCHESTER-OCHSNER pinza hemostática.....	BC-06
ROCHESTER-PEAN pinza hemostática.....	BC-06
ROEDER pinza para campos.....	BE-03
ROGER elevadores tabique.....	EG-11
ROGGE pinza para esterilización.....	CI-02
ROLLET	
cincel para extirpación.....	EC-06
separador.....	EC-06
Rompecráneo VIRCHOW.....	DC-17
Rompe hojas	
CASTROVIEJO.....	AG-14

DIMEDA.....	AG-14
TROUTMAN-CHRIS.....	AG-14
ROSE gancho traqueal.....	FE-03
ROSEN	
aguja.....	EE-14 hasta EE-15
ROSENBERG pinza laringe.....	FC-03
ROSEN	
cuchillo circular.....	EE-14
ROSER-KOENIG abreboca.....	EI-03
ROUX BABY separador.....	BI-02
ROUX MINI separador.....	BI-02
ROUX separador.....	BI-02
ROWE pinza boca.....	EI-06
RUBIN pinza para magullar tabique.....	EG-07
RUMEL pinza para torácica.....	BC-11
RUSKIN-LISTON pinza cortante para huesos.....	DC-06
RUSKIN pinza gubia.....	DC-04
RUSSIAN pinza de disección.....	BA-04
RYDEL-SEIFFER diapasones.....	EE-04
RYDER porta-aguja.....	CE-03

S

SAALFELD saca comedones.....	HE-02
Saca	
SAALFELD comedones.....	HE-02
SCHAMBERG comedones.....	HE-02
UNNA comedones.....	HE-02
WALTON comedones.....	HE-02
SACHS	
descolador duramadre.....	EA-05
gancho para nervios.....	EA-04
SADILLOT periostótomo.....	DC-19
SAENGER pinza para aborto y placenta.....	HC-07
SAIRGES pinza para coger el cuello del útero.....	HA-32
Salpingógrafo SCHULTZE.....	HA-47
SANVENERO	
tijera.....	AI-16
tijeras.....	AH-13
SAROT	
pinza bronquiales.....	FG-23
pinza hemostática bronquial.....	BC-12
porta-aguja.....	CE-04
SATINSKI pinza atraumática.....	BD-20
SATINSKY	
pinza para anastomosis (vena cava).....	FG-24 hasta FG-25
tijeras para torácica.....	AI-37
SATO cuchillo para corneal.....	EC-05
SAUERBRUCH	
caja para agujas.....	HE-02
costótomo.....	FG-05
SAUERBRUCH-FREY costótomo.....	FG-06
SAUERBRUCH	
pinza gubia.....	DC-05
pinza para desechos.....	CI-03
separador.....	BI-13
SAWTELL pinza para amígdalas.....	FA-03
SCAGLIETTI pinza gubia.....	DC-05
SCHAMBERG saca comedones.....	HE-02
SCHUDE cucharilla cortante.....	DC-12
SCHEIE	
canula oculares.....	ED-07
cuchillo para goniometría.....	EC-05
SCHEINMANN pinza laringe.....	FC-03
SCHERBAK espéculo vaginales.....	HA-21
SCHIMMELBUSCH tambor para esterilización.....	HE-12
SCHINK dermatógeno.....	AG-21
SCHIOETZ tonómetro.....	ED-08
SCHMIEDEN-PAYR sonda conductora.....	CG-04
SCHMIEDEN sonda conductora.....	CG-04
SCHMIEDEN-TAYLOR tijeras.....	AI-36

SCHNIDT pinza para amígdalas	FA-03
SCHOENBORN separador tiroide.....	FE-04
SCHOENBURG pinza para tejidos.....	GE-03
SCHROEDER	
cureta uterinas	HA-48
pinza para coger el cuello del útero	HA-31 hasta HA-32
SCHUBERT pinza sacabocado	
para el cuello del útero.....	HA-41
SCHUKNECHT	
cuchillo circular.....	EE-14
cuchillo forma hoz	EE-14
SCHULTZE salpingógrafo.....	HA-47
SCHUMACHER	
pinza larínge.....	FC-03
pinza sacabocado para el cuello del útero	HA-43
tijera para esternón	FG-07
tijeras para umbilicales	AI-34
SCHWEIGGER pinza capsulares	ED-04
SEEMANN-SEIFFERT abreboca.....	EI-04
SEGOND bisturi para fibroma.....	HA-46
SEIFFERT pinza larínge.....	FC-03
SELLHEIM separador para la salida de la cabeza.....	HC-09
SELLORS aproximadore para costillas	FG-18
SEMB	
periostótomo	DC-20
pinza bronquiales	FG-23
pinza cortante para huesos	DC-07
pinza gubia	DC-06
pinza para huesos	DC-07
SEMKEN pinza de disección	BA-05
SEMM espéculo vaginales.....	HA-07
SENN-GREEN separador.....	BI-07
SENN separador.....	BI-04
Sensímetro WARTENBERG	AC-08
Separador	BI-06, BI-10
ADSON	BI-15
ADSON Baby.....	BI-15
ALM	BI-14
AUFRIEHT para nasales	EG-17
BALFOUR abdominales	BI-22
BALFOUR Baby abdominales	BI-22
BECKMANN	BI-16
BECKMANN-ADSON	BI-15
BECKMANN-EATON	BI-16
BEESON para yesos	DA-03
BLOUNT para rodilla	DC-24
BOSE traqueal	FE-02
BUNNELL tendones.....	DC-25
CASPAR	BI-20
CASPAR para columna espinal.....	BI-18
CASPAR para columna vertebral	BI-19
CASTAÑEDA costales	FG-14
CHEVALLIER costales.....	FG-15
CLOWARD.....	BI-17
CLOWARD para cuerpos vertebrales	EA-07
COLLIN abdominales.....	BI-24 hasta BI-25
COLLIN-HARTMANN	BI-03
COOLEY atrium	FG-20
COOLEY costales.....	FG-09
COOLEY modif. STRUCK atrium	FG-20
CORYLLOS (Thorax).....	BI-13
COTTLE-NEIVERT para nasales	EG-17
COTTLE para nasales	EG-17
CRILE	BI-02
CUSHING	BI-07
DARLING.....	BI-17
DAVIDSON (Scapula).....	BI-13
DEAVER	BI-05
DEAVER Grip	BI-05
de labios y mejillas	EI-03
DESMARRES	BI-07

DIMEDA.....	BI-14
DOYEN	BI-12
Separadore	
ALAN-PARKS rectales	GI-03
SMITH-BUIE rectales	GI-03
Separador	
FARABEUF	BI-02
FINOCHIETTO-BABY costales.....	FG-09
FINOCHIETTO BURFORD costales	FG-12 hasta FG-14
FINOCHIETTO costales	FG-08, FG-10 hasta FG-11
FINOCHIETTO-HAIGHT BABY costales	FG-10
FINOCHIETTO INFANT costales.....	FG-12
FINOCHIETTO (modif) costales	FG-08
FINSEN	BI-14
FOMON para nasales.....	EG-17
FRAZIER	BI-21
FRIEDMAN perineorraf	HA-23
FRITSCH	BI-11
GELPI abdominales.....	BI-24
GOELET	BI-03
GOSSET abdominales	BI-21
GREEN	BI-10
HABERER	BI-04
HAGLUND-STILLE para yesos.....	DA-03
HAIGHT costales	FG-15
HARRINGTON.....	BI-05
HEANEY	BI-12
HENNIG para yesos	DA-03
HERMANN para yesos	DA-03
HERTZLER costales.....	FG-17
HOFER para pilar	FA-02
HRYNTSCHAK para prostata	GG-06
INGE para cuerpos vertebrales	EA-07
ISRAEL	BI-11
JACKSON traqueal	FE-02
JANSEN.....	BI-14
JUDD-MASSON vesicales	GG-04
KELLY	BI-04, BI-12
KELLY Grip.....	BI-04
KIRSCHNER abdominales	BI-23
KNAPP	EC-06
KOCHER	BI-10 hasta BI-11
KOERTE	BI-11
LAHEY	BI-08
LANGENBECK	BI-09
LEGUEU vesicales.....	GG-06
LITTLE	BI-08
LOVE uvula	FA-02
MATHIEU	BI-03
MERCEDES torácico	FG-16
MEYERDING	BI-08
MIDDELDORPF.....	BI-10
MIKULICZ	BI-12
MILLIN vesicales	GG-05
MOLLISON	BI-17
MORSE-FAVOLORO costales	FG-17
Separador ganchos musculares	BI-25
Separador	
NAGER paladar	FA-02
OLLIER	BI-10
O'SULLIVAN-O'CONNOR abdominales.....	BI-21
Separador para yesos.....	DA-03
Separador	
PARKER	BI-02
PITHA de labios.....	EI-06
PLESTER	BI-14
QUATTRO para yesos	DA-03
REVERDIN	BI-04
RIBBON	BI-04
RICHARDSON.....	BI-04
RICHARDSON-EASTMAN	BI-04

RICHARDSON Grip.....	BI-04	gubia.....	DC-15
RIGBY abdominales.....	BI-24	SMITH US ARMY tijeras de vendajes.....	AI-44
ROLLET.....	EC-06	SMITHWICK	
ROUX.....	BI-02	gancho para nervios.....	EA-04
ROUX BABY.....	BI-02	pinza para poner grapas.....	EA-02
ROUX MINI.....	BI-02	SNELLEN	
SAUERBRUCH.....	BI-13	asa.....	EC-08
SCHOENBORN tiroide.....	FE-04	pinza entropión.....	ED-06
SELLHEIM para la salida de la cabeza.....	HC-09	SOMER pinza para el útero.....	HA-37
SENN.....	BI-04	Sonda.....	CA-02
SENN-GREEN.....	BI-07	BOWMAN canal lacrimonal.....	EC-10
SIMON.....	BI-12	BRUNNER conductora.....	CG-04
STERNBERG de labios.....	EI-02	DESJARDINS para cálculos biliares.....	GC-05
TAYLOR espinal.....	DC-24	DOYEN.....	CA-02
THOMSON-WALKER vesicales.....	GG-06	FILIFORM.....	GG-12
TUFFIER costales.....	FG-16	KIRSCHNER conductora.....	CG-04
US Army (PARKER-LANGENBECK).....	BI-03	KOCHER bocio.....	FE-04
VOLKMANN.....	BI-07 hasta BI-08	KOENIG conductora.....	CG-04
WEITLANER.....	BI-14	MAYO para cálculos renales.....	GC-10
WEITLANER-WULLSTEIN.....	BI-14	mesurar.....	EE-15
YOUNG para prostata.....	GG-02	MOYNIHAN para cálculos biliares.....	GC-05
SEUTIN cizalla para yeso.....	DA-02	NABATOFF de plata auricular.....	CA-02
SEXTON cuchillo auriculares.....	EE-06	PAYR conductora.....	CG-04
SHEA tijeras auriculares micro.....	EE-09	SCHMIEDEN conductora.....	CG-04
SHORTBENT tijeras para puntas.....	AI-40	SCHMIEDEN-PAYR conductora.....	CG-04
SIEBOLD tijeras para ginecológicas.....	AH-21, AI-32	STACKE de plata auricular.....	CA-02
SIEGLE espéculos auriculares.....	EE-02	SPENCER tijeras para puntas.....	AI-40
SIEGLER HELLMANN pinza para el útero.....	HA-38	SPENCER-WELLS pinza hemostática.....	BC-07
Sierra		SPRATT cucharilla cortante.....	DC-12
BERGMANN para yesos.....	DA-02	SPURLING pinza cortantes para laminectomía.....	EA-08
CHARRIERE para amputacion.....	DD-03	STACKE sonda de plata auricular.....	CA-02
ENGEL para yesos.....	DA-02	Standard estuche de bolsillo y de sutura.....	CG-08
JOSEPH para nasales.....	EG-17	STAUDE-MOORE pinza	
LANGENBECK a dedo.....	DD-03	para coger el cuello de útero.....	HA-31
OLIVECRONA.....	EA-05	St. CLAIR-THOMSON cuchillo.....	EG-19
Sierra oscilante para yesos.....	DA-05 hasta DA-06	STEINER-AUVARD espéculo vaginales.....	HA-19
Sierra		STEINMANN clavo para huesos.....	DD-09
WIGMORE para yesos.....	DA-02	STELZNER tijera para recto.....	AI-38
SILVER		STERNBERG separador de labios.....	EI-02
cincel plástica para nasales.....	EG-14	STEVENS	
dermátomo.....	AG-20	gancho para cristalino.....	EC-06
SIMCOE canula sutura.....	ED-07	STEVENSON blefarostato.....	EC-03
SIMON		STEVENS	
cucharilla cortante.....	DC-13	pinza para iris.....	EC-11
cureta uterinas.....	HA-48	porta-aguja de oftalmología.....	CE-06
separador.....	BI-12	tijeras para tenotomía.....	AH-17
SIMPSON-BRAUN pinza obstétricas.....	HC-02	tijera tenotomía.....	AI-23
SIMPSON pinza obstétricas.....	HC-02	STIEGLITZ pinza para espinas.....	BA-06
SIMPSON-LUIKART pinza obstétricas.....	HC-03	STILLE	
SIMS		cincel.....	DC-14
cureta uterinas.....	HA-49 hasta HA-50	cizalla para yeso.....	DA-02
depresor uterino.....	HA-39	costótomo.....	FG-03
dilatador uterinos.....	HA-30	gubia.....	DC-14
espéculo rectales.....	GI-02	STILLE-HORSLEY pinza cortante para huesos.....	DC-07
espéculo vaginales.....	HA-17	STILLE-LISTON pinza cortante para huesos.....	DC-06
histerómetro.....	HA-39	STILLE-LUER pinza gubia.....	DC-04
SIMS-MAIER pinza para tapones.....	BG-05	STILLE	
SIMS		osteotomo.....	DC-14
tijeras para ginecológicas.....	AH-21, AI-32	perforador a mano.....	DD-04
SINGLEY pinza de disección.....	BA-05	pinza de disección.....	BA-02
Sisteme LEYLA de fijación.....	EA-14 hasta EA-18	pinza para pedícula renal.....	BC-16
SKENE pinza para coger el cuello del útero.....	HA-31	STILLE-RUSKIN pinza gubia.....	DC-05
SLUDER-BALLENGER amigdalotomo.....	FA-05	STILLE-SHERMAN perforador a mano.....	DD-04
SMELLIE		St. MARTIN pinza sutura.....	ED-05
gancho obstetrico.....	HC-06	STOCKMANN compressor uretrales.....	GG-12
perfora-cráneo.....	HC-09	STONE pinza para cerrar.....	GE-06
SMILLIE meniscotomo.....	DC-24	STONE-WATT pinza intestinales.....	GE-06
SMITH blefarostato.....	EC-02	STRATTE porta-aguja.....	CE-04
SMITH-BUIE separadore rectales.....	GI-03	STRAUSS compressor uretrales.....	GG-10
SMITH-PETERSEN		STRUEMPPEL pinza auriculares.....	EE-08
cincel.....	DC-15	STRULLY tijeras para neuroquirurgicas.....	AI-35

S

Índice alfabético
Español

STRUYCKEN pinza cortantes para nasales.....EG-07
SUBRAMANIAN pinza atraumaticaBD-31
SWEET pinza para poner grapasEA-02

T

TABB cuchillo forma hozEE-14
Taladros.....DD-04
 KIRSCHNER filiformesDD-09
Tambor
 KONRICH para esterilizaciónHE-12
 SCHIMMELBUSCH para esterilizaciónHE-12
Tamiz para especulo vaginal.....HA-22
TARNIER
 cranioclasto.....HC-09
 pinza obstétricas con dispositivo de tracciónHC-05
TarroHE-08
TAYLOR
 martillos de percusiónAC-07
 separador espinalDC-24
TEALE pinza para coger el cuello del úteroHA-33
Tensor
 LOUTE cierra-hiloDD-11
 para filfDD-10
TerrajaDD-15
TERSON pinza capsularesED-04
THOMS-ALLIS pinza para tejidos.....GE-02
THOMS-GAYLOR pinza sacabocado
 para el cuello del úteroHA-42
THOMSON-WALKER separador vesicalesGG-06
THOREK tijeras para pulmonaresAI-36
THUDICHUM espéculo para nasalesEG-02
TIECK-HALLE espéculo para nasales.....EG-03
TIEMANN pinza pra coger el cuello de úteroHA-32
Tijera
 AEBLI para cornealAI-22
Tijera de disecciónAI-19
Tijera finasAI-19
Tijera
 FINOCHIETTO para rectoAI-38
 GORNEY de disecciónAI-13
 IRISAI-19
 IRIS de oftalmologíaAI-22
 JOSEPHAI-16
 KILNERAI-17
 LEXER-BABY de disecciónAI-12
 LEXER-FINO de disecciónAI-12
 LITTLER de disecciónAI-13
 LOCKLINAI-18
 METZENBAUM de disecciónAI-13 hasta AI-14
 METZENBAUM FINO de disección.....AI-15
 METZENBAUM "S"AI-16
Tijera para enterótomos.....AI-39
Tijera
 REYNOLDSAI-18
Tijeras.....AH-02 hasta AH-04, AI-02 hasta AI-04
Tijera
 SANVENEROAI-16
Tijeras
 auriculares microEE-11
 auriculares micro miniEE-11
 BARRAQUER de colibri.....AJ-04
 BEEBEE para alambre y chapasAI-43
 BELLUCCI auriculares microEE-09
 BERGMANN de vendajesAI-46
 BEUSEAI-26
 BOETTCHER para amígdalas.....AI-27
 BRAUN-STADLER para episiotomía.....AH-22, AI-34
 BRUNS para yesoAI-48
 BUCK para puntas.....AI-40
 BUSCH para umbilicalesAI-34

CASTROVIEJO para cornealAJ-06
CASTROVIEJO para iridectomia.....AJ-05
Tijera
 SCHUMACHER para esternónFG-07
Tijeras
 COTTLE para nasales.....AH-18, AI-25
 CRAFOORD para pulmonaresAI-36
 CRUZ ROJA de vendajes.....AI-47
 cuticularHE-03
 DANDY para neuroquirurgicasAI-36
 DEAN para amígdalasAI-26
 DEAVERAH-05, AI-06
 DE BAKEY para vascularesAI-30
 DIETHRICH para vasculares.....AI-29
 DIMEDA de vendajesAI-46
 DOYEN para ginecológicas.....AI-33
 DUBOIS para ginecológicas.....AI-33
 ESMARCH de vendajesAI-46
Tijeras estrabismo.....AI-24
Tijeras
 FERGUSSONAI-49
Tijeras finas.....AI-24
Tijeras finas.....AI-05
Tijeras
 FOMON para nasalesAH-18, AI-25
 GOLDMAN-FOX para encíasAI-41
 GOOD para amígdalasAI-27
 HEATH para puntas.....AI-40
 HEYMANN para nasalesAH-18, AI-25
Tijeras incisionAI-05
Tijeras
 IRISAH-16, AI-21
 JACOBSON micro.....AJ-11
 JOSEPHAH-14
 KELLY para ginecológicas.....AH-22, AI-33
 KILNERAH-14
 KLINKENBERGH-LOTH para toracicaAI-37
 KNAPPAI-20
 KNOWLES de vendajesAI-47
 LAGRANGE para encíasAI-41
 LANDOLT enucleaciónAI-25
 LANGE de vendajesAI-44
 LEXERAH-09
 LEXER-BABYAH-10
 LEXER de disecciónAI-11
 LISTER de vendajesAH-23, AI-45
 LITTAUER para puntasAI-40
 LORENZ de vendajes.....AI-47
 MAYOAH-06, AI-07
 MAYO-NOBLEAH-08, AI-10
 MAYO-STILLEAH-07, AI-08 hasta AI-09
 MAYO zurdoAI-07
 McGUIRE para corneal.....AJ-05
 McINDOE para cartilago.....AI-35
 McPHERSON WESTCOTT para tenotomiaAJ-04
 METZENBAUMAH-11
 METZENBAUM FINOAH-12
 METZENBAUM "S"AH-13
Tijeras microAJ-06, AJ-13
Tijeras micro para ginecológicasAJ-07 hasta AJ-08
Tijeras
 MILLS para vasculares.....AI-27
 NORTHBENT para puntasAI-40
 NOYES para irisAJ-03 hasta AJ-04
 NOYES para tendonesAJ-03
Tijeras para encíasAI-41
Tijeras para estrabismo.....AH-17
Tijeras parametrio para vasculares.....AH-20
Tijeras para neuroquirurgicasAI-35
Tijeras para preparacionAI-34
Tijeras para vasculares.....AI-27

Tijeras para vasculares micro	AJ-09
Tijeras para yeso	AI-49
Tijeras	
POTTS DE MARTEL para vasculares	AI-27
POTTS-SMITH para vasculares	AH-19, AI-28
PRINCE para amígdalas	AI-27
QUINBY para encías	AI-42
REYNOLDS	AH-15
SANVENERO	AH-13
SATINSKY para torácica	AI-37
SCHMIEDEN-TAYLOR	AI-36
SCHUMACHER para umbilicales	AI-34
SHEA auriculares micro	EE-09
SHORTBENT para puntas	AI-40
SIEBOLD para ginecológicas	AH-21, AI-32
SIMS para ginecológicas	AH-21, AI-32
SMITH US ARMY de vendajes	AI-44
SPENCER para puntas	AI-40
STEVENS para tenotomía	AH-17
STRULLY para neuroquirúrgicas	AI-35
Tijera	
STELZNER para recto	AI-38
STEVENS tenotomía	AI-23
Tijeras	
THOREK para pulmonares	AI-36
TOENNIS-ADSON para neuroquirúrgicas	AI-35
TROUTMAN-CASTROVIEJO micro	AJ-07
UNIVERSAL de vendajes	AI-50
UNIVERSAL para alambre y chapas	AI-42
USA MODEL para umbilicales	AI-34
VANNAS micro	AJ-12 hasta AJ-13
VANNAS para iridectomía	AJ-05
WAGNER	AH-22
WAGNER para encías	AI-42
WALDMANN para episiotomía	AI-34
WECKER para iris	AJ-04
WERTHEIM para preparación	AI-32
WESTCOTT para iridectomía	AJ-02
WESTCOTT para tendones	AJ-02
WULLSTEIN auriculares micro	EE-11
WULLSTEIN auriculares micro mini	EE-11
YASARGIL micro	AJ-10 hasta AJ-11
TILLEY pinza auriculares	EE-08
Tirabuzón DOYEN para fibroma	HA-46
TISCHLER-KEVORKIAN pinza sacabocado	
para el cuello del útero	HA-44 hasta HA-45
TISCHLER-MORGAN pinza sacabocado	
para el cuello del útero	HA-43 hasta HA-44, HA-46
TIVNEN pinza coger amígdalas	FA-04
TOBOLD	
abajalengua	EI-02
estilete	CA-03
TOENNIS-ADSON tijeras para neuroquirúrgicas	AI-35
TOENNIS	
descolador duramadre	EA-05
pinza hemostática	BC-11
porta-aguja	CE-04
TOHOKU pinza para campos	BE-04
Tonómetro SCHIOETZ	ED-08
TOOK cuchillo para corneal	EC-05
Torniquete	AC-03, DD-02
TOTI fresa	DD-07
TOWNSEND-KEVORKIAN pinza sacabocado	
para el cuello del útero	HA-44
TOWNSEND-MINI (BABY TISCHLER) pinza	
sacabocado para el cuello del útero	HA-45
TOWNSEND-mini pinza sacabocado	
para el cuello del útero	HA-44
TOWNSEND pinza sacabocado	
para el cuello del útero	HA-44
TOWNSEND-TISCHLER pinza sacabocado	

para el cuello del útero	HA-44
TOYNBEE espéculos auriculares	EE-02
Tractor	
BARTON adecuada	
para todas las pinzas con mango	HC-04
BILL adecuada para todas las pinzas con mango	HC-05
LUIKART-BILL adecuada	
para todas las pinzas con mango	HC-05
TRAUBE martillos de percusión	AC-07
TRELAT espéculo vaginales	HA-07
Trépano	DD-04
CASTROVIEJO para corneal	ED-07
ELLIOT para corneal	ED-08
FRANCESCHETTI para corneal	ED-07
Trócar	CC-02
COAKLEY	CC-02
DOUGLAS	CC-02
FLEURANT	CC-02
LICHTWITZ	CC-02
MENGHINI	CC-03
NELSON	CC-02
OCHSNER	CC-02
PIERCE	CC-02
Trócar UCKERMANN traqueal	FE-02
Trócar	
UNIVERSAL	CC-02
TROELTSCH pinza para nasales	EG-04
TROEMNER martillos de percusión	AC-07
TROUSSEAU dilatador traqueal	FE-02
TROUTMAN-CASTROVIEJO tijeras micro	AJ-07
TROUTMAN-CHRIS rompe hojas	AG-14
TROUTMAN Colibri pinza para iris	EC-13
TROUTMAN pinza rectus	ED-02
TUBBS dilatador para válvula mitral	FG-27
Tübingen	
canula aire	ED-07
pinza ligaduras	ED-05
pinza para iris	EC-15
Tübingen TITAN	
pinza ligaduras	ED-05
pinza para iris	EC-15
Tubo	
ANDREWS-PINCHON de aspiración	AE-03
BRUENINGS alarmino	FC-03
BUIE de aspiración	GI-05
DE BAKEY de aspiración	AE-04
FRAZIER de aspiración	EA-07
JACKSON traqueal	FE-03
LUER traqueal	FE-03
MAGILL de aspiración	AE-04, AE-06
NUBOER de aspiración	AE-05
POOLE de aspiración	AE-02
WAGENER-MOSHER traqueal	FE-03
WALTON YANKAUER de aspiración	AE-03
YANKAUER de aspiración	AE-02
TUFFIER	
pinza hemostática	BC-08
separador costales	FG-16
TURNBULL pinza para unas 11,5 cm	HE-03
TURREL pinza sacabocado para biopsia	GI-05
TYDING	
cierranudos amígdalas	FA-05
pinza coger amígdalas	FA-04
U	
UCKERMANN	
estilete	CA-03
trocar traqueal	FE-02
ULRICH pinza porta esponjas	BG-06
UNIVERSAL	

S

Índice alfabético Español

pinza para esterilización.....	CI-02
tijeras de vendajes.....	AI-50
tijeras para alambre y chapas.....	AI-42
trócar.....	CC-02
UNNA saca comedones.....	HE-02
Uretrotomo OTIS.....	GG-08
Urinal.....	HE-10
USA	
cable electrobisturías.....	JA-07
USA MODEL tijeras para umbilicales.....	AI-34
USA	
pinza de disección.....	BA-02
US Army (PARKER-LANGENBECK) separador.....	BI-03
Uso único de bisturías estériles.....	AG-10 hasta AG-11

V

VALLEIX histerómetro.....	HA-39
Valva	
BALFOUR.....	BI-22
CASPAR.....	BI-20
CASPAR para columna vertebral.....	BI-19
KALLMORGEN vaginales.....	HA-15
KIRSCHNER.....	BI-23
KRISTELLER vaginales.....	HA-09 hasta HA-14
VAN BUREN	
bujía uretrales.....	GG-13
pinza para secuestros.....	DC-10
Van DOREN pinza sacabocado para el cuello del útero.....	HA-42
VANNAS	
tijeras micro.....	AJ-12 hasta AJ-13
tijeras para iridectomía.....	AJ-05
VARIFOCAL oftalmoscopio.....	AC-03
Vaso para medicamentos.....	HE-07
VERBRUGGE pinza para huesos.....	DC-09
VERRES aguja para punción, neumoperitoneo.....	CC-03
Vienna espéculo para nasales.....	EG-02
VIRCHOW	
cuchillo para cartílagos.....	AG-18
cuchillo para cerebro.....	AG-18
rompecráneo.....	DC-17
VIRTUS (RALK) pinza para espinas.....	BA-06
VOLKMANN	
cucharilla cortante.....	DC-12 hasta DC-13
separador.....	BI-07 hasta BI-08
VOLTOLINI espéculo para nasales.....	EG-02

W

WACHENFELDT pinza para grapas.....	CG-07
WADSWORTH-TODD cauterio.....	EC-08
WAGENER ganchito auriculares.....	EE-07
WAGENER-MOSHER tubo traqueal.....	FE-03
WAGNER	
pinza cortantes para laminectomía.....	EA-09
tijeras.....	AH-22
tijeras para encías.....	AI-42
WALDMANN tijeras para episiotomía.....	AI-34
WALLICH cureta para aborto y placenta.....	HC-08
WALSHAM pinza enderezar tabique.....	EG-18
WALTHER bujía uretrales.....	GG-17
WALTON	
gubia para cuerpos extraños.....	EC-06
saca comedones.....	HE-02
WALTON YANKAUER tubo de aspiración.....	AE-03
WANGENSTEEN	
pinza de disección.....	BA-05
porta-aguja.....	CE-03
WARTENBERG sensímetro.....	AC-08
WATSON-CHEYNE elevador.....	DC-22

WATSON dermatómo.....	AG-22
WEBER	
asa.....	EC-08
pinza traumática.....	BD-12
WECKER	
espatula para iris.....	EC-08
tijeras para iris.....	AJ-04
WEEK blefarostato.....	EC-02
WEIL-BLAKESLEY pinza cortantes para nasales.....	EG-06
WEISSBARTH espéculo vaginales.....	HA-22
WEISS pinza para cierra-tubo.....	BC-19
WEITLANER separador.....	BI-14
WEITLANER-WULLSTEIN separador.....	BI-14
WELLS espatula enucleación.....	EC-08
WERTHEIM-CULLEN pinza histerectomía.....	BC-18
WERTHEIM	
pinza histerectomía.....	BC-18
tijeras para preparación.....	AI-32
WEST	
cincel para nasales.....	EG-14
WESTCOTT	
tijeras para iridectomía.....	AJ-02
tijeras para tendones.....	AJ-02
WEST	
gubia para nasales.....	EG-14
WESTON cierranudo polipus rectal.....	GI-05
WHEELER	
cuchillo para discisión.....	EC-04
espatula ciclodialálisis.....	EC-09
WHITEHEAD abreboca.....	EI-04
WHITE pinza coger amígdalas.....	FA-03
WIEDER abajalengua.....	EI-02
WIENER (AUFRIECHT) lima para nasales.....	EG-15
WIENER	
gancho para iris.....	EC-06
lima para el seno.....	EG-15
WIGMORE sierra para yesos.....	DA-02
WILDE	
cierranudo auriculares.....	EE-07
cierranudos para nasales.....	EG-09
WILDER	
asa.....	EC-08
dilatador canal lacrimonasal.....	EC-10
WILDE (TROELTSCH) pinza auriculares.....	EE-07
WILLET-MARTELL pinza para pericráneo.....	BC-08
WILLIAMS	
blefarostato.....	EC-02
destornillador.....	DD-14
pinza para tejidos.....	GE-03
WILLIGER	
cucharilla cortante.....	DC-13
martillo.....	DC-18
periostótomo.....	DC-19
WINKELMANN instrumento para circuncisión.....	GG-09
WINTER pinza para aborto y placenta.....	HC-07
WITTNER pinza sacabocado para el cuello del útero.....	HA-43
WOLFF pinza para romper yesos.....	DA-04
WRIGLEY pinza obstétricas.....	HC-02
WULLSTEIN	
cuchillo forma hoz.....	EE-14
tijeras auriculares micro.....	EE-11
tijeras auriculares micro mini.....	EE-11
WYLIE	
dilatador uterinos.....	HA-30
pinza traumática.....	BD-21
Y	
YANKAUER	
espéculo nasofaringeo.....	EG-04

tubo de aspiración.....	AE-02
YASARGIL tijeras micro	AJ-10 hasta AJ-11
YEOMAN pinza sacabocado para biopsia	GI-05
YOUNG Boomerang aguja para ligaduras	CG-03
YOUNG	
pinza para coger prostata	GG-02
pinza tiralengua	EI-03
separador para prostata	GG-02

Z

ZAUFAL-JANSEN pinza gubia.....	DC-04
ZENKER pinza de disección y ligadura	BC-12
ZIEGLER	
blefarostato	EC-03
cuchillo capsulotomía	EC-05
cuchillo para iridectomía	EC-04
dilatador canal lacrimal	EC-10
espejo frontal	AC-05

Indice Italiano

A

Mano di piombo	DC-11	per chiodi centromid	DD-12
Abassalingua		ALEXANDER	
ANDREW	EI-02	periototomo	DC-19
BRUENINGS	EI-02	pinza tagliente per biopsia	HA-42
BUCHWALD	EI-02	scalpello	DC-14
FRENZEL	EI-02	sgorbia	DC-14
HARTMANN	EI-02	ALLIS-ADAIR pinza per afferrare tessuti	GE-02
legno	EI-02	ALLIS-Baby pinza per afferrare tessuti	GE-02
McIVOR	EI-05	ALLISON spatola polmone	FG-19
TOBOLD	EI-02	ALLIS pinza per afferrare tessuti	GE-02
WIEDER	EI-02	ALM divaricatore	BI-14
Accessori per contenitori		ALVIS curetta per corpi estranei	EC-06
per sterilizzazione	HE-38 lavorare a HE-41	Amniotomo BEACHAM	HA-39
Ad elettrodo mini	JA-03	ANDREW abassalingua	EI-02
Adenotomo LAFORCE	EG-19	ANDREWS-PINCHON tubi d'aspirazione	AE-03
ADLERKREUTZ pinza dissezione	BA-04	Anoscopio	
ADSON Baby		HIRSCHMANN	GI-04
divaricatore	BI-15	IVES-FANSLER	GI-04
ADSON BABY		Ansa	
pinza emostatica	BC-09	ARLT	EC-08
ADSON-BROWN pinza dissezione	BA-03	auricolare	EE-07
ADSON		BILLEAU auricolare	EE-07
divaricatore	BI-15	di filo	JA-03
divaricatore per nervi	EA-04	di nastro	JA-03
elevatore	DC-21	elettrodo mini	JA-02
pinza dissezione	BA-03	SNELLEN	EC-08
pinza dissezione, micro	BA-03	WEBER	EC-08
pinza emostatica	BC-09	WILDER	EC-08
pinza per ipofisi	EA-06	Anse	EG-09
pinza sgorbia	DC-03	tonsille	FA-04
port'aghi	CE-04	Apparecchio	
AEBLI forbici corneali	AI-22	per vuoto di sangue	DD-02
AESCLAP cavo elettrobisturi	JA-07	PETZ per sutura stomacali e intestinali	GE-09
Affilare ARKANSAS	AG-19	Approssimatori	
Ago		BAILEY-BABY costali	FG-18
BARBARA	EE-14	BAILEY costali	FG-18
BOWMAN per dissezione curva	EC-05	BAILEY-GIBBON costali	FG-18
COOPER per legature	CG-02	SELLORS costali	FG-18
DAVIS per corpi estranei	EC-05	Apribocca	
DESCHAMPS per legature	CG-02	DAVIS-BOYLE	EI-04
DIX	EC-09	DENHART	EI-03
DUPUY-WEISS tonsille	FA-03	DOYEN-JANSEN	EI-03
elettrodo mini	JA-02	HEISTER	EI-03
forma di ago	JA-03	JENNINGS	EI-04
FRANCIS per corpi estranei	EC-05	KILNER-DOUGHTY	EI-05
FRANKLIN-SILVERMANN da punzione	CC-03	MAUNDER legno	EI-06
KEITH suture	CG-06	McIVOR	EI-05
KOENIG suture	CG-06	ROSER-KOENIG	EI-03
KRONECKER per legature	CG-02	SEEMANN-SEIFFERT	EI-04
LEVINSON per corpi estranei	EC-05	WHITEHEAD	EI-04
LICHTWITZ seno	EG-09	ARCHER pinza schegge	BA-06
NELSON per legature	CG-02	Arco per estensione	DD-10
per cataratta stretta retta	EC-05	BOEHLER	DD-10
per corpi estranei retto	EC-05	KIRSCHNER	DD-10
POLITZER auricolare	EE-06	ARKANSAS affilare	AG-19
QUINKE da punzione	CC-03	ARLT ansa	EC-08
REVERDIN per legature	CG-03	ARRUGA	
ROSEN	EE-14 lavorare a EE-15	blefarostato	EC-02
Ago suture	CG-05 lavorare a CG-06	pinza capsulare	ED-04
Ago		port'aghi oftalmologia	CE-06
tonsille	FA-05	protettore	EC-08
VERRES da punzione pneumoperitoneo	CC-03	uncino	EC-06
YOUNG Boomerang per legature	CG-03	ASCH pinza raddrizzare setto	EG-18
Agrafes MICHEL	CG-07	Assordatore BARANY	EE-04
ALAN-PARKS dilatatore per l'ano e il retto	GI-03	Astucci per diagnostica	AC-04
ALBEE fresa	DD-07	Astucci per otoscopia	AC-04
Alesatore		Astucci tascabili e per sutura	
CRUTCHFIELD	EA-03	mini	CG-08
KUENTSCHER	DD-13	standard	CG-08
		AUFRIEHT divaricatore nasale	EG-17
		AUVARD specolo vaginali	HA-19

AXENFELD curetta per calazio EC-07
 AYER pinza calazio ED-06

B

BABCOCK pinza per afferrare tessuti GE-02
 BABINSKY martelli percussori AC-07
 Bacinella HE-05
 per placenta HE-06
 reniforme HE-07
 BACKHAUS-CLIP pinza fissateli porta tubo BE-03
 BACKHAUS KOCHER pinza fissateli BE-02
 BACKHAUS pinza fissateli BE-02
 BAGGISH pinza tagliente per biopsia HA-45
 BAILEY approssimatori costali FG-18
 BAILEY-BABY approssimatori costali FG-18
 BAILEY-GIBBON approssimatori costali FG-18
 BAINBRIDGE
 pinza atraumatica BD-09
 pinza emostatica BC-14
 BAKES dilatatore per condotti biliari GC-06
 BALFOUR Baby divaricatore addominale BI-22
 BALFOUR
 divaricatore addominale BI-22
 valva centrale BI-22
 BALL AND SOCKET pinza fissateli BE-04
 BALLENGER
 coltello girevole EG-11
 elevatore setto EG-12
 pinza tonsille FA-04
 BANGERTER spatola ciclodialisi EC-08
 BARANY assordatore EE-04
 BARBARA
 ago EE-14
 pick EE-14 lavorare a EE-15
 uncinetto EE-14
 BARKAN coltello per goniotomia EC-05
 BARNHILL coltello EG-19
 BARRAQ-KATZIN pinza iride EC-13
 BARRAQU Colibri pinza iride EC-13
 BARRAQUER Colibri blefarostato EC-02
 BARRAQUER
 coltello per cheratopl EC-05
 forbici colibri AJ-04
 pinza camara anteriore ED-02
 pinza depilatorie ED-08
 pinza fissaggio ED-03
 port'aghi CE-07
 BARRETT pinza per abbassare il collo dell'utero HA-32
 BARR specolo rettale GI-02
 BARTON
 forbici obstetriche HC-04
 trattore per manico standard HC-04
 BAUMGARTNER port'aghi CE-02
 BEACHAM amniotomo HA-39
 Becher HE-10
 BECKER cistitomo EC-06
 BECKMANN-ADSON divaricatore BI-15
 BECKMANN
 coltello EG-19
 divaricatore BI-16
 BECKMANN-EATON divaricatore BI-16
 BECK pinza atraumatica vascolare BD-25
 BEEBEE forbici filo metallo lamiera AI-43
 BEER pinza depilatorie ED-08
 BEESON divaricatori per gessi DA-03
 BELLUCCI forbici auricolari micro EE-09
 Benda per emostasi AC-03
 BENGOLEA pinza emostatica BC-09
 BENNETT elevatore per ossa DC-22
 BERENS cheratomo EC-04

BERGMANN FOERSTER pinza
 per tamponi e spugne BG-10
 BERGMANN
 forbici bendaggi AI-46
 sega per gessi DA-02
 BERKE pinza muscolre ED-02
 BERLIND-AUVARD specolo vaginali HA-19
 BERLINER martelli percussori AC-07
 BERNHARD pinza fissateli BE-05
 BERTILLON cefalometro AC-08
 BEST pinza intestinali GE-06
 BETHUNE costotomo FG-04
 BEUSE forbici AI-26
 BEYER
 pinza osteotomo EG-08
 pinza sgorbia DC-04
 Bicchiere graduato HE-07
 BILLEAU ansa auricolare EE-07
 BILL trattore per manico standard HC-05
 BIRCHER-GANSKE tenaglia per ossa DC-10
 BIRCHER meniscotomo DC-24
 BISHOP-HARMAN pinza iride EC-14
 Bisturi
 CONVERSE nasale EG-10
 dissezione AG-15
 FREER mucosa EG-10
 HALLE per duramadre EA-06
 JOSEPH nasale botton EG-10
 MALTZ cartilage angolat EG-11
 Bisturi per dissezione PARKER AG-15
 Bisturi
 SEGOND per fibromi HA-46
 Bisutri lama sterili AG-09
 Bituri forma di bisturi JA-03
 BLAKE
 curetta uterine HA-48
 pinza per calcoli biliari GC-03
 Blefarostato
 ARRUGA EC-02
 BARRAQUER Colibri EC-02
 BOWMAN EC-02
 CASTROVIEJO EC-03
 CLARK EC-02
 CRITCHETT EC-02
 GOLDSTEIN EC-03
 GRAEFE EC-02
 LANCASTER EC-03
 LISTER-BURCH EC-02
 MELLINGER EC-02
 MELLINGER-AXENFELD EC-02
 MUELLER EC-03
 MURDOCK EC-02
 PARK EC-03
 SMITH EC-02
 STEVENSON EC-03
 WEEK EC-02
 WILLIAMS EC-02
 ZIEGLER EC-03
 BLOHMKE pinza tonsille FA-04
 BLOUNT
 elevatore per ginocchio DC-24
 elevatore per ossa DC-24
 BLUMENTHAL pinza sgorbia DC-02
 BODENHAMMER specolo rettale GI-02
 BOEHLER arco per estensione DD-10
 BOERMA forbici obstetriche HC-04
 BOETTCHER forbici tonsillari AI-27
 BÖHLER
 cesoia per ossa DC-06
 pinza sgorbia DC-04
 BONACCOLTO pinza strabismo EC-14

Bonn	
cannula irrigazione	.ED-07
BONNEY pinza per tamponi e spugne	.BG-08
Bonn	
pinza iride	.EC-15
Bonn TITAN pinza iride	.EC-15
BORCHARDT fresa	.DD-07
BOSE	
divaricatore tracheale	.FE-02
uncino tracheale	.FE-02
BOUCHERON specoli auricolare	.EE-02
BOWLES stetoscopio	.AC-06
BOWMAN	
ago per disisione curva	.EC-05
blefarostato	.EC-02
coltello per disisione	.EC-04
specillo canale lacrimale	.EC-10
BOYNTON port'aghi oftalmologia	.CE-06
BOZEMANN-DOUGLAS pinza per medicatura	.BG-13
BOZEMANN	
pinza per medicatura	.BG-13
port'aghi	.CE-03
BRAIN	
clip emostatica per il cuoio capelluto	.EA-12
clip standard	.EA-13
BRAIN MINI pinza per posizionare clip	.EA-12
BRAIN STANDARD pinza per posizionare clip	.EA-12
BRAITHWAITE dermatomo	.AG-22
BRAUN	
cranioclasto	.HC-09
depressore uterino	.HA-39
pinza per abbassare il collo dell'utero	.HA-31, HA-34
specolo vaginali	.HA-16
BRAUN-STADLER forbici episiotomia	.AH-22, AI-34
BRAUN	
uncino per detroncazione	.HC-09
BREISKY specolo vaginali	.HA-20
BROCK	
dilatatore per valvole mitrali	.FG-26
manico per valvole mitrali	.FG-26
pinza tagliente	.FG-26
BROWN pinza dissezione	.BA-03
BRUENINGS	
abassalingua	.EI-02
coltello setto	.EG-11
pinza laringe	.FC-03
pinza tagliente nasale	.EG-05
serranodi tonsille	.FA-04
specoli auricolare	.EE-02
tubo allungo	.FC-03
BRUNETTI scalpello spinale	.DC-17
BRUNNER	
costotomo	.FG-07
pinza intestinale	.GE-06
sonda conduttrice	.CG-04
BRUNS	
curetta tagliente	.DC-12 lavorare a DC-13
forbici gesso	.AI-48
BRYANT pinza per tamponi e spugne	.BG-11
BUCHWALD abassalingua	.EI-02
BUCK	
curetta auricolare	.EE-05
forbici per legature	.AI-40
leva corpi estranei	.EE-08
martelli percussori	.AC-07
BUIE tubo di aspirazione	.GI-05
BUMM	
curetta uterina	.HA-49 lavorare a HA-50
pinza per afferrare l'utero	.HA-38
BUNGE curetta per palpebre	.EC-07
BUNNELL	
perforatore a mano	.DD-05
scollatendini	.DC-25
BUNT pinza per sterilizzazione	.CI-02
BURCH forchetta di fissaggio	.EC-05
BURKE-Baby pinza tagliente per biopsia	.HA-44
BURKE pinza tagliente per biopsia	.HA-44
BUSCH forbici ombelicali	.AI-34
C	
Calamita DIMEDA oculistica	.ED-08
Candeletta	
COXETER dilatatrici	.GG-17
DITTEL dilatatrici	.GG-18 lavorare a GG-19
FILIFORM	.GG-12
GUYON dilatatrici	.GG-12, GG-14 lavorare a GG-15
VAN BUREN dilatatrici	.GG-13
WALTHER dilatatrici	.GG-17
Cannula	
Bonn irrigazione	.ED-07
Hamburg bottonuta	.ED-07
KILLIAN	.EG-09
SCHEIE oculistica	.ED-07
SIMCOE sutura	.ED-07
Tübingen aria	.ED-07
Cannula	
FINSTERER per aspirazione e irrigazione	.AE-05
Capsula diametro	.HE-04 lavorare a HE-05
Capsulo DASTOOR aspiratore	.EC-09
CARMALT pinza schegge	.BA-06
CARPENTER coltello tonsille	.FA-02
CASPAR	
divaricatore	.BI-20
divaricatore lombar vertebrale	.BI-20
divaricatore spina cervica	.BI-18
divaricatore spina vertebrale	.BI-19
manico per bisutri, micro	.AG-12
valva	.BI-20
valva spina vertebrale	.BI-19
CASTAÑEDA	
divaricatore costali	.FG-14
pinza atraumatica	.BD-42
CASTROVIEJO	
blefarostato	.EC-03
cheratomo	.EC-04
dilatatore canale lacrimale	.EC-10
forbici corneali	.AJ-06
forbici iridectomia	.AJ-05
marcatore compasso	.EC-09
pinza capsulare	.ED-04
pinza fissaggio	.ED-03
pinza rompe lamette	.AG-14
pinza sutura	.ED-05
port'aghi	.CE-07
spatola ciclodialisi	.EC-08 lavorare a EC-09
trapano corneale	.ED-07
CATLIN coltello per amputazione	.AG-16
Cauterio WADSWORTH-TODD	.EC-08
Cavachiodi KUENTSCHER	.DD-13
Cavo	
AESCULAP elettrobisturi	.JA-07
ERBE SELECT elettrobisturi	.JA-07
MARTIN elettrobisturi	.JA-07
USA elettrobisturi	.JA-07
Cefalometro BERTILLON	.AC-08
Cesioia	
BÖHLER per ossa	.DC-06
COTTLE-KAZANJIAN per ossa	.DC-06
LISTON per ossa	.DC-06
RUSKIN-LISTON per ossa	.DC-06
SEMB per ossa	.DC-07

STILLE-HORSLEY per ossa	DC-07	BOWMAN per diszisione	EC-04
STILLE-LISTON per ossa	DC-06	BRUENINGS setto	EG-11
Cestelli		CARPENTER tonsille	FA-02
in acciaio perforato	HE-13	CATLIN per amputazione	AG-16
in rete metallica	HE-13	COTTLE nassale	EG-10
CHAPUT pinza emostatica	BC-08	DEAN per iridettomi	EC-04
CHARRIERE		DEUTSCHMANN per cataratta	EC-03
lama di ricambio	DD-03	ELSCHNIG per corneale	EC-05
sega per amputazione	DD-03	ESMARCH per gessi	DA-04
CHEATLE pinza per sterilizzazione	CI-02	FREER setto	EG-10
Cheratomo		GILL per corneale	EC-05
BERENS	EC-04	GRAEFE per cataratta	EC-03
CASTROVIEJO	EC-04	HOPKINS per gessi	DA-04
JAEGER	EC-04	JOSEPH smusso	EG-10
CHERON pinza per medicatura	BG-12	KNAPP per iridettomi	EC-04
CHEVALIER-JACKSON pinza laringe	FC-04	LANGENBECK per resezione	AG-17
CHEVALLIER divaricatore costali	FG-15	LISTON per amputazione	AG-16
Chiave	DD-10	MUCK periostale	EE-15
CHILDE pinza per agrafes	CG-07	PAUFIQUE per cheratopl	EC-05
Chiodo per ossa STEINMANN	DD-09	Coltello per amputazione	AG-16
CINELLI scalpello plastica nasale	EG-13	Coltello per cartilagini	AG-18
Cistitomo		Coltello per gessi	DA-04
BECKER	EC-06	Coltello	
GRAEFE	EC-06	PLESTER lobare	EE-14
CITELLI pinza osteotomo	EG-08	POLITZER auricolare	EE-06
CLARK blefarostato	EC-02	REINER per gessi	DA-04
CLAR		ROSEN circolare	EE-14
lampada frontale	AC-05	SATO per corneale	EC-05
mini	AC-05	SCHEIE per goniotomia	EC-05
CLEVELAND pinza sgorbia	DC-02	SCHUKNECHT circolare	EE-14
Clip		SCHUKNECHT falciforme	EE-14
BRAIN emostatica per il cuoio capelluto	EA-12	SEXTON auricolare	EE-06
BRAIN standard	EA-13	St. CLAIR-THOMSON	EG-19
EDWARDS	BD-21	TABB falciforme	EE-14
CLOWARD		TOOK per corneale	EC-05
divaricatore	BI-17	VIRCHOW per cartilagini	AG-18
divaricatore per corpi vertebrali	EA-07	VIRCHOW per il cervello	AG-18
COAKLEY		WHEELER per diszisione	EC-04
curetta per seno	EG-18	WULLSTEIN falciforme	EE-14
tre quarti	CC-02	ZIEGLER per capsulotomia	EC-05
COLCLOUGH pinza tagliente		ZIEGLER per iridettomi	EC-04
per dischi intervertebrali	EA-11	COLVER pinza tonsille	FA-03
COLLIER port'aghi	CE-02	Compressore CORWIN tonsille	FA-04
COLLIN		CONNIN-AMSLER marcatore	EC-09
dinamometro	AC-03	Cono	
divaricatore addominale	BI-24 lavorare a BI-25	di occlusione	HA-47
COLLIN-DUVAL pinza dissezione	BA-04	KNUTSON-KOCH per uretrografia	GG-09
COLLIN-HARTMANN divaricatore	BI-03	Contenitori per sterilizzazione	
COLLIN		3/4	HE-22 lavorare a HE-24
isterometro	HA-39	grossi	HE-18 lavorare a HE-20
manico per bisturi	AG-08	mezzi	HE-26 lavorare a HE-29
martello	DC-18	piatti mezzi	HE-30 lavorare a HE-31
pelvimetro	HC-06	piccoli	HE-32 lavorare a HE-33
pinza emostatica	BC-08	speciale	HE-34 lavorare a HE-37
pinza ombelicale	HC-06	CONVERSE bisturi nassale	EG-10
pinza per afferrare l'utero	HA-37	COOLEY	
pinza per agrafes	CG-07	costotomo prima	FG-05
pinza per medicatura	BG-11	COOLEY DERRA pinza atraumatica anastomosi	BD-39
pinza tiralingua	EI-03	COOLEY	
COLLIN-POZZI pinza		dilatatore per valvole mitrali	FG-27 lavorare a FG-29
per abbassare il collo dell'utero	HA-32	dilatatore vascolare	FG-30
COLLIN		divaricatore costali	FG-09
specolo vaginali	HA-04	divaricatore per cavità	FG-20
COLLYER pelvimetro	HC-06	COOLEY modif- STRUCK divaricatore per cavità	FG-20
Coltellino KUHNT per corneale	EC-05	COOLEY pinza atraumatica	
Coltello		BB-03, BD-35 lavorare a BD-37, BD-39, BD-41
BALLENGER girevole	EG-11	pinza atraumatica anastomosi	BD-37, BD-40
BARKAN per goniotomia	EC-05	pinza atraumatica bulldog	BD-33 lavorare a BD-34
BARNHILL	EG-19	pinza atraumatica iliaca	BD-37
BARRAQUER per cheratopl	EC-05	pinza atraumatica pediatrica	BD-38 lavorare a BD-39
BECKMANN	EG-19	pinza vascolari	BD-40

COOPER ago per legature	.CG-02	FAULKNER tagliente	.EG-18
CORDES pinza laringe	.FC-03	FOX per lupus	.HE-02
Corta-agrafes	.EA-02	GOURDET uterine	.HA-48
CORWIN compressore tonsille	.FA-04	GRAEFE per cataratta	.EC-07
CORYLLOS costotomo	.FG-04	GROSS auricolare	.EE-06
CORYLLOS Thorax divaricatore	.BI-13	HALLE tagliente	.DC-13
Costotomi	.FG-02	HEBRA per calazio	.EC-07
GLUCK	.FG-03	HOUSE	.EE-15
STILLE	.FG-03	KEVORKIAN di aspirazione per biopsia	.HA-40
Costotomo		KNAPP per cataratta	.EC-07
BETHUNE	.FG-04	LEMPERT tagliente	.DC-13
BRUNNER	.FG-07	MARTINI tagliente	.DC-13
COOLEY prima	.FG-05	MEYHOEFER per calazio	.EC-07
CORYLLOS	.FG-04	NOVAK di aspirazione per biopsia	.HA-40
GIERTZ-STILLE	.FG-06	per aspirazione	.HA-51
SAUERBRUCH	.FG-05	PESTALOZZA per placenta e per ovaie	.HC-08
SAUERBRUCH-FREY	.FG-06	PIFFARD per lupus	.HE-02
COTTLE		RANDALL di aspirazione per biopsia	.HA-40
coltello nasale	.EG-10	RECAIMER uterine	.HA-49 lavorare a HA-50
divaricatore nasale	.EG-17	SCHEDE tagliente	.DC-12
elevatore periostotomo	.EG-12	SCHROEDER uterine	.HA-48
elevatore setto	.EG-12	SIMON tagliente	.DC-13
forbici nasali	.AH-18, AI-25	SIMON uterine	.HA-48
COTTLE-KAZANJIAN cesoia per ossa	.DC-06	SIMS uterine	.HA-49 lavorare a HA-50
COTTLE-NEIVERT divaricatore nasale	.EG-17	SPRATT tagliente	.DC-12
COTTLE		VOLKMANN tagliente	.DC-12 lavorare a DC-13
scalpello plastica nasale	.EG-13	WALLICH per placenta e per ovaie	.HC-08
specolo nasale	.EG-03	WILLIGER tagliente	.DC-13
COXETER candeletta dilatatrici	.GG-17	Curette LANG	.EC-08
CRAFOORD		CUSCO specolo vaginali	.HA-04 lavorare a HA-06
forbici pulmonari	.AI-36	CUSHING	
pinza emostatica bronchiale	.BC-12	divaricatore	.BI-07
Cranioclasto		divaricatore per nervi	.EA-04
BRAUN	.HC-09	perforatore piano	.DD-04
TARNIER	.HC-09	pinza dissezione	.BA-03
CREDO tagliacalli	.HE-03	pinza tagliente per laminectomia	.EA-08
CRILE		spatole cerebr	.EA-07
divaricatore	.BI-02	CUZZI curretta per placenta e per ovaie	.HC-08
CRILE-MURRAY port'aghi	.CE-02	CZERNY	
CRILE		pinza per abbassare il collo dell'utero	.HA-34
pinza emostatica	.BC-05	pinza per calcoli biliari	.GC-03
port'aghi	.CE-04	specolo rettale	.GI-02
CRILE-RANKIN pinza emostatica	.BC-05		
CRILE TITAN pinza emostatica	.BC-05	D	
CRILE-WOOD port'aghi	.CE-02	DALE pinza atraumatica vascolare	.BD-24
CRITCHETT blefarostato	.EC-02	DANDY	
Crivello per specolo vaginale	.HA-22	divaricatore per nervi	.EA-04
CROCE RSSA forbici bendaggi	.AI-47	forbici neurochirurgia	.AI-36
CRUTCHFIELD		pinza emostatica	.BC-07
alesatore	.EA-03	DARDIK pinza atraumatica	.BD-07
pinza per trazione craniale	.EA-03	DARLING divaricatore	.BI-17
Cucchia GUTMANN per secrezioni	.GG-11	DARTIGUES pinza per afferrare l'utero	.HA-37
Cucchiaio		DASTOOR	
DESJARDINS per calcoli biliari	.GC-08	capsulo aspiratore	.EC-09
FERGUSON per calcoli biliari	.GC-07	pinza strabismo	.EC-14
LUER-KOERTE per calcoli biliari	.GC-09	DAVIDSON Scapula divaricatore	.BI-13
MAYO per calcoli biliari	.GC-07	DAVIEL curretta per cataratta	.EC-07
MOORE per calcoli biliari	.GC-05	DAVIS	
SELLHEIM ostetrico	.HC-09	ago per corpi estranei	.EC-05
CULLER spatola iride	.EC-08	DAVIS-BOYLE apribocca	.EI-04
Curetta		DAVIS	
ALVIS per corpi estranei	.EC-06	dissettore per duramadre	.EA-05
AXENFELD per calazio	.EC-07	pinza per sterilizzazione	.CI-02
BLAKE uterine	.HA-48	DAY uncinetto auricolare	.EE-07
BRUNS tagliente	.DC-12 lavorare a DC-13	DEAN	
BUCK auricolare	.EE-05	coltello per iridettomi	.EC-04
BUMM uterine	.HA-49 lavorare a HA-50	forbici tonsillari	.AI-26
BUNGE per palpebre	.EC-07	DEAVER	
COAKLEY per seno	.EG-18	divaricatore	.BI-05
CUZZI per placenta e per ovaie	.HC-08	forbici	.AH-05, AI-06
DAVIEL per cataratta	.EC-07		

DEAVER Grip divaricatore	.BI-05	BAKES per condotti biliari	.GC-06
DE BAKEY BAHNSON		BROCK per valvole mitrali	.FG-26
pinza atraumatica per aneurisma di aorta	.BD-14	CASTROVIEJO canale lacrimale	.EC-10
DE BAKEY		COOLEY per valvole mitrali	.FG-27 lavorare a FG-29
dilatatore vascolare	.FG-31	COOLEY vascolare	.FG-30
forbici vascolari	.AI-30	DE BAKEY vascolare	.FG-31
DE BAKEY MORRIS pinza atraumatica	.BD-16	GERBODE per valvole mitrali	.FG-28
DE BAKEY pinza atraumatica		GOODELL uterini	.HA-30
.BB-03, BD-02, BD-08, BD-16 lavorare a BD-17,		HANK uterini	.HA-28
BD-20, BD-29 lavorare a BD-30		HEGAR uterini	.HA-24 lavorare a HA-27
pinza atraumatica anastomosi	.BD-25	HETZER per valvole mitrali	.FG-29
pinza atraumatica anastomosi, pediatrica	.BD-28	LABORDE tracheale	.FE-02
pinza atraumatica bronchi	.BD-19	PRATT uterini	.HA-29
pinza atraumatica bulldog	.BC-02	SIMS uterini	.HA-30
pinza atraumatica		SMITH-BUIE per l'ano e il retto	.GI-03
dissezione e per legature	.BD-25, BD-32	TROUSSEAU tracheale	.FE-02
pinza atraumatica iliaca	.BD-11	TUBBS per valvole mitrali	.FG-27
pinza atraumatica		WILDER canale lacrimale	.EC-10
per aneurisma di aorta	.BD-13, BD-15, BD-18	WYLIE uterini	.HA-30
pinza atraumatica vascolare	.BD-06	ZIEGLER canale lacrimale	.EC-10
port'aghi	.CE-03	DIMEDA Alu diapason	.EE-03
DE BAKEY REYNOLDS		DIMEDA	
pinza atraumatica anastomosi	.BD-30	calamita oculistiche	.ED-08
DE BAKEY SATINSKY		divaricatore	.BI-14
pinza atraumatica	.BD-22	forbici bendaggi	.AI-46
DE BAKEY		pinza per rifiuti	.CI-03
tubi d'aspirazione	.AE-04	pinza rompe lamette	.AG-14
DEJERINE martelli percussori	.AC-07	specillo	.CA-03
De LEE forcipe obstetrici	.HC-02	taglia anelli	.DD-03
De MARTEL guida sega	.EA-05	Dinamometro COLLIN	.AC-03
DeMARTEL-WOLFSON pinza per anastomosi	.GE-07	DINGMANN tenaglia per ossa	.DC-10
DENHART apribocca	.EI-03	Dissettore	
Depressore		DAVIS per duramadre	.EA-05
BRAUN uterino	.HA-39	GREEN per corneale	.EC-06
SIMS uterino	.HA-39	HORSLEY per duramadre	.EA-06
Depressor REICHERT epiglottide	.FC-02	HURD tonsille	.FA-02
DERF port'aghi	.CE-02	MILLIGAN per duramadre	.EA-05
Dermatomo		PATON per corneale	.EC-05
BRAITHWAITE	.AG-22	PENFIELD per duramadre	.EA-06
HUMBY	.AG-20	per duramadre	.EA-05
SCHINK	.AG-21	ROBB vascolare	.FG-33
SILVER	.AG-20	SACHS per duramadre	.EA-05
WATSON	.AG-22	TOENNIS per duramadre	.EA-05
DERRA pinza atraumatica	.BD-28	Dissezione bisturi	.AG-15
DESCHAMPS ago per legature	.CG-02	Ditale LANGENBECK	.EI-06
DESJARDINS		DITTEL	
cucchiaio per calcoli biliari	.GC-08	candeletta dilatatrici	.GG-18 lavorare a GG-19
pinza per calcoli biliari	.GC-02	mandrino per sonde uretrali	.GG-19
pinza vie biliari	.BC-15	Divaricatore	.BI-06, BI-10
sonda per calcoli biliari	.GC-05	ADSON	.BI-15
DESMARRES		ADSON Baby	.BI-15
divaricatore	.BI-07	ADSON per nervi	.EA-04
pinza calazio	.ED-06	ALM	.BI-14
DEUTSCHMANN coltello per cataratta	.EC-03	AUFRIEHT nasale	.EG-17
DeVILBISS pinza cranecraneanea	.EA-05	BALFOUR addominale	.BI-22
DEWEY forcipe obstetrici		BALFOUR Baby addominale	.BI-22
con dispositivo di trazione	.HC-05	BECKMANN	.BI-16
Diamant tagliafilari	.DD-12	BECKMANN-ADSON	.BI-15
Diapason	.EE-04	BECKMANN-EATON	.BI-16
DIMEDA Alu	.EE-03	BOSE tracheale	.FE-02
HARTMANN	.EE-03	CASPAR	.BI-20
LUCAE	.EE-04	CASPAR lombar vertebrale	.BI-20
RYDEL-SEIFFER	.EE-04	CASPAR spina cervica	.BI-18
DIEFFENBACH pinza serrafina bulldog	.BC-03	CASPAR spina vertebrale	.BI-19
DIETER pinza la testa de mastello	.EE-10	CASTAÑEDA costali	.FG-14
DIETRICH		CHEVALLIER costali	.FG-15
forbici vascolari	.AI-29	CLOWARD	.BI-17
Pinza atraumatica	.BD-31	CLOWARD per corpi vertebrali	.EA-07
port'aghi vascolare	.CE-06	COLLIN addominale	.BI-24 lavorare a BI-25
Dilatatore		COLLIN-HARTMANN	.BI-03
ALAN-PARKS per l'ano e il retto	.GI-03	COOLEY costali	.FG-09

COOLEY modif- STRUCK per cavità	.FG-20	OLLIER	BI-10
COOLEY per cavità	.FG-20	O'SULLIVAN-O'CONNOR addominale	BI-21
CORYLLOS Thorax	.BI-13	PARKER	BI-02
COTTLE nasale	.EG-17	PITHA labbra	EI-06
COTTLE-NEIVERT nasale	.EG-17	PLESTER	BI-14
CRILE	.BI-02	REVERDIN	BI-04
CUSHING	.BI-07	RIBBON	BI-04
CUSHING per nervi	.EA-04	RICHARDSON	BI-04
DANDY per nervi	.EA-04	RICHARDSON-EASTMAN	BI-04
DARLING	.BI-17	RICHARDSON Grip	BI-04
DAVIDSON Scapula	.BI-13	RIGBY addominale	BI-24
DEAVER	.BI-05	ROLLET	.EC-06
DEAVER Grip	.BI-05	ROUX	BI-02
DESMARRES	.BI-07	ROUX aortica mini	BI-02
DIMEDA	.BI-14	ROUX BABY	BI-02
DOYEN	.BI-12	SACHS per nervi	.EA-04
FARABEUF	.BI-02	SAUERBRUCH	BI-13
FINOCHIETTO-BABY costali	.FG-09	SCHOENBORN tiroide	.FE-04
FINOCHIETTO BURFORD		SENN	BI-04
costali	.FG-12 lavorare a	SENN-GREEN	BI-07
FINOCHIETTO costali	.FG-08, FG-10 lavorare a	SIMON	BI-12
FINOCHIETTO-HAIGTH BABY costali	.FG-10	SMITHWICK per nervi	.EA-04
FINOCHIETTO INFANT costali	.FG-12	STERNBERG labbra	EI-02
FINOCHIETTO (modif) costali	.FG-08	TAYLOR spina	.DC-24
FINSEN	.BI-14	THOMSON-WALKER vescicale	.GG-06
FOMON nasale	.EG-17	TUFFIER costali	.FG-16
FRAZIER	.BI-21	US Army (PARKER-LANGENBECK)	BI-03
FRIEDMAN perineorraf	.HA-23	VOLKMANN	BI-07 lavorare a
FRTISCH	.BI-11	WEITLANER	BI-14
GELPI addominale	.BI-24	WEITLANER-WULLSTEIN	BI-14
GERSTER per tenaglie	.DC-11	YOUNG per prostata	.GG-02
GOELET	.BI-03	Divaricatori	
GOSSET addominale	.BI-21	BEESON per gessi	.DA-03
GRAHAM per nervi	.EA-04	HAGLUND-STILLE per gessi	.DA-03
GREEN	.BI-10	HENNIG per gessi	.DA-03
HABERER	.BI-04	HERMANN per gessi	.DA-03
HAIGHT costali	.FG-15	Divaricatori per gessi	.DA-03
HARRINGTON	.BI-05	Divaricatori	
HEANEY	.BI-12	QUATTRO per gessi	.DA-03
HERTZLER costali	.FG-17	Divisore per craneo VIRCHOW	.DC-17
HOFER pillare	.FA-02	DIX	
HRYNTSCHAK per prostata	.GG-06	ago	.EC-09
INGE per corpi vertebrali	.EA-07	scalpello per corpi estranei	.EC-06
ISRAEL	.BI-11	DOUGLAS	
JANSEN	.BI-14	pinza depilatoria	.ED-08
JUDD-MASSON vescicale	.GG-04	tre quarti	.CC-02
KELLY	.BI-04, BI-12	DOYEN-Baby pinza intestinali	.GE-03
KELLY GRIP	.BI-04	DOYEN	
KIRSCHNER addominale	.BI-23	divaricatore	BI-12
KNAPP	.EC-06	forbici ginecologiche	.AI-33
KOCHER	.BI-10 lavorare a	fresa	.DD-07
KOERTE	.BI-11	DOYEN-JANSEN apribocca	EI-03
labbra e guance	.EI-03	DOYEN	
LAHEY	.BI-08	periostotomo costali	.DC-20
LANGENBECK	.BI-09	pinza fissateli	.BE-05
LEGUEU vescicale	.GG-06	pinza intestinali	.GE-03
LITTLE	.BI-08	pinza per polipi uterine	.HA-36
LOVE per nervi	.EA-04	sonda	.CA-02
LOVE uvula	.FA-02	specolo vaginali	.HA-18, HA-20
MATHIEU	.BI-03	tiramiomi per fibromi	.HA-46
MERCEDES per il torace	.FG-16	DUBOIS forbici ginecologiche	.AI-33
MEYERDING	.BI-08	DUPLAY	
MIDDELDORPF	.BI-10	pinza per abbassare il collo dell'utero	.HA-31
MIKULICZ	.BI-12	pinza per medicatura	.BG-14
MILLIN del collo vescicale	.GG-07	DUPUY-WEISS ago tonsille	.FA-03
MILLIN vescicale	.GG-05	DUVAL	
MOLLISON	.BI-17	pinza dissezione	.BA-04
MORSE-FAVOLORO costali	.FG-17	pinza per afferrare tessuti	.GE-03
Divaricatore muscolari unicini	.BI-25		
Divaricatore			
NAGER palat	.FA-02		

E

ECHLIN pinza sgorbia	DC-05
EDWARDS	
clip	BD-21
pinza applicatore per clips	BD-21
Elettrodo per coagulazione mini	JA-02 lavorare a JA-03
Elevatore	
ADSON	DC-21
BALLENGER setto	EG-12
BENNETT per ossa	DC-22
BLOUNT per ginocchio	DC-24
BLOUNT per ossa	DC-24
COTTLE periostotomo	EG-12
COTTLE setto	EG-12
FREER setto	EG-11
HAJEK-BALLENGER setto	EG-12
HENKE tonsille	FA-02
HOHMANN mini per ossa	DC-23
HOHMANN per ossa	DC-22 lavorare a DC-23
JOSEPH periostotomo	EG-12
KEY	DC-21
KILLIAN setto	EG-12
LANGENBECK	DC-21
LEMPERT	EE-15
McDONALD	DC-22
McKENTY setto	EG-11
MURLESS per testa	HC-05
MURPHY-LANE	DC-22
per ossa	DC-23
ROGER setto	EG-11
WATSON-CHEYNE	DC-22
ELLIOT	
forbici obstetriche	HC-02
trapano corneale	ED-08
ELLIS sgorbia per corpi estranei	EC-06
ELSAESSER pinza per nefrostomia	GC-13
ELSCHNIG	
coltello per corneale	EC-05
pinza capsulare	ED-04
pinza fissaggio	ED-03
spatola ciclodialiisi	EC-08
EMMET uncini per fistole	HA-46
Emostasi PASSOW	EE-15
ENGEL sega per gessi	DA-02
EPPENDORFER-KEVORKIAN	
pinza tagliente per biopsia	HA-46
EPPENDORFER	
pinza tagliente per biopsia	HA-45 lavorare a HA-46
EPPENDORFER TISCHLER-MORGAN	
pinza tagliente per biopsia	HA-46
ERBE SELECT cavo elettrobisturi	JA-07
ESMARCH	
coltello per gessi	DA-04
forbici bendaggi	AI-46
EVES serranodi tonsille	FA-04
F	
FARABEUF	
divaricatore	BI-02
FARABEUF-LAMBOTTE tenaglia per ossa	DC-08
FARABEUF	
periostotomo	DC-19
tenaglia per ossa	DC-07
FARREL specillo	CA-03
FAULKNER curetta tagliente	EG-18
FAURE	
pinza peritoneali	BC-17
pinza tagliente per biopsia	HA-41
FEHLAND pinza intestinali	GE-06

FEILCHENFELD pinza schegge	BA-06
FERGUSSON	
cucchiaio per calcoli biliari	GC-07
forbici	AI-49
pinza emostatica	BC-07
tenaglia per ossa	DC-07
FERRIS pinza dissezione	BA-04
FERRIS-SMITH-KERRISON pinza tagliente per dischi intervertebrali	EA-10
FERRIS-SMITH pinza tagliente per laminectomia	EA-09
FILIFORM candeletta	GG-12
Fili	
KIRSCHNER	DD-09
per ossa	DD-11
FINOCHIETTO-BABY divaricatore costali	FG-09
FINOCHIETTO BURFORD	
divaricatore costali	FG-12 lavorare a FG-14
FINOCHIETTO	
divaricatore costali	FG-08, FG-10 lavorare a FG-11
forbici rette	AI-38
FINOCHIETTO-HAIGHT BABY divaricatore costali	FG-10
FINOCHIETTO INFANT divaricatore costali	FG-12
FINOCHIETTO (modif) divaricatore costali	FG-08
FINOCHIETTO	
pinza per bronchi	FG-21
port'aghi	CE-04
FINSEN divaricatore	BI-14
FINSTERER canunule per aspirazione e irrigazione	AE-05
FISCHER pinza iride	EC-13
FISCH scollato	EE-15
FLETCHER JAVERTS pinza per tamponi e spugne	BG-10
FLEURANT tre quarti	CC-02
FOERSTER	
pinza iride	EC-12
pinza per tamponi e spugne	BG-06 lavorare a BG-08
FOMON	
divaricatore nasale	EG-17
forbici nasali	AH-18, AI-25
raspa nasale	EG-15 lavorare a EG-16
scalpello plastica nasale	EG-13
Forbici	AH-02 lavorare a AH-04, AI-02 lavorare a AI-04
AEBLI corneali	AI-22
auricolari micro	EE-11
auricolari micro mini	EE-11
BARRAQUER colibri	AJ-04
BEEBEE filo metallo lamiera	AI-43
BELLUCCI auricolari micro	EE-09
BERGMANN bendaggi	AI-46
BEUSE	AI-26
BOETTCHER tonsillari	AI-27
BRAUN-STADLER episiotomia	AH-22, AI-34
BRUNS gesso	AI-48
BUCK per legature	AI-40
BUSCH ombelicali	AI-34
CASTROVIEJO corneali	AJ-06
CASTROVIEJO iridectomia	AJ-05
COTTLE nasali	AH-18, AI-25
CRAFOORD pulmonari	AI-36
CROCE RSSSA bendaggi	AI-47
DANDY neurochirurgia	AI-36
DEAN tonsillari	AI-26
DEAVER	AH-05, AI-06
DIMEDA bendaggi	AI-46
Forbici dissezione	AI-19
Forbici	
DOYEN ginecologiche	AI-33
DUBOIS ginecologiche	AI-33
Forbici enterotomia	AI-39
Forbici	
ESMARCH bendaggi	AI-46
FERGUSSON	AI-49

Forbici finiAI-05, AI-19, AI-24
Forbici	
FINOCHIETTO retteAI-38
FOMON nasaliAH-18, AI-25
Forbici gessoAI-49
Forbici ginecologiche microAJ-07 lavorare a AJ-08
Forbici gengivaliAI-41
Forbici	
GOLDMAN-FOX gengivaliAI-41
GORNEY dissezioneAI-13
HEATH per legatureAI-40
HEYMANN nasaliAH-18, AI-25
Forbici incisioneAI-05
Forbici	
IRISAH-16, AI-19, AI-21
IRIS oftalmologiaAI-22
JACOBSON microAJ-11
JOSEPHAH-14, AI-16
KELLY ginecologicheAH-22, AI-33
KILNERAH-14, AI-17
KLINKENBERGH-LOTH toracaliAI-37
KNAPPAI-20
KNOWLES bendaggiAI-47
LAGRANGE gengivaliAI-41
LANDOLT enucleazioneAI-25
LANGE bendaggiAI-44
LEXERAH-09
LEXER-BABYAH-10
LEXER-BABY dissezioneAI-12
LEXER dissezioneAI-11
LEXER-FINO dissezioneAI-12
LISTER bendaggiAH-23, AI-45
LITTAUER per legatureAI-40
LITTLER dissezioneAI-13
LOCKLINAI-18
LORENZ bendaggiAI-47
MAYOAH-06, AI-07
MAYO manciniAI-07
MAYO-NOBLEAH-08, AI-10
MAYO-STILLEAH-07, AI-08 lavorare a AI-09
McGUIRE cornealiAJ-05
McINDOE cartilagoAI-35
McPHERSON WESTCOTT tendiniAJ-04
METZENBAUMAH-11
METZENBAUM dissezioneAI-13 lavorare a AI-14
METZENBAUM FINOAH-12
METZENBAUM FINO dissezioneAI-15
METZENBAUM "S"AH-13, AI-16
Forbici microAJ-06
Forbici	
MICRO microAJ-13
Forbici neurochirurgiaAI-35
Forbici	
NORTHBENT per legatureAI-40
NOYES iridectomiaAJ-03
NOYES irisAJ-04
NOYES tendiniAJ-03
per pelleHE-03
per unghieHE-03
POTTS-SMITH vascolariAH-19
Forbici preparazioniAI-34
Forbici	
QUINBY gengivaliAI-42
REYNOLDSAH-15, AI-18
SANVENEROAH-13, AI-16
SATINSKY toracaliAI-37
SCHMIEDEN-TAYLORAI-36
SCHUMACHER ombelicaliAI-34
SCHUMACHER per sternoFG-07
SEUTIN per gessiDA-02
SHEA auricolari microEE-09
SHORTBENT per legatureAI-40
SIEBOLD ginecologicheAH-21, AI-32
SIMS ginecologicheAH-21, AI-32
SMITH US ARMY bendaggiAI-44
SPENCER per legatureAI-40
STELZNER retteAI-38
STEVENS tenotomiaAH-17
STEVENS tenotomyAI-23
STILLE per gessiDA-02
Forbici strabismoAH-17, AI-24
Forbici	
STRULLY neurochirurgiaAI-35
THOREK pulmonariAI-36
TOENNIS-ADSON neurochirurgiaAI-35
TROUTMAN-CASTROVIEJO microAJ-07
UNIVERSAL bendaggiAI-50
UNIVERSAL filo metallo lamieraAI-42
USA MODEL ombelicaliAI-34
VANNAS iridectomiaAJ-05
VANNAS microAJ-12 lavorare a AJ-13
Forbici vascolari microAJ-09
Forbici vascolari parametriumAH-20
Forbici	
WAGNERAH-22
WAGNER gengivaliAI-42
WALDMANN episiotomiaAI-34
WECKER tendiniAJ-04
WERTHEIM preparazionAI-32
WESTCOTT iridectomieAJ-02
WESTCOTT tendiniAJ-02
WULLSTEIN auricolari microEE-11
WULLSTEIN auricolari micro miniEE-11
YASARGIL microAJ-10 lavorare a AJ-11
Forchetta BURCH di fissaggioEC-05
Forbici	
BARTON obstetricheHC-04
BOERMA obstetricheHC-04
De LEE obstetricheHC-02
DEWEY obstetriche con dispositivo di trazioneHC-05
ELLIOT obstetricheHC-02
KIELLAND-LUIKART obstetricheHC-03
KIELLAND obstetricheHC-02
LUIKART obstetricheHC-03
McLEAN-LUIKART obstetricheHC-03
McLEAN obstetricheHC-04
McLEAN-TUCKER-LUIKART obstetricheHC-03
NAEGELE obstetricheHC-03
PIPER obstetricheHC-04
PIPER obstetriche con dispositivo di trazioneHC-04
SIMPSON-BRAUN obstetricheHC-02
SIMPSON-LUIKART obstetricheHC-03
SIMPSON obstetricheHC-02
TARNIER obstetriche con dispositivo di trazioneHC-05
WRIGLEY obstetricheHC-02
FORD BOWLES stetoscopioAC-06
FORD stetoscopioAC-06
Forbici	
DE BAKEY vascolariAI-30
DIETHRICH vascolariAI-29
GOOD tonsillariAI-27
MILLS vascolariAI-27
parametrio vascolariAI-31
POTTS DE MARTEL vascolariAI-27
POTTS-SMITH vascolariAI-28
PRINCE tonsillariAI-27
Forbici vascolariAI-27
FOX curretta per lupusHE-02
FRAENKEL	
pinza laringeFC-03
pinza polipus laringeFC-02
FRANCESCHETTI trapano cornealeED-07

FRANCIS ago per corpi estranei	EC-05
FRANKLIN-SILVERMANN ago da punzione	CC-03
FRAZIER	
divaricatore	BI-21
tubi d'aspirazione	EA-07
uncinetto	BI-06
FREER	
bisturi mucosa	EG-10
coltello setto	EG-10
elevatore setto	EG-11
scalpello setto	EG-12
sgorbia nasale	EG-14
FREEWAY-GRAVE specolo vaginali	HA-06
FRENZEL abassalingua	EI-02
Fresa	DD-07
ALBEE	DD-07
BORCHARDT	DD-07
Fresa cuneiforme HUDSON	DD-04
Fresa	
DOYEN	DD-07
per corticalis	DD-15
TOTI	DD-07
FRIEDMAN	
divaricatore perineorraf	HA-23
pinza sgorbia	DC-02
pinza sgorbia, mini	DC-02
FRTISCH divaricatore	BI-11
FRYKHOLM pinza sgorbia	DC-05
FUCHS pinza capsulare	ED-04

G

GALLAHER raspa per seno	EG-16
GAUSS pinza per pericranio	HC-06
GELLHORN pinza tagliente per biopsia	HA-42
GELPI divaricatore addominale	BI-24
GEMINI MINI pinza dissezione e per legature	BC-10
GEMINI pinza dissezione e per legature	BC-10
GERALD pinza dissezione	BA-05
GERBODE dilatatore per valvole mitrali	FG-28
GERSTER divaricatore per tenaglie	DC-11
GERZOG martello	DC-18
GIERTZ-STILLE costotomo	FG-06
GIGLI manico per sega	EA-05
GILL-ARRUGA pinza capsulare	ED-03
GILL	
coltello per corneale	EC-05
GILL-HESS pinza iride	EC-12
GILLIES	
pinza dissezione	BA-05
port'aghi	CE-05
uncinetto	EG-17
GILL	
pinza iride	EC-12
Giraviti	DD-14 lavorare a DD-15
LANE	DD-14
WILLIAMS	DD-14
GLOVER	
pinza atraumatica	BD-06, BD-30
pinza atraumatica anastomosi	BD-05
pinza atraumatica bulldog	BC-02
pinza atraumatica coartazione	BD-04
GLUCK costotomi	FG-03
GOELET divaricatore	BI-03
GOLDMAN-FOX forbici gengivali	AI-41
GOLDSTEIN blefarostato	EC-03
Goniometro MOELTGEN	AC-08
GOODELL dilatatore uterini	HA-30
GOOD forbici tonsillari	AI-27
GORNEY forbici dissezione	AI-13
GOSSET divaricatore addominale	BI-21

GOURDET curetta uterine	HA-48
GRADLE pinza depilatoria	ED-08
GRAEFE	
blefarostato	EC-02
cistitomo	EC-06
coltello per cataratta	EC-03
curetta per cataratta	EC-07
pinza dissezione	BA-03
pinza fissaggio	ED-03
pinza iride	EC-11
scarificatore	EC-04
GRAEFE-TITAN uncino per strabismo	EC-06
GRAEFE	
uncinetto	BI-06
uncino per strabismo	EC-06
GRAHAM divaricatore per nervi	EA-04
GRAVE specolo vaginali	HA-02
GRAY pinza vie biliari	BC-15
GREEN-ARMYTAGE pinza emostatica per tagli cesari	HC-06
GREEN	
dissetto per corneale	EC-06
divaricatore	BI-10
pinza fissaggio	ED-03
uncino muscolare	EC-06
GREGORY pinza atraumatica profonda	BD-33
GREVEN pinza auricolare micro	EE-10
GRIP pinza per afferare	DD-11
GROSS	
curetta auricolare	EE-06
GROSS-MAIER pinza per medicatura	BG-2 lavorare a BG-4
GROSS	
pinza per medicatura	BG-05
GRUBER specoli auricolare	EE-02
Guida sega De MARTEL	EA-05
GUTHRIE uncinetto	BI-06
GUTMANN cucchiaria per secrezioni	GG-11
GUYON	
candeletta dilatatrici	GG-12, GG-14 lavorare a GG-15
mandrino per sonde uretrali	GG-11
pinza peduncolo renale	BC-16
GUYTON-LUNDSGAARD sclerotomo	EC-05

H

HABERER divaricatore	BI-04
HAGLUND-STILLE divaricatori per gessi	DA-03
HAIGHT divaricatore costali	FG-15
HAJEK-BALLENGER elevatore setto	EG-12
HAJEK-CLAUS pinza seno	EG-08
HAJEK-KOFLER pinza tagliente nasale	EG-08
HAJEK sgorbia nasale	EG-14
HALLE	
bisturi per duramadre	EA-06
curetta tagliente	DC-13
HALSEY port'aghi	CE-02
HALSTED-MOSQUITO micro pinza emostatica	BC-04
HALSTED-MOSQUITO	
pinza atraumatica	BD-02
pinza emostatica	BC-04
HALSTED-MOSQUITO TITAN pinza emostatica	BC-04
Hamburg cannula bottonuta	ED-07
HANK dilatatore uterini	HA-28
HARKEN pinza atraumatica ventricolari	BD-23
HARRINGTON	
divaricatore	BI-05
pinza per bronchi	FG-21
HARTMANN	
abassalingua	EI-02
diapason	EE-03
HARTMANN-HALLE specolo nasale	EG-02

HARTMANN-HOFFMANN pinza auricolare	.EE-08
HARTMANN	
pinza auricolare	.EE-08
pinza emostatica	.BC-03
pinza nasale polipus	.EG-04
pinza tagliente nasale	.EG-07
sonda auricolare	.EE-06
specoli auricolare	.EE-02
HARTMANN-WULLSTEIN pinza auricolare	.EE-08
HEANEY	
divaricatore	.BI-12
pinza isterectomia	.BC-18
port'aghi	.CE-03
HEATH forbici per legature	.AI-40
HEBRA curetta per calazio	.EC-07
HEGAR dilatatore uterini	.HA-24 lavorare a HA-27
HEGENBARTH pinza per agrafes	.CG-07
HEIFETZ spatole cerebr	.EA-07
HEIMING pinza per calcoli renali	.GC-13
HEISS pinza emostatica	.BC-09
HEISTER apribocca	.EI-03
HENKE elevatore tonsille	.FA-02
HENNIG divaricatori per gessi	.DA-03
HENROTIN pinza per abbassare il collo dell'utero	.HA-34
HERMANN divaricatori per gessi	.DA-03
HERRICK pinza peritoneali	.BC-17
HERTZLER divaricatore costali	.FG-17
HESS	
pinza capsulare	.ED-04
pinza iride	.EC-12
HETZER dilatatore per valvole mitrali	.FG-29
HEYMANN	
forbici nasali	.AH-18, AI-25
HEYMANN-KNIGHT pinza nasale polipus	.EG-05
HEYMANN	
pinza tagliente nasale	.EG-05
HEYWOOD-SMITH pinza per ermorridda	.GI-05
HIBBS	
osteotome	.DC-16
scalpello	.DC-16
sgorbia	.DC-16
HIRSCHMANN anoscopio	.GI-04
HOESEL port'aghi	.CE-05
HOFER divaricatore pillare	.FA-02
HOFF pinza fissateli	.BE-03
HOHMANN elevatore per ossa	.DC-22 lavorare a DC-23
HOHMANN mini elevatore per ossa	.DC-23
HOKE scalpello	.DC-16
HOLTH pinza per capsulo	.EC-09
HOPKINS coltello per gessi	.DA-04
HORSLEY dissetto per duramadre	.EA-06
HOUSE curetta	.EE-15
HRYNTSCHAK divaricatore per prostata	.GG-06
HUBER manico universale	.FC-03
HUDSON	
fresa cuneiforme	.DD-04
perforatore a mano	.DD-04
HUMBY dermatomo	.AG-20
HUNTER pinza schegge	.BA-06
HURD dissetto tonsille	.FA-02
I	
Imbuti	.HE-07
INGE divaricatore per corpi vertebrali	.EA-07
Insoffiatore	
KABIERSKE per polvere	.EE-04
POLITZER d'aria	.EE-05
IOWA pinza per abbassare il collo dell'utero	.HA-35
IRIS	
forbici	.AH-16, AI-19, AI-21

forbici oftalmologia	.AI-22
Irrigatore	.HE-05
ISRAEL divaricatore	.BI-11
Isterometro	
COLLIN	.HA-39
MARTIN	.HA-39
SIMS	.HA-39
VALLEIX	.HA-39
ITARD sonda auricolare	.EE-06
ITERSON uncino tracheale	.FE-02
IVES-FANSLER anoscopio	.GI-04

J

JACKSON	
pinza taponi	.FC-02
specolo vaginali	.HA-16
tubo tracheale	.FE-03
uncino tracheale	.FE-02
JACOBSON forbici micro	.AJ-11
JACOBS pinza per abbassare il collo dell'utero	.HA-34
JAEGER	
cheratomo	.EC-04
placca per palpebre	.EC-03
JAMESON	
pinza strabismo	.EC-13
uncino per strabismo	.EC-06
JAMISON port'aghi	.CE-03
JANSEN	
divaricatore	.BI-14
pinza nasale	.EG-04
JARCHO pinza per abbassare il collo dell'utero	.HA-32
JATHO pinza nasofarinx tagliente	.EG-18
JAVID pinza atraumatica carotis	.BD-32
JENNINGS apribocca	.EI-04
JOBNS-HORNE specillo	.CA-03
JOHNS-HOPKINS	
pinza serratina bulldog	.BC-03
pinza vie biliari	.BC-14
JOHNSON port'aghi	.CE-04
JONES pinza fissateli porta tubo	.BE-02
JOSEPH	
bisturi nassale botton	.EG-10
coltello smusso	.EG-10
elevatore periostotomo	.EG-12
forbici	.AH-14, AI-16
JOSEPH (LEWIS) raspa nasale	.EG-15
JOSEPH	
lima per ossa	.EG-14
sega nasale	.EG-17
uncinetto	.BI-06
JUDD-ALLIS pinza per afferrare tessuti	.GE-02
JUDD-MASSON divaricatore vescicale	.GG-04
JURASZ pinza polipus laringe	.FC-02

K

KABIERSKE insoffiatore per polvere	.EE-04
KALLMORGEN	
specolo vaginali	.HA-15
valva vaginali	.HA-15
KALT-ARRUGA port'aghi	.CE-07
KALT	
pinza capsulare	.ED-04
port'aghi	.CE-07
KANE pinza ombelicale	.HC-06
KEITH ago suture	.CG-06
KELLY	
divaricatore	.BI-04, BI-12
forbici ginecologiche	.AH-22, AI-33
KELLY GRIP divaricatore	.BI-04

KELLY	
pinza emostatica	.BC-05
pinza per polipi uterine	.HA-36
proctoscopio	.GI-04
KELLY-RANKIN pinza emostatica	.BC-05
KELLY TITAN pinza emostatica	.BC-05
KERN tenaglia per ossa	.DC-08
KERRISON pinza tagliente nasale	.EG-08
KEVORKIAN	
curetta di aspirazione per biopsia	.HA-40
KEVORKIAN-Pacific pinza tagliente per biopsia	.HA-44
KEVORKIAN	
pinza tagliente per biopsia	.HA-43, HA-46
KEY elevatore	.DC-21
KEYES set di trapani cutanei	.HE-02
KIELLAND forcipe obstetrici	.HC-02
KIELLAND-LUIKART forcipe obstetrici	.HC-03
KILLIAN	
cannula	.EG-09
KILLIAN-CLAUS sgorbia nasale	.EG-14
KILLIAN	
elevatore setto	.EG-12
specolo setto	.EG-03
KILNER-DOUGHTY apribocca	.EI-05
KILNER	
forcipi	.AH-14, AI-17
uncinetto per pelle	.HE-02
KIRBY-ARTHUR pinza iride	.EC-13
KIRK martello	.DC-18
KIRSCHNER	
arco per estensione	.DD-10
divaricatore addominale	.BI-23
fili	.DD-09
perforatore a mano	.DD-05
sonda conduttrice	.CG-04
telaio	.BI-23
valva per telaio	.BI-23
KLINKENBERGH-LOTH forcipi toracali	.AI-37
KNAPP	
coltello per iridectomi	.EC-04
curetta per cataratta	.EC-07
divaricatore	.EC-06
forcipi	.AI-20
KNAPP-LUER pinza trichiasi	.ED-06
KNIGHT pinza tagliente nasale	.EG-05
KNOWLES forcipi bendaggi	.AI-47
KNUTSON-KOCH cono per uretrografia	.GG-09
KNUTSON strumento per uretrografia	.GG-09
KOCHER	
divaricatore	.BI-10 lavorare a BI-11
pinza emostatica delicate	.BC-06
pinza intestinali	.GE-04
sonda gozzo	.FE-04
spatola vescicali	.GG-04
KOENIG	
ago suture	.CG-06
sonda conduttrice	.CG-04
KOERTE divaricatore	.BI-11
KOGAN specolo endo	.HA-23
KONRICH tamburo per sterilizzazione	.HE-12
KRAUSE	
pinza laringe	.FC-03
serranodi	.EG-09
serranodi auricolare	.EE-07
KRISTELLER	
specolo vaginali	.HA-09 lavorare a HA-14
valva vaginali	.HA-09 lavorare a HA-14
KRONECKER ago per legature	.CG-02
KUENTSCHER	
alesatore	.DD-13
cavachiodi	.DD-13
strum per conficc	.DD-13
KUHNT coltellino per corneale	.EC-05
L	
LABORDE dilatatore tracheale	.FE-02
LAFORCE	
adenotomo	.EG-19
strumenti per corpi estranei	.EC-06
LAGRANGE forcipi gengivali	.AI-41
LAHEY	
divaricatore	.BI-08
pinza afferrare gozzo	.FE-04
pinza vie biliari	.BC-14
Lama bisturi sterili, micro	.AG-13
Lama bisuttri, sterili	.AG-06
Lama	
bisuttri sterile	.AG-09
CHARRIERE di ricambio	.DD-03
Lama di sega	.DA-05 lavorare a DA-06
Lama	
OTIS die ricambio	.GG-08
Lama per dermatomo	.AG-21
Lama per rasoio	.AG-19
Lama per togliere	.AG-06, AG-10
LAMBERT KAY	
pinza atraumatica aortica	.BD-10
pinza atraumatica iliaca	.BD-11
LAMBERT pinza calazio	.ED-06
LAMBOTTE mini osteotomo	.DC-15
LAMBOTTE	
osteotomo	.DC-15
periostotomo	.DC-19
tenaglia per ossa	.DC-08
Lamette per rasoio	.AG-14
Lampada frontale CLAR	.AC-05
Lampadina ricambio per laringoscopio fibre ottiche	.AE-20
Lampadina ricambio per laringoscopio standard	.AE-20
LANCASTER blefarostato	.EC-03
Lancetta elettrodo	.JA-03
LANDAU specolo vaginali	.HA-22
LANDOLT	
forcipi enucleazione	.AI-25
manico per bisuttri, micro	.AG-13
LANE	
giraviti	.DD-14
pinza dissezione	.BA-04
pinza fissateli	.BE-05
pinza porta placche	.DD-14
pinza porta viti	.DD-14
pinza stomacali	.GE-08
tenaglia per ossa	.DC-08
LANG curette	.EC-08
LANGE	
forcipi bendaggi	.AI-44
LANGENBECK	
coltello per resezione	.AG-17
ditale	.EI-06
divaricatore	.BI-09
elevatore	.DC-21
periostotomo	.DC-19
sega a dita	.DD-03
tenaglia per ossa	.DC-07
LANGE	
pinza laringe	.FC-03
Laringoscopio manico fibre ottiche	.AE-11
Laringoscopio manico standard	.AE-17
Laringoscopio set	
MACINTOSH fibre ottiche	.AE-12 lavorare a AE-13
MACINTOSH standard	.AE-18 lavorare a AE-19
MILLER fibre ottiche	.AE-12 lavorare a AE-13

MILLER standard	.AE-18 lavorare a AE-19
Laringoscopio spatole	
MACINTOSH fibre ottiche	.AE-10
MACINTOSH standard	.AE-15
MILLER fibre ottiche	.AE-10
MILLER standard	.AE-16
LAWRENCE pinza dissezione e per legature	.BC-13
LEBSCHKE scalpello sterno	.DC-17
LEES pinza atraumatica bronchi	.BD-03
LEGUEU	
divaricatore vescicale	.GG-06
spatola vescicali	.GG-04
LEKSELL STILLE pinza sgorbia	.DC-05
LELAND JONES pinza atraumatica vascolare	.BD-08 lavorare a BD-09
LEMPERT	
curetta tagliente	.DC-13
elevatore	.EE-15
pinza sgorbia	.DC-03
LERCHE pinza dissezione	.BA-04
LERICHE pinza emostatica	.BC-09
LESTER pinza fissaggio	.ED-03
Leva	
BUCK corpi estranei	.EE-08
QUIRE corpi estranei	.EE-08
LEVINSON ago per corpi estranei	.EC-05
LEWIN tenaglia per ossa	.DC-10
LEWKOWITZ pinza per placenta e per ovaie	.HC-07
LEXER-BABY	
forbici	.AH-10
forbici dissezione	.AI-12
LEXER-FINO forbici dissezione	.AI-12
LEXER	
forbici	.AH-09
forbici dissezione	.AI-11
LEXER mini	
scalpello	.DC-16
sgorbia	.DC-16
LEXER	
scalpello	.DC-16
sgorbia	.DC-16
LEYLA sistema da fissaggio	.EA-14 lavorare a EA-18
LICHTWITZ	
ago seno	.EG-09
tre quarti	.CC-02
LIDDLE pinza atraumatica aorta	.BD-10
Lima	
JOSEPH per ossa	.EG-14
per ossa	.DC-25
per unghie	.HE-03
PUTTI per ossa	.DC-25
LISTER-BURCH blefarostato	.EC-02
LISTER	
forbici bendaggi	.AH-23, AI-45
pinza sinus per tamponi e spugne	.BG-11
LISTON	
cesoia per ossa	.DC-06
coltello per amputazione	.AG-16
LITTAUER	
forbici per legature	.AI-40
pinza auricolare	.EE-08
pinza depilatoria	.ED-08
pinza nasale polipus	.EG-05
LITTLE divaricatore	.BI-08
LITTLER forbici dissezione	.AI-13
LOCKLIN forbici	.AI-18
LORENZ forbici bendaggi	.AI-47
LORNA pinza fissateli	.BE-04
LOUTE strumento tendifilo	.DD-11
LOVE	
divaricatore per nervi	.EA-04

divaricatore uvula	.FA-02
LOVE-GRUENWALD pinza tagliente per laminectomia	.EA-08
LOVELACE	
pinza emostatica	.BC-07
pinza per afferrare il polmone	.FG-19
LOWER pinza vie biliari	.BC-14
LOWMAN tenaglia per ossa	.DC-11
LUBET-BARBON pinza nasale polipus	.EG-05
LUCAE	
diapason	.EE-04
martello	.DC-18
pinza auricolare	.EE-07
LUC pinza tagliente nasale	.EG-06
LUER-KOERTE cucchiaino per calcoli biliari	.GC-09
LUER	
pinza sgorbia	.DC-03
tubo tracheale	.FE-03
LUIKART-BILL trattore per manico standard	.HC-05
LUIKART forbici ostetriche	.HC-03
LUNDGAARD sclerotomo	.EC-05
LUNIATSCHEK otturatore per garza	.FA-02
LURZ pinza per uretere	.GC-10

M

MACINTOSH	
laringoscopio set fibre ottiche	.AE-12 lavorare a AE-13
laringoscopio set standard	.AE-18 lavorare a AE-19
laringoscopio spatole fibre ottiche	.AE-10
laringoscopio spatole standard	.AE-15
MAGILL	
pinza per introdurre le sonde	.AE-06
stiletto	.AE-04
tubi d'aspirazione	.AE-04
MAIER pinza per medicatura	.BG-12
MALTZ	
bisturi cartilage angolat	.EG-11
MALTZ (COTTLE) raspa nasale	.EG-15
MALTZ	
raspa nasale	.EG-14
Mandrino	
DITTEL per sonde uretrali	.GG-11
GUYON per sonde uretrali	.GG-11
Manico	
BROCK per valvole mitrali	.FG-26
CASPAR per bisturi, micro	.AG-12
COLLIN per bisturi	.AG-08
GIGLI per sega	.EA-05
HUBER universale	.FC-03
LANDOLT per bisturi, micro	.AG-13
Manico per bisturi	.AG-02 lavorare a AG-05, AG-07 lavorare a AG-08
Manico per bisturi, micro	.AG-12
Manico	
per specchi laringei	.FC-04
Manometro per salpingografo	.HA-47
Marcatore	
CASTROVIEJO compasso	.EC-09
CONNIN-AMSLER	.EC-09
MARSCHIK pinza tonsille	.FA-04
Martelli percussori	
BABINSKY	.AC-07
BERLINER	.AC-07
BUCK	.AC-07
DEJERINE	.AC-07
TAYLOR	.AC-07
TRAUBE	.AC-07
TROEMNER	.AC-07
Martello	.DC-18
COLLIN	.DC-18
con fessura	.DD-13

GERZOG	DC-18
KIRK	DC-18
LUCAE	DC-18
MEAD	DC-18
QUISLING	DC-18
WILLIGER	DC-18
MARTEL pinza cuoio capelluto	BC-08
MARTIN	
cavo elettrobisturi	JA-07
MARTINI curetta tagliente	DC-13
MARTIN	
isterometro	HA-39
pelvimetro	HC-06
pinza per medicatura	BG-02, BG-14
pinza per sequestri	DC-10
Maschio per vite	DD-15
MASSON port'aghi	CE-03
MASTIN pinza muscolare	FE-04
MATHIEU	
divaricatore	BI-03
pinza per corpi estranei	GG-07
port'aghi	CE-05
specolo rettale	GI-02
MATSON periostotomo	DC-21
MAUNDER apribocca legno	EI-06
MAYO BLAKE pinza per calcoli biliari	GC-04
MAYO	
cucchiaio per calcoli biliari	GC-07
forbici	AH-06, AI-07
forbici mancini	AI-07
MAY oftalmoscopio	AC-03
MAYO-GUYON pinza peduncolo renale	BC-16
MAYO-HEGAR port'aghi	CE-02
MAYO-NOBLE forbici	AH-08, AI-10
MAYO	
pinza per sterilizzazione	CI-02
MAYO-ROBSON pinza intestinali	GE-05
MAYO	
sonda per calcoli renali	GC-10
MAYO-STILLE forbici	AH-07, AI-08 lavorare a AI-09
McCLINTOCK pinza per placenta e per ovaie	HC-07
McCULLOUGH pinza strabismo	EC-13
McDONALD elevatore	DC-22
McGEE pinza auricolare micro	EE-10
McGUIRE forbici corneali	AJ-05
McINDOE	
forbici cartilago	AI-35
pinza dissezione	BA-04
McIVOR	
abassalingua	EI-05
apribocca	EI-05
McKENTY elevatore setto	EG-11
McKENZIE	
perforatore piano	DD-04
pinza per applicare e agrafes	EA-02
McLEAN forbici ostetriche	HC-04
McLEAN-LUIKART forbici ostetriche	HC-03
McLEAN-TUCKER-LUIKART forbici ostetriche	HC-03
McPHERSON pinza legature	ED-05
McPHERSON TITAN pinza legature	ED-05
McPHERSON WESTCOTT forbici tendini	AJ-04
MEAD	
martello	DC-18
pinza sgorbia	DC-02
MEEKER pinza dissezione e per legature	BC-13
MELLINGER-AXENFELD blefarostato	EC-02
MELLINGER blefarostato	EC-02
MENGHINI trequarti	CC-03
Meniscotomo	
BIRCHER	DC-24
NEFF	DC-24
SMILLIE	DC-24
MERCEDES divaricatore per il torace	FG-16
METZENBAUM FINO	
forbici	AH-12
forbici dissezione	AI-15
METZENBAUM	
forbici	AH-11
forbici dissezione	AI-13 lavorare a AI-14
port'aghi	CE-04
METZENBAUM "S" forbici	AH-13, AI-16
MEYERDING divaricatore	BI-08
MEYHOEFER curetta per calazio	EC-07
MICHEL	
agrafes	CG-07
pinza per agrafes	CG-07
specchio	EG-04
MICRO forbici micro	AJ-13
MIDDELDORPF divaricatore	BI-10
MIDDLETON-JANSEN pinza tagliente nasale	EG-09
MIKULICZ	
divaricatore	BI-12
pinza peritoneali	BC-17
MILLER	
laringoscopio set fibre ottiche	AE-12 lavorare a AE-13
laringoscopio set standard	AE-18 lavorare a AE-19
laringoscopio spatole fibre ottiche	AE-10
laringoscopio spatole standard	AE-16
MILLIGAN dissettore per duramadre	EA-05
MILLIN	
divaricatore del collo vescicale	GG-07
divaricatore vescicale	GG-05
pinza per afferrare la capsula	GG-03
pinza per lobuli anteriori	GG-03
pinza porta-filo	GG-03
supporto per luce fredda	GG-05
MILLS forbici vascolari	AI-27
Mini	
astucci tascabili e per sutura	CG-08
CLAR	AC-05
MIXTER BABY pinza emostatica bronchiale	BC-13
MIXTER O'SHAUGNESSY pinza emostatica	BC-14
MIXTER	
pinza emostatica	BC-14
pinza emostatica bronchiale	BC-13
pinza per calcoli biliari	GC-04
pinza vie biliari	BC-15
MOELTGEN goniometro	AC-08
MOGAN strumento per circoncisione	GG-09
MOLLISON divaricatore	BI-17
MOORE	
cucchiaio per calcoli biliari	GC-05
perforatore a mano	DD-04
MOORFIELD pinza sutura	ED-05
MORSE-FAVOLORO divaricatore costali	FG-17
MOYNIHAN	
pinza fissateli	BE-05
pinza vie biliari	BC-15
sonda per calcoli biliari	GC-05
MUCK coltello periostale	EE-15
MUELLER blefarostato	EC-03
MURDOCK blefarostato	EC-02
MURLESS elevatore per testa	HC-05
MURPHY-LANE elevatore	DC-22
MURPHY pinza serratubi	BC-19
MUSEUX pinza per abbassare il collo dell'utero	HA-33
MYLES pinza tagliente nasale	EG-07
N	
NABATOFF sonda auricolare argento	CA-02
NAEGELE forbici ostetriche	HC-03

NÄGELE spezzacraneo	.HC-09
NAGER divaricatore palat	.FA-02
Nastro metrico	.AC-08
Nastro PARHAM solo	.DC-11
NEFF meniscotomo	.DC-24
NEGUS pinza tonsille	.FA-03
NEIVERT port'aghi	.CE-02
NELSON	
ago per legature	.CG-02
pinza dissezione	.BA-05
trequarti	.CC-02
NEUBÜSER pinza per afferare trompe	.HA-51
NORTHBENT forbici per legature	.AI-40
NOTO pinza per polipi uterine	.HA-36
NOVAK curetta di aspirazione per biopsia	.HA-40
NOYES	
forbici iridectomia	.AJ-03
forbici iris	.AJ-04
forbici tendini	.AJ-03
pinza nasale polipus	.EG-05
NUBOER tubi d'aspirazione	.AE-05
O	
OCHSNER	
pinza atraumatica aorta	.BD-31
trequarti	.CC-02
O' CONNOR uncino per iris	.EC-06
Oftalmoscopio	
MAY	.AC-03
VARIFOCALE	.AC-03
OLDBERG pinza tagliente per laminectomia	.EA-09
OLIVECRONA	
pinza sgorbia	.DC-03
sega	.EA-05
spatole cerebr	.EA-07
OLIVECRONA-TOENNIS pinza per applicare e agrafes	.EA-02
OLLIER divaricatore	.BI-10
OLSEN-HEGAR port'aghi	.CE-05
Osteotome HIBBS	.DC-16
Osteotomo	.DC-14
LAMBOTTE	.DC-15
LAMBOTTE mini	.DC-15
STILLE	.DC-14
O'SULLIVAN-O'CONNOR	
divaricatore addominale	.BI-21
specolo vaginali	.HA-08
OTIS	
lama die ricambio	.GG-08
uretrotomo	.GG-08
Otturatore LUNIATSCHEK per garza	.FA-02
OVERHOLT-GEISSENDOERFER pinza dissezione e per legature	.BC-10
OVERHOLT periostotomo	.DC-21
P	
Padella	.HE-06
Parametro forbici vascolari	.AI-31
PARHAM nastro solo	.DC-11
PARK blefarostato	.EC-03
PARKER	
bisturi per dissezione	.AG-15
divaricatore	.BI-02
PARTSCH	
scalpello	.DC-14
sgorbia	.DC-14
PASSOW emostasi	.EE-15
PATON dissetto per corneale	.EC-05
PAUFIQUE	
coltello per cheratopl	.EC-05

pinza legature	.ED-05
PAUFIQUE TITAN pinza legature	.ED-05
PAYR-Baby pinza stomacali	.GE-09
PAYR	
pinza stomacali	.GE-09
sonda conduttrice	.CG-04
PEAN	
pinza atraumatica	.BD-02
pinza emostatica	.BC-08
pinza emostatica delicate	.BC-06
PEDERSON specolo vaginali	.HA-03
PEERS BERTRAM pinza fissateli	.BE-03
PEET pinza schegge	.BA-06
PELKMANN pinza per medicatura	.BG-12
Pelvimetro	
COLLIN	.HC-06
COLLYER	.HC-06
MARTIN	.HC-06
PENFIELD dissetto per duramadre	.EA-06
PENNINGTON pinza emostatica	.BC-07
PERCY retrattore per amputazione	.DD-03
Perforatore	
a mano	.DD-05
BUNNELL a mano	.DD-05
HUDSON a mano	.DD-04
KIRSCHNER a mano	.DD-05
McKENZIE piano	.DD-04
MOORE a mano	.DD-04
per mandrino jacobs	.DD-06
RALK a mano	.DD-05
STILLE a mano	.DD-04
STILLE-SHERMAN a mano	.DD-04
Perforatore CUSHING piano	.DD-04
Periostotomo	
ALEXANDER	.DC-19
DOYEN costali	.DC-20
FARABEUF	.DC-19
LAMBOTTE	.DC-19
LANGENBECK	.DC-19
MATSON	.DC-21
OVERHOLT	.DC-21
SADILLOT	.DC-19
SEMB	.DC-20
WILLIGER	.DC-19
Per per intima	.FG-32
PERTHES punteruoli	.DD-08
PESTALOZZA curetta per placenta e per ovaie	.HC-08
PETRI scatola	.HE-08
PETZ apparecchio	
per sutura stomacali e intestinali	.GE-09
PHANEUF pinza peritoneali	.BC-17
Piastra per tendere la pelle	.AG-21
Pick	.EE-15
BARBARA	.EE-14 lavorare a
PIERCE trequarti	.CC-02
PIFFARD curetta per lupus	.HE-02
PINARD stetoscopio	.AC-06
Pinza	
ADLERKREUTZ dissezione	.BA-04
ADSON BABY emostatica	.BC-09
ADSON-BROWN dissezione	.BA-03
ADSON dissezione	.BA-03
ADSON dissezione, micro	.BA-03
ADSON emostatica	.BC-09
ADSON per ipofisi	.EA-06
ADSON sgorbia	.DC-03
ALEXANDER tagliente per biopsia	.HA-42
ALLIS-ADAIR per afferrare tessuti	.GE-02
ALLIS-Baby per afferrare tessuti	.GE-02
ALLIS per afferrare tessuti	.GE-02
ARCHER schegge	.BA-06

ARRUGA capsulare	ED-04
ASCH raddrizzare setto	EG-18
Pinza atraumatica pediatrica vascolare	BD-43
Pinza	
auricolare micro	EE-09 lavorare a EE-10, EE-12
auricolare micro mini	EE-13
AYER calazio	ED-06
BABCOCK per afferrare tessuti	GE-02
BACKHAUS-CLIP fissateli porta tubo	BE-03
BACKHAUS fissateli	BE-02
BACKHAUS KOCHER fissateli	BE-02
BAGGISH tagliente per biopsia	HA-45
BAINBRIDGE atraumatica	BD-09
BAINBRIDGE emostatica	BC-14
BALL AND SOCKET fissateli	BE-04
BALLENGER tonsille	FA-04
BARRAQ-KATZIN iride	EC-13
BARRAQU Colibri iride	EC-13
BARRAQUER camara anteriore	ED-02
BARRAQUER depilatoria	ED-08
BARRAQUER fissaggio	ED-03
BARRETT per abbassare il collo dell'utero	HA-32
BECK atraumatica vascolare	BD-25
BEER depilatoria	ED-08
BENGOLEA emostatica	BC-09
BERGMANN FOERSTER per tamponi e spugne	BG-10
BERKE muscolre	ED-02
BERNHARD fissateli	BE-05
BEST intestinali	GE-06
BEYER osteotomo	EG-08
BEYER sgorbia	DC-04
BISHOP-HARMAN iride	EC-14
BLAKE per calcoli biliari	GC-03
BLOHMKE tonsille	FA-04
BLUMENTHAL sgorbia	DC-02
BÖHLER sgorbia	DC-04
BONACCOLTO strabismo	EC-14
BONNEY per tamponi e spugne	BG-08
Bonn iride	EC-15
Bonn TITAN iride	EC-15
BOZEMANN-DOUGLAS per medicatura	BG-13
BOZEMANN per medicatura	BG-13
BRAIN MINI per posizionare clip	EA-12
BRAIN STANDARD per posizionare clip	EA-12
BRAUN per abbassare il collo dell'utero	HA-31, HA-34
BROCK tagliente	FG-26
BROWN dissezione	BA-03
BRUENINGS laringe	FC-03
BRUENINGS tagliente nasale	EG-05
BRUNNER intestinali	GE-06
BRYANT per tamponi e spugne	BG-11
BUMM per afferrare l'utero	HA-38
BUNT per sterilizzazione	CI-02
BURKE-Baby tagliente per biopsia	HA-44
BURKE tagliente per biopsia	HA-44
CARMALT schegge	BA-06
CASTAÑEDA atraumatica	BD-42
CASTROVIEJO capsulare	ED-04
CASTROVIEJO fissaggio	ED-03
CASTROVIEJO rompe lamette	AG-14
CASTROVIEJO sutura	ED-05
CHAPUT emostatica	BC-08
CHEATLE per sterilizzazione	CI-02
CHERON per medicatura	BG-12
CHEVALIER-JACKSON laringe	FC-04
CHILDE per agrafes	CG-07
CITELLI osteotomo	EG-08
CLEVELAND sgorbia	DC-02
coagulazione bipolare	JA-04 lavorare a JA-06
COLCLOUGH tagliente per dischi intervertebrali	EA-11
COLLIN-DUVAL dissezione	BA-04

COLLIN emostatica	BC-08
COLLIN ombelicale	HC-06
COLLIN per afferrare l'utero	HA-37
COLLIN per agrafes	CG-07
COLLIN per medicatura	BG-11
COLLIN-POZZI	
per abbassare il collo dell'utero	HA-32
COLLIN tiralingua	EI-03
COLVER tonsille	FA-03
COOLEY atraumatica	
BB-03, BD-35 lavorare a BD-37, BD-39, BD-41	
COOLEY atraumatica anastomosi	BD-37, BD-40
COOLEY atraumatica bulldog	BD-33 lavorare a BD-34
COOLEY atraumatica iliaca	BD-37
COOLEY atraumatica pediatrica	BD-38 lavorare a BD-39
COOLEY DERRA atraumatica anastomosi	BD-39
COOLEY vascolare	BD-40
CORDES laringe	FC-03
CRAFOORD emostatica bronchiale	BC-12
CRILE emostatica	BC-05
CRILE-RANKIN emostatica	BC-05
CRILE TITAN emostatica	BC-05
CRUTCHFIELD per trazione craniale	EA-03
CUSHING dissezione	BA-03
CUSHING tagliente per laminectomia	EA-08
CZERNY per abbassare il collo dell'utero	HA-34
CZERNY per calcoli biliari	GC-03
DALE atraumatica vascolare	BD-24
DANDY emostatica	BC-07
DARDIK atraumatica	BD-07
DARTIGUES per afferrare l'utero	HA-37
DASTOOR strabismo	EC-14
DAVIS per sterilizzazione	CI-02
DE BAKEY atraumatica	
BB-03, BD-02, BD-08, BD-16 lavorare a BD-17, BD-20, BD-29 lavorare a BD-30	
DE BAKEY atraumatica anastomosi	BD-25
DE BAKEY atraumatica anastomosi, pediatrica	BD-28
DE BAKEY atraumatica bronchi	BD-19
DE BAKEY atraumatica bulldog	BC-02
DE BAKEY atraumatica	
dissezione e per legature	BD-25, BD-32
DE BAKEY atraumatica iliaca	BD-11
DE BAKEY atraumatica	
per aneurisma di aorta	BD-13, BD-15, BD-18
DE BAKEY atraumatica vascolare	BD-06
DE BAKEY BAHNSON atraumatica	
per aneurisma di aorta	BD-14
DE BAKEY MORRIS atraumatica	BD-16
DE BAKEY REYNOLDS atraumatica anastomosi	BD-30
DE BAKEY SATINSKY atraumatica	BD-22
DeMARTEL-WOLFSON per anastomosi	GE-07
depilatoria	ED-08
DERRA atraumatica	BD-28
DESJARDINS per calcoli biliari	GC-02
DESJARDINS vie biliari	BC-15
DESMARRES calazio	ED-06
DeVILBISS crancraneanea	EA-05
DIEFFENBACH serraфина bulldog	BC-03
DIETER la testa de mastello	EE-10
Pinza	
DIETHRICH atraumatica	BD-31
Pinza	
DIMEDA per rifiuti	CI-03
DIMEDA rompe lamette	AG-14
Pinza di orologio	BA-06
Pinza dissezione	BA-02
Pinza	
DOUGLAS depilatorie	ED-08
DOYEN-Baby intestinali	GE-03
DOYEN fissateli	BE-05

DOYEN intestinali	GE-03	HALSTED-MOSQUITO micro emostatica	BC-04
DOYEN per polipi uterine	HA-36	HALSTED-MOSQUITO TITAN emostatica	BC-04
DUPLAY per abbassare il collo dell'utero	HA-31	HARKEN atraumatica ventricolari	BD-23
DUPLAY per medicatura	BG-14	HARRINGTON per bronchi	FG-21
DUVAL dissezione	BA-04	HARTMANN auricolare	EE-08
DUVAL per afferrare tessuti	GE-03	HARTMANN emostatica	BC-03
ECHLIN sgorbia	DC-05	HARTMANN-HOFFMANN auricolare	EE-08
EDWARDS applicatore per clips	BD-21	HARTMANN nasale polipus	EG-04
ELSAESSER per nefrostomia	GC-13	HARTMANN tagliente nasale	EG-07
ELSCHNIG capsulare	ED-04	HARTMANN-WULLSTEIN auricolare	EE-08
ELSCHNIG fissaggio	ED-03	HEANEY isterectomia	BC-18
EPPENDORFER-KEVORKIAN		HEGENBARTH per agrafes	CG-07
tagliente per biopsia	HA-46	HEIMING per calcoli renali	GC-13
EPPENDORFER		HEISS emostatica	BC-09
tagliente per biopsia	HA-45 lavorare a HA-46	HENROTIN per abbassare il collo dell'utero	HA-34
EPPENDORFER TISCHLER-MORGAN		HERRICK peritoneali	BC-17
tagliente per biopsia	HA-46	HESS capsulare	ED-04
FAURE peritoneali	BC-17	HESS iride	EC-12
FAURE tagliente per biopsia	HA-41	HEYMANN-KNIGHT nasale polipus	EG-05
FEHLAND intestinali	GE-06	HEYMANN tagliente nasale	EG-05
FEILCHENFELD schegge	BA-06	HEYWOOD-SMITH per ermorridia	GI-05
FERGUSSON emostatica	BC-07	HOFF fissateli	BE-03
FERRIS dissezione	BA-04	HOLTH per capsulo	EC-09
FERRIS-SMITH-KERRISON tagliente per dischi intervertebrali	EA-10	HUNTER schegge	BA-06
EA-10		IOWA per abbassare il collo dell'utero	HA-35
FERRIS-SMITH tagliente per laminectomia	EA-09	JACKSON tapponi	FC-02
FINOCHIETTO per bronchi	FG-21	JACOBS per abbassare il collo dell'utero	HA-34
FISCHER iride	EC-13	JAMESON strabismo	EC-13
Pinza fissateli modello delicato	BE-02	JANSEN nasale	EG-04
Pinza		JARCHO per abbassare il collo dell'utero	HA-32
FLETCHER JAVERTS per tamponi e spugne	BG-10	JATHO nasofarinx tagliente	EG-18
FOERSTER iride	EC-12	JAVID atraumatica carotis	BD-32
FOERSTER per tamponi		JOHNS-HOPKINS serrafina bulldog	BC-03
e spugne	BG-06 lavorare a BG-08	JOHNS-HOPKINS vie biliari	BC-14
FRAENKEL laringe	FC-03	JONES fissateli porta tubo	BE-02
FRAENKEL polipus laringe	FC-02	JUDD-ALLIS per afferrare tessuti	GE-02
FRIEDMAN sgorbia	DC-02	JURASZ polipus laringe	FC-02
FRIEDMAN sgorbia, mini	DC-02	KALT capsulare	ED-04
FRYKHOLM sgorbia	DC-05	KANE ombelicale	HC-06
FUCHS capsulare	ED-04	KELLY emostatica	BC-05
GAUSS per pericraneo	HC-06	KELLY per polipi uterine	HA-36
GELLHORN tagliente per biopsia	HA-42	KELLY-RANKIN emostatica	BC-05
GEMINI dissezione e per legature	BC-10	KELLY TITAN emostatica	BC-05
GEMINI MINI dissezione e per legature	BC-10	KERRISON tagliente nasale	EG-08
GERALD dissezione	BA-05	KEVORKIAN-Pacific tagliente per biopsia	HA-44
GILL-ARRUGA capsulare	ED-03	KEVORKIAN tagliente per biopsia	HA-43, HA-46
GILL-HESS iride	EC-12	KIRBY-ARTHUR iride	EC-13
GILLIES dissezione	BA-05	KNAPP-LUER trichiasi	ED-06
GILL iride	EC-12	KNIGHT tagliente nasale	EG-05
GLOVER atraumatica	BD-06, BD-30	KOCHER emostatica delicate	BC-06
GLOVER atraumatica anastomosi	BD-05	KOCHER intestinali	GE-04
GLOVER atraumatica bulldog	BC-02	KRAUSE laringe	FC-03
GLOVER atraumatica coartazione	BD-04	LAHEY afferrare gozzo	FE-04
GRADLE depilatorie	ED-08	LAHEY vie biliari	BC-14
GRAEFE dissezione	BA-03	LAMBERT calazio	ED-06
GRAEFE fissaggio	ED-03	LAMBERT KAY atraumatica aortica	BD-10
GRAEFE iride	EC-11	LAMBERT KAY atraumatica iliaca	BD-11
GRAY vie biliari	BC-15	LANE dissezione	BA-04
GREEN-ARMYTAGE emostatica		LANE fissateli	BE-05
per tagli ceserei	HC-06	LANE porta placche	DD-14
GREEN fissaggio	ED-03	LANE porta viti	DD-14
GREGORY atraumatica profonda	BD-33	LANE stomacali	GE-08
GREVEN auricolare micro	EE-10	LANGE laringe	FC-03
GRIP per afferrare	DD-11	LAWRENCE dissezione e per legature	BC-13
GROSS-MAIER per medicatura	BG-02 lavorare a BG-04	LEES atraumatica bronchi	BD-03
GROSS per medicatura	BG-05	LEKSELL STILLE sgorbia	DC-05
GUYON peduncolo renale	BC-16	LELAND JONES atraumatica	
HAJEK-CLAUS seno	EG-08	vascolare	BD-08 lavorare a BD-09
HAJEK-KOFLER tagliente nasale	EG-08	LEMPET sgorbia	DC-03
HALSTED-MOSQUITO atraumatica	BD-02	LERCHE dissezione	BA-04
HALSTED-MOSQUITO emostatica	BC-04	LERICHE emostatica	BC-09

LESTER fissaggio	ED-03
LEWKOWITZ per placenta e per ovaie	HC-07
LIDDLE atraumatica aorta	BD-10
LISTER sinus per tamponi e spugne	BG-11
LITTAUER auricolare	EE-08
LITTAUER depilatorie	ED-08
LITTAUER nasale polipus	EG-05
LORNA fissateli	BE-04
LOVE-GRUENWALD tagliente per laminectomia	EA-08
LOVELACE emostatica	BC-07
LOVELACE per afferrare il polmone	FG-19
LOWER vie biliari	BC-14
LUBET-BARBON nasale polipus	EG-05
LUCAE auricolare	EE-07
LUC tagliente nasale	EG-06
LUER sgorbia	DC-03
LURZ per uretere	GC-10
MAGILL per introdurre le sonde	AE-06
MAIER per medicatura	BG-12
MARSHIK tonsille	FA-04
MARTEL cuoio capelluto	BC-08
MARTIN per medicatura	BG-02, BG-14
MARTIN per sequestri	DC-10
MASTIN muscolare	FE-04
MATHIEU per corpi estranei	GG-07
MAYO BLAKE per calcoli biliari	GC-04
MAYO-GUYON peduncolo renale	BC-16
MAYO per sterilizzazione	CI-02
MAYO-ROBSON intestinali	GE-05
McCLINTOCK per placenta e per ovale	HC-07
McCULLOUGH strabismo	EC-13
McGEE auricolare micro	EE-10
McINDOE dissezione	BA-04
MCKENZIE per applicare e agrafes	EA-02
McPHERSON legature	ED-05
McPHERSON TITAN legature	ED-05
MEAD sgorbia	DC-02
MEEKER dissezione e per legature	BC-13
MICHEL per agrafes	CG-07
Pinza micro	BB-02
Pinza	
MIDDLETON-JANSEN tagliente nasale	EG-09
MIKULICZ peritoneali	BC-17
MILLIN per afferrare la capsula	GG-03
MILLIN per lobuli anteriori	GG-03
MILLIN porta-filo	GG-03
MIXTER BABY emostatica bronchiale	BC-13
MIXTER emostatica	BC-14
MIXTER emostatica bronchiale	BC-13
MIXTER O'SHAUGNESSY emostatica	BC-14
MIXTER per calcoli biliari	GC-04
MIXTER vie biliari	BC-15
MOORFIELD sutura	ED-05
MOYNIHAN fissateli	BE-05
MOYNIHAN vie biliari	BC-15
MURPHY serratubi	BC-19
MUSEUX per abbassare il collo dell'utero	HA-33
MYLES tagliente nasale	EG-07
NEGUS tonsille	FA-03
NELSON dissezione	BA-05
NEUBÜSER per afferrare trompe	HA-51
NOTO per polipi uterine	HA-36
NOYES nasale polipus	EG-05
OCHSNER atraumatica aorta	BD-31
OLDBERG tagliente per laminectomia	EA-09
OLIVECRONA sgorbia	DC-03
OLIVECRONA-TOENNIS per applicare e agrafes	EA-02
OVERHOLT-GEISSENDOERFER	
dissezione e per legature	BC-10
PAUFIQUE legature	ED-05
PAUFIQUE TITAN legature	ED-05
PAYR-Baby stomacali	GE-09
PAYR stomacali	GE-09
PEAN atraumatica	BD-02
PEAN emostatica	BC-08
PEAN emostatica delicate	BC-06
PEERS BERTRAM fissateli	BE-03
PEET schegge	BA-06
PELKMANN per medicatura	BG-12
PENNINGTON emostatica	BC-07
per fissare	GG-10
per fissare il tronco spermatico	GG-10
Pinza per sequestri	DC-10
Pinza per sterilizzazione	CI-02
Pinza	
PHANEUF peritoneali	BC-17
piatta	DD-11
POTTS atraumatica	BD-26 lavorare a BD-27
POTTS atraumatica anastomosi	BD-05
POTTS atraumatica coartazione	BD-04
POTTS-SMITH dissezione	BA-02
POZZI per abbassare il collo dell'utero	HA-31
PRATT emostatica	BC-08
PRATT per abbassare	
il collo dell'utero	HA-34 lavorare a HA-35
PRESBYTERIAN HOSPITAL serratubi	BC-19
PRICE-THOMAS per bronchi	FG-22
PRINCE muscole	ED-02
PROVIDENCE-HOSPITAL emostatica	BC-05
RADOLF per unghie	DD-03
RAMPLEY per tamponi e spugne	BG-09
RANDALL per calcoli renali	GC-11 lavorare a GC-12
RANEY emostatica per il cuoio capelluto	EA-03
RANEY per applicare e togliere	EA-03
RANKIN atraumatica	BD-02
RICHTER-HEATH per agrafes	CG-07
ROBERTS emostatica	BC-11
ROCHESTER-CARMALT emostatica	BC-07
ROCHESTER-OCHSNER emostatica	BC-06
ROCHESTER-PEAN emostatica	BC-06
ROEDER fissateli	BE-03
ROGGE per sterilizzazione	CI-02
ROSENBERG laringe	FC-03
ROWE bocca	EI-06
RUBIN per ammaccare il setto	EG-07
RUMEL toracale	BC-11
RUSKIN sgorbia	DC-04
RUSSIAN dissezione	BA-04
SAENGER per placenta e per ovale	HC-07
SAIRGES per abbassare il collo dell'utero	HA-32
SAROT emostatica bronchiale	BC-12
SAROT per bronchi	FG-23
SATINSKY atraumatica	BD-20
SATINSKY	
per anastomosi (vena cava)	FG-24 lavorare a FG-25
SAUERBRUCH per rifiuti	CI-03
SAUERBRUCH sgorbia	DC-05
SAWTELL tonsille	FA-03
SCAGLIETTI sgorbia	DC-05
Pinza schegge	BA-06
Pinza	
SCHEINMANN laringe	FC-03
SCHNIDT tonsille	FA-03
SCHOENBURG per afferrare tessuti	GE-03
SCHROEDER per abbassare il collo	
dell'utero	HA-31 lavorare a HA-32
SCHUBERT tagliente per biopsia	HA-41
SCHUMACHER laringe	FC-03
SCHUMACHER tagliente per biopsia	HA-43
SCHWEIGGER capsulare	ED-04
SEIFFERT laringe	FC-03
SEMB per bronchi	FG-23

SEMB sgorbia	.DC-06	WEIL-BLAKESLEY tagliente nasale	.EG-06
SEMKEN dissezione	.BA-05	WEISS serratubi	.BC-19
Pinza serratubi	.BC-19	WERTHEIM-CULLEN isterectomia	.BC-18
Pinza		WERTHEIM isterectomia	.BC-18
SIEGLER HELLMANN per afferrare l'utero	.HA-38	WESTON polipus rettali	.GI-05
SIMS-MAIER per medicatura	.BG-05	WHITE tonsille	.FA-03
SINGLEY dissezione	.BA-05	WILDE (TROELTSCH) auricolare	.EE-07
SKENE per abbassare il collo dell'utero	.HA-31	WILLET-MARTELL cuoio capelluto	.BC-08
SMITHWICK per applicare e agrafes	.EA-02	WILLIAMS per afferrare tessuti	.GE-03
SNELLEN entropio	.ED-06	WINTER per placenta e per ovale	.HC-07
SOMER per afferrare l'utero	.HA-37	WITTNER tagliente per biopsia	.HA-43
SPENCER-WELLS emostatica	.BC-07	WOLFF per gessi	.DA-04
SPURLING tagliente per laminectomia	.EA-08	WYLIE atraumatica	.BD-21
STAUDE-MOORE per abbassare il collo dell'utero	.HA-31	YEOMAN per biopsia	.GI-05
STEVENS iride	.EC-11	YOUNG per afferrare la prostata	.GG-02
STIEGLITZ schegge	.BA-06	YOUNG tiralingua	.EI-03
STILLE dissezione	.BA-02	ZAUFAL-JANSEN sgorbia	.DC-04
STILLE-LUER sgorbia	.DC-04	ZENKER dissezione e per legature	.BC-12
STILLE peduncolo renale	.BC-16	PIPER	
STILLE-RUSKIN sgorbia	.DC-05	forbici ostetriche	.HC-04
St. MARTIN sutura	.ED-05	forbici ostetriche con dispositivo di trazione	.HC-04
STONE per serra	.GE-06	Placca JAEGER per palpebre	.EC-03
STONE-WATT intestinali	.GE-06	PLESTER	
STRUEMPEL auricolare	.EE-08	coltello lobare	.EE-14
STRUYCKEN tagliente nasale	.EG-07	divaricatore	.BI-14
SUBRAMANIAN atraumatica	.BD-31	POLITZER	
SWEET per applicare e agrafes	.EA-02	ago auricolare	.EE-06
tagliafili e per piegare	.DD-11	coltello auricolare	.EE-06
TEALE per abbassare il collo dell'utero	.HA-33	insoffiatore d'aria	.EE-05
TERSON capsulare	.ED-04	POOLE tubi d'aspirazione	.AE-02
THOMS-ALLIS per afferrare tessuti	.GE-02	Port'aghi	
THOMS-GAYLOR tagliente per biopsia	.HA-42	ADSON	.CE-04
TIEMANN per abbassare il collo dell'utero	.HA-32	ARRUGA oftalmologia	.CE-06
TILLEY auricolare	.EE-08	BARRAQUER	.CE-07
TISCHLER-KEVORKIAN tagliente		BAUMGARTNER	.CE-02
per biopsia	.HA-44 lavorare a HA-45	BOYNTON oftalmologia	.CE-06
TISCHLER-MORGAN tagliente		BOZEMANN	.CE-03
per biopsia	.HA-43 lavorare a HA-44, HA-46	CASTROVIEJO	.CE-07
TIVNEN tonsille	.FA-04	COLLIER	.CE-02
TOENNIS emostatica	.BC-11	CRILE	.CE-04
TOHOKU fissateli	.BE-04	CRILE-MURRAY	.CE-02
TOWNSEND-KEVORKIAN tagliente per biopsia	.HA-44	CRILE-WOOD	.CE-02
TOWNSEND-MINI (BABY TISCHLER) tagliente per biopsia	.HA-45	DE BAKEY	.CE-03
TOWNSEND-mini tagliente per biopsia	.HA-44	DERF	.CE-02
TOWNSEND tagliente per biopsia	.HA-44	DIETHRICH vascolare	.CE-06
TOWNSEND-TISCHLER tagliente per biopsia	.HA-44	FINOCHIETTO	.CE-04
TROELTSCH nasale	.EG-04	GILLIES	.CE-05
TROUTMAN-CHRIS rompe lamette	.AG-14	HALSEY	.CE-02
TROUTMAN Colibri iride	.EC-13	HEANEY	.CE-03
TROUTMAN rectus	.ED-02	HOESEL	.CE-05
Tübingen iride	.EC-15	JAMISON	.CE-03
Tübingen legature	.ED-05	JOHNSON	.CE-04
Tübingen TITAN iride	.EC-15	KALT	.CE-07
Tübingen TITAN legature	.ED-05	KALT-ARRUGA	.CE-07
TUFFIER emostatica	.BC-08	MASSON	.CE-03
TURREL per biopsia	.GI-05	MATHIEU	.CE-05
TYDING tonsille	.FA-04	MAYO-HEGAR	.CE-02
ULRICH per tamponi e spugne	.BG-06	METZENBAUM	.CE-04
UNIVERSAL per sterilizzazione	.CI-02	NEIVERT	.CE-02
USA dissezione	.BA-02	OLSEN-HEGAR	.CE-05
VAN BUREN per sequestri	.DC-10	RYDER	.CE-03
van DOREN tagliente per biopsia	.HA-42	SAROT	.CE-04
Pinza vascolare flessibile	.BD-44 lavorare a BD-45	STEVENS oftalmologia	.CE-06
Pinza		STRATTE	.CE-04
VIRTUS (RALK) schegge	.BA-06	TOENNIS	.CE-04
WACHENFELDT per agrafes	.CG-07	WANGENSTEEN	.CE-03
WAGNER tagliente per laminectomia	.EA-09	POTTS DE MARTEL forbici vascolari	.AI-27
WALSHAM raddrizzare setto	.EG-18	POTTS	
WANGENSTEEN dissezione	.BA-05	pinza atraumatica	.BD-26 lavorare a BD-27
WEBER atraumatica	.BD-12	pinza atraumatica anastomosi	.BD-05
		pinza atraumatica coartazione	.BD-04

POTTS-SMITH	
forbici vascolari	.AH-19
forbici vascolari	.AI-28
pinza dissezione	.BA-02
POZZI pinza per abbassare il collo dell'utero	.HA-31
PRATT	
dilatatore uterini	.HA-29
pinza emostatica	.BC-08
pinza per abbassare il collo dell'utero	.HA-34 lavorare a HA-35
specolo rettale	.GI-02
unicino cistico	.GI-04
PRESBYTERIAN HOSPITAL pinza serratubi	.BC-19
PRICE-THOMAS pinza per bronchi	.FG-22
PRINCE	
forbici tonsillari	.AI-27
pinza muscolre	.ED-02
Proctoscopio KELLY	.GI-04
Protettore	
ARRUGA	.EC-08
di tessuto	.DD-15
PROVIDENCE-HOSPITAL pinza emostatica	.BC-05
Punte	.DD-04
Punteruoli	.DD-08
PERTHES	.DD-08
PUTTI lima per ossa	.DC-25

Q

QUATTRO divaricatori per gessi	.DA-03
QUINBY forbici gengivali	.AI-42
QUINKE ago da punzione	.CC-03
QUIRE leva corpi estranei	.EE-08
QUISLING martello	.DC-18

R

Rachiotomo	.DC-17
RADOLF pinza per unghie	.DD-03
RALK perforatore a mano	.DD-05
RAMPLEY pinza per tamponi e spugne	.BG-09
RANDALL	
curetta di aspirazione per biopsia	.HA-40
pinza per calcoli renali	.GC-11 lavorare a GC-12
RANEY	
pinza emostatica per il cuoio capelluto	.EA-03
pinza per applicare e togliere	.EA-03
RANKIN pinza atraumatica	.BD-02
Rasoio	.AG-14, AG-19
Raspa	
FOMON nasale	.EG-15 lavorare a EG-16
GALLAHER per seno	.EG-16
JOSEPH (LEWIS) nasale	.EG-15
MALTZ (COTTLE) nasale	.EG-15
MALTZ nasale	.EG-14
WIENER (AUFRICHT) nasale	.EG-15
WIENER per seno	.EG-15
RECAIMER curetta uterine	.HA-49 lavorare a HA-50
Recipiente cylindr	.HE-08
Regolo acciaio	.AC-08
REICHERT depressor epiglottide	.FC-02
REINER	
coltello per gessi	.DA-04
siringa auricolare	.EE-05
Retratore PERCY per amputazione	.DD-03
Rettoscopio luce fredda	.GI-03
REVERDIN	
ago per legature	.CG-03
divaricatore	.BI-04
REYNOLDS forbici	.AH-15, AI-18
RIBBON divaricatore	.BI-04

RICHARDSON divaricatore	.BI-04
RICHARDSON-EASTMAN divaricatore	.BI-04
RICHARDSON Grip divaricatore	.BI-04
RICHTER-HEATH pinza per agrafes	.CG-07
RIGBY divaricatore addominale	.BI-24
ROBB dissetto vascolare	.FG-33
ROBERTS pinza emostatica	.BC-11
ROCHESTER-CARMALT pinza emostatica	.BC-07
ROCHESTER-OCHSNER pinza emostatica	.BC-06
ROCHESTER-PEAN pinza emostatica	.BC-06
ROEDER pinza fissateli	.BE-03
ROGER elevatore setto	.EG-11
ROGGE pinza per sterilizzazione	.CI-02
ROLLET	
divaricatore	.EC-06
scalpello per sacco	.EC-06
ROSEN	
ago	.EE-14 lavorare a EE-15
ROSENBERG pinza laringe	.FC-03
ROSEN	
coltello circolare	.EE-14
ROSER-KOENIG apribocca	.EI-03
ROSE uncino tracheale	.FE-03
ROUX BABY divaricatore	.BI-02
ROUX	
divaricatore	.BI-02
divaricatore aortica mini	.BI-02
ROWE pinza bocca	.EI-06
RUBIN pinza per ammaccare il setto	.EG-07
RUMEL pinza toracale	.BC-11
RUSKIN-LISTON cesoia per ossa	.DC-06
RUSKIN pinza sgorbia	.DC-04
RUSSIAN pinza dissezione	.BA-04
RYDEL-SEIFFER diapason	.EE-04
RYDER port'aghi	.CE-03

S

SAALFELD tiracomedoni	.HE-02
SACHS	
dissetto per duramadre	.EA-05
divaricatore per nervi	.EA-04
SADILLOT periostotomo	.DC-19
SAENGER pinza per placenta e per ovaie	.HC-07
SAIRGES pinza per abbassare il collo dell'utero	.HA-32
Salpingografo SCHULTZE	.HA-47
SANVENERO forbici	.AH-13, AI-16
SAROT	
pinza emostatica bronchiale	.BC-12
pinza per bronchi	.FG-23
port'aghi	.CE-04
SATINSKY	
forbici toracali	.AI-37
pinza atraumatica	.BD-20
pinza per anastomosi (vena cava)	.FG-24 lavorare a FG-25
SATO coltello per corneale	.EC-05
SAUERBRUCH	
costotomo	.FG-05
divaricatore	.BI-13
SAUERBRUCH-FREY costotomo	.FG-06
SAUERBRUCH	
pinza per rifiuti	.CI-03
pinza sgorbia	.DC-05
scatola port'aghi	.HE-02
SAWTELL pinza tonsille	.FA-03
SCAGLIETTI pinza sgorbia	.DC-05
Scalpello	.DC-14
ALEXANDER	.DC-14
CINELLI plastica nasale	.EG-13
COTTLE plastica nasale	.EG-13
DIX per corpi estranei	.EC-06

FOMON plastica nasale	EG-13	SEIFFERT pinza laringe	FC-03
FREER setto	EG-12	SELLHEIM cucchiaino ostetrico	HC-09
HIBBS	DC-16	SELLORS approssimatori costali	FG-18
HOKE	DC-16	SEMB	
LEXER	DC-16	cesoia per ossa	DC-07
LEXER mini	DC-16	periostotomo	DC-20
PARTSCH	DC-14	pinza per bronchi	FG-23
ROLLET per sacco	EC-06	pinza sgorbia	DC-06
SILVER plastica nasale	EG-14	tenaglia per ossa	DC-07
SMITH-PETERSEN	DC-15	SEMKEN pinza dissezione	BA-05
Scalpello spinale BRUNETTI	DC-17	SEMM specolo vaginali	HA-07
Scalpello sterno LEBSCHKE	DC-17	SENN divaricatore	BI-04
Scalpello		SENN-GREEN divaricatore	BI-07
STILLE	DC-14	Sensimetro WARTENBERG	AC-08
WEST nasale	EG-14	Serranodi	
Scarificatore GRAEFE	EC-04	BRUENINGS tonsille	FA-04
Scatola		EVES tonsille	FA-04
acciaio inossidabile	HE-03	KRAUSE	EG-09
PETRI	HE-08	KRAUSE auricolare	EE-07
port'aghi	HE-02	TYDING tonsille	FA-05
SAUERBRUCH port'aghi	HE-02	WILDE	EG-09
vetro	HE-03	WILDE auricolare	EE-07
SCHAMBERG tiracomedoni	HE-02	Serrapene	
SCHEDE curetta tagliente	DC-12	STOCKMANN	GG-10
SCHEIE		STRAUSS	GG-10
cannula oculistiche	ED-07	Set	
coltello per goniotomia	EC-05	KEYES di trapani cutanei	HE-02
SCHEINMANN pinza laringe	FC-03	Set per autopsia	DC-17
SCHERBAK specolo vaginali	HA-21	Set	
SCHIMMELBUSCH tamburo per sterilizzazione	HE-12	per manicure per infermiere	HE-03
SCHINK dermatomo	AG-21	SEUTIN forbici per gessi	DA-02
SCHIOETZ tonometro	ED-08	SEXTON coltello auricolare	EE-06
SCHMIEDEN-PAYR sonda conduttrice	CG-04	Sfera elettrodo per coagulazione	JA-03
SCHMIEDEN sonda conduttrice	CG-04	Sferica	DD-04
SCHMIEDEN-TAYLOR forbici	AI-36	Sfigmomanometro	AC-02
SCHNIDT pinza tonsille	FA-03	Sgorbia	DC-14
SCHOENBORN divaricatore tiroide	FE-04	ALEXANDER	DC-14
SCHOENBURG pinza per afferrare tessuti	GE-03	ELLIS per corpi estranei	EC-06
SCHROEDER		FREER nasale	EG-14
curetta uterine	HA-48	HAJEK nasale	EG-14
pinza per abbassare il collo dell'utero	HA-31 lavorare a HA-32	HIBBS	DC-16
SCHUBERT pinza tagliente per biopsia	HA-41	KILLIAN-CLAUS nasale	EG-14
SCHUKNECHT		LEXER	DC-16
coltello circolare	EE-14	LEXER mini	DC-16
coltello falciforme	EE-14	PARTSCH	DC-14
SCHULTZE salpingografo	HA-47	SMITH-PETERSEN	DC-15
SCHUMACHER		STILLE	DC-14
forbici ombelicali	AI-34	WALTON per corpi estranei	EC-06
forbici per sterno	FG-07	WEST nasale	EG-14
pinza laringe	FC-03	SHEA forbici auricolari micro	EE-09
pinza tagliente per biopsia	HA-43	SHORTBENT forbici per legature	AI-40
SCHWEIGGER pinza capsulare	ED-04	SIEBOLD forbici ginecologiche	AH-21, AI-32
Sclerotomo		SIEGLER HELLMANN pinza per afferrare l'utero	HA-38
GUYTON-LUNDSGAARD	EC-05	SIEGLE specoli auricolare	EE-02
LUNDSGAARD	EC-05	SILVER	
Scollatendini BUNNELL	DC-25	dermatomo	AG-20
Scollato FISCH	EE-15	scalpello plastica nasale	EG-14
Secchi per rifiuti	HE-11	SIMCOE cannula sutura	ED-07
SEEMANN-SEIFFERT apribocca	EI-04	SIMON	
Sega		curetta tagliente	DC-13
BERGMANN per gessi	DA-02	curetta uterine	HA-48
CHARRIERE per amputazione	DD-03	divaricatore	BI-12
ENGEL per gessi	DA-02	SIMPSON-BRAUN forcipe ostetriche	HC-02
JOSEPH nasale	EG-17	SIMPSON forbici ostetriche	HC-02
LANGENBECK a dita	DD-03	SIMPSON-LUIKART forbici ostetriche	HC-03
OLIVECRONA	EA-05	SIMS	
Sega per gessi oscillante	DA-5 lavorare a DA-6	curetta uterine	HA-49 lavorare a HA-50
Sega		depressore uterino	HA-39
per taglia anelli	DD-03	dilatatore uterini	HA-30
WIGMORE per gessi	DA-02	forbici ginecologiche	AH-21, AI-32
SEGOND bisturi per fibromi	HA-46	isterometro	HA-39

SIMS-MAIER pinza per medicatura	.BG-05	TOBOLD	.CA-03
SIMS		UCKERMANN	.CA-03
specolo rettale	.GI-02	Specoli	
specolo vaginali	.HA-17	BOUCHERON auricolare	.EE-02
SINGLEY pinza dissezione	.BA-05	BRUENINGS auricolare	.EE-02
Siringa		GRUBER auricolare	.EE-02
REINER auricolare	.EE-05	HARTMANN auricolare	.EE-02
tonsille	.FA-05	SIEGLE auricolare	.EE-02
Sistema LEYLA da fissaggio	.EA-14 lavorare a	TOYNBEE auricolare	.EE-02
SKENE pinza per abbassare il collo dell'utero	.HA-31	Specolo	
SLUDER-BALLENGER tonsillotomo	.FA-05	AUVARD vaginali	.HA-19
SMELLIE		BARR rettale	.GI-02
spezzacrano	.HC-09	BERLIND-AUVARD vaginali	.HA-19
uncino uncino ostetrico	.HC-06	BODENHAMMER rettale	.GI-02
SMILLIE meniscotomo	.DC-24	BRAUN vaginali	.HA-16
SMITH blefarostato	.EC-02	BREISKY vaginali	.HA-20
SMITH-BUIE dilatatore per l'ano e il retto	.GI-03	COLLIN vaginali	.HA-04
SMITH-PETERSEN		COTTLE nasale	.EG-03
scalpello	.DC-15	CUSCO vaginali	.HA-04 lavorare a
sgorbia	.DC-15	CZERNY rettale	.GI-02
SMITH US ARMY forbici bendaggi	.AI-44	DOYEN vaginali	.HA-18, HA-20
SMITHWICK		FREEWAY-GRAVE vaginali	.HA-06
divaricatore per nervi	.EA-04	GRAVE vaginali	.HA-02
pinza per applicare e agrafes	.EA-02	HARTMANN-HALLE nasale	.EG-02
SNELLEN		JACKSON vaginali	.HA-16
ansa	.EC-08	KALLMORGEN vaginali	.HA-15
pinza entropio	.ED-06	KILLIAN setto	.EG-03
SOMER pinza per afferrare l'utero	.HA-37	KOGAN endo	.HA-23
Sonda	.CA-02	KRISTELLER vaginali	.HA-09 lavorare a
BRUNNER conduttrice	.CG-04	LANDAU vaginali	.HA-22
DESJARDINS per calcoli biliari	.GC-05	MATHIEU rettale	.GI-02
DOYEN	.CA-02	O'SULLIVAN-O'CONNOR vaginali	.HA-08
HARTMANN auricolare	.EE-06	PEDERSON vaginali	.HA-03
ITARD auricolare	.EE-06	PRATT rettale	.GI-02
KIRSCHNER conduttrice	.CG-04	SCHERBAK vaginali	.HA-21
KOCHER gozzo	.FE-04	SEMM vaginali	.HA-07
KOENIG conduttrice	.CG-04	SIMS rettale	.GI-02
MAYO per calcoli renali	.GC-10	SIMS vaginali	.HA-17
misurare	.EE-15	STEINER-AUVARD vaginali	.HA-19
MOYNIHAN per calcoli biliari	.GC-05	THUDICHUM nasale	.EG-02
NABATOFF auricola argento	.CA-02	TIECK-HALLE nasale	.EG-03
PAYR conduttrice	.CG-04	TRELAT vaginali	.HA-07
per uomini metallica	.GG-16	Vienna nasale	.EG-02
SCHMIEDEN conduttrice	.CG-04	VOLTOLINI nasale	.EG-02
SCHMIEDEN-PAYR conduttrice	.CG-04	WEISSBARTH vaginali	.HA-22
STACKE auricola argento	.CA-02	YANKAUER nasofarins	.EG-04
Spatola	.CA-03	SPENCER forbici per legature	.AI-40
ALLISON polmone	.FG-19	SPENCER-WELLS pinza emostatica	.BC-07
BANGERTER ciclodialisi	.EC-08	Spezzacrano	
CASTROVIEJO ciclodialisi	.EC-08 lavorare a	NÄGELE	.HC-09
CULLER iride	.EC-08	SMELLIE	.HC-09
ELSCHNIG ciclodialisi	.EC-08	SPRATT curetta tagliente	.DC-12
KOCHER vescicali	.GG-04	SPURLING pinza tagliente per laminectomia	.EA-08
LEGUEU vescicali	.GG-04	Sputacchiera	.HE-06
WECKER iride	.EC-08	STACKE sonda auricola argento	.CA-02
WELLS enucleaciona	.EC-08	Standard astucci tascabili e per sutura	.CG-08
WHEELER ciclodialisi	.EC-09	STAUDE-MOORE pinza	
Spatole		per abbassare il collo dell'utero	.HA-31
CUSHING cerebr	.EA-07	St. CLAIR-THOMSON coltello	.EG-19
HEIFETZ cerebr	.EA-07	STEINER-AUVARD specolo vaginali	.HA-19
OLIVECRONA cerebr	.EA-07	STEINMANN chiodo per ossa	.DD-09
Spazzola per pulire	.CI-04 lavorare a	STELZNER forbici rette	.AI-38
Specchio frontale ZIEGLER	.AC-05	STERNBERG divaricatore labbra	.EI-02
Specchio		Stetoscopio	
laringei	.FC-04	BOWLES	.AC-06
MICHEL	.EG-04	Stetoscopio duplex	.AC-06
Specillo	.CA-03	Stetoscopio	
BOWMAN canale lacrimale	.EC-10	FORD	.AC-06
DIMEDA	.CA-03	FORD BOWLES	.AC-06
FARREL	.CA-03	PINARD	.AC-06
JOBSON-HORNE	.CA-03	STEVENS	

forbici tenotomia	.AH-17
forbici tenotomy	.AI-23
STEVENSON blefarostato	.EC-03
STEVENS	
pinza iride	.EC-11
port'aghi oftalmologia	.CE-06
uncino per cristallino	.EC-06
STIEGLITZ pinza schegge	.BA-06
Stiletto MAGILL	.AE-04
STILLE	
costotomi	.FG-03
forbici per gessi	.DA-02
STILLE-HORSLEY cesoia per ossa	.DC-07
STILLE-LISTON cesoia per ossa	.DC-06
STILLE-LUER pinza sgorbia	.DC-04
STILLE	
osteotomo	.DC-14
perforatore a mano	.DD-04
pinza dissezione	.BA-02
pinza peduncolo renale	.BC-16
STILLE-RUSKIN pinza sgorbia	.DC-05
STILLE	
scalpello	.DC-14
sgorbia	.DC-14
STILLE-SHERMAN perforatore a mano	.DD-04
St. MARTIN pinza sutura	.ED-05
STOCKMANN serrapene	.GG-10
STONE pinza per serra	.GE-06
STONE-WATT pinza intestinali	.GE-06
STRATTE port'aghi	.CE-04
STRAUSS serrapene	.GG-10
Stripper anello	.CA-03
STRUEMPPEL pinza auricolare	.EE-08
STRULLY forbici neurochirurgia	.AI-35
Strumenti LAFORCE per corpi estranei	.EC-06
Strumento	
KNUTSON per uretrografia	.GG-09
LOUTE tendifilo	.DD-11
MOGAN per circoncisione	.GG-09
per circoncisione	.GG-09
WINKELMANN per circoncisione	.GG-09
Strum	
KUENTSCHER per conficc	.DD-13
per conficc	.DD-12
STRUYCKEN pinza tagliente nasale	.EG-07
SUBRAMANIAN pinza atraumatica	.BD-31
Supporto MILLIN per luce fredda	.GG-05
SWEET pinza per applicare e agrafes	.EA-02
T	
TABB coltello falciforme	.EE-14
Taglia anelli DIMEDA	.DD-03
Tagliacalli CREDO	.HE-03
Tagliafilii	.DD-12
Diamant	.DD-12
Tamburo	
KONRICH per sterilizzazione	.HE-12
SCHIMMELBUSCH per sterilizzazione	.HE-12
TARNIER	
cranioclasto	.HC-09
forbici ostetriche con dispositivo di trazione	.HC-05
TAYLOR	
divaricatore spina	.DC-24
martelli percussori	.AC-07
TEALE pinza per abbassare il collo dell'utero	.HA-33
Telaio KIRSCHNER	.BI-23
Tenaglia	
BIRCHER-GANSKE per ossa	.DC-10
DINGMANN per ossa	.DC-10
FARABEU-FERRELL per ossa	.DC-07
FERGUSSON per ossa	.DC-07
KERN per ossa	.DC-08
LAMBOTTE per ossa	.DC-08
LANE per ossa	.DC-08
LANGENBECK per ossa	.DC-07
LEWIN per ossa	.DC-10
LOWMAN per ossa	.DC-11
Tenaglia per ossa	.DC-09 lavorare a DC-10
Tenaglia	
SEMB per ossa	.DC-07
VERBRUGGE per ossa	.DC-09
Tenditore di fili	.DD-10
TERSON pinza capsulare	.ED-04
THOMS-ALLIS pinza per afferrare tessuti	.GE-02
THOMS-GAYLOR pinza tagliente per biopsia	.HA-42
THOMSON-WALKER divaricatore vescicale	.GG-06
THOREK forbici pulmonari	.AI-36
THUDICHUM specolo nasale	.EG-02
TIECK-HALLE specolo nasale	.EG-03
TIEMANN pinza per abbassare il collo dell'utero	.HA-32
TILLEY pinza auricolare	.EE-08
Tiracomedoni	
SAALFELD	.HE-02
SCHAMBERG	.HE-02
UNNA	.HE-02
WALTON	.HE-02
Tiramiomi DOYEN per fibromi	.HA-46
TISCHLER-KEVORKIAN pinza	
tagliente per biopsia	.HA-44 lavorare a HA-45
TISCHLER-MORGAN pinza	
tagliente per biopsia	.HA-43 lavorare a HA-44, HA-46
TIVNEN pinza tonsille	.FA-04
TOBOLD	
abassalingua	.EI-02
specillo	.CA-03
TOENNIS-ADSON forbici neurochirurgia	.AI-35
TOENNIS	
dissettore per duramadre	.EA-05
pinza emostatica	.BC-11
port'aghi	.CE-04
TOHOKU pinza fissateli	.BE-04
Tonometro SCHIOETZ	.ED-08
Tonsillotomo SLUDER-BALLENGER	.FA-05
TOOK coltello per corneale	.EC-05
TOTI fresa	.DD-07
TOWNSEND-KEVORKIAN pinza	
tagliente per biopsia	.HA-44
TOWNSEND-MINI (BABY TISCHLER) pinza	
tagliente per biopsia	.HA-45
TOWNSEND-mini pinza tagliente per biopsia	.HA-44
TOWNSEND pinza tagliente per biopsia	.HA-44
TOWNSEND-TISCHLER pinza tagliente per biopsia	.HA-44
TOYNBEE specoli auricolare	.EE-02
Trapano	.DD-04
CASTROVIEJO corneale	.ED-07
ELLIOT corneale	.ED-08
FRANCESCHETTI corneale	.ED-07
Trattore	
BARTON per manico standard	.HC-04
BILL per manico standard	.HC-05
LUIKART-BILL per manico standard	.HC-05
TRAUBE martelli percussori	.AC-07
TRELAT specolo vaginali	.HA-07
Trequarti	.CC-02
COAKLEY	.CC-02
DOUGLAS	.CC-02
FLEURANT	.CC-02
LICHTWITZ	.CC-02
MENGHINI	.CC-03
NELSON	.CC-02

OCHSNER	CC-02
PIERCE	CC-02
UCKERMANN tracheale	FE-02
UNIVERSAL	CC-02
TROELTSCH pinza nasale	EG-04
TROEMNER martelli percussori	AC-07
Tronchesina	
per pelle	HE-03
per unghie	HE-03
TURNBULL per unghie	HE-03
TROUSSEAU dilatatore tracheale	FE-02
TROUTMAN-CASTROVIEJO forbici micro	AJ-07
TROUTMAN-CHRIS pinza rompe lamette	AG-14
TROUTMAN Colibri pinza iride	EC-13
TROUTMAN pinza rectus	ED-02
TUBBS dilatatore per valvole mitrali	FG-27
Tubi d'aspirazione	
ANDREWS-PINCHON	AE-03
DE BAKEY	AE-04
FRAZIER	EA-07
MAGILL	AE-04
NUBOER	AE-05
POOLE	AE-02
WALTON YANKAUER	AE-03
YANKAUER	AE-02
Tübingen	
cannula aria	ED-07
pinza iride	EC-15
pinza legature	ED-05
Tübingen TITAN	
pinza iride	EC-15
pinza legature	ED-05
Tubo	
BRUENINGS allungo	FC-03
BUIE di aspirazione	GI-05
JACKSON tracheale	FE-03
LUER tracheale	FE-03
WAGENER-MOSHER tracheale	FE-03
TUFFIER	
divaricatore costali	FG-16
pinza emostatica	BC-08
TURNBULL tronchesina per unghie	HE-03
TURREL pinza per biopsia	GI-05
TYDING	
pinza tonsille	FA-04
serranodi tonsille	FA-05
U	
UCKERMANN	
specillo	CA-03
trequarti tracheale	FE-02
ULRICH pinza per tamponi e spugne	BG-06
Uncinetto	EE-15
BARBARA	EE-14
DAY auricolare	EE-07
FRAZIER	BI-06
GILLIES	EG-17
GRAEFE	BI-06
GUTHRIE	BI-06
JOSEPH	BI-06
KILNER per pelle	HE-02
WAGENER auricolare	EE-07
Uncini EMMET per fistole	HA-46
Uncino	
ARRUGA	EC-06
BOSE tracheale	FE-02
BRAUN per detroncazione	HC-09
cava chiodi	DD-13
elettrodo mini	JA-02
GRAEFE per strabismo	EC-06
GRAEFE-TITAN per strabismo	EC-06
GREEN muscolare	EC-06
ITERSON tracheale	FE-02
JACKSON tracheale	FE-02
JAMESON per strabismo	EC-06
O' CONNOR per iris	EC-06
per estensione piccolo	DD-10
ROSE tracheale	FE-03
SMELLIE uncino ostetrico	HC-06
STEVENS per cristallino	EC-06
WIENER per iris	EC-06
Uncino PRATT cistico	GI-04
UNIVERSAL	
forbici bendaggi	AI-50
forbici filo metallo lamiera	AI-42
pinza per sterilizzazione	CI-02
trequarti	CC-02
UNNA tiracomedoni	HE-02
Uretrotomo OTIS	GG-08
Urinal	HE-10
USA	
cavo elettrobisturi	JA-07
USA MODEL forbici ombelicali	AI-34
USA	
pinza dissezione	BA-02
US Army (PARKER-LANGENBECK) divaricatore	BI-03
Uso bisturi, sterili	AG-10 lavorare a AG-11
V	
VALLEIX isterometro	HA-39
Valva	
BALFOUR centrale	BI-22
CASPAR	BI-20
CASPAR spina vertebrale	BI-19
KALLMORGEN vaginali	HA-15
KIRSCHNER per telaio	BI-23
KRISTELLER vaginali	HA-09 lavorare a HA-14
VAN BUREN	
candeletta dilatatrici	GG-13
pinza per sequestri	DC-10
Van DOREN pinza tagliente per biopsia	HA-42
VANNAS	
forbici iridectomia	AJ-05
forbici micro	AJ-12 lavorare a AJ-13
VARIFOCAL oftalmoscopio	AC-03
Vassoio	
per medicamento	HE-07
per strumenti	HE-08 lavorare a HE-09
VERBRUGGE tenaglia per ossa	DC-09
VERRES ago da punzione pneumoperitoneo	CC-03
Vienna specolo nasale	EG-02
VIRCHOW	
coltello per cartilagini	AG-18
coltello per il cervello	AG-18
divisore per craneo	DC-17
VIRTUS (RALK) pinza schegge	BA-06
VOLKMANN	
curetta tagliente	DC-12 lavorare a DC-13
divaricatore	BI-07 lavorare a BI-08
VOLTOLINI specolo nasale	EG-02
W	
WACHENFELDT pinza per agrafes	CG-07
WADSWORTH-TODD cauterio	EC-08
WAGENER-MOSHER tubo tracheale	FE-03
WAGENER uncinetto auricolare	EE-07
WAGNER	
forbici	AH-22
forbici gengivali	AI-42

pinza tagliente per laminectomia	.EA-09
WALDMANN forbici episiotomia	.AI-34
WALLICH curetta per placenta e per ovaie	.HC-08
WALSHAM pinza raddrizzare setto	.EG-18
WALTHER candeletta dilatatrici	.GG-17
WALTON	
sgorbia per corpi estranei	.EC-06
tiracomedoni	.HE-02
WALTON YANKAUER tubi d'aspirazione	.AE-03
WANGENSTEEN	
pinza dissezione	.BA-05
port'aghi	.CE-03
WARTENBERG sensimetro	.AC-08
WATSON-CHEYNE elevatore	.DC-22
WATSON dermatomo	.AG-22
WEBER	
ansa	.EC-08
pinza atraumatica	.BD-12
WECKER	
forbici tendini	.AJ-04
spatola iride	.EC-08
WEEK blefarostato	.EC-02
WEIL-BLAKESLEY pinza tagliente nasale	.EG-06
WEISSBARTH specolo vaginali	.HA-22
WEISS pinza serratubi	.BC-19
WEITLANER divaricatore	.BI-14
WEITLANER-WULLSTEIN divaricatore	.BI-14
WELLS spatola enucleaciona	.EC-08
WERTHEIM-CULLEN pinza isterectomia	.BC-18
WERTHEIM	
forbici preparazion	.AI-32
pinza isterectomia	.BC-18
WESTCOTT	
forbici iridectomie	.AJ-02
forbici tendini	.AJ-02
WESTON pinza polipus rettali	.GI-05
WEST	
scalpello nasale	.EG-14
sgorbia nasale	.EG-14
WHEELER	
coltello per diszisione	.EC-04
spatola ciclodialis	.EC-09
WHITEHEAD apribocca	.EI-04
WHITE pinza tonsille	.FA-03
WIEDER abassalingua	.EI-02
WIENER (AUFRIEHT) raspa nasale	.EG-15
WIENER	
raspa per seno	.EG-15
uncino per iris	.EC-06
WIGMORE sega per gessi	.DA-02
WILDER	
ansa	.EC-08
dilatatore canale lacrimale	.EC-10
WILDE	
serranodi	.EG-09
serranodi auricolare	.EE-07
WILDE (TROELTSCH) pinza auricolare	.EE-07
WILLET-MARTELL pinza cuoio capelluto	.BC-08
WILLIAMS	
blefarostato	.EC-02
giraviti	.DD-14
pinza per afferrare tessuti	.GE-03
WILLIGER	
curetta tagliente	.DC-13
martello	.DC-18
periostotomo	.DC-19
WINKELMANN strumento per circoncisione	.GG-09
WINTER pinza per placenta e per ovale	.HC-07
WITTNER pinza tagliente per biopsia	.HA-43
WOLFF pinza per gessi	.DA-04
WRIGLEY forbici ostetriche	.HC-02

WULLSTEIN	
coltello falciforme	.EE-14
forbici auricolari micro	.EE-11
forbici auricolari micro mini	.EE-11
WYLIE	
dilatatore uterini	.HA-30
pinza atraumatica	.BD-21

Y

YANKAUER	
specolo nasofarins	.EG-04
tubi d'aspirazione	.AE-02
YASARGIL forbici micro	.AJ-10 lavorare a AJ-11
YEOMAN pinza per biopsia	.GI-05
YOUNG Boomerang ago per legature	.CG-03
YOUNG	
divaricatore per prostata	.GG-02
pinza per afferrare la prostata	.GG-02
pinza tiralingua	.EI-03

Z

ZAUFAL-JANSEN pinza sgorbia	.DC-04
ZENKER pinza dissezione e per legature	.BC-12
ZIEGLER	
blefarostato	.EC-03
coltello per capsulotomia	.EC-05
coltello per iridettomi	.EC-04
dilatatore canale lacrimale	.EC-10
specchio frontale	.AC-05



CM Instrumente GmbH
Gänsäcker 56
78532 Tuttlingen
Germany

Tel. +49 7462 20420-61
Fax +49 7462 20420-62
info@cm-instrumente.de
www.cm-instrumente.de