

FLEXTRONICS X

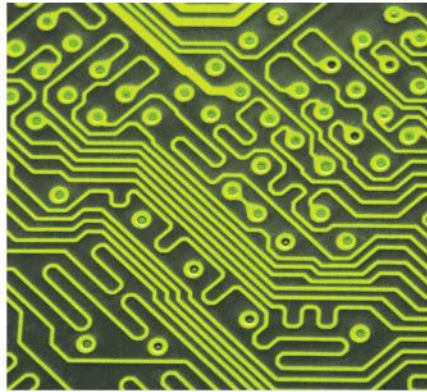
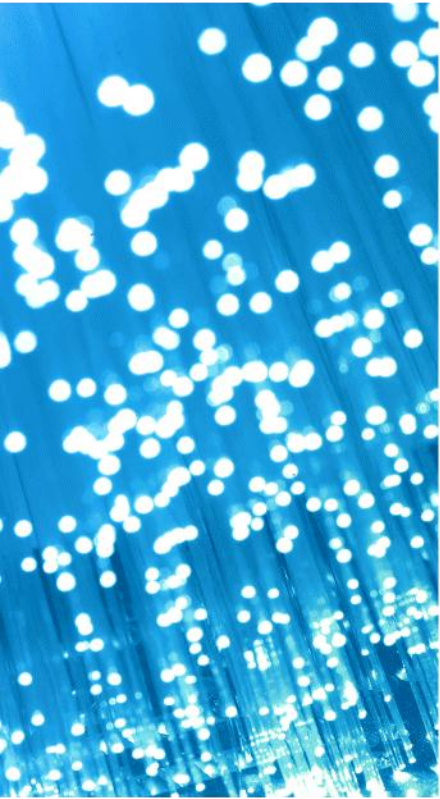

Application Of Build-in Self Test In Functional Test Of DSL

YaJun Gu, Ye Qin, ZhiJun Wang, David Wei, Andrew Ho, Stephen Chen, Zhen (Jane) Feng Ph. D., Murad Kurwa

No.77 Yong Sheng Road, Malu, Jiading, Shanghai, 201801, China

Summary

1. What is BIST

2. What is DSL

3. DSL test items

4. Digital & Analog DSL test

5. BIST on DSL

6. Comparison & Benefits

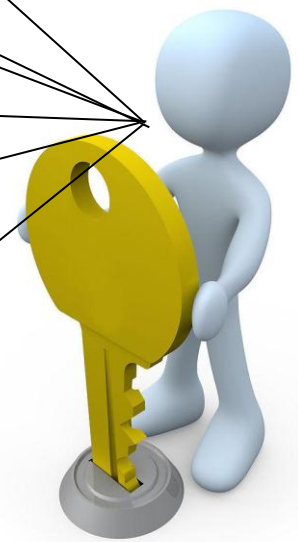

Acronym

BIST	Build-in Self Test
ATE	Automated Test Equipment
DRAM	Dynamic Random Access Memory
DFT	Design-for-Testability
ROM	Read Only Memory
DSL	Digital Subscriber Line
DSLAM	Digital Subscriber Line Access Multiplexer
ADSL	Asymmetric Digital Subscriber Line
ATM	Asynchronous Transfer Mode
DMM	Digital Multiplexer
GPIB	General-Purpose Interface Bus
ETH	Ethernet
UUT	Unit Under Test
IPC	Industrial Personal Computer
DSP	Digital Signal Processing
POTS	Plain Old Telephone Service
NTF	No Trouble Found
ISP	Internet Service Provider



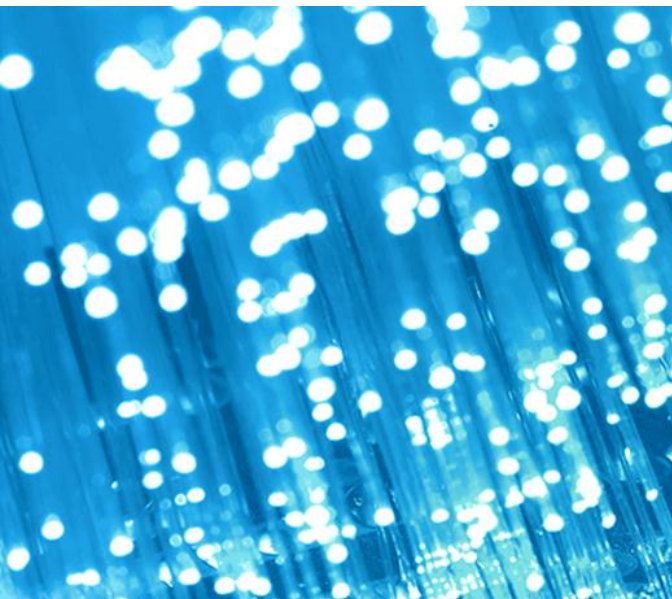

1. What is BIST?

BIST Introduction - 1



BIST (build-in self test) is the technique of designing additional hardware and software features into integrated circuits to allow them to perform self-testing, i.e., testing of their own operation (functionally, parametrically, or both) using their own circuits, thereby reducing dependence on an external automated test equipment (ATE).

BIST is a Design-for-Testability (DFT) technique, because it makes the electrical testing of a chip easier, faster, more efficient, and less costly. The concept of BIST is applicable to just about any kind of circuit, so its implementation can vary as widely as the product diversity that it caters to. As an example, a common BIST approach for DRAM's includes the incorporation onto the chip of additional circuits for pattern generation, timing, mode selection, and go-/no-go diagnostic tests.

BIST Introduction - 2

The main drivers for the widespread development of BIST techniques are the fast-rising costs of ATE testing and the growing complexity of integrated circuits. It is now common to see complex devices that have functionally diverse blocks built on different technologies inside them. Such complex devices require high-end mixed-signal testers that possess special digital and analog testing capabilities. BIST can be used to perform these special tests with additional on-chip test circuits, eliminating the need to acquire such high-end testers.

BIST is also the solution to the testing of critical circuits that have no direct connections to external pins, such as embedded memories used internally by the devices. In the near future, even the most advanced tester may no longer be adequate for the fastest chip, a situation wherein self-testing may be the best solution for it.

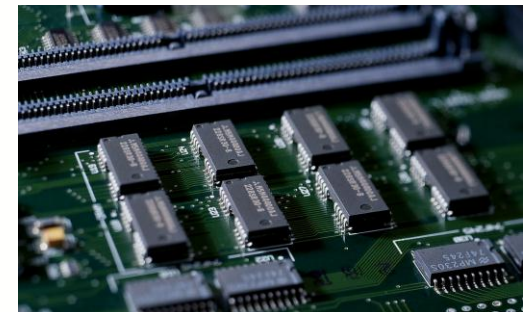

BIST Advantages & Disadvantages

Advantages :

1. Lower cost of test
2. Better fault coverage
3. Shorter test times
4. Easier customer support
5. Capability to perform tests outside the production electrical testing environment

Disadvantages :

1. Additional silicon area and fab processing requirements for the BIST circuits
2. Reduced access times
3. Additional pin (and possibly bigger package size) requirements
4. Possible issues with the correctness of BIST results

BIST Implementation

Issues that need to be considered when implementing BIST are:

1. Faults to be covered by the BIST and how these will be tested for
2. How much chip area will be occupied by the BIST circuits
3. External supply and excitation requirements of the BIST
4. Test time and effectiveness of the BIST
5. Flexibility and changeability of the BIST (i.e., can the BIST be reprogrammed through an on-chip ROM?)
6. How the BIST will impact the production electrical test processes that are already in place.

BIST is fast becoming an alternative solution to the rising costs of external electrical testing and increasing complexity of devices. This approach will find greater deployment in a wider variety of circumstances as more and better BIST techniques are developed

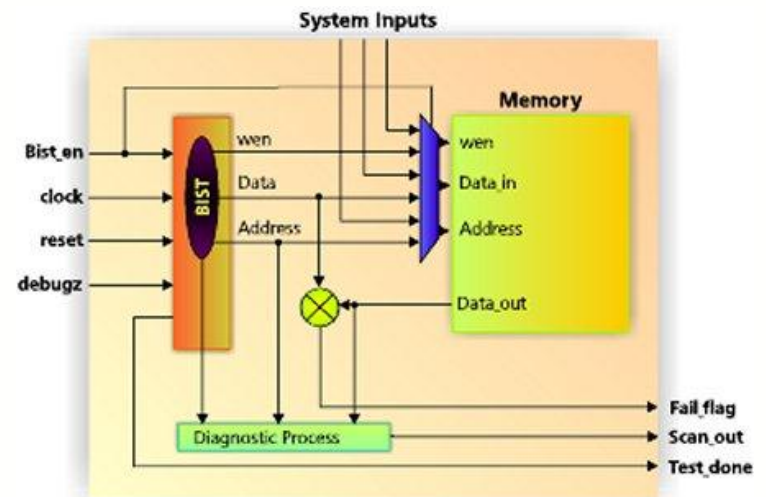

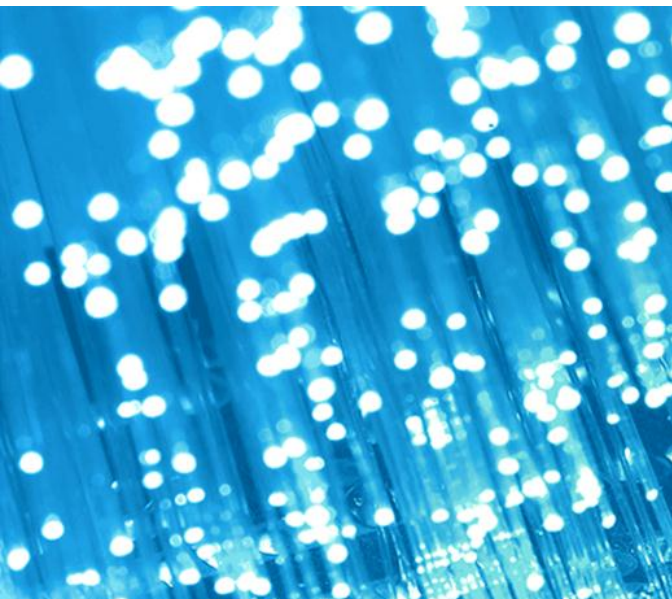

2. What is DSL?

DSL Introduction - 1

DSL (Digital Subscriber Line) is a telecommunications service that makes it possible to transform an ordinary phone line into a high-speed conduit for data, voice and video. As long as your home or business is close enough to your service providers central office (a local office with switching equipment which connects everyone in a certain area to the companies net-work), you'll be able to subscribe to DSL service. Typical connections allow users to receive data at 1.5 Mbps and send data at approximately 256 Kbps, though actual speed is determined by the proximity to the providers central office. DSL service is always on – users don't need to dial a connection to gain access to the Internet – and some services even allow users to use the same line for voice and data traffic.

Standard modem:



DSL:

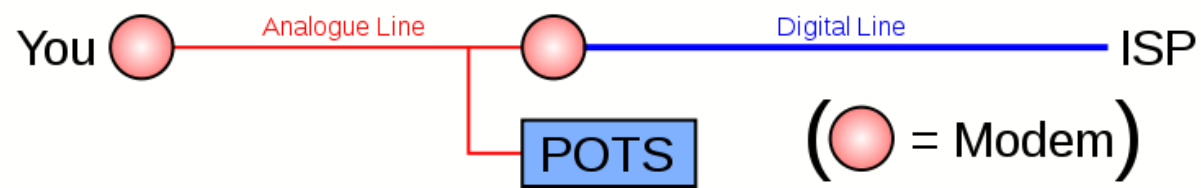

DSL Introduction - 2

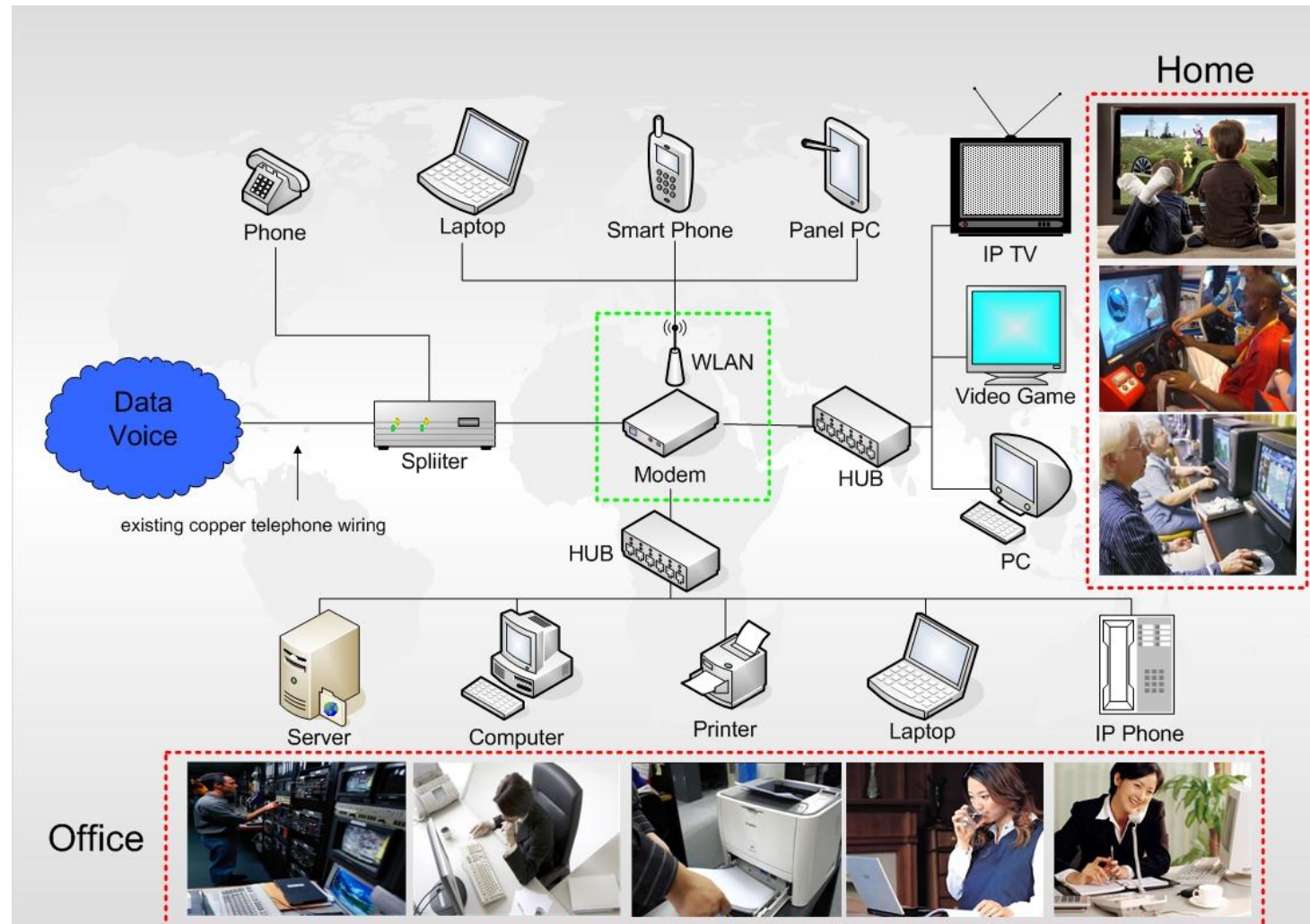

DSL Typical Setup

User terminal device is a DSL modem. Convert it into digital electrical pulse binary data, makes the signal in the digital audio streams within the transmission band. Also, if a user with an old-fashioned phone lines, you also need to install a passive electronic filter (a lot of it is called, "filter", "differentiator" or "splitter") (which may also help to improve the DSL terminal signal suppress the echo signal). This would ensure that the DSL modem and phone designed to use only receive their signal. line access multiplexer (DSLAM) will be gathering data on the DSL circuits and then forwarded to other network. It can also separate the voice part.

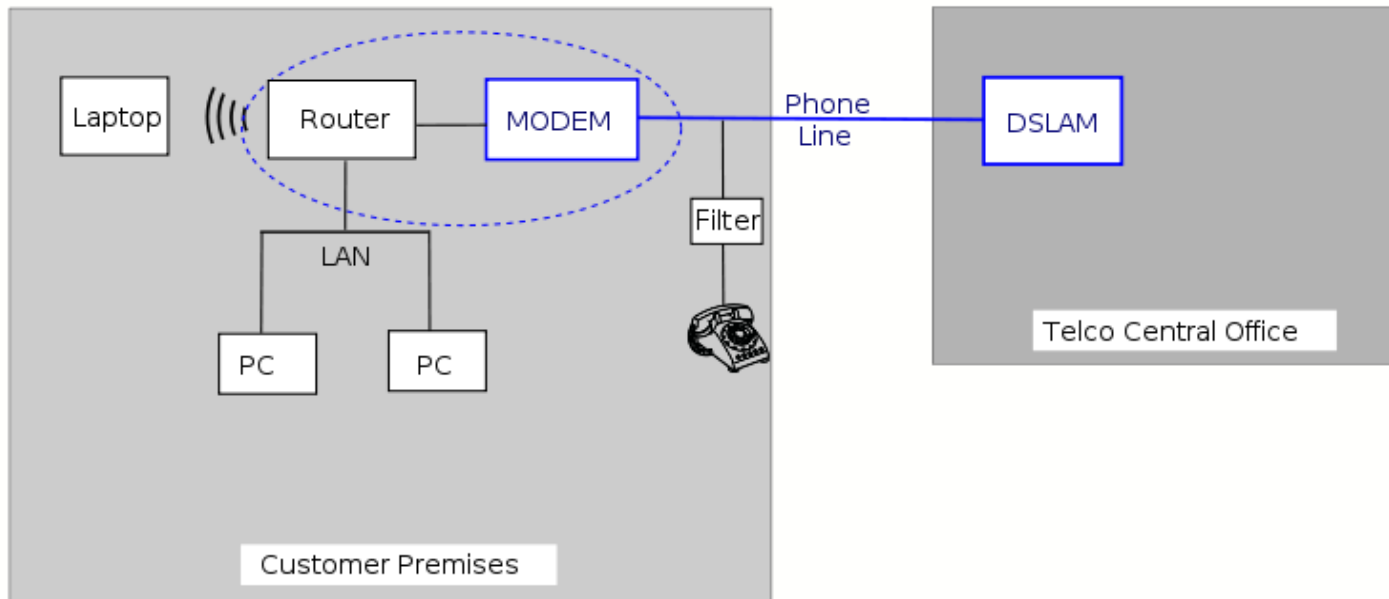

DSL Equipment

Exchange Equipment

At the exchange, a digital subscriber line access multiplexer (DSLAM) terminates the DSL circuits and aggregates them, where they are handed off onto other networking transports. In the case of ADSL, the voice component is also separated at this step, either by a filter integrated in the DSLAM or by a specialized filtering equipment installed before it. The DSLAM terminates all connections and recovers the original digital information.

Customer Equipment

The customer end of the connection consists of a terminal adaptor or "DSL modem". This converts data between the digital signals used by computers and the voltage signal of a suitable frequency range which is then applied to the phone line.

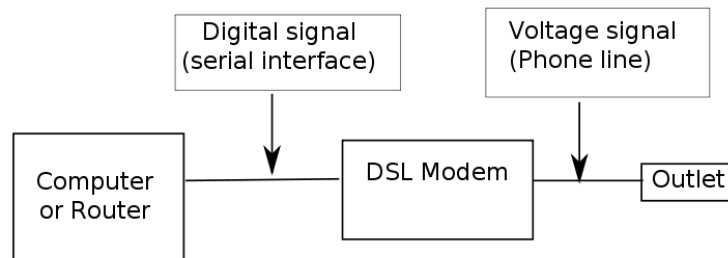

DSL Technologies

Digital Subscriber Line DSL has many different branches, and its often referred to as xDSL, more mature xDSL digital subscriber line options are ADSL, HDSL, SDSL and VDSL etc. But no matter what kind of xDSL, are achieved through a pair of modems, including a modem placed in the bureau (ISP), and another placed in the user modem

ADSL (Asymmetric Digital Subscriber Line), the volume of data flow is greater in one direction than the other.

HDSL (High Data Rate Digital Subscriber Line), was the first DSL technology that used a higher frequency spectrum of copper, twisted pair cables.

SDSL (Symmetric Digital Subscriber Line), the volume of data flow is equal in both directions.

VDSL (Very High Speed Digital Subscriber Line)

xDSL	Downstream	Upstream
HDSL	1.544 Mbps	1.544 Mbps
SDSL	1.568 Mbps	1.568 Mbps
ADSL	8 Mbps	1.1 Mbps
VDSL	55 Mbps	19.2 Mbps

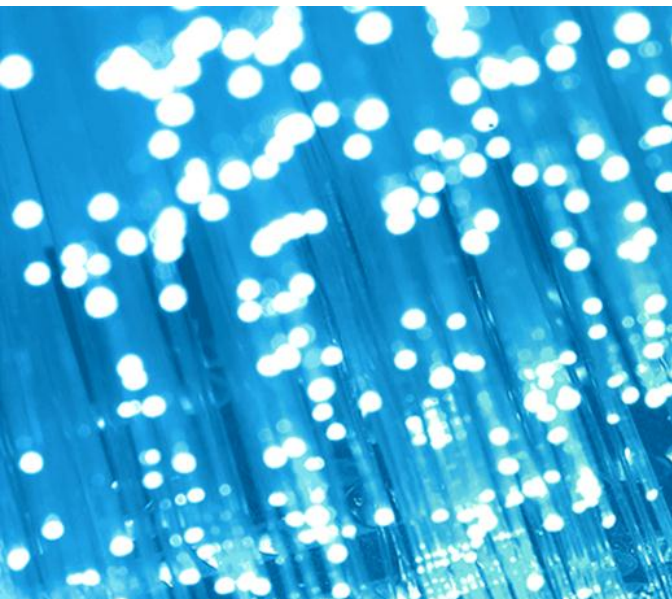

3. DSL Test Items

DSL Test Items

DSL service using existing copper resources to achieve high-speed data, voice and image transmission, and enhance the traditional operators in the data access advantages, moreover brings new challenges. As the ADSL transmission rate higher than the old-fashioned business of ordinary telephone subscriber lines so it needs a higher quality requirements.

For DSL access equipment, it requires test items as follows:

1. Loop voltage
2. Loop current
3. Ring voltage
4. VF measurements
5. Idle channel noise
6. Total Harmonic Distortion plus noise test
7. Digital loopback test
8. Analog loopback test
9. Data test



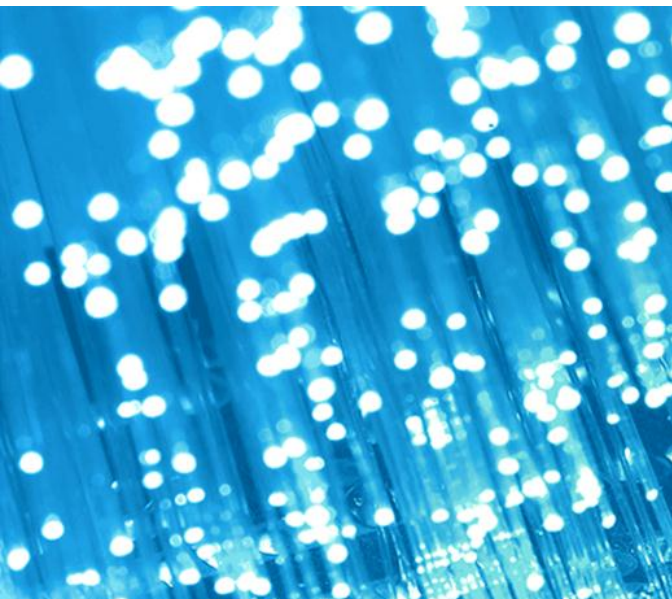

4. Digital & Analog DSL Test

Equipment

Traditional digital & analog DSL test requires external test instruments, such as modems, multiline production tester, loads, DC electronic load, performance analyzers, traffic generator, switches, DMMs, and power supplies.



Configuration

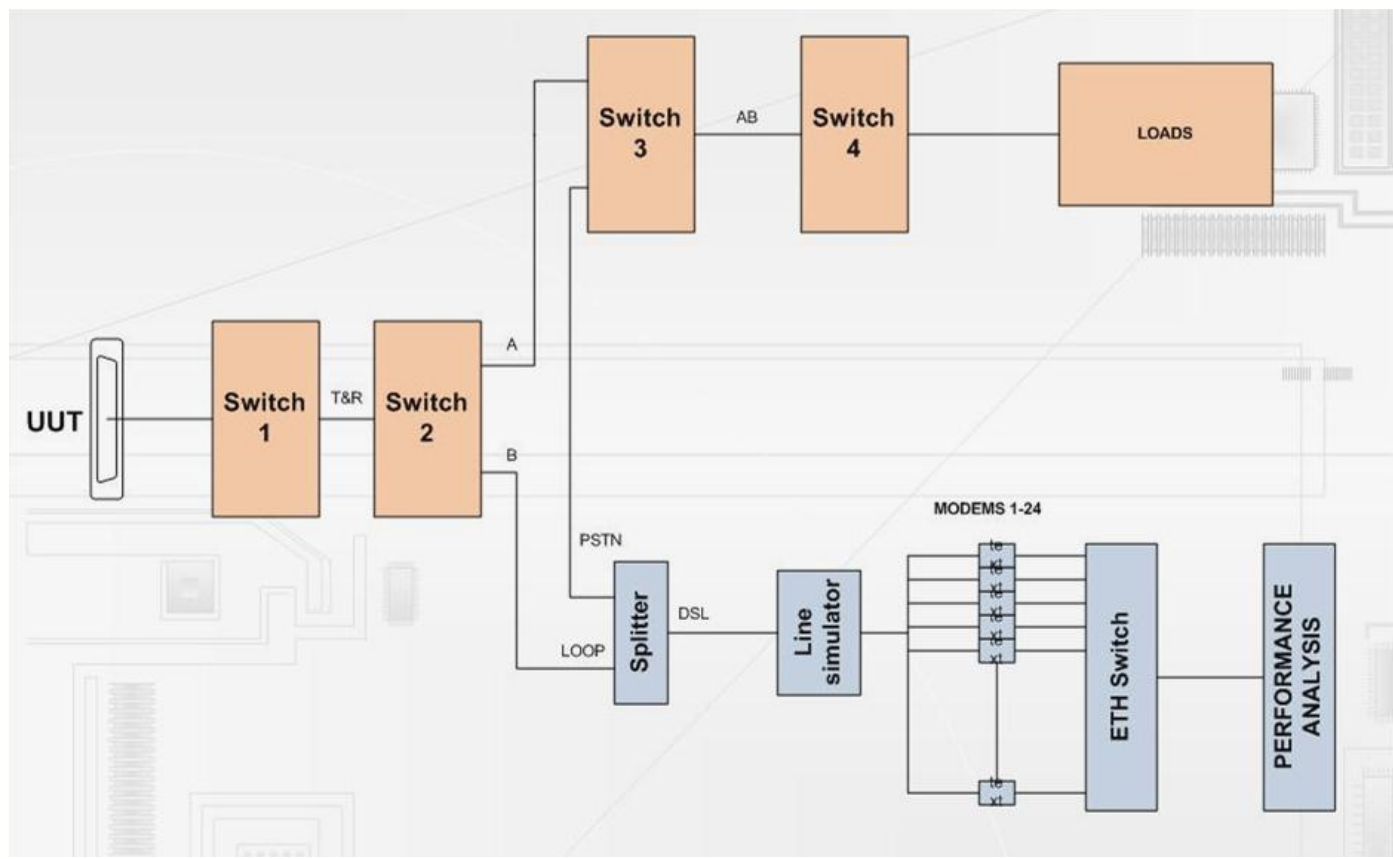

External test instruments are connected together through wire, and controlled by controller through GPIB, series or ETH, which is more easier to generate false reject.

Traditional DSL Test Station

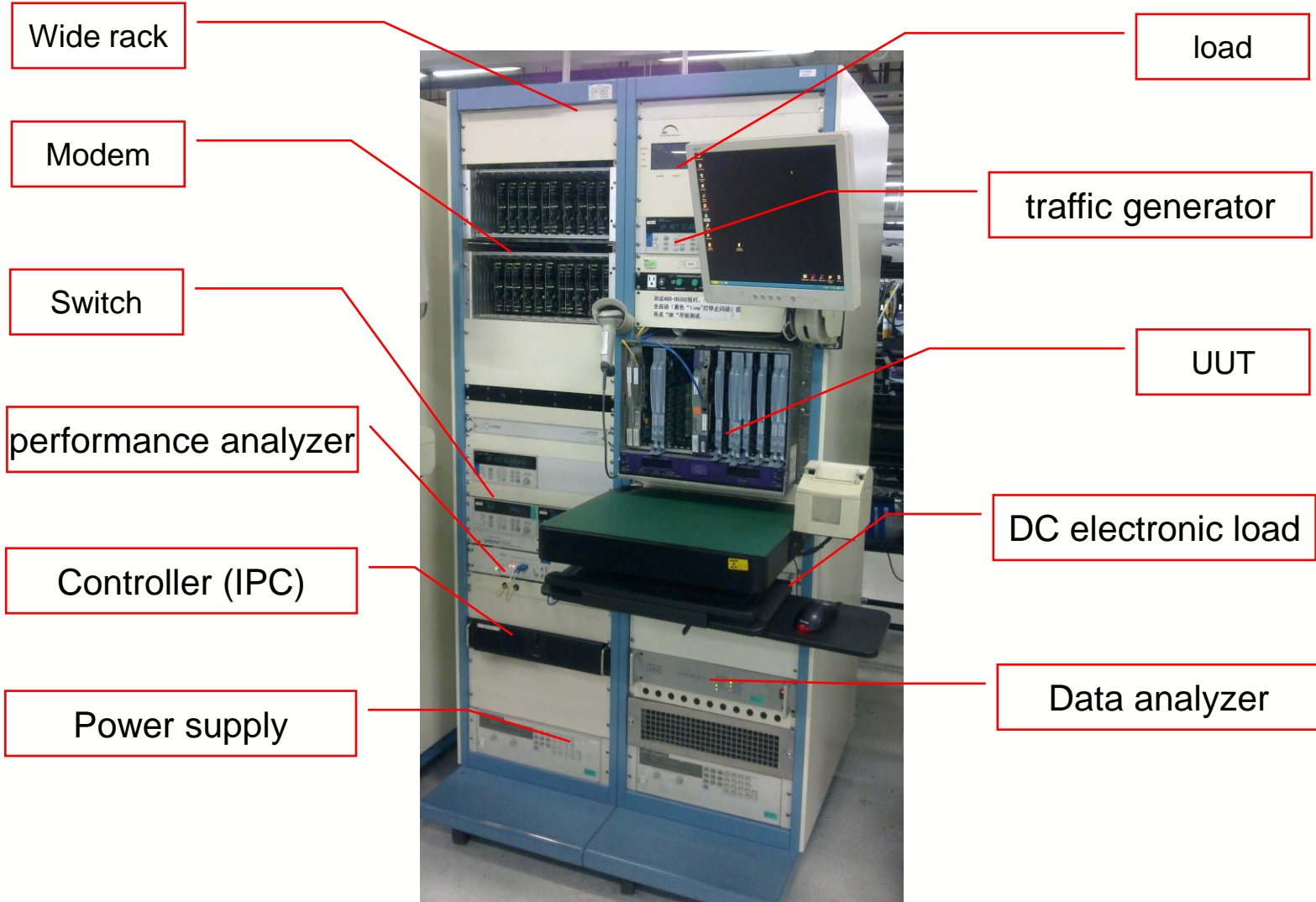

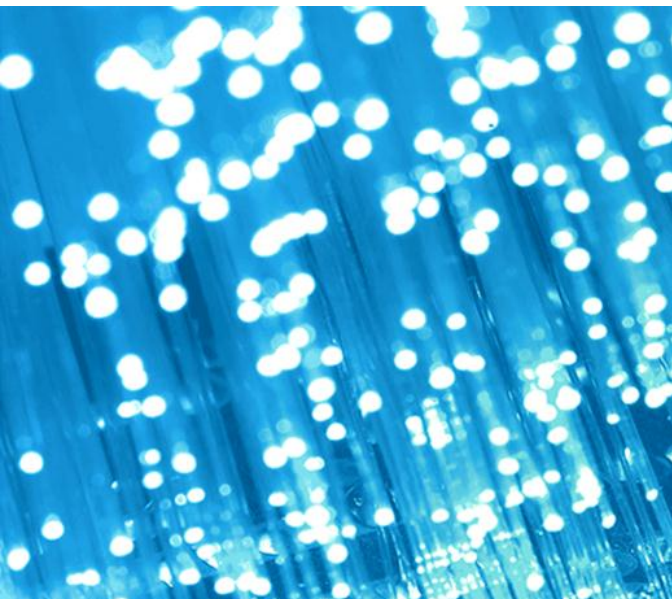

5. BIST on DSL

Application

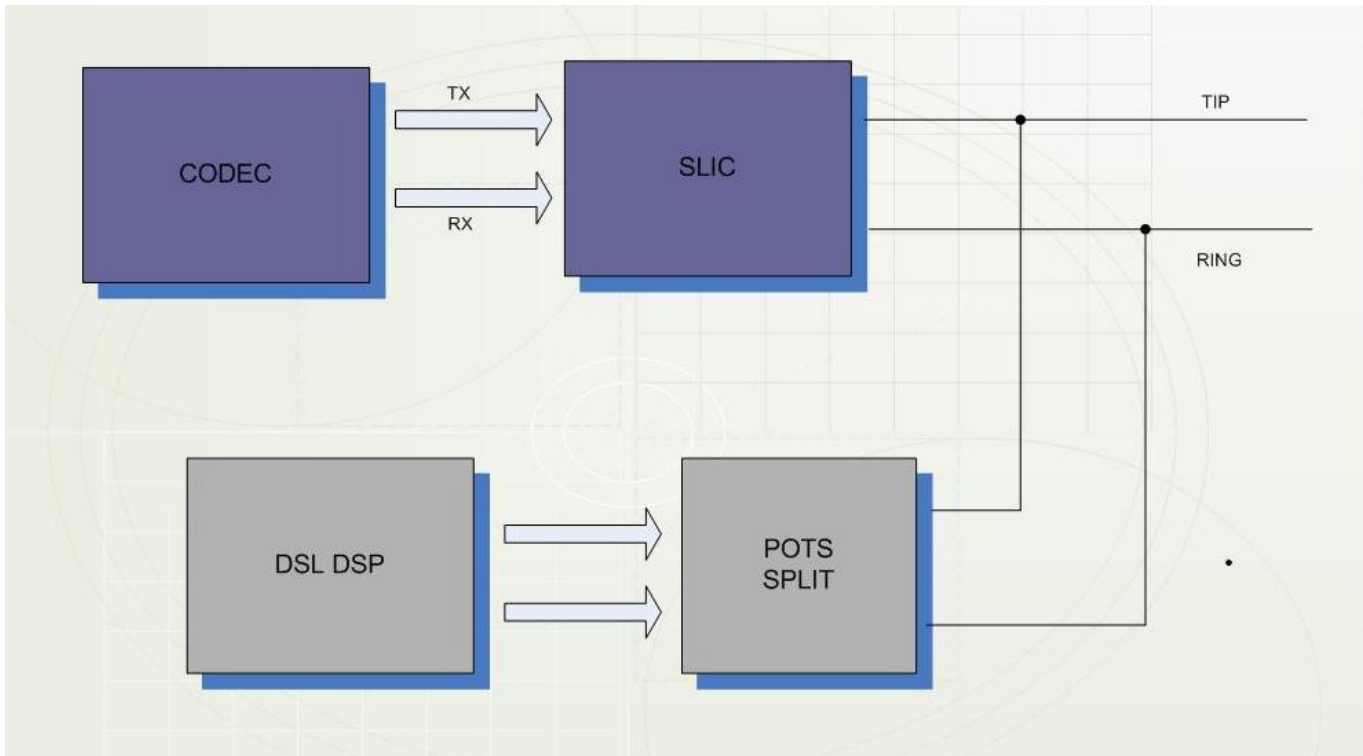

The figure above is a representation of the basic functional components. This refers to the DSL section (DSP and POTS) tests require that tip and ring be unterminated. The tip ring supply is a current source .

Configuration

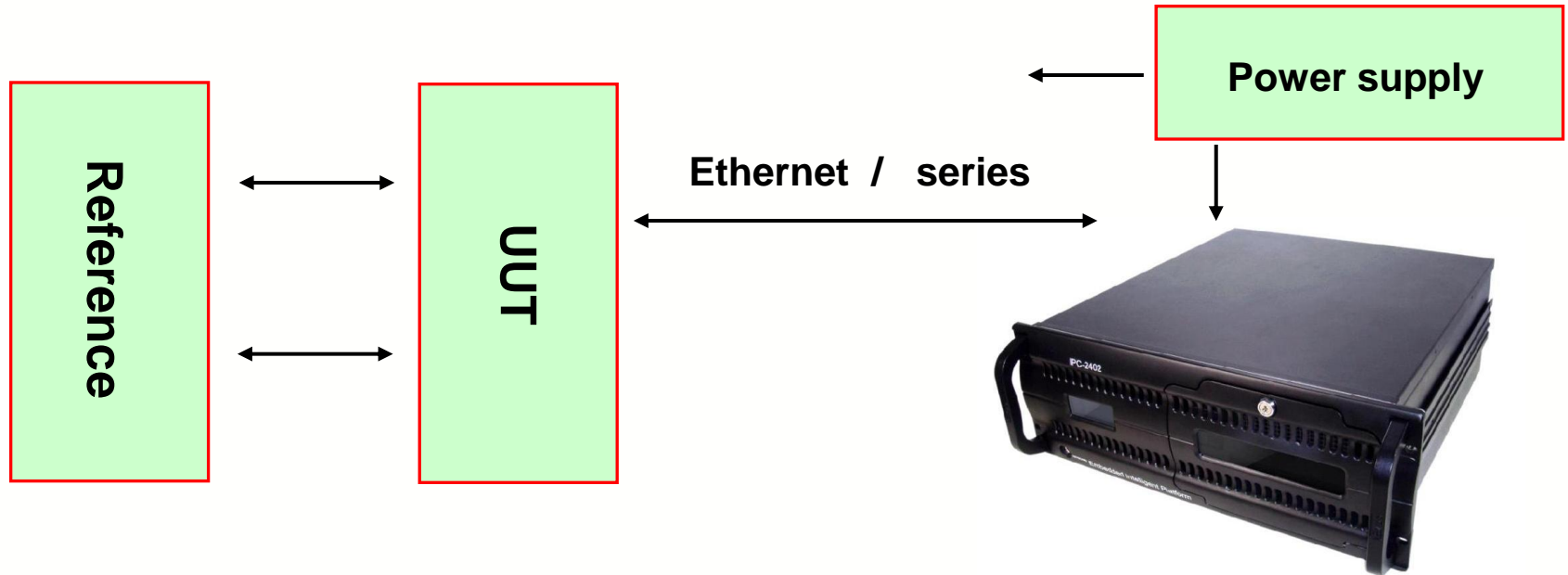

BIST for DSL test only requires power supply and IPC (industrial PC), reference unit provides BIST software support, so it needn't redesign UUT (unit under test) adding extra logic chips and memories; UUT performs shelf-test by getting controlled from IPC and download synchronous software from the reference unit.

BIST DSL Test Station

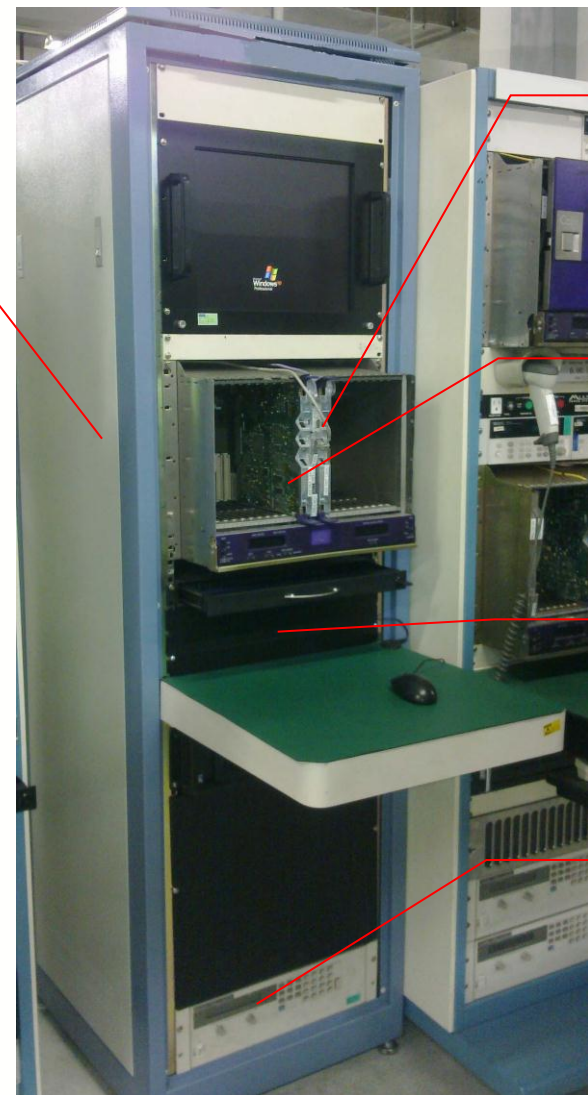

Single rack

UUT

Reference

Controller (IPC)

Power supply

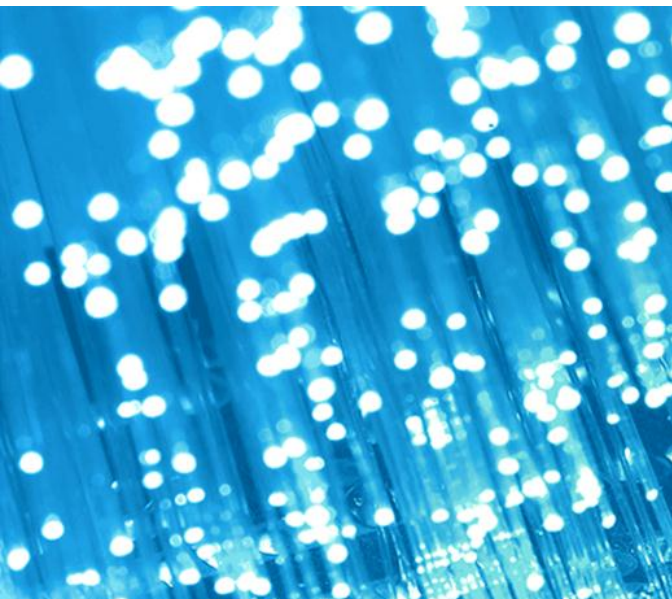

6. Comparison & Benefits

Comparison - 1

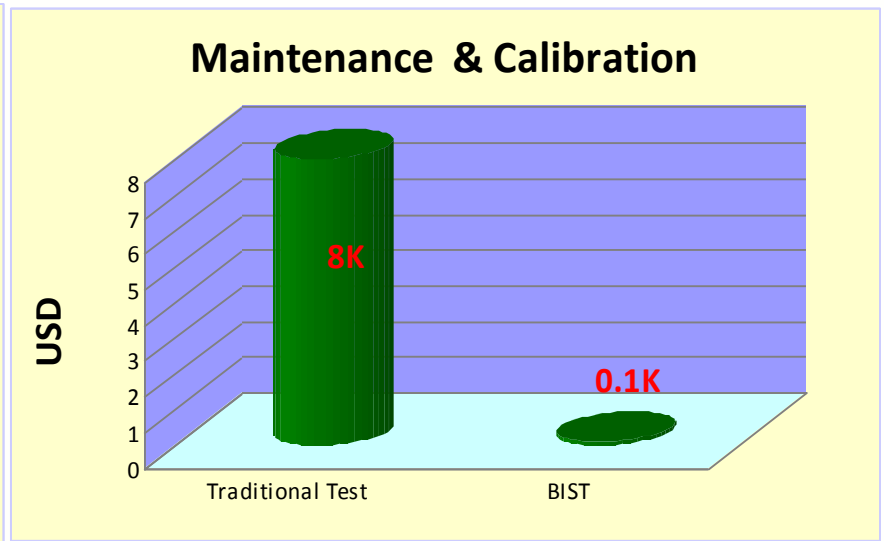
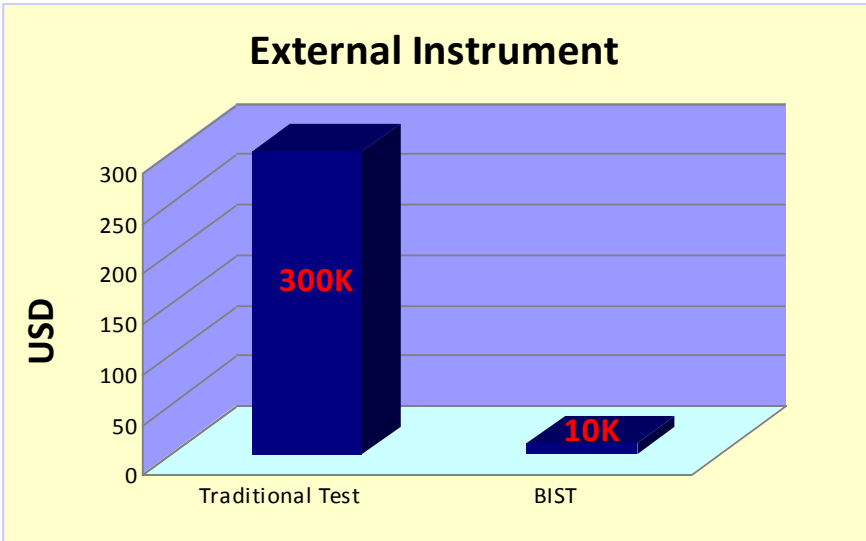

- The main purpose of BIST is to reduce the complexity, and thereby decrease the cost and reduce reliance upon external (pattern-programmed) test equipment.
- After experiments, BIST reduces cost in two ways
 1. External instrument cost is reduced from ~\$300K to ~\$10k
 2. For annual tester calibration and regular maintenance, the cost is decreased from ~8K to only \$0.1K

Comparison - 2

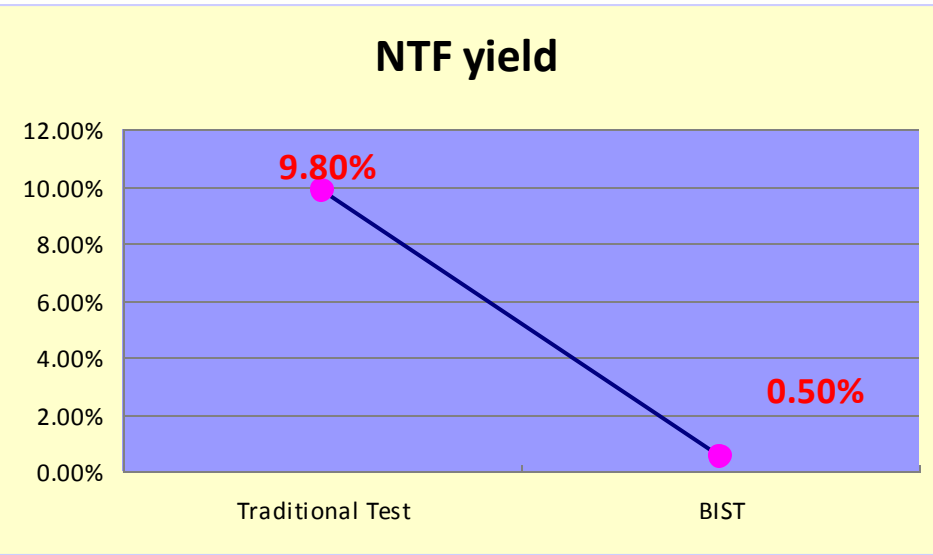
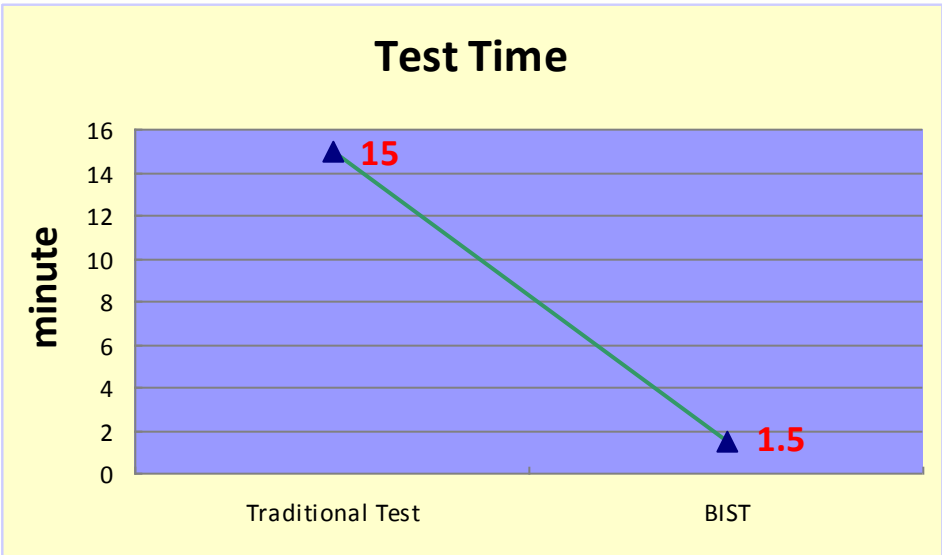

- The test cycle time are improved from ~ 15 min to 1.5 min;
- The NTF yield are reduced from ~9.80% to~ 0.50%.

Benefits

Item	Traditional Test	BIST	improvement
External Instrument	300K USD	10K USD	96.70%
Maintenance & Calibration	8K USD	0.1K	98.8%
Test Time	15 mins	1.5 mins	90.0%
NTF yield	9.80%	0.50%	94.9%

Overall, compared with traditional test, BIST test on DSL has the obvious superiority, It will be a good substitute for digital & analog test, for providing lower cost and higher Efficiency. Not only in DSL test, it also can be extended to optical and ETH test.

Acknowledgement

The authors would like to thank Flextronics Malu, China test team and Flextronics's customers for their help and great support.



Contact Information:

YaJun Gu

yj.gu@cn.flextronics.com

+86 (21) 39158389

We will continue to deliver!

FLEXTRONICS 

Thank you

