

PB22 | PB32

Mobile Label and Receipt Printer



User's Guide

Intermec Technologies Corporation

Worldwide Headquarters

6001 36th Ave.W.

Everett, WA 98203

U.S.A.

www.intermec.com

The information contained herein is provided solely for the purpose of allowing customers to operate and service Intermec-manufactured equipment and is not to be released, reproduced, or used for any other purpose without written permission of Intermec Technologies Corporation.

Information and specifications contained in this document are subject to change without prior notice and do not represent a commitment on the part of Intermec Technologies Corporation.

© 2009–2011 by Intermec Technologies Corporation. All rights reserved.

The word Intermec, the Intermec logo, Norand, ArciTech, Beverage Routebook, CrossBar, dcBrowser, Duratherm, EasyADC, EasyCoder, EasySet, Fingerprint, i-gistics, INCA (under license), Intellitag, Intellitag Gen2, JANUS, LabelShop, MobileLAN, Picolink, Ready-to-Work, RoutePower, Sabre, ScanPlus, ShopScan, Smart Mobile Computing, SmartSystems, TE 2000, Trakker Antares, and Vista Powered are either trademarks or registered trademarks of Intermec Technologies Corporation.

There are U.S. and foreign patents as well as U.S. and foreign patents pending.

Document Change Record

This page records changes to this document. The document was originally released as Revision 001.

Version Number	Date	Description of Change
004	5/2011	Revised battery information. Added procedures for configuring wireless network with PrintSet.
003	2/2011	Revised to to include correct information on how to load media, and how to load media for self-strip printing.
002	12/2010	Revised to add information for upgrading the firmware.

Contents

Before You Begin.....	ix
Safety Information.....	ix
Global Services and Support.....	ix
Warranty Information.....	ix
Web Support.....	ix
Telephone Support.....	x
Service Location Support.....	x
Who Should Read This Manual.....	x
Related Documents.....	xi

1 Using the PB22 and PB32 Mobile Label and Receipt Printer..... 1

Introducing the PB22 and PB32 Mobile Label and Receipt Printer.....	2
What's New.....	2
Features of the Printer.....	2
Identifying the Parts of the Printer.....	3
Understanding the Control Panel.....	4
Understanding the Printer Language.....	6
Changing the Printer Language.....	7
Understanding the Printer Sounds.....	10
Understanding the Backlight.....	10
Using the Batteries.....	11
Installing the Battery.....	12
Charging the Batteries.....	13
Understanding the Battery Icons.....	13
Extending Battery Life.....	14
Loading Media.....	15
Printing on Floodcoated Media.....	19
Understanding the Display Modes.....	20
Understanding Ready Mode.....	20
Understanding Information Mode.....	20
Understanding Pause Mode.....	21
Understanding Setup Mode.....	21
Understanding Error Mode.....	23
Understanding Test Mode.....	23
Changing Configuration Settings From the Display.....	25

Contents

Printing a Test Page	26
2 Configuring the PB22 and PB32	29
Connecting the Printer to Your PC	30
Connecting the Printer Through the USB Interface	30
Connecting the Printer Through the Serial Port	31
Connecting the Printer to Your Network	33
Setting Up Bluetooth Communications	33
Setting Up 802.11 Radio Communications	34
Configuring Wireless Printing Using IPL	38
Configuring Wireless Printing Using Fingerprint	40
Configuring the Printer Settings	42
Changing Configuration Settings From PrintSet	43
Changing Configuration Settings Using the Command Line	43
Changing Configuration Settings From the Printer Home Page	44
Changing Configuration Settings Using SmartSystems Foundation	45
Upgrading the Firmware	45
Upgrading the Printer Firmware Using PrintSet	45
Upgrading the Printer Firmware Using the Printer Home Page	47
Upgrading Printer Firmware Using SmartSystems Foundation	50
Upgrading the Printer Firmware Using a Communications Program	51
Downloading Fonts and Graphics	54
3 Troubleshooting and Maintaining the PB22 and PB32	55
Troubleshooting the Printer	56
Contacting Product Support	56
Understanding Error Messages	56
Troubleshooting Printer Problems and Finding Solutions	58
Troubleshooting Communication Problems	60
Using the Line Analyzer in Fingerprint	60
Using Dump Mode in IPL	61
Resetting the Printer	62
Cleaning the Printer	62
Cleaning the Printhead	63
Cleaning the Platen Roller	64
Cleaning the Printer Exterior	64

Cleaning the Printer Media Compartment	64
A Specifications	67
Specifications	68
Interfaces	71
RS-232 Serial Interface	72
USB Interface	73
Accessories	74
B Default Settings	77
Factory Default Settings (Fingerprint Printers)	78
Factory Default Settings (IPL Printers)	79
Factory Default Settings (ESC/P Printers)	80
C IPL and Fingerprint Setup Menus	83
IPL Setup Menu	84
Fingerprint Setup Menu	85
I Index	87

Contents

Before You Begin

This section provides you with safety information, technical support information, and sources for additional product information.

Safety Information

Your safety is extremely important. Read and follow all warnings and cautions in this document before handling and operating Intermec equipment. You can be seriously injured, and equipment and data can be damaged if you do not follow the safety warnings and cautions.

This section explains how to identify and understand warnings, cautions, and notes that are in this document.



A warning alerts you of an operating procedure, practice, condition, or statement that must be strictly observed to avoid death or serious injury to the persons working on the equipment.



A caution alerts you to an operating procedure, practice, condition, or statement that must be strictly observed to prevent equipment damage or destruction, or corruption or loss of data.



Note: Notes either provide extra information about a topic or contain special instructions for handling a particular condition or set of circumstances.

Global Services and Support

Warranty Information

To understand the warranty for your Intermec product, visit the Intermec web site at www.intermec.com and click **Support > Returns and Repairs > Warranty**.

Web Support

Visit the Intermec web site at www.intermec.com to download our current manuals (in PDF). To order printed versions of the Intermec manuals, contact your local Intermec representative or distributor.

Before You Begin

Visit the Intermec technical knowledge base (Knowledge Central) at www.intermec.com and click **Support > Knowledge Central** to review technical information or to request technical support for your Intermec product.

Telephone Support

In the U.S.A. and Canada, call **1-800-755-5505**.

Outside the U.S.A. and Canada, contact your local Intermec representative. To search for your local representative, from the Intermec web site, click **About Us > Contact Us**.

Service Location Support

For the most current listing of service locations, go to www.intermec.com and click **Support > Returns and Repairs > Repair Locations**.

For technical support in South Korea, use the after service locations listed below:

AWOO Systems

102-1304 SK Ventium

522 Dangjung-dong

Gunpo-si, Gyeonggi-do Korea, South 435-776

Contact: Mr. Sinbum Kang

Telephone: +82-31-436-1191

E-mail: mjyun@awoo.co.kr

IN Information System PTD LTD

6th Floor

Daegu Venture Center Bldg 95

Shinchun 3 Dong

Donggu, Daegu City, Korea

E-mail: jmyou@idif.co.kr or korlim@gw.idif.co.kr

Who Should Read This Manual

This user's guide is for the person who is responsible for installing, configuring, and maintaining the PB22 and PB32 printer.

This guide provides you with information about the features of the PB22 and PB32, and how to install, configure, operate, maintain, and troubleshoot it.

Related Documents

This is a list of related Intermec documents.

- *Intermec Fingerprint Command Reference Manual*
- *Intermec Fingerprint Developer's Guide*
- *Intermec Printer Language (IPL) Developer's Guide*
- *ESC/P Programmer's Reference Manual*
- *ZSim Programmer's Guide*

The Intermec web site at www.intermec.com contains our documents (as PDF files) that you can download for free.

To download documents

- 1** Visit the Intermec web site at www.intermec.com.
- 2** Click the **Products** tab.
- 3** Using the **Products** menu, navigate to your product page. For example, to find the PB22 product page, click **Printers and Media** > **Mobile Printers** > **PB22**.
- 4** Click the **Manuals** tab.

If your product does not have its own product page, click **Support** > **Manuals**. Use the **Product Category** field, the **Product Family** field, and the **Product** field to help you locate the documentation for your product.

Before You Begin

1

Using the PB22 and PB32 Mobile Label and Receipt Printer

Use this chapter to familiarize yourself with the PB22 and PB32 mobile label and receipt printer. In this chapter you will find these sections:

- **Introducing the PB22 and PB32 Mobile Label and Receipt Printer**
- **Features of the Printer**
- **Using the Batteries**
- **Loading Media**
- **Printing on Floodcoated Media**
- **Understanding the Display Modes**
- **Printing a Test Page**

Introducing the PB22 and PB32 Mobile Label and Receipt Printer

The PB22 and PB32 is a rugged mobile label and receipt printer that is designed for use with Intermec mobile computers, Intermec vehicle mount computers, and the SF51 and SR61 scanners. The PB22 uses 50.8 mm (2 in) media and the PB32 uses 76.2 mm (3 in) media.

The PB22 and PB32 provides:

- a print resolution of 203 dpi.
- print speeds of up to 101.6 mm per second (4 ips).
- 802.11 b/g or Bluetooth radio options.



Note: Unless otherwise noted, this manual uses the term “printer” to refer to both the PB22 and PB32 printers.

What’s New

This document was revised to include correct information on how to load media, and how to load media for self-strip printing.

Features of the Printer

Use this section to understand how to use the printer. This section contains information about the:

- parts of the printer.
- control panel.
- printer language.
- printer sounds.

Identifying the Parts of the Printer

Use this illustration to familiarize yourself with some of the features of the printer.

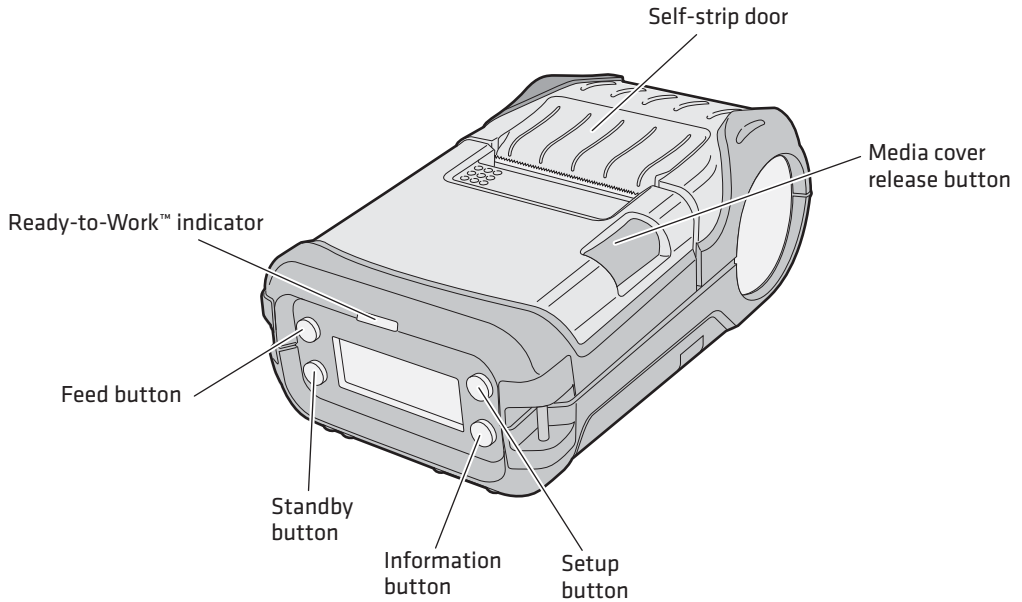

PB22 and PB32 : This illustration shows the important features of the printer. A weather-resistant flap protects the communications ports and the external power connector.

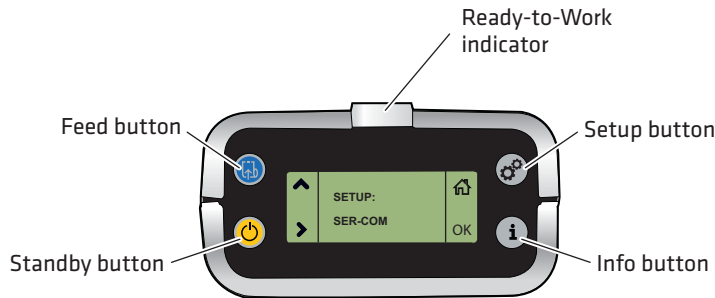

Understanding the Control Panel

The printer control panel contains four buttons, a liquid crystal display (LCD), and one LED indicator. Use the four buttons to navigate the menu system and perform functions on the printer. See the following tables to understand the buttons, the menu system, and what the LED means.



Printer Control Panel

Understanding How to Use the PB22 and PB32 Buttons









Button Name	Button	Function
Feed		Press to advance the media. The amount of media that feeds is dependent on the type of media you are using. It will advance by 5 mm (0.2 inch), or feed a configured length of media based on your media and settings. If the printer is printing, pressing this button causes the printer to pause. Press the button again to resume printing.
Setup		Press to display the Setup menu. With ESC/P firmware, press and hold to cancel printing.
Standby (Power)		Press to put the printer in Standby mode. In Standby mode, power to the radio, the display, and the backlight are turned off. Press to turn the printer back on and put in Ready mode.

Understanding How to Use the PB22 and PB32 Buttons (continued)

Button Name	Button	Function
Info		<p>Press to display a summary of network connection information and error conditions. Each setting in the summary information displays on the screen for five seconds.</p> <p>In Fingerprint and IPL, press this button in Pause mode to cancel the print job. The info button is not functional with ESC/P.</p>

All of the buttons can act as “soft keys,” which means that the function of each button depends on the state of the printer. A small icon appears in the screen next to the button to indicate the function it performs.

Understanding the Soft Keys

Button	Soft Keys	Description
		<ul style="list-style-type: none"> Moves up one level in the menu system. This soft key appears in Setup mode.
		<ul style="list-style-type: none"> Increases the value of a number when editing settings such as an IP address. This soft key appears in Setup mode.
		<ul style="list-style-type: none"> Pauses the printing job. This icon appears only when you are printing.
		Exit Setup mode and return to Ready mode.
		Moves through the settings at the same level in the menu system.
	OK	<ul style="list-style-type: none"> Moves down one level in the menu system and saves changes to a setting.
		<ul style="list-style-type: none"> Exits a printing job or exits Information mode.

There is only one LED on the printer: the Ready-to-Work™ indicator.

Understanding the Ready-to-Work Indicator

Indicator State	Description
Off	One of several conditions: <ul style="list-style-type: none">• The printer is in Standby mode.• The printer is in Info mode.• The printer is in Setup mode.
On	The printer is turned on and operating.
Blinking	One of several conditions: <ul style="list-style-type: none">• The printer is out of paper.• The media cover is open.• There is a printer error that requires you to perform an action. For a list of possible problems, see “Troubleshooting the Printer” on page 56.

Understanding the Printer Language

Your printer comes with Intermec Printer Language (IPL), Fingerprint, ESC/P, ZSim, and the ability to run any one of the printer languages. The language you choose affects the functionality of the printer and how you interact with it. This manual contains information for using the different types of printer language.

When the printer is shipped from the factory, the first person to turn on the printer will have the option of choosing which printer language to run on the printer. The language you select automatically runs each time you turn on your printer.

To select the printer language on first use

- Press the appropriate button to choose a language.

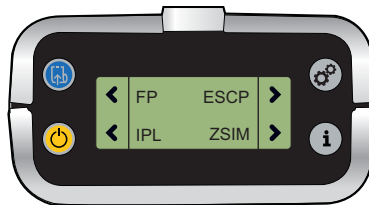

The current firmware type and version display on the printer screen when the printer is in Ready mode.

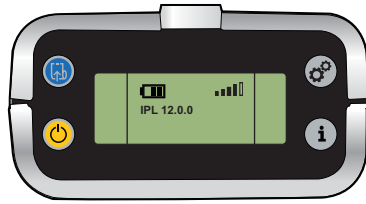

The Screen of a PB22 and PB32 Running IPL Firmware

Changing the Printer Language

The printer language you choose affects the functionality of the printer and how you interact with it. You can change the printer language using PrintSet, the printer home page, a communications program like HyperTerminal, or the printer display.

To change the printer language using PrintSet

- 1 Connect your printer to your PC using a serial cable. For help, see [“Connecting the Printer Through the Serial Port” on page 31.](#)
- 2 Open PrintSet. The Intermec PrintSet dialog box appears.
- 3 Under My Printers, click the printer you want to work with.
- 4 Click **Printer > Language Wizard**. The Language Wizard appears.
- 5 Follow the prompts to change the printer language.

To change the printer language using Fingerprint and a communications program

- 1 Connect your printer to your PC using a serial cable. For help, see [“Connecting the Printer Through the Serial Port” on page 31.](#)
- 2 Start a communications program like HyperTerminal.
- 3 Send the enable administrator rights command:

```
run "su -p pass admin
```
- 4 Send the run command to change the printer language:

```
setlanguage IPL -r
```

To change the printer language using IPL and a communications program

- 1 Connect your printer to your PC using a serial cable. For help, see **“Connecting the Printer Through the Serial Port” on page 31.**
- 2 Start a communications program like HyperTerminal.
- 3 Send the enable administrator rights command:
`<STX><ESC>.y, su -p pass admin <ETX>`
- 4 Send the run command to change the printer language:
`<STX><EXC> .y,setlanguage FP -r<ETX>`

To change the printer language using ESC/P and a communications program

- 1 Connect your printer to your PC using a serial cable. For help, see **“Connecting the Printer Through the Serial Port” on page 31.**
- 2 Start a communications program like HyperTerminal.
- 3 Enter U-shell. Press the ESC key and type:
`{SYS:USH}`
- 4 Send the enable administrator rights command:
`su -p pass admin`
- 5 Send the run command to change the printer language:
`setlanguage IPL -r`

To change the printer language using the display and Fingerprint

- 1 Press the **Setup button**. The Setup menu system appears.
- 2 Press **➤** until you reach **Print Defs**.
- 3 Press **OK** to enter the Print Defs menu system.
- 4 Press **➤** until you reach **CMD Language**.
- 5 Press **OK** to enter the CMD Language menu system.
- 6 Press **➤** until you see the language of you want to select.
- 7 Press **OK** to select the printer language.
- 8 Cold boot the printer:
 - a Remove the printer battery.
 - b Replace the printer battery.

- c** Turn the printer on.

To change the printer language using the display and IPL

- 1** Press the **Setup** button. The Setup menu system appears.
- 2** Press **▶** until you reach **Test/Service**.
- 3** Press **OK** to enter the Test/Service menu system.
- 4** Press **▶** until you reach **CMD Language**.
- 5** Press **OK** to enter the CMD Language menu system.
- 6** Press **▶** until you see the language you want to select.
- 7** Press **OK** to select the language.
- 8** Cold boot the printer:
 - a** Remove the printer battery.
 - b** Replace the printer battery.
 - c** Turn the printer on.

To change the printer language using the display and ESC/P

- 1** Make sure the printer is in Ready mode.
- 2** Turn the printer off.
- 3** Open the media door.
- 4** Press and hold the **Feed** and **Power** buttons until the display shows “Close Printer Door.”
- 5** Press **▶** until you reach **CMD Language**.
- 6** Press **OK**.
- 7** Press and hold the **Power** button until the different command languages scroll automatically.
- 8** Press **OK** to select the printer language. The printer reboots.

Understanding the Printer Sounds

The printer plays sounds in response to several actions that you can take with the printer. Use the following table to understand when the sounds occur and what they mean.

Understanding the Printer Sounds

Sound	Occurs When:
Power	<ul style="list-style-type: none">• You insert a battery in the printer.• The printer starts charging the battery.• You plug in the AC adapter.
Hardware	You open the media door, close the media door, or insert a cable.
Button	You press any of the buttons.
Error	<ul style="list-style-type: none">• The printer cannot feed paper or print a job because of a hardware issue such as the media door open, a paper jam, or there is no media.• An error occurs such as a paper jam, a print error, or the printer is out of range.

Understanding the Backlight

The screen backlight on the printer behaves the same way as a screen saver on your PC. After a set amount of time elapses without any user interaction, the backlight goes off. The screen backlight turns on when:

- the printer begins printing.
- you press a button.
- you connect the printer to external power.
- you are communicating with or sending data to the printer.

Use the Setup menu to change change the amount of time the backlight turns off. Options for backlight are always off, always on, 5 seconds, 10 seconds, 20 seconds, 30 seconds, or 60 seconds.

Using the Batteries

The printer uses a rechargeable 7.4 V 2300 (typical) mAh lithium-ion battery (Model AB27) for power. You must fully charge the battery before you can use the printer. The battery retains a charge for up to five days when the printer is in Standby mode.

A fully charged battery can usually print over 300 6-inch labels (PB32) or 500 6-inch labels (PB22) at 25% print density. When the printer reports low battery, it can usually print over 50 6-inch labels at 10% print density. The number of labels you can print varies with the:

- Age of the battery.
- Temperature and humidity of the operating environment.
- Printer configuration, including network connection settings.
- Type of media loaded in the printer.
- Amount of data printed for each label.
- Threshold at which you configure the low battery warning.



Use Intermec Model AB27 battery only. Use of another battery may present a risk of fire or explosion.

The Model AB27 battery may present a fire or chemical burn hazard if mistreated. Do not disassemble, heat above 100°C (212°F), or incinerate.

Dispose of used batteries promptly. Keep away from children.

Installing the Battery

Make sure you fully charge the battery before you use your printer. You can charge the battery before or after you install it into the printer.

To install the battery

- 1** Lay the printer upside down on a flat surface.
- 2** Insert the battery with the tab facing away from the front control panel.

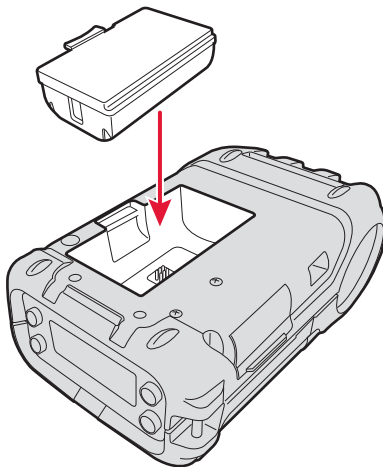

- 3** Insert the edge of the battery under the lip of the printer and then push down until you hear the battery latch click.

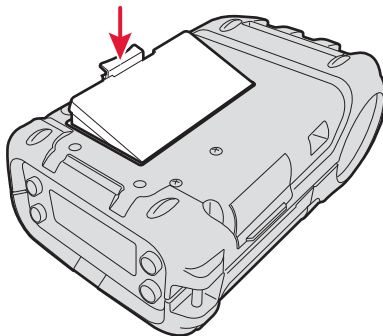

Charging the Batteries

There are two ways to charge the printer battery:

- Charge the battery in the AC18 4-bay battery charger. It takes approximately 4 hours to charge your batteries using the 4-bay battery charger. For information on charging your battery in the 4-bay battery charger, see the [AC18 4-Bay Battery Charger Instructions](#).
- Leave the battery in the printer and connect the printer to a 12 VDC power supply as described in the next procedure.

It takes approximately 3 hours to charge the battery while it is installed in the printer. To charge the battery inside the printer, you need:

- an Intermec 12 VDC power supply (Model AE19).
- an AC power cord.



To charge the battery inside the printer

- 1 Install the battery in the printer. For help, see the previous section, [“Installing the Battery” on page 12](#).
- 2 Connect the power supply to the DC power connector on the printer.
- 3 Connect one end of the power cord to the power supply and then plug the other end into an AC outlet.



Understanding the Battery Icons

The easiest way to tell the status of your battery is to look at the battery icons on the control panel of the printer.

Battery Icon Status

Icon	Status
	Battery is fully charged.
	Battery has a medium charge. You should be able to work for several more hours before charging or replacing the battery.
	Battery is low. Recharge the battery.

Battery Icon Status (continued)

Icon	Status
	Battery is critically low. You need to replace the battery now.
	Battery charging error. You may need to replace the battery.
	External power connected and there is no battery in the printer.

Extending Battery Life

Here are some tips for extending the overall life of your battery:

- Never expose the battery to direct sunlight or temperatures over 50°C (122°F).
- Only charge the battery inside the printer using a power supply or in the 4-bay battery charger (Model AC18).
- Do not set the backlight to always on. The always on setting disabled automatic power saving modes.

Here are some tips for extending the life of your battery between charges:

- Press the **Standby** button to put the printer in Standby mode.
- Remove the battery if you do not need to use the printer for three days or more.
- Do not operate the printer when the ambient temperature is -20°C (-4°F) or lower. Using the printer in temperatures below freezing reduces the overall battery life.

Remember that any rechargeable battery loses its ability to maintain a charge over time. You can only recharge it a finite number of times before you must replace it.

Loading Media

You can use roll or fanfold receipt media with the printer. The PB22 and PB32 ship with a test page printed to verify that the printer works. For information on media, see **“Specifications” on page 68**.

Additionally, the PB22 and PB32 also support self-strip printing. For more information on how to correctly load media for self-strip printing, see **“To load media for self-strip printing” on page 17**.

To load media

- 1 Press down on the blue media cover release button until the cover releases.

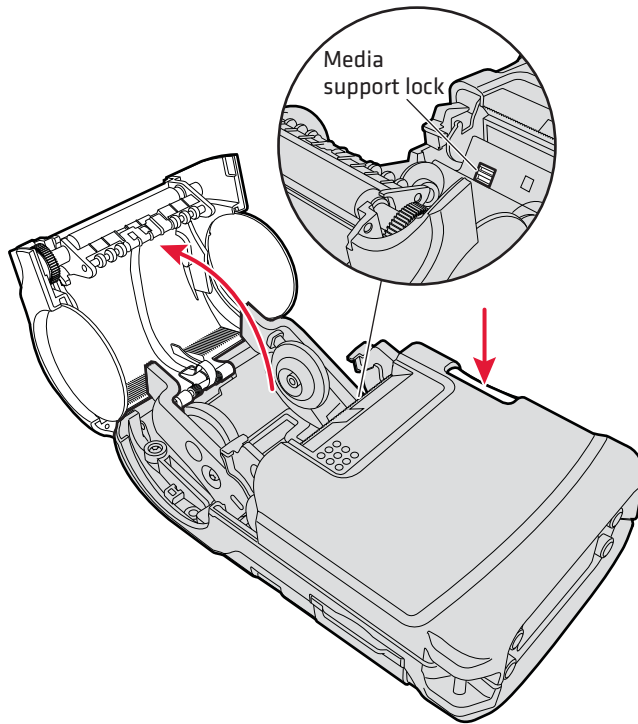

Chapter 1 – Using the PB22 and PB32 Mobile Label and Receipt Printer

- 2 If necessary, unlock the media support lock before sliding the two media supports apart.
- 3 Insert a roll of media and close the media supports so the roll is held firmly in place. Make sure you load the media clockwise so that it pulls off the core from the bottom of the printer.

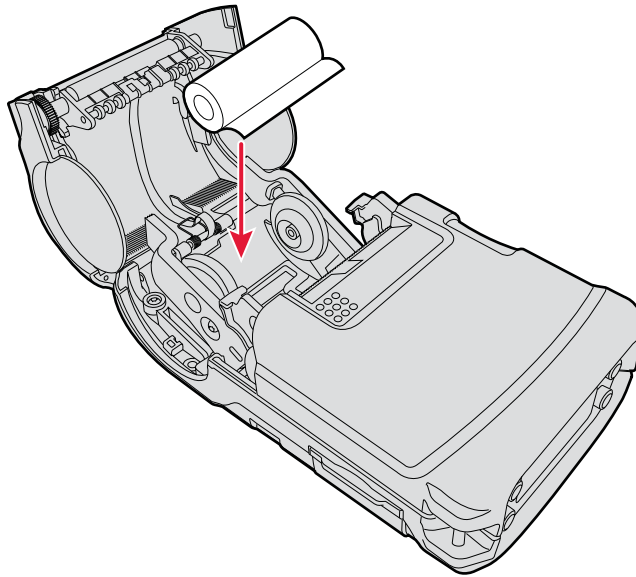

- 4 Lock the media support lock.



Note: The only time you need to unlock and lock the media support lock again is when you are changing to a roll with a different width.

- 5 Pull out approximately 8 cm (3 in) of the media.

- 6 Close the media cover until it latches.

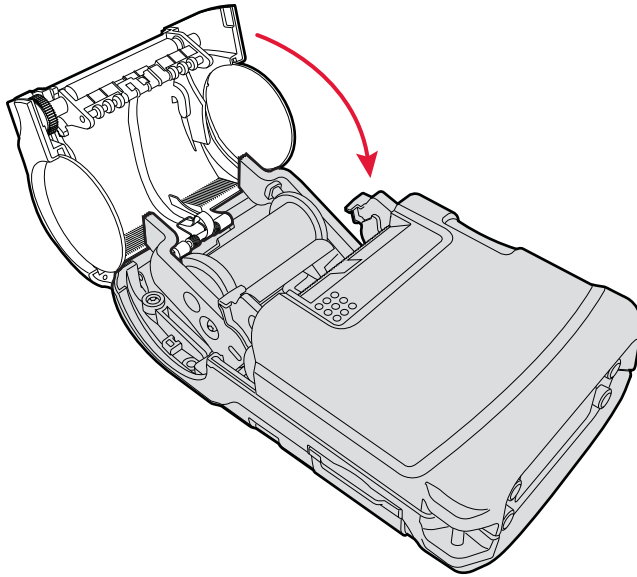

- 7 Press the **Feed** button to advance the media.

To load media for self-strip printing

- 1 Complete Steps 1 through 4 in the previous procedure.
- 2 Open the self-strip door in the media cover.

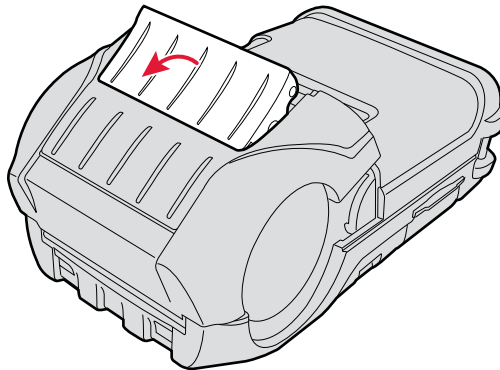

- 3 Remove a label from the roll of media so that you are left with several inches of label liner.

Chapter 1 – Using the PB22 and PB32 Mobile Label and Receipt Printer

- 4** Feed the label liner over the self-strip bar and out the back of the self-strip door.

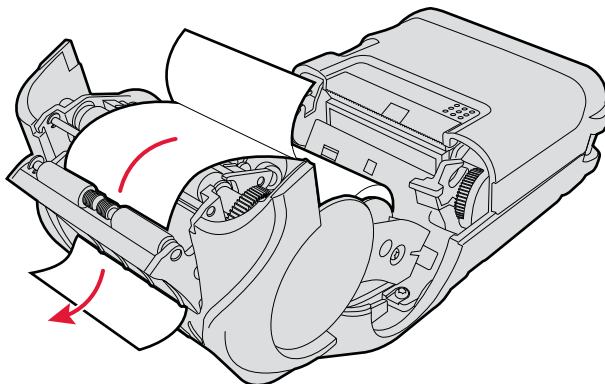

- 5** Close the media cover until it latches and press down on the self-strip door to make sure it locks. The separated liner and media spool from the self-strip mechanism.

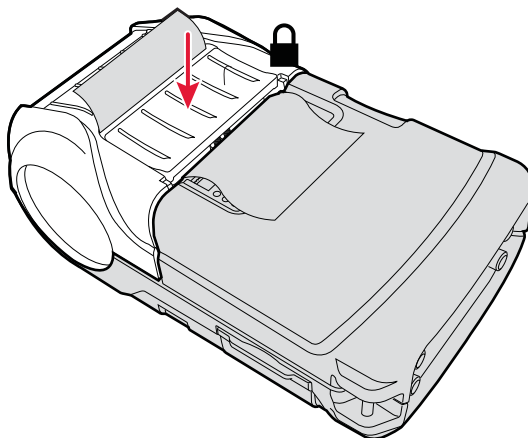

Printing on Floodcoated Media

If you are using colored media, also known as floodcoated media, you may need to adjust the settings to enable better printing.

To configure the printer to print on floodcoated media

- 1 Press the **Setup** button.
- 2 Press **➤** until you reach **Media**.
- 3 Press **OK** to enter the Media menu system.
- 4 Press **➤** until you reach **Advanced**.
- 5 Press **OK** to enter the Advanced menu system.
- 6 Press **➤** until you reach **Thermal Management**.
- 7 Press **OK** to enter the Thermal Management menu system.
- 8 Press **➤** until you reach **Custom TM**.
- 9 Press **OK** to select Custom TM.

To adjust the print speed for floodcoated media

- 1 Press the **Setup** button.
- 2 Press **➤** until you reach **Media**.
- 3 Press **OK** to enter the Media menu system.
- 4 Press **➤** until you reach **Advanced**.
- 5 Press **OK** to enter the Advanced menu system.
- 6 Press **➤** until you reach **Min Speed**.
- 7 Press the **Feed** button to scroll through a list of numbers. Choose a number that is appropriate for the floodcoated media. To see a list of sensitivity settings for each media type, go to **“Recommended Media Sensitivity and Constant” on page 71**.
- 8 Press **OK** to select a number.
- 9 Reboot your printer.

Understanding the Display Modes

The printer has six display modes to help you effectively interact with the printer: Ready, Information, Pause, Setup, Error, and Test. Use the following sections to understand the different printer modes.

Understanding Ready Mode

The printer is in Ready mode when the printer is on and ready to print. The main screen displays the power status, the radio status, and the printer language and version.

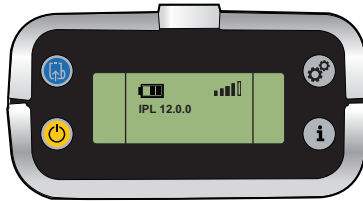

The PB22 and PB32 in Ready Mode

Understanding Information Mode

When the printer is in Information mode, it displays a subset of pertinent information about the printer. If the printer experienced an error, the error message displays first followed by the printer information. Each message displays on the screen for five seconds. After five seconds on the last information screen, the printer exits Information mode.



The PB22 and PB32 in Information Mode

To enter Information mode

- Press the **Information** button on the control panel.

Understanding Pause Mode

Use Pause mode to momentarily stop printing or to cancel a current print job. Once you pause the printer, the Pause mode screen appears. Use the **Feed** button to both pause and resume printing.

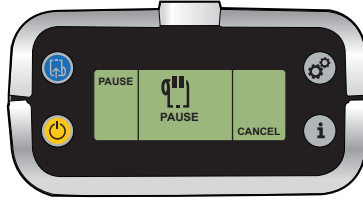

The PB22 and PB32 in Pause Mode

To enter Pause mode

- Press the **Feed** button while the printer is printing.

To resume printing

- Press the **Feed** button.

To cancel a print job

- 1 Press the **Feed** button to pause printing (Fingerprint, IPL, or ESC/P).
- 2 Press the **Information** button (or **X** soft key) to cancel the print job (Fingerprint or IPL) or press and hold the **Pause** button in ESC/P.

Understanding Setup Mode

Use Setup mode to change the settings on the printer.



Sample Setup Mode Screen

To enter or exit Setup mode

- Press the **Setup** button.

Once you enter Setup mode, there are two editing modes: normal and enhanced.

Editing Settings in Setup Mode

Editing Mode	To Navigate	To Accept Value
Normal	<ul style="list-style-type: none">Press > to move among choices.Press ^ to go up a level in menu system.	Press OK .
Enhanced	<ul style="list-style-type: none">Press > to move within the editable fields. When the field blinks, you can edit it.Press + to increase the value of the field.	Press OK .

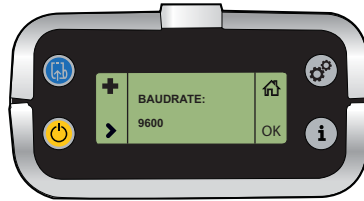

Normal Editing Mode: In normal editing mode, you see an up arrow and a right arrow for making selections.



Enhanced Editing Mode: In enhanced editing mode you have a plus sign and a right arrow to change the value of numeric fields.

Understanding Error Mode

The printer enters Error mode when it detects an error condition such as a low battery or a paper fault. Some error messages appear on the screen immediately when they occur, such as DOOR OPEN. Other error messages do not appear until you press the **Information** button. If there is more than one error at a given time, the errors display in the order that they occurred.

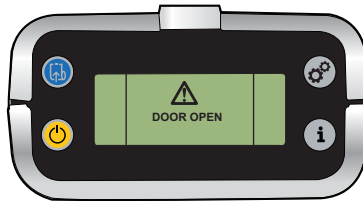

Sample Error Mode Screen

If you encounter an error message, see [“Understanding Error Messages” on page 56](#) for information on how to fix the problem.

Understanding Test Mode

Use Test mode to verify printer settings, test printing, restore factory default settings, or enter Dump mode for troubleshooting purposes. Two test modes are available: Test mode and Extended Test mode.

Using Test Mode

Test mode is a simple sequence of events which requires little user interaction. Extended Test mode requires more user interaction and lets you choose which actions you want the printer to perform.

To enter Test mode

- 1** Make sure the printer is in Ready mode and is loaded with media.
- 2** Press and hold the **Feed** and **Standby** buttons at the same time until Select Media appears on the screen and it displays the type of media you are using.
- 3** Release both buttons. The printer performs a test feed (sensor calibration), prints, and then enters Dump mode.

The printer is now in Dump mode and it scans the communication ports. Any characters received on the communication ports are printed.

- 4 Press **Feed** to exit Dump mode.

After you exit Dump mode, the printer returns to Ready mode. For more information on Dump mode, see “**Troubleshooting Communication Problems**” on page 60.

Using Extended Test Mode

Use Extended Test mode to run additional diagnostic tests, enter Dump mode, or reset the printer to factory defaults.

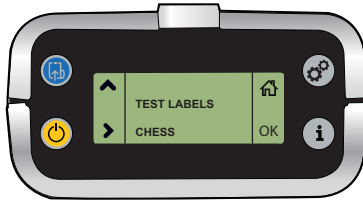

Sample Extended Test Mode Screen

To enter Extended Test mode

- 1 Make sure that the printer is loaded with media.
- 2 Press the media cover release button to open the media cover.
- 3 Press the **Standby** button to turn the printer off.
- 4 Press **Feed** and **Standby** buttons at the same time until CLOSE PRINTER DOOR appears on the screen.
- 5 Close the media cover. You are now in Extended Test mode.
 - Press **➤** to cycle through the options.
 - Press **OK** to select a test option.
 - Press **⏪** to exit Extended Test mode.

Options in Extended Test Mode

Function	Description
Select Media	This option is almost the same as the process in Test mode, except that the printer performs a slow test feed in Extended Test mode. The slow test feed enables the printer to perform a slow sensor calibration which can help resolve mark detection problems.

Options in Extended Test Mode (continued)

Function	Description
Test Labels	This option allows you to print test labels one at a time. Press OK to print the next label.
Dump Mode	This options enters Dump mode. For more information on Dump mode, see “Troubleshooting Communication Problems” on page 60.
Factory Default	This option restores the factory default settings. Press OK to select this option and then follow the instructions on the screen.
Exit to Setup	This option exits Extended Test mode and puts the printer in Setup mode.
Exit	This option exits Extended Test mode.

Changing Configuration Settings From the Display

You need to enter Setup mode before you can change configuration settings. For more information on entering Setup mode and navigating through the settings, see **“Understanding Setup Mode” on page 21.**

The top levels of the Setup menu are organized in a one-way loop. Each level has several sub-levels.

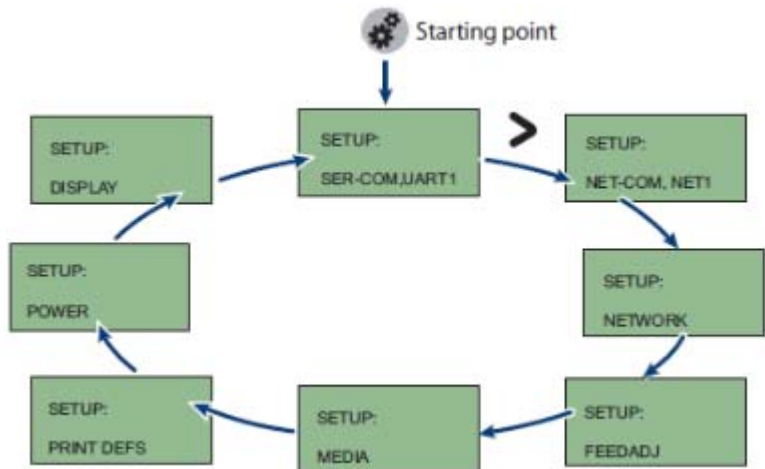

The Main Levels of the Setup Menu in Fingerprint

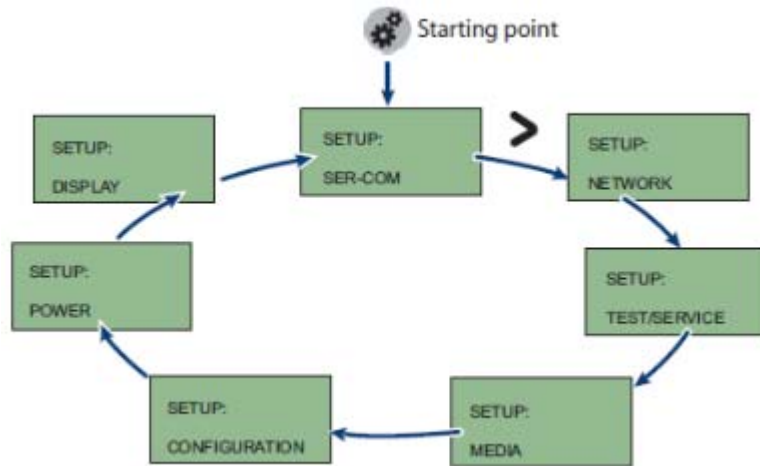

The Main Levels of the Setup Menu in IPL

ESC/P supports six types of setup commands:

- Bluetooth - set Bluetooth parameters
- Download - download fonts and graphics to the printer
- Easy print mode - print receipts, tickets, and reports
- Line printer mode - print receipts, tickets, and reports
- Query - retrieve information about the printer or a print request, cancel printing, or reset the printer
- Wi-Fi - set Wi-Fi parameters

Printing a Test Page

After you have loaded media in the printer, you are ready to print a test page. You can choose from several test page options for each of the printer languages. If you cannot get the test page information to print, see **“Troubleshooting the Printer” on page 56**.

To print a test page with a printer loaded with IPL

- 1** Press the **Setup** button.
- 2** Press **➤** until you reach **Test/Service**.
- 3** Press **OK** to enter the Test/Service menu system.

- 4** Press **OK** to enter the Testprint Config menu.
- 5** Press **OK** to enter the Config menu.
- 6** Press **➤** to choose a testprint.
- 7** Press **OK** to print the Config testprint of your choice.

To print a test page with a printer loaded with Fingerprint

- 1** Press the **Setup** button.
- 2** Press **➤** until you reach **Print Defs.**
- 3** Press **OK** to enter the Print Defs menu system.
- 4** Press **➤** until you reach **Testprint.**
- 5** Press **OK** to enter the Testprint menu.
- 6** Press **➤** to choose a testprint.
- 7** Press **OK** to print the testprint of your choice.

To print a self test with a printer loaded with ESC/P

- 1** Press and hold the **Feed** and **Power** buttons simultaneously for approximately five seconds.
- 2** Release the **Feed** and **Power** buttons when the printer displays the media you are printing on.
- 3** Press the **Feed** button to exit Dump Mode.

2

Configuring the PB22 and PB32

In this chapter you will find these sections:

- **Connecting the Printer to Your PC**
- **Connecting the Printer to Your Network**
- **Configuring the Printer Settings**
- **Upgrading the Firmware**
- **Downloading Fonts and Graphics**

Connecting the Printer to Your PC

You can easily connect to the printer to your PC using one of these ports:

- USB port
- RS-232 serial interface port

Connecting the Printer Through the USB Interface

To connect the printer to your PC using the USB port, you need a USB cable (P/N 321-611-xxx) and to install Intermec InterDriver® software. To make sure you have the latest version of InterDriver, you may want to go to the downloads page for the printer on <http://www.intermec.com/support/downloads/index.aspx>.

To connect the printer through a USB port

- 1 Open the Interdriver executable.
- 2 The File Download - Security Warning screen appears. Click **Run** to run the executable. The Intermec End User License Agreement screen appears.
- 3 Read the agreement and select the radio button to accept the agreement, and then click **Next**. The Installation Directory screen appears.
- 4 The default installation directory is c:\Intermec\InterDriver7. Click **Next** to use the default directory or specify a different location to install the files. The Installation Information screen appears.
- 5 Clear the **Run Add Print Wizard after unpacking drivers** check box and click **Finish**.
- 6 On the New Hardware Wizard screen, select **Install from a list or specific location** and then click **Next** to continue.



Note: For LPT connections, you must restart your computer for Windows to detect the new hardware. For USB connections, the New Hardware Wizard will launch automatically when the printer is connected and turned on.

- 7 On the Search and Installation Options screen, click **Next**.

- 8** On the Hardware Installation warning screen, click **Continue Anyway**.
- 9** Click **Finish** to exit the New Hardware Wizard. InterDriver files are now installed on your computer.
- 10** Connect the USB cable to the connector on the back of the printer and connect the other end to your PC. You do not need to set up any parameters for USB communications.

Connecting the Printer Through the Serial Port

You can use a serial cable (P/N 075497) to communicate with your PC and run PrintSet, LabelShop, or InterDriver. You can also use the serial port to send commands directly to the printer through a communications program like HyperTerminal.

The serial communication parameters control the communication between the printer and the PC connected on the serial port, referred to as “uart1:” on the printer. Make sure the serial port settings on the printer match the settings on the connected device. The default serial communication settings on the printer are: 115200 baud rate, 8 data bits, no parity, 1 stop bit and no flow control.

The serial cable you need is not included in the shipping box with the printer.

To connect the printer to a PC through the serial port using PrintSet

- 1** Connect the 8-pin circular DIN connector to the serial port on the printer. Connect the other end of the serial cable to a serial port on your PC.
- 2** Start PrintSet.
- 3** Click **File > Add printer**.
Or, in the **General Tasks** list, click **Add printer**.
- 4** Click **Next**.
- 5** Select **Serial**, then click **Next**.
- 6** Make sure that the **COM Port** is set to the correct serial port, and that **Automatically detect communication parameters** is selected. Click **Next**.

- 7** PrintSet attempts to connect to your printer. If it cannot find your printer, click **Back** to review the communication settings, then try again. When PrintSet connects to your printer, click **Next**.
- 8** Click **Finish**. Your printer appears in the **My Printers** list.

To connect the printer to a PC through the serial port using HyperTerminal

- 1** Connect the 8-pin circular DIN connector to the serial port on the printer. Connect the other end of the serial cable to a serial port on your PC.
- 2** On your PC, start the communications program.
- 3** If necessary, configure the port settings so they match those of your printer.

Bits per second: 115200

Data bits: 8

Parity: None

Stop bits: 1

Flow control: XON_XOFF

- 4** If you are using HyperTerminal:
 - a** Click **OK**.
 - b** Click the **Settings** tab.
 - c** Click **ASCII Setup**. The ASCII Setup window appears.
 - d** Check the following check boxes:
 - **Send line ends with line feed**
 - **Echo typed characters locally**
 - **Append line feeds to incoming line ends**
- 5** Click **OK** to save and exit ASCII Setup.
- 6** Test your connection by typing one of the following commands into the communications program window:
 - For IPL, press **Ctrl** and in the communications program window simultaneously type:
b, w, c

- For Fingerprint, type :
FF
and press **Enter**.
- For ESC/P, press the **ESC** key and type:
EZ {AHEAD:10}

The printer responds by feeding a small amount of media.

Connecting the Printer to Your Network

The printer provides two ways to connect to a network:

- Bluetooth radio communications
- 802.11 b/g radio communications

Setting Up Bluetooth Communications

The printer can contain a Bluetooth radio that allows wireless communications with a remote device from distances up to 100 meters (approximately 328 feet) depending on the Bluetooth range capabilities of the remote device, environmental conditions, and obstructions. For the Bluetooth-enabled devices to exchange data, both devices must establish a connection. Bluetooth software is always running in the background.

The printer cannot initiate a Bluetooth connection. One of the devices must request a connection with the printer. The printer then accepts or rejects the connection. Use Intermec Settings on the mobile computer to enable the Bluetooth settings on the printer.

The printer can also connect to Bluetooth scanners, such as the SF51 and the SR61. You can create the bar code labels you need to connect the printer to a Bluetooth scanner using EasySet software. You can download a free version of EasySet from the Intermec web site at www.intermec.com.

Each printer equipped with a Bluetooth radio has a unique Bluetooth Device Address (BDA) loaded into its module when manufactured. You can find the BDA on the certification label located on the bottom of the printer.

To set up Bluetooth communications with a mobile computer

- Follow the procedure to discover and connect to Bluetooth devices in your mobile computer user’s manual.





Note: For maximum security, you need to configure a Bluetooth passcode for the printer. The default passcode for the PB22 and PB32 is “1234.”

To set up Bluetooth communications with a scanner

- 1 Download and install EasySet.
- 2 Create the following bar code labels using EasySet:
 - Administrator reset factory defaults
 - Bluetooth parameters - security - not active
 - Bluetooth parameters - connect/disconnect - compose BT address
 - Bluetooth parameters - security - compose PIN
- 3 Scan the bar code labels with the Bluetooth scanner.

Understanding Bluetooth Radio Icons

Icon	Description
	The Bluetooth radio is on and the printer is not connected to a serial cable.
	The Bluetooth radio is turned off. The Bluetooth radio turns off when you connect a serial cable.

Setting Up 802.11 Radio Communications

The printer can have an internal 802.11 b/g radio to transfer and receive data using wireless communications. This manual assumes that you have already set up your wireless communications network including your access points. The following procedures include information on setting up wireless security for both IPL and Fingerprint versions of the printer.

The printer supports these authentication modes: none, WEP, WPA Personal and Enterprise mode (802.1x authentication), WPA2 Personal and Enterprise mode (802.1x authentication).



Note: WPA and WPA2 Enterprise modes currently support PEAP, TTLS, and LEAP. For LEAP authentication, the printer supports Open EAP, but does not support Network EAP.

To set up the printer to work in your wireless network, you need:

- Serial cable (P/N 075497-xxx).
- Host PC running Windows or Linux.
- Active 802.11b or 802.11g wireless access point.
- Communications application, such as PrintSet or HyperTerminal.



Note: If you are using IPL commands with HyperTerminal, you may want to be able to see the commands as you type them on your screen. For help, see [“Changing Configuration Settings Using the Command Line” on page 43](#).

To set up the printer for wireless communications using PrintSet

- 1** Connect the 8-pin circular DIN connector to the serial port on the printer. Connect the other end of the serial cable to a serial port on your PC.
- 2** On your PC, start PrintSet.
- 3** Select your printer from the My Printers list. For more information on how to add a printer to PrintSet, see [“To connect the printer to a PC through the serial port using PrintSet” on page 31](#).
- 4** In the **Printer Tasks** list, click **Wireless Setup Wizard**. If you are prompted for the administrator username and password, type them and click **Next**.
- 5** If your wireless access point uses DHCP, select **Get TCP/IP parameters automatically**. If the access point does not use DHCP, select **Use the following TCP/IP parameters** and type the device **IP Address**, **Network Mask**, **Default Router** (default gateway), and **Name Server** (primary DNS server). Click **Next**.

- 6 Type the **SSID (Network Name)**. For peer-to-peer access points, select **This is an ad hoc network** and select the **Channel** you want to use. The channel setting must be the same on all wireless devices on the ad-hoc network. Click **Next**.
- 7 Select the security options required to connect to your wireless network. Click **Next**.
- 8 If you selected **Static WEP, Dynamic WEP (802.1x), or Wi-Fi Protected Access** in Step 7, type the WEP keys or network credentials required for authentication. Click **Next**.
- 9 Wait for PrintSet to apply your settings. Click **Next**, then click **Finish** to complete the wizard.

To set up the printer for wireless communications using HyperTerminal

- 1 Connect the 8-pin circular DIN connector to the serial port on the printer. Connect the other end of the serial cable to a serial port on your PC.
- 2 On your PC, start a communications program window like HyperTerminal and configure the following parameters for the serial port:

Parameter	Default Setting
Baud rate	115200
Data bits	8
Parity	None
Stop bits	1

- 4 From the host PC, check the wireless settings.

If you have an IPL version of the printer, send these commands to the printer:

```
<STX><SI>wt , SSID<ETX>  
<STX><SI>wt , WEP1<ETX>  
<STX><SI>wt , WEP2<ETX>  
<STX><SI>wt , WEP3<ETX>  
<STX><SI>wt , WEP4<ETX>  
<STX><SI>wt , AUTH<ETX>  
<STX><SI>wt , WPA<ETX>  
<STX><SI>wt , WPA2<ETX>
```









```
<STX><SI>wt ,WPA_PSK<ETX>  
<STX><SI>wt ,ROAM<ETX>  
<STX><SI>wt ,PWR_MODE<ETX>  
<STX><SI>wt ,CHANNEL<ETX>  
<STX><SI>wt ,AP_MAC<ETX>  
<STX><SI>wt ,SIGNAL<ETX>  
<STX><SI>wt ,SPEED<ETX>  
<STX><SI>wt ,ACTIVE<ETX>
```

If you have a Fingerprint version of the printer, send this command to the printer:

```
setup write "wlan", "uart1:"
```

- 5** Set up the printer to use the correct SSID and authentication modes. See one of the following procedures to configure wireless printing on your IPL or Fingerprint printer.
- 6** If you are going to use certificates for validation, transfer the certificate to the printer. The printer can accept .pfx, .pem, and .der certificates.
- 7** Verify that the printer is connected to the access point and make sure it has an IP address allocated to it.

Understanding the 802.11 Radio Icons

Icon	Description
	Excellent signal
	Strong signal
	Good signal
	Weak signal
	Poor signal
	No signal

Use the following sections to set most of your wireless communication settings. For help with additional commands and information, see either the *Intermec Fingerprint Developer's Guide* or the *IPL Developer's Guide*. You can download both documents from the Intermec web site at www.intermec.com.

Configuring Wireless Printing Using IPL

Use the following procedures to configure your printer with IPL for wireless printing.

To configure the printer to use WEP authentication

- 1 Send the following commands to login as an admin and set the SSID:

```
<STX><ESC>.x,su -p pass admin<ETX>  
<STX><SI>ws , SSID ,xxxxxx<ETX>
```

where *xxxxxx* can be from 0 to 32 alphanumeric characters.



Note: The default password for logging in as an admin is “pass.” If you have changed the password, you will need to use your password instead of “pass.”

- 2 Send the following commands to configure the WEP keys. The following example sets WEP key 1 to 1234 and enables WEP key 1.

```
<STX><SI>ws , WEP1 , 0x0001020304<ETX>  
<STX><SI>ws , .WEP_KEY , 1<ETX>
```

- 3 Send the following command to activate the settings.

```
<STX><SI>ws , ACTIVE , 1<ETX>
```

To configure the printer to use WPA-PSK or WPA2-PSK mode

- 1 Send the following commands to login as an admin and set the SSID:

```
<STX><ESC>.x,su -p pass admin<ETX>  
<STX><SI>ws , SSID ,xxxxxx<ETX>
```

where *xxxxxx* can be from 0 to 32 alphanumeric characters.

- 2 Send one of the following commands to turn on WPA or WPA2 authentication. Send the WPA-PSK or WPA2-PSK command to set a pre-shared key:

```
<STX><SI>ws , WPA , ON<ETX>  
<STX><SI>ws , WPA2 , ON<ETX>  
<STX><SI>ws , WPA_PSK , xxxxxxxxxxxx<ETX>
```

where *xxxxxxxxxx* is a value between 8 and 64 characters.

- 3 Send the following command to activate the settings:

```
<STX><SI>ws , ACTIVE , 1<ETX>
```

To configure the printer to use WPA or WPA2 Enterprise mode

- 1 Send the following commands to login as an admin and set the SSID:

```
<STX><ESC>.x,su -p pass admin<ETX>
<STX><SI>ws , SSID , xxxxxx<ETX>
```

where *xxxxxx* can be from 0 to 32 alphanumeric characters.



Note: The default password for logging in as an admin is “pass.” If you have changed the password, you will need to use your password instead of “pass.”

- 2 Send one of the following commands to enable WPA-802.1x or WPA2-802.1x authentication. You should also send the WPA_PSK command that does not contain a value:

```
<STX><SI>ws , WPA , ON<ETX>
<STX><SI>ws , WPA2 , ON<ETX>
<STX><SI>ws , WPA_PSK , <ETX>
```

- 3 Send these commands to configure the EAP_TYPE:

```
<STX><SI>ws , EAP_TYPE , xxxxx<ETX>
```

where *xxxxx* can be OFF, LEAP, PEAP, or TTLS.

```
<STX><SI>ws , . EAP_USER , xxxxx<ETX>
<STX><SI>ws , . EAP_PASS , xxxxx<ETX>
```

where *xxxxx* is the unique username and the unique password for this protocol.

- 4 If you are using TTLS, you may need to send this command to set the TTLS outer name:

```
<STX><SI>ws , TTLS_USER , xxxxx <ETX>
```

where *xxxxx* is the outer name.

- 5 If you are using certificates for validation, here are some commands you may need to use.

- Send the following commands to set a certificate and enable validation:

```
<STX><SI>ws , CA_CERT , c : / testCA . pfx @ export <ETX>  
<STX><SI>ws , VALIDATE , ON <ETX>
```

where *c:/testCA.pfx* is the location and name of the certificate and *export* is the passphrase.

- Send the following commands to set a common name for server 1 and server 2:

```
<STX><SI>ws , . SERVER_CN1 , xxxxxxxxxxxx <ETX>  
<STX><SI>ws , . SERVER_CN2 , xxxxxxxxxxxx <ETX>
```

where *xxxxxxxxxx* can be a value from 0 to 64 characters.

- Send the following command to make sure your values match those used by the access point:

```
<STX><SI>wt , [ variable name ] <ETX>
```

All variables are returned with the exception of EAP_PASS which always returns “****” if configured and CA_CERT which transmits the name of the last certificate authority successfully installed. An additional read-only variable for the supplicant state, called STATE, is also returned.

- You may need to send the following command several times for the wireless station to connect:

```
<STX><SI>ws , ACTIVE , 1 <ETX>
```

Configuring Wireless Printing Using Fingerprint

Use the following procedures to configure your printer with Fingerprint for wireless printing.

To configure the printer to use WEP authentication

- 1 Send the following commands to login as an admin and set the SSID:

```
run "su -p pass admin"  
setup write "wlan" , "uart1 : "  
setup "wlan" , "SSID" , "xxxxxx"
```

where *xxxxxx* can be from 0 to 32 alphanumeric characters.



Note: The default password for logging in as an admin is “pass.” If you have changed the password, you will need to use your password instead of “pass.”

- 2 Send the following commands to configure the WEP keys. The following example sets WEP key 1 to 1234 and enables WEP key 1.

```
setup "wlan", "WEP1", "0x0001020304"  
setup "wlan", ".WEP_KEY", "1"  
setup "wlan", "ACTIVE", "1"  
setup write "wlan", "uart1:"
```

To configure the printer to use WPA-PSK or WPA2-PSK mode

- 1 Send the following commands to login as an admin and set the SSID:

```
run"su-p pass admin"  
setup write "wlan", "uart1:"  
setup "wlan", "SSID", "xxxxxx"
```

where *xxxxxx* can be from 0 to 32 alphanumeric characters.

- 2 Send one of the following WPA/WPA2 ON commands to turn on WPA or WPA2 authentication. Send the WPA-PSK or WPA2-PSK command to set a pre-shared key:

```
setup "wlan", "WPA", "ON"  
setup "wlan", "WPA2", "ON"  
setup "wlan", "WPA_PSK", "xxxxxxxxxxxx"  
setup "wlan", "ACTIVE", "1"  
setup write "wlan", "uart1:"
```

where *xxxxxxxxxxxx* is a value between 8 and 64 characters.

To configure the printer to use WPA or WPA2 Enterprise mode

- 1 Send the following commands to login as an admin and set the SSID:

```
run"su-p pass admin"  
setup write "wlan", "uart1:"  
setup "wlan", "SSID", "xxxxxx"
```

where *xxxxxx* can be from 0 to 32 alphanumeric characters.

- 2 Send one of the following WPA/WPA2 ON commands to set up WPA-802.1x or WPA2-802.1x authentication. You should also send the WPA_PSK command that does not contain a value:

```
setup "wlan", "WPA", "ON"  
setup "wlan", "WPA2", "ON"  
setup "wlan", "WPA_PSK", ""  
setup write "wlan", "uart1:"
```

- 3 To view the 802.1x values, send this command:

```
setup write "8021x", "uart1:"
```

- 4** Send these commands to configure the EAP_TYPE:

```
setup "8021x", "EAP_TYPE", "xxxx"
```

where *xxxx* can be OFF, LEAP, PEAP, or TTLS.

```
setup "8021x", ".EAP_USER", "xxxx"  
setup "8021x", "EAP_PASS", "xxxx"
```

where *xxxx* is the unique username and the unique password for this protocol.

- 5** If you are using TTLS, you may need to send this command to set the TTLS outer name:

```
setup "8021x", "TTLS_USER", "xxxx"
```

where *xxxx* is the outer name.

- 6** If you are using certificates for validation, here are some commands you may need to use.

- Send the following commands to set a certificate and enable validation:

```
setup "8021x", "CA_CERT", "c:/test.pfx@export"  
setup "8021x", "VALIDATE", "ON"
```

where *c:/test.pfx* is the location and name of the certificate and *export* is the passphrase.

- Send the following commands to set a common name for server 1 and server 2:

```
setup "8021x", ".SERVER_CN1", "xxxxxxxxxxxx"  
setup "8021x", ".SERVER_CN2", "xxxxxxxxxxxx"
```

where *xxxxxxxxxxxx* can be a value from 0 to 64 characters.

- Send the following command to make sure your values match those used by the access point:

```
setup write "8021x", "uart1:"
```

- You may need to send the following command several times for the wireless station to connect:

```
setup "wlan", "ACTIVE", "1"
```

Configuring the Printer Settings

You can change the configuration settings of the printer directly from:

- the display.
- the host PC using PrintSet.
- the host PC using the command line.
- the printer home page.
- SmartSystems™ Foundation.

For more information on the IPL and Fingerprint menu systems, see **“IPL and Fingerprint Setup Menus” on page 83**.

Changing Configuration Settings From PrintSet

PrintSet is a printer configuration tool that you can download from the Intermec web site. PrintSet can communicate with your printer through a serial cable or a network connection. It works on all PCs running Windows 98 (or later). PrintSet allows you to easily change all of the setup parameters. It also includes setup wizards to guide you through some common configuration tasks.

Changing Configuration Settings Using the Command Line

You can change configuration parameters by sending commands directly to the printer using your a communications program like HyperTerminal and a serial or network connection.

If your printer uses the Fingerprint language, you use the SETUP command, followed by the node, subnode, and parameters setting. Fingerprint automatically sends feedback to your communications program window as you type.

If you want to see what you are typing with IPL, you need to complete the following procedure.

To see IPL commands as you type

- 1** From the HyperTerminal menu, select **File > Properties > the Settings** tab.
- 2** Click the **ASCII Setup** button.
- 3** Select **Echo typed characters locally**.
- 4** Click **OK** twice.

Changing Configuration Settings From the Printer Home Page

If you have a printer with an 802.11 wireless radio, you can change configuration settings from the home page of the printer.

To make changes to the configuration

- 1 Establish a connection between your printer and the network. For help see **“Setting Up 802.11 Radio Communications” on page 34**.
- 2 Connect your PC to the same network that the printer is on.
- 3 Change the printer language to Fingerprint or IPL. For help, see **“Changing the Printer Language” on page 7**.
- 4 If you are using Fingerprint or IPL:
 - a Press the **Setup** button.
 - b Press the **➤** until you reach **Network**.
 - c Press **OK** to enter the Network system menu.
 - d Press **➤** until you reach **IP address**.
 - e Press **OK** to view the IP address.
- 5 Start a web browser.
- 6 In the address field, type the IP address of your printer and press **Enter**. The home page of the printer appears.
- 7 Click **Login** and enter your administrator name and password.
- 8 On the home page of the printer, click **Configuration**.

For help with Fingerprint, IPL, ESC/P, or SmartSystems Foundation commands and information, see either the:

- *[Intermec Fingerprint Command Reference Manual](#)*
- *[Intermec Printer Language \(IPL\) Command Reference Manual](#)*
- *[ESC/P Programmer’s Reference Manual](#)*
- SmartSystems Foundation Online Help.

You can download these documents from the Intermec web site at www.intermec.com.

Changing Configuration Settings Using SmartSystems Foundation

You can use the SmartSystems console to change configuration settings on your printer. The printer ships with the SmartSystems client loaded on it. The console is part of SmartSystems Foundation and is available from the Intermec web site. To download SmartSystems Foundation, go to www.intermec.com/products/smrtsysfoundation/index.aspx.

Upgrading the Firmware

The latest firmware and software is available for download from the Intermec web site at www.intermec.com. You can upgrade the firmware on your printer using:

- PrintSet. You can download PrintSet from the downloads page for the printer on the Intermec web site at www.intermec.com.
- the printer home page.
- SmartSystems™ Foundation.
- a serial cable and a communications program like HyperTerminal.



Warning

When upgrading your firmware, make sure the battery in the printer is fully charged. If the printer loses power during the upgrade, the printer may be permanently damaged.

Upgrading the Printer Firmware Using PrintSet

You can only upgrade your printer using PrintSet when the printer is running IPL, Fingerprint, or ESC/P printer languages. To upgrade the printer using PrintSet, you need to install PrintSet to your PC and purchase a serial cable (P/N 075497).

To upgrade the printer firmware using PrintSet

- 1 If your printer is running ZSim or DSim, change the printer language to IPL, Fingerprint, or ESC/P. For help, see **“Changing the Printer Language” on page 7**.

- 2** Connect your printer to your printer using a serial cable. For help, see **“Connecting the Printer Through the Serial Port” on page 31**.
- 3** Download the firmware (.bin) file you want to upgrade to a location on your PC.
 - a** Go to **www.intermec.com**.
 - b** Click **Support > Downloads**.
 - c** Use the **Product Category**, **Product Family**, and **Product fields**, to select the printer model.
 - d** Click **Submit**. The latest available software appears on the page.
 - e** Download the latest firmware version to your PC.
 - f** Extract the .zip file to a folder on your PC.

4 Open PrintSet. The Intermec PrintSet dialog box appears.

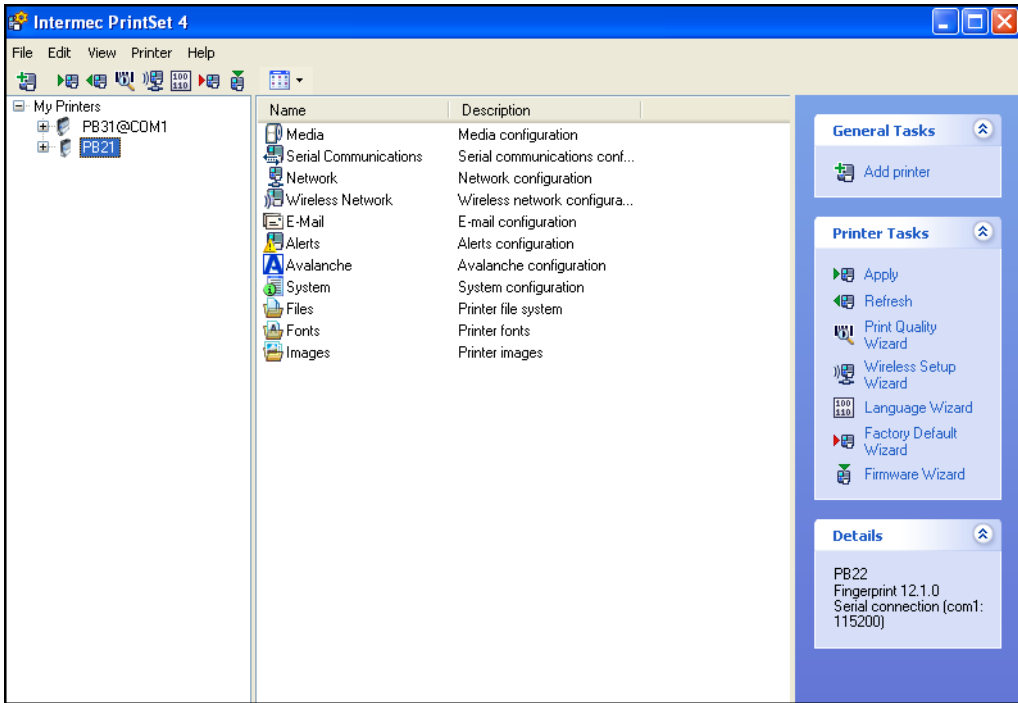

- 5 Under My Printers, click the printer whose firmware you want to upgrade.
- 6 Under Printer Tasks in the right-hand column, click **Firmware Wizard**.
- 7 Click **Next**. The Firmware Wizard dialog box appears.
- 8 Click **Browse** and navigate to the firmware (.bin) file you want to upgrade to. Wait approximately five minutes as your printer upgrades to the new firmware.

Upgrading the Printer Firmware Using the Printer Home Page

You can upgrade your printer using the printer home page with a printer with an 802.11 radio running IPL or Fingerprint.

To upgrade using the printer home page

- 1** Establish a connection between your printer and the network. For help, see “**Setting Up 802.11 Radio Communications**” on **page 34**.
- 2** Establish a connection between your PC and the network your printer is on.
- 3** Download the firmware (.bin) file you want to upgrade to a location on your PC.
 - a** Go to **www.intermec.com**.
 - b** Click **Support > Downloads**.
 - c** Use the **Product Category**, **Product Family**, and **Product fields**, to select the printer model.
 - d** Click **Submit**. The latest available software appears on the page.
 - e** Download the latest firmware version to your PC.
 - f** Extract the .zip file to a folder on your PC.
- 4** If you are using Fingerprint or IPL, use the display to find the printer’s IP address.
 - Press the **Setup** button.
 - Press **➤** until you reach Network.
 - Press **OK** to enter the Network menu.
 - Press **➤** until you reach IP Address.
 - Press **OK** to select and view the IP Address.
 - Press the **Setup** button to exit the menu.
- 5** Start a web browser.

- 6 In the address field type the IP address of your printer and press **Enter**.



INTERMEC034005 [Home](#) [Configuration](#) [Maintenance](#) [Support](#)

EasyCoder PB22

Name (WINS):	INTERMEC034005
Firmware Version:	MCS 1911, 11-Aug-09 11:36:46
Active Command Set:	IPL 12.1.0
MAC Address:	00:21:00:03:40:05
IP Address:	20.2.3.220
Image buffer:	label.png
RtW™:	Setup mode entered

7 Click **Maintenance**. The Maintenance page appears.

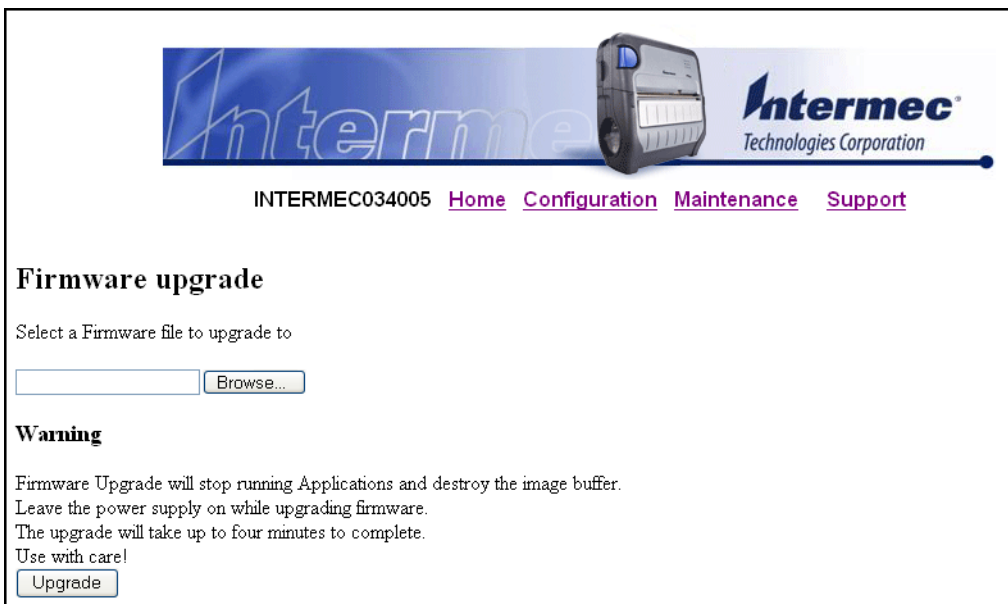

The screenshot shows the Intermec Technologies Corporation website's Maintenance page. At the top, there is a navigation bar with the Intermec logo and a printer image. Below the navigation bar, the page ID "INTERMEC034005" is displayed, followed by links for "Home", "Configuration", "Maintenance", and "Support". The main heading is "Firmware upgrade". Below this, there is a text prompt "Select a Firmware file to upgrade to" followed by a text input field and a "Browse..." button. A "Warning" section follows, containing the text: "Firmware Upgrade will stop running Applications and destroy the image buffer. Leave the power supply on while upgrading firmware. The upgrade will take up to four minutes to complete. Use with care!". At the bottom of the warning section is an "Upgrade" button.

8 When prompted, enter your user name and password.

9 Browse to the (.bin) file you want to upgrade to and select it.

10 Click **Upgrade**.

Wait approximately five minutes for the firmware upgrade to complete. The printer automatically reboots.

Upgrading Printer Firmware Using SmartSystems Foundation

You can use the SmartSystems console to upgrade the printer firmware. Your printer ships with the SmartSystems client loaded on it. The console is part of SmartSystems Foundation and is available from the Intermec web site. To download SmartSystems Foundation, go to www.intermec.com/products/smrtsysfoundation/index.aspx.

Upgrading the Printer Firmware Using a Communications Program

You can upgrade your printer firmware using a communications program like HyperTerminal and a printer running either the IPL, Fingerprint or ESC/P printer language. Using a communications program is not the preferred method for upgrading printer firmware. When possible, upgrade using PrintSet or the home page of the printer.

To upgrade the printer firmware using communications program and IPL

- 1 Connect your printer to your PC using a serial cable. For help, see **“Connecting the Printer Through the Serial Port” on page 31.**

or

Establish a connection between your printer and your network.
“Connecting the Printer to Your Network” on page 33.

- 2 If you connected your printer to the network, establish a connection between your PC and the network your printer is on.
- 3 Download the firmware (.bin) file you want to upgrade to a location on your PC.
 - a Go to **www.intermec.com**.
 - b Click **Support > Downloads**.
 - c Use the **Product Category**, **Product Family**, and **Product fields**, to select the printer model.
 - d Click **Submit**. The latest available software appears on the page.
 - e Download the latest firmware version to your PC.
 - f Extract the .zip file to a folder on your PC.
- 4 Open a communications program. The communications program window appears.
- 5 In the communications program window, type:
`<STX><ESC> . y , ush<ETX>`
and press **Enter**. You will be prompted for more data.

6 Type :

```
su -p pass admin.
```

7 Type :

```
dlk -z
```

The printer's display will read "Upgrading".

8 In the communications program window, click **Transfer > Send File**. A dialog box will appear.

9 In the protocol drop-down box, choose **Zmodem**.

10 Browse to the firmware (.bin) file you want to upgrade to and select it.

Wait approximately five minutes for the firmware upgrade to complete. When the upgrade is complete, the communications program window will display "kernel flashing ok." The printer automatically reboots.

To upgrade the printer firmware using a communications program and Fingerprint

1 Connect your printer to your PC using a serial cable. For help, see **"Connecting the Printer Through the Serial Port" on page 31**.

2 Download the firmware (.bin) file you want to upgrade to a location on your PC.

a Go to **www.intermec.com**.

b Click **Support > Downloads**.

c Use the **Product Category**, **Product Family**, and **Product fields**, to select the printer model.

d Click **Submit**. The latest available software appears on the page.

e Download the latest firmware version to your PC.

f Extract the .zip file to a folder on your PC.

3 Open a communications program.

4 Type

```
run "su -p pass admin"
```

5 Type:

```
run "dlk -z"
```

The printer's display will read "Upgrading".

- 6** In the communications program window, click **Transfer > Send File**. A dialog box will appear.
- 7** In the protocol drop-down box, choose **Zmodem**.
- 8** Browse to the firmware (.bin) file you want to upgrade to and select it.

Wait approximately five minutes for the firmware upgrade to complete. When the upgrade is complete, the communications program window will display "kernal flashing ok." The printer will automatically reboot.

To upgrade the printer firmware using a communications program window and ESC/P

- 1** Connect your printer to your PC using a serial cable. For help, see "**Connecting the Printer Through the Serial Port**" on page 31.
- 2** Download the firmware (.bin) file you want to upgrade to a location on your PC.
 - a** Go to www.intermec.com.
 - b** Click **Support > Downloads**.
 - c** Use the **Product Category**, **Product Family**, and **Product fields**, to select the printer model.
 - d** Click **Submit**. The latest available software appears on the page.
 - e** Download the latest firmware version to your PC.
 - f** Extract the .zip file to a folder on your PC.
- 3** Open a communications program.
- 4** Reboot the printer.
- 5** Press the **Esc** key and in the communications program window type :
{SYS:USH}
- 6** Type :
su -pass admin.

7 Type

```
d1k -z .
```

The printer's display will read "Upgrading".

8 In the communications program window, click **Transfer > Send File**. A dialog box will appear.

9 In the protocol drop-down box, choose Zmodem.

10 Browse to the firmware (.bin) file you want to upgrade to and select it.

11 Browse to the firmware (.bin) file you want to upgrade to and select it.

Wait approximately five minutes for the firmware upgrade to complete. When the upgrade is complete, the communications program window will display "kernel flashing ok." The printer will automatically reboot.

Downloading Fonts and Graphics

The easiest way to download fonts and graphics is to use PrintSet. You can download PrintSet from the downloads page for the printer on the Intermec web site at www.intermec.com. Follow the procedures in the PrintSet online help to download fonts and graphics.

For help with Fingerprint, IPL, ESC/P, or SmartSystems Foundation commands and information, see either the:

- *Intermec Fingerprint Command Reference Manual*
- *Intermec Printer Language (IPL) Command Reference Manual*
- *ESC/P Programmer's Reference Manual*
- SmartSystems Foundation Online Help

3

Troubleshooting and Maintaining the PB22 and PB32

Use this chapter to solve problems you may encounter while using the PB22 and PB32. This chapter contains the following sections.

- **Troubleshooting the Printer**
- **Resetting the Printer**
- **Cleaning the Printer**

Troubleshooting the Printer

You may have printer operation, print quality, or printer communication problems at some time during the life of the printer. It is easy to fix most of the problems and you will find solutions in “**Troubleshooting Printer Problems and Finding Solutions**” on page 58. If you cannot find the answer to your problem, you may need to contact Product Support.

Contacting Product Support

Before you call Intermec Product Support, you may want to visit the Intermec technical knowledge base (Knowledge Central) at intermec.custhelp.com to review technical information or to request technical support. If you still need help after visiting Knowledge Central, you may need to call Product Support.

To talk to an Intermec Product Support representative in the U.S.A. or Canada, call:

1-800-755-5505

Outside the U.S.A. and Canada, go to www.intermec.com and click **Contact** to find your local Intermec representative.

Before you call Intermec Product Support, make sure you have the following information ready:









- Printer serial number
- Firmware type and version
- Bluetooth, wireless, or serial port settings

You can find all of the information listed above in the printer menu system or on a test print page.

Understanding Error Messages

Use the following tables to troubleshoot some common error messages you may see display on the printer’s screen. Some of the error messages are specific to the type of firmware you have loaded on your printer.

Possible Printer Error Icons and Messages

Error Icon	Error Message	Description
	Pause	The print job is paused.
	Paper out (IPL) Out of Paper (Fingerprint)	The printer is out of paper. Load a new roll of media. For help, see “Loading Media” on page 15 .
	Testfeed not done	The printer did not perform a test feed before printing. It is important to perform a test feed because it calibrates the sensor. To perform a testfeed: <ul style="list-style-type: none"> • In Fingerprint and ESC/P, press the Feed button for more than 1 second. • In IPL open and close the media door and then Press the Feed button.
	Printhead hot	The printhead is overheated and needs to cool down. In IPL, wait for printing to resume automatically. In Fingerprint and ESC/P, you need to restart your print job.
	Upgrading	The printer is loading new firmware.
	LSS too high, LSS too low	These errors can occur when you run a test feed without any media installed, or if you have incorrect media settings. Load the printer with media (see “Loading Media” on page 15), run Test mode (see “Understanding Test Mode” on page 23), and select the appropriate media type.
	IP configuration error	The printer is trying to acquire an IP address from the network. Wait for the printer to complete the task before taking any action.
	IP link error	No network connection.
	Field out of label	You are attempting to print in an area that extends beyond the print window. See the programmer’s reference manual for your type of firmware (IPL, Fingerprint, or ESC/P) for information on how to set the media parameters.

Possible Printer Error Icons and Messages (continued)

Error Icon	Error Message	Description
	Door open	The printer is not completely closed. Press down on the media cover to make sure it is latched.

Troubleshooting Printer Problems and Finding Solutions

Use the following tables to troubleshoot some common problems you may encounter with the printer.

Printer Problems and Solutions

Problem	Possible Solution
The printer does not turn on when you press Standby .	<ul style="list-style-type: none"> • Replace the battery with a charged battery. • Connect external power to make sure the printer works correctly and to charge the battery.
The blue light (Ready-to-Work indicator) is blinking.	<ul style="list-style-type: none"> • Make sure media is loaded and the media cover is closed. For help, see “Loading Media” on page 15. • There is a printing error. The screen displays an error message containing information on the error. • The printer is paused. The printer is cancelling a print job.
Printer keeps printing or feeding when it should stop.	<ul style="list-style-type: none"> • Check media settings.
The printout is not in the desired position.	<ul style="list-style-type: none"> • Check for errors in the software application.
The printer is not printing with an 802.11 wireless connection.	<ul style="list-style-type: none"> • Verify that the wireless settings are correct. For help, see “Setting Up 802.11 Radio Communications” on page 34. • Make sure the printer has an IP address. • Make sure the printer is connected to the network. • Make sure the printer is in Ready mode.

Printer Problems and Solutions (continued)

Problem	Possible Solution
The printer is not printing with a Bluetooth connection.	<ul style="list-style-type: none"> • Re-establish a Bluetooth connection with the mobile computer or scanner. For help, see your mobile computer user's manual or “Setting Up Bluetooth Communications” on page 33. • Make sure the mobile computer can print to a known good printer. • Print a Bluetooth test print page to make sure that the mobile computer discovered your printer. For help, see “Printing a Test Page” on page 26. • Make sure the printer is in Ready mode.
Printout is faded or weak.	<ul style="list-style-type: none"> • Fingerprint users: adjust the media constant/factor and contrast (-10% to +10%). • IPL users: adjust the media sensitivity setting (-10 to +10). • ESC/P users: adjust the Media Sensitivity command or the Set Dark Adjust command. For help, see the ESC/P Programmer's Reference Manual. • Check to see if the printhead needs cleaning. For help, see “Upgrading the Firmware” on page 45.
The battery charge is not lasting as long as it should.	<ul style="list-style-type: none"> • Check the battery date. If the battery is a few years old, the shortened life may be due to normal aging. • Replace the battery.
The test pages do not print.	<ul style="list-style-type: none"> • Make sure that the blue light is not blinking. If it is, make sure your printer has media and that the media cover is closed. • Make sure that you can advance media by pressing the Feed button.

Printer Problems and Solutions (continued)

Problem	Possible Solution
Print quality is poor.	<ul style="list-style-type: none">• Clean the printhead. For help, see “Upgrading the Firmware” on page 45.• Check the battery and recharge or replace as necessary. For help, see “Charging the Batteries” on page 13.• Check the quality of the media. Use only Intermec media to ensure superior print quality and product performance.• Check that the printer is set to the appropriate Constant/Factory or sensitivity number for the media you are using. If you are using floodcoated media, see “Printing on Floodcoated Media” on page 19.

Troubleshooting Communication Problems

Use Dump mode to verify that the printer is receiving data from the host correctly.

Using the Line Analyzer in Fingerprint

In Dump mode, the printer runs a Fingerprint program called Line Analyzer. The Line Analyzer captures incoming characters on the communication ports and prints them.

The easiest way to enter Dump mode is through Test mode or Extended Test mode. For help, see [“Understanding Test Mode” on page 23](#).

After the printer enters Dump mode, it tells you it has entered Dump mode by printing it on a label. The display shows the Dump mode icon and printer is ready to receive data.

While the printer is receiving data, the Ready-to-Work indicator blinks. After a half of a second, if no more characters have been received, the printer times out. The program considers the transmission terminated and prints out a label.

Printable characters are printed in black-on-white. Control characters and space characters (ASCII 000 to 032 dec) are printed in white-on-black.

As long as a continuous string of characters is being received, the program wraps the lines until the label is full and then starts to print another label. After each character transmission, the following information prints:

- Page number
- Number of characters printed on the label
- Total number of characters received so far

When you exit Dump mode, a final label prints to inform you that it is exiting from Dump mode.

Using Dump Mode in IPL

When you enter Dump mode, the printer captures incoming characters on the communication ports and prints them on one or more labels.

If you have IPL firmware on your printer, you can access Dump mode in two different ways with slightly different results:

- You can access Dump mode through Test mode or Extended Test mode and you will receive printouts that look exactly like those produced with the Line Analyzer program in Fingerprint. For more information, see the previous procedure, [“Using the Line Analyzer in Fingerprint” on page 60](#).
- You can access Dump mode from the Setup menu. If you access Dump mode this way, characters are printed on a continuous line along with corresponding hexadecimal numbers.

To enter Dump mode from the Setup menu

- 1 Press the **Setup** button.
- 2 Press **➤** until you reach **Test/Service**.
- 3 Press **OK** to enter the Test/Service menu.
- 4 Press **➤** until you reach **Data Dump** and then press **OK**.
- 5 Press **➤** to select Yes and then press **OK**.
- 6 Cold boot the printer to exit Dump mode. For help, see the next section.

Resetting the Printer

You rarely need to reset the printer, unless you are upgrading the firmware. If your printer occasionally locks up, you will want to reset it. A reset reinitializes the 802.11 radio and clears the working memory.



Note: The Setup menu is not affected by a reset. Your printer retains all of your configuration settings after the printer powers back up.

To reset the Printer

- 1 Disconnect the printer from power if externally powered.
- 2 Remove the battery from the printer for at least one second.
- 3 Insert the battery back into the printer.
- 4 Reconnect external power if your printer is externally powered.

Cleaning the Printer

To properly maintain your printer, you must clean it at the recommended interval. Use the following illustration to locate the parts of your printer to clean.

Make sure to clean the following parts:

- Printhead
- Platen roller
- Paper sensors
- Tear bar
- Printer exterior
- Media compartment



To avoid possible personal injury or damage to the printer, never insert any pointed or sharp objects into the printer.



Use only the cleaning agents specified in this section. Intermec is not responsible for damage caused by any other cleaning materials used on this printer.

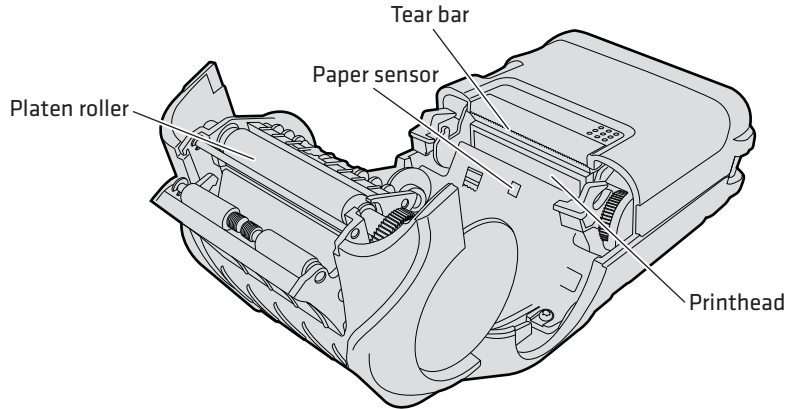

PB22 and PB32 Mobile Label and Receipt Printer: Identifying the parts of the printer to clean regularly

Cleaning the Printhead

Clean the printhead every five rolls of media to prolong the life of the printhead and ensures that you maintain high print quality.

Clean the printhead with the cleaning swab. The cleaning swab is shipped with the printer and can also be purchased separately from www.intermec.com.



Note: The cleaning swab is the recommended method for cleaning the printhead and platen roller. Using other methods for cleaning may damage the printer.

To clean the printhead

- 1 Open the media cover.
- 2 Remove the media and ribbon.
- 3 Use the cleaning swab to dissolve any contamination on the line of heat-emitting objects at the front/bottom of the printhead.
- 4 Wait 30 seconds and carefully rub off any contamination.
- 5 Repeat Steps 4 and 5 if necessary.

- 6 Allow the printhead to dry for a minute or more before loading a new supply of media and ribbon.

Cleaning the Platen Roller

Regular cleaning of the platen roller every five rolls of media prolongs the life of the printhead and ensures that you maintain high print quality.

Clean the printhead with the cleaning swab. The cleaning swab is shipped with the printer and can also be purchased separately from www.intermec.com.



Note: The cleaning swab is the recommended method for cleaning the printhead and platen roller. Using other methods for cleaning may damage the printer.

To clean the platen roller

- Rotate the platen roller and clean it thoroughly with the cleaning swab.

Be sure to clean the following parts using the cleaning swab:

- Paper sensors
- Tear bar

Cleaning the Printer Exterior

Make sure to keep the exterior of the printer clean, this will reduce the risk of dust or foreign particles reaching the inside of the printer and affect printer functionality.

To clean the printer exterior

- 1 Close the media cover.
- 2 Use a soft cloth, possibly moistened with water or a mild detergent and wipe the printer exterior.

Make sure to keep the surface surrounding the printer clean as well.

Cleaning the Printer Media Compartment

- 1 Open the media cover.

Chapter 3 – Troubleshooting and Maintaining the PB22 and PB32

- 2** Remove the media and ribbon.
- 3** Use a brush or air blow the compartment.
Make sure the paper sensors are free of dust.

A

Specifications

Specifications

PB22 Physical Dimensions

Depth:	71.1 mm (2.8 in)
Height:	176.4 mm (6.9 in)
Width:	101.6 mm (4.0 in)
Weight:	678 g (1.5 lb) with battery

PB32 Physical Dimensions

Depth:	81.6 mm (3.2 in)
Height:	182.2 mm (7.2 in)
Width:	127.6 mm (5.0 in)
Weight:	828 g (1.8 lb) with battery

PB32 Physical Dimensions

Depth:	81.6 mm (3.2 in)
Height:	182.2 mm (7.2 in)
Width:	127.6 mm (5.0 in)
Weight:	828 g (1.8 lb) with battery

Power Specifications

AC power adapter voltage:	100 to 240 V, 47 to 63 Hz
Printer voltage:	12 VDC, 4.15 A
Operating power:	Rechargeable 7.4 V 2300 mAh (typical) lithium-ion battery

Temperature and Humidity Specifications

Operating temperature:	-15°C to 50°C (-5°F to 122°F)
Storage temperature:	-30°C to 70°C (-22°F to 158°F)
Charging temperature:	0°C to 45°C (32°F to 113°F)

Temperature and Humidity Specifications

Relative humidity:	10 to 90% non-condensing
Sealing:	IP54 is used. Paper path and card reader slots are excluded from IP54.

Memory

RAM:	16 MB
Flash:	64 MB

Print Speed and Resolution

Print speed:	4 ips (100 mm/s)
Resolution:	203 dpi (8 dots/mm)

Media Specifications

Minimum black mark length:	3.17 mm (0.125 in)
Minimum black mark, and notch length:	12.7 mm (0.50 in)
Minimum notch length:	6.35 mm (0.25 in)
Minimum notch width:	12.7 mm (0.50 in)
Black mark width:	Full width of media
Core inside diameter:	19.05 mm (0.75 in)
Roll outside diameter:	PB22 57.15 mm (2.25 in) PB32 67.31 mm (2.65 in)
Tracking	Center
Maximum caliper for tags:	0.15 mm (0.006 in)
Minimum media length:	12.7 mm (0.5 in)
Maximum media length:	Continuous

Receipt roll stock media is supplied as a continuous roll. Tag, and fanfold media use repeat indicators for non-continuous media. Gap, notch, and black marks are used as repeat indicators:

Appendix A – Specifications

- **Notch:** Tag media
- **Black mark:** Tag, and fanfold media

Here are a few things to keep in mind when ordering media for the printer:

- Black marks are detected only on the back (non-thermally sensitive) side of the media.
- You can use higher caliper media in the printer, but print quality will be reduced.
- Receipt roll stock media has an end of roll indicator. The end of roll indicator is a red marking on the front (thermally sensitive) side of the paper, usually on the last three feet of the roll.

External Fanfold Media Specifications

Stack height:	70 mm (2.75 in)
Page length:	152 mm (6 in) to 305 mm (12 in)



Note: A 6-inch page length is supplied in 12-inch long stacks (two 6-inch stacks of equal height with the bottom page linked).

Specialty media is required for unique customer environments, including printer operating temperature extremes. Intermec recommends that you test the media in your application.

Supported Media

The printer supports direct thermal label, tag, and receipt media. Both North American and European label media are supported in multiple label lengths. Receipt media is supported in both a top coated and an uncoated paper in continuous roll stock only.



Note: For help to configure the printer for coated media (floodcoated media), see **“Printing on Floodcoated Media” on page 19**.

The default media sensitivity number is: 180.

Use the following table as a guide when setting sensitivity numbers.

Recommended Media Sensitivity and Constant

Sensitivity	Constant	Description
North American Label Media		
720	60	Duratherm Lightning Plus
470	52	Duratherm Lightning Perm
450	48	Duratherm III IR
430	100	Duratherm III Synthetic
180	80	Duratherm II Label
180	80	Duratherm III Label
180	80	Duratherm Near IR
150	70	Duratherm 5 mil Tag
North America Receipt Media		
401	85	Duratherm TC
102	32	Duratherm NTC - 2
101	30	Duratherm NTC
104	80	Duratherm Receipt - Fanfold
103	100	Duratherm Linerless
430	100	Duratherm II Floodcoated (NTC)
180	80	Duratherm III Floodcoated (TC)
180	80	Duratherm III NIR Floodcoated (FedEx)
European Label Media		
440	47	Thermal Eco
140	70	Thermal Top
120	47	Thermal Eco Board 140 gr

Interfaces

This section describes the standard interfaces available on the PB22 and PB32 printers.

RS-232 Serial Interface

Use the following tables and graphics to understand the default settings of the serial port.

Default Settings of the Serial Port

Parameter	Default Setting
Baud rate	115200
Character Length or Data Bits	8
Parity	None
Stop Bits	1
Handshaking	none (Fingerprint) XON/XOFF (IPL)

The illustration below shows printer end of the serial cable.

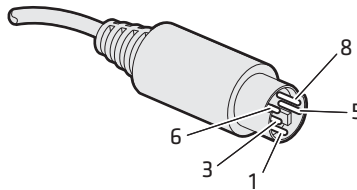

Serial Cable (Printer End)

Serial Cable Pins and Descriptions (Printer End)

Pins	Signal	Description
1	HHC RXD	Receive data from host (input)
3	HHC CTS	Clear to send from printer (output)
5	HHC RTS	Request to send from host (input)
6	HHC TXD	Transmit data to printer (output)
8	GND	Ground

The illustration below shows the PC end of the serial cable.

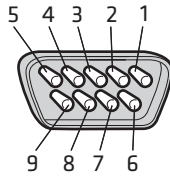

RS-232 Serial Cable DB9 Pins

Serial Cable Pins and Description (PC End)

Pin	Signal	Description
1	DCD	Data carrier detect
2	RXD	Receive data from host (input)
3	TXD	Transmit data to printer (output)
4	DTR	Data terminal ready
5	GND	Ground
6	DSR	Data set ready
7	RTS	Request to send from host (input)
8	CTS	Clear to send from printer (output)
9	RI	Ring indicator

USB Interface

To use the USB interface to print from a PC, you need to have the Intermec InterDriver printer driver installed on your PC. For help setting up USB communications, see **“[Connecting the Printer Through the USB Interface](#)” on page 30.**

Appendix A – Specifications

The USB cable that ships with the printer has a USB Type A connector on one end to connect to the PC and a USB Type B connector on the other end to connect to the printer. You do not need to configure communications for the USB port.

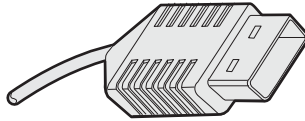

USB Type A Connector

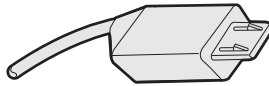

USB Type B Connector

Accessories

You can use these accessories with the printer. To order accessories, contact your local Intermec sales representative.

AB27 Battery

Use the 7.4 V 2300 mAh (typical) lithium-ion battery to provide power to the printer.

Power Supply (Model AE19)

Provides power to the printer and the 4-bay battery charger (Model AC18).

AC18 4-Bay Battery Charger

Use the AC18 to charge up to four batteries at a time. The battery charger is designed to sense when a battery is fully charged and not overcharge it, ensuring long and consistent battery life.

AV14 Vehicle Dock

Use the vehicle dock to attach the printer to a truck.

Cart Mount

Stands the printer vertically when placed on a flat surface. Excellent for cart or desktop use.

Belt Clip

Use the printer belt clip to attach the printer to your belt.

Handstrap

Use the printer handstrap to conveniently carry your printer. With the handstrap attached, you can also attach the shoulder strap.

Intermec Cleaning Swab

Use the Intermec cleaning swab to clean the printhead and platen roller. One cleaning swab is included in the box with the printer. You can also purchase the cleaning swab from www.intermec.com.

Media

You can use tag, label, or receipt media with the printer. Printer media does not ship in the box with the printer but may be purchased from www.intermec.com.

Media Core

Use the media core to hold the media in place. By default the 0.75 in media core ships with the printer. You can also order the 0.4 in media core separately.

Printhead Cleaning Pen

Use the cleaning pen to clean the printhead.

Protective Case

Use the protective case to transport and store your printer. The protective case keeps the printer free of dust, dirt, and moisture and still provides easy access to the printer for printing.

Shoulder Strap

Use the shoulder strap in combination with the handstrap to easily carry the printer. The wide padded strap makes it comfortable to wear the printer for long periods of time

Serial Cable

The serial adapter is an 8-pin DIN to DB9 connector that connects from the printer to your desktop PC.

B

Default Settings

Factory Default Settings (Fingerprint Printers)

Factory Default Settings for Fingerprint Printers

Setting	Default Value
Xstart	0
Display	
Orientation	Normal
Contrast	Medium
Media	
Width	Printhead width
Length	1200
Test feed mode	Fast
Type	Variable length strip
Contrast	0%
Xstart	0
Label constant	80
Label factor	40
Print definitions	
Clip default	Off
Print speed	75 mm/s
Feed adjust	
Start adjust	0
Stop adjust	0
Power	
Low battery indicator	7.4 V
Sleep timer	20 sec
Standby timer	30 min
Bluetooth	
Discoverable	Enable
Connectable	Enable
Encryption	Disable
Authentication	Disable

Factory Default Settings for Fingerprint Printers (continued)

Setting	Default Value
Reserve printer	Disable
Device name	1-16 characters
Passcode	1234

Factory Default Settings (IPL Printers)**Factory Default Settings for IPL Printers**

Setting	Default Value
Auto detect printer	Enable
Display	
Orientation	Normal
Contrast	Medium
Print engine emulation mode	None
Media	
Form adjust dots X	0
Form adjust dots Y	0
Test feed mode	Fast
Media type	Continuous
Darkness	0
Sensitivity	180
Print speed	3 ips
Power	
Low battery indicator	7.4 V
Sleep timer	20 sec
Standby timer	30 min
Ser-Com	
Baud rate	115200
Data bits	8
Parity	None
Stop bits	1

Factory Default Settings for IPL Printers (continued)

Setting	Default Value
Protocol	XON/XOFF
Network	
IP selection	DHCP and BOOTP
IP address	0.0.0.0
Netmask	0.0.0.0
Default router	0.0.0.0
Name server	0.0.0.0
MAC address	Unique
Bluetooth	
Discoverable	Enable
Connectable	Enable
Encryption	Disable
Authentication	Disable
Reserve printer	Disable
Device name	1-16 characters
Passcode	1234

Factory Default Settings (ESC/P Printers)

Factory Default Settings for ESC/P Printers

Setting	Default Value
Auto detect printer	Enable
Media dark adjust	100
Print speed	75 mm/s
Power	
Low battery indicator	7.4 V
Sleep timer	20 sec
Standby timer	30 min
Bluetooth	
Discoverable	Enable

Factory Default Settings for ESC/P Printers (continued)

Setting	Default Value
Connectable	Enable
Encryption	Disable
Authentication	Disable
Reserve printer	Disable
Device name	1-16 characters
Passcode	1234
Serial-Com	
Baud rate	115200
Data bits	8
Parity	None
Stop bits	1
Protocol	XON/XOFF
Network	
IP selection	DHCP and BOOTP
IP address	0.0.0.0
Netmask	0.0.0.0
Default router	0.0.0.0
Name server	0.0.0.0
MAC address	Unique

Appendix B – Default Settings

C

IPL and Fingerprint Setup Menus

IPL Setup Menu

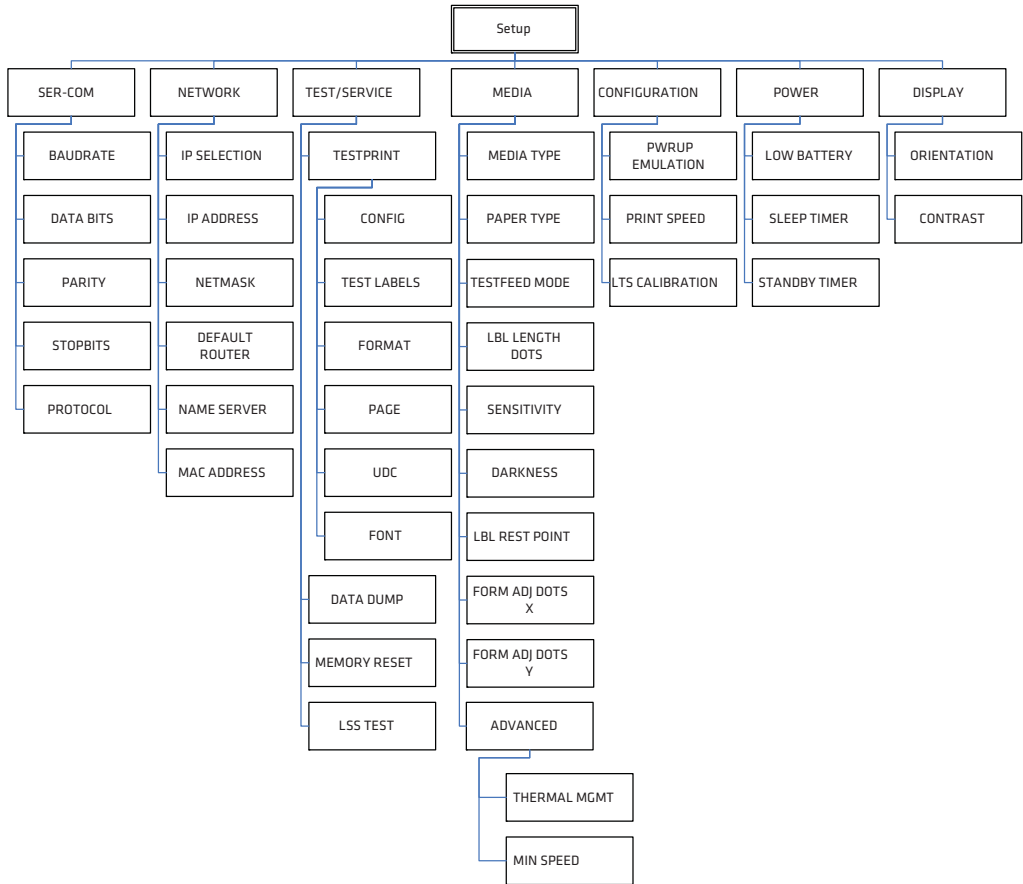

Fingerprint Setup Menu

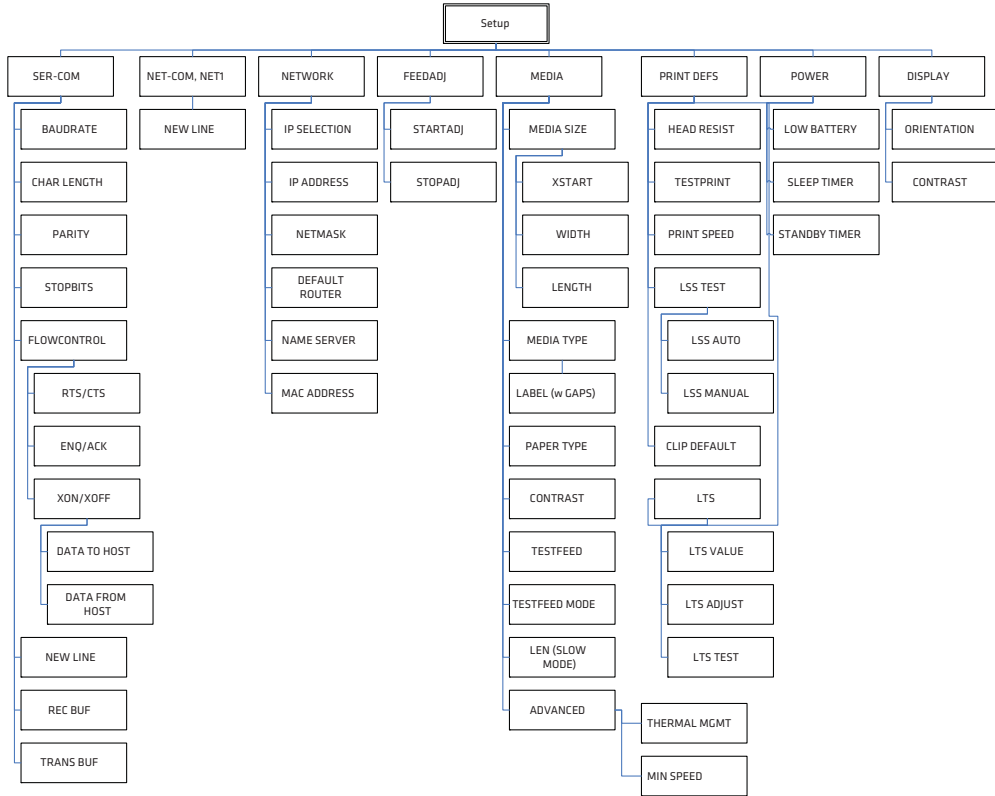

Appendix C – IPL and Fingerprint Setup Menus



Index

Numerics

- 802.11
 - radio icons, understanding [37](#)
 - setting up communications [34](#)

A

- AB27 battery [74](#)
- AC18 battery charger [13](#), [74](#)
- accessories
 - AB27 battery [74](#)
 - AC18 battery charger [74](#)
 - AV14 vehicle dock [74](#)
 - belt clip [75](#)
 - cart mount [74](#)
 - handstrap [75](#)
 - power supply [74](#)
 - serial cable [75](#)
 - shoulder strap [75](#)
- AV14 vehicle dock [74](#)

B

- backlight, understanding [10](#)
- batteries
 - AC18 charger [13](#)
 - charging [13](#)
 - charging time [11](#)
 - extending life [14](#)
 - installing [11](#), [12](#)
 - status icons [13](#)
 - using [11](#)
- Bluetooth communications [33](#)
- button functions [4](#)

- C**
 - cleaning the printer 62
 - cold boot 62
 - communication problems 60
 - using Dump mode in IPL 61
 - using the line analyzer in Fingerprint 60
 - communications
 - setting up 802.11 radio communications 34
 - setting up Bluetooth radio communications 33
 - wireless printing with Fingerprint 40
 - wireless printing with IPL 38
 - configuration settings display modes 20
 - configuration settings
 - changing 42
 - configuration settings
 - changing from printer home page 44
 - changing using the command line
 - HyperTerminal, sending printer commands 43
 - changing with PrintSet 43
 - changing with SmartSystems 45, 50
 - connecting to the printer using USB 30
 - control panel features 4
- D**
 - default settings
 - ESC/P printers 80
 - Fingerprint printers 78
 - IPL printers 79
 - display modes
 - error 23
 - information 20
 - pause 21
 - ready 20
 - setup 21
 - test 23
 - downloading fonts and graphics 54
- E**
 - error messages and icons
 - door open 58
 - field out of label 57
 - IP configuration error 57
 - IP link error 57
 - LSS too high/low 57
 - out of paper 57
 - pause 57
 - printead hot 57
 - upgrading 57
 - Error mode 23
 - ESC/P
 - change printer language 8
 - default settings 80
 - setup commands 26
- F**
 - Fingerprint
 - change printer language 7
 - configuring wireless printing 40
 - default settings 78
 - setup menu 25, 85
 - WEP
 - authentication,configuring to use 40
 - WPA/WPA2
 - authentication,configuring to use 41
 - WPA-PSK/WPA2-PSK
 - authentication,configuring to use 41
 - firmware upgrade
 - cold boot 62
- H**
 - HyperTerminal
 - upgrade firmware using 51
 - view IPL commands 43
- I**
 - Information mode 20
 - IPL
 - change printer language 8
 - configuring wireless printing 38
 - default settings 79
 - setup commands 26
 - setup menu 84
 - view commands as you type 43
 - WEP
 - authentication,configuring to use 38
 - WPA/WPA2
 - authentication,configuring to use 39

- WPA-PSK/WPA2-PSK authentication, configuring to use 38
- L**
- language, see printer language
 - load media 15
- M**
- media
 - loading 15
 - recommended sensitivity and constant 71
 - supported 70
 - media specifications 69
- P**
- Pause mode 21
 - power specifications 68
 - print speed and resolution 69
 - printer
 - backlight 10
 - charging batteries 13
 - cleaning 62
 - cold boot 62
 - communication problems 60
 - configuring 42
 - control panel 4
 - default settings 78
 - downloading fonts and graphics 54
 - features 2
 - home page 44
 - languages, choosing 6
 - loading media 15
 - memory 69
 - parts 2
 - printing a test page 26
 - Ready-to-Work indicator 6
 - soft keys 5
 - sounds, understanding 10
 - specifications 68
 - troubleshooting problems 58
 - using the batteries 11
 - using the buttons 4
 - printer language
 - change using ESC/P 8
 - change using Fingerprint 7
 - change using IPL 8
 - change using PrintSet 7
 - PrintSet
 - change printer language 7
 - changing configuration settings 43
 - downloading fonts and graphics 54
 - upgrade firmware using 45
- R**
- Ready mode 20
 - Ready-to-Work indicator states 6
- S**
- setup commands
 - ESC/P 26
 - IPL 26
 - setup menu
 - Fingerprint 25, 85
 - IPL 84
 - Setup mode 21
 - SmartSystems, changing configuration settings 45, 50
 - soft keys, using 5
 - sounds, status 10
 - specifications
 - external fanfold media 70
 - media 69
 - memory 69
 - physical dimensions 68
 - power 68
 - print speed and resolution 69
 - supported media 70
 - temperature and humidity 68
- T**
- temperature and humidity specifications 68
 - Test mode 23
 - test page, printing 26
 - troubleshooting
 - communication problems 60
 - contacting product support 56
 - error messages 56
 - printer problems and solutions 58
 - using Dump mode in IPL 61
 - using the line analyzer in Fingerprint 60
- U**
- upgrading firmware
 - using HyperTerminal 51
 - using PrintSet 45
- USB

Index

- connecting to the printer 30
- W**
- WEP authentication
 - configuring with Fingerprint 40
 - configuring with IPL 38
- WPA/WPA2 authentication
 - configuring with Fingerprint 41
 - configuring with IPL 39
- WPA-PSK/WPA2-PSK authentication
 - configuring with Fingerprint 41
 - configuring with IPL 38



Worldwide Headquarters
6001 36th Avenue West
Everett, Washington 98203
U.S.A.

tel 425.348.2600

fax 425.355.9551

www.intermec.com

© 2011 Intermec Technologies
Corporation. All rights reserved.

PB22 and PB32 Mobile Label and Receipt Printer User's Guide



P/N 934-046-004