



# PRODUCT PORTFOLIO EMEA



INJECTION | MASSAGING | BRINE PREPARATION | PORTIONING | COATING | FRYING | COOKING  
SEARING | GRILLING | PROOFING | CHILLING | FREEZING | X-RAY TECHNOLOGY  
STEAMING TECHNOLOGY | HIGH PRESSURE PROCESSING | TRAY SEALING TECHNOLOGY

## Table Of Contents

Injection, Massaging, Brine preparation .....	3 - 8
Portioning Systems.....	9 - 13
Coating Systems.....	14 - 21
Frying/Filtering.....	22 - 27
Cooking/Searing and Grill-Marking.....	28 - 33
Spiral Freezers.....	34 - 43
Impingement Freezers.....	44 - 47
IQF Freezers.....	48 - 51
LVS Refrigeration System.....	52
Crust Freezer.....	53
Inspection.....	54 - 55
More solutions from JBT .....	56 - 57
FTNON.....	58 - 59
AVURE.....	60 - 61
PROSEAL Tray Sealing.....	62 - 67
Food Technology Centres .....	68 - 69
Customer Care.....	70 - 74

# Patented technologies for every stage of the food processing chain

JBT supplies technology solutions for the global food industry, offering integrated solutions across the entire food processing continuum, from meat, seafood and poultry, to fruit and vegetables, baked goods, and convenience foods.

We can provide you with flexible, customised solutions for injection, massaging, brine preparation, portioning, coating, frying, cooking, baking, chilling, freezing and inspection that run like clockwork, deliver maximum uptime, match your toughest hygiene demands and make your processing profitable.

Our range of food processing technologies includes the **Schröder™** injection, massaging and brine preparation systems, **DSI®** portioning systems, **Stein®** coating and frying equipment, the **Double D®** range of impingement cookers and searer/grill-markers, **Formcook®** contact and combi cookers, **XVision™** inspection technology and the world-leading **Frigoscandia®** freezer systems, which have been leading the way in freezing technology for over 50 years. More solutions from JBT are **FTNON** Specialists in Fresh Cut and Thermal Food Processing, **AVURE** High pressure processing (HPP) systems, **Proseal** Environmentally-friendly Packaging Systems.

In this brochure you will find information on the complete JBT cooking and freezing portfolio, with at-a-glance information, application options and detailed specifications to help you identify the best equipment to meet your requirements. All JBT equipment in this brochure can be provided as stand-alone, or as part of a fully integrated in-line production process.

We stand by the reliability and payback of our products and invite you to test our equipment at our Food Technology Centres in Helsingborg in Sweden, and near Edinburgh in the UK. Here, you can simulate production, conduct research, train your technicians, or preview the latest processing equipment with the supervision of a trained technical team.

To find out more, talk to your local JBT representative or email: [info-europe@jbtc.com](mailto:info-europe@jbtc.com)



**We're with you, right down the line.™**





# Injection, Massaging, Brine preparation



# Schröder Marination Technology

## Injection technology

The processing principle of the IMAX technology is based on classic injection curing by means of hollow needles. This is where know-how regarding needle type, inlet and exit holes and needle stitch pattern plays a decisive role. The brine/emulsion to be injected is carried directly to the product by a system of pumps and pipes.

Pork, beef, boneless products, bone-in meat, poultry and fish can be injected.



## Massaging technology

The operating principle of MAX technology is based on the horizontal mounting of a rotating paddle shaft in the fixed container. The massage effect is achieved by the spirally arranged paddles. They work directly in the meat mass and thus bring the mass energy directly to the muscle. The specific paddle positions generate a horizontal and vertical flow of material within the tank. This results in a uniform and effective massaging action, which is additionally supported and accelerated by the high degree of filling of the system



## Brine preparation

BRIMAX technology allows the production of all types of brine used in injection, massing and/or tumbling procedures, whilst maintaining a standardised product quality under the most stringent hygiene requirements. A unique feature is the software, which has been developed and refined using years of experience, that performs, controls and documents the entire system, as the operator.



*Each machine from Schröder is designed to provide the optimal solution for its individual task. At the same time, they are also designed to function as modules. Integrated solutions with high degrees of automation require adaptability and connectivity from each individual machine. Intelligent networking capability. These aspects are an integral part of each of our modules. The machines are controlled and monitored by VISMAXpro, the in-house SCHRÖDER software, which can also be connected to ERP systems such as SAP. The systems are designed individually, and fulfil increasing customer demands for complex production lines.*



# Injection

## Schröder IMAX

A new benchmark in injection technology. What sets us apart is our knowledge of the perfect combination of components. Whether manifolds, injection needles, pumps or brine feeds – each component is researched in detail, designed and coordinated to work seamlessly together. In conjunction with intelligent electronics, this combination guarantees the following:

- High levels of performance and precise injection accuracy
- Optimal brine distribution in the product
- High product yields
- Optimal adaptation to recipes and products
- Flexible configuration for process and production conditions

### Options:

- Tenderizer head
- Meat-in Meat injection (HVB)
- Integration in process visualization software VISMAX
- In-line weighing



# Massaging

## Schröder MAX

Massage technology for increased productivity. This is the key to higher water retention and a higher yield at the slicer through better slice cohesion. Available sizes from 600 kg up to 6.000 kg. Thanks to active massaging of the meat using special paddles, Schröder MAX technology allows the following in an extremely short period of time.

- Intra- and extramuscular protein activation
- Significantly improved water retention
- Active incorporation of brine in an extremely short time
- Efficient utilisation of drum capacity

### Options:

- Different paddle styles for softer/harder treatment
- Integrated weighing system
- Automatic lubrication
- FlowMAX automatic discharging system



# Brine preparation

## Schröder BRIMAX



Special brine preparation system for mixing, cooling and holding the brine for the marination process.

The thorough preparation of brine is a critical part of the overall injection and processing concept. This is much more than simple mixing. Electronically controlled and monitored processes, individually configured recipe programs, effective cooling and independent additive intake guarantee the following:

- Standardization of brine making process
- Swift insertion of additives
- Homogenous mixing process
- Repeat accuracy for recipes
- Effective cooling

### Options:

- Agitator
- Shear pump for difficult soluble additives, such as potato starch, vegetable proteins etc. and reduces the mixing times of all brines
- Cleaning nozzles
- Pipe-heat exchanger for heavy brines



Operational		Kassierkarte		04/14/2018		13:59:00	
Component	Description	Set weight (kg)	Act weight (kg)				
1	Fresh water	750.000					
2	Salz	100.000					
3	Laktat	50.000					
4	Phosphat	00.000					
5							
6							
7							
8							
	<b>Target total weight</b>	<b>Target actual weight</b>	<b>Component target weight</b>	<b>Component actual weight</b>	<b>Component residual weight</b>		
	1000.0 kg	0.0 kg	0.000 kg	0.000 kg	0.000 kg		

Operational		cooked ham		04/20/2018		14:00:24	
		00.00	00.00	mm:ss	Mixing		
					Stirring		
		0.0	0.0	°C	Cooling		
					Water		
		0.0	750.0	mS/cm	consumer	Vibration	
							Home

# Other Marination Equipment



T-MAX 620



MacMAX 500



PSM 650

## Schröder PREMAX

For the production of high-quality cooked ham, massaging the muscles is an important part of the process. Protein is activated which ensures optimum bonding. This process supported by the Schröder PREMAX machines for mechanical treatment.

### PSM 650 – Curing press

Processing muscles with a hard structure needs special attention, the lack of flexibility makes the forming and filling process more difficult. In order to balance out the different muscle textures, the PSM 650 is used. The roller pairs break down the internal structures without destroying the surface.



PSM 650



T-MAX 620



MacMAX 500

### T-MAX 620 – Needle tenderiser

The Schröder TMAX needle tenderizer penetrates the entire muscle. Its blade-like sharpened tips cut through the fibres of the muscle and shorten them in the process. Replacing the injected brine during the fibre process is then possible, the distribution is optimized and the muscle is also perfectly prepared for absorbing the protein during massaging

### MacMAX 500 – Roller Tenderiser

The blade rollers cut into the surface, enlarge it and increase the output of protein. The MacMAX also cuts large tendons which reduces muscle contraction during cooking.

## Schröder HAMAX

The clever way of filling large cuts of meat. This is the optimal method of combining muscles of different sizes, such as racks of pork, beef roulade or pork bellies. The cuts of meat are calibrated and cut to an individually selectable uniform product length, regardless of the size of the cut.

- Up to 1.2 tons per hour (pork loins)
- Efficient High Risk/Low Risk control
- Use plastic casings and nettings
- Exact caliber filling with defined filling lengths
- Cut losses reduced by up to 50 %
- Casing consumption reduced by up to 30 %
- Prepared for connection to a double-clipping machine



Hamax 800





A photograph of a white ceramic ramekin filled with a thick, red sauce, likely ketchup or barbecue sauce. In the foreground, three golden-brown, breaded chicken tenders are arranged on a dark, textured surface. The tenders are slightly overlapping and have a crispy, textured coating. A small green garnish is visible behind the tenders. The background is dark and out of focus.

# Portioning Systems

# Portioning Systems



## DSI® 800 Series Portioner

The 8 cutter Portioning System from DSI delivers groundbreaking functionality and versatility in a compact, cost-effective and easy-to-use package.

### Designed for:

High volume portioning; a precision machine for intense, high-accuracy cuts, using a new generation scanner for effortless all-in-one fat trimming.

### Key features:

- High yield
- Reduced labour
- More throughput
- Matches your product mix and orders on any given day

### Applications:

- Whole muscle chicken strips and tenders
- Nuggets and double-weight portions
- Chicken thigh meat chunks/portions
- "Perfect" fat-free retail portions
- QSR specific portions
- Red meat fat trimming and portioning
- Pork belly trimming
- Fish portioning
- Baked goods (pizza, pies etc.)

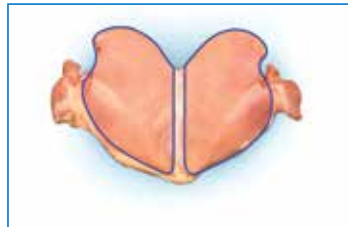

*Fat trim*



*4 portions per whole breast  
(Shape it with "bun" coverage control)*

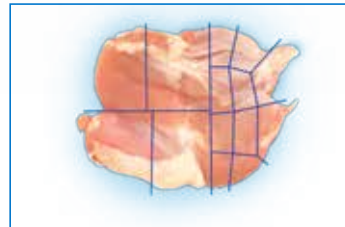

*Thigh steaks with shots*



*Mini strips with portion*



*Sirloin fat trim, both sides*

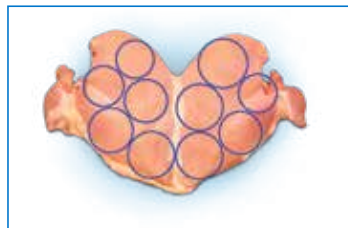

*Medallion cut*



*Magnolia blossom cut*



*Tail portions with  
fat-trimmed nuggets*



*Half-breast strips with nuggets*



*Pork belly trimming*



## DSI® Adaptive 3D Portioning™ System



The DSI Adaptive 3D Portioning™ System is a precise horizontal band saw slicer, which divides the input product into an upper and a lower portion.

### Designed for:

Horizontal slicing to achieve portion weight or equal weights.

### Key features:

- Adapting to the shape and size variation on unsorted incoming product to maximise yield
- Slicing product optimally and only when necessary
- Slicing more consistently
- Directing each product to its best use
- Generating more full membrane portions

### Applications:

- Adaptive 3D portioning
- Achieve 2, 4, 6 or more portions per butterfly by combining the A3D with our water jet portioning system

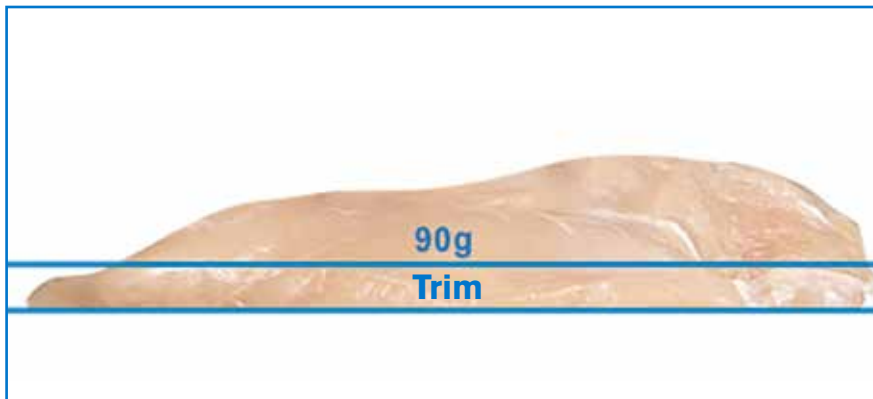

*Slice to achieve portion weight*

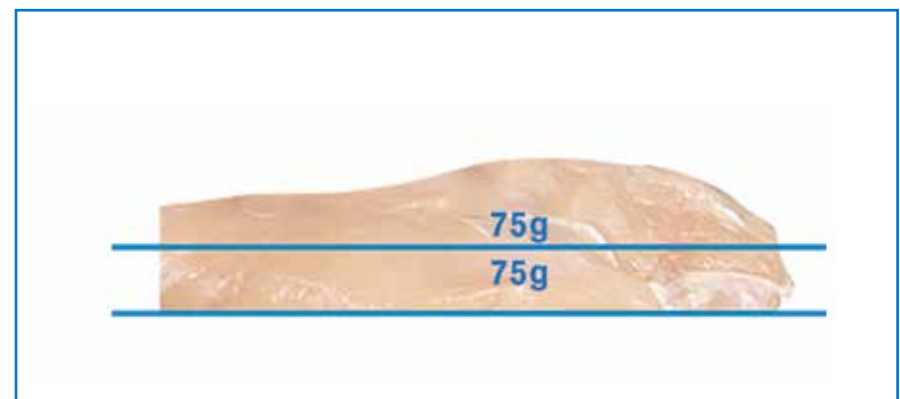

*Slice to equal weights*

# Portioning Systems

## DSI® DB20 Dual-Blade Portioning System



The DSI DB20 Dual-Blade Portioning System delivers superior scanning with a single, high-performance sensor that continuously self-calibrates while detecting product shape as well as fat vs. lean.

### Designed for:

Simple linear poultry and fish portioning applications; a perfect solution for plants that may have water, noise or electrical power restrictions.

### Key features:

- Low-maintenance blade portioner
- DSI Q-LINK portioning software
- Sophisticated yield optimisation software
- Suitable for a wide range of linear portioning applications
- Dual-lane system can run a separate application on each lane

### Applications:

- Poultry
  - ▶ Tenders split to equal weights
  - ▶ Weight-controlled tenders with nuggets
  - ▶ Thigh rectangular steak
  - ▶ Kakugiri
  - ▶ Linear fat trim and keel removal with dimensional strips
  - ▶ Dimensional strips
  - ▶ Half-breast strips
  - ▶ Half-breast shots
  - ▶ Angle-cut tail portions with strips
- Fish portioning

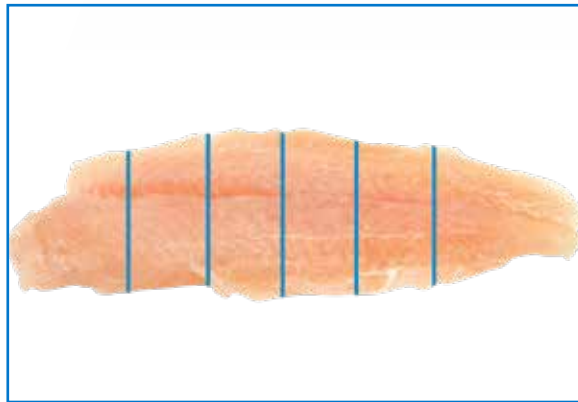

*Cod portions*



*Half-breast strips*

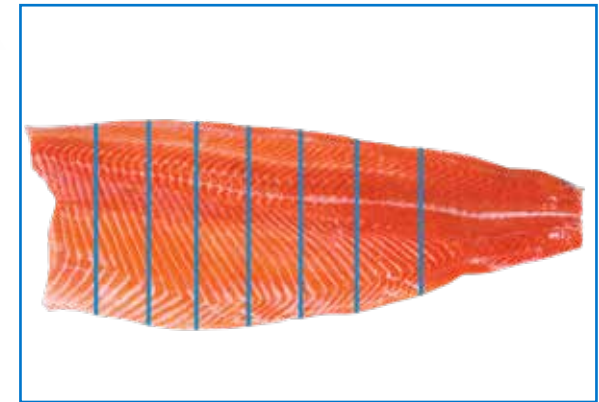

*Salmon portions*



## DSI<sup>®</sup> Waterjet portioning

*More possibilities than you ever imagined*



A close-up photograph of several pieces of golden-brown, fried chicken, including a drumstick and a thigh, resting on a bed of fresh green and red leafy salad. The background is a plain, light color.

# Coating Systems



# Stein<sup>®</sup> high performance coating systems

## From the inventor of coating equipment

JBT's range of Stein<sup>®</sup> coating systems are synonymous with continuous, conveyerised batter and breading applications. Since introducing the first commercially successful batter and breading applicator in 1955, the Stein brand has continued to lead the industry with innovative and robust equipment, and now has the largest installed base of coating systems in the world.

The main features and benefits of the Stein coating systems are:

Quality



Flexibility



Consistency



*JBT offers a wide selection of specialised batter and breading applicators in a variety of sizes to meet virtually any application or capacity requirement.*

# Coating Systems

## Stein® Ultra V™ Batter Applicator



Conveyorised batter applicator with top submerger hold down, for total immersion-style application or batter trough for overflow-style application with a batter recirculation pump.

### Designed for:

Applying standard or leavened batters to a wide range of food substrates prior to a breading or frying step.

### Key features:

- Variable speed drive 0 – 18 m/min
- Adjustable top submerger with 2-curtain overflow
- Infeed conveyors for ease of product transfers from predest or first breading application
- Centrifugal recirculation batter pump and batter blow-off features, to maintain desired pickup and weight. Can be used in conjunction with automated batter mixer

### Options:

- Infeed conveyor extensions
- Positive displacement batter recirculation pump
- Electric or hydraulic drives
- Push button or PLC controls
- Usable belt widths of 600 and 1,000 mm
- Jacket tank for batter temperature control
- Tie bar connections

## Stein® T-1 Tempura Batter Applicator



Conveyorised batter applicator with a top submerger conveyor for immersion-style application.

### Designed for:

Applying heavy (viscous) leavened tempura-style batters to a wide range of food substrates prior to the frying step.

### Key features:

- Variable speed drive 0 – 18 m/min
- Infeed conveyors for ease of transfer from predest step
- Batter blow to maintain desired pickup and weight

### Options:

- Main belt discharge options for specific products to effectively transfer into fryer
- Available in electric or hydraulic drives
- Push button controls
- Usable belt widths from 400 mm to 1,000 mm
- Tie bar connections

## Stein® Ultra V™ Batter Mixer



Semi-automated batch-style batter mixer.

### Designed for:

Mixing conventional non-leavened and leavened batters for small to medium coating lines.

### Key features:

- Metric design
- Large mixing impeller for effective mixing
- Push button controls
- Manual water valve and tank-mounted scale
- Centrifugal batter transfer pump

### Options:

- Automatic water flow meter
- Cooling jacket
- PLC control with positive displacement batter transfer pump
- 100 L or 200 L tank size
- Variable speed mixer for delicate batter
- Tempura-style impeller

## Stein® ProMIX™ Batter Mixer



Fully automatic, continuous batter mixer.

### Designed for:

Mixing and maintaining constant viscosity and temperature for conventional batters. Batter is continuously recirculated between mixer and batter applicator.

### Key features:

- Shaft driven (1,800 RPM) single impeller mixer
- Pressure transducer-style viscosity control
- Automatic dry mix feed
- Automatic water feed
- 17 kW refrigeration coils in mixing tank, centrifugal batter transfer pump
- Mixes up to 1400 kg/hr of batter

- 200 L mixing tank
- Touch screen interface

### Options:

- Brookfield viscometer viscosity control
- Positive displacement-style batter transfer pump



# Coating Systems



## Stein® TM-3 and TM-4 Tempura Batter Mixer

Semi-automated batch-style batter mixer.

### Designed for:

Mixing highly leavened and viscous tempura-style batters and delivering mixed batter to tempura-style batter applicators.

### Key features:

- Gentle mixing action
- Adjustable speed orbiting/rotating cage-style mixer
- 120 L water tank with automatic and adjustable water feed to maintain dry mix/water ratio
- Dry mix hopper 1 or 2 bags (25 kg - 50 kg) with automatic dry mix feed
- 17 kW refrigeration mix-tank with cooling jacket and automatic positive displacement batter feed pump
- Batter applicator level probes

### TM-3

- Hydraulic drives
- Push button controls

### Options:

- Electric drives
- PLC controls



## Stein® Ultra V™ Breeding Applicator

Versatile breeding applicator that can be converted from flour to bread crumb application in minutes.

### Designed for:

Application of flour, free-flow and J-crumb\* coating materials to a wide range of food substrates while maintaining full belt width, product orientation and gentle product handling. Can be used as first step predest or final breeding application.

### Key features:

- Independent main product belt variable speed drive 3 - 21 m/min
- Easy set up for a large range of applications
- Simple operation, minimal adjustments required
- Robust direct drivers for reduced maintenance
- Hygienic design

### Options:

- PLC controls
- Electric or hydraulic drives
- Usable belt widths 600 and 1,000 mm
- Electric blower on machine or external blower
- Dust extraction connections

\* also known as Japanese crumb

## Stein® 100 Series Flour Applicator



Conveyorised flat bed flour applicator. Available with level glide or flip discharge.

### Designed for:

Application of flour or granular free-flow coating materials to a wide range of food substrates while maintaining full belt width, product orientation and gentle product handling. Can be used as first step predust or final breading application.

### Key features:

- Electrical variable speed drive 4.6 - 12 m/min
- Push button controls
- Rotating vibrator to remove excess coating material
- Sifter conveyor to remove lumps from circulation
- Sprinkle conveyor to guarantee uniform pick-up
- Electrical blower on machine

- Adjustable lower coating bed depth, adjustable top flow hopper discharge and breading sifter
- Adjustable pressure roll and breading blow-off tubes

### Options:

- Tie bar connections
- Off-machine blower
- Electric or hydraulic drives
- Usable belt widths of 400 and 600 mm

## Stein® E™ Series Breading Applicator



Breading applicator for free-flow and J-crumb\*. Unique circulation system for maximum crumb size retention.

### Designed for:

Application of granular free-flow and J-crumb\* coating materials to a wide range of food substrates while maintaining full belt width, product orientation and gentle product handling.

### Key features:

- Electric variable speed drive 4.6 - 12 m/min
- Push button controls
- Adjustable lower coating bed depth, adjustable top flow hopper discharge and breading sifter
- Adjustable pressure roll and breading blow-off tubes

### Options:

- Hydraulic drives
- Usable belt widths of 400 and 600 mm
- Tie bar connections
- Off-machine blower
- Sifter conveyor to remove lumps from circulation (400 mm)
- J-crumb\* circulation kit to control crumb size distribution

\* also known as Japanese crumb

# Coating Systems

## Stein® 5-Star HomeStyle™ Flour Applicator

A uniquely designed breeder which applies an appealing home-style surface texture with consistency and high quality.

### Designed for:

Application of flour coating materials to a wide range of food substrates while maintaining full belt width, product orientation and providing a unique home-style surface texture. Can be used as first step pre dust or final breading application.

### Key features:

- 5 unique vertically-stacked stainless steel star rollers provide tumbling action in coating process
- Independent main product belt variable speed drive 3 - 18 m/min
- Push button controls
- Improve product quality and consistency
- No product distribution required due to full line width
- Handles all flour due to augerless circulation
- Independent drives for transfer conveyor, star rollers rotational speed and discharge conveyor
- Adjustable pressure roll and breading blow-off tubes

- Easy to operate
- Easy to clean
- Electric blower
- Rotating vibrator

### Options:

- Off-machine blower
- Rotating belt vibrator speed
- Electric or hydraulic drives
- Tie bar connection
- Usable belt widths of 600 and 1,000 mm





## Stein® Drum Breeding 4 Xtra™ Applicator

Continuous rotary drum dry-breeding material applicator with tumble-style coating application, for a home-style product.

### Designed for:

Application of flour or free-flow coating material to a variety of irregular shapes such as bone-in poultry, vegetables, whole muscle chicken pieces, shrimp and calamari. Can aggressive tumbling action during the coating process can be applied to products that tolerate this process.

### Key features:

- Variable speed drive for infeed conveyor, vertical auger, cross-feed auger, drum rotational speed and discharge conveyor
- Breeding sifter conveyor
- Controls with digital read-out
- Push button controls

### Options:

- Electric or hydraulic drives







# Frying/Filtering



# Frying/Filtering

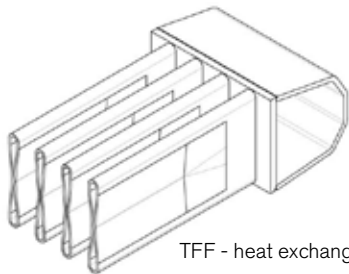

TFF - heat exchanger

## Stein® M-Fryer™

Conveyorised immersion-style fryer, electrical or thermal fluid heated, with electro-polished heat exchanger fins for the thermal fluid version.

### Designed for:

Pre-frying a wide range of coated and uncoated products to set the coating and impart oil to aid flavour development.

### Key features:

- THERMoFIN® radiator with electro-polished fins for high rates of heat transfer and lower heat flux with unique design to minimise risk of debris sticking to the fins
- Electric heated with modulation power control for accurate temperature control
- Fin-shaped electrical heating elements
- Improved oil quality and management, and lower oil usage cost
- Sediment collects at infeed for fast removal from fryer
- Integrated sediment removal filter significantly extends the life of the oil
- Accurate temperature control from side-to-side and end-to-end
- Raised interlocking hood enables easy access for efficient and hygienic cleaning
- Built-in oil mist eliminators
- Integrated fire protection system
- Single or double exhaust stack

### Options:

- Integration of Stein SF or MX filtration system
- Secondary oil filtration system for tempura-coated products
- Tempura belt infeed
- Choice of fire suppression system, water mist or CO2
- Usable belt widths of 600 or 1000 mm
- Various frying lengths from 4 to 8 metres





# Frying/Filtering



## Stein® DHF™ Direct Heat Fryer

### Designed for:

Frying a wide range of coated products to set the coating and impart oil to aid in flavour development; able to cook a wide range of coated and uncoated food substrates to a targeted end point internal temperature.

### Direct Electric

Conveyorised immersion-style deep fat fryer, with electric heated fins.

### Key features:

- Single zone, electric-heated immersion tubes provide consistent oil temperature end-to-end and side-to-side
- Automated and continuous sediment removal conveyor
- Electric drive
- Low level oil safety
- Automatic oil level control
- Adjustable top submerger conveyor
- Insulated hood design with manual electric hoist for hood, top submerger conveyor and main product conveyor
- Preparation for CO<sub>2</sub> fire extinguisher system

### Options:

- Tempura conveyor modifications with Teflon® slat infeed
- Oil supply tank
- Stainless steel piping package
- Push button controls
- Usable belt width of 370 mm
- Usable conveyor length of 4000 mm
- Steam vent fan

### Thermal Fluid

Conveyorised immersion-style deep fat fryer, heated with ThermoFin® exchanger.

### Key features:

- CoolHeat® vertical fin, single zone control and thermal fluid heat exchanger for gentle heat transfer and uniform oil temperature end-to-end and side-to-side
- Electric drive
- Prepared for CO<sub>2</sub> fire extinguisher system
- Fast response to changing heat loads
- Automated and continuous sediment removal conveyor
- Low level oil safety
- Automatic oil level control
- Adjustable top submerger hold-down conveyor
- Insulated hood design with manual electric hoist for hood, top submerger conveyor and main product conveyor

### Options:

- Tempura conveyor modifications with Teflon slat infeed
- Oil supply tank
- Stainless steel piping package
- Push button controls
- Usable belt width of 370 mm
- Usable conveyor length of 4000 mm
- Steam vent fan

## Stein® FA-5/Lab Fryer



Conveyorised immersion-style deep fat fryer, heated, with electric heated fins.

### Designed for:

Pre-frying a wide range of coated products to set the coating and impart oil to aid in flavour development; able to cook a wide range of coated and uncoated food substrates to a targeted end point internal temperature.

### Key features:

- Stainless steel tank and frame
- Low level oil safety
- Adjustable top submerger hold-down conveyor
- Insulated hood
- Onboard oil storage tank and circulation pump with manual sediment trap
- Push button controls
- DC drives
- Usable belt width of 380 mm
- Usable frying length of 1200 mm

### Options:

- Tempura conveyor modifications with Teflon slat infeed
- Hang-on infeed conveyor

# Frying/Filtering



## Stein® MX Series MicroMax™ - II & III Centrifugal-Style Hot Oil Filter

Decanter-style, continuous centrifugal hot oil filter.

### Designed for:

The continuous removal of flour and other debris from frying oil.

### Key features:

- Decanter filter
- Rotating stainless steel bowl provides separation via difference in specific gravity of sediment and oil
- Filters down to single digit micron levels
- Continuous operation and automatic removal of sediment from the fryer/filter system
- Built-in CIP system

- Continuous 75 or 114 lpm positive displacement-style feed pump, and 114 lpm positive displacement-style clean oil return pump
- Removes 50% more free oil from sediment than other filter methods

### Options:

- Centrifugal or positive displacement oil pump



## Stein® SF™ Force Flow Hot Oil Filter

Automatic oil level-based, semi-continuous force flow filter utilising stainless steel mesh filter media.

### Designed for:

The continuous removal of coating sediment and other frying debris from a conveyorised frying system.

### Key features:

- Stainless steel woven mesh belt filter media in 60 or 80 micron filtration size
- Variable flow centrifugal-style feed pump activated by oil level float system
- Centrifugal-style filter suction/discharge pump
- Push button controls

### Options:

- Paper filter attachment for finer filtration
- Controls integrated with fryer controls
- Size ranges 0,28 m<sup>2</sup>, 0,65 m<sup>2</sup> and 1,02 m<sup>2</sup>
- Crumb cart









# Cooking/Searing and Grill-Marking





# Cooking/Searing and Grill-Marking

## Stein® TwinDrum™ 600 Spiral Oven



A twin drum in-line oven with a unique airflow system guaranteeing superior heat transfer and uniform temperature and product colour.

### Designed for:

Cooking, steam-cooking, frying or pre-frying all forms of poultry and breaded products; a high temperature capability ensures excellent results on roasted boneless and bone-in chicken.

### Key features:

- Compact design, 9.4 x 3.8 metres
- Low roof height, 2.9/3.6 metres high (production mode)
- Heat and humidity controlled separately in each zone
- Airflow technology with superior heat transfer rate and uniformity
- Excellent colour consistency right across the belt
- Uniform airflow across all tiers guarantees high product yield
- Hot belt return to save energy
- Independent humidity and temperature controls, 2-zone cooking

- Fans positioned at floor level for easy access and cleaning
- Split-level hood
- Extended belt life due to innovative drive system
- Automatic cleaning with recirculating cleaning system
- PRoLINK™ controls
- Built-in SCADA-ready network

### Options:

- Various belt configurations
- Various belt types
- Standard or high capacity heat exchanger
- Automatic humidity control options
- Different belt wash systems





# Cooking/Searing and Grill-Marking

## Double D® Revoband Continuous Protein Oven



High volume, high impingement, indirect-fired linear oven with independently controlled zones and accurate temperature and airflow control.

### Designed for:

High volume in-line cooking, roasting or steaming of meat, poultry, fish and vegetables.

### Key features:

- High impingement airflow ensures excellent product consistency and colour
- Cook by dry heat up to 280°C (540°F)
- Combination cook using dry heat and live steam
- Custom-built stainless steel travelling belt with variable speed controls
- Independently controlled fans

- Air delivery from both above and below the belt
- Variable fan speed
- Independently controlled zones to suit product requirements
- Indirect-fired
- Heated by thermal fluid, indirect gas or electricity
- Menu-driven PLC with 100 programme settings

### Options:

- Browning tunnel for generating high colour on large joints of meat, without additives
- Hold-down belt for producing ultra flat cooked bacon
- Infra-red sealing and searing unit
- Clean In Place system

## Double D® Revoband Searer/Grill-Marker



Conveyorised direct-fired gas surface treatment system for grill-marking and/or surface searing.

### Designed for:

Surface treatment of a variety of protein substrates requiring grill marks or surface searing.

### Key features:

- Chain-edged stainless steel continuous belt
- Fully welded stainless steel enclosure with side doors and infeed/discharge pivoting hoods
- Simultaneous searing and grill-marking
- Temperature controlled adjustable rings for even grill-marking
- Fully controlled, high capacity, interchangeable burners
- Variable belt speed

- Stainless steel motors and gear boxes
- Automatic cooling system
- In-built safety and fire suppression system
- Water bath to collect 'cook-out' residue
- Access doors
- PLC controls

### Options:

- 300 mm in-feed and discharge conveyor extensions
- Available with direct electric drives with heat sink
- Vented hood (gives an insulated outer shell)
- Infra-red

## Double D® Revorack Multi-Purpose Cooker



A versatile cooker capable of any task in the further processing of meat, fish, poultry, vegetables and ready meals.

### Designed for:

Versatile, efficient and consistent steam cooking, roasting or baking of a large variety of products on racks.

### Key features:

- Rotating turntable for consistently cooked and evenly coloured product every time
- Turntable moves the product continuously through a highly efficient air distribution system
- Available from single rack to 10-rack capacity

- Efficient High Risk/Low Risk control
  - ▶ Rear door as standard
  - ▶ Interlocking doors
  - ▶ Operator controls on both sides of the cooker
- Optional Clean In Place system



# Cooking/Searing and Grill-Marking

## Formcook® Contact Cooker



Continuous direct contact cooking on two sides simultaneously; fast heating of products creates uniform and natural looking appearance.

### Designed for:

Sealing natural fats and juices in a wide range of products for highest product quality, home-made appearance and minimum cooking losses.

### Key features:

- Electric or thermal fluid oil heat source
- Adjustable cooking time
- Temperature range up to 260°C
- Accommodates products up to 70 mm high
- Automatically controlled belt tracking and tension
- Independent electrical plate temperature control

- Adaptable infeed and outfeed lengths
- Continuous belt cleaning system

### Options:

- Oil applicators
- Pre-heated infeed
- Overall belt widths of 400, 600 and 1100 mm
- Thermal fluid mild steel platens for thin products
- High resolution lift
- High resolution drive
- Fat removal system

## Formcook® Combi Cooker



Contact, convection and steam cooking, all in one machine; products are cooked on a solid non-stick cooking belt that runs over heating plates using steam and forced air on the top to provide the necessary temperature and colour.

### Designed for:

Cooking all types of products, with or without bone, providing high quality products with a home-made appearance.

### Key features:

- Electric heat
- Temperature range up to 260°C on the heating plate and 280°C on air
- Automatically controlled belt tracking and tension
- Independent platen, air temperature and steam control
- Adaptable infeed and outfeed lengths

- Continuous belt cleaning system

### Options:

- Product flip
- Oil applicators
- Pre-heated infeed
- Overall belt widths of 600 and 1100 mm



## Double D® Forced Convection Oven



Steam and high temperature forced air convection oven.

### Designed for:

Cooking or pre-frying a wide range of products, particularly those that require long cooking times, or to achieve the final core temperature after having been pre-cooked in another oven.

### Key features:

- Electric heat source
- Adjustable cooking time
- Temperature range up to 280°C on air
- Steam is 'sprayed' on products from both top and bottom
- Accommodates products up to 150 mm high
- Adaptable infeed and outfeed lengths
- Continuous belt cleaning system

### Options:

- Can be used as a complement to other processing equipment such as a contact cooker, a combi cooker or a fryer, to achieve the correct core temperature in the product

## JBT Dry-Fry System

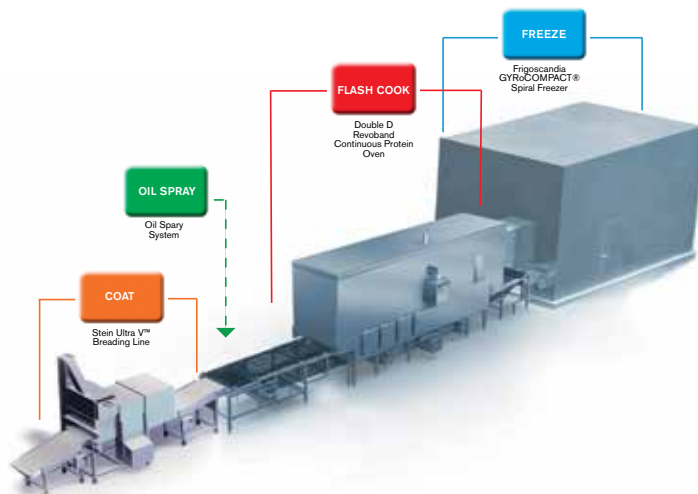

A complete in-line process which includes the Stein Ultra V™ coating line, a fully controllable oil spray system, the Double D® Revoband Continuous Protein Oven and the Frigoscandia GYROCOMPACT® Spiral Freezer or Chiller.

### Designed for:

Processing a wide range of healthier food options by reducing the amount of oil delivered to the product, while maintaining a 'just fried' taste and appearance.

### Key features:

- Elimination of pre-frying stage means cleaner, healthier and better tasting product
- Controlled oil levels can produce 'lower fat' or 'never been fried' options with up to 50%+ reduction in oil pick-up
- High impingement airflow system enables excellent setting and colouring of coating
- Fan speed control in each zone produces unlimited flexibility and precision

- High temperature up to 280°C
- Coated and sprayed product is flash-cooked for 1 – 2½ minutes ensuring efficient setting of coating
- Process suitable for any pre-dust batter, J-crumb\*, or coating suitable for baking
- Final product colour can be carefully controlled to achieve specific requirements
- Powerful Clean In Place system removes crumbs and coating residue

### Options:

- Oil levels can be varied to produce 'reduced fat', 'lower fat' or 'low fat' options
- Products can be sprayed with a range of oils such as vegetable oil, olive oil or flavoured oils to aid new product development

\* also known as Japanese crumb



# Spiral Freezers





# Frigoscandia® Spiral Freezers

## The most effective spiral freezer, chiller and proofer

The Frigoscandia GYRoCOMPACT® Spiral Freezer, Chiller or Proofer is the industry benchmark for performance, hygiene and overall operating economy. With its patented FRIGoBELT® self-stacking belt and no-tension drive system this freezer outperforms all other spiral freezers on the market with over 4,000 installations worldwide. The unique self-stacking belt provides a self-contained, 100% cleanable product zone with a vertical controlled airflow that delivers uniform air distribution across and through the belt stack.

### The main features and benefits of the GYRoCOMPACT Spiral Freezer, Chiller and Proofer are:

#### 1) Self-supporting product zone

- The belt forms its own support structure
- 100% cleanable
- No glide strips or support structure in the product zone

#### 2) Vertical controlled airflow

- Highest possible heat transfer
- No risk for moving products
- Even product temperature

#### 3) No tension drive system

- No drum to wrap the belt around
- No risk of overstretching the belt
- All forces in the drive system instead of in the belt



*The GYRoCOMPACT Spiral Freezer is available in belt widths from 400 mm up to 1,000 mm in a large variety of capacity sizes, options and layouts.*



# Spiral Freezers

## Self-Stacking Spiral System



### Frigoscandia GYRoCOMPACT® 40 Spiral Freezer and Chiller

The industry standard for freezing operations in the lower capacity segments from about 300 kg up to 1,000 kg/hr; the GYRoCOMPACT 40 Spiral Freezer is preassembled and can be put into operation in a factory environment in a very short time; the compact dimensions and the preassembly mean that the freezer can also be relocated in a relatively easy manner.

#### Key features:

- Very compact footprint
- FRIGoBELT® Nova self-stacking stainless steel mesh belt
- Fully seal-welded, stainless steel floor design with elevated floor-to-wall joint
- Fully preassembled for quick installation and easy transportation
- FRIGoDRIVE® system replaces outdated wagon drive system
- Vertical airflow with countercurrent heat exchange for maximum heat transfer rate

#### Options:

- Available with multiple belt options:
  - ▶ 3 levels of vertical product clearance available, 50, 65, and 85 mm
  - ▶ Wide range of tiers
  - ▶ Choice of several types of mesh belt
- Straight through or U-shaped layout
- Air Defrost (ADF) system for simple, durable and energy-efficient operation
- Wide variety of different cleaning systems, including full extended CIP capability
- Frigoscandia's renowned LVS system for energy-efficient refrigeration
  - ▶ Minimises pressure drop between freezer and refrigeration system
  - ▶ Reduces the refrigerant charge by a minimum of 50%



## Frigoscandia GYRoCOMPACT® 60 Spiral Freezer and Chiller

A highly modular and flexible self-stacking spiral freezer from the GYRoCOMPACT range, with a 600 mm wide FRIGoBELT® Nova belt and a freezing capacity of between 800 kg and 3,000 kg/hr, depending on product and freezer specifications.



### Key features:

- Compact footprint
- FRIGoBELT Nova self-stacking stainless steel mesh belt
- Fully seal-welded, stainless steel floor design with elevated floor-to-wall joint
- Preassembled for quick installation and easy transportation
- FRIGoDRIVE® conveyor system for trouble-free no-tension function with no centre drum
- Vertical airflow with countercurrent heat exchange for maximum heat transfer rate

### Options:

- Available with multiple belt options:
  - ▶ 3 levels of vertical product clearance available, 65, 85, and 105 mm
  - ▶ Wide range of tiers
  - ▶ Choice of several types of mesh belt
- Straight through, angled or U-shaped layout
- Air Defrost (ADF) system for simple, durable and energy-efficient operation
- 4 different cleaning systems
  - ▶ Belt rinse
  - ▶ Belt CIP for cleaning of the product contact zone
  - ▶ Basic CIP for cleaning of the product contact zone and evaporator area
  - ▶ Extended CIP for cleaning of the entire freezer
- Frigoscandia's renowned LVS system for energy-efficient refrigeration
  - ▶ Minimises pressure drop between freezer and refrigeration system
  - ▶ Reduces the refrigerant charge by a minimum of 50%



# Spiral Freezers

## Frigoscandia GYRoCOMPACT® 70 Spiral Freezer and Chiller

The Frigoscandia GYRoCOMPACT® 70 Spiral Freezer has evolved from one of JBT's best selling products, the GYRoCOMPACT® M7 Spiral Freezer. It retains all the best Frigoscandia® technology, including the Frigoscandia Nova self-stacking belt, which can include a 10-year warranty.



### Key features:

- Increased capacity of up to 20% on a smaller space
- Enhanced hygienic design ensures superior food safety
- Sustainable design leads to reduced cost of ownership
- Oil consumption reduced by up to 75%
- System innovations provide enhanced performance and efficiency
- Improved FRIGoBELT® Nova optimises efficiency, capacity and layout flexibility
- Open profile self-stacking spiral design is 100% cleanable
- Improved airflow reduces air infiltration and reduces energy consumption
- Enhanced drive system allows increased stack weight up to additional 10%
- Cloud-based iOPS, data transformation and airflow control provide enhanced performance and efficiency

### Options:

- Three different levels of Clean In Place systems
- Performance optimization system, iOPS, to gather and analyse data
- More tier capability due to higher air flow performance
- New belt configurations for products up to 50mm allow more tiers in given headroom
- Options for shortened turn-around time such as improved drying functions





## Frigoscandia GYRoCOMPACT® M7 Spiral Freezer and Chiller

A highly modular and flexible self-stacking spiral freezer from the GYRoCOMPACT range, with a 700 mm wide FRIGoBELT® Nova belt and a freezing capacity of between 1,000 kg and 4,500 kg/hr, depending on product and freezer specifications.

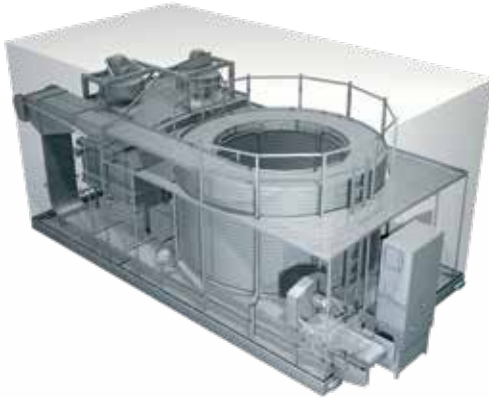

### Key features:

- Compact footprint
- FRIGoBELT Nova self-stacking stainless steel mesh belt
- Fully seal-welded, stainless steel floor design with elevated floor-to-wall joint
- Preassembled for quick installation and easy transportation
- FRIGoDRIVE® M conveyor system for trouble-free no-tension function with no centre drum
  - ▶ Allows for trouble-free operation with high stack weights and belt speeds
- Vertical airflow with countercurrent heat exchange for maximum heat transfer rate

### Options:

- Available with multiple belt options:
  - ▶ 5 levels of vertical product clearance available, 65, 85, 105, 135 and 165 mm
  - ▶ Wide range of tiers
  - ▶ Choice of several types of mesh belt
- 2 or 3 fan versions for optimal energy-efficiency and capacity
- Straight through, angled or U-shaped layout
- Several evaporator options for optimal energy efficiency and capacity
- Air Defrost (ADF) system for simple, durable and energy-efficient operation
- Sequential defroster
- 4 different cleaning systems
  - ▶ Belt rinse
  - ▶ Belt CIP for cleaning of the product contact zone
  - ▶ Basic CIP for cleaning of the product contact zone and evaporator area
  - ▶ Extended CIP for cleaning of the entire freezer
- Frigoscandia's renowned LVS system for energy-efficient refrigeration
  - ▶ Minimises pressure drop between freezer and refrigeration system
  - ▶ Reduces the refrigerant charge by a minimum of 50%



# Spiral Freezers

## Frigoscandia GYRoCOMPACT® M10 Tight Curve Spiral Freezer

A highly modular and flexible self-stacking freezer from the GYRoCOMPACT Spiral Freezer range; the 1,015 mm wide FRIGoBELT® W self-stacking belt has a very small footprint creating a tight spiral, and a capacity of between 1,500 and 4,500 kg/hr, depending on product and freezer specifications.



### Key features:

- Compact footprint, same width as the GYRoCOMPACT M7 Spiral Freezer
- FRIGoBELT W Tight Curve self-stacking stainless steel mesh belt
- Fully seal-welded, stainless steel floor design with elevated floor-to-wall joint
- Preassembled for quick installation and easy transportation
- FRIGoDRIVE M conveyor system for trouble-free no-tension function with no centre drum
- Vertical airflow with countercurrent heat exchange for maximum heat transfer rate

### Options:

- Available with multiple belt options:
  - ▶ 4 levels of vertical product clearance available, 65, 85, 105 and 135 mm
  - ▶ Wide range of tiers
  - ▶ Choice of several types of mesh belt
- Straight through, angled or U-shaped layout
- 3-fan version or low energy version for optimal energy efficiency and capacity
- Air Defrost (ADF) system for simple, durable and energy-efficient operation
- Sequential defroster
- 4 different cleaning systems
  - ▶ Belt rinse
  - ▶ Belt CIP for cleaning of the product contact zone
  - ▶ Basic CIP for cleaning of the product contact zone and evaporator area
  - ▶ Extended CIP for cleaning of the entire freezer
- Frigoscandia's renowned LVS system for energy-efficient refrigeration
  - ▶ Minimises pressure drop between freezer and refrigeration system
  - ▶ Reduces the refrigerant charge by a minimum of 50%



## Frigoscandia GYRoCOMPACT® M9 Spiral Freezer and Chiller

A highly modular and flexible self-stacking spiral freezer from the GYRoCOMPACT range, with a 875 mm wide FRIGoBELT® Nova belt and a freezing capacity of between 1,500 kg and 6,000 kg/hr, depending on product and freezer specifications.

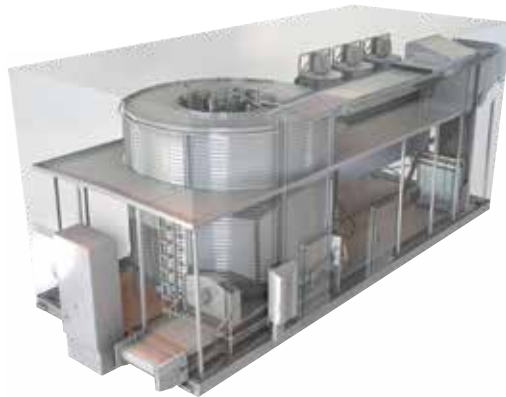

### Key features:

- High capacity related to actual footprint
- FRIGoBELT W (reinforced) self-stacking stainless steel mesh belt
- Fully seal-welded, stainless steel floor design with elevated floor-to-wall joint
- FRIGoDRIVE® M conveyor system for trouble-free no-tension function with no centre drum
  - ▶ Allows for trouble-free operation with high stack weights and belt speeds
- Vertical airflow with countercurrent heat exchange for maximum heat transfer rate

### Options:

- Available with multiple belt options:
  - ▶ 4 levels of vertical product clearance available, 65, 85, 105 and 135 mm
  - ▶ Wide range of tiers
  - ▶ Choice of several types of mesh belt
- Straight through, angled or U-shaped layout
- 3, 4 or 5 fan versions for optimal energy efficiency and capacity
- Air Defrost (ADF) system for simple, durable and energy-efficient operation
- Sequential defroster
- 4 different cleaning systems
  - ▶ Belt rinse
  - ▶ Belt CIP for cleaning of the product contact zone
  - ▶ Basic CIP for cleaning of the product contact zone and evaporator area
  - ▶ Extended CIP for cleaning of the entire freezer
- Frigoscandia's renowned LVS system for energy-efficient refrigeration
  - ▶ Minimises pressure drop between freezer and refrigeration system
  - ▶ Reduces the refrigerant charge by a minimum of 50%





# Spiral Freezers

## Frigoscandia GYRoCOMPACT® M10 Spiral Freezer and Chiller

A highly modular and flexible self-stacking spiral freezer from the GYRoCOMPACT range, with a 1,015 mm wide FRIGoBELT® Nova belt and a freezing capacity of between 2,000 kg and 7,000 kg/hr, depending on product and freezer specifications.

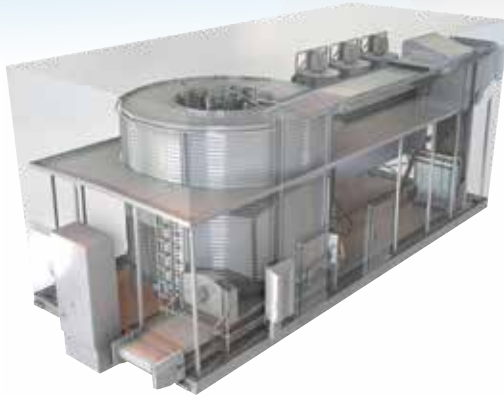

### Key features:

- High capacity related to actual footprint
- FRIGoBELT W (reinforced) self-stacking stainless steel mesh belt
- Fully seal-welded, stainless steel floor design with elevated floor-to-wall joint
- FRIGoDRIVE® M conveyor system for trouble-free no-tension function with no centre drum
  - ▶ Allows for trouble-free operation with high stack weights and belt speeds
- Vertical airflow with countercurrent heat exchange for maximum heat transfer rate

### Options:

- Available with multiple belt options:
  - ▶ 4 levels of vertical product clearance available, 65, 85, 105 and 135 mm
  - ▶ Wide range of tiers
  - ▶ Choice of several types of mesh belt
- Straight through, angled or U-shaped layout
- 4, 5 or 6 fan versions for optimal energy efficiency and capacity
- Air Defrost (ADF) system for simple, durable and energy-efficient operation
- Sequential defroster
- 4 different cleaning systems
  - ▶ Belt rinse
  - ▶ Belt CIP for cleaning of the product contact zone
  - ▶ Basic CIP for cleaning of the product contact zone and evaporator area
  - ▶ Extended CIP for cleaning of the entire freezer
- Frigoscandia's renowned LVS system for energy-efficient refrigeration
  - ▶ Minimises pressure drop between freezer and refrigeration system
  - ▶ Reduces the refrigerant charge by a minimum of 50%







A close-up photograph of several pieces of raw, red meat, likely beef, arranged on a wooden cutting board. The meat is vibrant red with visible marbling. In the foreground, there are fresh green herbs, possibly rosemary, and a variety of whole spices including black, white, and red peppercorns. The background is softly blurred, showing more of the cutting board and some additional herbs.

# Impingement Freezers



# Frigoscandia ADVANTEC™ Impingement Freezers

## Airflow technology that delivers quality and profit

Achieving rapid heat removal without otherwise affecting the product, our patented Frigoscandia ADVANTEC impingement airflow technology excels both at freezing and chilling. Dehydration is minimised and yield is maximised. This means that taste, mouthfeel and product quality are assured. Custom-designed to quickly and efficiently freeze flat products up to 25 mm thick, and to chill and crust-freeze products up to 200 mm thick, ADVANTEC impingement freezing is tailored to rapidly and cost-effectively freeze or chill every product.

### The main features and benefits of the Advantec Impingement Freezers are:

#### 1) Well-balanced high velocity impingement airflow, from top and bottom

- Very high heat transfer for optimal product quality
- Controlled airflow pushes product against belt to avoid product movement
- Optimised airflow means low power consumption

#### 2) Modular design and various options

- Easy to customise for individual factory requirements
- Cleaning options to cater for different cleaning needs
- Air defrost for longer operating time between defrosts

#### 3) Hygiene by design

- All stainless steel design
- All areas of freezer accessible for cleaning



*Our ADVANTEC freezer product line comes in many different sizes and with many options to make it as optimised as possible for your specific production needs.*

# Impingement Freezers



## Frigoscandia ADVANTEC™ Impingement Freezer

An efficient impingement freezer or chiller ideal for freezing small and thin products, or for crust-freezing larger products with minimal dehydration.

### Key features:

- Balanced high velocity impingement airflow for maximum freezing efficiency and lowest dehydration
- Modular system with many different sizes and capacity levels
- Fan arrangement is designed so that no high air pressure affects the enclosure panel walls
- Single or double belt configuration
- Overall belt widths of 1250 or 1800 mm
- Fully seal-welded stainless steel floor design with elevated floor-to-wall joint

### Options:

- Single or double belt configuration
- Overall belt widths of 1250 or 1800 mm
- CIP system available
- Air Defrost system (ADF) for longer operating time between defrosts
- Frigoscandia's renowned LVS system for energy-efficient refrigeration
  - ▶ Minimises pressure drop between freezer and refrigeration system
  - ▶ Reduces the refrigerant charge by a minimum of 50%





### Frigoscandia ADVANTEC™ Compact Chiller

A modular 'plug-and-play' in-line production source for operations where a faster, more cost-effective way to surface-stabilise or rapidly chill product prior to slicing is needed.

#### Key features:

- Delivered completely preassembled for quick installation and easy relocation if necessary
- Fully welded floor and enclosure for maximum hygiene
- Identical balanced highly efficient impingement airflow system as the ADVANTEC Impingement Freezer
- 1,250 mm belt width
- Sliding doors on each side for easy access for cleaning and maintenance

#### Options:

- Single or double belt configuration
- Available in 3 capacity steps
- Frigoscandia's renowned LVS system for energy-efficient refrigeration
  - ▶ Minimises pressure drop between freezer and refrigeration system
  - ▶ Reduces the refrigerant charge by a minimum of 50%





The background of the slide is a close-up photograph of fresh produce. The top half shows a dense field of bright green peas, while the bottom half shows a dense field of white onions. A semi-transparent white horizontal band runs across the middle of the image, serving as a background for the title text.

# IQF Freezers

# Frigoscandia FLoFREEZE® IQF Freezers

## The most effective and flexible IQF freezer

The Frigoscandia FLoFREEZE IQF Freezer, with its ingenious fully fluidising principle, has been the standard in the industry since the early 1960s. IQF freezing with true fluidisation was invented in 1962, creating a new way for consumers to enjoy fresh fruit and vegetables many months after they are harvested. True fluidisation gives you premium IQF results, and thus the best return of investment. Thanks to our continuous technological advancements, you can now IQF freeze a much greater range of products, in much less space, at much lower cost. At JBT, we promise you IQF freezing capabilities that serve and stimulate your growth and profit in this market.

### The main features and benefits of the FLoFREEZE IQF freezers are:

#### 1) True fluidisation

- Highest possible heat transfer
- Minimises risk of products sticking together
- Gentle handling of products

#### 2) Versatile for many different products

- Belt agitation for separation at the critical crust-freezing stage
- Pulsation for gentle separation of delicate products to minimise lumps

#### 3) Hygiene by design

- All stainless steel design
- All areas of freezer accessible for cleaning



*The FLoFREEZE IQF freezers are available in capacities from 500 kg/hr to over 17,000 kg/hr in a large variety of capacity sizes and options.*

# IQF Freezers

## Frigoscandia FLoFREEZE® A IQF Freezer

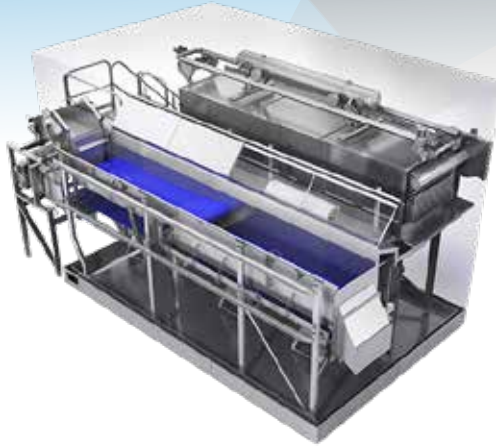

The optimal solution for very high quality IQF freezing for capacities between 1,000 kg/hr and 6,000 kg/hr.

- A freezer for every IQF need with built-in versatility
  - Available in 5 sizes, FLoFREEZE A10 to A50
  - Available in tray or track configuration
  - Tray configuration for products that are easier to fluidise and to satisfy high hygiene demands
  - Special IQF track configuration with dual zone fluidisation for optimal freezing conditions
  - Air pulsator for gentle handling of delicate products for highest possible product quality
  - Track agitation for separation of long or sticky products
  - Modular design for quicker installation
- Stainless steel floor with bathtub design for optimal hygiene
  - Automatic Air Defrost (ADF) system for energy efficient operation with minimum 22 hours between defrosts
  - Frigoscandia's renowned LVS system for energy-efficient refrigeration
    - ▶ Minimises pressure drop between freezer and refrigeration system
    - ▶ Reduces the refrigerant charge by a minimum of 50%

## Frigoscandia FLoFREEZE® M IQF Freezer

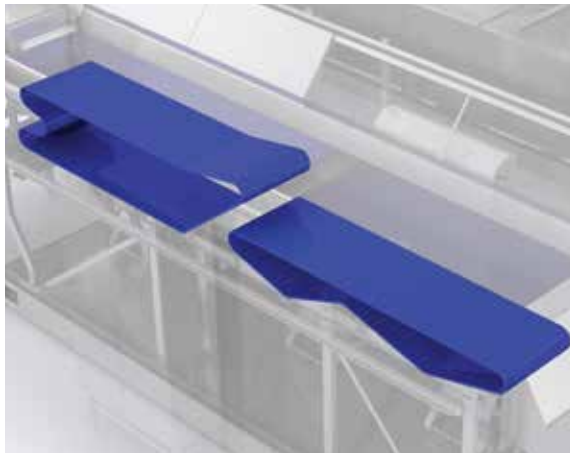

High quality and high capacity IQF Freezing for capacities between 6,000 kg/hr and 17,500 kg/hr

- A freezer for every IQF need with built-in versatility
  - Available in 6 sizes, FLoFREEZE M20, M25, M30, M40, M50 and M60
  - Available in tray or track configuration
  - Special IQF track configuration with dual zone fluidisation for optimal freezing conditions
  - Air pulsator for gentle handling of delicate products for highest possible product quality
  - Track agitation for separation of long or sticky products
  - Stainless steel floor with bathtub design for optimal hygiene
- Automatic Air Defrost (ADF) system for energy efficient operation with minimum 22 hours between defrosts
  - Frigoscandia's renowned LVS system for energy-efficient refrigeration
    - ▶ Minimises pressure drop between freezer and refrigeration system
    - ▶ Reduces the refrigerant charge by a minimum of 50%



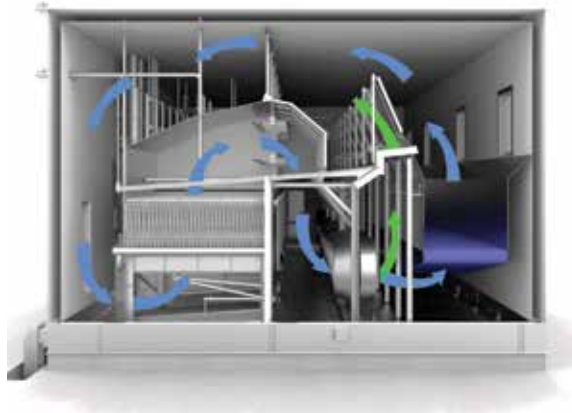

## Frigoscandia FLoFREEZE® M Sequential Defrost IQF Freezer

High quality and high capacity IQF freezing for capacities between 7,500 kg/hr and 15,000 kg/hr with extended run time between defrosts.

- A freezer for every IQF need with built-in versatility
- Designed for long operation time between defrosts above 24 hours of continuous operations
- Available in 6 sizes, FLoFREEZE M3SD, M4SD, M5SD and M6SD, M7SD
- IQF track configuration with dual zone fluidisation for optimal freezing conditions
- Air pulsator for gentle handling of delicate products for highest possible product quality
- Track agitation for separation of long or sticky products
- Stainless steel floor with bathtub design for optimal hygiene
- Sequentially defrosted evaporators for non-stop production more than 144 hours continuously
- Possibility to add re-freezing belt
- Frigoscandia's renowned LVS system for energy-efficient refrigeration
  - ▶ Minimises pressure drop between freezer and refrigeration system
  - ▶ Reduces the refrigerant charge by a minimum of 50%



# LVS Refrigeration System

## LVS Refrigeration System

LVS Refrigeration utilises optimised low-pressure-drop evaporator design, in conjunction with specially designed LVS vessels, which maintain correct liquid flow through the evaporator to ensure optimal evaporator performance; no valve adjustment is needed to achieve this flow as it is a function of the design.

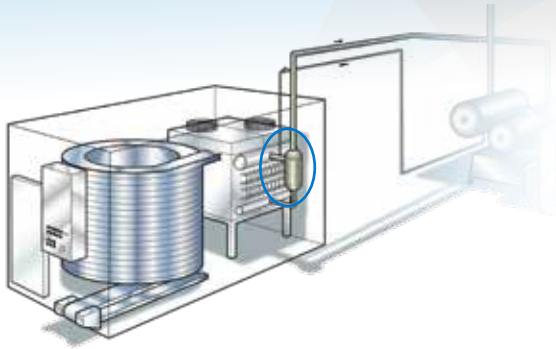

### Designed for:

Supporting freezing and chilling systems by supplying and managing refrigerant to and from freezing and chilling equipment, including but not limited to all lines of JBT spiral and linear freezing systems with a wide range of capacities.

### Key features:

- Reduces pressure drop from freezer to compressor
- Improves the evaporator performance
- Eliminates fluctuating evaporation temperatures caused by liquid build-up in risers
- Eliminates the liquid distribution problems associated with various freezers working at different capacities
- Increases the refrigeration capacity of existing vessels and reduces the required refrigerant charge
- Enables operation at evaporation temperatures down to  $-50^{\circ}\text{C}$  provided installed equipment is suitable for the required temperature
- Refrigerant pumps may either be eliminated or will work at lower flow rates, where they are generally less susceptible to cavitation problems
- Stainless steel vessel for internal or external installation
- Wide range of evaporator temperatures available

### Option:

- LVS QuickDry - Reduce your drying time to half
  - ▶ A unique option to the LVS-system
  - ▶ Dries your freezer efficiently and quick for smooth and efficient freezer turn-around
  - ▶ Requires hotgas availability

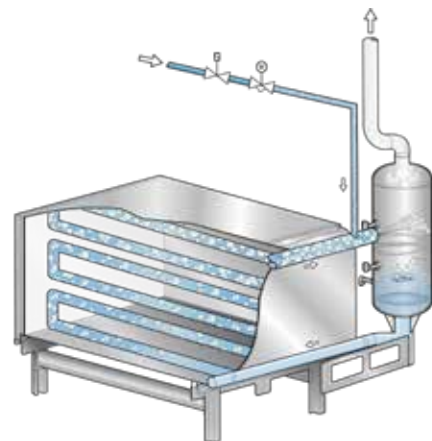

Want to have up  
to an hour of  
extra production?

# Crust Freezer

## Frigoscandia SuperCONTACT® Crust Freezer

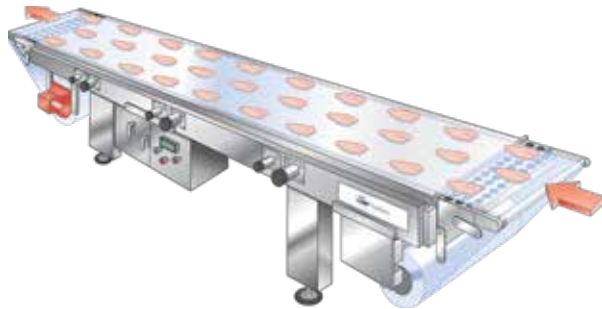

A linear, fully modular, contact crust freezing system utilising a disposable film conveyor; surface or crust freezing is achieved by contact with a refrigerated plate.

### Designed for:

Crust freezing the bottom of a variety of soft and sticky items prior to the full freezing step, to improve material handling, yield and minimise mesh belt marks.

### Key features:

- Disposable film makes the conveyor system ultra hygienic
- Simplified installation and start-up
- Stainless steel frame

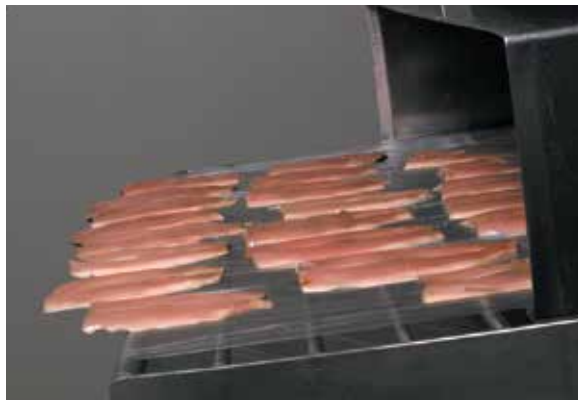





# X-ray technology



# X-ray technology



## XVision™ CCPX™-Pack 1408

The JBT® XVision™ CCPX™ Pack™ 1408 with Single Push Arm have made X-ray contaminant detection of case ready, ready meals, and heat and eat products simple.

### Designed for:

Detects a wide range of contaminants to include stainless steel, ferrous, non-ferrous metals, stone, dense rubber, glass and package weight.

### Features & Benefits:

- Immune to foil lined packaging, trays and lids
- Near 2x improvement in Stainless Steel detection over metal detectors
- Application optimized software ignores foil pie plates while still inspecting 100% of the product
- Available curtain-less design prevents damage to bakery products and delicate pies
- Interlocked extended covers for optimal operator safety compliance
- Dynamic box edge detection for 100% product inspection
- Broader contaminant detection and product quality applications as compared to metal detection
- Tool-less break down for cleaning allowing for a short sanitation cycle-cooking





A top-down view of various fresh green vegetables arranged on a light-colored, textured surface. In the upper left, a large head of curly green broccoli is prominent. To its right are several bunches of green onions. Below the broccoli, a whole green bell pepper is visible. In the lower right, there is a zucchini, a bunch of green grapes, and a small white bowl filled with bean sprouts. An avocado is also present in the middle right area. The overall composition is vibrant and emphasizes freshness.

More food technology solutions





from JBT

# FTNON Hygienic DCC Steaming Technology

## Maximal energy savings (from 30 to 90%)

FTNON has a long tradition of producing blanchers and steamers. The FTNON Dynamic Cloud Control (DCC) is a revolutionary hygienic, steaming technology, that considerably improves the energy efficiency of steamers. Compared to conventional steamers, the exhaust of steam from the steamer is reduced to a minimum and considerable reductions on steam consumption, ranging from 30 up to 90%, are achieved. The related savings on water and energy consumption are really spectacular.



## DCC Steaming Technology

The DCC - Dynamic Cloud Control - concept is based on the use of difference in density between atmospheric steam and air. The system automatically creates a balanced and 100% steam atmosphere. Thanks to atmospheric pressure, the temperature will be  $\pm 98-100^{\circ}\text{C}$  /  $208-212^{\circ}\text{F}$ . The steam demand is based on product temperature and capacity.

*Highly hygienic steaming systems.*

*The FTNON DCC Steamers are available in belt and screw type, and in a large variety of capacities, sizes and options.*



## Optimal steaming process by means of a 100% steam atmosphere

The primary purpose of steaming is to improve shelf life. Furthermore, it is possible to improve the organoleptic properties, like taste, bite, smell and texture. Additional applications are:

- Inactivation of enzymes
- Inactivation of bacteria
- Compression of cooking time
- Improvement of product quality
- Gelatinization of starch
- Sanitizing / Disinfection
- Thawing



## Belt and Screw Type Systems

System used depending on product specification.



## Key Features

- Optimal heat transfer
- Minimum start-up time
- Minimum steam required for start-up
- Automatic steam regulation: no product = no steam
- Energy efficient system
- Minimum product colour loss
- No flushing out of nutrients, vitamins etc.
- Minimal waste water (only condensate)
- No need for exhaust systems
- Less time required for cleaning, because of top hygienic design and liftable hood
- Top hygienic design



*Thanks to the highly hygienic DCC process you can save considerably on energy.*



# Avure High Pressure Processing (HPP)

## JBT - Avure HPP Processing Machines

HIGH PRESSURE PASTEURIZATION (HPP) is cold pasteurization in pure water; it uses ultra-high pressure purified water to keep packaged food pathogen-free to stay fresh longer. At very high pressures bacteria such as Listeria, E. coli, and Salmonella are inactivated. Foods using HPP include ready-to-eat and ready-to-cook meats, ready-meals, fruits and vegetables, juices and smoothies, soups and sauces, wet salads and dips, dairy products, seafood and shellfish. HPP helps producers increase food safety and extend shelf-life while providing consumers with nutritious, natural, flavorful food.

JBT-AVURE helps producers implement HPP from recipe development to installation and beyond of the fastest and most reliable systems. AVURE equipment is used to treat the majority of all HPP-protected food around the world.

### Why HPP?

- GREATER PROFITABILITY: Than Conventional Processing
- FRESH TASTE: Not Altered by Heat, Chemical or Irradiation
- CLEAN LABEL: Aligns with Consumer Trends
- LONGER SHELF LIFE: Drastically Reduces Spoilage
- FOOD SAFETY: Extreme Pressure Inactivates Pathogens

### Why Avure?

- Most Experienced
- Highest Productivity
- Robust Engineering
- Application Expertise
- 24/7 Support





# Avure High Pressure Processing (HPP)

## JBT - Avure HPP Processing Machines



### **AV-40X-70X:**

40-70 Million Pounds Per Year  
19-32 Kilograms Per Year



### **AV-20M-40M:**

22-40 Million Pounds Per Year  
10-18,1 Kilograms Per Year



### **AV-10:**

10 Million Pounds Per Year  
4.5 Million Kilograms Per Year

# Proseal Tray Sealing Technology

Proseal designs and manufactures high quality tray sealing machines, conveyor systems and sealing tools for food industry markets worldwide.

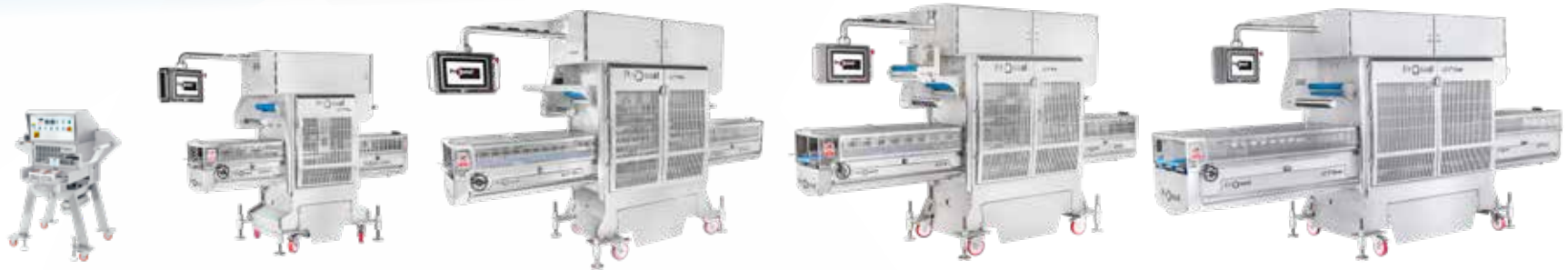

**GTR**

**GT0s**

**GT2e**

**GT4s**

**GT6eXTwin**



**ATMOSPHERIC SEAL**



**GAS FLUSH**



**HERMETIC SHRINK**



**VACUUM / GAS**



**SKIN PACK**



**SKIN PLUS**



**SKIN DEEP**



Proseal machinery is designed to be innovative, user friendly and hygienic whilst offering all of the flexibility and speed demanded by the fastpaced food industry.

As well as designing its machines for long term durability, reliability and efficiency Proseal is committed to surpassing customer expectations, supporting all its machines throughout their lifetimes with unrivalled after-sales service support.



# Tray Sealing Solutions

## Why Proseal?

- 24/7 365 Service Support
- Leading-Edge Control Systems Technology
- Energy Saving Design Features
- Test Kitchen Facilities
- 20 Years of Machinery Integration Expertise
- Cut Labour Costs
- Shelf Life Extension
- Eco Friendly Benefits
- An Extremely Flexible Packaging Format
- Easily Integrated into Production Lines

## Food Categories

- Ready Meals
- Red Meat
- Pork
- Poultry
- Sandwiches & Snack Foods
- Fish & Seafood
- Produce
- Desserts



## Conveyor Systems

Packed with hygienic and user friendly features.

This includes a flat-belt SC Conveyor ideal for product assembly lines to the ultra-hygienic spec of the open chain OC Conveyor, perfectly suited to 'high-care' production environments with open wiring looms and a fully-folded construction which eliminates food traps and allows for the most thorough wash down.

The SlipStream converging conveyor can seamlessly channel a single lane of trays into a twin-lane format.



# Tray Sealing - Semi Automatic



## Proseal TTe

**Semi-automatic, drawer type, tray sealing machine with full vacuum facility.**

Capable of sealing up to 10 Vacuum/Gas packs per minute, with a 2 impression tool.

At the core of the 'e' design is its flexibility to perform any style of heat seal to a pre-formed tray, be that atmospheric, MAP, VMAP, Skin, Skin Plus, or Skin Deep. Each of these options can be added now or at a later date, or indeed removed as necessary. This flexibility provides the user with the assurance that whatever the latest packaging trend might be, they have equipment suitably geared for the future.



## Proseal GTR

**Semi-automatic, two-station, rotary-table, tray sealing machine.**

Capable of up to 30 Atmospheric packs per minute with a 2 impression tool, the GTR machine is the workhorse of the ready meal industry. It is fully portable with automatic film-feed. Ultra-reliable and easy to operate, the GTR is used around the world and has become the benchmark for portable tray sealing equipment.

**Optional:** 'free-flow' gas flush Modified Atmosphere Packaging (MAP) available for extended shelf life.

The quick-release tooling allows the user to change from one tray size to another in less than two minutes.



## Proseal GTRe

**Semi-automatic, two-station, rotary-table, tray sealing machine with full vacuum facility**

Capable of sealing up to 20 Vacuum/Gas packs per minute with a 2 impression tool.

At the core of the 'e' design is its flexibility to perform any style of heat seal to a pre-formed tray, be that atmospheric, MAP, VMAP, Skin, Skin Plus, or Skin Deep. Each of these options can be added now or at a later date, or indeed removed as necessary. This flexibility provides the user with the assurance that whatever the latest packaging trend might be, they have equipment suitably geared for the future.

# Tray Sealing - Automatic in-line



## GT4s Tray Sealer

The Proseal GT4s is an automatic, large-capacity, high-speed, in-line tray sealing system designed to cut labor costs.

The GT4s combines high throughput with rapid tool-changing and space-saving compact design. Capable of up to **140 Atmospheric packs per minute with a 7-impession tool**, the **GT4s** system is packed with user-friendly benefits including our unique **QR** modular conveyor system.

### Design features:

- Two minute tool changeover
- Fully portable and castor mounted
- Food industry approved hygienic construction and wash-down protection
- **Eseal®** energy efficient electric seal system that boasts a massive increase in seal force and a 92% reduction in energy consumption.
- **ProMotion** high accuracy continuous motion tray infeed system, which increases production speed whilst reducing machine duty.
- **QR Conveyors** with quick release belts for easy hygiene and maintenance

## GT5eXTwin Tray Sealer

The Proseal GT5eXTwin is an automatic, large-capacity tray sealing system designed for high-speed production, efficiently cutting labor costs. Available in two formats; standard twin-lane or extra-wide-single-lane capable of taking packs up to 400mm wide long edge leading into the machine.

**Capable of 168 Vacuum Gas packs per minute on a 14-impression tool**; the **GT5eX-Twin** is a high throughput modular, twin-lane, linear, heat-sealing system. It is designed to run in conjunction with auxiliary equipment such as tray de-nesters, fillers, multi-head weighers and labellers, combining into a stand-alone, fully automatic production line

### Design features:

- Five-minute tool changeover
- Fully portable and castor mounted
- Food industry approved hygienic construction and wash-down protection
- Simple design and operation
- **Eseal®** energy efficient electric seal system that boasts a massive increase in seal force and a 92% reduction in energy consumption.
- **ProMotion** high accuracy continuous motion tray infeed system, which increases production speed whilst reducing machine duty.
- **QR Conveyors** with quick release belts for easy hygiene and maintenance.





# Tray Sealing - Sandwich Packaging



## Proseal GTSV Sandwich Carton Wedge Erecting & Sealing Machine

The Proseal GTSV is the world's first MA (modified atmosphere) carton sandwich wedge erecting and sealing machine

A high throughput carton sandwich wedge de-nest and erect, Vacuum/Gas Sealing machine, capable of up to **50 packs per minute in the Vacuum/Gas cycle.**

An Atmospheric Seal mode is available, capable of up to **70 packs per minute.** This range has a unique 3 axis carton sandwich wedge transfer system enabling the sandwich cartons to be conveyed on hygienic carriers that have a single point size adjustment.

Able to handle a wide variety of carton sandwich wedge sizes, and with a sub 5 minute size change over, the **GTSV** is perfect for users requiring maximum throughput with the minimum of labour.

The **GTSV** has station options for label applicators and printers offering the customer a turnkey production line solution for carton sandwich packaging.

# Lidding and Forming Machinery



## GT1-Lid Clipping Machine

The Proseal GT1-Lid is fully automatic, in-line, lid placing de-nesting and tamping system designed to cut labour costs.

This is the first of our **GTlid** machine range. The **GTlid** range is based on the knowledge and experience gathered from our world-renowned GT tray-sealing machine series and the key principles found within. Some of these key principles include an integral space-saving design, an impressive 5-minute tool change time, our **ProMotion** pause-free tray spacing and our **Eseal**® 'all-electric' seal actuator.

The **GT1-Lid** system is designed to accept trays from any conveyors, clip lids on to film-sealed trays, and take trays directly from a filling conveyor when no film lid is required. Through using the aforementioned features to avoid any loading errors, the **GT1-Lid** system can be fully integrated with any other in-line equipment including upstream tray-sealing machines.



### Design features:

- Five minute tool changeover
- Simple design and operation
- Low lid warning / error
- Self-centering tray guides
- Self diagnostic system
- On-screen data capture and trends with wireless connection option
- Eseal® energy efficient electric seal system that boasts a massive increase in seal force and a 92% reduction in energy consumption.

### Trays and Lidding:

- Trays and Lidding
- C-PET
- A-PET
- R-PET
- Polypropylene
- Smooth Wall Foil



Snack Food | A-PET



Ready Meals | Thermoformed Polyprop



Ready Meals | Injection Moulded Polyprop



Ready Meals | Thermoformed Polyprop



Snack Food | A-PET



A top-down view of various fresh ingredients including chicken, salmon, beef, vegetables, and spices. The ingredients are arranged on a dark grey surface. In the center, there is a piece of raw beef on a white paper. To the left, there is a piece of raw chicken. To the right, there is a piece of raw salmon. In the foreground, there are several cherry tomatoes, a halved avocado, and two brown eggs. In the background, there are various vegetables like broccoli, green beans, and mushrooms, along with a bowl of yellow powder and a small bowl of red grapes. The text "Food Technology Centres" is overlaid in the center in a blue font.

# Food Technology Centres





# Food Technology Centres



**Plan a visit to JBT's European Food Technology Centres in either Helsingborg in Sweden or near Edinburgh in the UK, to enhance your current products and create successful new ones for the future.**

For over 40 years, JBT's Food Technology Centres (FTCs) have been popular destinations for hundreds of food processors throughout Europe, Middle East and the rest of the world.

You can come for training, product development, testing and to simulate runs in the privacy of our 2,000 m<sup>2</sup> facility in Sweden and 300 m<sup>2</sup> in the UK.

The FTCs are aimed at providing you with a complete processing plant away from home, where you can portion, coat, fry, cook and freeze with our new and enhanced equipment in a totally secure and private environment.

You can also learn how to improve throughput, yield, speed, product quality and consistency, and more.

**With the best knowledge comes the best product.**

There's no substitute for a knowledgeable staff. Keeping up with the latest technologies and trends is crucial to efficient production. Our trained and experienced team at JBT will ensure you always get the most value out of your product.

We can create a training programme tailored to your exact needs. Whether it's process and equipment applications, preventative equipment maintenance or another programme, our FTCs have all the equipment and resources to suit your needs. We also offer classroom and hands-on lab sessions.

With knowledge of over 10,000 different food processing applications, we can train your team at our facility, or yours, to create the best value.

***To make reservations for the FTCs, contact your local JBT office.***



# Customer Care

# Customer Care

## PRoCARE® Service Overview

PRoCARE® is our branded service level agreements, designed to optimise uptime for your JBT equipment and therefore offers a range of fully customisable services that can be adapted to both the size and nature of your organisation. Keep in mind that before we even begin our preventative care program, we perform a thorough inspection of your equipment, establishing a good baseline performance level to ensure everything is running as it should from the start.

Our mission is to provide and ensure productivity. The offering is scalable, we offer you uptime, reduced risk, and a flexible and skilled service partner.

### Some of the PRoCARE building blocks:

#### Inspections

Regular inspections is the basis for safe and reliable operation. Our skilled service technicians will carry out the inspection and provide you with a detailed report that gives you an overview of the status of your equipment together with our recommendation of actions.

#### Formula Family Consumables

To reduce equipment wear, the specially developed Formula lubricants from JBT are included in the agreement. Add cleaning chemicals to assure food safety and avoid unnecessary wear caused by wrong chemicals. Our consumables are especially developed for our equipment's.

#### Extended pro-rata warranty

For certain drive components of your Frigoscandia GYRoCOMPACT® we also include an extended pro-rata warranty.

#### Spare parts discount

Since original spare parts offer the best advantage for your equipment's operation, you'll receive a discount on JBT standard spare parts.

#### Emergency support

A well maintained machine shouldn't stop, but if it does, we will do our utmost to get you up and running again. Phone support during business hours is included, as well as remote support via HMI access for connected equipment, and emergency call out options can be included.

#### Emergency parts on local stock

We will compile and review an emergency parts kit to support you and your need for production uptime in the best way possible.

#### Original wear parts

With the goal of keeping equipment optimised with only the best parts, JBT will provide wear parts for the applicable equipment according to a pre-agreed wear parts list.

#### Training programme

By regularly training of your personnel, we reinforce best practices in maintenance, operation and cleaning, and also make sure new employees receive appropriate training.

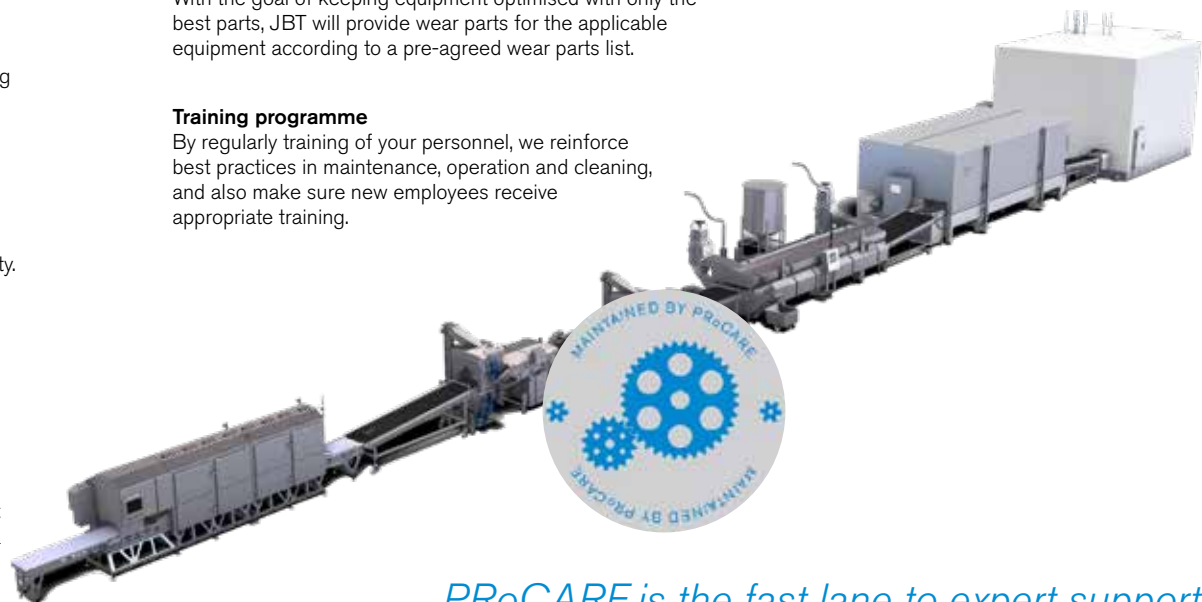

*PRoCARE is the fast lane to expert support*



# Customer Care

## What can we do for you?

Our focus is to assist you in maximising your return on investment by optimising your equipment throughout time and changes. We have a long tradition of working together with our customers to develop optimal solutions in terms of production, cost and processed food quality. Our expert team is spread over EMEA and understands your needs. Ready to serve you at short notice, whether your need is technical service, application adjustments or help with food safety improvement or productivity solutions. As a valued JBT customer, you always have a team of skilled customer support and service people ready to help.

### Spare Parts

We are committed to providing OEM quality parts and service. No matter the age of your equipment, we do our utmost to identify and fulfil your specific spare parts needs and provide you with the latest technology. If you want guaranteed results there really is no substitute.

### Upgrade Kits for optimised ROI

As your product range changes, or as production grows, your existing equipment is not always perfectly suited to give you the best throughput, quality or food safety. We understand clearly what you need – to get the most from your equipment, and even to enhance its performance.

Our upgrade kits are complete tailored original component packages, that deliver cost-effective, quality results. Quick installation, commissioning and operator training by our skilled service teams help you maximize your return on investment.

### Relocations

Perhaps you've bought new equipment and no longer need your old – or at least not where it is today.

No problem! We help you to modernize and move your equipment to a new location.

And when you no longer need it, it may still have a value to someone else.



*Hop on the productivity spiral with us!*

### iOPS® is an Industrial Internet of Things performance optimisation platform

A secure big data analytics technology that gathers and analyses your JBT equipment and process performance in real time.

A system that can inform your people when actions required or automate that action for lightning- fast response.

A solution that will maximise uptime, productivity and profit, painlessly.

#### Maximise

- Equipment uptime
- Profit per machine
- Process efficiency/throughput
- Labour productivity

#### Minimise

- Equipment downtime
- Maintenance expense
- Cost of ownership
- Labour shortage/turnover impact

#### Realise

- Maximum Return of investment (ROI)
- Optimum business results
- The promise of Industry 4.0

***A solution that will maximise uptime, productivity and profit. Painlessly.***

# Customer Care Parts and Service



## Certified is safer

For the safety and convenience of our customers we offer certified products for cleaning and maintaining your equipment. By using JBT Certified cleaning agents and lubricants you are ensured to get the best suited products, customized to fulfil your needs and prolong the lifespan of your investment.

## Formula Family Lubricants

The Formula family is developed to answer the stringent food safety requirements and temperature extremes of the food processing industry. Tested and proven under the most severe operating conditions, Formula lubricants support safe, smooth operation and maximised operating uptime with the perfect cocktail of pour point and viscosity.

Each of our environmental-friendly food-grade lubricants is specifically developed to perform a specific task, and is available in a range of containers and volumes to match your production requirements. The lubricants are USDA H1-authorized.

## Formula Clean Detergents

When you buy cleaning chemicals from JBT, we don't just sell you a pallet of chemicals, we look at your cleaning process to make sure you use the right mix of cleaning agents and the right dosage, to save on chemical consumption, water and our environment while ensuring food safety.

Choosing the right detergent for your food processing equipment is very important to prevent contamination and bacterial growth.

The Formula Clean® family is developed to fit JBT product lines specifically and to avoid unnecessary wear of the materials in our equipment. Each product of the Formula Clean family has its purpose and special qualities and comes in different containers to fit your needs.

*Ensure you use the right cleaning chemicals  
and clean in a correct way!*

# Good buy

## You know it's not goodbye - it's a good buy

In every aspect in the development of a solution from JBT you can rest assured that great considerations have been taken in regards of sustainability and ethics. When you buy your machinery from JBT you know that it has been developed and manufactured in a responsible way. And you know that you get a piece of equipment that utilises the latest scientific advances in technology to minimise your environmental footprint. But it doesn't end there. Our solutions and processes come with a commitment to constantly improve their impacts in the areas of CSR. Whether it is by developing more energy efficient drive lines, decreasing consumption of water and chemicals or offering training and support to create more sustainable work flows.

Our focus on minimising the environmental footprint of our business does not end with a closed deal on a piece of equipment. We are committed to long-term partnerships with our customers. JBT's customer care services ensure that even old equipment receives high quality maintenance and machine upgrades so that you are getting the most value out of the equipment and realise more operational savings. We offer upgrade kits and solutions that are designed and engineered to maximise operating efficiency while minimising environmental impact.

## *What's good for you is also good for the environment.*









# *We are your single source for profitable processing solutions*

## **Sweden**

John Bean Technologies AB  
Rusthällsgatan 21,  
Box 913  
SE-251 09 Helsingborg, Sweden  
Phone: +46 42 490 4000  
E-mail: info-europe@jbtc.com

## **France**

John Bean Technologies SA  
Taverparc - Bâtiment 2.1  
62 Boulevard Henri Navier  
95150 Taverny, FRANCE  
Phone : +33 1 84 28 02 00  
E-mail: info-europe@jbtc.com

## **Germany**

John Bean Technologies GmbH  
Esch 11  
33824 Werther  
Germany  
Phone: +49 5203 9700 970  
E-mail: info-europe@jbtc.com

## **Italy**

John Bean Technologies SpA  
Via Mantova 63/A  
43100 Parma  
Italy  
Phone: +39 0521 908411  
E-mail: info-europe@jbtc.com

## **Poland**

John Bean Technologies Sp. z o.o.  
Ul. Stryjeńskich 19 lok. 21/21A  
02-791 Warszawa  
Poland  
Phone: +48 22 894 9025  
E-mail: info-poland@jbtc.com

## **Spain**

John Bean Technologies Spain  
S.L.  
Carretera A2, Km. 34,400  
28805 Alcalá de Henares Madrid,  
Spain  
Phone: +34 913 046 698  
E-mail: info-europe@jbtc.com

## **UK**

John Bean Technologies Ltd  
Heather Park  
Kirkton South Road, Livingston  
West Lothian EH54 7BT  
Scotland, UK  
Phone: +44 1506 857112  
E-mail: info-europe@jbtc.com

## **Europe**

John Bean Technologies AB  
Rusthällsgatan 21, Box 913  
SE-251 09 Helsingborg  
SWEDEN  
Phone +46 42 490 4000  
E-mail: info-europe@jbtc.com

## **North America**

JBT Corporation  
1622 First Street  
Sandusky, OH 44870  
USA  
Phone: +1 419 626 0304  
E-mail: process-solutions@jbtc.com

## **Latin America**

JBT Máquinas e Equipamentos Industriais Ltda.  
Av Eng Camilo Dinucci 4605  
14808-900 Araraquara  
São Paulo BRAZIL  
Phone + 55 16 3301 2000  
E-mail: latinamerica.info@jbtc.com

## **Asia**

John Bean Technologies Ltd.  
159/26 Serm-Mit Tower, Room no. 1602-3  
Sukhumvit 21 Road, Klongtoey Nua Sub-district  
Wattana District, Bangkok 10110 THAILAND  
Phone: + 66 2257 4000  
E-mail: infoasia-jbtfoodtech@jbtc.com

## **Australia**

John Bean Technologies Australia Limited  
Unit 1, 40 Rivergate Place  
Murarrie QLD 4172 Australia  
Phone: +61 7 3896 6100  
E-mail: info.au@jbtc.com  
E-mail: info.nz@jbtc.com



[www.jbtc.com/foodtech](http://www.jbtc.com/foodtech)