

# SECOMP

## CATALOG 2018/2019



IT-Accessories

Network Components

Office Equipment



[www.secomp-international.com](http://www.secomp-international.com)



Catalog 2018/2019

**roline**<sup>®</sup>  
Designed for Professionals

**THE QUALITY LINE**



## PROFESSIONAL PRODUCTS FOR PROFESSIONAL USERS

- **ROLINE Brand Packings with EAN-Code and 7-Language-Stickers**
  - **Methodical Quality Inspections for all Products**
    - **2 Years Warranty for all ROLINE Products**
    - **Free Marketing and Technical Support**
      - **All Products available from Stock**
        - **Bonded Warehouse**
          - **Best Prices**



Jose Horstman  
Export Manager



Leonarda Moccia  
Executive Assistant



Emily Chen  
Export Administration



Kirsten Langer  
Export Administration  
Shipping Department



# Valued Customer our Commitment to you!

## Product Selection

All products are acquired from established and experienced manufactures across the globe, which lead the way within the computer accessory industry. To a large extent they are produced according to our internal specifications. Our products comply with all relevant technical requirements including the RoHS, WEEE & CE regulations.



## ROLINE Brand

A brand that you can trust! - ROLINE is a brand name for high quality accessories and a product that is of very good quality, excellent reliability and also attractively priced. ROLINE branded products come with a 2-year warranty.

**roline**<sup>®</sup>  
Designed for Professionals

## VALUE Brand

Quality products and highly aggressive pricing makes the VALUE range ideally suited for Distribution Partners. All VALUE products are supplied with a 1-year warranty.

**Value**<sup>®</sup>

## Quality Control

All our products are tested systematically according to DIN-ISO 2859 rules. They are tested under real working conditions, which shows confidence in the quality of product we supply to the trade.



## On Stock

All catalogue products are on stock or will be available within a short period of time.



## Good Price

High purchasing volume and long-term relationships with highly specialised manufactures gives you the advantage to buy always at competitive prices 'value for money'.



## Service and Support

We provide assistance and guidance for technical questions & product enquiries against our entire Computer Accessory product portfolio.



**Please contact us now!**

Quality and Service Performance

# CONTENTS - 11 product chapters providing easy selection.

# N



## NEWSSHOP - New Products

ROLINE FO Jumper Cables LSH / LC Duplex.....	NEW.2	VALUE / ROLINE Type C - HDMI Adapter .....	NEW.5
VALUE Cat.6 / Cat.6A Field Plug .....	NEW.2	VALUE 19" Industrial Rack Mount Server Chassis .....	NEW.5
VALUE Connection Module Cat.6A .....	NEW.3	ROLINE Wireless Charger .....	NEW.6
VALUE Keystone Cat.6A .....	NEW.3	ROLINE Wall Charger .....	NEW.6
ROLINE KVM Switch DisplayPort .....	NEW.3	ROLINE PDU for Cabinets .....	NEW.6
ROLINE HDMI UHD Cables .....	NEW.3	VALUE Power Strip Holder / Organizer .....	NEW.7
VALUE / ROLINE Cabeladapters DP/HDMI .....	NEW.4	VALUE Monitor Arm .....	NEW.7
VALUE Type C - VGA/DVI/HDMI Cables .....	NEW.4	VALUE / ROLINE TV Holder .....	NEW.8

# 1



## Network Components / Cables

Fast- / Gigabit Ethernet Converter .....	1.02	Patch Panels .....	1.32 - 1.36
Fast- / Gigabit Ethernet Switches .....	1.03 - 1.04	Mount Boxes .....	1.37
Media Converters .....	1.04, 1.05, 1.09	Modular Plugs, Couplers, Junction Boxes,	
PoE Injectors / PoE Switches .....	1.05 - 1.07	Keystones .....	1.38 - 1.41
Industrial Networking .....	1.06 - 1.10	Fibre Optic Jumper Cables .....	1.41 - 1.45
Dummy Surveillance Cameras .....	1.11	FO Cleaning Accessories .....	1.46
TP Cables Overview .....	1.12 - 1.13	FO Adapter .....	1.47
Cable Assembly .....	1.14	MPO Cabling System .....	1.48
Installation Cables .....	1.15 - 1.17	19" LCD KVM Consoles .....	1.49
Patch Cords .....	1.18 - 1.31	19" Wall Cabinets .....	1.50

# 2



## Switchboxes / Hubs

"Star" KVM Switches .....	2.02	KVM DVI Switches / Extender .....	2.07, 2.08
19"Desktop" KVM Switches .....	2.03	KVM HDMI Switches .....	2.09, 2.10
19" KVM Switches .....	2.03 - 2.05	KVM Gigabit Ethernet Extender .....	2.09
19" LCD KVM Switches .....	2.05	Manual USB Switches .....	2.10 - 2.11
KVM DVI Dual Head Switches .....	2.06	USB 2.0 / 3.0 Hubs .....	2.11 - 2.14
KVM DisplayPort Switches .....	2.06	USB 3.0 Hubs (Type C) .....	2.14
IP KVM / KVM Extenders .....	2.07, 2.08, 2.09		
KVM Switches with USB Hub .....	2.07		

# 3



## Computer Cables / Connectors / Adapters

ROLINE - THE difference .....	3.02 - 3.03	Adapters VGA/DVI/HDMI/DP .....	3.27, 3.30 - 3.34
USB2.0/USB3.0/USB3.1 Cables ....	3.04 - 3.11, 3.24, 3.25	USB Type C Display Adapters .....	3.33 - 3.35
USB Extenders .....	3.08, 3.09	USB Type C Docking Stations .....	3.36
9-pole / 25-pole / Serial / -Link Cables .....	3.13	Audio / Video Cables / Adapters .....	3.37 - 3.38
Printer Cables, parallel .....	3.13	SATA Cables .....	3.32, 3.39, 3.40
Keyboard Cables PS/2 .....	3.14	Internal Power Cables .....	3.41
Monitor Connection Cables VGA .....	3.14 - 3.15	Power Cords .....	3.42 - 3.43
Monitor Connection Cables DVI .....	3.15 - 3.16, 3.26	Telephone Cables / Accessories; Ferrites .....	3.43, 3.44
HDMI Cables .....	3.16 - 3.20, 3.27 - 3.29	Gender Changers .....	3.44
DisplayPort Cables .....	3.20 - 3.23, 3.26	Adapters / Converters .....	3.45 - 3.50

# 4



## Peripheral Devices

I/O Cards .....	4.02 - 4.04	Barcode Scanner .....	4.09
Card Readers .....	4.04, 4.05	Keypad / Calculator Keypad .....	4.09
HDD Enclosures / Mobile Racks .....	4.06, 4.07	Mouses .....	4.10
HDD Docking Station .....	4.06	Mouspads .....	4.10
Mounting Material .....	4.07		
19" Industrial Server Chassis .....	4.07, 4.08		

# 5



## Mobile Computing

Gigabit Ethernet Converter + Hub .....	5.02	USB Charger .....	5.08
Sync- & Charging Cables / Adapters .....	5.02 - 5.03	Stand / Holder for Tablet .....	5.09
USB Card Reader .....	5.05	Stand for Homepod / Echo .....	5.10
3.5mm Audio Adapters .....	5.07	Security Locks .....	5.10
Docking Stations .....	5.06, 5.07		

# 6



## Multimedia

USB Display Adapters .....	6.02	HDMI Matrix Switches .....	6.12, 6.13
Audio/Video Extenders over TP .....	6.03 – 6.05	HDMI Emulator .....	6.13
HDMI / DP Extenders .....	6.04 – 6.07	Audio Extractor .....	6.14
Wireless HDMI Audio/Video Systems .....	6.05	Audio Adapters / Converters .....	6.15
UHD HDMI Active Cables .....	6.06 – 6.07	Headsets .....	6.15, 6.16
Audio/Video Splitters .....	6.08 – 6.10, 6.11, 6.13	Video Grabber / Converter .....	6.15
Audio/Video Switches .....	6.11 – 6.12, 6.13	Multimedia Audio/Video Modules .....	6.16

# 7



## UPS Systems / Power Distribution

Line-Interactive UPS .....	7.02 – 7.03	USB Power Cables .....	7.08
Online UPS .....	7.03	USB Power Stations .....	7.08
Power Strips .....	7.04, 7.05	Power Cords .....	7.09 – 7.10
USB Chargers / Car Chargers .....	7.05 – 7.07	Power Extension Cables .....	7.10
PDU for Cabinets .....	7.06, 7.07		
IP Power Strip / Remote Switch .....	7.06		
Universal Power Adapters .....	7.07		

# 8



## Test / Measurement / Tools

Cable Testers / Network Tools .....	8.02 – 8.03	Cable Ties / Installation Tools / Clips .....	8.10
USB Type C Measurement .....	8.03	Cable Tunnel Organizers .....	8.10
Crimping Pliers / Tools .....	8.04 – 8.05		
Fiber Optic Cleaning Tools .....	8.06		
Service Kits .....	8.07 – 8.10		

# 9



## Office Equipment / Consumables

Mouse Pads .....	9.02	Wall / Ceiling Projector Mount .....	9.16
Wristrests .....	9.02	Monitor Stand .....	9.17
VESA Adapters .....	9.03	Power Strip Holder .....	9.19
LCD Monitor Arms / Mounts .....	9.04 – 9.10	Printer Tables .....	9.20
Wall Mount Workstation .....	9.11	PC Workstations .....	9.18, 9.20, 9.21
Monitor / PC Stands .....	9.11, 9.12, 9.13, 9.15	Cleaning Sets .....	9.21 – 9.22
Cable Cover Organizer .....	9.15		
PC Holder .....	9.13 – 9.14, 9.15		

# 10



## TV Holders / Furnitures

TV Wall Holders .....	10.02 – 10.06	TV Ceiling Holders .....	10.10
TV Mobile Cart .....	10.08 – 10.10	TV Board/Stand / Sideboards .....	10.11
Digital Signage .....	10.07 – 10.08	Cable Box .....	10.11

# %



## SELLOFF - as long as we have stock

Internal Hubs .....	A.02	HDMI Switch .....	A.05
SATA Cables / Charging Cables .....	A.02	Wire Crimper / Cutter / Tools .....	A.05, A.06
ROLINE / VALUE HDMI Cables .....	A.02	Screwdrivers Sets .....	A.06
Smartphone Accessories .....	A.03	ROLINE Wall Mount Kits .....	A.07
VALUE / ROLINE Bluetooth Headsets .....	A.03, A.04	VALUE / ROLINE Monitor Arms .....	A.07, A.08
VALUE / ROLINE Smartphone Holder .....	A.04		
ROLINE Tablet Headrest Holder .....	A.05		
ROLINE DP to DVI Converter .....	A.05		

**ROLINE FO Jumper Cable Duplex, 9/125µm, OS2, LSH/LC, APC Polish, LSOH**

**High-quality fibre optic cable with the high protective, secured LSH connection on one side and LC plug on the other side - both connections are APC polished.**

- Duplex cable with fiber type 9/125µm OS2
- Cable material: sheath halogen-free and flame-retardant, yellow, solid core with aramid strain relief
- LC connector: connector with high mechanical load capacity, push-pull latched with anti-rotation lock, APC ground joint, ceramic ferrule
- LSH connector: precision-manufactured connectors with low return loss (RL), APC ground joint, ceramic ferrule, green
- The LSH connector has a spring-loaded shutter, which fully protects the ferrule from dust and scratches

- APC Polish (8° - APC- Angled Physical Contact- allows tighter connection and smaller end-face radii)
- IL < 0.25dB, RL > 60dB
- IL (typical) < 0.12dB
- Cable OD (outer diameter): 3.0 x 6.0mm



Halogenfree  
Flame retardant  
Low Smoke

**roline**<sup>®</sup>  
Designed for Professionals

	Order-No.	P.U.
ROLINE FO Jumper Cable Duplex, 9/125µm, OS2, LSH/LC, APC Polish, LSOH, yellow, 0.5 m	21.15.9480	- 10
ROLINE FO Jumper Cable Duplex, 9/125µm, OS2, LSH/LC, APC Polish, LSOH, yellow, 1.0 m	21.15.9481	- 10
ROLINE FO Jumper Cable Duplex, 9/125µm, OS2, LSH/LC, APC Polish, LSOH, yellow, 2.0 m	21.15.9482	- 10
ROLINE FO Jumper Cable Duplex, 9/125µm, OS2, LSH/LC, APC Polish, LSOH, yellow, 3.0 m	21.15.9483	- 5
ROLINE FO Jumper Cable Duplex, 9/125µm, OS2, LSH/LC, APC Polish, LSOH, yellow, 5.0 m	21.15.9485	- 5
ROLINE FO Jumper Cable Duplex, 9/125µm, OS2, LSH/LC, APC Polish, LSOH, yellow, 7.5 m	21.15.9486	- 5
ROLINE FO Jumper Cable Duplex, 9/125µm, OS2, LSH/LC, APC Polish, LSOH, yellow, 10.0 m	21.15.9487	- 5

**ROLINE FO Jumper Cable LSH Duplex, 9/125µm, OS2, LSH APC / LC UPC, LSOH**

**High-quality fibre optic cable with the high protective, secured APC polished LSH connection on one side and UPC polished LC plug on the other side.**

- Duplex cable with fiber type 9/125µm OS2
- Cable material: sheath halogen-free and flame-retardant, yellow, solid core with aramid strain relief

- LC connector: connector with high mechanical load capacity, push-pull latched with anti-rotation lock, APC ground joint, ceramic ferrule
- LSH connectors: precision-manufactured connectors with low return loss, APC ground joint, ceramic ferrule, grey
- The LSH connector has a spring-loaded shutter, which fully protects the ferrule

- from dust and scratches
- LSH APC Polish (8°) / LC UPC Polish
- IL < 0.25dB, RL > 25dB
- IL (typical) < 0.12dB
- Cable OD (outer diameter): 3.0 x 6.0mm

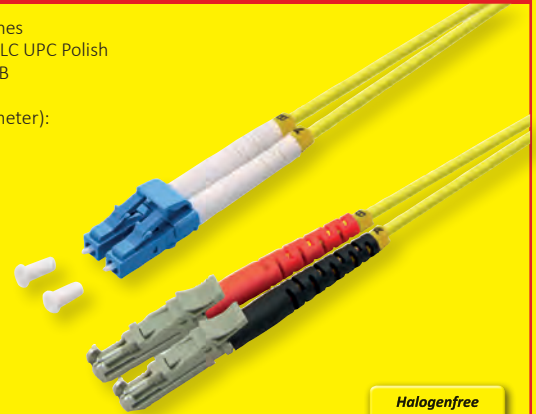

Halogenfree  
Flame retardant  
Low Smoke

**roline**<sup>®</sup>  
Designed for Professionals

	Order-No.	P.U.
ROLINE FO Jumper Cable LSH Duplex, 9/125µm, OS2, LSH APC / LC UPC, LSOH, yellow, 0.5 m	21.15.9510	- 10
ROLINE FO Jumper Cable LSH Duplex, 9/125µm, OS2, LSH APC / LC UPC, LSOH, yellow, 1.0 m	21.15.9511	- 10
ROLINE FO Jumper Cable LSH Duplex, 9/125µm, OS2, LSH APC / LC UPC, LSOH, yellow, 2.0 m	21.15.9512	- 10
ROLINE FO Jumper Cable LSH Duplex, 9/125µm, OS2, LSH APC / LC UPC, LSOH, yellow, 3.0 m	21.15.9513	- 5
ROLINE FO Jumper Cable LSH Duplex, 9/125µm, OS2, LSH APC / LC UPC, LSOH, yellow, 5.0 m	21.15.9515	- 5
ROLINE FO Jumper Cable LSH Duplex, 9/125µm, OS2, LSH APC / LC UPC, LSOH, yellow, 7.5 m	21.15.9516	- 5
ROLINE FO Jumper Cable LSH Duplex, 9/125µm, OS2, LSH APC / LC UPC, LSOH, yellow, 10.0 m	21.15.9517	- 5

**VALUE Field Plug Cat.6, UTP/STP**

- Fast and easy tool-free installable unshielded/shielded RJ45 connector
- Cat.6/Class E performance according to ISO/IEC11801 and IEC60603-7
- Compact cable manager for round Solid cable AWG 23-26(1/0.41-1/0.575mm) and stranded cable AWG 24-26(7/0.16-7/0.20mm)
- For cable with outer diameter OD: 6.0- 9.0mm

- Pair management according to TIA 568B and TIA 568A colour codes
- Strain relief with cable tie and black transparent dust cup and boot
- Color: Transparent black



Available November 2018



Order-No. – P.U.

VALUE Field Plug Cat.6, UTP	26.99.0370	- 50
VALUE Field Plug Cat.6, STP	26.99.0371	- 50

**VALUE Field Plug Cat.6A, UTP/STP**

- Fast and easy tool-free installable unshielded/shielded RJ45 connector
- Cat.6A / Class EA performance according to ISO/IEC11801 and IEC60603-7
- Compact cable manager for round Solid cable AWG 23-26(1/0.41-1/0.575mm) and stranded cable AWG 24-26(7/0.16-7/0.20mm)
- For cable with outer diameter OD: 6.0- 9.0mm

- Pair management according to TIA 568B and TIA 568A colour codes
- Strain relief with cable tie and black transparent dust cup and boot
- Color: Transparent black



Available November 2018



Order-No. – P.U.

VALUE Field Plug Cat.6A, UTP	26.99.0372	- 50
VALUE Field Plug Cat.6A, STP	26.99.0373	- 50



## VALUE Connection Module Cat.6A, STP

- The VALUE Junction module is used to repair or extend shielded Cat. 6A cables
- With this module all 4 or 8 wired installation cables with AWG24 and with an outside diameter from 6.2mm can be installed
- Equipped with the modern LSA connection technology, all cables in accordance with EIA/TIA 568A or 568B can be easily installed
- With the use of the STP type junction box, it's safe against electrical and magnetical interferences



Available November 2018

Order-No. – P.U.

VALUE Connection Module Cat.6A, STP

26.99.0380 – 50

## VALUE Cat.6A Keystone, RJ-45, w.ith Shutter, Tool-free

The low-cost solution for Cat 6.A cabling for data rates up to 10Gbit/s!

Cat.6A/Class EA Keystone jack for installation in a Keystone blank 19" patch panel module frame.

- Toolless mounting- without using a LSA tool: cable wires are simply placed into the guides of Keystone module, the module is closed and compressed- the connection is ready for use
- Cat.6A Keystone Jack (Module) UTP/STP
- Unshielded/shielded housing
- Contacts gold plated

- Slim type
- With plastic internal shutter black
- 180 degree cable entry
- Support PoE per IEEE 802.3af, PoE+ per IEEE 802.3at
- For cable AWG 22-24(0.45-0.65mm)
- For cable OD: 5.0-8.5mm
- Color code on the Keystone jacks based on the standard EIA/TIA 568 A & B
- Dimensions (L x W x H): 37.9x 15.8 x 22.2mm



Tool-free

Available November 2018

Order-No. – P.U.

VALUE Cat.6A Keystone, RJ-45, UTP, with shutter, tool-free

26.99.0377 – 50

VALUE Cat.6A Keystone, RJ-45, STP, with shutter, tool-free

26.99.0378 – 50

## ROLINE KVM Switch, 1 User - 2 PCs, DisplayPort, with USB Hub

4K 2160p ULTRA HD

Automatic DisplayPort v1.2 KVM Switch for 1 User / 2 PCs, with 2-Port USB 3.0 Hub and resolutions of up to 3840x2160 @60Hz!

- Switching between PCs is done either by hot key or automatically during scan run
- Keyboard and mouse emulation via two separate USB 2.0 ports
- Supports graphics cards and monitors with DisplayPort connectors, with a resolution of max. 4096x2160 @60Hz
- LED display informs about the channel assignment
- Additional 2-port USB 3.0 hub for connecting e.g. USB sticks or SSDs
- Contents: KVM switch, power supply, manual

**roline**  
Designed for Professionals



Available November 2018

Order-No. – P.U.

ROLINE KVM Switch, 1 User - 2 PCs, DisplayPort, with USB Hub

14.01.3331 – 2

## ROLINE HDMI Ultra HD Cable + Ethernet, Active

4K 3D Capable 2160p ULTRA HD

High-quality HDMI connection cable with HDMI connectors for optimal transmission of digital HDTV signals at data rates up to 18 Gbit/s (600MHz). For the transmission of films in digital cinema-quality, with a resolution of up to 3840x2160 @60Hz!

- HDMI Ethernet Channel
- Audio Return Channel
- 3D- Defines input/output protocols for major 3D video formats
- Cable with HDMI male connector on both sides
- High quality cable with golden plated shell
- Gold plated contacts for higher durability

Order-No. – P.U.

ROLINE HDMI Ultra HD Cable + Ethernet, active, M/M, black, 1.0 m 11.04.5910 – 20

ROLINE HDMI Ultra HD Cable + Ethernet, active, M/M, black, 1.5 m 11.04.5911 – 20

ROLINE HDMI Ultra HD Cable + Ethernet, active, M/M, black, 2.0 m 11.04.5912 – 15

ROLINE HDMI Ultra HD Cable + Ethernet, active, M/M, black, 3.0 m 11.04.5913 – 15

ROLINE HDMI Ultra HD Cable + Ethernet, active, M/M, black, 5.0 m 11.04.5915 – 10

**roline**  
Designed for Professionals



Available November 2018



**VALUE Cableadapters, DP / Mini DP to VGA / DVI / HDMI**

- If you want to connect a graphic card with DisplayPort Female to a monitor by using a DVI cable, you need this DisplayPort to DVI adapter
- Connectors: DisplayPort Male, Mini Display Port



Available November 2018



Picture	Order-No. – P.U.	Adapter / Cableadapter	Type	Connector	Length	Version	Active	Passive	Color	Max. nom. Resolution	4K
A	12.99.3136 – 10	Cableadapter	DP – VGA	M/F	0.15	v1.1	–	yes	black	1920 x 1080@60Hz	–
B	12.99.3137 – 10	Cableadapter	DP – DVI	M/F	0.15	v1.1	–	yes	black	1920 x 1080@60Hz	–
C	12.99.3138 – 10	Cableadapter	DP – HDMI	M/F	0.15	v1.1	–	yes	black	1920 x 1080@60Hz	–
D	12.99.3139 – 10	Cableadapter 4K	DP – HDMI	M/F	0.15	v1.1	–	yes	black	3840 x 2160@30Hz	yes
E	12.99.3126 – 10	Cableadapter	Mini DP – VGA	M/F	0.15	v1.1	–	yes	black	1920 x 1080@60Hz	–
F	12.99.3130 – 10	Cableadapter	Mini DP – HDMI	M/F	0.15	v1.1	–	yes	black	1920 x 1080@60Hz	–
G	12.99.3143 – 10	Cableadapter 4K	Mini DP – HDMI	M/F	0.15	v1.1	–	yes	black	3840 x 2160@30Hz	yes

**ROLINE DisplayPort-HDMI Adapter, 4K@60Hz, DP v1.4, DP M - HDMI F**

**For connecting an HDMI cable to a DisplayPort socket with a resolution of up to 3840x2160 @60Hz and HDR 10 support!**

- If you want to connect a graphic card with DisplayPort Female to a monitor by using a HDMI cable, you need this DisplayPort to HDMI adapter
- Connectors: DisplayPort Male, HDMI Female

- DisplayPort Version 1.4 allows increased resolutions, higher refresh rates, and greater color depth
- Support HRD10 (High Dynamic Range 10 static)
- Remark: The DisplayPort-HDMI adapter is only working in one direction: the DisplayPort plug has to be connected to the source device (e.g. graphic card)

**Order-No. – P.U.**

ROLINE DisplayPort-HDMI Adapter, 4K@60Hz, DP v1.4, DP M - HDMI F 12.03.3164 – 10

**VALUE Cables Type C - VGA, DVI, HDMI, DisplayPort**

- **USB 3.1 Cable Type C to VGA/DVI/HDMI/DisplayPort for Macbook**
- Connect your MacBook with USB-C port to any correspondent display or projector
- This adapter allows you to mirror your MacBook display to your TV or display
- No power adapter required
- Supports maximum resolutions up to 1920 x 1080 @60Hz (Full HD 1080p) – Type C- VGA
- Supports maximum resolutions up to 3840x2160 @ 30Hz- Type C- DVI
- Supports maximum resolutions up to 3840x2160 @ 60Hz- Type C- HDMI/DP

- Connectors: VGA Male and Type C Male (11.99.5820/11.99.5821/11.99.5822)
- Connectors: DVI Male and Type C Male (11.99.5830/11.99.5831)
- Connectors: HDMI Male and Type C Male (11.99.5840/11.99.5841)
- Connectors: DisplayPort Male and Type C Male (11.99.5845/11.99.5846)
- DisplayPort Version 1.2 allows increased resolutions, higher refresh rates, and greater color depth

**Order-No. – P.U.**

VALUE USB Type C - VGA Cable, M/M, 1.0 m 11.99.5820 – 10

VALUE USB Type C - VGA Cable, M/M, 2.0 m 11.99.5821 – 10

VALUE USB Type C - VGA Cable, M/M, 3.0 m 11.99.5822 – 10

**Order-No. – P.U.**

VALUE USB Type C - DVI Cable, M/M, 1.0 m 11.99.5831 – 10

VALUE USB Type C - DVI Cable, M/M, 2.0 m 11.99.5832 – 10

**Order-No. – P.U.**

VALUE Type C - HDMI Cable, M/M, 1.0 m 11.99.5840 – 10

VALUE Type C - HDMI Cable, M/M, 2.0 m 11.99.5841 – 10

**Order-No. – P.U.**

VALUE Type C - DisplayPort Cable, M/M, 1.0 m 11.99.5845 – 10

VALUE Type C - DisplayPort Cable, M/M, 2.0 m 11.99.5846 – 10

### ROLINE Type C - HDMI Adapter, M/F

4K 2160p ULTRA HD

Connect a monitor or projector with HDMI interface to your MacBook, Ultrabook, notebook/laptop or PC with USB Type C port - with a maximum resolution of up to 3840x2160 @60Hz; The flat silicone cable provides maximum flexibility!

- USB 3.1 Type C to HDMI Cableadapter
- Connect your device with USB-C port to any HDMI display or projector
- This adapter allows you to mirror or extend your display to any HDMI-enabled TV or display
- Portable design

- No power adapter required
- Connectors: HDMI Female and Type C Male
- Cable length: ca. 13 cm

**roline**  
Designed for Professionals



Available November 2018

Order-No. – P.U.

ROLINE Type C - HDMI Adapter, M/F, 0.13 m

12.03.3212 – 10

### VALUE Type C - HDMI Adapter, M/F, 2x USB 3.0 A F, 1x PD (Power Delivery)

4K

Connect your Macbook, Ultrabook, notebook/laptop or PC with USB Type C connection quickly and easily to a monitor or TV via HDMI - with a resolution of up to 3840x2160 @30Hz! The additional ports (1x USB Type C with Power Delivery, 1x USB 3.0 and 2x USB 2.0) allow you to connect many different peripherals, such as keyboard, mouse, HDD/SSD and a power supply via USB Type C!

- USB 3.1 Type C to HDMI cable adapter for e. g. MacBook
- Connecting an HDMI monitor or projector with HDMI connection
- Mirror your display onto an HDMI-capable TV or monitor
- Portable, compact design
- No power supply required
- Power delivery function (for charging devices via the additional USB Type C connector; 14.5V 2A)
- Connections: USB Type C plug, 1x HDMI socket, 1x USB 3.0 Type A socket, 2x USB 2.0 Type A socket and USB Type C socket (Power Delivery)
- Cable length: approx. 10 cm

**Value**

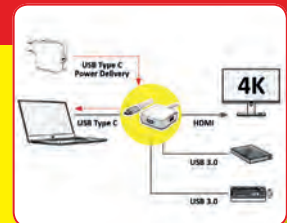

Order-No. – P.U.

VALUE Type C - HDMI Adapter, M/F, 2x USB 3.0 A F, 1x PD (Power Delivery)

12.99.1133 – 10

### VALUE 19" Industrial Rack-Mount Server Chassis, 4UH

DATA CENTER Product

- Versatile 4U 19" industrial PC housing
- Rugged construction and design for harsh industrial environment
- 4UH rack with a long installation depth (650mm)
- Supports ATX / (eATX) / Baby AT motherboard
- Max Mainboard Size: 305 x 345 mm (12" x 13.5")
- Provides enough space for HDD disks (up to 11x 3.5" HDDs)
- Mounting rails for screw less installation of internal 3.5" and external 5.25" drives (included)
- Seven fans are preinstalled, which allows an optimal cooling of the installed hardware (5x 120x120mm; 2x 80x80mm)
- Embedded dust filter, which can be removed for cleaning, is located behind the lockable front door and prevents both removable HDD cages from dust
- 2x front USB ports (1x USB 2.0 and 1x USB 3.0)
- Space for installation of an ATX power supply (not included in delivery)
- Contents: Casing, keys, screw set, mounting frame for mini redundant power supply, wrench for assembly of the spacer, mounting rails for 5.25" and 3.5" drives



Order-No. – P.U.

VALUE 19" Industrial Rack-Mount Server Chassis, 4UH, black

19.99.0116 – 1

VALUE Telescopic rails for VALUE Industrial Rack-Mount Server Chassis, 19990116

19.99.0117 – 1



**Value**

## ROLINE Wireless Charger for Mobile Devices, 10W

**Qi is an interface standard for inductive energy transfer of the „Wireless Power Consortium“. Members of this consortium include, without limitation known companies such as HTC, Samsung, Nokia, Sony, and many others.**

How does wireless charging work?

For inductive charging requires two devices. A receiver (Qi compatible device) and a transmitter (charging station).

The power transmission is effected via coils which generate a magnetic field. Above this magnetic field,

the receiver can accommodate up to 10W and thereby recharge the internal battery.

- Loads a smartphone with the associated receiver or other Qi compatible devices
- No drivers needed
- Plug & Play
- Ideal for traveling, office, leisure, etc.
- LED display
- Colour: black
- Contents: Qi charger, power adapter, USB charging cable



**Order-No. – P.U.**

ROLINE Wireless Charger for Mobile Devices, 10W

19.11.1010 – 10

**roline**  
Designed for Professionals

Available November 2018

## ROLINE USB Wall Chargers Euro Plug, 2 / 3 Ports, QC3.0

**For charging or as a PSU over the USB port of your device. Fast charging through Quick Charge 3.0!**

- For charging of mobile devices (tablets / smartphones)
- Quick Charge 3.0 / Type C (PD) supported (only 19.11.1032)
- Multi-Protection: Over Current / Short Circuit / Over Voltage Protection
- Compact Design
- Power IQ technology- identifies what kind of device is plugged into and delivers the proper voltage/ampereage
- Input: 100- 240 V AC, 50- 60 Hz

Technical data:	19.11.1032	19.11.1033
Input:	100 - 240 VAC	100 - 240 VAC
Output:	1x USB A F - 18W(3.6-6.5V/3A 6.5-9V/2A 9-12V/1.5A) 1x C PD30W (5V 3A/9V 3A/15V 2A/20V1.5A)	2x USB A F (5V; 2.4A) 1x USB A F QC3.0 24W(3.6-6.5V/3A & 6.5V-9V/2A & 9-12V/2A)
Power (max.):	49.5 W	36W
Dimensions:	62.5 x 28.5 x 88 mm	64 x 28.5 x 88 mm
Additional features	IQ technology QC 3.0 (Quick Charge)	IQ technology QC 3.0 (Quick Charge)



19.11.1032

19.11.1033

**Order-No. – P.U.**

ROLINE USB Wall Charger Euro Plug, 2 Ports, 1x QC3.0 + 1x C (PD), 49.5W 19.11.1032 – 10

ROLINE USB Wall Charger, 3 Ports (1x QC3.0 + 2x 5V/2.4A), 36W 19.11.1033 – 10

**roline**  
Designed for Professionals

Available November 2018

## ROLINE 19" PDU for Cabinets 8x IEC320 C13 - C20 / German Type / C14

DATA CENTER  
capable

- 19" socket (1UH) for installation in 19" cabinets, incl. installation angle
- Arrangement of sockets: 90°
- Profile of anodized aluminium

- Cable type:  
2.0m H05VV-F 3G 1mm<sup>2</sup> (19.07.1629),  
2.0m H05VV-F 3G 1.5mm<sup>2</sup> (19.07.1627/19.07.1628) black
- Max load/power:  
10A 2300W (19.07.1629)  
16A 3600W (19.07.1627 / 19.07.1628)
- Color: ALU / light gray RAL 7035
- Width: 440mm

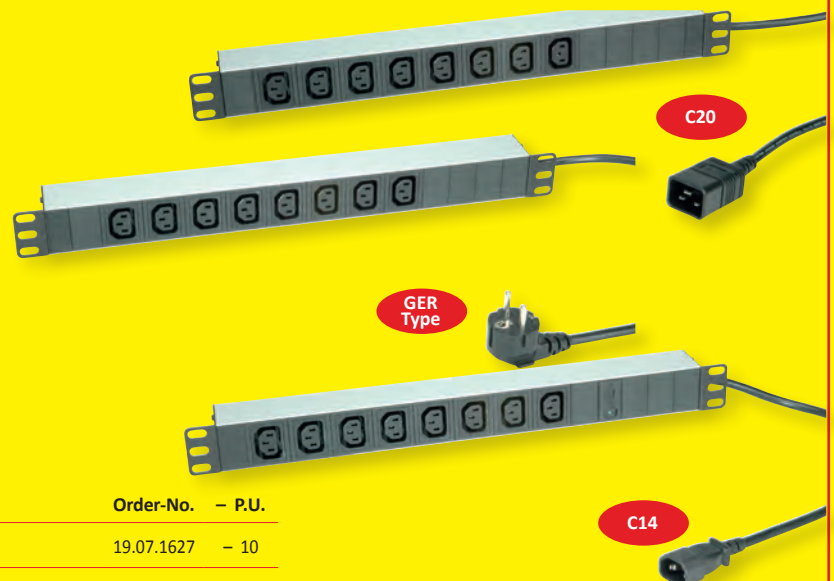

**roline**  
Designed for Professionals

**Order-No. – P.U.**

ROLINE 19" PDU for Cabinets 8x 2300W, IEC320 C13 - C20 M, Aluminium, 2.0 m

19.07.1627 – 10

ROLINE 19" PDU for Cabinets 8x 3600W, IEC320 C13 - German Type M, Aluminium, 2.0 m

19.07.1628 – 10

ROLINE 19" PDU for Cabinets 8x 3600W, IEC320 C13 - C14 M, 10 A Fuse, Aluminium, 2.0 m

19.07.1629 – 10

Available November 2018



### VALUE Clamp-On Power Strip Holder

- Suitable next to desktops, multimedia systems, etc.
- For an organized desktop/office
- Clamp-On power strip holder
- Clamps onto surfaces up to 50 mm thickness
- Width adjustment range of the kept devices: min. 50mm- max. 70mm
- Silicone pads prevent the mounted device from scratching and accidental dropping (e.g. secure hold of power strip...)
- Cable management



Order-No. – P.U.

VALUE Clamp-On Power Strip Holder, white

19.99.3230 – 10

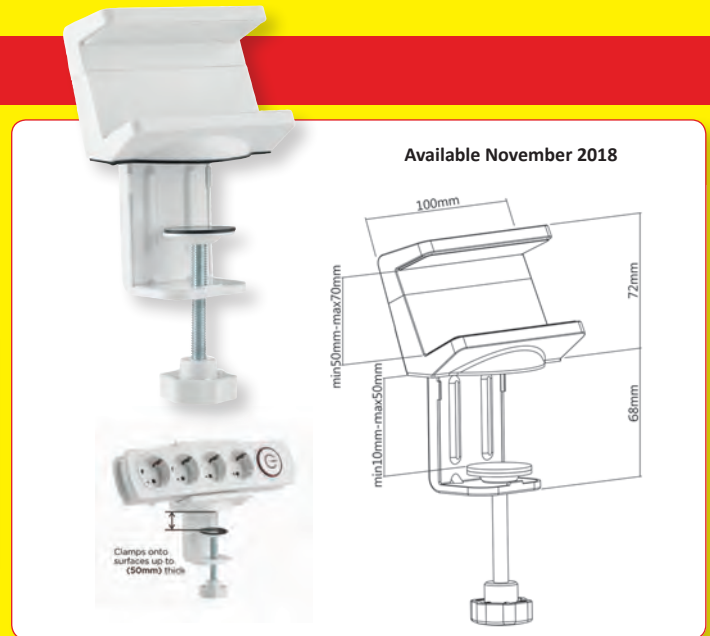

### VALUE Power Strip Organizer, Table-Mounted

- For an organized desktop/office
- Table-Mounted Power Strip Organizer
- Designed to work on an open desktop or shelf
- Adhesive tape keeps organizer & power strip in place without damaging surfaces
- Patterned grooves keep a better cable organization
- Heavy-Duty steel construction
- Dimensions: 180 x 140 x 63 mm

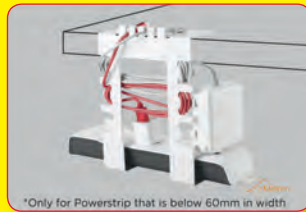

Order-No. – P.U.

VALUE Power Strip Organizer, Table-Mounted, white

19.99.3232 – 10

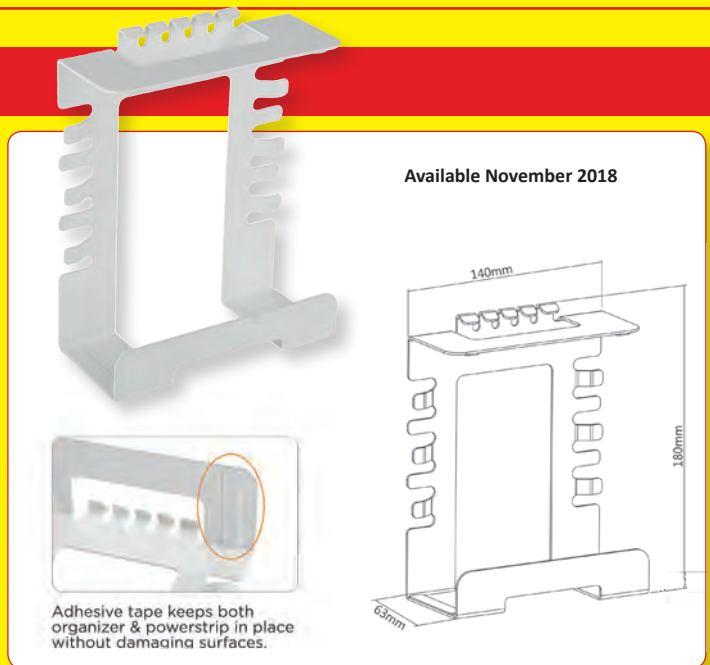

### VALUE Single Monitor Arm, for 17.03.1177/17.99.1177

Stationary monitor arm as an attachment for 17.03.1177/17.99.1177 or generally for mounting a monitor on the desk with the smallest space requirement!

- Single Monitor Arm for Sit-Stand Workstation, compatible for 17.03.1177 and 17.99.1177) – Please see page 9.18
- Sleek design blends into various modern interior designs
- Easy-grip knobs for quick tilt and lock
- Cable management
- Provides extra height adjustment range for flat surface sit-stand workstations
- Mounting possibilities: desk clamp mounting
- Max. load capacity: 8kg



Order-No. – P.U.

VALUE Single Monitor Arm, for 17.03.1177/17.99.1177, 3 Joints

17.99.1179 – 4



**VALUE LCD/Plasma TV Wall Holder, Low Profile, for Samsung Q Series (Q7 / Q8 / Q9)**

This wall mount allows a very discreet installation of a LCD/Plasma TV, perfect for e.g. a wooden wall.

- Weight capacity: up to 50 kg
- Screen Size: up to 165.1 cm
- Low profile- very small distance to wall, 17- 92 mm
- Integrated bubble level assures alignment and provides installation instructions
- Innovative quick-release mechanism allows for a quick and easy installation

Available November 2018

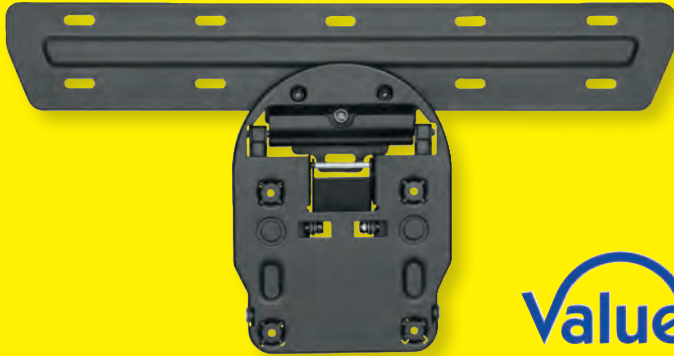

**ZERO Gap Design**  
gains more space and adds a modern look to your house



**Various Positions for Profile Adjustment**  
provides easy access for installation



**Tool-Less Tilting**  
adjusts to any viewing position



**Simple Minimalist Design**

Order-No. – P.U.

VALUE LCD/Plasma TV Wall Holder, Low Profile, for Samsung Q Series (Q7 / Q8 / Q9)

17.99.1166 – 5

**ROLINE Menu Board Wall Mount Sytem, 3x Displays, up to 127cm**

Install a new or expand an existing linear display installation with this Menu Board TV wall mount for up to three monitors (max. 127cm 50") - the adjustments are easily achieved through levels in the holders, so the alignment is as easy and the installation time is as short as it gets!

- Supports maximum VESA 600x400 (VESA: 200x200, 300x200, 300x300, 400x200, 400x300, 400x400, 600x400)
- Versatile use for customer information and communication- directly at the point of sale or point of interest:
  - Display information films on the attached monitors (e.g. at trade fairs, in museums or in shops)
  - Use advertisements for the orientation of visitors (e.g. in conference rooms)
  - Show current offers or menus digitally in your shop

- Heavy quality: the fixing rod is made of light, durable aluminium, the VESA holders are made of solid steel
- Angle of inclination adjustable via steps from -10° to approximately +20°, the orientation can be fixed in the desired position for quick and easy installation
- Suitable for indoor use
- On the back of the monitor holder there is a storage space for e.g. a power supply unit.
- Load capacity up to 50kg
- Dimensions: 2885x440x102mm (WxHxD)

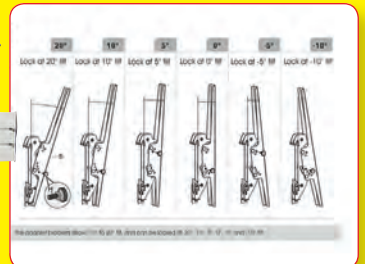

Order-No. – P.U.

ROLINE Menu Board Wall Mount System, 3x Displays, up to 127cm

17.03.1253 – 1



Available November 2018





**roline**<sup>®</sup>  
Designed for Professionals

## Network Components / Cables

# 1

Fast- / Gigabit Ethernet Converter . . . . .	1.02
Fast- / Gigabit Ethernet Switches . . . . .	1.03 – 1.04
Media Converters . . . . .	1.04, 1.05, 1.09
PoE Injectors / PoE Switches . . . . .	1.05 – 1.07
Industrial Networking . . . . .	1.06 – 1.10
Dummy Surveillance Cameras . . . . .	1.11
TP Cables Overview . . . . .	1.12 – 1.13
Cable Assembly . . . . .	1.14
Installation Cables . . . . .	1.15 – 1.17
Patch Cords . . . . .	1.18 – 1.31
Patch Panels . . . . .	1.32 – 1.36
Mount Boxes . . . . .	1.37
Modular Plugs, Couplers, Junction Boxes, Keystones . . . . .	1.38 – 1.41
Fibre Optic Jumper Cables . . . . .	1.41 – 1.45
FO Cleaning Accessories . . . . .	1.46
FO Adapter . . . . .	1.47
MPO Cabling System . . . . .	1.48
19" LCD KVM Consoles . . . . .	1.49
19" Wall Cabinets . . . . .	1.50

## VALUE USB 3.0 to Gigabit Ethernet Converter

This converter is a cost effective solution to convert a USB 3.0 port into a 10/100/1000Base-T Ethernet port

- Supports 10/100/1000 Mbit/s auto-sensing capability
- Supports USB 3.0
- Bus powered

- Supports both full-duplex and half-duplex operation in Gigabit Ethernet
- Supports Windows XP/7/10, Mac OS X
- Contents: Converter with moulded USB cable, driver CD



Order-No. – P.U.

VALUE USB 3.0 to Gigabit Ethernet Converter

12.99.1105 – 10

## ROLINE USB 3.0 to Gigabit Ethernet Converter

This converter is a cost effective solution to convert a USB 3.0 port into a 10/100/1000Base-T Ethernet port

- Supports 10/100/1000 Mbit/s auto-sensing capability
- Supports USB 3.0
- Bus powered
- Supports both full-duplex and half-duplex operation in Gigabit Ethernet
- Supports Windows XP/7, Mac OS X
- Contents: Converter, driver CD



Order-No. – P.U.

ROLINE USB 3.0 to Gigabit Ethernet Converter

12.02.1106 – 10

## VALUE USB 3.0 to Gigabit Ethernet Converter + Hub 3x

This converter is a cost effective solution to convert a USB 3.0 port into a 10/100/1000Base-T Ethernet port

- Supports 10/100/1000 Mbit/s auto-sensing capability
- Supports USB 3.0
- Bus powered
- Supports both full-duplex and half-duplex operation in Gigabit Ethernet
- Hub function, 3x
- Supports Windows XP/7/8/10, Mac OS X

- Contents: Converter



Order-No. – P.U.

VALUE USB 3.0 to Gigabit Ethernet Converter + Hub 3x

12.99.1108 – 10

## ROLINE USB 3.0 to Gigabit Ethernet Converter + Hub 3x

This converter is a cost effective solution to convert a USB 3.0 port into a 10/100/1000Base-T Ethernet port

- Supports 10/100/1000 Mbit/s auto-sensing capability
- Supports USB 3.0
- Bus powered

- Supports both full-duplex and half-duplex operation in Gigabit Ethernet
- Hub function, 3x
- Supports Windows XP/7/8/10, Mac OS X
- Contents: Converter, driver CD



Order-No. – P.U.

ROLINE USB 3.0 to Gigabit Ethernet Converter + Hub 3x

12.02.1107 – 5

## VALUE USB 2.0 to Fast Ethernet Converter

Cost-effective solution for connecting a PC or notebook with USB port to a 10/100 network.

- USB 2.0 to 10/100Mbit/s controller
- Compliant with USB 2.0, USB 1.1
- Supports both full-duplex and half-duplex operations

- Supports USB to ethernet bridging or vice versa in hardware
- Supported Operating Systems: Windows 2000/XP/Vista/7, Mac OS X
- Contents: Converter, driver CD



Order-No. – P.U.

VALUE USB 2.0 to Fast Ethernet Converter

12.99.1107 – 10

## VALUE USB 3.1 to Gigabit Ethernet Converter

This converter is a cost effective solution to convert a USB 3.1 port into a 10/100/1000Base-T Ethernet port

- Supports 10/100/1000 Mbit/s auto-sensing capability
- Supports USB 3.0
- Type C Connector
- Bus powered

- Supports both full-duplex and half-duplex operation in Gigabit Ethernet
- Supports Windows XP / 7 / 8 / 10, Mac OS X
- Contents: Converter, manual



Order-No. – P.U.

VALUE USB 3.1 to Gigabit Ethernet Converter

12.99.1115 – 10

## ROLINE USB 3.1 to Gigabit Ethernet Converter

This converter is a cost effective solution to convert a USB 3.1 port into a 10/100/1000Base-T Ethernet port

- Supports 10/100/1000 Mbit/s auto-sensing capability
- Supports USB 3.0
- Type C Connector
- Bus powered
- Supports both full-duplex and half-duplex operation in Gigabit Ethernet
- Supports Windows XP / 7 / 8 / 10, Mac OS X
- Contents: Converter, manual



Order-No. – P.U.

ROLINE USB 3.1 to Gigabit Ethernet Converter

12.02.1109 – 10

### ROLINE Fast Ethernet Switch, Pocket

Very flat pocket size switch in stable metal casing.

- Ports: 5x/8x 10/100BaseTX
- Metal casing
- Auto-MDI/MDIX
- Auto-Negotiation
- Store and Forward
- Non-Blocking
- Supports full-duplex and Flow Control
- MAC addresses: 2K
- Dimensions:  
79 x 62 x 20 mm / 94 x 62 x 20 mm
- Power supply: 5 VDC 1.2A or over USB connection from the PC
- Contents: Switch, power supply, USB power cable, manual



**roline**  
Designed for Professionals

Order-No. – P.U.

ROLINE Fast Ethernet Switch, Pocket, 5 Ports	21.14.3133 – 4
ROLINE Fast Ethernet Switch, Pocket, 8 Ports	21.14.3134 – 4

### ROLINE Gigabit Ethernet Switch, Pocket

This product is compact in size, making it ideal for SOHO users with limited space to strengthen its network connection.

- 4x 10/100/1000BaseTX ports
- Very compact, metal pocket size casing
- Auto-MDI/MDIX
- Auto-negotiation
- Store and forward switching
- Non-blocking
- MAC addresses: 1K
- Power supply: 5 VDC 1.2A or over USB connection from the PC
- Contents: Switch, power supply, USB power cable, manual



**roline**  
Designed for Professionals

Order-No. – P.U.

ROLINE Gigabit Ethernet Switch, Pocket, 4 Ports	21.14.3514 – 4
---	----------------

### ROLINE Gigabit Ethernet Switch, unmanaged

- Provides 8x 10/100/1000Mbit/s Gigabit Ethernet ports
- All 10/100/1000M ports support auto-negotiation and auto-MDI/MDI-X detection
- Supports full/half-duplex transfer mode for 10/100Mbit/s
- Supports full-duplex transfer mode for 1000Mbit/s
- Store-and-Forward switching method
- Wire-speed packet filtering and forwarding rate
- Supports IEEE 802.3x flow control
- Supports Jumbo Frame up to 9.6K bytes
- MAC Address Table: 8K
- Buffer Memory: 256K bytes
- LED Indication
- Environment Operating Temperature: 0°C ~ 40°C (main device)
- Dimensions (WxDxH): 155 x 86 x 26 mm
- Contents: Switch, power supply (5V DC, 1A), manual



**roline**  
Designed for Professionals

Order-No. – P.U.

ROLINE Gigabit Ethernet Switch, 8x RJ-45, unmanaged	21.14.3521 – 1
---	----------------

### ROLINE Gigabit Ethernet Switch, 5x (4xGbE + 1xGbic(SFP))

- Provides 4x TP 10/100/1000Mbit/s Gigabit Ethernet ports and 1x Gbic (SFP) 100/1000Mbit/s
- Fibre: MultiMode 50/125µm, 60/125µm, SingleMode 9/125µm
- All 10/100/1000M ports support auto-negotiation and auto-MDI/MDI-X detection
- Supports full/half-duplex transfer mode for 10/100Mbit/s
- Supports full-duplex transfer mode for 1000Mbit/s
- Store-and-Forward switching method
- Wire-speed packet filtering and forwarding rate
- Supports IEEE 802.3x flow control
- Supports Jumbo Frame up to 8K Bytes
- MAC Address Table: 2K
- Buffer Memory: 128 kBytes
- LED Indication
- Environment Operating Temperature: 0°C ~ 40°C (main device)
- Dimensions (WxDxH): 148 x 107 x 29 mm
- Contents: Switch, power supply (5V DC, 1A), manual



**roline**  
Designed for Professionals

Order-No. – P.U.

ROLINE Gigabit Ethernet Switch, 5x (4xGbE + 1xGbic(SFP))	21.14.3522 – 1
--	----------------

## ROLINE Gigabit Switch, Web-Smart

**This Gigabit switch allows the transfer of data over Gigabit Ethernet through copper or fibre optical connections.**

- Connections: 5x shielded RJ-45 ports and 1x mini GBIC modular slot (fibre optical)
- Mini GBIC port enables the installation of one SX/LC module (21.14.3500/1/2)
- Supports auto-negotiation, full-duplex mode and auto-MDI/MDIX detection

- Supports store and forward switching
- Web Smart management
- Dimensions (WxDxH): 144 x 105 x 26 mm
- Power supply over included external power adapter
- Contents: Switch, power supply (7,5V DC, 1A), CD (manual)



**roline**  
Designed for Professionals

Order-No. – P.U.

ROLINE Gigabit Switch, 5x RJ-45 + 1 SFP-Slot, Web-Smart	21.14.3523 – 1
ROLINE Mini-GBIC Modul SX/LC, Multi Mode	21.14.3500 – 1
ROLINE Mini-GBIC Module LX/LC, Single Mode, 10 km	21.14.3501 – 1
ROLINE Mini-GBIC Module LX/LC, Single Mode, 20 km	21.14.3502 – 1

## ROLINE 19" Gigabit Ethernet Switch

- 24x 10/100/1000Mbit/s Gigabit Ethernet ports
- 2x 10/100/1000Mbit/s SFP Ports
- Compliant with the IEEE802.3 10Base-T Ethernet, IEEE802.3u 100Base-TX, IEEE802.3ab 1000Base-T specifications
- Supports auto-negotiation and auto-MDI/MDIX detection
- Supports full/half-duplex transfer mode

- Store-and-Forward switching method
- IEEE 802.3x flow control for full-duplex mode
- Backpressure flow control for half-duplex mode
- MAC addresses: 8K
- 19" rack mountable
- Contents: Switch, power cord, 19" rack mount kit, driver CD, manual



**roline**  
Designed for Professionals

Order-No. – P.U.

ROLINE Gigabit Ethernet Switch, 24x 10/100/1000 Ports + 2x SFP Ports	21.14.3519 – 1
--	----------------

## ROLINE RC-100FX/ST Fast Ethernet Converter, RJ-45 to ST, Loop-back

- These converters are the ideal connectivity solution for networks using a combination of STP and fiber optic types
- Provides media conversion from STP to multimode ST media type
- RC-100FX/ST: The maximum cable length for fiber is 2000 m by using a 50/125µm fiber
- Loop-back-test

- Configuration: TP Mode, TP Duplex, TP Speed
- 6 LEDs: TP Speed, Link/Activity, Power, Duplex, Fiber Signal
- Power supplied by included external power supply
- Colour: grey
- Dimensions (WxLxH): 72.5 x 108 x 23 mm
- Contents: Converter, power supply (7.5V DC, 500mA), manual



**roline**  
Designed for Professionals

Order-No. – P.U.

ROLINE RC-100FX/ST Fast Ethernet Converter, RJ-45 to ST, Loop-back	21.13.1070 – 5
ROLINE RC-100FX/SC Fast Ethernet Converter, RJ-45 to SC, Loop-back	21.13.1071 – 5

## ROLINE Gigabit Converter

**Convert a fiber optic (FX) signal into a Twisted Pair (TP) signal. And we offer you the according modules.**

- Connections: 1x RJ-45 on the TP side / 1x (21.13.1069) resp. 2x (21.13.1067) Mini GBIC modular slot on the fibre optical side
- Compliant with 1000BaseT and 1000BaseSX/LX Gigabit Ethernet standards
- TP port supports full-duplex, auto-MDI/MDIX, auto-negotiation
- Each SFP slot supports both singlemode and multimode, or mixed
- Link Loss Forwarding (LLF) / Link Fault Pass Through (LFP)

- Power supply over included external power supply
- Contents: Converter, power supply, CD

- 21.13.1069:** Dimensions (WxDxH): 73 x 108 x 23 mm
- 21.13.1067:** Dimensions (WxDxH): 74 x 102 x 22 mm

- 21.14.3500:** Mini GBIC Modul SX/LC: The maximum cable length for the fibre optic cable is 220 m (62.5/125 µm fibre) and 500 m (50/125 µm fibre)



**roline**  
Designed for Professionals

Order-No. – P.U.

ROLINE Gigabit Converter, incl. mini GBIC, RJ45 to LC	21.13.1069 – 5
ROLINE Gigabit Converter, RJ-45 to Mini GBIC	21.13.1067 – 2
ROLINE Mini-GBIC Modul SX/LC, Multi Mode	21.14.3500 – 1
ROLINE Mini-GBIC Module LX/LC, Single Mode, 10 km	21.14.3501 – 1
ROLINE Mini-GBIC Module LX/LC, Single Mode, 20 km	21.14.3502 – 1



### ROLINE 10/100/1000Base-T to Dual-speed Fiber Media Converter

**Ethernet-Fiber converter which enables connections of copper-based Ethernet equipment over a fiber optic link**

- Tri-speed 10/100/1000Mbit/s copper to dual-speed 1G/100Mbps fiber conversion
- Support full wire speed conversion for Gigabit copper to Gigabit fiber
- Comply with IEEE 802.3, 802.3u, 802.3ab, 802.3z standard

- Auto-negotiation
- Auto-MDI/MDI-X detection
- Supports jumbo frame length of 9.2K bytes
- Supports 802.3x flow control
- LED Indication Unit: Power status, per port: Fiber Speed/Link/Activity, Copper Speed/Link/Activity
- Metal casing
- Contents: Converter, power supply, manual



Order-No. – P.U.

ROLINE 10/100/1000Base-T to Dual-speed Fiber Media Converter 21.13.1174 – 1

### VALUE 19" PoE Fast Ethernet Switch, 8 Ports

Designed for small or medium network environment to strengthen its network connection. This product is compact in size, making it ideal for desktop users with limited space. The switch features 4 IEEE 802.3af Power over Ethernet (PoE) ports supplying up to 15.4 W per port. This product can convert standard 100~240V/AC power into low-voltage DC that runs over an existing LAN cable to power up IEEE 802.3af compliant network accessories like e.g. workgroupswitches, network-cameras, access points, IP-phones.

- 8x 10/100Mbit/s Fast Ethernet ports
- 8 ports are 802.3af/at-compliant PoE-enabled PSE ports
- 1x Gigabit Uplink port
- 1x Gigabit SFP port
- Each port provides up to 15.4 W power
- Auto-MDI/MDIX
- Auto-negotiation
- Supports 802.3x flow control for full-duplex and backpressure for half-duplex
- Provides full wire speed forwarding
- LED indicators
- Casing: metal
- Internal power supply
- Dimensions (LxWxH): 280 x 180 x 44 mm
- Content: Switch, power cord, manual



Order-No. – P.U.

VALUE PoE Fast Ethernet Switch, 8 Ports + 1 Gigabit Ethernet Combo Port 21.99.1197 – 1

### VALUE PoE Fast Ethernet Switch, 5 Ports (4x PoE)

Designed for small or medium network environment to strengthen its network connection. This product is compact in size, making it ideal for desktop users with limited space. The switch features 4 IEEE 802.3af Power over Ethernet (PoE) ports supplying up to 15.4 W per port. This product can convert standard 100~240V/AC power into low-voltage DC that runs over an existing LAN cable to power up IEEE 802.3af compliant network accessories like e.g. workgroupswitches, network-cameras, access points, IP-phones.

- 4x 10/100Mbit/s Fast Ethernet ports
- 4 ports are 802.3af-compliant PoE-enabled PSE ports
- Each port provides up to 15.4 W power
- Auto-MDI/MDIX
- Auto-negotiation
- Supports 802.3x flow control for full-duplex and backpressure for half-duplex
- Provides full wire speed forwarding
- Fanless design
- LED indicators
- Casing: metal
- Internal power supply
- Dimensions (LxWxH): 92 x 82 x 22 mm
- Contents: Switch, power cord, manual



Order-No. – P.U.

VALUE PoE Fast Ethernet Switch, 5 Ports, (4x PoE) 21.99.1196 – 1

### ROLINE PoE Fast Ethernet Switch, 5 Ports (1x PoE)

**The ROLINE PoE Fast Ethernet Switch is designed for small network environment to strengthen its network connection. It's also specially designed for video surveillance in buses, trains, subway cars and emergency vehicles. This product is compact in size, making it ideal for every user with limited space.**

- 5x 10/100BaseTx ports, including 1xPoE (Power over Ethernet) port
- PoE port 802.3af compliant
- PoE port provides 48 VDC with up to 15.4 W power
- Auto-MDI/MDIX
- Auto-negotiation
- Full wire speed forwarding
- MAC addresses: 1K
- Casing: metal
- External power supply (40 W)

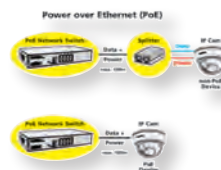

Order-No. – P.U.

ROLINE PoE Fast Ethernet Switch, 5 Ports (1x PoE) 21.13.1190 – 2

ROLINE PoE Fast Ethernet Switch, 5 Ports (4x PoE) 21.13.1189 – 2

ROLINE PoE Fast Ethernet Switch, 130 W, 8 Ports 21.13.1191 – 2



## VALUE Gigabit PoE Injector

The VALUE Gigabit PoE Injector is a so-called PSE, a unit to supply power for e.g. surveillance cameras, and LAN devices such as access points, bridges and routers over Ethernet cable.

A PSE supplies the current together with the data in the network cable. It doesn't need no longer an additional own power supply of the device.

- Supply of data and power into the network cables

- Connectors: 1x RJ-45 port (Data In, Data input), 1x IEC power socket (Power In, input power supply), 1x RJ-45 port (Data & Power Out, output data and power)
- Compatible with 802.3af and 802.3at
- Power via PoE: up to 30W
- LED indicators for Power, Link / Act. and PoE
- Output voltage: 802.3af standard (46V-55V DC)
- Contents: Injector, manual

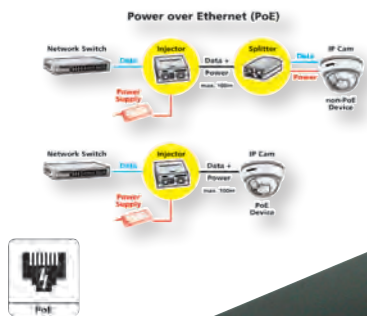

Order-No. – P.U.

VALUE Gigabit PoE Injector

21.99.1498 – 10

## ROLINE Gigabit PoE Injector

The ROLINE Gigabit PoE Injector is a so-called PSE, a unit to supply power for e.g. surveillance cameras, and LAN devices such as access points, bridges and routers over Ethernet cable.

A PSE supplies the current together with the data in the network cable. It doesn't need no longer an additional own power supply of the device.

- Supply of data and power into the network cables
- Connectors: 1x RJ-45 port (Data In,

Data input), 1x IEC power socket (Power In, input power supply), 1x RJ-45 port (Data & Power Out, output data and power)

- Compatible with 802.3af and 802.3at
- Power via PoE: up to 30W
- LED indicators for Power, Link / Act. and PoE
- Output voltage: 802.3af standard (46V-52V DC)
- Contents: Injector, manual

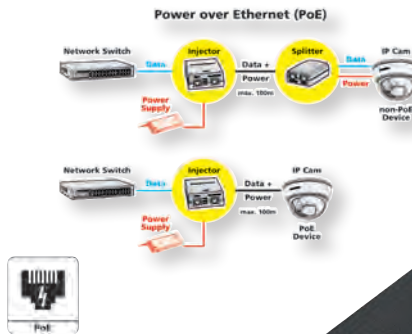

Order-No. – P.U.

ROLINE Gigabit PoE Injector

21.13.1199 – 6

## ROLINE PoE Gigabit Injector

With this ROLINE Gigabit Ethernet PoE injector you can supply with power simultaneously 4 PoE-capable work-group switches, network cameras, access points, IP phones, etc. via TP connecting cable

- Inputs: 4x 10/100/1000 ports for data
- Outputs: 4x 10/100/1000 ports for data and power
- Supports PoE IEEE 802.3af / at: Up to 30 W per port can be fed into the TP cable
- Power supply via terminal block or external DC power supply (48V to) 56V DC Port
- Weight: 190 g

- Dimensions (L x W x H): 94 x 62 x 20 mm
- Metal housing

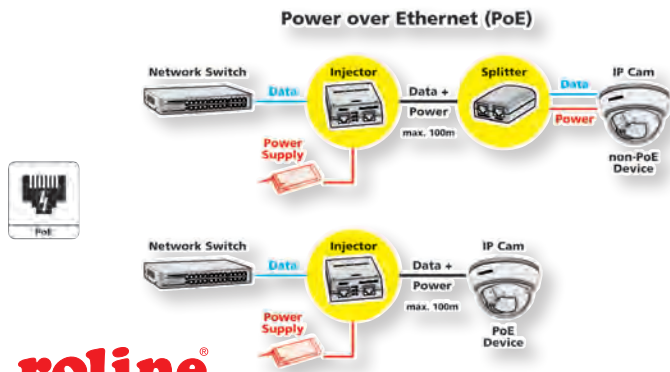

Order-No. – P.U.

ROLINE PoE Gigabit Injector, 4 Ports

21.13.1198 – 1

## ROLINE Gigabit PoE+ Extender

- 2 port Gigabit PoE extender designed for extending connection distance for another 100m on both ends via Cat-5e cable or better
- For covering longer distances by cascading multiple PoE extender together on a network
- No need any additional power supply
- LAN cable to power IEEE 802.3at compliant network accessories
- Features PoE awareness to verify whether the network device receive power is IEEE 802.3at compliant, or only the data will be sent through LAN cable
- No special networking cable required
- Input: 1x 10/100/1000 ports for data and power

- Output: 1x 10/100/1000 ports for data and power
- By adding PoE devices, it's possible to use an existing standard Cat.5e/6 Ethernet cable without a new electrical outlet for both power and data
- Supports PoE IEEE 802.3af/at
- Own power supply via PoE-consumption about 2W
- Metal enclosure- Wall mounting
- Contents: Power over Ethernet Injector (incl. power cable, 1.5 m), manual



Order-No. – P.U.

ROLINE Gigabit PoE+ Extender, 2 Port

21.13.1188 – 1

**VALUE PoE Switch, Gigabit Ethernet, 8 Ports**

This Gigabit Ethernet PoE switch is designed for small or medium network environments to strengthen its network connection. It converts standard 100~240V/AC power into low-voltage DC that runs over an existing LAN cable to power up Power over Ethernet (PoE) compliant network accessories like e.g. workgroup switches, network cameras, access points, IP-phones.

- 8x 10/100/1000 Mbit/s Auto-Negotiation PoE ports with 1 Gigabit Uplink Port
- Compliant with IEEE802.3af standard (IEEE802.3, 802.3u, 802.3af, 802.3x)
- IEEE802.3x flow control for Full-Duplex

- Mode and back-pressure for Half-Duplex Mode
- Bandwidth 18Gbit/s
- Detects your PoE devices according to PoE standard
- Supports automatic detect functionality to protect the system when the system power is overloaded or there is non-POE device
- LED indicators for monitoring power, link, activity and speed
- Switching method: Store-and-forward
- Metal casing
- Contents: Switch, power cord, manual

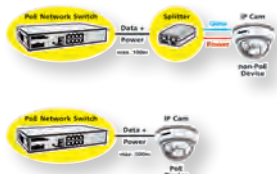

Order-No. – P.U.

VALUE PoE Switch, Gigabit Ethernet, 8 Ports

21.99.1194 – 1

**ROLINE Gigabit Ethernet Switch 8 Ports (4x PoE Ports)**

8-way Gigabit Ethernet switch that supplies IEEE 802.3af/at Power over Ethernet (PoE) (ports 1-4) compliant network accessories like e. g. workgroup switches, network cameras, access points, IP-phones with data and power over one LAN cable.

- Data-in Ports: 8x 10/100/1000 BaseTX, Data + Power-out Ports: 4x 10/100/1000BaseTX
- Standards: IEEE 802.3 10BaseT, IEEE 802.3u 100BaseTX, IEEE 802.3x Flow Control, IEEE 802.3af/at PoE

- PoE capable ports: Port 1-4 up to 30 W per port
- PoE power budget: 60 W
- Status LEDs
- Metal casing
- External power supply (5 V DC, 1.3A)
- Dimensions (WxDxH): 165 x 118 x 39 mm
- Contents: Switch, main adapter, manual



**roline**  
Designed for Professionals

Order-No. – P.U.

ROLINE Gigabit Ethernet Switch 8 Ports (4x PoE Ports)

21.13.1183 – 1

**ROLINE 19" PoE MID-Span Power Supply**

8-way injector that supplies IEEE 802.3af Power over Ethernet (PoE) compliant network accessories like e. g. workgroup switches, network cameras, access points, IP-phones with data and power over one LAN cable.

- Data-in Ports: 8x 10/100BaseTX, Data + Power-out Ports: 8x 10/100BaseTX
- Standards: IEEE 802.3 10BaseT, IEEE 802.3u 100BaseTX, IEEE 802.3x Flow Control, IEEE 802.3af PoE
- Max. power output: 48 VDC / 15.4 W per port
- PoE capable ports: Port 1-8 up to 15.4 W per port

- PoE power budget: 110 W
- Max. power consumption (without PoE): 122 W (12 W)
- Status LEDs
- Metal casing, 19" rack-mountable (rack-mount kit included)
- Active cooling with integrated fan
- Internal power supply
- Dimensions (WxDxH): 440 x 220 x 44 mm
- Contents: Switch, power cord, rack mount kit, manual



**roline**  
Designed for Professionals

Order-No. – P.U.

ROLINE 19" PoE MID-Span Power Supply, 8 Midspanports

21.13.1181 – 1

**ROLINE High Power PoE Splitter, 30W**

- High power PoE splitter which integrates Power over Ethernet (PoE) technology to PoE incapable network device by just using a single Cat.5 cable for both power and data transaction
- For easier, cost-effective PoE network installation, the PoE splitter is the best solution to protect original investment.
- IEEE 802.3at and 802.3af compliance
- Support 10BASE-T, 100BASE-TX, and 1000BASE-T
- Support Alternative A or Alternative B PoE input over Cat.5

- Provide a power class selection DIP for demanding power from PSE
- Support Type 1 PSE classification (for power up to 13 Watts min.) and Type 2 PSE 2-event classification (for power up to 30 Watts)
- Regulated DC power output with four optional voltages
- Flexible mounting support, light weight and compact
- Metal housing
- Dimension: 73 x 85 x 24 mm



**roline**  
Designed for Professionals



Order-No. – P.U.

ROLINE High Power PoE Splitter, 30W

21.13.1172 – 1

## ROLINE Fast Ethernet Switches for Industrial Environments, unmanaged

- Fast Ethernet switch with 5/8 shielded 10/100 Base-T copper ports
- Wide operating temperature range for temperature critical environment
- Auto MDI/MDI-X crossover function
- Supports IEEE 802.3x flow control for full-duplex operation
- Supports back-pressure flow control for half-duplex operation
- Supports DIN-rail mounting and panel mounting
- Fanless, rugged metal casing
- Operating Temperature: - 20 °C- +70 °C
- DC Input via terminal block or DC power jack (6.3mm / 2.0mm)
- Contents: Switch

- 21.13.1155/21.13.1156**
- Power: Input: 5- 30 VDC, consumption: 2.15W resp. 2.3W (max)
  - Dimensions: 95 x 40 x 80 mm (WxDxH)
- 21.13.1157**
- Power: Input: 4.5- 50V DC, consumption: 3.4W (max.)
  - Dimensions: 140 x 106 x 40 mm (WxDxH)



**roline**  
Designed for Professionals

Order-No. – P.U.

ROLINE Industrial Switch, 5x RJ-45, unmanaged	21.13.1155 – 1
ROLINE Industrial Switch, 8x RJ-45, unmanaged	21.13.1156 – 1
ROLINE Industrial Switch, 16x RJ-45, unmanaged	21.13.1157 – 1

## ROLINE Gigabit Industrial Switch, managed

**A managed 6-port Gigabit Ethernet switch which is featured with five copper ports, one mini-GBIC (SFP) port and the following advantages in a small footprint box.**

- Provides 5 10/100/1000Base-T ports and 1x 1000Base-SX port
- Provides in-band web-based management interface
- All copper ports support auto-negotiation and auto-MDI/MDI-X detection
- Provides full wire speed forwarding
- Supports 802.3x flow control for full-duplex and backpressure for half-duplex
- Provides port status, statistic monitoring and control function
- Supports port-based and 802.1Q Tag-based VLAN
- Provides QoS function
- Provides 802.1x authentication
- Supports configuration backup and upload

- Provides port link aggregation (trunking) function
- Provides port mirroring function
- Industrial-rated emission and immunity performance
- Power: Input: 6,5- 32V DC, Consumption: 3.6W (max.)
- Operating Temperature- 40 °C- +70 °C
- DC Input via terminal block or DC power jack (6.3mm/2.0mm)
- As according Power Supply Unit we recommend 21.13.1226
- Contents: Switch, power supply, manual, 1x GBIC



**roline**  
Designed for Professionals



Order-No. – P.U.

ROLINE Gigabit Industrial Switch, 5x RJ-45, 1x LC, managed	21.13.1159 – 1
--	----------------

## ROLINE Gigabit Ethernet Industrial Switch

- Provides 8 10/100/1000Mbps copper ports
- Auto-negotiation
- Auto MDI/MDI-X crossover function
- Supports IEEE 802.3x flow control for full duplex
- Supports back pressure flow control for half duplex
- Fully non-blocking Gigabit full wire speed switching performance
- Jumbo frame support
- Alarm relay output for power failure event and configured port link fault events
- Wide operating temperature range
- Supports Green Ethernet power saving
- Supports IEEE 802.3az Energy Efficient Ethernet
- Supports DIN-Rail mounting and panel mounting
- Industrial-rated emission and immunity performance
- Contents: Switch, power supply, manual

**roline**  
Designed for Professionals



Order-No. – P.U.

ROLINE Gigabit Ethernet Industrial Switch, 8x	21.13.1161 – 1
---	----------------

## ROLINE Fast Ethernet Switches with Fiber Port for Industrial Environments

- Eight Fast Ethernet copper ports and (optional) fiber ports
- Port 7 and Port 8 provide either 10/100BaseT or 100BaseFX (model dependent)
- All copper ports support auto-negotiation and auto-MDI/MDIX configuration
- Unmanaged switches for industrial environments
- Provides wire speed store and forward switching
- Wide operating temperature range for temperature critical environment
- Industrial-rated emission and immunity performance
- Fanless, extra rugged metal housing
- Support DIN rail mounting and panel mounting
- As according power supply we recommend using DIN-rail power supply unit 21.13.1226



**roline**  
Designed for Professionals

Order-No. – P.U.

ROLINE Industrial Switch, 7x RJ-45, 1x ST, unmanaged	A 21.13.1151 – 1
ROLINE Industrial Switch, 7x RJ-45, 1x SC, unmanaged	B 21.13.1152 – 1
ROLINE Industrial Switch, 6x RJ-45, 2x ST, unmanaged	C 21.13.1153 – 1
ROLINE Industrial Switch, 6x RJ-45, 2x SC, unmanaged	D 21.13.1154 – 1



**ROLINE Gigabit Ethernet Industrial Switch, 5x RJ45 + 1x SFP**

**5-Port Gigabit network switch for use in an industrial environment - including an additional SFP-Port!**

- Provides 5x 10/100/1000Mbps copper ports + 1x dual SFP slot
- Auto-negotiation
- Auto MDI/MDI-X crossover function
- Provides in-band web-based management interface
- Supports IEEE 802.3x flow control for full duplex
- Supports back pressure flow control for half duplex
- Supports port-based and 802.1Q Tag-based VLAN
- Provides QoS function
- Provides 802.1x authentication
- Supports configuration backup and upload
- Provides port mirroring function
- Supports 802.1w RSTP
- Provides IGMP snooping
- MAC Address Table 8K entries
- Buffer Memory 136K bytes
- Operating Power: +6.5VDC to +32VDC
- DC Power Input Screwed Terminal Block: +6.5VDC- +32VDC
- DC IN Jack:-D 6.3mm/+D 2.0mm
- External power adapter rating: +6.5VDC- +32VDC



**roline**  
Designed for Professionals

Order-No. – P.U.

ROLINE Gigabit Ethernet Industrial Switch, 5x RJ45 + 1x SFP

21.13.1162 – 1

**ROLINE Converter for Industrial Environments, RS232 - Multimode Optical Fiber**

- Transparent conversion for all RS-232 signals
- Designed for industrial environments
- RS-232 surge, ESD, and isolation protection
- DIN-rail and panel mounting support
- Wide power voltage range support
- Terminal block and DC plug power connectors
- Wide operating temperature range
- Industrial-rated emission and immunity performance
- Fanless, rugged metal housing
- Power: Input: 7-30 VDC
- As according power supply we recommend using DIN-rail power supply unit 21.13.1226

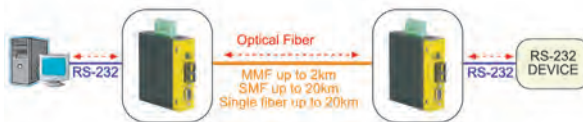

**roline**  
Designed for Professionals



Order-No. – P.U.

ROLINE Industrial Converter RS232 - Multimode Optical Fiber, ST A 21.13.1140 – 1

ROLINE Industrial Converter RS232 - Multimode Optical Fiber, SC B 21.13.1141 – 1



**ROLINE Converter for Industrial Environments, 10/100Base-T - Multimode Optical Fiber**

- Support full wire speed copper-to-fiber media conversion for 10/100Mbit/s speed and media types
- Support auto-negotiation 10/100Mbit/s or forced mode on TP copper port
- Auto MDI/MDIX
- Provide comprehensive manual configuration settings
- Transparent conversion to 802.1Q VLAN tagged packets
- Low power consumption
- Two power interface types: screw terminal block and DC plug
- Supports DIN-rail mounting and optional screwed plane mounting
- Industrial-rated emission and immunity performance
- Fanless, rugged metal casing
- As according power supply we recommend using DIN-rail power supply unit 21.13.1226

**roline**  
Designed for Professionals



Order-No. – P.U.

ROLINE Industrial Converter 10/100Base-T - Multimode Optical Fiber, ST 21.13.1142 – 1

ROLINE Industrial Converter 10/100Base-T - Multimode Optical Fiber, SC 21.13.1143 – 1

ROLINE Industrial Mini Converter, 10/100TX - 100FX (SC) 21.13.1147 – 1

## ROLINE Industrial Ethernet to Serial Media Converters (RS-232), 1x SFP

### Network media converter from Ethernet (RJ-45) to serial (RS-232), for use in industrial environments - including an additional SFP port!

- Ethernet interface provides combo port of 10/100Mbps copper RJ-45 and 100M fiber SFP slot
- Serial interface RS-232
- Serial port supports baud-rate up to 230400bps
- Galvanic isolation on serial interface
- Data conversion throughput up to 230Kbps
- Wide range of direct power voltage support, DC 8V-60V
- Powered over Ethernet through RJ-45 interface (PoE-enabled)
- Alarm relay output for power failure, port link down and failure in connecting to server
- Application support for remote COM port, serial server over TCP, reverse telnet, pair connection, and serial broadcast
- Remote COM driver support for Windows PC
- Web-based and serial-based console configuration

- Event notification over SMTP and SNMP traps
- Designed for industrial environments with:
  - Terminal block and DC plug (6.3 mm/2.0 mm) power connectors
  - Fanless, rugged metal housing
- Power: Input: 8- 60 VDC
- Power over Ethernet:
  - IEEE 802.3af, voltage input range: +36- +57VDC
- Operating Temperature:- 30 °C- +70 °C



**roline**  
Designed for Professionals



Order-No. – P.U.

ROLINE Industrial Ethernet to Serial Media Converters (RS-232), 1x SFP

21.13.1138 – 1

## ROLINE Industrial Converter RS422/485 - Multimode Optical Fiber, 1x SFP

### Network media converter from Ethernet (RJ-45) to serial (RS-422/RS-485), for use in industrial environments - with an additional SFP port!

- Ethernet interface provides combo port of 10/100Mbps copper RJ-45 and 100M fiber SFP slot
- Serial interface RS-422/485
- Serial port supports baud-rate up to 230400bps
- Galvanic isolation on serial interface
- Data conversion throughput up to 230Kbps
- Wide range of direct power voltage support, DC 8V-60V
- Powered over Ethernet through RJ-45 interface (PoE-enabled)
- Alarm relay output for power failure, port link down and failure in connecting to server
- Application support for remote COM port, serial server over TCP, reverse telnet, pair connection, and serial broadcast
- Remote COM driver support for Windows PC

- Web-based and serial-based console configuration
- Event notification over SMTP and SNMP traps
- Designed for industrial environments with:
  - Terminal block and DC plug (6.3 mm/2.0 mm) power connectors
  - Fanless, rugged metal housing
- Power: Input: 8- 60 VDC
- Power over Ethernet:
  - IEEE 802.3af, voltage input range: +36- +57VDC
- Operating Temperature:- 30 °C- +70 °C



**roline**  
Designed for Professionals



Order-No. – P.U.

ROLINE Industrial Converter RS422/485 - Multimode Optical Fiber, 1x SFP

21.13.1139 – 1

## MEAN WELL DIN-Rail Power Supply Unit

- Type: constant current limiting
- DIN-rail mounting
- LED indication

Technical data:	21.13.1226	21.13.1228
Output voltage:	24 VDC	48 VDC
Output current:	0 to 2 A	0 to 1.6 A
Output power:	45 W	75 W
Input:	85...264 VAC	85...264 VAC
Dimensions (mm):	78 x 93 x 67	56 x 125 x 100



**MW**  
MEAN WELL

Order-No. – P.U.

MEAN WELL DR-45-24 DIN-Rail Power Supply Unit, 45W 24V DC

21.13.1226 – 1

MEAN WELL DR-75-48 DIN-Rail Power Supply Unit, 75W 48V DC

21.13.1228 – 1





**VALUE Dummy Dome Camera with LED Flashlight**

Fake security cameras can help you to deter burglars: Use these dummy cameras in combination with your security cameras to make it look like you have more surveillance than you do.

- Realistic look
- Application: indoor
- Fixing: ceiling mount
- Red LED flashlight that can be seen at night

- Housing: plastic
- CCTV (Closed-circuit television) sticker for an authentic presentation
- Requires 2 AA batteries (not included)
- Contents: Dummy camera, mounting material, CCTV (Closed-circuit television) sticker



Order-No. – P.U.

VALUE Dummy Dome Camera with LED Flashlight, white

21.99.1625 – 1

**VALUE Dummy Indoor Camera with LED Flashlight**

Fake security cameras can help you to deter burglars: Use these dummy cameras in combination with your security cameras to make it look like you have more surveillance than you do.

- Realistic look
- Application: indoor
- Fixing: wall mount
- Red LED flashlight that can be seen at night

- Housing: plastic
- CCTV (Closed-circuit television) sticker for an authentic presentation
- Requires 2 AAA batteries (not included)
- Contents: Dummy camera, mounting material, CCTV (Closed-circuit television) sticker



Order-No. – P.U.

VALUE Dummy Indoor Camera with LED Flashlight, black

21.99.1627 – 1

**VALUE Dummy IR Outdoor Camera with LED Flashlight**

Fake security cameras can help you to deter burglars: Use these dummy cameras in combination with your security cameras to make it look like you have more surveillance than you do.

- Realistic look
- Application: indoor or outdoor
- Fixing: wall mount
- Red LED flashlight that can be seen at night

- Housing: plastic
- CCTV (Closed-circuit television) sticker for an authentic presentation
- Requires 2 AA batteries (not included)
- Contents: Camera, mounting material, CCTV (Closed-circuit television) sticker



Order-No. – P.U.

VALUE Dummy IR Outdoor Camera with LED Flashlight, black

21.99.1626 – 1

**VALUE Dummy IR Outdoor Camera with LED Flashlight**

Fake security cameras can help you to deter burglars: Use these dummy cameras in combination with your security cameras to make it look like you have more surveillance than you do.

- Realistic look
- Application: indoor or outdoor
- Fixing: wall mount
- Red LED flashlight that can be seen at night

- Housing: plastic
- CCTV (Closed-circuit television) sticker for an authentic presentation
- Alimentation: solar panel (rechargeable Li-Ion polymer battery) or 2 AA batteries (not included)
- Contents: Camera, mounting material, CCTV (Closed-circuit television) sticker



Order-No. – P.U.

VALUE Dummy IR Outdoor Camera with LED Flashlight

21.99.1628 – 1

# TWISTED-PAIR-CABLES

## OVERVIEW

On the following pages we keep repeating the aspects described herein.

- Please pay attention in particular on the notes shielding, transmission quality and fire protection.
- You will find the corresponding buttons and logos, placed again at the various products.



### Shielding

There are different approaches whether and how twisted-pair cables are being protect. In this case, significant differences in the quality of the cable are related to the intended use. Especially at higher transmission rates and for greater lengths shielded cables have a significantly better transmission quality.

- It is important that the decision is made consistently in terms of shielding for an installation.
- The following shielding types are within our product portfolio:

#### U / UTP (unscreened / unshielded twisted pair) or short-UTP:

- These cables have neither a common shield, nor an individual shield for each separate twisted pair.
- They have the lowest protection against electromagnetic influences.



U/UTP

#### F / UTP (Foiled / Unshielded Twisted Pair) or short FTP:

- The pairs are unshielded, the cable has a full shield aluminium-laminated foil that wraps all the pairs together.
- A version thereof is S / UTP (Screened / Unshielded Twisted Pair):
- The pairs are also unshielded, the overall shield consists of a tinned copper braid. The quality of this cable is much higher than for U / UTP cables.



F/UTP

#### SF / UTP (Foiled / Unshielded Twisted Pair) or simply S / FTP:

- The pairs are unshielded, there is an overall shield made of aluminium-laminated foil and also a tinned copper braid.
- The protective effect of this combination is again higher than with a simple shielding.



SF/UTP

#### S / FTP (screened / shielded twisted pair) or simply S / FTP:

- All wire pairs are shielded with aluminium laminated foil, and there is an overall shielding of a tinned copper braid.
- The paired shielding attenuates the disruption of the pairs („crosstalk“) considerably. The combination of foil and braid also has the highest possible protection against electromagnetic influences from outside.

(Green: laminated aluminum foil / Red: tinned copper braid)



S/FTP

### General Information

„Twisted pair“ is the English name for network cable with twisted or stranded wire pairs. Twisted pair cables provide a better protection against external alternating magnetic fields and electrostatic interference. Likewise, the crosstalk between adjacent pairs is reduced within the cable.

The copper wires of installing cables are made of solid wires while patch cables are made of stranded wires, usually produced with 7 individual wires.

- The diameter of the wires are defined in AWG. Solid wires typically have a thickness of 22 to 24 AWG, stranded wires AWG 24-27th

- The insulation of the wires as well as the sheath of the cable as a whole are often made of PVC, but now often made of a halogen-free low-smoke plastic mixture.

More on this in the section fire safety.

AWG	Diameter		Cross section
	(inch)	(mm)	(mm <sup>2</sup> )
22	0.0253	0.644	0.326
23	0.0226	0.573	0.258
24	0.0201	0.511	0.205
25	0.0179	0.455	0.162
26	0.0159	0.405	0.129
27	0.0142	0.361	0.102

### Quality

Twisted pair cable – as well as the associated components (e.g., junction boxes) – are classified according to transmission quality into classes or categories. Each class or category covers various requirements and quality standards. The concept of category (abbreviated „Cat.“) is mainly extracted from the American standardization (EIA / TIA), the class of the international (ISO / IEC) or from the European (EN).

- There is a distinction between data for individual parts or components (patch cables, connectors, installation cables, patch panels, etc.) and information for so-called links. Links can be used as a permanent link (Patch Panel + Installation + cable junction box) and as a channel (s. Figure above), which includes the patch cable.

- The class C to EA (corresponding categories 3 to 6A) are defined and valid. Class F (equivalent to Category 7) is defined, but the standardization is not further pursued. The FA class is currently in the process of standardization.

#### Two comments on it:

1. The Class EA (equivalent to Category 6A) was specified so that 10 Gigabit Ethernet can be transmitted.
  2. For classes from F (equivalent categories as of 7) the current state of RJ-45 due to the close contact assembly cannot meet the required specifications.
- If patch cables are still designated „Cat.7“, it is just because the cable (material) meets the requirements of Cat.7 – even the highest quality RJ-45 maximum fulfills Cat.6A.

- In order to achieve optimal performance from your network, all components (patch cables, connectors, installation cables, patch panels, etc.) of a link must support the same category or class.

- The component with the lowest performance determines the transmission class (Link Class) of the entire system. When using e.g. a Cat 5e cable with Cat. 6 connector components, the entire link still only fulfills Class D (Cat.5e).



Category	Class	Max. Frequency	Application
3	C	16 MHz	Fast Ethernet
5e	D	100 MHz	Gigabit Ethernet
6	E	250 MHz	Gigabit Ethernet
6A	EA	500 MHz	10 Gigabit Ethernet
7	F	600 MHz	10 Gigabit Ethernet
7A	FA	1 GHz	40 Gigabit Ethernet (under Discussion)

# TWISTED-PAIR-CABLES

## OVERVIEW

### Fire protection: flame resistance, smoke-free, halogen-free

Particularly in large installations, it is important that attention is paid to the needs of fire protection. There are three important must-haves for the cable sheath and wire insulation. These properties are flame resistance, low-smoke and zero halogen.

#### Flame resistance:

– A cable is classified as flame retardant in accordance with IEC 60332, if it does not or only a specified short piece continues to burn, while the rest of the cable is set on fire for a long time.

#### Smoke poverty:

– The idea is that in case of fire not too much smoke may be released. To test the smoke poverty according to IEC 61034 cable pieces are placed in a chamber for a long time under fire and the light transmittance of the resulting smoke measured by photocell inside the chamber.

#### Halogen-free:

– The measurement of halogen-free is prescribed in IEC 60754. Halogens in the material on the one hand lead to combustion toxic fumes and on the other hand to the formation of corrosive or caustic acids.

#### LSOH:

– There is often also the name Low Smoke Zero Halogen (LSZH or LSOH) for the classification of cable material. In this case, although reference is made to smoke and zero halogen poverty, but not on the flame resistance.

Therefore, we call on the following pages individually the three properties described above.

**\* Halogenfree  
Flame retardant  
Low Smoke**

### Our products

Cat.5e

Cat.6

Cat.6A

Cat.7

**roline**<sup>®</sup>  
Designed for Professionals

**Value**<sup>®</sup>

#### VALUE Patchcords

VALUE has a budget patch cables product line with a very good price / performance ratio. Available in the Category 5e, 6, 6a and „7“ in various shielding types, lengths and colors.

#### ROLINE Patchcords

Quality makes the difference!

ROLINE offers a wide range of high quality patch cables with reserves in the transmission quality even in critical environments.

Available in the Category 5e, 6, 6a and „7“ in various shielding types, lengths and colors. 2 years warranty!

### ROLINE Components – Recommendation for structured cabling

Category	Type	LAN Cable	Wall Jack	Patch Panel	Patch Cord	Test / Certification
Cat.5e	UTP	21.15.0511 300m	25.16.8506 w/F	26.11.0349 blk	21.15.0505 5m	GHMT / z1325a-04-D
Cat.5e	UTP	21.15.0512 100m	25.16.8501 iv/F	26.11.0347 lgrey		
Cat.5e	UTP		25.16.8406 w/S			
Cat.5e	UTP		25.16.8401 iv/S			
Cat.5e	S/FTP	21.15.0019 100m	25.16.8487 w/F	26.11.0328 blk	21.15.0305 5m	GHMT / z1326a-04-D
Cat.5e	S/FTP	21.15.0020 300m	25.16.8486 iv/F	26.11.0329 lgrey		
Cat.5e	S/FTP		25.16.8387 w/S			
Cat.5e	S/FTP		25.16.8386 iv/S			
Cat.6	UTP	21.15.0990 100m	25.16.8494 w/F	26.11.0362 blk	21.15.0935 5m	GHMT / z2329b-10-E (Flush) / z2330b-10-E (Surface)
Cat.6	UTP	21.15.0991 300m	25.16.8500 iv/F	26.11.0361 lgrey		
Cat.6	UTP		25.16.8394 w/S			
Cat.6	UTP		25.16.8395 iv/S			
Cat.6	S/FTP	21.15.0890 100m	25.16.8492 w/F	26.11.0351 blk	21.15.0835 5m	GHMT / z2365b-10-E (Flush) / z2364b-10-E (Surface)
Cat.6	S/FTP	21.15.0891 300m	25.16.8493 iv/F	26.11.0361 lgrey		
Cat.6	S/FTP		25.16.8392 w/S			
Cat.6	S/FTP		25.16.8393 iv/S			

### VALUE Components – Recommendation for structured cabling

Category	Type	LAN Cable	Wall Jack	Patch Panel	Patch Cord	Test / Certification
Cat.5e	UTP	21.99.0596 300m	25.16.8506 w/F	26.99.0349 blk	21.99.0505 5m	Laboratory 100m Channel / Class D
Cat.5e	UTP		25.16.8501 iv/F	26.99.0347 lgrey		
Cat.5e	UTP		25.16.8406 w/S			
Cat.5e	UTP		25.16.8401 iv/S			
Cat.5e	S/FTP	21.99.0196 300m	25.16.8487 w/F	26.99.0328 blk	21.99.0105 5m	Laboratory 100m Channel / Class D
Cat.5e	S/FTP		25.16.8486 iv/F	26.99.0329 lgrey		
Cat.5e	S/FTP		25.16.8387 w/S			
Cat.5e	S/FTP		25.16.8386 iv/S			
Cat.6	UTP	21.99.0995 300m	25.99.8494 w/F	26.99.0362 blk	21.99.0905 5m	Laboratory 100m Channel / Class E
Cat.6	UTP		25.99.8394 w/S	26.99.0355 lgrey		
Cat.6	S/FTP	21.99.0892	25.99.8392	26.99.0353 blk	21.99.0805 5m	Laboratory 100m Channel / Class E
Cat.6	S/FTP		25.99.8492	26.99.0354 lgrey		
Cat.6a	UTP	21.99.1685	25.16.8484	26.99.0359 lgrey	21.99.0875 5m	Laboratory 100m Channel / Class E
Cat.6a	UTP		25.16.8579	26.99.0358 blk		
Cat.6a	S/FTP	21.99.0882	25.16.8579	26.11.0359 blk	21.99.0865 5m	Laboratory 100m Channel / Class E
Cat.6a	S/FTP	21.99.0884	25.16.8484	26.11.0360 lgrey		

F - Flush Mount / S - Surface Mount w - white / iv - ivory



# Cable Assembly Inquiry Form

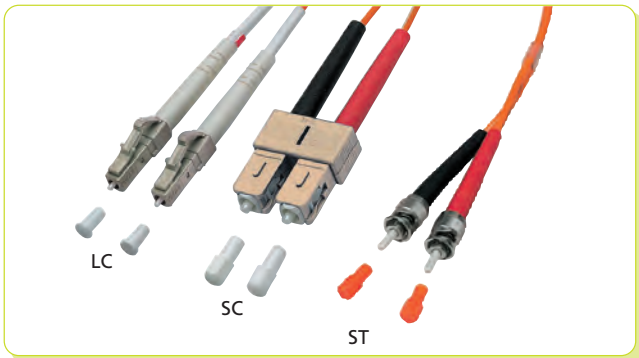

## Fiber Optic Cable

### Fiber Type

- Multimode 62,5/125 μm
- Multimode 50/125 μm
- Single mode 9/125 μm

### Fiber Quality

- OM1
- OM2
- OM3
- OM4
- OS1
- OS2

Number of Fibers (1/2/4/8/12/24 ...) \_\_\_\_\_

### Cable Type

- Indoor (Duplex)
- Indoor trunk, Breakout Cable
- Outdoor trunk / Universal Cable
- Underground Cable (longitudinally waterproof, rodent protection)

### Plug Type

- |   |   |
|---|---|
| <b>Side A</b>   | <b>Side B</b>   |
| <input type="checkbox"/> LC   | <input type="checkbox"/> LC   |
| <input type="checkbox"/> SC   | <input type="checkbox"/> SC   |
| <input type="checkbox"/> ST   | <input type="checkbox"/> ST   |
| <input type="checkbox"/> E2000  | <input type="checkbox"/> E2000  |
| <input type="checkbox"/> 8° Diagonal Cross section (single mode only) | <input type="checkbox"/> 8° Diagonal Cross section (single mode only) |
| <input type="checkbox"/> Other _____                                  | <input type="checkbox"/> Other _____                                  |

### Cable Length / Options

- Length: \_\_\_\_\_
- Labeling

**Side A** \_\_\_\_\_ **Side B** \_\_\_\_\_

- Pulling Aid**  
(Breakout, Universal and underground cables)

**Quantity:** \_\_\_\_\_

**Your additional technical notes:** \_\_\_\_\_  
 \_\_\_\_\_  
 \_\_\_\_\_

**Your contact details**

**Customer-No. :** \_\_\_\_\_

**Contact Person:** \_\_\_\_\_

**Phone:** \_\_\_\_\_

**e-Mail :** \_\_\_\_\_

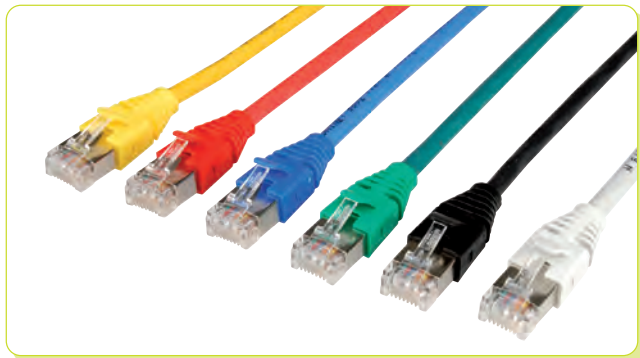

## Twisted Pair Wire

### Cable Type

Brandname / Class (e.g. Draka, Leoni Kerpen, Cat. 6a): \_\_\_\_\_

PVC / Halogen-Free / PE-Sheath / PUR-Sheath: \_\_\_\_\_

Color: \_\_\_\_\_

- Stranded WireFlexible patch cord  Stranded Wire Fixed Installation Cable
- Flat  Round

Technical Note: \_\_\_\_\_

### Shielding

- UTP=U/UTP
- FTP=F/FTP
- S/FTP=SF/UTP (Cat.5e)
- S/FTP=S/FTP (Cat.6) (PIMF)

### Plug Type

Brandname / Class: e.g. RJ11 / RJ12 / RJ45 (Cat.5e / Cat.6) / HiRose TM11, TM21, TM31 / GG45 / Siemon Tera / EC7 / BTR Field Plug, ...

**Side A** \_\_\_\_\_ **Side B** \_\_\_\_\_

Color Plug **Side A** \_\_\_\_\_ **Side B** \_\_\_\_\_

### Pin Assignment

- 1:1 EIA / TIA 568A
- 1:1 EIA / TIA 568B

- |                                     |               |                              |
|-------------------------------------|---------------|------------------------------|
| <b>Customer-specific assignment</b> | <b>Side A</b> | <b>Side B</b>                |
|                                     | Pin 1         | Pin <input type="checkbox"/> |
|                                     | Pin 2         | Pin <input type="checkbox"/> |
|                                     | Pin 3         | Pin <input type="checkbox"/> |
|                                     | Pin 4         | Pin <input type="checkbox"/> |
|                                     | Pin 5         | Pin <input type="checkbox"/> |
|                                     | Pin 6         | Pin <input type="checkbox"/> |
|                                     | Pin 7         | Pin <input type="checkbox"/> |
|                                     | Pin 8         | Pin <input type="checkbox"/> |

**Quantity** \_\_\_\_\_

**Your additional technical notes:** \_\_\_\_\_  
 \_\_\_\_\_  
 \_\_\_\_\_

**Please call us for a telephone consultation**

**Important Note: Individual cable assemblies require a written order. All orders are final. Subsequent requests of cancellation, refunds or exchange cannot be accepted.**

## VALUE UTP Cable Cat.5e

- Structured building cabling
- Impedance: 100 Ohm
- Length: 300 m
- Colour: Grey
- Construction: 8 lines, copper, solid wire AWG24

**For a structured cabling system we recommend to use the following components:**  
 VALUE Cat.5e UTP Cable, Solid Wire, AWG24, 300 m: 21.99.0596  
 ROLINE Cat.5e Flush/Surface Mount Wall Jack, unshielded: 25.16.8506 (white), 25.16.8501 (ivory)/25.16.8406 (white), 25.16.8401 (ivory)  
 VALUE Cat.5e 19" Patch Panel, 24 Ports, unshielded: 26.99.0349 (black), 26.99.0347 (light grey)  
 VALUE Cat.5e UTP Patch Cord, grey, 5 m: 21.99.0505

Our in-house laboratory has tested this cable-plug combination, in a Channel of 100 meters, in compliance with Class D specifications.



**Order-No. – P.U.**

VALUE UTP Cable Cat.5e, Solid Wire, AWG24, 300 m

21.99.0596 – 2

## ROLINE UTP Cable Cat.5e

- Structured building cabling
- Impedance: 100 Ohm
- Colour: Grey
- Construction (21.15.0512/11): 8 lines, copper, solid wire AWG24
- Construction (21.15.0518/20): 8 lines, copper, stranded wire AWG24

**For a structured cabling system we recommend to use the following components:**  
 ROLINE Cat.5e UTP Cable, Solid Wire, AWG24: 21.15.0512 (100 m), 21.15.0511 (300 m)  
 ROLINE Cat.5e Flush/Surface Mount Wall Jack, unshielded: 25.16.8506 (white), 25.16.8501 (ivory)/25.16.8406 (white), 25.16.8401 (ivory)  
 ROLINE Cat.5e 19" Patch Panel, 24 Ports, unshielded: 26.11.0349 (black), 26.11.0347 (light grey)  
 ROLINE Cat.5e UTP Patch Cord, grey, 5 m: 21.15.0505

Our in-house laboratory has tested this cable-plug combination, in a Channel of 100 meters, in compliance with Class D specifications.



**Order-No. – P.U.**

ROLINE UTP Cable Cat.5e, Solid Wire, 100 m

21.15.0512 – 2

ROLINE UTP Cable Cat.5e, Solid Wire, 300 m

21.15.0511 – 1

ROLINE UTP Cable Cat.5e, Stranded Wire, 100 m

21.15.0518 – 2

ROLINE UTP Cable Cat.5e, Stranded Wire, 300 m

21.15.0520 – 1

## VALUE FTP Cable Cat.5e

- Structured building cabling
- Impedance: 100 Ohm
- Length: 300 m
- Colour: Grey
- Construction: 8 lines, copper, solid wire, complete shielding with aluminium clad polyester foil

**For a structured cabling system we recommend to use the following components:**  
 VALUE Cat.5e FTP Cable, Solid Wire, 300 m: 21.99.0196  
 ROLINE Cat.5e Flush/Surface Mount Wall Jack, shielded: 25.16.8487 (white), 25.16.8486 (ivory)/25.16.8387 (white), 25.16.8386 (ivory)  
 VALUE Cat.5e 19" Patch Panel, 24 Ports, shielded: 26.99.0328 (black), 26.99.0329 (light grey)  
 VALUE Cat.5e FTP Patch Cord, grey, 5 m: 21.99.0105

Our in-house laboratory has tested this cable-plug combination, in a Channel of 100 meters, in compliance with Class D specifications.



**Order-No. – P.U.**

VALUE FTP Cable Cat.5e, Solid Wire, 300 m

21.99.0196 – 2

## ROLINE FTP Cable Cat.5e

- Structured building cabling
- Impedance: 100 Ohm
- Colour: Grey
- Construction (21.15.0009/10): 8 lines, copper, solid wire AWG24, screening: alu-laminated foil
- Construction (21.15.0119/21): 8 lines, copper, stranded wire AWG26, screening: alu-laminated foil

**For a structured cabling system we recommend to use the following components:**  
 ROLINE Cat.5e FTP Cable, Solid Wire, AWG24: 21.15.0009 (100 m), 21.15.0010 (300 m)  
 ROLINE Cat.5e Flush/Surface Mount Wall Jack, shielded: 25.16.8487 (white), 25.16.8486 (ivory)/25.16.8387 (white), 25.16.8386 (ivory)  
 ROLINE Cat.5e 19" Patch Panel, 24 Ports, shielded: 26.11.0329 (light grey), 26.11.0328 (black)  
 ROLINE Cat.5e FTP Patch Cord, grey, 5 m: 21.15.0105

Our in-house laboratory has tested this cable-plug combination, in a Channel of 100 meters, in compliance with Class D specifications.



**Order-No. – P.U.**

ROLINE FTP Cable Cat.5e, Solid Wire, 100 m

21.15.0009 – 2

ROLINE FTP Cable Cat.5e, Solid Wire, 300 m

21.15.0010 – 1

ROLINE FTP Cable Cat.5e, Stranded Wire, 100 m

21.15.0119 – 2

ROLINE FTP Cable Cat.5e, Stranded Wire, 300 m

21.15.0121 – 1

## ROLINE S/FTP Cable Cat.5e

- Structured building cabling
- Impedance: 100 Ohm
- Colour: Grey
- Construction (21.15.0019/20): 8 lines, copper, solid wire AWG24, screening: alu-laminated foil, shielding: copper braid
- Construction (21.15.0319/21): 8 lines, copper, stranded wire AWG26, screening: alu-laminated foil, shielding: copper braid
- Diagram: attenuation/near end crosstalk

**For a structured cabling system we recommend to use the following components:**  
 ROLINE Cat.5e S/FTP Cable, Solid Wire, AWG24: 21.15.0019 (100 m), 21.15.0020 (300 m)  
 ROLINE Cat.5e Flush/Surface Mount Wall Jack, shielded: 25.16.8487 (white), 25.16.8486 (ivory)/25.16.8387 (white), 25.16.8386 (ivory)  
 ROLINE Cat.5e 19" Patch Panel, 24 Ports, shielded: 26.11.0329 (light grey), 26.11.0328 (black)  
 ROLINE Cat.5e S/FTP Patch Cord, grey, 5 m: 21.15.0305

Our in-house laboratory has tested this cable-plug combination, in a Channel of 100 meters, in compliance with Class D specifications.

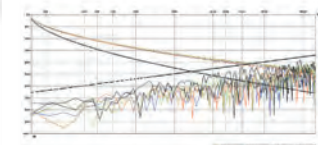
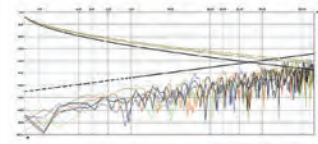

**Order-No. – P.U.**

ROLINE S/FTP Cable Cat.5e, Solid Wire, 100 m

21.15.0019 – 2

ROLINE S/FTP Cable Cat.5e, Solid Wire, 300 m

21.15.0020 – 1

ROLINE S/FTP Cable Cat.5e, Stranded Wire, 100 m

21.15.0319 – 2

ROLINE S/FTP Cable Cat.5e, Stranded Wire, 300 m

21.15.0321 – 1



## VALUE UTP Cable Cat.6

- Structured building cabling
- Impedance: 100 Ohm
- Colour: Grey
- Construction: 8 lines, copper, solid wire AWG24

**For a structured cabling system we recommend to use the following components:**  
 VALUE Cat.6 UTP Cable, Solid Wire, AWG24, 300 m: 21.99.0995  
 VALUE Cat.6 Flush/Surface Mount Wall Jack, unshielded, white: 25.99.8494/25.99.8394  
 VALUE Cat.6 19" Patch Panel, 24 Ports, unshielded: 26.99.0351 (black), 26.99.0352 (grey)  
 VALUE Cat.6 UTP Patch Cord, grey, 5 m: 21.99.0905

Our in-house laboratory has tested this cable-plug combination, in a Channel of 100 meters, in compliance with Class E specifications.



**Order-No. – P.U.**

VALUE UTP Cable Cat.6, Solid Wire, AWG24, 300 m

21.99.0995 – 2

## VALUE S/FTP (PiMF) Cable Cat.6/Class E

- Structured building cabling
- Impedance: 100 Ohm
- Colour: Grey
- Construction:
  - 8 lines, solid copper wire, AWG23
  - pairs shielded with aluminium foil
  - complete shielding in tinned copper braid

**For a structured cabling system we recommend to use the following components:**  
 21.99.0892 VALUE S/FTP Cat.6/Class E solid wire installation cable  
 25.99.8392/25.99.8492 VALUE Cat.6/Class E Surface / flush box  
 26.99.0353/26.99.0354 VALUE Cat.6/Class E 19" Patch Panel, black/grey  
 21.99.0805 VALUE S/FTP Patch Cable Cat.6, 5m

This product combination has been measured in our own laboratory in the Channel of 100 meters, in compliance with Class E specifications



**Order-No. – P.U.**

VALUE S/FTP-(PiMF) Cable Cat.6/Class E, Solid Wire, 300.0 m

21.99.0892 – 1

## VALUE UTP Cable Cat.6A

- Cable for structured building cabling
- 300 meter/box
- Impedance: 100 Ohm
- Construction:
  - 8 lines, solid copper wire
- Colour: grey

**For a structured unshielded cabling system Cat.6A we recommend to use the following components:**  
 VALUE Cat.6A UTP Cable, Solid Wire: 21.99.1685(300m)  
 Flush Mount Wall Jack for Keystones, 2-port: 25.16.8579  
 ROLINE Cat.6 Keystone, RJ45, unshielded: 26.11.0337  
 19" Keystone Patch Panel, 24 Ports, unshielded: 26.11.0358 (black)/26.11.0357 (grey)  
 VALUE Cat.6A UTP Patch Cord, grey, 5 m: 21.99.0875



**Order-No. – P.U.**

VALUE UTP Cable Cat.6A, Solid Wire, 300 m

21.99.1685 – 2

## ROLINE UTP Cable Cat.6

- Structured building cabling
- Impedance: 100 Ohm
- Colour: Grey
- Construction: 8 lines, copper, solid wire

**\* Halogenfree  
Flame retardant  
Low Smoke**



**roline**  
Designed for Professionals

**For a structured cabling system we recommend to use the following components:**  
 ROLINE Cat.6 UTP Cable, Solid Wire, AWG23: 21.15.0990 (100 m), 21.15.0991 (300 m)  
 ROLINE Cat.6 Flush Mount Wall Jack, unshielded: 25.16.8494 (white), 25.16.8500 (ivory)  
 ROLINE Cat.6 Surface Mount Wall Jack, unshielded: 25.16.8394 (white), 25.16.8395 (ivory)  
 ROLINE Cat.6 19" Patch Panel, 24 Ports, unshielded: 26.11.0355 (light grey), 26.11.0362 (black), ROLINE Cat.6 UTP Patch Cord, grey, 5 m: 21.15.0935.

The accredited German laboratory GHMT has tested and certified this product combination, in a Channel of 100 meters, as being compliant to Class E specifications; certificate no. z2329b-10-E (with flush mount)/z2330b-10-E (with surface mount).

**Order-No. – P.U.**

ROLINE UTP Cable Cat.6 / Class E, Solid Wire, AWG23, 100 m

21.15.0990 – 1

ROLINE UTP Cable Cat.6 / Class E, Solid Wire, AWG23, 300 m

21.15.0991 – 1

ROLINE UTP Cable Cat.6 / Class E, Stranded, AWG23, 300 m

21.15.0992 – 1

ROLINE UTP Cable Cat.6 / Class E, Solid Wire, AWG24, 300m, halogen-free\*

21.15.1789 – 1

## ROLINE S/FTP-(PiMF) Cable Cat.6/Class E

- Structured building cabling
- Impedance: 100 Ohm
- Colour: Grey
- Construction:
  - 8 lines, solid copper wire, AWG23
  - pairs shielded with aluminium foil
  - complete shielding in tinned copper braid

**\* Halogenfree  
Flame retardant  
Low Smoke**



**roline**  
Designed for Professionals

**For a structured cabling system we recommend to use the following components:**  
 ROLINE Cat.6 S/FTP Cable, Solid Wire, AWG23: 21.15.0890 (100 m), 21.15.0891 (300 m)  
 ROLINE Cat.6 Flush Mount Wall Jack, shielded: 25.16.8492 (white), 25.16.8493 (ivory)  
 ROLINE Cat.6 Surface Mount Wall Jack, shielded: 25.16.8392 (white), 25.16.8393 (ivory)  
 ROLINE Cat.6 19" Patch Panel, 24 Ports, shielded: 26.11.0351 (light grey), 26.11.0361 (black), ROLINE Cat.6 S/FTP Patch Cord, grey, 5 m: 21.15.0835.

The accredited German laboratory GHMT has tested and certified this product combination, in a Channel of 100 meters, as being compliant to Class E specifications; certificate no. z2365b-10-E (with flush mount)/z2364b-10-E (with surface mount).

**Order-No. – P.U.**

ROLINE S/FTP-(PiMF) Cable Cat.6/Class E, Solid Wire, AWG 23, 100 m

21.15.0890 – 2

ROLINE S/FTP-(PiMF) Cable Cat.6/Class E, Solid Wire, AWG 23, 300 m

21.15.0891 – 1

ROLINE S/FTP-(PiMF) Cable Cat.6/Class E, Stranded, AWG 23, 300 m

21.15.0892 – 1

ROLINE S/FTP-(PiMF) Cable Cat.6/Class E, Solid Wire, AWG 23, 300m, halogen-free\*

21.15.1889 – 1

## ROLINE UTP Cable Cat.6A

- Cables for structured building cabling, data rates up to 10 Gbit/s
- 100 or 300 meter/box
- Impedance: 100 Ohm
- Construction:
  - 8 lines, solid copper wire
- Colour: grey

**For a structured unshielded cabling system Cat.6A we recommend to use the following components:**  
 ROLINE Cat.6A UTP Cable, Solid Wire: 21.15.1685(300m)  
 Flush Mount Wall Jack for Keystones, 2-port: 25.16.8579  
 ROLINE Cat.6 Keystone, RJ45, unshielded: 26.11.0337  
 19" Keystone Patch Panel, 24 Ports, unshielded: 26.11.0356/26.11.0357  
 ROLINE Cat.6A UTP Patch Cord, grey, 5 m: 21.15.1665

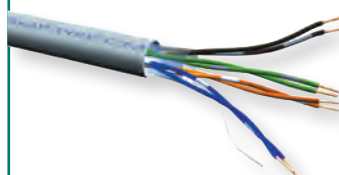

**roline**  
Designed for Professionals

**Order-No. – P.U.**

ROLINE UTP Cable Cat.6A, Solid Wire, 100 m

21.15.1684 – 4

ROLINE UTP Cable Cat.6A, Solid Wire, LSOH, 100 m

21.15.1686 – 4

ROLINE UTP Cable Cat.6A, Solid Wire, 300 m

21.15.1685 – 2

ROLINE UTP Cable Cat.6A, Solid Wire, LSOH, 300 m

21.15.1687 – 2

ROLINE UTP Cable Cat.6A, Stranded, 300 m

21.15.1682 – 1



**VALUE S/FTP (PiMF) Cable Cat.6A**

- Cable for structured building cabling
- 300 meter / box
- Impedance: 100 Ohm
- Construction:
  - 8 lines, solid copper wire, AWG23
  - pairs shielded with aluminium foil
  - complete shielding in tinned copper braid
- Colour: grey

**For a structured Cat. 6A S/FTP Cabling we recommend to use the following components:**

The following products combination has been tested:  
 21.99.0884 VALUE S/FTP Cable, Cat. 6A, Solid Wire  
 25.16.8484 Surface Wall Mount Frame  
 25.16.8579 Flush Mount Wall Outlet for Keystones, 2port  
 26.99.0366 VALUE Cat.6A Keystone, RJ-45, shielded, toolless  
 26.11.0359/.0360 Keystone 19" Module frame Cat.5/Cat.6/Cat.6A, 24 Ports, shielded grey/black  
 21.99.0865 VALUE S/FTP Patch Cord Cat.6A, grey, 5m

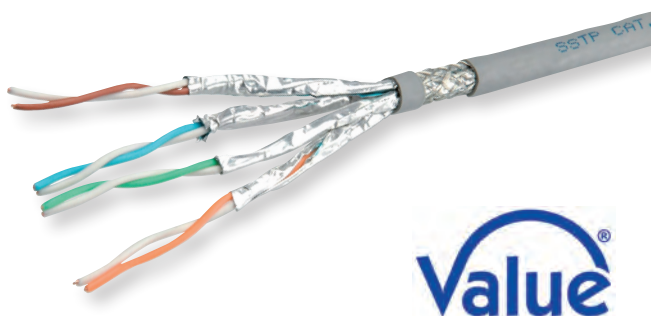

Order-No. – P.U.

VALUE S/FTP (PiMF) Cable Cat.6A, Solid Wire, 300 m

21.99.0884 – 1

**ROLINE S/FTP (PiMF) Cable Cat.6A**

- Cable for structured building cabling
- 300 meter / box ; 100 meter as coil
- Impedance: 100 Ohm
- Construction:
  - 8 lines, solid copper wire, AWG23
  - pairs shielded with aluminium foil
  - complete shielding in tinned copper braid
- Colour: grey

**For a structured Cat. 6A S/FTP Cabling we recommend to use the following components:**

21.15.0883 ROLINE S/FTP Cable, Cat. 6A, Solid Wire, AWG23  
 25.16.8579 Flush Mount Wall Outlet for Keystones, 2-port  
 26.11.0367 ROLINE Cat. 6A Keystone, RJ-45, Shielded, Silver  
 26.11.0359/.0360 ROLINE Patchpanel for Keystones 19", 24x  
 21.15.0865 ROLINE S/FTP Patch Cable Cat. 6A, Grey

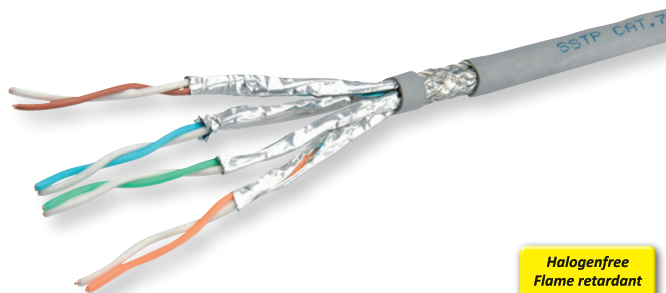

Halogenfree  
Flame retardant  
Low Smoke



Order-No. – P.U.

ROLINE S/FTP (PiMF) Cable Cat.6A, Solid Wire, LSOH, 100 m

21.15.0883 – 4

ROLINE S/FTP (PiMF) Cable Cat.6A, Solid Wire, LSOH, 300 m

21.15.0884 – 1

ROLINE S/FTP (PiMF) Cable Cat.6A, Stranded, 300 m

21.15.0882 – 1

**ROLINE S/FTP (PiMF) Cable Cat.7**

- Cable for structured building cabling
- Impedance: 100 Ohm
- 100 meter as coil / 300 meter as box
- 3P certified
- Construction: 8 lines, solid copper wire, AWG23 / Pairs shielded with aluminium foil / Complete shielding in copper braid

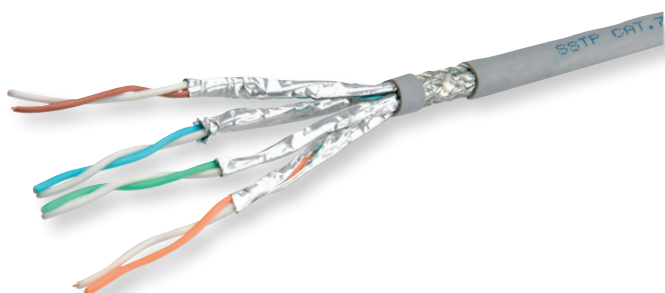

Halogenfree  
Flame retardant  
Low Smoke



Order-No. – P.U.

ROLINE S/FTP (PiMF) Cable Cat.7, Solid Wire, 100m

21.15.0001 – 5

ROLINE S/FTP (PiMF) Cable Cat.7, Solid Wire, 300m

21.15.0003 – 1

ROLINE S/FTP (PiMF) Cable Cat.7, Solid Wire, halogen-free, 100 m

21.15.0002 – 2

ROLINE S/FTP (PiMF) Cable Cat.7, Solid Wire, halogen-free, 300 m

21.15.0004 – 1

**ROLINE UTP Patch Cord Cat.5e, Retractable**

- For a fast network connection without any cable hassle, ideal for travellers
- Flat cable with two unshielded RJ-45 connectors
- In housing with auto-roll-extender, stretches out to a total length of 2 m
- Length scales in inches and centimetres printed on cable
- Cable colour: Black



Order-No. – P.U.

ROLINE UTP Patch Cord Cat.5e, black, 2.0 m, Retractable

21.15.0591 – 20

## VALUE UTP Patch Cord Cat.5e

Cat.5e U/UTP

- Prepared cable with unshielded RJ-45 plug on both ends (without coding) incl. kink protection.
- Connection cable for structured building cabling.
- Impedance: 100 Ohm.
- Contact settings 1:1 in accordance with EIA / TIA 568, 8 lines.
- Construction: internal line 8 wires



Order-No. – P.U.

VALUE UTP Patch Cord Cat.5e, grey, 0.5 m	21.99.0500 – 250
VALUE UTP Patch Cord Cat.5e, grey, 1.0 m	21.99.0501 – 200
VALUE UTP Patch Cord Cat.5e, grey, 2.0 m	21.99.0502 – 150
VALUE UTP Patch Cord Cat.5e, grey, 3.0 m	21.99.0503 – 100
VALUE UTP Patch Cord Cat.5e, grey, 5.0 m	21.99.0505 – 70
VALUE UTP Patch Cord Cat.5e, grey, 7.0 m	21.99.0507 – 50
VALUE UTP Patch Cord Cat.5e, grey, 10.0 m	21.99.0510 – 40
VALUE UTP Patch Cord Cat.5e, grey, 15.0 m	21.99.0515 – 25
VALUE UTP Patch Cord Cat.5e, grey, 20.0 m	21.99.0520 – 20

## ROLINE UTP Patch Cord Cat.5e, crossover / Adapter

Cat.5e U/UTP

### 21.15.0603

- Prepared UTP connection cable with crimped RJ-45 connectors on both sides
- Crossed version for special applications such as the cascading of hubs/switches or for direct connection between two PCs
- Very flexible cable
- Impedance: 100 Ohm
- Construction: 8 wires
- Colours (cable and connectors): grey

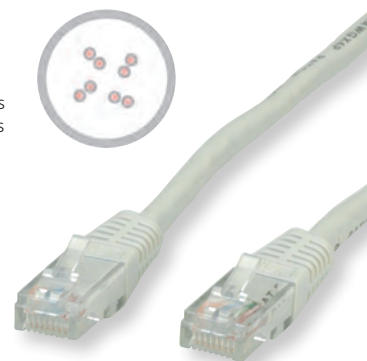

### 21.17.3076

- Converts each patch cable into a crossover patch cable, which is necessary for special applications such as cascading of hubs / switches or for the direct connection of two PCs
- UTP version
- Cat.5e compliant
- Suitable for 10/100/1000Base-T applications
- Crossover assignment pairs (pair 1,2 with 3,6)
- Dimensions: 45 x 20 x 18 mm

**roline**  
Designed for Professionals

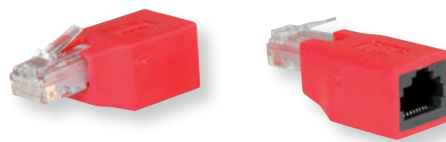

Order-No. – P.U.

ROLINE UTP Patch Cord Cat.5e, crossover, grey, 3 m	21.15.0603 – 50
ROLINE RJ45 Crossover Adapter UTP, Cat.5e	21.17.3076 – 50

## ROLINE UTP Patch Cord Cat.5e

Cat.5e U/UTP

- Patch cable for networking connections between devices.
- Prepared unshielded Twisted Pair cable with RJ-45 connectors on both ends. Durable due to moulded kink protection.
- Flexible cable, suitable for narrow bending. High quality plugs with gold plated contacts.
- Contact settings 1:1, in accordance with the EIA/TIA 568 standard.
- Construction: 4-pair stranded copper wire.



### For a structured cabling system we recommend to use the following components:

- ROLINE Cat.5e UTP Cable, Solid Wire, AWG24: 21.15.0512 (100 m), 21.15.0511 (300 m);
- ROLINE Cat.5e Flush/Surface Mount Wall Jack, unshielded: 25.16.8506 (white), 25.16.8501 (ivory) / 25.16.8406 (white), 25.16.8401 (ivory);
- ROLINE Cat.5e 19" Patch Panel, 24 Ports, unshielded: 26.11.0349 (black), 26.11.0347 (light grey);
- ROLINE Cat.5e UTP Patch Cord, grey, 5 m: 21.15.0505.

Our in-house laboratory has tested this cable-plug combination, in a Channel of 100 meters, in compliance with Class D specifications.

Length	grey	red	yellow	green	blue	black	– P.U.
0.5 m	21.15.0500	21.15.0521	21.15.0522	21.15.0523	21.15.0524	21.15.0525	– 100
1 m	21.15.0501	21.15.0531	21.15.0532	21.15.0533	21.15.0534	21.15.0535	– 100
2 m	21.15.0502	21.15.0541	21.15.0542	21.15.0543	21.15.0544	21.15.0545	– 100
3 m	21.15.0503	21.15.0551	21.15.0552	21.15.0553	21.15.0554	21.15.0555	– 50
5 m	21.15.0505	21.15.0561	21.15.0562	21.15.0563	21.15.0564	21.15.0565	– 50
7 m	21.15.0507						– 50
10 m	21.15.0510	21.15.0421	21.15.0422	21.15.0423	21.15.0424	21.15.0425	– 40
15 m	21.15.0515	21.15.0431	21.15.0432	21.15.0433	21.15.0434	21.15.0435	– 30
20 m	21.15.0519	21.15.0441	21.15.0442	21.15.0443	21.15.0444	21.15.0445	– 20

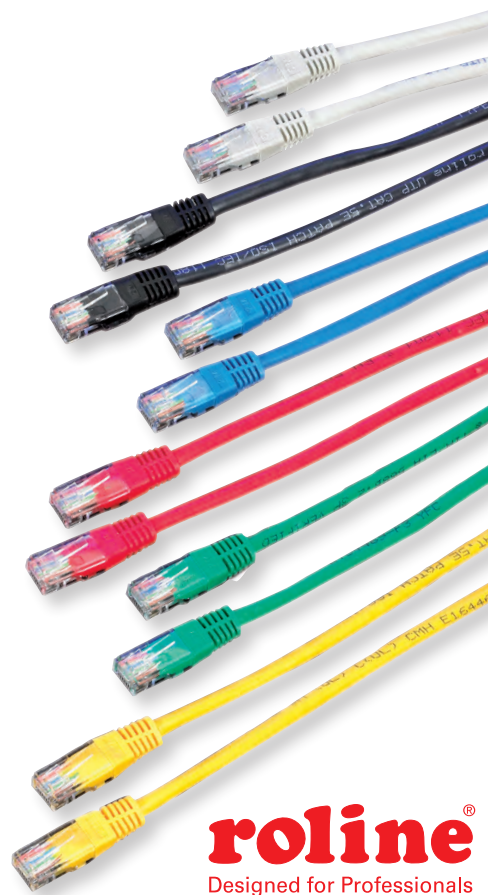

**roline**  
Designed for Professionals

VALUE FTP Patch Cord Cat.5e

Cat.5e F/UTP

- Prepared cable with screened RJ-45 plug on both ends (without coding) incl. kink protection.
- Connection cable for structured building cabling.
- Impedance: 100 Ohm.
- Contact settings 1:1 in accordance with EIA / TIA 568, 8 lines.
- Construction: Internal line 8 wires. Complete screening: aluminium laminated foil
- Colour: grey

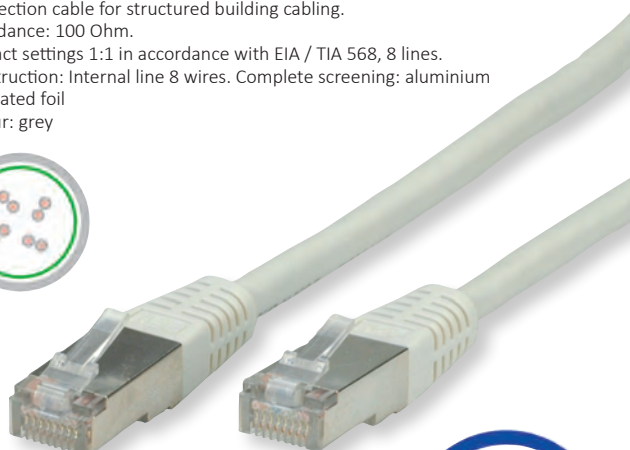

Order-No. – P.U.

VALUE FTP Patch Cord Cat.5e, grey, 0.5 m	21.99.0100 – 250
VALUE FTP Patch Cord Cat.5e, grey, 1.0 m	21.99.0101 – 200
VALUE FTP Patch Cord Cat.5e, grey, 2.0 m	21.99.0102 – 150
VALUE FTP Patch Cord Cat.5e, grey, 3.0 m	21.99.0103 – 100
VALUE FTP Patch Cord Cat.5e, grey, 5.0 m	21.99.0105 – 70
VALUE FTP Patch Cord Cat.5e, grey, 7.0 m	21.99.0107 – 50
VALUE FTP Patch Cord Cat.5e, grey, 10.0 m	21.99.0110 – 40
VALUE FTP Patch Cord Cat.5e, grey, 15.0 m	21.99.0115 – 25
VALUE FTP Patch Cord Cat.5e, grey, 20.0 m	21.99.0120 – 20

ROLINE FTP Patch Cord Cat.5e, crossover / Adapter

Cat.5e F/UTP

- 21.15.0203**
  - Prepared cable with shielded RJ-45 connectors on both ends, incl. kink protection
  - Crossed version for special applications such as the cascading of hubs/switches or for the direct connection between two PCs
  - Construction: 8 wires copper; complete shielding aluminium laminated foil
  - Colours (cable and connectors): Grey
- 21.17.3077**
  - Converts each patch cable into a crossover patch cable, which is necessary for special applications such as cascading of hubs / switches or for the direct connection of two PCs
  - S/FTP version, shielded, also used for UTP applications
  - Cat 5e compliant, Gigabit compatible
  - Suitable for 10/100/1000Base-T applications
  - Crossover assignment pairs (pair 1,2 with 3,6)
  - Dimensions: 45 x 20 x 18 mm

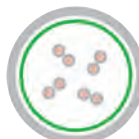

Order-No. – P.U.

ROLINE FTP Patch Cord Cat.5e, crossover, grey, 3 m	21.15.0203 – 50
ROLINE RJ45 Crossover Adapter STP, Cat.5e	21.17.3077 – 50

ROLINE FTP Patch Cord Cat.5e

Cat.5e F/UTP

- Patch cable for networking connections between devices. Prepared double shielded Twisted Pair cable with screened RJ-45 connectors on both ends. Durable due to moulded kink protection.
- Flexible cable, suitable for narrow bending. High quality plugs with gold plated contacts.
- Contact settings 1:1, in accordance with the EIA/TIA 568 standard.
- Construction: 4-pair stranded copper wire. Complete shielding with aluminium clad polyester foil.

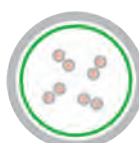

For a structured cabling system we recommend to use the following components:

ROLINE Cat.5e FTP Cable, Solid Wire, AWG24: 21.15.0009 (100 m), 21.15.0010 (300 m);  
 ROLINE Cat.5e Flush/Surface Mount Wall Jack, shielded: 25.16.8487 (white), 25.16.8486 (ivory)/25.16.8387 (white), 25.16.8386 (ivory),  
 ROLINE Cat.5e 19" Patch Panel, 24 Ports, shielded: 26.11.0329 (light grey), 26.11.0328 (black);  
 ROLINE Cat.5e FTP Patch Cord, grey, 5 m: 21.15.0105.

Our in-house laboratory has tested this cable-plug combination, in a Channel of 100 meters, in compliance with Class D specifications.

Length	grey	red	yellow	green	blue	black	– P.U.
0.5 m	21.15.0100	21.15.0181	21.15.0182	21.15.0183	21.15.0184	21.15.0185	– 100
1 m	21.15.0101	21.15.0131	21.15.0132	21.15.0133	21.15.0134	21.15.0135	– 100
2 m	21.15.0102	21.15.0141	21.15.0142	21.15.0143	21.15.0144	21.15.0145	– 100
3 m	21.15.0103	21.15.0151	21.15.0152	21.15.0153	21.15.0154	21.15.0155	– 50
5 m	21.15.0105	21.15.0161	21.15.0162	21.15.0163	21.15.0164	21.15.0165	– 50
7 m	21.15.0107						– 50
10 m	21.15.0110	21.15.0451	21.15.0452	21.15.0453	21.15.0454	21.15.0455	– 40
15 m	21.15.0115	21.15.0461	21.15.0462	21.15.0463	21.15.0464	21.15.0465	– 30
20 m	21.15.0120	21.15.0471	21.15.0472	21.15.0473	21.15.0474	21.15.0475	– 20





## VALUE S/FTP Patch Cord Cat.5e

Cat.5e

SF/UTP

- Prepared cable with screened RJ-45 plug on both ends incl. kink protection
- Connection cable for a structured building cabling
- Impedance: 100 Ohm
- Contact settings 1:1 in accordance with EIA/TIA568
- Construction: Internal line 8 wires copper wire
- Complete screening aluminium laminated foil with additional braided shield

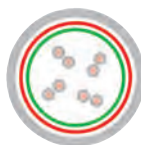

## Order-No. – P.U.

VALUE S/FTP Patch Cord Cat.5e, grey, 0.5 m	21.99.0300 – 250
VALUE S/FTP Patch Cord Cat.5e, grey, 1.0 m	21.99.0301 – 200
VALUE S/FTP Patch Cord Cat.5e, grey, 2.0 m	21.99.0302 – 150
VALUE S/FTP Patch Cord Cat.5e, grey, 3.0 m	21.99.0303 – 100
VALUE S/FTP Patch Cord Cat.5e, grey, 5.0 m	21.99.0305 – 70
VALUE S/FTP Patch Cord Cat.5e, grey, 7.0 m	21.99.0307 – 50
VALUE S/FTP Patch Cord Cat.5e, grey, 10.0 m	21.99.0310 – 40
VALUE S/FTP Patch Cord Cat.5e, grey, 15.0 m	21.99.0315 – 25
VALUE S/FTP Patch Cord Cat.5e, grey, 20.0 m	21.99.0320 – 20

## ROLINE S/FTP Patch Cord Cat.5e

Cat.5e

SF/UTP

- Patch cable for networking connections between devices.
- Prepared double shielded Twisted Pair cable with screened RJ-45 connectors on both ends. Durable due to moulded kink protection.
- Flexible cable, suitable for narrow bending. High quality plugs with gold plated contacts.
- Contact settings 1:1, in accordance with the EIA/TIA 568 standard.
- Construction: 4-pair stranded copper wire.
- Complete braid shielding and aluminium clad polyester foil.

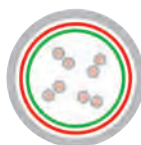

## For a structured cabling system we recommend to use the following components:

ROLINE Cat.5e S/FTP Cable, Solid Wire, AWG24:

21.15.0019 (100 m), 21.15.0020 (300 m);

ROLINE Cat.5e Flush/Surface Mount Wall Jack, shielded: 25.16.8487 (white), 25.16.8486 (ivory)/25.16.8387 (white), 25.16.8386 (ivory); ROLINE Cat.5e 19" Patch Panel, 24 Ports, shielded: 26.11.0329 (light grey), 26.11.0328 (black);

ROLINE Cat.5e S/FTP Patch Cord, grey, 5 m: 21.15.0305.

Our in-house laboratory has tested this cable-plug combination, in a Channel of 100 meters, in compliance with Class D specifications.

Length	grey	red	yellow	green	blue	black	– P.U.
0.5 m	21.15.0300	21.15.0381	21.15.0382	21.15.0383	21.15.0384	21.15.0385	– 100
1 m	21.15.0301	21.15.0331	21.15.0332	21.15.0333	21.15.0334	21.15.0335	– 100
2 m	21.15.0302	21.15.0341	21.15.0342	21.15.0343	21.15.0344	21.15.0345	– 100
3 m	21.15.0303	21.15.0351	21.15.0352	21.15.0353	21.15.0354	21.15.0355	– 50
5 m	21.15.0305	21.15.0361	21.15.0362	21.15.0363	21.15.0364	21.15.0365	– 50
7 m	21.15.0307						– 50
10 m	21.15.0310	21.15.0721	21.15.0722	21.15.0723	21.15.0724	21.15.0725	– 40
15 m	21.15.0315	21.15.0731	21.15.0732	21.15.0733	21.15.0734	21.15.0735	– 30
20 m	21.15.0320	21.15.0741	21.15.0742	21.15.0743	21.15.0744	21.15.0745	– 20



Designed for Professionals

VALUE UTP Patch Cord, Cat.6

Cat.6 U/UTP

- Patch cable for networking connections between devices.
- Prepared unshielded Twisted Pair cable with RJ-45 connectors on both ends.
- Durable due to moulded kink protection.
- Flexible cable, suitable for narrow bending.
- Plugs with gold plated contacts.
- Contact settings 1:1, in accordance with the EIA/TIA 568 standard
- Construction: 4-pair stranded wire.



For a structured cabling system we recommend to use the following components:

VALUE Cat.6 UTP Cable, Solid Wire, AWG24, 300 m: 21.99.0995.  
 VALUE Cat.6 Flush/Surface Mount Wall Jack, unshielded, white: 25.99.8494/25.99.8394;  
 VALUE Cat.6 19" Patch Panel, 24 Ports, unshielded: 26.99.0351 (black), 26.99.0352 (grey);  
 VALUE Cat.6 UTP Patch Cord, grey, 5 m: 21.99.0905.

Our in-house laboratory has tested this cable-plug combination, in a Channel of 100 meters, in compliance with Class E specifications.



Length	grey	red	yellow	green	blue	black	white	- P.U.
0.5 m	21.99.0900	21.99.1521	21.99.1522	21.99.1523	21.99.1524	21.99.1525	21.99.1526	- 250
1 m	21.99.0901	21.99.1531	21.99.1532	21.99.1533	21.99.1534	21.99.1535	21.99.1536	- 200
1.5 m	21.99.0950	21.99.0951	21.99.0952	21.99.0953	21.99.0954	21.99.0955	21.99.0956	- 150
2 m	21.99.0902	21.99.1541	21.99.1542	21.99.1543	21.99.1544	21.99.1545	21.99.1546	- 150
3 m	21.99.0903	21.99.1551	21.99.1552	21.99.1553	21.99.1554	21.99.1555	21.99.1556	- 100
5 m	21.99.0905	21.99.1561	21.99.1562	21.99.1563	21.99.1564	21.99.1565	21.99.1566	- 70
7 m	21.99.0907	21.99.1571	21.99.1572	21.99.1573	21.99.1574	21.99.1575	21.99.1576	- 50
10 m	21.99.0910	21.99.1581	21.99.1582	21.99.1583	21.99.1584	21.99.1585	21.99.1586	- 40

VALUE UTP Cable Cat.6, halogen-free

Cat.6 U/UTP

- Patch cable for networking connections between devices.
- Prepared unshielded Twisted Pair cable with RJ-45 connectors on both ends.
- Durable due to moulded kink protection.
- Flexible cable, suitable for narrow bending.
- High quality plugs with gold plated contacts.
- Contact settings 1:1, in accordance with the EIA/TIA 568 standard
- Construction: 4-pair stranded wire.
- Halogen-free, flame retardant, low smoke.



Halogenfree  
Flame retardant  
Low Smoke



For a structured halogen-free cabling system we recommend to use the following components:

ROLINE Cat.6 UTP Cable, Solid Wire, LSOH, 300 m: 21.15.1789  
 VALUE Cat.6 Flush/Surface Mount Wall Jack, unshielded, white: 25.99.8494/25.99.8394  
 VALUE Cat.6 19" Patch Panel, 24 Ports, unshielded: 26.99.0351 (black), 26.99.0352 (grey)  
 VALUE Cat.6 UTP Patch Cord, grey, LSOH: 21.99.0205

Our in-house laboratory has tested this cable-plug combination, in a Channel of 100 meters, in compliance with Class E specifications.

Length	grey	red	yellow	green	blue	black	white	- P.U.
0.5 m	21.99.0200	21.99.1021	21.99.1022	21.99.1023	21.99.1024	21.99.1025	21.99.1026	- 250
1 m	21.99.0201	21.99.1031	21.99.1032	21.99.1033	21.99.1034	21.99.1035	21.99.1036	- 200
1.5 m	21.99.0250	21.99.0251	21.99.0252	21.99.0253	21.99.0254	21.99.0255	21.99.0256	- 150
2 m	21.99.0202	21.99.1041	21.99.1042	21.99.1043	21.99.1044	21.99.1045	21.99.1046	- 150
3 m	21.99.0203	21.99.1051	21.99.1052	21.99.1053	21.99.1054	21.99.1055	21.99.1056	- 100
5 m	21.99.0205	21.99.1061	21.99.1062	21.99.1063	21.99.1064	21.99.1065	21.99.1066	- 70
7 m	21.99.0207	21.99.1071	21.99.1072	21.99.1073	21.99.1074	21.99.1075	21.99.1076	- 50
10 m	21.99.0210	21.99.1081	21.99.1082	21.99.1083	21.99.1084	21.99.1085	21.99.1086	- 40

**ROLINE UTP Patch Cord, Cat.6**

Cat.6 U/UTP

- Patch cable for networking connections between devices.  
Prepared unshielded Twisted Pair cable with RJ-45 connectors on both ends.
- Durable due to moulded kink protection.
- Flexible cable, suitable for narrow bending.
- High quality plugs with gold plated contacts.
- Contact settings 1:1, in accordance with the EIA/TIA 568 standard.
- Construction: 4-pair stranded copper wire.



**For a structured cabling system we recommend to use the following components:**  
 ROLINE Cat.6 UTP Cable, Solid Wire, AWG23: 21.15.0990 (100 m), 21.15.0991 (300 m);  
 ROLINE Cat.6 Flush Mount Wall Jack, unshielded: 25.16.8494 (white), 25.16.8500 (ivory);  
 ROLINE Cat.6 Surface Mount Wall Jack, unshielded: 25.16.8394 (white), 25.16.8395 (ivory);  
 ROLINE Cat.6 19" Patch Panel, 24 Ports, unshielded: 26.11.0355 (light grey), 26.11.0362 (black);  
 ROLINE Cat.6 UTP Patch Cord, grey, 5 m: 21.15.0935.

The accredited German laboratory GHMT has tested and certified this product combination, in a Channel of 100 meters, as being compliant to Class E specifications; certificate no. z2329b-10-E (with flush mount)/z2330b-10-E (with surface mount).

**roline**<sup>®</sup>  
 Designed for Professionals

Length	grey	red	yellow	green	blue	black	white	orange	- P.U.
0.3 m	21.15.1510	21.15.1511	21.15.1512	21.15.1513	21.15.1514	21.15.1515	21.15.1516	21.15.1517	- 50
0.5 m	21.15.0930	21.15.1521	21.15.1522	21.15.1523	21.15.1524	21.15.1525	21.15.1526	21.15.1527	- 100
1 m	21.15.0931	21.15.1531	21.15.1532	21.15.1533	21.15.1534	21.15.1535	21.15.1536	21.15.1537	- 100
1.5 m	21.15.0923	21.15.0924	21.15.0925	21.15.0926	21.15.0927	21.15.0928	21.15.0929	21.15.0921	- 100
2 m	21.15.0932	21.15.1541	21.15.1542	21.15.1543	21.15.1544	21.15.1545	21.15.1546	21.15.1547	- 100
3 m	21.15.0933	21.15.1551	21.15.1552	21.15.1553	21.15.1554	21.15.1555	21.15.1556	21.15.1557	- 50
5 m	21.15.0935	21.15.1561	21.15.1562	21.15.1563	21.15.1564	21.15.1565	21.15.1566	21.15.1567	- 50
7 m	21.15.0937	21.15.1571	21.15.1572	21.15.1573	21.15.1574	21.15.1575	21.15.1576	21.15.1577	- 50
10 m	21.15.0940	21.15.1581	21.15.1582	21.15.1583	21.15.1584	21.15.1585	21.15.1586	21.15.1587	- 40
15 m	21.15.0945	21.15.1591	21.15.1592	21.15.1593	21.15.1594	21.15.1595	21.15.1596	21.15.1597	- 30
20 m	21.15.0950	21.15.1601	21.15.1602	21.15.1603	21.15.1604	21.15.1605	21.15.1606	21.15.1607	- 20

**VALUE UTP Patch Cord, Cat.6**

Cat.6 U/UTP

- Prepared cable with unshielded RJ-45 plug on both ends
- Extra flat cable for special applications
- Durable cables thanks to kink protection
- Contact settings 1:1 in accordance with EIA/TIA 568, 8 lines
- Construction: internal line 8 wires
- Plug with gold plated contacts
- Colour: black



Order-No. - P.U.

VALUE UTP Patch Cord, Cat.6, extra-flat, black, 0.5 m	21.99.0960 - 40
VALUE UTP Patch Cord, Cat.6, extra-flat, black, 1.0 m	21.99.0961 - 40
VALUE UTP Patch Cord, Cat.6, extra-flat, black, 1.5 m	21.99.0964 - 40
VALUE UTP Patch Cord, Cat.6, extra-flat, black, 2.0 m	21.99.0962 - 40
VALUE UTP Patch Cord, Cat.6, extra-flat, black, 3.0 m	21.99.0963 - 40
VALUE UTP Patch Cord, Cat.6, extra-flat, black, 5.0 m	21.99.0965 - 40

**VALUE FTP Patch Cord, Cat.6**

Cat.6 F/UTP

- Prepared cable with shielded RJ-45 plug on both ends
- Durable cables thanks to kink protection
- Extra flat cable for special applications
- Contact settings 1:1 in accordance with EIA/TIA 568, 8 lines
- Construction: internal line 8 wires, pairs shielded with aluminium clad foil
- Plug with gold plated contacts
- Colour: black

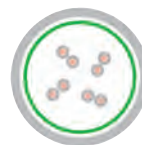

Order-No. - P.U.

VALUE FTP Patch Cord, Cat.6, extra-flat, black, 0.5 m	21.99.0970 - 40
VALUE FTP Patch Cord, Cat.6, extra-flat, black, 1.0 m	21.99.0971 - 40
VALUE FTP Patch Cord, Cat.6, extra-flat, black, 1.5 m	21.99.0974 - 40
VALUE FTP Patch Cord, Cat.6, extra-flat, black, 2.0 m	21.99.0972 - 40
VALUE FTP Patch Cord, Cat.6, extra-flat, black, 3.0 m	21.99.0973 - 40
VALUE FTP Patch Cord, Cat.6, extra-flat, black, 5.0 m	21.99.0975 - 40



VALUE S/FTP (PiMF) Patch Cord, Cat.6

Cat.6

S/FTP

- Prepared shielded Twisted Pair cable with RJ-45 connectors on both sides. Used as patch cable in wiring cabinet or as direct connection cable between devices.
- Flexible cable suitable for narrow bending.
- Contact settings 1:1, according to EIA/TIA 568, 8 wires.
- Construction: 8 wires stranded copper wire, braid shield. Pairs shielded with aluminium clad polyester foil.
- Impedance: 100 Ohm

For a structured cabling system we recommend to use the following components:

- ROLINE Cat.6 S/FTP Cable, Solid Wire, AWG23: 21.15.0890 (100 m), 21.15.0891 (300 m).
- VALUE Cat.6 Flush/Surface Mount Wall Jack, shielded, white: 25.99.8492/25.99.8392.
- VALUE Cat.6 19" Patch Panel, 24 Ports, shielded: 26.99.0353 (black), 26.99.0354 (grey).
- VALUE Cat.6 S/FTP Patch Cord, grey, 5 m: 21.99.0805.

Our in-house laboratory has tested this cable-plug combination, in a Channel of 100 meters, in compliance with Class E specifications.



Length	grey	red	yellow	green	blue	black	white	- P.U.
0.5 m	21.99.0800	21.99.1321	21.99.1322	21.99.1323	21.99.1324	21.99.1325	21.99.1326	- 250
1 m	21.99.0801	21.99.1331	21.99.1332	21.99.1333	21.99.1334	21.99.1335	21.99.1336	- 200
1.5 m	21.99.0811	21.99.0812	21.99.0813	21.99.0814	21.99.0815	21.99.0816	21.99.0817	- 150
2 m	21.99.0802	21.99.1341	21.99.1342	21.99.1343	21.99.1344	21.99.1345	21.99.1346	- 150
3 m	21.99.0803	21.99.1351	21.99.1352	21.99.1353	21.99.1354	21.99.1355	21.99.1356	- 100
5 m	21.99.0805	21.99.1361	21.99.1362	21.99.1363	21.99.1364	21.99.1365	21.99.1366	- 70
7 m	21.99.0807	21.99.1371	21.99.1372	21.99.1373	21.99.1374	21.99.1375	21.99.1376	- 50
10 m	21.99.0810	21.99.1381	21.99.1382	21.99.1383	21.99.1384	21.99.1385	21.99.1386	- 40

VALUE S/FTP (PiMF) Patch Cord Cat.6, halogen-free

Cat.6

S/FTP

- Prepared shielded Twisted Pair cable with RJ-45 connectors on both sides. Used as patch cable in wiring cabinet or as direct connection cable between devices.
- Flexible cable suitable for narrow bending.
- Contact settings 1:1, according to EIA/TIA 568, 8 wires.
- Construction: 8 wires stranded copper wire, braid shield. Pairs shielded with aluminium clad polyester foil.
- Impedance:100 Ohm.
- Cable jacketing: LSOH- Low Smoke Zero Halogen - cable emits limited smoke and no halogens when exposed to high sources of heat.

For a structured cabling system we recommend to use the following components:

- ROLINE Cat.6 S/FTP Cable, Solid Wire, LSOH: 21.15.1889.
- VALUE Cat.6 Flush/Surface Mount Wall Jack, shielded, white: 25.99.8492/25.99.8392.
- VALUE Cat.6 19" Patch Panel, 24 Ports, shielded: 26.99.0353 (black), 26.99.0354 (grey).
- VALUE Cat.6 S/FTP Patch Cord, LSOH, grey, 5 m: 21.99.0705.

Our in-house laboratory has tested this cable-plug combination, in a Channel of 100 meters, in compliance with Class E specifications.



Halogenfree  
Flame retardant  
Low Smoke

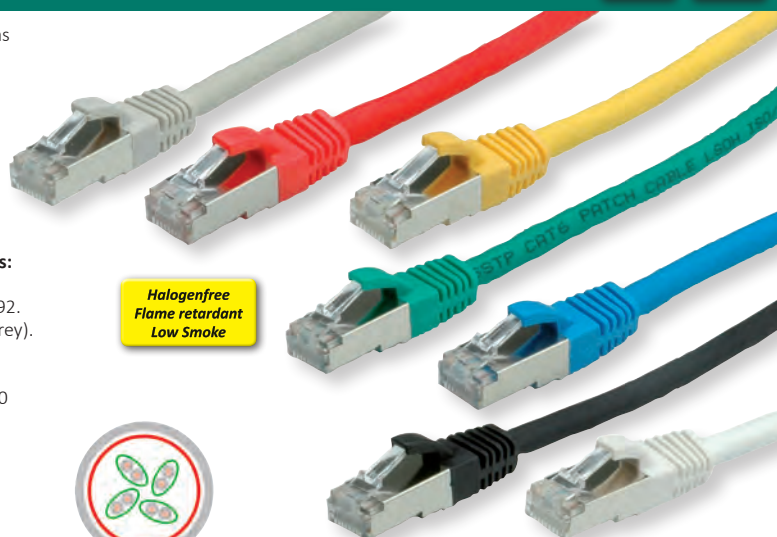

Length	grey	red	yellow	green	blue	black	white	- P.U.
0.5 m	21.99.0700	21.99.1221	21.99.1222	21.99.1223	21.99.1224	21.99.1225	21.99.1226	- 250
1 m	21.99.0701	21.99.1231	21.99.1232	21.99.1233	21.99.1234	21.99.1235	21.99.1236	- 200
1.5 m	21.99.0711	21.99.0712	21.99.0713	21.99.0714	21.99.0715	21.99.0716	21.99.0717	- 150
2 m	21.99.0702	21.99.1241	21.99.1242	21.99.1243	21.99.1244	21.99.1245	21.99.1246	- 150
3 m	21.99.0703	21.99.1251	21.99.1252	21.99.1253	21.99.1254	21.99.1255	21.99.1256	- 100
5 m	21.99.0705	21.99.1261	21.99.1262	21.99.1263	21.99.1264	21.99.1265	21.99.1266	- 70
7 m	21.99.0707	21.99.1271	21.99.1272	21.99.1273	21.99.1274	21.99.1275	21.99.1276	- 50
10 m	21.99.0710	21.99.1281	21.99.1282	21.99.1283	21.99.1284	21.99.1285	21.99.1286	- 40

## ROLINE S/FTP (PiMF) Patch Cord, Cat.6

Cat.6

S/FTP

- Patch cable for networking connections between devices. Prepared double shielded Twisted Pair cable with screened RJ-45 connectors on both ends.
- Durable due to moulded kink protection. Flexible cable, suitable for narrow bending.
- High quality plugs with gold plated contacts.
- Contact settings 1:1, in accordance with the EIA/TIA 568 standard.
- Construction: 4-pair stranded copper wire.
- Complete braid shielding. Pairs shielded with aluminium clad polyester foil.



### For a structured cabling system we recommend to use the following components:

ROLINE Cat.6 S/FTP Cable, Solid Wire, AWG23: 21.15.0890 (100 m), 21.15.0891 (300 m);  
 ROLINE Cat.6 Flush Mount Wall Jack, shielded: 25.16.8492 (white), 25.16.8493 (ivory);  
 ROLINE Cat.6 Surface Mount Wall Jack, shielded: 25.16.8392 (white), 25.16.8393 (ivory);  
 ROLINE Cat.6 19" Patch Panel, 24 Ports, shielded: 26.11.0351 (light grey), 26.11.0361 (black);  
 ROLINE Cat.6 S/FTP Patch Cord, grey, 5 m: 21.15.0835.

The accredited German laboratory GHMT has tested and certified this product combination, in a Channel of 100 meters, as being compliant to Class E specifications; certificate no. z2365b-10-E (with flush mount)/z2364b-10-E (with surface mount).



**roline**<sup>®</sup>  
Designed for Professionals

Length	grey	red	yellow	green	blue	black	white	orange	brown	pink	violet	- P.U.
0.3 m	21.15.1310	21.15.1311	21.15.1312	21.15.1313	21.15.1314	21.15.1315	21.15.1316	21.15.1317	21.15.1318	21.15.1319	21.15.1320	- 50
0.5 m	21.15.0830	21.15.1321	21.15.1322	21.15.1323	21.15.1324	21.15.1325	21.15.1326	21.15.1327	21.15.1328	21.15.1329	21.15.1330	- 100
1 m	21.15.0831	21.15.1331	21.15.1332	21.15.1333	21.15.1334	21.15.1335	21.15.1336	21.15.1337	21.15.1338	21.15.1339	21.15.1340	- 100
1.5 m	21.15.0823	21.15.0824	21.15.0825	21.15.0826	21.15.0827	21.15.0828	21.15.0829	21.15.0821	21.15.0842	21.15.0843	21.15.0844	- 100
2 m	21.15.0832	21.15.1341	21.15.1342	21.15.1343	21.15.1344	21.15.1345	21.15.1346	21.15.1347	21.15.1348	21.15.1349	21.15.1350	- 100
3 m	21.15.0833	21.15.1351	21.15.1352	21.15.1353	21.15.1354	21.15.1355	21.15.1356	21.15.1357	21.15.1358	21.15.1359	21.15.1360	- 50
5 m	21.15.0835	21.15.1361	21.15.1362	21.15.1363	21.15.1364	21.15.1365	21.15.1366	21.15.1367	21.15.1368	21.15.1369	21.15.1370	- 50
7 m	21.15.0837	21.15.1371	21.15.1372	21.15.1373	21.15.1374	21.15.1375	21.15.1376	21.15.1377	21.15.1378	21.15.1379	21.15.1380	- 50
10 m	21.15.0840	21.15.1381	21.15.1382	21.15.1383	21.15.1384	21.15.1385	21.15.1386	21.15.1387	21.15.1388	21.15.1389	21.15.1390	- 40
15 m	21.15.0845	21.15.1391	21.15.1392	21.15.1393	21.15.1394	21.15.1395	21.15.1396	21.15.1397	21.15.1398	21.15.1399	21.15.1400	- 30
20 m	21.15.0850	21.15.1401	21.15.1402	21.15.1403	21.15.1404	21.15.1405	21.15.1406	21.15.1407	21.15.1408	21.15.1409	21.15.1410	- 20

## VALUE UTP Patch Cord Cat.6A

Cat.6A

U/UTP

- The cheap solution for data transfer rates of up to 10 Gbit/s and a bandwidth of 500 MHz
- Patch cable for networking connections between devices
- Prepared shielded Twisted Pair cable (PiMF) with RJ-45 connectors on both ends.
- Durable due to moulded kink protection.
- Flexible cable, suitable for narrow bending.
- Impedance: 100 Ohm
- Contact settings 1:1, in accordance with the EIA/TIA 568 standard.
- Construction: 8 lines, pairs shielded with aluminium foil, complete shielding in tinned copper braid



### For a structured shielded Cat.6A cabling system we recommend to use the following components:

VALUE Cat.6A UTP Cable, Solid Wire, 300 m: 21.99.1681  
 Flush Mount Wall Jack for Keystones: 25.16.8579  
 Surface Wall Mount Frame: 25.16.8484  
 VALUE Cat.6A Keystone, RJ-45, shielded: 26.99.0366  
 19" Keystone Patch Panel: 26.11.0358 / 26.11.0359  
 VALUE Cat.6A S/FTP Patch Cord, 5 m: 21.99.0875



**Value**<sup>®</sup>

Length	grey	red	yellow	green	blue	black	white	- P.U.
0.5 m	21.99.0870	21.99.1420	21.99.1430	21.99.1440	21.99.1450	21.99.1460	21.99.1470	- 100
1 m	21.99.0871	21.99.1421	21.99.1431	21.99.1441	21.99.1451	21.99.1461	21.99.1471	- 100
1.5 m	21.99.1480	21.99.1481	21.99.1482	21.99.1483	21.99.1484	21.99.1485	21.99.1486	- 100
2 m	21.99.0872	21.99.1422	21.99.1432	21.99.1442	21.99.1452	21.99.1462	21.99.1472	- 100
3 m	21.99.0873	21.99.1423	21.99.1433	21.99.1443	21.99.1453	21.99.1463	21.99.1473	- 50
5 m	21.99.0875	21.99.1425	21.99.1435	21.99.1445	21.99.1455	21.99.1465	21.99.1475	- 50
7 m	21.99.0876	21.99.1426	21.99.1436	21.99.1446	21.99.1456	21.99.1466	21.99.1476	- 40
10 m	21.99.0877	21.99.1427	21.99.1437	21.99.1447	21.99.1457	21.99.1467	21.99.1477	- 40
15 m	21.99.0878	21.99.1428	21.99.1438	21.99.1448	21.99.1458	21.99.1468	21.99.1478	- 30
20 m	21.99.0879	21.99.1429	21.99.1439	21.99.1449	21.99.1459	21.99.1469	21.99.1479	- 20

**VALUE S/FTP (PiMF) Patch Cord Cat.6A**

Cat.6A S/FTP

The cheap solution for data transfer rates of up to 10 Gbit/s and a bandwidth of 500 MHz. Patch cable for networking connections between devices.

- Prepared shielded Twisted Pair cable (PiMF) with RJ-45 connectors on both ends.
- Durable due to moulded kink protection. Flexible cable, suitable for narrow bending.
- Impedance: 100 Ohm. Contact settings 1:1, in accordance with the EIA/TIA 568 standard.
- Construction: 8 lines, pairs shielded with aluminium foil, complete braided shielding.

For a structured shielded Cat.6A cabling system we recommend to use the following components:

- VALUE Cat.6A S/FTP Cable, Solid Wire, 100 m: 21.99.0881.
- Flush Mount Wall Jack for Keystones: 25.16.8579.
- Surface Wall Mount Frame: 25.16.8484.
- VALUE Cat.6A Keystone, RJ-45, shielded: 26.99.0366.
- 19" Keystone Patch Panel: 26.11.0359.
- VALUE Cat.6A S/FTP Patch Cord, 5 m: 21.99.0865.

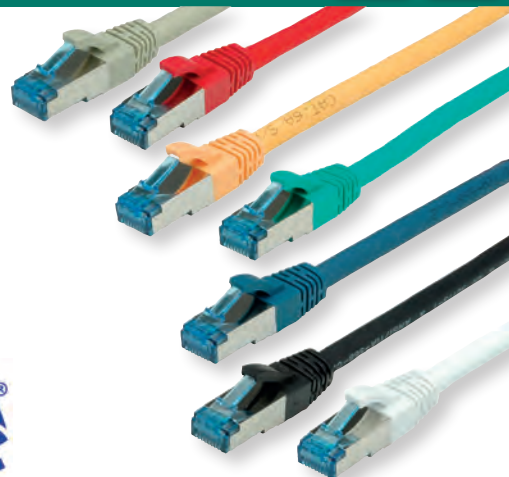

Length	grey	red	yellow	green	blue	black	white	- P.U.
0.5 m	21.99.0860	21.99.1920	21.99.1930	21.99.1940	21.99.1950	21.99.1960	21.99.1970	- 100
1 m	21.99.0861	21.99.1921	21.99.1931	21.99.1941	21.99.1951	21.99.1961	21.99.1971	- 100
1.5 m	21.99.1990	21.99.1991	21.99.1992	21.99.1993	21.99.1994	21.99.1995	21.99.1996	- 100
2 m	21.99.0862	21.99.1922	21.99.1932	21.99.1942	21.99.1952	21.99.1962	21.99.1972	- 100
3 m	21.99.0863	21.99.1923	21.99.1933	21.99.1943	21.99.1953	21.99.1963	21.99.1973	- 50
5 m	21.99.0865	21.99.1925	21.99.1935	21.99.1945	21.99.1955	21.99.1965	21.99.1975	- 50
7 m	21.99.0866	21.99.1926	21.99.1936	21.99.1946	21.99.1956	21.99.1966	21.99.1976	- 40
10 m	21.99.0867	21.99.1927	21.99.1937	21.99.1947	21.99.1957	21.99.1967	21.99.1977	- 40
15 m	21.99.0868	21.99.1928	21.99.1938	21.99.1948	21.99.1958	21.99.1968	21.99.1978	- 30
20 m	21.99.0869	21.99.1929	21.99.1939	21.99.1949	21.99.1959	21.99.1969	21.99.1979	- 20

**VALUE UTP Patch Cord, Cat.6A**

Cat.6A U/UTP

- Prepared cable with unshielded RJ-45 plug on both ends
- Extra flat cable for special applications
- Durable cables thanks to kink protection
- Contact settings 1:1 in accordance with EIA/TIA 568, 8 lines

- Construction: internal line 8 wires
- Plug with gold plated contacts
- Colour: black

REMARK: Product is going to be delivered with pulling nose similar to the FTP Version

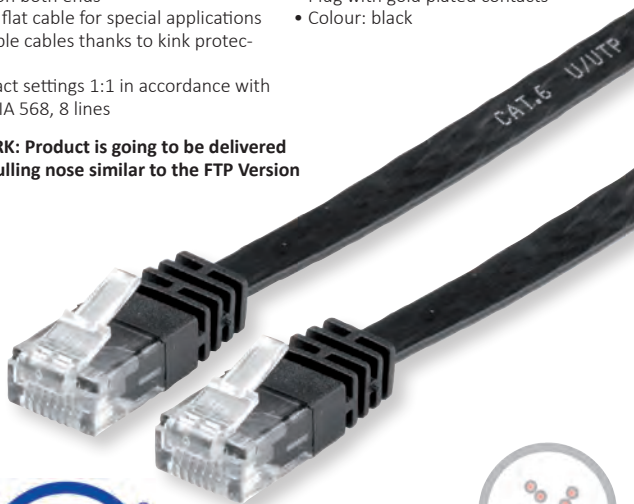

Order-No. - P.U.

VALUE UTP Patch Cord, Cat.6A, black, 0.5 m, extra-flat	21.99.0820 - 40
VALUE UTP Patch Cord, Cat.6A, black, 1.0 m, extra-flat	21.99.0821 - 40
VALUE UTP Patch Cord, Cat.6A, black, 1.5 m, extra-flat	21.99.0824 - 40
VALUE UTP Patch Cord, Cat.6A, black, 2.0 m, extra-flat	21.99.0822 - 40
VALUE UTP Patch Cord, Cat.6A, black, 3.0 m, extra-flat	21.99.0823 - 40
VALUE UTP Patch Cord, Cat.6A, black, 5.0 m, extra-flat	21.99.0825 - 40

**VALUE FTP Patch Cord, Cat.6A**

Cat.6A F/UTP

- Prepared cable with shielded RJ-45 plug on both ends
- Durable cables thanks to kink protection
- Extra flat cable for special applications
- Contact settings 1:1 in accordance with EIA/TIA 568, 8 lines

- Construction: internal line 8 wires, pairs shielded with aluminium clad foil
- Plug with gold plated contacts
- Colour: black

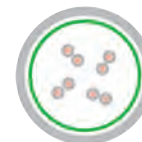

Order-No. - P.U.

VALUE FTP Patch Cord, Cat.6A, black, 0.5 m, extra-flat	21.99.0830 - 40
VALUE FTP Patch Cord, Cat.6A, black, 1.0 m, extra-flat	21.99.0831 - 40
VALUE FTP Patch Cord, Cat.6A, black, 1.5 m, extra-flat	21.99.0834 - 40
VALUE FTP Patch Cord, Cat.6A, black, 2.0 m, extra-flat	21.99.0832 - 40
VALUE FTP Patch Cord, Cat.6A, black, 3.0 m, extra-flat	21.99.0833 - 40
VALUE FTP Patch Cord, Cat.6A, black, 5.0 m, extra-flat	21.99.0835 - 40



## ROLINE UTP Patch Cord, Cat.6, Slim

Cat.6 U/UTP

- Patch cable for networking connections between devices.
- Prepared unshielded Twisted Pair cable with RJ-45 connectors on both ends.
- Durable due to moulded kink protection.
- **Slim, flexible cable, suitable for narrow bending.**
- Contact settings 1:1, in accordance with the EIA/TIA 568 standard.
- Construction: 4-pair stranded copper wire.



**roline**  
Designed for Professionals

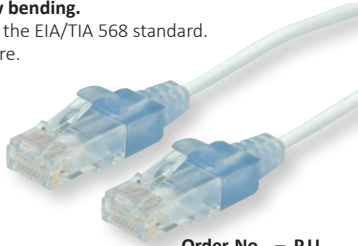

Order-No. – P.U.

ROLINE UTP Patch Cord, Cat.6, slim, white, 0.5 m	21.15.0960 – 100
ROLINE UTP Patch Cord, Cat.6, slim, white, 1.0 m	21.15.0961 – 100
ROLINE UTP Patch Cord, Cat.6, slim, white, 1.5 m	21.15.0964 – 100
ROLINE UTP Patch Cord, Cat.6, slim, white, 2.0 m	21.15.0962 – 100
ROLINE UTP Patch Cord, Cat.6, slim, white, 3.0 m	21.15.0963 – 50
ROLINE UTP Patch Cord, Cat.6, slim, white, 5.0 m	21.15.0965 – 50

## ROLINE UTP Patch Cord Cat.6A, Slim

Cat.6A S/FTP

- Patch cable for networking connections between devices.
- Prepared unshielded Twisted Pair cable with RJ-45 connectors on both ends.
- Durable due to moulded kink protection.
- **Slim, flexible cable, suitable for narrow bending.**
- Contact settings 1:1, in accordance with the EIA/TIA 568 standard.
- Construction: 4-pair stranded copper wire.



**roline**  
Designed for Professionals

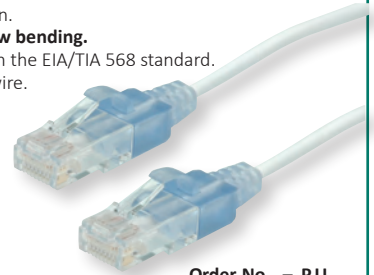

Order-No. – P.U.

ROLINE UTP Patch Cord Cat.6A, slim, white, 0.5 m	21.15.0970 – 100
ROLINE UTP Patch Cord Cat.6A, slim, white, 1.0 m	21.15.0971 – 100
ROLINE UTP Patch Cord Cat.6A, slim, white, 1.5 m	21.15.0974 – 100
ROLINE UTP Patch Cord Cat.6A, slim, white, 2.0 m	21.15.0972 – 100
ROLINE UTP Patch Cord Cat.6A, slim, white, 3.0 m	21.15.0973 – 50
ROLINE UTP Patch Cord Cat.6A, slim, white, 5.0 m	21.15.0975 – 50

## ROLINE U/FTP DataCenter Patch Cord Cat.6A, LSOH, Slim

Cat.6A U/FTP

Category 6A twisted-pair patch cable with RJ45 connectors on both sides. Particularly thin and flexible cable with individual pairs of wires in aluminium laminated foil for use in confined spaces, such as in data centres.

Halogenfree  
Flame retardant  
Low Smoke



**NEW**

**roline**  
Designed for Professionals

- Durable thanks to moulded-on kink protection
- Suitable as patch cable in patch panels or as device connection cable and intended for use in the LAN
- Contact assignment: 1:1 according to EIA/TIA568, 8 cores
- Structure: 8 cores stranded wire

Order-No. – P.U.

ROLINE U/FTP DataCenter Patch Cord Cat.6A, LSOH, slim, 0.5 m	21.15.1700 – 100
ROLINE U/FTP DataCenter Patch Cord Cat.6A, LSOH, slim, 1.0 m	21.15.1701 – 100
ROLINE U/FTP DataCenter Patch Cord Cat.6A, LSOH, slim, 1.5 m	21.15.1704 – 100
ROLINE U/FTP DataCenter Patch Cord Cat.6A, LSOH, slim, 2.0 m	21.15.1702 – 100
ROLINE U/FTP DataCenter Patch Cord Cat.6A, LSOH, slim, 3.0 m	21.15.1703 – 50
ROLINE U/FTP DataCenter Patch Cord Cat.6A, LSOH, slim, 5.0 m	21.15.1705 – 50

## ROLINE U/FTP Data Center Cable Cat.7, with RJ45 Plug, 500 MHz, LSOH, Slim

Cat.7 U/FTP

Category 7 twisted-pair cable with RJ45 (500MHz) connectors on both sides. Particularly thin and flexible cable with individual pairs of wires in aluminium-laminated foil for use in confined spaces, such as in data centres.

Halogenfree  
Flame retardant  
Low Smoke

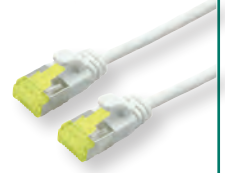

**NEW**

**roline**  
Designed for Professionals

- Durable cable thanks to moulded-on bend protection
- Suitable as a cable in patch panels or as device connection cable and intended for use in the LAN
- Contact assignment: 1:1 according to EIA/TIA568, 8 cores
- Structure: 8 cores stranded wire

Order-No. – P.U.

ROLINE U/FTP Data Center Cable Cat.7, with RJ45 Plug, 500 MHz, LSOH, slim, 0.5 m	21.15.1710 – 100
ROLINE U/FTP Data Center Cable Cat.7, with RJ45 Plug, 500 MHz, LSOH, slim, 1.0 m	21.15.1711 – 100
ROLINE U/FTP Data Center Cable Cat.7, with RJ45 Plug, 500 MHz, LSOH, slim, 1.5 m	21.15.1714 – 100
ROLINE U/FTP Data Center Cable Cat.7, with RJ45 Plug, 500 MHz, LSOH, slim, 2.0 m	21.15.1712 – 100
ROLINE U/FTP Data Center Cable Cat.7, with RJ45 Plug, 500 MHz, LSOH, slim, 3.0 m	21.15.1713 – 50
ROLINE U/FTP Data Center Cable Cat.7, with RJ45 Plug, 500 MHz, LSOH, slim, 5.0 m	21.15.1715 – 50

## ROLINE GOLD S/FTP (PiMF) Patch Cord Cat.6A

Cat.6A S/FTP

Patch cable for networking connections between devices

- Prepared double shielded Twisted Pair cable with screened RJ-45 connectors on both ends
- Durable due to moulded kink protection

- Suitable for PoE applications and multimedia applications where the extension is working over TP
- High quality plugs with gold plated contacts
- Textile cable jacket

- Contact settings 1:1, in accordance with the EIA/TIA 568 standard
- Construction: 4-pair stranded copper wire, complete braid shielding, pairs shielded with aluminium clad polyester foil

Order-No. – P.U.

ROLINE GOLD S/FTP (PiMF) Patch Cord Cat.6A, 0.5 m	21.15.2180 – 100
ROLINE GOLD S/FTP (PiMF) Patch Cord Cat.6A, 1.0 m	21.15.2181 – 100
ROLINE GOLD S/FTP (PiMF) Patch Cord Cat.6A, 2.0 m	21.15.2182 – 100
ROLINE GOLD S/FTP (PiMF) Patch Cord Cat.6A, 3.0 m	21.15.2183 – 50
ROLINE GOLD S/FTP (PiMF) Patch Cord Cat.6A, 5.0 m	21.15.2185 – 50
ROLINE GOLD S/FTP (PiMF) Patch Cord Cat.6A, 7.0 m	21.15.2186 – 40
ROLINE GOLD S/FTP (PiMF) Patch Cord Cat.6A, 10.0 m	21.15.2187 – 40
ROLINE GOLD S/FTP (PiMF) Patch Cord Cat.6A, 15.0 m	21.15.2188 – 30
ROLINE GOLD S/FTP (PiMF) Patch Cord Cat.6A, 20.0 m	21.15.2189 – 20

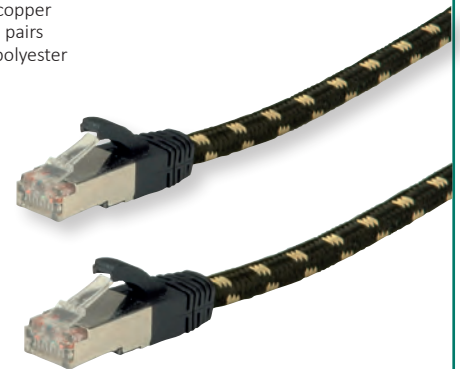

**roline**  
Designed for Professionals



## ROLINE EASY Patch UTP Patch Cord Cat. 6A / EASY Patch Cord, Removal Tool Clamp

Cat.6A

U/UTP

Unshielded twisted pair patch cable with RJ-45 connectors on both sides. The special connector allows you to easily remove the cable from e.g. your patchpanel (in collaboration with our 19.06.1032 Easy Patch Removal Tool). It fits perfectly in any high density network environment!

- Patch cable for networking connections between devices.
- Prepared unshielded Twisted Pair cable with RJ-45 connectors on both ends.
- Durable due to moulded kink protection.
- Flexible cable, suitable for narrow bending.
- Contact settings 1:1, in accordance with the EIA/TIA 568 standard.
- Construction: 4-pair stranded copper wire

Order-No. – P.U.

ROLINE EASY Patch UTP Patch Cord Cat. 6A, white, 0.3 m	21.15.2460 – 125
ROLINE EASY Patch UTP Patch Cord Cat. 6A, white, 0.5 m	21.15.2461 – 100
ROLINE EASY Patch UTP Patch Cord Cat.6A, white, 1.0 m	21.15.2462 – 120
ROLINE EASY Patch UTP Patch Cord Cat.6A, white, 2.0 m	21.15.2463 – 80
ROLINE EASY Patch UTP Patch Cord Cat.6A, white, 3.0 m	21.15.2464 – 70
ROLINE EASY Patch UTP Patch Cord Cat.6A, white, 5.0 m	21.15.2465 – 50
<b>Order-No. – P.U.</b>	
EASY Patch Cord, Removal Tool Clamp, green	19.06.1032 – 5

Removal Tool for our Easy Patch cords! Helps you to easily remove your High Density ROLINE Easy Patch cords.

- Handy and easy to use
- Removal tool made of plastic with instructions
- Only for our ROLINE Easy Patch Cords (e.g. 21.15.2474)



**roline**  
Designed for Professionals

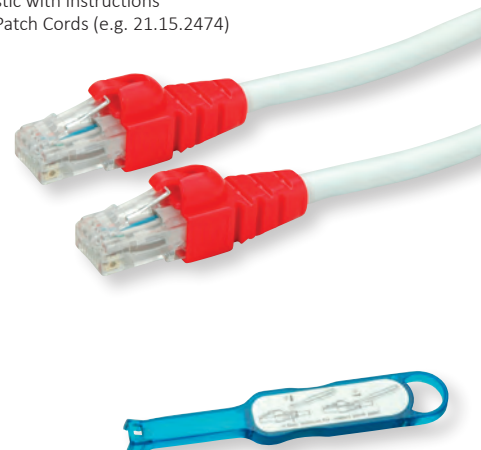

## ROLINE EASY Patch S/FTP (PiMF) Patch Cord Cat.6A / EASY Patch Cord, Removal Tool Clamp

Cat.6A

S/FTP

Twisted pair patch cable with RJ-45 connectors on both sides. The special connector allows you to easily remove the cable from e.g. your patchpanel (in collaboration with our 19.06.1032 Easy Patch Removal Tool). It fits perfectly in any high density network environment and data centers!

- Patch cable for networking connections between devices.
- Prepared unshielded Twisted Pair cable with RJ-45 connectors on both ends.
- Durable due to moulded kink protection.
- Flexible cable, suitable for narrow bending.
- Contact settings 1:1, in accordance with the EIA/TIA 568 standard.
- Construction: 4-pair stranded copper wire.

Order-No. – P.U.

ROLINE EASY Patch S/FTP (PiMF) Patch Cord Cat.6A, white, 0.3 m	21.15.2470 – 125
ROLINE EASY Patch S/FTP (PiMF) Patch Cord Cat.6A, white, 0.5 m	21.15.2471 – 100
ROLINE EASY Patch S/FTP (PiMF) Patch Cord Cat.6A, white, 1.0 m	21.15.2472 – 120
ROLINE EASY Patch S/FTP (PiMF) Patch Cord Cat.6A, white, 2.0 m	21.15.2473 – 80
ROLINE EASY Patch S/FTP (PiMF) Patch Cord Cat.6A, white, 3.0 m	21.15.2474 – 70
ROLINE EASY Patch S/FTP (PiMF) Patch Cord Cat.6A, white, 5.0 m	21.15.2475 – 50
<b>Order-No. – P.U.</b>	
EASY Patch Cord, Removal Tool Clamp, green	19.06.1032 – 5

Removal Tool for our Easy Patch cords! Helps you to easily remove your High Density ROLINE Easy Patch cords.

- Handy and easy to use
- Removal tool made of plastic with instructions
- Only for our ROLINE Easy Patch Cords (e.g. 21.15.2474)



**roline**  
Designed for Professionals



## COMPONENT LEVEL Patch Cords - Considerations

100% Component Level Tested

Cat.6

Cat.6A

U/UTP

S/FTP

As streaming media applications such as video and multimedia become commonplace, the demands for faster data rates will increase and spawn new applications that will benefit from the higher bandwidth offered by Category 6 or 6A.

When it comes to structured cabling performance, the objectives of a standard are both to ensure the performance of present, foreseen and perhaps unforeseen applications, and to allow interoperability of components from multiple manufacturers that make up a structured cabling system.

When a structured cabling system has components from different manufacturers, the overall performance margin can drop, due to the need to work with connectivity that may be anywhere in the performance envelope defined by the standard for a channel or permanent link.

### COMPONENT LEVEL Patch Cords - Considerations

When a new cabling system is installed, the installed cabling becomes a permanent infrastructure in the building. The cable itself is routed through hidden pathways within walls, under floors and in ceilings or in cable trays and conduit. Upon completion

of the installation, each permanent link is certified from the termination in a patch panel to the outlet or jack in the work area or office at the other end.

Nevertheless the quality and performance of connecting hardware as patch cords have a tremendous impact on the performance of a cabling channel. The patch cords are after all the first component in the channel in either direction.

ROLINE Category 6 / 6A Component LEVEL cords are 100% transmission tested to component level performance as specified in TIA/EIA-568-B.2-1.

- They are assembled in a controlled environment using advanced manufacturing techniques to insure consistent quality.
- These patch cords have been tested on **COMPONENT LEVEL**. This means, you can add them to ANY Permanent Link that fulfils Cat.6 / Cat.6A and the resulting Channel will also fulfil Cat.6 / Cat.6A.

Even more, combining any components (patch cords, jacks, patchpanels, wall boxes) that are tested on **COMPONENT LEVEL**, will result in a Channel that fulfills the norm.

**ROLINE Category 6 / 6A Component LEVEL patch cords have a**

- protection of the plug latch,- durable cable strain relief, Are flexible,
- LSOH (flame retardant, low smoke and halogen free)
- and last but not least they are compatible with both T568A and T568B cabling systems.

These patch cords are designed for greater flexibility and service life and are available in seven colors (grey / red / yellow / green / blue / black / white / orange / brown / pink / purple) and in eleven standard lengths. Please see therefore the next following pages.

### Key Features:

- Transmission performance TIA/EIA 568-B.2-1 Component, permanent link, and channel level
- 100% factory transmission tested to Component Level per TIA/EIA 568-B.2-1
- T568A/B Wiring Scheme
- Durable flexible cable strain relief
- Maximum strength and durability construction

Halogenfree  
Flame retardant  
Low Smoke

**ROLINE UTP Cable Cat.6 Component Level, LSOH**

100% Component Level Tested

Cat.6

U/UTP

- Patch cable for networking connections between devices.
- Prepared unshielded Twisted Pair cable with RJ-45 connectors on both ends.
- Durable due to moulded kink protection.
- Flexible cable, suitable for narrow bending.
- High quality plugs with gold plated contacts.
- Contact settings 1:1, in accordance with the EIA/TIA 568 standard.
- Construction: 4-pair stranded copper wire.
- Halogen-free, flame retardant, low smoke.
- 100 % Component level testing

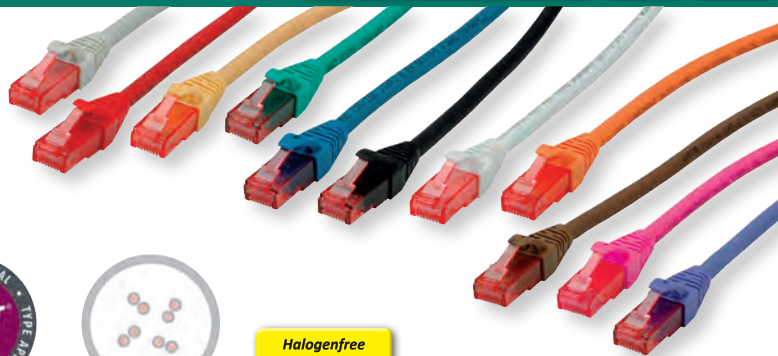

Halogenfree  
Flame retardant  
Low Smoke

**roline**<sup>®</sup>  
Designed for Professionals

Length	grey	red	yellow	green	blue	black	white	orange	brown	pink	purple	P.U.
0.3m	21.15.2940	21.15.2941	21.15.2942	21.15.2943	21.15.2944	21.15.2945	21.15.2946	21.15.2947	21.15.2948	21.15.2949	21.15.2950	- 50
0.5m	21.15.2500	21.15.2510	21.15.2520	21.15.2530	21.15.2540	21.15.2550	21.15.2560	21.15.2570	21.15.2580	21.15.2590	21.15.2900	- 100
1 m	21.15.2501	21.15.2511	21.15.2521	21.15.2531	21.15.2541	21.15.2551	21.15.2561	21.15.2571	21.15.2581	21.15.2591	21.15.2901	- 100
1.5 m	21.15.2504	21.15.2514	21.15.2524	21.15.2534	21.15.2544	21.15.2554	21.15.2564	21.15.2574	21.15.2584	21.15.2594	21.15.2904	- 100
2 m	21.15.2502	21.15.2512	21.15.2522	21.15.2532	21.15.2542	21.15.2552	21.15.2562	21.15.2572	21.15.2582	21.15.2592	21.15.2902	- 100
3 m	21.15.2503	21.15.2513	21.15.2523	21.15.2533	21.15.2543	21.15.2553	21.15.2563	21.15.2573	21.15.2583	21.15.2593	21.15.2903	- 50
5 m	21.15.2505	21.15.2515	21.15.2525	21.15.2535	21.15.2545	21.15.2555	21.15.2565	21.15.2575	21.15.2585	21.15.2595	21.15.2905	- 50
7.5m	21.15.2506	21.15.2516	21.15.2526	21.15.2536	21.15.2546	21.15.2556	21.15.2566	21.15.2576	21.15.2586	21.15.2596	21.15.2906	- 40
10 m	21.15.2507	21.15.2517	21.15.2527	21.15.2537	21.15.2547	21.15.2557	21.15.2567	21.15.2577	21.15.2587	21.15.2597	21.15.2907	- 40
15 m	21.15.2508	21.15.2518	21.15.2528	21.15.2538	21.15.2548	21.15.2558	21.15.2568	21.15.2578	21.15.2588	21.15.2598	21.15.2908	- 30
20 m	21.15.2509	21.15.2519	21.15.2529	21.15.2539	21.15.2549	21.15.2559	21.15.2569	21.15.2579	21.15.2589	21.15.2599	21.15.2909	- 20

**ROLINE S/FTP (PiMF) Patch Cord Cat.6 Component Level, LSOH**

100% Component Level Tested

Cat.6

S/FTP

- Patch cable for networking connections between devices.
- Prepared double shielded Twisted Pair cable with screened RJ-45 connectors on both ends.
- Durable due to moulded kink protection
- Flexible cable, suitable for narrow bending.
- High quality plugs with gold plated contacts.
- Contact settings 1:1, in accordance with the EIA/TIA 568 standard.
- Construction: 4-pair stranded copper wire. Complete braid shielding.
- Pairs shielded with aluminium clad polyester foil.
- Halogen-free, flame retardant, low smoke.
- 100% Component Level testing



Halogenfree  
Flame retardant  
Low Smoke

**roline**<sup>®</sup>  
Designed for Professionals

Length	grey	red	yellow	green	blue	black	white	orange	brown	pink	purple	P.U.
0.3m	21.15.2951	21.15.2952	21.15.2953	21.15.2954	21.15.2955	21.15.2956	21.15.2957	21.15.2958	21.15.2959	21.15.2960	21.15.2961	- 50
0.5m	21.15.2600	21.15.2610	21.15.2620	21.15.2630	21.15.2640	21.15.2650	21.15.2660	21.15.2670	21.15.2680	21.15.2690	21.15.2910	- 100
1 m	21.15.2601	21.15.2611	21.15.2621	21.15.2631	21.15.2641	21.15.2651	21.15.2661	21.15.2671	21.15.2681	21.15.2691	21.15.2911	- 100
1.5 m	21.15.2604	21.15.2614	21.15.2624	21.15.2634	21.15.2644	21.15.2654	21.15.2664	21.15.2674	21.15.2684	21.15.2694	21.15.2914	- 100
2 m	21.15.2602	21.15.2612	21.15.2622	21.15.2632	21.15.2642	21.15.2652	21.15.2662	21.15.2672	21.15.2682	21.15.2692	21.15.2912	- 100
3 m	21.15.2603	21.15.2613	21.15.2623	21.15.2633	21.15.2643	21.15.2653	21.15.2663	21.15.2673	21.15.2683	21.15.2693	21.15.2913	- 50
5 m	21.15.2605	21.15.2615	21.15.2625	21.15.2635	21.15.2645	21.15.2655	21.15.2665	21.15.2675	21.15.2685	21.15.2695	21.15.2915	- 50
7.5m	21.15.2606	21.15.2616	21.15.2626	21.15.2636	21.15.2646	21.15.2656	21.15.2666	21.15.2676	21.15.2686	21.15.2696	21.15.2916	- 40
10 m	21.15.2607	21.15.2617	21.15.2627	21.15.2637	21.15.2647	21.15.2657	21.15.2667	21.15.2677	21.15.2687	21.15.2697	21.15.2917	- 40
15 m	21.15.2608	21.15.2618	21.15.2628	21.15.2638	21.15.2648	21.15.2658	21.15.2668	21.15.2678	21.15.2688	21.15.2698	21.15.2918	- 30
20 m	21.15.2609	21.15.2619	21.15.2629	21.15.2639	21.15.2649	21.15.2659	21.15.2669	21.15.2679	21.15.2689	21.15.2699	21.15.2919	- 20

## ROLINE UTP Patch Cord Cat.6A, Component Level, LSOH

100% Component Level Tested

Cat.6A

U/UTP

- Patch cable for networking connections between devices.
- Prepared unshielded Twisted Pair cable with RJ-45 connectors on both ends.
- Durable due to moulded kink protection.
- Flexible cable, suitable for narrow bending.
- High quality plugs with gold plated contacts.
- Contact settings 1:1, in accordance with the EIA/TIA 568 standard.
- Construction: 4-pair stranded copper wire.
- Halogen-free, flame retardant, low smoke.
- 100 % Component level testing

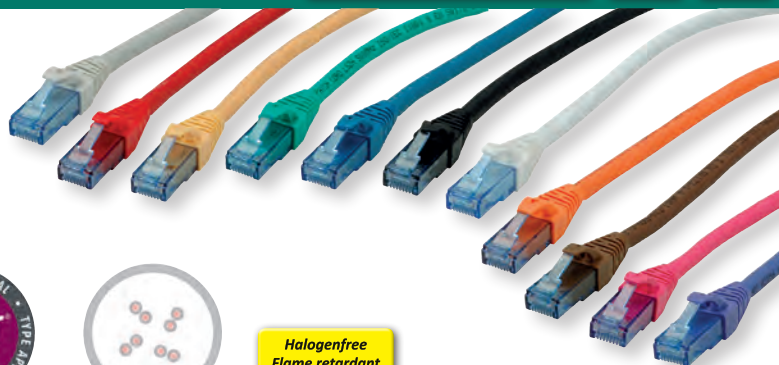

**roline**<sup>®</sup>  
Designed for Professionals



Halogenfree  
Flame retardant  
Low Smoke

Length	grey	red	yellow	green	blue	black	white	orange	brown	pink	purple	P.U.
0.3m	21.15.2981	21.15.2982	21.15.2983	21.15.2984	21.15.2985	21.15.2986	21.15.2987	21.15.2988	21.15.2989	21.15.2990	21.15.2991	- 50
0.5m	21.15.2700	21.15.2710	21.15.2720	21.15.2730	21.15.2740	21.15.2750	21.15.2760	21.15.2770	21.15.2780	21.15.2790	21.15.2920	- 100
1m	21.15.2701	21.15.2711	21.15.2721	21.15.2731	21.15.2741	21.15.2751	21.15.2761	21.15.2771	21.15.2781	21.15.2791	21.15.2921	- 100
1.5m	21.15.2704	21.15.2714	21.15.2724	21.15.2734	21.15.2744	21.15.2754	21.15.2764	21.15.2774	21.15.2784	21.15.2794	21.15.2924	- 100
2m	21.15.2702	21.15.2712	21.15.2722	21.15.2732	21.15.2742	21.15.2752	21.15.2762	21.15.2772	21.15.2782	21.15.2792	21.15.2922	- 100
3m	21.15.2703	21.15.2713	21.15.2723	21.15.2733	21.15.2743	21.15.2753	21.15.2763	21.15.2773	21.15.2783	21.15.2793	21.15.2923	- 50
5m	21.15.2705	21.15.2715	21.15.2725	21.15.2735	21.15.2745	21.15.2755	21.15.2765	21.15.2775	21.15.2785	21.15.2795	21.15.2925	- 50
7.5m	21.15.2706	21.15.2716	21.15.2726	21.15.2736	21.15.2746	21.15.2756	21.15.2766	21.15.2776	21.15.2786	21.15.2796	21.15.2926	- 40
10m	21.15.2707	21.15.2717	21.15.2727	21.15.2737	21.15.2747	21.15.2757	21.15.2767	21.15.2777	21.15.2787	21.15.2797	21.15.2927	- 40
15m	21.15.2708	21.15.2718	21.15.2728	21.15.2738	21.15.2748	21.15.2758	21.15.2768	21.15.2778	21.15.2788	21.15.2798	21.15.2928	- 30
20m	21.15.2709	21.15.2719	21.15.2729	21.15.2739	21.15.2749	21.15.2759	21.15.2769	21.15.2779	21.15.2789	21.15.2799	21.15.2929	- 20

## ROLINE S/FTP (PiMF) Patch Cord Cat.6A, Component Level, LSOH

100% Component Level Tested

Cat.6A

S/FTP

- Patch cable for networking connections between devices.
- Prepared double shielded Twisted Pair cable with screened RJ-45 connectors on both ends.
- Durable due to moulded kink protection.
- Flexible cable, suitable for narrow bending.
- High quality plugs with gold plated contacts.
- Contact settings 1:1, in accordance with the EIA/TIA 568 standard.
- Construction: 4-pair stranded copper wire. Complete braid shielding.
- Pairs shielded with aluminium clad polyester foil.
- Halogen-free, flame retardant, low smoke.
- 100 % Component level testing



**roline**<sup>®</sup>  
Designed for Professionals



Halogenfree  
Flame retardant  
Low Smoke

Length	grey	red	yellow	green	blue	black	white	orange	brown	pink	purple	P.U.
0.3m	21.15.2970	21.15.2971	21.15.2972	21.15.2973	21.15.2974	21.15.2975	21.15.2976	21.15.2977	21.15.2978	21.15.2979	21.15.2980	- 50
0.5m	21.15.2800	21.15.2810	21.15.2820	21.15.2830	21.15.2840	21.15.2850	21.15.2860	21.15.2870	21.15.2880	21.15.2890	21.15.2930	- 100
1m	21.15.2801	21.15.2811	21.15.2821	21.15.2831	21.15.2841	21.15.2851	21.15.2861	21.15.2871	21.15.2881	21.15.2891	21.15.2931	- 100
1.5m	21.15.2804	21.15.2814	21.15.2824	21.15.2834	21.15.2844	21.15.2854	21.15.2864	21.15.2874	21.15.2884	21.15.2894	21.15.2934	- 100
2m	21.15.2802	21.15.2812	21.15.2822	21.15.2832	21.15.2842	21.15.2852	21.15.2862	21.15.2872	21.15.2882	21.15.2892	21.15.2932	- 100
3m	21.15.2803	21.15.2813	21.15.2823	21.15.2833	21.15.2843	21.15.2853	21.15.2863	21.15.2873	21.15.2883	21.15.2893	21.15.2933	- 50
5m	21.15.2805	21.15.2815	21.15.2825	21.15.2835	21.15.2845	21.15.2855	21.15.2865	21.15.2875	21.15.2885	21.15.2895	21.15.2935	- 50
7.5m	21.15.2806	21.15.2816	21.15.2826	21.15.2836	21.15.2846	21.15.2856	21.15.2866	21.15.2876	21.15.2886	21.15.2896	21.15.2936	- 40
10m	21.15.2807	21.15.2817	21.15.2827	21.15.2837	21.15.2847	21.15.2857	21.15.2867	21.15.2877	21.15.2887	21.15.2897	21.15.2937	- 40
15m	21.15.2808	21.15.2818	21.15.2828	21.15.2838	21.15.2848	21.15.2858	21.15.2868	21.15.2878	21.15.2888	21.15.2898	21.15.2938	- 30
20m	21.15.2809	21.15.2819	21.15.2829	21.15.2839	21.15.2849	21.15.2859	21.15.2869	21.15.2879	21.15.2889	21.15.2899	21.15.2939	- 20



## VALUE S/FTP Patch Cord Cat.6A, solid Cat.6A S/FTP

### Patch cable for networking connections between devices

- Prepared double shielded Twisted Pair cable with screened RJ-45 connectors on both ends
- Durable due to moulded kink protection

- Construction: 4-pair solid copper wire, complete braid shielding, pairs shielded with aluminium clad polyester foil



### • Suitable for PoE applications and multimedia applications where the extension is working over TP

- High quality plugs with gold plated contacts
- Contact settings 1:1, in accordance with the EIA/TIA 568 standard



Halogenfree  
Flame retardant  
Low Smoke

### Order-No. – P.U.

VALUE S/FTP Patch Cord Cat.6A, solid, LSOH, grey, 20.0 m	21.99.0844 – 5
VALUE S/FTP Patch Cord Cat.6A, solid, LSOH, grey, 30.0 m	21.99.0846 – 5
VALUE S/FTP Patch Cord Cat.6A, solid, LSOH, grey, 50.0 m	21.99.0847 – 2
VALUE S/FTP Patch Cord Cat.6A, solid, LSOH, grey, 70.0 m	21.99.0848 – 2
VALUE S/FTP Patch Cord Cat.6A, solid, LSOH, grey, 90.0 m	21.99.0849 – 2

## VALUE S/FTP Cable (Cat.7), with RJ-45 connectors (500 MHz) Cat.7 S/FTP

- The cheap solution for data transfer rates of up to 10 Gbit/s and a bandwidth of 500 MHz; up to 40Gbit/s for Cat.7 (cable material is able to transfer category 7 - 600 MHz).
- Patch cable for networking connections between devices. Prepared shielded Twisted Pair cable (PiMF) with RJ-45 connectors on both ends.
- Durable due to moulded kink protection.
- Flexible cable, suitable for narrow bending.
- Impedance: 100 Ohm.
- Contact settings 1:1, in accordance with the EIA/TIA 568 standard.

- Construction: 8 lines, pairs shielded with aluminium foil, complete braided shielding.

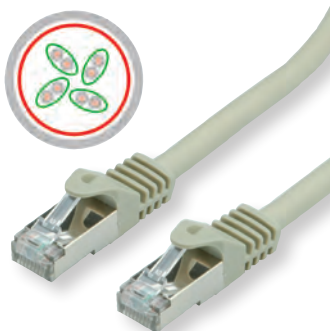

### Order-No. – P.U.

VALUE S/FTP Cable (Cat.7), with RJ-45 connectors (500 MHz), grey, 0.5 m	21.99.0850 – 100
VALUE S/FTP Cable (Cat.7), with RJ-45 connectors (500 MHz), grey, 1.0 m	21.99.0851 – 100
VALUE S/FTP Cable (Cat.7), with RJ-45 connectors (500 MHz), grey, 2.0 m	21.99.0852 – 100
VALUE S/FTP Cable (Cat.7), with RJ-45 connectors (500 MHz), grey, 3.0 m	21.99.0853 – 50
VALUE S/FTP Cable (Cat.7), with RJ-45 connectors (500 MHz), grey, 5.0 m	21.99.0855 – 50

## ROLINE Lockable RJ45 Plug with Key

- Provides a cost effective solution to secure an exposed network jack by restricting access from an unauthorized user with an endpoint devices like network switches, routers and servers
- For blocking unused ports on a switch to prevent unauthorized access
- To prevent damage of an upgrade port on a wide range of devices
- Snaps securely into any industry-standard RJ45 port, physically restricting and blocking cord access to unauthorized users and to prevent tampering, such as the insertion of a foreign object into the jack

## ROLINE S/FTP Patch Cord Cat.6A, solid Cat.6A S/FTP

### Patch cable for networking connections between devices

- Prepared double shielded Twisted Pair cable with screened RJ-45 connectors on both ends
- Durable due to moulded kink protection

- Construction: 4-pair solid copper wire, complete braid shielding, pairs shielded with aluminium clad polyester foil



\* Halogenfree  
Flame retardant  
Low Smoke

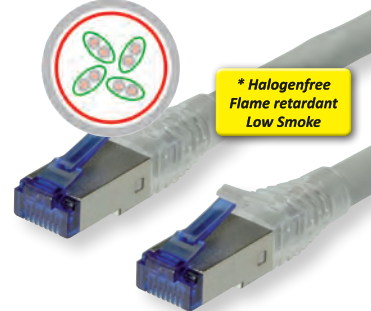

### • Suitable for PoE applications and multimedia applications where the extension is working over TP

- High quality plugs with gold plated contacts
- Contact settings 1:1, in accordance with the EIA/TIA 568 standard



Designed for Professionals

### Order-No. – P.U.

ROLINE S/FTP Patch Cord Cat.6A, solid, grey, 20.0 m	21.15.0870 – 5
ROLINE S/FTP Patch Cord Cat.6A, solid, grey, 30.0 m	21.15.0871 – 5
ROLINE S/FTP Patch Cord Cat.6A, solid, grey, 50.0 m	21.15.0872 – 2
ROLINE S/FTP Patch Cord Cat.6A, solid, grey, 70.0 m	21.15.0873 – 2
ROLINE S/FTP Patch Cord Cat.6A, solid, grey, 90.0 m	21.15.0875 – 2
ROLINE S/FTP Patch Cord Cat.6A, solid, *LSOH, grey, 20.0 m	21.15.0874 – 5
ROLINE S/FTP Patch Cord Cat.6A, solid, *LSOH, grey, 30.0 m	21.15.0876 – 5
ROLINE S/FTP Patch Cord Cat.6A, solid, *LSOH, grey, 50.0 m	21.15.0877 – 2
ROLINE S/FTP Patch Cord Cat.6A, solid, *LSOH, grey, 70.0 m	21.15.0878 – 2
ROLINE S/FTP Patch Cord Cat.6A, solid, *LSOH, grey, 90.0 m	21.15.0879 – 2

## ROLINE S/FTP Cable (Cat.7), with RJ-45 connectors (500 MHz), LSOH Cat.7 S/FTP

- The cheap solution for data transfer rates of up to 10 Gbit/s for Cat.6a bandwidth of 500 MHz; up to 40 Gbit/s for Cat.7 (cable material is able to transfer Category 7 - 600 MHz)
- Patch cord for networking connections between devices
- Prepared shielded Twisted Pair cable (PiMF) with RJ-45 connectors on both ends
- Durable due to moulded kink protection
- Flexible cable, suitable for narrow bending

- Impedance: 100 Ohm
- Colour: grey
- Contact settings 1:1, in accordance with the EIA/TIA 568 standard
- Construction: 8 lines + pairs shielded with aluminium foil, complete shielding in tinned copper braid



Halogenfree  
Flame retardant  
Low Smoke

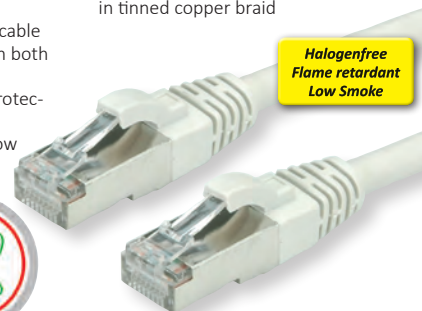

Designed for Professionals

### Order-No. – P.U.

ROLINE S/FTP Cable (Cat.7), with RJ-45 connectors (500 MHz), LSOH, grey, 0.5 m	21.15.0854 – 100
ROLINE S/FTP Cable (Cat.7), with RJ-45 connectors (500 MHz), LSOH, grey, 1.0 m	21.15.0851 – 100
ROLINE S/FTP Cable (Cat.7), with RJ-45 connectors (500 MHz), LSOH, grey, 2.0 m	21.15.0852 – 100
ROLINE S/FTP Cable (Cat.7), with RJ-45 connectors (500 MHz), LSOH, grey, 3.0 m	21.15.0853 – 50
ROLINE S/FTP Cable (Cat.7), with RJ-45 connectors (500 MHz), LSOH, grey, 5.0 m	21.15.0855 – 50



Designed for Professionals

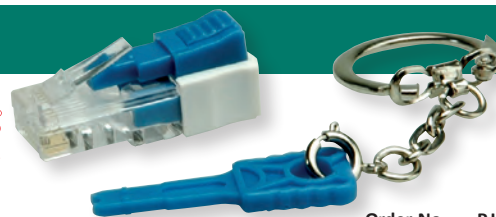

### Order-No. – P.U.

ROLINE Lockable RJ45 Plug with Key

21.17.3067 – 10



## Category 8 Cabling



Cat.8

S/FTP

The demand of bandwidth continues to increase, and most of the existing network cable infrastructures in data centers, which were designed earlier for an intended lifespan of more than 15 years, must face today's challenges and future requirements, which are often unpredictable.

Under these circumstances, the new standard Category 8 cabling has been developed and approved by TIA to provide numerous benefits for data centers looking to seamlessly add bandwidth for Ethernet.

Category 8, the standard for next-generation twisted-pair cabling specifications, allows the transport data up to four times faster on the same type of cabling already being used, supporting 25GBASE-T and 40GBASE-T applications for short distances (up to 30 meters) for switch-to-server connections (primarily in top-of-rack or end-of-row topologies)

### The advantages of Category 8 cabling:

- Category 8 offers four times the bandwidth of Category 6A cabling, with internal impairments specified up to 2 GHz
- Category 8 cables are shielded, though shielded cabling systems must be grounded, this is also not an issue in most data centers, since the connections are closer together. Shielding problems like ground loops can typically be avoided when both ends of the channel are in the same room and nearby
- Category 8 connectors use the familiar RJ45 interface. The jacks require proper grounding to the cable and to the device they are installed into (patch panel or outlet), therefore they are designed for field termination
- Category 8 number of connectors is limited to two connectors in the copper channel (excluding connections on end equipment), this is typically adequate in a data center environment and many common enterprise links.
- Maximum reach: 30 meter of channel (maximum 24m link cable + 2x 3m patch cable)

Category	ISO Channel Class	Maximum Bandwidth	Maximum Ethernet Data Rate	Cabling System	Connector Type
6	E	250 MHz	1000 Mbit/s	Unshielded or shielded	RJ45
6A	EA	500 MHz	10 Gbit/s	Unshielded or shielded	RJ45
7*	F	600 MHz	10 Gbit/s	Shielded only	Non-RJ45 (IEC 60603-7-71 and IEC 61076-3-104)
7A*	FA	1000 MHz	10 Gbit/s	Shielded only	Non-RJ45 (IEC 60603-7-71 and IEC 61076-3-104)
8	8.I and 8.II	2000 MHz	25 Gbit/s / 40 Gbit/s	Shielded only	RJ45

\* Category 7 and 7A are not recognized by ANSI/TIA-568-C.2

For a Cat.8 channel link S/FTP Cabling we recommend to use the following components:

- 21.15.0005 ROLINE S/FTP Cable, Cat.8, Solid Wire, AWG22
- 26.11.0381 ROLINE Cat.8 RJ45 Keystone, Jack, toolless
- 21.17.3086 ROLINE Cat.8 Shielded Field Connector RJ45 plug
- 21.15.1851 to 21.15.1851 ROLINE S/FTP Patch Cable Solid Cat.8, Yellow (1m to 3m)
- 21.15.1861 to 21.15.1863 ROLINE S/FTP Patch Cable Stranded Cat.8, Yellow (1m to 3m)

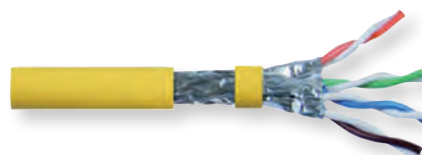

21.15.0005



21.15.1851



21.15.1861



21.17.3086



26.11.0381



**roline**  
Designed for Professionals



Halogenfree  
Flame retardant  
Low Smoke

ROLINE S/FTP Cable Cat.8, Solid Wire, LSOH, 100 m	Order-No. – P.U. 21.15.0005 – 2
ROLINE S/FTP Patch Cord Cat.8, solid, LSOH, yellow, 1.0 m	Order-No. – P.U. 21.15.1851 – 100
ROLINE S/FTP Patch Cord Cat.8, solid, LSOH, yellow, 2.0 m	21.15.1852 – 100
ROLINE S/FTP Patch Cord Cat.8, solid, LSOH, yellow, 3.0 m	21.15.1853 – 50
ROLINE S/FTP Patch Cord Cat.8, stranded, LSOH, yellow, 1.0 m	Order-No. – P.U. 21.15.1861 – 100
ROLINE S/FTP Patch Cord Cat.8, stranded, LSOH, yellow, 2.0 m	21.15.1862 – 100
ROLINE S/FTP Patch Cord Cat.8, stranded, LSOH, yellow, 3.0 m	21.15.1863 – 50
ROLINE Cat.8 Field Connector Plug RJ45	Order-No. – P.U. 21.17.3086 – 50
ROLINE Keystone Jack, Cat.8, RJ-45, STP, tool-free, silver	Order-No. – P.U. 26.11.0381 – 50

## VALUE Cat.5e 19" Patch Panel, 24 Ports, UTP



- The panel complies with the EIA/TIA 568 TSB40a standard
- The cable connection on the back is implemented via LSA-plus connection technology with colour coding on the top in accordance with EIA/TIA 568 A/B
- 24 unshielded ports

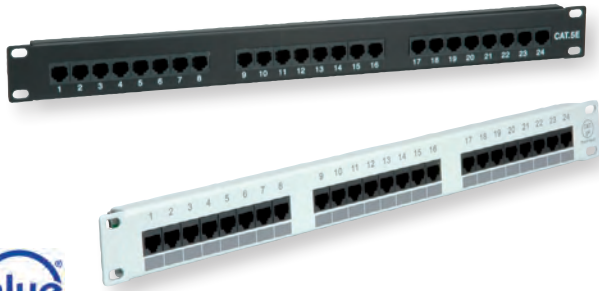

Order-No. – P.U.

VALUE Cat.5e 19" Patch Panel, 24 Ports, UTP, black 26.99.0349 – 5

VALUE Cat.5e 19" Patch Panel, 24 Ports, UTP, light grey 26.99.0347 – 5

## ROLINE Cat.5e 19" Patch Panel, 24 Ports, UTP



- The UTP patch panels are compliant with EIA/TIA 568 TSB40a
- LSA-plus technology
- 24 unshielded ports

(ivory)/25.16.8406 (white), 25.16.8401 (ivory)  
 ROLINE Cat.5e 19" Patch Panel, 24 Ports, unshielded: 26.11.0349 (black), 26.11.0347 (light grey)  
 ROLINE Cat.5e UTP Patch Cord, grey, 5 m: 21.15.0505  
 Our in-house laboratory has tested this cable-plug combination, in a Channel of 100 meters, in compliance with Class D specifications.

**For a structured unshielded cabling system we recommend to use the following components:**

ROLINE Cat.5e UTP Cable, Solid Wire, AWG24: 21.15.0512 (100 m), 21.15.0511 (300 m)  
 ROLINE Cat.5e Flush/Surface Mount Wall Jack, unshielded: 25.16.8506 (white), 25.16.8501

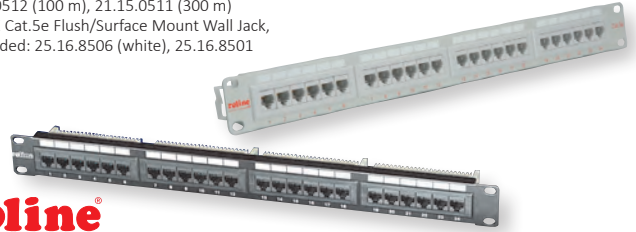

Order-No. – P.U.

ROLINE Cat.5e 19" Patch Panel, 24 Ports, UTP, black 26.11.0349 – 5

ROLINE Cat.5e 19" Patch Panel, 24 Ports, UTP, light grey 26.11.0347 – 5

## VALUE Cat.5e 19" Patch Panel, 24 Ports, STP



- The VALUE Cat.5e patch panels comply with the EIA/TIA 568 TSB40a standard
- The cable connection on the back is implemented via LSA-plus connection technology with colour coding on the top in accordance with EIA/TIA 568
- Casing and covering hood of sheet steel
- 24 shielded Ports



Order-No. – P.U.

VALUE Cat.5e 19" Patch Panel, 24 Ports, STP, black 26.99.0328 – 5

VALUE Cat.5e 19" Patch Panel, 24 Ports, STP, light grey 26.99.0329 – 5

## ROLINE Cat.5e 19" Patch Panel, 24 Ports, STP



- The panels comply with the EIA / TIA 568 Cat. 5e TSB40A standard
- The cable connection on the back is implemented via LSA-plus connection technology with colour coding on the top in accordance with EIA/TIA 568
- Sheet steel housing and cover
- 24 shielded Ports

ROLINE Cat.5e Flush/Surface Mount Wall Jack, shielded: 25.16.8487 (white), 25.16.8486 (ivory)/25.16.8387 (white), 25.16.8386 (ivory)  
 ROLINE Cat.5e 19" Patch Panel, 24 Ports, shielded: 26.11.0329 (light grey), 26.11.0328 (black)  
 ROLINE Cat.5e S/FTP Patch Cord, grey, 5 m: 21.15.0305  
 Our in-house laboratory has tested this cable-plug combination, in a Channel of 100 meters, in compliance with Class D specifications.

**For a structured cabling system we recommend to use the following components:**

ROLINE Cat.5e S/FTP Cable, Solid Wire, AWG24: 21.15.0019 (100 m), 21.15.0020 (300 m)



Order-No. – P.U.

ROLINE Cat.5e 19" Patch Panel, 24 Ports, STP, black 26.11.0328 – 3

ROLINE Cat.5e 19" Patch Panel, 24 Ports, STP, light grey 26.11.0329 – 3

## VALUE Cat.6/Class E 19" Patch Panel, 24 Ports, UTP



- Cost-effective VALUE patch panels for use in Fast Ethernet and Gigabit Ethernet networks
- The panels comply with the EIA/TIA 568A
- The cable connection on the back is implemented via LSA-plus connection technology with colour coding on the top in accordance with EIA/TIA 568
- 24 unshielded ports



Order-No. – P.U.

VALUE Cat.6/Class E 19" Patch Panel, 24 Ports, UTP, black 26.99.0362 – 5

VALUE Cat.6/Class E 19" Patch Panel, 24 Ports, UTP, light grey 26.99.0355 – 5



## VALUE Cat.6/Class E 19" Patch Panel, 24 Ports STP



- The VALUE Cat.6/Class E 19" patch panels fulfil the Cat.6/Class E Permanent Link Standard and is ideal for Gigabit Ethernet networks
- Cable assembly takes place using LSA-plus piercing terminals with colour coding on the top in accordance with EIA/TIA 568
- Sheet steel housing and cover

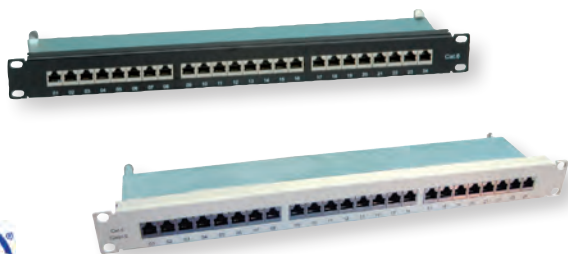

Order-No. – P.U.

VALUE Cat.6/Class E 19" Patch Panel, 24 Ports, STP, black	26.99.0353 – 5
VALUE Cat.6/Class E 19" Patch Panel, 24 Ports, STP, grey	26.99.0354 – 5

## ROLINE Cat.6/Class E 19" Patch Panel, 24 Ports UTP



- The ROLINE Cat.6/Class E 19" patch panels fulfil the Cat.6/Class E Permanent Link Standard and is ideal for Gigabit Ethernet networks
- Cable assembly takes place using LSA-plus piercing terminals with colour coding on the top in accordance with EIA/TIA 568

**For a structured cabling system we recommend to use the following components:**  
 ROLINE Cat.6 UTP Cable, Solid Wire, AWG23: 21.15.0990 (100 m), 21.15.0991 (300 m)  
 ROLINE Cat.6 Flush Mount Wall Jack, unshielded: 25.16.8494 (white), 25.16.8500 (ivory)  
 ROLINE Cat.6 Surface Mount Wall Jack, unshielded: 25.16.8394 (white), 25.16.8395 (ivory)  
 ROLINE Cat.6 19" Patch Panel, 24 Ports, unshielded: 26.11.0355 (light grey), 26.11.0362 (black); ROLINE Cat.6 UTP Patch Cord, grey, 5 m: 21.15.0935

**The accredited German laboratory GHMT has tested and certified this product combination, in a Channel of 100 meters, as being compliant to Class E specifications; certificate no. z2329b-10-E (with flush mount)/z2330b-10-E (with surface mount).**

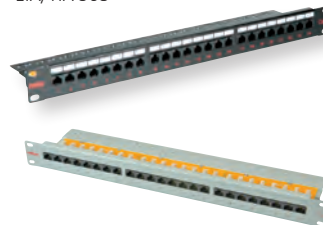

Order-No. – P.U.

ROLINE Cat.6/Class E 19" Patch Panel, 24 Ports, UTP, black	26.11.0362 – 3
ROLINE Cat.6/Class E 19" Patch Panel, 24 Ports, UTP, light grey	26.11.0355 – 3



## ROLINE Cat.6/Class E 19" Patch Panel, 24 Ports STP



- The ROLINE Cat.6/Class E 19" patch panels fulfil the Cat.6/Class E Permanent Link Standard and is ideal for Gigabit Ethernet networks
- Cable assembly takes place using LSA-plus piercing terminals with colour coding on the top in accordance with EIA/TIA 568
- Sheet steel housing and cover

**For a structured cabling system we recommend to use the following components:**  
 ROLINE Cat.6 S/FTP Cable, Solid Wire, AWG23: 21.15.0890 (100 m), 21.15.0891 (300 m)  
 ROLINE Cat.6 Flush Mount Wall Jack, shielded: 25.16.8492 (white), 25.16.8493 (ivory)  
 ROLINE Cat.6 Surface Mount Wall Jack, shielded: 25.16.8392 (white), 25.16.8393 (ivory)  
 ROLINE Cat.6 19" Patch Panel, 24 Ports, shielded: 26.11.0351 (light grey), 26.11.0361 (black)  
 ROLINE Cat.6 S/FTP Patch Cord, grey, 5 m: 21.15.0835

**The accredited German laboratory GHMT has tested and certified this product combination, in a Channel of 100 meters, as being compliant to Class E specifications; certificate no. z2365b-10-E (with flush mount) / z2364b-10-E (with surface mount).**



Order-No. – P.U.

ROLINE Cat.6/Class E 19" Patch Panel, 24 Ports, STP, black	26.11.0361 – 3
ROLINE Cat.6/Class E 19" Patch Panel, 24 Ports, STP, light grey	26.11.0351 – 3

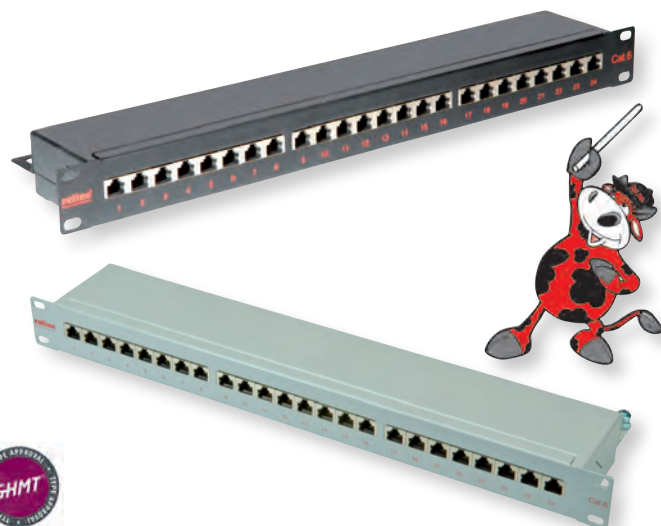

## VALUE Cat.6A 19" Patch Panel, 24 Ports UTP



- The VALUE Cat. 6A 19" patch panels fulfil the Cat. 6A/Class EA permanent link standard and are ideal for 10 Gigabit Ethernet networks
- Cable assembly takes place using LSA plus piercing terminals with colour coding on the top in accordance with EIA/TIA 568A
- Sheet steel

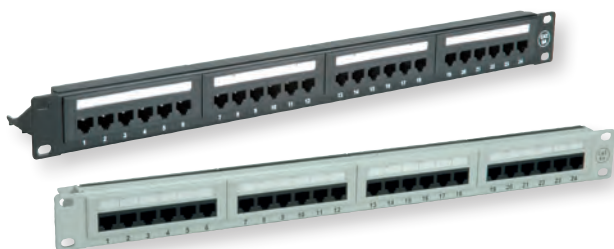

Order-No. – P.U.

VALUE Cat.6A 19" Patch Panel, 24 Ports, UTP, black, black	26.99.0358 – 5
VALUE Cat.6A 19" Patch Panel, 24 Ports, UTP, grey	26.99.0359 – 5

## VALUE Cat.6A 19" Patch Panel, 24 Ports STP



- The VALUE Cat. 6A 19" patch panels fulfil the Cat. 6A/Class EA permanent link standard and are ideal for 10 Gigabit Ethernet networks
- Cable assembly takes place using LSA plus piercing terminals with colour coding on the top in accordance with EIA/TIA 568A
- Sheet steel housing and cover



Order-No. – P.U.

VALUE Cat.6A 19" Patch Panel, 24 Ports, STP, black	26.99.0360 – 5
VALUE Cat.6A 19" Patch Panel, 24 Ports, STP, grey	26.99.0361 – 5



## ROLINE Cat.5e Keystone Jack, RJ-45, UTP

DATA CENTER  
Product

- The system is composed of a 19" patch panel frame and the UTP Cat.5e RJ-45 keystone jack
- Assembling takes place over LSA-plus
- Colour code on the keystone jacks based on the standard EIA/TIA 568 A and 568 B

**For a structured unshielded Cat.5e cabling system we recommend to use the following components:**

ROLINE Cat.5e UTP Cable, Solid Wire, AWG24: 21.15.0512 (100 m), 21.15.0511 (300 m)  
ROLINE Flush Mount Wall Jack for Keystone, unloaded: 25.16.8579  
ROLINE Cat.5e Keystone, RJ-45, unshielded: 26.11.0343 (light grey), 26.11.0342 (black)

ROLINE Cat.5e 19" Keystone Patch Panel, 24 Ports, unshielded: 26.11.0344 (black), 26.11.0345 (light grey)  
ROLINE Cat.5e UTP Patch Cord, grey, 5 m: 21.15.0505  
Our in-house laboratory has tested this cable-plug combination, in a Channel of 100 meters, in compliance with Class D specification.

Order-No. – P.U.

ROLINE Cat.5e Keystone Jack, RJ-45, UTP, black	26.11.0342 – 60
Keystone 19" Module frame Cat.5/Cat.6, 24 Ports, blank, UTP, black	26.11.0357 – 5
ROLINE Cat.5e Keystone Jack, RJ-45, UTP, light grey	26.11.0343 – 60
Keystone 19" Module frame Cat.5/Cat.6, 24 Ports, blank, UTP, light grey	26.11.0356 – 5



**roline**  
Designed for Professionals

## ROLINE Cat.6 19"-Patch Panel, 24P, Half Height Unit

DATA CENTER  
Product

- The ROLINE Cat. 6/Class E 19" patch panels fulfil the Cat 6/Class E Permanent Link Standard and are ideal for Gigabit Ethernet networks
- Cable assembly takes place using LSA-plus piercing terminals with colour coding on the top in accordance with EIA/TIA 568
- The patch panel delivers a high density offering with the benefit of a single row of piercing terminals. The single row of

terminals means that the installation is straight forward. As the panel is only 0.5U in height it allows, by using two panels together, the ability to present 48 ports in 1U of rack space.

- Every port is equipped with a protective flap
- Casing of sheet steel
- Bar for strain relief with cable ties
- Installation height: only 0.5U (half height: 22 mm)

Order-No. – P.U.

ROLINE Cat.6 19"-Patch Panel, 24P, UTP, black, 0.5 U. (Half height unit), black	26.11.0372 – 6
ROLINE Cat.6 19"-Patch Panel, 24P, STP, black, 0.5 U. (Half height unit), black	26.11.0373 – 6

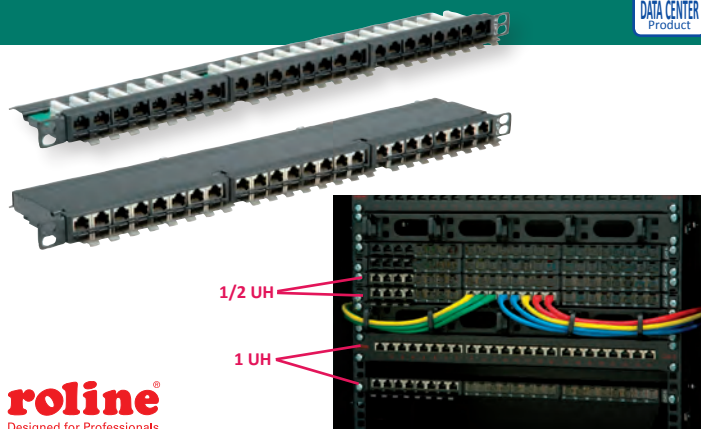

**roline**  
Designed for Professionals

## VALUE Keystone Jack, Cat.6, RJ-45, UTP, 180°, Tool-free

Tool-free

**Cat.6/Class E Keystone jack for installation in a Keystone blank 19" patch panel module frame.**

- Unshielded construction
- Colour code on the keystone jacks is based on the standard EIA/TIA 568 A and 568 B
- Toolless installation
- Colour: white



Order-No. – P.U.

VALUE Keystone Jack, Cat.6, RJ-45, UTP, 180°, tool-free, white	26.99.0363 – 40
Keystone 19" Module frame Cat.5/Cat.6, 24 Ports, blank, UTP, light grey	26.11.0356 – 5
Keystone 19" Module frame Cat.5/Cat.6, 24 Ports, blank, UTP, black	26.11.0357 – 5

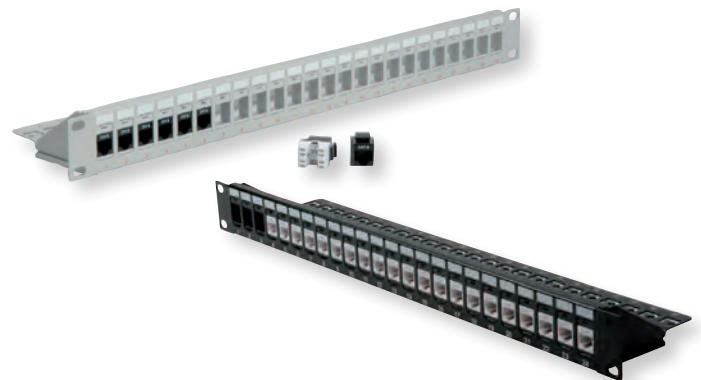

## ROLINE Cat.6/Class E Keystone Jack, RJ-45, UTP, Tool-free

Tool-free

- The system is composed of a 19" patch panel frame and the UTP Cat.6 RJ-45 keystone jacks
- Assembling of cables and keystone takes place over LSA-plus or toolless
- Colour code on the keystone jacks, based on the standard EIA/TIA 568 A and 568 B

**For a structured unshielded Cat.6 cabling system we recommend to use the following components:**

ROLINE Cat.6 UTP Cable, Solid Wire, AWG23: 21.15.0990 (100 m), 21.15.0991 (300 m)  
Flush Mount Wall Jack for Keystone, unloaded: 25.16.8579  
ROLINE Cat.6 Keystone, RJ-45, unshielded: 26.11.0352 (black), 26.11.0353 (white)

19" Keystone Patch Panel, 24 Ports, unshielded: 26.11.0356 (light grey), 26.11.0357 (black)  
ROLINE Cat.6 UTP Patch Cord, grey, 5 m: 21.15.0935  
Our in-house laboratory has tested this cable-plug combination, in a Channel of 100 meters, in compliance with Class E specifications.

Order-No. – P.U.

ROLINE Cat.6/Class E Keystone Jack, RJ-45, UTP, tool-free, black	26.11.0352 – 60
Keystone 19" Module frame Cat.5/Cat.6, 24 Ports, blank, UTP, black	26.11.0357 – 5
ROLINE Cat.6 Keystone Jack, RJ-45, UTP, tool-free, white	26.11.0353 – 60
Keystone 19" Module frame Cat.5/Cat.6, 24 Ports, blank, UTP, light grey	26.11.0356 – 5

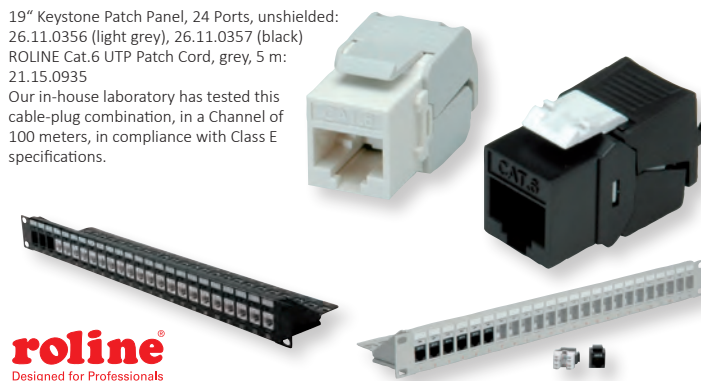

**roline**  
Designed for Professionals

## ROLINE Cat.6/Class E Keystone Jack, RJ-45, STP, Tool-free

Tool-free

- The ROLINE Cat. 6/Class E 19" keystone patch panel system is composed of a 19" STP patch panel frame (please order separately!) and these shielded Cat.6 RJ-45 keystone jacks
- Colour code on the keystone jacks based on the standard EIA/TIA 568
- Colour: silver

**For a structured shielded Cat.6 cabling system we recommend to use the following components:**

ROLINE Cat.6 S/FTP Cable, Solid Wire, AWG23: 21.15.0890 (100 m), 21.15.0891 (300 m)  
 ROLINE Flush Mount Wall Jack for Keystones, unloaded: 25.16.8579  
 ROLINE Cat.6 Keystone, RJ-45, shielded: 26.11.0358  
 ROLINE Cat.6 19" Keystone Patch Panel, 24 ports, shielded: 26.11.0359 (light grey),

26.11.0360 (black)  
 ROLINE Cat.6 S/FTP Patch Cord, grey, 5 m: 21.15.0835

Our in-house laboratory has tested this cable-plug combination, in a Channel of 100 meters, in compliance with Class E specification.

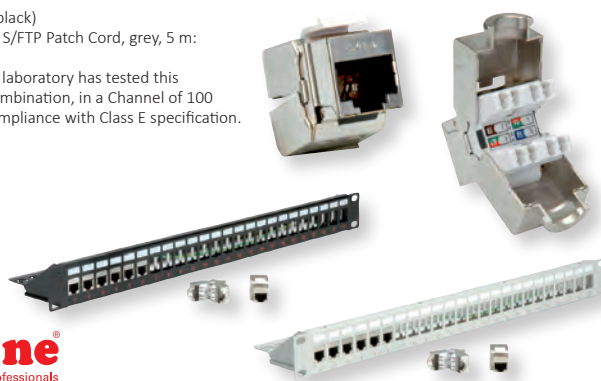

**roline**  
 Designed for Professionals

	Order-No. – P.U.
ROLINE Cat.6/Class E Keystone Jack, RJ-45, STP, tool-free, silver	26.11.0358 – 60
Keystone 19" Module frame Cat.5/6/6A, 24 Ports, STP, black	26.11.0360 – 5
Keystone 19" Module frame Cat.5/6/6A, 24 Ports, STP, light grey	26.11.0359 – 5

## ROLINE Keystone Jack, Cat. 6A, RJ-45, UTP, Tool-free

Tool-free

- The Cat.6A keystones support data transfer rates of up to 10 GBit/s and a bandwidth of 500 MHz
- Colour code on the keystone jacks is based on the standard EIA/TIA 568

- Can be used together with Keystone Module frame 26.11.0357 (black) or 26.11.0356 (light grey), Flush Mount Wall Outlet for Keystones, 2-port (25.16.8579)
- Colour: white

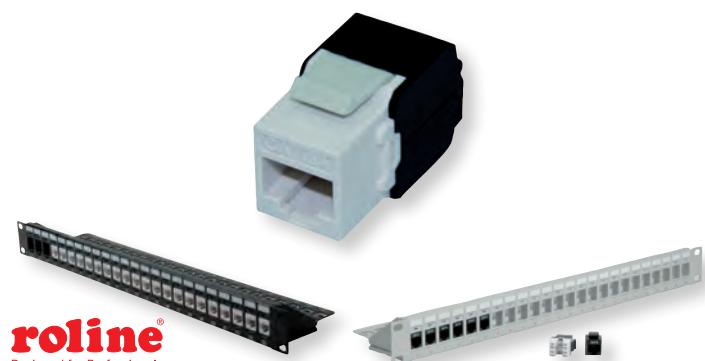

**roline**  
 Designed for Professionals

	Order-No. – P.U.
ROLINE Keystone Jack, Cat. 6A, RJ-45, UTP, tool-free, white	26.11.0337 – 50
Keystone 19" Module frame Cat.5/Cat.6, 24 Ports, blank, UTP, black	26.11.0357 – 5
Keystone 19" Module frame Cat.5/Cat.6, 24 Ports, blank, UTP, light grey	26.11.0356 – 5

## VALUE Cat.6A Keystone, RJ-45, STP, Tool-free

Tool-free

**The low-cost solution for Cat 6A cabling for data rates up to 10Gbit/s!**

Cat.6/Class E Keystone jack for installation in a Keystone blank 19" patch panel module frame.

- Connect the cable to the Keystones on modified LSA connections

- Toolless mounting- without using a LSA tool: cable wires are simply placed into the guides of Keystone module, the module is closed and compressed- the connection is ready for use
- Colour code on the Keystone jacks based on the standard EIA/TIA 568 A & B
- Colour: silver

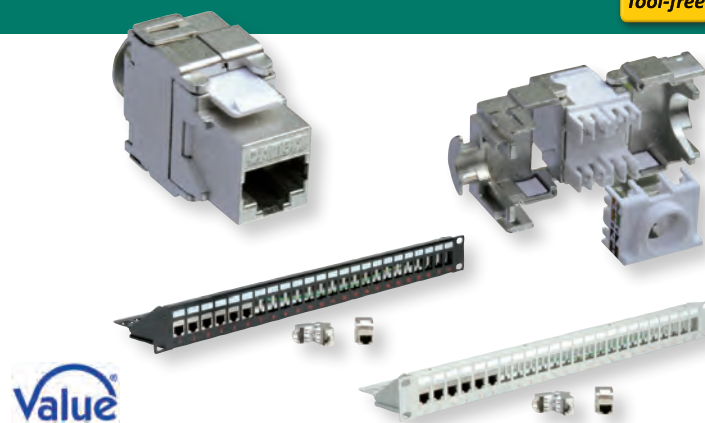

**Value**

	Order-No. – P.U.
VALUE Cat.6A Keystone, RJ-45, STP, tool-free, silver	26.99.0366 – 40
Keystone 19" Module frame Cat.5/Cat.6/Cat.6A, 24 Ports, STP, black	26.11.0360 – 5
Keystone 19" Module frame Cat.5/Cat.6/Cat.6A, 24 Ports, STP, light grey	26.11.0359 – 5

## ROLINE Keystone Jack, Cat.6A, RJ-45, STP, Tool-free

Tool-free

**Keystone in proven ROLINE quality!**

- The ROLINE Cat.6A Keystones are ideal for use in Gigabit Ethernet networks. They support data transfer rates up to 10 Gbit/s with a bandwidth of 500 MHz
- Connect the cable to the Keystones via LSA connections without special tools - place the cable ends simply into the guides (with color coding), close and compress the module- the connection is ready for use

- The Keystone modules can be „latched“ into a 19" module support rack, which is optionally available in black (26.11.00360) or light gray (26.11.0359). Or in combination with a module receptacle (25.16.8579) you can realise a junction box.
- The Keystones are coded according to EIA/TIA 568

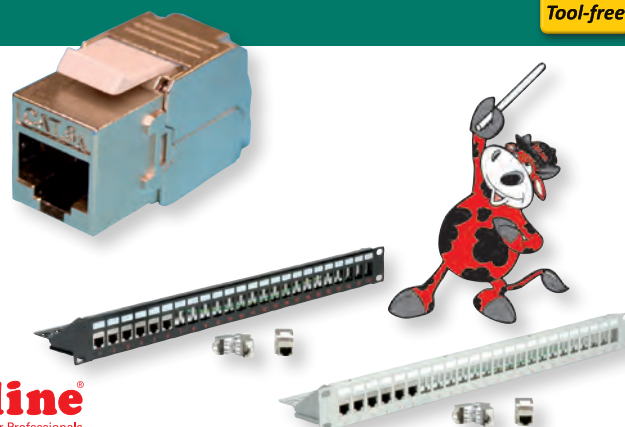

**roline**  
 Designed for Professionals

	Order-No. – P.U.
ROLINE Keystone Jack, Cat.6A, RJ-45, STP, tool-free, silver	26.11.0367 – 50
Keystone 19" Module frame Cat.5/Cat.6/Cat.6A, 24 Ports, STP, black	26.11.0360 – 5
Keystone 19" Module frame Cat.5/Cat.6/Cat.6A, 24 Ports, STP, light grey	26.11.0359 – 5

## VALUE Field Plug Cat.6, UTP/STP

Tool-free

- Fast and easy tool-free installable unshielded/shielded RJ45 connector
- Cat.6/Class E performance according to ISO/IEC11801 and IEC60603-7
- Compact cable manager for round Solid cable AWG 23-26(1/0.41-1/0.575mm) and stranded cable AWG 24-26(7/0.16-7/0.20mm)
- For cable with outer diameter OD: 6.0- 9.0mm
- Pair management according to TIA 568B and TIA 568A colour codes
- Strain relief with cable tie and black transparent dust cup and boot
- Color: Transparent black

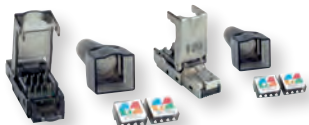

Order-No. – P.U.

VALUE Field Plug Cat.6, UTP 26.99.0370 – 50

VALUE Field Plug Cat.6, STP 26.99.0371 – 50



## VALUE Field Plug Cat.6A, UTP/STP

Tool-free

- Fast and easy tool-free installable unshielded/shielded RJ45 connector
- Cat.6A / Class EA performance according to ISO/IEC11801 and IEC60603-7
- Compact cable manager for round Solid cable AWG 23-26(1/0.41-1/0.575mm) and stranded cable AWG 24-26(7/0.16-7/0.20mm)
- For cable with outer diameter OD: 6.0- 9.0mm
- Pair management according to TIA 568B and TIA 568A colour codes
- Strain relief with cable tie and black transparent dust cup and boot
- Color: Transparent black



Order-No. – P.U.

VALUE Field Plug Cat.6A, UTP 26.99.0372 – 50

VALUE Field Plug Cat.6A, STP 26.99.0373 – 50



## VALUE Connection Module Cat.6A, STP

Tool-free

- The VALUE Junction module is used to repair or extend shielded Cat. 6A cables
- With this module all 4 or 8 wired installation cables with AWG24 and with an outside diameter from 6.2mm can be installed
- Equipped with the modern LSA connection technology, all cables in accordance with EIA/TIA 568A or 568B can be easily installed
- With the use of the STP type junction box, it's safe against electrical and magnetical interferences



Order-No. – P.U.

VALUE Connection Module Cat.6A, STP 26.99.0380 – 50



## 19" Cable Management plate with Horizontal/Vertical Cable Rings for Cabinets

DATA CENTER capable

- Essential piece of equipment for server or data cabinets environments
- Suitable for mounting on all 19" data cabinets and server racks, allowing cables to be neatly routed for a higher reliability of connections throughout the cabinet or rack
- The cable rings create an ideal bend radius for the networking cables and greatly assists keeping the patch neat, they can be used vertically or horizontally
- Designed to give extra support for patch leads and prevents obscuring other equipment and to prevent cable strain
- Makes installation neater and more professional
- Cables slide in and out comfortable with out falling out by themselves
- 1UH quality metal bar
- 5 cable rings (hooks) for great cable management
- Contents: 19"-Panel, 5 cable rings (hooks)

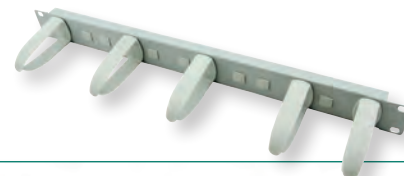

Order-No. – P.U.

19" Cable Management plate with Horizontal/Vertical cable rings for Cabinets, grey 26.99.0345 – 20

19" Cable Management plate with Horizontal/Vertical Cable Rings for Cabinets, black 26.99.0346 – 20

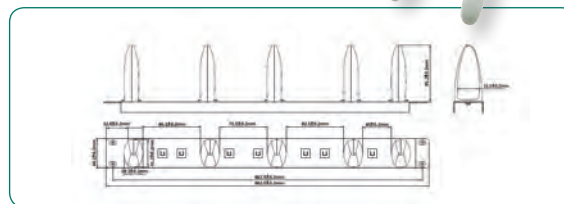

## ROLINE Surface Wallbox for Keystones

- Wall Mount surface box with modular outlet
- Supports up to 6 RJ-45 Keystone Connectors
- Space saving, easy to install
- Plastic material
- Colour: White



- Remark: Keystones are not included. Please order them separately.



Order-No. – P.U.

ROLINE Surface Wallbox for 6x Keystones, white 26.11.0380 – 20



## VALUE USB 3.0 / HDMI / Keystone Module

Ideal solution to easily connect a Macbook, Ultrabook, Notebook/Laptop or PC to a HDD/SSD through e.g. a floor tank, wall outlet or table box.

- Keystone with two USB 3.0 F/F sockets
- Ideal for home offices, conference rooms and classrooms
- For use with USB cables
- Contents: 1x Keystone



Order-No. – P.U.

VALUE USB 3.0 Keystone Module, 1pc/set, black 25.99.8207 – 20

VALUE HDMI Keystone Module, black 25.99.8208 – 20

VALUE Keystone Socket Cover, 10pcs/set , black 25.99.8209 – 20





## ROLINE Cat.5e Wall Mount Patch Panel

- The ROLINE connection takes place using LSA plus cable clamps marked with the appropriate colour coding EIA / TIA 568A specifications. The screen connection and strain relief takes place using metallic cable clips.
- The cable connection takes place using LSA plus cable clamps marked with the appropriate colour coding EIA / TIA 568A specifications. The screen connection and strain relief takes place using metallic cable clips

- Housing and dust cover: metal



Order-No. – P.U.

ROLINE Cat.5e Wall Mount Patch Panel, 8 Ports, STP, black	26.11.0310 – 10
ROLINE Cat.5e Wall Mount Patch Panel, 8 Ports, STP, light grey	26.11.0304 – 10

## ROLINE Cat.6 10" Patch Panel

- For smaller Network Installations 10"-Patch Panels are used
- This ROLINE 10"-Patchpanel offers 12 Ports
- Shielded version, Metal-Casing
- The Panel complies to the Standard of Cat. 6

- The cable connection on the back is implemented via LSA plus technology with colour coding in accordance with standard



**roline**  
Designed for Professionals

Order-No. – P.U.

ROLINE Cat.6 10" Patch Panel, 12 Ports, STP, grey	26.11.0315 – 5
---	----------------

## ROLINE Cat.6A Flush Mount Wall Jack, STP

- The ROLINE Cat.6A wall jacks fulfil the Cat.6/Class EA Permanent Link Standard and are ideal for Gigabit Ethernet networks
- Fully screened box in a metal housing, provides security against EMI (shielded version)
- Cable assembly takes place using LSAPlus piercing terminals with colour coding on the top in accordance with EIA/TIA 568



**roline**  
Designed for Professionals

Order-No. – P.U.

ROLINE Cat.6A Flush Mount Wall Jack, STP, white	25.16.8490 – 20
---	-----------------

## VALUE Cat.6 Surface/Flush Mount Wall Jack

- The VALUE Cat.6/Class E wall mount jacks fulfil the Cat.6/Class E Permanent Link Standard and are ideal for gigabit ethernet networks
- Cable assembly takes place using LSAPlus piercing terminals with colour coding on the top in accordance with EIA/TIA 568



Order-No. – P.U.

VALUE Cat.6 Surface Mount Wall Jack, STP, white	25.99.8392 – 20
VALUE Cat.6 Surface Mount Wall Jack, UTP, white	25.99.8394 – 20
VALUE Cat.6 Flush Mount Wall Jack, STP, white	25.99.8492 – 20
VALUE Cat.6 Flush Mount Wall Jacks, UTP, white	25.99.8494 – 20

## ROLINE Surface Mount Wall Jack, Cat.5e

- The wall jacks are suitable for a transmission rate of 100Mbit/s and are fitted with two jacks
- Fully screened box in a metal housing; provides high security against EMI
- Cable assembly takes place using LSA-plus piercing terminals with colour coding on the top in accordance with EIA/TIA 568
- 45° tilted plug assembly

Wall Jack, shielded: 25.16.8487 (white), 25.16.8486 (ivory)/25.16.8387 (white), 25.16.8386 (ivory)  
ROLINE Cat.5e 19" Patch Panel, 24 Ports, shielded: 26.11.0329 (light grey), 26.11.0328 (black); ROLINE Cat.5e S/FTP Patch Cord, grey, 5 m: 21.15.0305.  
Our in-house laboratory has tested this cable-plug combination, in a Channel of 100 meters, in compliance with Class D specifications.

For a structured shielded cabling system we recommend to use the following components:  
ROLINE Cat.5e S/FTP Cable, Solid Wire, AWG24: 21.15.0019 (100 m), 21.15.0020 (300 m); ROLINE Cat.5e Flush/Surface Mount



**roline**  
Designed for Professionals

Order-No. – P.U.

ROLINE Surface Mount Wall Jack, Cat.5e, STP, ivory	25.16.8386 – 20
ROLINE Flush Mount Wall Jack, Cat.5e, STP, ivory	25.16.8486 – 20
ROLINE Surface Mount Wall Jack, Cat.5e, STP, white	25.16.8387 – 20
ROLINE Flush Mount Wall Jack, Cat.5e, STP, white	25.16.8487 – 20
ROLINE Surface Mount Wall Jack, Cat.5e, UTP, ivory	25.16.8401 – 20
ROLINE Flush Mount Wall Jack, Cat.5e, UTP, ivory	25.16.8501 – 20
ROLINE Surface Mount Wall Jack, Cat.5e, UTP, white	25.16.8406 – 20
ROLINE Flush Mount Wall Jack, Cat.5e, UTP, white	25.16.8506 – 20
ROLINE Faceplate for Flush Mount Wall Jack, white	25.16.8398 – 20
ROLINE Faceplate for Flush Mount Wall Jack, ivory	25.16.8399 – 20

## VALUE Cat.6A Flush Mount Wall Jack, STP

- The VALUE Cat.6A wall jacks fulfil the Cat.6/Class EA Permanent Link Standard and are ideal for gigabit ethernet networks
- Fully screened box in a metal housing, provides security against EMI (shielded version)

- Cable assembly takes place using LSAPlus piercing terminals with colour coding on the top in accordance with EIA/TIA 568

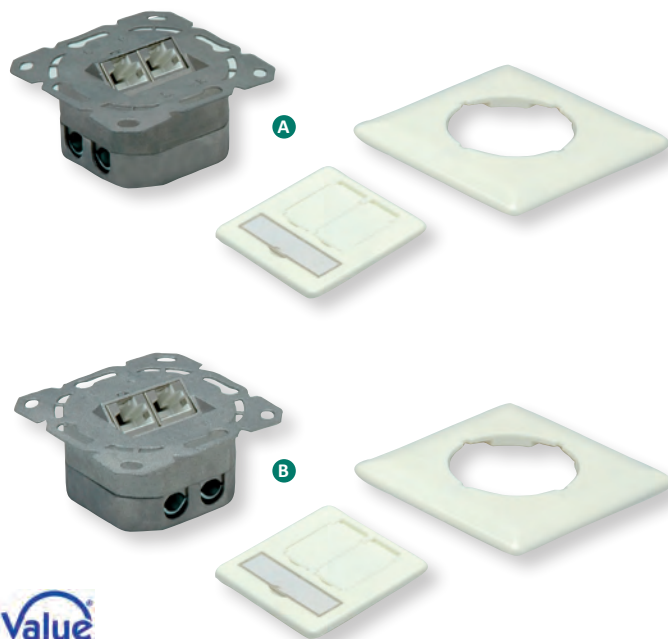

**Value**

Order-No. – P.U.

VALUE Cat.6A Flush Mount Wall Jack, STP, horizontal, white	A 25.99.8490 – 20
VALUE Cat.6A Flush Mount Wall Jack, STP, vertical, white	B 25.99.8491 – 20

## ROLINE Cat.5e/Cat.6 Keystone Jack, RJ-45

- For data transfer rates of up to 1000Mbit/s
- Cable assembly takes place using LSA-plus piercing terminals with colour coding on the top in accordance with EIA/TIA 568

### For a structured unshielded Cat.5e cabling system we recommend to use the following components:

ROLINE Cat.5e UTP Cable, Solid Wire, AWG24: 21.15.0512 (100 m), 21.15.0511 (300 m)  
 Flush Mount Wall Jack for Keystones, unloaded: 25.16.8579  
 ROLINE Cat.5e Keystone, RJ-45, unshielded: 26.11.0343 (light grey), 26.11.0342 (black)  
 19" Keystone Patch Panel, 24 Ports, unshielded: 26.11.0356 (light grey), 26.11.0357 (black)  
 ROLINE Cat.5e UTP Patch Cord, grey, 5 m: 21.15.0505

### For a structured unshielded Cat.6 cabling system we recommend to use the following components:

ROLINE Cat.6 UTP Cable, Solid Wire, AWG23: 21.15.0990 (100 m), 21.15.0991 (300 m)  
 Flush Mount Wall Jack for Keystones, unloaded: 25.16.8579  
 ROLINE Cat.6 Keystone, RJ-45, unshielded: 26.11.0353  
 19" Keystone Patch Panel, 24 Ports, unshielded: 26.11.0356 (light grey), 26.11.0357 (black)  
 ROLINE Cat.6 UTP Patch Cord, grey, 5 m: 21.15.0935

### For a structured shielded Cat.6 cabling system we recommend to use the following components:

ROLINE Cat.6 S/FTP Cable, Solid Wire, AWG23: 21.15.0890 (100 m), 21.15.0891 (300 m)  
 ROLINE Flush Mount Wall Jack for Keystones, unloaded: 25.16.8579  
 ROLINE Cat.6 Keystone, RJ-45, shielded: 26.11.0358  
 ROLINE Cat.6 19" Keystone Patch Panel, 24 ports, shielded: 26.11.0359 (light grey), 26.11.0360 (black)  
 ROLINE Cat.6 S/FTP Patch Cord, grey, 5 m: 21.15.0835  
 Our in-house laboratory has tested this cable-plug combination, in a Channel of 100 meters, in compliance with Class E specification.

### For a structured shielded Cat.6 cabling system we recommend to use the following components:

ROLINE Cat.6 S/FTP Cable, Solid Wire, AWG23: 21.15.0890 (100 m), 21.15.0891 (300 m)  
 Flush Mount Wall Jack for Keystones, unloaded: 25.16.8579  
 ROLINE Cat.6 Keystone, RJ-45, shielded: 26.11.0358  
 19" Keystone Patch Panel, 24 ports, shielded: 26.11.0359 (light grey), 26.11.0360 (black)  
 ROLINE Cat.6 S/FTP Patch Cord, grey, 5 m: 21.15.0835  
 Our in-house laboratory has tested this cable-plug combination, in a Channel of 100 meters, in compliance with Class D resp. Class E specifications.



**roline**  
Designed for Professionals

Order-No. – P.U.

ROLINE Cat.5e Keystone Jack, RJ-45, UTP, light grey	A	26.11.0343	– 60
ROLINE Cat.6 Keystone Jack, RJ-45, UTP, tool-free, white	B	26.11.0353	– 60
ROLINE Cat.6/Class E Keystone Jack, RJ-45, STP, tool-free, silver	C	26.11.0358	– 60
Flush Mount Wall Outlet for Keystones, 2-port	D	25.16.8579	– 20
Surface Wall Mount Frame	E	25.16.8484	– 20

## VALUE Cat.6A Keystone, RJ-45, STP, Tool-free

### The low-cost solution for Cat 6A cabling for data rates up to 10Gbit/s!

Cat.6/Class EA Keystone jack for installation in a Keystone blank 19" patch panel module frame.

- Connect the cable to the Keystones on modified LSA connections
- Toolless mounting- without using a LSA tool: cable wires are simply placed into the guides of Keystone module, the module is closed and compressed- the connection is ready for use
- Colour code on the Keystone jacks based on the standard EIA/TIA 568 A & B
- Colour: silver

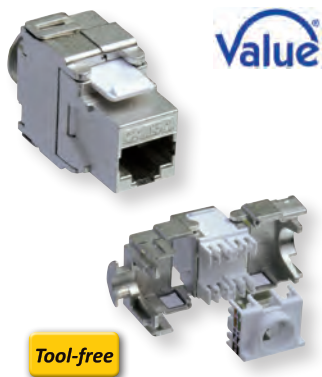

**Value**

Tool-free

Order-No. – P.U.

VALUE Cat.6A Keystone, RJ-45, STP, tool-free, silver	A	26.99.0366	– 40
Flush Mount Wall Outlet for Keystones, 2-port	B	25.16.8579	– 20
Surface Wall Mount Frame	C	25.16.8484	– 20

## ROLINE Surface Mount Wall Jack, Cat.6

- The ROLINE Cat.6/Class E wall outlet sockets fulfil the Cat.6/Class E Permanent Link standard and are ideal for Gigabit Ethernet networks
- Fully screened box in a metal housing, provides security against EMI (shielded version)
- Cable assembly takes place using LSA-plus piercing terminals with colour coding on the top in accordance with EIA/TIA 568
- 45° tilted plug assembly

### For a structured unshielded cabling system we recommend to use the following components:

ROLINE Cat.6 UTP Cable, Solid Wire, AWG23: 21.15.0990 (100 m), 21.15.0991 (300 m)  
 ROLINE Cat.6 Flush Mount Wall Jack, shielded: 25.16.8494 (white), 25.16.8500 (ivory)  
 ROLINE Cat.6 Surface Mount Wall Jack, unshielded: 25.16.8394 (white), 25.16.8395 (ivory)  
 ROLINE Cat.6 19" Patch Panel, 24 Ports, unshielded: 26.11.0355 (light grey), 26.11.0362 (black); ROLINE Cat.6 UTP Patch Cord, grey, 5 m: 21.15.0935

The accredited German laboratory GHMT has tested and certified this product combination, in a Channel of 100 meters, as being compliant to Class E specifications; certificate no. z2329b-10-E (with flush mount)/z2330b-10-E (with surface mount).

### For a structured shielded cabling system we recommend to use the following components:

ROLINE Cat.6 S/FTP Cable, Solid Wire, AWG23: 21.15.0890 (100 m), 21.15.0891 (300 m)  
 ROLINE Cat.6 Flush Mount Wall Jack, shielded: 25.16.8492 (white), 25.16.8493 (ivory)  
 ROLINE Cat.6 Surface Mount Wall Jack, shielded: 25.16.8392 (white), 25.16.8393 (ivory)  
 ROLINE Cat.6 19" Patch Panel, 24 Ports, shielded: 26.11.0351 (light grey), 26.11.0361 (black); ROLINE Cat.6 S/FTP Patch Cord, grey, 5 m: 21.15.0835

The accredited German laboratory GHMT has tested and certified this product combination, in a Channel of 100 meters, as being compliant to Class E specifications; certificate no. z2365b-10-E (with flush mount)/z2364b-10-E (with surface mount).

**roline**  
Designed for Professionals



Order-No. – P.U.

ROLINE Surface Mount Wall Jack, Cat.6, STP, white	A	25.16.8392	– 20
ROLINE Surface Mount Wall Jack, Cat.6, STP, ivory	B	25.16.8393	– 20
ROLINE Flush Mount Wall Jack, Cat.6, STP, white	C	25.16.8492	– 20
ROLINE Flush Mount Wall Jack, Cat.6, STP, ivory	D	25.16.8493	– 20
ROLINE Surface Mount Wall Jack, Cat.6, UTP, white	E	25.16.8394	– 20
ROLINE Surface Mount Wall Jacks, Cat.6, UTP, ivory	F	25.16.8395	– 20
ROLINE Flush Mount Wall Jack, Cat.6, UTP, white	G	25.16.8494	– 20
ROLINE Flush Mount Wall Jack, Cat.6, UTP, ivory	H	25.16.8500	– 20
ROLINE Faceplate for Flush Mount Wall Jack, white	I	25.16.8398	– 20
ROLINE Faceplate for Flush Mount Wall Jack, ivory	J	25.16.8399	– 20

## ROLINE Keystone Jack, Cat.6A, RJ-45, Tool-free

- The Cat.6A keystones support data transfer rates of up to 10 Gbit/s and a bandwidth of 500 MHz
- Assembling takes place over LSA plus
- Colour code on the keystone jacks is based on the standard EIA/TIA 568

Our in-house laboratory has tested these cable-plug combinations, in a Channel of 100 meters, in compliance with Class EA specifications.

### For a structured shielded Cat.6A cabling system we recommend to use the following components:

ROLINE Cat.6A S/FTP Cable, Solid Wire, 300 m: 21.15.0881; ROLINE Cat.6A Keystone, RJ-45, shielded: 21.11.0367; Flush Mount Wall Jack for Keystones: 25.16.8579; ROLINE Cat.6A 19" Keystone Patch Panel Module frame STP: 26.11.0360/0356; ROLINE Cat.6A S/FTP Patch Cord, 5 m: 21.15.0865.



**roline**  
Designed for Professionals

Order-No. – P.U.

ROLINE Keystone Jack, Cat. 6A, RJ-45, UTP, tool-free, white	A	26.11.0337	– 50
ROLINE Keystone Jack, Cat.6A, RJ-45, STP, tool-free, silver	B	26.11.0367	– 50
Flush Mount Wall Outlet for Keystones, 2-port	C	25.16.8579	– 20
Surface Wall Mount Frame	D	25.16.8484	– 20

## VALUE RJ-45 Modular Couplers, Cat.6

- The couplers are available in 2 versions:
  - shielded with metal housing, colour: silver
  - unshielded with plastic housing, colour: black
- The couplers are able to extend Cat.6 cables
- All couplers with eight contacts, 1:1 connected

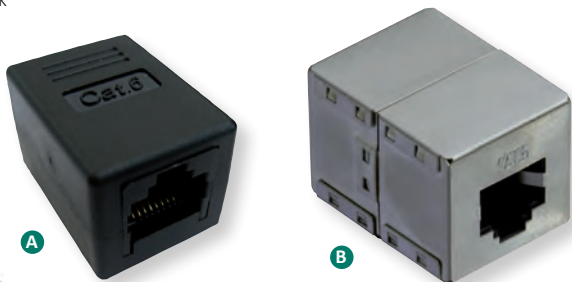

Order-No. – P.U.

VALUE RJ-45 Modular Coupler, Cat.6, UTP, black	A	21.99.3001	– 20
VALUE RJ-45 Modular Coupler, Cat.6, STP, silver	B	21.99.3002	– 20

## RJ-45 Keystone Modular Couplers, Cat.6

- The couplers are available in 2 versions:
  - shielded with metal housing, colour: silver
  - unshielded with plastic housing, colour: black
- The couplers are able to extend Cat.6 cables
- All couplers with eight contacts, 1:1 connected
- Can be installed in suitable keystone patch panels, e. g.:
  - Keystone Blank Patch Panel, 24 Ports, unshielded, light grey (26.11.0356)
  - Keystone Blank Patch Panel, 24 Ports, unshielded, black (26.11.0357)
  - Keystone Blank Patch Panel, 24 Ports, shielded, light grey (26.11.0359)
  - Keystone Blank Patch Panel, 24 Ports, shielded, black (26.11.0360)

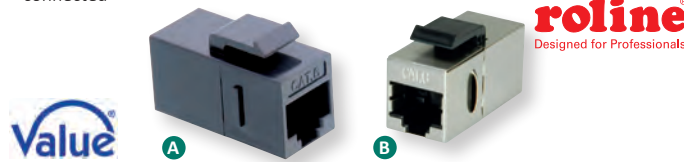

**roline**  
Designed for Professionals

Order-No. – P.U.

VALUE RJ-45 Keystone Modular Coupler, Cat.6, UTP, black	A	21.99.3003	– 20
VALUE RJ-45 Keystone Modular Coupler, Cat.6, STP	B	21.99.3004	– 20
ROLINE RJ-45 Keystone Modular Coupler, Cat.6, UTP, black	A	21.17.3003	– 20
ROLINE RJ-45 Keystone Modular Coupler, Cat.6, STP, silver	B	21.17.3004	– 20

## ROLINE Cat.5e Modular Couplers

- The ROLINE couplers are available in two versions:
  - shielded with metal housing to safe the signals against electrical and magnetic interferences, colour: silver
  - unshielded with plastic housing, colour: white resp. black
- The couplers are able to extend Cat.5e resp. Cat.6 cables
- All couplers with eight contacts, 1:1 connected

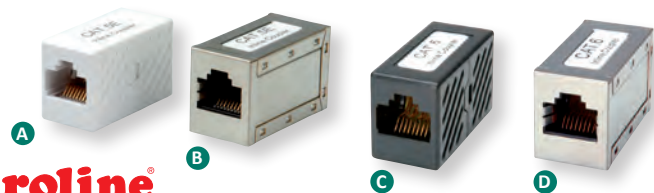

Order-No. – P.U.

ROLINE Cat.5e Modular Coupler, UTP, white	A	21.17.3001	– 20
ROLINE Cat.5e Modular Coupler, STP, silver	B	21.17.3002	– 20
ROLINE RJ-45 Modular Coupler, Cat.6, UTP, black	C	21.17.3043	– 200
ROLINE RJ-45 Modular Coupler, Cat.6, STP, silver	D	21.17.3041	– 200

## VALUE T-Adapters Cat.5e

- For the use with two 10/100 LAN connections over one (full wired) 8-wire cable
- Connection cable (17 cm) with RJ-45 plug; adapter with two RJ-45 jacks
- Pin assignment of connectors: pairs 1, 2 and 3, 6
- Wiring scheme on the adapter
- For Cat. 5e installations
- Note: The adapters can be used only pairwise

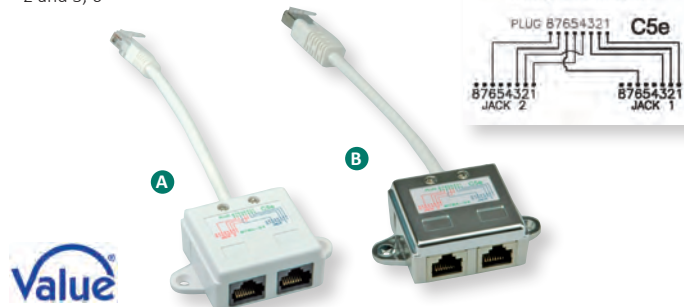

Order-No. – P.U.

VALUE T-Adapter Cat.5e, UTP, white	A	21.99.3045	– 50
VALUE T-Adapter Cat.5e, STP, silver	B	21.99.3050	– 50

## ROLINE Modular Plugs

- For Cat.5e/Cat.6 cabling systems
- Modular plugs shielded/unshielded
- 12.01.1087/1089, 21.17.3060/3061 for stranded wire
- 21.17.3062 for solid wire; with insert
- Package unit: 10 pieces

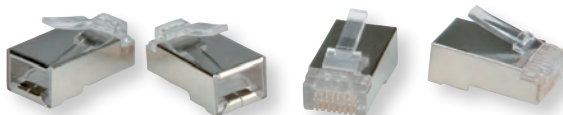

Order-No. – P.U.

ROLINE Cat.5e Modular Plug, 8p8c, UTP, for Stranded Wire, 10 pcs.	12.01.1087	– 100
ROLINE Cat.5e Modular Plug, 8p8c, STP, for Stranded Wire, 10 pcs.	12.01.1089	– 100
ROLINE Cat.6 Modular Plug, UTP, for Stranded Wire, 10 pcs.	21.17.3060	– 50
ROLINE Cat.6 Modular Plug, STP, for Stranded Wire, 10 pcs.	21.17.3061	– 50
ROLINE Cat.6 Modular Plug, UTP, for Solid Wire, 10 pcs.	21.17.3062	– 50
ROLINE Cat.6 Modular Plug, STP, for Solid Wire, 10 pcs.	21.17.3063	– 50

## VALUE Cat.6/6A Modular Plug, UTP, for Stranded Wire

- Modular Plugs unshielded
- Gold plated
- For stranded wire
- Package unit 10 /100 connectors

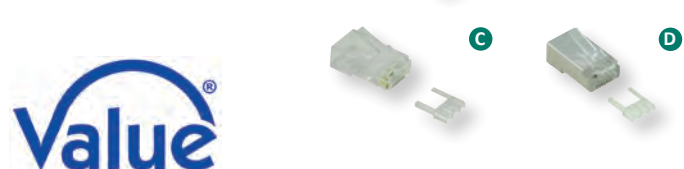

Order-No. – P.U.

VALUE Cat.5e Modular Plug, UTP, for Stranded Wire, 10 pcs.	A	21.99.3060	– 50
VALUE Cat.5e Modular Plug, STP, for Stranded Wire, 10 pcs.	B	21.99.3061	– 50
VALUE Cat.6 Modular Plug, UTP, for Stranded Wire, 10 pcs.	C	21.99.3062	– 50
VALUE Cat.6 Modular Plug, STP, for Stranded Wire, 10 pcs.	D	21.99.3063	– 50
VALUE Cat.6/6A Modular Plug, UTP, for Stranded Wire, 100 pcs.		21.99.3064	– 5
VALUE Cat.6/6A Modular Plug, STP, for Stranded Wire, 100 pcs.		21.99.3065	– 5



## VALUE Kink Protection Hood for RJ-45

- Kink protection hood for RJ45 cables
- Suitable for round cables with max. external diameter 6.5 mm
- Not suitable for HiRose plugs
- Package unit 10 connectors



Order-No. – P.U.

VALUE Kink protection hood for RJ-45, grey, grey, 10 pcs.

12.99.0000 – 10

## VALUE Junction Box Cat.6A

- The VALUE Junction box is used to repair or extend Cat.6A cables
- With this box all 4 or 8 wired installation cables with AWG24 and with an outside diameter from 4mm can be installed
- Equipped with the modern LSA connection technology, all cables in accordance with EIA/TIA 568A or 568B can be easily installed



Order-No. – P.U.

VALUE Junction Box Cat.6A, UTP

A 21.99.3048 – 25

VALUE Junction Box Cat.6A, STP

21.99.3049 – 25

## ROLINE Cat.6/6A Wall Jacks Keystone

### Cat.6 Keystones in ROLINE quality for use in Gigabit Ethernet networks or in Cat.6A 10 Gigabit Ethernet networks with a bandwidth of 500 MHz

- Connect the cable to the Keystones without the use of tools- the cable wires are simply placed in the guides, the module should be closed and compressed- ready is the connection
- Toolless Assembling
- The Keystone modules can be hooked into a 19" module (unshielded: 26.11.0357 26.11.0356 in black or light gray / black or shielded 26.11.0360 26.11.0359 in light gray). Or together with a flush mount wall jack module for keystones 25.16.8579 they become a junction box

- Colour code on the keystone jacks is based on the standard EIA/TIA 568
- The ROLINE Cat 6 / Class E 19"-Keystones satisfy the transmission properties of a Cat 6 / Class E links
- The ROLINE Cat 6A / Class EA 19"-Keystones meet the transmission properties of a Cat 6A / Class EA links
- Unique wire management stuffer cap separates pairs, prevents crossed pairs, and reduces crosstalk

### Shielded Versions:

- Shield housing made of die-cast solid zinc for better ANEXT and EMI protection.



Tool-free

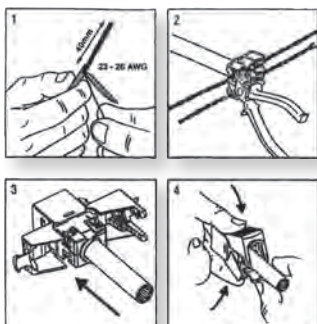

Order-No. – P.U.

ROLINE Cat.6/Class E Keystone Jack SLIM, RJ-45, UTP, tool-free, black

26.11.0375 – 50

ROLINE Keystone Jack, Cat. 6A, RJ-45, UTP, tool-free, SLIM, black

26.11.0376 – 50

ROLINE Cat.6/Class E Keystone Jack, RJ-45, STP, SLIM, tool-free, silver

26.11.0377 – 50

ROLINE Keystone Jack, Cat.6A, RJ-45, STP, tool-free, SLIM, silver

26.11.0378 – 50

## ROLINE Junction Boxes

### The ROLINE junction box is used to repair or extend Cat.5e and Cat.6 cables.

- Four different types are available, two UTP types for the unshielded cable and two STP types for the shielded cable
- With this box all 4 or 8 wired installation cables with AWG24 and with a cover from 4 mm (UTP type) up to 6.2 mm (STP type) can be installed
- Equipped with the LSA connection technology, all cables in accordance with EIA/TIA 568 can be easily installed
- With the use of the STP type junction

box, it's safe against electrical and magnetical interferences

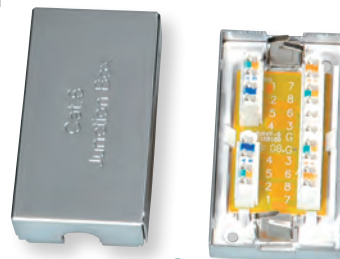

A



Order-No. – P.U.

ROLINE Junction Box Cat.5e, STP

21.17.3035 – 100

ROLINE Junction Box Cat.5e, UTP

21.17.3036 – 200

ROLINE Junction Box Cat.6, STP

A 21.17.3065 – 20

ROLINE Junction Box Cat.6, UTP

21.17.3066 – 20

## ROLINE Cat.6A Keystone Modular Coupler, STP

- The shielded RJ-45 couplers are able to extend Twisted Pair Cat.6A cables
- Best transmission characteristics for pair combination 1/2 and 3/6 (as used by all Ethernet versions)
- Hole Housing of metal to safe the signals against electrical and magnetical interferences
- 8 contacts, 1:1 connected



Order-No. – P.U.

ROLINE Cat.6A Keystone Modular Coupler, STP

21.17.3006 – 20

## VALUE Cat.6A Keystone, RJ-45, w. Shutter, Tool-free

### The low-cost solution for Cat 6.A cabling for data rates up to 10Gbit/s! Cat.6A/Class EA Keystone jack for installation in a Keystone blank 19" patch panel module frame.

- Toolless mounting- without using a LSA tool: cable wires are simply placed into the guides of Keystone module, the module is closed and compressed- the connection is ready for use
- Cat.6A Keystone Jack (Module) UTP/ STP
- Unshielded/shielded housing

- Contacts gold plated
- Slim type
- With plastic internal shutter black
- 180 degree cable entry
- Support PoE per IEEE 802.3af, PoE+ per IEEE 802.3at
- For cable AWG 22-24(0.45-0.65mm)
- For cable OD: 5.0-8.5mm
- Color code on the Keystone jacks based on the standard EIA/TIA 568 A & B
- Dimensions (L x W x H): 37.9x 15.8 x 22.2mm



NEW

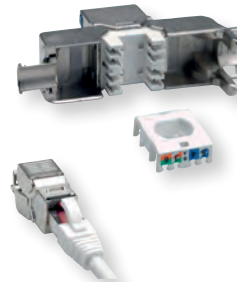

Tool-free

Order-No. – P.U.

VALUE Cat.6A Keystone, RJ-45, UTP, with shutter, tool-free

26.99.0377 – 50

VALUE Cat.6A Keystone, RJ-45, STP, with shutter, tool-free

26.99.0378 – 50

**ROLINE Keystone Holder (26.11.0375/0376) for DIN Rail**

- Cable access variable 45° from the top or at the bottom, connection direction 45° downwards
- Construction width 1 unit
- Potential equalization via an integrated potential equalization plate
- Integrated dust cover
- Snap mechanism
- Suitable modules: 26.11.0375 or 26.11.0376



Order-No. – P.U.

ROLINE Keystone Holder (26.11.0375/0376) for DIN Rail

26.11.0339 – 20

**VALUE Fibre Optic Jumper Cables, 50/125µm, OM3**

- VALUE Fibre Optic Jumper Cables with OM3 quality for high performance wiring
- Duplex Cable with fibre type Multi-mode 50/125µm, OM3
- Available length: 0,5m, 1m, 2m, 3m, 5m, 10m, 15m and 20m
- Color: turquoise

LC

SC

ST

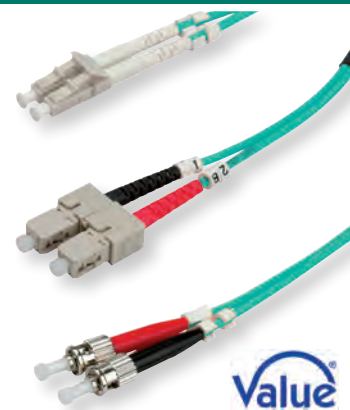

Length	Type LC/LC – P.U.	Type LC/ST – P.U.	Type LC/SC – P.U.
0.5 m	21.99.8700 – 10	21.99.8720 – 10	21.99.8710 – 10
1 m	21.99.8701 – 10	21.99.8721 – 10	21.99.8711 – 10
2 m	21.99.8702 – 10	21.99.8722 – 10	21.99.8712 – 10
3 m	21.99.8703 – 5	21.99.8723 – 5	21.99.8713 – 5
5 m	21.99.8705 – 5	21.99.8725 – 5	21.99.8715 – 5
10 m	21.99.8708 – 10	21.99.8728 – 10	21.99.8718 – 10
15 m	21.99.8706 – 5		
20 m	21.99.8707 – 5		

**ROLINE Fibre Optic Jumper Cables, 50/125µm, OM3**

- ROLINE Fibre Optic Jumper Cables with OM3 quality for high performance wiring
- The quality of the connectors and fibres and an optimal assembly procedure lead to extremely good characteristics in respect of insertion loss and reflection
- Compact conductor (fibre movable in secondary coating)
- Duplex Cable with fibre type Multi-mode 50/125µm, OM3
- Cable construction: Kevlar tension reduction, PVC outer coating, Ø 2.8 x 6 mm
- Color: turquoise

LC

SC

ST

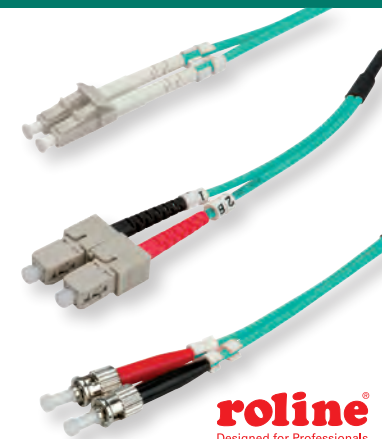

Length	Type LC/LC – P.U.	Type LC/ST – P.U.	Type LC/SC – P.U.
0.5 m	21.15.8700 – 10	21.15.8720 – 10	21.15.8710 – 10
1 m	21.15.8701 – 10	21.15.8721 – 10	21.15.8711 – 10
2 m	21.15.8702 – 10	21.15.8722 – 10	21.15.8712 – 10
3 m	21.15.8703 – 5	21.15.8723 – 5	21.15.8713 – 5
5 m	21.15.8705 – 5	21.15.8725 – 5	21.15.8715 – 5
10 m	21.15.8708 – 10	21.15.8728 – 10	21.15.8718 – 10
15 m	21.15.8706 – 5		
20 m	21.15.8707 – 5		

**ROLINE FO Jumper Cables 50/125µm OM3, Low-Loss-Connector**

- Security for the future! The OM3 fiber and connector quality with very low insertion loss ensure an excellent quality at very high bandwidths.
- Material and assembly in ROLINE quality
- The cable assembled with „low-loss“ connectors achieve very good values for insertion loss and reflection. In comparison:
  - Typical attenuation of a standard LC connector: 0.5 dB
  - Typical attenuation of a low-loss LC connector: 0.15 dB
- Duplex cables with fiber type Multi-mode 50/125µm, OM3
- Color: turquoise

Halogenfree  
Flame retardant  
Low Smoke

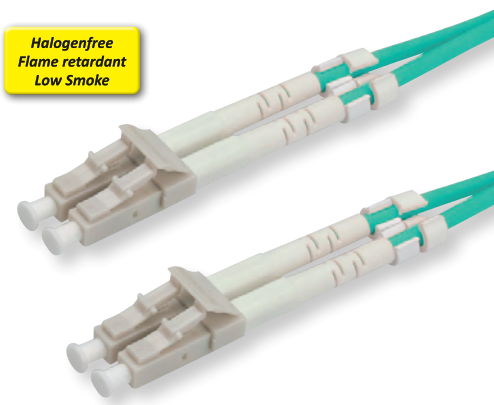

	Order-No.	– P.U.
ROLINE FO Jumper Cable 50/125µm OM3, LC/LC, Low-Loss-Connector, turquoise, 0.5 m	21.15.8820	– 5
ROLINE FO Jumper Cable 50/125µm OM3, LC/LC, Low-Loss-Connector, turquoise, 1.0 m	21.15.8821	– 5
ROLINE FO Jumper Cable 50/125µm OM3, LC/LC, Low-Loss-Connector, turquoise, 2.0 m	21.15.8822	– 5
ROLINE FO Jumper Cable 50/125µm OM3, LC/LC, Low-Loss-Connector, turquoise, 3.0 m	21.15.8823	– 5
ROLINE FO Jumper Cable 50/125µm OM3, LC/LC, Low-Loss-Connector, turquoise, 5.0 m	21.15.8825	– 5
ROLINE FO Jumper Cable 50/125µm OM3, LC/LC, Low-Loss-Connector, turquoise, 10 m	21.15.8828	– 5
ROLINE FO Jumper Cable 50/125µm OM3, LC/LC, Low-Loss-Connector, turquoise, 15 m	21.15.8829	– 5
ROLINE FO Jumper Cable 50/125µm OM3, LC/LC, Low-Loss-Connector, turquoise, 20 m	21.15.8830	– 5

VALUE Fibre Optic Jumper Cables, 50/125 µm, OM4

OM4 fiber for existing 1 and 10 Gbit/s applications as well as future 40 and 100 Gbit/s systems. Allows extended reach upwards of 550 meters at 10 Gbit/s for ultra long building backbones and medium length campus backbones. With an laser bandwidth

of 4700 MHz– km (more than double the IEEE requirement for 10 Gbit/s 300 meter support), the OM4 fiber is also especially well suited for shorter distances in data centers and high performance computing applications.

- VALUE OM4 Fibre Optic Jumper cable with fiber type 50/125 µm
- Color: purple

Length	Type LC/LC – P.U.	Type LC/ST – P.U.	Type LC/SC – P.U.
0.5 m	21.99.8750 – 10	21.99.8770 – 10	21.99.8760 – 10
1 m	21.99.8751 – 10	21.99.8771 – 10	21.99.8761 – 10
2 m	21.99.8752 – 10	21.99.8772 – 10	21.99.8762 – 10
3 m	21.99.8753 – 5	21.99.8773 – 5	21.99.8763 – 5
5 m	21.99.8755 – 5	21.99.8775 – 5	21.99.8765 – 5
10 m	21.99.8758 – 5	21.99.8778 – 5	21.99.8768 – 5
15 m	21.99.8756 – 5		
20 m	21.99.8757 – 5		

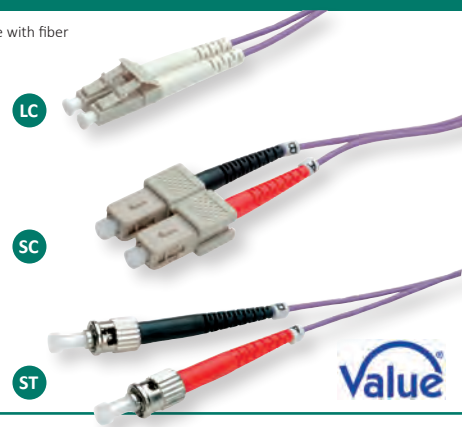

ROLINE Fibre Optic Jumper Cables, 50/125 µm, OM4

OM4 fiber for existing 1 and 10 Gbit/s applications as well as future 40 and 100 Gbit/s systems. Allows extended reach upwards of 550 meters at 10 Gbit/s for ultra long building backbones and medium length campus backbones. With an laser bandwidth

of 4700 MHz– km (more than double the IEEE requirement for 10 Gbit/s 300 meter support), the OM4 fiber is also especially well suited for shorter distances in data centers and high performance computing applications.

- ROLINE OM4 Fibre Optic Jumper cable with fiber type 50/125 µm
- Color: purple

Length	Type LC/LC – P.U.	Type LC/ST – P.U.	Type LC/SC – P.U.
0.5 m	21.15.8750 – 10	21.15.8770 – 10	21.15.8760 – 10
1 m	21.15.8751 – 10	21.15.8771 – 10	21.15.8761 – 10
2 m	21.15.8752 – 10	21.15.8772 – 10	21.15.8762 – 10
3 m	21.15.8753 – 5	21.15.8773 – 5	21.15.8763 – 5
5 m	21.15.8755 – 5	21.15.8775 – 5	21.15.8765 – 5
10 m	21.15.8758 – 5	21.15.8778 – 5	21.15.8768 – 5
15 m	21.15.8756 – 5		
20 m	21.15.8757 – 5		

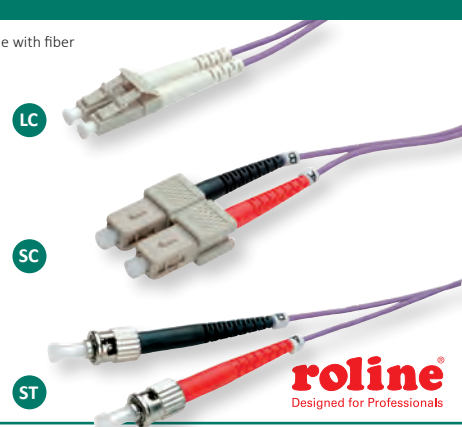

ROLINE FO Jumper Cables 50/125µm OM4, Low-Loss-Connector

**Security for the future! The OM4 fiber and connector quality with very low insertion ensure an excellent quality at very high bandwidths.**

- It supports 10 Gb/s Ethernet, Fibre Channel, and OIF applications to 550 meters, extends the system cost benefits to ultra long building backbones and medium length campus backbones.

- The cable assembled with „low– loss“ connectors achieve very good values for insertion loss and reflection. In comparison:
  - Typical attenuation of a standard LC connector: 0.5 dB
  - Typical attenuation of a low– loss LC connector: 0.15 dB

- Modal Bandwidth: 4700 MHz– km (this bandwidth is based on application– specific implementation of the EMBC requirements)
- Duplex cables with fiber type Multi– mode 50/125µm, OM4

	Order-No.	– P.U.
ROLINE FO Jumper Cable 50/125µm OM4, LC/LC, Low-Loss-Connector, violet, 0.5 m	21.15.8850	– 3
ROLINE FO Jumper Cable 50/125µm OM4, LC/LC, Low-Loss-Connector, violet, 1.0 m	21.15.8851	– 3
ROLINE FO Jumper Cable 50/125µm OM4, LC/LC, Low-Loss-Connector, violet, 2.0 m	21.15.8852	– 3
ROLINE FO Jumper Cable 50/125µm OM4, LC/LC, Low-Loss-Connector, violet, 3.0 m	21.15.8853	– 3
ROLINE FO Jumper Cable 50/125µm OM4, LC/LC, Low-Loss-Connector, violet, 5.0 m	21.15.8855	– 3
ROLINE FO Jumper Cable 50/125µm OM4, LC/LC, Low-Loss-Connector, violet, 10 m	21.15.8858	– 3
ROLINE FO Jumper Cable 50/125µm OM4, LC/LC, Low-Loss-Connector, violet, 15 m	21.15.8859	– 5
ROLINE FO Jumper Cable 50/125µm OM4, LC/LC, Low-Loss-Connector, violet, 20 m	21.15.8860	– 5

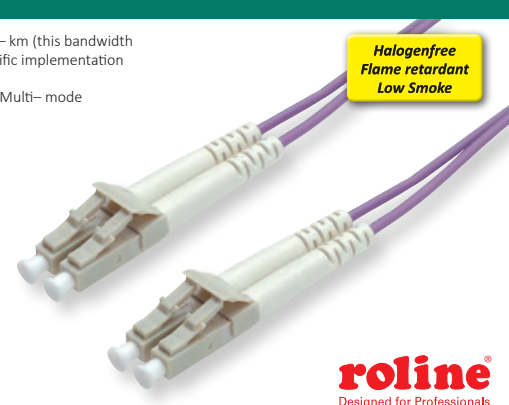

ROLINE FO Jumper Cables 50/125µm OM4, Low-Loss-Connector, for Data Center

DATA CENTER capable

**This fibre optic cable with the new connector significantly reduces the amount of space needed in rack, helping to control costs and improve efficiency**

- To double the density of fibers per rack and improve handling in Central Offices and Data Centres

- The new connector significantly reduces the amount of space needed, helping to control costs and improve efficiency.
- For a more efficient handling the connector of the fibre optic cable is equipped with a rigid, extended lever that employs a new way of push/pull mechanism

- For both installation and for ongoing handling, vertical space and finger access at the connection are needed

- The OM4 fiber and connector quality ensures an excellent quality at very high bandwidths.
- Color: purple

	Order-No.	– P.U.
ROLINE FO Jumper Cable 50/125µm OM4, LC/LC, Low-Loss-Connector, 0.5 m	21.15.8870	– 5
ROLINE FO Jumper Cable 50/125µm OM4, LC/LC, Low-Loss-Connector, 1.0 m	21.15.8871	– 5
ROLINE FO Jumper Cable 50/125µm OM4, LC/LC, Low-Loss-Connector, 2.0 m	21.15.8872	– 5
ROLINE FO Jumper Cable 50/125µm OM4, LC/LC, Low-Loss-Connector, 3.0 m	21.15.8873	– 5
ROLINE FO Jumper Cable 50/125µm OM4, LC/LC, Low-Loss-Connector, 5.0 m	21.15.8875	– 5
ROLINE FO Jumper Cable 50/125µm OM4, LC/LC, Low-Loss-Connector, 10 m	21.15.8880	– 5
ROLINE FO Jumper Cable 50/125µm OM4, LC/LC, Low-Loss-Connector, 15 m	21.15.8885	– 5
ROLINE FO Jumper Cable 50/125µm OM4, LC/LC, Low-Loss-Connector, 20 m	21.15.8890	– 5





**VALUE Fibre Optic Jumper Cable, 50/125 µm, LSOH, LC/LC, OM4**

DATA CENTER Product

OM4 fiber for existing 1 and 10 Gbit/s applications as well as future 40 and 100 Gbit/s systems. Allows extended reach upwards of 550 meters at 10 Gbit/s for ultra long building backbones and medium length campus backbones. With a laser bandwidth of 4700 MHz-km (more than double the IEEE requirement for 10 Gbit/s 300 meter support), the OM4 fiber is also especially well suited for shorter reach in data centers and high performance computing applications.

- VALUE OM4 Fibre Optic Jumper cable with fiber type 50/125 µm
- Color: purple

**Halogenfree  
Flame retardant  
Low Smoke**

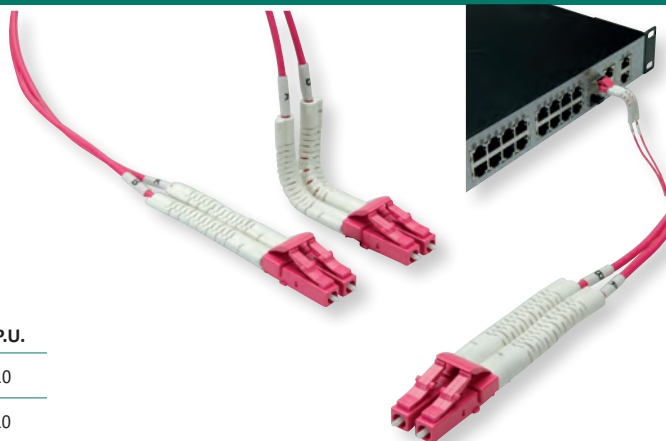

	Order-No. – P.U.
VALUE Fibre Optic Jumper Cable, 50/125 µm, LSOH, LC/LC, OM4, violet, 0.5 m	21.99.8790 – 10
VALUE Fibre Optic Jumper Cable, 50/125 µm, LSOH, LC/LC, OM4, violet, 1.0 m	21.99.8791 – 10
VALUE Fibre Optic Jumper Cable, 50/125 µm, LSOH, LC/LC, OM4, violet, 2.0 m	21.99.8792 – 10
VALUE Fibre Optic Jumper Cable, 50/125 µm, LSOH, LC/LC, OM4, violet, 3.0 m	21.99.8793 – 10
VALUE Fibre Optic Jumper Cable, 50/125 µm, LSOH, LC/LC, OM4, violet, 5.0 m	21.99.8794 – 5

**ROLINE FO SLIM Jumper Cable 50/125µm OM4, LC/LC, OD 1.2mm**

**The solution for space problems in the fiber optic area of your data center!**

**Extra-thin ROLINE fiber optic patch cables in OM4 quality for high-performance fiber optic cabling in high-density environments.**

The LC connector with its small cross-section allows high densities in the distribution area. And thanks to the extra-thin cable with a straight 1.2mm diameter, we now also have the appropriate supplement to this connector.

- Security for the future! The OM4 fiber and connector quality with very low insertion ensure an excellent qua-

lity at very high bandwidths of up to 10 Gb/s Ethernet, Fibre Channel, and OIF applications to 550 meters- extends the system cost benefits to ultra long building backbones and medium length campus backbones.

- Material and clothing in ROLINE quality
- Outer diameter: 1.2 x 2.4mm
- UPC polish
- Modal Bandwidth: 4700 MHz-km (this bandwidth is based on application-specific implementation of the EMBC requirements)
- Duplex cables with fiber type Multi-mode 50/125µm, OM4

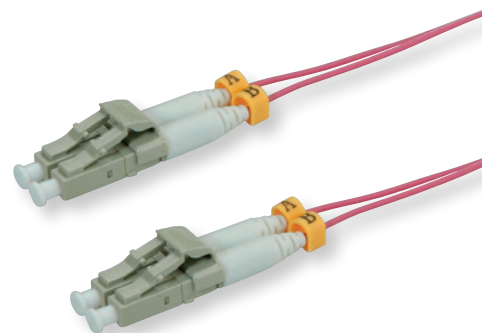

	Order-No. – P.U.
ROLINE FO SLIM Jumper Cable 50/125µm OM4, LC/LC, OD 1.2mm, violet, 1.0 m	21.15.9261 – 10
ROLINE FO SLIM Jumper Cable 50/125µm OM4, LC/LC, OD 1.2mm, violet, 2.0 m	21.15.9262 – 10
ROLINE FO SLIM Jumper Cable 50/125µm OM4, LC/LC, OD 1.2mm, violet, 3.0 m	21.15.9263 – 10
ROLINE FO SLIM Jumper Cable 50/125µm OM4, LC/LC, OD 1.2mm, violet, 5.0 m	21.15.9264 – 5
ROLINE FO SLIM Jumper Cable 50/125µm OM4, LC/LC, OD 1.2mm, violet, 10.0 m	21.15.9265 – 5

**ROLINE Fibre Optic Jumper Cable, 50/125 µm, LC/LC, OM5**

**ROLINE fiber optic patch cables in OM5 quality for high-performance fiber optic cabling in high-density environments.**

- Security for the future! The OM5 fiber connector quality with very low insertion ensures an excellent quality at very high bandwidths of up to 100 Gbit/s Ethernet, Fibre Channel, and OIF applications with up to 150 meters- extends the system cost benefits to ultra long building backbones and medium length campus backbones.
- Material and clothing in ROLINE quality
- Duplex cables with fiber type Multimode 50/125µm, OM5

- Attenuation 850nm ≤ 2.3 dB/km, 953nm ≤ 1.7 dB/km, 1300nm ≤ 0.6 dB/km
- The cable assembled with „low-loss“ connectors achieve very good values for insertion loss and reflection. Insertion loss of less than 0.3dB
- Outer diameter: 2.0mm
- UPC polish
- Modal Bandwidth: 4700 MHz-km (this bandwidth is based on application-specific implementation of the EMBC requirements)

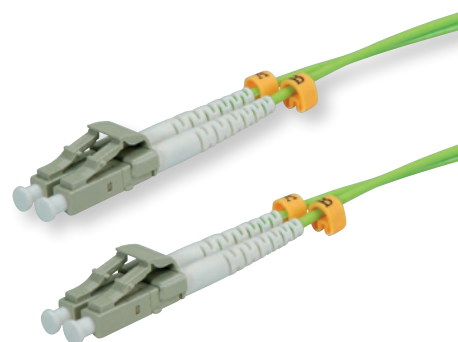

	Order-No. – P.U.
ROLINE Fibre Optic Jumper Cable, 50/125 µm, LC/LC, OM5, green, 1.0 m	21.15.9271 – 10
ROLINE Fibre Optic Jumper Cable, 50/125 µm, LC/LC, OM5, green, 2.0 m	21.15.9272 – 10
ROLINE Fibre Optic Jumper Cable, 50/125 µm, LC/LC, OM5, green, 3.0 m	21.15.9273 – 10
ROLINE Fibre Optic Jumper Cable, 50/125 µm, LC/LC, OM5, green, 5.0 m	21.15.9274 – 5
ROLINE Fibre Optic Jumper Cable, 50/125 µm, LC/LC, OM5, green, 10.0 m	21.15.9275 – 5

## ROLINE Fibre Optic Jumper Cables, 9/125µm, OS2, LC/LC, Duplex, LSOH

### ROLINE LSOH fiber optic patch cable with single mode fibers in OS2 quality.

- Cable sheathing made of halogen-free, low smoke and flame-retardant material
- Assembled with high-quality connectors with ceramic ferrule
- Core structure: Duplex cable I-VH
- High tensile strength due to Kevlar with aramid fibres

Halogen-free, flame retardant, low smoke.

	Order-No. – P.U.
ROLINE FO Jumper Cable duplex, 9/125µm, OS2, LC/LC, duplex, yellow, 0.5 m	21.15.8780 – 10
ROLINE FO Jumper Cable duplex, 9/125µm, OS2, LC/LC, duplex, yellow, 1.0 m	21.15.8781 – 10
ROLINE FO Jumper Cable duplex, 9/125µm, OS2, LC/LC, duplex, yellow, 2.0 m	21.15.8782 – 10
ROLINE FO Jumper Cable duplex, 9/125µm, OS2, LC/LC, duplex, yellow, 3.0 m	21.15.8783 – 5
ROLINE FO Jumper Cable duplex, 9/125µm, OS2, LC/LC, duplex, yellow, 5.0 m	21.15.8785 – 5
ROLINE FO Jumper Cable duplex, 9/125µm, OS2, LC/LC, duplex, yellow, 10.0 m	21.15.8789 – 5
ROLINE FO Jumper Cable duplex, 9/125µm, OS2, LC/LC, duplex, yellow, 15.0 m	21.15.8786 – 5
ROLINE FO Jumper Cable duplex, 9/125µm, OS2, LC/LC, duplex, yellow, 20.0 m	21.15.8787 – 5

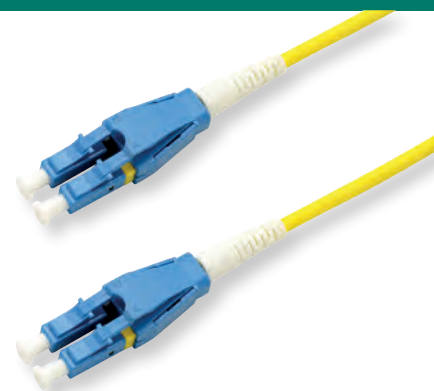

**roline**<sup>®</sup>  
Designed for Professionals

Halogenfree  
Flame retardant  
Low Smoke

## ROLINE Fibre Optic Jumper Cables 9/125µm, OS2, LC/LC, UPC Polish, Simplex, LSOH

### ROLINE LSOH fiber optic patch cable with single mode fibers in OS2 quality.

- Connects optical fibre socket to switch/router/internet box
- Suitable for high-speed Internet
- Fiber optic patch cable simplex with single mode fibers in OS2 quality

Halogen-free, flame retardant, low smoke.

	Order-No. – P.U.
ROLINE FO Jumper Cable 9/125µm, OS2, LC/LC, UPC, simplex, LSOH, yellow, 0.5 m	21.15.8840 – 10
ROLINE FO Jumper Cable 9/125µm, OS2, LC/LC, UPC, simplex, LSOH, yellow, 1.0 m	21.15.8841 – 10
ROLINE FO Jumper Cable 9/125µm, OS2, LC/LC, UPC, simplex, LSOH, yellow, 2.0 m	21.15.8842 – 10
ROLINE FO Jumper Cable 9/125µm, OS2, LC/LC, UPC, simplex, LSOH, yellow, 3.0 m	21.15.8843 – 5
ROLINE FO Jumper Cable 9/125µm, OS2, LC/LC, UPC, simplex, LSOH, yellow, 5.0 m	21.15.8845 – 5
ROLINE FO Jumper Cable 9/125µm, OS2, LC/LC, UPC, simplex, LSOH, yellow, 7.0 m	21.15.8846 – 5
ROLINE FO Jumper Cable 9/125µm, OS2, LC/LC, UPC, simplex, LSOH, yellow, 10.0 m	21.15.8847 – 5



**roline**<sup>®</sup>  
Designed for Professionals

Halogenfree  
Flame retardant  
Low Smoke

## ROLINE Fibre Optic Jumper Cables 50/125µm OM4, LSH/LC, UPC Polish, LSOH

### High-quality fibre optic cables with the high protective, secured LSH connection on one side and LC plug on the other side - both connections are UPC polished.

- Duplex cable with 50/125µm OM4 fibre type
- Cable material: sheath halogen-free and flame-retardant, violet
- LC connector: plug with high mechanical load capacity, push-pull latched with anti-rotation device, ceramic ferrule
- LSH connector: precisely manufactured connector with low return loss, ceramic ferrule
- UPC Polish (Ultra Physical Contact)
- IL < 0.25dB, RL > 25dB
- IL (typical) < 0.12dB
- Cable OD (outer diameter): 3.0 x 6.0mm

	Order-No. – P.U.
ROLINE FO Jumper Cable 50/125µm OM4, LSH/LC, UPC Polish, LSOH, violet, 0.5 m	21.15.9470 – 10
ROLINE FO Jumper Cable 50/125µm OM4, LSH/LC, UPC Polish, LSOH, violet, 1.0 m	21.15.9471 – 10
ROLINE FO Jumper Cable 50/125µm OM4, LSH/LC, UPC Polish, LSOH, violet, 2.0 m	21.15.9472 – 10
ROLINE FO Jumper Cable 50/125µm OM4, LSH/LC, UPC Polish, LSOH, violet, 3.0 m	21.15.9473 – 5
ROLINE FO Jumper Cable 50/125µm OM4, LSH/LC, UPC Polish, LSOH, violet, 5.0 m	21.15.9475 – 5
ROLINE FO Jumper Cable 50/125µm OM4, LSH/LC, UPC Polish, LSOH, violet, 7.5 m	21.15.9476 – 5
ROLINE FO Jumper Cable 50/125µm OM4, LSH/LC, UPC Polish, LSOH, violet, 10.0 m	21.15.9477 – 5

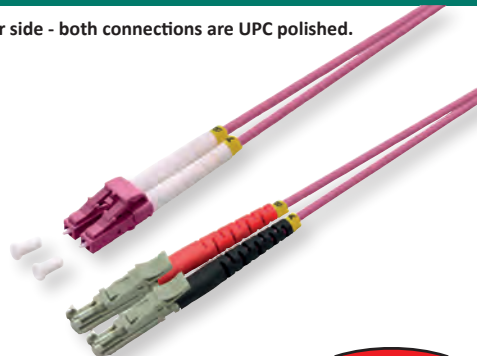

**NEW**

**roline**<sup>®</sup>  
Designed for Professionals

Halogenfree  
Flame retardant  
Low Smoke

### ROLINE FO Jumper Cable Duplex, 50/125µm OM4, LSH/LSH, UPC Polish, LSOH

**High-quality fibre optic cable with the high protective, secured LSH connection on both sides - both connections are UPC polished.**

- Duplex cable with 50/125µm OM4 fibre type
- Cable material: sheath halogen-free and flame-retardant, violet, solid core with aramid strain relief
- LSH connector: precisely manufactured connector with low return loss, ceramic ferrule, beige
- The LSH connector has a spring-loaded shutter, which fully protects the ferrule from dust and scratches
- UPC Polish (Ultra Physical Contact)

- IL < 0.25dB, RL > 25dB
- IL (typical) < 0.12dB
- Cable OD (outer diameter): 3.0 x 6.0mm



Halogenfree  
Flame retardant  
Low Smoke

**roline**<sup>®</sup>  
Designed for Professionals

**NEW**

	Order-No.	-	P.U.
ROLINE FO Jumper Cable Duplex, 50/125µm OM4, LSH/LSH, UPC Polish, LSOH, violet, 0.5 m	21.15.9490	-	10
ROLINE FO Jumper Cable Duplex, 50/125µm OM4, LSH/LSH, UPC Polish, LSOH, violet, 1.0 m	21.15.9491	-	10
ROLINE FO Jumper Cable Duplex, 50/125µm OM4, LSH/LSH, UPC Polish, LSOH, violet, 2.0 m	21.15.9492	-	10
ROLINE FO Jumper Cable Duplex, 50/125µm OM4, LSH/LSH, UPC Polish, LSOH, violet, 3.0 m	21.15.9493	-	5
ROLINE FO Jumper Cable Duplex, 50/125µm OM4, LSH/LSH, UPC Polish, LSOH, violet, 5.0 m	21.15.9495	-	5
ROLINE FO Jumper Cable Duplex, 50/125µm OM4, LSH/LSH, UPC Polish, LSOH, violet, 7.5 m	21.15.9496	-	5
ROLINE FO Jumper Cable Duplex, 50/125µm OM4, LSH/LSH, UPC Polish, LSOH, violet, 10.0 m	21.15.9497	-	5

### ROLINE FO Jumper Cable Duplex, 9/125µm, OS2, LSH/LC, APC Polish, LSOH

**High-quality fibre optic cable with the high protective, secured LSH connection on one side and LC plug on the other side - both connections are APC polished.**

- Duplex cable with fiber type 9/125µm OS2
- Cable material: sheath halogen-free and flame-retardant, yellow, solid core with aramid strain relief
- LC connector: connector with high mechanical load capacity, push-pull latched with anti-rotation lock, APC ground joint, ceramic ferrule
- LSH connector: precision-manufactured connectors with low return loss (RL), APC ground joint, ceramic ferrule, green
- The LSH connector has a spring-loaded shutter, which fully protects the ferrule from dust and scratches

- APC Polish (8° - APC- Angled Physical Contact- allows tighter connection and smaller end-face radii)
- IL < 0.25dB, RL > 60dB
- IL (typical) < 0.12dB
- Cable OD (outer diameter): 3.0 x 6.0mm



Halogenfree  
Flame retardant  
Low Smoke

**roline**<sup>®</sup>  
Designed for Professionals

**NEW**

	Order-No.	-	P.U.
ROLINE FO Jumper Cable Duplex, 9/125µm, OS2, LSH/LC, APC Polish, LSOH, yellow, 0.5 m	21.15.9480	-	10
ROLINE FO Jumper Cable Duplex, 9/125µm, OS2, LSH/LC, APC Polish, LSOH, yellow, 1.0 m	21.15.9481	-	10
ROLINE FO Jumper Cable Duplex, 9/125µm, OS2, LSH/LC, APC Polish, LSOH, yellow, 2.0 m	21.15.9482	-	10
ROLINE FO Jumper Cable Duplex, 9/125µm, OS2, LSH/LC, APC Polish, LSOH, yellow, 3.0 m	21.15.9483	-	5
ROLINE FO Jumper Cable Duplex, 9/125µm, OS2, LSH/LC, APC Polish, LSOH, yellow, 5.0 m	21.15.9485	-	5
ROLINE FO Jumper Cable Duplex, 9/125µm, OS2, LSH/LC, APC Polish, LSOH, yellow, 7.5 m	21.15.9486	-	5
ROLINE FO Jumper Cable Duplex, 9/125µm, OS2, LSH/LC, APC Polish, LSOH, yellow, 10.0 m	21.15.9487	-	5

### ROLINE FO Jumper Cable Duplex, 9/125µm, OS2, LSH/LSH, APC Polish, LSOH

**High-quality fibre optic cable with the high protective, secured LSH connection on both sides - both connections are APC polished.**

- Duplex cable with fiber type 9/125µm OS2
- Cable material: sheath halogen-free and flame-retardant, yellow, solid core with aramid strain relief
- LSH connectors: precision-manufactured connectors with low return loss, APC ground joint, ceramic ferrule
- The LSH connector has a spring-loaded shutter, which fully protects the ferrule from dust and scratches

- APC Polish (8° - APC- Angled Physical Contact- allows tighter connection and smaller end-face radii)
- IL < 0.25dB, RL > 60dB
- IL (typical) < 0.12dB
- Cable OD (outer diameter): 3.0 x 6.0mm



Halogenfree  
Flame retardant  
Low Smoke

**roline**<sup>®</sup>  
Designed for Professionals

**NEW**

	Order-No.	-	P.U.
ROLINE FO Jumper Cable Duplex, 9/125µm, OS2, LSH/LSH, APC Polish, LSOH, yellow, 0.5 m	21.15.9500	-	10
ROLINE FO Jumper Cable Duplex, 9/125µm, OS2, LSH/LSH, APC Polish, LSOH, yellow, 1.0 m	21.15.9501	-	10
ROLINE FO Jumper Cable Duplex, 9/125µm, OS2, LSH/LSH, APC Polish, LSOH, yellow, 2.0 m	21.15.9502	-	10
ROLINE FO Jumper Cable Duplex, 9/125µm, OS2, LSH/LSH, APC Polish, LSOH, yellow, 3.0 m	21.15.9503	-	5
ROLINE FO Jumper Cable Duplex, 9/125µm, OS2, LSH/LSH, APC Polish, LSOH, yellow, 5.0 m	21.15.9505	-	5
ROLINE FO Jumper Cable Duplex, 9/125µm, OS2, LSH/LSH, APC Polish, LSOH, yellow, 7.5 m	21.15.9506	-	5
ROLINE FO Jumper Cable Duplex, 9/125µm, OS2, LSH/LSH, APC Polish, LSOH, yellow, 10.0 m	21.15.9507	-	5



## ROLINE FO Jumper Cable LSH Duplex, 9/125µm, OS2, LSH APC / LC UPC, LSOH

**High-quality fibre optic cable with the high protective, secured APC polished LSH connection on one side and UPC polished LC plug on the other side.**

- Duplex cable with fiber type 9/125µm OS2
- Cable material: sheath halogen-free and flame-retardant, yellow, solid core with aramid strain relief

- LC connector: connector with high mechanical load capacity, push-pull latched with anti-rotation lock, APC ground joint, ceramic ferrule
- LSH connectors: precision-manufactured connectors with low return loss, APC ground joint, ceramic ferrule, grey
- The LSH connector has a spring-loaded shutter, which fully protects the ferrule

- from dust and scratches
- LSH APC Polish (8°) / LC UPC Polish
- IL < 0.25dB, RL > 25dB
- IL (typical) < 0.12dB
- Cable OD (outer diameter): 3.0 x 6.0mm



Halogenfree  
Flame retardant  
Low Smoke

**roline**<sup>®</sup>  
Designed for Professionals

**NEW**

	Order-No. – P.U.
ROLINE FO Jumper Cable LSH Duplex, 9/125µm, OS2, LSH APC / LC UPC, LSOH, yellow, 0.5 m	21.15.9510 – 10
ROLINE FO Jumper Cable LSH Duplex, 9/125µm, OS2, LSH APC / LC UPC, LSOH, yellow, 1.0 m	21.15.9511 – 10
ROLINE FO Jumper Cable LSH Duplex, 9/125µm, OS2, LSH APC / LC UPC, LSOH, yellow, 2.0 m	21.15.9512 – 10
ROLINE FO Jumper Cable LSH Duplex, 9/125µm, OS2, LSH APC / LC UPC, LSOH, yellow, 3.0 m	21.15.9513 – 5
ROLINE FO Jumper Cable LSH Duplex, 9/125µm, OS2, LSH APC / LC UPC, LSOH, yellow, 5.0 m	21.15.9515 – 5
ROLINE FO Jumper Cable LSH Duplex, 9/125µm, OS2, LSH APC / LC UPC, LSOH, yellow, 7.5 m	21.15.9516 – 5
ROLINE FO Jumper Cable LSH Duplex, 9/125µm, OS2, LSH APC / LC UPC, LSOH, yellow, 10.0 m	21.15.9517 – 5

## ROLINE Fibre Optic Adapter, LSH, Flange

**ROLINE fiber optic coupler for the connection of fiber optic patch cables with LSH connector.**

- Fiber optic adapters and couplings for cost effective fiber-optic cabling
- LSH/LSH- socket
- To extend fiber optic cables
- Guide sleeves of the ferrule ceramic

- IL(typical) < 0.15dB
- RL(typical) > 60dB
- With nut and screw applicability



**roline**<sup>®</sup>  
Designed for Professionals

**NEW**

Order-No. – P.U.

ROLINE Fibre Optic Adapter, LSH, Flange, green	21.17.0040 – 50
ROLINE Fibre Optic Adapter, LSH, Flange, beige	21.17.0041 – 50

## VALUE Fibre Optic Universal-Cleaning Cassette

- Can be used for any optical fiber cables plug type independently
- The cassette cleaner wipes away contaminants from optical connector end face
- Designed for all types of connectors
- Compact size for easy hand-held operations
- Dry-clean without the use of harmful substances
- Cleaning micro fibers are densely stranded and debris free
- Constructed with anti-static material
- Up to 500 cleanings per unit possible
- Contents: 100 Cleaning-Tissues



**Value**<sup>®</sup>

Order-No. – P.U.

VALUE Fibre Optic Universal-Cleaning Cassette

13.99.3005 – 5

## VALUE Fibre Optic Cleaning Pen for SC/LC Plug

- Ergonomic and comfortable design for SC/LC cleaning SC connections
- Consistent cleaning results due to its precise mechanical action
- Economical solution with up to 800 endface cleanings in one unit possible
- Cleans both APC and UPC connectors
- Effective on a variety of contaminants, including: Dust / Lint / Oil / Grease



**Value**

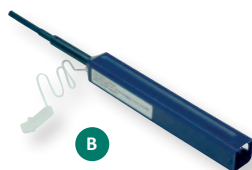

Order-No. – P.U.

VALUE Fibre Optic Cleaning Pen for SC Plug, 2.5mm	A 13.99.3006 – 5
VALUE Fibre Optic Cleaning Pen for LC Plug, 1.25mm	B 13.99.3007 – 5

## Portable Laser Fiber Checker Pro

- For the quick test of Fibre Optic cables.
- Sends a visible (650 nm) strong laser signal through the cable-breaking points become transparent by a visible light in the area of the damage
- Universal-connector can be used with common connector types (ST, SC, FC and others)

- Reversible between continuous and pulsing ray
- Both Multi-mode and Single-mode distances suitable
- Batteries (not included in delivery): 2x Mignon (AA) 1.5V (LR06)



**Value**<sup>®</sup>

Order-No. – P.U.

Portable Laser Fiber Checker Pro

13.99.3011 – 25

### ROLINE Fiber Optic Keystone Jacks

- ROLINE quality keystone adapter for fiber optic cabling
- 2x LC / 2x LC plug
- For installation in fiber optic front plates or for extending fiber optic jumper cables
- High quality plastic housing with keystone technicque
- Sleeve of the ferrule made of phosphor-bronze (PB)
- For Multimode fiber optic jumper cables
- Can be used with 19" Patch Panel Module frame (26.11.0357 or 26.11.0356)
- Can be used together with a Flush Mount Wall Jack for keystones, 2-port (25.16.8579) or with a Surface Wall Mount Frame (25.15.8484)



**roline**  
Designed for Professionals

	Order-No.	P.U.
ROLINE Fiber Optic Keystone Jack, LC Duplex, Multimode, OM3	A 21.17.0001	- 20
ROLINE Fiber Optic Keystone Jack, LC/LC Duplex, Multimode, OM4	B 21.17.0002	- 20
Keystone 19" Module frame Cat.5/Cat.6, 24 P., blank, UTP, light grey	C 26.11.0356	- 5
Keystone 19" Module frame Cat.5/Cat.6, 24 Ports, blank, UTP, black	D 26.11.0357	- 5
Flush Mount Wall Outlet for Keystones, 2-port	E 25.16.8579	- 20
Surface Wall Mount Frame	F 25.16.8484	- 20

### VALUE Fibre Optic Adapters

- Fiber optic adapters and couplings for the cost effective fiber-optic cabling
- For mounting in fiber optic faceplates or for the extension for fiber optic cables
- The adapters are made of high quality plastic
- The guide sleeve for the ferrules are available in phosphor bronze (PB) for OM3/OM4

- 21.99.0650**
- 19" FO panel to split multi-core fiber optic cable on single cores
  - Prepared for splice trays
  - 1.5 mm sheet steel, black
  - Cable entry: PG 13
  - Space for max. 24 SC duplex couplings 21.99.0655/0656/0657 or 24 LC couplings (quadruple) 21.99.0660/0661/0662

**Value**

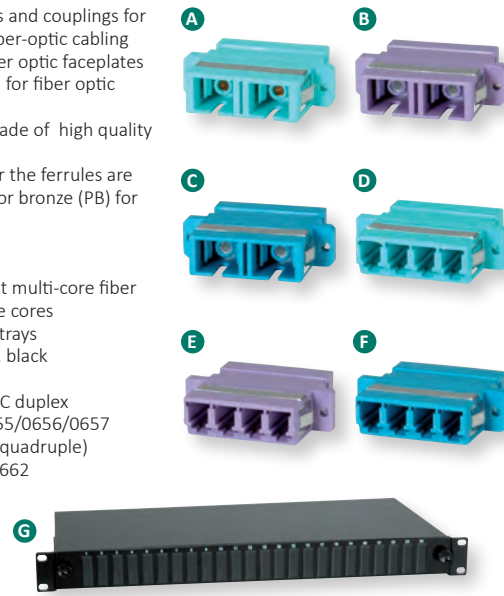

	Order-No.	P.U.
VALUE Fibre Optic Adapter SC/SC Duplex, OM3, PB	A 21.99.0655	- 50
VALUE Fibre Optic Adapter SC/SC Duplex, OM4, PB	B 21.99.0656	- 50
VALUE Fibre Optic Adapter SC/SC Duplex, OS2, Z	C 21.99.0657	- 50
VALUE Fibre Optic Adapter LC quadruple, OM3, PB	D 21.99.0660	- 50
VALUE Fibre Optic Adapter LC quadruple, OM4, PB	E 21.99.0661	- 50
VALUE Fibre Optic Adapter LC quadruple, OS2, Z	F 21.99.0662	- 50
VALUE 19" splice box empty 1U, extendable, 24x SC-DX quadruple	G 21.99.0650	- 4

### ROLINE Fibre Optic Adapters

- Fiber optic adapters and couplings for the cost effective fiber-optic cabling
- For mounting in fiber optic faceplates or for the extension for fiber optic cables
- The ST simplex adapters are made of metal, all other adapters from high quality plastic
- The guide sleeve for the ferrules are available for every type and version of phosphor bronze (PB) as well as a version of zirconium (Z)
- The version of zirconium ferrule is also suitable for single-mode

**roline**  
Designed for Professionals

	Order-No.	P.U.
ROLINE Fibre Optic Adapter, ST, Thread, MultiMode, PB	A 21.17.0015	- 50
ROLINE Fibre Optic Adapter, ST, Thread, SingleMode, Z	A 21.17.0011	- 50
ROLINE Fibre Optic Adapter, ST, Flange, MultiMode, PB	B 21.17.0025	- 50
ROLINE Fibre Optic Adapter, ST, Flange, SingleMode, Z	B 21.17.0021	- 50
ROLINE Fibre Optic Adapter, ST Duplex, MultiMode, PB	C 21.17.0035	- 50
ROLINE Fibre Optic Adapter, ST Duplex, SingleMode, Z	C 21.17.0031	- 50
ROLINE Fibre Optic Adapter SC Simplex Multimode, PB	D 21.17.0075	- 50
ROLINE Fibre Optic Adapter SC Simplex Single-Mode, Z	D 21.17.0071	- 50
ROLINE Fibre Optic Adapter SC Duplex Multimode, PB	E 21.17.0085	- 50
ROLINE Fibre Optic Adapter SC Duplex Single-Mode, Z	E 21.17.0081	- 50
ROLINE Fibre Optic Adapter ST/SC Simplex Multimode, PB	F 21.17.0105	- 50
ROLINE Fibre Optic Adapter ST/SC Simplex Single-Mode, Z	F 21.17.0101	- 50
ROLINE Fiber Optic Adapter ST/SC Duplex Multimode, PB	G 21.17.0125	- 50
ROLINE Fiber Optic Adapter ST/SC Duplex Single-Mode, Z	G 21.17.0121	- 50
ROLINE Fiber Optic Adapter LC Duplex Multimode, PB	H 21.17.0145	- 50
ROLINE Fibre Optic Adapter LC Duplex Single-Mode, Z	H 21.17.0141	- 50

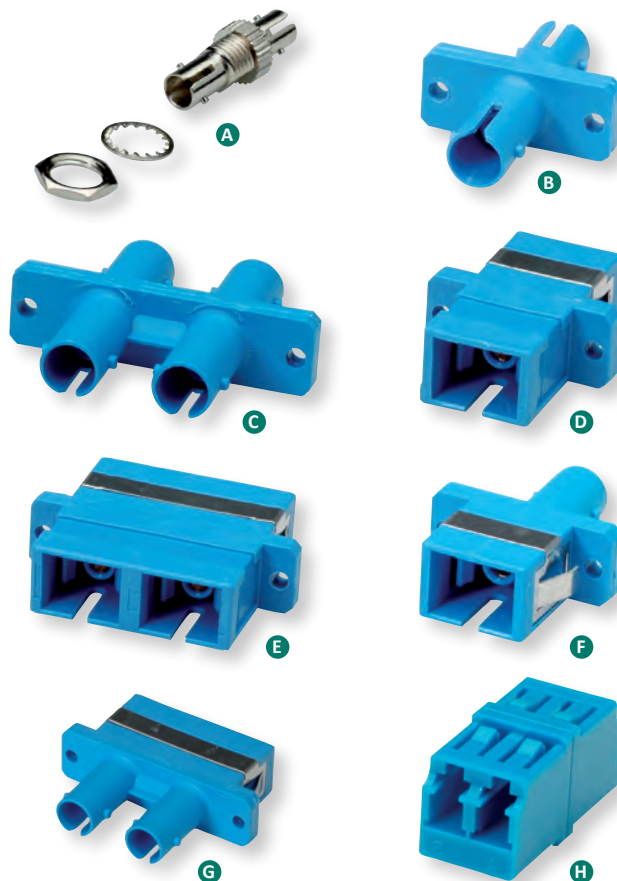

## ROLINE Fibre Optic Adapter LC quadruple, Multimode, OM5

- Fiber optic adapters and couplings for cost effective fiber-optic cabling
- 4x LC / 4x LC socket
- For installation or extension of fiber optic cables
- High quality plastic housing (green)
- Guide sleeves of the ferrule made of zirconium (Z)
- Suitable for multi-mode fiber optic cable
- Quad LC coupling- fits in front panel cutouts for duplex SC

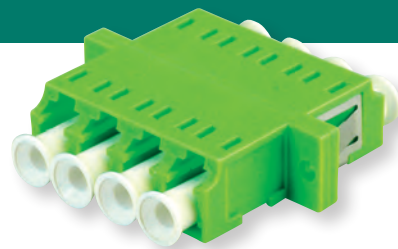

Order-No. – P.U.

ROLINE Fibre Optic Adapter LC quadruple, Multimode, OM5, Z 21.17.0050 – 50

**roline**  
Designed for Professionals

## ROLINE MPO (multi-fibre push-on) Cabling System

DATA CENTER  
Product

The MPO (multi-fibre push-on) cabling system is an easy-to-use solution based on a high density connector and ribbon-fiber cables with 12 cores. This system is commonly used in data centers but also e.g. between server rooms. It is designed for reliable and quick operations with the obvious benefits of less space requirements and improved scalability. The pre-terminated MPO cables can fan-out to other connections, usually to LC, to interconnect with standard-density products or services, using modules or fan-out cables.

### Key Facts MPO

- Fully supports all optical fiber applications within the Ethernet family
- Modular solution with reusable modules and cables
- High-density cabling saves pathway space and gives improved airflow compared to traditional cable bundles
- Cables are pre-terminated in the factory to the correct length with high density connectivity

### MPO components

MPO connectors contact usually 12 fibers in a single connection. A connection must be stable and its ends correctly aligned. These aspects are essential for achieving the required transmission. MPO connectors are available in a male version (with pins) or a female version (without pins). The pins ensure that the fronts of the connectors are exactly aligned on contact and that the end-faces of the fibers are not offset.

Remark: all cables are halogen-free (LSOH). The connectors are low-loss connectors with a very low attenuation.

### 1. Cables

MPO cables are delivered already terminated. That requires greater care in planning in advance but it has a number of advantages: short installation times, tested and guaranteed quality and great reliability.

### Trunk cables:

Trunk cables serve as a permanent link connecting the MPO modules to each other. Trunk cables are available with 12 fibers. Their ends are terminated with 12-fiber MPO connectors female version (without pins).

### Fan-Out cables:

Fan-Out cables are used for the connection of a MPO cable to standard-density connectors, usually to 12 LC connectors.

### Fiber optic - Cable OM3:

Please see the ROLINE Fiber optic jumper cable 50/125µm OM3 in the catalogue on page 1.35. The key point of each installation is to ensure the correct wiring from transmitter to receiver. In case of using a set of cassettes, trunkcables and duplex patchcords- you need to follow a certain guideline for the polarity method of the trunkcables. The case described in the graphic is according to the polarity A method, means the duplex fibre optic jumper cables MUST be CROSS connected on one side and STRAIGHT connected on the second side.

### 2. Adapters

Adapters are used to connect two MPO connectors. They enforce that both keys are up. So the two connectors are connected while in the same position in relation to each other.

### 3. Modules

Modules and adapter plates are what connect the permanent link to the standard-density patch cable.

The MPO module enables the user to take the fibers brought by a trunk cable and distribute them to a duplex cable. As already assembled units, the MPO modules are fitted with 12 fibers and have LC adapters on the front side and MPO at the rear.

The modules can be built in panels to be installed in a 19" rack.

### Connection rules

- When creating an MPO connection, always use one male connector and one female connector plus one MPO adapter.
  - Never connect a male to a male or a female to a female.
- With a female-to-female connection, the fiber cores of the two connectors will not be at the exact same height because the guide pins are missing. That will lead to losses in performance.

A male-to-male connection has even more disastrous results. There the guide pins hit against guide pins so no contact is established. This can also damage the connectors.

c) Never dismantle an MPO connector.

The pins are difficult to detach from an MPO connector and the fibers might break in the process.

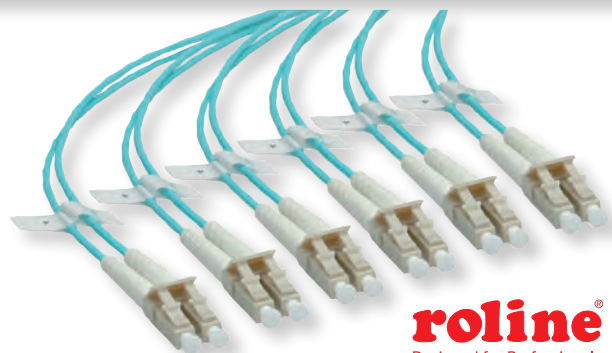
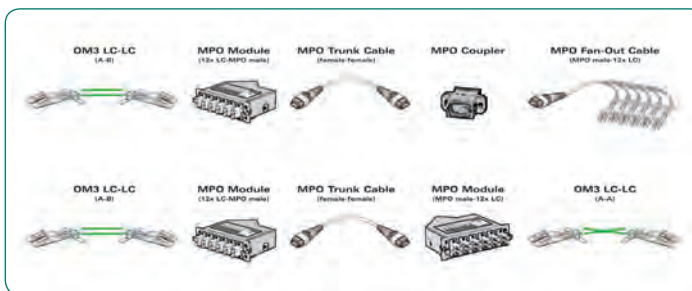

**roline**  
Designed for Professionals

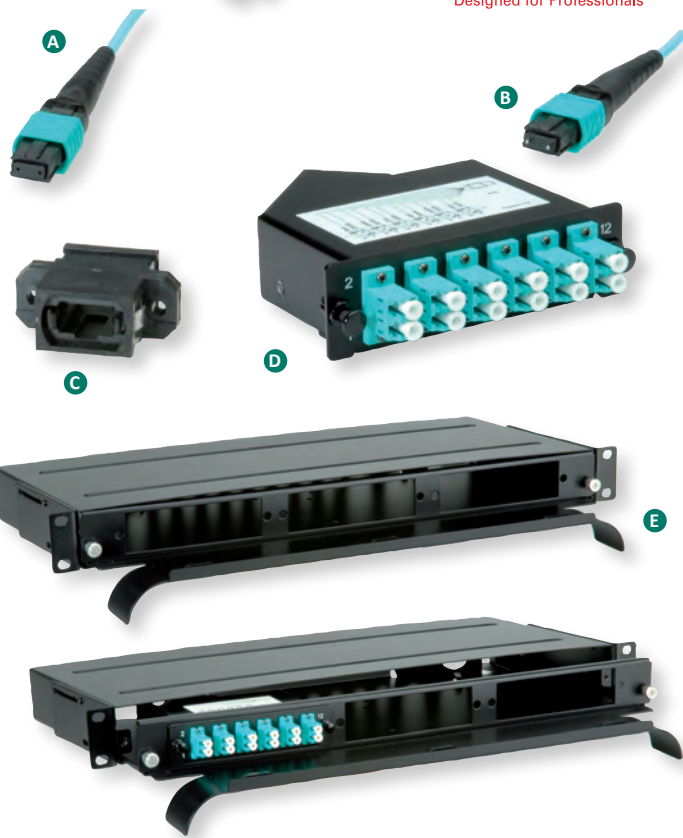

Order-No. – P.U.

ROLINE MPO Trunk Cable 50/125µm OM3, MPO/MPO, turquoise, 3m A 21.17.0303 – 10

ROLINE MPO Trunk Cable 50/125µm OM3, MPO/MPO, turquoise, 5m A 21.17.0305 – 10

ROLINE MPO Trunk Cable 50/125µm OM3, MPO/MPO, turquoise, 10m A 21.17.0310 – 5

ROLINE MPO Trunk Cable 50/125µm OM3, MPO/MPO, turquoise, 15m A 21.17.0315 – 5

ROLINE MPO Fan-Out Cable 50/125µm OM3, MPO/12x LC, turquoise, 2m B 21.17.0300 – 5

ROLINE MPO/MPO Coupler C 21.17.0319 – 10

ROLINE MPO-Modul, MPO-Male /12x LC - Female D 21.17.0348 – 3

ROLINE MPO-Panel 19" for 3 Modules E 21.17.0349 – 1



VALUE / ROLINE 19" LCD KVM Consoles

The professional solution for server-management.

- 19" LCD console combines the function of a keyboard, a touchpad and a 43 cm/48 cm TFT together in a 1 U casing for a 19" rack
- For an installation depth of 63 to 90 cm
- Keyboard layout: English (UK), others on demand
- Contents: Console, rails with mounting accessories, rack mount brackets, keys, KVM cable (HDDB-15/VGA + 2x PS/2, 1.8 m), USB cable, power supply, power cord, CD with manual, quick installation guide
- **Technical particularity of the ROLINE consoles:** Dual rail design for independent panel and keyboard drawer. Panel can be left open while rack door is closed, so that it can e. g. be used as a surveillance monitor.

Monitor data:

- Panel protected by tempered glass
- Active 43 cm/48 cm matrix TFT display
- Max. resolution (nominal): 1280 x 1024 Pixel (4:3 Format) or 1920 x 1080 Pixel (DVI, 4:3 Format), 1440 x 900 Pixel (16:10 Format)
- Refresh rate: up to 80 kHz
- Contrast: 400:1
- Brightness: 250 cd/m<sup>2</sup>



Recommended switches and cables (ONLY for ROLINE Consoles):

- 14.01.3224 ROLINE 19" KVM Switch, 1 User- 8 PC, USB and PS/2
- 14.01.3225 ROLINE 19" KVM Switch, 1 User- 16 PC, USB and PS/2
- Cable for PS/2: 11.01.5521 (1.8 m), 11.01.5522 (3 m)
- Cable for USB: 11.01.5525 (1.8 m), 11.01.5526 (3 m)



26.99.010x



26.50.008x,  
26.50.030x,  
26.50.020x

Dimensions (mm)

	A	B	C	D
VALUE 19" KVM Console, 43 cm (26.99.010x)	645	570- 850	-	645
VALUE 19" KVM Console, 48 cm (26.99.011x)	645	570- 850	-	645
ROLINE 19" KVM Console, 43 cm (26.50.008x, 26.50.030x)	460	560- 870	640	640
ROLINE 19" KVM Console, 48 cm (26.50.020x)	530	635- 950	730	730

Legend:

- A- Installation depth of console
- B- Distance of 19" cabinet's vertical posts
- C- Installation depth of console with switch (14.01.3224/5)
- D- Length of rails

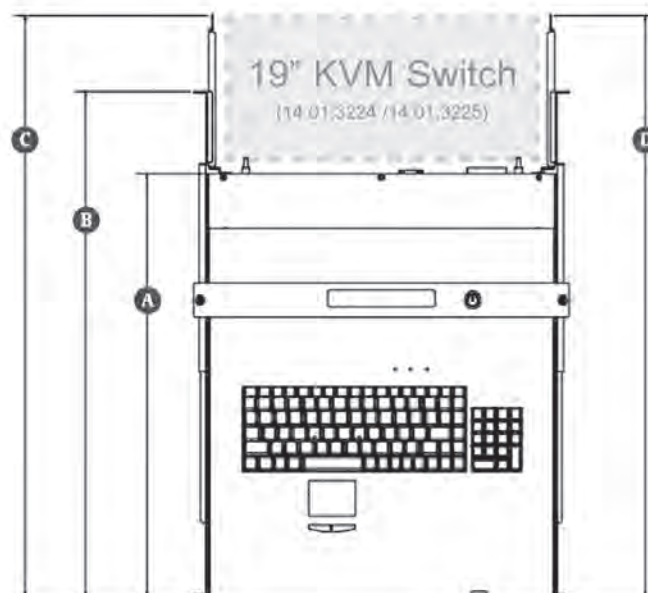

Order-No. – P.U.

VALUE 19" LCD KVM Console, 43 cm (17") TFT, VGA, USB + PS/2, UK	26.99.0100	- 1
VALUE 19" LCD KVM Console, 43 cm (17") TFT, VGA, USB + PS/2, German	26.99.0101	- 1
VALUE 19" LCD KVM Console, 43 cm (17") TFT, VGA, USB + PS/2, Swiss	26.99.0102	- 1
VALUE 19" LCD KVM Console, 43 cm (17") TFT, VGA, USB + PS/2, French	26.99.0103	- 1
VALUE 19" LCD KVM Console, 48 cm (19") TFT, VGA, USB + PS/2, UK	26.99.0110	- 1
VALUE 19" LCD KVM Console, 48 cm (19") TFT, VGA, USB + PS/2, German	26.99.0111	- 1
VALUE 19" LCD KVM Console, 48 cm (19") TFT, VGA, USB + PS/2, Swiss	26.99.0112	- 1
VALUE 19" LCD KVM Console, 48 cm (19") TFT, VGA, USB + PS/2, French	26.99.0113	- 1
ROLINE 19" LCD KVM Console, 43 cm (17") TFT, VGA, USB + PS/2, UK	26.50.0081	- 1
ROLINE 19" LCD KVM Console, 43 cm (17") TFT, VGA, USB + PS/2, German	26.50.0082	- 1
ROLINE 19" LCD KVM Console, 43 cm (17") TFT, VGA, USB + PS/2, Swiss	26.50.0083	- 1
ROLINE 19" LCD KVM Console, 43 cm (17") TFT, VGA, USB + PS/2, French	26.50.0084	- 1
ROLINE 19" LCD KVM Console, 43 cm (17") TFT, DVI-I, USB + PS/2, UK	26.50.0301	- 1
ROLINE 19" LCD KVM Console, 43 cm (17") TFT, DVI-I, USB + PS/2, D	26.50.0302	- 1
ROLINE 19" LCD KVM Console, 43 cm (17") TFT, DVI-I, USB + PS/2, CH	26.50.0303	- 1
ROLINE 19" LCD KVM Console, 43 cm (17") TFT, DVI-I, USB + PS/2, French	26.50.0304	- 1
ROLINE 19" LCD KVM Console, 48 cm (19") TFT, VGA, USB + PS/2, UK	26.50.0201	- 1
ROLINE 19" LCD-KVM Console, 48 cm (19") TFT, VGA, USB + PS/2, German	26.50.0202	- 1
ROLINE 19" LCD-KVM Console, 48 cm (19") TFT, VGA, USB + PS/2, Swiss	26.50.0203	- 1
ROLINE 19" LCD-KVM Console, 48 cm (19") TFT, VGA, USB + PS/2, French	26.50.0204	- 1



## VALUE Stand/Wall Mount Cabinets with Glass Front

- VALUE stand/wall mount cabinets for the installation of active and passive network components
- Toughened glass front with lock with rotary handle, the direction of opening the door can be changed according to the requirement, the opening degree of the door is more than 180°
- Quick open side door, convenient for equipment installation and maintaining
- One cable channel on the top and the other on the bottom
- 19" standard installation, installation depth can be adjusted according to the requirement
- Colour: black (RAL 7021)
- Remark: Delivery as an assembly set
- Maximum load capacity: 60kg
- Contents: Wall mount rack, grounding set, installation material



### Order-No. – P.U.

VALUE 19" Wall Mount Rack 6U, 368x570x450mm (HxWxD)	26.99.0146 – 1
VALUE 19" Wall Mount Rack 6U, 368x570x600mm (HxWxD)	26.99.0147 – 1
VALUE 19" Wall Mount Rack 9U, 505x570x450mm (HxWxD)	26.99.0149 – 1
VALUE 19" Wall Mount Rack 9U, 505x570x600mm (HxWxD)	26.99.0150 – 1
VALUE 19" Wall Mount Rack 12U, 640x570x450mm (HxWxD)	26.99.0151 – 1
VALUE 19" Wall Mount Rack 12U, 640x570x600mm (HxWxD)	26.99.0152 – 1
VALUE 19" Wall Mount Rack 15U, 775x570x450mm (HxWxD)	26.99.0154 – 1
VALUE 19" Wall Mount Rack 15U, 775x570x600mm (HxWxD)	26.99.0155 – 1
VALUE 19" Wall Mount Rack 18U, 910x570x450mm (HxWxD)	26.99.0157 – 1
VALUE 19" Wall Mount Rack 18U, 910x570x600mm (HxWxD)	26.99.0158 – 1



## VALUE Network / Server Cabinets 42U

DATA CENTER  
Product

### VALUE 19"-Cabinets, black, in 42 U, with two versions - as Server and as Cabling Cabinet

- Server Cabinet in BxT 800x1000mm with vented doors on front and back side
- Cabling Cabinet in BxT 800x800mm with a glass door on the front side and a back door in sheet steel
- Two pairs of 19"-profiles
- All doors are lockable with single point locking
- Both Cabinet versions have 4 castors as well as 4 adjustable feet
- Demountable side panels, convenient for installation and maintenance
- Top cover of Server Cabinet with cable entry opening possibility
- Top cover of Cabling Cabinet with cable entry opening possibility and with 4 cooling fans included
- All cabinets come with 3 fixed shelves and a pair of vertical cable management

#### REMARK:

Please be aware that the cabinets are assembled.

To avoid damage during transport, a special care is needed.

The transport sizes are different (larger) to the mentioned dimensions in the description.

The transport has to be done in a vertical position!



### Order-No. – P.U.

VALUE Network Cabinet 42U, 2000x800x800 mm	A 26.99.0810 – 1
VALUE Server Cabinet 42U, 2000x800x1000 mm	B 26.99.0820 – 1



A



B





## Switchboxes / Hubs

2

“Star” KVM Switches . . . . .	2.02
19“Desktop” KVM Switches . . . . .	2.03
19” KVM Switches . . . . .	2.03 – 2.05
19” LCD KVM Switches . . . . .	2.05
KVM DVI Dual Head Switches . . . . .	2.06
KVM DisplayPort Switches . . . . .	2.06
IP KVM / KVM Extenders . . . . .	2.07, 2.08, 2.09
KVM Switches with USB Hub . . . . .	2.07
KVM DVI Switches / Extender . . . . .	2.07, 2.08
KVM HDMI Switches . . . . .	2.09, 2.10
KVM Gigabit Ethernet Extender . . . . .	2.09
Manual USB Switches . . . . .	2.10 – 2.11
USB 2.0 / 3.0 Hubs . . . . .	2.11 – 2.14
USB 3.0 Hubs (Type C) . . . . .	2.14



### VALUE KVM Switch „Star“ 1 User - 2/4 PCs, VGA, USB

- Two/four PCs can be handled with one monitor, one keyboard and one mouse
- Console side Connector: 1x HD15 F, 2x USB Type A
- Switching can be done by several ways:
  - Hot keys (keyboard combination)
  - Manual switching with direct-access port selectors on top of the switch
- Max. resolution: 1920 x 1200 @ 75Hz
- LEDs for easy status monitoring
- USB bus powered
- No firmware or drivers required for Windows
- Contents: Switch with integrated KVM cables (each 1.15 m), HD15 M, USB Type A, manual

Technical Data:	14.99.3261	14.99.3267
Monitor connection:	1x HD15 F	1x HD15 F
Keyboard connection:	1x USB Type A F*	1x USB Type A F*
Mouse connection:	1x USB Type A F*	1x USB Type A F*

PC monitor connection:	2x HD15 M*	4x HD15 M*
PC keyboard connection*:	1x USB Type A F*	-
PC mouse connection*:	1x USB Type A F*	-
PC mouse and keyboard*:	-	4x USB Type A M*
Max. resolution (nominal):	1024 x 768	1920 x 1440
Casing:	Plastic	Plastic

\*attached moulded Cables

Order-No. – P.U.

VALUE KVM Switch „Star“ 1 User - 2 PCs, VGA, USB A 14.99.3261 – 5

VALUE KVM Switch „Star“ 1 User - 4 PCs, USB B 14.99.3267 – 5



### ROLINE KVM Switch „Star“ 1 User - 2 PCs, Audio, USB

#### One USB keyboard, USB mouse and VGA monitor controls two computers

- Automatic KVM-Switch with attached moulded cables
- Computer selection via hot key
- Easy to install, no software required
- Keyboard, mouse and monitor emulation

Technical data:	14.01.3234
PC Monitor connection:	1x VGA
PC Keyboard / Mouse connection:	2x USB Type A
Audio connection:	2x 3.5 mm stereo plug
Keyboard/mouse emulation:	yes
Max. resolution (nominal):	1920 x 1080

**roline**  
Designed for Professionals

- Audio (speaker) enabled
- LEDs for easy status monitoring
- No power supply needed
- Contents: Switch with 2 integrated KVM cables (each 1.1 m)
- Contents: Switch, manual



Order-No. – P.U.

ROLINE KVM Switch „Star“ 1 User - 2 PCs, Audio, USB 14.01.3234 – 3

### VALUE KVM Switch „Star“, 1 User - 2 PCs, USB, DVI, Audio

- Controls two computers from a single console (USB keyboard, DVI monitor, USB mouse)
- Switch with two attached KVM cables (each 1.2 m)
- Max. resolution (nominal): 1920 x 1080 @ 60Hz
- Connectors console side: 1x DVI, 2x USB, 2x 3.5mm audio plug
- Connectors computer side: 2x DVI, 2x USB, 4x 3.5mm audio plug
- Supports independent audio switching
- Easy switching by push buttons or hot keys; auto scan function
- Keyboard and mouse emulation
- LED display for PC status monitoring
- Hot-swapping and plug & play
- Bus powered
- Supports Windows 98SE/ME/2000/XP/2003 Server/Vista
- Contents: Switch with attached KVM cables (each 1.2 m), manual



Order-No. – P.U.

VALUE KVM Switch „Star“, 1 User - 2 PCs, USB, DVI, Audio 14.99.3259 – 5



#### Technical Data:

Monitor connection:	1x DVI-I F
Keyboard connection:	1x USB Type A F
Mouse connection:	1x USB Type A F
Audio connection:	2x 3.5 mm stereo plug
PC monitor connection*:	2x DVI M
PC keyboard/mouse connection*:	2x USB Type A M
PC audio connection*:	4x 3.5 mm stereo plug*
Max. resolution (nominal):	1920 x 1080
Casing:	Plastic

\*attached moulded Cables

**VALUE KVM Switch, 1 User - 2/4 PCs, DVI, USB, Audio**

- Automatic KVM Switch
- Up to 2/4 PCs can be used with only one Keyboard (USB), one mouse (USB) and one monitor (DVI-I)
- PC side connectors: 2x/4x DVI F, 2x/4x USB Type B, 2x 3.5 mm Stereo Jack
- Console side connectors: 1x DVI F, 2x USB Type A, 2x 3.5 mm Stereo Jack
- The switching can be done on several ways:
  - Automatically in a scan run
  - Manually by buttons on front side of switchbox
  - Hot key (keyboard combination)
- Fully compliant with USB 1.1
- LEDs for easy status monitoring
- Contents: KVM Switch, manual, cables



Technical Data:	14.99.3246	14.99.3247
Monitor connection:	1x DVI F	1x DVI F
Keyboard connection:	1x USB Type A F	1x USB Type A F
Mouse connection:	1x USB Type A F	1x USB Type A F
Audio connection:	2x 3.5mm Stereo Jack	2x 3.5mm Stereo Jack
PC monitor connection:	2x DVI (DVI-I) F	4x DVI (DVI-I) F
PC connection:	2x USB Type B F	4x USB Type B F
Max. resolution (nominal):	2560x1600	2560x1600
PC audio connection:	1x 3.5mm Stereo Jack	1x 3.5mm Stereo Jack
Casing:	Metal	Metal

Order-No. – P.U.

VALUE KVM Switch, 1 User - 2 PCs, DVI, USB, Audio	14.99.3246 – 10
VALUE KVM Switch, 1 User - 4 PCs, DVI, USB, Audio	14.99.3247 – 8

**VALUE KVM Switch „Star“, 1 User - 2 PCs, HDMI, USB**

**This 2-port USB KVM Star switch employs HDMI display technology for use with high definition digital monitors and HDTVs.**

- Contents: Switch with KVM cables (each 1.2 m), manual



- Controls 2 computers from a single USB console (keyboard/mouse)
- Easy switching by push buttons or hot keys from USB keyboard
- Supports Auto-Scan function
- Max. resolution (nominal): 1920 x 1200
- Connectors console side: 1x HDMI, 2x USB (keyboard, mouse)
- Connectors computer side: 2x HDMI, 1x USB (keyboard/mouse)
- LEDs for PC and audio status monitoring
- Hot-swapping and plug & play
- Self powered through USB connection

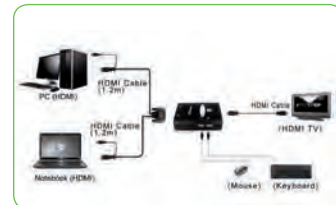

Technical data:	
Monitor connection:	1x HDVideo F
Keyboard connection:	1x USB Type A F
Mouse connection:	1x USB Type A F
PC monitor connection:	2x HDVideo F
PC keyboard/mouse connection:	2x USB Type A M
Max. resolution (nominal):	1920 x 1200
Dimensions:	65 x 85 x 25 mm
Weight:	330 g



Order-No. – P.U.

VALUE KVM Switch „Star“, 1 User - 2 PCs, HDMI, USB	14.99.3250 – 6
--	----------------

**VALUE 19“ KVM Switch with OSD, 1 User - 8 PCs, VGA, USB**

- Up to 8 PCs can be handled with one keyboard, one mouse and one monitor
- The switching can be done on several ways:
  - Manually by buttons on the front side of the switchbox
  - Hot key (keyboard combination)
  - Through OSD (On Screen Display)
- Max. resolution (nominal): 1920 x 1440
- Cascadable
- 19“ rack mountable
- Remark: For connecting PCs special cable 11.99.5503 (3 m length, with HD15 and USB) has to be ordered separately
- Contents: Switch, power supply, 19“ brackets, manual



Technical data:	14.99.3214
Monitor VGA-connection:	1x HD 15-pin F
Keyboard connection:	1x USB type A / PS/2
Mouse connection:	1x USB type A / PS/2
PC-connection:	8x SPHD 15-pin F
Housing:	metal
Dimensions:	438 x 170 x 44 mm
Height:	1 U
Power supply:	9 VDC 1 A
Power supply output	-



Order-No. – P.U.

VALUE 19“ KVM Switch with OSD, 1 User - 8 PCs, VGA, USB	14.99.3214 – 2
VALUE KVM Cable USB, VGA + USB for 14.99.3214/15, 3 m	11.99.5503 – 10

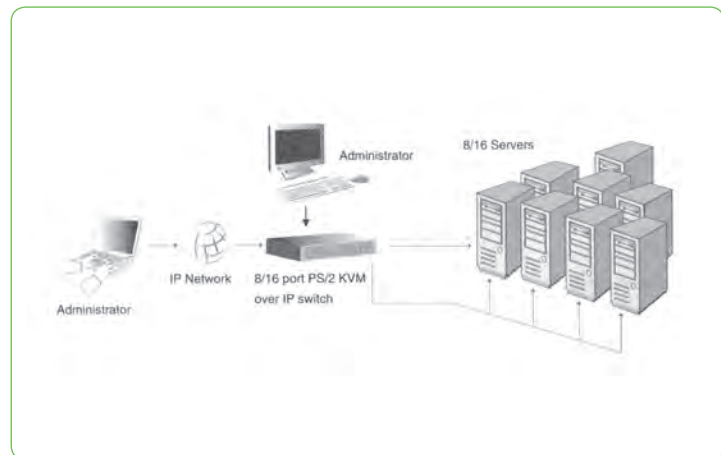

## VALUE 19" KVM Switch with OSD, PS/2+USB

- Automatic KVM Switch
- Up to 8/16 PCs can be handled with one keyboard, one mouse and one monitor
- The switch is cascadable, up to 64/128 PCs can be handled with one keyboard, mouse and one monitor
- The switching can be done on several ways:
  - Automatically in a scan run (Scan Interval adjustable: 5- 99 sec.)
  - Manually by buttons on front side of the switchbox
  - Hot key (keyboard combination)
  - Through OSD (On Screen Display)
- Max. resolution (nominal): 1280 x 1024 (local unit); 1024 x 786 (remote unit with optional IP module)
- Hot-swappable function
- LEDs for channel display
- 19"-rack mountable
- Remote control over standard IP connection: Supports an optional remote console over VALUE IP Module (please order 14.99.3030 separately)
- Remark: For connecting PCs, special cables are needed, that have to be ordered separately (3 m length, USB: 11.99.5501; 3 m length, PS/2: 11.99.5502)
- Contents: KVM switch, power supply, 19" brackets, manual

## REMARK: Product similar to picture

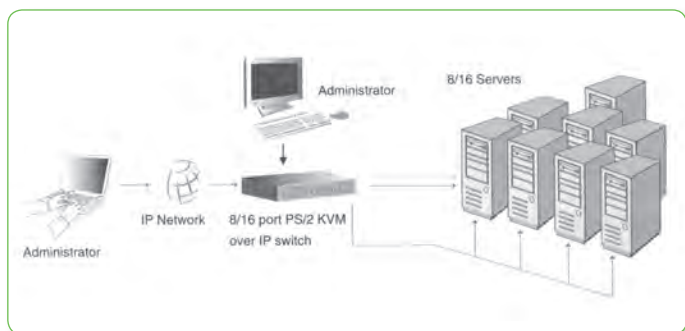
Technical Data:	14.99.3222	14.99.3223
Monitor connection:	1x HD15 F	1x HD15 F
Keyboard connection:	1x USB Type A F	1x USB Type A F
Mouse connection:	1x USB Type A F	1x USB Type A F
PC connection:	8x SPHD15 F	16x SPHD15 F
Casing:	Metal	Metal
Dimensions (WxDxH):	448 x 190 x 44 mm	448 x 190 x 44 mm
Height:	1 U	1 U
Power supply:	5V DC, 1A	5V DC, 1A

## Order-No. – P.U.

VALUE 19" KVM Switch with OSD, 1 User - 8 PCs, PS/2+USB	14.99.3222	- 2
VALUE 19" KVM Switch with OSD, 1 User - 16 PCs, PS/2+USB	14.99.3223	- 2
VALUE IP Module for KVM Switch 14.99.3222/14.99.3223	14.99.3030	- 1
VALUE KVM Cable (USB) for 14.99.3222/.3223, black, 3.0 m	11.99.5501	- 8
VALUE KVM Cable (PS/2) for 14.99.3222/.3223, black, 3.0 m	11.99.5502	- 8

## VALUE 19" LCD KVM Consoles &amp; Switches

## The professional solution for server management.

## VALUE 19" consoles:

- The VALUE 19" LCD consoles combine the function of a keyboard, a touchpad and a 43 cm TFT together in a 1 U casing for a 19" rack
- Easy to install, single rail design
- Supports USB and PS/2 keyboard and mouse, VGA
- For an installation depth of 63 cm

## Monitor data 43/48 cm

- Panel protected by tempered glass
- Active 43/48 cm matrix TFT display
- Screen ratio: 4:3
- Max. resolution (nominal): 1920 x 1080 Pixel
- Contents: Console, rails with mounting accessories, rack mount brackets, keys, KVM cable (HDDB-15/VGA + 2x PS/2, 1.8m), USB cable, power supply, power cord, CD with manual, quick installation guide

## VALUE 19" KVM switches

- Additional to 19" LCD KVM Consoles
- Up to 8 PCs can be controlled with one keyboard, one mouse and one monitor
- Supports both PS/2 and USB interface for connecting to PC ports conveniently
- No software required- easy PC selection via On Screen Display (OSD), push buttons, hot-keys
- Hot-pluggable- add or remove connected PCs without powering off the KVM switch or PCs
- Contents: switch, rails with mounting accessories, rack mount brackets, KVM cable (HDDB-15/VGA + 1x USB + 2x PS/2, 1.8m), power adapter, power cord, CD with manual, quick installation guide

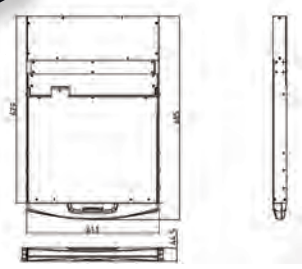

## Order-No. – P.U.

VALUE 19" LCD KVM Console, 43 cm (17") TFT, VGA, USB + PS/2, UK	26.99.0100	- 1
VALUE 19" LCD KVM Console, 43 cm (17") TFT, VGA, USB + PS/2, German	26.99.0101	- 1
VALUE 19" LCD KVM Console, 43 cm (17") TFT, VGA, USB + PS/2, Swiss	26.99.0102	- 1
VALUE 19" LCD KVM Console, 43 cm (17") TFT, VGA, USB + PS/2, French	26.99.0103	- 1
VALUE 19" LCD KVM Console, 48 cm (19") TFT, VGA, USB + PS/2, UK	26.99.0110	- 1
VALUE 19" LCD KVM Console, 48 cm (19") TFT, VGA, USB + PS/2, German	26.99.0111	- 1
VALUE 19" LCD KVM Console, 48 cm (19") TFT, VGA, USB + PS/2, Swiss	26.99.0112	- 1
VALUE 19" LCD KVM Console, 48 cm (19") TFT, VGA, USB + PS/2, French	26.99.0113	- 1
VALUE 19" LCD KVM Switch 1 User - 8PCs, 43 cm (17") TFT (4:3), VGA, USB + PS/2, UK	26.99.0170	- 1
VALUE 19" LCD KVM Switch 1 User - 8PCs, 43 cm (17") TFT (4:3), VGA, USB + PS/2, D	26.99.0171	- 1
VALUE 19" LCD KVM Switch 1 User - 8PCs, 43 cm (17") TFT (4:3), VGA, USB + PS/2, CH	26.99.0172	- 1
VALUE 19" LCD KVM Switch 1 User - 8PCs, 43 cm (17") TFT (4:3), VGA, USB + PS/2, F	26.99.0173	- 1
VALUE 19" LCD KVM Switch 1 User - 8PCs, 48 cm (19") TFT (4:3), VGA, USB + PS/2, UK	26.99.0180	- 1
VALUE 19" LCD KVM Switch 1 User - 8PCs, 48 cm (19") TFT (4:3), VGA, USB + PS/2, D	26.99.0181	- 1
VALUE 19" LCD KVM Switch 1 User - 8PCs, 48 cm (19") TFT (4:3), VGA, USB + PS/2, CH	26.99.0182	- 1
VALUE 19" LCD KVM Switch 1 User - 8PCs, 48 cm (19") TFT (4:3), VGA, USB + PS/2, F	26.99.0183	- 1



## ROLINE 19" LCD KVM Consoles

 DATA CENTER  
Product

### The professional solution for server-management.

#### ROLINE 19" consoles:

- The ROLINE 19" LCD Console combines the function of a keyboard, a touchpad and a 43 cm/48 cm TFT together in a 1 U casing for a 19" rack
- For an installation depth of 63 to 90 cm
- Keyboard layout: English (UK)

- Technical particularity of the ROLINE consoles: Dual rail design for independent panel and keyboard drawer. Panel can be left open while rack door is closed, so that it can e.g. be used as a surveillance monitor.

#### Monitor data:

- Panel protected by tempered glass
- Active 43 cm/48 cm matrix TFT display
- Max. resolution (nominal): 1280 x 1024 Pixel (4:3 Format) or 1920 x 1080 Pixel (DVI, 4:3 Format) 1440 x 900 Pixel (16:10 Format)
- Refresh rate: up to 80 KHz
- Contrast: 400:1
- Brightness: 250 cd/m<sup>2</sup>

- Contents: Console, rails with mounting accessories, rack mount brackets, keys, KVM cable (HDDB-15/VGA + 2x PS/2, 1.8 m), USB cable, power supply, power cord, CD with manual, quick installation guide

#### ROLINE 19" KVM Switches:

- For combination with the ROLINE 19" LCD KVM Consoles
- Up to 8/16 PCs can be controlled with one keyboard, one mouse and one monitor
- Supports both PS/2 and USB interface for connecting to PC ports conveniently
- No software required- easy PC selection via On Screen Display (OSD), push buttons, hot-keys
- Hot-pluggable- add or remove connected PCs without powering off the KVM switch or PCs
- Support two layers password security protection and search PC server name
- Keyboard status restored when switching PCs
- Please find adequate Cat. 5 and IP modules on the following pages

- **Remark:** Please order KVM cables separately:  
Cable for PS/2: 11.01.5521, 11.01.5522  
Cable for USB: 11.01.5525, 11.01.5526

- Contents: Switch, installaion brackets, screws, manual

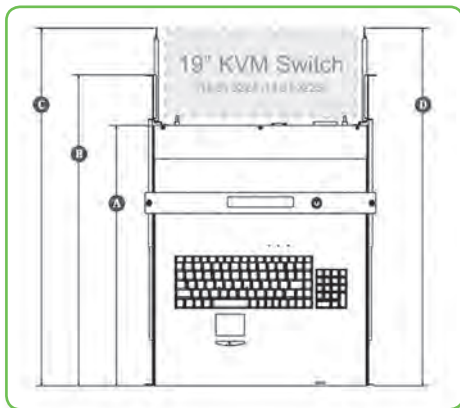

#### Dimensions (mm)

	A	B	C	D
ROLINE 19" KVM Console, 43 cm (26.50.008x)	460	560 – 870	640	640
ROLINE 19" KVM Console, 48 cm (26.50.020x / 030x)	530	635 – 950	730	730

#### Legend:

- A – Installation depth of console
- B – Distance of 19" cabinet's vertical posts
- C – Installation depth of console with switch (14.01.3224/5)
- D – Length of rails

**roline**<sup>®</sup>  
Designed for Professionals



#### Order-No. – P.U.

ROLINE 19" LCD KVM Console, 43 cm (17") TFT, VGA, USB + PS/2, UK	26.50.0081 – 1
ROLINE 19" LCD KVM Console, 43 cm (17") TFT, VGA, USB + PS/2, German	26.50.0082 – 1
ROLINE 19" LCD KVM Console, 43 cm (17") TFT, VGA, USB + PS/2, Swiss	26.50.0083 – 1
ROLINE 19" LCD KVM Console, 43 cm (17") TFT, VGA, USB + PS/2, French	26.50.0084 – 1
ROLINE 19" LCD KVM Console, 48 cm (19") TFT, VGA, USB + PS/2, UK	26.50.0201 – 1
ROLINE 19" LCD-KVM Console, 48 cm (19") TFT, VGA, USB + PS/2, German	26.50.0202 – 1
ROLINE 19" LCD-KVM Console, 48 cm (19") TFT, VGA, USB + PS/2, Swiss	26.50.0203 – 1
ROLINE 19" LCD-KVM Console, 48 cm (19") TFT, VGA, USB + PS/2, French	26.50.0204 – 1
ROLINE 19" LCD KVM Console, 43 cm (17") TFT, DVI-I, USB + PS/2, UK	26.50.0301 – 1
ROLINE 19" LCD KVM Console, 43 cm (17") TFT, DVI-I, USB + PS/2, D	26.50.0302 – 1
ROLINE 19" LCD KVM Console, 43 cm (17") TFT, DVI-I, USB + PS/2, CH	26.50.0303 – 1
ROLINE 19" LCD KVM Console, 43 cm (17") TFT, DVI-I, USB + PS/2, French	26.50.0304 – 1
ROLINE 19" KVM Switch VGA, 1 User - 8 PCs, USB + PS/2	14.01.3224 – 2
ROLINE 19" KVM Switch VGA, 1 User - 16 PCs, USB + PS/2	14.01.3225 – 2
ROLINE KVM Cable Switch - PC, PS/2 for 14.01.3224 and 14.01.3225, 1.8 m	11.01.5521 – 8
ROLINE KVM Cable Switch - PC, PS/2, 3.0 m, for 14.01.3224 and 14.01.3225	11.01.5522 – 4
ROLINE KVM Cable Switch - PC, USB, 1.8 m, for 14.01.3224 and 14.01.3225	11.01.5525 – 8
ROLINE KVM Cable Switch - PC, USB, 3.0 m, for 14.01.3224 and 14.01.3225	11.01.5526 – 4



## ROLINE Dual Head KVM Switch, 1 User - 2/4 PCs, DVI, Audio

- Supports DVI dual head graphic cards
- Controls two computers with one USB keyboard, USB mouse and two/four DVI monitors
- Audio function (speaker, microphone)
- Supports DVI-D Single Link
- Max. resolution (nominal): up to 1920 x 1200
- Front panel push buttons, keyboard hot-keys or mouse (optional) for easy computer selection
- Auto scan function with selectable scan time interval
- Auto skip for inactive ports
- Easy to install- no software required
- Hot-pluggable
- Supported Operating Systems: Windows, Mac
- Contents: Switch, power supply, manual



**roline**  
Designed for Professionals

Order-No. – P.U.

ROLINE Dual Head KVM Switch, 1 User - 2 PCs, DVI, Audio 14.01.3361 – 2

ROLINE Dual Head KVM Switch, 1 User - 4 PCs, DVI, Audio 14.01.3362 – 2

### Technical data:

	14.01.3361	14.01.3362
Monitor connection:	2x DVI F	2x DVI F
Keyboard/mouse connection:	2x USB type A F	2x USB type A F
Audio connection:	2x 3.5 mm F	2x 3.5 mm F
PC monitor connection:	4x DVI F	8x DVI F
PC keyboard/mouse connection:	2x USB type B F	4x USB type B F
PC audio connection:	4x 3.5 mm F	8x 3.5 mm F
Max. resolution (nominal):	1920 x 1200	1920 x 1200
Dimensions (WxDxH):	42 x 200 x 80 mm	44 x 340 x 114 mm
Power supply:	9 VDC, 1 A	9 VDC, 1 A

## VALUE KVM Switch, 1 User - 4 PCs, HDMI 4K, USB, Audio, USB Hub



- 4-port KVM switch with HDMI, USB and USB hub
- One console controls up to 4 HDMI graphic PCs and one additional USB device
- Integrated 1-port USB 2.0 hub
- Microphone support
- Fully compliant with HDMI High Speed
- Supports nominal 480p, 720p, 1080i and 1080p; 3840x2160 (30Hz)
- 3D capable
- Switching via front panel push buttons or IR remote control
- Keyboard and mouse emulation
- Supports Windows 98SE/ME/2000/XP/Vista/7/8
- Contents: Switch, power supply, remote control, manual



**Value**

**digital signage**

Order-No. – P.U.

VALUE KVM Switch, 1 User - 4 PCs, HDMI 4K, USB, Audio, USB Hub 14.99.3337 – 5

### Technical data:

	14.99.3337
Monitor connection:	1x HDMI F
Keyboard connection:	1x USB Type A
Mouse connection:	1x USB Type A
Audio connection:	1x 3.5 mm audio jack
PC monitor connection:	4x HDMI F
PC keyboard/mouse connection:	4x USB Type B
PC audio connection:	4x 3.5 mm audio jack
Dimensions (WxDxH):	46.5 x 170 x 75 mm

## ROLINE KVM Switch, 1 User - 2/4 PCs, DisplayPort, with USB Hub

- Control 2/4 computers from a single USB console (DisplayPort monitor, USB mouse and keyboard)
- Supports DisplayPort with a resolution up to 2560 x 1600
- Integrated 1-port USB 2.0 hub allows 2/4 computers to share a USB device
- Front panel push button or hot-key function for easy computer selection
- No software required
- Supports Windows
- Contents: KVM switch, power supply, manual

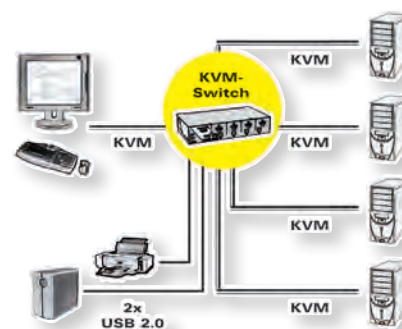

**roline**  
Designed for Professionals

**digital signage**

Order-No. – P.U.

ROLINE KVM Switch, 1 User - 2 PCs, DisplayPort, with USB Hub 14.01.3327 – 4

ROLINE KVM Switch, 1 User - 4 PCs, DisplayPort, with USB Hub 14.01.3329 – 1

### Technical data:

	14.01.3327	14.01.3329
Monitor connection:	1x DP F	1x DP F
Keyboard/mouse connection:	2x USB type B F	2x USB type B F
PC monitor connection:	2x DP F	4x DP F
PC keyboard/mouse connection:	2x USB type B F	4x USB type B F
Dimensions (WxDxH):	40 x 125 x 70 mm	44 x 220 x 130 mm
Max. resolution (nominal)	1920 x 1200	1920 x 1200
Dimensions (HxWxD)	40 x 125 x 70 mm	44 x 220 x 130 mm

**ROLINE KVM Switch, 1 User - 2 PCs, DisplayPort, with 2x USB3.0 Hub**

**4K** **2160p**  
ULTRA HD

**Automatic DisplayPort v1.2 KVM Switch for 1 User / 2 PCs, with 2-Port USB 3.0 Hub and resolutions of up to 3840x2160 @60Hz!**

- Switching between PCs is done either by hot key or automatically during scan run
- Keyboard and mouse emulation via two separate USB 2.0 ports

- Supports graphics cards and monitors with DisplayPort connectors, with a resolution of max. 3840x2160 @60Hz
- LED display informs about the channel assignment
- Additional 2-port USB 3.0 hub for connecting e.g. USB sticks or SSDs

- Contents: KVM switch, power supply, manual

**roline**  
Designed for Professionals



Order-No. – P.U.

ROLINE KVM Switch, 1 User - 2 PCs, DisplayPort, with USB Hub

14.01.3331 – 2

**VALUE KVM Switch, 1 User - 4 PCs, HDMI, USB, Audio, USB Hub, Matrix**

**3D** capable **1080p**  
FULL HD

- Can be used as a 4 in to 2 out Matrix Switch with keyboard / Mouse support
- The 2 HDMI output ports can be from the same or different sources (matrix functionality)
- 4-port KVM switch with HDMI, USB and USB hub
- One console controls up to 4 HDMI graphic PCs and one additional USB device
- Integrated 1-port USB 2.0 hub
- Fully compliant with HDMI High Speed
- Supports nominal 480p, 720p, 1080i and 1080p; 1920x1200
- 3D capable
- Switching via front panel push buttons or IR remote control
- Keyboard and mouse emulation
- Supports Windows XP/Vista/7/8
- Contents: Switch, power supply, remote control, manual

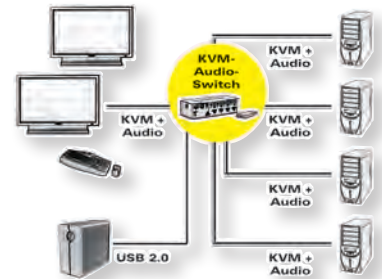

**Technical data:**

- Monitor connection: 2x HDMI F
- Keyboard connection: 1x USB Type A
- Mouse connection: 1x USB Type A
- Audio connection: 1x 3.5 mm audio jack
- PC monitor connection: 4x HDMI F
- PC keyboard/mouse connection: 4x USB Type B
- PC audio connection: 4x 3.5 mm audio jack
- Dimensions (WxDxH): 171 x 75.5 x 46.5 mm
- Power supply output: 5V 1A

14.99.3340

Order-No. – P.U.

VALUE KVM Switch, 1 User - 4 PCs, HDMI, USB, Audio, USB Hub, Matrix

14.99.3340 – 5

**Value**

**VALUE KVM Extender over Cat. 5, VGA, USB**

**USB KVM extender allows access to a computer system from up to 150 meters away from a remote USB console (USB keyboard, monitor and USB mouse).**

- USB KVM extender allows access to a computer system from up to 150 meters away from a remote USB console (USB keyboard, mouse and VGA monitor)
- One Cat.5e cable connects the local and remote unit- up to 150 m away
- Dual console operation- control your system from both the local and remote console
- Max. video resolution (nominal): 1280 x 1024

- Auto resolution of the active console
- Supports VGA, SVGA
- Local monitor supports DDC, DDC2, DDC2B
- Casing: Metal
- Contents: Local unit, remote unit, 2x power adapters, USB KVM cable, manual

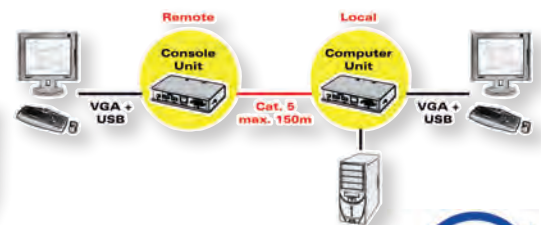
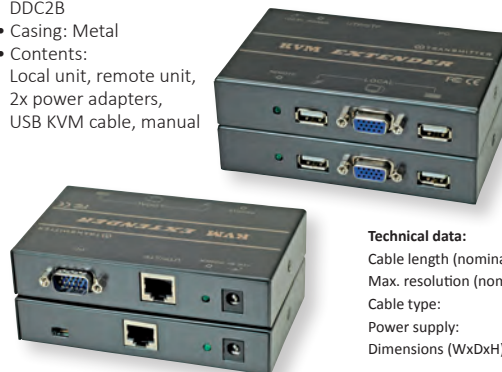

**Technical data:**

- Cable length (nominal): up to 150 m
  - Max. resolution (nominal): 1280 x 1024 (depends on cable length)
  - Cable type: Cat.5e TP cable
  - Power supply: 5 VDC, 1 A
  - Dimensions (WxDxH): 82 x 25 x 13 mm
- |                 |                    |                   |
|-----------------|--------------------|-------------------|
| Connectors:     | <b>remote unit</b> | <b>local unit</b> |
| Monitor:        | 1x HD 15-pin F     | 1x HD 15-pin F    |
| Mouse/keyboard: | 2x USB type A F    | 2x USB type A F   |
| PC connection:  | 1x HD 15-pin F     | 1x HD 15-pin F    |

14.99.3328

Order-No. – P.U.

VALUE VGA KVM Extender over RJ-45, USB

14.99.3328 – 5

**Value**



## VALUE KVM Extender over Cat.5, DVI/VGA, USB

## KVM extension over up to 150 m

- Supports DVI with high resolution video up to 1920 x 1200 (WUXGA), 1920 x 1080 (Full HD)
- Extends IR control by the Cat.5 connection
- For professional A/V applications
- Audio output on the remote unit
- No drivers, no software required
- Stable, metal housing
- 2x external power supplies
- Console unit connectors: Monitor: 1x DVI; keyboard/mouse: 2x USB A; audio: 1x MIC, 1x speaker; 1x RJ-45
- Computer unit connectors: Monitor: 2x DVI; keyboard/mouse: 2x USB A; audio: 1x MIC, 1x speaker; 1x RJ-45, 1x USB B

- Contents: Local unit, remote unit, 2x DVI/VGA adapter, 2x power supply, manual



Order-No. – P.U.

VALUE KVM Extender over Cat.5, DVI/VGA, USB, 150 m

14.99.3040 – 2



Value®

**Technical data:**  
 Cable length (nominal): up to 150 m  
 Max. resolution (nominal): 1920 x 1200 (WUXGA)  
 Cable type: Cat.5e TP cable  
 Dimensions (HxWxD): 36 x 180 x 90 mm

14.99.3040

**Connectors:**  
 Monitor:  
 Mouse/keyboard:

**remote unit**  
 1x DVI F  
 2x USB Type A F

**local unit**

2x DVI F  
 2x USB Type A F  
 1x USB Type B F  
 3.5mm 1x MIC, 1x speaker

Audio:

3.5mm 1x MIC, 1x speaker

## ROLINE Smart KVM Extender, VGA, USB

## Smart combination of KVM Extender, KVM Switch and PC Share

- Remotely locates the keyboard, mouse and monitor up to 150 m away from a computer
- Connection of the Computer Unit and Station Unit via Cat. 5e TP cable
- Supports USB consoles
- Video compensation can be adjusted by hot key to ensure the optimum signal quality for any length of cable within the limit
- Locates the computer away from your desk and work area, saving you valuable space
- Allows two users to share one computer both in local and remote areas
- Beeps confirmation for key control makes the operation easier and cross-checked
- Easy installation
- Supports standard USB keyboards and mice
- Compatible with XGA, VGA and SVGA system
- Contents: Local unit with power supply unit, remote unit, manual

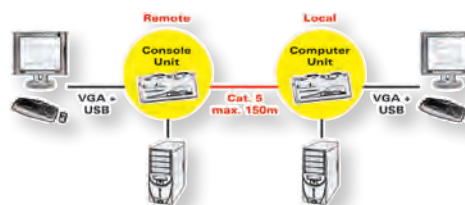

**Example of use:** ROLINE KVM extension for remote operation of a workplace. The system provides a local, and a remote unit to connect another console. This can be operated via a Cat5 cable with remote VGA and USB control unit. Up to 150 m away from the PC, the console can be placed in convenient access while the PC is installed themselves in a safe environment.

**Technical Data:**  
 Max resolution (nominal): 1024 x 768  
 Cable type: Cat.5e TP cable  
 Cable length: up to 150 m  
 Power supply for local unit: 9V DC, 600mA  
 Dimensions (each WxDxH): 156 x 65 x 20 mm  
 Connections:  
 Monitor: 1x HD15 F  
 Mouse/keyboard: 1x USB F  
 PC connection: 1x SPHD15 F

14.01.3249

(depends on cable length)  
 (recommended:  
 solid wire AWG24)

**Remote Unit**

1x HD15 F  
 1x USB F  
 1x SPHD15 F

**roline**  
 Designed for Professionals

Order-No. – P.U.

ROLINE Smart KVM Extender, VGA, USB

14.01.3249 – 6

## ROLINE KVM Extender over Cat.5, DVI, USB

## KVM extension over up to 100 m

- Supports DVI with high resolution video up to 1600 X 1200 (UXGA), 1920 x 1200 (WUXGA), 1920 x 1080 (Full HD)
- Ability to extend IR control through the Cat.5 connection
- Supports PS/2 and USB PC or KVM
- Ideal for professional audio/video applications
- Audio output on the remote unit
- No drivers needed or software required
- Stable, metal housing
- Power supplied by a single power supply unit
- Console unit connectors: Monitor: 1x DVI; keyboard/mouse: 2x USB A; audio: 1x MIC, 1x speaker; 1x RJ-45
- Computer unit connectors: Monitor: 1x DVI; keyboard/mouse: USB + PS/2 (Y-cable included); audio: 1x MIC, 1x speaker; 1x RJ-45
- Contents: Local unit, remote unit, 1x power supply, manual



**Technical data:**  
 Cable length (nominal): up to 100 m  
 Max. resolution (nominal): 1920 x 1080 / 1600 x 1200 (UXGA)  
 Cable type: Cat.5e TP cable  
 Power supply: 12VDC; 1.0A  
 Dimensions (HxWxD): 27 x 131 x 130 mm  
 Connectors:  
 Monitor: 1x DVI F  
 Mouse/keyboard: 2x USB Type A F

14.01.3040

(depends on cable length)

**local unit**

1x DVI F  
 USB Type B F

**roline**  
 Designed for Professionals

Order-No. – P.U.

ROLINE KVM Extender over Cat.5, DVI, USB, 100 m

14.01.3040 – 1

## ROLINE KVM Extender over Gigabit Ethernet, DVI, USB

### KVM extension over Gigabit Ethernet through Cat.5 connection

- Supports DVI with high resolution video up to 1920 x 1200 (WUXGA), 1920 x 1080 (Full HD)
- Supports USB PC or KVM switch
- Ideal for professional video applications
- 8 selections on the DIP rotary switch available for pairing
- Up to 4 pairings can be transmitted simultaneously over the Gigabit Ethernet switch (max. 3 stages)
- Stable, metal housing
- Power supply via an external power supply
- Correspondent receiver unit: 14.01.3045



### Technical specifications:

- Max resolution (nominal): 1920 x 1200 (WUXGA), 1920 x 1080 (Full HD)
- Dimensions: 31 x 131 x 150 mm
- Power supply: 12V DC; 1.5A
- Connectors: DVI Female, USB B connector female, RJ-45 socket (LAN)
- Contents: Transmitter unit, 1x power supply, patchcable, manual

### Technical data:

Cable length (nominal):	up to 100 m
Max. resolution (nominal):	1920 x 1080 (depends on cable length)
Cable type:	Cat.5e TP cable
Power supply:	12VDC; 1.5A
Dimensions (HxWxD):	30 x 132 x 150 mm

Connectors:	Receiver (remote unit)	Transmitter (local unit)
Monitor:	1x HDMI F	1x HDMI F
Mouse/keyboard:	4x USB Type A F	USB Type B F

### Order-No. – P.U.

ROLINE KVM Extender over Gigabit Ethernet, DVI, USB, Transmitter (TX) 14.01.3044 – 4

ROLINE KVM Extender over Gigabit Ethernet, DVI, USB, Receiver (RX) 14.01.3045 – 4

### Connection Pattern



### Pairing Modes

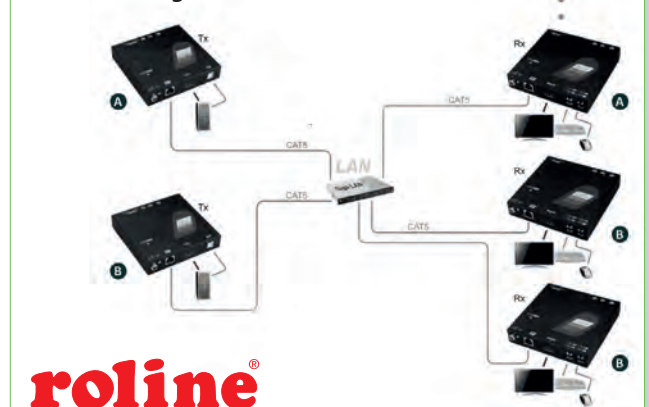

**roline®**  
Designed for Professionals

## ROLINE KVM Extender over Gigabit Ethernet, HDMI, USB

1080p  
FULL HD

### KVM extension over Gigabit Ethernet through Cat.5 connection

- Supports HDMI with high resolution video up to 1920 x 1080 (Full HD)
- Supports USB PC or KVM switch
- Ideal for professional video applications
- 8 selections on the DIP rotary switch available for pairing
- Up to 4 pairings can be transmitted simultaneously over the Gigabit Ethernet switch (max. 3 stages)
- HDCP-compliant
- No drivers needed or software required
- Stable, metal housing
- Correspondent receiver unit: 14.01.3043



### Technical specifications:

- Max resolution (nominal): 1920 x 1080 (Full HD)
- Dimensions: 31 x 131 x 150 mm
- Power supply: 12V DC; 1.5A
- Connectors: HDMI jack, USB B connector, RJ-45 socket (LAN)
- Transmitter (TX) unit connectors:  
Monitor: 1x HDMI; 1x USB type B F; 1x RJ45
- Contents: Transmitter unit, power adapter, patch cable, CD with manual, Quick Start Guide

**roline®**  
Designed for Professionals

### Technical data:

Cable length (nominal):	up to 100 m
Max. resolution (nominal):	1920 x 1080 / 1920 x 1200 (WUXGA) (depends on cable length)
Power supply:	12VDC; 1.5A
Dimensions (HxWxD):	30 x 132 x 150 mm

Connectors:	Receiver (remote unit)	Transmitter (local unit)
Monitor:	1x DVI F	1x DVI F
Mouse/keyboard:	4x USB Type A F	1x USB Type B F
Power supply output	DC 12V; 1.5A	DC 12V; 1.5A

### Order-No. – P.U.

ROLINE KVM Extender over Gigabit Ethernet, HDMI, USB, Transmitter (TX) 14.01.3042 – 4

ROLINE KVM Extender over Gigabit Ethernet, HDMI, USB, Receiver (RX) 14.01.3043 – 4

### Connection Pattern

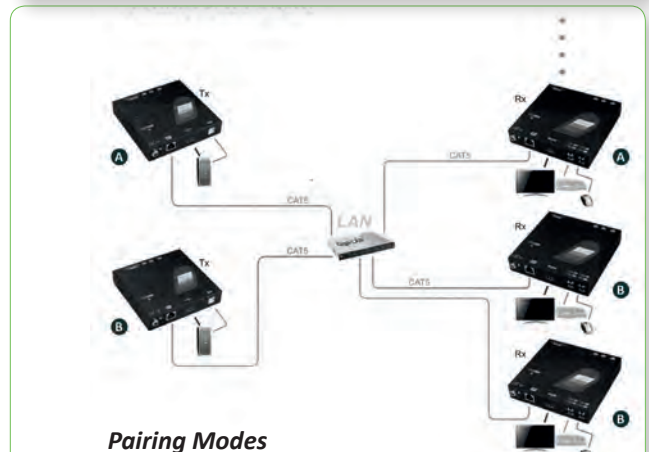

### Pairing Modes

## VALUE KVM Extender over Cat.6, HDMI, 4x USB

1080p  
FULL HD**KVM extension over up to 60 m through the Cat.6 connection**

- Supports HDMI with high resolution video up to 1920 x 1080 (Full HD)
- Supports USB PC or KVM switch
- Ideal for professional video applications
- HDCP-compliant
- No drivers needed or software required
- Stable, metal housing
- Power supplied

- Receiver (RX) unit connectors: Monitor: 1x HDMI; 4x USB type A F; 1x Mini USB 5-pin F, 2x RJ45
- Transmitter (TX) unit connectors: Monitor: 1x HDMI; 2x Mini USB 5-pin F; 2x RJ45
- Contents: Transmitter unit, receiver unit, 2x power supply, manual



<b>Technical data:</b>	<b>14.99.3041</b>
Cable length (nominal):	up to 60 m
Max. resolution (nominal):	1920 x 1080 (depends on cable length)
Cable type:	Cat.6 TP cable
Power supply:	5VDC; 1A
Dimensions (HxWxD):	22 x 84 x 78 mm

Connectors:	<b>Receiver (remote unit)</b>	<b>Transmitter (local unit)</b>
Monitor:	1x HDMI F	1x HDMI F
Peripheral devices:	4x USB Type A F	1x USB Mini 5-pin F

Order-No. – P.U.

VALUE KVM Extender over Cat.6, HDMI, 4x USB, 60 m

14.99.3041 – 4



## VALUE Manual USB 2.0 Printer Switches

- This USB Switch offers the possibility for 2 PCs to share a single USB device such as a printer, scanner or digital camera
- Access to the USB device manually via button on the switch
- Supports USB 2.0
- Two LEDs indicate the active Port
- Bus-powered mode

- Contents: USB Switch



<b>Technical information</b>	<b>14.99.5032</b>	<b>14.99.5034</b>
Input connections	2x USB Type B	4x USB Type B
Output connections	1x USB Type A	1x USB Type A
Dimensions (HxWxD)	90 x 70 x 25 mm	90 x 70 x 25 mm
	<b>Order-No. – P.U.</b>	

VALUE Manual USB 2.0 Printer Switch, 2 Ports

14.99.5032 – 10

VALUE Manual USB 2.0 Printer Switch, 4 Ports

14.99.5034 – 10

## ROLINE Manual USB 2.0 Printer Switches

- This USB switch offers the possibility for 2 PCs to share a single USB device (e.g. a USB printer or scanner)
- Access to the USB device is via push button on switch or via hot key on keyboard
- Supports USB 2.0
- Two LEDs for port status indicator
- Bus-powered mode, no external power supply needed

- Remark: Product similar to picture (4-port version)
- Contents: Switch, manual

**roline**  
Designed for Professionals

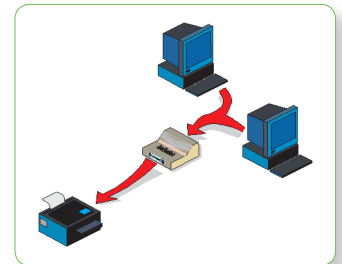

<b>Technical information</b>	<b>14.01.2332</b>	<b>14.01.2334</b>
Input connections	2x USB Type B	4x USB Type B
Output connections	1x USB Type A	1x USB Type A
Dimensions (HxWxD)	-	-
	<b>Order-No. – P.U.</b>	

ROLINE Manual USB 2.0 Printer Switch, 2 Ports

14.01.2332 – 20

ROLINE Manual USB 2.0 Printer Switch, 4 Ports

14.01.2334 – 20

## VALUE Manual USB 3.0 Switch, 2 Ports

**Manual USB 3.0 switch to access a USB device from different computers**

- Excellent solution to share a USB device- as e. g. a printer, scanner, flash drive- between two PCs.
- Compatible with USB 3.0, USB 2.0, USB 1.1
  - Switch the USB device port between PCs via Push button
  - USB Bus powered, no additional power adapter or wall outlet required
  - Plug-and-Play, no software or drivers required
  - Contents: Switch, manual



Order-No. – P.U.

VALUE Manual USB 3.0 Switch, 2 Ports

14.99.2015 – 10

**Value**





### ROLINE Manual USB 3.0 Switch, 2 Ports

Excellent solution to share an USB device- as e. g. a printer, scanner, flash drive- between two PCs.

- Compatible with USB 3.0, USB 2.0, USB 1.1
- Switch the USB device port between PCs via Push button or Hot Key
- USB Bus powered, no additional power adapter or wall outlet required
- Plug-and-Play, no software or drivers required
- LED indicator

- Supported Operating Systems: Windows 2000/ XP / Vista / 7 / 8, Mac OS 10.3 and higher
- Contents: Switch, manual



<b>Technical information</b>	<b>14.01.2325</b>
Input connections	2x USB Type B
Output connections	1x USB Type A
Dimensions (HxWxD)	-

<b>Order-No. – P.U.</b>	
ROLINE Manual USB 3.0 Switch, 2 Ports	14.01.2325 – 10

### ROLINE USB 3.0 Peripheral Sharing Device

- Enables 2/4 computers to share 4 USB 3.0 devices
- Simple port selection via remote port selector for a convenient switch placement
- USB 3.0 compliant, supporting data transfer rates of up to 5Gbps
- Backwards compatible with USB 2.0 and USB1.1
- LEDs indicates which computer is active
- Over-current protection
- Multiplatform support – Windows (Vista/7/8/8.1/10) and Mac OS X 10.3+
- Bus-powered
- Micro USB power jack for additional power supply
- Hot pluggable, no additional driver or software required
- Contents: Switch, 2x/4x USB 3.0 cables (Type A/B, 1.1m), 1x remote port selector, manual



**Order-No. – P.U.**

ROLINE USB 3.0 Peripheral Sharing Device, 2 PCs, 4x USB 3.0 Ports	14.01.2312 – 3
ROLINE USB 3.0 Peripheral Sharing Device, 4 PCs, 4x USB 3.0 Ports	14.01.2314 – 3

<b>Technical information</b>	<b>14.01.2312</b>	<b>14.01.2314</b>
Input connections	2x USB Type B	4x USB Type B
Output connections	4x USB Type A	4x USB Type A

### VALUE USB 2.0 Notebook Hub, 4 Ports

- This hub can connect up to four USB devices
- Compact and nice design with attached USB cable
- Fully backwards compatible with USB 1.1
- Automatically switches to the highest speed supported by the connected device
- LED display for power and port-status
- Power is supplied by PC interface
- Contents: Hub, attached USB cable (3 cm)

**Technical data:**

PC connection:	1x USB type A (attached cable)
Input:	4x USB type A
Dimensions (WxDxH):	90 x 44 x 14 mm
Power supply (for 14.99.5016):	5 VDC, 2 A



**Order-No. – P.U.**

VALUE USB 2.0 Notebook Hub, 4 Ports	14.99.5015 – 10
VALUE USB 2.0 Notebook Hub, 4 Ports, with power supply	14.99.5016 – 20

### ROLINE USB 2.0 Hub, with Repeater

**This hub with an active repeater cable extends the distance between the hub and the computer up to 12 m.**

- Active extension of USB 2.0 bus
- The extension acts like a USB hub with 12 m cable
- Full compliance with USB 2.0, USB 1.1
- Plug & play, no additional drivers required
- Power over USB port from the PC

- Additional extension: With its unique design, this hub can lock to USB 2.0 active repeater cable 12.04.1086 by clipping- which offers another 12 m of length. With up to 5 of this hub & repeater cables chained together, you can reach a maximum distance of up to 60 m. The active repeater cable 12.04.1086 is only compatible with 12.04.1085 and can't be separately used.

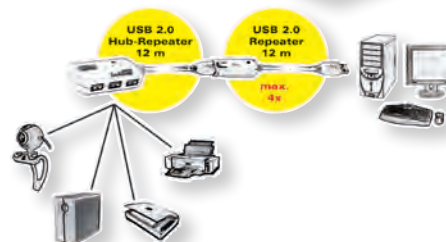

<b>Technical information</b>	<b>12.04.1085</b>	<b>12.04.1086</b>
Side A connection (PC)	1x USB Type A Male	Type A Male
Side B connection (Peripherals)	4x USB Type A Female	Type A Female
Length	12 m	12 m

**Order-No. – P.U.**

ROLINE USB 2.0 Hub, 4 Ports, with Repeater, 12.0 m	12.04.1085 – 10
ROLINE USB 2.0 Active Repeater Cable for 12.04.1085, 12.0 m	12.04.1086 – 10





# Light

# Light



## ROLINE USB Hubs „Black and White“

- These hubs allow you to connect up to 4/7 USB peripheral devices to your computer or notebook over one USB port
- Stylish „Black and White“ design and compact size
- USB 2.0, compatible with USB 1.1
- Power LED
- Plug & play
- Bus-power and self-power mode (power supply included)
- **14.02.5011:** stand for upstanding or flat mounting included
- **Contents:** Hub, power supply, USB 2.0 cable, manual

### Remark 11.02.8849:

- Special USB connection cable for the ROLINE hubs 14.02.5011
- For the connection between the hub (14.02.5011) and a USB device (e.g. printer, scanner, ...)

**roline**<sup>®</sup>  
Designed for Professionals

Technical data:	14.02.5013	14.02.5011	14.02.5027	14.02.5028
PC connection:	1x USB 2.0 5-Pin Mini	1x USB 2.0 Type B	1x USB 3.0 Type B	1x USB 3.0 Micro B
Input:	4x USB 2.0 Type A	7x USB 2.0 Type A	4x USB 3.0 Type A	7x USB 3.0 Type A
Dimensions (WxDxH):	18 x 65 x 40 mm	85 x 25 x 70 mm	23 x 100 x 63 mm	26 x 145 x 63 mm

	Order-No. – P.U.
ROLINE USB 2.0 Hub „Black and White“, 4 Ports, with Power Supply	A 14.02.5013 – 20
ROLINE USB 2.0 Hub „Black & White“, 7 Ports, with Power Supply	B 14.02.5011 – 10
ROLINE USB 2.0 Cable type A/B for USB Hub 14.02.5011, 12 m	11.02.8849 – 5
ROLINE USB 3.0 Hub „Black & White“, 4 Ports, with Power Supply	C 14.02.5027 – 10
ROLINE USB 3.0 Hub „Black & White“, 7 Ports, with Power Supply	D 14.02.5028 – 5

### ROLINE USB 3.0 Hub with Repeater

**This hub with an active repeater cable extends the distance between the hub and the computer up to 10 m.**

- Active extension of USB 3.0 bus
- The extension acts like a USB hub with 10 m cable
- Full compliance with USB 2.0, USB 1.1

- Plug & play, no additional drivers required
- USB Bus powered
- Cascadable one time
- Power adapter (5V/3.5A, included) for heavy power consumption devices
- Compatible with Win XP / 7
- Contents: Cable



**Technical data:**

- Connectors: 1x USB type A M, 4x USB Type A F
- Cable length: 10 m
- Housing dimensions: 81 x 40 x 17 mm



Order-No. – P.U.

ROLINE USB 3.0 Hub, 4 Ports, with Repeater, 10,0 m

12.04.1097 – 4

### VALUE USB 3.0 Desktop Hubs

**These hubs can connect up to seven USB devices with SuperSpeed**

- 7x USB 3.0 Type A SuperSpeed ports
- Data transfer rates of up to 5.0 Gbit/s
- Fully backwards compatible with USB 2.0
- Hot-swappable

- Battery charger function
- Dimensions (HxWxD): 15 x 85 x 59 mm
- Power supply (5V, 2A/4A) included
- Colour: Black
- Contents: Hub, power supply, USB 3.0 cable (1.1 m), manual



**Technical data:**

- PC connection: 1x USB 3.0 Micro Type B
- Input: 7x USB 3.0 Type A
- Dimensions (HxWxD): 15 x 85 x 59 mm
- Power supply: 5V 4A

14.99.5047

Order-No. – P.U.

VALUE USB 3.0 Desktop Hub, 7 Ports, with Power Supply

14.99.5047 – 5

### ROLINE USB 3.0 Hub

**This hub can connect up to four USB devices with SuperSpeed**

- Data transfer rates of up to 5 Gbit/s
- Fully backwards compatible with USB 2.0, USB 1.1
- PC connection: 1x USB 3.0 Type B
- Input: 4 USB 3.0 Type A SuperSpeed ports

- LED status indicator for each port
- Hot-swappable
- Colour: Black
- Contents: Hub, power supply, USB 3.0 cable



**Technical data:**

- PC connection: 1x USB 3.0 Type B
- Input: 4x USB 3.0 Type A
- Dimensions (HxWxD): 24 x 95 x 55 mm
- Power supply: 5V 4A

Order-No. – P.U.

ROLINE USB 3.0 Hub, 4 Ports, with Power Supply

14.02.5015 – 10

### ROLINE USB 3.0 Hub

**This hub can connect up to four USB devices with SuperSpeed**

- Data transfer rates of up to 5 Gbit/s
- Fully backwards compatible with USB 2.0, USB 1.1
- PC connection: 1x USB 3.0 Type B
- Input: 4 USB 3.0 Type A SuperSpeed ports

- Hot-swappable
- Colour: White
- Contents: Hub, power supply, USB 3.0 cable



**Technical data:**

- PC connection: 1x USB 3.0 Type A
- Input: 4x USB 3.0 Type A
- Dimensions (HxWxD): 22 x 84 x 51 mm
- Power supply: 5V 4A

1x USB 3.0 Type A

Order-No. – P.U.

ROLINE USB 3.0 Hub, 4 Ports, with Power Supply

14.02.5040 – 5

### ROLINE USB 3.0 Hub with Charging Ports

**This hub can connect up to four USB devices with SuperSpeed**

- Data transfer rates of up to 5 Gbit/s
- Fully backwards compatible with USB 2.0, USB 1.1
- PC connection: 1x USB 3.0 Type B
- Input: 4 USB 3.0 Type A SuperSpeed ports
- LED status indicator for each port
- Hot-swappable
- Colour: Black
- Contents: Hub, power supply, USB 3.0 cable

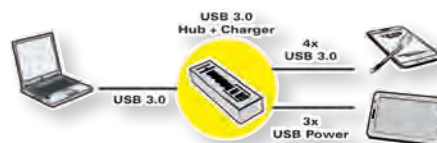

**Technical data:**

- PC connection: 1x USB 3.0 Type B
- Input: 4x USB 3.0 Type A
- Charging Ports: 3x USB Typ A
- Dimensions (HxWxD): 24 x 38 x 133 mm
- Power supply: 5V 4A



Order-No. – P.U.

ROLINE USB 3.0 Hub, 4 Ports + 3x Charging Ports

14.02.5042 – 5



### ROLINE USB 3.0 Hub, Type C Connection

This ROLINE hub can connect up to four USB 3.0 devices (Type A) to a USB Type C port

- Data transfer rates of up to 5 Gbit/s
- Fully backwards compatible with USB 2.0, USB 1.1
- LED status indicator for each port



- Hot-swappable
- Colour: Black
- Contents: Hub, power supply, USB 3.0 cable



<b>Technical information</b>	<b>14.02.5035</b>
PC connection	1x USB Type C
Device connection	4x USB Type A
Dimensions (HxWxD)	15 x 90 x 40 mm

**roline**<sup>®</sup>  
Designed for Professionals

Order-No. – P.U.

ROLINE USB 3.0 Hub, 4 Ports, Type C Connection Cable, with Power Supply 14.02.5035 – 5

### ROLINE USB 3.1 Hub, Type C Connection, with PD

This ROLINE hub can connect up to four USB 3.0 devices (Type A) to a USB Type C port and has 1 additional Type C Power Delivery port (1x PD)

- Data transfer rates of up to 5 Gbit/s
- Fully backwards compatible with USB 2.0, USB 1.1



<b>Technical information</b>	<b>14.02.5045</b>
PC connection	1x USB Type C
Device connection	4x USB Type A
Dimensions (HxWxD)	11 x 94 x 181 mm

**roline**<sup>®</sup>  
Designed for Professionals

Order-No. – P.U.

ROLINE USB 3.1 Hub, 4 Ports, Type C Connection Cable, w. Power Delivery (PD) 14.02.5045 – 10

### ROLINE USB 3.0 Hub, 4 Ports, Type C Connection Cable

This ROLINE hub can connect up to four USB 3.0 devices (Type A) to a USB Type C port

- Data transfer rates of up to 5 Gbit/s
- Fully backwards compatible with USB 2.0, USB 1.1
- LED status indicator for each port
- Hot-swappable
- USB Micro B connector for optional power supply via power supply unit
- Dimensions: 11 x Ø 60 x 200 mm
- Colour: silver
- Contents: Hub, power supply, USB 3.0 cable



**NEW**

**roline**<sup>®</sup>  
Designed for Professionals

Order-No. – P.U.

ROLINE USB 3.0 Hub, 4 Ports, Type C Connection Cable 14.02.5036 – 10

### ROLINE USB 2.0 Notebook Hub, 4 Ports, Type A+C Connection Cable

4-Port USB 2.0 Notebook Hub with Type A+C connection cable for data and power supply.

- This hub can connect up to four USB devices via USB type A or C
- Compact and nice design with attached USB cable
- Fully backwards compatible with USB 1.1
- Automatically switches to the highest

speed supported by the connected device

- LED display for power
- Power is supplied by PC interface or main adapter (A or C port)
- Contents: Hub, attached USB cable (30 cm Type A)

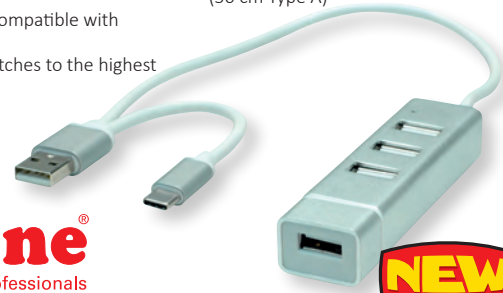

**roline**<sup>®</sup>  
Designed for Professionals

**NEW**

Order-No. – P.U.

ROLINE USB 2.0 Notebook Hub, 4 Ports, Type A+C Connection Cable 14.02.5037 – 10

### VALUE USB 3.1 to Gigabit Ethernet Converter + 3x USB3.0 Hub

This converter is a cost effective solution to convert a USB 3.1 port type C into a 10/100/1000Base-T Ethernet port

- Supports 10/100/1000 Mbit/s auto-sensing capability
- Supports USB 3.0
- Bus powered

- Supports both full-duplex and half-duplex operation in Gigabit Ethernet
- Hub function, 3x
- Supports Windows XP/7/8, Mac OS X
- Contents: Converter



**Value**<sup>®</sup>

Order-No. – P.U.

VALUE USB 3.1 to Gigabit Ethernet Converter + 3x USB3.0 Hub 12.99.1109 – 10

### VALUE CardReader Typ C + 3x USB 3.0 Hub, SD/Micro SD Card Reader

- Suitable for Smartphone+Tablets
- Transfer your precious vacation pictures/videos from the memory card of your digital camera on your tablet, Macbook ...
- Supports USB 2.0

- Card Reader works with multiple media, as e.g. SD (Secure Digital) Card, SDHC, Micro SD
- Contents: Card Reader

**Value**<sup>®</sup>



Order-No. – P.U.

VALUE CardReader Typ C + 3x USB3.0 Hub, SD/Micro SD Card Reader 15.99.6252 – 20



## Computer Cables / Connectors / Adapters

# 3

ROLINE- THE difference. . . . .	3.02 – 3.03
USB2.0/USB3.0/USB3.1 Cables. . . . .	3.04 – 3.11, 3.24, 3.25
USB Extenders . . . . .	3.08, 3.09
9-pole / 25-pole / Serial /-Link Cables . . . . .	3.13
Printer Cables, parallel . . . . .	3.13
Keyboard Cables PS/2 . . . . .	3.14
Monitor Connection Cables VGA . . . . .	3.14 – 3.15
Monitor Connection Cables DVI. . . . .	3.15 – 3.16, 3.26
HDMI Cables. . . . .	3.16 – 3.20, 3.27 – 3.29
DisplayPort Cables. . . . .	3.20 – 3.23, 3.26
Adapters VGA/DVI/HDMI/DP . . . . .	3.27, 3.30 – 3.34
USB Type C Display Adapters . . . . .	3.33 – 3.35
USB Type C Docking Stations . . . . .	3.36
Audio / Video Cables / Adapters . . . . .	3.37 – 3.38
SATA Cables . . . . .	3.32, 3.39, 3.40
Internal Power Cables . . . . .	3.41
Power Cords . . . . .	3.42 – 3.43
Telephone Cables / Accessories; Ferrites . . . . .	3.43, 3.44
Gender Changers. . . . .	3.44
Adapters / Converters . . . . .	3.45 – 3.50

## ROLINE – Quality is the Difference!

ROLINE products are developed for professional users and differ considerably in their quality from comparable products in the IT environment. Their high compatibility in combination with other devices is excellent.

ROLINE sets standards for high-quality, practical, user-friendly products, suitable for continuous use at a reasonable price.

ROLINE products comply with EU standards and directives such as CE, ErP, RoHS and REACH. The specifications and defaults of the various standards and technologies are strictly adhered, too.

The difference between ROLINE and cheap standard products is exemplified in the following product categories.

**roline**<sup>®</sup>  
Designed for Professionals

Well Shielded  
ROLINE Cable



Bad Shielded  
Cheap Cable



## ROLINE GOLD – for the most demanding Requirements

ROLINE GOLD products combine the outstanding ROLINE quality with a golden shell, an exceptional design and a protective cotton sheath around the cable.

They also provide metal plugs and gilded contacts to ensure the best possible connection between your devices.

**roline**<sup>®</sup> GOLD

## USB Cables: Facts and Comparison

### ROLINE USB Cables

- The data wires meet **AWG<sup>1</sup> 28**.
- The power wires meet **AWG 24** - these wires are especially thick to protect the cable from overheating.
- The used material is **solid copper**, also called bare copper.
- The shielding consists of a foil screen and a tinned copper braid shield with a coverage of **more than 65%**.

### Influence of bad cables:

- Data loss due to bad electrical characteristics of wire pairs.
- Already on short distances, the power supply of the connected devices is no longer assured, because of a too big ohmic resistance of the power wire.
- High susceptibility due to bad shield characteristics results in data loss and data transfer errors.

### Cheap USB Cables

- The data wires meet **AWG 30 and worse**.
- The power wires meet **AWG 30 and worse**, which results in **potential fire hazard**.
- The used material is **CCA<sup>2</sup>** - solid aluminium covered with a thin copper coating.
- The shielding consists of a foil screen and a braided shield composed of an alloy with a coverage of **less than 30% or completely without a shielding**.

<sup>1</sup>: American Wire Gauge- the cross section of the cable. The lower the AWG, the higher the cross section is.

A cable with a low AWG has a higher quality, than a cable with a large AWG.

<sup>2</sup>: CCA- Copper Clad Aluminium has a bigger ohmic resistance and therefore a power supply of the connected devices isn't assured even over short distances. Data loss and low data transfer rates because of bad electrical characteristics of each pair of wires is also a danger- this can't happen with high quality copper wires.

## USB Cables: Standards and Wires

### Power Delivery (PD)

- Power delivery provides up to **100W (20V 5A)**
- PD is its own specification, which requires E-Mark chips in all components- through the E-Mark chip, a profile will automatically be chosen dependend on the maximum available capacity of the connected components.

### USB 3.0, 3.1 Gen 1 and Gen 2

- **USB 3.1 Gen 1** is former known as **USB 3.0**- both are identical based on their wires and protocols and have a data transmission rate of **up to 5Gb/s**. USB 3.0 has been reintroduced as 3.1 Gen 1 together with a new connector, the Type C. USB 3.1 Gen 1 is available for the USB connectors A, B, C and Micro A/B.
- **USB 3.1 Gen 2** is limited to the USB Type C connector only. It offers even more than USB 3.1 Gen 1, such as data transmission rates of **up to 10Gb/s** and the **full PD potential with up to 100W (20V 5A)** - those cables are **also called „Full-Featured“ and are the state of the art, when it comes to USB Performance**. Both, USB 3.1 Gen 1 and USB 3.1 Gen 2 have identical wires and just differ from the used protocols.

### USB Type C Connector

- USB Type C is the newest sort of USB connector and is available for the USB standards 2.0, 3.0 / 3.1 Gen 1 and 3.1 Gen 2.
- Thanks to the symmetrical construction, a reversible usage is possible, now. This is a significant improvement to the predecessors and allows a longer lifespan of the plugs.

USB 2.0 Cable

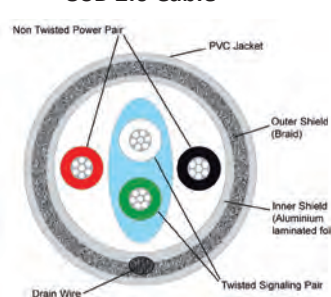

USB 3.0/3.1 Cable



- The data transfer rate and PD function each depend on the USB specification and are not exclusively for the USB Type C plug.
- A Full-Featured USB 3.1 Gen 2 cable has to be with Type C connectors on both ends to grant both, the data transmission rate of 10Gb/s and the full PD functionality.



## HDMI and DisplayPort – Future-Proofed technology in up to 8K!

**HDMI** is the most common cable type nowadays used in the home user multimedia environment- the brands ROLINE and VALUE include a wide range of HDMI products, from HDMI High Speed (1920x1080 @60Hz) to one of the most future-proofed standards: HDMI Ultra HD with Ethernet, with resolutions of up to **7680x4320 @60Hz (8K)** and **HDR support** for an even more impressive color depth.

### ROLINE Cables

- Separately shielded twisted wire pairs; Data wires meet at least **AWG 30**, but can go up to **AWG 24** – depending on the length of the cable.
- The used material is **solid copper**.
- The shielding consists of a **foil screen** and a **tinned copper braid** plus a **shielded connector housing**.
- The contacts of the connector are **gold plated**.

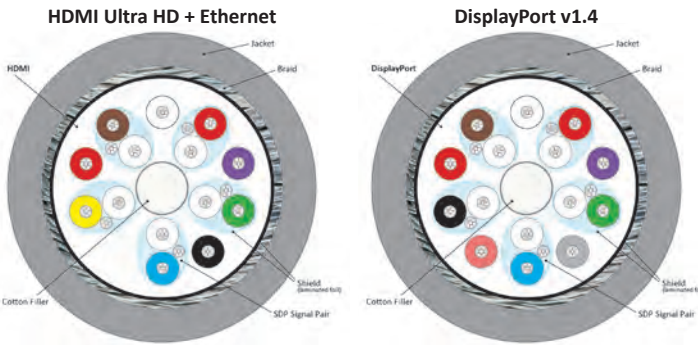

**DisplayPort** cables are as advanced as HDMI and available in ROLINE and VALUE from the first available version, v1.1 (1920x1080 @60Hz), to the newest one, v1.4. DisplayPort v1.4 offers the same maximum resolution as its HDMI equivalent, **7680x4320 @60Hz**. It's the identical wire as used for DP v1.3 (capable of 5k resolutions), but with an additional **Display Screen Compression**, and **HDR support**.

### Cheap Cables

- There are **no twisted wire pairs** used; the data wires are **worse than AWG 30**.
- The used material is **CCS<sup>1</sup>** - solid steel covered with a thin copper coating.
- There is **no shield** for the single twisted wire pairs.
- The total shield consists of a foil screen and a braid shield with very low coverage, or the braid shield is **totally missing**.
- The contacts of the connector are **not gold plated** but – at best – gold touched.

### Influence of bad cables:

- **No picture transmission already on short distances** due to bad electrical characteristics of the data wires.
- **High susceptibility** due to bad shield characteristics result in **interference of the picture transmission**.
- No more trouble-free contacting after a low number of contact durability, which causes **sporadic interruptions or complete malfunctions**.

<sup>1</sup>: CCS- Copper Clad Steel is an even worse wire material than CCA (Copper Clad Aluminium), with the highest ohmic resistance. It's extremely rigid, which results in kinks even after slight bending of the cable, which will easily lead to data loss or total malfunctions.

## SVGA Cables

### ROLINE Cables

- The RGB wires are coaxial cables with 75 Ohm.
- The data wires meet AWG 28 and there are – depending on the cable – 7 or 9 of them.
- The used material is solid copper.
- The shielding consists of a foil screen with drain wire and a tinned copper braid plus a shielded connector housing.
- The contacts of the connector are gold plated.

### Influence of bad cables:

- **Very bad picture quality** already on short distances, because of bad electrical characteristics of the data wires and because of missing RGB coaxial wires.
- **No more synchronisation** is possible already on short distances, because the disturbance of the data signal by a too big ohmic resistor of the cable is becoming too strong.
- High susceptibility due to bad shield characteristics result in **interferences of the picture transmission**.
- After a low number of contact durability, trouble-free contacting is not possible anymore, which results in **interruptions or total malfunctions**.

### Cheap Cables

- For the RGB signals, **no coaxial wires** are used.
- The data wires meet **AWG 30 and worse**; there are **max. 4** of them.
- The used material is **CCS** = solid steel covered with a thin copper coating.
- The shielding consists of a foil screen without a drain wire, braid shield is missing and the connector housings are not shielded.
- The contacts of the connector are **gold touched** in the best case.

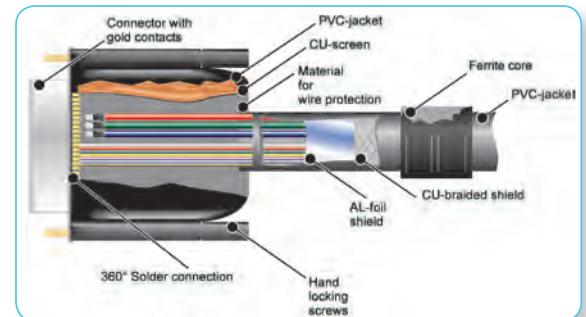

## Patch Cords

### ROLINE Patch Cords

- The cables **meet the norms of CAT.6 and CAT. 6a**. Some of them were even tested by the GHMT in Germany.
- The used material is **solid copper**.
- The RJ-45 connectors are assembled with a **solid gold plating for the best possible connectivity**.

### Cheap Patch Cords

- The cables don't meet any norm and don't pass any legit test.
- The used material is **CCA**- solid aluminium covered with a thin copper coating.
- The RJ-45 connectors are **gold touched** in the best case.

### Influence of bad cables:

- The normed bandwidth of 250MHz for CAT. 6 and 500MHz for CAT. 6a **won't be reached at all**.

- After bending the cable several times, the nonelastic material leads to **interruption and data loss**.
- After a low number of contact durability, trouble-free contacting is not possible anymore, which results in **interruptions or total malfunctions**.



## Power Cords

### ROLINE & VALUE Power Cords

- The wires meet a cross section of **at least 0.75 mm<sup>2</sup>** (standard size) in a length of up to 2m.
- The used material is **solid copper**.
- The cables **meet the guidelines and norms regarding the equipment safety**.

### Cheap Power Cords

- The wires meet a cross section of **only 0.1 – 0.2 mm<sup>2</sup>** in a length of up to 2m.
- The cables **do not meet the guidelines and norms regarding the equipment safety**, because they are approved up to 10A but do only guarantee equipment safety for up to 1A at all.

### Influence of bad cables:

- **There's a major risk of overheating and fire hazard as soon as the cheap cable is used with high-powered**

devices with more than 1A of power consumption.

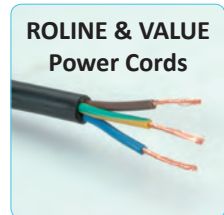

## VALUE USB 2.0 Cables

- High quality USB cable with different types of USB connector
- For the connection of devices with USB connector; e.g. digital cameras, mobile phones, MP3 players or PDAs
- Meets standard USB 2.0 (transfer rate up to 480 Mbit/s)
- Colour: white
- Type: A-B, A-A
- Length: 0.8 m

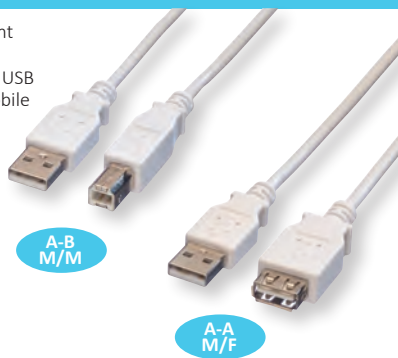
A-B  
M/MA-A  
M/F

Order-No. – P.U.

VALUE USB 2.0 Cable, A - B, M/M, white, 0.8 m	11.99.8809 – 50
VALUE USB 2.0 Cable, A - B, M/M, white, 1.8 m	11.99.8819 – 100
VALUE USB 2.0 Cable, A - B, M/M, white, 3.0 m	11.99.8831 – 100
VALUE USB 2.0 Cable, A - B, M/M, white, 4.5 m	11.99.8841 – 100
VALUE USB 2.0 Cable, A - A, M/M, white, 0.8 m	11.99.8909 – 50
VALUE USB 2.0 Cable, A - A, M/M, white, 1.8 m	11.99.8919 – 100
VALUE USB 2.0 Cable, A - A, M/M, white, 3.0 m	11.99.8931 – 100
VALUE USB 2.0 Cable, A - A, M/M, white, 4.5 m	11.99.8944 – 100
VALUE USB 2.0 Cable, A - A, M/F, white, 0.8 m	11.99.8946 – 50
VALUE USB 2.0 Cable, A - A, M/F, white, 1.8 m	11.99.8949 – 100
VALUE USB 2.0 Cable, A - A, M/F, white, 3.0 m	11.99.8961 – 100

## ROLINE USB 2.0 Cables

**High quality USB cable with one USB Type A and one USB Type B connector.**

- Improved shielding
- For the connection of devices with USB Type B connector; e.g. printer
- Meets standard USB 2.0 (transfer rate up to 480 Mbit/s)
- Colour: Black

A-B  
M/MA-A  
M/F

Designed for Professionals

Order-No. – P.U.

ROLINE USB 2.0 Cable, A - B, M/M, black, 0.8 m	11.02.8808 – 50
ROLINE USB 2.0 Cable, A - B, M/M, black, 1.8 m	11.02.8818 – 100
ROLINE USB 2.0 Cable, A - B, M/M, black, 3.0 m	11.02.8830 – 100
ROLINE USB 2.0 Cable, A - B, M/M, black, 4.5 m	11.02.8845 – 100
ROLINE USB 2.0 Cable, A - A, M/M, black, 0.8 m	11.02.8908 – 50
ROLINE USB 2.0 Cable, A - A, M/M, black, 1.8 m	11.02.8918 – 100
ROLINE USB 2.0 Cable, A - A, M/M, black, 3.0 m	11.02.8930 – 100
ROLINE USB 2.0 Cable, A - A, M/M, black, 4.5 m	11.02.8945 – 100
ROLINE USB 2.0 Cable, A - A, M/F, black, 0.8 m	11.02.8947 – 50
ROLINE USB 2.0 Cable, A - A, M/F, black, 1.8 m	11.02.8948 – 100
ROLINE USB 2.0 Cable, A - A, M/F, black, 3.0 m	11.02.8960 – 100

## VALUE USB 2.0 Cables, A - Micro B

- USB Cable with one Type A and one Micro B USB Connector
- Meets standard USB 2.0 (transfer rate up to 480 Mbit/s)
- Colour: white



Micro A

Micro B

Order-No. – P.U.

VALUE USB 2.0 Cable, A - Micro B, M/M, 0.15 m	11.99.8751 – 50
VALUE USB 2.0 Cable, A - Micro B, M/M, 0.8 m	11.99.8754 – 10
VALUE USB 2.0 Cable, A - Micro B, M/M, 1.8 m	11.99.8752 – 10
VALUE USB 2.0 Cable, A - Micro B, M/M, 3.0m	11.99.8755 – 10
VALUE USB 2.0 Cable, Micro A - Micro B, M/M, 1.8 m	11.99.8753 – 10

## ROLINE USB 2.0 Cables, A - Micro B

**High quality USB cable with one Type A and one Micro USB connector.**

- Improved shielding
- For the connection of devices with Micro USB connector; e.g. digital cameras / DSLRs or mobile phones / smartphones
- Meets standard USB 2.0 (transfer rate up to 480 Mbit/s)
- Colour: black



Type A

Micro A

Micro B

Order-No. – P.U.

ROLINE USB 2.0 Cable, A - Micro B, M/M, 0.15 m	11.02.8310 – 25
ROLINE USB 2.0 Cable, A - Micro B, M/M, 0.8 m	11.02.8754 – 10
ROLINE USB 2.0 Cable, A - Micro B, M/M, 1.8 m	11.02.8752 – 10
ROLINE USB 2.0 Cable, A - Micro B, M/M, 3.0 m	11.02.8755 – 10
ROLINE USB 2.0 Cable, Micro A - Micro B, M/M, 1.8 m	11.02.8753 – 10

## ROLINE USB 2.0 Flat Cables

**USB Flat Cable for connection of an USB peripheral device with the USB port of your PC**

- USB Type A-B cable
- Meets standard USB 2.0 (transfer rate up to 480 Mbps)
- Ultra light and flat, stable cable for use with notebooks

- Just hide it e.g. under the carpet
- Colour: black
- Length: 0.8m

A-B  
M/M

Order-No. – P.U.

ROLINE USB 2.0 Flat Cable, 0.8 m	11.02.8867 – 10
ROLINE USB 2.0 Flat Cable, 1.8 m	11.02.8868 – 20



## ROLINE USB 2.0 Cables, A - Micro B

- High quality USB cable with one Type A and one Micro USB connector
- For the connection of devices with Micro USB connector; e.g. smartphones / mobile phones, digital cameras / DSLR or other equipment
- Meets standard USB 2.0 (transfer rate up to 480 Mbit/s)
- Elastic and very flexible
- Material: TPE (thermoplastic elastomer)
- Colour: black



Designed for Professionals

Order-No. – P.U.

ROLINE USB 2.0 Cable, A - Micro B, M/M, black, 1.0 m	11.02.8760 – 10
ROLINE USB 2.0 Cable, A - Micro B, M/M, white, 1.0 m	11.02.8761 – 10
ROLINE USB 2.0 Cable, A - Micro B, M/M, pink, 1.0 m	11.02.8762 – 10
ROLINE USB 2.0 Cable, A - Micro B, M/M, green, 1.0 m	11.02.8763 – 10

**VALUE USB 2.0 Cables, A - 5-Pin Mini**

- USB cable with one Type A and one USB 5-pin Mini connector
- Meets standard USB 2.0 (transfer rate up to 480 Mbit/s)
- Colour: white



Order-No. – P.U.

VALUE USB 2.0 Cable, A - 5-Pin Mini, M/M, white, 0.8 m	11.99.8708 – 10
VALUE USB 2.0 Cable, A - 5-Pin Mini, M/M, white, 1.8 m	11.99.8718 – 20
VALUE USB 2.0 Cable, A - 5-Pin Mini, M/M, white, 3.0 m	11.99.8730 – 10

**ROLINE USB 2.0 Cables, A - 5-Pin Mini**

- USB cable with one Type A and one USB 5-pin Mini connector
- Meets standard USB 2.0 (transfer rate up to 480 Mbit/s)
- Colour: black



Order-No. – P.U.

ROLINE USB 2.0 Cable, A - 5-Pin Mini, M/M, black, 0.8 m	11.02.8708 – 10
ROLINE USB 2.0 Cable, A - 5-Pin Mini, M/M, black, 1.8 m	11.02.8719 – 20
ROLINE USB 2.0 Cable, A - 5-Pin Mini, M/M, black, 3.0 m	11.02.8730 – 10

**VALUE Lightning to USB Cable for iPhone, iPod, iPad**

- Using 8 pins instead of 30, Lightning is significantly more compact than the 30-pin dock connector and can be inserted with either side facing up
- For the connection of devices like the iPhone on from the iPhone 5 that introduced the Lightning connector, as well as for iPods and iPads on from that generation
- This product is only made for devices with Lightning connector! It is NOT compatible with cables and peripherals designed for its predecessor, unless used with an adapter.
- High quality USB cable with one Type A (male) and one Lightning connector
- Improved shielding
- Meets standard USB 2.0 (transfer rate up to 480 Mbit/s)
- Colour: black



Order-No. – P.U.

VALUE Lightning to USB Cable for iPhone, iPod, iPad, 0.15 m	11.99.8326 – 20
VALUE Lightning to USB Cable for iPhone, iPod, iPad, 1.0 m	11.99.8321 – 20
VALUE Lightning to USB Cable for iPhone, iPod, iPad, 1.8 m	11.99.8322 – 20

**ROLINE Lightning to USB Cable for iPhone, iPod, iPad**

- Using 8 pins instead of 30, Lightning is significantly more compact than the 30-pin dock connector and can be inserted with either side facing up
- For the connection of devices like the iPhone on from the iPhone 5 that introduced the Lightning connector, as well as for iPods and iPads on from that generation
- This product is only made for devices with Lightning connector! It is NOT compatible with cables and peripherals designed for its predecessor, unless used with an adapter.
- High quality USB cable with one Type A (male) and one Lightning connector
- Improved shielding
- Meets standard USB 2.0 (transfer rate up to 480 Mbit/s)
- Colour: white



Order-No. – P.U.

ROLINE Lightning to USB Cable for iPhone, iPod, iPad, white, 0.15 m	11.02.8326 – 20
ROLINE Lightning to USB Cable for iPhone, iPod, iPad, white, 1.0 m	11.02.8321 – 20
ROLINE Lightning to USB Cable for iPhone, iPod, iPad, white, 1.8 m	11.02.8322 – 20

**VALUE/ROLINE Adapter 8pin-MicroB, M/F**

- For the connection of devices like the iPhone on from the iPhone 5 that introduced the Lightning connector, as well as for iPods and iPads on from that generation
- This product is only made for devices with Lightning connector! It is NOT compatible with cables and peripherals designed for its predecessor, unless used with an adapter.
- Connects to your iPhone, iPad, or iPod with Lightning Connector or Android smartphone and charges/syncs by connecting the USB connector into your wall charger or computer
- Colour: black



Order-No. – P.U.

VALUE Adapter 8pin-MicroB, M/F, black	11.99.8324 – 20
ROLINE Adapter 8pin-MicroB, M/F, white	11.02.8324 – 20

**VALUE/ROLINE 8pin + MicroB to USB Charge & Sync Cable**

- For the connection of devices like the iPhone on from the iPhone 5 that introduced the Lightning connector, as well as for iPods and iPads on from that generation
- This product is only made for devices with Lightning connector! It is NOT compatible with cables and peripherals designed for its predecessor, unless used with an adapter.
- Lighting and micro USB combo allows the cable to perform 2-in-1 functionality
- Connects to your iPhone, iPad, or iPod with Lightning Connector or Android smartphone and charges/syncs by connecting the USB connector into your wall charger or computer



Order-No. – P.U.

VALUE 8pin + MicroB to USB Charge & Sync Cable, black, 1.0 m	11.99.8325 – 10
ROLINE 8pin + MicroB to USB Charge & Sync Cable, white, 1.0 m	11.02.8325 – 10

**ROLINE 8pin + MicroB + Type C to USB Charge & Sync Cable**

- Connect almost all popular smartphones or tablets via Apple Lightning, USB Type C or USB Micro B plug to e.g. your PC or charger - suitable for loading and for data transfers!**
- USB 2.0 cable with one USB Type A connector and one Apple Lightning (8pin), USB Micro B and USB Type C connector each

- For the connection of devices with Apple Lightning or Micro USB / USB Type C socket- so almost all common smartphones or tablets can be connected!
- With the revolutionary USB Type C connector you are prepared for future generations of devices.
- The Lightning plug (8pin) is suitable for all iPhones

- and iPads from the fifth generation onwards, e.g. for iPhone 8 or iPhone X
- Complies with USB 2.0 standard (transmission up to 480 Mbit/s)
- Allows loading of mobile devices and data exchange
- Colour: white



Order-No. – P.U.

ROLINE 8pin + MicroB + Type C to USB Charge & Sync Cable, white, 1.0 m	11.02.8329 – 10
--	-----------------





**ROLINE USB 2.0 Spiral Cable, A - Micro B**

**High quality USB cable with one Type A and one Micro USB connector**

- Improved shielding
- For the connection of devices with Micro USB connector; e.g. smartphones / mobile phones or digital cameras / DSLR

- Meets standard USB 2.0 (transfer rate up to 480 Mbit/s)
- Colour: black



**roline**  
Designed for Professionals

Order-No. – P.U.

ROLINE USB 2.0 Spiral Cable, A - Micro B, M/M, 1.0 m

11.02.8317 – 10

**ROLINE USB 2.0 Cable, reversible, A - Micro B**

**High quality USB cable with one Type A and one Micro USB connector (both reversible)**

- For the connection of devices with Micro USB connector; e.g. smartphones / mobile phones or digital cameras / DSLR
- Meets standard USB 2.0 (transfer rate up to 480 Mbit/s)
- Colour: black



**roline**  
Designed for Professionals

Order-No. – P.U.

ROLINE USB 2.0 Cable, reversible, A - Micro B, M/M, 1.0 m

11.02.8765 – 10

**VALUE/ROLINE USB 2.0 Cables, OTG**

- High quality USB cable with one Type A (female) and one Micro B USB connector
- For the connection of devices with Micro USB connector; e.g. digital cameras, mobile phones, MP3 players or PDAs

- Not suitable for Samsung Galaxy S3 mini (GT-I8190)
- Meets standard USB 2.0 (transfer rate up to 480 Mbit/s)
- Colour: black



**Value**  
**roline**  
Designed for Professionals

Order-No. – P.U.

VALUE USB 2.0 Cable, A - Micro B, F/M, OTG, 0.15 m

11.99.8311 – 100

ROLINE USB 2.0 Cable, A - Micro B, F/M, OTG, 0.15 m

11.02.8311 – 25

**USB 2.0 Charging Cables, Micro B - Micro B**

- Charging cable for USB devices with USB Micro B connector
- To connect an USB device with USB Micro B to another device with USB Micro B connector for charging

- Only charging, no data transfer
- Not suitable for NOKIA or BLACKBERRY
- Color: white/black
- Length: 0,3m

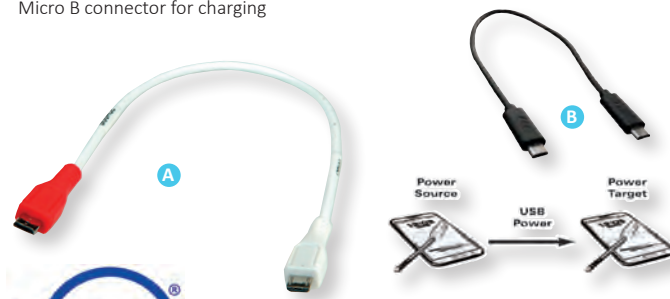

**Value**  
**roline**  
Designed for Professionals

Order-No. – P.U.

VALUE USB 2.0 Charging Cable, Micro B - Micro B, M/M, 0.3m

A 11.99.8307 – 25

ROLINE USB 2.0 Charging Cable, Micro B - Micro B, M/M, 0.3m

B 11.02.8307 – 10

**ROLINE USB 2.0 LED Charging Cable**

- For Power Charging, Data Sync and Data Transfer
- LED lighting effect lets you know your device is charging (RED color while charging, continuous BLUE color when the charging process is finished)
- Supports data transfer- you can move

- music, pictures, videos and any other files to and from your device
- Cable design prevents kinks, knots or tangles in the cable
- Color: black



Micro B

**roline**  
Designed for Professionals

Order-No. – P.U.

ROLINE USB 2.0 LED Charging Cable, A - Micro B, M/M, 1.0 m

11.02.8318 – 10

**ROLINE USB 2.0 Cables, A - Micro B (reversible)**

**High quality USB cable with one Type A and one reversible Micro USB connector.**

- Improved shielding
- For the connection of devices with Micro USB connector; e.g. smartphones / mobile phones or digital cameras / DSLR

- Meets standard USB 2.0 (transfer rate up to 480 Mbit/s)



Micro B reversible

**roline**  
Designed for Professionals

Order-No. – P.U.

ROLINE USB 2.0 Cable, A - Micro B (reversible), M/M, 0.8 m

11.02.8770 – 10

ROLINE USB 2.0 Cable, A - Micro B (reversible), M/M, 1.8 m

11.02.8771 – 10

ROLINE USB 2.0 Cable, A - Micro B (reversible), M/M, 3.0 m

11.02.8772 – 10

**ROLINE USB 2.0 Cables, A reversible - Micro B (90° angled)**

**To connect smartphones, Tablets, external hard drives (HDD/SSD) and other USB devices to your PC, laptop or charger with USB Micro B connection - both connectors are angled!**

- Improved shielding
- For the connection of devices with Micro USB connector; e.g. smartphones / mobile phones or digital cameras / DSLR
- Meets standard USB 2.0 (transfer rate up to 480 Mbit/s)
- Special feature: 90° angled Micro B connector and reversible Type A connector
- Colour: black



Micro B

**roline**  
Designed for Professionals

Order-No. – P.U.

ROLINE USB 2.0 Cable, A reversible - Micro B (90° angled), M/M, 0.8 m

11.02.8720 – 10

ROLINE USB 2.0 Cable, A reversible - Micro B (90° angled), M/M, 1.8 m

11.02.8721 – 10

ROLINE USB 2.0 Cable, A reversible - Micro B (90° angled), M/M, 3.0 m

11.02.8722 – 10

**ROLINE USB 2.0 Cables, C - A**

For connecting smartphones or tablets with USB Type C connection to a wall charger or e.g. for connection of hard disks (HDD/SSD) and other end devices.

- USB 2.0 connection cable with Type A to Type C male/male connector
- Suitable for data transfer rates of up to 480 Mbit/s
- Connectors: 1x USB Type A connector, 1x USB type C connector
- Color: silver/ black



**roline**  
Designed for Professionals

Order-No. – P.U.

ROLINE USB 2.0 Cable, C - A, M/M, black, 0.8 m	11.02.9027 – 10
ROLINE USB 2.0 Cable, C - A, M/M, black, 1.8 m	11.02.9028 – 10
ROLINE USB 2.0 Cable, C - A, M/M, black, 3.0 m	11.02.9029 – 10

**ROLINE USB 2.0 Cables, C (90° angled) - A reversible**

To connect smartphones, Tablets, external hard drives (HDD/SSD) and other USB devices to your PC, laptop or charger with the new USB Type C connection - both connectors are angled!

- USB 2.0 connection cable with Type A to Type C male/male connector (L-Shape, 90° angled)
- Suitable for data transfer rates of up to 480 Mbit/s
- Connectors: 1x USB Type A connector, 1x USB type C (L-Shape, 90° angled) connector
- Color: black



**roline**  
Designed for Professionals

Order-No. – P.U.

ROLINE USB 2.0 Cable, C (90° angled) - A reversible, M/M, black, 0.8 m	11.02.9035 – 10
ROLINE USB 2.0 Cable, C (90° angled) - A reversible, M/M, black, 1.8 m	11.02.9036 – 10
ROLINE USB 2.0 Cable, C (90° angled) - A reversible, M/M, black, 3.0 m	11.02.9037 – 10

**VALUE/ROLINE USB 2.0 Cables, C - Micro B**

To connect smartphones, tablet PCs, external hard drives, MP3 players and other micro B USB devices to your PC, laptop or charger with the new type C connection.

- USB 2.0 connection cable with micro B to type C male/male connector
- Suitable for data transfer rates of up to 480 Mbit/s
- Backwards compatible with USB 1.0
- Connectors: 1x USB Micro B connector, 1x USB type C connector
- Type: C - Micro B
- Colour: white / Black



**Value** **roline**  
Designed for Professionals

Order-No. – P.U.

VALUE USB 2.0 Cable, C - Micro B, M/M, white, 1.0 m	11.99.9020 – 10
VALUE USB 2.0 Cable, C - Micro B, M/M, white, 2.0 m	11.99.9021 – 10
ROLINE USB 2.0 Cable, C - Micro B, M/M, black, 1.0 m	11.02.9020 – 10
ROLINE USB 2.0 Cable, C - Micro B, M/M, black, 2.0 m	11.02.9021 – 10

**ROLINE USB2.0 Y Cable, 2x Type A M/F - 1x MicroB M, 1m**

- For the connection of high-power USB 2.0 devices as e.g. external HDDs
- Very helpful if you want to connect your USB 2.0 device with Micro USB B (smartphone, tablet, digital camera) with an external HDD which needs additional power from a second USB port like PC/notebook/USB charger
- OTG functionality



**roline**  
Designed for Professionals

Order-No. – P.U.

ROLINE USB2.0 Y Cable, 2x Type A M/F - 1x MicroB M, 1m	19.08.1009 – 25
--	-----------------

**ROLINE USB 2.0 Cables, C - Micro B (reversible)**

**roline**  
Designed for Professionals

Order-No. – P.U.

ROLINE USB 2.0 Cable, C - Micro B (reversible), M/M, black, 1.8 m	11.02.8780 – 10
ROLINE USB 2.0 Cable, C - Micro B (reversible), M/M, black, 3.0 m	11.02.8781 – 10
ROLINE USB 2.0 Cable, C - Micro B (reversible), M/M, black, 4.5 m	11.02.8782 – 5

**USB 2.0 Hi-Speed cable with high quality and improved shielding.**

- For the connection of devices with Micro USB connector; e.g. smartphones / mobile phones or digital cameras / DSLR
- Improved shielding
- Supports data transfer rates of up to 480 Mbit/s
- High quality USB cable with one Type C and one reversible Micro USB connector
- Meets standard USB 2.0 (transfer rate up to 480 Mbit/s)
- Colour: black

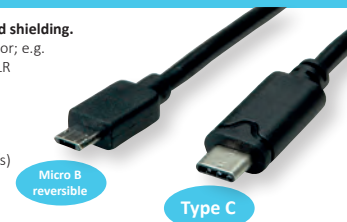

**ROLINE USB Type C (M) + Micro B (M) to USB A (M or F), OTG**

**Multipurpose USB 2.0 cable**

- USB Type C and micro B combo allows the cable to perform 2-in-1 functionality
- Connect the cable to your Smartphone or tablet and charge your device by connecting the USB connector into your wall charger or transfer data by connecting it with your computer
- One end of the cable is equipped with a Micro USB B plug, alternatively through an attachment with a type C plug
- The second side of the cable has a type A plug, which can be converted into a type A socket by a side slider- and vice versa

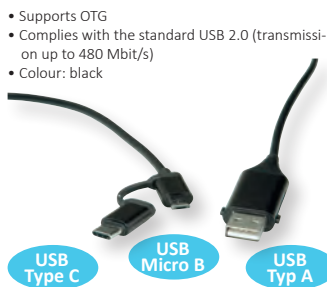

**roline**  
Designed for Professionals

Order-No. – P.U.

ROLINE USB Type C (M) + Micro B (M) to USB A (M or F), OTG, black, 1.0 m	11.02.8327 – 10
--	-----------------

**ROLINE Cable USB Micro B + Type C M/M to USB2.0 A M**

**USB 2.0 cable with 2-in1 connector**

- USB Type C and Micro B combo allows the cable to perform 2-in-1 functionality
- Allows you to transfer data from your mobile device
- Connect the cable to your Smartphone or tablet and charge your device by connecting the USB connector into your wall charger or transfer data by connecting it with your computer
- The one end of the cable is equipped with a Micro USB B plug, alternatively by an attachment with a type C connector, the second side has a type A connector

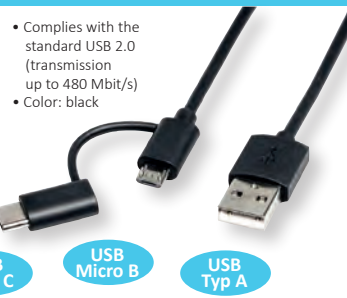

**roline**  
Designed for Professionals

Order-No. – P.U.

ROLINE Cable USB Micro B + Type C M/M to USB2.0 A M, black, 1.0 m	11.02.8328 – 10
---	-----------------

### ROLINE Magnetic USB2.0 Cable, A-MicroB

- High quality USB cable with one Type A and one Micro USB B connector
- Improved shielding
- For the connection of devices with Micro USB connector; e.g. digital cameras, mobile phones, MP3 players or PDAs
- Meets standard USB 2.0 (transfer rate up to 480 Mbit/s)
- Magnetic adapter seamlessly attaches to the cable once they are in close proximity
- Helps to protect the Micro USB B port (e.g. smartphone, tablet) from dust
- Unlike a constant plug-in and unplugging of a normal cable, both ports can

be protected during frequent use due to their magnetic connection.

- Attach and detach this magnetic connector through magnetic force
- **For additional magnetic connectors please order the item 11.02.8313 or 11.02.8309 (Type C) (3 pieces)**

**roline**<sup>®</sup>  
Designed for Professionals

Order-No. – P.U.

ROLINE Magnetic USB2.0 Cable, A-MicroB, M/M, 1.0 m A 11.02.8312 – 10

ROLINE Detachable Magnetic Connector for 11.02.8312, 3 pcs. B 11.02.8313 – 20

ROLINE Detachable Magnetic Connector for 11.02.8312, Type C, 3 pcs. C 11.02.8309 – 20

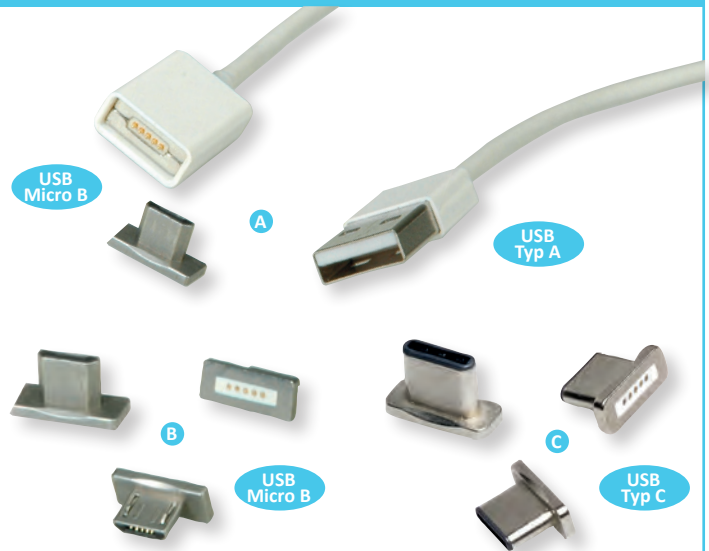

### VALUE USB 2.0 Extension Cables

- Supports USB 2.0
- The cable extends the distance of a USB 2.0 device by 5 m
- Meets USB 2.0 specifications and works with low-speed, high-speed and full-speed devices
- Hot-pluggable
- Cable length: 5 m

**Value**<sup>®</sup>

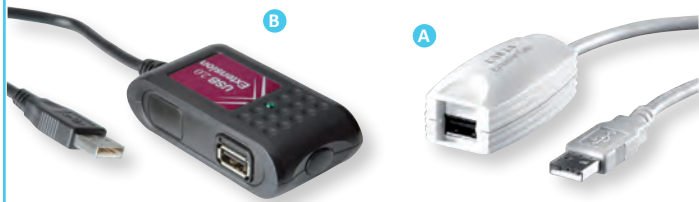

Order-No. – P.U.

VALUE USB 2.0 Extender, 1 Port, white, 5.0 m A 12.99.1100 – 10

VALUE USB 2.0 Extender, 2 Ports, black, 5.0 m B 12.99.1089 – 10

### VALUE USB 2.0 Extension Cables, Active

- Supports USB 2.0
- The cable extends the distance of a USB 2.0 device by 12 m / 30m
- Meets USB 2.0 specifications and works with low-speed, high-speed and full-speed devices
- Hot-pluggable
- Cable length: 12 m / 30m



Order-No. – P.U.

VALUE USB 2.0 Extension Cable, active, with Repeater, 12.0 m A 12.99.1110 – 10

VALUE USB 2.0 Extension Cable, active, with Repeater, 30.0 m B 12.99.1111 – 5

### ROLINE USB 2.0 Extension Cables

- Supports USB 2.0
- The cable extends the distance of a USB 2.0 device by 5 m
- The cable acts as a single port hub, which means that multiple cables can be cascaded to increase the distance between your computer and USB 2.0 devices
- Meets USB 2.0 specifications and works with low-speed, high-speed and full-speed devices
- Hot-pluggable
- Contents: Cable

**roline**<sup>®</sup>  
Designed for Professionals



Order-No. – P.U.

ROLINE USB 2.0 Extension Cable, 1 Port, white, 5.0 m A 12.04.1088 – 10

ROLINE USB 2.0 Extension Cable, 1 Port, black, 5.0 m B 12.04.1089 – 10

### ROLINE USB 2.0 Extension Cable, Active

- Active USB extension cable- ensures good signal quality to meet USB specification, even over a distance of 15 meters
- Active USB extension cable
- Compliant with USB 2.0
- Supports data transfer rates of up to 480 Mbit/s
- Cable length: 15 m

- Connectors: USB type A M to USB type A F
- Hot-swappable, plug & play, no drivers required
- Power supply over USB port from the PC
- Supported operating systems: Windows 98SE / 2000 / XP / Vista / 7, Mac OS X
- Contents: Cable



**roline**<sup>®</sup>  
Designed for Professionals



Order-No. – P.U.

ROLINE USB 2.0 Extension Cable, active, 15 m

12.04.1091 – 5



**ROLINE USB 2.0 Hub with Repeater**

This hub with an active repeater cable extends the distance between the hub and the computer up to 12 m.

With its unique design, this hub can lock to USB 2.0 Active Repeater Cable 12.04.1086 by clipping- which offers another 12 m of length- between USB A Male and Female end. With up to 5 of this hub & USB Active Repeater Cables chained together, you can reach for a maximum distance up to 60 meters.

- 4x USB 2.0 ports
- Full compliance with USB 2.0 / 1.1 specification
- Plug & play. no additional drivers required
- Cable length: 12 m
- Housing dimensions: 81.7 x 41 x 16.7 mm
- Connectors: 1x USB Type A Male and 4x USB Type A Female
- Supports Windows
- Contents: Cable



Order-No. - P.U.

ROLINE USB 2.0 Hub, 4 Ports, with Repeater, 12.0 m 12.04.1085 - 10

ROLINE USB 2.0 Active Repeater Cable for 12.04.1085, 12.0 m 12.04.1086 - 10

**VALUE USB 1.1 Extender over RJ-45**

- Allows you to extend the connection to a USB peripheral device up to 45 meters by using a Cat.5e/6 patch cable
- Applications: e.g. WEB camera, surveillance camera, scanner, printer
- Compliant with USB 1.1
- Supports full-speed (12 Mbit/s) or low-speed (1.5 Mbit/s) USB devices

- Supports Windows 98SE/2000/XP/Vista
- Contents: Master unit (RJ-45 Female; USB Type A Male with 10 cm cable), remote unit (RJ-45 Female; USB Type A Female with 10 cm cable)
- Contents: Master Unit, Remote Unit



Order-No. - P.U.

VALUE USB 1.1 Extender over RJ-45

12.99.1121 - 10

**VALUE USB 2.0 Extender over RJ-45, max. 50m**

Use this USB 2.0 extender in combination with a RJ45 cable to extend your USB connection up to 50m!

- Extend your USB port over RJ-45 (up to 50 meters)
- For example to connect an USB printer in another room with your PC
- Supports USB 2.0, downwards compatible with USB 1.1/1.0
- Hot plug
- No additional software for extender required
- Connection via Cat.5e/Cat. 6 Twisted Pair cable
- Transmitter: USB A Male connector/RJ-45, Receiver: USB A Female connector/RJ-45
- Supports data rates up to 480Mbit/s
- Contents: Master unit (RJ-45 Female; USB Type A Male with 21 cm cable),

remote unit (RJ-45 Female; USB Type A Female)



Order-No. - P.U.

VALUE USB 2.0 Extender over RJ-45, max. 50m 12.99.1122 - 5

**ROLINE USB 2.0 Extender over RJ-45, max. 50m**

- Extend your USB port over RJ-45 (up to 50 meters)
- For example to connect an USB printer in another room with your PC
- Supports USB 2.0, downwards compatible with USB 1.1/1.0

- Hot plug
- No additional software for extender required
- Connection via Cat.5e/Cat. 6 Twisted Pair cable
- Supports data rates up to 480Mbit/s



Order-No. - P.U.

ROLINE USB 2.0 Extender over RJ-45, max. 50m A 12.04.1100 - 5

ROLINE USB 2.0 Extender over RJ-45, PoC, 1x USB, max. 50m B 12.04.1102 - 4

ROLINE USB 2.0 Extender over RJ-45, PoC, 4x USB, max. 50m C 12.04.1101 - 4

**ROLINE USB 3.0 Hub with Repeater**

This hub with an active repeater cable extends the distance between the hub and the computer up to 10 m.

- 4x USB 3.0 ports
- Full compliance with USB 2.0 / 1.1 specification
- Plug & play. no additional drivers required
- USB Bus powered
- Cable length: 10 m

- Housing dimensions: 81 x 40 x 17 mm
- Connectors: 1x USB Type A Male and 4x USB Type A Female
- Supports Windows XP / 7
- Power adapter (5V/3.5A, included) for heavy power consumption devices
- Contents: Cable



Order-No. - P.U.

ROLINE USB 3.0 Hub, 4 Ports, with Repeater, 10.0 m 12.04.1097 - 4

**ROLINE USB 3.0 Active Repeater Cable**

Extends the connection distance of an external HDD, hub, printer, scanner or other USB 3.0 device to your computer by 5 meters.

- Active USB extension cable- ensures good signal quality
- Compliant with SuperSpeed USB 3.0, USB 2.0, USB 1.1
- Supports data rates up to 5 Gbit/s
- Plug & play
- Supported Operating Systems: Windows 2000/XP/Vista/7, Mac OS
- Contents: USB 3.0 Active repeater cable



Order-No. - P.U.

ROLINE USB 3.0 Active Repeater Cable, black, 5.0 m 12.04.1096 - 8

**ROLINE USB 3.0 Active Repeater Cables**

Extends the connection distance of an external HDD, hub, printer, scanner or other USB 3.0 device to your computer by 20 meters.

- Active USB extension cable- ensures good signal quality
- Compliant with SuperSpeed USB 3.0, USB 2.0, USB 1.1
- Supports data rates up to 5 Gbit/s
- Plug & play

- Supported Operating Systems: Windows 2000/XP/Vista/7/8, Mac OS
- Contents: USB 3.0 Active repeater cable



**roline**  
Designed for Professionals

Order-No. – P.U.

ROLINE USB 3.0 Active Repeater Cable, black, 10.0 m	12.04.1080 – 5
ROLINE USB 3.0 Active Repeater Cable, black, 15.0 m	12.04.1081 – 5
ROLINE USB 3.0 Active Repeater Cable, black, 20.0 m	12.04.1082 – 5

**VALUE USB 3.0 SuperSpeed Cables**

A new major feature of USB 3.0 is SuperSpeed bus, which increases the maximum transfer rate to 5.0 Gbit/s. USB 3.0 receptacles are compatible with USB 2.0 device plugs for the respective physical form factors. The cables can be used with PCs with the actual Type A F.

Color: white



**Value**

Order-No. – P.U.

VALUE USB 3.0 Cable, A - B, M/M, 0.8 m	11.99.8869 – 10
VALUE USB 3.0 Cable, A - B, M/M, 1.8 m	11.99.8870 – 50
VALUE USB 3.0 Cable, A - B, M/M, 3.0 m	11.99.8871 – 50
VALUE USB 3.0 Cable, A - A, M/M, 1.8 m	11.99.8975 – 50
VALUE USB 3.0 Cable, A - A, M/M, 3.0 m	11.99.8976 – 50
VALUE USB 3.0 Cable, A - A, M/F, 0.8 m	11.99.8977 – 50
VALUE USB 3.0 Cable, A - A, M/F, 1.8 m	11.99.8978 – 50
VALUE USB 3.0 Cable, A - Micro A, M/M, 0.8 m	11.99.8872 – 10
VALUE USB 3.0 Cable, A - Micro A, M/M, 2.0 m	11.99.8874 – 10
VALUE USB 3.0 Cable, A - Micro B, M/M, 0.15m	11.99.8876 – 10
VALUE USB 3.0 Cable, A - Micro B, M/M, 0.8 m	11.99.8873 – 10
VALUE USB 3.0 Cable, A - Micro B, M/M, 2.0 m	11.99.8875 – 10
VALUE USB 3.0 Cable, A - Micro B, M/M, 3.0 m	11.99.8877 – 10

**ROLINE USB 3.0 SuperSpeed Cables**

USB 3.0 SuperSpeed cables with high quality and improved shielding for transfer rates of up to 5 Gbit/s. USB 3.0 receptacles are partly compatible with USB 2.0 device plugs for the respective physical form factors. The cables can be used with PCs with the actual type A interface. The new USB 3.0 Type B connectors are not downwards compatible.

- Colour: black



**roline**  
Designed for Professionals

Order-No. – P.U.

ROLINE USB 3.0 Cable, A - B, M/M, 0.8 m	11.02.8869 – 10
ROLINE USB 3.0 Cable, A - B, M/M, 1.8 m	11.02.8870 – 50
ROLINE USB 3.0 Cable, A - B, M/M, 3.0 m	11.02.8871 – 50
ROLINE USB 3.0 Cable, A - A, M/M, 1.8 m	11.02.8970 – 50
ROLINE USB 3.0 Cable, A - A, M/M, 3.0 m	11.02.8971 – 50
ROLINE USB 3.0 Cable, A - A, M/F, 0.8 m	11.02.8977 – 50
ROLINE USB 3.0 Cable, A - A, M/F, 1.8 m	11.02.8978 – 50
ROLINE USB 3.0 Cable, A - Micro A, M/M, 0.8 m	11.02.8872 – 10
ROLINE USB 3.0 Cable, A - Micro A, M/M, 2.0 m	11.02.8874 – 10
ROLINE USB 3.0 Cable, A - Micro B, M/M, 0.15 m	11.02.8876 – 25
ROLINE USB 3.0 Cable, A - Micro B, M/M, 0.8 m	11.02.8873 – 10
ROLINE USB 3.0 Cable, A - Micro B, M/M, 2.0 m	11.02.8875 – 10
ROLINE USB 3.0 Cable, A - Micro B, M/M, 3.0 m	11.02.8877 – 10

**ROLINE USB 3.0 Y Power Cable**

- For the connection of high-power SuperSpeed USB 3.0 devices as e. g. external HDDs
- Very helpful if you want to connect your USB 3.0 device to a PC with USB 2.0 ports



Order-No. – P.U.

ROLINE USB 3.0 Y Cable, 2x Type A M - 1x Micro B M, 1.8 m	19.08.1008 – 10
---	-----------------

VALUE USB 3.0 „DOME“ Cable

- Brings your computer's USB port directly on your desktop
- Two USB 3.0 ports: One for data, one for power/charging
- Supports SuperSpeed USB 3.0 with data rates of up to 5 Gbit/s
- Backwards compatible with USB 2.0, USB 1.1
- Integrated magnet, which allows you to „stick“ it on metal surfaces or furniture



Order-No. – P.U.

VALUE USB 3.0 „DOME“ Cable, black, 1.5 m

11.99.8999 – 12

VALUE USB 3.0 Cables, C - B

To connect e.g. external hard drives (HDD/SSD) and other USB devices to your PC, laptop or charger with the new USB Type C connection.

- USB 3.0 connection cable with Type B to Type C male/male connector
- Suitable for data transfer rates of up to 5 Gbit/s
- Connectors: 1x USB Type B connector, 1x USB Type C connector
- Color: white



Order-No. – P.U.

VALUE USB 3.0 Cable, C - B, M/M, 1.8 m

11.99.8880 – 10

VALUE USB 3.0 Cable, C - B, M/M, 3.0 m

11.99.8881 – 10

ROLINE USB 3.0 Cables, C - B

To connect smartphones, Tablets, external hard drives (HDD/SSD) and other USB devices to your PC, laptop or charger with the new USB Type C connection.

- USB 3.0 connection cable with Type B to Type C male/male connector
- Suitable for data transfer rates of up to 5 Gbit/s
- Connectors: 1x USB Type B connector, 1x USB type C connector
- Color: black



Order-No. – P.U.

ROLINE USB 3.0 Cable, C - B, M/M, black, 1.8 m

11.02.8880 – 10

ROLINE USB 3.0 Cable, C - B, M/M, black, 3.0 m

11.02.8881 – 10

VALUE USB 3.1 Cables, PD (Power Delivery)

The new SuperSpeed+ USB 10 Gbit/s (USB 3.1) specification adds a 10 Gbit/s speed mode that uses a more efficient data encoding and will deliver more than twice the effective data through-put performance of existing Super-Speed USB over enhanced, fully backward compatible USB connectors and cables.

- High quality cable with improved shielding
- With the new reversible Type C connectors at both ends
- Gold-plated contacts for low wear at high plugging cycles

- Suitable for data transfer rates of up to 10 Gbit/s
- Supports USB Power Delivery up to 20V / 5A



Order-No. – P.U.

VALUE USB 3.1 Cable, PD (Power Delivery) 20V5A, with Emark, C-C, M/M, 0.5 m

11.99.9050 – 20

VALUE USB 3.1 Cable, PD (Power Delivery) 20V5A, with Emark, C-C, M/M, 1.0 m

11.99.9051 – 10

VALUE USB 3.1 Cable, A-C, M/M, 0.5 m

11.99.9010 – 20

VALUE USB 3.1 Cable, A-C, M/M, 1 m

11.99.9011 – 10

ROLINE USB 3.1 Cables, PD (Power Delivery)

The new SuperSpeed+ USB 10 Gbit/s (USB 3.1) specification adds a 10 Gbit/s speed mode that uses a more efficient data encoding and will deliver more than twice the effective data through-put performance of existing Super-Speed USB over enhanced, fully backward compatible USB connectors and cables.

- High quality cable with improved shielding
- With the new reversible Type C connectors at both ends
- Gold-plated contacts for low wear at high plugging cycles
- Suitable for data transfer rates of up to 10 Gbit/s
- Supports USB Power Delivery to 20V / 5A



Order-No. – P.U.

ROLINE USB 3.1 Cable, PD (Power Delivery) 20V5A, with Emark, C-C, M/M, 0.5 m

11.02.9050 – 20

ROLINE USB 3.1 Cable, PD (Power Delivery) 20V5A, with Emark, C-C, M/M, 1.0 m

11.02.9051 – 10

ROLINE USB 3.1 Cable, A-C, M/M, black, 0.5 m

11.02.9010 – 20

ROLINE USB 3.1 Cable, A-C, M/M, black, 1.0 m

11.02.9011 – 10

VALUE USB 3.1 Cable, PD (Power Delivery) 20V5A, with Emark, C-C

Full-featured USB 3.1 Gen 2 cable with data transmission rate of up to 10 Gbit/s and full Power Delivery support of up to 20V 5A!

- High quality cable with improved shielding
- With the new reversible Type C connectors at both ends
- Gold-plated contacts for low wear at high plugging cycles
- Suitable for data transfer rates of up to 10 Gbit/s

- Supports USB Power Delivery to 20V / 5A



Order-No. – P.U.

VALUE USB 3.1 Cable, PD (Power Delivery) 20V5A, with Emark, C-C, 0.5 m

11.99.9052 – 20

VALUE USB 3.1 Cable, PD (Power Delivery) 20V5A, with Emark, C-C, 1.0 m

11.99.9053 – 10

ROLINE USB 3.1 Cable, PD (Power Delivery) 20V5A, with Emark, C-C

Full-featured USB 3.1 Gen 2 cable, with a data transmission rate of up to 10 Gbit/s and full Power Delivery support of up to 20V 5A!

- High quality cable with improved shielding
- With the new reversible Type C connectors at both ends
- Gold-plated contacts for low wear at high plugging cycles
- Suitable for data transfer rates of up to 10 Gbit/s

- Supports USB Power Delivery to 20V / 5A



Order-No. – P.U.

ROLINE USB 3.1 Cable, PD (Power Delivery) 20V5A, with Emark, C-C, 0.5 m

11.02.9052 – 20

ROLINE USB 3.1 Cable, PD (Power Delivery) 20V5A, with Emark, C-C, 1.0 m

11.02.9053 – 10



## VALUE Cableadapter, USB3.1, C-A, OTG



- High quality USB 3.1 cable with one Type A (female) and one Type C USB connector (male)
- Meets standard USB3.1 (transfer rate up to 10 Gbit/s)
- Colour: black

**Value**<sup>®</sup>

Order-No. – P.U.

VALUE Cableadapter, USB3.1, C-A, M/F, OTG, black, 0.15 m

11.99.9030 – 25

## ROLINE Cableadapter, USB3.1, C-A, M/F, OTG

- High quality USB 3.1 cable with one Type A (female) and one Type C USB connector (male)
- Meets standard USB3.1 (transfer rate up to 10 Gbit/s)
- Colour: black



**roline**<sup>®</sup>  
Designed for Professionals

Order-No. – P.U.

ROLINE Cableadapter, USB3.1, C-A, M/F, OTG, black, 0.15 m

11.02.9030 – 10

## ROLINE Adapter, USB3.1, A - C, M/F

- Active USB interface converter with a male USB Type-A and a female USB Type-C receptacle
- To plug new coming USB-C devices or cables into your existing computer/ laptop
- USB3.1 SuperSpeed 10Gbit/s data transfer performance
- Power charging with over current protection 5V@1000mA
- Colour: black

- **REMARK: This dongle supports both, USB data communication and power charging features, but does NOT support USB-C DisplayPort Alternate Mode video device, such as USB-C to HDMI adapter.**

**roline**<sup>®</sup>  
Designed for Professionals



Order-No. – P.U.

ROLINE Adapter, USB3.1, A - C, M/F

12.03.2995 – 10

## ROLINE USB 3.1 Cable, C-C, M/F

To protect the Type C plug of your PC, Macbook, Notebook or other devices. Also enhances the length of e.g. an adapter, so that you have more workspace on your desk!

- High quality cable with improved shielding
- With the new reversible Type C connectors at both ends
- Gold-plated contacts for low wear at high plugging cycles
- Suitable for data transfer rates of up to 10 Gbit/s

**roline**<sup>®</sup>  
Designed for Professionals



Order-No. – P.U.

ROLINE USB 3.1 Cable, C-C, M/F, black, 0.2 m

11.02.9015 – 10

## VALUE Adapter, USB 2.0, C-Micro B, OTG

- Connect your Apple Macbook, or Lumia Smartphone to a computer or USB charger for transferring data or charging
- Reversible Design
- Plug and unplug easily without checking for the connector orientation (for type C connector)
- OTG functionality
- Data transfer rate up to 480MBit/s
- Colour: black



**Value**<sup>®</sup>

Order-No. – P.U.

VALUE Adapter, USB2.0, C - Micro B, M/F, OTG

12.99.3190 – 10

## ROLINE USB 3.1 Cables, C-Micro B

- Compatible with existing USB 3.0 software stacks and device protocols
- Works with both existing 5Gbit/s USB 3.0 hubs and devices, as well as USB 2.0 products
- The USB type-C defines a new small reversible-plug connector for USB 3.1 devices
- The type-C plug can be used at both host and device side, replacing multiple type-B and type-A connectors and cables
- USB 3.1 high-speed cable in high quality with improved shielding
- Data transfer rates up to 10 Gbit/s
- Type: C - Micro B
- Length: 0.5 m / 1m
- Colour: black
- **Only suitable for USB standard power supply to 5V / 900mA!**



**roline**<sup>®</sup>  
Designed for Professionals

Order-No. – P.U.

ROLINE USB 3.1 Cable, C-Micro B, M/M, black, 0.5 m

11.02.9005 – 20

ROLINE USB 3.1 Cable, C-Micro B, M/M, black, 1.0 m

11.02.9006 – 10

## ROLINE USB Type C 90° angled - A, M/F, OTG

- Connect the cable to your Smartphone or tablet and charge your device by connecting the USB connector into your wall charger or transfer data by connecting it with your computer
- One end of the cable is equipped with a type C plug
- The second side of the cable has a type A female
- Supports OTG
- Complies with the standard USB 3.1 Gen1 (transmission up to 5 Gbit/s)
- Colour: black



**roline**<sup>®</sup>  
Designed for Professionals

**NEW**

Order-No. – P.U.

ROLINE USB Type C 90° angled - A, M/F, OTG, black, 0.15 m

11.02.9031 – 10

## ROLINE RS232 Cables

- Cable with two 25-pole D-Sub connectors
- Connector casing moulded with special plastic for best strain relief
- Connects a switchbox with a computer or two serial interfaces
- Very good screening prevents data loss and electromagnetic interference
- 25 lines connected 1:1
- Hand locking screws
- Screen line connected to the cable foil screen and both connectors
- Bronze contacts with gold coating



	Order-No. – P.U.
ROLINE RS232 Cable, M - M, 1.8 m	11.01.3518 – 50
ROLINE RS232 Cable, M - M, 3.0 m	11.01.3530 – 50
ROLINE RS232 Cable, M - M, 4.5 m	11.01.3545 – 25
ROLINE RS232 Cable, M - M, 6.0 m	11.01.3560 – 25
ROLINE RS232 Cable, M - M, 9.0 m	11.01.3590 – 25
ROLINE RS232 Cable, M - F, 1.8 m	11.01.3618 – 25
ROLINE RS232 Cable, M - F, 3.0 m	11.01.3630 – 50
ROLINE RS232 Cable, M - F, 4.5 m	11.01.3645 – 25
ROLINE RS232 Cable, M - F, 6.0 m	11.01.3660 – 25
ROLINE RS232 Cable, M - F, 9.0 m	11.01.3690 – 20
ROLINE RS232 Cable, F - F, 1.8 m	11.01.3718 – 50
ROLINE RS232 Cable, F - F, 3.0 m	11.01.3730 – 50

## ROLINE Parallel Printer Cables

- For printers with Centronics connection
- Cable with 25-pole D-Sub plug and 36-pole Centronics plug
- 25 lines
- Screen line connected with the foil screen and both plugs
- Connector casing moulded with special plastic, for optimal strain reduction, cable break not possible
- Very good screening prevents data loss and electromagnetic interference
- Thumbscrews
- Bronze contacts with gold coating



**Connection list for parallel printer cable**  
 25-pole connector: 1-14|15|16|17|18|19|20|21|22|23|24|25  
 36-pole connector: 1-14|32|31|36|33|19|21|23|25|27|29|30

	Order-No. – P.U.
ROLINE Parallel Printer Cable, DB25 M - C36 M, grey, 1.8 m	11.01.1018 – 50
ROLINE Parallel Printer Cable, DB25 M - C36 M, grey, 3.0 m	11.01.1030 – 50
ROLINE Parallel Printer Cable, DB25 M - C36 M, grey, 4.5 m	11.01.1045 – 25
ROLINE Parallel Printer Cable, DB25 M - C36 M, grey, 6.0 m	11.01.1060 – 25
ROLINE Parallel Printer Cable, DB25 M - C36 M, grey, 9.0 m	11.01.1090 – 20

## ROLINE Serial Link Cables

- Connects two PCs via the serial interface, whereby the cable acts as a null modem
- Two 9-pole D-Sub sockets
- Connector casing moulded with special plastic, so optimal strain reduction, cable break not possible
- Very good screening prevents data loss and electromagnetic interference



9- pole F: 1|7|2|3| 4 |6|8|5|9  
 9- pole F: 7|1|3|2|6|8| 4 |5|9

	Order-No. – P.U.
ROLINE Serial Link Cable, DB9 F/F, 1.8 m	11.01.9018 – 50
ROLINE Serial Link Cable, DB9 F/F, 3.0 m	11.01.9030 – 50

## VALUE RS232 Cables

- Cable with two 9-pole D-Sub connectors, assembled
- Connects e.g. the serial IBM AT interface with a switchbox
- All lines connected 1:1
- Screen line connected with the foil screen and both connectors



A

	Order-No. – P.U.
VALUE RS232 Cable, DB9 M - M, 1.8 m	11.99.6018 – 50
VALUE RS232 Cable, DB9 M - F, 1.8 m	11.99.6218 – 50
VALUE RS232 Cable, DB9 M - F, 3.0 m	11.99.6233 – 50
VALUE RS232 Cable, DB9 M - F, 1.0 m Screw/Nuts	A 11.99.6210 – 50

## ROLINE RS232 Cables

- Cable with two 9-pole D-Sub connectors
- Connects e.g. the serial IBM AT interface with a switchbox
- All lines connected 1:1
- Screen line connected with the foil screen and both connectors



	Order-No. – P.U.
ROLINE RS232 Cable, DB9 M - M, 1.8 m	11.01.6018 – 50
ROLINE RS232 Cable, DB9 M - F, 1.8 m	11.01.6218 – 50
ROLINE RS232 Cable, DB9 M - F, 3.0 m	11.01.6230 – 50
ROLINE RS232 Cable, DB9 M - F, 6.0 m	11.01.6260 – 25
ROLINE RS232 Cable, DB9 M - F, 10.0 m	11.01.6290 – 25
ROLINE RS232 Cable, DB9 F - F, 1.8 m	11.01.5918 – 50

## ROLINE Modem Cables

- Cable with a 9-pole D-Sub socket and a 25-pole D-Sub plug
- Connects PC and modem
- Connector casing moulded with special plastic, thus optimal strain reduction, no cable breaks
- Very good screening prevents data loss and electromagnetic interference
- Hand locking screws
- Bronze contacts with gold coating



DB9 F: 1|2|3| 4 |5|6|7|8|9  
 DB25 M: 8|3|2|20|7|6|4|5|22

	Order-No. – P.U.
ROLINE Modem Cable, DB9 F - DB25 M, 1.8 m	11.01.4518 – 50
ROLINE Modem Cable, DB9 F - DB25 M, 3.0 m	11.01.4530 – 50
ROLINE Modem Cable, DB9 F - DB25 M, 6.0 m	11.01.4560 – 20

## ROLINE Serial Printer Cables

- Cable with a 9-pole D-Sub socket and a 25-pole D-Sub plug
- Connects PC and modem
- Connector casing moulded with special plastic, thus optimal strain reduction, no cable breaks
- Very good screening prevents data loss and electromagnetic interference
- Hand locking screws
- Bronze contacts with gold coating



DB9 F: 1|2|3| 4 |5|6|7|8|9  
 DB25 M: 8|3|2|20|7|6|4|5|22

	Order-No. – P.U.
ROLINE Serial Printer Cable, DB9 F - DB25 M, 1.8 m	11.01.4618 – 50
ROLINE Serial Printer Cable, DB9 F - DB25 M, 3.0 m	11.01.4630 – 50

## ROLINE PS/2 Cables

- Extends the keyboard or mouse cable of a PC, e.g. for location of the computer under a table or for connection to a switchbox
- Cable with 6-pole Mini DIN plug and socket, 1:1



**roline**<sup>®</sup>  
Designed for Professionals

Order-No. – P.U.

ROLINE PS/2 Cable, M - F, 1.8 m	11.01.5618 – 50
ROLINE PS/2 Cable, M - F, 3.0 m	11.01.5630 – 50
ROLINE PS/2 Cable, M - F, 6.0 m	11.01.5660 – 25
ROLINE PS/2 Cable, M - F, 10.0 m	11.01.5690 – 25
ROLINE PS/2 Cable, M - M, 1.8 m	11.01.5818 – 50
ROLINE PS/2 Cable, M - M, 3.0 m	11.01.5830 – 50
ROLINE PS/2 Cable, M - M, 6.0 m	11.01.5860 – 25

## ROLINE VGA Cables, HD15

- Cable for connection of a monitor to a graphics card or to a switch
- 14 lines and additionally a screen line which is connected to the foil screen of the cable and to both connectors
- Moulded connector casings
- Hand-locking screws



**roline**<sup>®</sup>  
Designed for Professionals

Order-No. – P.U.

ROLINE VGA Cable, HD15, F/M, 1.8 m	11.01.6518 – 50
ROLINE VGA Cable, HD15, F/M, 3.0 m	11.01.6530 – 50
ROLINE VGA Cable, HD15, F/M, 6.0 m	11.01.6560 – 25
ROLINE VGA Cable, HD15, F/M, 10.0 m	11.01.6590 – 25
ROLINE VGA Cable, HD15, M/M, 1.8 m	11.01.6618 – 50
ROLINE VGA Cable, HD15, M/M, 3.0 m	11.01.6630 – 50

## VALUE SVGA Cables, HD15

- Quality cable for connection of a monitor to a graphics card or VGA splitter or amplifier
- Suitable for covering long distances (depending on graphics card and resolution) with high resolution
- Double-shielded cable (braided and foil shield) consisting of: 3 coax lines for the RGB signals and 7 AWG28 wires
- Thumbscrews



**Value**<sup>®</sup>

Order-No. – P.U.

VALUE SVGA Cable, HD15, M/M, 2.0 m	11.99.5252 – 20
VALUE SVGA Cable, HD15, M/M, 3.0 m	11.99.5253 – 20
VALUE SVGA Cable, HD15, M/M, 6.0 m	11.99.5256 – 10
VALUE SVGA Cable, HD15, M/M, 10.0 m	11.99.5257 – 5
VALUE SVGA Cable, HD15, M/M, 15.0 m	11.99.5258 – 2
VALUE SVGA Cable, HD15, M/M, 20.0 m	11.99.5259 – 2

## ROLINE HQ VGA Cables, HD15

- High quality cable for connection of a monitor to a graphics card or VGA splitter or amplifier
- Suitable for covering long distances (depending on graphics card and resolution) with high resolution; with amplifier up to 100 m
- Double-shielded cable (braided and foil shield)
- **3 coax lines for the RGB signals and 7 AWG28 wires (13 wires connected)**
- **Pin 9 (missing) and Pin 15 (not connected)**
- Thumbscrews



**roline**<sup>®</sup>  
Designed for Professionals

Order-No. – P.U.

ROLINE HQ VGA Cable, HD15, M/M, 2.0 m	11.04.5202 – 20
ROLINE HQ VGA Cable, HD15, M/M, 3.0 m	11.04.5203 – 20
ROLINE HQ VGA Cable, HD15, M/M, 6.0 m	11.04.5206 – 10
ROLINE HQ VGA Cable, HD15, M/M, 10.0 m	11.04.5210 – 5
ROLINE HQ VGA Cable, HD15, M/M, 15.0 m	11.04.5215 – 2
ROLINE HQ VGA Cable, HD15, M/M, 20.0 m	11.04.5220 – 2
ROLINE HQ VGA Cable, HD15, M/M, 30.0 m	11.04.5230 – 2
ROLINE HQ VGA Cable, HD15, M/F, 2.0 m	11.04.5302 – 20
ROLINE HQ VGA Cable, HD15, M/F, 3.0 m	11.04.5303 – 20
ROLINE HQ VGA Cable, HD15, M/F, 6.0 m	11.04.5306 – 10
ROLINE HQ VGA Cable, HD15, M/F, 10.0 m	11.04.5310 – 5
ROLINE HQ VGA Cable, HD15, M/F, 20.0 m	11.04.5320 – 2
ROLINE HQ VGA Cable, HD15, M/F, 30.0 m	11.04.5330 – 2

## ROLINE HQ VGA Cables + Ferrite, HD15

- High quality cable for connection of a monitor to a graphics card or VGA splitter or amplifier
- As monitor connection cable with two additional ferrite cores
- **3 coax lines for the RGB signals and 7 AWG28 wires (13 wires connected)**
- **Pin 9 (missing) and Pin 15 (not connected)**
- Connector casings moulded
- Double screened cable (braided and foil shield)
- Hand locking screws

**roline**<sup>®</sup>  
Designed for Professionals



Order-No. – P.U.

ROLINE HQ VGA Cable + Ferrite, HD15, M/M, 2.0 m	11.04.5252 – 20
ROLINE HQ VGA Cable + Ferrite, HD15, M/M, 3.0 m	11.04.5253 – 20
ROLINE HQ VGA Cable + Ferrite, HD15, M/M, 6.0 m	11.04.5256 – 10
ROLINE HQ VGA Cable + Ferrite, HD15, M/M, 10.0 m	11.04.5260 – 5
ROLINE HQ VGA Cable + Ferrite, HD15, M/M, 15.0 m	11.04.5265 – 2
ROLINE HQ VGA Cable + Ferrite, HD15, M/M, 20.0 m	11.04.5270 – 2
ROLINE HQ VGA Cable + Ferrite, HD15, M/M, 30.0 m	11.04.5280 – 2
ROLINE HQ VGA Cable + Ferrite, HD15, M/F, 2.0 m	11.04.5352 – 20
ROLINE HQ VGA Cable + Ferrite, HD15, M/F, 3.0 m	11.04.5353 – 20
ROLINE HQ VGA Cable + Ferrite, HD15, M/F, 6.0 m	11.04.5356 – 10
ROLINE HQ VGA Cable + Ferrite, HD15, M/F, 10.0 m	11.04.5360 – 5
ROLINE HQ VGA Cable + Ferrite, HD15, M/F, 20.0 m	11.04.5370 – 2
ROLINE HQ VGA Cable + Ferrite, HD15, M/F, 30.0 m	11.04.5380 – 2

## ROLINE HQ VGA Cables + Ferrite + DDC, HD15

- High quality cable for connection of a monitor to a graphics card or VGA splitter or amplifier
- Additionally with two ferrite cores and DDC functionality
- **3 coax lines for the RGB signals and 9 AWG28 wires (all pins connected, incl. pin 9 and pin 15)**
- Double screened cable (braided and foil shielding)
- Thumbscrews



**roline**<sup>®</sup>  
Designed for Professionals

Order-No. – P.U.

ROLINE HQ VGA Cable + Ferrite + DDC, HD15, M/M, 2.0 m	11.04.5652 – 20
ROLINE HQ VGA Cable + Ferrite + DDC, HD15, M/M, 3.0 m	11.04.5653 – 20
ROLINE HQ VGA Cable + Ferrite + DDC, HD15, M/M, 6.0 m	11.04.5656 – 10
ROLINE HQ VGA Cable + Ferrite + DDC, HD15, M/M, 10.0 m	11.04.5660 – 5
ROLINE HQ VGA Cable + Ferrite + DDC, HD15, M/M, 15.0 m	11.04.5665 – 2
ROLINE HQ VGA Cable + Ferrite + DDC, HD15, M/M, 20.0 m	11.04.5670 – 2
ROLINE HQ VGA Cable + Ferrite + DDC, HD15, M/F, 2.0 m	11.04.5651 – 20
ROLINE HQ VGA Cable + Ferrite + DDC, HD15, M/F, 3.0 m	11.04.5654 – 20
ROLINE HQ VGA Cable + Ferrite + DDC, HD15, M/F, 6.0 m	11.04.5655 – 10
ROLINE HQ VGA Cable + Ferrite + DDC, HD15, M/F, 10.0 m	11.04.5659 – 5



**ROLINE Combi Cables, VGA + Audio**

- To connect in an easy way PC or Switch with your PC
- The separate cable VGA and 3.5 mm Audio are now combined in only one cable
- On both side are HD15 M and 3.5 mm M connectors
- Colour: dark grey



**roline**  
Designed for Professionals

	Order-No. – P.U.
ROLINE Combi Cable, VGA + Audio, M-M, 3.0 m	11.04.5153 – 20
ROLINE Combi Cable, VGA + Audio, M-M, 6.0 m	11.04.5156 – 10
ROLINE Combi Cable, VGA + Audio, M-M, 10.0 m	11.04.5160 – 5
ROLINE Combi Cable, VGA + Audio, M-M, 15.0 m	11.04.5162 – 3
ROLINE Combi Cable, VGA + Audio, M-M, 20.0 m	11.04.5164 – 2

**VALUE DVI Cables, DVI (18+5) - HD15**

- Used for the connection of a TFT monitor with an analogue DVI connector to a standard VGA graphic card
- Cable with one DVI male connector and one HD15 male connector



	Order-No. – P.U.
VALUE DVI Cable, DVI (18+5) - HD15, M/M, 2.0 m	11.99.5420 – 25
VALUE DVI Cable, DVI (18+5) - HD15, M/M, 3.0 m	11.99.5430 – 20
VALUE DVI Cable, DVI (18+5) - HD15, M/M, 5.0 m	11.99.5449 – 10

**ROLINE DVI Cables, DVI (12+5) - HD15**

**VGA / DVI connection cable to use a VGA monitor with a DVI-I output on the graphics card. The cable is connected between the VGA graphics card and the digital monitor or between the VGA graphics card and the DVI-I interface of the monitor.**

- Used for the connection of a monitor with a DVI connector to a standard VGA graphics card
- Cable with one DVI Male connector and one HD15 Male connector

**roline**  
Designed for Professionals



	Order-No. – P.U.
ROLINE DVI Cable, DVI (12+5) - HD15, M/M, 2.0 m	11.04.5420 – 25
ROLINE DVI Cable, DVI (12+5) - HD15, M/M, 3.0 m	11.04.5430 – 20
ROLINE DVI Cable, DVI (12+5) - HD15, M/M, 5.0 m	11.04.5450 – 10

**VALUE DVI Cables, DVI (24+1), Dual Link**

- DVI is the standard for the digital transmission between graphic card and digital monitor (e.g. TFT)
- Advantage: No quality loss during digital/analog conversion
- Colour: black



	Order-No. – P.U.
VALUE Monitor DVI Cable, DVI (24+1), Dual Link, M/M, 1.0 m	11.99.5521 – 40
VALUE Monitor DVI Cable, DVI (24+1), Dual Link, M/M, 2.0 m	11.99.5525 – 25
VALUE Monitor DVI Cable, DVI (24+1), Dual Link, M/M, 3.0 m	11.99.5535 – 20
VALUE Monitor DVI Cable, DVI (24+1), Dual Link, M/M, 5.0 m	11.99.5555 – 10
VALUE Monitor DVI Cable, DVI (24+1), Dual Link, M/M, 7.5 m	11.99.5556 – 10
VALUE Monitor DVI Cable, DVI (24+1), Dual Link, M/M, 10.0 m	11.99.5595 – 10
VALUE Monitor DVI Cable, DVI (24+1), Dual Link, M/F, 1.0 m	11.99.5562 – 10
VALUE Monitor DVI Cable, DVI (24+1), Dual Link, M/F, 2.0 m	11.99.5563 – 10
VALUE Monitor DVI Cable, DVI (24+1), Dual Link, M/F, 3.0 m	11.99.5564 – 10
VALUE Monitor DVI Cable, DVI (24+1), Dual Link, M/F, 5.0 m	11.99.5565 – 5

**ROLINE DVI Cables, DVI (24+1), Dual Link**

DVI is a video interface standard designed to provide very high visual quality on digital display devices such as flat panel LCD computer displays and digital projectors. It was developed to replace the VGA connector standard. It is designed for carrying uncompressed digital video data to a display.

- Advantage: No quality loss during digital/analog conversion
- Colour: Black

**roline**  
Designed for Professionals

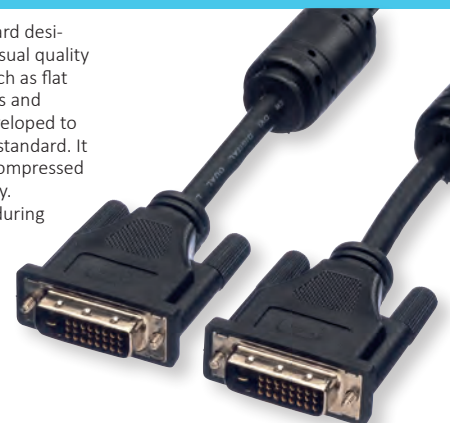

	Order-No. – P.U.
ROLINE Monitor Cable, DVI (24+1), Dual Link, M/M, 1.0 m	11.04.5521 – 25
ROLINE Monitor Cable, DVI (24+1), Dual Link, M/M, 2.0 m	11.04.5525 – 25
ROLINE Monitor Cable, DVI (24+1), Dual Link, M/M, 3.0 m	11.04.5535 – 20
ROLINE Monitor Cable, DVI (24+1), Dual Link, M/M, 5.0 m	11.04.5555 – 10
ROLINE Monitor Cable, DVI (24+1), Dual Link, M/M, 7.5 m	11.04.5556 – 10
ROLINE Monitor Cable, DVI (24+1), Dual Link, M/M, 10.0 m	11.04.5595 – 10
ROLINE Monitor Cable, DVI (24+1), Dual Link, M/M, 15.0 m	11.04.5598 – 4
ROLINE Monitor Cable, DVI (24+1), Dual Link, M/M, 20.0 m	11.04.5599 – 3

## VALUE DVI Cables, DVI (18+1) - HDMI

1080p  
FULL HD

VALUE HDMI to DVI cable for connecting an ultrabook, notebook/laptop or PC to a monitor, TV or projector - for screen transmissions in excellent quality with a resolution of up to 1920x1080 @60Hz!

- The connector requires less space and is therefore more suitable for portable display devices (ultrabooks, notebooks/laptops) or for 2 connectors on a graphics card (on a slot plate).
- High-quality, double-shielded cable (foil+braid) with gold-plated contacts for optimum transmission of image signals
- Connectors: DVI-D (18+1) to HDMI



Order-No. – P.U.

VALUE DVI Cable, DVI (18+1) - HDMI, M/M, black, 1.0 m	11.99.5519 – 20
VALUE DVI Cable, DVI (18+1) - HDMI, M/M, black, 1.5 m	11.99.5516 – 20
VALUE DVI Cable, DVI (18+1) - HDMI, M/M, black, 2.0 m	11.99.5522 – 20
VALUE DVI Cable, DVI (18+1) - HDMI, M/M, black, 3.0 m	11.99.5532 – 20
VALUE DVI Cable, DVI (18+1) - HDMI, M/M, black, 5.0 m	11.99.5552 – 10
VALUE DVI Cable, DVI (18+1) - HDMI, M/M, black, 10.0 m	11.99.5553 – 5

## ROLINE DVI Cables, DVI (18+1) - HDMI

1080p  
FULL HD

ROLINE HDMI to DVI cable for connecting an ultrabook, notebook/laptop or PC to a monitor, TV or projector - for screen transmissions in excellent quality with a resolution of up to 1920x1080 @60Hz!

- The connector requires less space and is therefore more suitable for portable display devices (ultrabooks, notebooks/laptops) or for 2 connectors on a graphics card (on a slot plate).
- High-quality, double-shielded cable (foil+braid) with gold-plated contacts for optimum transmission of image signals



- Connectors: DVI-D (18+1) to HDMI

**roline**  
Designed for Professionals

Order-No. – P.U.

ROLINE DVI Cable, DVI (18+1) - HDMI, M/M, black, 1.0 m	11.04.5519 – 20
ROLINE DVI Cable, DVI (18+1) - HDMI, M/M, black, 1.5 m	11.04.5516 – 20
ROLINE DVI Cable, DVI (18+1) - HDMI, M/M, black, 2.0 m	11.04.5522 – 20
ROLINE DVI Cable, DVI (18+1) - HDMI, M/M, black, 3.0 m	11.04.5532 – 20
ROLINE DVI Cable, DVI (18+1) - HDMI, M/M, black, 5.0 m	11.04.5552 – 10
ROLINE DVI Cable, DVI (18+1) - HDMI, M/M, black, 10.0 m	11.04.5553 – 5

## ROLINE Monitor Cables, DVI (24+1), Dual Link

4K

Connect your Macbook, Ultrabook, Notebook/Laptop or PC to a DVI monitor or projector with DVI - with a maximum resolution of 3840x2160 @30Hz!

- DVI-D dual link version with (24+1)-pin assignment, recommended for monitors with bigger screen sizes
- ROLINE cable with gold plated contacts and metal connector housing
- Maximum resolution: 3840x2160 @30Hz
- Nylon-reinforced cable outer material for a better stability
- Thumbscrews



**roline**  
Designed for Professionals

Order-No. – P.U.

ROLINE Monitor Cable, DVI (24+1), Dual Link, M/M, black /silver, 1.0 m	11.04.5860 – 25
ROLINE Monitor Cable, DVI (24+1), Dual Link, M/M, black /silver, 2.0 m	11.04.5861 – 25
ROLINE Monitor Cable, DVI (24+1), Dual Link, M/M, black /silver, 3.0 m	11.04.5862 – 20
ROLINE Monitor Cable, DVI (24+1), Dual Link, M/M, black /silver, 5.0 m	11.04.5863 – 10
ROLINE Monitor Cable, DVI (24+1), Dual Link, M/M, black /silver, 7.5 m	11.04.5864 – 10
ROLINE Monitor Cable, DVI (24+1), Dual Link, M/M, black /silver, 10.0 m	11.04.5865 – 10

## ROLINE Monitor Cables, DVI (24+1) - HDMI, Dual Link

4K

ROLINE HDMI to DVI cable for connecting an ultrabook, notebook/laptop or PC to a monitor, TV or projector - for screen transmissions in excellent quality with a resolution of up to 3840x2160 @30Hz!

- The rugged nylon braid protects the cable effectively and makes it look stunning.
- High-quality, double-shielded cable (foil+braid) with gold-plated contacts for optimum transmission of image signals
- Connectors: DVI-D (24+1) to HDMI



**roline**  
Designed for Professionals

Order-No. – P.U.

ROLINE Monitor Cable, DVI (24+1) - HDMI, Dual Link, M/M, black /silver, 1.0 m	11.04.5870 – 10
ROLINE Monitor Cable, DVI (24+1) - HDMI, Dual Link, M/M, black /silver, 1.5 m	11.04.5876 – 10
ROLINE Monitor Cable, DVI (24+1) - HDMI, Dual Link, M/M, black /silver, 2.0 m	11.04.5871 – 10
ROLINE Monitor Cable, DVI (24+1) - HDMI, Dual Link, M/M, black /silver, 3.0 m	11.04.5872 – 10
ROLINE Monitor Cable, DVI (24+1) - HDMI, Dual Link, M/M, black /silver, 5.0 m	11.04.5873 – 10
ROLINE Monitor Cable, DVI (24+1) - HDMI, Dual Link, M/M, black /silver, 7.5 m	11.04.5874 – 5
ROLINE Monitor Cable, DVI (24+1) - HDMI, Dual Link, M/M, black /silver, 10 m	11.04.5875 – 5

## VALUE HDMI High Speed Cables

3D  
capable1080p  
FULL HD

- HDMI supports standard, enhanced, or high-definition video, plus multi-channel digital audio on a single cable. It transmits all ATSC HDTV standards and supports 8-channel digital audio, with bandwidth to spare to accommodate future enhancements and requirements.
- Maximum resolution: 1920x1080 @60Hz
- HDMI High Speed increases single-link bandwidth to 340 MHz (10.2 Gbit/s)



Order-No. – P.U.

VALUE HDMI High Speed Cable, M/M, black, 1.0 m	11.99.5526 – 20
VALUE HDMI High Speed Cable, M/M, black, 2.0 m	11.99.5527 – 20
VALUE HDMI High Speed Cable, M/M, black, 3.0 m	11.99.5537 – 20
VALUE HDMI High Speed Cable, M/M, black, 5.0 m	11.99.5557 – 10
VALUE HDMI High Speed Cable, M/M, black, 10.0 m	11.99.5558 – 10
VALUE HDMI High Speed Cable, M/M, black, 15.0 m	11.99.5534 – 5
VALUE HDMI High Speed Cable, M/M, black, 20.0 m	11.99.5536 – 5

## ROLINE HDMI High Speed Cables

3D  
capable1080p  
FULL HD

HDMI (High-Definition Multimedia Interface) supports standard, enhanced, or high-definition video, plus multi-channel digital audio on a single cable.

- Maximum resolution: 1920x1080 @60Hz
- HDMI High Speed increases single-link bandwidth to 340 MHz (10.2 Gbit/s)
- HDMI High Speed supports 10-bit, 12-bit and 16-bit (RGB or YCbCr) color depths, for stunning rendering of over one billion colors in unprecedented detail
- ROLINE cable with high quality shielding
- Colour: black



**roline**  
Designed for Professionals

Order-No. – P.U.

ROLINE HDMI High Speed Cable, M/M, 1.0 m	11.04.5571 – 20
ROLINE HDMI High Speed Cable, M/M, 2.0 m	11.04.5572 – 20
ROLINE HDMI High Speed Cable, M/M, 3.0 m	11.04.5573 – 20
ROLINE HDMI High Speed Cable, M/M, 5.0 m	11.04.5575 – 10
ROLINE HDMI High Speed Cable, M/M, 10.0 m	11.04.5576 – 5
ROLINE HDMI High Speed Cable, M/M, 15.0 m	11.04.5577 – 5
ROLINE HDMI High Speed Cable, M/M, 20.0 m	11.04.5578 – 5

## VALUE HDMI High Speed Cables + Ethernet



Allowing a maximum video resolution of up to 3840x2160 @30Hz!

- HDMI Ethernet Channel- Adds high-speed networking to an HDMI link, allowing users to take full advantage of their IP-enabled devices without a separate ethernet cable
- Audio Return Channel
- 3D- Defines input/output protocols for major 3D video formats, paving the way for true 3D gaming and 3D home theater applications
- Additional Color Spaces- Adds support for additional color models used in digital photography and computer graphics
- Colour: black



Order-No. – P.U.

VALUE HDMI High Speed Cable + Ethernet, M/F, 1.0 m	11.99.5574	– 10
VALUE HDMI High Speed Cable + Ethernet, M/F, 1.5 m	11.99.5571	– 10
VALUE HDMI High Speed Cable + Ethernet, M/F, 2.0 m	11.99.5575	– 10
VALUE HDMI High Speed Cable + Ethernet, M/F, 3.0 m	11.99.5576	– 10
VALUE HDMI High Speed Cable + Ethernet, M/F, 5.0 m	11.99.5577	– 5
VALUE HDMI High Speed Cable + Ethernet, M/M, black, 1.0 m	11.99.5541	– 10
VALUE HDMI High Speed Cable + Ethernet, M/M, black, 1.5 m	11.99.5531	– 10
VALUE HDMI High Speed Cable + Ethernet, M/M, black, 2.0 m	11.99.5542	– 10
VALUE HDMI High Speed Cable + Ethernet, M/M, black, 3.0 m	11.99.5543	– 10
VALUE HDMI High Speed Cable + Ethernet, M/M, black, 5.0 m	11.99.5545	– 10
VALUE HDMI High Speed Cable + Ethernet, M/M, black, 7.5 m	11.99.5544	– 10
VALUE HDMI High Speed Cable + Ethernet, M/M, black, 10.0 m	11.99.5546	– 5
VALUE HDMI High Speed Cable + Ethernet, M/M, black, 15.0 m	11.99.5547	– 5
VALUE HDMI High Speed Cable + Ethernet, M/M, black, 20.0 m	11.99.5548	– 5
VALUE HDMI High Speed Cable + Ethernet, M/M, white, 1.0 m	11.99.5701	– 10
VALUE HDMI High Speed Cable + Ethernet, M/M, white, 1.5 m	11.99.5704	– 10
VALUE HDMI High Speed Cable + Ethernet, M/M, white, 2.0 m	11.99.5702	– 10
VALUE HDMI High Speed Cable + Ethernet, M/M, white, 3.0 m	11.99.5703	– 10
VALUE HDMI High Speed Cable + Ethernet, M/M, white, 5.0 m	11.99.5705	– 10
VALUE HDMI High Speed Cable + Ethernet, M/M, white, 7.5 m	11.99.5706	– 10
VALUE HDMI High Speed Cable + Ethernet, M/M, white, 10.0 m	11.99.5710	– 5
VALUE HDMI High Speed Cable + Ethernet, M/M, white, 15.0 m	11.99.5715	– 5
VALUE HDMI High Speed Cable + Ethernet, M/M, white, 20.0 m	11.99.5720	– 5

**\*Halogenfree  
Flame Retardant  
Low Smoke**

Order-No. – P.U.

VALUE HDMI High Speed Cable + Ethernet, LSOH, M/M, black, 1.0 m	11.99.5731	– 10
VALUE HDMI High Speed Cable + Ethernet, LSOH, M/M, black, 1.5 m	11.99.5732	– 10
VALUE HDMI High Speed Cable + Ethernet, LSOH, M/M, black, 2.0 m	11.99.5733	– 10
VALUE HDMI High Speed Cable + Ethernet, LSOH, M/M, black, 3.0 m	11.99.5733	– 10
VALUE HDMI High Speed Cable + Ethernet, LSOH, M/M, black, 5.0 m	11.99.5735	– 10
VALUE HDMI High Speed Cable + Ethernet, LSOH, M/M, black, 7.5 m	11.99.5736	– 10
VALUE HDMI High Speed Cable + Ethernet, LSOH, M/M, black, 10.0 m	11.99.5740	– 5
VALUE HDMI High Speed Cable + Ethernet, LSOH, M/M, black, 15.0 m	11.99.5745	– 5
VALUE HDMI High Speed Cable + Ethernet, LSOH, M/M, black, 20.0 m	11.99.5750	– 5

## ROLINE HDMI High Speed Cables + Ethernet



ROLINE HDMI High Speed Cables with Ethernet - offering even more HDTV features, at a resolution of up to 3840x2160 @30Hz!

- HDMI Ethernet Channel
- Audio Return Channel
- 3D- Defines input/output protocols for major 3D video formats
- Quality cable with improved shielding
- Colour: black/white
- Cable with HDMI male connector on both sides



Order-No. – P.U.

ROLINE HDMI High Speed Cable + Ethernet, M/M, black, 1.0 m	11.04.5541	– 10
ROLINE HDMI High Speed Cable + Ethernet, M/M, black, 1.5 m	11.04.5531	– 10
ROLINE HDMI High Speed Cable + Ethernet, M/M, black, 2.0 m	11.04.5542	– 10
ROLINE HDMI High Speed Cable + Ethernet, M/M, black, 3.0 m	11.04.5543	– 10
ROLINE HDMI High Speed Cable + Ethernet, M/M, black, 5.0 m	11.04.5545	– 10
ROLINE HDMI High Speed Cable + Ethernet, M/M, black, 7.5 m	11.04.5544	– 10
ROLINE HDMI High Speed Cable + Ethernet, M/M, black, 10.0 m	11.04.5547	– 5
ROLINE HDMI High Speed Cable + Ethernet, M/M, black, 15.0 m	11.04.5548	– 5
ROLINE HDMI High Speed Cable + Ethernet, M/M, black, 20.0 m	11.04.5549	– 5
ROLINE HDMI High Speed Cable + Ethernet, M/M, black, 30.0 m	11.04.5546	– 2
ROLINE HDMI High Speed Cable + Ethernet, M/M, white, 1.0 m	11.04.5701	– 10
ROLINE HDMI High Speed Cable + Ethernet, M/M, white, 1.5 m	11.04.5704	– 10
ROLINE HDMI High Speed Cable + Ethernet, M/M, white, 2.0 m	11.04.5587	– 10
ROLINE HDMI High Speed Cable + Ethernet, M/M, white, 3.0 m	11.04.5703	– 10
ROLINE HDMI High Speed Cable + Ethernet, M/M, white, 5.0 m	11.04.5588	– 10
ROLINE HDMI High Speed Cable + Ethernet, M/M, white, 7.5 m	11.04.5706	– 10
ROLINE HDMI High Speed Cable + Ethernet, M/M, white, 10.0 m	11.04.5710	– 5
ROLINE HDMI High Speed Cable + Ethernet, M/M, white, 15.0 m	11.04.5715	– 5
ROLINE HDMI High Speed Cable + Ethernet, M/M, white, 20.0 m	11.04.5720	– 5

**\*Halogenfree  
Flame Retardant  
Low Smoke**

Order-No. – P.U.

ROLINE HDMI High Speed Cable + Ethernet, LSOH, M/M, black, 1.0 m	11.04.5731	– 10
ROLINE HDMI High Speed Cable + Ethernet, LSOH, M/M, black, 1.5 m	11.04.5734	– 10
ROLINE HDMI High Speed Cable + Ethernet, LSOH, M/M, black, 2.0 m	11.04.5732	– 10
ROLINE HDMI High Speed Cable + Ethernet, LSOH, M/M, black, 3.0 m	11.04.5733	– 10
ROLINE HDMI High Speed Cable + Ethernet, LSOH, M/M, black, 5.0 m	11.04.5735	– 10
ROLINE HDMI High Speed Cable + Ethernet, LSOH, M/M, black, 7.5 m	11.04.5736	– 10
ROLINE HDMI High Speed Cable + Ethernet, LSOH, M/M, black, 10.0 m	11.04.5740	– 5
ROLINE HDMI High Speed Cable + Ethernet, LSOH, M/M, black, 15.0 m	11.04.5745	– 5
ROLINE HDMI High Speed Cable + Ethernet, LSOH, M/M, black, 20.0 m	11.04.5750	– 5



**ROLINE Notebook HDMI High Speed Cables + Ethernet**

**4K**

High quality HDMI High Speed Cable with Ethernet - offering even more HDTV features, with a resolution of up to 3840x2160 @30Hz!

- HDMI Ethernet Channel
- Audio Return Channel
- 3D- Defines input/output protocols for major 3D video formats
- Quality cable with improved shielding
- Colour: black
- Cable with extra compact HDMI male connector on both sides, perfectly suited for mobile applications, like e.g. for Ultrabooks/Notebooks



**roline**  
Designed for Professionals

Order-No. – P.U.

ROLINE Notebook HDMI High Speed Cable + Ethernet, M/M, black, 1.0 m	11.04.5591	– 20
ROLINE Notebook HDMI High Speed Cable + Ethernet, M/M, black, 1.5 m	11.04.5596	– 20
ROLINE Notebook HDMI High Speed Cable + Ethernet, M/M, black, 2.0 m	11.04.5592	– 20
ROLINE Notebook HDMI High Speed Cable + Ethernet, M/M, black, 3.0 m	11.04.5593	– 20
ROLINE Notebook HDMI High Speed Cable + Ethernet, M/M, black, 5.0 m	11.04.5594	– 10

**ROLINE HDMI High Speed Cables + Ethernet**

**4K**

ROLINE HDMI cable with double-sided HDMI connection for connecting an ultrabook, notebook/laptop or PC to a monitor, TV or projector - for screen transmissions in excellent quality with a resolution of up to 3840x2160 @30Hz!

- The rugged nylon braid protects the HDMI cable effectively and makes it look stunning.
- High-quality, double-shielded cable (foil+braid) with gold-plated contacts for optimum transmission of image signals
- Supports 3D video

- HDMI Ethernet channel
- Audio return channel for forwarding signals to the audio/video receiver.
- Black metallic connector housing



**roline**  
Designed for Professionals

Order-No. – P.U.

ROLINE HDMI High Speed Cable + Ethernet, M/M, black /silver, 1.0 m	11.04.5850	– 10
ROLINE HDMI High Speed Cable + Ethernet, M/M, black /silver, 1.5 m	11.04.5856	– 10
ROLINE HDMI High Speed Cable + Ethernet, M/M, black /silver, 2.0 m	11.04.5851	– 10
ROLINE HDMI High Speed Cable + Ethernet, M/M, black /silver, 3.0 m	11.04.5852	– 10
ROLINE HDMI High Speed Cable + Ethernet, M/M, black /silver, 5.0 m	11.04.5853	– 10
ROLINE HDMI High Speed Cable + Ethernet, M/M, black /silver, 7.5 m	11.04.5854	– 5
ROLINE HDMI High Speed Cable + Ethernet, M/M, black /silver, 10.0 m	11.04.5855	– 5

**VALUE HDMI High Speed Cables + Ethernet, Type C/D**

**3D capable** **1080p FULL HD**

For the connection of e. g. mobile phones, smart phones, PDAs, digital cameras.

- HDMI Ethernet Channel
- Audio Return Channel
- 3D- Defines input/output protocols for major 3D video formats
- Connectors: HDMI Type A F to HDMI Type C (Mini HDMI) M or Type D (Micro HDMI) M

- Quality cable with improved shielding
- Colour: black



**Value**

Order-No. – P.U.

VALUE HDMI High Speed Cable + Ethernet, A - C, F/M, 0.15 m	A	11.99.5586	– 25
VALUE HDMI High Speed Cable + Ethernet, A - D, F/M, 0.15 m	B	11.99.5584	– 25

**ROLINE HDMI High Speed Cables + Ethernet, Type C/D**

**3D capable** **1080p FULL HD**

For the connection of e. g. mobile phones, smart phones, PDAs, digital cameras.

- HDMI Ethernet Channel
- Audio Return Channel
- 3D- Defines input/output protocols for major 3D video formats
- Connectors: HDMI Type A F to HDMI Type C (Mini HDMI) M or Type D (Micro HDMI) M

- Quality cable with improved shielding
- Colour: black



**roline**  
Designed for Professionals

Order-No. – P.U.

ROLINE HDMI High Speed Cable + Ethernet, A - C, F/M, 0.15 m	A	11.04.5586	– 10
ROLINE HDMI High Speed Cable + Ethernet, A - D, F/M, 0.15 m	B	11.04.5584	– 10

**VALUE HDMI High Speed Cables + Ethernet, Type C/D**

**3D capable** **1080p FULL HD**

For the connection of e. g. mobile phones, smart phones, PDAs, digital cameras.

- Video resolution: 1920 x 1080 Pixel
- Connectors: HDMI Type A M to HDMI Type C (Mini HDMI) M HDMI Type A M to HDMI Type D (Micro HDMI) M
- Quality cable with gold plated contacts for enhanced durability



**Value**

Order-No. – P.U.

VALUE HDMI High Speed Cable + Ethernet, A - C, M/M, 0.8 m	11.99.5578	– 10
VALUE HDMI High Speed Cable + Ethernet, A - C, M/M, 2.0 m	11.99.5580	– 10
VALUE HDMI High Speed Cable + Ethernet, A - D, M/M, 0.8 m	11.99.5579	– 10
VALUE HDMI High Speed Cable + Ethernet, A - D, M/M, 2.0 m	11.99.5581	– 10

**ROLINE HDMI High Speed Cables + Ethernet, Type C/D**

**3D capable** **1080p FULL HD**

For the connection of e. g. mobile phones, smart phones, PDAs, digital cameras.

- Video resolution: 1920 x 1080 Pixel
- Connectors: HDMI Type A M to HDMI Type C (Mini HDMI) M HDMI Type A M to HDMI Type D (Micro HDMI) M
- Quality cable with improved shielding



**roline**  
Designed for Professionals

Order-No. – P.U.

ROLINE HDMI High Speed Cable + Ethernet, A - C, M/M, 0.8 m	11.04.5568	– 10
ROLINE HDMI High Speed Cable + Ethernet, A - C, M/M, 2.0 m	11.04.5580	– 10
ROLINE HDMI High Speed Cable + Ethernet, A - D, M/M, 0.8 m	11.04.5569	– 10
ROLINE HDMI High Speed Cable + Ethernet, A - D, M/M, 2.0 m	11.04.5581	– 10

**VALUE HDMI Ultra HD Cables + Ethernet**



**High-quality HDMI connection cable with HDMI connectors for optimal transmission of digital HDTV signals at data rates up to 18 Gbit/s (600MHz). For the transmission of films in digital cinema-quality, with a resolution of up to 3840x2160 @60Hz!**

- HDMI Ethernet Channel- Adds high-speed networking to an HDMI link, allowing users to take full advantage of their IP-enabled devices without a separate ethernet cable
- Audio Return Channel- Allows an HDMI-connected TV with a built-in tuner to send audio data „upstream“ to a surround audio system, eliminating the need for a separate audio cable
- 3D- Defines input/output protocols for major 3D video formats

- High quality cable with a gold plated metal connector housing and shell for better shielding
- Gold plated contacts for higher durability



**Order-No. – P.U.**

VALUE HDMI Ultra HD Cable + Ethernet, M/M, black, 1.0 m	11.99.5680 – 10
VALUE HDMI Ultra HD Cable + Ethernet, M/M, black, 1.5 m	11.99.5688 – 10
VALUE HDMI Ultra HD Cable + Ethernet, M/M, black, 2.0 m	11.99.5681 – 10
VALUE HDMI Ultra HD Cable + Ethernet, M/M, black, 3.0 m	11.99.5682 – 10
VALUE HDMI Ultra HD Cable + Ethernet, M/M, black, 5.0 m	11.99.5683 – 10

**ROLINE HDMI Ultra HD Cables + Ethernet**



**High-quality HDMI connection cable with HDMI connectors for optimal transmission of digital HDTV signals at data rates up to 18 Gbit/s (600MHz). For the transmission of films in digital cinema-quality, with a resolution of up to 3840x2160 @60Hz!**

- HDMI Ethernet Channel- Adds high-speed networking to an HDMI link, allowing users to take full advantage of their IP-enabled devices without a separate ethernet cable
- Audio Return Channel- Allows an HDMI-connected TV with a built-in tuner to send audio data „upstream“ to a surround audio system, eliminating the need for a separate audio cable
- 3D- Defines input/output protocols for major 3D video formats

- High quality cable with golden metal connector housing and shell for better shielding
- Gold plated contacts for higher durability



**Order-No. – P.U.**

ROLINE HDMI Ultra HD Cable + Ethernet, M/M, black, 1.0 m	11.04.5680 – 10
ROLINE HDMI Ultra HD Cable + Ethernet, M/M, black, 1.5 m	11.04.5688 – 10
ROLINE HDMI Ultra HD Cable + Ethernet, M/M, black, 2.0 m	11.04.5681 – 10
ROLINE HDMI Ultra HD Cable + Ethernet, M/M, black, 3.0 m	11.04.5682 – 10
ROLINE HDMI Ultra HD Cable + Ethernet, M/M, black, 5.0 m	11.04.5683 – 10
ROLINE HDMI Ultra HD Cable + Ethernet, M/M, black, 7.5 m	11.04.5684 – 10
ROLINE HDMI Ultra HD Cable + Ethernet, M/M, black, 10.0 m	11.04.5685 – 10
ROLINE HDMI Ultra HD Cable + Ethernet, M/M, black, 15.0 m	11.04.5686 – 10
ROLINE HDMI Ultra HD Cable + Ethernet, M/M, black, 20.0 m	11.04.5687 – 10

**ROLINE HDMI Ultra HD Cable + Ethernet, Active**



**High-quality HDMI connection cable with HDMI connectors for optimal transmission of digital HDTV signals at data rates up to 18 Gbit/s (600MHz). For the transmission of films in digital cinema-quality, with a resolution of up to 3840x2160 @60Hz!**

- HDMI Ethernet Channel- Adds high-speed networking to an HDMI link, allowing users to take full advantage of their IP-enabled devices without a separate ethernet cable
- Audio Return Channel- Allows an HDMI-connected TV with a built-in tuner to send audio data „upstream“ to a surround audio system, eliminating the need for a separate audio cable
- 3D- Defines input/output protocols for major 3D video formats
- Cable with HDMI male connector on both sides

- High quality cable with golden plated shell
- Gold plated contacts for higher durability



**Order-No. – P.U.**

ROLINE HDMI Ultra HD Cable + Ethernet, active, M/M, black, 1.0 m	11.04.5910 – 20
ROLINE HDMI Ultra HD Cable + Ethernet, active, M/M, black, 1.5 m	11.04.5911 – 20
ROLINE HDMI Ultra HD Cable + Ethernet, active, M/M, black, 2.0 m	11.04.5912 – 15
ROLINE HDMI Ultra HD Cable + Ethernet, active, M/M, black, 3.0 m	11.04.5913 – 15
ROLINE HDMI Ultra HD Cable + Ethernet, active, M/M, black, 5.0 m	11.04.5915 – 10

**ROLINE PREMIUM HDMI Ultra HD Cables + Ethernet**



**High-quality HDMI connection cable with HDMI connectors for optimal transmission of digital HDTV signals at data rates up to 18 Gbit/s (600MHz). For the transmission of films in digital cinema-quality, with a resolution of up to 3840x2160 @60Hz!**

- HDMI Ethernet Channel- Adds high-speed networking to an HDMI link, allowing users to take full advantage of their IP-enabled devices without a separate ethernet cable
- Audio Return Channel- Allows an HDMI-connected TV with a built-in tuner to send audio data „upstream“ to a surround audio system, eliminating the need for a separate audio cable
- 3D- Defines input/output protocols for major 3D video formats
- 4k support- Enables video resolutions up to 2160p60 far beyond 1080p, supporting next-generation displays
- Cable with HDMI male connector on both sides
- High quality cable with golden metal connector housing and shell for better shielding

- Gold plated contacts for higher durability



**Order-No. – P.U.**

ROLINE PREMIUM HDMI Ultra HD Cable + Ethernet, M/M, 1.0 m	11.04.5801 – 10
ROLINE PREMIUM HDMI Ultra HD Cable + Ethernet, M/M, 2.0 m	11.04.5802 – 10
ROLINE PREMIUM HDMI Ultra HD Cable + Ethernet, M/M, 3.0 m	11.04.5803 – 10
ROLINE PREMIUM HDMI Ultra HD Cable + Ethernet, M/M, 4.5 m	11.04.5804 – 10
ROLINE PREMIUM HDMI Ultra HD Cable + Ethernet, M/M, 7.5 m	11.04.5805 – 5

### VALUE HDMI 8K (7680 x 4320) Ultra HD Cables + Ethernet

8K

3D  
capable4320p  
ULTRA HD

High quality HDMI cable with HDMI connectors for optimal transmission of digital UHD signals at very high data rates. For transfer of films in digital cinema quality with up to 8K at 60Hz.

- HDMI Ethernet Channel- Adds high-speed networking to an HDMI link, allowing users to take full advantage of their IP-enabled devices without a separate ethernet cable
- Audio Return Channel- Allows a HDMI-connected TV with a built-in tuner to send audio data „upstream“ to a surround audio system, eliminating the need for a separate audio cable
- 3D- Defines input/output protocols for major 3D video formats
- 8k support- Enables video resolutions up to 4320p @60Hz far beyond 1080p, supporting next-generation displays
- Cable with HDMI male connector on both sides
- High quality cable with golden metal connector housing and shell for better

- shielding
- Gold plated contacts for higher durability

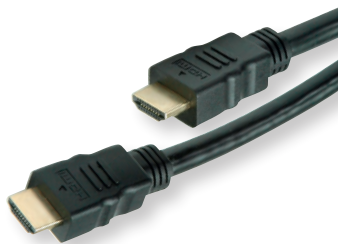

**Value**

Order-No. – P.U.

VALUE HDMI 8K (7680 x 4320) Ultra HD Cable + Ethernet, M/M, black, 1.0 m	11.99.5901 – 10
VALUE HDMI 8K (7680 x 4320) Ultra HD Cable + Ethernet, M/M, black, 2.0 m	11.99.5902 – 10
VALUE HDMI 8K (7680 x 4320) Ultra HD Cable + Ethernet, M/M, black, 3.0 m	11.99.5903 – 10

### ROLINE HDMI 8K (7680 x 4320) Ultra HD Cables + Ethernet

8K

3D  
capable4320p  
ULTRA HD

High quality HDMI cable with HDMI connectors for optimal transmission of digital UHD signals at data rates up to 35.8 Gbit/s. For transfer of films in digital cinema quality with up to 8K at 60Hz.

- HDMI Ethernet Channel- Adds high-speed networking to an HDMI link, allowing users to take full advantage of their IP-enabled devices without a separate ethernet cable
- Audio Return Channel- Allows a HDMI-connected TV with a built-in tuner to send audio data „upstream“ to a surround audio system, eliminating the need for a separate audio cable
- 3D- Defines input/output protocols for major 3D video formats
- 8k support- Enables video resolutions up to 4320p @60Hz far beyond 1080p, supporting next-generation displays
- Cable with HDMI male connector on both sides
- High quality cable with golden metal

- connector housing and shell for better shielding
- Gold plated contacts for higher durability



**roline**  
Designed for Professionals

Order-No. – P.U.

ROLINE HDMI 8K (7680 x 4320) Ultra HD Cable + Ethernet, M/M, red, 1.0 m	11.04.5901 – 10
ROLINE HDMI 8K (7680 x 4320) Ultra HD Cable + Ethernet, M/M, red, 2.0 m	11.04.5902 – 10
ROLINE HDMI 8K (7680 x 4320) Ultra HD Cable + Ethernet, M/M, red, 3.0 m	11.04.5903 – 10
ROLINE HDMI 8K (7680 x 4320) Ultra HD Cable + Ethernet, M/M, red, 5.0 m	11.04.5905 – 10

### VALUE DisplayPort Cables, DP-DP

4K

2160p  
ULTRA HD

VALUE DisplayPort Cable with DP connection on both sides for connecting an Ultrabook, Notebook/Laptop or PC to a monitor, TV or projector - for screen transmissions in excellent quality with resolutions of up to 3840x2160 @60Hz!

- DisplayPort is a universal connection standard for the transmission of picture and sound signals. Applications include mainly the connection of monitors and televisions to computers, BluRay players and similar devices.
- The connector requires less space and is therefore more suitable for portable display devices (ultrabooks, notebooks/laptops) or for 2 connectors on a graphics card (on a slot plate).
- The practical plug design prevents the cable from slipping out of the DisplayPort socket.
- Compliant DP v1.2 (max. 3840 x 2160 @60Hz)

**Value**

Order-No. – P.U.

VALUE DisplayPort Cable, DP-DP, M/M, black, 1.0 m	11.99.5601 – 20
VALUE DisplayPort Cable, DP-DP, M/M, black, 1.5 m	11.99.5629 – 20
VALUE DisplayPort Cable, DP-DP, M/M, black, 2.0 m	11.99.5602 – 10
VALUE DisplayPort Cable, DP-DP, M/M, black, 3.0 m	11.99.5603 – 10
VALUE DisplayPort Cable, DP-DP, M/M, black, 5.0 m	11.99.5605 – 10
VALUE DisplayPort Cable, DP-DP, M/M, black, 7.5 m	11.99.5604 – 6
VALUE DisplayPort Cable, DP-DP, M/M, black, 10.0 m	11.99.5609 – 5

\*Halogenfree  
Flame Retardant  
Low Smoke

Order-No. – P.U.

VALUE DisplayPort Cable, DP-DP, LSOH, M/M, 1.0 m	11.99.5761 – 20
VALUE DisplayPort Cable, DP-DP, LSOH, M/M, 1.5 m	11.99.5767 – 20
VALUE DisplayPort Cable, DP-DP, LSOH, M/M, 2.0 m	11.99.5762 – 10
VALUE DisplayPort Cable, DP-DP, LSOH, M/M, 3.0 m	11.99.5763 – 10
VALUE DisplayPort Cable, DP-DP, LSOH, M/M, 5.0 m	11.99.5764 – 10
VALUE DisplayPort Cable, DP-DP, LSOH, M/M, 7.5 m	11.99.5765 – 10
VALUE DisplayPort Cable, DP-DP, LSOH, M/M, 10.0 m	11.99.5766 – 5

### ROLINE DisplayPort Cables, DP-DP

4K

2160p  
ULTRA HD

ROLINE DisplayPort Cable with DP connection on both sides for connecting an Ultrabook, Notebook/Laptop or PC to a monitor, TV or projector - for screen transmissions in excellent quality with resolutions of up to 3840x2160 @60Hz!

- DisplayPort is a universal connection standard for the transmission of picture and sound signals. Applications include mainly the connection of monitors and televisions to computers, BluRay players and similar devices.
- The connector requires less space and is therefore more suitable for portable display devices (ultrabooks, notebooks/laptops) or for 2 connectors on a graphics card (on a slot plate).
- The practical plug design prevents the cable from slipping out of the DisplayPort socket.
- Compliant DP v1.2 (max. 3840 x 2160 @60Hz)

**roline**  
Designed for Professionals

Order-No. – P.U.

ROLINE DisplayPort Cable, DP-DP, M/M, black, 1.0 m	11.04.5601 – 20
ROLINE DisplayPort Cable, DP-DP, M/M, black, 1.5 m	11.04.5629 – 20
ROLINE DisplayPort Cable, DP-DP, M/M, black, 2.0 m	11.04.5602 – 20
ROLINE DisplayPort Cable, DP-DP, M/M, black, 3.0 m	11.04.5603 – 20
ROLINE DisplayPort Cable, DP-DP, M/M, black, 5.0 m	11.04.5605 – 10
ROLINE DisplayPort Cable, DP-DP, M/M, black, 7.5 m	11.04.5604 – 10
ROLINE DisplayPort Cable, DP-DP, M/M, black, 10.0 m	11.04.5609 – 5

\*Halogenfree  
Flame Retardant  
Low Smoke

Order-No. – P.U.

ROLINE DisplayPort Cable, DP-DP, LSOH, M/M, 1.0 m	11.04.5761 – 20
ROLINE DisplayPort Cable, DP-DP, LSOH, M/M, 1.5 m	11.04.5767 – 20
ROLINE DisplayPort Cable, DP-DP, LSOH, M/M, 2.0 m	11.04.5762 – 20
ROLINE DisplayPort Cable, DP-DP, LSOH, M/M, 3.0 m	11.04.5763 – 20
ROLINE DisplayPort Cable, DP-DP, LSOH, M/M, 5.0 m	11.04.5764 – 10
ROLINE DisplayPort Cable, DP-DP, LSOH, M/M, 7.5 m	11.04.5765 – 10
ROLINE DisplayPort Cable, DP-DP, LSOH, M/M, 10.0 m	11.04.5766 – 5



**ROLINE DisplayPort Cables, DP-DP, v1.2**

**4K**

For the connection of e. g. mobile phones / smartphones or digital cameras / DSLRs.

- Cable with DisplayPort male connector on both sides
- Double shielded
- High quality cable with golden shell for better shielding
- Gold plated contacts for enhanced durability
- Nylon-reinforced outer material for a better stability



**roline**  
Designed for Professionals

Order-No. – P.U.

ROLINE DisplayPort Cable, DP-DP, v1.2, M/M, 1.0 m	11.04.5880 – 20
ROLINE DisplayPort Cable, DP-DP, v1.2, M/M, 1.5 m	11.04.5886 – 20
ROLINE DisplayPort Cable, DP-DP, v1.2, M/M, 2.0 m	11.04.5881 – 20
ROLINE DisplayPort Cable, DP-DP, v1.2, M/M, 3.0 m	11.04.5882 – 20
ROLINE DisplayPort Cable, DP-DP, v1.2, M/M, 5.0 m	11.04.5883 – 10

**VALUE DisplayPort Cable, v1.3/v1.4, DP-DP**

**5K**

**VALUE DisplayPort Cable with DP connection on both sides for connecting an Ultrabook, Notebook/Laptop or PC to a monitor, TV or projector - for screen transmissions in excellent quality with resolutions of up to 5120x2880 @60Hz!**

- DisplayPort is a universal connection standard for the transmission of picture and sound signals. Applications include mainly the connection of monitors and televisions to computers, BluRay players and similar devices.
- The connector requires less space and is therefore more suitable for portable display devices (ultrabooks, notebooks/laptops) or for 2 connectors on a graphics card (on a slot plate).
- The practical plug design prevents the cable from slipping out of the DisplayPort socket.

- Compliant to DP v1.3 (max. 5120x2880 @60Hz)



**Value** **NEW**

Order-No. – P.U.

VALUE DisplayPort Cable, v1.3/v1.4, DP-DP, M/M, black, 1.0 m	11.99.5810 – 20
VALUE DisplayPort Cable, v1.3/v1.4, DP-DP, M/M, black, 2.0 m	11.99.5811 – 10
VALUE DisplayPort Cable, v1.3/v1.4, DP-DP, M/M, black, 3.0 m	11.99.5812 – 10

**ROLINE DisplayPort Cable, v1.3/v1.4, DP-DP**

**5K**

**ROLINE DisplayPort Cable with DP connection on both sides for connecting an Ultrabook, Notebook/Laptop or PC to a monitor, TV or projector - for screen transmissions in excellent quality with resolutions of up to 5120x2880 @60Hz!**

- DisplayPort is a universal connection standard for the transmission of picture and sound signals. Applications include mainly the connection of monitors and televisions to computers, BluRay players and similar devices.
- The connector requires less space and is therefore more suitable for portable display devices (ultrabooks, notebooks/laptops) or for 2 connectors on a graphics card (on a slot plate).
- The practical plug design prevents the cable from slipping out of the DisplayPort socket.

- Compliant to DP v1.3 (max. 5120 x 2880 @60Hz)



**roline** **NEW**  
Designed for Professionals

Order-No. – P.U.

ROLINE DisplayPort Cable, v1.3/v1.4, DP-DP, M/M, black, 1.0 m	11.04.5810 – 20
ROLINE DisplayPort Cable, v1.3/v1.4, DP-DP, M/M, black, 1.5 m	11.04.5798 – 20
ROLINE DisplayPort Cable, v1.3/v1.4, DP-DP, M/M, black, 2.0 m	11.04.5811 – 10
ROLINE DisplayPort Cable, v1.3/v1.4, DP-DP, M/M, black, 3.0 m	11.04.5812 – 10
ROLINE DisplayPort Cable, v1.3/v1.4, DP-DP, M/M, black, 5.0 m	11.04.5813 – 10

**VALUE DisplayPort Cables, DP - Mini DP**

**1080p FULL HD**

DisplayPort is a digital display interface standard that defines a new digital audio/video interconnection. The intention of the DisplayPort is to be used primarily between a computer and its display monitor, or a computer and a home-theater. The DisplayPort and the HDMI signal are compatible.

- Cable with DisplayPort male to Mini DisplayPort male (e.g. for MAC)
- **Compliant DP v1.1**



**Value**

Order-No. – P.U.

VALUE DisplayPort Cable, DP - Mini DP, M/M, black, 1.0 m	11.99.5634 – 20
VALUE DisplayPort Cable, DP - Mini DP, M/M, black, 1.5 m	11.99.5638 – 20
VALUE DisplayPort Cable, DP - Mini DP, M/M, black, 2.0 m	11.99.5635 – 20
VALUE DisplayPort Cable, DP - Mini DP, M/M, black, 3.0 m	11.99.5636 – 20
VALUE DisplayPort Cable, DP - Mini DP, M/M, black, 5.0 m	11.99.5637 – 10

**ROLINE DisplayPort Cables, DP - Mini DP**

**1080p FULL HD**

DisplayPort is a digital display interface standard that defines a new digital audio/video interconnection. The intention of the DisplayPort is to be used primarily between a computer and its display monitor, or a computer and a home-theater. The DisplayPort and the HDMI signal are compatible.

- Cable with DisplayPort male to Mini DisplayPort male (e.g. for MAC)
- **Compliant DP v1.1**



**roline**  
Designed for Professionals

Order-No. – P.U.

ROLINE DisplayPort Cable, DP - Mini DP, M/M, black, 1.0 m	11.04.5634 – 20
ROLINE DisplayPort Cable, DP - Mini DP, M/M, black, 1.5 m	11.04.5638 – 20
ROLINE DisplayPort Cable, DP - Mini DP, M/M, black, 2.0 m	11.04.5635 – 20
ROLINE DisplayPort Cable, DP - Mini DP, M/M, black, 3.0 m	11.04.5636 – 20
ROLINE DisplayPort Cable, DP - Mini DP, M/M, black, 5.0 m	11.04.5637 – 10

**ROLINE DisplayPort Cables, Mini DP - Mini DP**

1080p FULL HD

DisplayPort is a digital display interface standard that defines a new digital audio/video interconnection. The intention of the DisplayPort is to be used primarily between a computer and its display monitor, or a computer and a home-theater.

- Compliant DP v1.1



**roline**  
Designed for Professionals

Order-No. – P.U.

ROLINE DisplayPort Cable, Mini DP - Mini DP, M/M, 2.0 m	11.04.5640 – 20
ROLINE DisplayPort Cable, Mini DP - Mini DP, M/M, 3.0 m	11.04.5641 – 20

**ROLINE Mini DisplayPort Cable, v1.3/v1.4, mDP-DP**

5K

**ROLINE DisplayPort cable with a Mini DP and a DP connector for connecting an ultrabook, notebook/laptop or PC to a monitor, TV or projector - for screen transmissions in excellent quality with a resolution of up to 5120x2880 @60Hz!**

- Compliant to DP v1.3 (max. 5120x2880 @60Hz)

- DisplayPort is a universal connection standard for the transmission of picture and sound signals. Applications include mainly the connection of monitors and televisions to computers, BluRay players and similar devices.
- The connector requires less space and is therefore more suitable for portable display devices (ultrabooks, notebooks/laptops) or for 2 connectors on a graphics card (on a slot plate).
- The practical plug design prevents the cable from slipping out of the DisplayPort socket.



**NEW roline**  
Designed for Professionals

Order-No. – P.U.

ROLINE Mini DisplayPort Cable, v1.3/v1.4, mDP-DP, M/M, black, 1.0 m	11.04.5814 – 20
ROLINE Mini DisplayPort Cable, v1.3/v1.4, mDP-DP, M/M, black, 2.0 m	11.04.5815 – 10

**ROLINE Mini DisplayPort Cable, v1.3/v1.4, mDP-mDP**

5K

**ROLINE DisplayPort Cable with Mini DP connection on both sides for connecting an Ultrabook, Notebook/Laptop or PC to a monitor, TV or projector - for screen transmissions in excellent quality with resolutions of up to 5120x2880 @60Hz!**

- DisplayPort is a universal connection standard for the transmission of picture and sound signals. Applications include mainly the connection of monitors and televisions to computers, BluRay players and similar devices.
- The connector requires less space and is therefore more suitable for portable display devices (ultrabooks, notebooks/laptops) or for 2

- connectors on a graphics card (on a slot plate).
- Compliant to DP v1.3 (max. 5120 x 2880 @60Hz)

Order-No. – P.U.

ROLINE Mini DisplayPort Cable, v1.3/v1.4, mDP-mDP, M/M, black, 1.0 m	11.04.5817 – 20
ROLINE Mini DisplayPort Cable, v1.3/v1.4, mDP-mDP, M/M, black, 2.0 m	11.04.5818 – 10

**NEW**

**roline**  
Designed for Professionals



**VALUE DisplayPort Cable, DP-DVI (24+1)**

1080p FULL HD

**Connect your graphics card to a monitor with DVI connection via DisplayPort - with a maximum resolution of up to 1920x1080 @60Hz!**

- DVI is the standard for digital video transmission in the computer sector.
- Display Port is the new standard for digital audio/video transmission in the TV and multimedia sector, e. g. for connecting a monitor with DVI interface to a graphic card with DisplayPort connection. The DisplayPort is signal compatible to DVI.
- Cable with one DisplayPort connector and one DVI connector
- Compliant DP v1.1 (max. 1920 x 1080 / 1920 x 1200 @60Hz)



**Value**

**Remark: The DisplayPort to DVI cable is only working in one direction: the DisplayPort plug has to be connected to the source device (e.g. graphic card)**

**\*Halogenfree  
Flame Retardant  
Low Smoke**

Order-No. – P.U.

VALUE DisplayPort Cable, DP-DVI (24+1), M/M, black, 1.0 m	11.99.5613 – 10
VALUE DisplayPort Cable, DP-DVI (24+1), M/M, black, 1.5 m	11.99.5619 – 10
VALUE DisplayPort Cable, DP-DVI (24+1), M/M, black, 2.0 m	11.99.5610 – 10
VALUE DisplayPort Cable, DP-DVI (24+1), M/M, black, 5.0 m	11.99.5612 – 10
VALUE DisplayPort Cable, DP-DVI (24+1), M/M, black, 3.0 m	11.99.5611 – 10
VALUE DisplayPort Cable, DP-DVI (24+1), LSOH, M/M, black, 1.0 m	11.99.5614 – 10
VALUE DisplayPort Cable, DP-DVI (24+1), LSOH, M/M, black, 1.5 m	11.99.5608 – 10
VALUE DisplayPort Cable, DP-DVI (24+1), LSOH, M/M, black, 2.0 m	11.99.5615 – 10
VALUE DisplayPort Cable, DP-DVI (24+1), LSOH, M/M, black, 3.0 m	11.99.5616 – 10
VALUE DisplayPort Cable, DP-DVI (24+1), LSOH, M/M, black, 5.0 m	11.99.5617 – 10

**ROLINE DisplayPort Cable, DP-DVI (24+1)**

1080p FULL HD

**Connect your graphics card to a monitor with DVI connection via DisplayPort - with a maximum resolution of up to 1920x1080 @60Hz!**

- DVI is the standard for digital video transmission in the computer sector.
- Display Port is the new standard for digital audio/video transmission in the TV and multimedia sector, e. g. for connecting a monitor with DVI interface to a graphic card with DisplayPort connection. The DisplayPort is signal compatible to DVI.
- Cable with one DisplayPort connector and one DVI connector
- Compliant DP v1.1 (max. 1920 x 1080 / 1920 x 1200 @60Hz)



**roline**  
Designed for Professionals

**Remark: The DisplayPort to DVI cable is only working in one direction: the DisplayPort plug has to be connected to the source device (e.g. graphic card)**

**\*Halogenfree  
Flame Retardant  
Low Smoke**

Order-No. – P.U.

ROLINE DisplayPort Cable, DP-DVI (24+1), M/M, black, 1.0 m	11.04.5613 – 10
ROLINE DisplayPort Cable, DP-DVI (24+1), M/M, black, 1.5 m	11.04.5619 – 10
ROLINE DisplayPort Cable, DP-DVI (24+1), M/M, black, 2.0 m	11.04.5610 – 10
ROLINE DisplayPort Cable, DP-DVI (24+1), M/M, black, 3.0 m	11.04.5611 – 10
ROLINE DisplayPort Cable, DP-DVI (24+1), M/M, black, 5.0 m	11.04.5612 – 10
ROLINE DisplayPort Cable, DP-DVI (24+1), LSOH, M/M, black, 1.0 m	11.04.5771 – 20
ROLINE DisplayPort Cable, DP-DVI (24+1), LSOH, M/M, black, 1.5 m	11.04.5775 – 20
ROLINE DisplayPort Cable, DP-DVI (24+1), LSOH, M/M, black, 2.0 m	11.04.5772 – 20
ROLINE DisplayPort Cable, DP-DVI (24+1), LSOH, M/M, black, 3.0 m	11.04.5773 – 20
ROLINE DisplayPort Cable, DP-DVI (24+1), LSOH, M/M, black, 5.0 m	11.04.5774 – 10

VALUE Mini-/DisplayPort Cable, DP - HDTV

1080p FULL HD

DisplayPort to HDTV cable for transferring content from your graphics card (DisplayPort) to your TV (HDTV) - with a quality of up to 1920x1080 @60Hz, incl. audio transmission!

- HDTV is the standard for digital video transmission in the TV/multimedia sector for e. g.: Connection of a TV set with HDMI interface to a playback device with DisplayPort connection.
- Cable with one DisplayPort and one HDTV plug. DisplayPort is signal compatible with HDMI.
- Note: A DisplayPort HDTV cable can only be used in one direction: the DisplayPort connector can only be used on the data source side (e.g. graphics card).



Order-No. - P.U.

VALUE DisplayPort Cable, DP - HDTV, M/M, black, 1.0 m	11.99.5780 - 10
VALUE DisplayPort Cable, DP - HDTV, M/M, black, 1.5 m	11.99.5779 - 10
VALUE DisplayPort Cable, DP - HDTV, M/M, black, 2.0 m	11.99.5781 - 10
VALUE DisplayPort Cable, DP - HDTV, M/M, black, 3.0 m	11.99.5782 - 10
VALUE DisplayPort Cable, DP - HDTV, M/M, black, 4.5 m	11.99.5783 - 10
VALUE DisplayPort Cable, DP - HDTV, M/M, black, 10.0 m	11.99.5784 - 5
VALUE Mini DisplayPort Cable, Mini DP-HDTV, M/M, black, 1.0 m	11.99.5790 - 10
VALUE Mini DisplayPort Cable, Mini DP-HDTV, M/M, black, 2.0 m	11.99.5791 - 10
VALUE Mini DisplayPort Cable, Mini DP-HDTV, M/M, black, 3.0 m	11.99.5792 - 10
VALUE Mini DisplayPort Cable, Mini DP-HDTV, M/M, black, 4.5 m	11.99.5793 - 10

ROLINE Mini-/DisplayPort Cable, DP - HDTV

1080p FULL HD

DisplayPort to HDTV cable for transferring content from your graphics card (DisplayPort) to your TV (HDTV) - with a quality of up to 1920x1080 @60Hz, incl. audio transmission!

- HDTV is the standard for digital video transmission in the TV/multimedia sector for e. g.: Connection of a TV set with HDMI interface to a player with DisplayPort connection.
- Cable with one DisplayPort and one HDTV plug.
- Note: A DisplayPort HDTV cable can only be used in one direction: the DisplayPort connector can only be used on the data source side (e. g. graphics card).



Order-No. - P.U.

ROLINE DisplayPort Cable, DP - HDTV, M/M, black, 1.0 m	11.04.5780 - 10
ROLINE DisplayPort Cable, DP - HDTV, M/M, black, 1.5 m	11.04.5779 - 10
ROLINE DisplayPort Cable, DP - HDTV, M/M, black, 2.0 m	11.04.5781 - 10
ROLINE DisplayPort Cable, DP - HDTV, M/M, black, 3.0 m	11.04.5782 - 10
ROLINE DisplayPort Cable, DP - HDTV, M/M, black, 4.5 m	11.04.5783 - 10
ROLINE Mini DisplayPort Cable, Mini DP-HDTV, M/M, black, 1.0 m	11.04.5790 - 10
ROLINE Mini DisplayPort Cable, Mini DP-HDTV, M/M, black, 1.5 m	11.04.5789 - 10
ROLINE Mini DisplayPort Cable, Mini DP-HDTV, M/M, black, 2.0 m	11.04.5791 - 10
ROLINE Mini DisplayPort Cable, Mini DP-HDTV, M/M, black, 3.0 m	11.04.5792 - 10
ROLINE Mini DisplayPort Cable, Mini DP-HDTV, M/M, black, 4.5 m	11.04.5793 - 10

VALUE DP/Mini DisplayPort Cable, DP/Mini DP-UHDTV

4K

2160p ULTRA HD

Mini DisplayPort to UHDTV cable for transferring content from your graphics card (DisplayPort) to your TV (UHDTV) - with a quality of up to 3840x2160 @60Hz, incl. audio transmission!

- UHDTV is the standard for digital video transmission in the TV/multimedia sector for e. g.: Connection of a TV set with HDMI interface to a player with Mini DisplayPort connection.
- Cable with one Mini DisplayPort and one HDTV plug. DisplayPort is signal compatible with HDMI.
- Note: A DisplayPort UHDTV cable can only be used in one direction: the Mini DisplayPort connector can only be used on the data source side (e. g. graphics card, Macbook, Ultrabook, laptop/notebook or PC).



Order-No. - P.U.

VALUE DisplayPort Cable, DP - UHDTV, M/M, black, 1.0 m	11.99.5785 - 10
VALUE DisplayPort Cable, DP - UHDTV, M/M, black, 2.0 m	11.99.5786 - 10
VALUE DisplayPort Cable, DP - UHDTV, M/M, black, 3.0 m	11.99.5787 - 10
VALUE DisplayPort Cable, DP - UHDTV, M/M, black, 5.0 m	11.99.5788 - 10
VALUE DisplayPort Cable, DP - UHDTV, M/M, black, 7.5 m	11.99.5789 - 10
VALUE Mini DisplayPort Cable, Mini DP-UHDTV, M/M, black, 1.0 m	11.99.5795 - 10
VALUE Mini DisplayPort Cable, Mini DP-UHDTV, M/M, black, 2.0 m	11.99.5796 - 10
VALUE Mini DisplayPort Cable, Mini DP-UHDTV, M/M, black, 3.0 m	11.99.5797 - 10

ROLINE DP/Mini DisplayPort Cables, DP/Mini DP-UHDTV

4K

2160p ULTRA HD

Mini DisplayPort to UHDTV cable for transferring content from your graphics card (DisplayPort) to your TV (UHDTV) - with a quality of up to 3840x2160 @60Hz, incl. audio transmission!

- UHDTV is the standard for digital video transmission in the TV/multimedia sector for e. g.: Connection of a TV set with HDMI interface to a player with Mini DisplayPort connection.
- Cable with one Mini DisplayPort and one HDTV plug. DisplayPort is signal compatible with HDMI.
- Note: A DisplayPort UHDTV cable can only be used in one direction: the Mini DisplayPort connector can only be used on the data source side (e. g. graphics card).



Order-No. - P.U.

ROLINE DisplayPort Cable, DP - UHDTV, M/M, black, 1.0 m	11.04.5785 - 10
ROLINE DisplayPort Cable, DP - UHDTV, M/M, black, 2.0 m	11.04.5786 - 10
ROLINE DisplayPort Cable, DP - UHDTV, M/M, black, 3.0 m	11.04.5787 - 10
ROLINE DisplayPort Cable, DP - UHDTV, M/M, black, 5.0 m	11.04.5788 - 10
ROLINE Mini DisplayPort Cable, Mini DP-UHDTV, M/M, black, 1.0 m	11.04.5795 - 10
ROLINE Mini DisplayPort Cable, Mini DP-UHDTV, M/M, black, 2.0 m	11.04.5796 - 10
ROLINE Mini DisplayPort Cable, Mini DP-UHDTV, M/M, black, 3.0 m	11.04.5797 - 10





**roline**<sup>®</sup>  
Designed for Professionals



**roline**<sup>®</sup> GOLD

Light

Light

**ROLINE GOLD USB 2.0 Cables**

**ROLINE GOLD - Top quality without any compromises!** Cables in ROLINE GOLD quality come with high quality shielding and gilded contacts for contact safety even at high plug-in cycles. The plugs are gold coated to enhance their contact durability. Nylon-reinforced outer material in golden/black provides a better stability and gives the cable a stunning look.

- The plugs are gold coated to enhance their contact durability
- Nylon-reinforced outer material for a better stability
- Supports data transfer rates of up to 480 Mbit/s

- **11.02.8314 (Picture A)**  
USB cable with a combined connector consisting of a foldable type A (connector) and a Micro B (connector) on one side and another Micro B (connector) on the other side
- **11.02.8319 (Picture B)**  
Quick Charge 2.0  
With practical LED display, which shows the current loading status of the connected device

	Order-No.	- P.U.
ROLINE GOLD USB 2.0 Cable, A - B, M/M, 1.8 m	11.02.8802	- 10
ROLINE GOLD USB 2.0 Cable, A - B, M/M, 3.0 m	11.02.8803	- 10
ROLINE GOLD USB 2.0 Cable, A - B, M/M, 4.5 m	11.02.8805	- 5
ROLINE GOLD USB 2.0 Cable, A - 5-Pin Mini, M/M, 0.8 m	11.02.8821	- 10
ROLINE GOLD USB 2.0 Cable, A - 5-Pin Mini, M/M, 1.8 m	11.02.8822	- 10
ROLINE GOLD USB 2.0 Cable, A - 5-Pin Mini, M/M, 3.0 m	11.02.8823	- 10
ROLINE GOLD USB 2.0 Cable, A - Micro B, M/M, 0.8 m	11.02.8825	- 10
ROLINE GOLD USB 2.0 Cable, A - Micro B, M/M, 1.8 m	11.02.8826	- 10
ROLINE GOLD USB 2.0 Cable, A - Micro B (reversible), M/M, 0.8 m	11.02.8827	- 10
ROLINE GOLD USB 2.0 Cable, A - Micro B (reversible), M/M, 1.8 m	11.02.8828	- 10
ROLINE GOLD USB 2.0 OTG Cable, A + Micro B - Micro B, M/M, 1.0 m	11.02.8314	- 25
ROLINE GOLD LED USB 2.0 Cable, reversible, A-Micro B, M/M, QC2.0, 1.0 m	11.02.8319	- 10
ROLINE GOLD USB 2.0 Cable, C - Micro B (reversible), M/M, 1.8 m	11.02.8790	- 10
ROLINE GOLD USB 2.0 Cable, C - Micro B (reversible), M/M, 3.0 m	11.02.8791	- 10
ROLINE GOLD USB 2.0 Cable, C - Micro B (reversible), M/M, 4.5 m	11.02.8792	- 5

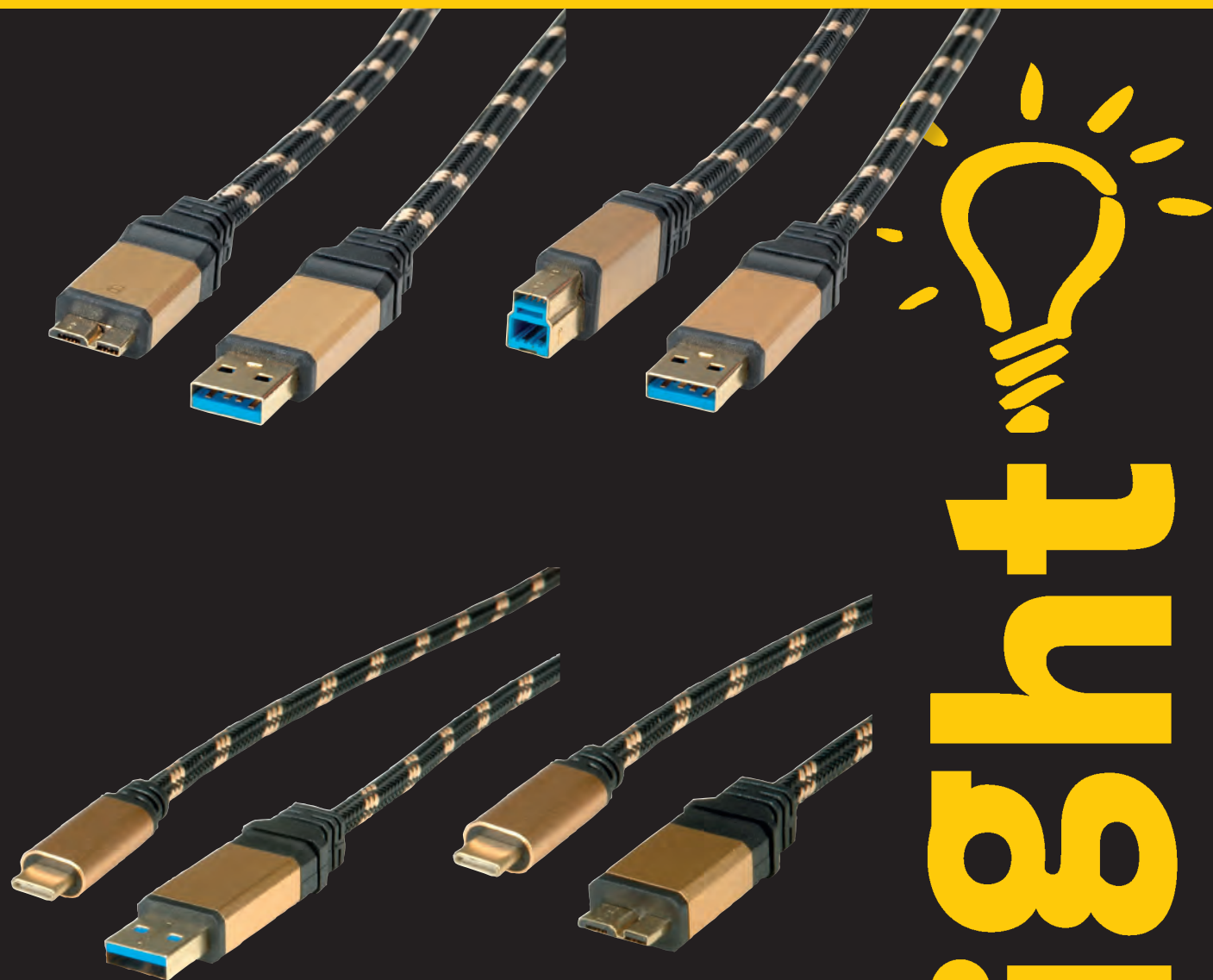

**roline**<sup>®</sup> GOLD

**5 Gbit/s**

## ROLINE GOLD USB 3.0 / 3.1 Cables

**ROLINE GOLD - Top quality without any compromises!** Cables in ROLINE GOLD quality come with high quality shielding and gilded contacts for contact safety even at high plug-in cycles. The plugs are gold coated to enhance their contact durability. Nylon-reinforced outer material in golden/black provides a better stability and gives the cable a stunning look.

### ROLINE GOLD USB 3.0 SuperSpeed Cables

- The plugs are gold coated to enhance their contact durability
- Nylon-reinforced outer material for a better stability
- Supports data transfer rates of up to 5 Gbit/s
- Connectors: USB 3.0 Type A M to Type B M
- Improved data encoding for more efficient data transfer leading to higher through-put and improved I/O power efficiency
- The contact plugs are gold coated to enhance their contact durability
- Compatible with existing USB 3.0 software stacks and device protocols

### ROLINE GOLD USB 3.1 Cables, A – C and C – MicroB

- Works with both existing 5Gbit/s USB 3.0 hubs and devices, as well as USB 2.0 products
- USB 3.1 high-speed cable in high quality with improved shielding
- Only suitable for USB standard power supply to 5V / 900mA!
- Type: A-C

**roline**<sup>®</sup>  
Designed for Professionals

	Order-No.	– P.U.
ROLINE GOLD USB 3.0 Cable, A - B, M/M, 0,8 m	11.02.8900	– 10
ROLINE GOLD USB 3.0 Cable, A - B, M/M, 1,8 m	11.02.8902	– 10
ROLINE GOLD USB 3.0 Cable, A - B, M/M, 3,0 m	11.02.8903	– 10
ROLINE GOLD USB 3.0 Cable, A - Micro B, M/M, 0,8 m	11.02.8878	– 10
ROLINE GOLD USB 3.0 Cable, A - Micro B, M/M, 2,0 m	11.02.8879	– 10
ROLINE GOLD USB 3.1 Cable, A-C, M/M, 0,5 m	11.02.9012	– 20
ROLINE GOLD USB 3.1 Cable, A-C, M/M, 1,0 m	11.02.9013	– 10
ROLINE GOLD USB 3.1 Cable, C-Micro B, M/M, 0,5 m	11.02.9025	– 20
ROLINE GOLD USB 3.1 Cable, C-Micro B, M/M, 1,0 m	11.02.9026	– 10



# Light

# Right

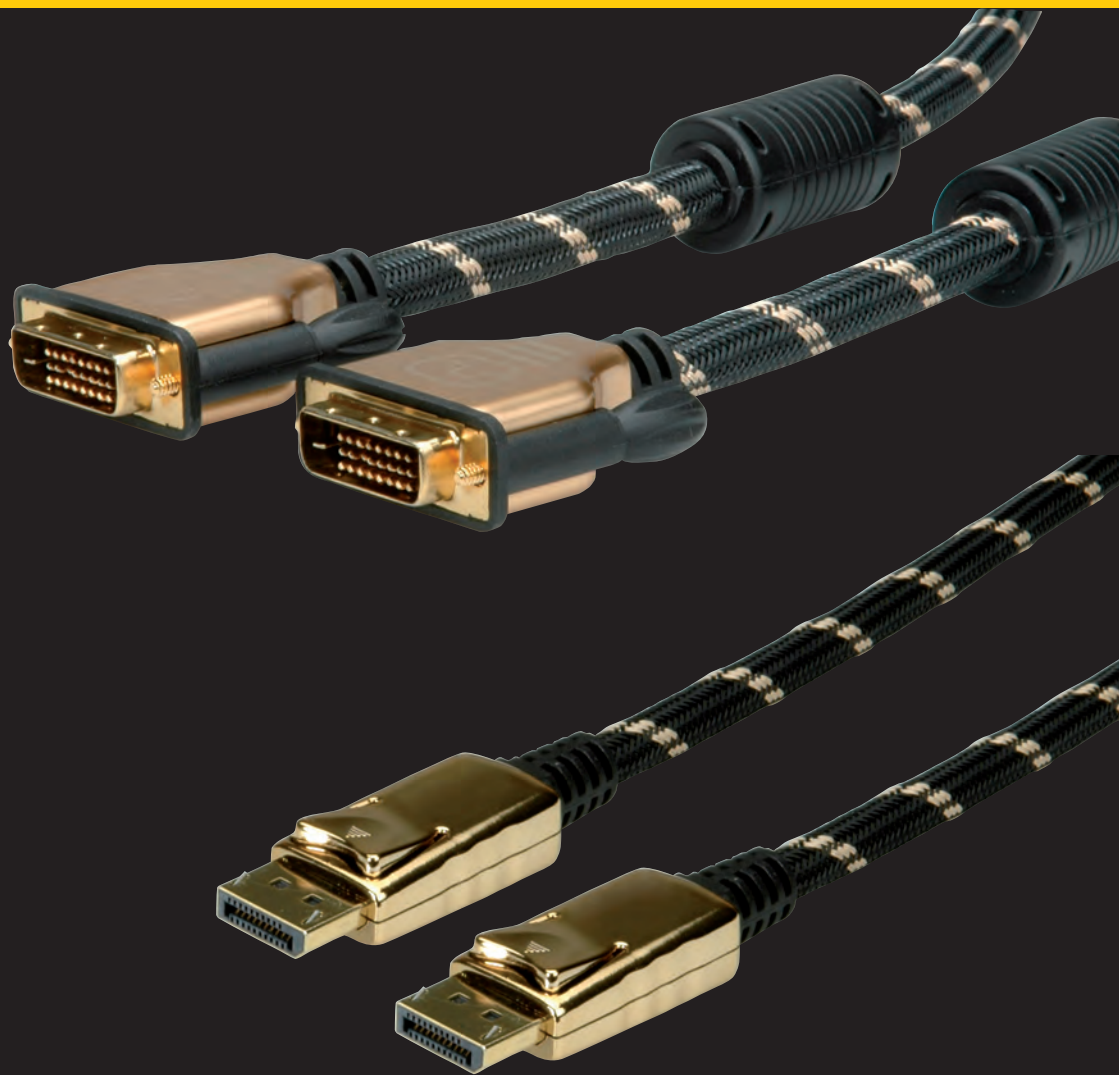

## roline<sup>®</sup> GOLD

### ROLINE GOLD DVI and DisplayPort Monitor Cables

4K

**ROLINE GOLD - Top quality without any compromises!** Cables in ROLINE GOLD quality come with high quality shielding and gilded contacts for contact safety even at high plug-in cycles. The plugs are gold coated to enhance their contact durability.

Nylon-reinforced outer material in golden/black provides a better stability and gives the cable a stunning look.

#### ROLINE GOLD DVI Monitor Cables

- DVI-D dual link version with (24+1)-pin assignment, recommended for monitors with bigger screen sizes
- ROLINE Gold cable with gold plated contacts and metal connector housing
- Nylon-reinforced cable outer material for a better stability
- Ferrite cores
- Thumbscrews

#### ROLINE GOLD DisplayPort Cables

- Cable with DisplayPort male connector on both sides
- Gold plated contacts for enhanced durability
- Nylon-reinforced outer material for a better stability
- **Compliant DP v1.2**

**roline<sup>®</sup>**  
Designed for Professionals

	Order-No.	P.U.
ROLINE GOLD Monitor Cable, DVI (24+1), Dual Link, M/M, 1.0 m	11.04.5511	- 10
ROLINE GOLD Monitor Cable, DVI (24+1), Dual Link, M/M, 2.0 m	11.04.5512	- 10
ROLINE GOLD Monitor Cable, DVI (24+1), Dual Link, M/M, 3.0 m	11.04.5513	- 10
ROLINE GOLD Monitor Cable, DVI (24+1), Dual Link, M/M, 5.0 m	11.04.5514	- 10
ROLINE GOLD Monitor Cable, DVI (24+1), Dual Link, M/M, 7.5 m	11.04.5515	- 6
ROLINE GOLD Monitor Cable, DVI (24+1), Dual Link, M/M, 10.0 m	11.04.5518	- 5
ROLINE GOLD DisplayPort Cable, DP-DP, M/M, 1.0 m	11.04.5644	- 10
ROLINE GOLD DisplayPort Cable, DP-DP, M/M, 1.5 m	11.04.5639	- 10
ROLINE GOLD DisplayPort Cable, DP-DP, M/M, 2.0 m	11.04.5645	- 10
ROLINE GOLD DisplayPort Cable, DP-DP, M/M, 3.0 m	11.04.5646	- 10
ROLINE GOLD DisplayPort Cable, DP-DP, M/M, 5.0 m	11.04.5647	- 5
ROLINE GOLD DisplayPort Cable, DP-DP, M/M, 7.5 m	11.04.5648	- 6
ROLINE GOLD DisplayPort Cable, DP-DP, M/M, 10.0 m	11.04.5649	- 5



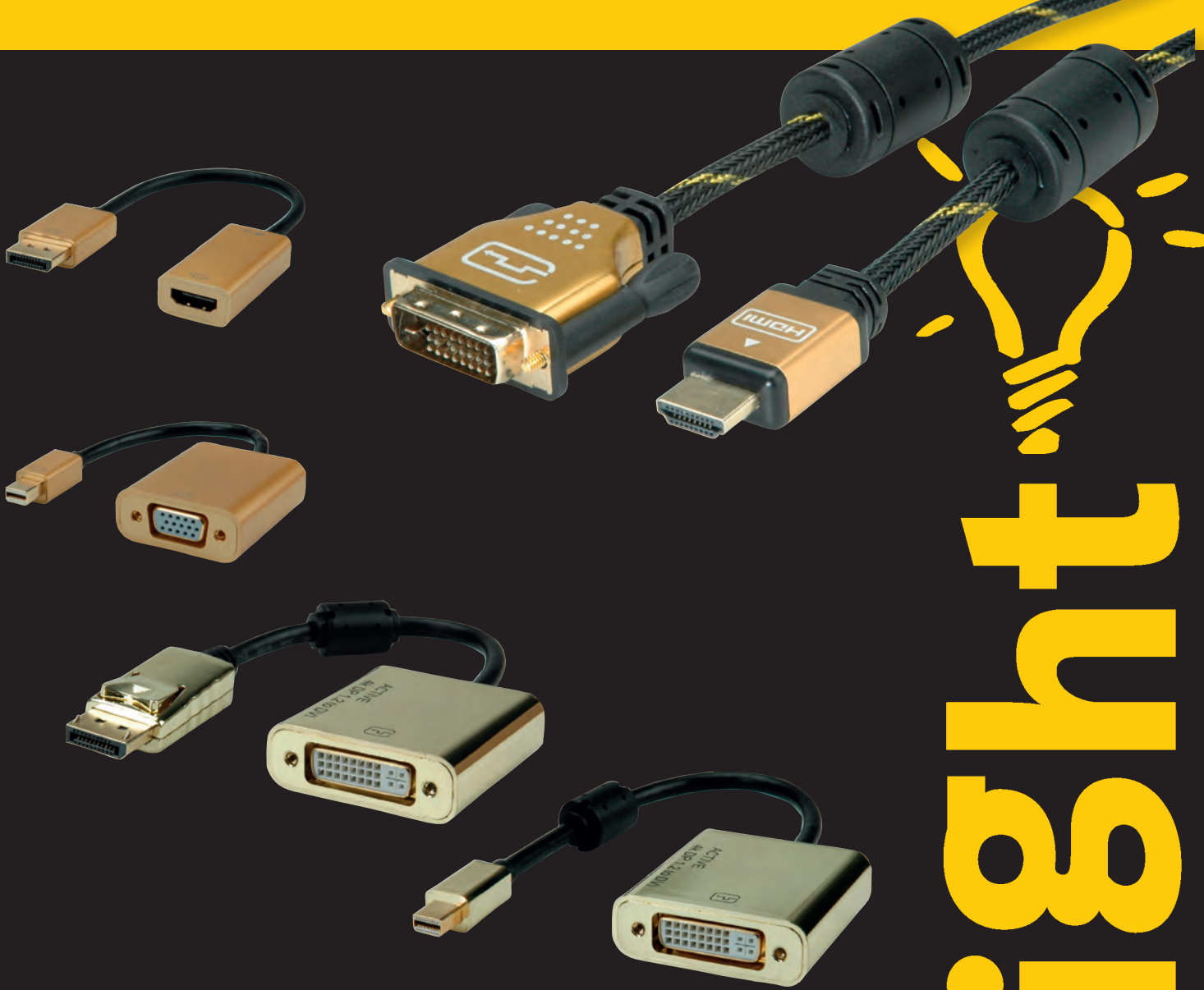

roline<sup>®</sup> GOLD

roline<sup>®</sup> Gold

**ROLINE GOLD DisplayPort-Adapter and Monitor Cables DVI-HDMI**

**4K**

**ROLINE GOLD HDMI to DVI cable for connecting an ultrabook, notebook/laptop or PC to a monitor, TV or projector - for screen transmissions in excellent quality with a resolution of up to 3840x2160 @30Hz!**

- The rugged nylon braid protects the cable effectively and makes it look stunning.
- High-quality, double-shielded cable (foil+braid) with gold-plated contacts for optimum transmission of image signals
- Supports 3D video
- HDMI Ethernet channel
- Audio return channel for forwarding signals to the audio/video receiver
- Golden connector housing
- Connectors: DVI-D (24+1) to HDMI

**ROLINE GOLD DisplayPort to HDMI cable adapter for connecting a graphics card with DP to a monitor with HDMI connection - with a resolution of up to 3840x2160 @30Hz!**

- If you want to connect a graphic card with DisplayPort Female to a monitor by using a HDMI cable, you need this DisplayPort to HDMI adapter
- Connectors: DisplayPort Male, HDMI Female
- DisplayPort version 1.2 allows increased resolutions, higher refresh rates, and greater color depth
- Max. resolution: 3840 x 2160 (@30Hz)
- Active

**ROLINE GOLD Mini DisplayPort to VGA cable adapter for connecting a graphics card with Mini DP to a monitor with VGA connector - with a resolution of up to 1920x1080 / 1920x1200 @60Hz!**

- Remark: The DisplayPort-HDMI adapter is only working in one direction: the DisplayPort plug has to be connected to the source device (e.g. graphic card)

**roline<sup>®</sup>**  
Designed for Professionals

	Order-No.	- P.U.
ROLINE GOLD Adapter Mini DisplayPort-VGA, v1.2, Mini DP M - VGA F	12.03.3171	- 10
ROLINE GOLD 4K Adapter DisplayPort-DVI, DP M - DVI F	12.03.3175	- 10
ROLINE GOLD 4K Adapter Mini DisplayPort-DVI, MiniDP M - DVI F	12.03.3176	- 10
ROLINE GOLD 4K Adapter, Active, v1.2, DP-HDMI, M/F	12.03.3170	- 10
ROLINE GOLD Monitor Cable, DVI (24+1) - HDMI, Dual Link, M/M, 1.0 m	11.04.5890	- 10
ROLINE GOLD Monitor Cable, DVI (24+1) - HDMI, Dual Link, M/M, 1.5 m	11.04.5896	- 10
ROLINE GOLD Monitor Cable, DVI (24+1) - HDMI, Dual Link, M/M, 2.0 m	11.04.5891	- 10
ROLINE GOLD Monitor Cable, DVI (24+1) - HDMI, Dual Link, M/M, 3.0 m	11.04.5892	- 10
ROLINE GOLD Monitor Cable, DVI (24+1) - HDMI, Dual Link, M/M, 5.0 m	11.04.5893	- 10
ROLINE GOLD Monitor Cable, DVI (24+1) - HDMI, Dual Link, M/M, 7.5 m	11.04.5894	- 5
ROLINE GOLD Monitor Cable, DVI (24+1) - HDMI, Dual Link, M/M, 10.0 m	11.04.5895	- 5



# Light

# High



**roline**<sup>®</sup> GOLD

## ROLINE GOLD HDMI High Speed Cables / with Ethernet



**ROLINE GOLD - Top quality without any compromises!** Cables in ROLINE GOLD quality come with high quality shielding and gilded contacts for contact safety even at high plug-in cycles. The plugs are gold coated to enhance their contact durability. Nylon-reinforced outer material in golden/black provides a better stability and gives the cable a stunning look.

- Cable with HDMI male connector on both sides
- HDMI Ethernet Channel- Adds high-speed networking to an HDMI link, allowing users to take full advantage of their IP-enabled devices without a separate ethernet cable
- Audio Return Channel- Allows an HDMI-connected TV with a built-in tuner to send audio data „upstream“ to a surround audio system, eliminating the need for a separate audio cable
- 3D- Defines input/output protocols for major 3D video formats
- **11.04.5507:** One connector with swivel functionality, so that the cable will not be bent, when there is only small space to the wall

	Order-No.	- P.U.
ROLINE GOLD HDMI High Speed Cable, M/M, 1.0 m	11.04.5561	- 20
ROLINE GOLD HDMI High Speed Cable, M/M, 2.0 m	11.04.5562	- 20
ROLINE GOLD HDMI High Speed Cable, M/M, 3.0 m	11.04.5563	- 20
ROLINE GOLD HDMI High Speed Cable, M/M, 5.0 m	11.04.5565	- 10
ROLINE GOLD HDMI High Speed Cable, M/M, 10.0 m	11.04.5566	- 5
ROLINE GOLD HDMI High Speed Cable, M/M, 15.0 m	11.04.5560	- 5
ROLINE GOLD HDMI High Speed Cable, M/M, 20.0 m	11.04.5564	- 5
ROLINE GOLD HDMI High Speed Cable + Ethernet, M/M, 1.0 m	11.04.5501	- 20
ROLINE GOLD HDMI High Speed Cable + Ethernet, M/M, 1.5 m	11.04.5500	- 20
ROLINE GOLD HDMI High Speed Cable + Ethernet, M/M, 2.0 m	11.04.5502	- 20
ROLINE GOLD HDMI High Speed Cable + Ethernet, M/M, 3.0 m	11.04.5503	- 20
ROLINE GOLD HDMI High Speed Cable + Ethernet, M/M, 5.0 m	11.04.5505	- 10
ROLINE GOLD HDMI High Speed Cable + Ethernet, M/M, 7.5 m	11.04.5504	- 6
ROLINE GOLD HDMI High Speed Cable + Ethernet, M/M, 10.0 m	11.04.5506	- 5
ROLINE GOLD HDMI High Speed Cable + Ethernet, M/M, 15.0 m	11.04.5508	- 5
ROLINE GOLD HDMI High Speed Cable + Ethernet, M/M, 20.0 m	11.04.5510	- 5
ROLINE GOLD HDMI High Speed Cable + Ethernet, 3D-Swivel, 2.0 m	11.04.5507	- 10

# roline®

Designed for Professionals



# Light is Bright

## roline® GOLD

### ROLINE GOLD HDMI Ultra HD Cables with Ethernet

4K 3D capable 2160p ULTRA HD

**ROLINE GOLD** - Top quality without any compromises! Cables in **ROLINE GOLD** quality come with high quality shielding and gilded contacts for contact safety even at high plug-in cycles. The plugs are gold coated to enhance their contact durability.

Nylon-reinforced outer material in golden/black provides a better stability and gives the cable a stunning look.

High-quality HDMI connection cable with HDMI connectors for optimal transmission of digital HDTV signals at data rates up to 18 Gbit/s (600MHz). For the transmission of films in digital cinema-quality, with a resolution of up to 3840x2160 @60Hz!

- HDMI Ethernet Channel- Adds high-speed networking to an HDMI link, allowing users to take full advantage of their IP-enabled devices without a separate ethernet cable
- Audio Return Channel- Allows an HDMI-connected TV with a built-in tuner to send audio data „upstream“ to a surround audio system, eliminating the

need for a separate audio cable

- The rugged nylon braid protects the HDMI cable effectively and makes it look stunning.
- 3D- Defines input/output protocols for major 3D video formats
- Cable with HDMI male connector on both sides
- High quality cable with golden metal connector housing and shell for better shielding
- Gold plated contacts for higher durability

Order-No. – P.U.

ROLINE GOLD HDMI Ultra HD Cable + Ethernet, M/M, 1,0 m	11.04.5690	– 10
ROLINE GOLD HDMI Ultra HD Cable + Ethernet, M/M, 1,5 m	11.04.5694	– 10
ROLINE GOLD HDMI Ultra HD Cable + Ethernet, M/M, 2,0 m	11.04.5691	– 10
ROLINE GOLD HDMI Ultra HD Cable + Ethernet, M/M, 3,0 m	11.04.5692	– 10
ROLINE GOLD HDMI Ultra HD Cable + Ethernet, M/M, 5,0 m	11.04.5693	– 10

**roline®**  
Designed for Professionals



## VALUE VGA-DVI-HDMI-DP Adapters

**12.99.3115:**

- To connect a DVI cable to an HDMI interface
- Adapter with HDMI plug and 24+1 DVI-D socket

**12.99.3116:**

- To connect an HDMI cable to a DVI interface
- Adapter with HDMI socket and 24+1 DVI-D plug

**12.99.3120/12.99.3152:**

- For combining HDMI cable and components with mini HDMI connector
- Adapter with HDMI socket and HDMI mini plug

**12.99.3123/12.99.3151:**

- For connecting two HDMI cables
- Adapter with HDMI socket and HDMI socket

**12.99.3114/12.99.3113:**

- For connecting a VGA cable to e.g. a notebook with HDMI socket
- Adapter with VGA socket and HDMI plug

**12.99.3135:**

- For combining VGA cables and components with display port connection
- Adapter with DisplayPort plug and VGA socket

**12.99.3133:**

- For combining DVI cable and components with display port connection
- Adapter with DisplayPort connector and 24+1 DVI-D socket

**12.99.3134/12.99.3144:**

- For combining HDMI cable and components with display port connection
- Adapter with DisplayPort plug and HDMI socket
- 12.99.3144: Compliant with DP v1.2

**12.99.3125:**

- Mini DisplayPort DVI adapter for connecting a VGA M/M cable to a Mini DisplayPort connector of the graphics card
- Adapter with Mini DisplayPort plug and VGA socket

**12.99.3128:**

- Mini DisplayPort DVI adapter for connecting a DVI M/M cable to a Mini DisplayPort connector of the graphics card
- Adapter with Mini DisplayPort plug and DVI socket

**12.99.3129/12.99.3142:**

- Mini DisplayPort HDMI adapter for connecting an HDMI M/M cable to a Mini DisplayPort connector of the graphics card
- Adapter with Mini DisplayPort plug and HDMI socket
- 12.99.3142: Compliant with DP v1.2

**12.99.3150:**

- The image signal is electronically converted in the adapter.
- Adapter with Mini DisplayPort connector and DP, DVI and HDMI jack.

**12.99.3153:**

- The image signal is electronically converted in the adapter.
- Maximum resolution: 3840x2160 @60Hz
- Adapter with DisplayPort connector and VGA, DVI and HDMI jack.

**12.99.3154:**

- The image signal is electronically converted in the adapter.
- Maximum resolution: 3840x2160 @60Hz
- Adapter with Mini DisplayPort connector and DP, DVI and HDMI jack.

**Notice:**

**A DisplayPort to HDMI or DVI connection can only be used in one direction. The DisplayPort connector can only be used on the data source side (e.g. graphics card).**



Picture	Order-No. – P.U.	Adapter / Cableadapter	Type	Connector	Length	Version	Active	Passive	Color	Max. nom. Resolution	4K (@30Hz)
A	12.99.3115 – 50	Cableadapter	HDMI – DVI	M/F	0.15	–	–	yes	black	1600 x 1080	–
B	12.99.3116 – 50	Cableadapter	DVI – HDMI	M/F	0.15	–	–	yes	black	1600 x 1080	–
C	12.99.3120 – 25	Cableadapter	HDMI – HDMI Mini	F/M	0.15	–	–	yes	black	1920 x 1080	–
D	12.99.3152 – 20	Adapter	HDMI – HDMI Mini	F/M	–	–	–	yes	black	1920 x 1080	–
E	12.99.3123 – 20	Cableadapter	HDMI – HDMI	F/F	0.15	–	–	yes	black	1920 x 1080	–
F	12.99.3151 – 20	Adapter	HDMI – HDMI	F/F	–	–	–	yes	black	1920 x 1080	–
G	12.99.3114 – 10	Cableadapter	HDMI – VGA	M/F	0.15	–	yes	–	black	1920 x 1080	–
H	12.99.3113 – 10	Adapter	HDMI – VGA	M/F	–	–	yes	–	black	1920 x 1080	–
I	12.99.3135 – 10	Cableadapter	DP – VGA	M/F	0.15	v 1.1	yes	–	black	1920 x 1080	–
J	12.99.3133 – 10	Cableadapter	DP – DVI	M/F	0.15	v 1.1	–	yes	black	1920 x 1080	–
K	12.99.3134 – 10	Cableadapter	DP – HDMI	M/F	0.15	v 1.1	–	yes	black	1920 x 1080	–
L	12.99.3144 – 10	Cableadapter	DP – HDMI	M/F	0.15	v 1.2	–	yes	black	3840 x 2160	yes
M	12.99.3125 – 10	Cableadapter	Mini DP – VGA	M/F	0.15	v 1.1	yes	–	black	1920 x 1080	–
N	12.99.3128 – 10	Cableadapter	Mini DP – DVI	M/F	0.15	v 1.1	–	yes	black	1920 x 1080	–
O	12.99.3129 – 10	Cableadapter	Mini DP – HDMI	M/F	0.15	v 1.1	–	yes	black	1920 x 1080	–
P	12.99.3142 – 10	Cableadapter	Mini DP – HDMI	M/F	0.15	v 1.2	–	yes	black	3840 x 2160	yes
Q	12.99.3150 – 20	Cableadapter	Mini DP – HDMI/DP/DVI**	M/F	0.1	v 1.1	yes	–	black	1920 x 1080	–
R	12.99.3153 – 20	Cableadapter	DP – VGA/DVI/HDMI**	M/F	–	v 1.2	yes	–	black	3840 x 2160	yes
S	12.99.3154 – 20	Cableadapter	Mini DP – VGA/DVI/HDMI**	M/F	–	v 1.2	yes	–	black	3840 x 2160	yes

\*\* only ONE single output available (DVI or HDMI or DP - 12.99.3150 or VGA/DVI/HDMI - 12.99.3153/12.99.3154)

## ROLINE VGA-DVI-HDMI-DP Adapters

### 12.03.3105:

- To connect a VGA monitor to a DVI graphics card
- Adapter with HD15-pin socket and DVI-A plug

### 12.03.3110:

- To connect a DVI monitor to a VGA graphics card
- Adapter with HD15-pin plug and DVI-I socket

### 12.03.3114/12.03.3117:

- To connect a VGA cable to an HDMI interface
- Adapter with HDMI plug and VGA socket

### 12.03.3115:

- To connect a DVI cable to an HDMI interface
- Adapter with HDMI plug and 24+1 DVI-D socket

### 12.03.3116:

- To connect an HDMI cable to a DVI interface
- Adapter with HDMI socket and 24+1 DVI-D plug

### 12.03.3122:

- For combining HDMI cable and components with mini HDMI connector
- Adapter with HDMI socket and HDMI mini plug

### 12.03.3151:

- For connecting two HDMI cables
- Adapter with HDMI socket and HDMI socket

### 12.03.3135/12.03.3146:

- For combining VGA cables and components with display port connection
- Adapter with DisplayPort plug and VGA socket, cable length approx. 10cm

### 12.03.3133/12.03.3136:

- For combining DVI cable and components with display port connection
- Adapter with DisplayPort connector and 24+1 DVI-D socket

### 12.03.3134/.3144/.3160/.3162:

- For combining HDMI cable and components with display port connection
- Adapter with DisplayPort plug and HDMI socket

### 12.03.3125/12.03.3140:

- Mini DisplayPort VGA adapter for connecting a VGA M/M cable to a Mini DisplayPort connector of the graphics card
- Adapter with Mini DisplayPort plug and VGA socket, cable length approx. 10cm

### 12.03.3128/12.03.3137:

- Mini DisplayPort DVI adapter for connecting a DVI M/M cable to a Mini DisplayPort connector of the graphics card
- Adapter with Mini DisplayPort plug and DVI socket, cable length approx. 10cm

### 12.03.3129/12.03.3142/12.03.3161:

- Mini DisplayPort HDMI adapter for connecting an HDMI M/M cable to a Mini DisplayPort connector of the graphics card
- Adapter with Mini DisplayPort plug and HDMI socket, cable length approx. 10cm
- 12.03.3161: additional VGA socket

### 12.03.3130/12.03.3163:

- For connecting a normal DP cable to e.g. a notebook with Mini DP socket
- Adapter with DisplayPort socket and Mini DisplayPort plug

### 12.03.3132:

- For combining a Mini DP cable to a device with DP socket
- Adapter with DisplayPort connector and Mini DisplayPort socket

**Note: A DisplayPort to HDMI or DVI connection can only be used in one direction. The DisplayPort connector can only be used on the data source side (e.g. graphics card).**



**roline**<sup>®</sup>  
Designed for Professionals

Picture	Order-No. – P.U.	Adapter / Cableadapter	Type	Connector	Length	Version	Active	Passive	Color	Max. nom. Resolution	4K (@30Hz)
A	12.03.3105 – 50	Adapter	DVI – VGA	M/F	–	–	–	yes	black	1920 x 1080 (*)	–
B	12.03.3110 – 50	Adapter	DVI – VGA	F/M	–	–	–	yes	black	1920 x 1080 (*)	–
C	12.03.3117 – 10	Adapter	HDMI – VGA	M/F	–	–	yes	–	black	1920 x 1080	–
D	12.03.3114 – 10	Cableadapter	HDMI – VGA	M/F	0.15	–	yes	–	white	1920 x 1080	–
E	12.03.3115 – 50	Adapter	HDMI – DVI	M/F	–	–	–	yes	black	1920 x 1080	–
F	12.03.3116 – 50	Adapter	DVI – HDMI	M/F	–	–	–	yes	black	1920 x 1080	–
G	12.03.3152 – 20	Adapter	HDMI – HDMI Mini	F/M	–	–	–	yes	black	1920 x 1080	–
H	12.03.3151 – 20	Adapter	HDMI – HDMI	F/F	–	–	–	yes	black	1920 x 1080	–
J	12.03.3135 – 10	Cableadapter	DP – VGA	M/F	0.15	v 1.1a	yes	–	white	1920 x 1080	–
J	12.03.3146 – 10	Cableadapter	DP – VGA	M/F	0.15	v 1.2	yes	–	white	1920 x 1080	–
K	12.03.3133 – 10	Cableadapter	DP – DVI	M/F	0.1	v 1.1a	–	yes	white	1920 x 1080	–
L	12.03.3136 – 10	Cableadapter	DP – DVI	M/F	0.1	v 1.2	–	yes	white	3840 x 2160	yes
M	12.03.3134 – 10	Cableadapter	DP – HDMI	M/F	0.1	v 1.1a	–	yes	white	1920 x 1080	yes
M	12.03.3144 – 10	Cableadapter	DP – HDMI	M/F	0.15	v 1.2	yes	–	white	3840 x 2160	yes
N	12.03.3162 – 10	Cableadapter	DP – HDMI	M/F	0.1	v 1.2	yes	–	white	3840 x 2160	yes
O	12.03.3160 – 10	Cableadapter	DP – HDMI	M/F	0.1	v 1.2	yes	–	white	3840 x 2160	yes
P	12.03.3125 – 10	Cableadapter	Mini DP – VGA	M/F	0.15	v 1.1a	yes	–	white	1920 x 1080	–
P	12.03.3140 – 10	Cableadapter	Mini DP – VGA	M/F	0.15	v 1.2	yes	–	white	1920 x 1080	–
Q	12.03.3128 – 10	Cableadapter	Mini DP – DVI	M/F	0.1	v 1.1a	–	yes	white	1920 x 1080	–
R	12.03.3137 – 10	Cableadapter	Mini DP – DVI	M/F	0.1	v 1.2	–	yes	white	3840 x 2160	yes
S	12.03.3129 – 10	Cableadapter	Mini DP – HDMI	M/F	0.1	v 1.1a	–	yes	white	1920 x 1080	–
S	12.03.3142 – 10	Cableadapter	Mini DP – HDMI	M/F	0.15	v 1.2	yes	–	white	3840 x 2160	yes
T	12.03.3161 – 5	Cableadapter	Mini DP – HDMI/VGA**	M/F	0.1	v 1.2	yes	–	silver	3840 x 2160	yes
U	12.03.3130 – 20	Adapter	Mini DP – DP	M/F	–	v 1.2	–	yes	black	3840 x 2160	yes
V	12.03.3163 – 10	Cableadapter	DP – Mini DP	F/M	0.1	v 1.2	–	–	white	3840 x 2160	yes
W	12.03.3132 – 20	Cableadapter	DP – Mini DP	M/F	0.1	v 1.2	–	yes	white	3840 x 2160	yes

\* depends on graphic card / \*\* only ONE single output available (DVI or HDMI or DP - 12.99.3150) / (HDMI or VGA - 12.03.3161)

**VALUE DisplayPort - VGA / DVI / HDMI Adapter, M/F, v1.2****4K**

- You want to connect your graphics card with DisplayPort connector to a DVI monitor? Or a display device with VGA input? Or a TV with an HDMI connection? The solution is the VALUE Adapter Cable DisplayPort- VGA / DVI / HDMI
- Cable length: ca. 10 cm
- Adapter with DisplayPort connector and VGA, DVI and HDMI socket.

**Order-No. – P.U.**

VALUE DisplayPort - VGA / DVI / HDMI Adapter, v1.2, Active

12.99.3153 – 20

**VALUE Mini DisplayPort - DVI / VGA / HDMI Adapter, M/F, v1.2****4K**

- You want to connect your graphics card with Mini DisplayPort connector to a DVI monitor? Or a display device with VGA input? Or a TV with an HDMI connection? The solution is the VALUE Adapter Cable with Mini DisplayPort to DVI, DP and HDMI.
- Cable length: ca. 10 cm
- Adapter with Mini DisplayPort connector and DP, DVI and HDMI socket.

**Order-No. – P.U.**

VALUE Mini DisplayPort - DVI/VGA/HDMI Adapter, M/F, v1.2, Active 12.99.3154 – 20

**VALUE Cableadapter, VGA+Audio - HDMI, M/F**

- Easy and simple solution to connect media and display devices
- Ideal for projectors, presentations or any other audio/visual project (e.g. multimedia presentation) you may have
- Allows the upscaling of analog VGA signals to digital HDMI signals, ideal for connecting PCs and laptops to HDMI displays such as HDTVs
- Supports both video and audio, 1080p resolution
- The converter takes audio from the computer via 3.5mm connector and embeds it to the HDMI output along with the video
- The cableadapter features a MicroB USB port for an connection to a USB power source (connection is required)

- VGA cable adapter: 0.15m Audio cable length: 0.5m USB cable length: 1m
- Maximum resolution: 1920 x 1080
- Color: black

**Order-No. – P.U.**

VALUE Cableadapter, VGA+Audio - HDMI, M/F, 0.15 m

12.99.3117 – 10

**VALUE Cableadapter, Micro HDMI - VGA, M/F**

- Micro HDMI to VGA Cableadapter provides you the interoperability of notebooks/laptops systems (with a Micro HDMI out interface) with analog projectors/ displays (with VGA connector).
- Connect the laptop to an extended display (with VGA connector) with VGA projectors.
- Audio is not supported over the VGA cable, it will be transmitted separately (3.5mm F)
- HDCP compliant
- Molded strain relief
- The approx. 10cm cableadapter reduces stain on the HDMI port of your tablet
- Maximum resolution: 1920 x 1080
- Length: 0.15m
- Color: black

**Order-No. – P.U.**

VALUE Cableadapter, Micro HDMI - VGA, M/F, 0.15 m

12.99.3118 – 10

**VALUE Cableadapter, HDMI - VGA+Audio, M/F, (Stereo)****Use modern notebooks with HDMI output on display units which have a VGA input!**

- Easy and simple solution to connect media and display devices
- Ideal for projectors, presentations or any other audio/visual project (e.g. multimedia presentation) you may have
- Supports both video and audio, 1080p resolution
- The audio signal from the HDMI source is transmitted to the audio input using a 3.5mm plug
- The cableadapter features a MicroB USB port for an connection to a USB power source (connection is required)
- Maximum resolution: 1920 x 1080 (1080p)
- Color: silver/black

- Length: 0.15m (HDMI)
- Note: this adapter works only in one direction from HDMI to VGA

**Order-No. – P.U.**

VALUE Cableadapter, HDMI - VGA+Audio, M/F, (Stereo)

12.99.3119 – 10

**ROLINE Cableadapter, VGA+Audio - HDMI, M/F, (7.1CH Audio Converter)**

- Easy and simple solution to connect media and display devices
- Ideal for projectors, presentations or any other audio/visual project (e.g. multimedia presentation) you may have
- Allows the upscaling of analog VGA signals to digital HDMI signals, ideal for connecting PCs and laptops to HDMI displays such as HDTVs
- Supports both video and audio, 1080p resolution
- The converter takes audio from the computer via USB connector and embeds it to the HDMI output along with the video
- VGA cable adapter: 0.15m USB cable length: 0.15m
- Maximum resolution: 1920 x 1080
- Color: black



Designed for Professionals

**Order-No. – P.U.**

ROLINE Cableadapter, VGA+Audio - HDMI, M/F, (7.1CH Audio Converter)

12.03.3119 – 10



**ROLINE DisplayPort-HDMI Adapter, 4K@60Hz, DP v1.4, DP M - HDMI F**



**For connecting an HDMI cable to a DisplayPort socket with a resolution of up to 3840x2160 @60Hz and HDR 10 support!**

- If you want to connect a graphic card with DisplayPort Female to a monitor by using a HDMI cable, you need this DisplayPort to HDMI adapter
- Connectors: DisplayPort Male, HDMI Female
- DisplayPort Version 1.4 allows increased resolutions, higher refresh rates, and greater color depth
- Support HRD10 (High Dynamic Range 10 static)

• Remark: The DisplayPort-HDMI adapter is only working in one direction: the DisplayPort plug has to be

connected to the source device (e.g. graphic card)  
 What are the benefits of using Active adapters and converters? Active products can have a huge advantage when working with long cable runs and video conversion applications. In terms of video converters, active units generally have hardware inside to improve your image.



Order-No. – P.U.

ROLINE DisplayPort-HDMI Adapter, 4K@60Hz, DP v1.4, DP M - HDMI F 12.03.3164 – 10

**VALUE Cables Type C - VGA, DVI, HDMI, DisplayPort**

- **USB 3.1 Cable Type C to VGA/DVI/HDMI/DisplayPort for Macbook**
- Connect your MacBook with USB-C port to any correspondent display or projector
- This adapter allows you to mirror your MacBook display to your TV or display
- No power adapter required
- Supports maximum resolutions up to 1920 x 1080 @60Hz (Full HD 1080p) – Type C- VGA
- Supports maximum resolutions up to 3840x2160 @ 30Hz- Type C- DVI
- Supports maximum resolutions up to 3840x2160 @ 60Hz- Type C- HDMI/DP

- Connectors: VGA Male and Type C Male (11.99.5820/11.99.5821/11.99.5822)
- Connectors: DVI Male and Type C Male (11.99.5830/11.99.5831)
- Connectors: HDMI Male and Type C Male (11.99.5840/11.99.5841)
- Connectors: DisplayPort Male and Type C Male (11.99.5845/11.99.5846)
- DisplayPort Version 1.2 allows increased resolutions, higher refresh rates, and greater color depth



Order-No. – P.U.

VALUE USB Type C - VGA Cable, M/M, 1,0 m 11.99.5820 – 10

VALUE USB Type C - VGA Cable, M/M, 2,0 m 11.99.5821 – 10

VALUE USB Type C - VGA Cable, M/M, 3,0 m 11.99.5822 – 10

Order-No. – P.U.

VALUE USB Type C - DVI Cable, M/M, 1,0 m 11.99.5831 – 10

VALUE USB Type C - DVI Cable, M/M, 2,0 m 11.99.5832 – 10

Order-No. – P.U.

VALUE Type C - HDMI Cable, M/M, 1,0 m 11.99.5840 – 10

VALUE Type C - HDMI Cable, M/M, 2,0 m 11.99.5841 – 10

Order-No. – P.U.

VALUE Type C - DisplayPort Cable, M/M, 1,0 m 11.99.5845 – 10

VALUE Type C - DisplayPort Cable, M/M, 2,0 m 11.99.5846 – 10

**ROLINE Cables Type C - VGA, DVI, HDMI, DisplayPort**

- **USB 3.1 Cable Type C to VGA/DVI/HDMI/DisplayPort for Macbook**
- Connect your MacBook with USB-C port to any correspondent display or projector
- This adapter allows you to mirror your MacBook display to your TV or display
- No power adapter required
- Supports maximum resolutions up to 1920 x 1080 @60Hz (Full HD 1080p) – Type C- VGA
- Supports maximum resolutions up to 3840x2160 @ 30Hz- Type C- DVI
- Supports maximum resolutions up to 3840x2160 @ 60Hz- Type C- HDMI/DP

- Connectors: VGA Male and Type C Male (11.04.5820/11.04.5821/11.04.5822)
- Connectors: DVI Male and Type C Male (11.04.5830/11.04.5831)
- Connectors: HDMI Male and Type C Male (11.04.5840/11.04.5841)
- Connectors: DisplayPort Male and Type C Male (11.04.5845/11.04.5846)
- DisplayPort Version 1.2 allows increased resolutions, higher refresh rates, and greater color depth



Order-No. – P.U.

ROLINE USB Type C - VGA Cable, M/M, 1,0 m 11.04.5820 – 10

ROLINE USB Type C - VGA Cable, M/M, 2,0 m 11.04.5821 – 10

ROLINE USB Type C - VGA Cable, M/M, 3,0 m 11.04.5822 – 10

Order-No. – P.U.

ROLINE USB Type C - DVI Cable, M/M, 1,0 m 11.04.5830 – 10

ROLINE USB Type C - DVI Cable, M/M, 2,0 m 11.04.5831 – 10

Order-No. – P.U.

ROLINE Type C - HDMI Cable, M/M, 1,0 m 11.04.5840 – 10

ROLINE Type C - HDMI Cable, M/M, 2,0 m 11.04.5841 – 10

ROLINE Type C - HDMI Cable, M/M, 3,0 m 11.04.5842 – 10

ROLINE Type C - HDMI Cable, M/M, 5,0 m 11.04.5843 – 10

Order-No. – P.U.

ROLINE Type C - DisplayPort Cable, M/M, 1,0 m 11.04.5845 – 10

ROLINE Type C - DisplayPort Cable, M/M, 2,0 m 11.04.5846 – 10

## VALUE Display Adapter, USB 3.1 Type C to VGA / DVI / HDMI / DisplayPort

Connect one or more monitors to your tablet - such as a MacBook - with a USB type C port, or Projectors on.

These display adapters are available for VGA, DVI, HDMI and (Mini-)DisplayPort.  
 - No software is required; simply connect - ready!  
 - Portable, compact design  
 - No power supply required  
 - Cable length: approx. 10 cm



**Value**

Brand	Description / Connection Type	Video-Connection	USB3.1 PD Connection	Other Connections	Max. Resolution	Picture	Order-No.-P.U.
	<b>USB 3.1 Display Adapter Type</b>						
VALUE	C - VGA	1x HD15 F	-		2048 x 1536@50Hz	A	12.99.3200-10
VALUE	C - VGA + Audio	1x HD15 F	-	1x 3.5mm F	1920 x 1080@60Hz	B	12.99.3203-10
VALUE	C - VGA + USB3.0 A + Typ C (PD)	1x HD15 F	yes	1x USB3.0 A F	2048 x 1536@50Hz	C	12.99.3201-10
VALUE	C - DVI	1x DVI-D F	-		1920 x 1200@60Hz	D	12.99.3205-10
VALUE	C - HDMI	1x HDMI F	-		3840 x 2160@30Hz	E	12.99.3210-10
VALUE	C - 2x HDMI	2x HDMI F	-		3840 x 2160@30Hz	F	12.99.1132-10
VALUE	C - HDMI 4K	1x HDMI F	-		3840 x 2160@60Hz	G	12.99.3211-10
VALUE	C - VGA + HDMI	1x HDMI F	-	1x HD15 F	HDMI: 3840 x 2160@30Hz VGA: 1920 x 1080@60Hz (2 output using at the same time: 1920 x 1080@60Hz)	H	12.99.3215-10
VALUE	C - HDMI + 2x USB 3.0 A + PD	1x HDMI F	yes	2x USB3.0 A F	3840 x 2160@30Hz	I	12.99.1133-10
VALUE	C - HDMI + USB 3.0 A + PD	1x HDMI F	yes	1x USB3.0 A F	3840 x 2160@30Hz	J	12.99.1131-10
VALUE	C - DisplayPort v1.2	1x DP F, v1.2	-		3840 x 2160@60Hz	K	12.99.3220-10
VALUE	C - Mini DisplayPort v1.2, white	1x Mini DP F, v1.2	-		3840 x 2160@60Hz	L	12.99.3225-10
VALUE	C - Mini DisplayPort v1.2, black	1x Mini DP F, v1.2	-		3840 x 2160@60Hz	M	12.99.3226-10
VALUE	C - VGA + HDMI + DVI	1x HDMI F	-	1x HD15 F + DVI-D F	3840 x 2160@60Hz	N	12.99.3229-10

**ROLINE Display Adapter, USB 3.1 Type C to VGA / DVI / HDMI / DisplayPort**

Connect one or more monitors or projectors to your tablet - such as a MacBook - with a USB Type C port. These display adapters are available for VGA, DVI, HDMI and (Mini-)DisplayPort.

- No software is required; simply connect ready!
- Portable, compact design
- No power supply required
- Cable length: approx. 10 cm

• Only for 12.03.3201, 12.02.1130 and 12.02.1131: The tablet can be charged via USB 3.1 Power Delivery (PD) in parallel to video operation



**roline**<sup>®</sup>  
Designed for Professionals

Brand	Description / Connection Type	Video-Connection	USB3.1 PD Connection	Other Connections	Max. Resolution	Picture	Order-No.-P.U.
	<b>USB 3.1 Display Adapter Type</b>						
ROLINE	C - VGA	1x HD15 F	-	-	1920 x 1080@60Hz	A	12.03.3200-10
ROLINE	C - VGA + USB3.0 Typ A + PD	1x HD15 F	yes	1x USB3.0 A F	1920 x 1200@60Hz	B	12.03.3202-10
ROLINE	C - DVI	1x DVI-I F	-	-	3840 x 2160@30Hz	C	12.03.3205-10
ROLINE	C - DVI + USB3.0 Typ A + PD	1x DVI-I F	yes	1x USB3.0 A F	1920 x 1080@60Hz	D	12.02.1130-10
ROLINE	C - HDMI	1x HDMI F	-	-	3840 x 2160@60Hz	E	12.03.3210-10
ROLINE	C - 2x HDMI	2x HDMI F	-	-	3840 x 2160@30Hz	F	12.02.1132-10
ROLINE	C - HDMI + USB3.0 Typ A + PD	1x HDMI F	yes	1x USB3.0 A F	3840 x 2160@30Hz	G	12.02.1131-10
ROLINE	C - HDMI + PD	1x HDMI F	yes	-	3840 x 2160@60Hz	H	12.03.3211-10
ROLINE	C - DisplayPort v1.2	1x DP F, v1.2	-	-	3840 x 2160@60Hz	J	12.03.3220-10
ROLINE	C - Mini-DisplayPort v1.2	1x Mini DP F, v1.2	-	-	3840 x 2160@60Hz	K	12.03.3225-10
ROLINE	C - 2x DisplayPort v1.2 (MST)	2x DP F, v1.2	-	-	3840 x 2160@60Hz	L	12.02.1133-5
ROLINE	C - DisplayPort v1.2 + PD	1x DP F, v1.2	yes	-	3840 x 2160@60Hz	M	12.03.3221-10
ROLINE	C - VGA + HDMI	1x HD15 + HDMI F	-	-	HDMI: 3480 x 2160@30Hz VGA: 1920 x 1080@60Hz	N	12.03.3215-5
ROLINE	C - VGA + HDMI + DP	1x HD15 + HDMI + DP F	-	-	3840 x 2160@60Hz	O	12.03.3230-8

**ROLINE Type C - HDMI Adapter, M/F**

**4K** **2160p**  
ULTRA HD

Connect a monitor or projector with HDMI interface to your MacBook, Ultrabook, notebook/laptop or PC with USB Type C port - with a maximum resolution of up to 3840x2160 @60Hz; The flat silicone cable provides maximum flexibility!

- USB 3.1 Type C to HDMI Cableadapter
- Connect your device with USB-C port to any HDMI display or projector
- This adapter allows you to mirror or extend your display to any HDMI-enabled TV or display
- Portable design

- No power adapter required
- Connectors: HDMI Female and Type C Male
- Cable length: ca. 13 cm

**roline**<sup>®</sup>  
Designed for Professionals



Order-No. - P.U.

ROLINE Type C - HDMI Adapter, M/F, 0.13 m

12.03.3212 - 10



### ROLINE USB Type C Docking Station, 4K HDMI, 1x USB 3.0 Port, 1x USB Type C PD (Power Delivery), 1x Gigabit Ethernet

4K

2160p  
ULTRA HD

The docking station is supplied for Macbooks, Ultrabooks or Notebooks/Laptops and provides a quick and easy connection to the workplace peripherals that you use every day, including one HDMI connector, that allows you a maximum resolution of up to 3840x2160 @60Hz!

- Plug & Play
- Aluminium casing
- Small, compact design
- System requirement: Windows 7/8/10 or MacOS X10.2 and higher

Connection to device:

- 1x USB 3.1 Type C F

Connection for peripheral devices

- 1x HDMI Video Output: Mirror or extend your screen to a TV, monitor or projector.
- 1x USB 3.0 ports (data transfer rate up to 5Gbit/s), for connection of wired keyboard/mouse, USB HDD/SSD, etc.
- 1x USB Type C PD (Power Delivery)- for charging your connected notebook
- 1x RJ45 for Gigabit Ethernet
- Contents: Docking Station, manual



Order-No. – P.U.

12.02.1020 – 10

**roline**<sup>®</sup>  
Designed for Professionals

ROLINE USB Type C Docking Station, 4K HDMI, 1x USB 3.0 Port, 1x USB Type C PD (Power Delivery), 1x Gigabit Ethernet

### ROLINE USB Type C Docking Station, 4K HDMI, 2x USB3.0 Ports, 1x SD/MicroSD Card Reader

4K

2160p  
ULTRA HD

The docking station is supplied for Macbooks, Ultrabooks or Notebooks/Laptops and provides a quick and easy connection to the workplace peripherals that you use every day, including one HDMI connector, that allows you a maximum resolution of up to 3840x2160 @60Hz!

- Plug & Play
- Aluminium casing
- Small, compact design
- System requirement: Windows 7/8/10 or MacOS X10.2 and higher

Connection to device:

- 1x USB 3.1 Type C F

Connection for peripheral devices

- 1x HDMI Video Output: Mirror or extend your screen to a TV, monitor or projector.
- 2x USB 3.0 ports (data transfer rate up to 5Gbit/s), for connection of wired keyboard/mouse, USB HDD/SSD, etc.
- 1x SD/TF Card Reader
- Contents: Docking Station, manual



Order-No. – P.U.

12.02.1041 – 5

**roline**<sup>®</sup>  
Designed for Professionals

ROLINE USB Type C Docking Station, 4K HDMI, 2x USB3.0 Ports, 1x SD/MicroSD Card Reader

### ROLINE USB C Docking Station, 4K HDMI, 2x USB3.0 Ports, 1x SD/MicroSD Card Reader, 1x USB Type C PD (Power Delivery), 1x Gigabit Ethernet

4K

2160p  
ULTRA HD

The docking station is supplied for Macbooks, Ultrabooks or Notebooks/Laptops and provides a quick and easy connection to the workplace peripherals that you use every day, including one HDMI connector, that allows you a maximum resolution of up to 3840x2160 @60Hz!

- Plug & Play
- Aluminium casing
- Small, compact design
- System requirement: Windows 7/8/10 or MacOS X10.2 and higher

Connection to device:

- 1x USB 3.1 Type C F

Connection for peripheral devices

- 1x HDMI Video Output: Mirror or extend your screen to a TV, monitor or projector.
- 2x USB 3.0 ports (data transfer rate up to 5Gbit/s), for connection of wired keyboard/mouse, USB HDD/SSD, etc.
- 1x SD/TF Card Reader
- 1x USB Type C PD (Power Delivery)
- 1x RJ45 for Gigabit Ethernet
- Contents: Docking Station, manual



Order-No. – P.U.

12.02.1037 – 5

**roline**<sup>®</sup>  
Designed for Professionals

ROLINE USB Type C Docking Station, 4K HDMI, 2x USB3.0 Ports, 1x SD/MicroSD Card Reader, 1x USB Type C PD (Power Delivery), 1x Gigabit Ethernet

VALUE / ROLINE Audio Adapters



	Order-No. – P.U.
VALUE 3.5mm Adapter, 1x 3.5mm M to 2x 3.5mm F	A 11.99.4440 – 100
VALUE 3.5mm Adapter, 1x 3.5mm M to 2x RCA F	B 11.99.4441 – 100
ROLINE 4 Conductor 3.5 mm Stereo Plug (speaker+microphone), 15 cm	C 11.09.4441 – 20
ROLINE 3.5 mm Stereo Coupler, F/F	D 11.09.4442 – 10
ROLINE Stereo Adapter 3.5 mm Male - 6.35 mm Female	E 11.09.4443 – 10
ROLINE Stereo Adapter 6.35 mm Male - 3.5 mm Female	F 11.09.4444 – 10
ROLINE Stereo Adapter 3.5 mm Male - 2.5 mm Female	G 11.09.4445 – 10
ROLINE Stereo Adapter 2.5 mm Male - 3.5 mm Female	H 11.09.4446 – 10
ROLINE Audio Converter Digital to Analogue	I 14.01.3441 – 5



ROLINE GOLD Audio / Video Cables

- The plugs are gold coated to enhance their contact durability
- Nylon-reinforced outer material for a better stability
- Color: Black / Gold

Audio- / Video Cables	Length	Order-No. – P.U.
<b>Cinch-Extension Cable (Picture A)</b>		
ROLINE GOLD Cinch-Extension Cable simplex M / F, red	2.5m	11.09.4234 – 10
ROLINE GOLD Cinch-Extension Cable simplex M / F, white	2.5m	11.09.4235 – 10
ROLINE GOLD Cinch-Extension Cable simplex M / F, yellow	2.5m	11.09.4236 – 10
ROLINE GOLD Cinch-Extension Cable simplex M / F, red	5.0m	11.09.4254 – 5
ROLINE GOLD Cinch-Extension Cable simplex M / F, white	5.0m	11.09.4255 – 5
ROLINE GOLD Cinch-Extension Cable simplex M / F, yellow	5.0m	11.09.4256 – 5
ROLINE GOLD Cinch-Extension Cable simplex M / F, red	10m	11.09.4294 – 5
ROLINE GOLD Cinch-Extension Cable simplex M / F, white	10m	11.09.4295 – 5
ROLINE GOLD Cinch-Extension Cable simplex M / F, yellow	10m	11.09.4296 – 5
<b>Cinch Cable (Picture B)</b>		
ROLINE GOLD Cinch Cable simplex M / M, red	2.5m	11.09.4231 – 10
ROLINE GOLD Cinch Cable simplex M / M, white	2.5m	11.09.4232 – 10
ROLINE GOLD Cinch Cable simplex M / M, yellow	2.5m	11.09.4233 – 10
ROLINE GOLD Cinch Cable simplex M / M, red	5.0m	11.09.4251 – 5
ROLINE GOLD Cinch Cable simplex M / M, white	5.0m	11.09.4252 – 5
ROLINE GOLD Cinch Cable simplex M / M, yellow	5.0m	11.09.4253 – 5
ROLINE GOLD Cinch Cable simplex M / M, red	10m	11.09.4291 – 5
ROLINE GOLD Cinch Cable simplex M / M, white	10m	11.09.4292 – 5
ROLINE GOLD Cinch Cable simplex M / M, yellow	10m	11.09.4293 – 5
<b>3.5mm-to-Cinch Cable (Picture C)</b>		
ROLINE GOLD Audio Cable 3.5mm Stereo – 2x Cinch (RCA), M / M	2.5m	11.09.4273 – 10
ROLINE GOLD Audio Cable 3.5mm Stereo – 2x Cinch (RCA), M / M	5.0m	11.09.4276 – 5
ROLINE GOLD Audio Cable 3.5mm Stereo – 2x Cinch (RCA), M / M	10m	11.09.4279 – 5
<b>3.5mm Cable (Picture D)</b>		
ROLINE GOLD 3.5mm Audio Cable M / M	2.5m	11.09.4283 – 10
ROLINE GOLD 3.5mm Audio Cable M / M	5.0m	11.09.4285 – 5
ROLINE GOLD 3.5mm Audio Cable M / M	10m	11.09.4289 – 5
<b>3.5mm Extension Cable (Picture E)</b>		
ROLINE GOLD 3.5mm Audio-Extension Cable M / F	2.5m	11.09.4753 – 10
ROLINE GOLD 3.5mm Audio-Extension Cable M / F	5.0m	11.09.4755 – 5
ROLINE GOLD 3.5mm Audio-Extension Cable M / F	10m	11.09.4759 – 5
<b>3.5mm Adapter</b>		
ROLINE GOLD Stereo Adapter 6.35 mm M – 3.5 mm F (Picture F)		11.09.4211 – 10
ROLINE GOLD Stereo Adapter 3.5 mm M – 6.35 mm F (Picture G)		11.09.4212 – 10
ROLINE GOLD 3.5mm Adaptercable (1x M, 2x F) (Picture H)	0.2m	11.09.4213 – 10
<b>S-Video Cable, Mini DIN 4pin M / M</b>		
ROLINE GOLD S-Video Cable, M / M	2.5m	11.09.4263 – 10
ROLINE GOLD S-Video Cable, M / M	5.0m	11.09.4265 – 5
ROLINE GOLD S-Video Cable, M / M	10m	11.09.4269 – 5



Antenna Cable 75 Ohm, 9,5mm	Length	Order-No. – P.U.
ROLINE GOLD Antenna Cable M / F	2.5m	11.09.4243 – 10
ROLINE GOLD Antenna Cable M / F	5.0m	11.09.4245 – 5
ROLINE GOLD Antenna Cable M / F	10m	11.09.4249 – 5

## VALUE / ROLINE Audio / Video Cables

- Area of application: multimedia, home theater and hi-fi systems (connection between DVD players or game consoles equipped with a Dolby Digital / dts decoder ...)

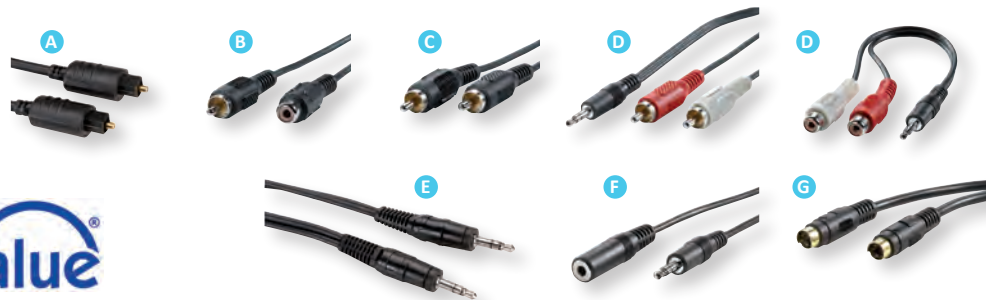

**roline**<sup>®</sup>  
Designed for Professionals

**Value**<sup>®</sup>

Audio / Video Cable	Length	Order-No. – P.U.
<b>AV-Fiber Cable (Picture A)</b>		
VALUE Fiber Cable Toslink M-M	1.0 m	11.99.4381 – 50
VALUE Fiber Cable Toslink M-M	2.0 m	11.99.4382 – 30
VALUE Fiber Cable Toslink M-M	3.0 m	11.99.4383 – 20
VALUE Fiber Cable Toslink M-M	5.0 m	11.99.4385 – 10
VALUE Fiber Cable Toslink M-M	10.0 m	11.99.4389 – 5
ROLINE Fiber Cable Toslink M-M	1.0 m	11.09.4381 – 50
ROLINE Fiber Cable Toslink M-M	2.0 m	11.09.4382 – 30
ROLINE Fiber Cable Toslink M-M	3.0 m	11.09.4383 – 20
ROLINE Fiber Cable Toslink M-M	5.0 m	11.09.4385 – 10
ROLINE Fiber Cable Toslink M-M	10.0 m	11.09.4389 – 5
<b>Cinch Cable (Picture B)</b>		
VALUE Cinch Cable simplex M-F	5.0 m	11.99.4325 – 30
VALUE Cinch Cable simplex M-F	10.0 m	11.99.4329 – 20
VALUE Cinch Cable duplex M-F	5.0 m	11.99.4326 – 20
VALUE Cinch Cable duplex M-F	10.0 m	11.99.4330 – 15
ROLINE Cinch Cable duplex M-F	5.0 m	11.09.4326 – 20
ROLINE Cinch Cable duplex M-F	10.0 m	11.09.4330 – 15
<b>Cinch Cable (Picture C)</b>		
VALUE Cinch Cable simplex M-M	2.5 m	11.99.4332 – 50
VALUE Cinch Cable simplex M-M	5.0 m	11.99.4335 – 30
VALUE Cinch Cable simplex M-M	10.0 m	11.99.4339 – 20
VALUE Cinch Cable duplex M-M	2.5 m	11.99.4333 – 25
VALUE Cinch Cable duplex M-M	5.0 m	11.99.4336 – 20
VALUE Cinch Cable duplex M-M	10.0 m	11.99.4338 – 15
ROLINE Cinch Cable duplex M-M	2.5 m	11.09.4333 – 25
ROLINE Cinch Cable duplex M-M	5.0 m	11.09.4336 – 20
ROLINE Cinch Cable duplex M-M	10.0 m	11.09.4338 – 15

Audio / Video Cable	Length	Order-No. – P.U.
<b>3.5mm Cinch Cable (Picture D)</b>		
VALUE 3.5mm (M) Cinch (2x M) Cable	1.5 m	11.99.4341 – 50
VALUE 3.5mm (M) Cinch (2x M) Cable	5.0 m	11.99.4345 – 30
VALUE 3.5mm (M) Cinch (2x F) Cable	0.2 m	11.99.4340 – 100
ROLINE 3.5mm (M) Cinch (2x M) Cable	1.5 m	11.09.4341 – 50
ROLINE 3.5mm (M) Cinch (2x M) Cable	5.0 m	11.09.4345 – 30
ROLINE 3.5mm (M) Cinch (2x M) Cable	10.0 m	11.09.4349 – 20
ROLINE 3.5mm (M) Cinch (2x F) Cable	0.2 m	11.09.4340 – 100
<b>3.5mm Cable (Picture E)</b>		
ROLINE 3.5mm Cable M-M	0.2 m	11.09.4500 – 150
ROLINE 3.5mm Cable M-M	1.0 m	11.09.4501 – 100
ROLINE 3.5mm Cable M-M	2.0 m	11.09.4502 – 50
ROLINE 3.5mm Cable M-M	3.0 m	11.09.4503 – 30
ROLINE 3.5mm Cable M-M	5.0 m	11.09.4505 – 20
ROLINE 3.5mm Cable M-M	10.0 m	11.09.4510 – 10
<b>3.5mm Extension Cable (Picture F)</b>		
VALUE 3.5mm Extension Cable M-F	2.0 m	11.99.4352 – 20
VALUE 3.5mm Extension Cable M-F	3.0 m	11.99.4353 – 50
VALUE 3.5mm Extension Cable M-F	5.0 m	11.99.4355 – 30
VALUE 3.5mm Extension Cable M-F	10.0 m	11.99.4359 – 20
ROLINE 3.5mm Extension Cable M-F	2.0 m	11.09.4352 – 20
ROLINE 3.5mm Extension Cable M-F	3.0 m	11.09.4353 – 50
ROLINE 3.5mm Extension Cable M-F	5.0 m	11.09.4355 – 30
ROLINE 3.5mm Extension Cable M-F	10.0 m	11.09.4359 – 20
<b>S-Video Cable, Mini DIN 4pol. M-M (Picture G)</b>		
VALUE S-Video Cable	3.0 m	11.99.4363 – 50
VALUE S-Video Cable	5.0 m	11.99.4365 – 30
VALUE S-Video Cable	10.0 m	11.99.4369 – 20

## VALUE Internal SATA 3.0 Gbit/s Cable

- Cables for the connection of a SATA 3.0 Gbit/s (SATA II) HDD to a Serial ATA controller
- Support data transfer rates of up to 3.0 Gbit/s
- Compatible with SATA 1.5 Gbit/s (SATA I)
- Narrow cable design to increase internal air flow
- 4-pin cable with ground wires
- Connectors: 2x internal 7-pin SATA



**Value**<sup>®</sup>

Order-No. – P.U.

VALUE Internal SATA 3.0 Gbit/s Cable, 0.5 m	11.99.1555 – 100
VALUE Internal SATA 3.0 Gbit/s Cable, 1.0 m	11.99.1560 – 100
VALUE Internal SATA 3.0 Gbit/s Cable, angled, 0.5 m	11.99.1556 – 100
VALUE Internal SATA 3.0 Gbit/s Cable, angled, 1.0 m	11.99.1561 – 100

## ROLINE Internal SATA 3.0 Gbit/s Cable

- Support data transfer rates of up to 3.0 Gbit/s (SATA II)
- Compatible with SATA 1.5 Gbit/s (SATA I)
- 4-pin cable with ground wires
- Connectors: 2x internal 7-pin SATA



**roline**<sup>®</sup>  
Designed for Professionals

Order-No. – P.U.

ROLINE Internal SATA 3.0 Gbit/s Cable, 0.5 m	11.03.1555 – 100
ROLINE Internal SATA 3.0 Gbit/s Cable, 1.0 m	11.03.1560 – 100
ROLINE Internal SATA 3.0 Gbit/s Cable, angled, 0.5 m	11.03.1556 – 100
ROLINE Internal SATA 3.0 Gbit/s Cable, angled, 1.0 m	11.03.1561 – 100



**ROLINE Internal SATA 3.0 Gbit/s Cable with Latch**

Utilizing the SATA II specification and with it's unique locking latch, you can rest assured your system is safe and secure.

- Connect your high-speed Serial ATA device (e. g. HDD) to a Serial ATA Controller
- Support data transfer rates of up to 3.0 Gbit/s

- Compatible with SATA 1.5 Gbit/s (SATA I)
- With latch on both connectors
- Narrow cable design to increase internal air flow
- 4-pin cable with ground wires
- Connectors: 2x internal 7-pin SATA

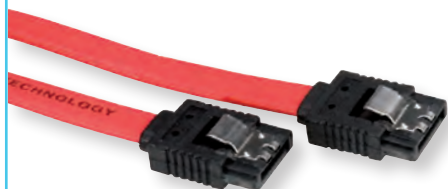

Order-No. – P.U.

ROLINE Internal SATA 3.0 Gbit/s Cable with Latch, 0,5 m	11.03.1554 – 50
ROLINE Internal SATA 3.0 Gbit/s Cable with Latch, 1,0 m	11.03.1559 – 50

**VALUE Internal SATA 6.0 Gbit/s Cable with Latch**

Some of the advantages of the new ATA series (SATA technology) are conditional on the use of relatively thin and flexible cables, which simplifies the use in the computer substantially and also brings a clear improvement to the air flow inside the computer housing.

- Support data transfer rates of up to 6.0 Gbit/s
- Compatible with SATA 1.5 Gbit/s (SATA I) and 3.0 Gbit/s (SATA II)
- 4-pin cable with ground wires
- Connectors: 2x internal 7-pin SATA with latch on both connectors

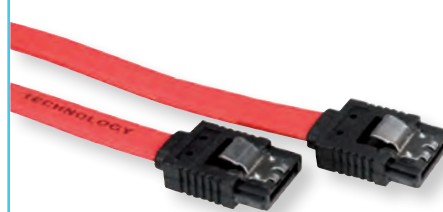

Order-No. – P.U.

VALUE Internal SATA 6.0 Gbit/s Cable with Latch, 0,5 m	11.99.1550 – 20
VALUE Internal SATA 6.0 Gbit/s Cable with Latch, 1,0 m	11.99.1551 – 20

**ROLINE Internal SATA 6.0 Gbit/s Cables with Latch**

Utilizing the SATA III specification and with it's unique locking latch, you can rest assured your system is safe and secure.

- Connect your high-speed Serial ATA device (e. g. HDD) to a Serial ATA Controller
- Support data transfer rates of up to 6.0 Gbit/s
- Compatible with SATA 1.5 Gbit/s (SATA I) and 3.0 Gbit/s (SATA II)
- Cable With latch on both connectors
- Narrow cable design to increase internal air flow
- 4-pin cable with ground wires
- Connectors: 2x internal 7-pin SATA



Order-No. – P.U.

ROLINE Internal SATA 6.0 Gbit/s Cable with Latch, 0,5 m	11.03.1552 – 50
ROLINE Internal SATA 6.0 Gbit/s Cable with Latch, 1,0 m	11.03.1553 – 50

**ROLINE Internal SATA 6.0 Gbit/s Cables, angled, with Latch**

Utilizing the SATA III specification and with it's unique locking latch, you can rest assured your system is safe and secure.

- Connect your high-speed Serial ATA device (e. g. HDD) to a Serial ATA Controller
- Support data transfer rates of up to 6.0 Gbit/s
- Compatible with SATA 1.5 Gbit/s (SATA I) and 3.0 Gbit/s (SATA II)
- Cable with latch on both connectors
- Cable with connector angled to one side, with pull for easy removal
- Narrow cable design to increase internal air flow
- 4-pin cable with ground wires
- Connectors: 2x internal 7-pin SATA

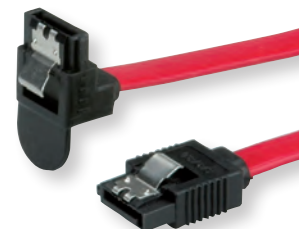

Order-No. – P.U.

ROLINE Internal SATA 6.0 Gbit/s Cable, angled, with Latch, 0,5 m	11.03.1564 – 25
ROLINE Internal SATA 6.0 Gbit/s Cable, angled, with Latch, 1,0 m	11.03.1565 – 25

**ROLINE SATA 3.0 Gbit/s Data and Power Cable (4-pin HDD)**

- Serial ATA is a high performance interface for IDE storage devices, and is the evolutionary replacement for the longstanding ATA physical storage interface
- High quality combo-cable for a SATA HDD
- Can be utilized alongside the existing PC architecture without the need for physical modification
- The thin serial ATA cables also significantly improve airflow within a computer's chassis
- Transfer rate: up to 3.0 Gbit/s (SATA II)
- 4-pin cable with ground wire for data transfer
- 4 wires for the power supply (with adapter 5.25 power connector to SATA power connector)
- Connectors: SATA power and data connector to 7-pin SATA data and 4-pin 5.25 power connector

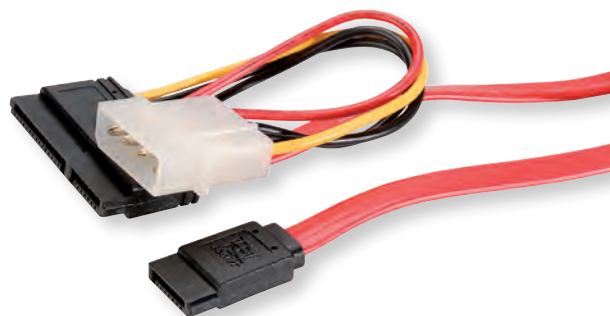

Order-No. – P.U.

ROLINE SATA 3.0 Gbit/s Data and Power Cable (4-pin HDD), 1,0 m	11.03.1250 – 30
--	-----------------

### ROLINE External SATA 3.0 Gbit/s Cables

ROLINE high quality HDD cables for the connection of an external SATA hard disk.

- Support data transfer rates of up to 3.0 Gbit/s (SATA II)
- Compatible with SATA 1.5 Gbit/s (SATA I)
- 4-pin cable with ground wires
- Connectors: 2x external 7-pin SATA 3.0 Gbit/s

Order-No. – P.U.

ROLINE External SATA 3.0 Gbit/s Cable, 0,5 m 11.03.1575 – 50

ROLINE External SATA 3.0 Gbit/s Cable, 1,0 m 11.03.1580 – 50

**roline**<sup>®</sup>  
Designed for Professionals



### ROLINE External SATA 6.0 Gbit/s Cables

ROLINE high quality HDD cables for the connection of an external SATA hard disk.

- Support data transfer rates of up to 6.0 Gbit/s (SATA III)
- Compatible with SATA 3.0 Gbit/s (SATA II), SATA 1.5 Gbit/s (SATA I)
- 4-pin cable with ground wires
- Connectors: 2x external 7-pin SATA 3.0 Gbit/s

Order-No. – P.U.

ROLINE External SATA 6.0 Gbit/s Cable, 0,5 m 11.03.1548 – 50

ROLINE External SATA 6.0 Gbit/s Cable, 1,0 m 11.03.1549 – 50

**roline**<sup>®</sup>  
Designed for Professionals



### ROLINE SAS Data and Power Cable

- High quality combi cable for the actual SATA/SAS technique for connecting HDDs
- Supports SATA 3.0 Gbit/s (SATA II), SATA 1.5 Gbit/s (SATA I) and SAS
- Connectors:
  - 1x Internal SATA/SAS data connector (SF-8482) to
  - 1x 4-pin HDD plug and 2x 7-pin SATA data connector

Order-No. – P.U.

ROLINE SAS Data and Power Cable, 0,5 m 11.03.1065 – 20

**roline**<sup>®</sup>  
Designed for Professionals

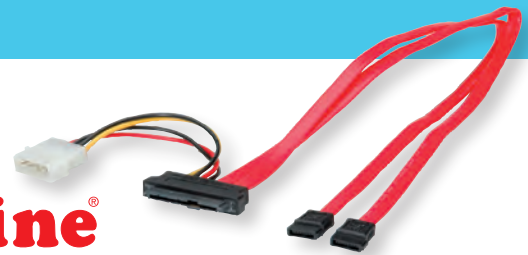

### ROLINE Adapter, mSATA SSD to 2.5 SATA 22pin

Best Solution that convert and easily retain mSATA SSD as normally standard 2.5 SATA SSD

- Convert Full Size mSATA SSD to 2.5 Form Factor
- Supports up to SATA 6Gb/s
- Compatible with 2.5 SATA drive mechanical specifications
- 22 pin SATA (signals and power) male connector on board
- Transparent to the operating system and no driver required
- Latch mSATA connector on board, no need the screw for the retention of mSATA module
- Contents: adapter, 2.5 drive metal frame (with 8 mounting holes and 4 HDD screws), manual

Order-No. – P.U.

ROLINE Adapter, mSATA SSD to 2.5 SATA 22pin 11.03.1567 – 10

**roline**<sup>®</sup>  
Designed for Professionals

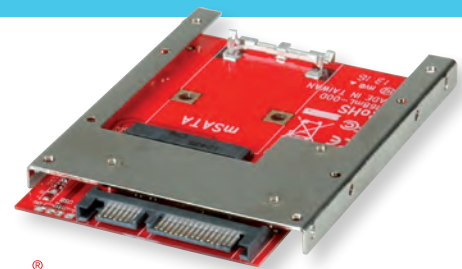

### ROLINE M.2 to SATA III SSD H/W adapter, 2x M.2 NGFF SSD, bootable and RAID-capable

2.5-inch H/W adapter for the installation of two M. 2 SSDs (NGFF), bootable and RAID-compatible and with 6Gbit/s SATA connection!

- Supports two M. 2 NGFF SSDs with form factor 2230, 2242, 2260 and 2280
- M.2 NGFF SATA SSDs can be primary boot device and contain operating system and applications.
- RAID 0 and RAID 1 configurable via hardware or software; configuration on the hardware side via 6 pins with jumper (jumper table on the back of the board)
- The 2.5 inch H/W adapter can be installed in a 2.5" housing and is therefore perfectly suited for mobile use.
- No drivers required
- Contents: HDD adapter

Order-No. – P.U.

ROLINE M.2 to SATA III SSD H/W adapter, 2x M.2 NGFF SSD, bootable and RAID-capable

16.01.4145 – 10

**roline**<sup>®</sup>  
Designed for Professionals

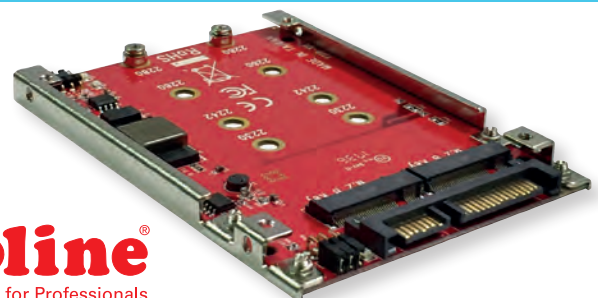

ROLINE Internal Power Supply Cables

- **11.03.1016: (A)**  
• Extension cable from the power supply to the ATX 2.0 motherboard; 24-pin motherboard connector (M/F); length: 0.3 m
- **11.03.1019: (B)**  
• For connection of a power supply to a Intel Pentium mainboard with P4 port via standard power supply and HDD-4-pin power plug; length: 0.15m
- **11.03.1021: (C)**  
• Additional power supply cable for mainboard and CPU. Plugs: Power 8 pin PCI Express > HDD-4-pin power plug (3 pin connected); length: 0.15 m
- **11.03.1010: (D)**  
• Internal power supply cables for an additional type 5.25 or type 3.5 disk drives; Y-model; 4-pin HDD M to 4-pin HDD F / 4-pin FDD F; length: 0.3 m
- **11.03.1005: (E)**  
• Internal power supply cables for two additional type 5.25 disk drives; Y-model; 4-pin HDD M to 2x 4-pin HDD F; length: 0.3 m
- **11.03.1003: (F)**  
• To expand the 4-pin HDD plug to four 4-pin HDD plugs, angled (90°); length: 2x 0.45 m; distance between 4-pin HDD plug and first angled 4-pin HDD plug: 0.3 m; distance between first angled 4-pin HDD plug and second angled 4-pin HDD plug: 0.15 m
- **11.03.1050: (G)**  
• To convert the 4-pin HDD plug to two SATA power connectors; to connect two SATA devices to one 4-pin HDD plug; length: 2x 0.12 m
- **11.03.1055: (H)**  
• Adapter cable for converting the 4-pin HDD interface to the SATA power connector; 4-pin cable, connections: 4-pin HDD plug to 15-pin SATA power connector; length: 0.15 m
- **11.03.1061: (I)**  
• Adapter cable for converting the 4-pin HDD interface to the SATA power connector; 4-pin HDD plug to 15-pin SATA power connector; angled (90°); length: 0.1 m
- **11.03.1060: (J)**  
• Adapter for converting the 4-pin HDD interface to the SATA power connector
- **11.03.1040: (K)**  
• Y-adapter cable for converting the SATA power connector to up to 3 additional 4-pin HDD plugs; 3x 4-pin HDD plug to 1x SATA; length 11.5 cm and 12.5 cm
- **11.03.1041: (L)**  
• Y-adapter cable for converting one SATA power connector to up to 3 additional SATA power connectors; 3x SATA M to 1x SATA; length 0.24 m and 0.23 m
- **11.03.1042: (M)**  
• Extension cable for a SATA power connection; SATA M to SATA F; length: 0.3 m



	Order-No. – P.U.
ROLINE ATX 2.0 Power Extension Cable, 24-pin, 0.3 m	11.03.1016 – 50
ROLINE Internal Power Cable, 4-pin HDD/ ATX12V-P4 4-pin Power, 0.15 m	11.03.1019 – 10
ROLINE Internal Power Cable, 8 pin PCI Express Plug - P4 Plug, 0.15 m	11.03.1021 – 10
ROLINE Int. Y-Power Cable, 4-pin HDD to 4-pin HDD+4-pin FDD, 0.3 m	11.03.1010 – 100
ROLINE Internal Y-Power Cable, 4-pin HDD to 2x 4-pin HDD, 0.3 m	11.03.1005 – 100
ROLINE Internal Y-Power Cable, 4-pin HDD to 4x 4-pin HDD (90°), 0.15 m	11.03.1003 – 50
ROLINE Internal Y-Power Cable, 4-Pin HDD to 2x SATA, 0.12 m	11.03.1050 – 50
ROLINE Power Adapter Cable, 4-Pin HDD to SATA, 0.15 m	11.03.1055 – 50
ROLINE Power Adapter Cable, 4-pin HDD to SATA (90°), 0.1 m	11.03.1061 – 25
ROLINE Power Adapter, 4-pin HDD to SATA	11.03.1060 – 25
ROLINE Internal Y-Power Cable, SATA to 3x 4-pin HDD	11.03.1040 – 25
ROLINE Internal Y-Power Cable, SATA to 3x SATA	11.03.1041 – 25
ROLINE SATA Power Extension Cable, 0.3 m	11.03.1042 – 25



## VALUE / ROLINE Monitor Power Cables

- Monitor power cable with moulded plugs
- Connectors: IEC 320-C14 plug to IEC 320-C13 plug
- Nominal data: 250V AC/10A
- Colour: black



**Value roline**  
Designed for Professionals

Order-No. – P.U.

VALUE Monitor Power Cable, black, 0.5 m, IEC 320 C14 - C13	19.99.1505 – 20
VALUE Monitor Power Cable, black, 1.0 m, IEC 320 C14 - C13	19.99.1510 – 20
VALUE Monitor Power Cable, black, 1.8 m, IEC 320 C14 - C13	19.99.1515 – 50
VALUE Monitor Power Cable, black, 3.0 m, IEC 320 C14 - C13	19.99.1530 – 50
ROLINE Monitor Power Cable, black, 0.5 m, IEC 320 C14 - C13	19.08.1505 – 50
ROLINE Monitor Power Cable, black, 1.0 m, IEC 320 C14 - C13	19.08.1510 – 30
ROLINE Monitor Power Cable, black, 1.8 m, IEC 320 C14 - C13	19.08.1515 – 50
ROLINE Monitor Power Cable, black, 3.0 m, IEC 320 C14 - C13	19.08.1530 – 50

## VALUE / ROLINE Monitor Power Cables

- Monitor power cable with moulded plugs
- Connectors: IEC 320-C14 plug to IEC 320-C13 plug
- Nominal data: 250V AC/10A

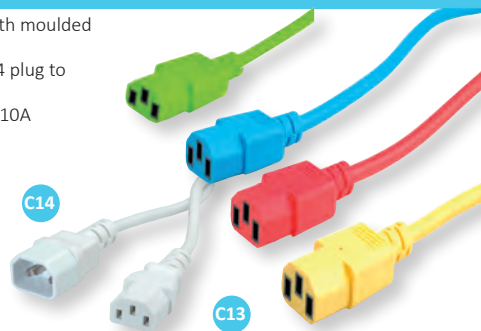

**Value**

Order-No. – P.U.

VALUE Monitor Power Cable, white, 1.8 m, IEC 320 C14 - C13	19.99.1516 – 50
ROLINE Monitor Power Cable, red, 1.8 m, IEC 320 C14 - C13	19.08.1520 – 25
ROLINE Monitor Power Cable, yellow, 1.8 m, IEC 320 C14 - C13	19.08.1521 – 25
ROLINE Monitor Power Cable, blue, 1.8 m, IEC 320 C14 - C13	19.08.1522 – 25
ROLINE Monitor Power Cable, green, 1.8 m, IEC 320 C14 - C13	19.08.1523 – 25

## VALUE Power Cable, straight IEC Connector

Cable with safety plug 90° angulate (German safety plug) and IEC 320-C13

- Plugs: German safety plug to C13 plug
- Nominal data: 250V AC/2.5A
- Colour: black



**Value**

Order-No. – P.U.

VALUE Power Cable, straight IEC Connector, black, 1.8 m	19.99.1018 – 50
VALUE Power Cable, straight IEC Connector, white, 1.8 m	19.99.1019 – 50
VALUE Power Cable, angled IEC Connector, black, 1.8 m	19.99.1118 – 50
VALUE Power Cable, straight Compaq Connector, black, 1.8 m	19.99.1028 – 20

## ROLINE Power Cable, straight IEC Connector

Cable with safety plug 90° angulate (german type) and IEC 320-C13

- Plugs: safety plug to C13 plug
- Nominal data: 250V AC/2.5A
- Colour: red, yellow, blue, green



**roline**  
Designed for Professionals

Order-No. – P.U.

ROLINE Power Cable, straight IEC Connector, red, 1.8 m	19.08.1010 – 25
ROLINE Power Cable, straight IEC Connector, yellow, 1.8 m	19.08.1011 – 25
ROLINE Power Cable, straight IEC Connector, blue, 1.8 m	19.08.1012 – 25
ROLINE Power Cable, straight IEC Connector, green, 1.8 m	19.08.1013 – 25

## ROLINE Power Cable, straight IEC Connector

Cable with safety plug 90° angulate (German safety plug) and IEC 320-C13

- Plugs: German safety plug to C13 plug
- Nominal data: 250V AC/2.5A
- Colour: black

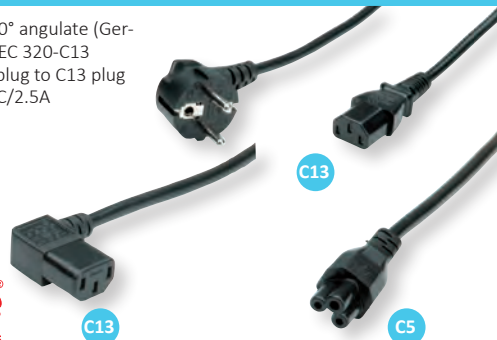

**roline**  
Designed for Professionals

Order-No. – P.U.

ROLINE Power Cable, straight IEC Connector, 1.8 m	19.08.1018 – 50
ROLINE Power Cable, straight IEC Connector, 3.0 m	19.08.1030 – 50
ROLINE Power Cable, angled IEC Connector, 1.8 m	19.08.1118 – 50
ROLINE Power Cable, straight Compaq Connector, 1.8 m	19.08.1028 – 20

## VALUE Power Cord German Safety Plug, IEC320 - C19 16A

Cable often used for UPS from 3000 VA and for connecting Blade servers.

- Connection cable 16 A with IEC320 C19 Female and German safety plug, angled
- Cable: H05VV-F 3G1.5 3x 1.5mm<sup>2</sup>
- Nominal data: 250 VAC/16 A
- Colour: black



**Value**

Order-No. – P.U.

VALUE Power Cord German Type, IEC320 - C19 16A, black, 2.0 m	19.99.1552 – 20
VALUE Power Cord German Type, IEC320 - C19 16A, black, 3.0 m	19.99.1553 – 20
ROLINE Power Cord German Type, IEC320 - C19 16A, black, 2.0 m	19.08.1552 – 14
ROLINE Power Cord German Type, IEC320 - C19 16A, black, 3.0 m	19.08.1553 – 10
ROLINE Power Cord IEC320/C19 - C20 16A, black, 2.0 m	19.08.1562 – 14
ROLINE Power Cord IEC320/C19 - C20 16A, black, 3.0 m	19.08.1563 – 10

**VALUE / ROLINE Euro Power Cables, 2-Pin**

- Suitable e.g. for notebook power supply
- Connectors: Europlug to IEC320-C7 plug
- Moulded plugs
- 250V AC/2.5A



	Order-No.	P.U.
VALUE Euro Power Cable, 2-Pin, black, 1.8 m	19.99.2096	- 100
VALUE Euro Power Cable, 2-Pin, white, 1.8 m	19.99.2095	- 100
VALUE Euro Power Cable, 2-Pin, black, 3.0 m	19.99.2092	- 50
VALUE Euro Power Cable, 2-Pin, black, 5.0 m	19.99.2094	- 50
ROLINE Euro Power Cable, 2-Pin, black, 1.8 m	19.07.2096	- 100
ROLINE Euro Power Cable, 2-Pin, black, 3.0 m	19.07.2073	- 50
ROLINE Euro Power Cable, 2-Pin, black, 5.0 m	19.07.2078	- 50

**ROLINE Power Cable with German Type Connector / Open End, AC 230V**

- Cable with German Type male connector, 16A / 230V ~
- Cable: H05VV-F 3G1 3x 0.75mm<sup>2</sup>
- Nominal data: 250 VAC/16 A
- Colour: black

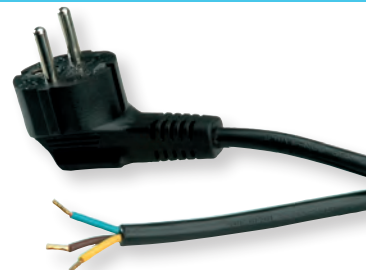

	Order-No.	P.U.
ROLINE Power Cable w. German connector / open end, AC 230V, black, 1.8 m	19.08.1110	- 10
ROLINE Power Cable w. German connector / open end, AC 230V, black, 3.0 m	19.08.1111	- 10

**VALUE Power Cables, Italy**



- Nominal data: 250V AC/2.5A
- Colour: black
- Cable with Italy safety plug 90° angled and IEC 320-C13 (19.99.2070)
- Cable with safety plug 90° angled and 3-pin notebook plug (Compaq plug IEC 320-C5) (19.99.2071)
- Cable with Italy plug 90° angled and IEC 320-C13 (19.99.2072)

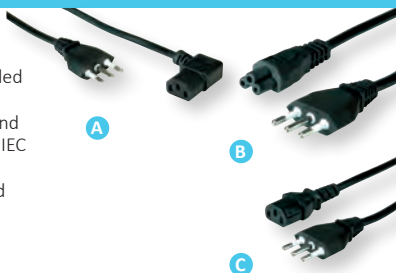

	Order-No.	P.U.
VALUE Power Cable, angled IEC Connector, Italy, 1.8 m	A 19.99.2070	- 50
VALUE Power Cable, straight Compaq Connector, Italy, 1.8 m	B 19.99.2071	- 50
VALUE Power Cable, straight IEC Connector, Italy Version, 1.8 m	C 19.99.2072	- 50

**VALUE UK Power Cables, 3A/10A**



- Cables with UK plug and**
- 3-pin notebook plug (Compaq plug IEC 320-C5 - 19.99.2016)
  - IEC320-C7 plug - 19.99.2017
  - IEC320-C13 plug - 19.99.2018/2019



- Nominal data: 250V AC/3A
- Colour: black

	Order-No.	P.U.
VALUE UK Power Cable, straight Compaq Connector, 3A, 1.8 m	A 19.99.2016	- 1
VALUE UK Power Cable, 2-pin, 3A, 1.8 m	B 19.99.2017	- 1
VALUE UK Power Cable, straight IEC Connector, 10A, 1.8 m	C 19.99.2018	- 1
VALUE UK Power Cable, straight IEC Connector, 10A, 3.0 m	C 19.99.2019	- 1

**Power Cable, NEMA-5 – IEC C13 Connector, USA**

**Cable with plug NEMA-5 and IEC-C13**

- Plugs: NEMA-5 male to C13 female
- Nominal data: 125V AC/10A
- Colour: black
- Suitable for USA



	Order-No.	P.U.
Power Cable, NEMA-5 - straight IEC Connector C13, USA, 1.8 m	19.99.1495	- 50

**VALUE /ROLINE Y-Power Cable, 2x straight IEC Connector**

**Cable with safety plug 90° angled (German Type plug) and 2x IEC 320-C13 plug straight**

- Suitable for PC and monitor power connection
- Connectors: German Type plug to 2x C13 plug
- Nominal data: 250V AC/10A
- Colour: black



	Order-No.	P.U.
VALUE Y-Power Cable, 2x straight IEC Connector C13, 1.8 m	19.99.1022	- 50
ROLINE Y-Power Cable, 2x straight IEC Connector C13, 1.8 m	19.08.1022	- 50

**RJ-12 Cable, 6P4C**

- 4-wire flat telephone cable with 6-pole 4-contact RJ-12 (Western) plug
- Colour: white
- All pins connected 1: 1



	Order-No.	P.U.
RJ-12 Cable, 6P4C, 6 m	11.04.1906	- 10
RJ-12 Cable, 6P4C, 15 m	11.04.1915	- 10

Filter Ferrite Cores

- For interference suppression on data lines
- For PC and peripherals
- Simple subsequent assembly
- Split conduit cores
- Nylon clip casing
- Protected against damage
- The casing clamps securely on the cable
- Universal application
- Casing UL 94-V-0

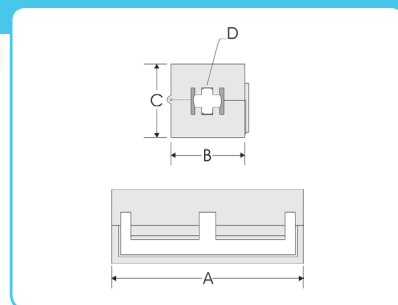
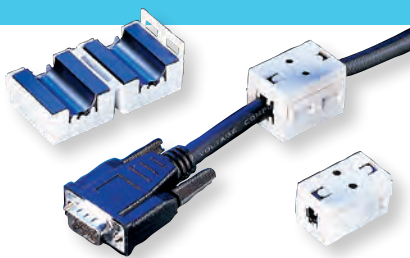

	Order-No.	P.U.
Filter Ferrite - 6.5 mm	11.05.1006	200
Filter Ferrite - 10 mm	11.05.1010	190

Model	Dimensions in mm				Impedance (Ohm)		Frequency Range
	A	B	C	D	25MHz	100MHz	
Filter-ferrite-6.5	32.0	19.5	19.0	6.5	125	275	300MHz
Filter-ferrite-10	32.0	24.5	23.0	10.0	130	290	300MHz

Should not be mounted on the cable any further away than 10 cm from the plug!

ROLINE Mini Gender Changers

- Connection between two similar connectors
- Low leverage on the computer connector due to compact construction (17 mm long)
- All lines are connected 1:1
- Incl. locking screws

	Order-No.	P.U.
ROLINE Mini Gender Changer, 9-pin M - M	12.03.2025	50
ROLINE Mini Gender Changer, 9-pin F - F	12.03.2030	50
ROLINE Mini Gender Changer, 15-pin HD M - M	12.03.2016	50
ROLINE Mini Gender Changer, 15-pin HD F - F	12.03.2021	50
ROLINE Mini Gender Changer, 25-pin M - M	12.03.2005	50
ROLINE Mini Gender Changer, 25-pin F - F	12.03.2010	50



**roline**  
Designed for Professionals

ROLINE Cat.5e Modular Plug, 8p8c, UTP, for Stranded Wire

- Unshielded modular plug for round cables
- For stranded wire AWG26
- For Cat.5e cabling systems
- Package unit: 10 pieces



**roline**  
Designed for Professionals

	Order-No.	P.U.
ROLINE Cat.5e Modular Plug, 8p8c, UTP, for Stranded Wire, 10 pcs. A	12.01.1087	100
ROLINE Cat.5e Modular Plug, 8p8c, STP, for Stranded Wire, 10 pcs. B	12.01.1089	100
ROLINE Kink protection hood for RJ-45, grey, 10 pcs. C	12.01.1085	100
VALUE Kink protection hood for RJ-45 connector, grey, 10 pcs. D	12.99.0000	10

**Value**

D-Sub Connector Casings

- Suitable for D-Sub plug connectors
- Screwed, stable plastic casing
- Internal strain reduction
- With UN-4-40 locking screws which can't be lost
- Without connector

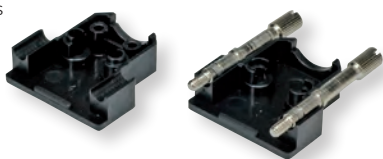

	Order-No.	P.U.
D-Sub Connector Casing 9-pin/HD15	12.01.4005	200
D-Sub Connector Casing 15-pin	12.01.4010	200
D-Sub Connector Casing 25-pin	12.01.4015	200

ROLINE USB 2.0 Gender Changer, Type A F/F

- Compact and small design
- Adaption of frequent USB interfaces
- Colour: Black

**roline**  
Designed for Professionals



	Order-No.	P.U.
ROLINE USB 2.0 Gender Changer, Type A F/F	A 12.03.2960	50
ROLINE USB 3.0 Gender Changer, Type A F/F	B 12.03.2991	20



**VALUE PS/2 to USB Adapter**

- Only for USB / PS/2 combo mice
- USB mouse has to be connected to the adapter and the adapter has to be connected to the PS/2 port of the PC
- Ports: 1x USB Type A F, 1x PS/2 M

	Order-No. – P.U.
VALUE PS/2 to USB Adapter, Mouse, green	A 12.99.1072 – 25
VALUE PS/2 to USB Adapter, Keyboard, purple	B 12.99.1073 – 25

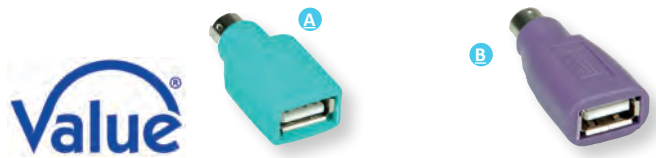

**VALUE USB to 2x PS/2 Adapter Cable**

- Ideal for the use with actual notebooks, which do not offer PS/2 ports any longer
- The converter offers two additional PS/2 ports e.g to connect keyboard and mouse
- Compact converter for the connection to the USB interface of a notebook or PC
- Power over USB interface
- Connection: 1x USB Type A Male, 2x PS/2 F

	Order-No. – P.U.
VALUE USB to 2x PS/2 Adapter Cable	12.99.1075 – 50

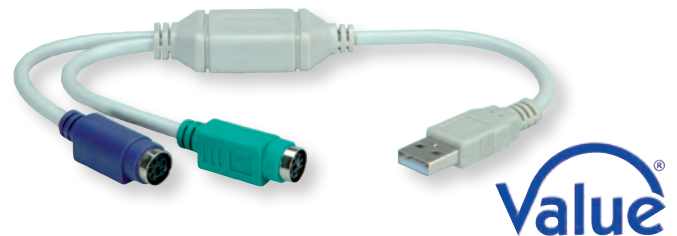

**ROLINE USB to IEEE1284 Converter, C36**

- For the connection of a printer with parallel port (IEEE 1284) to a PC with USB port
- USB specification revision 1.1 compliant
- Truly bi-directional communication between PC and printer
- Connection PC: USB type A Male
- Connection printer: Centronics 36-pole Male
- Bus powered
- Length: 1.8 m
- Colour: black
- Supported operating systems: Windows 2000/XP/Vista/7, Mac OS X
- Contents: Converter cable

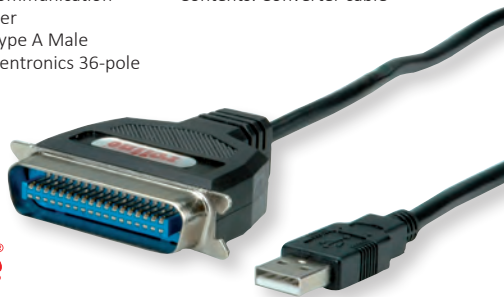

	Order-No. – P.U.
ROLINE USB to IEEE1284 Converter, C36, 1.8 m	12.02.1073 – 10

**VALUE USB to IEEE1284 Converter Cable**

- To connect a printer with parallel interface (IEEE1284) to a PC with USB port
- Easy to install
- Power supplied by USB interface
- Connector: Centronics 36-pole male/ USB Type A Male
- Colour: turquoise (semi translucent)
- Contents: Converter cable

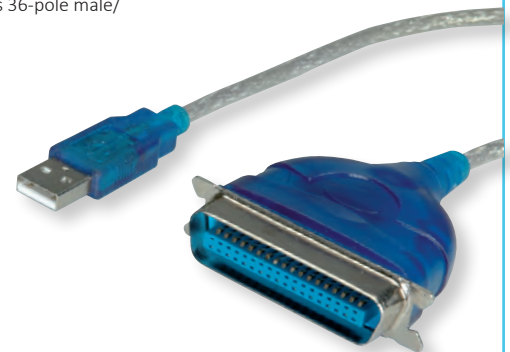

	Order-No. – P.U.
VALUE USB to IEEE1284 Converter Cable, 1.8 m	12.99.1150 – 10

**VALUE USB to RS-485 Converter**

- This converter provides an extra Serial Com port via USB connection**
- To connect serial devices (e.g. modem) to one USB port
  - Can be configured to work with RS-485 peripherals
  - Full compliance with the USB specification 1.1
  - Supports data transfer rates of up to 3 Mbit/s
  - USB bus powered - no external power supply is needed
  - Plug & play
  - Supports Windows 98SE / ME / 2000 / XP / Vista / 7
  - Contents: Converter, driver CD, manual



	Order-No. – P.U.
VALUE USB to RS-485 Converter	12.99.1074 – 25

**Converter Cable Parallel to USB**

- To connect a printer with USB port to a PC with parallel interface (IEEE1284)
- Easy to install
- Power supplied by external power supply unit that is fixed to the converter
- Connection PC: parallel interface (IEEE1284) DB25 F
- Connection printer: USB type B
- Length: 1.8 m
- Colour: black
- Contents: Converter (cable length: 1.8 m) with moulded Power Supply Unit

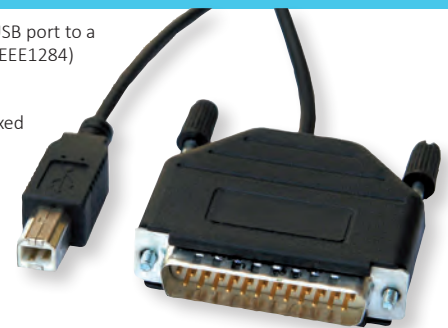

	Order-No. – P.U.
Converter Cable Parallel to USB, 1.8 m	12.02.1074 – 1

### VALUE USB 3.0 to SATA 6.0 Gbit/s Adapter

- Easy way to connect a SATA 6.0 Gbit/s hard disk to a computer or notebook over a SuperSpeed USB 3.0 port
- Suitable for type 2.5/3.5 Serial ATA HDD/SSD
- Compliant with USB 3.0, USB 2.0, USB 1.1
- Compliant with SATA 6.0 Gbit/s, SATA 3.0 Gbit/s, SATA 1.5 Gbit/s
- Supports transfer rates of up to 5.0 Gbit/s
- Connection to computer: USB 3.0
- Connection to HDD: 15-pin SATA power + 7-pin SATA data
- Hot-swappable, plug & play
- Length USB cable: 1.20 m
- Power supply included
- Supported Operating Systems: 2000/XP/Vista/7/8
- Contents: Adapter, power supply, manual



**Value**

Order-No. – P.U.

VALUE USB 3.0 to SATA 6.0 Gbit/s Adapter, 1,2 m

12.99.1049 – 10

### ROLINE USB 3.0 to SATA 6Gb/s Adapter

- Easy way to connect a SATA 6.0 Gbit/s hard disk to a computer or notebook over a SuperSpeed USB 3.0 port
- Suitable for type 2.5/3.5 Serial ATA HDD/SSD
- Compliant with USB 3.0, USB 2.0, USB 1.1
- Compliant with SATA 6.0 Gbit/s, SATA 3.0 Gbit/s, SATA 1.5 Gbit/s
- Supports transfer rates of up to 5.0 Gbit/s
- Connection to computer: USB 3.0
- Connection to HDD: 15-pin SATA power + 7-pin SATA data
- Hot-swappable, plug & play
- Length USB cable: 0.15 m
- Supported Operating Systems: 2000/XP/Vista/7/8
- Contents: Adapter, manual



**roline**  
Designed for Professionals



Order-No. – P.U.

ROLINE USB 3.0 to SATA 6Gb/s Adapter, 0,15 m

12.02.1043 – 10

### VALUE USB 3.1 to SATA 6.0 Gbit/s Adapter

#### The simple way to connect a SATA III 6.0 Gbit/s hard drive to a computer or notebook via USB 3.1 Type C.

- Easy way to connect a SATA 6.0 Gbit/s hard disk to a computer or notebook over a SuperSpeed USB 3.1 port
- Suitable for type 2.5 Serial ATA HDD/SSD
- Compliant with USB 3.0, USB 2.0
- Compliant with SATA 6.0 Gbit/s, SATA 3.0 Gbit/s, SATA 1.5 Gbit/s
- Supports transfer rates of up to 5.0 Gbit/s
- Connection to computer: USB 3.1
- Connection to HDD: 15-pin SATA power + 7-pin SATA data
- Additional Micro USB B connection for power supply (if needed)
- Hot-swappable, plug & play
- Length USB cable: 0.15 m
- Supported Operating Systems: 2000/XP/Vista/7/8/10
- Contents: Adapter, manual

**Value**



Order-No. – P.U.

VALUE USB 3.1 to SATA 6.0 Gbit/s Adapter, 1 m

12.99.1051 – 10

### ROLINE Converter Cable USB Type C to SATA (7+15pin)

#### Quick solution for the use of HDD/SSDs in combination with Macbooks, Ultrabooks, Notebooks / Laptops or PCs with USB Type C interface. Supports a maximum data transmission rate of up to 6Gbit/s!

- Full compliance with USB 3.1 Gen 2, USB 2.0, USB 1.1
- Connect your SATA connector directly to a SATA SSD/HDD, without any accessories
- Portable adapter cable, easy to use without any needed accessories
- Data transfer rate of up to 6Gbit/s
- Supports SATA I / II / III
- Connections: 1x USB Type C, 1x SATA III (7+15) connector
- Supported Operating Systems: Windows 7 / 8 / 10, Mac OS X
- Contents: Converter cable, adapter DB9 F-DB25 M, driver CD

**roline**  
Designed for Professionals



Order-No. – P.U.

ROLINE Converter Cable USB Type C to SATA (7+15pin)

12.02.1162 – 10

### VALUE Converter Cable USB Type C to Serial

- Quick solution for the use of peripheral devices with serial interfaces (e.g. modems, digital cameras, printers) with notebooks or computers with USB interface using a USB Type C connector
- Full compliance with USB 2.0, USB 1.1
- Data transfer rate of over 1Mbit/s
- Supports RS232 serial interface
- Supports automatic handshake mode
- Supports remote wakeup and power management
- Power Mode: Bus-powered
- Connections: 1x USB Type C, 1x DB 9-pin connector, 1x DB 25-pin connector
- Supported Operating Systems: Windows 98, 2000, XP, Vista, Win 7 / 8 / 10, Mac OS X
- Contents: Converter cable, adapter DB9 F-DB25 M, driver CD

**Value**



Order-No. – P.U.

VALUE Converter Cable USB Type C to Serial, black, 1,8 m

12.99.1161 – 5

**ROLINE Converter Cable USB Type C to Serial**

**Quick solution for the use of peripheral devices with serial interfaces (e.g. modems, printers) with notebooks or computers with USB interface using a USB Type C connector**

- Full compliance with USB 2.0, USB 1.1
- Data transfer rate of over 1Mbit/s
- Supports RS-232 serial interface
- Supports automatic handshake mode
- Supports remote wakeup and power management
- Power Mode: Bus-powered
- Connections: 1x USB Type C, 1x DB 9-pin connector
- Supported Operating Systems: Windows 98, 2000, XP, Vista, Win 7 / 8 / 10, Mac OS X
- Contents: Converter cable, adapter DB9 F-DB25 M, driver CD



Order-No. – P.U.

ROLINE Converter Cable USB Type C to Serial, black, 1.8 m

12.02.1161 – 10

**VALUE Converter Cable USB to Serial**

- Quick solution for the use of peripheral devices with serial interfaces (e.g. modems, digital cameras, printers) with notebooks or computers with USB interface
- Data transfer rate of over 1Mbit/s
- Connections: 1x USB Type A, 1x DB 9-pin connector
- Equivalent to the USB 1.1 specification
- Length: 1.8 m
- Contents: Converter cable, adapter DB9 F-DB25 M, driver CD



Order-No. – P.U.

VALUE Converter Cable USB to Serial, 1.8 m

12.99.1160 – 10

**ROLINE Converter Cable USB to Serial**

- With this converter you can easily connect peripheral devices, such as analogue and ISDN modems, digital cameras and handheld computers, which have a serial interface to an USB environment
- Easy installation
  - True plug & play
  - Supports automatic handshake mode
  - Supports remote wake up and power management

- Needs no interrupt (IRQ)
- Length: 1.8 m
- Supported operating systems: Windows 98SE/ME/2000/XP/7/8
- Contents: Converter cable, driver CD, manual



Order-No. – P.U.

ROLINE Converter Cable USB to Serial, 1.8 m

12.02.1160 – 10

**ROLINE Converter Cable USB to RS232+DB25**

- Ideal for notebooks that nowadays only offer USB interfaces
- To connect one serial device (e. g. modem) and one parallel device (e. g. printer) to the USB port of a PC or notebook
- No external power supply needed
- Supported operating systems: Windows 2000/XP/Vista/7
- Contents: Converter, driver CD, manual



Order-No. – P.U.

ROLINE Converter Cable USB to RS232+DB25

12.02.1049 – 20

**ROLINE USB to 2x RS232 Converter**

- Converts one PC USB Port into two serial ports
- To connect two serial devices (e. g. modem) with the USB port of a PC or notebook
- Ideal for notebook users
- Supports data transfer rates of up to 1Mbit/s

- No external power supply is needed
- Supported operating systems: Windows 2000/XP/Vista/7
- Contents: Converter, driver CD, manual



Order-No. – P.U.

ROLINE USB to 2x RS232 Converter

12.02.1048 – 20



### ROLINE USB to 4x RS232 Converter

Allows the connection of four serial devices (e. g. a modem or printer) via the USB port of a PC or notebook - the four differently colored RS232 connectors help to provide a clear differentiation.

- Converts one PC USB Port into four serial ports
- Supports data transfer rates of up to 1Mbit/s
- No external power supply is needed
- Supported operating systems: Windows 2000/XP/Vista/7
- Contents: Converter, driver CD, manual

**roline**  
Designed for Professionals



Order-No. – P.U.

ROLINE USB to 4x RS232 Converter

12.02.1016 – 5

### ROLINE USB 2.0 to RS232 Adapter, for DIN Rail

Converter to connect serial devices to a USB port on your PC

- Compatible with USB 2.0, USB 1.1, USB 1.0
- Data transfer rate of up to 115 Kbit/s
- 15 KV ESD protection for all RS232 ports
- Connectors: 1x DB9 Male, 1x Mini USB type B
- For DIN Rail mounting
- Windows 98SE/ME/2000/Server 2003/XP/Server 2008/XP/Vista/7
- Power supply over Mini USB type B connector (40mA)
- Contents: Converter, driver CD, manual

**roline**  
Designed for Professionals

Order-No. – P.U.

ROLINE USB 2.0 to RS232 Adapter, for DIN Rail, 1 Port

A 12.02.1001 – 4

ROLINE USB 2.0 to RS232 Adapter, for DIN Rail, 2 Ports

B 12.02.1002 – 4

ROLINE USB 2.0 to RS232 Adapter, for DIN Rail, 4 Ports

12.02.1003 – 4

ROLINE USB 2.0 to RS232 Adapter, with Isolation, for DIN Rail, 1 Port

12.02.1007 – 2



### ROLINE USB 2.0 to RS422/485 Adapter, with Isolation, for DIN Rail

- Converter to connect serial devices to a USB port on your PC
- Mode: Asynchronous serial communication
- Compatible with USB 2.0, USB 1.1, USB 1.0
- Isolation 3000 VDC (optical)
- Connectors: 5-pin terminal block, 1x Mini USB type B
- Data transfer rate of up to 115 Kbit/s
- Terminal resistance and Echo mode
- DIP switches for terminal settings
- Signals: TX+, TX-, RX+, RX-, SGND
- Protection: 15 KV ESD protection for all signals, RS-422/485 signals surge protection
- Status LEDs
- For DIN rail mounting
- Power supply over Mini USB type B connector (54 mA)
- Windows 98SE/ME/2000/Server 2003/XP/Server 2008/XP/Vista/7
- Contents: Converter, USB cable, driver CD, manual

**roline**  
Designed for Professionals

Order-No. – P.U.

ROLINE USB 2.0 to RS422/485 Adapter, with Isolation, for DIN Rail

12.02.1004 – 4



**ROLINE Device Server 1x RS232, for DIN Rail, black**

- Expands RS232 COM ports over Ethernet networking
- Mode: Asynchronous serial communication
- Connectors: 1x DB9 M, 1x RJ-45 (10/100 Mbit/s)
- 10/100 Mbit/s, auto MDI/MDIX
- Gateway, IP address
- Baud rate up to 460.3 Kbit/s
- Operation mode: VSP COM (Virtual Serial Port), TCP Server, TCP Client, UDP, Paired Mode
- Signals: TXD, RXD, RTS, CTS, DTR, DSR, DCD, GND
- Flow Control: RTS/CTS, X-On/X-Off
- Supports HTTP, DHCP, ICMP (PING), Static IP and ARP
- 15 kV ESD protection for RS232 serial port
- For DIN Rail mounting
- Power connectors: 2-pin terminal block, DC socket
- Power Input: 9- 30VDC or main adapter 12 VDC, 1A
- Supported Operating Systems: Windows 2000 / XP / 2008 / Vista/ 7 / 8 (32/64-bit)



Order-No. – P.U.

ROLINE Device Server 1x RS232, for DIN Rail, black

15.06.0503 – 4

**VALUE RS-232 Extender over TP**

- Offers the possibility to extend your RS232 Ports over twisted pair, up to 1000 m
- Sends RS-232 signals with a data transfer rate of 230kbit/s
- Durable metal casing
- Supports Full-Duplex data transfer
- Hardware solution, no compatibility problems
- Contents: 2x Transceiver, 2x Power Supply (9V DC, 300mA), Manual, Null-Modem cable DB9 M-M (20cm)

**Technical data:**

RS-232 connection: 1x DB9 F  
 TP port: 1x RJ-45  
 Casing: Metal  
 Dimensions (LxWxH): 92 x 34 x 22 mm



Order-No. – P.U.

VALUE RS-232 Extender over TP

14.99.3456 – 10

**ROLINE RS-232 Extender over TP, for DIN Rail**

- Connectors: DB9 F (RS-232), RJ-45 F (Ethernet)
- Connection between both units by Cat.5e cable
- High speed baud rate up to 921.6 Kbit/s at 100 m
- Data transfer rate of up to 115.2 Kbit/s at 1.2 km
- Compatible with all RS-232 protocols
- Supports Full-duplex
- Built-in 15 kV ESD protection for all RS-232 signals
- Built-in 600 W surge protection for RJ-45 port
- For DIN rail mounting (DIN rail kit included) or desktop use
- Hardware solution, no software required
- RS-232 port powered technology
- Contents: Sender, receiver, manual



Order-No. – P.U.

ROLINE RS-232 Extender over TP, for DIN Rail

14.01.3456 – 2

**ROLINE RS-232 over Ethernet Adapter**

- This adapter easily allows to connect a current RS-232 serial device to a 10/100 LAN over ethernet connection. It provides a quick, simple and cost-effective way to access, manage and configure RS-232 devices and equipment over the internet from anywhere in the world or over the house internal IP LAN.
- Expands one RS-232 serial port on system via ethernet connection
  - Ethernet: 10/100 Mbit/s, Auto-select 10BaseT or 100BaseTX
  - Cable length: 30 cm
  - Supports Windows XP / 7 / 8 / 8.1 / 10
  - Contents: Adapter (DB-9 male, RJ-45 female), power supply (5 V DC, 1 A), driver CD, manual



Order-No. – P.U.

ROLINE RS-232 over Ethernet Adapter

15.06.0016 – 10

**Converter RS232-RS485, without or with Galvanic Isolation**

- DCE/DTE adjustable
- Full duplex transfer over 4 lines
- Only the data lines are converted
- 25 pin socket on the RS232 side
- Power supply via mains adapter
- Robust plastic casing
- Contents: converter, power supply unit (9V DC, 300mA), manual

**Technical data:**

RS-232 connection: D-Sub 25-pin F  
 RS-485 connection: Terminal block (4 clamps)  
 Data transfer rate: Up to ca. 100 Kbit/s  
 Transfer distance: Up to ca. 1 km  
 Power supply: DC 9V, 200mA  
 Weight: 60 g  
 Dimensions (WxDxH): 74.5 x 54 x 18.5 mm

Order-No. – P.U.

Converter RS232-RS485, without Galvanic Isolation

12.02.1028 – 20

Converter RS232-RS485, with Galvanic Isolation

12.02.1029 – 10



### ROLINE Converter RS232 to RS422/485, with Isolation, for DIN Rail

- Converts RS232 signals to RS-422 or RS-485
- Fully compliant with PC serial COM ports
- Isolation 3000 VDC (optical)
- Connectors: RS232: DB9 Female, RS-422/485: 7-pin terminal block
- Auto toggling by hardware
- Data transfer rate of up to 115.2 Kbit/s
- Terminal resistance and Echo mode
- DIP switches for terminal settings
- Signals: TXD, RXD, RTS, CTS, GND for RS232
- Protection: 15 kV ESD protection for all signals, RS-422/485 signals surge protection
- Status LEDs
- For DIN rail mounting
- DC power supply 10~30 V (built-in surge protector)
- Hardware solution, no software required

Environmental Limits:  
 Operating Temperature: -30° ~ 75°C  
 Storage Temperature: -40° ~ 85°C  
 Ambient Relative Humidity: 5 ~ 95%  
 Non-Condensing

- Contents: converter, manual

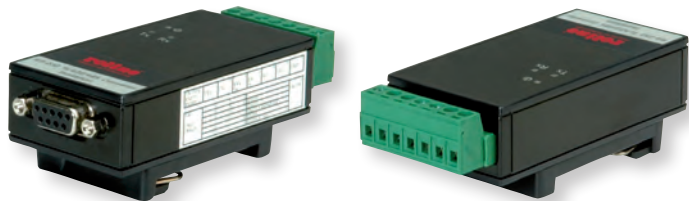

**roline**  
 Designed for Professionals

Order-No. – P.U.

ROLINE Converter RS232 to RS422/485, with Isolation, for DIN Rail 12.02.1005 – 4

ROLINE Converter RS232 to RS-422/485, with Isolation, for DIN Rail, Professional 12.02.1006 – 4

ROLINE RS232 to RS-422/485 Converter, Din Rail, self powered 12.02.1008 – 4

### VALUE RS232 Optical Coupler

- To connect serial devices to a RS232 port on your PC with a electrical isolation
- Data transfer rate of up to 56.25 kbit/s
  - 2.5 kV ESD protection for RS232 ports
  - With galvanic isolation
  - Easy to connect, no configuration, no power supply
  - Connectors: 1x DB9 Male, 1x DB9 Female
  - Contents: Coupler, manual



**Value**  
 Order-No. – P.U.

VALUE RS232 Optical Coupler

12.99.1015 – 30

### ROLINE Device Server over Ethernet RS232 & Printer Port Replicator

**roline**  
 Designed for Professionals

**With Ethernet hot-plug and system auto-detect capability, user can expand RS232 COM and printer LPT port easily without complex software configuration.**

- Expands RS232 COM and Printer LPT ports over Ethernet networking
- Works similar as a PCIe add-on card operating experience with Ethernet Hot-Plug capability.
- Supports secured connection between PC host and Device Server
- Plug & Play
- Supports:
  - Port auto-mapping with real time data transmit and receive communication

- Physical COM and LPT port accessed via device manager
- Up to 12 COM and 3 LPT ports working on windows system simultaneously
- Accesses tradition COM and LPT port by using existing software
- Low power consumption
- 15kV ESD protection for all serial signals (meets IEC-61000-4-2 standard)
- Supports: Microsoft Client: XP / 7 / 8 / 8.1 (X86 / X64), Microsoft Server: 2003 / 2008 / 2012R2 (X64)
- Contents: Device Server, USB power cable

Technical Data:  
 Serial Communication:  
 Interface: RS232  
 Baud rate: 50bps ~115.2Kbps  
 Stop bit: 1, 1.5, 2  
 Parity: even, odd, none, mark, space  
 Ethernet Flow Control: Xon/Xoff (software)  
 FIFO: 1Kbyte Hardware / per port  
 Connector: DB9 Male  
 Signal: DCD, TxD, RxD, RTS, CTS, DTR, DSR, GND, RI  
 Protection: ±15kV ESD IEC60000-4-2 Air Discharge  
 ±8kV ESD IEC61000-4-2 Contact Discharge  
 ±4kV ESD IEC61000-4-2 Level2 Line-to-Line

Parallel Communication:  
 Interface: IEEE1284 Printer Support  
 FIFO: 1Kbyte Hardware / per port  
 Speed: Maximum 2.7Mbps  
 Connector: DB25 Female

Ethernet Communication:  
 Number of Ports: 2x RJ45 (Upstream to Ethernet Switch / Downstream to PC Host)  
 Speed: 10/100 Mbps, auto MDI/MDIX

Input Voltage: 5 to 12VDC  
 Power Consumption: 2.5W @ 5VDC  
 Connector: DC-Jack  
 Weight: 150g  
 Dimensions: 121 x 81.93 x 27mm



Order-No. – P.U.

ROLINE Device Server over Ethernet RS232 & Printer Port Replicator 15.06.0500 – 6

### ROLINE Device Server over Ethernet 2x RS232 Port Replicator

**roline**  
 Designed for Professionals

**With Ethernet hot-plug and system auto-detect capability, user can expand RS232 COM port easily without complex software configuration.**

- Expands RS232 COM ports over Ethernet networking
- Works similar as a PCIe add-on card operating experience with Ethernet Hot-Plug capability.
- Supports secured connection between PC host and Device Server
- Plug & Play
- Supports:
  - Port auto-mapping with real time data transmit and receive communication
  - Physical COM port accessed via device manager

- Up to 256 COM and 3 LPT ports working on windows system simultaneously
- Accesses tradition COM port by using existing software
- Low power consumption
- 15kV ESD protection for all serial signals (meets IEC-61000-4-2 standard)
- Supports: Microsoft Client: XP / 7 / 8 / 8.1 (X86 / X64), Microsoft Server: 2003 / 2008 / 2012R2 (X64)
- Contents: device server, 1x USB power cable

Technical Data:  
 Serial Communication:  
 Interface: RS232  
 Baud rate: 50bps ~115.2Kbps  
 Stop bit: 1, 1.5, 2  
 Parity: even, odd, none, mark, space  
 Ethernet No. of Ports: 2x / 4x port  
 Flow Control: Xon/Xoff (software)  
 FIFO: 1Kbyte Hardware / per port  
 Connector: DB9 Male  
 Signal: DCD, TxD, RxD, RTS, CTS, DTR, DSR, GND, RI  
 Protection: ±15kV ESD IEC60000-4-2 Air Discharge  
 ±8kV ESD IEC61000-4-2 Contact Discharge  
 ±4kV ESD IEC61000-4-2 Level2 Line-to-Line

Ethernet communication:  
 Number of Ports: 2x RJ45 (Upstream to Ethernet Switch / Downstream to PC Host)  
 Speed: 10/100 Mbps, auto MDI/MDIX

Input Voltage: 5 to 12VDC  
 Power Consumption: 2.5W @ 5VDC  
 Connector: DC-Jack  
 Weight: 150g  
 Dimensions: 121 x 81.93 x 27mm



Order-No. – P.U.

ROLINE Device Server over Ethernet 2x RS232 Port Replicator 15.06.0501 – 6

ROLINE Device Server over Ethernet 4x RS232 Port Replicator 15.06.0502 – 6





## Peripheral Devices

# 4

I/O Cards . . . . .	4.02 – 4.04
Card Readers . . . . .	4.04, 4.05
HDD Enclosures / Mobile Racks . . . . .	4.06, 4.07
HDD Docking Station . . . . .	4.06
Mounting Material. . . . .	4.07
19" Industrial Server Chassis . . . . .	4.07, 4.08
Barcode Scanner . . . . .	4.09
Keypad / Calculator Keypad . . . . .	4.09
Mouses . . . . .	4.10
Mouspads. . . . .	4.10

## VALUE I/O Cards

Upgrade your PC with additional interfaces like e.g. USB 2.0, USB 3.0, USB 3.1, Serial ATA and EPP/ECP parallel resp. RS232 serial ports.

- PCI adapters
- PCI-Express adapters
- Contents: Adapter, driver CD, manual

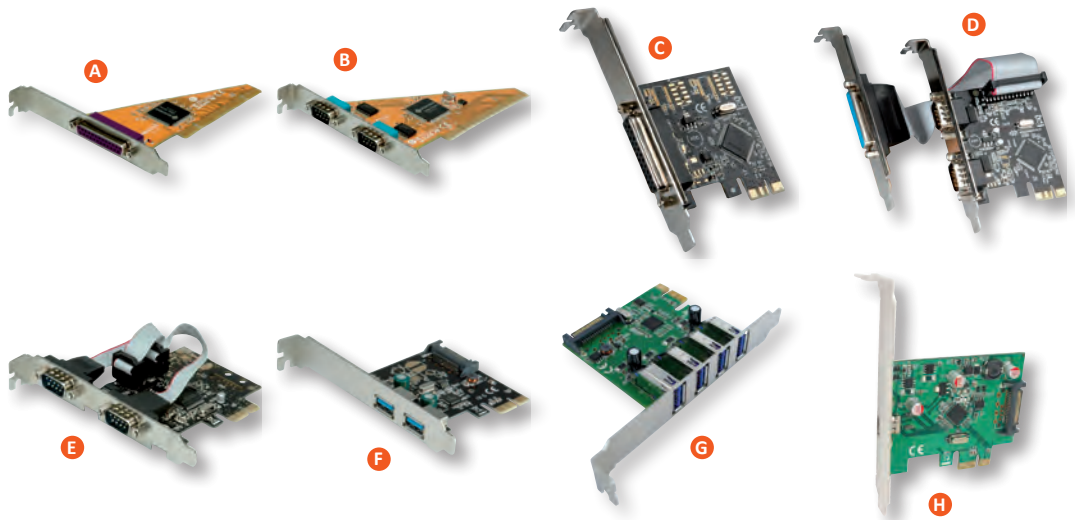

**Value**

	Picture	Interfaces	Connectors	Card type	Order-No.	- P.U.
VALUE PCI Adapter, 1x Parallel ECP/EPP Port	A	LPT 1-3	1x DB25 F external	PCI	15.99.2088	- 20
VALUE PCI Adapter, 2x Serial RS232, D-Sub 9 Port	B	COM 1-256	2x DB9 M external	PCI	15.99.2086	- 20
VALUE PCI-Express Adapter, 1x Parallel ECP/EPP Port	C	LPT 1-3	1x DB25 F external	PCI-Express x1	15.99.2114	- 10
VALUE PCI-Express Adapter, 2x Serial RS232 D-Sub 9 + 1x Parallel EPP/ECP Ports	D	COM 1-256, LPT 1-3	2x DB9 M/1x DB25 F	PCI-Express x1	15.99.2116	- 10
VALUE PCI-Express Adapter, 2x Serial RS232 D-Sub 9 Ports	E	COM 1-256	2x DB9 M	PCI-Express x1	15.99.2118	- 10
VALUE PCI-Express Adapter, 2x USB 3.0, 5 Gbit/s	F	USB 3.0	2x USB 3.0 Type A F	PCI-Express x1	15.99.2111	- 5
VALUE PCI-Express Adapter, 4x USB 3.0, 5 Gbit/s	G	USB 3.0	4x USB 3.0 Type A F	PCI-Express x1	15.99.2115	- 5
VALUE PCI-Express Adapter, 1x Port Type C USB3.1	H	USB 3.1	1x USB 3.1 Type C F	PCI-Express x1	15.99.2119	- 10

## ROLINE I/O Cards

Upgrade your PC with additional interfaces like e.g. USB 2.0, USB 3.0, USB 3.1, SATA and parallel EPP/ECP resp. RS-232 serial ports.

- PCI adapters
- PCI-Express adapters
- Cardbus adapters
- ExpressCard/34 adapters
- Contents: Adapter, driver CD, manual



**roline**  
Designed for Professionals

	Picture	Interfaces	Connectors	Card type	Order-No.	- P.U.
ROLINE PCI-Express Adapter, 2x USB 3.0 Ports	A	USB 3.0	2x USB 3.0 type A external	PCI-Express x1	15.06.2113	- 10
ROLINE PCI-Express Adapter, 4x USB 3.0, 5 Gbit/s	B	USB 3.0	4x USB 3.0 type A external	PCI-Express x1	15.06.2117	- 10
ROLINE ExpressCard/34 to CardBus Adapter	C	CardBus	1x CardBus	ExpressCard/34	15.06.2149	- 10
ROLINE PCI-Express x4 Adapter, 2x Ports Type C USB3.1	D	USB 3.1	2x USB 3.1 Type C	PCI-Express x1	15.06.2143	- 10
ROLINE PCI-Express x4 Adapter, 2x Ports Type A USB3.1	E	USB 3.1	2x USB 3.1 Type A	PCI-Express x1	15.06.2144	- 10

## ROLINE PCI-Express Adapter, 6x+1x USB 3.0

### Expand your PC with six SuperSpeed USB 3.0 ports.

- 6x External and 1x Internal USB 3.0 Type-A Ports
- Supports PCIe 1.0 and PCIe 2.0 motherboard
- PCIe v2 x1 Lane Host Adapter
- Compliant with USB3.0 Specification Revision 1.0
- Support USB3.0, USB2.0 and USB1.1 devices
- Compliant with PCI Express Specification 2.0
- Low Profile PCIe Form Factor
- Provides 5V/1A USB bus power to USB devices from Motherboard PCIe slot directly, or sufficient 5V current from PC power supply if 15Pin SATA Power connector connected

- Supports: Windows XP/Vista/7/8/10 as well as Windows Server 2008 R2
- Regular size PCIe bracket on board and Low Profile PCIe Bracket included
- Contents: Adapter, low profile bracket, driver CD, manual

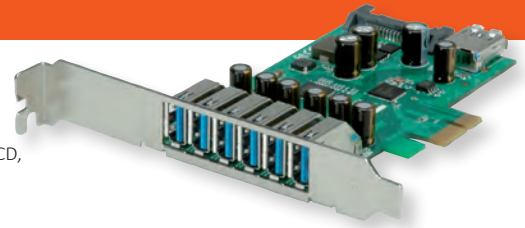

**roline**<sup>®</sup>  
Designed for Professionals

Order-No. – P.U.

ROLINE PCI-Express Adapter, 6x+1x USB 3.0

15.06.2134 – 10

## ROLINE PCIe Adapter 2x 110mm M.2 SATA SSD

- Hardware PCIe Adapter 2x 110mm M.2 NGFF SSD
- Supports 6Gbps, 3Gbps SATA based M.2 NGFF 110mm, 80mm, 60mm, 42mm, 30mm SSD
- 2x M.2 NGFF type 22110-D5-B connector on board
- Movable M.2 NGFF stand-off and multiple plated-holes supports type 22110, 2280, 2260, 2242 and 2230 SSD
- Supports dual-sided SSD module 1.5mm component height on the top and bottom side
- 4pin power connector on board (12V)
- Transparent to the operating system and no driver required
- Supports: Windows 7/8/10, Vista, Server 2008/2012 (64bit / 32bit), and Mac OS 10.x

- Contents: Adapter, driver CD, manual

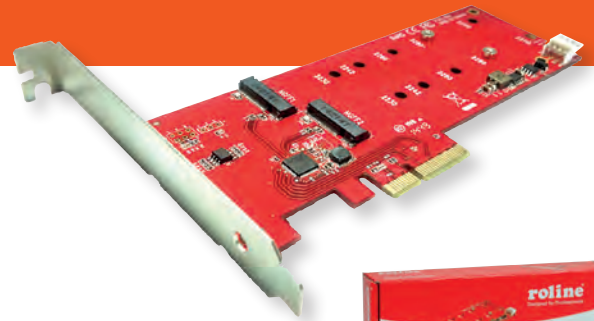

**roline**<sup>®</sup>  
Designed for Professionals

Order-No. – P.U.

ROLINE PCIe Adapter 2x 110mm M.2 SATA SSD

15.06.2171 – 10

## ROLINE PCIe Adapter 2x SATA M.2 NGFF + 1x PCIe M.2 NGFF

- Hardware PCIe Adapter 2x SATA M.2 NGFF SSD + 1x PCIe M.2 NGFF SSD
- Supports M.2 NGFF 110mm, 80mm, 60mm, 42mm SSD
- 2x M.2 NGFF type 22110-D5-B + 1x M.2 NGFF type 22110-D5-M connector on board and 2x 7pin SATA connector
- Movable M.2 NGFF stand-off and multiple plated-holes supports type 22110, 2280, 2260, 2242 and 2230 SSD
- Supports dual-sided SSD module 1.5mm component height on the top and bottom side
- 1x 15 pin power connector on board
- Transparent to the operating system and no driver required

- Supports: Windows 7/8/10, Vista, Server 2008/2012 (64bit / 32bit), and Mac OS 10.x
- Contents: Adapter, driver CD, manual

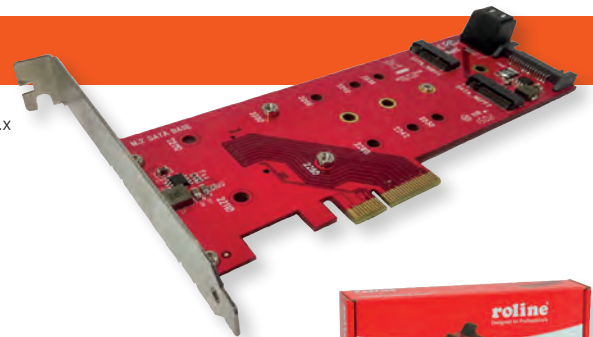

**roline**<sup>®</sup>  
Designed for Professionals

Order-No. – P.U.

ROLINE PCIe Adapter 2x SATA M.2 NGFF + 1x PCIe M.2 NGFF

15.06.2172 – 10

## ROLINE PCIe 3.0 x4 Host Adapter for M.2 NGFF PCIe SSD

- Convert M.2 NGFF PCIe based SSD to work in main board PCIe x4 bus slot
- PCI Express 3.0 x4 Lane Host adapter
- Supports PCIe Gen3 and PCIe Gen2 M.2 NGFF 80mm, 60mm, 42mm SSD
- M.2 NGFF type 2280-D5-M connector on board
- Movable M.2 NGFF stand-off and multiple plated-holes supports type 2280, 2260 and 2242 SSD
- Supports PCIe 3.0, PCIe 2.0 and PCIe 1.0 motherboard
- Supports dual-sided SSD module 1.5mm component height on the top and bottom side
- Compliant with PCI Express 3.0
- Pin header on board for drive LED connection

- Low Profile PCIe Form Factor
- Regular size PCIe bracket on board and Low Profile bracket included
- Transparent to the operating system and no driver required
- Operating systems: Windows 10 / 8.1 / Server 2012 R2
- M.2 PCIe SSD power from motherboard PCIe bus slot 3.3V
- Contents: Adapter, manual

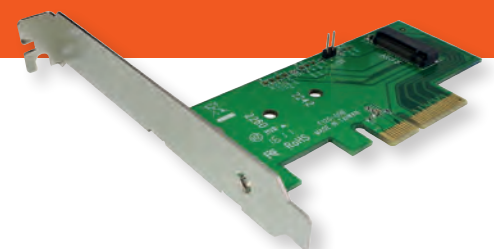

**roline**<sup>®</sup>  
Designed for Professionals

Order-No. – P.U.

ROLINE PCIe 3.0 x4 Host Adapter for M.2 NGFF PCIe SSD

15.06.2192 – 10



### ROLINE PCIe 3.0 x4 3.3V5A Host Adapter for PCIe-NVMe M.2 110mm SSD

- PCIe 3.0 x4 NVMe and PCIe-AHCI M.2 SSD work in main board PCIe x4 bus slot
- PCI Express 3.0 x4 Lane Host adapter
- Supports PCIe Gen3 and PCIe Gen2 M.2 NGFF 110mm, 80mm, 60mm, 42mm SSD
- M.2 NGFF type 22110-D5-M connector on board
- Movable M.2 NGFF stand-off and multiple plated-holes supports type 22110, 2280, 2260 and 2242 SSD
- Supports PCIe 3.0, PCIe 2.0 motherboard
- Supports dual-sided SSD module 1.5mm component height on the top and bottom side
- Compliant with PCI Express 3.0
- Pin header on board for drive LED connection
- Low Profile PCIe Form Factor
- Low Profile PCIe bracket on board and Regular size bracket included
- Transparent to the operating system and no board driver required
- Operating system: Windows 10, Win8.1, Windows Server 2012 R2
- Supports M.2 PCIe SSD High Power 3.3V5A
- Contents: Adapter, driver CD, manual

**roline**  
Designed for Professionals

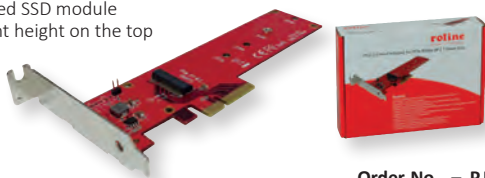

Order-No. – P.U.

ROLINE PCIe 3.0 x4 3.3V5A Host Adapter for PCIe-NVMe M.2 110mm SSD

15.06.2193 – 10

### ROLINE 2.5" NVMe U.2 SSD PCIe 3.0 x4 Carrier Adapter

- Connect your PCIe-NVMe U.2 2.5" SSD card (disk) to your desktop, server or workstation
- Works in mainboard PCIe x4 bus slot
- Supports PCIe 3.0, PCIe 2.0 motherboard
- Compliant with PCI Express 3.0
- 68Pin SFF-8639 interface connector to 2.5" U.2 SSD
- Transparent to the operating system and no board driver required
- Windows 10, Win8.1, Windows Server 2012 R2
- Microsoft Update to support NVMe Express by using native drivers in Windows 7 or Windows Server 2008 R2
- Contents: Adapter, manual

**roline**  
Designed for Professionals

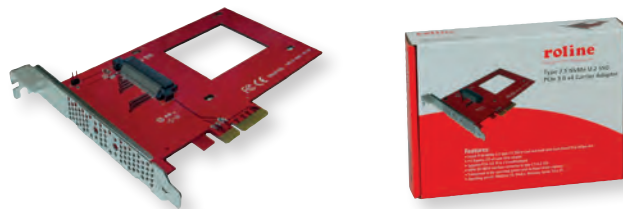

Order-No. – P.U.

ROLINE 2.5" NVMe U.2 SSD PCIe 3.0 x4 Carrier Adapter

15.06.2194 – 10

### ROLINE PCIe Adapter RAID

- Hardware PCIe Adapter 2x 110mm M.2 NGFF SSD
- Supports 6Gbps, 3Gbps SATA based M.2 NGFF 110mm, 80mm, 60mm, 42mm, 30mm SSD
- 2x M.2 NGFF type 22110-D5-B connector on board
- Movable M.2 NGFF stand-off and multiple plated-holes supports type 22110, 2280, 2260, 2242 and 2230 SSD
- Supports dual-sided SSD module 1.5mm component height on the top and bottom side
- 4pin power connector on board (12V)
- Transparent to the operating system and no driver required
- Supports: Windows 7 / 8 / 10, Vista, Server 2008/2012 (64bit / 32bit), and Mac OS 10.x
- Contents: Adapter, driver CD, manual

**roline**  
Designed for Professionals

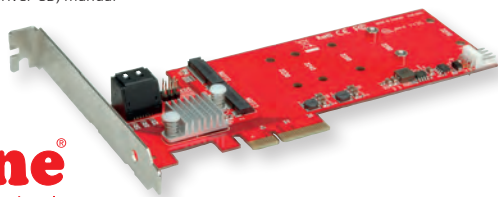

Order-No. – P.U.

ROLINE PCIe Adapter RAID, 2x M.2+2x SATA

15.06.2119 – 10

### ROLINE M.2 to SATA III SSD H/W adapter, 2x M.2 NGFF SSD, bootable and RAID-capable

#### 2.5-inch H/W adapter for the installation of two M. 2 SSDs (NGFF), bootable and RAID-compatible and with 6Gbit/s SATA connection!

- Supports two M. 2 NGFF SSDs with form factor 2230, 2242, 2260 and 2280
- M.2 NGFF SATA SSDs can be primary boot device and contain operating system and applications.
- RAID 0 and RAID 1 configurable via hardware or software; configuration

on the hardware side via 6 pins with jumper (jumper table on the back of the board)

- The 2.5 inch H/W adapter can be installed in a 2.5" housing and is therefore perfectly suited for mobile use.
- No drivers required
- Contents: HDD adapter

**roline**  
Designed for Professionals



Order-No. – P.U.

ROLINE M.2 to SATA III SSD H/W adapter, 2x M.2 NGFF SSD, bootable/RAID-capable

16.01.4145 – 10

### VALUE CardReader Type C + 3x USB 3.0, SD/Micro

- Suitable for Smartphone+Tablets, DSLR, photo equipment
- Transfer your precious vacation pictures/videos from the memory card of your digital camera on your tablet, Macbook ...
- Supports USB 2.0
- Card Reader works with multiple media, as e.g. SD (Secure Digital) Card, SDHC, Micro SD
- Contents: Card Reader

**Value**



Order-No. – P.U.

VALUE CardReader Type C + 3x USB 3.0, SD/Micro SD Card Reader

15.99.6252 – 20

### ROLINE CardReader Type C + 2x USB3.0 Hub, 1x PD

- Suitable for Smartphone+Tablets, DSLR, photo equipment
- Transfer your precious vacation pictures/videos from the memory card of your digital camera on your tablet, Macbook ...
- Supports USB 2.0
- Card Reader works with multiple media, as e.g. SD (Secure Digital) Card, SDHC, MS (Memory Stick), MS Duo, mini/micro SD
- No adapter required for Micro SD/M2 Cards
- Power Delivery Function (for charging of devices via the additional type-C connection; 20V3A)
- Contents: Card Reader

**roline**  
Designed for Professionals



Order-No. – P.U.

ROLINE CardReader Type C + 2x USB3.0 Hub, 1x PD (Power Delivery)

15.08.6257 – 10

### VALUE USB 2.0 Notebook Card Reader 50+

- Read and write to the most popular flash cards- CF/SD/SDXC/MMC/Mini SD/T-Flash/ MS/MS Duo
- USB 2.0 & USB 1.1 compatible
- Supports Hot-swapping
- Read/Write LED indicator
- Compact and modern white/black design
- USB Bus-powered, no external power supply is needed
- Supports Windows 2000/ME/XP/Vista/10
- Contents: Card Reader, USB cable (75 cm), driver CD, manual



**Value**<sup>®</sup>

Order-No. – P.U.

VALUE USB 2.0 Notebook Card Reader 50+, white/black

15.99.6231 – 20

### ROLINE USB 2.0 Notebook Card Reader 50+

- Read & write to the most popular flash cards like SD, SDHC, Micro SD (TF), CF, MD, MMC, MS and many variants
- Very easy installation, supports plug & play
- Compact and flat housing, ideal for mobile use
- USB 2.0, USB 1.1 compatible
- USB bus-powered, no external power supply is needed
- LEDs for status indication
- Dimensions (WxDxH): 93 x 52 x 8 mm
- Contents: Card Reader, USB cable Type A/5-pin Mini



**roline**<sup>®</sup>  
Designed for Professionals

Order-No. – P.U.

ROLINE USB 2.0 Notebook Card Reader 50+, black

15.08.6247 – 10

### ROLINE USB 3.0 Multi Card Reader, external

The external Multi Card Reader reads all important and common formats and offers the highest possible compatibility.

- Supports SuperSpeed USB 3.0, compliant with USB 2.0, USB 1.1
- Card Reader works with multiple media, as e.g. CF (Compact Flash) Card I/II, SD (Secure Digital) Card, SDHC, SDXC, MMC (MultiMedia Card), MS (Memory Stick), MS Pro, MS Duo, microSD and many variants
- Supports Extended Capacity SD memory cards (SDXC)
- No adapter required for Micro SD/ M2 Cards
- Supported Operating Systems: Windows 2000/XP/Vista/7/8/10, Mac OS X
- Contents Card reader, USB 3.0 cable

**NEW**

**roline**<sup>®</sup>  
Designed for Professionals



Order-No. – P.U.

ROLINE USB 3.0 Multi Card Reader, external, black

15.08.6248 – 10

### ROLINE CardReader Type C + SD/MicroSD/CF - CFast 2.0

Transfer the data from the CFast 2.0 memory card of your high-end DSLR, digital camera or other devices via USB Type C to your Macbook or another USB Type C device!

- Ideal for connection to PCs or Macbooks, ultrabooks or notebooks/ laptops
- Reads the most important formats, such as SD and Micro SD, but also the CFast 2.0 memory cards used by professionals.
- Power supply via USB Type C interface
- Compact plastic housing, perfect for mobile use
- Contents: Card Reader



**roline**<sup>®</sup>  
Designed for Professionals

Order-No. – P.U.

ROLINE CardReader Type C + SD/MicroSD/CF - CFast 2.0

15.08.6258 – 5

### ROLINE Mobile CardReader USB Type C + SD/MicroSD

Transfer the data from your memory card of your DSLR, digital camera or other equipment to your tablet, Macbook or other USB Type C device with this practical USB stick shaped card reader!

- Ideal for smartphones and tablets, but also suitable for connection to PCs or Macbooks, ultrabooks or notebooks/laptops due to the reversible and universally usable USB type C plug
- Reads the most important formats, such as SD and Micro SD cards
- In practical USB stick shape and therefore perfect for mobile use
- Power supply via USB Type C interface
- Compact aluminium housing
- Contents: Card Reader

**roline**<sup>®</sup>  
Designed for Professionals

**NEW**

Order-No. – P.U.

ROLINE Mobile CardReader USB Type C + SD/MicroSD

15.08.6259 – 20



### VALUE External Type 2.5 SATA HDD/SSD Pocket Enclosure with USB 2.0

- Transfer rate of USB 2.0 Hi-Speed up to 480 Mbit/s
- For type 2.5 HDD/SSDs with height up to 9.5 mm
- External interface: USB, internal interface: SATA
- Aluminium material for excellent heat-dissipation
- Supports bus power mode over included USB Y- cable and self-power mode over optional power supply
- LEDs for power and bus activities indication
- Hot-swappable and plug & play
- Supports Windows 2000/ME/XP/Vista/7/8/10, Mac OS X
- Contents: HDD/SSD Enclosure, USB cable

#### Technical data:

Internal connection:	1x SATA
External connection:	1x USB 2.0
Dimensions (WxDxH):	83 x 131 x 16 mm
Casing:	Metal, black
Power supply:	over included Y-USB cable or optional power supply



Order-No. – P.U.

VALUE External Type 2.5 SATA HDD/SSD Pocket Enclosure with USB 2.0 16.99.4204 – 10

### VALUE External Type 2.5 SATA 6.0 Gbit/s HDD/SSD Enclosure with USB 3.1 Type C

- Portable Drive Enclosure with USB Type C connector
- Input Interface: SATA 6Gbit/s
- Output Interface: USB Type C
- Compatible: 2.5 SATA HDD/SSD
- Compliant with SuperSpeed USB 3.0 specification with data transfer rates of up to 10 Gbit/s
- Supports type 2.5 HDD/SSDs with SATA connection and height up to 9.5 mm
- Color: Silver
- Plug & play
- Housing: Aluminium
- Supports Windows 2000/ME/XP/Vista/7/8/10, Mac OS X
- Contents: HDD Enclosure, manual



Order-No. – P.U.

VALUE External Type 2.5 SATA 6.0 Gbit/s HDD/SSD Enclosure with USB 3.1 Type C 16.99.4212 – 10

### ROLINE 2.5 + 3.5 SATA HDD Docking Station, USB3.0

- Easy way to connect a SATA 6.0 Gbit/s hard disk to a computer or notebook over a SuperSpeed USB 3.0 port
- Suitable for type 2.5/3.5 Serial ATA HDD/SSD (up to 4TB)
- Compliant with USB 3.0, USB 2.0, USB 1.1
- Compliant with SATA 6.0 Gbit/s, SATA 3.0 Gbit/s, SATA 1.5 Gbit/s
- Supports transfer rates of up to 5.0 Gbit/s
- Connection to computer: USB 3.0
- Connection to HDD: 15-pin SATA power + 7-pin SATA data
- Hot-swappable, plug & play
- Length USB cable: 1 m
- Power supply included
- Supported Operating Systems: Windows XP/ Vista / 7 / 8 / 10 / Server 2003 & 2008 (32-/64-bit)
- Contents: HDD Docking station, USB cable, power supply, manual

**roline**  
Designed for Professionals



Order-No. – P.U.

ROLINE 2.5 + 3.5 SATA HDD Docking Station, USB3.0 16.01.4121 – 5

### ROLINE 2.5 + 3.5 SATA HDD Docking Station, USB3.0, HD Copy-Function

- Easy way to connect a SATA 6.0 Gbit/s hard disk to a computer or notebook over a SuperSpeed USB 3.0 port
- 2 SATA- HD can be copied directly, without Software
- Suitable for type 2.5/3.5 Serial ATA HDD/SSD (up to 4TB capacity)
- Compliant with USB 3.0, USB 2.0, USB 1.1
- Compliant with SATA 6.0 Gbit/s, SATA 3.0 Gbit/s, SATA 1.5 Gbit/s
- Supports transfer rates of up to 5.0 Gbit/s
- Connection to computer: USB 3.0
- Connection to HDD: 15-pin SATA power + 7-pin SATA data
- Hot-swappable, plug & play
- Length USB cable: 1 m
- Power supply included
- Supported Operating Systems: Windows XP/ Vista / 7 / 8 / (32 / 64-bit) / 10 / Mac OS X
- Contents: HDD Docking station, USB cable, power supply, manual

**roline**  
Designed for Professionals



Order-No. – P.U.

ROLINE 2.5 + 3.5 SATA HDD Docking Station, USB3.0, HD Copy-Function 16.01.4122 – 5



### External Type 3.5 HDD Plug-In Enclosure USB 3.0 / S-ATA 6G

Smart HDD plug-in casing. Plug your HDD directly in the slot without screwdrivers and additional casings.

- Fits for all type 3.5 SATA 6 Gbit/s HDDs
- Connectors: Internal SATA, External USB 3.0
- Stable metal plug in casing
- Integrated fan prevents overheating
- Colour: Black
- Contents: HDD Casing, Power Supply Unit, USB Cable (1.5 m), Manual



#### Technical data:

Internal connection:	SATA 7-pin M
External connection:	USB 3.0
Fan:	1
Dimensions (WxDxH):	45 x 126 x 207 mm
Power supply:	over included power supply (12V, 2A)

Order-No. – P.U.

External Type 3.5 HDD Plug-In Enclosure USB 3.0 / S-ATA 6G

16.01.4142 – 1

### HDD Mounting Adapter Type 3.5/2.5

#### 16.01.3031:

- This hard disk mounting adapter serves for installation of type 2.5 hard disks into a free type 3.5 slot
- For installation of type 2.5 hard disks in a type 3.5 slot
- Nickel plated
- Contents: 2 brackets, screws

#### 16.01.3006:

- For installation of type 3.5 enclosures (e. g. floppy drives) in an (open) type 5.25 slot
- Solid ABS-plastic, black
- Screws included

#### 16.01.3007:

- For the installation of up to two type 2.5 HDDs into any type 3.5 drive bay of a computer case
- Solid plastic, black
- Screws included

#### 16.01.3028:

- This hard disk mounting adapter serves for installation of type 3.5 hard disks into a free type 5.25 slot
- Nickel plated
- Contents: 2 brackets, screws

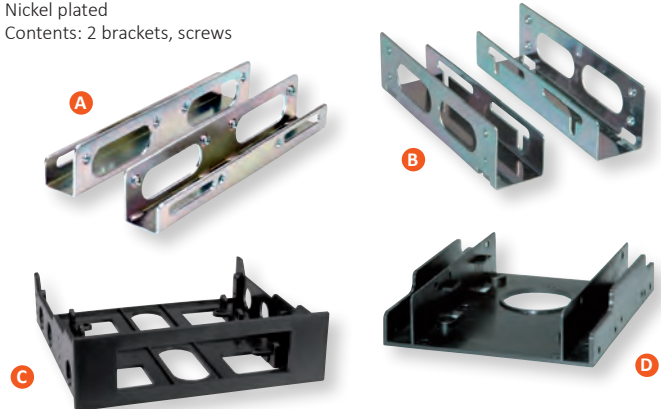

Order-No. – P.U.

HDD Mounting Adapter Type 3.5/2.5

A 16.01.3031 – 25

HDD Mounting Adapter, Type 3.5/5.25

B 16.01.3028 – 50

Floppy Mounting Adapter Frame, Type 3.5/5.25, black

C 16.01.3006 – 40

HDD Mounting Adapter Type 3.5 for 2x Type 2.5 HDDs, black

D 16.01.3007 – 20

### VALUE 19" Industrial Rack-Mount Server Chassis

- Versatile 4U 19" industrial PC housing
- Rugged construction and design for harsh industrial environment
- Supports ATX/Baby AT motherboard
- Hold-Down clamp design to protect plug-in cards from vibration
- Shock resistant drive bracket exposed
- A lockable front door for dust-proof integrity and running security
- 12x12 cm ball bearing fan with replaceable air filter on the front for a better ventilation, rear space for the installation of two fans à 80x80 mm
- Space for installation of an ATX power supply (not included in delivery)
- Max Mainboard Size: 305x270 mm (12" x 10,6")
- Color: Black
- Optional accessories: Telescope rail 19.99.0114
- Contents: Casing, screws

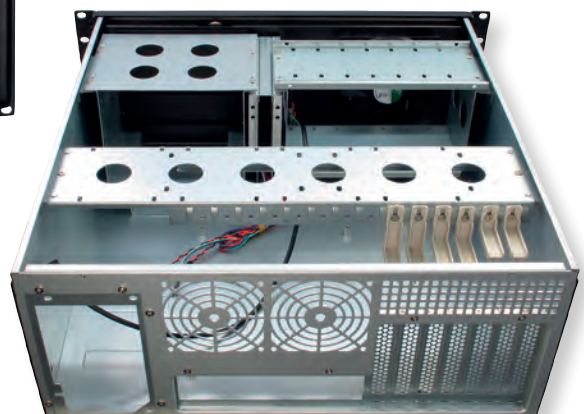

#### Technical Data:

Type 5.25 slots:	3
Type 3.5 slots:	8x int. (HDD),
Dimensions (WxLxH):	178 x 480 x 485/530* mm
Weight:	10 kg
Connectors front:	2x USB 2.0
Fan front:	120 mm

\*) with holder

Order-No. – P.U.

VALUE 19" Industrial Rack-Mount Server Chassis STD, black

19.99.0104 – 1

VALUE Telescopic rails for VALUE Ind. Rack-Mount Server Chassis, 510-820 mm

19.99.0114 – 1

VALUE 19" Industrial Rack-Mount Server Chassis, 1UH



- Versatile 1U 19" industrial PC housing
- Rugged construction and design for harsh industrial environment
- Supports ITX motherboard
- Max Mainboard Size: 170 x 170 mm
- 4 x 4 cm ball bearing fan on the front for a better ventilation
- Space for optional 1x 3.5 or 2x 2.5 HDD
- Space for installation of an FLEX-ATX power supply (not included in delivery)
- Buttons: Controls Power-Button / Reset-Button
- LED: Power / HDD Activity / Network Activity / Overheating Alert / Power Failure
- Front connectors: 1x USB2.0, 1x USB3.0
- Color: Black
- Contents: Casing, screws

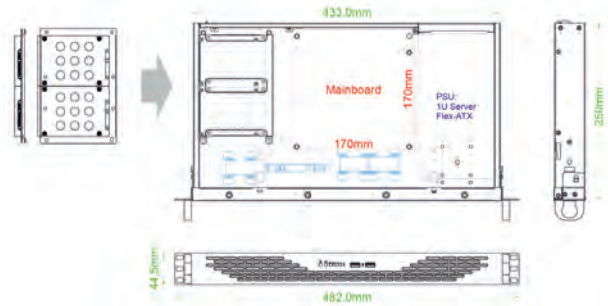

Order-No. – P.U.

VALUE 19" Industrial Rack-Mount Server Chassis, 1UH, black

19.99.0115 – 1

VALUE 19" Industrial Rack-Mount Server Chassis, 4UH



- Versatile 4U 19" industrial PC housing
- Rugged construction and design for harsh industrial environment
- 4UH rack with a long installation depth (650mm)
- Supports ATX / (eATX) / Baby AT motherboard
- Max Mainboard Size: 305 x 345 mm (12" x 13.5")
- Provides enough space for HDD disks (up to 11x 3.5" HDDs)
- Mounting rails for screw less installation of internal 3.5" and external 5.25" drives (included)
- Seven fans are preinstalled, which allows an optimal cooling of the installed hardware (5x 120x120mm; 2x 80x80mm)
- Embedded dust filter, which can be removed for cleaning, is located behind the lockable front door and prevents both removable HDD cages from dust
- 2x front USB ports (1x USB 2.0 and 1x USB 3.0)
- Space for installation of an ATX power supply (not included in delivery)
- Contents: Casing, keys, screw set, mounting frame for mini redundant power supply, wrench for assembly of the spacer, mounting rails for 5.25" and 3.5" drives



Order-No. – P.U.

VALUE 19" Industrial Rack-Mount Server Chassis, 4UH, black

19.99.0116 – 1

VALUE Telescopic rails for VALUE Industrial Rack-Mount Server Chassis, 19990116

19.99.0117 – 1



### VALUE 1D Laser Scanner S-61 USB

If you are looking for an entry-level device that brings reliable performance, is easy to use and impresses with its price, then the laser scanner VALUE S-61 is the right one. Especially in applications with medium scanning volume, for example in the retail sector makes its perfect. The integration could not be easier thanks to the USB port.

Reads all standard 1D bar codes with its advanced laser engine accurate and fast (72 scan lines / sec.). By single-line laser technology and the accurate targeting falls when collecting barcodes from lists and menus easily.

To increase the lifetime of the laser is a flashing scan mode available, in which the laser pulses. The S-61 has a larger

scanning field as CCD scanners, reading distance and maximum width of readable barcodes will depend on the resolution. Users will appreciate the ergonomic housing and the low weight of the laser scanner, whereby the continuous operation is not strained unnecessarily.

- Easy and convenient Data retrieval even from the distance
- Versatile laser scanner for all 1D bar codes
- Powerful laser engine for high throughput
- Simply connect via USB
- Customizable by lightweight body and ergonomic shape
- Connection over USB



VALUE 1D Laser Scanner S-61 USB

Order-No. – P.U.

18.99.3071 – 1

### VALUE CCD Scanner 2009U USB

Its 80mm scan width of the scanner reads all common barcodes, such as EAN codes, PZN, ISBN, etc.

- Easy and convenient Data retrieval even from the distance

- Simply connect via USB
- CCD touch scanner for bar codes
- 80 mm scanning width
- Reads all commercial bar code types
- With trigger on the underside



Value

B

Order-No. – P.U.

VALUE CCD Scanner 2009U USB, grey

A 18.99.3070 – 1

VALUE CCD Scanner 2009U USB, black

B 18.99.3076 – 1

### ROLINE Numeric Keypad, USB

The USB numeric keypad is ideal for the mobile user either at home or in the office. The low profile keys are comfortable, easy to use and the perfect complement to your notebook. Great for anyone working on spreadsheets, accounting or financial applications.

- Slim, light design
- 19 keys
- Easy plug & play
- Cable length: 95 cm



**roline**  
Designed for Professionals

Order-No. – P.U.

ROLINE Numeric Keypad, USB

18.02.3229 – 10

### ROLINE Calculator Keypad, 2x USB 3.0 Hub

Unique combination of commercial calculator, keypad and USB 3.0 Hub with 2 ports.

- Fast switching between commercial calculator and keypad mode
- In keypad mode, you expand your notebook keyboard to the usual numeric keypad - the entering of numbers it's safer, more comfortable and faster
- In calculator mode, you can use the basic arithmetical operations plus square root function and the function of a tax calculation. (the device keep the result via buffer). The result of a calculation can be sent to the PC (eg, for further use in an Excel sheet).
- PC Keypad and commercial calculator
- 2x USB 3.0 Hub
- Plug & Play
- Easily transfer your typo to Excel
- Powered by battery, solar cells or the USB interface
- USB cable length: about 1.40 m
- Contents: Calculator / numeric keypad, USB cable, user manual

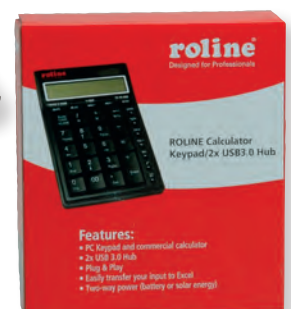

**roline**  
Designed for Professionals

Order-No. – P.U.

ROLINE Calculator Keypad, 2x USB 3.0 Hub

18.02.2900 – 10



## ROLINE Mouse, optical, USB

- Super high sensitive 1600/1200/800 cpi (switchable)
- USB connector
- Surface: Red rubber coating
- Suitable for right and left-handed users
- Supported Operating Systems: Windows 2000/XP/Vista/7/10
- Contents: Mouse



**roline**<sup>®</sup>  
Designed for Professionals



A



B

Order-No. – P.U.

ROLINE Mouse, optical, USB, red/black

A 18.01.1082 – 10

ROLINE Mouse, optical, cordless, USB, red/black

B 18.01.1083 – 10

## VALUE Mouse, optical, USB

- 3 button mouse
- With integrated scroll wheel
- USB connector
- Optical resolution: 1000 dpi
- Color: Blue/black
- Supports Windows 98SE/ME/2000/XP/Vista/7/10



**Value**<sup>®</sup>

Order-No. – P.U.

VALUE Mouse, optical, USB, blue/black

18.99.1076 – 40

## ROLINE Soft Gaming Pad

- Designed for professional gamers
- Provides excellent gliding of the mouse
- Natural rubber base for maximum grip on any surface
- Excellent performance for laser and optical mice
- Material: Surface: high performance textile surface / Base: nature rubber
- Dimensions: 350x260x3mm
- Colour: Black

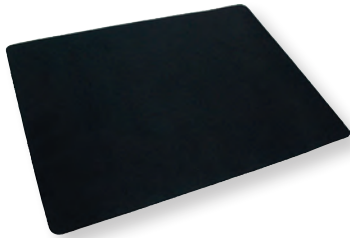

**roline**<sup>®</sup>  
Designed for Professionals

Order-No. – P.U.

ROLINE Soft Gaming Pad, black

18.01.2044 – 20

## ROLINE Gaming Mouse Pad

- Designed for professional gamers
- Provides excellent gliding of the mouse
- The fine textured weave increases accuracy and speed, decreases friction
- Sliding fast and reduce wrist strain without the height difference between pad and desk
- Anti-slippery silicone base gives maximum grip
- Compatible with laser and optical mice
- Material: Surface: high quality textile / Base: premium silicone adhesive
- Dimensions: 350x260x3mm
- Colour: Black



**roline**<sup>®</sup>  
Designed for Professionals

Order-No. – P.U.

ROLINE Gaming Mouse Pad

18.01.2045 – 20

## ROLINE Soft Gaming Pad, Leather Imitation

Perfectly sized mousepad for mobile applications, e.g. when you just work with your Notebook or at a workstation - the leather-like surface gives the mousepad a great look and makes it very durable!

- Designed for professional gamers and office environments
- Provides excellent gliding of the mouse
- Natural rubber base for maximum grip on any surface
- Excellent performance for laser and optical mice
- Material: Surface: high performance textile surface / Base: nature rubber
- Colour: Black
- Dimensions: 220 x 180 x 3mm



**roline**<sup>®</sup>  
Designed for Professionals

Order-No. – P.U.

ROLINE Soft Gaming Pad, Leather Imitation, black

18.01.2046 – 20

## ROLINE Notebook Combo Mousepad (280x160x0.5mm)

Perfect fit between most Macbooks, Ultrabooks, Notebooks/Laptops - suitable for cleaning your display/device, as a mousepad and to protect the Notebook keyboard from dirt and dust!

- Designed for professional gamers and office environments
- Provides excellent gliding of the mouse
- Natural rubber base for maximum grip on any surface
- Excellent performance for laser and optical mice
- Material: Surface: high performance textile surface / Base: nature rubber
- Colour: Black



**roline**<sup>®</sup>  
Designed for Professionals

Order-No. – P.U.

ROLINE Notebook Combo Mousepad (280x160x0.5mm), black

18.01.2047 – 20



## Mobile Computing

Gigabit Ethernet Converter + Hub . . . . .	5.02
Sync- & Charging Cables / Adapters . . . . .	5.02 – 5.03
USB Card Reader . . . . .	5.05
3.5mm Audio Adapters . . . . .	5.07
Docking Stations . . . . .	5.06, 5.07
USB Charger . . . . .	5.08
Stand / Holder for Tablet . . . . .	5.09
Stand for Homepod / Echo . . . . .	5.10
Security Locks . . . . .	5.10

### VALUE USB 3.0 to Gigabit Ethernet Converter + Hub

This converter is a cost effective solution to convert a USB 3.0 port into a 10/100/1000Base-T Ethernet port

- Supports 10/100/1000 Mbit/s auto-sensing capability
- Supports USB 3.0
- Bus powered
- Supports both full-duplex and half-duplex operation in Gigabit Ethernet
- Hub function, 3x

- Supports Windows XP/7/8, Mac OS X
- Contents: Converter



Order-No. – P.U.

VALUE USB 3.0 to Gigabit Ethernet Converter + Hub 3x

12.99.1108 – 10

### VALUE USB 3.1 to Gigabit Ethernet Converter + Hub 3x

This converter is used to connect your device to a Gigabit Ethernet network using a USB 3.1 Type C interface.

- Supports USB 3.0, compatible with USB 2.0 and 1.1
- Easy installation - just plug the converter into the USB port, connect the LAN cable- done
- Supports Gigabit Ethernet with Auto-negotiation, Auto-MDI /-MDIX and half / full duplex
- LED indicators for link and speed

- Additional USB hub function with 3 USB 3.0 Type A ports
- Power supply via the USB interface



Value

Order-No. – P.U.

VALUE USB 3.1 to Gigabit Ethernet Converter + Hub 3x

12.99.1109 – 10

### ROLINE USB 3.0 to Gigabit Ethernet Converter + Hub

This converter is a cost effective solution to convert a USB 3.0 port into a 10/100/1000Base-T Ethernet port

- Supports 10/100/1000 Mbit/s auto-sensing capability
- Supports USB 3.0
- Bus powered
- Supports both full-duplex and half-duplex operation in Gigabit Ethernet
- Hub function, 3x

- Supports Windows XP/7/8, Mac OS X
- Contents: Converter, driver CD



roline  
Designed for Professionals

Order-No. – P.U.

ROLINE USB 3.0 to Gigabit Ethernet Converter + Hub 3x

12.02.1107 – 5

### VALUE USB 3.1 to Gigabit Ethernet Converter

This converter is a cost effective solution to convert a USB 3.1 port into a 10/100/1000Base-T Ethernet port

- Supports 10/100/1000 Mbit/s auto-sensing capability
- Supports USB 3.0
- Type C Connector
- Bus powered

- Supports both full-duplex and half-duplex operation in Gigabit Ethernet
- Supports Windows XP/7/8, Mac OS X
- Contents: Converter, manual

Value



Order-No. – P.U.

VALUE USB 3.1 to Gigabit Ethernet Converter

12.99.1115 – 10

### ROLINE USB 3.1 to Gigabit Ethernet Converter

This converter is a cost effective solution to convert a USB 3.1 port into a 10/100/1000Base-T Ethernet port

- Supports 10/100/1000 Mbit/s auto-sensing capability
- Supports USB 3.0
- Type C Connector
- Bus powered

- Supports both full-duplex and half-duplex operation in Gigabit Ethernet
- Supports Windows XP/7/8, Mac OS X
- Contents: Converter, manual



roline  
Designed for Professionals

Order-No. – P.U.

ROLINE USB 3.1 to Gigabit Ethernet Converter

12.02.1109 – 10

### ROLINE UTP Patch Cord Cat.5e, Retractable

- For a fast network connection without any cable hassle, ideal for travellers
- Flat cable with two unshielded RJ-45 connectors
- In housing with auto-roll-extender, stretches out to a total length of 2 m
- Length scales in inches and centimetres printed on cable
- Cable colour: Black



roline  
Designed for Professionals

Order-No. – P.U.

ROLINE UTP Patch Cord Cat.5e, black, 2.0 m, Retractable

21.15.0591 – 20

### VALUE USB 2.0 Cables, OTG

- High quality USB cable with one Type A (female) and one Micro B USB connector
- For the connection of devices with Micro USB connector; e.g. digital cameras, mobile phones, MP3 players or PDAs

- Not suitable for Samsung Galaxy S3 mini (GT-I8190)
- Meets standard USB 2.0 (transfer rate up to 480 Mbit/s)
- Colour: black



Order-No. – P.U.

VALUE USB 2.0 Cable, A - Micro B, F/M, OTG, 0.15 m

11.99.8311 – 100

ROLINE USB 2.0 Cable, A - Micro B, F/M, OTG, 0.15 m

11.02.8311 – 25

### ROLINE USB 2.0 Y Cable

- For the connection of high-power USB 2.0 devices as e. g. external HDDs
- Very helpful if you want to connect your USB 2.0 device with Micro USB B (smartphone, tablet, digital camera) with an external HDD which needs additional power from a second USB port like PC/notebook/USB charger
- OTG functionality



roline  
Designed for Professionals

Order-No. – P.U.

ROLINE USB 2.0 Y Cable, 2x Type A M/F - 1x MicroB M, 1m

19.08.1009 – 25



**VALUE Cableadapter, USB 3.1, C-A, M/F, OTG**

- High quality USB 3.1 cable with one Type A (female) and one Type C USB connector (male)
- Meets standard USB3.1 (transfer rate up to 10 Gbit/s)
- Colour: black



Order-No. – P.U.

VALUE Cableadapter, USB3.1, C-A, M/F, OTG, black, 0.15 m

11.99.9030 – 25

**ROLINE Cableadapter, USB3.1, C-A, M/F, OTG**

- High quality USB 3.1 cable with one USB Type C connector (male) and one Type A (female)
- Meets standard USB 3.1 with transfer rates up to 5 Gbit/s



Order-No. – P.U.

ROLINE Cableadapter, USB3.1, C-A, M/F, OTG, black, 0.2 m

11.02.9030 – 10

**VALUE Adapter, USB2.0, OTG**

- Connect your Apple Macbook, or Lumia Smartphone to a computer or USB charger for transferring data or charging
- Reversible Design
- Plug and unplug easily without checking for the connector orientation (for type C connector)
- OTG functionality
- Data transfer rate up to 480Mbit/s
- Colour: black



Order-No. – P.U.

VALUE Adapter, USB2.0, C - Micro B, M/F, OTG

12.99.3190 – 10

**ROLINE Adapter, USB 3.1, Type A - C, M/F**

**For connecting devices with USB Type C connection to a USB 3.1 type A connection!**

- Active USB interface converter with a male USB Type-A and a female USB Type-C receptacle
- To plug new coming USB-C devices or cables into your existing computer/ laptop
- USB3.1 SuperSpeed 10G data transfer performance

- Power charging with over current protection 5V@1000mA
- Colour: black
- REMARK: This dongle supports both, USB data communication and power charging features, but does NOT support USB-C DisplayPort Alternate Mode video device, such as USB Type C to HDMI adapter.



Order-No. – P.U.

ROLINE Adapter, USB 3.1, Type A - C, M/F

12.03.2995 – 10

**ROLINE Type C + MicroB to USB A Cable , M/F**

- Compatibility: for most Android / Windows smartphones/tablets ...
- **Type C and Micro USB combo allows the cable to perform 2-in-1 functionality**
- Allows you to transfer date from your mobile device
- Connects to your Smartphone or Android smartphone and charges/syncs by connecting the USB connector into your wall charger or computer
- Colour: black



Order-No. – P.U.

ROLINE Type C + MicroB to USB A Cable , M/F, black, 1.0 m

11.02.8327 – 10

**ROLINE Cable USB MicroB + C M/M to USB2.0 A M**

- Compatibility: for most Android / Windows smartphones/tablets ...
- Type C and micro USB combo allows the cable to perform 2-in-1 functionality
- Allows you to transfer date from your mobile device
- Connects to your Smartphone or Android smartphone and charges/syncs by connecting the USB connector into your wall charger or computer
- Colour: black



Order-No. – P.U.

ROLINE Cable USB MicroB + C M/M to USB2.0 A M/F, black, 1.0 m

11.02.8328 – 10

### VALUE Lightning to USB Cables for iPhone, iPod, iPad

- Lightning is a proprietary computer bus and power connector created by Apple Inc. to replace its previous proprietary 30-pin dock connector, intended to connect mobile devices like iPhones to host computers.
- Using 8 pins instead of 30, Lightning is significantly more compact than the 30-pin dock connector and can be inserted with either side facing up
- For the connection of devices like the iPhone 5, 5s, 6, 6plus, 6s, 6s plus, iPod Touch (5th generation), the iPod Nano (7th generation), the iPad (4th generation), and the iPad Mini (all generations)
- It is NOT compatible with cables and peripherals designed for its predecessor, unless used with an adapter
- High quality USB cable with one Type A (male) and one Lightning connector
- Improved shielding
- Meets standard USB 2.0 (transfer rate up to 480 Mbit/s)



Order-No. – P.U.

VALUE Lightning to USB Cable for iPhone, iPod, iPad, black, 0.15 m 11.99.8326 – 20

VALUE Lightning to USB Cable for iPhone, iPod, iPad, black, 1.0 m 11.99.8321 – 20

VALUE Lightning to USB Cable for iPhone, iPod, iPad, black, 1.8 m 11.99.8322 – 20

### ROLINE Lightning to USB Cables for iPhone, iPod, iPad

- Lightning is a proprietary computer bus and power connector created by Apple Inc. to replace its previous proprietary 30-pin dock connector, intended to connect mobile devices like iPhones to host computers.
- Using 8 pins instead of 30, Lightning is significantly more compact than the 30-pin dock connector and can be inserted with either side facing up
- For the connection of devices like the iPhone 5, 5s, 6, 6 plus, 6s, 6s plus, iPod Touch (5th generation), the iPod Nano (7th generation), the iPad (4th generation), and the iPad Mini (all generations)
- It is NOT compatible with cables and peripherals designed for its predecessor, unless used with an adapter
- High quality USB cable with one Type A (male) and one Lightning connector
- Improved shielding
- Meets standard USB 2.0 (transfer rate up to 480 Mbit/s)



Order-No. – P.U.

ROLINE Lightning to USB Cable for iPhone, iPod, iPad, white, 0.15 m 11.02.8326 – 20

ROLINE Lightning to USB Cable for iPhone, iPod, iPad, white, 1.0 m 11.02.8321 – 20

ROLINE Lightning to USB Cable for iPhone, iPod, iPad, white, 1.8 m 11.02.8322 – 20

### VALUE Lightning Adapter / Cables

- Compatibility: for most Apple / Android / Windows smartphones/ tablets including iPhone 6 Plus / 6 / 5s / 5c / 5 / iPad Air / iPad mini / mini 2 / iPad 4th generation and iPod nano 7th generation, Samsung Galaxy (S5/S4/S3/S2 Note4/Note3/Note2/ Note Tab3/Tab2), other Android & Windows Smartphones / Tablets...
- Lighting and micro USB combo allows the cable to perform 2-in-1 functionality
- Allows you to transfer data from your mobile device
- Connects to your iPhone, iPad, or iPod with Lightning Connector or Android smartphone and charges/syncs by connecting the USB connector into your wall charger or computer



Order-No. – P.U.

VALUE Adapter 8pin-MicroB, M/F, black 11.99.8324 – 20

VALUE 8pin + MicroB to USB Charge & Sync Cable, black, 1.0 m 11.99.8325 – 10

### ROLINE Lightning Adapter/Cables

- Compatibility: for most Apple / Android / Windows smartphones/ tablets including iPhone 6 Plus / 6 / 5s / 5c / 5 / iPad Air / iPad mini / mini 2 / iPad 4th generation and iPod nano 7th generation, Samsung Galaxy (S5/S4/S3/S2 Note4/Note3/Note2/ Note Tab3/Tab2), other Android & Windows Smartphones / Tablets...
- Lighting and micro USB combo allows the cable to perform 2-in-1 functionality
- Allows you to transfer data from your mobile device
- Connects to your iPhone, iPad, or iPod with Lightning Connector or Android smartphone and charges/syncs by connecting the USB connector into your wall charger or computer



Order-No. – P.U.

ROLINE Adapter 8pin-MicroB, M/F, white 11.02.8324 – 20

ROLINE 8pin + MicroB to USB Charge & Sync Cable, white, 1.0 m 11.02.8325 – 10

### ROLINE 8pin + MicroB + Type C to USB Charge & Sync Cable

Connect almost all popular smartphones or tablets via Apple Lightning, USB Type C or USB Micro B plug to your device - suitable for loading and for data transfers!

- USB 2.0 cable with one USB Type A connector and one Apple Lightning (8pin), USB Micro B and USB Type C connector each
- For the connection of devices with Apple Lightning or Micro USB / USB Type C socket - so almost all common smartphones or tablets can be connected!
- With the revolutionary USB Type C connector you are prepared for future

- generations of devices.
- The Lightning plug (8pin) is suitable for all iPhones and iPads from the fifth generation onwards, e.g. for iPhone 8 or iPhone X
- Complies with USB 2.0 standard (transmission up to 480 Mbit/s)
- Allows loading of mobile devices and data exchange
- Colour: white



Order-No. – P.U.

ROLINE 8pin + MicroB + Type C to USB Charge & Sync Cable, 1.0 m 11.02.8329 – 10

### VALUE USB 2.0 Charging Cables

Charging cable for USB devices with USB Micro B connector

- To connect a USB device with USB Micro B to another device with USB Micro B connector for charging
- Only charging, no data transfer
- Not suitable for NOKIA or BLACKBERRY
- Color: white (11.99.8307) / black (11.02.8307)
- Length: 0,3m



Order-No. – P.U.

VALUE USB 2.0 Charging Cable, Micro B - Micro B, M/M, 0.3m 11.99.8307 – 25

ROLINE USB 2.0 Charging Cable, Micro B - Micro B, M/M, 0.3m 11.02.8307 – 10

**ROLINE Magnetic USB2.0 Cable, A-MicroB / Type C**

- High quality USB cable with one Type A and one Micro USB B connector
- Improved shielding
- For the connection of devices with Micro USB connector; e.g. digital cameras, mobile phones, MP3 players or PDAs
- Meets standard USB 2.0 (transfer rate up to 480 Mbit/s)
- Magnetic adapter seamlessly attaches to the cable once they are in close proximity
- Helps to protect the Micro USB B port (e.g. smartphone, tablet) from dust
- Unlike a constant plug-in and unplugging of a normal cable, both ports can be protected during frequent use due to their magnetic connection.
- Attach and detach this magnetic connector through magnetic force

• For additional magnetic connectors please order the item **11.02.8313** or **11.02.8309 (Type C)** (3 pieces)



Order-No. – P.U.

ROLINE Magnetic USB2.0 Cable, A-MicroB, M/M, 1.0 m 11.02.8312 – 10

ROLINE Detachable Magnetic Connector for 11.02.8312, 3 pcs. 11.02.8313 – 20

ROLINE Detachable Magnetic Connector for 11.02.8312, Type C, 3 pcs. 11.02.8309 – 20

**ROLINE GOLD USB 2.0 OTG Cable, A + Micro B - Micro B**

- USB cable with a combined connector consisting of a foldable type A (connector) and a Micro B (connector) on one side and another Micro B (connector) on the other side
- Improved shielding
- For the connection of devices with Micro USB connector; e.g. digital cameras, mobile phones, MP3 players or PDAs
- Meets standard USB 2.0 (transfer rate up to 480 Mbit/s)
- Colour: black/golden



**roline**  
Designed for Professionals

Order-No. – P.U.

ROLINE GOLD USB 2.0 OTG Cable, A + Micro B - Micro B, M/M, 1.0 m 11.02.8314 – 25

**ROLINE GOLD LED USB 2.0 Cable, Reversible, A-Micro B**

- USB 2.0 Hi-Speed cable with high quality and improved shielding.
- For the connection of devices with Micro USB connector; e.g. digital cameras, mobile phones, MP3 players or PDAs
- Improved shielding
- The plugs are gold coated to enhance their contact durability
- Nylon-reinforced outer material for a better stability
- Supports data transfer rates of up to 480 Mbit/s
- High quality USB cable with one Type A and one Micro USB connector
- Meets standard USB 2.0 (transfer rate up to 480 Mbit/s)
- Quick Charge 2.0
- With practical LED display, which shows the current loading status of the connected device



• Colour: gold and black

**roline**  
Designed for Professionals

Order-No. – P.U.

ROLINE GOLD LED USB 2.0 Cable, reversible, A-Micro B, M/M, 1.0 m 11.02.8319 – 10

**VALUE CardReader Typ C + 3x USB 3.0, SD/Micro SD Card Reader**

- Suitable for Smartphone+Tablets
- Transfer your precious vacation pictures/videos from the memory card of your digital camera on your tablet, Macbook ...
- Supports USB 2.0
- Card Reader works with multiple media, as e.g. SD (Secure Digital) Card, SDHC, Micro SD



**roline**  
Designed for Professionals

Order-No. – P.U.

VALUE CardReader Typ C + 3x USB 3.0, SD/Micro SD Card Reader 15.99.6252 – 20

**ROLINE CardReader Type C + 2x USB 3.0 Hub, 1x PD (Power Delivery)**

- Suitable for Smartphone+Tablets, DSLR, photo equipment
- Transfer your precious vacation pictures/videos from the memory card of your digital camera on your tablet, Macbook ...
- Supports USB 2.0
- Card Reader works with multiple media, as e.g. SD (Secure Digital) Card, SDHC, MS (Memory Stick), MS Duo, mini/micro SD
- No adapter required for Micro SD/M2 Cards
- Power Delivery Function (for charging of devices via the additional type-C connection; 20V3A)
- Contents: Card Reader



**roline**  
Designed for Professionals

Order-No. – P.U.

ROLINE CardReader Type C + 2x USB3.0 Hub, 1x PD (Power Delivery) 15.08.6257 – 10



### ROLINE USB Type C Docking Station, 4K HDMI, 1x USB 3.0 Port, 1x USB Type C PD (Power Delivery), 1x Gigabit Ethernet

4K

2160p  
ULTRA HD

The docking station is supplied for Macbooks, Ultrabooks or Notebooks/Laptops and provides a quick and easy connection to the workplace peripherals that you use every day, including one HDMI connector, that allows you a maximum resolution of up to 3840x2160 @60Hz!

- Plug & Play
- Aluminium casing
- Small, compact design
- System requirement: Windows 7/8/10 or MacOS X10.2 and higher

Connection to device:

- 1x USB 3.1 Type C F

Connection for peripheral devices

- 1x HDMI Video Output: Mirror or extend your screen to a TV, monitor or projector.
- 1x USB 3.0 ports (data transfer rate up to 5Gbit/s), for connection of wired keyboard/mouse, USB HDD/SSD, etc.
- 1x USB Type C PD (Power Delivery)- for charging your connected notebook
- 1x RJ45 for Gigabit Ethernet
- Contents: Docking Station, manual



Order-No. – P.U.

12.02.1020 – 10

**roline**<sup>®</sup>  
Designed for Professionals

ROLINE USB Type C Docking Station, 4K HDMI, 1x USB 3.0 Port, 1x USB Type C PD (Power Delivery), 1x Gigabit Ethernet

### ROLINE USB Type C Docking Station, 4K HDMI, 2x USB3.0 Ports, 1x SD/MicroSD Card Reader

4K

2160p  
ULTRA HD

The docking station is supplied for Macbooks, Ultrabooks or Notebooks/Laptops and provides a quick and easy connection to the workplace peripherals that you use every day, including one HDMI connector, that allows you a maximum resolution of up to 3840x2160 @60Hz!

- Plug & Play
- Aluminium casing
- Small, compact design
- System requirement: Windows 7/8/10 or MacOS X10.2 and higher

Connection to device:

- 1x USB 3.1 Type C F

Connection for peripheral devices

- 1x HDMI Video Output: Mirror or extend your screen to a TV, monitor or projector.
- 2x USB 3.0 ports (data transfer rate up to 5Gbit/s), for connection of wired keyboard/mouse, USB HDD/SSD, etc.
- 1x SD/TF Card Reader
- Contents: Docking Station, manual



Order-No. – P.U.

12.02.1041 – 5

**roline**<sup>®</sup>  
Designed for Professionals

ROLINE USB Type C Docking Station, 4K HDMI, 2x USB3.0 Ports, 1x SD/MicroSD Card Reader

### ROLINE USB C Docking Station, 4K HDMI, 2x USB3.0 Ports, 1x SD/MicroSD Card Reader, 1x USB Type C PD (Power Delivery), 1x Gigabit Ethernet

4K

2160p  
ULTRA HD

The docking station is supplied for Macbooks, Ultrabooks or Notebooks/Laptops and provides a quick and easy connection to the workplace peripherals that you use every day, including one HDMI connector, that allows you a maximum resolution of up to 3840x2160 @60Hz!

- Plug & Play
- Aluminium casing
- Small, compact design
- System requirement: Windows 7/8/10 or MacOS X10.2 and higher

Connection to device:

- 1x USB 3.1 Type C F

Connection for peripheral devices

- 1x HDMI Video Output: Mirror or extend your screen to a TV, monitor or projector.
- 2x USB 3.0 ports (data transfer rate up to 5Gbit/s), for connection of wired keyboard/mouse, USB HDD/SSD, etc.
- 1x SD/TF Card Reader
- 1x USB Type C PD (Power Delivery)
- 1x RJ45 for Gigabit Ethernet
- Contents: Docking Station, manual



Order-No. – P.U.

12.02.1037 – 5

**roline**<sup>®</sup>  
Designed for Professionals

ROLINE USB Type C Docking Station, 4K HDMI, 2x USB3.0 Ports, 1x SD/MicroSD Card Reader, 1x USB Type C PD (Power Delivery), 1x Gigabit Ethernet

**ROLINE USB Type C Docking Station, 4K HDMI, 3x USB 3.0 Ports, 1x SD/MicroSD Card Reader, 1x USB Type C PD (Power Delivery)**

4K

The docking station is supplied for Macbooks, Ultrabooks or Notebooks/ Laptops and provides a quick and easy connection to the workplace peripherals that you use every day, including one HDMI connector, that allows you a maximum resolution of up to 3840x2160 @30Hz!



- Plug & Play
- Aluminium casing
- Small, compact design
- System requirement: Windows 7/8/10 or MacOS X10.2 and higher

**Connection to device:**

- 1x USB 3.1 Type C M

**Connection for peripheral devices**

- 1x HDMI Video Output: Mirror or extend your screen to a TV, monitor or projector.
- 3x USB 3.0 ports (data transfer rate up to 5Gbit/s), for connection of wired keyboard/ mouse, USB HDD/SSD, etc.
- 1x SD/TF Card Reader
- 1x USB Type C PD (Power Delivery)
- Contents: Docking Station, manual

NEW

**roline**  
Designed for Professionals

Order-No. – P.U.

ROLINE USB Type C Docking Station, 4K HDMI, 3x USB 3.0 Ports, 1x SD/MicroSD Card Reader, 1x USB Type C PD (Power Delivery)

12.02.1115 – 5

**ROLINE USB Type C Docking Station, 1x 4K HDMI, 1x VGA, 1x DP, 1x Fast Ethernet**

4K

The docking station is supplied for Macbooks, Ultrabooks or Notebooks/ Laptops and provides a quick and easy connection to the workplace peripherals that you use every day, including one HDMI connector, that allows you a maximum resolution of up to 3840x2160 @30Hz!



- Plug & Play
- Aluminium casing
- Small, compact design
- System requirement: Windows 7/8/10 or MacOS X10.2 and higher

**Connection to device:**

- 1x USB 3.1 Type C FM

**Connection for peripheral devices**

- 1x HDMI Video Output: Mirror or extend your screen to a TV, monitor or projector (max. resolution 2160p)
- 1x VGA (max. resolution 1080p)
- 1x DP (max. resolution 2160p)
- 1x RJ45 for Gigabit Ethernet
- Contents: Docking Station, manual

NEW

**roline**  
Designed for Professionals

Order-No. – P.U.

ROLINE USB Type C Docking Station, 1x 4K HDMI, 1x VGA, 1x DP, 1x Fast Ethernet

12.02.1116 – 10

**ROLINE Dual Head Docking Station, HDMI, USB 3.0**

The Dual Head docking station for net-/notebooks provides a quick and easy connection to the workplace peripherals that you use every day.



**Connection to net-/notebook:**

- 1x USB 3.0 Type B F

**Connection for peripheral devices**

- 1x DVI-I monitor output- supports video resolutions up to 1920 x 1080
- 1x HDMI monitor output- supports video resolutions up to 1920 x 1080 (FullHD)
- 4x USB 2.0 ports make connections quick and easy
- 2x USB 3.0 for HDD or other fast USB 3.0 devices, ideal for use with „quick access“ devices
- 1x RJ45 Gigabit LAN jack
- 1x 3,5mm mikrophone jack on the front
- 1x 3,5mm headphone jack on the front
- Gain instant access to your keyboard, monitor, mouse and all peripherals with one USB plug
- DualView lets you expand your work area across your notebook screen and external monitor
- Dual display settings- Allows you to switch between mirror and extended video mode
- Plug & Play
- Supports Windows 2000/XP/Vista/7
- Contents: Docking Station, power supply, USB cable, stand, driver CD, manual



**roline**  
Designed for Professionals

Order-No. – P.U.

ROLINE Dual Head Docking Station for Net-/Notebooks, „Black and White“, USB 3.0

12.02.1042 – 5

**ROLINE USB to HDMI Adapter for iOS/Android Smartphones**

Connect your smartphone/tablet (Apple iOS/ Android) to a monitor or TV via USB cable and use it to mirror your smartphone screen to display pictures and videos - with resolutions of up to 1920x1080 @60Hz!

- Fast video adapter that streams iOS or Android multimedia applications to an HDMI output (up to 1080p)
- Mirrors the display and transmits the audio signals from the iPhone or Android smartphone to an HDMI monitor/-TV

- Supports almost all iOS and Android device versions
- Power supply via USB Micro B socket (5VDC, max. 0.5A) possible and recommended from our point of view
- Connection to smartphone via USB (Type A socket)
- Requires the use of an app that can be downloaded from popular app stores
- Contents: Adapter, manual



NEW

Order-No. – P.U.

ROLINE USB to HDMI Adapter for iOS/Android Smartphones

14.01.3419 – 10

**VALUE / ROLINE 3.5mm Adapters**

- Use in multimedia environment
- Adapter to connect 3,5mm Stereo male plug to 2 x 3,5mm Stereo female plug (Audio)



Order-No. – P.U.

VALUE 3.5mm Adapter, 1x 3.5mm M to 2x 3.5mm F

A 11.99.4440 – 100

VALUE 3.5mm Adapter, 1x 3.5mm M to 2x RCA F

B 11.99.4441 – 100

ROLINE 4 Conductor 3.5 mm Stereo Plug (speaker+microphone), 15 cm C 11.09.4441 – 20

### VALUE USB Power Chargers

- Wall chargers resp. car charger with 2 USB type A F connectors
- For power supply and charging of devices with external power supply over USB
- E.g. for MP3 players, mobile phones, smart phones etc.
- Handy to use whether at home or in the hotel



**Value**

**TOP**

Technical data:	19.99.1064	19.99.1059
Input:	100-240 V AC, 50-60 Hz	12-24 V DC, 2.1A max.
Output:	2x USB Type A F	2x USB Type A F
Power:	10W (5VDC;2A)	10W (5VDC; .12A)
Dimensions:	46x28x85mm	33x35mm

Order-No. – P.U.

VALUE USB Wall Charger, 2 Ports, 10W A 19.99.1064 – 20

VALUE USB Car Charger, 2 Port, 10W B 19.99.1059 – 20

### ROLINE USB Car Charger, 2 Port, 15W

Now you can easily charge your tablet PC, iPad, smart phone, iPhone, MP3 player and other USB devices in your car!

- Connector: 2x USB type A F
- Input voltage: DC 12 V- 24 V
- Output voltage: 5 V DC/ 3100 mA max. car!



Technical data:	19.07.1054	19.07.1055
Input:	12-24 V DC	12-24 V DC
Output:	2x USB A F	2x USB A F
Power:	15,5W (5VDC;3,1A)	15,5W (5VDC;3,1A)
Dimensions:	33 x 60 mm	38 x 75 mm

**roline**  
Designed for Professionals

Order-No. – P.U.

ROLINE USB Car Charger, 2 Port, 15W A 19.07.1054 – 10

ROLINE LED USB Car Charger, 2 Port, 15W B 19.07.1055 – 10

### ROLINE USB QC3.0 Car Charger, 2 Port, (A + C), 12W

Now you can easily charge your tablet PC, iPad, smart phone, iPhone, MP3 player and other USB devices in your car!

- Quick Charge 3.0
- Connector: 1x USB Type A F, 1x Type C F
- Input voltage: DC 12 V- 24 V
- Output voltage: 5 V DC/ 2400 mA max.



**roline**  
Designed for Professionals

Order-No. – P.U.

ROLINE USB QC3.0 Car Charger, 2 Port, (A + C), 12W 19.07.1053 – 20

### VALUE Car Charger with 4x USB 2.0 Ports

- 4 port USB car charger with two ports in front (where you plug in the car adapter- cigarette lighter) and two ports extension for the backseat
- Super convenient on long trips, because 4 devices (tablets/smartphones ...) can be charged simultaneously
- The 4x USB 2.0 ports are equipped with blue LED indicator
- The cable for the backseat port extension is about 1.8m long and has a clip which helps you to attach it to the pockets behind the front seats
- Power Output: 48 W (4x 5V DC, 2.4A)
- Smart IC, detects the correct maximum output for the plugged in device
- Material: ABS+PC



Order-No. – P.U.

VALUE Car Charger with 4x USB 2.0 ports, black 19.99.1063 – 10

### VALUE USB Charging Station, 7 Port, with Storage Box

Charges up to 7 devices simultaneously via USB, such as smartphones, tablets, eReader and many other devices.

- Provides 7 USB sockets (5x type A, 1x QC3.0, 1x type C)
- Easy to use at home or on the go; most smartphones and tablets fit (even with a case) into the holders on the device.
- Detachable connection cable (1.2m). (IEC320 C7 on Euro flat plug)
- Overvoltage protection on each port
- Smart charging function: Determines the charging demand of each connected device and charges- controlled- according to
- The power supply unit, cables and the corresponding holding rails can be stowed in the housing in a space-saving and safe manner

#### Technical Specifications

- Charger with mains input and seven USB outputs, 5x type A socket, 1x QC3.0, 1x type C
- Input voltage: 100- 240V AC, 50- 60Hz
- Output voltage: 5x type A DC 5V 1.5A/2.4A; 1x QC3.0 DC 3.6V- 5V / 2A, 5.2V- 9V / 2A, 9.2V- 12V /1.5A; 1x type C 5V 3A

- Contents: 1x USB 7-Port Smart Charging Hub, 1x main adaptor 15VDC/4A + AC Power Cable, 1x Storage Box, 8x Removable Brackets

**REMARK:**  
Please see for additional charging stations page 7.08

**Value**

**NEW**



Order-No. – P.U.

VALUE USB Charging Station, 7 Port, with Storage Box 19.99.1069 – 4



### Hook-and-loop stripes

With this silicon stripes, it's possible to neatly arrange all the cables that you use in your daily business, e.g. headphone or adapter cables. For an easy cable management of your household!

- Versatile and reusable design
- User-friendly

- The detachable silicone closure allows easy but secure closure and opening
- Durable and elastic silicone material
- 4 gray hook-and-loop stripes- available in two different lengths

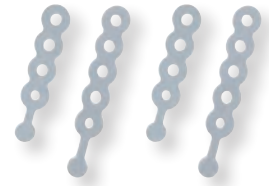

Order-No. – P.U.

Hook-and-loop stripes, 4 pcs.

19.08.3251 – 25

**roline**  
Designed for Professionals

### VALUE USB Wall Charger (EU+UK)

For charging mobile devices, even two at one time.

- Wall power adapter with two USB type A F connectors and 2 adapters (EU+UK)
- It's handy to use whether at home or in the hotel
- For charging smart phones, tablet PCs (e. g. iPad), MP3 players ...
- Input range: 100- 240 V AC, 50- 60 Hz
- Output voltage: 5 V
- Output rate: 10 W (2 A)
- Dimensions: 42 x 42 x 25 mm



**Value**

Order-No. – P.U.

VALUE USB Wall Charger (EU+UK), 2 Ports, 10W

19.99.1061 – 20

### ROLINE Holder for iPad/Ebook/Tablet, Wallmount

- Wall/under cabinet mount for most of the tablets like iPad1, iPad2, iPad3, iPad 4, iPad Air and iPad Air 2, Samsung Galaxy 10.1 and Tab 2
- 360° rotation of panel and base
- Flexible angle between two legs of 36°~ 180°
- Adjustable top leg length of 26-64mm
- Die casting joint part connecting aluminum arms with length of 120mm

- Freely ±30° tilted silicone feet for holding your tablets perfectly
- Tilt of panel: ±125°
- Tilt of arms: ±100°
- Material: aluminum/steel/plastic

**roline**  
Designed for Professionals



Order-No. – P.U.

ROLINE Holder for iPad/Ebook/Tablet, Wallmount, 4 Joints

17.03.0023 – 5

### VALUE Holder for iPad/Ebook/Tablet

- Wall/under desk (clamp) cabinet mount for most of the tablets like iPad1, iPad2, iPad3, iPad 4, iPad Air and iPad Air 2, Samsung Galaxy 10.1 and Tab 2
- 360° rotation of panel and base
- Flexible angle between two legs of 36°~ 180°
- Adjustable top leg length of 26-64mm
- Die casting joint part connecting aluminum arms with length of 120mm
- Freely ±30° tilted silicone feet for holding your tablets perfectly
- Tilt of panel: ±125°
- Tilt of arms: ±100°
- Material: aluminum/steel/plastic

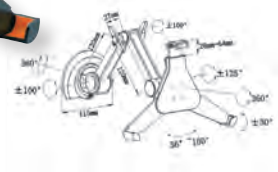

Order-No. – P.U.

VALUE Holder for iPad/Ebook/Tablet, Wall- / Under Cabinet Mount, 4 Joints A 17.99.1150 – 5

VALUE Holder for iPad/Ebook/Tablet, Clamp Type, 4 Joints B 17.99.1151 – 5

### VALUE Universal Tablet Headrest Holder

- Car headrest holder for iPad 1/2/3/4/ Air/Air2, 8.9"-10.4" Galaxy and other tablets
- Range of headrest pin width: 156mm~186mm
- Suit headrest pins up to 16mm in diameter
- Flexible angle between two legs of 36°~ 180°
- Adjustable top leg length of 26-64mm
- Freely ±30° tilted silicone feet for holding your iPad perfectly
- 360° rotation allows portrait and landscape viewing

- Easy and secure attachment
- Clamper width:184mm
- Material: steel + plastic

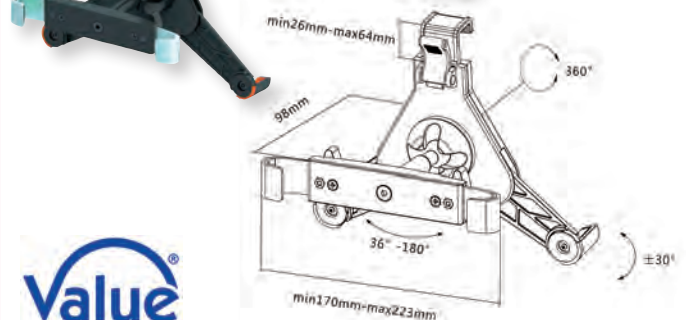

**Value**

Order-No. – P.U.

VALUE Universal Tablet Headrest Holder

17.99.1152 – 10

### VALUE Holder for iPad/Ebook/Tablet, Wall- / Under Cabinet Mount

- Wall/under cabinet mount for most of the tablets like iPad, Samsung Galaxy 10.1 and Tab 2 etc.
- 360° rotation of panel and base
- The casting joint part connecting aluminum arms with length of 120mm, 190 mm
- Silicone feet for holding your tablets perfectly
- Adjustable Length: 128-224mm
- Tilt of panel: 360°
- Tilt of arms: 0°- 170°, - 40° - +180°
- Material: aluminum/steel/plastic

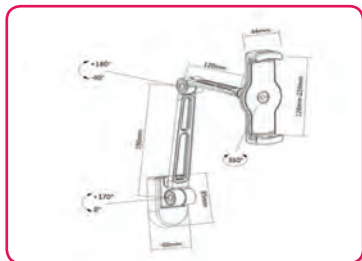
Order-No. – P.U.

VALUE Holder for iPad/Ebook/Tablet, Wall- / Under Cabinet Mount, black, 4 Joints 17.99.1158 – 10

### VALUE Smart Speaker Wall Mount for Echo and Homepod

**In the huge smart speaker market, this wall mount is the perfect way to store your devices - from Amazon Echo to the Apple Homepod!**

- Designed for smart speakers like Google Home, Amazon Echo or the Apple Homepod
- Space-saving organization- seamlessly integrates all your smart speakers into your home without them getting in the way.
- The stability of the speaker on the solid steel bracket is supported by a magnetic plate on the underside of the speaker.
- Black powder coating
- The open, floating design keeps the microphone and speakers completely free for a balanced sound and speech experience.
- Material: steel, aluminium, plastic
- Load capacity: 2kg





Order-No. – P.U.

VALUE Smart Speaker Wall Mount for Echo and Homepod, 3 Joints 17.99.1327 – 20

### ROLINE Universal Tablet Holder, flexible, VESA compatible

**Tablet Holder for e.g. tablets/iPads and e-book reader - usable in any case due to the mounting function via VESA 75 or by screws, as a stand or on e.g. a fridge due to the magnetic stripe on the holders back!**

- Can accommodate different tablet sizes: 18 cm to 25.65 cm (7"-10.1")
- Anti-slip pad on the inside of the holder
- Useable for portrait or landscape screen; perfect for browsing, reading, watching movies or any other popular multimedia application.

- Wall mounting of the bracket by means of screws on an existing VESA 75 bracket or directly on the wall through the two screw holes on the rear side of the bracket.
- The two additional magnetic strips on the rear side of the holder also ensure universal usability, for example on refrigerators.
- VESA 75 x 75 mm
- Dimensions: max. 265 x 140 x 14 mm
- Colour: white



Designed for Professionals

Order-No. – P.U.

ROLINE Universal Tablet Holder, flexible, VESA compatible, white 17.03.0029 – 10

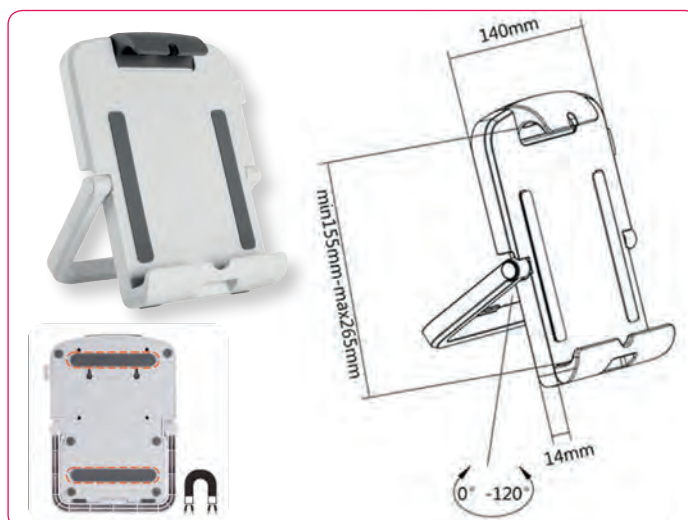

### VALUE Universal Smartphone / Tablet Lock

**Glue-On Locking Plate with a built in security slot**

- Application: stores, display units, trade shows and more
- Easy to use: loop the cable around a fixed object and secure the locking head into the locking plate on the tablet/iPad/ Smartphone

- 3mm industrial glue- this plates are removable and offer a perfect balance between security, aesthetics and the ability to remove without damaging the devices or leaving glue behind
- Steel cable: 4mm thick, ca. 1.6 m length with PVC coating
- Content: 1x glue-on Locking Plate (45x45mm) with a built in security slot, 1x strong steel cable, 2x keys
- Contents: Anti-Theft Cable with keys



Order-No. – P.U.

VALUE Universal Smartphone / Tablet Lock, with key 19.99.3025 – 5

### VALUE Notebook Cable Security Lock

**Suitable for all notebooks with „security hole“**

- Easy use and installation: tie the steel cable around any furniture or something like that
- Install the security lock in the „security hole“ and lock it with the key
- Zinc alloy housing and brass cylinder
- Satin nickel plated standard, other finishes available upon request
- 7-pin tumbler mechanism
- Steel made tubular keys, nickel plated
- Key withdrawals in one position only

- 90 degrees turn to unlock
- Stainless steel cable: 5 mm diameter, 1.7 m length, dark grey with transparent PVC coating
- Contents: Anti-Theft Cable with keys



Order-No. – P.U.

VALUE Notebook Cable Security Lock, with key 19.99.3022 – 50



## Multimedia

USB Display Adapters .....	6.02
Audio/Video Extenders over TP .....	6.03 – 6.05
HDMI / DP Extenders.....	6.04 – 6.07
Wireless HDMI Audio/Video Systems .....	6.05
UHD HDMI Active Cables .....	6.06 – 6.07
Audio/Video Splitters .....	6.08 – 6.10, 6.11, 6.13
Audio/Video Switches .....	6.11 – 6.12, 6.13
HDMI Matrix Switches.....	6.12, 6.13
HDMI Emulator .....	6.13
Audio Extractor .....	6.14
Audio Adapters / Converters .....	6.15
Headsets.....	6.15, 6.16
Video Grabber / Converter .....	6.15
Multimedia Audio/Video Modules.....	6.16



## VALUE USB Display Adapter, USB 3.0 to VGA

- Compliant with USB 3.0 specification revision 1.0
- Compliant to USB A/V standard
- USB upstream port supporting SuperSpeed/HighSpeed data rate (5 Gbit/s / 480Mbit/s)
- Video output up to 1920 x 1080 @ 60 Hz in USB 3.0 application
- Video output 800 x 600 in USB 2.0 application
- Plug & Play
- Contents: USB display adapter

**Value**<sup>®</sup>

Order-No. – P.U.

VALUE USB Display Adapter, USB3.0 to VGA

12.99.1037 – 10



## ROLINE USB Display Adapter, USB - DVI/VGA

**Quick add-on of a monitor, LCD or projector with DVI or VGA connector through a single USB 2.0 port of your PC or notebook.**

- Minimum cost for having equivalent extra video card performance
- Small form factor for easy portability
- Enlarges the area of screen and allows you to have more convenience for windows allocation
- Supported resolutions: 640 x 480, 800 x 600, 1024 x 768, 1280 x 720, 1280 x 768, 1280 x 800, 1280 x 1024, 1366 x 768, 1400 x 1050, 1600 x 1200, 1680 x 1050, 1920 x 1080

- Supported modes: Mirrored Desktop, Extended Desktop, Primary Display
- Up to 6 USB Display Adapters can work simultaneously
- Plug & play, easy for installation and use
- Hot-pluggable; Add or remove monitor without system reboot
- For connection of a VGA (HD15) device the included DVI/VGA converter has to be used
- Colour: Charcoal grey
- Supports Windows 2000/XP/Vista/7
- Contents: USB Display Adapter, DVI to VGA converter, USB cable (90 cm), driver CD, manual

**roline**<sup>®</sup>  
Designed for Professionals

Order-No. – P.U.

ROLINE USB Display Adapter, USB - DVI/VGA

12.02.1051 – 5

ROLINE USB Display Adapter, USB - DVI/VGA, high resolution

12.02.1052 – 5



## ROLINE USB 3.0 Display Adapter, HDMI, 4K, black

3D  
capable

4K

- Add one monitor or projector through a single USB 3.0 port to your PC or notebook
- Video output: HDMI
- Supports high resolutions up to 3840x2160 (nominal)
- Supported modes: Extended desktop, Mirrored desktop, Primary display
- Downwards compatible with USB 2.0 (lower resolution and video performance)

- Hot-pluggable- add or remove a monitor without system reboot
- Various USB display adapters can work simultaneously (up to six, dependent upon system)
- Contents: USB Display Adapter, USB cable (40 cm), driver CD, manual

### Connectors:

PC: 1x USB 3.0  
Peripherals: 1x HDMI

**roline**<sup>®</sup>  
Designed for Professionals

Order-No. – P.U.

ROLINE USB 3.0 Display Adapter, HDMI, 4K, black

12.02.1034 – 5



### VALUE USB 3.0 Mini DP Docking Station

1080p FULL HD



- USB 3.0 Mini DP docking station
- Upstream connection: 1x USB3.0
- Downstream connection 2x USB3.0
- HDMI port with a resolution: up to 1920 x 1080
- 1x RJ45 Ethernet port (Fast Ethernet 10/100) network can be accessed through the USB port
- Power Mode: Bus-powered
- Supported Operating System: Windows 7/ 8/ 8.1/10 and Mac OS 10
- Dimensions: 305 x 120 x 20 mm
- Contents: Adapter

- Connectors front side:**
- 2x USB3.0 Type A F for connection of computer/notebook peripherals (printer, scanner...)
  - 1x HDMI F port for video output
  - 1x DP F port for video output
  - 1x RJ45- 10/100 Fast Ethernet LAN port

- Connectors back side:**
- 1x USB 3.0 M
  - 1x Mini DP M



Order-No. – P.U.

VALUE USB3.0 Mini DP Docking Station

12.99.1041 – 10

### VALUE VGA Extender over Twisted Pair

- Extension of VGA signal over Cat. 5e cable, up to 80 m
- Equalization length is adjustable
- VGA signal gain is adjustable
- Durable metal casing
- Supports power over cable technique, only one unit has to be connected to power
- Hardware solution, no compatibility problems
- Contents: Local unit, remote unit, 1x power supply (12V DC, 600mA) for remote unit, VGA cable HD15 M-M (1.2 m), manual

**Technical data:** each unit  
 1x USB 3.0  
 VGA connection: 1x HD15 F  
 TP ports: 1x RJ-45  
 Max. resolution (nominal): 1280 x 1024 @ 60Hz  
 Casing: Metal  
 Power supply: 12V DC, 1A

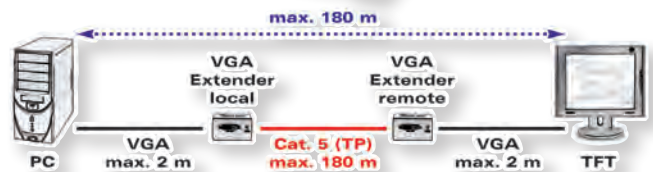

Order-No. – P.U.

VALUE VGA Extender over Twisted Pair, 80 m

14.99.3431 – 10

VALUE VGA Extender over Twisted Pair, 180 m

14.99.3430 – 10

### ROLINE Active DVI Extender over Twisted Pair

- DVI Extender (one Local and one Remote Unit) in combination with a twisted pair cable extends a DVI-D video signal up to 50 meters
- Max. distance from local unit to remote unit: 50 m
- Supports DVI-D
- EDID Function
- Max. resolution (nominal): 1920 x 1080
- Metal housing
- Contents: Local unit (RJ-45 F, DVI F), remote unit (RJ-45 F, DVI F), 2x power supply, manual

**Technical Data:**  
 Max. resolution (nom.): 1920 x 1080  
 Local Unit: 1x RJ-45 F, 1x DVI F  
 Remote Unit: 1x RJ-45 F, 1x DVI F

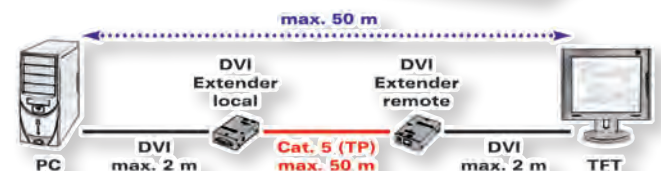

Order-No. – P.U.

ROLINE Active DVI Extender over Twisted Pair, 50 m

14.01.3408 – 5

VALUE HDMI Extender over TP

3D capable 1080p FULL HD

- The transmission distance of the HDMI signal can be extended up to 25 meters by using two Cat. 5e/6 cables
- Max. resolution (nominal) while using two Cat.5e cables, 25 m: 1080p
- HDCP pass-through
- Stable metal casing
- Power supply included in delivery
- Contents: Transmitter (2x RJ-45 F, HDMI F), Receiver (2x RJ-45, HDMI F), 1x power supply (5V DC, 2A) for receiver, manual

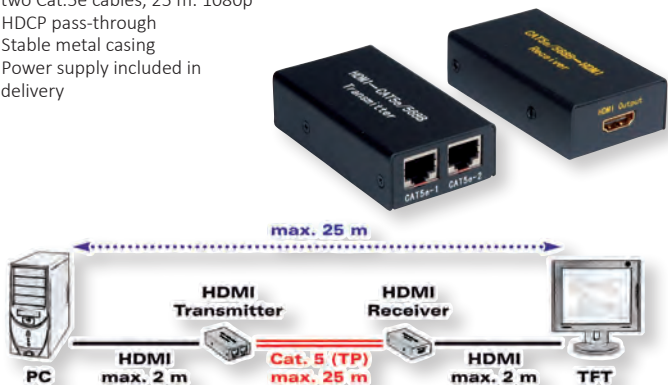

**Technical Data:**  
 Max. resolution (nominal): 1.920 x 1.200, 1080p  
 Local unit: 2x RJ-45 F, 1x HDMI F  
 Remote unit: 2x RJ-45 F, 1x HDMI F  
 Dimensions: 20 x 45 x 80 mm  
 Power supply: DC 5V; 2A



Order-No. – P.U.

VALUE HDMI Extender over Twisted Pair, 25 m

14.99.3460 – 5

ROLINE HDMI Extender over TP

3D capable 1080p FULL HD

- The transmission distance of the HDMI signal can be extended up to 50 meters by using only one Cat.6 cable
- Additional HDMI port on transmitter to connect a local display
- Max. resolution (nominal) over 50 meters: 1920 x 1080, 1080p
- Works with HDMI switch, HDMI splitter and all kinds of HDMI/HDCP source and output displays
- No software installation required
- Metal housing
- Power supply included
- Contents: Transmitter (1x RJ-45 F, 2x HDMI F), Receiver (1x RJ-45 F, 1x HDMI F), 2x power supply (for transmitter), manual

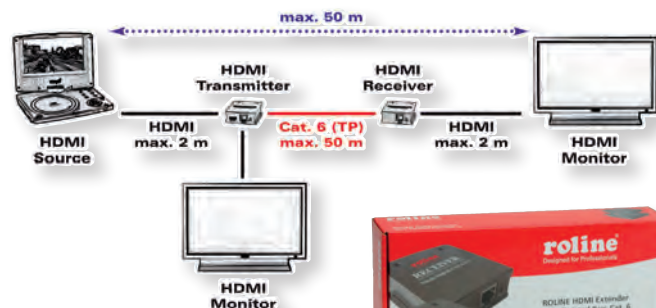

**Technical data (14.01.3461):**  
 Max. resolution (nominal): 1.920 x 1.200, 1080p  
 Transmitter: RJ-45 F, 2x HDMI F  
 Receiver: RJ-45 F, 1x HDMI F  
**Technical data (14.01.3462):**  
 Max. resolution (nominal): 1.920 x 1.200, 1080p  
 Transmitter: RJ-45 F, 1x HDMI F  
 Receiver: RJ-45 F, 1x HDMI F



Order-No. – P.U.

ROLINE HDMI Extender over Twisted Pair, Cat.6, 50m

14.01.3461 – 5

ROLINE HDMI Extender over Twisted Pair, Cat.5/6, 100 m

14.01.3462 – 1

ROLINE HDMI Extender over Twisted Pair, Cat.5/6, chainable

1080p FULL HD

The transmission distance of the HDMI signal can be extended up to 100 m by using one Cat.5e or Cat.6 cable.

- Easily connect the transmitter and the receiver unit with a twisted pair cable of up to 100 m length
- Max. resolution (nominal) over 100 m: 1920 x 1200, 1080p
- Supports uncompressed HDMI signal
- Supports CEC pass-through
- Supports uncompressed audio stereo
- External infrared emitters- allow using the remote control of the source device

- Metal housing
- Power supply included in content of delivery
- Contents: Transmitter (1x RJ-45 F, 2x HDMI F), receiver (3x RJ-45 F, 1x HDMI F), infrared extender transmitter, infrared extender receiver, 2x power supply, 2x cables IR (1.1m), 2x serial cables (3.5mm/DB9F, 1.1m), manual



**Technical data (14.01.3468):**  
 Max. resolution (nominal): 1.920 x 1.200, 1080p  
 Transmitter: RJ-45 F, 2x HDMI F  
 Receiver: RJ-45 F, 1x HDMI F  
**Technical data (14.01.3469):**  
 Max. resolution (nominal): 1.920 x 1.200, 1080p  
 Receiver: 3x RJ-45 F, 1x HDMI F  
 Dimensions: 115 x 91 x 28mm

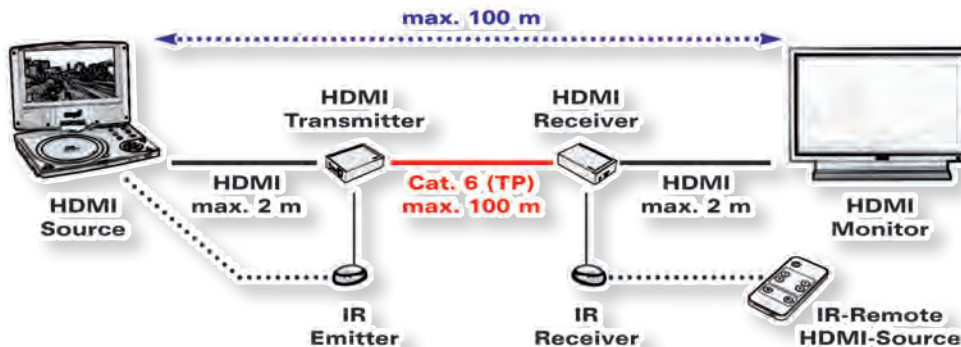

Order-No. – P.U.

ROLINE HDMI Extender over TP, Cat.5/6, chainable, 100 m

A+B 14.01.3468 – 1

ROLINE HDMI Receiver over TP, for 14.01.3468, 100 m

B 14.01.3469 – 1





**VALUE Wireless Audio/Video System, HDMI**

**1080p**  
FULL HD

The VALUE Wireless HDMI A/V (Audio/Video) system transmits an HDMI signal wirelessly from a HD video source (e. g. BluRay player, laptop, computer) to a HD TV or HD projector. This means that a television or similar can be set up completely independent of a TV connection and can be set up at a distance of up to 100m; with a resolution of up to 1920x1080 @60Hz!

Devices are connected via HDMI. Built-in antennas enable wireless transmission of the encrypted HDMI signal between transmitter and receiver over distances of up to 100 meters.

Widely applicable to office presentation, lecture, education, conference, family entertainments etc.

- Transmits a HDMI signal wirelessly from a HD source to a HD TV or HD beamer.
- External dual gain antenna for wireless data transmission of up to 100 m
- Resolution: Full HD 1080p (up to 1920 x 1080 nominal)
- Works in 2.4/5GHz frequency band
- Supports HDMI mirror output and infrared remote control extension
- External infrared transmitter to transmit the remote control signal
- HDCP compatible
- Contents: Sender, receiver, 2x base stand, external infrared emitter, 2x power supply, manual



Order-No. – P.U.

VALUE Wireless Audio/Video System, HDMI, 100m

14.99.3412 – 2

**ROLINE Wireless A/V System, HDMI**

**3D**  
capable

**1080p**  
FULL HD

The ROLINE Wireless Audio/Video system transmits an HDMI signal wirelessly from an HD source device (e. g. DVD player, set-top-box, game console or a computer) to an HD TV or HD projector. So e. g. a TV set can be installed totally flexible and independent of a TV connection.

- Wireless data transmission of up to 50 m
- Compliant with IEEE 802.11n WLAN standard

- Supports Frequency range up to 5GHz
- With dual antenna for WiFi
- Resolution HDMI: Full HD 1080p (up to 1920 x 1080 nominal)
- External infrared emitter for extending the IR remote receiving function of e. g. your DVD player remote control
- HDCP compatible

- Contents: transmitter, receiver, external infrared emitter, 2x power supply, manual



**roline**  
Designed for Professionals



Order-No. – P.U.

ROLINE Wireless Audio/Video System, HDMI, 30.0 m

14.01.3411 – 1

**ROLINE DisplayPort Extender over Twisted Pair, Cat.5/6, 70m**

The transmission distance of the DisplayPort signal can be extended up to 70 m by using one Cat.5e or Cat.6 cable.

- Ideal for display applications in conference rooms, classrooms & training facilities etc.
- Extend the DisplayPort signal up to 70 meters by using only one Cat.5/6 cable
- Support Phantom Power – use a single power supply at either the transmitter or receiver unit (Tx & Rx)
- EDID migration ensures the optimum video performance
- Max. resolution (nominal) over 70 meters: 1920x1080 @60Hz
- HDTV compatible
- HDCP compliant

**roline**  
Designed for Professionals



Order-No. – P.U.

ROLINE DisplayPort Extender over Twisted Pair, Cat.5/6, 70m, 100 m

14.01.3471 – 3

- LED Indicator
- Plug & Play
- Metal housing
- Power supply included in delivery (12 VDC, 1.5A)
- Contents: Transmitter (1x RJ-45 F, 1x DP F), receiver (1x RJ-45 F, 1x DP F), 1x power supply, manual



**ROLINE HDMI High Speed Cable with Repeater**

**3D**  
capable

**1080p**  
FULL HD

- For a total length of 30 meters between PC and monitor
- Hardware solution, no software required
- Integrated repeater without external power supply
- Dimensions of repeater: 15 x 23 x 75 mm
- Color: black
- Contents: cable with integrated repeater

**digital signage** **roline**  
Designed for Professionals



Order-No. – P.U.

ROLINE HDMI High Speed Cable, M - M, with Repeater, 30 m

14.01.3465 – 1

**ROLINE HDMI High Speed Cable with Ethernet with Repeater**

**3D**  
capable

**1080p**  
FULL HD

- For a total length of 25 meters between computer and monitor
- Active repeater is integrated in the connectors
- Hardware solution, no software required
- No external power supply needed
- Connectors: HDMI Type A M
- Color: Black

**digital signage** **roline**  
Designed for Professionals



Order-No. – P.U.

ROLINE HDMI High Speed Cable w.Eth., M - M, with Repeater, 25 m

14.01.3466 – 1

## ROLINE HDMI High Speed Cable with Ethernet, with Repeater

4K

High-quality HDMI connection cable with HDMI connectors for optimal transmission of digital UHD TV signals at resolutions of up to 3840x2160 @30Hz at up to 50m.

- For a total length of 50 meters between Transmitter (PC, BluRay player, ...) and Receiver (Monitor, TV, Beamer)
- Active repeater for optimal signal transmission
- Hardware solution, no software required
- Connectors: HDMI Type A M/M
- Color: Black

**roline** or: Black  
Designed for Professionals

NEW



Order-No. – P.U.

ROLINE HDMI High Speed Cable with Ethernet, M/M, with Repeater, 50.0 m	14.01.3464 – 2
--	----------------

## ROLINE HDMI Ultra HD Cable + Ethernet, Active, Short Lengths

4K

2160p  
ULTRA HD

High-quality HDMI connection cable with HDMI connectors for optimal transmission of digital HDTV signals at data rates up to 18 Gbit/s (600MHz). For the transmission of films in digital cinema-quality, with a resolution of up to 3840x2160 @60Hz!

- HDMI Ethernet Channel- Adds high-speed networking to an HDMI link, allowing users to take full advantage of their IP-enabled devices without a separate ethernet cable

- Audio Return Channel- Allows an HDMI-connected TV with a built-in tuner to send audio data „upstream“ to a surround audio system, eliminating the need for a separate audio cable
- 3D- Defines input/output protocols for major 3D video formats
- Cable with HDMI male connector on both sides
- High quality cable with golden plated shell
- Gold plated contacts for higher durability

NEW



Order-No. – P.U.

ROLINE HDMI Ultra HD Cable + Ethernet, active, M/M, black, 1.0 m	11.04.5910 – 20
ROLINE HDMI Ultra HD Cable + Ethernet, active, M/M, black, 1.5 m	11.04.5911 – 20
ROLINE HDMI Ultra HD Cable + Ethernet, active, M/M, black, 2.0 m	11.04.5912 – 15
ROLINE HDMI Ultra HD Cable + Ethernet, active, M/M, black, 3.0 m	11.04.5913 – 15
ROLINE HDMI Ultra HD Cable + Ethernet, active, M/M, black, 5.0 m	11.04.5915 – 10

**roline**<sup>®</sup>  
Designed for Professionals

## VALUE UHD HDMI 4K Active Cables

4K

2160p  
ULTRA HD

This cable achieves resolutions with up to 4K UHD (3840x2160) @ 60Hz in up to 25m distance between data source and receiver! It's 3D capable and audio transmission is included.

- For a total length of 25 meters between computer and monitor
- Active repeater is integrated in the connectors
- Hardware solution, no software required
- No external power supply needed
- Connectors: HDMI Type A M
- Max. resolution: 3840x2160 @60Hz



Order-No. – P.U.

VALUE UHD HDMI 4K2K Active Cable, M/M, 10.0 m	14.99.3451 – 5
VALUE UHD HDMI 4K2K Active Cable, M/M, 15.0 m	14.99.3452 – 5
VALUE UHD HDMI 4K2K Active Cable, M/M, 20.0 m	14.99.3453 – 5
VALUE UHD HDMI 4K2K Active Cable, M/M, 25.0 m	14.99.3454 – 5

## ROLINE UHD HDMI 4K Active Cables

4K

2160p  
ULTRA HD

This cable achieves resolutions with up to 4K UHD (3840x2160) @ 60Hz in up to 25m distance between data source and receiver! It's 3D capable and audio transmission is included.

- For a total length of 10 meters e.g. between computer and monitor
- Active repeater is integrated in the connectors
- Hardware solution, no software required
- No external power supply needed
- Connectors: HDMI Type A M
- Max. resolution: 3840 x 2160 @60Hz

**roline**<sup>®</sup>  
Designed for Professionals



Order-No. – P.U.

ROLINE UHD HDMI 4K Active Cable, M/M, 10.0 m	14.01.3451 – 5
ROLINE UHD HDMI 4K Active Cable, M/M, 15.0 m	14.01.3452 – 5
ROLINE UHD HDMI 4K Active Cable, M/M, 20.0 m	14.01.3453 – 5
ROLINE UHD HDMI 4K Active Cable, M/M, 25.0 m	14.01.3454 – 5

## ROLINE USB to HDMI Power Supply Cable, M/F

4K

2160p  
ULTRA HD

The perfect extension for powering AOC HDMI cables over long distances (>=50m)!

- As support for active HDMI cables- Ensures power supply
- Hardware solution, no software

- required
- Small connector dimensions
- Maximum resolution up to 3840x2160 @60Hz
- **REMARK: Please be noted that this cable is NOT an active repeater!**

NEW

**roline**<sup>®</sup>  
Designed for Professionals



Order-No. – P.U.

ROLINE USB to HDMI Power Supply Cable, M/F, 0.2 m	14.01.3481 – 30
---	-----------------

VALUE Cable UHD HDMI Active Optical (AOC)



With our UHD (3840x2160 @60Hz) capable HDMI fiber cable you have the possibility to establish a connection of up to 50m between your devices. The active cable (AOC) does not require a separate power supply and is particularly well suited for routing in a cable duct.

- Total length of the terminal distance (e.g., from notebook / laptop to beamer or PC to monitor): 50 meters
- Hardware solution, no software required
- A signal repeater is installed in the connectors
- No external power supply required
- Low plug dimensions
- Maximum resolution of up to 3840x2160 @60Hz



Order-No. – P.U.

VALUE Cable UHD HDMI Active Optical (AOC), M/M, 50.0 m

14.99.3482 – 1

ROLINE Cable UHD HDMI Active Optical (AOC)



With our UHD (3840x2160 @60Hz) capable HDMI fiber cable you have the possibility to establish a connection of up to 50m between your devices. The active cable (AOC) does not require a separate power supply and is particularly well suited for routing in a cable duct.

- Total length of the terminal distance (e.g., from notebook / laptop to beamer or PC to monitor): 50 meters
- Hardware solution, no software required
- A signal repeater is installed in the connectors
- No external power supply required
- Low plug dimensions
- Maximum resolution of up to 3840x2160 @60Hz



Order-No. – P.U.

ROLINE Cable UHD HDMI Active Optical (AOC), M/M, 50 m

14.01.3482 – 1

VALUE DisplayPort Active Cable, v1.2, Active



With our UHD (3840x2160 @60Hz) bi-directional DisplayPort cable you can connect up to 15m between your devices. The active cable does not require a separate power supply.

- Total length of the end device distance (e.g. from notebook/laptop to beamer or PC to monitor): 15 meters
- Hardware solution, no software required
- A signal repeater is built into the connectors.
- The practical plug design prevents the cable from slipping out of the DisplayPort socket.
- Bidirectional: the cable can be used independently of the plug-in direction.
- Compliant DP v1.2 (max. 3840x2160 @60Hz)



Order-No. – P.U.

VALUE DisplayPort Active Cable, v1.2, active, M/M, 15.0 m

14.99.3495 – 2

VALUE DisplayPort Active Cable, v1.2, active, M/M, 20.0 m

14.99.3496 – 2

ROLINE DisplayPort Cables (AOC)



With our UHD (3840x2160 @60Hz) capable DisplayPort fiber cable you have the possibility to establish a connection of up to 50m between your devices. The active cable (AOC) does not require a separate power supply and is particularly well suited for routing in a cable duct.

- Total length of the terminal distance (e.g., from notebook / laptop to beamer or PC to monitor): 30 meters
- Hardware solution, no software required
- A signal repeater is installed in the connectors
- No external power supply required
- Low plug dimensions
- Maximum resolution of up to 3840x2160 @60Hz



Order-No. – P.U.

ROLINE DisplayPort Cable (AOC), M/M, 30m

14.01.3490 – 1

ROLINE DisplayPort Cable (AOC), M/M, 50m

14.01.3492 – 1

VALUE / ROLINE Ultra HD HDMI Repeater, 4K



Allows you to extend the transmission range of your HDMI connection by up to 20m in total. Supports a maximum resolution of up to 3840x2160 @60Hz!

This 4k2k HDMI repeater regenerates the incoming HDMI Signal by decoding and re-encoding it to a new standard HDMI signal, so it can extend the transmission range without degradation. Up to 20 meters transmission distance. The repeater supports a resolution up to Ultra HD (4K)

- Support 3D and up to 3840x2160 @60Hz
- Compliant with HDCP
- Compatible to Full-HD 1080P
- Frequency bandwidth: up to 340MHz

- Input/output resolution: HD:480i@60Hz, 576i@50Hz, 480p@60Hz, 1080p@50Hz, 1080p@60Hz, 1080i@50Hz, 1080p@30Hz, 1080p@25Hz, 1080p@24Hz, 2160P@30Hz, 2160P@60Hz
- Dimensions (WxHxD): 14.01.3459: 28 x 13 x 51mm



Order-No. – P.U.

VALUE 4K HDMI Repeater, 20m

A 14.99.3459 – 20

Order-No. – P.U.

ROLINE Ultra HDMI Repeater, 4K

B 14.01.3459 – 10



### Converter Scart/HDMI to HDMI 720p/1080p

The SCART+HDMI to HDMI converter can convert 480i(NTSC)/576i(PAL) format signal to 720p/1080p HDMI signal output

- SCART input interface: DVD, set-top box, other players
  - SCART input format: PAL/NTSC-M/NTSC4.43/SECAM/PAL-M/PAL-N
- HDMI input format: 480i/576i/480p/576p/720p@50/60Hz, 1080i@50/60Hz, 1080p@50/60Hz
- HDMI output interface: connect with high definition TV or high definition projector
  - HDMI output format: 720p@50/60Hz, 1080p@50/60Hz
  - Audio output format: Digital coaxial audio, analog stereo audio

- 3.5mm audio interface: Connect with analog audio amplifier or headphones input interface
- Digital coaxial output: Connect with digital audio amplifier
- SCART audio is integrated into HDMI out as well as pass-through to earphone or sound box output
- Automatically detect RGB(50/60Hz), Composite Video(NTSC/PAL);
- Color: Black
- Material: metal case
- Contents: converter, manual, power adapter



Order-No. – P.U.

Converter Scart/HDMI to HDMI 720p/1080p

14.01.3463 – 10

### VALUE VGA Video Splitters, 2/4-way

- Duplicates VGA video signals to two/ four video outputs
- Applications: multimedia, presentations, demos, etc.
- Max. resolution (nominal): 1920 x 1440 (14.99.3523) 1920 x 1080 (14.99.3527/3529)
- Video bandwidth: 250 MHz / 500 MHz
- Supports DDC and DDC2 on Port 1 (14.99.3523)
- Video input: 1x HD15 M, Video output: 2x / 4x HD15 F
- Contents: Video splitter (cable length: 65 cm + 30 cm USB cable for power supply- 14.99.3523) 14.99.3527 /14.99.3529 – splitter, main adapter 9VDC, 300mA

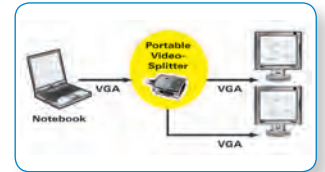

Technical data:	14.99.3523	14.99.3527	14.99.3529
VGA input:	1x HD15 M	1x HD15 M	1x HD15 M
VGA output:	2x HD15 F	2x HD15 F	4x HD15 F
Video bandwidth:	250 MHz	500 MHz	500 MHz
Max. resolution (nominal):	1920 x 1440	1920 x 1080	1920 x 1080

Order-No. – P.U.

VALUE Portable VGA Video Splitter, 250 MHz, 2-way

14.99.3523 – 5

VALUE VGA Video Splitter, 500 MHz, 2-way

14.99.3527 – 10

VALUE VGA Video Splitter, 500 MHz, 4-way

14.99.3529 – 10

### ROLINE VGA Video Splitter, 450 MHz, 2-way

- Applications
  - High Quality Multimedia Presentations
  - Video Conferencing
  - Education
  - Public Broadcasting Systems
  - Demos
- Duplicates one video signal to two outputs
- Supports 450 MHz bandwidth
- Max. resolution (nominal): 1920 x 1440
- DDC compatible
- USB Bus powered (USB power cable included)
- Cascadable
- Plastic casing
- Contents: Splitter, USB power cable (1.1m)

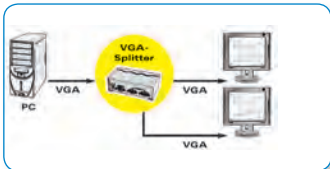

Technical Data:	14.01.3534
Input:	1x HD15 M
Output:	2x HD15 F
VGA bandwidth (-3db):	450MHz
Max resolution (nominal):	1920x1080
Cable distance:	30 m
Power supply:	5VDC, 0.5A



Order-No. – P.U.

ROLINE VGA Video Splitter, 450 MHz, 2-way

14.01.3534 – 3

### VALUE DVI Video Splitter

- Applications: multimedia, presentations, demos, etc.
- Duplicates DVI Video signals to two/ four DVI Video outputs
- Video-bandwidth: 225MHz
- Max. resolution: 1920x1080
- Supports cascading of splitters
- Contents: Splitter, main adapter, manual

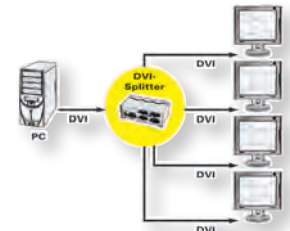

Technical Data:	14.99.3501	14.99.3503
Input:	1x DVI F	1x DVI F
Output:	2x DVI F	4x DVI F
Max. resolution (nominal):	1920 x 1080	1920 x 1080
Dimensions (LxWxH):	155 x 70 x 23 mm	155 x 70 x 23 mm
Power supply:	5V DC, 2A	5V DC, 2A



Order-No. – P.U.

VALUE DVI Video Splitter, 2-way

14.99.3501 – 5

VALUE DVI Video Splitter, 4-way

14.99.3503 – 5

### ROLINE DVI Video Splitter

- Applications: multimedia, presentations, demos, etc.
- Duplicates DVI Video signals to two DVI Video outputs
- Max. resolution: 1920x1200
- Supports cascading of splitters
- Contents: Splitter, main adapter, manual

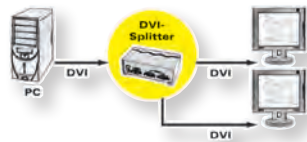

**Technical Data:**  
 Input video: 1x DVI F  
 Output video: 2x DVI F  
 Input audio: 1x 3,5mm F  
 Output audio: 2x 3,5mm F  
 Max. resolution (nominal): 1920 x 1200  
 Dimensions (LxWxH): 180 x 85 x 20 mm  
 Power supply: 9V DC, 0,6A



**roline**  
 Designed for Professionals

Order-No. – P.U.

ROLINE DVI Video Splitter, 2-way

14.01.3550 – 6

### ROLINE HDMI to VGA Splitter

1080p  
FULL HD

- Duplicates a HDMI video signal to two VGA video signals
- Connectors: 1 HDMI Input (e.g. DVD-player), 2 VGA outputs
- Supports 1920 x 1080, 1080p
- No software installation required
- Contents: splitter, manual



**roline**  
 Designed for Professionals



Order-No. – P.U.

ROLINE HDMI to VGA Splitter, 2-way

14.01.3526 – 5

### VALUE HDMI Splitter

3D  
capable

1080p  
FULL HD

- Shows the HDMI signal of one device to four/eight HDMI outputs
- E.g. for application at presentations or trainings
- Connectors: 5x / 8x HDMI Female (1x input, 4x / 8x output)
- Max. resolution (nominal): 1920 x 1080
- Supports 480i, 480p, 720i, 720p, 1080i and 1080p
- Status LEDs
- On/off switch
- Contents: HDMI Splitter, power supply, manual

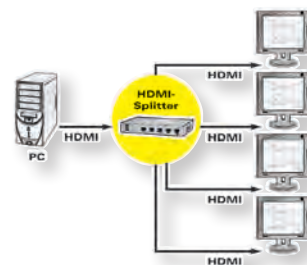

**Technical data:**  
 Input: 1x HDMI F  
 Output: 4x HDMI F  
 Dimensions (WxDxH): 185 x 116 x 32 mm



Order-No. – P.U.

VALUE HDMI Splitter, 4-way

14.99.3506 – 10

VALUE HDMI Splitter, 8-way

14.99.3507 – 10

### ROLINE HDMI Splitter, 2/4-way

4K

- Duplicates a HDMI video signal to two/four HDMI video signals
- Connectors: 1 HDMI Input (e.g. DVD-player), 2/4 HDMI outputs
- Supports 480i, 480p, 720i, 720p, 1080i, 1080p, 3840x2160 @30Hz
- Plug & play, easy to install and simple to operate
- No software installation required
- HDCP 1.3 compliant
- Contents: splitter, manual



**roline**  
 Designed for Professionals



Order-No. – P.U.

ROLINE HDMI Splitter, 2-way

14.01.3555 – 10

ROLINE HDMI Splitter, 4-way

14.01.3553 – 2

VALUE HDMI Splitter, 4K

4K 3D capable 2160p ULTRA HD

- Duplicates a HDMI video signal to two HDMI video signals with a 4K resolution
- Connectors: 1 HDMI Input (e.g. DVD-player), 2/8 HDMI outputs
- Supports 480i, 480p, 720i, 720p, 1080i, 1080p, 3840 x 2160 (@60Hz)
- Supports VGA, SVGA, XGA, UXGA
- Supports 3D
- Plug & play, easy to install and simple to operate
- No software installation required
- Contents: splitter, manual, power-supply

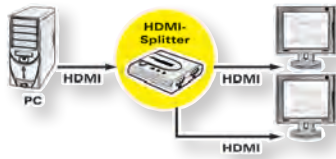

Order-No. – P.U.

VALUE HDMI Splitter, 4K2K, 2-way

14.99.3582 – 10

ROLINE HDMI Splitter, 4K

4K 2160p ULTRA HD

- Duplicates a HDMI video signal to 2/4/8 HDMI video signals with a 4K resolution
- Connectors: 1 HDMI Input (e.g. DVD-player), 2/4/8 HDMI outputs
- Supports 480i, 480p, 720i, 720p, 1080i, 1080p, 3840 x 2160 (@60Hz)

- Supports VGA, SVGA, XGA, UXGA
- Supports 3D
- Plug & play, easy to install and simple to operate
- No software installation required
- Contents: splitter, manual, powersupply

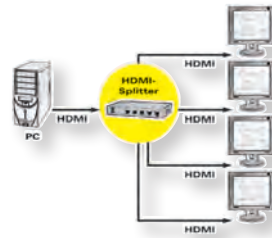

Order-No. – P.U.

ROLINE HDMI Splitter, 4K, 2-way

14.01.3585 – 5

ROLINE HDMI-splitter, 4K, 4-way

14.01.3586 – 5

ROLINE HDMI Splitter, 4K, 8-way



14.01.3583 – 6

VALUE HDMI / Mini DisplayPort/ HDMI to HDMI Switch

4K 2160p ULTRA HD

Displays the video output of 2 HDMI or Mini DisplayPort sources on a monitor, TV, or projector.

Allows several HDMI and DisplayPort sources to be connected to one HDMI display like e.g. a monitor, TV, projector.

- Connectors input 3-way: 2x HDMI Type A F, 1x Mini DisplayPort F
- Connector output: 1x HDMI F
- Supports 480p, 720p, 1080i and 1080p, 2160p

- Selects input source via push button
- LED indication for source selection
- Plug & play, no software required
- HDCP 2.2 supported

- Contents: Switch, power supply, manual



Order-No. – P.U.

VALUE HDMI / Mini DisplayPort/ HDMI to HDMI Switch

14.99.3540 – 15

VALUE HDMI / Mini DisplayPort/ DisplayPort to HDMI Switch

4K 2160p ULTRA HD

Displays the video output of an HDMI, DisplayPort or Mini DisplayPort sources on a monitor, TV, or projector.

Allows several HDMI and DisplayPort sources to be connected to one HDMI display like e.g. a monitor, TV, projector.

- Connectors input 3-way: 1x HDMI Type A F, 1x DisplayPort F, 1x Mini DisplayPort F

- Connector output: 1x HDMI F
- Supports 480p, 720p, 1080i and 1080p, 2160p
- Selects input source via push button
- LED indication for source selection
- Plug & play, no software required
- HDCP 2.2 supported
- Contents: Switch, power supply, manual



Order-No. – P.U.

VALUE HDMI / Mini DisplayPort/ DisplayPort to HDMI Switch

14.99.3541 – 15



**ROLINE DisplayPort Splitter**

4K

- The DisplayPort splitter allows single DP source to be displayed on two/four DP input monitors simultaneously
- Supports video resolution up to 3840 x 2160 (@30Hz) and audio up to PCM 7.1 (32-192 kHz sample rate)
- Supports 1.62/2.7 Gb/s data rate (Low/High bit rate)
- Ideal device for your DP source to ap-

- Applications like multi display, information sharing, advertising program
- Remark: the device supports only DisplayPort mode, it can not connect DP to HDMI level shift convert
- Contents: splitter, power supply, manual

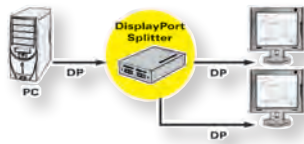

**roline**  
Designed for Professionals

Order-No. – P.U.

ROLINE DisplayPort Splitter, 2-way

14.01.3590 – 10

**ROLINE HDMI/DisplayPort Switch**

1080p FULL HD

**Allows several HDMI and DisplayPort sources to be connected to one HDMI display like e.g. a monitor, TV, projector.**

- Connectors input 2/4-way: 2x HDMI Type A F, 2x DisplayPort F (2 ports, each with 1 HDMI connector and 1 DisplayPort connector, whereof only 1 connector can be used)
- Connector output: 1x HDMI F

- Supports 480p, 720p, 1080i and 1080p resolution, 1920 x 1080 (nominal)
- Selects input source via push button
- LED indication for source selection
- Plug & play, no software required
- HDCP supported
- Contents: Switch, power supply, manual



**roline**  
Designed for Professionals



**Technical Data:**

	<b>14.01.3572</b>	<b>14.01.3574</b>
Input:	1x HDMI A F/DisplayPort F*	2x HDMI A F
	1x HDMI A F/DisplayPort F*	2x DisplayPort F
Output:	1x HDMI	1x HDMI
Max. resolution (nominal):	1920 x 1080	1920 x 1080
Dimensions (WxDxH):	157 x 65 x 20 m	157 x 65 x 20 m
Power supply:	5VDC; 2A	5VDC; 2A

\*) 2 ports, each with 1 HDMI connector and 1 DisplayPort connector, whereof only 1 connector can be used

Order-No. – P.U.

ROLINE HDMI/DisplayPort Switch, 2-way

14.01.3572 – 6

ROLINE HDMI/DisplayPort Switch, 4-way

14.01.3574 – 6

**VALUE HDMI Switch, Automatic**

3D capable

1080p FULL HD

- Shows the Video output of 3 HDMI devices like e.g. DVD player, video camera or game console on one monitor
- Supports HDMI High Speed
- Video input can be switched automatically or by button on the switch
- Supports nominal resolution of up to 1920 x 1080
- Supports high-resolution display of up to 480p, 576p, 720p, 1080i, 1080p

- Supports uncompressed audio such as LPCM
- Supports compressed audio such as DTS Digital, Dolby Digital (incl. DTS-HD and Dolby True HD)
- No power supply needed
- Colour: Black
- Contents: HDMI switch

**Value**



Order-No. – P.U.

VALUE HDMI Switch, Automatic, 3-way

14.99.3565 – 5

**ROLINE HDMI Switch, 4K, 3-way**

4K

2160p ULTRA HD

- Shows the Video output of 3 HDMI devices like e.g. DVD player, video camera or game console on one monitor
- Supports HDMI High Speed
- Video input can be switched automatically or by button on the switch
- Supports nominal resolution of up to 3840 x 2160@60Hz
- Supports high-resolution display of up to 480p, 576p, 720p, 1080i, 1080p,

- Supports uncompressed audio such as LPCM
- Supports compressed audio such as DTS Digital, Dolby Digital (including DTS-HD and Dolby True HD)
- Power supply needed (5VDC, 1A)
- Colour: Black
- Contents: HDMI switch



**roline**  
Designed for Professionals

Order-No. – P.U.

ROLINE 4K HDMI Switch, 3-way

14.01.3575 – 5

## ROLINE HDMI 4x1 QUAD Multi-Viewer with Seamless Switch

**1080p**  
FULL HD

### Displays the video output of up to 4 HDMI sources on a monitor or projector.

- Application example: A display device (monitor/TV/beamer) is powered by several HDMI sources such as BluRay players, etc. By pressing the button, the desired source can be selected for single display or up to four sources at a time using different display options. Or, if only one source is active at a time, the switch automatically changes to this source.
- Switching between PCs is done via buttons on the switch or via remote control
- Supports 1080p (1920x1080 @60Hz)
- Installation is possible without software- only the HDMI cables have to be connected to the Quad Multi Viewer.
- Flat, black metal housing
- Remote control and IR receiver included
- Power supply 12VDC; 2A included in delivery

### Technical data:

- Input: 4x HDMI A jack
- Output: 1x HDMI A jack
- Contents: HDMI Switch, main adapter, remote control

**roline**  
Designed for Professionals

**Order-No. – P.U.**

ROLINE HDMI 4x1 QUAD Multi-Viewer with Seamless Switch

14.01.3569 – 5

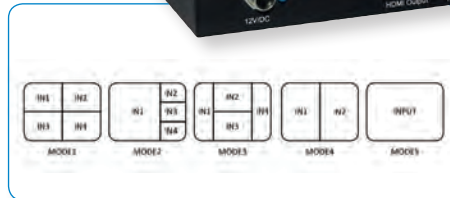
**NEW**

## VALUE HDMI 4K Matrix Switch, 6 x 2, with Remote Control

**4K**

### Ideal solution for multiple HDMI distribution use in retail product demonstration, training and public display applications

- Six HDMI High Speed input signals can be switched to two HDMI High Speed output devices
- Supports Full HD
- Supports 3D
- PIP- Picture-in-Picture functionality- helps for a quickly overview of all the other 5 input sources (synchronously)
- Max. resolution (nominal): 3840 x 2160 @30Hz
- Supports 480i, 480p, 720i, 720p, 1080i and 1080p

- Supports Blu-ray 24/50/60fps/HD-DVD/xvYCC
- Supported digital audio formats: DTS-HD/ Dolby-trueHD/LPCM7.1/DTS/Dolby-AC3/DSD
- Supports SPDIF digital audio format: Dolby Digital (AC3)/ DTS/ LPCM 2CH
- Input devices can be switched by IR remote control or by push buttons on the switch
- HDMI input signal /output signal can be transmitted over distances of up to 10m (1080p) / 5m (4K@30Hz)
- Contents: HDMI Matrix Switch, power supply, remote control, QIG

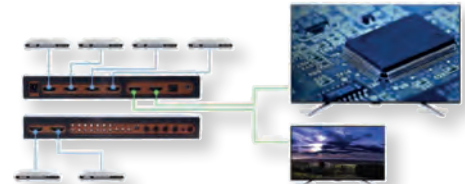
**Value**

**Order-No. – P.U.**

VALUE HDMI 4K Matrix Switch, 6 x 2, with Remote Control

14.99.3579 – 5

**NEW**

## ROLINE HDMI Matrix Switch

**3D**  
capable

**1080p**  
FULL HD

- Four HDMI High Speed input signals can be switched to two/four HDMI High Speed output devices
- Supports Full HD
- Supports 3D
- Max. resolution (nominal): 1920 x 1080
- Supports 480i, 480p, 720i, 720p, 1080i and 1080p
- Supports Blu-ray 24/50/60fs/HD-DVD/xvYCC
- Supported digital audio formats: DTS-HD/Dolby-trueHD/LPCM7.1/DTS/Dolby-AC3/DSD
- Input devices can be switched by IR remote control or by push buttons on the switch
- Contents: Switch, power supply, remote control, manual

**roline**  
Designed for Professionals

**Order-No. – P.U.**

ROLINE HDMI Matrix Switch, 4 x 2 (Full HD, 1080P)

A 14.01.3566 – 1



### ROLINE 4K HDMI Matrix Switch, 4 x 2, with Remote Control



- Four HDMI High Speed input signals can be switched to two HDMI High Speed output devices
- Supports Full HD
- Supports 3D
- Max. resolution (nominal): 3840 x 2160
- Supports 480i, 480p, 720i, 720p, 1080i and 1080p, 2160p
- Supports Blu-ray 24/50/60fs/HD-DVD/xvYCC
- Supported digital audio formats: DTS-HD/Dolby-trueHD/LPCM7.1/DTS/Dolby-AC3/DSD
- Input devices can be switched by IR remote control or by push buttons on the switch
- Contents: Switch, power supply, remote control, manual
- Contents:



ROLINE 4K HDMI Matrix Switch, 4 x 2, with Remote Control

Order-No. – P.U.

14.01.3578 – 5



### ROLINE Display Adapter, Virtual HDMI Emulator (EDID), 4K



- Works with any graphics card that has HDMI output and acts exactly the same as real LCD monitor
- Up to 4K resolution can be simulated, 3840x2160@60Hz
- Compliant with HDCP
- Compact design, small size
- Plug & Play
- Hot Plug
- No drivers, no configuration needed



ROLINE Display Adapter, Virtual HDMI Emulator (EDID), 4K

Order-No. – P.U.

14.01.3416 – 30

### VALUE Display Port Splitter (Hub), 2 Ports



- Offers solutions for digital entertainment center, conference room presentation, school and corporate training environments...
- This is a two ports DisplayPort hub, designed for transmitting signals from one DisplayPort source device to two DisplayPort displays
- This hub owns both SST and MST functions- which allow you to enjoy one picture with dual monitors or independent pictures on each monitor respectively
- Connected to earlier revisions of DisplayPort, the hub can act as a video splitter
- Support DisplayPort 1.2
- Max. resolution up to 4K@30Hz (3840x2160)
- HDCP 1.3 compliant
- EDID 1.4 compliant
- Power supply included in delivery (5 VDC, 2A)
- Contents: splitter, manual, power supply

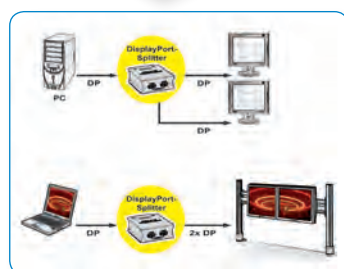

VALUE Display Port Splitter (Hub), 2 Ports

Order-No. – P.U.

14.99.3590 – 5

### ROLINE HDMI/VGA/DP to HDMI Switch / Converter



- High performance video adapter, which supports three types of input sources (HDMI / DP / VGA) and one HDMI output
- Ideal for multimedia applications
- Support maximum resolution up to 4K (HDMI or DP 3840x2160 @60Hz) and up to 1080p (VGA)
- Easy to install and simple to use
- Source selection by- auto detect / IR remote / Select button on the front panel
- LED Status
- Power adapter (5VDC, 1A)



ROLINE HDMI/VGA/DP to HDMI Switch / Converter

Order-No. – P.U.

14.01.3568 – 5



## VALUE HDMI Full HD Audio Extractor

**1080p**  
 FULL HD

The VALUE HDMI Full HD Audio Extractor allows to uncouple audio signals from the HDMI signal. For a better home cinema feeling you can redirect the extracted audio signals via S/PDIF (optical) or analog via 3.5mm ports on a speaker system.

- Supports HDMI, HDCP 1.2
- Audio-rate (sampling frequency for S/PDIF as HDMI) to 192kHz
- Supports high bit-rate audio
- Supports video resolution up Full HD and 3D
- Power supply (5 V DC, 1 A) included
- Contents: extractor, power adapter, user manual

**Order-No. – P.U.**

VALUE HDMI Full HD Audio Extractor

14.99.3442 – 5

## ROLINE HDMI 4K Audio Extractor LPCM 2.1

**4K**

The ROLINE HDMI 4K2K Audio Extractor allows you to decouple audio signals from the HDMI signal.

Not all monitors have good speakers. With the extractor you can redirect the audio signals via S/PDIF (optical) or analog via 3.5mm ports on a speaker system, the pure image signal goes to the screen.

- Supports HDMI, HDCP 1.2
- Audio-rate (sampling frequency for S/PDIF as HDMI) to 192kHz
- Supports high bit-rate audio
- Supports video resolution up 4K and 3D
- HBR audio supported
- Supports CEC bypass
- Supports up to 4 x 3.5 mm phone jacks for analog multi-channel audio outputs
- Power supply (5V DC, 3A) included
- Contents: extractor, power adapter, user manual

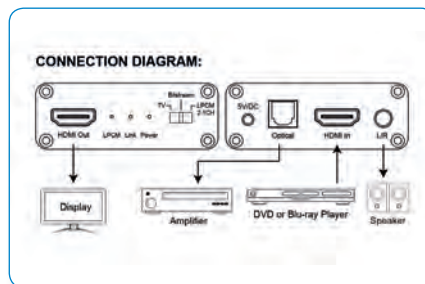
**roline**  
 Designed for Professionals

**Order-No. – P.U.**

ROLINE HDMI 4K Audio Extractor LPCM 2.1

14.01.3443 – 20

## ROLINE HDMI 4K Audio Extractor LPCM 7.1

**4K**

The ROLINE HDMI 4K2K Audio Extractor allows to uncouple audio signals from the HDMI signal.

Not all monitors have good speakers. With the extractor you can redirect the audio signals via S/PDIF (optical) or analog via 3.5mm ports on a speaker system, the pure image signal goes to the screen.

- Supports HDMI, HDCP 1.2
- Audio-rate (sampling frequency for S/PDIF as HDMI) to 192kHz
- Supports high bit-rate audio
- Supports video resolution up 4K2K and 3D
- HBR audio supported
- Supports CEC bypass
- Supports up to 4 x 3.5 mm phone jacks for analog multi-channel audio outputs
- Power supply (5 V DC, 2 A) included
- Contents: extractor, power adapter, user manual

**roline**  
 Designed for Professionals

**Order-No. – P.U.**

ROLINE HDMI 4K Audio Extractor LPCM 7.1

14.01.3442 – 10

VALUE / ROLINE Audio Adapters



	Order-No.	P.U.
VALUE 3.5mm Adapter, 1x 3.5mm M to 2x 3.5mm F	A	11.99.4440 - 100
VALUE 3.5mm Adapter, 1x 3.5mm M to 2x RCA F	B	11.99.4441 - 100
VALUE Toslink Optical Adapter(Female) to 3.5mm Mini Jack Plug Adapter(Male)	C	11.99.4447 - 50
ROLINE 4 Conductor 3.5 mm Stereo Plug (speaker+microphone), 15 cm	D	11.09.4441 - 20
ROLINE 3.5 mm Stereo Coupler, F/F	E	11.09.4442 - 10
ROLINE Stereo Adapter 3.5 mm Male - 6.35 mm Female	F	11.09.4443 - 10
ROLINE Stereo Adapter 6.35 mm Male - 3.5 mm Female	G	11.09.4444 - 10
ROLINE Stereo Adapter 3.5 mm Male - 2.5 mm Female	H	11.09.4445 - 10
ROLINE Stereo Adapter 2.5 mm Male - 3.5 mm Female	J	11.09.4446 - 10
ROLINE Toslink Optical Adapter(Female) to 3.5mm Mini Jack Plug Adapter(Male)	K	11.09.4447 - 50

- Audio Y-cable for connection of a speaker/headphone with volume control
- Connectors:
  - 1x 3.5 mm stereo plug M, 3-pole, for connection to a speaker output, eg on the PC or iPod
  - 2x 3.5 mm jack, 3-pole, for connecting speakers or headphones
- Volume control for both lines, separately adjustable for each output line
- Length: 30 cm

	Order-No.	P.U.
ROLINE Y Audio Cable with 3.5 mm Stereo Plug (2x speaker lines)	11.09.4439	- 25



VALUE Audio Converter Digital to Analogue

Connects a LCD TV, CD/DVD player or set-top box with digital output to an analogue amplifier with stereo input.

- Converts digital audio signals from Toslink (optical) or RCA (coaxial) to analogue Stereo 2x RCA
- Supports up to 24bit/96kHz
- Power supply included
- Contents: Audio converter, power supply, manual



	Order-No.	P.U.
VALUE Audio Converter - Digital to Analogue	14.99.3441	- 6

ROLINE Audio Converter Digital to Analogue

Connects a LCD TV, CD/DVD player or set-top box with digital output to an analogue amplifier with stereo input.

- Converts digital audio signals from Toslink (optical) or RCA (coaxial) to analogue Stereo 2x RCA
- Supports up to 24bit/192kHz
- Power supply included
- Contents: Audio converter, power supply, manual



	Order-No.	P.U.
ROLINE Audio Converter Digital to Analogue	14.01.3441	- 5

VALUE / G-SOUND Headsets

- Ideal device for multimedia applications and video conferencing
- With integrated microphone (not 15.99.1316)
- With volume control on the cable
- Connection to PC over 3.5 mm stereo plug
- Cable length: ca. 1.8 m

- 15.08.1303**
- Attractive products with modern design, ideal for multimedia applications
  - Quick and easy installation
  - With volume control on the cable
  - Padded earpieces



	Order-No.	P.U.
VALUE Stereo Headphone with Volume Control, light grey	A	15.99.1316 - 50
G-SOUND Headset Multimedia, silver/white	B	15.08.1303 - 10

LIFEVIEW Video Editor USB DeLuxe

- Create your home video library
- Real-time Mpeg 4/2/1 encoding
- Burn edited files onto DVD, VCD, SVCD etc.
- Capture video source from VHS, V8 etc.
- Burn your own DVD and VCD

- Connectors: USB to S-Video, Composite Video, Audio (R), Audio (L)
- Supported Operating Systems: Windows XP/Vista/7
- Contents: Video Editor USB, installation CD, quick installation guide



	Order-No.	P.U.
LIFEVIEW Video Editor USB DeLuxe	15.08.1594	- 1

## BLUEDIO Headset R+, BT 4.0 HiFi, NFC

### Comfortable headset with Bluetooth and NFC functionality for wireless music enjoyment

- Stylish design
- Adjustable headband and comfortable ear cushions (the pads offers a optimum comfort)
- High level of comfort
- Provides a high-definition wireless sound
- Digital, intelligent sound optimization (intelligent control of the built-in speakers- per side 1x subwoofer (50mm), 3x 13mm Neodymium )
- NFC ( Near Field Communication) functionality (wireless connection to mobile devices such as smartphones)
- Bluetooth (v4.0, aptX profiles, A2DP, AVRCP, HFP, HSP)
- Easy connect to Bluetooth enabled devices due to the Bluetooth 4.0 + EDR technology
- Smartphones, tablet PCs, computer or MP3 player can be connected via Bluetooth or via cable to the headset

- Offers a wide motion range (max. range: up to 20m) and a long battery life
- Thanks to the integrated microphone a hands-free phone calls are possible
- Colour: black
- Contents: Headset, 3.5mm audio Micro USB charging cable, velvet bag

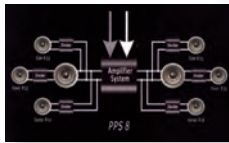

Order-No. – P.U.

**Bluedio**  
— FEELING MUSIC —

BLUEDIO Headset R+, BT 4.0 HiFi, NFC

15.08.1350 – 1

## BLUEDIO Headset R2 BT 4.0 HiFi

### Comfortable headset with Bluetooth functionality for wireless music enjoyment

- Stylish design
- Adjustable headband and comfortable ear cushions (the pads offers a optimum comfort)
- High level of comfort
- Provides a high-definition wireless sound
- Digital, intelligent sound optimization (intelligent control of the built-in speakers- per side 1x subwoofer (50mm), 3x 13mm Neodymium)
- Bluetooth (v4.0, profiles: aptX, A2DP, AVRCP, HFP, HSP)
- Easy connect to Bluetooth enabled devices due to the Bluetooth 4.0 + EDR technology
- Smartphones, tablet PCs, computer or MP3 player can be connected via Bluetooth to the headset
- Offers a wide motion range (max. range: up to 20m) and a long battery life

- Thanks to the integrated microphone a hands-free phone calls are possible
- Colour: black
- Contents: Headset, Micro USB charging cable, velvet bag

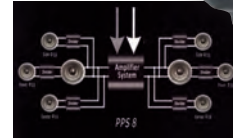

**Bluedio**  
— FEELING MUSIC —

BLUEDIO Headset R2 BT 4.0 HiFi

Order-No. – P.U.

15.08.1351 – 1

## VALUE A/V Modules

Multimedia connection system: computer, video, audio, control or network connections can be easily integrated with the modular multimedia connection system in switch programs. With the unsightly, lying around or hanging cables is now finally concluded. The system is cost-effective and future-proof as it can be expanded at any time to new interfaces.

### 25.99.8200 - VALUE A/V Faceplate, 86x86mm

- Triple gang, 86mm x 86mm
- White plastic triple gang frame
- Triple 44 x 66 mm wide aperture for 3 x 22mm modules
- Color: White



### 25.99.8201 - VALUE A/V Wall Cup, 86x86mm

- Flush wall mounted back boxes for AV wall plates
- The boxes are designed to be quickly fitted into partitioned walls (horizontally or vertically)
- Cable access points and standard fixing centres for face plates
- This AV back box is 42mm deep to allow most AV wall plates to fit
- Wall cup, 86mm x 86mm x 42mm
- Color: White

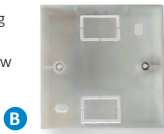

### 25.99.8202 - VALUE A/V Module (2xAudio, 1x Video)

- Ideal for home offices, conference rooms, classrooms, board rooms
- Plug-in installation on both sides of the plate, no soldering necessary
- Plus three phono connections for composite video plus audio
- Connection: RCA Composite Video Audio Male Jacks
- Color: White



### 25.99.8203 - VALUE A/V Module (HDMI F adapter,angled)

- Ideal for home offices, conference rooms, classrooms, board rooms
- Wall plate HDMI socket
- For use with HDMI cables
- This convenient wall plate has a female connector on the front and in back for easy installation
- The rear socket is aligned such that a side entry HDMI cable should pass through one of the side knock-outs in a wall cup (25.99.8201)



**REMARK:** Depending on the used plug size some modification may be necessary, no additional possibility for using another A/V module type in the same wall cup

### 25.99.8204 - VALUE A/V Module (USB 2.0 Type A)

- Ideal for home offices, conference rooms, classrooms, board Mount an external USB port quickly and easily with our USB face plates
- Easy to install
- Compliant USB 2.0
- Color: White
- 1 x USB-A Female



### 25.99.8205 - VALUE A/V Module - Blind plate

- Protects your wall mount from dust
- Easy to install and remove
- Color: White



### 25.99.8206 - VALUE Cable Exit Brush Wall Plate, 86x86mm

- Soft, densely packed Nylon bristles protect cable jackets from damage and prevent cables from falling behind the wall
- This single gang wall plate with brush bristles allows the cables running behind your walls to exit the wall and connect to your devices for neat professional look
- The aperture is large enough for VGA, HDMI, DVI, DisplayPort, Cat5e/6 and other types of cables

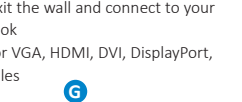

Order-No. – P.U.

VALUE A/V Faceplate, 86x86mm, white A 25.99.8200 – 20

VALUE A/V Wall Cup, 86x86mm, white B 25.99.8201 – 5

VALUE A/V Module (2xAudio, 1x Video) C 25.99.8202 – 20

VALUE A/V Module (HDMI F adapter,angled) D 25.99.8203 – 20

VALUE A/V Module (USB 2.0 Type A) E 25.99.8204 – 20

VALUE A/V Module - Blind plate F 25.99.8205 – 20

VALUE Cable Exit Brush Wall Plate, 86x86mm G 25.99.8206 – 10



**Value**<sup>®</sup>





## UPS Systems / Power Distribution

# 7

Line-Interactive UPS . . . . .	7.02 – 7.03
Online UPS . . . . .	7.03
Power Strips . . . . .	7.04, 7.05
USB Chargers / Car Chargers. . . . .	7.05 – 7.07
PDU for Cabinets . . . . .	7.06, 7.07
IP Power Strip / Remote Switch . . . . .	7.06
Universal Power Adapters. . . . .	7.07
USB Power Cables . . . . .	7.08
USB Power Stations . . . . .	7.08
Power Cords . . . . .	7.09 – 7.10
Power Extension Cables . . . . .	7.10

## VALUE UPS, Line-Interactive, USB Port

## Quality Protection for Small Servers, Workstation &amp; PC

- Line interactive design
- Boost and buck AVR (Auto voltage regulation)
- Fully digitized microprocessor controlled
- Energy saving function (UPS green mode)
- 50/60Hz frequency auto sensing and selection
- Cold start function (DC power on)
- Lightning and surge protection
- Short circuit and overload protection
- Advanced battery management (ABM technology)

- Tel/Modem internet surge suppression
- Smart USB communication port
- Automatically charging when UPS off
- History record of power failure events
- Back up, on-line, battery status, power status display by software
- Schedule shutdown & reboot
- Windows 98/Me/NT/2000/XP/2003/7/8/10
- Contents: UPS, Software, Cable-Set



Description	Output (VA/W)	Backup time	Dimensions (HxWxD)	Weight	Internal cooling	Order-No.	- P.U.
VALUE UPS, Line-Interactive, 400VA, USB Port	400 / 240	4 min	135 x 97 x 320 mm	4.5 kg	Passive	19.99.3424	- 1
VALUE UPS, Line-Interactive, 600VA, USB Port	600 / 420	4 min	135 x 97 x 320 mm	4.5 kg	Passive	19.99.3426	- 1
VALUE UPS, Line-Interactive, 800VA, USB Port	800 / 480	3 min	135 x 97 x 320 mm	6.5 kg	Passive	19.99.3428	- 1
VALUE UPS, Line-Interactive, 1200VA, USB Port	1200 / 720	3 min	192 x 382 x 130 mm	14 kg	Passive	19.99.3430	- 1

## Special Battery for UPS Systems

- Maintenance free spare battery for all actual and former UPS models
- Spare battery for e.g. ROLINE, APC, EATON, VALUE, Fujitsu, Effekta, POWERWARE, AEG, FISKARS, BESTPOWER and others
- Contents: Battery



Description	Dimensions (HxWxD)	Weight	Order-No.	- P.U.
Special Battery for UPS 12V 7Ah	100x65x155 mm	2.6 kg	19.49.1207	- 1
Special Battery for UPS 12V 9Ah	100x65x155 mm	3 kg	19.49.1209	- 1
Special Battery for UPS 12V 12Ah	100x100x155 mm	3.9 kg	19.49.1212	- 1
Special Battery for UPS 12V 17Ah	167x76x181 mm	5.8 kg	19.49.1217	- 1
Special Battery for UPS 12V 5Ah	107x70x90 mm	1.8 kg	19.49.1205	- 1

## ROLINE LineSecure / LineSecure II – Line Interactive UPS

LineSecure UPS's work with the „buck & boost“ line interactive technology; used when reliable protection against strong voltage fluctuations is essential. Protect against: power failure, power sag, power surge, under voltage, over voltage.

## Product features:

- Compact, quiet, user-friendly
- Desktop and 19" RM models
- Short circuit and overload protection
- AVR (Automatic Voltage Regulation)
- ABM (Automatic Battery Management) increases battery life up to 50%
- Telephone/Modem connections
- Shutdown software including License for 1 server
- Serial Port for advanced Power Management Software (incl. in content of delivery)
- UPS Management Software :  
Windows NT/ 2k / XP / 7 / 8 / 10 / Server 2003 / 2008 / 2012 x86/x64, MAC OS X (Intel) 10.6.x, 10.7.x, 10.8.x Mountain Lion, 10.9.x Mavericks/MAC OS
- Contents: UPS, Software, Cable Set



DATA CENTER Product

DATA CENTER Product



**roline** ups

Description	Output (VA/W)	Backup time	Dimensions (HxWxD)	Weight	Internal cooling	Order-No.	- P.U.
ROLINE LineSecure1000	1000 / 700	3 min	210 x 140 x 436 mm	15 kg	Active, fan	19.40.1110	- 1
ROLINE LineSecure1500	1500 / 960	3 min	226 x 170 x 450 mm	6.9 kg	Active, fan	19.40.1115	- 1
ROLINE LineSecure 1000R	1000 / 670	3 min	84 x 483 x 430 mm	20 kg	Active, fan	19.40.1111	- 1
ROLINE LineSecure 1500R	1500 / 960	3 min	130 x 483 x 381 mm	25 kg	Active, fan	19.40.1116	- 1
ROLINE LineSecure II 1000	1000 / 700	3 min	210 x 140 x 436 mm	15 kg	Active, fan	19.40.1112	- 1
ROLINE LineSecure II 1500	1500 / 960	3 min	226 x 170 x 450 mm	6.9 kg	Active, fan	19.40.1117	- 1
ROLINE LineSecure II 2000	2000 / 1300	3 min	226 x 170 x 450 mm	30 kg	Active, fan	19.40.1120	- 1
ROLINE LineSecure II 1000R	1000 / 670	3 min	84 x 483 x 430 mm	20 kg	Active, fan	19.40.1113	- 1
ROLINE LineSecure II 1500R	1500 / 960	3 min	130 x 483 x 381 mm	25 kg	Active, fan	19.40.1119	- 1
ROLINE LineSecure II 2000R	2000 / 1300	3 min	130 x 483 x 381 mm	29 kg	Active, fan	19.40.1121	- 1
ROLINE UPS 19" Rail Kit 2/3U 58-90 cm			58-90 cm, 2 UH	0.4 kg		19.40.2177	- 1

**ROLINE DesignSecure – Line Interactive UPS**

- Compact designed UPS in futuristic design
- For Workstations and PCs
- LineInteractive UPS
- AVR (Automatic Voltage Regulation)
- Digital status display
- Integrated overvoltage protection
- Telephone/Modem connections
- USB Port for advanced Power Management Software (incl. in content of delivery)
- EMI/RFI Noise Filter
- Dimensions (HxLxW) 168 x 105 x 334 mm
- Backup Time: up to 4 Minutes
- Contents: UPS, Software, Cable Set

**Technical data:**  
 Input:  
 Voltage: 230 V +/- 25%  
 Frequency: 50 Hz +/- 10% (automatic detection)  
 Breaker or protection for overload and short circuit  
 Automatic UPS shut down in case of overload  
 Output (battery mode):  
 Voltage: simulated sinus at 230 V +/- 5%  
 Frequency: 50 Hz +/- 1Hz  
 Circuit time: 2/4 milliseconds reaction time  
 Voltage regulation (AVR): 9% - 25% to nominal voltage  
 Telephone protection  
 Short circuit protection



Description	Output (VA/W)	Backup time	Dimensions (HxWxD)	Weight	Internal cooling	Order-No. – P.U.
ROLINE DesignSecure 525	525/315	3 min	168 x 105 x 334 mm	5.8 kg	Passive	19.40.1205 – 1
ROLINE DesignSecure 625	625/375	3 min	168 x 105 x 334 mm	6.4 kg	Passive	19.40.1206 – 1
ROLINE DesignSecure 825	825/495	2 min	168 x 105 x 334 mm	6.3 kg	Passive	19.40.1208 – 1
ROLINE DesignSecure 1200	1200/720	3 min	168 x 105 x 334 mm	14 kg	Passive	19.40.1212 – 1
ROLINE DesignSecure 2000	2000 / 1200	2 min	192 x 130 x 382 mm	16 kg	Passive	19.40.1220 – 1

**ROLINE ProSecure II / III – Online UPS**

**The ROLINE ProSecure Series - for optimum power protection is a truly state of the art online double conversion UPS, ideal for all essential computer systems and servers. Protects against: power failure, power sag, power surge, under voltage, over voltage, switch transient, line noise, frequency variation, harmonic distortion.**

Product features:

- Cold start function (DC power on)
- Lightning and surge protection
- Battery replacement warning
- Emergency Power Off function
- Battery remain time display
- LCD display front panel
- Power factor correction
- Support USB communication
- Multiple language LCD display
- On line output voltage selected
- Hot swappable battery by user
- True on-line technology provides all power protection
- Pure sine-wave output with less than 3% THD
- Fully digitized microprocessor controlled
- Short Circuit and overload protection
- Advanced management (ABM)



- Automatic battery charge in UPS off mode
- Automatic diagnostics & battery check
- RS-232 communication port with monitoring software
- Network/fax/modem surge protection
- Extended back up time with battery pack
- Load segmentation receptacles controllable
- High efficiency mode selectable
- Fan speed auto control when loads varies
- UPS Management Software:  
 Windows NT/ 2k/ XP / 7 / 8 / 10 / Server 2003 / 2008 / 2012 x86/x64, MAC OS X (Intel) 10.6.x, 10.7.x, 10.8.x Mountain Lion, 10.9.x Mavericks/MAC OS
- Contents: UPS, Software, Cable Set

**Technical data:**

Input:  
 Input voltage range: 160 VAC - 276 VAC  
 Frequency: 50 Hz  
 Input power factor: 0.97  
 Freq. window from mains: 45 - 65 Hz  
 Synchronization window: ± 3 Hz  
 Output:  
 Output voltage: 208/220/230/240 VAC, selectable from LCD panel  
 Voltage regulation: ± 2%  
 Voltage distortion: < 5% THD at full non-linear load, < 3% THD at full linear load  
 Overload capacity: 100 - 125% 1 min., 125 - 150% 10 sec  
 Efficiency: greater than 86%



DATA CENTER Product



Description	Output (VA/W)	Backup time	Dimensions (HxWxD)	Weight	Internal cooling	Order-No. – P.U.
ROLINE ProSecure II 700 - Online UPS	700 / 490	5 min	235 x 155 x 410 mm	15 kg	Active, fan	19.40.1081 – 1
ROLINE ProSecure II 1000 - Online UPS	1000 / 700	6 min	235 x 155 x 410 mm	16 kg	Active, fan	19.40.1082 – 1
ROLINE ProSecure II 1500 - Online UPS	1500 / 1050	5 min	235 x 155 x 410 mm	20 kg	Active, fan	19.40.1083 – 1
ROLINE ProSecure II 2000 - Online UPS	2000 / 1400	6 min	365 x 216 x 405 mm	31 kg	Active, fan	19.40.1084 – 1
ROLINE ProSecure II 3000 - Online UPS	3000 / 2100	5 min	365 x 216 x 405 mm	37 kg	Active, fan	19.40.1085 – 1
ROLINE ProSecure II 700 RM1U - Online UPS, 19" Rack Version	700 / 490	4 min	44 x 428 x 610 mm; 1 UH	16 kg	Active, fan	19.40.1086 – 1
ROLINE ProSecure II 1000 RM1U - Online UPS, 19" Rack Version	1000 / 700	2 min	44 x 428 x 610 mm; 1 UH	16 kg	Active, fan	19.40.1087 – 1
ROLINE ProSecure II 700 RM2U - Online UPS, 19" Rack Version	700 / 490	6 min	88 x 428 x 425 mm; 2 UH	16 kg	Active, fan	19.40.1088 – 1
ROLINE ProSecure II 1000 RM2U - Online UPS, 19" Rack Version	1000 / 700	5 min	88 x 428 x 425 mm; 2 UH	17 kg	Active, fan	19.40.1089 – 1
ROLINE ProSecure II 1500 RM2U - Online UPS, 19" Rack Version	1500 / 1050	5 min	88 x 428 x 425 mm; 2 UH	18 kg	Active, fan	19.40.1090 – 1
ROLINE ProSecure II 2000 RM2U - Online UPS, 19" Rack Version	2000 / 1400	6 min	88 x 428 x 610 mm; 2 UH	32 kg	Active, fan	19.40.1091 – 1
ROLINE ProSecure II 3000 RM2U - Online UPS, 19" Rack version	3000 / 2100	5 min	88 x 428 x 610 mm; 2 UH	32 kg	Active, fan	19.40.1092 – 1
ROLINE ProSecure III 1000 - Online UPS	1000 / 900	3 min	238 x 152 x 420 mm	14 kg	Active, fan	19.40.1062 – 1
ROLINE ProSecure III 1500 - Online UPS	1500 / 1350	5 min	235 x 155 x 410 mm	20 kg	Active, fan	19.40.1063 – 1
ROLINE ProSecure III 2000 - Online UPS	2000 / 1800	3 min	358 x 225 x 420 mm	31 kg	Active, fan	19.40.1064 – 1
ROLINE ProSecure III 3000 - Online UPS	3000 / 2700	5 min	365 x 216 x 405 mm	37 kg	Active, fan	19.40.1065 – 1
ROLINE ProSecure III 1000 RM2U - Online UPS, 19" Rack Version, black	1000 / 900 @ Pf. 0,9	3 min	88 x 428 x 425 mm; 2 UH	17 kg	Active, fan	19.40.1069 – 1
ROLINE ProSecure III 1500 RM2U - Online UPS, 19" Rack Version, black	1500 / 1350 @ Pf. 0,9	3 min	88 x 428 x 425 mm; 2 UH	18 kg	Active, fan	19.40.1070 – 1
ROLINE ProSecure III 2000 RM2U - Online UPS, 19" Rack Version, black	2000 / 1800 @ Pf. 0,9	3 min	88 x 428 x 610 mm; 2 UH	32 kg	Active, fan	19.40.1071 – 1
ROLINE ProSecure III 3000 RM2U - Online UPS, 19" Rack Version, black	3000 / 2700 @ Pf. 0,9	3 min	88 x 428 x 610 mm; 2 UH	33 kg	Active, fan	19.40.1072 – 1



## VALUE Power Strips

- 3/6-way power strip with plastic housing
- Sockets are 45° rotated
- Colour: white

**Technical data:**  
 - Wire: H05VV-F 3G 1.50 mm<sup>2</sup>  
 - Cable length: up to 10 m  
 - Illuminated 2-pole rocker switch  
 - Max. load: 250 VAC, 10/16A, 3600 W



## Order-No. – P.U.

VALUE Power Strip, 3-way, white, 1.5 m	19.99.1040 – 20
VALUE Power Strip, 3-way, white, 3 m	19.99.1042 – 10
VALUE Power Strip, 3-way, with Switch, white, 1.5 m	19.99.1041 – 20
VALUE Power Strip, 3-way, with Switch, white, 3 m	19.99.1043 – 10
VALUE Power Strip, 3-way, with Switch, white, 6 m	19.99.1065 – 10
VALUE Power Strip, 3-way, with Switch, white, 10 m	19.99.1066 – 10
VALUE Power Strip, 6-way, white, 1.5 m	19.99.1044 – 20
VALUE Power Strip, 6-way, white, 3 m	19.99.1046 – 10
VALUE Power Strip, 6-way, with Switch, white, 1.5 m	19.99.1045 – 20
VALUE Power Strip, 6-way, with Switch, white, 3 m	19.99.1047 – 10
VALUE Power Strip, 6-way, with Switch, white, 6 m	19.99.1067 – 10
VALUE Power Strip, 6-way, with Switch, white, 10 m	19.99.1068 – 10
VALUE Power Strip, 3-way UTE, white, 3 m	19.99.1048 – 1
VALUE Power Strip, 6-way UTE, white, 3 m	19.99.1049 – 1
VALUE Power Strip, 3-way, with Switch, Surge Protection, white, 1.5 m	A 19.99.1070 – 20
VALUE Power Strip, 6-way, with Switch, Surge Protection, white, 1.5 m	B 19.99.1071 – 20



## VALUE Power Strip, 6-way UTE, with Switch

- 6-way power strip with plastic housing
- Sockets are 45° rotated
- With illuminated 2-pole rocker switch
- Colour: white



## Order-No. – P.U.

VALUE Power Strip, 6-way UTE, with Switch, white, 1.5 m	19.99.1030 – 1
---	----------------



## VALUE Power Strip, 3/5-way, with Switch, 2x USB

**3/5-way power strip with off/on switch and two separate USB ports for charging devices such as smartphones or tablets.**

- Plastic housing
- Sockets are 45° rotated
- With illuminated 2-pole rocker switch
- **2x USB, 5VDC, 2.1A**
- Colour: white



## Order-No. – P.U.

VALUE Power Strip, 3-way, with Switch, 2x USB, white, 1.5 m	A 19.99.1035 – 20
VALUE Power Strip, 5-way, with Switch, 2x USB, white, 1.5 m	B 19.99.1036 – 20



**VALUE Clamp-On Power Strip Holder**

- Suitable next to desktops, multimedia systems, etc.
- For an organized desktop/office
- Clamp-On power strip holder
- Clamps onto surfaces up to 50 mm thickness
- Width adjustment range of the kept devices: min. 50mm- max. 70mm

- Silicone pads prevent the mounted device from scratching and accidental dropping (e.g. secure hold of power strip...)
- Cable management
- **Please see also page 9.19**



**NEW**



VALUE Clamp-On Power Strip Holder, white	Order-No. – P.U. 19.99.3230 – 10
--	-------------------------------------

**ROLINE Power Strip**

- 6 AC outlets, rotated 45°
- Children safety shutters
- 5 standard sockets plus 1 „block space“ socket
- 10 A resettable circuit breaker
- 1-pole rocker switch, lighted
- Max. load 10 A 230 V
- Power cord 1.8 m length, with right angle power plug



**roline**  
Designed for Professionals

	Order-No. – P.U.
ROLINE Power Strip, 6-way	19.07.1601 – 20
ROLINE Power Strip, 6-way, Surge Protection	19.07.1606 – 20

**ROLINE Power Wall Outlet, 2x USB Charger**

- Electrical Rating : 16A, 250 VAC
- S1/S3 Type MOV (Metal-Oxid Varistor) Technology
- Children safety
- Max. Peak Spike Current : 12.000 A
- Max. Spike Voltage 6 kV
- Power ON Indicator (LED indicator)
- 2-port 5V/2.1A USB Charger

**roline**  
Designed for Professionals



	Order-No. – P.U.
ROLINE Power Wall Outlet, 2x USB Charger	A 19.07.1616 – 10
ROLINE Power Wall Outlet, 2x USB Charger, UTE version	B 19.07.1617 – 10

**ROLINE USB Wall Chargers**

**For charging or powering a device via its USB input.**

- For charging of mobile devices (tablets / smartphones)
- Quick Charge 2.0 supported (19.11.1025 / 19.11.1024 QC3.0)
- Multi-Protection: Over Current / Short Circuit / Over Voltage Protection
- Compact Design

- PowerIQ technology- identifies what kind of device is plugged into and delivers the proper voltage/amperage
- Input: 100- 240 V AC, 50- 60 Hz

Technical data:	19.11.1025	19.11.1026	19.11.1024	19.11.1029
Input:	100 - 240 VAC	100 - 240 VAC	100 - 240 VAC	100 - 240 VAC
Output:	1x USB A F (5V 2.4A; 9V 1.8A; 12V 1.3A)	2x USB A F (5V; 2.4A)	1x USB A F 3.6V-6.5V/3A, 6.5V-9V/2A, 9V-12V/2A (max. 24 W)	1x USB C 5V-3A, 9V-3A, 15V-3A, 20V-3.5A (max. 65 W)
Power (max.):	16W	5VDC; 4.8A	24W	65W
Dimensions:	37 x 24 x 82 mm	64 x 27 x 88 mm	55 x 29 x 88 mm	55 x 29 x 88 mm
Additional features	IQ technology QC 2.0 (Quick Charge)	IQ technology	QC 3.0 (Quick Charge)	IQ technology Power Delivery



	Order-No. – P.U.
ROLINE USB Wall Charger, Euro Plug, 1 Port, QC, 12W	A 19.11.1025 – 10
ROLINE USB Wall Charger, Euro Plug, 2 Port, 24W	B 19.11.1026 – 10
ROLINE USB Wall Charger, Euro Plug, 1 Port, QC3.0, 24W	C 19.11.1024 – 10
ROLINE USB Wall Charger, Euro Plug, 1 Port, Type C, 65W	D 19.11.1029 – 10

**roline**  
Designed for Professionals

## ROLINE USB Chargers, 4 / 6 Ports, up to max. 60W

- For charging mobile devices (tablets / smartphones), even four at one time.
- Multi-Protection: Over Current / Short Circuit / Over Voltage Protection
- IQ technology

- Input range: 100- 240 V AC, 50- 60 Hz
- Contents: USB charger, power cable (2pin Euro) 1,2m



## Technical data:

Input:

Output:

Power (max.):

Dimensions:

Additional features

19.11.1027

100 - 240 VAC

3x USB A F (5V; 2.4A)

1x USB C F (5V; 3A)

5VDC; 8A

28 x 58 x 90 mm

IQ technology

19.11.1030

100 - 240 VAC

4x USB A F

1x USB A F, QC3.0

3.6V-6.5V/3A,

6.5V-9V/2A,

9V-12V/2A

1x USB C F (5V; 3A)

60W

28 x 67 x 101 mm

IQ technology

QC 3.0 (Quick Charge)

19.11.1028

100 - 240 VAC

5x USB A F (5V; 2.4A)

1x USB A F QC2.0

5V/2.4A, 9V/2A, 12V/2A

60W

28 x 66 x 100 mm

IQ technology

1x QC 2.0 (Quick Charge)

19.11.1031

100 - 240 VAC

2x USB A F

1x USB A F, QC3.0

3.6V-6.5V/3A, 6.5V-9V/2A,

9V-12V/2A

1x USB C F (5V; 3A)

40W

28 x 58 x 91 mm

IQ technology

QC 3.0 (Quick Charge)

ROLINE USB Charger, 4 Ports (3x USB + 1x USB C), max. 40W

A

Order-No. – P.U.

19.11.1027 – 10

ROLINE USB Charger, 6 Ports (4x USB A, 1x USB C, 1x USB A QC3.0), max. 60W

B

19.11.1030 – 10

ROLINE USB Charger, 6 Ports (5x USB + 1x USB QC), max. 60W

C

19.11.1028 – 10

ROLINE USB Charger, 4 Ports (3x USB + 1x USB C), max. 40W

D

19.11.1031 – 10

  
Designed for Professionals

## VALUE IP Power Strip

DATA CENTER  
Product

The VALUE IP power strip provides the on/off-switching of electrical devices over a TCP/IP network. Easily connect the VALUE IP power strip to a power supply system and the network. After allocating a free IP address, every single port can be independantly switched with every common webbrowser.

- For installation in a 19" cabinet, height: 1U
- Easy and quick plug & play installation
- Easy and flexible configuration over a webbrowser
- IP adress fix or over DHCP
- LED indication for power status of every port
- Digital display for total power
- Mail and SNMP-Server
- Automatic circuit breaker protection
- SSL-encryption
- Contents: IP power bar



## Technical data:

Connections:

Output:

Input:

Rocker switch:

Indication:

Protocol:

Addressing:

Dimensions (WxDxH):

RJ-45, Ethernet 10/100Mbit, front side

8x IEC320 C13 (10A)

1x IEC320 C20 (16A)

Back side, lighted, 2-pole

8 LEDs

http

DHCP or fix IP-Address

430 x 90 x 44 mm

Order-No. – P.U.

VALUE IP Power Strip, 8-way

19.99.3405 – 1

## ROLINE PDU for Cabinets

DATA CENTER  
Product

- 19" socket (1UH) for installation in 19" cabinets, incl. installation angle
- Arrangement of sockets: 45 °
- Profile of anodized aluminium

- Cable type: 2.0m H05VV-F 3G 1,50mm<sup>2</sup>, black
- Max load/power: 16A 3600W; VDE / GS tested
- Color: ALU / light gray RAL 7035
- Width: 440mm

  
Designed for Professionals

Order-No. – P.U.

ROLINE PDU for Cabinet, 9x socket, 45°, 16A, Aluminium, 2m

19.07.1620 – 10

ROLINE PDU for Cabinet, 9x socket, 45°, 16A, black, 2m

19.07.1621 – 10

ROLINE 19" PDU for Cabinet 8x 2300W, IEC320 C14 M, Aluminium, 2m

19.07.1622 – 10

ROLINE 19" PDU for Cabinet 8x 2300W, IEC320 C14 M, black, 2m

19.07.1623 – 10

ROLINE 19" PDU for Cabinet 9x socket, 45°, 16A, UTE Version, black, 2m

19.07.1624 – 10

## ROLINE 19" PDU for Cabinets 8x 2300W, UTE Version, IEC320 C14 M

DATA CENTER  
Product

- 19 "socket (1UH) for installation in 19" cabinets, incl. installation angle
- Arrangement of sockets: 45°
- Profile of anodized aluminium

- Cable type: 2.0m H05VV-F 3G 1mm<sup>2</sup>, black
- Max load/power: 10A 2300W; VDE / GS tested
- Color: black
- Width: 440mm



Order-No. – P.U.

ROLINE 19" PDU for Cabinets 8x 2300W, UTE Version, IEC320 C14 M, black, 2.0 m

19.07.1626 – 10

  
Designed for Professionals



**ROLINE 19" PDU for Cabinets 8x IEC320 C13 - C20 / German Type / C14**

- 19" socket (1UH) for installation in 19" cabinets, incl. installation angle
- Arrangement of sockets: 90°
- Profile of anodized aluminium
- Cable type:
  - 2.0m H05VV-F 3G 1mm<sup>2</sup> (19.07.1629),
  - 2.0m H05VV-F 3G 1.5mm<sup>2</sup> (19.07.1627/19.07.1628) black
- Max load/power:
  - 10A 2300W (19.07.1629)
  - 16A 3600W (19.07.1627 / 19.07.1628)
- Color: ALU / light gray RAL 7035
- Width: 440mm

**NEW**

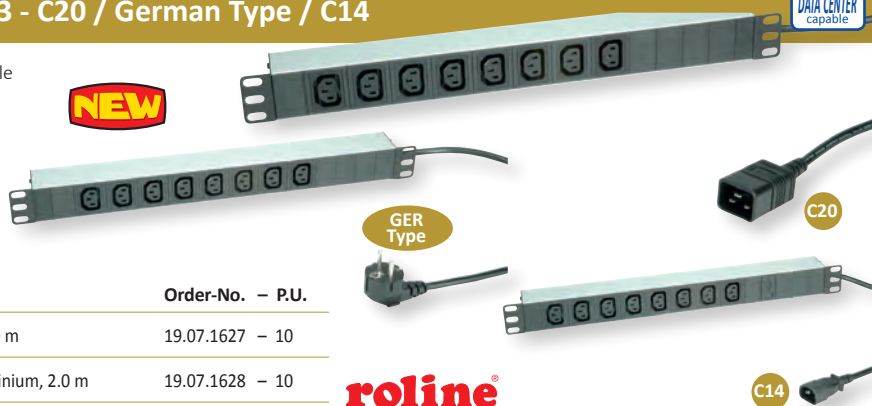

	Order-No. – P.U.
ROLINE 19" PDU for Cabinets 8x 2300W, IEC320 C13 - C20 M, Aluminium, 2.0 m	19.07.1627 – 10
ROLINE 19" PDU for Cabinets 8x 3600W, IEC320 C13 - German Type M, Aluminium, 2.0 m	19.07.1628 – 10
ROLINE 19" PDU for Cabinets 8x 3600W, IEC320 C13 - C14 M, 10 A Fuse, Aluminium, 2.0 m	19.07.1629 – 10

**roline**  
Designed for Professionals

**Universal Wall Power Supply**

For small devices as battery alternative or spare part

- Input: 230V/50 Hz
- Output: 500 mA
- Connection cable length: 1.5 m
- Voltage (VDC): 3 / 4.5 / 6 / 7.5 / 9 / 12 selectable with sliding switch
- Polarity +/- reversible (with plug adaptor)
- Contents: Power Supply Unit with 6 removable plugs (3.5 / 1.4x4 / 2.1x5 / 2.5x5.5 / 0.75x2.5 / 35x3.5 mm)



	Order-No. – P.U.
Universal Wall Power Supply 500mA	19.11.1097 – 1
Universal Wall Power Supply 1000mA	19.11.1098 – 1

**VALUE USB Power Chargers**

- Wall chargers resp. car charger with 2 USB type A F connectors
- For power supply and charging of devices with external power supply over USB
- E.g. for MP3 players, mobile phones, smart phones etc.
- Handy to use whether at home or in the hotel



	19.99.1064	19.99.1059	Order-No. – P.U.
Technical data:			
Input:	100-240 V AC, 50-60 Hz	12-24 V DC, 2.1A max.	
Output:	2x USB Type A F	2x USB Type A F	
Power:	10W (5VDC; 2A)	10W (5VDC; .12A)	
Dimensions:	46x28x85mm	33x35mm	
	VALUE USB Wall Charger, 2 Ports, 10W	VALUE USB Car Charger, 2 Port, 10W	
	A 19.99.1064 – 20	B 19.99.1059 – 20	

**ROLINE USB Power Car Charger**

- Car charger with 2 USB type A F connectors
- For power supply and charging of devices with external power supply over USB
- E.g. for MP3 players, mobile phones, smart phones etc.



**roline**  
Designed for Professionals

	Order-No. – P.U.
ROLINE USB Car Charger, 2 Port, 15W	A 19.07.1054 – 10
ROLINE LED USB Car Charger, 2 Port, 15W	B 19.07.1055 – 10

	19.07.1054	19.07.1055
Technical data:		
Input:	12-24 V DC	12-24 V DC
Output:	2x USB A F	2x USB A F
Power:	15,5W (5VDC; 3,1A)	15,5W (5VDC; 3,1A)
Dimensions:	33 x 60 mm	38 x 75 mm

**ROLINE USB QC Car Charger, 2 Port, (A + C), 12W**

Now you can easily charge your tablet PC, iPad, smart phone, iPhone, MP3 player and other USB devices in your car!

- Connector: 1x USB Type A F, 1x Type C F
- Input voltage: DC 12 V- 24 V
- Output voltage: 3.6V – 6V 3A / 6.1V – 9V 2A / 9.1V – 12V 1.5A

- Power output: 18W
- Supports Quick Charging to QC 3.0
- Dimensions: 33 x 68 mm

	Order-No. – P.U.
ROLINE USB QC Car Charger, 2 Port, (A + C), 12W	19.07.1053 – 20

**roline**  
Designed for Professionals



### ROLINE USB 3.0 Y Cable

- For the connection of high-power SuperSpeed USB 3.0 devices as e. g. external HDDs
- Very helpful if you want to connect your USB 3.0 device to a PC with USB 2.0 ports

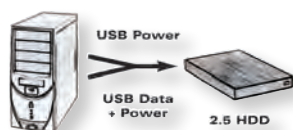

**roline**  
Designed for Professionals

Order-No. – P.U.

ROLINE USB 3.0 Y Cable, 2x Type A M - 1x Micro B M, 1,8 m

19.08.1008 – 10

### VALUE USB Wall Charger (EU+UK)

**For charging mobile devices, even two at one time.**

- Wall power adapter with two USB type A F connectors and 2 adapters (EU+UK)
- It's handy to use whether at home or in the hotel
- For charging smart phones, tablet PCs (e. g. iPad), MP3 players ...
- Input range: 100- 240 V AC, 50- 60 Hz
- Output voltage: 5 V
- Output rate: 10 W (2 A)
- Dimensions: 42 x 42 x 25 mm



**Value**

Order-No. – P.U.

VALUE USB Wall Charger (EU+UK), 2 Ports, 10W

19.99.1061 – 20

### VALUE Car Charger with 4x USB 2.0 ports

- 4 port USB car charger with two ports in front (where you plug in the car adapter- cigarette lighter) and two ports extension for the backseat
- Super convenient on long trips, because 4 devices (tablets/smartphones ...) can be charged simultaneously
- The 4x USB 2.0 ports are equipped with blue LED indicator
- The cable for the backseat port extension is about 1.8m long and has a clip which helps you to attach it to

- the pockets behind the front seats
- Power Output: 48 W (4x 5V DC, 2.4A)
- Smart IC, detects the correct maximum output for the plugged in device
- Material: ABS+PC

Order-No. – P.U.

VALUE Car Charger with 4x USB 2.0 ports, black

19.99.1063 – 10

**Value**



### ROLINE USB Charging Stations

- For charging smart phones, tablet PCs (e. g. iPad), MP3 players ...
- Power and charge up to 5/7 devices at once in one convenient location on your desk-top, counter top, lobby, or waiting room.
- Perfect for home or office use, most cell phones and tablets fit in station's slots without removing protective cases (slot widths- 19mm)
- 5/7 Powered USB Ports (5x 2.4A)- Simply connect your own charging cable and the charging station will charge up to 5/7 devices, including smartphones and high-powered devices such as tablets
- Organize up to 5/7 devices- 5/7 slots with anti-scratch silicone pads organize your devices even with the cases still on
- Surge protection on each port
- Built-in smart charging chipset provides and determines the charge needed for your device, delivering a steady and safe charge
- Power in a compact space
- Power Supply: 19VDC; 3.4A
- Output: 5x/7x 2.4A
- Contents: USB charger, power adapter

Technical data:	19.07.1050	19.07.1051
Number of ports:	5	7
Output:	5x USB 2.0 A, F	7x USB 2.0 A, F
Input Voltage:	100 - 240V AC, 50 - 60Hz	100 - 240V AC, 50 - 60Hz
Output Voltage:	5VDC	5VDC
Power Output rate:	5x 5V DC 2.4A	7x 5V DC 2.4A
Colour:	black	black
Material (housing):	plastic	plastic



Order-No. – P.U.

ROLINE USB Charging Station, 5 Port

19.07.1050 – 4

ROLINE USB Charging Station, 7 Port

19.07.1051 – 10

**roline**  
Designed for Professionals

VALUE / ROLINE Monitor Power Cables

- Monitor power cable with moulded plugs
- Connectors: IEC 320-C14 plug to IEC 320-C13 plug
- Nominal data: 250V AC/10A
- Colour: black



	Order-No.	P.U.
VALUE Monitor Power Cable, black, 0.5 m, IEC 320 C14 - C13	19.99.1505	- 20
VALUE Monitor Power Cable, black, 1.0 m, IEC 320 C14 - C13	19.99.1510	- 20
VALUE Monitor Power Cable, black, 1.8 m, IEC 320 C14 - C13	19.99.1515	- 50
VALUE Monitor Power Cable, black, 3.0 m, IEC 320 C14 - C13	19.99.1530	- 50
ROLINE Monitor Power Cable, black, 0.5 m, IEC 320 C14 - C13	19.08.1505	- 50
ROLINE Monitor Power Cable, black, 1.0 m, IEC 320 C14 - C13	19.08.1510	- 30
ROLINE Monitor Power Cable, black, 1.8 m, IEC 320 C14 - C13	19.08.1515	- 50
ROLINE Monitor Power Cable, black, 3.0 m, IEC 320 C14 - C13	19.08.1530	- 50

VALUE / ROLINE Monitor Power Cables

- Monitor power cable with moulded plugs
- Connectors: IEC 320-C14 plug to IEC 320-C13 plug
- Nominal data: 250V AC/10A

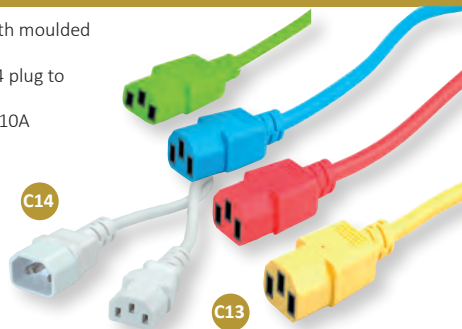

	Order-No.	P.U.
VALUE Monitor Power Cable, white, 1.8 m, IEC 320 C14 - C13	19.99.1516	- 50
ROLINE Monitor Power Cable, red, 1.8 m, IEC 320 C14 - C13	19.08.1520	- 25
ROLINE Monitor Power Cable, yellow, 1.8 m, IEC 320 C14 - C13	19.08.1521	- 25
ROLINE Monitor Power Cable, blue, 1.8 m, IEC 320 C14 - C13	19.08.1522	- 25
ROLINE Monitor Power Cable, green, 1.8 m, IEC 320 C14 - C13	19.08.1523	- 25

VALUE Power Cable, straight IEC Connector

- Cable with safety plug 90° angulate (German safety plug) and IEC 320-C13
- Plugs: German safety plug to C13 plug
  - Nominal data: 250V AC/2.5A
  - Colour: black



	Order-No.	P.U.
VALUE Power Cable, straight IEC Connector, black, 1.8 m	19.99.1018	- 50
VALUE Power Cable, straight IEC Connector, white, 1.8 m	19.99.1019	- 50
VALUE Power Cable, angled IEC Connector, black, 1.8 m	19.99.1118	- 50
VALUE Power Cable, straight Compaq Connector, black, 1.8 m	19.99.1028	- 20

ROLINE Power Cable, straight IEC Connector

- Cable with safety plug 90° angulate (german type) and IEC 320-C13
- Plugs: safety plug to C13 plug
  - Nominal data: 250V AC/2.5A
  - Colour: red, yellow, blue, green



	Order-No.	P.U.
ROLINE Power Cable, straight IEC Connector, red, 1.8 m	19.08.1010	- 25
ROLINE Power Cable, straight IEC Connector, yellow, 1.8 m	19.08.1011	- 25
ROLINE Power Cable, straight IEC Connector, blue, 1.8 m	19.08.1012	- 25
ROLINE Power Cable, straight IEC Connector, green, 1.8 m	19.08.1013	- 25

ROLINE Power Cable, straight IEC Connector

- Cable with safety plug 90° angulate (German safety plug) and IEC 320-C13
- Plugs: German safety plug to C13 plug
  - Nominal data: 250V AC/2.5A
  - Colour: black

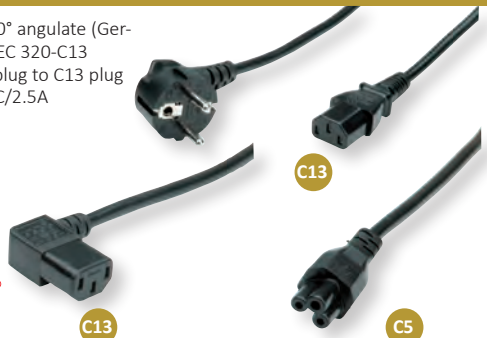

	Order-No.	P.U.
ROLINE Power Cable, straight IEC Connector, 1.8 m	19.08.1018	- 50
ROLINE Power Cable, straight IEC Connector, 3.0 m	19.08.1030	- 50
ROLINE Power Cable, angled IEC Connector, 1.8 m	19.08.1118	- 50
ROLINE Power Cable, straight Compaq Connector, 1.8 m	19.08.1028	- 20

VALUE Power Cord German Safety Plug, IEC320 - C19 16A

- Cable often used for UPS from 3000 VA and for connecting Blade servers.
- Connection cable 16 A with IEC320 C19 Female and German safety plug, angled
  - Cable: H05VV-F 3G1.5 3x 1.5mm<sup>2</sup>
  - Nominal data: 250 VAC/16 A
  - Colour: black



	Order-No.	P.U.
VALUE Power Cord German Type, IEC320 - C19 16A, black, 2.0 m	19.99.1552	- 20
VALUE Power Cord German Type, IEC320 - C19 16A, black, 3.0 m	19.99.1553	- 20
ROLINE Power Cord German Type, IEC320 - C19 16A, black, 2.0 m	19.08.1552	- 14
ROLINE Power Cord German Type, IEC320 - C19 16A, black, 3.0 m	19.08.1553	- 10
ROLINE Power Cord IEC320/C19 - C20 16A, black, 2.0 m	19.08.1562	- 14
ROLINE Power Cord IEC320/C19 - C20 16A, black, 3.0 m	19.08.1563	- 10



### VALUE / ROLINE Euro Power Cables, 2-Pin

- Suitable e.g. for notebook power supply
- Connectors: Europlug to IEC320-C7 plug
- Moulded plugs
- 250V AC/2.5A



	Order-No.	P.U.
VALUE Euro Power Cable, 2-Pin, black, 1.8 m	19.99.2096	- 100
VALUE Euro Power Cable, 2-Pin, white, 1.8 m	19.99.2095	- 100
VALUE Euro Power Cable, 2-Pin, black, 3.0 m	19.99.2092	- 50
VALUE Euro Power Cable, 2-Pin, black, 5.0 m	19.99.2094	- 50
ROLINE Euro Power Cable, 2-Pin, black, 1.8 m	19.07.2096	- 100
ROLINE Euro Power Cable, 2-Pin, black, 3.0 m	19.07.2073	- 50
ROLINE Euro Power Cable, 2-Pin, black, 5.0 m	19.07.2078	- 50

### ROLINE Power Cable with German Type Connector / Open End, AC 230V

- Cable with German Type male connector, 16A / 230V ~
- Cable: H05VV-F 3G1 3x 0.75mm<sup>2</sup>
- Nominal data: 250 VAC/16 A
- Colour: black

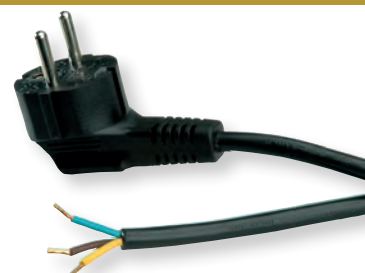

**roline**<sup>®</sup>  
Designed for Professionals

	Order-No.	P.U.
ROLINE Power Cable w. German connector / open end, AC 230V, black, 1.8 m	19.08.1110	- 10
ROLINE Power Cable w. German connector / open end, AC 230V, black, 3.0 m	19.08.1111	- 10

### VALUE Power Cables, Italy



- Nominal data: 250V AC/2.5A
- Colour: black
- Cable with Italy safety plug 90° angled and IEC 320-C13 (19.99.2070)
- Cable with safety plug 90° angled and 3-pin notebook plug (Compaq plug IEC 320-C5) (19.99.2071)
- Cable with Italy plug 90° angled and IEC 320-C13 (19.99.2072)

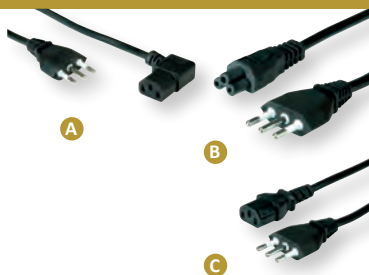

**Value**

	Order-No.	P.U.
VALUE Power Cable, angled IEC Connector, Italy, 1.8 m	A 19.99.2070	- 50
VALUE Power Cable, straight Compaq Connector, Italy, 1.8 m	B 19.99.2071	- 50
VALUE Power Cable, straight IEC Connector, Italy Version, 1.8 m	C 19.99.2072	- 50

### VALUE UK Power Cables, 3A/10A



#### Cables with UK plug and

- 3-pin notebook plug (Compaq plug IEC 320-C5 - 19.99.2016)
- IEC320-C7 plug - 19.99.2017
- IEC320-C13 plug - 19.99.2018/2019

- Nominal data: 250V AC/3A
- Colour: black



**Value**

	Order-No.	P.U.
VALUE UK Power Cable, straight Compaq Connector, 3A, 1.8 m	A 19.99.2016	- 1
VALUE UK Power Cable, 2-pin, 3A, 1.8 m	B 19.99.2017	- 1
VALUE UK Power Cable, straight IEC Connector, 10A, 1.8 m	C 19.99.2018	- 1
VALUE UK Power Cable, straight IEC Connector, 10A, 3.0 m	C 19.99.2019	- 1

### Power Cable, NEMA-5 – IEC C13 Connector, USA

#### Cable with plug NEMA-5 and IEC-C13

- Plugs: NEMA-5 male to C13 female
- Nominal data: 125V AC/10A
- Colour: black
- Suitable for USA



**Value**

**NEW**

	Order-No.	P.U.
Power Cable, NEMA-5 - straight IEC Connector C13, USA, 1.8 m	19.99.1495	- 50

### VALUE Extension Cable with German Type Connectors

- Extension cable with German Type male and female connector, 16A / 230V ~
- Cable: H05VV-F 3G1.5 3x 1.5mm<sup>2</sup>
- Nominal data: 250 VAC/16 A
- Colour: black

#### UTE Version

- Suitable for France, Czech Republic, Slovakia



**Value**

UTE Version

**NEW**

	Order-No.	P.U.
VALUE Extension Cable w. German Type connectors, AC 230V, black, 3 m	19.99.1166	- 20
VALUE Extension Cable w. German Type connectors, AC 230V, black, 5 m	19.99.1167	- 20
VALUE Extension Cable w. German Type connectors, AC 230V, black, 10 m	19.99.1168	- 10
	<b>Order-No.</b>	<b>P.U.</b>
VALUE Extension Cable with 3P. Connectors, UTE Version, AC 230V, black, 3.0 m	19.99.1170	- 20
VALUE Extension Cable with 3P. Connectors, UTE Version, AC 230V, black, 5.0 m	19.99.1171	- 20
VALUE Extension Cable with 3P. Connectors, UTE Version, AC 230V, black, 10.0 m	19.99.1172	- 10

### VALUE / ROLINE Y-Power Cable, 2x straight IEC Connector

Cable with safety plug 90° angled (German Type plug) and 2x IEC 320-C13 plug straight

- Suitable for PC and monitor power connection
- Connectors: German Type plug to 2x C13 plug
- Nominal data: 250V AC/10A
- Colour: black



**Value** **roline**<sup>®</sup>  
Designed for Professionals

	Order-No.	P.U.
VALUE Y-Power Cable, 2x straight IEC Connector C13, 1.8 m	19.99.1022	- 50
ROLINE Y-Power Cable, 2x straight IEC Connector C13, 1.8 m	19.08.1022	- 50



## Test / Measurement / Tools

8

Cable Testers / Network Tools . . . . .	8.02 – 8.03
USB Type C Measurement . . . . .	8.03
Crimping Pliers / Tools. . . . .	8.04 – 8.05
Fiber Optic Cleaning Tools. . . . .	8.06
Service Kits . . . . .	8.07 – 8.10
Cable Ties / Installation Tools / Clips . . . . .	8.10
Cable Tunnel Organizers . . . . .	8.10

VALUE LAN Quicker Cable Tester

- For the quick test of RJ-45/UTP, RJ-45/STP cabling
- OPEN, SHORT and CROSS test function
- LED indicator on both main unit and remote unit
- Beep sound warning
- Step/Auto select function
- Low battery indication
- Auto power off

- Small size, easy to carry
- Carrying case included
- Ideal for LAN installation
- Dimensions: 104 x 78 x 33 mm
- Contents: Cable tester, 9V battery, carrying case



Order-No. – P.U.

VALUE LAN Quicker Cable Tester

13.99.3001 – 5

VALUE LAN Cable Multifunction Tester

- The tester can check UTP and STP Cat.5e, Cat.6, Cat.6a and coaxial cables
- It can identify and locate the distance to an open or short circuit
- Uses TDR (Time Domain Reflectometer) to measure the length and distance to the defective of a cable

- Identification of wiring and pin assignment
- LCD backlight display
- Low battery indication



Order-No. – P.U.

VALUE LAN Cable Multifunction Tester

13.99.3002 – 1

VALUE LANtest Multi-Network Cable + PoE Tester

- Continuity testing of coax cables with BNC connectors and 8-pole data lines w. fitted RJ-45 connectors
- The device recognises open and short-circuited (wire/wire or wire/shield) connections
- A two-line display (LEDs) indicates sequentially which pin of the RJ-45 connector at cable end A is connected with which pin at cable end B and manual or automatic switch advancing is possible; in the case of a short-circuit more than two LEDs light up simultaneously
- The device has 2 RJ-45 sockets; with the supplied Remote Kit cables laid in the wall can also be tested
- Two adapter cables (BNC/RJ-45) are supplied for testing coax cables
- PoE check- the PoE Finder allows the network administrator to find out if a

network cable is supplied via PoE. Just plug in the network cable that has to be tested. The LED of the PoE finder will shine if the cable is supplied with power.

- Battery (not included in delivery): 1x E-block 9V (6LR61/AM-6)



Order-No. – P.U.

VALUE LANtest Multi-Network Cable + PoE Tester

13.99.3003 – 5

HOBBS LANtest Multinetwork Cable Tester

- Continuity testing of coax cables with BNC connectors and 8-pole data lines w. fitted RJ-45 connectors
- The device recognises open and short-circuited (wire/wire or wire/shield) connections
- A two-line display (LEDs) indicates sequentially which pin of the RJ-45 connector at cable end A is connected with which pin at cable end B and manual or automatic switch advancing is possible; in the case of a short-circuit more than two LEDs light up simultaneously
- The device has 2 RJ-45 sockets; with the supplied Remote Kit cables laid in the wall can also be tested
- Two adapter cables (BNC/RJ-45) are supplied for testing coax cables
- Battery (not included in delivery): 1x E-block 9V (6LR61/AM-6)



Order-No. – P.U.

HOBBS LANtest Multinetwork Cable Tester

13.01.3383 – 20

VALUE PoE / PoE+ - Tester/Detector

With the increase of connecting PoE equipment over data lines you can damage sensitive equipment (like e.g. IP-telephony, access points, routers, network cameras, etc.) with a simple misconnection, therefore you may protect your investment in expensive network equipment by testing the lines before you plug in anything.

The new useful PoE Finder allows the network administrator to find out in one second if a network cable is supplied with current. Protect old devices and quickly and easily find wires supplied with current. The use of the PoE Finder is very easy. Just plug in the network cable that has to be tested. The LED of the PoE finder will shine if the cable is supplied with power.

- Compact designed PoE tester ideal for testing of PoE installations
- Compliant with 802.3af / 802.3at PoE standard and passive PoE at 10/100/1000 data rates
- Test mode A PoE (pins 12, 36) (Endspan)
- Test mode B PoE (pins 45, 78) (Midspan)



Order-No. – P.U.

VALUE PoE - Tester/Detector

A 13.99.3009 – 20

VALUE PoE/PoE+ - Tester/Detector

B 13.99.3010 – 20



### HOBBS PoE Finder



PoE (Power over Ethernet) that is power over the LAN cabling becomes more and more important and is used for general applications like e.g. IP-telephony, access points, routers, newwork cameras, etc.

The useful PoE Finder allows the network administrator

to find out in one second if a network cable is supplied with current. Protect old devices and quickly and easily find wires supplied with current. The use of the PoE Finder is very easy. Just plug in the network cable that has to be tested. The LED of the PoE finder will shine if the cable is supplied with power.



Order-No. – P.U.

HOBBS PoE Finder

13.01.3342 – 1

### HOBBS LANtest Multinetwork PoE Cable Tester

- Easy verification for cabling faults including discontinuity, open wires, shorts (short-circuited- wire/wire or wire/shield- connections), miswiring and crossed pairs is quickly detected with the LANtest's unique LED display
- Wiring configuration for Cat5, coaxial and modular telephone cables by comparing one transmitting end to another receiving end
- Continuity testing of coax cables with BNC connectors and 8-pole data lines w. fitted RJ-45 connectors
- A two-line display (LEDs) indicates sequentially which pin of the RJ-45 connector at cable end A is connected with which pin at cable end B and manual or automatic switch advancing is possible; in the case of a short-circuit more than two LEDs light up simultaneously

- The device has 2 RJ-45 sockets; with the supplied Remote Kit cables laid in the wall can also be tested
- Two adapter cables (BNC/RJ-45) are supplied for testing coax cables
- Check the existence of PoE in a second
- Identifies the type of PSE, whether the PoE voltage is detected on the pair 12-36 (Endspan), or on the 45-78 (Midspan)
- Compliant with IEEE802.3af and IEEE802.3at standard
- Battery (not included in delivery):  
1x E-block 9V (6LR61/AM-6)



Order-No. – P.U.

HOBBS LANtest Multinetwork PoE Cable Tester

13.01.3371 – 20

### USB Type C Measurement Instrument with Display

This meter allows you to determine the power quality between your USB Type C sockets.

**Voltage and current are measured simultaneously.**

**Simply connect the meter between your Macbook/notebook and the power supply and read off the charging current - ideal for quick testing of power supplies, sockets and cables!**

- The optimal solution for monitoring the power supply of your USB Type C ports
- With the USB Type C meter you can measure voltage and current of the compatible USB Type C ports.
- Also for measuring USB Type C laptops or smartphones.
- Compact design, with bright, clear display for easy reading of the measured values
- Display of the values in volts, amps and mAh
- Indication of the current direction during charging process
- Passthrough charging functionality: the meter monitors power consumption and simultaneously charges your USB Type C device.
- Bypass of all USB data (Version 1.1 to 3.1 Gen 2): data running over the cable route is not disturbed.
- Without affecting the normal USB operation, also with USB Type C alternate mode- Video and USB Type C charging process
- Maximum voltage and current range: 20V 5A
- voltage and current measurement accuracy +/- 5%.
- Power consumption 5V / 30mA



Order-No. – P.U.

USB Type C Measurement Instrument with Display

13.01.3331 – 10

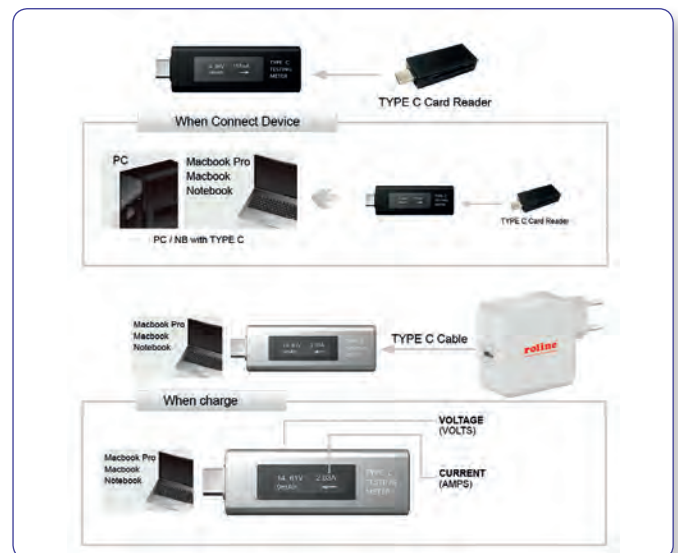

## Network Tool Set

- **1x Punch Down Tool** - for inserting wire into insulation-displacement connectors on e.g. punch down blocks, patch panels, keystone modules, surface mount boxes
- **1x LAN Tester**
  - Line tester for continuity test of Cat.5/6/6A and ISDN network lines
  - Separate receiver for long length cable, the main unit and separate receiver can be attached to each other via a lateral guide rail
  - Connection test with LED display for 8 single wires and shielding / detection of continuity, misalignment, interruption, short circuit, crossover cable
  - Power supply via 9VDC block battery (not supplied)
  - Compatible with the following connectivity modular plugs: RJ45 (8P8C), RJ12 (6P6C), RJ11 (6P4C, 6P2C)
  - Supported network standards: 10Base-T, 10Base-T2, 285A, TIA568A / 568B
- **1x Cable Stripper** - with 4 different blades for cutting the PVC jacket of cables of various sizes
- **1x RJ45 Crimping Tool**



Order-No. – P.U.

Network Tool Set, 4 pcs.

19.06.2034 – 10

## VALUE Crimping Tool 8P8C

- Solid metal pliers for cutting, stripping and crimping
- For RJ-45 connectors with 8 pins and 8 contacts



Order-No. – P.U.

VALUE Crimping Tool 8P8C

25.99.8791 – 5

## Crimping Tool 8-Pin 8-Contact

- Solid metal pliers for cutting, stripping and crimping
- For RJ45 connectors with 8 pins and 8 contacts



Order-No. – P.U.

Crimping Tool 8-Pin 8-Contact

19.06.1020 – 10

## VALUE Multifunction Crimping Tool 8P+6P+4P

- For 4/6/8-pole modular plugs
- Suitable for cutting, insulation removal (ribbon cable) and crimping
- Fitted with a forced lock with unlocking capability in the case of incorrect use
- Universally usable
- Robust metal tongs



Order-No. – P.U.

VALUE Multifunction Crimping Tool 8P+6P+4P

25.99.8790 – 5

**VALUE Universal Crimping Tool 8P6P, 6P4C**

- For 6/8-pole crimping modular plugs (RJ-11, RJ-12, RJ-45)
- Suitable for cutting, insulation removal (ribbon cable) and crimping
- Fitted with a forced lock with unlocking capability
- Universally usable
- Robust metal tongs

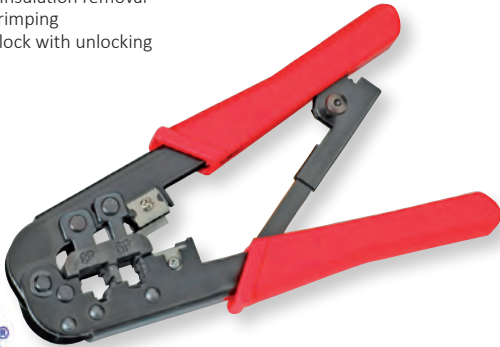

Order-No. – P.U.

VALUE Universal Crimping Tool 8P6P, 6P4C

25.99.8792 – 5

**Universal Modular Crimping Tool**

- For crimping modular plug: 8p8c/RJ-45, 6p6c/RJ-12 and 6p4c/RJ-11
- Suitable for cutting, insulation removal (ribbon cable) and crimping
- Fitted with a forced lock with unlocking capability
- Universally usable
- Robust metal tongs

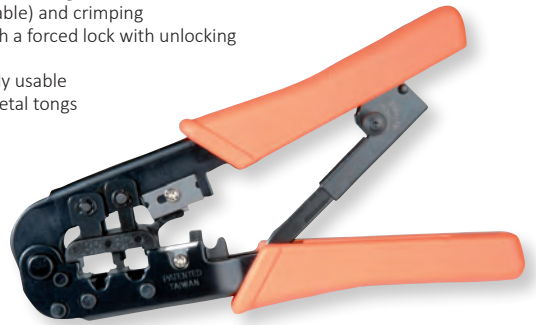

Order-No. – P.U.

Universal Modular Crimping Tool

19.06.1021 – 5

**Universal Crimping Tool for Modular Plugs**

- For 4/6/8-pole modular plugs from AMP System WE or DEC (RJ-12 and MMJ)
- Suitable for cutting, insulation removal (ribbon cable) and crimping
- Fitted with a forced lock with unlocking capability in the case of incorrect use
- Universally usable
- Robust metal tongs



Order-No. – P.U.

Universal Crimping Tool for Modular Plugs

19.06.1048 – 10

**Crimping Tool for Hirose RJ-45 Plug, TM11/TM21**

- Special crimping tool only suitable for HiRose modular plugs TM11
- Presses the connectors and the housing screening together in one movement
- In possible case of wrong handling, compulsory block through unlocking function
- Stable construction
- Metal



Order-No. – P.U.

Crimping Tool for Hirose RJ-45 Plug, TM11, green

19.06.1029 – 10

Crimping Tool for Hirose RJ-45 Plug, TM21, blue

19.06.1031 – 10

**VALUE Universal Wire Stripper**

- Light weight, compact, cost-effective stripper, simple to operate.
- Adjustable stripping blade for different insulation thickness, prevents damage of shielding and conductors
- For stripping coaxial cables RG59, RG6, RG7/11
- For stripping round networking cables
- For stripping flat 4P/6P/8P telephone cables

- The cassette can be reversed to change different coaxial cables
- For cutting cables
- Weight: ca. 70 g



Order-No. – P.U.

VALUE Universal Wire Stripper

25.99.8793 – 6

**VALUE IDC Tool**

- Excellent value for money
- Punch down tool for terminating into Cat. 5 patch panels with IDC blocks



Order-No. – P.U.

VALUE IDC Tool

25.99.8799 – 20



VALUE Fibre Optic Universal-Cleaning Products

13.99.3005 - VALUE Fibre Optic Universal Cleaning Cassette

- Application range: can be used for any optical fiber cables plug type independently
- The cassette cleaner wipes away contaminants from optical connector end face
- Designed for all types of connectors
- Compact size for easy hand-held operations
- Dry-clean without the use of harmful substances
- Cleaning micro fibers are densely stranded and debris free
- Constructed with anti-static material
- Up to 500 cleanings per unit possible
- Contents: 100 Cleaning-Tissues

13.99.3006 - VALUE Fibre Optic Cleaning Pen for SC Plug, 2.5mm

- Ergonomic and comfortable design for cleaning SC connections
- Consistent cleaning results due to its precise mechanical action
- Economical solution with up to 800 endface cleanings in one unit possible
- Cleans both APC and UPC connectors
- Effective on a variety of contaminants, including: Dust / Lint / Oil / Grease

13.99.3007 - VALUE Fibre Optic Cleaning Pen for LC Plug, 1.25mm

- Ergonomic and comfortable design for cleaning SC connections
- Consistent cleaning results due to its precise mechanical action
- Economical solution with up to 800 endface cleanings in one unit possible
- Cleans both APC and UPC connectors
- Effective on a variety of contaminants, including: Dust / Lint / Oil / Grease

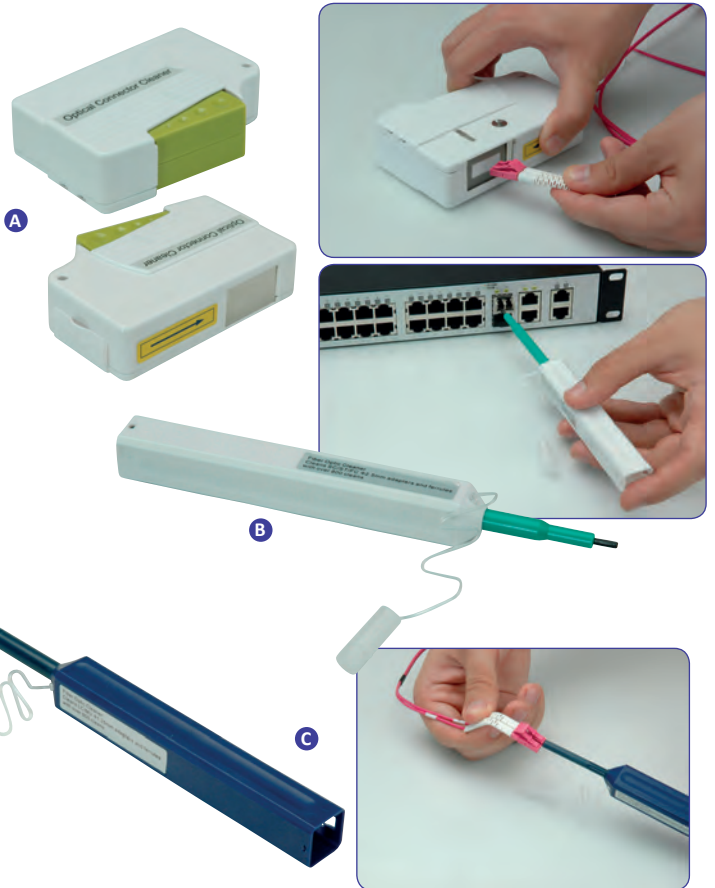

Order-No. – P.U.

VALUE Fibre Optic Universal-Cleaning Cassette A 13.99.3005 – 5

VALUE Fibre Optic Cleaning Pen for SC Plug, 2.5mm B 13.99.3006 – 5

VALUE Fibre Optic Cleaning Pen for LC Plug, 1.25mm C 13.99.3007 – 5

Portable Laser Fiber Optic Checker Pro

For the quick test of Fibre Optic cables.

- Sends a visible (650 nm) strong laser signal through the cable- braking points become transparent by a visible light in the area of the damage
- Universal-connector can be used with common connector types (ST, SC, FC and others)
- Reversible between continuous and pulsing ray
- Both Multi-mode and Single-mode distances suitable
- Batteries (not included in delivery): 2x Mignon (AA) 1.5V (LR06)



Order-No. – P.U.

Portable Laser Fiber Checker Pro

13.99.3011 – 25

### Electronic Mini Screwdriver Set, 12-in-1

- This kit is perfect for technicians, do-it-yourself or anyone who needs to carry a useful precision tool while travelling
- High quality CRV steel material, with deluxe leather bag
- Ideal for repairing glasses, mobiles, electronic & computer or any precision equipment
- Contents:
  - 1 handle with fast chuck
  - 3 Phillips screw bits PH000, PH00, PH0
  - 3 slotted screw bits 1.5, 2, 2.5 mm
  - 6 T-screw bits T5, T6, T7, T8, T9, T10



Order-No. – P.U.

Electronic Mini Screwdriver Set, 12-in-1

19.06.2032 – 20

### 28-in-1 Screwdriver Set

- Mini screwdriver series
- Plastic etui
- Precasted holder for tools to avoid loss
- Heavy-Duty handle made of plastic for comfortable operation
- Fast turning swivel caps on handle
- Tools made of Chrome Vanadium alloy
- Contents:
  - 1 Handle with bit holder
  - 5 Phillips bits: PH000, PH00, PH0, PH1, PH2
  - 5 Slotted bits: SL1.5, SL1.7, SL2, SL3, SL4
  - 8 T-bits: T5, T6, T7, T8, T9, T10, T15, T20
  - 7 Hex bits: HN3, HN3.5, HN4, HN4.5, HN5, HN5.5, HN6
  - 2 U shape antenna remover
  - 1 Hex bit extender
  - Leather casing



Order-No. – P.U.

28-in-1 Screwdriver Set

19.06.2085 – 20

### Precision Pliers + Screwdriver Set, 19-piece

- This kit is perfect for technicians, do-it-yourself or anyone who needs to carry a useful precision tool while travelling
- High quality CRV steel material, with deluxe bag in grey and black colour
- Ideal for repairing glasses, mobiles, electronic & computer or any precision equipment
- Contents:
  - 1 long long-nose plier
  - 1 long-nose plier
  - 1 angled long-nose plier
  - 1 flat-nose plier
  - 1 crusher
  - 1 wire cutting plier
  - 1 tweezer
  - 3 Phillips screwdrivers PH00 x50 mm, PH0 x50 mm, PH1 x50 mm
  - 3 slotted screwdrivers 2 x50 mm, 2,5 x50 mm, 3 x50 mm
  - 6 torx screwdrivers T6 x50 mm, T7 x50 mm, T8 x50 mm, T9 x50 mm, T10 x50 mm, T15 x50 mm



Order-No. – P.U.

Precision Pliers + Screwdriver Set, 19-piece

19.06.2033 – 20

### Electronic Precision Tool-Kit

- All the necessary tools in a mini zipper bag (245 x 140 x 40 mm)
- The right equipment wherever you are
- Contents:
  - 2 Precision screwdrivers: 2.0x50, 2.4x 50
  - 2 Precision Phillips screwdrivers: #100x50, #0x75
  - 2 Screwdrivers: slot: 5x100, Phillips: 1x100
  - 2 Pliers: side cutter (127 mm), long nose (152 mm)
  - 1 Tweezer: Fine tip straight (120 mm)
  - 1 Sliding magnifier
  - 1 Flash light

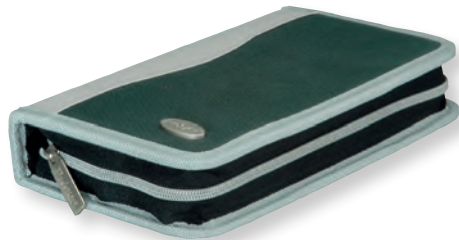

Order-No. – P.U.

Electronic Precision Tool-Kit

19.06.2029 – 30

### Precision Tool Kit, 73 pieces

- Ideal for opening, refurbishing, repairing Smartphone, PAD, notebook, camera and video games.
- Complete, comprehensive kit
- It includes the essential tools for the repair and refurbish market
- It allows opening of tablets, notebooks, electronic device cases such as Apple, HTC, Samsung, Sony etc.
- 58pcs driver Kit:
  - 42pcs/ 4.0x28 mm, AISI 8660 Cr-Mo-V steel (- #000, #00, #0, #1, #2 /- 1.0, 1.3, 1.5, 2.0, 2.5, 3.0, 3.5, 4.0 mm /- T3, T4 /- T5H, T6H, T7H, T8H, T9H, T10H, T15H, T20H /- 0.7, 0.9, 1.3, 1.5, 2.0, 2.5, 3.0, 3.5, 4.0 mm /- #0, #1, #2 /- 3.0 mm /- #0, #1 /- 3.0 mm /- Pentalobe: P2, P5, P6 (iPhone, MacBook Air, MacBook Pro))
  - 6 pcs 4.0x30 mm, material: 50BV30 Cr-V steel (- 2.5, 3.0, 3.5, 4.0, 4.5, 5.0 mm)
  - 5 pcs diam. 6.3x25mm, material: AISI 6150 Cr-V steel (- #2, 6.0 mm, 4.5, 5.0, 6.0 mm)
  - 2 pcs diam. 6.3x38mm, material: AISI 6150 Cr-V steel (Torx plus socket, TS3.8, TS4.5)
  - 1 pcs diam. 4.0mm to diam. 1/4" adaptor 50 mm
  - 1 pcs diam. 4.0x125mm extension bar
  - 1 pcs TPR non-slip handle

#### Kit includes:

##### Opening and prying tools

- Prying Paddle 30.5x30.5x30.5mm
- Opening Lever (POM) 88.7mm
- Opening Lever (POM) 84.4mm
- Suction Cup diameter: 36mm
- Point-Blade Solder Aid Tools (155mm)
- Solder Aid Tools (140mm)
- Fork-Blade Solder Aid Tools (173mm)
- Double-end Metal Spudger (185mm)
- Metal spudger tool (123x12mm)
- Tweezers: super fine tip straight 120.5 mm / fine tip curved 120.5 mm / super fine tip straight 120.5 mm
- Static protection tools: Wrist Strap 3m, to avoid sensitive electronic components, from electrostatic damage
- Lineal
- Precision Knife
- Tool bag (233x150x55 mm)



Order-No. – P.U.

Precision Tool Kit, 73 pieces

19.06.2047 – 8

### Electronics Master Kit

- Ideal for electronic / electric telecommunications and computer service workers
- Contents:
  - 127 mm side cutter
  - 127 mm long nose plier
  - 114 mm bent nose plier
  - 152 mm side cutter
  - 152 mm long nose plier
  - 203 mm combination plier
  - 241 mm water pump plier
  - 241 mm crimping tool
  - 6 pcs. precision screw drivers
  - Duplex colour screw drivers: Phillips: 3x75, 5x, 6x100, 6x38 mm / slotted: 3x75, 5x, 6x100, 6x38 mm / Nut: 5 mm, 6 mm
  - Testing driver
  - Alignment driver
  - Utility knife
  - 152 mm tweezer
  - IC Extractor
  - 7 pcs. Folding type hex key wrench
  - Brush
  - 3 prong holder
  - Flash light
  - Inspection mirror
  - 6 pcs. Open-end wrench set
  - 152 mm stainless scissors
  - 5 pcs. File set
  - 152 mm adjustable wrench
  - 3 pcs. soldering aid kit
  - Utility component storage box
- Carpenter hammer
- Oil can
- Parts tube
- Heat sink
- 3.3 m measuring ruler
- Solder wick
- Soldering iron stand
- Solder core
- Desoldering pump
- 30 W ceramic 3 way soldering iron
- 2 pcs. removable pallets
- Tool-carrying case (456 x 330 x 105 mm)
- Lockable



Order-No. – P.U.

Electronics Master Kit

19.06.2045 – 2



## Computer Tool Case, 61-piece

### Ideal for electronic / electric telecommunications and computer service workers

It includes all the most frequently need to repair or maintenance computer or TV, radio set and other electronic equipments.

- Contents:
- 25 Watt soldering iron
- Soldering iron stand
- 15 gr. solder
- Vacuum desoldering tool
- Fine point/cutting probe
- 3-prong retriever
- IC inserter/extractor
- Crimping tool wire cutter stripper
- Inspection mirror
- 102 mm precision long-nosed pliers
- 89 mm precision diagonal cutting pliers
- Screwdriver handle w/nut driver head

- 6 mm
- Philips bit: #1, #2, #3
- Slotted bit: 4 mm, 5 mm, 6 mm
- Hex bit: 1.5 mm, 2 mm, 2.3 mm, 3.1 mm, 4 mm
- T-Bit: T5, T8, T10, T20
- Nut-driver: 6 mm, 5 mm, 5.5 mm, 7.9 mm, 7.1 mm
- Precision screwdriver Philips: #0
- Slot: 3.1 mm
- Magnetic telescoping P/U tool
- Stainless tweezers
- Stainless clamp on tweezers
- Snap-Blode knife
- Parts tube
- Part box
- 20 ties



Order-No. – P.U.

Computer Tool Case, 61-piece

19.06.2040 – 7

## Electronic Troubleshooter Kit, 39-piece

### Ideal for electronic / electric telecommunications and computer service workers

It includes all the most frequently need to repair or maintenance computer or TV, radio set and other electronic equipments.

- Contents:
- Precision grip screwdriver: 4 pcs slotted 1.4, 2, 2.4, 3 mm / 2 pcs. Philips 2.4 mm, 3 mm
- Standard tweezer
- Snap-off blade cutters
- Solder core 15g
- 152 mm adjustable wrench: Hex wrench folding type (1, 1.5, 2, 3, 4, 5, 6 mm)
- Desoldering pump
- Soldering iron 30 Watt
- Soldering accessories: 178 mm brush-knife / 178 mm hook-scraper / 178 mm fork-spike
- 2x 152 mm side cutting plier
- 32 mm long nose plier
- 152 mm long nose plier
- 51 mm diagonal plier
- Tape measure 3.3 m
- 6 pcs. screwdriver set: 3 pcs. slotted 4.7 mm, 5.6 mm, 7.1 mm / 3 pcs. Philips 4 mm, 5 mm, 6 mm
- PVC electrical tape 10 m black
- Solder stand
- Needle file round and flat 170 mm
- Dust-brush
- Flat wrench
- Double head screwdriver (pen-form) slotted (3.2 mm) and Philips (3 mm)



Order-No. – P.U.

Electronic Troubleshooter Kit, 39-piece

19.06.2041 – 5

## LAN Master Engineers Tool Kit, 58-piece

### Ideal for electronic / electric telecommunications and computer service workers

It includes all the most frequently need to install, repair or maintenance LANs, computer or TV, radio set and other electronic equipments.

#### Kit includes:

- Fine tip straight tweezers
- Side cutter 125 mm
- Long nose plier 138 mm
- RJ-45 die set
- RJ-11 die set
- RG-58, RG-59/62, BNC/TNC die set
- RJ-22 die set
- RG-58, RG-59/62 AU BNC/TNC die set
- Supercrimp crimp tool frame
- Spring hook
- Desoldering pump
- Adjustable wrench 152 mm
- Quick heat ceramic soldering iron 110V or 220V
- Straight forceps 152 mm
- Round cable cutter
- Wire stripper tool
- Screwdriver 5 mm
- Screwdriver 6 mm
- Screwdriver #3.2x75 mm
- Screwdriver #0x75 mm
- Screwdriver #5x75 mm
- Screwdriver #1x75 mm
- Screwdriver #2x100 mm
- Desoldering wick
- Precision wire stripper
- Punch down tool with 110/66 blades
- UTP/STP cable stripper
- Utility



Order-No. – P.U.

LAN Master Engineers Tool Kit, 58-piece

19.06.2046 – 1

## PC Troubleshooting Tool Set, 145-piece

This tool case is perfect for the computer, electronics and do-it-yourselfer. It includes all the most frequently need to repair or maintenance computer or TV, radio set and other electronic equipments.

### • Contents:

- 3 way ratchet driver with storage
- Hollow star bits: T-8H, T-10H, T-15H, T-20H, T-25H, T-27H, T-30H, T-35H, T-40H
- Hex key set: 2 mm, 2.4 mm, 2.8, 3.2 mm, 3.6 mm, 4 mm
- Metric hex key set: 2 mm, 2.5 mm, 3 mm, 4 mm, 5 mm, 6 mm
- Spanner set: 4, 9, 8, 10
- Tri-wing set: 1, 2, 3, 4
- Torq set: 6, 8, 10
- Solid star bit: T-8, T-10, T-15, T-20, T-27
- #1 pozidriver bit
- #4 and #6 slotted bits
- #1 Philips bit
- Square bit: 50, 51, 52, 53
- Nutdriver socket adapter
- Bit holder
- 5-pc. nutdriver set: 4.7 mm, 6.4 mm, 7.9 mm, 8.7 mm, 9.5 mm
- 5-pc. metric nutdriver set: 6mm, 7mm, 8mm, 9mm, 10mm
- Tweezers
- Pen knife
- Needle nose pliers
- Diagonal cutting pliers
- 6-pc. precision screwdriver set.
- Insulted chip extractor
- 3 pronged parts retriever
- Magnetic telescope picking up tool
- Flash light
- Wire strippers
- Deluxe wire strippers
- PC board brush
- Electrical PCV tape
- Soldering iron
- Solder remover
- Solder wire
- Solder stand
- Metal hammer with rubber
- 9 wrenches
- Mini vacuum cleaner witch accessories
- 1 scalpel
- 20 cable ties
- 1 set with cable terminal attachments



Order-No. – P.U.

PC Troubleshooting Tool Set, 145-piece

19.06.2031 – 5

## Cable Ties / Cable Tie Installation Tool

- Range of cable ties suitable for general cabling use in all indoor or outdoor applications
- Available in 4 different length (15 cm, 25 cm, 30 cm, 44 cm) and 2 different width (3.7 mm, 4.8 mm)
- Additional description field (suitable only for 19.08.3276)
- Polybag with 100 pieces each

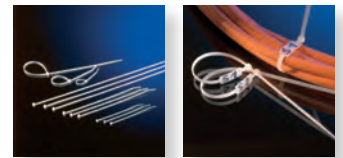

### Installation Tool

- Tool operation: actuate trigger until cut-off occurs. Cut-off depends on the tension setting selected

Order-No. – P.U.

Cable Tie, 3.7 mm, angled, 15 cm	19.08.3270 – 200
Cable Tie, 4.8 mm, angled, 25 cm	19.08.3272 – 100
Cable Tie, 4.8 mm, 44 cm	19.08.3274 – 60
Cable Tie, 4.8 mm, with description field, 30 cm	19.08.3276 – 80
Cable Tie Gun	19.06.1000 – 20

## Hook-and-Loop Stripes

- Versatile and reusable design
- User-friendly
- The detachable silicone closure allows easy but secure closure and opening
- Durable and elastic silicone material
- Available in two different lengths (4 gray hook-and-loop stripes)

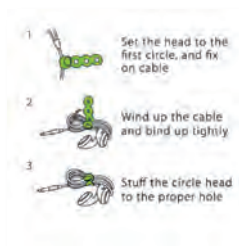
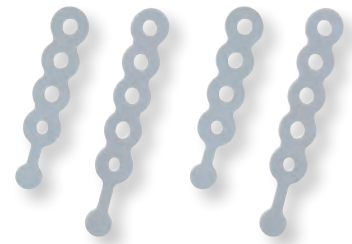

**roline**<sup>®</sup>  
Designed for Professionals

Order-No. – P.U.

Hook-and-Loop Stripes, 4 pcs.

19.08.3251 – 25

## VALUE Cable Tunnel Organizer

- Ideal for cable management
- Applicable for all computer cables
- Stable and resistant material, ideal use as a floor cable tunnel
- Bottom of tunnel has pressure sensitive tapes
- Color: Dark grey
- Dimensions (LxW): 100 cm x 6 cm
- Content: 1 cable-tunnel

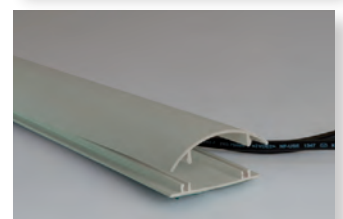
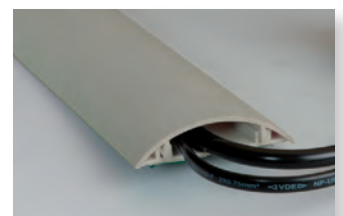

**Value**<sup>®</sup>

Order-No. – P.U.

VALUE Cable Tunnel Organizer, Closed, 6 cm x 100 cm

19.99.3235 – 20



## Office Equipment / Consumables

Mouse Pads .....	9.02
Wristrests .....	9.02
VESA Adapters .....	9.03
LCD Monitor Arms / Mounts .....	9.04 – 9.10
Wall Mount Workstation.....	9.11
Monitor / PC Stands .....	9.11, 9.12, 9.13, 9.15
Cable Cover Organizer .....	9.15
PC Holder .....	9.13 – 9.14, 9.15
Wall / Ceiling Projector Mount .....	9.16
Monitor Stand .....	9.17
Power Strip Holder .....	9.19
Printer Tables .....	9.20
PC Workstations.....	9.18, 9.20, 9.21
Cleaning Sets .....	9.21 – 9.22



### Mouse Pad, Cloth

- Optimal use on smooth surfaces
- Upper layer: Nylon cloth
- Optimized for optical and laser mouses
- Dimensions: 255x215x5mm
- Colour: Black

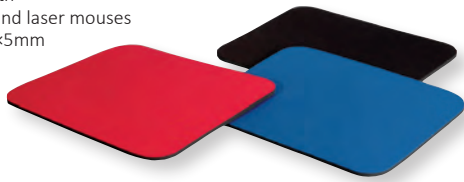

Order-No. – P.U.

Mouse Pad, Cloth, black	18.01.2040 – 50
Mouse Pad, Cloth, blue	18.01.2041 – 50
Mouse Pad, Cloth, red	18.01.2042 – 50

### Laser Mouse Pad

- Mouse pad for optical mice, ideal also for laser mice
- Ultra flat and anti slip surface
- Dimensions: 220 x 180 x 0.4 mm
- Note: Mouse is not included in delivery



Order-No. – P.U.

Laser Mouse Pad, blue	18.02.2005 – 200
Laser Mouse Pad, black	18.02.2006 – 200

### ROLINE Soft Gaming Pad

- Designed for professional gamers
- Provides excellent gliding of the mouse
- Natural rubber base for maximum grip on any surface
- Excellent performance for laser and optical mice
- Material: Surface: high performance textile surface / Base: nature rubber
- Dimensions: 350 x 260 x 3mm
- Colour: Black



**roline**  
Designed for Professionals

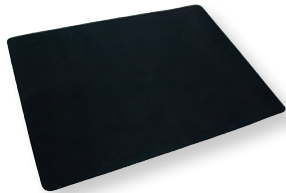

Order-No. – P.U.

ROLINE Soft Gaming Pad, black	18.01.2044 – 20
-------------------------------	-----------------

### ROLINE Gaming Mouse Pad

- Designed for professional gamers
- Provides excellent gliding of the mouse
- The fine textured weave increases accuracy and speed, decreases friction
- Sliding fast and reduce wrist strain without the height difference between pad and desk
- Anti-slippery silicone base gives maximum grip
- Compatible with laser and optical mice
- Material: Surface: high quality textile / Base: premium silicone adhesive
- Dimensions: 350x260x3mm
- Colour: Black

**roline**  
Designed for Professionals



Order-No. – P.U.

ROLINE Gaming Mouse Pad	18.01.2045 – 20
-------------------------	-----------------

### ROLINE Soft Gaming Pad, Leather Imitation

Perfectly sized mousepad for mobile applications, e.g. when you just work with your Notebook or at a workstation - the leather-like surface gives the mousepad a great look and makes it very durable!

- Designed for professional gamers and office environments
- Provides excellent gliding of the mouse
- Natural rubber base for maximum grip on any surface
- Excellent performance for laser and optical mice
- Material: Surface: high performance textile surface / Base: nature rubber

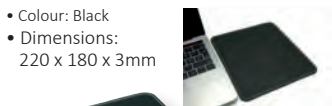

**roline**  
Designed for Professionals

Order-No. – P.U.

ROLINE Soft Gaming Pad, Leather Imitation, black	18.01.2046 – 20
--	-----------------

### ROLINE Notebook Combo Mousepad (280x160x0.5mm)

Perfect fit between most Macbooks, Ultrabooks, Notebooks/Laptops - suitable for cleaning your display/device, as a mousepad and to protect the Notebook keyboard from dirt and dust!

- Designed for professional gamers and office environments
- Provides excellent gliding of the mouse
- Natural rubber base for maximum grip on any surface
- Excellent performance for laser and optical mice
- Material: Surface: high performance textile surface / Base: nature rubber
- Colour: Black



**roline**  
Designed for Professionals



Order-No. – P.U.

ROLINE Notebook Combo Mousepad (280x160x0.5mm), black	18.01.2047 – 20
---	-----------------

### Silicon Mousepad with Wristrest, transparent blue

- During work with your Mouse your wrist can rest on the integrated Palmrest
- The silicon filling will adapt itself to your wrist, effective support will help you in giving you a relaxed feeling once working with your mouse
- Colour: transparent blue
- Dimensions: 227 x 250 x 22 mm
- Note: Mouse is not included in delivery



Order-No. – P.U.

Silicon Mousepad with Wristrest, transparent blue	18.01.2029 – 24
---	-----------------

### Silicon Wrist Pad for Keyboard, transparent blue

- Great outcome for frequent PC users; it will reduce the danger of RSI (Repetitive Strain Injury)
- The silicon filling will adapt itself to your wrist, effective support will help you in giving you a relaxed feeling once working with your keyboard
- Suitable for all current keyboards (with straight side)

- Colour: transparent blue
- Dimensions: 455x80x22 mm

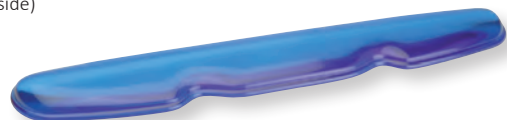

Order-No. – P.U.

Silicon Wrist Pad for Keyboard, transparent blue	18.02.3033 – 20
--	-----------------

### ROLINE VESA Adapter

- **17.03.1100/17.03.1102:**
- Accommodates standard VESA 100 compliant monitors (100 x 100 mm resp. 100 x 200 mm) to mounting systems with VESA 75 (75 x 75 mm)

- **17.03.1106:**
- Accommodates monitors with standard VESA 100, 200 (100 x 200 and 200 x 200 mm) to mounting systems with VESA 100 (100 x 100 mm)
- Variable adjustable

- **17.03.1103:**
- Accommodates monitors with standard VESA 400, 200 (400 x 400 mm) to mounting systems with VESA 100 (100 x 100 mm)
- Variable adjustable

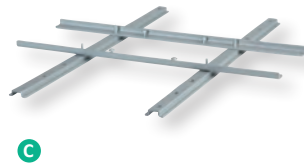
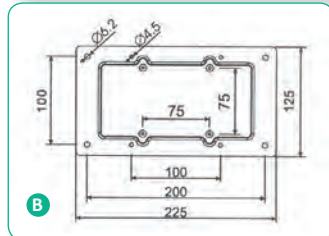
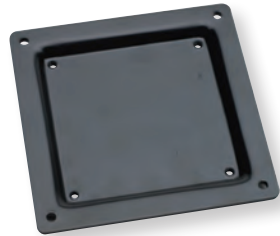

Order-No. – P.U.

ROLINE VESA Adapter, black	A 17.03.1100 – 1
ROLINE VESA Adapter 75x75 to 100x100/100x200, black	B 17.03.1102 – 1
ROLINE VESA Adapter 100x100-100x200/200x200, variable, silver	17.03.1106 – 1
ROLINE VESA Adapter 100x100-400x400, variable, silver	C 17.03.1103 – 1

### ROLINE LCD Monitor Wall Mount Kits

- Space saving mounting of monitor on Walls
- VESA 75 fixation

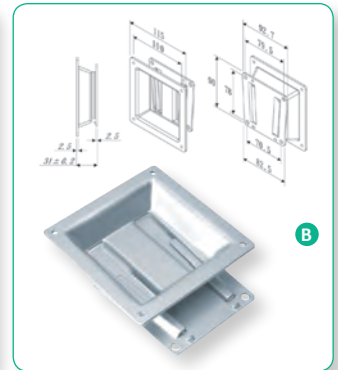

<b>Technical data:</b>	<b>17.03.1180</b>	<b>17.03.1181</b>
Load capacity:	1-20 kg	1-20 kg
VESA:	75x75 mm	100x100 mm



Order-No. – P.U.

ROLINE LCD Monitor Wall Mount Kit, -20 kg, VESA 75	A 17.03.1180 – 1
ROLINE LCD Monitor Wall Mount Kit, -20 kg, VESA 100	B 17.03.1181 – 1

### VALUE VESA Adapter 75x75 to 100x100/100x200

- Accommodates standard VESA 100 compliant monitors (100 x 100 mm/100 x 200 mm) to fastening systems with VESA 75 (75 x 75 mm)
- Fixing screws included in delivery

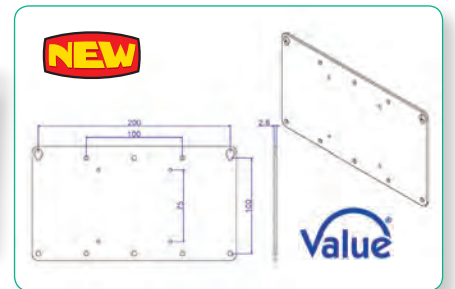

Order-No. – P.U.

VALUE VESA Adapter 75x75 to 100x100/100x200, grey	17.99.1110 – 20
---	-----------------

### ROLINE Vertical VESA Adjustment Plate

- Perfect option to add more **VERTICAL** adjustability (15 cm mobility to go up and down) to an existing monitor mount
- Track-mounted monitor holder
- Easy installation on most monitor mounts with standard VESA plates (75mm x 75mm/100mm x 100mm)
- The toothed track keeps the adjustment smooth and stable
- Maximum load up to 8 kg

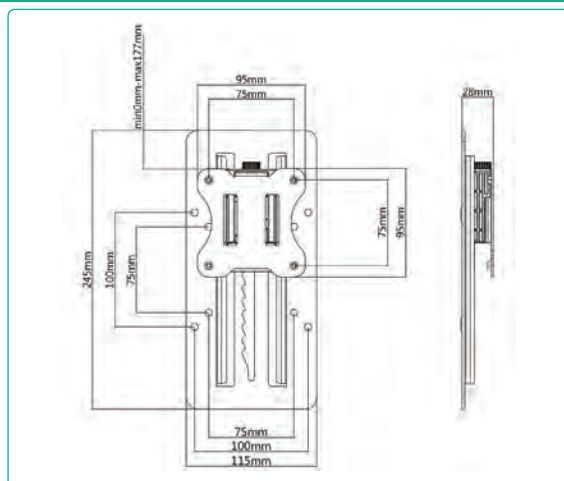

Order-No. – P.U.

ROLINE Vertical VESA adjustment plate	17.03.1101 – 16
---------------------------------------	-----------------

### VALUE LCD Monitor Wall Mount Kit

- Space saving and solid mounting of a monitor on walls
- Easy to mount with sliding bracket design (2 pieces) - one piece has to be fixed to the wall, the other one has to be screwed with VESA on the monitor
- Slim design, just 15mm from the wall
- Monitor has to be mount from the upside into the wall mount
- Meets with VESA 75 (75 x 75 mm) or VESA 100 (100 x 100 mm)
- Load capacity: 25 kg

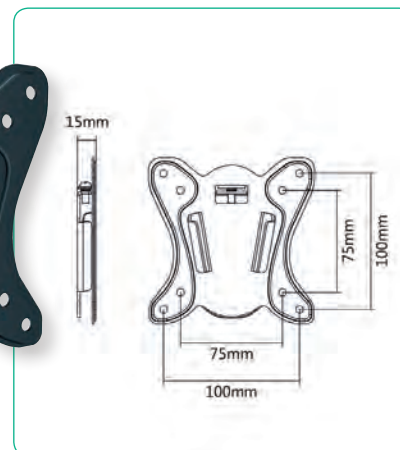

Order-No. – P.U.

VALUE LCD Monitor Wall Mount Kit

17.99.1141 – 10

### VALUE LCD Monitor Wall Mount Kit

- For screen sizes: 36 cm up to 61 cm
- Weight capacity: up to 15 kg
- Tilttable: 160° up or down
- Swiveling (Pivot function): 270°
- Meets VESA standard VESA 75 (75x75 mm) and VESA 100 (100x100 mm)
- Material: Cold steel construction
- Colour: Black

Technical data:	17.99.1120	17.99.1121
Fixing:	wall mount	wall mount
Load capacity:	15 kg	15 kg
Screen size:	36 cm up to 61 cm	36 cm up to 61 cm
Pivot function:	270°	270°
Tilttable up or down:	160°	180°
Rotatable right or left:	-	180°
Arm length:	up to 90 mm	up to 130 mm



Order-No. – P.U.

VALUE LCD Monitor Wall Mount Kit, 1 Joint

A 17.99.1120 – 10

VALUE LCD Monitor Wall Mount Kit, black, 2 Joints

B 17.99.1121 – 10

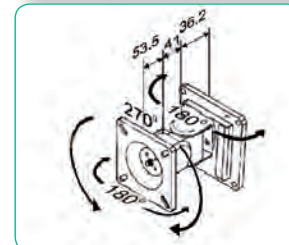
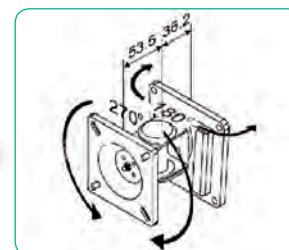

### VALUE LCD Monitor Arm Gas Spring, Wall Mount

- LCD monitor wall mount
- Arm length: 360 mm
- Weight capacity: max 15 kg
- Meets with VESA 75x75 or 100x100mm
- Monitor can be tilted, swiveled and rotated
- Color: silver
- Monitor can be adjustment: -15° - +15°
- Arm height adjustment: max. 335mm

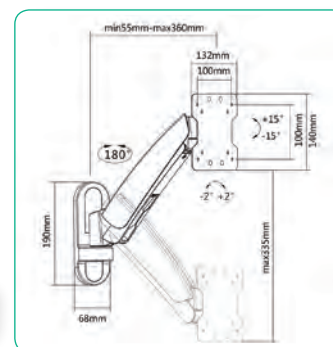

Order-No. – P.U.

VALUE LCD Monitor Arm Gas Spring, Wall Mount

17.99.1119 – 6









**roline**<sup>®</sup>  
Designed for Professionals

### ROLINE LCD Monitor Arm, Wall Mount, 2 Joints

- Quick and simple installation
- Meets VESA 50/75/100/150/200x100/200
- Wall mount fixing
- Material: steel
- Colour: black

TV size: 25 - 100cm (10" - 40")  
Load capacity: up to 20 kg  
No. of pivots: 2  
Max. arm length: 9 cm  
Tiltable up and down: 20°

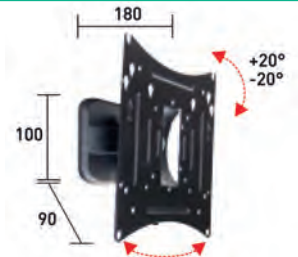

Order-No. – P.U.

ROLINE LCD Monitor Arm, Wall Mount, 2 Joints

17.03.0005 – 1

### ROLINE LCD Monitor Arm, Wall Mount, 3 Joints

- Quick and simple installation
- Meets VESA 75/100/200x100
- Wall mount fixing
- Material: steel
- Colour: black

TV size: 25 - 81 cm (10" - 32")  
Load capacity: up to 20 kg  
No. of pivots: 5  
Max. arm length: 12,2 cm  
Tiltable up and down: 20°

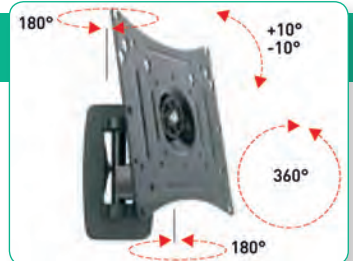

Order-No. – P.U.

ROLINE LCD Monitor Arm, Wall Mount, 3 Joints

17.03.0006 – 1

### ROLINE LCD Monitor Arm, Extra, Wall Mount, 3 Joints

- Quick and simple installation
- Meets VESA 75/100/200x100/180x120/200
- Wall mount fixing
- Material: steel
- Colour: black

TV size: 25 - 100 cm (10" - 40")  
Load capacity: up to 25 kg  
No. of pivots: 5  
Max. arm length: 28 cm  
Tiltable up and down: 10°

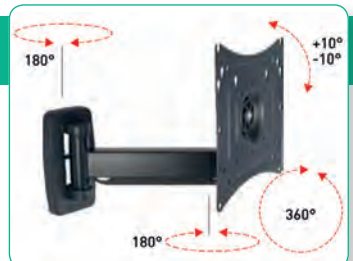

Order-No. – P.U.

ROLINE LCD Monitor Arm, Extra, Wall Mount, 3 Joints

17.03.0007 – 1

### ROLINE LCD Monitor Arm, Wall Mount, 4 Joints

- Quick and simple installation
- Meets VESA 75/100/200x100
- Wall mount fixing
- Material: steel
- Colour: black

TV size: 25 - 81 cm (10" - 32")  
Load capacity: up to 20 kg  
No. of pivots: 4  
Max. arm length: 43 cm  
Tiltable up and down: 20°

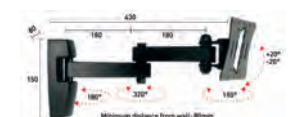

Order-No. – P.U.

ROLINE LCD Monitor Arm, Wall Mount, 4 Joints

17.03.0008 – 1

### ROLINE LCD Monitor Arm, Extra, Wall Mount, 5 Joints

- Quick and simple installation
- Meets VESA 75/100/200x100/180x120/200
- Wall mount fixing
- Material: steel
- Colour: black

TV size: 25 - 100 cm (10" - 40")  
Load capacity: up to 25 kg  
No. of pivots: 6  
Max. arm length: 36 cm  
Tiltable up and down: 10°

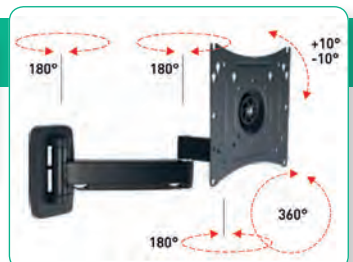

Order-No. – P.U.

ROLINE LCD Monitor Arm, Extra, Wall Mount, 5 Joints

17.03.0009 – 1



**ROLINE LCD Monitor Stand Pneumatic, Wall Mount, Pivot**

- Delicate and streamlined design
- Made of high quality aluminum alloy
- Gas spring integrated allows users to move the LCD panel in most positions at will
- Meets VESA 75 (75x75 mm) or VESA 100 (100x100 mm)
- Special feature: Pivot function- screen is 90 degrees rotatable
- Wall Mount
- A clever cable management is built into the rear arm

Technical data: 17.03.1178  
 Fixing: wall mount  
 Load capacity: 3 - 8 kg  
 No. of pivots: 4  
 Pivot function: yes  
 Arm length: up to 486 mm  
 Particularities: gas spring, cable management

Specifications:

- Arm extension: ~ 486 mm
- Lift: 200 ~ 500 mm
- Monitor pivot: 180°
- Rotation: 360° (arm & display)
- Loading capacity: 3 ~ 8 kg



Order-No. – P.U.

ROLINE LCD Monitor Stand Pneumatic, Wall Mount, Pivot, 2 Joints 17.03.1178 – 1

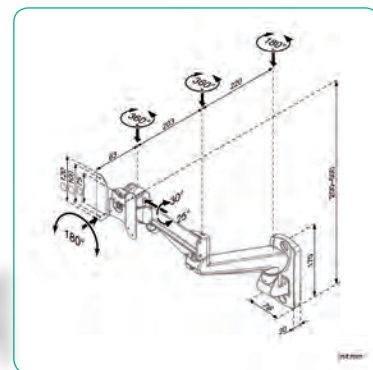

**ROLINE LCD Monitor Stand Pneumatic, Desk Clamp, Pivot**

- These pneumatic LCD monitor arms allow you to adjust the monitor to the most comfortable viewing angle
- Arms provide up and down, left and right, front and back pivot and tilting capability
- Desk clamp mount (max. 56mm) and grommet mount (max. 36mm)
- Monitor weight adjustment
- Monitor arms with wall mount fixing
- Meet VESA 75 (75 x 75 mm) or VESA 100 (100 x 100 mm)

Technical data:	17.03.1149	17.03.1147	17.03.1148	17.03.1122
Fixing:	desk clamp	desk clamp	desk clamp	wall mount
Load capacity:	3 - 8 kg	3 - 8 kg	3 - 8 kg	3 - 8 kg
No. of pivots:	4	4	4	4
Pivot function:	yes	yes	yes	yes
Arm length:	up to 266 mm	up to 486 mm	up to 486 mm	up to 440 mm
Particularities:	gas spring, cable management	gas spring, cable management	gas spring, cable management	gas spring, cable management, weight adjustment
	-	-	Dual LCD	

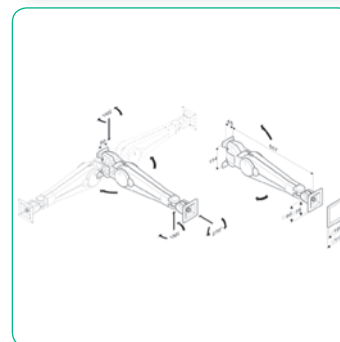
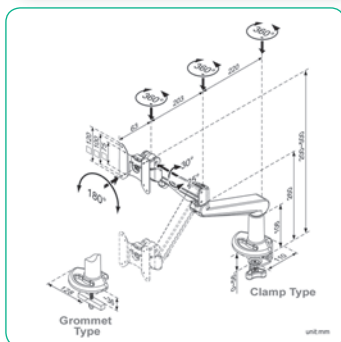
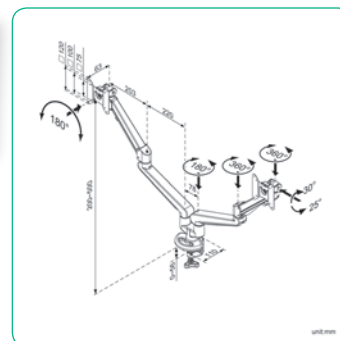
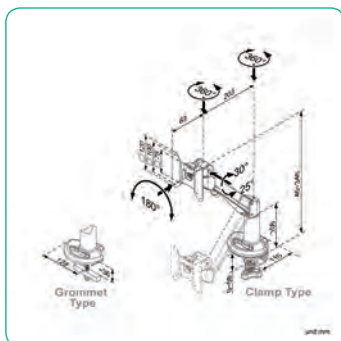

Order-No. – P.U.

ROLINE LCD Monitor Stand Pneumatic, Desk Clamp, Pivot, 1 Joint	A	17.03.1149	- 1
ROLINE LCD Monitor Stand Pneumatic, Desk Clamp, Pivot, 2 Joints	B	17.03.1147	- 1
ROLINE Dual LCD Monitor Stand Pneumatic, Desk Clamp, Pivot, 2 Joints	C	17.03.1148	- 1
ROLINE LCD Monitor Arm Pneumatic, Pivot, Wall Mount	D	17.03.1122	- 1



**VALUE Single LCD Monitor Arms, Desk Clamp**

- Aluminum two-step arm with four joints
- With a C-clamp for desk mount up to 8 cm thickness
- The height of the LCD monitor is adjustable
- Meets VESA 75 (75 x 75 mm) or VESA 100 (100 x 100 mm)
- Load capacity: up to 10 kg



Technical data:	17.99.1132	17.99.1133	17.99.1136
Load capacity:	10 kg	2x 6 kg	3x 8 kg
No. of pivots:	5	2x 5	5
Fixing:	Desk clamp	Desk clamp	Desk clamp
Arm length:	450 mm	2x 350 mm	1290 mm

	Order-No.	P.U.
VALUE Single LCD Monitor Arm, 4 Joints, Desk Clamp	A 17.99.1132	- 4
VALUE Dual LCD Monitor Arm, Desk Clamp, 4 Joints	B 17.99.1133	- 2
VALUE Triple LCD Arm, Desk Clamp, black	C 17.99.1136	- 1

**ROLINE Single LCD Monitor Arms, Desk Clamp**

- This flexible monitor arm allows the user to adjust a monitor with perfect angle of view
- Fixing by desk clamp (up to 100 mm)
- The sturdy main frame can still move smoothly under heavy load
- High quality aluminum alloy
- Meets VESA 75 (75 x 75 mm) or VESA 100 (100 x 100 mm)
- Load capacity: 12 kg
- Length of pillar: 400 mm
- Arm length: 190 mm

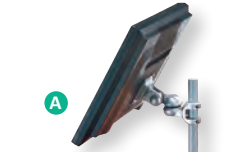
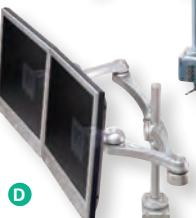

**roline**  
Designed for Professionals

Technical Data:	17.03.1132/1230	17.03.1133	17.03.1134
Fixing:	desk clamp (up to 100 mm)	desk clamp (up to 100 mm)	desk clamp (up to 100 mm)
Load capacity:	8 kg	10 kg	12 kg
Length of pillar:	400 mm	400 mm	400 mm
Arm length:	620 mm	440 mm	190 mm

	Order-No.	P.U.
ROLINE Single LCD Monitor Arm, 2 Joints, Desk Clamp	A 17.03.1134	- 1
ROLINE Single LCD Monitor Arm, 3 Joints, Desk Clamp	B 17.03.1133	- 1
ROLINE Single LCD Monitor Arm, 5 Joints, Desk Clamp	C 17.03.1132	- 1
ROLINE Dual LCD Monitor Arm, Desk Clamp, 4 Joints	D 17.03.1230	- 1

**VALUE LCD Monitor Arm Standard, Wall Mount or Desk Clamp**

- Provides the screen at three positions for the most comfortable viewing level and provide the monitor or LCD TV tilt, left or right
- Supports wall mounting as well as desk clamp (with C-clamp mounting bracket)
- Meets VESA 75 (75 \* 75 or VESA 100 (100 \* 100 mm)

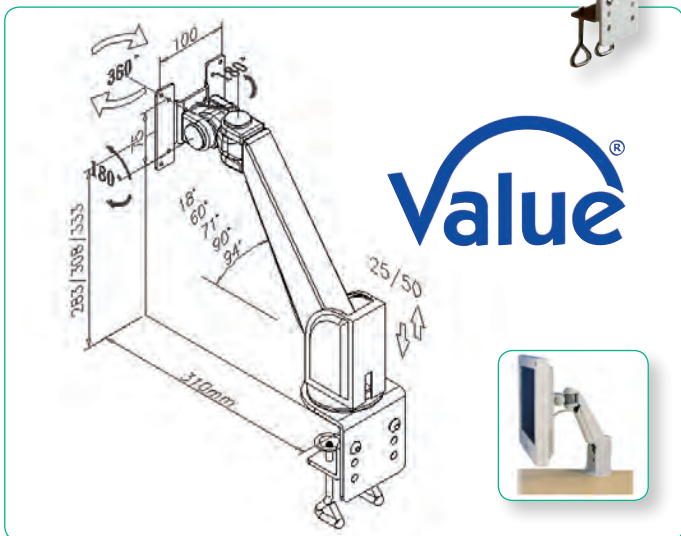

	Order-No.	P.U.
VALUE LCD Monitor Arm Standard, Wall Mount or Desk Clamp	17.99.1123	- 4

**VALUE Single/ Dual LCD Monitor Stand Pneumatic, Desk Clamp, Pivot**

- LCD monitor arm with gas spring for easy and reliable adjustment of a monitor weighing up to 6.5kg and VESA 75 / 100!
- Made of high quality aluminum alloy
- Meets VESA 75 (75x75 mm) or VESA 100 (100x100 mm)
- Special feature: Pivot function- screen is 90 degrees rotatable
- Small desktop mount saves space
- A clever cable management is built into the rear arm

- Specifications:**
- Arm extension: ~ 500 mm
  - Lift: 160 ~ 410 mm
  - Monitor pivot: 180°
  - Rotation: 360° (arm & display)
  - Loading capacity: max. 6.5 kg

**NEW**

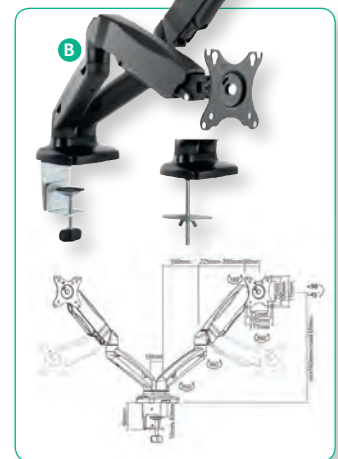

	Order-No.	P.U.
VALUE LCD Monitor Stand Pneumatic, Desk Clamp, Pivot, 2 Joints	A 17.99.1155	- 4
VALUE Dual LCD Monitor Stand Pneumatic, Desk Clamp, Pivot, 2 Joints	B 17.99.1163	- 3





## VALUE Dual LCD Monitor Arm, Desk Clamp, height adjustable separately

The Dual LCD Arm makes your workstation more efficient and you gain more workspace.

- Designed for two monitors
- The two aluminium arms are easy to adjust for swinging into any position
- Each display can be tilted to any angle you need

- The height of the LCD monitors is for both monitors separately adjustable
- Load capacity: up to 5 kg each monitor
- Meets VESA 75 (75 x 75 mm) or VESA 100 (100 x 100 mm)
- Arm length: up to 2x 350 mm
- With a C-clamp for desk mount

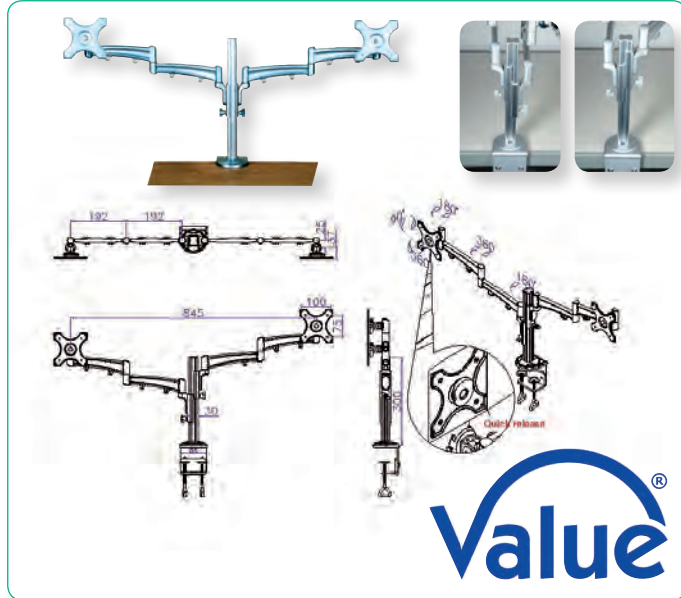

Order-No. – P.U.

VALUE Dual LCD Monitor Arm, Desk Clamp, 4 Joints, height adjustable separately

17.99.1134 – 2

## VALUE Wallmount Workstation, with Keyboard Tray

MEDICAL ENVIRONMENT

- This is a complete solution that accommodates a LCD, keyboard/mouse, creating a sit-stand workstation
- This wall mounted computer workstations include a sturdy 90.5mm (width) x 500mm (length) x 20mm (depth) (x 2pcs.) aluminum posts that mounts to wall
- Articulating arms built-in VESA 75/100 compliant mount bracket can be tilted, panned and rotated.

- The keyboard holder adjusts to hold items up to 100mm (width) securely and includes non-skid cushions to prevent marring
- Keyboard holder weight capacity: 3-5kg
- Monitor holder weight capacity: up to 15kg



Order-No. – P.U.

VALUE Wallmount Workstation, with Keyboard Tray

17.99.1137 – 1

## VALUE Wallmount Workstation, Pneumatic

MEDICAL ENVIRONMENT

- This is a complete solution that accommodates a LCD, keyboard and CPU, creating a sit-stand workstation
- It is perfect for space-constrained areas by simply fold the keyboard and LCD tight against the wall when not in use
- This wall mounted computer workstations include a sturdy 90.5mm (width) x 500mm (length) x 20mm (depth) (x 2pcs.) aluminum posts that mounts to wall

- Articulating arms built-in VESA 75/100 compliant mount bracket can be tilted, panned and rotated.
- The CPU/power supply holder adjusts to hold items up to 100mm (width) securely and includes non-skid cushions to prevent marring
- CPU holder weight capacity: up to 10kg
- Keyboard holder weight capacity: 3-5kg
- Monitor holder weight capacity: 3-5kg

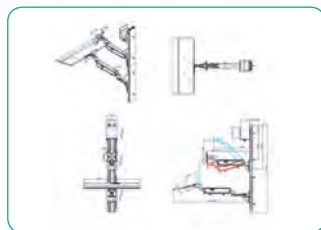

Order-No. – P.U.

VALUE Wallmount Workstation, Pneumatic

17.99.1139 – 1

## ROLINE LCD TV Mobile Cart

- Positions a LCD monitor in an ideal viewing position and offers a flexible use
- Gas spring inside
- With cable management
- Pedal function for easy and comfortable height adjustment
- Load capacity: up to 15 kg
- Screen size: up to 66 cm
- Display tiltable up to 40°

- Material: Aluminium
- Lift: 79-113 cm
- Meets VESA 75 (75 x 75 mm) and VESA 100 (100 x 100 mm)

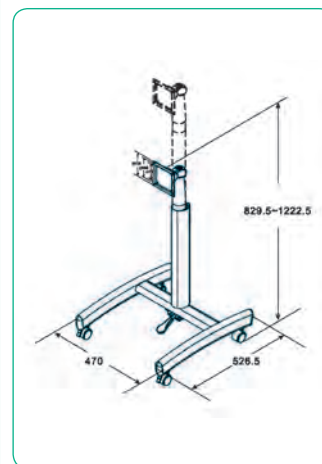

**roline**  
Designed for Professionals

Order-No. – P.U.

ROLINE LCD TV Mobile Cart

17.03.1155 – 1

VALUE Mobile PC Cart, silver



- Mobile computing platform that can be used in factories, hospitals, etc.
- This model is fitted with wheels and allows easy movement of a full PC setup
- Carries one pc tower, keyboard and mouse platform and a LCD monitor
- Monitor and keyboard/mouse can be easily positioned to the exact working height
- For monitors with VESA 75 (75 x 75 mm) resp. VESA 100 (100 x 100 mm)
- LCD monitor adapter bracket provides swivel, tilt and rotation function
- Adjustable LCD monitor height from 110 cm to 170 cm
- 5 wheels, whereof 3 are lockable

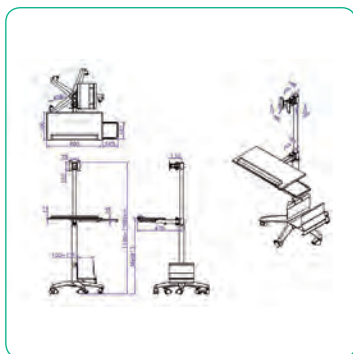

Order-No. – P.U.

VALUE Mobile PC Cart, silver

17.99.1174 – 1

ROLINE LCD TV + PC Mobile Computing Platform



- A mobile computing platform that can be used in factories, hospitals, shopping malls, retail stores and department stores, etc.
- Adaptable for sitting or standing users and adjusts to different user heights
- For monitors with VESA 75 (75 x 75 mm) resp. VESA 100 (100 x 100 mm)
- Pivots upwards to 10 degrees and downwards to 25 degrees
- Mouse support tray can be attached to the right or left hand side
- Safety belt adjusts for different sizes of CPU holders and UPS
- Material: aluminum alloy which has a neat and artistic appearance
- 5 wheels, whereof 3 are lockable
- Height: 180 cm

- Optional printer holder: 17.03.1152 - ROLINE Printer Holder for LCD TV Mobile Computing Platform



**roline**  
Designed for Professionals

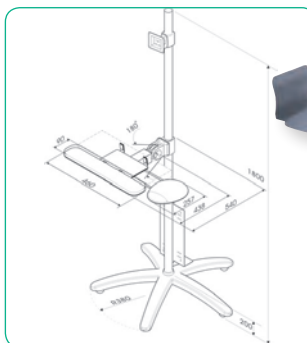

Order-No. – P.U.

ROLINE LCD TV + PC Mobile Computing Platform, 180 cm

A 17.03.1174 – 1

ROLINE Printer Holder for LCD TV Mobile Computing Platform

B 17.03.1152 – 1

ROLINE LCD TV+PC Mobile Computing Workstation



- A mobile computing platform that can be used in factories, hospitals, shopping malls, retail stores and department stores, etc.
- Adaptable for sitting or standing users and adjusts to different user heights
- For monitors with VESA 75 (75 x 75 mm) resp. VESA 100 (100 x 100 mm)
- Locks your laptop in a drawer for anti-theft and leave clean desktop for working
- Accommodates widescreen laptops with 17" screen
- Height adjustable working area is comfortable for sitting or standing users
- Pull-out keyboard storage and mouse stage can be the left or right side
- Organizes the cable management is place to have a clear look
- This model is fitted with wheels for easy movement and with lock while working
- Help to improve workflow efficiency and upgrade patient care
- Install dual LCD arm to have the monitor in a better viewing position
- Height of monitor can be adjustable
- Monitor can be swiveled, rotated and tilted
- Max loading including monitor: 5-8kg
- Mouse support tray can be attached to the right or left hand side
- Additional CPU holder



**roline**  
Designed for Professionals

Order-No. – P.U.

ROLINE LCD TV + PC Mobile Computing Workstation

17.03.1175 – 1

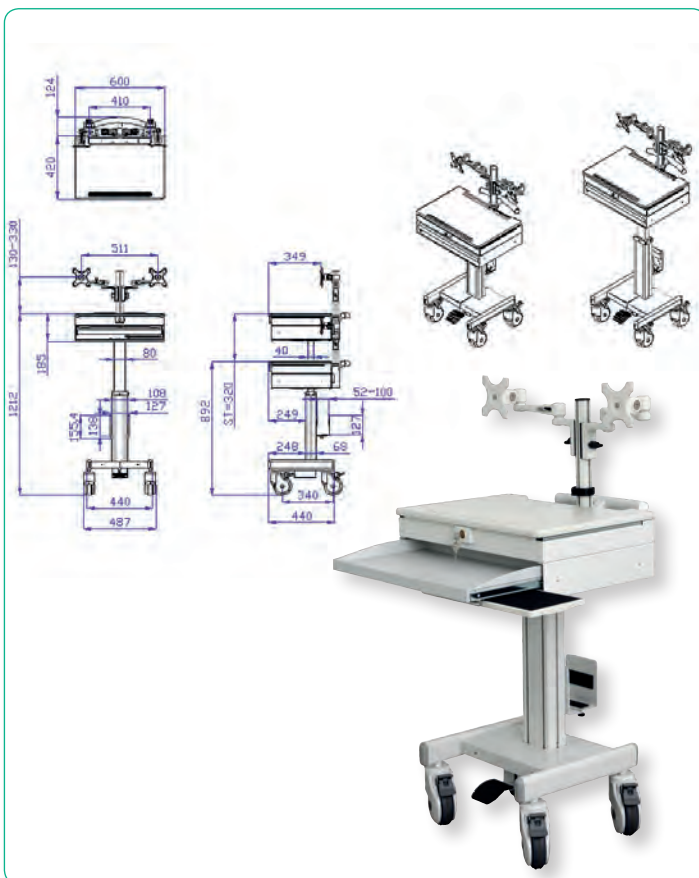

## VALUE LCD/Keyboard Holder, Desk Clamp, Rotatable

Height-adjustable, solid standing workstation made of powder-coated steel in black for two monitors, with shelf for keyboard and mouse

- Adjustment can be carried out in a few simple steps
- Rotatable workstation for maximum flexibility
- For table mounting with C-clamp or grommet
- For mounting screens with VESA 75 (75x75mm) or VESA 100 (100x100mm)
- With wrist rests for keyboard and mouse

- The keyboard/mouse tray can be folded upwards
- The monitors can be rotated, tilted and adjusted in height
- Flowing transitions from one position to the other through the integrated gas spring
- Cable management clamps prevent computer cables from catching
- Ergonomic thanks to adjustable height as required
- Mounting possibilities: grommet and desk clamp mounting



Order-No. – P.U.

VALUE LCD/Keyboard Holder, Desk Clamp, rotatable

17.99.1220 – 1

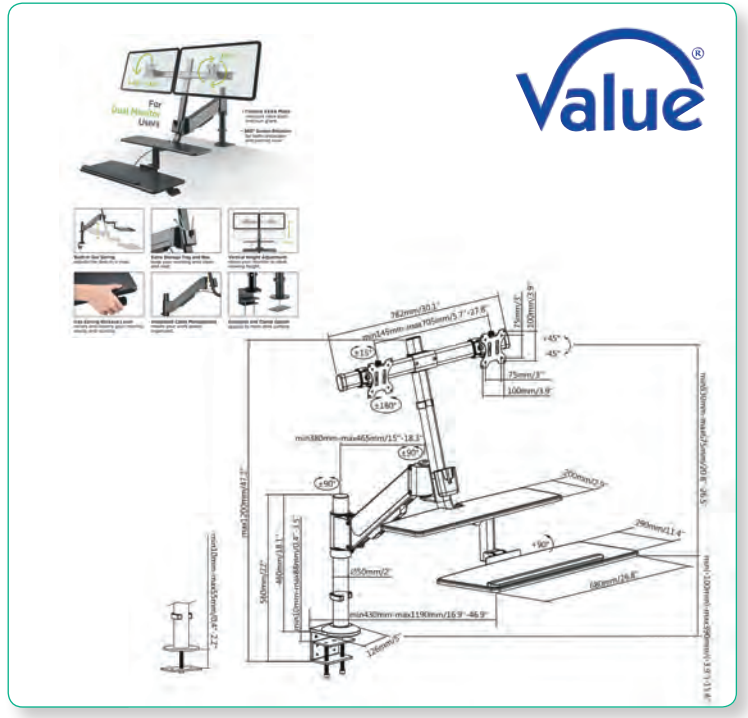

## VALUE Mini PC Holder

- Space-saving Mini PC holder which offers more room at your desk
- For Mini PCs
- Stable steel construction
- To be fixed under your table board (screws not included)
- Height and width of holder is adjustable

Value®



Order-No. – P.U.

VALUE Mini PC Holder, black

17.99.1140 – 1

## ROLINE Mini PC Holder, Lockable

- Space-saving Mini PC holder which offers more room at your desk
- For Mini PCs
- Stable steel construction
- To be fixed under your table board (screws not included)
- Height and width of holder is adjustable
- Lockable with key

roline®  
Designed for Professionals



Order-No. – P.U.

ROLINE Mini PC Holder, lockable, silver

17.03.1145 – 1

ROLINE Mini PC Holder, lockable, black

17.03.1156 – 1





## VALUE Mobile PC Stand

- Creates more space on your desk, due to it being under the table
- Stable metal construction with high tilt-stability
- Adjustable from 119- 209 mm PC width
- More flexible in use
- 2 locking heavy-duty casters



**NEW**

Order-No. – P.U.

VALUE Mobile PC Stand, black

17.99.1500 – 6

## Mobile PC Stand

- Creates more space on your desk, due to it being under the table
- Stable metal construction with high tilt-stability
- Adjustable from 140-250 mm PC width
- Fitted with rubber mats against slipping and scratching
- More flexible in use



Order-No. – P.U.

Mobile PC Stand

17.05.1516 – 5

## VALUE Cable Cover Organizer (Under Desk Mount)

### For clean cable routing under the desk

- Desktop cable tray organizer
  - Simple design: hides wire and power cords for a clean workspace
  - Manage all cables: enough room for power stripes, network, and computer cabling
  - Easy installation
  - Dimensions: 600 x 114 x 76 mm
  - Contents:
- 1x cable manager à 600 x 114 x 76 mm

**NEW**

Order-No. – P.U.

VALUE Cable Cover Organizer (Under Desk Mount), black

17.99.1315 – 6

VALUE Cable Cover Organizer (Under Desk Mount), white

17.99.1316 – 6

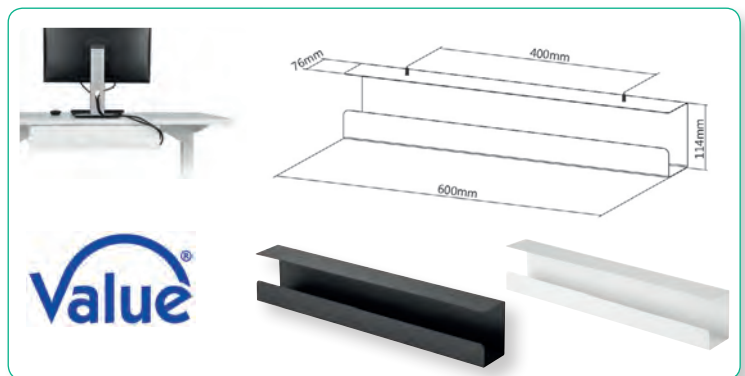

## ROLINE Cable Cover Organizer (Under Desk Mount)

- Contents: 2x cable manager à 530 x 110 x 80 mm

**roline**  
Designed for Professionals

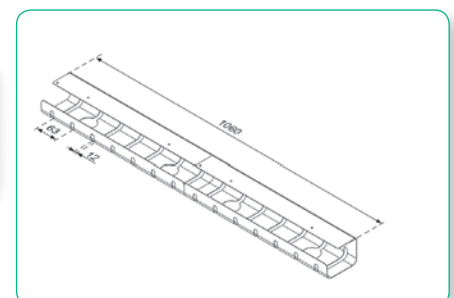
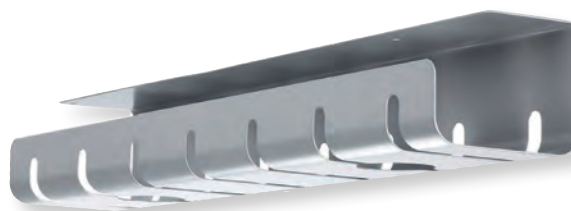

Order-No. – P.U.

ROLINE Cable Cover Organizer (Under Desk Mount)

17.03.1302 – 1

### VALUE Ceiling Projector Mount, small

- Ceiling mount for LCD projector
- Universal spider mount style fits most projectors
- With tilt and swivel function
- Weight capacity: 25 kg
- Max. projector size in diameter: 500 mm
- Distance to ceiling: 135 mm
- Colour: white
- Content: Ceiling mount, mounting material

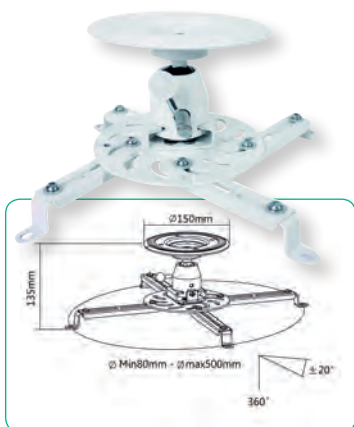

Order-No. – P.U.

VALUE Ceiling Projector Mount, small

17.99.1100 – 5

### VALUE Ceiling Projector Mount, big

- Ceiling mount for LCD projector
- Universal spider mount style fits most projectors
- With tilt and swivel function
- Weight capacity: 11.5 kg
- Max. projector size in diameter: 390 mm
- Adjustable ceiling tube can be extended from 37.5 cm to 47.5 cm off the ceiling
- Cables can go through the tube
- Colour: Grey
- Remark: Product similar to picture. Colour: Grey!
- Content: Ceiling mount, mounting material



Order-No. – P.U.

Technical data:  
Fixing: 17.99.1102 ceiling mount  
Load capacity: up to 11.5 kg  
Distance to ceiling: 375 - 475 mm, adjustable  
Weight: 2.5 kg  
Max. projector size diameter: 390 mm  
Colour: grey

VALUE Ceiling Projector Mount, big

17.99.1102 – 6

### ROLINE Ceiling Projector Mount, small

- Ceiling mount for LCD projector
- Universal spider mount style fits most projectors
- With tilt and swivel function
- Weight capacity: 10 kg
- Max. projector size in diameter: 390 mm
- Distance to ceiling: 110 mm
- Colour: grey
- Content: Ceiling mount, mounting material



Technical data:  
Fixing: 17.99.1101 ceiling mount  
Load capacity: up to 10 kg  
Distance to ceiling: 110 mm  
Weight: 1.3 kg  
Max. projector size diameter: 390 mm  
Colour: grey

**roline**  
Designed for Professionals

Order-No. – P.U.

ROLINE Ceiling Projector Mount, small

17.03.1176 – 12

### VALUE Wall Projector Mount, adjustable

- Universal mount style fits various sizes of most projectors
- With tilt and swivel function
- the projector can be rotated full 360°
- the projector can be tilted on the support arm (up to 12° in each direction), fine adjustment by a further 3° possible
- Cables can go through the tubes
- Max. Weight load capacity: 20kg
- Max projector size: 430 mm in diameter
- Adjustable ceiling tube can be extended from minimum size 61-76cm off the ceiling.
- Ceiling brackets
- Color: black

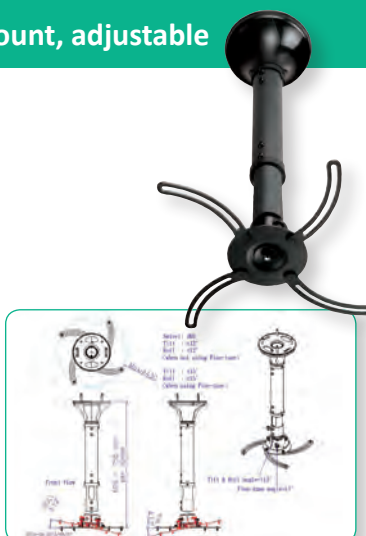

Order-No. – P.U.

VALUE Wall Projector Mount, adjustable

17.99.1180 – 2

### VALUE Wall Projector Mount

- Universal mount style fits various sizes of most projectors
- With tilt and swivel function
- Adjustable wall tube- can be extended from 73-123 cm off the wall
- Max projector size: 390 mm in diameter
- Load capacity: 8 kg
- Cables can go through the tubes



Technical data:  
Fixing: wall mount  
Load capacity: up to 11.5 kg  
Arm length: 73 - 123 cm  
Weight: 1.3 kg  
Max. projector size diameter: 390 mm  
Colour: black

Order-No. – P.U.

VALUE Wall Projector Mount

17.99.1104 – 2

### ROLINE Wall Projector Mount

- Universal mount style fits various sizes of most projectors
- With tilt and swivel function
- Wall tube, specially designed to mount a short throw projector, from 10 to 60 cm off the wall
- Max projector size: 390 mm in diameter
- Load capacity: 10 kg
- Cables can go through the tubes
- Colour: silver



Technical data:  
Fixing: wall mount  
Load capacity: up to 10 kg  
Arm length: 10 - 60 cm  
Weight: 2.7 kg  
Max. projector size diameter: 390 mm  
Colour: silver

**roline**  
Designed for Professionals

Order-No. – P.U.

ROLINE Wall Projector Mount

17.03.0000 – 2



## VALUE Smart Speaker Wall Mount for Echo and Homepod

- Designed for smart speakers like Google Home, Amazon Echo or the Apple Homepod
- Space-saving organization- seamlessly integrates all your smart speakers into your home without them getting in the way.
- The stability of the speaker on the solid steel bracket is supported by a magnetic plate on the underside of the speaker.
- Black powder coating
- The open, floating design keeps the microphone and speakers completely free for a balanced sound and speech experience.

- Material: steel, aluminium, plastic
- Load capacity: 2kg

**NEW**
**Order-No. – P.U.**

VALUE Smart Speaker Wall Mount for Echo and Homepod, 3 Joints 17.99.1327 – 20

## LCD Monitor Stand

- Stable Mesh monitor stand made of steel
- Holds up LCD monitors
- Provides storage place for pencils, stocks and much more
- Platform size: 420 x 280 mm
- Temporary storage of the keyboard (470 x 280 mm) and for documents or under the monitor platform
- Two side compartments
- Non-slip feet
- Max. loading: 15 kg
- Height 145 mm
- Pull-out drawer (W x H x D): 300 x 230 x 70 mm
- Dimensions of stand (W x H x D): 505 x 300 x 145 mm
- Colour: black

**Order-No. – P.U.**

LCD Monitor Stand, black, black

17.99.1159 – 6

## LCD/CRT Monitor Stand Trend

- Holds up to 51 cm (20") LCD or CRT monitor
- Create extra storage (ca. 500 x 60 mm) for your keyboard or documents and office stationery under the platform
- Enlarged utility space on the platform to accommodate your speakers or media storage box next to a monitor
- Additional tube support avoids monitor to lean backwards
- Special handle design on side panels for easy movement of the stand
- Max. loading: 20 kg
- Dimensions of stand (LxWxH): 580 x 335 x 70 mm
- Colour: Black/grey

**Order-No. – P.U.**

LCD/CRT Monitor Stand Trend, black

17.02.3370 – 2

## Dual Monitor/Printer Stand Trend

- Top wood platform supports A4 laser/inkjet printers
- Double drawers to storage provides multi storage of documents (A4, letters sized papers) and office stationery
- Special concave design provides more conveniences of picking up the thin pile of documents
- Special handle design on side panels for easy movement of the stand
- Platform size (LxW): 450 x 350 mm
- Colour: Black/grey

**Order-No. – P.U.**

Dual Monitor/Printer Stand Trend, black

17.02.3375 – 2

## LCD Monitor Stand Adjustable Tempered Glass Surface Risers (Square)

- Compact design with smooth edges all around
- Increased storage room beneath the desktop
- Create extra storage (ca. 500 x 210 mm) for your keyboard or documents and office stationery under the platform
- Stepless height settings for your free height adjustment (75- 85 mm)
- Max. loading: 20 kg
- Dimensions of stand (LxWxH): 580 x 210 x 75- 85 mm

 Suggested Screen Size:  
up to 81cm (13"-32")

 Max. Load: 20 kg  
Adjustable Height:  
75mm - 85mm

Glass Thickness: 5mm

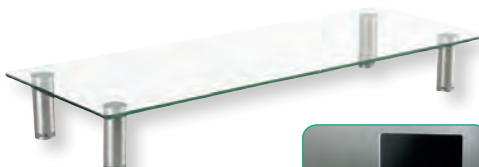
 Material:  
Glass, Stainless Steel  
Dimensions:  
580 x 210 x 85mm

**Order-No. – P.U.**

LCD Monitor Stand Adjust. Tempered Glass Surface Risers (Square) 17.02.3376 – 6

## LCD Monitor Stand Adjustable Tempered Glass Surface Risers (Triangle)

- Compact design with smooth edges all around
- Increased storage room beneath the desktop
- Create extra storage (ca. 500 x 280 mm) for documents and office stationery under the platform
- Stepless height settings for your free height adjustment (75- 85 mm)
- Max. loading: 20 kg
- Dimensions of stand (LxWxH): 580 x 280 x 75- 85 mm

 Suggested Screen Size:  
up to 81cm (13"-32")

 Max. Load: 20 kg  
Adjustable Height:  
75mm - 85mm

Glass Thickness: 5mm

 Material:  
Glass, Stainless Steel  
Dimensions:  
580 x 280 x 85mm

**Order-No. – P.U.**

LCD Monitor Stand Adjust. Tempered Glass Surface Risers (Triangle) 17.02.3377 – 10

## VALUE Adjustable Desktop Workstation, Sit - Stand Up

Turn your office table into an ergonomic, comfortable workspace within seconds. Enables you to switch between sitting and standing (orthopedic and occupational medicine recommended), thus increasing your own health and well-being.

- Steplessly height-adjustable (minimum 165 mm - max 505 mm), thus you can customize your workplace according to your own needs
- Double-sided gas spring lifting mechanism - for easy and effortless height adjustment of the workstation
- With a durable working surface of 600 x 400 mm, this workstation provides enough space for up to two monitors (when a monitor arm is used)
- Ergonomic keyboard / mouse shelf (690 x 255 mm)
- Maximum depth of 636 mm (when the keyboard / mouse tray is extended)
- Plate thickness 15 mm
- Maximum load: up to 15 kg
- Rounded corners and edges
- Robust construction
- Color: Black
- Delivery is carton-packed, requires self-assembly only for the keyboard/mouse tray



Order-No. – P.U.

VALUE Adjustable Desktop Workstation, Sit - Stand Up, black

17.99.1177 – 1

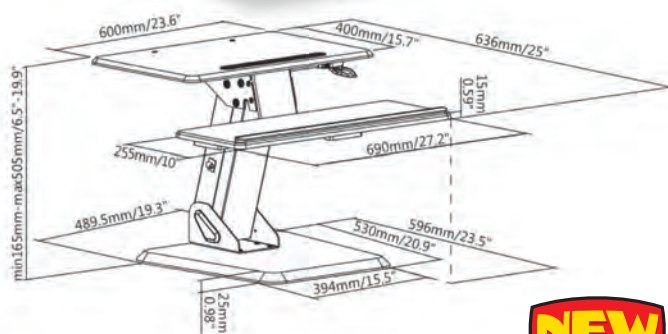

**NEW**

## ROLINE Adjustable Desktop Workstation, Sit - Stand Up

Turn your existing office table into an ergonomic, comfortable workspace within seconds. Enables you to switch between sitting and standing (orthopedic and occupational medicine recommended), thus increasing your own health and well-being.

- Steplessly height-adjustable (minimum 130 mm - max 500 mm), thus you can customize your workplace according to your own needs
- Double-sided gas spring lifting mechanism - for easy and effortless height adjustment of the workstation
- With a durable working surface of 1050 x 630 mm, this workstation

provides enough space for up to two monitors

- Ergonomic keyboard / mouse tray (710 x 300 mm)
- Maximum depth 640 mm (when the keyboard / mouse tray is extended)
- Plate thickness 15 mm
- Maximum load: up to 15 kg
- Rounded corners and edges
- Robust construction
- Color: Black
- Delivery is carton-packed and ready to be used, no self-assembly required

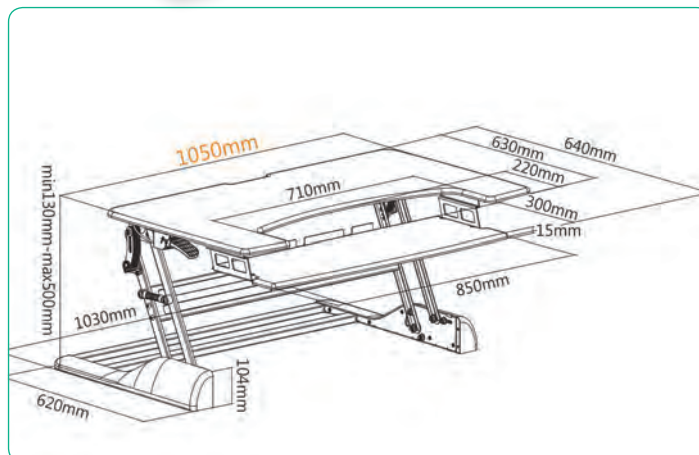

**roline**<sup>®</sup>  
Designed for Professionals



Order-No. – P.U.

ROLINE Adjustable Desktop Workstation, Sit - Stand Up, black

17.03.1177 – 1

## VALUE Single Monitor Arm, for 17.03.1177/17.99.1177

Stationary monitor arm as an attachment for 17.03.1177/17.99.1177 or generally for mounting a monitor on the desk with the smallest space requirement!

- Single Monitor Arm for Sit-Stand Workstation, compatible for 17.03.1177 and 17.99.1177) – Please see page 9.18
- Sleek design blends into various modern interior designs
- Easy-grip knobs for quick tilt and lock
- Cable management
- Provides extra height adjustment range for flat surface sit-stand workstations
- Mounting possibilities: desk clamp mounting
- Max. load capacity: 8kg



Order-No. – P.U.

VALUE Single Monitor Arm, for 17.03.1177/17.99.1177, 3 Joints

17.99.1179 – 4

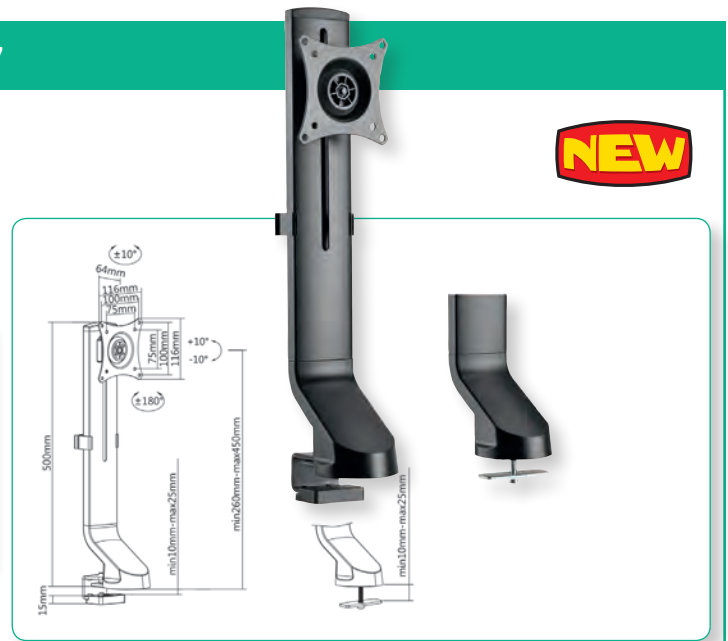

## VALUE Clamp-On Power Strip Holder

- Suitable next to desktops, multimedia systems, etc.
- For an organized desktop/office
- Clamp-On power strip holder
- Clamps onto surfaces up to 50 mm thickness
- Width adjustment range of the kept devices: min. 50mm- max. 70mm
- Silicone pads prevent the mounted device from scratching and accidental dropping (e.g. secure hold of power strip...)
- Cable management



Order-No. – P.U.

VALUE Clamp-On Power Strip Holder, white

19.99.3230 – 10

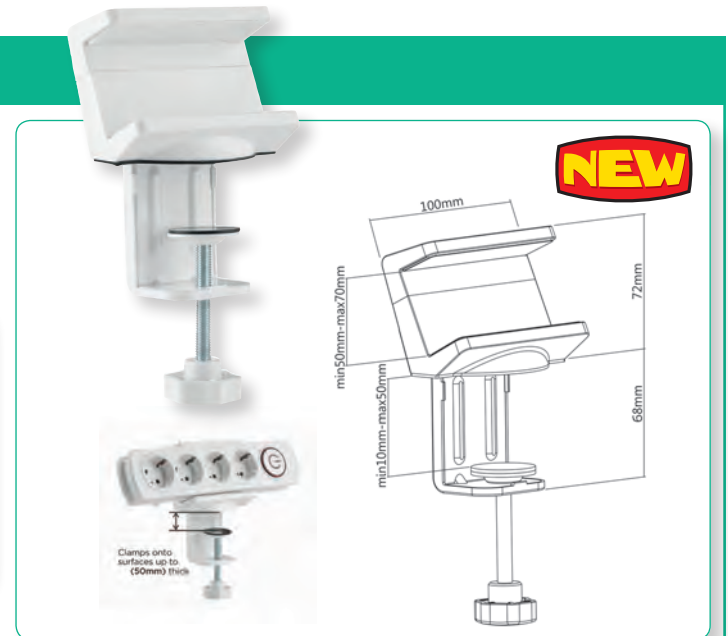

## VALUE Power Strip Organizer, Table-Mounted

- For an organized desktop/office
- Table-Mounted Power Strip Organizer
- Designed to work on an open desktop or shelf
- Adhesive tape keeps organizer & power strip in place without damaging surfaces
- Patterned grooves keep a better cable organization
- Heavy-Duty steel construction
- Dimensions: 180 x 140 x 63 mm

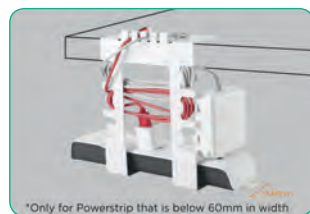
Order-No. – P.U.

VALUE Power Strip Organizer, Table-Mounted, white

19.99.3232 – 10



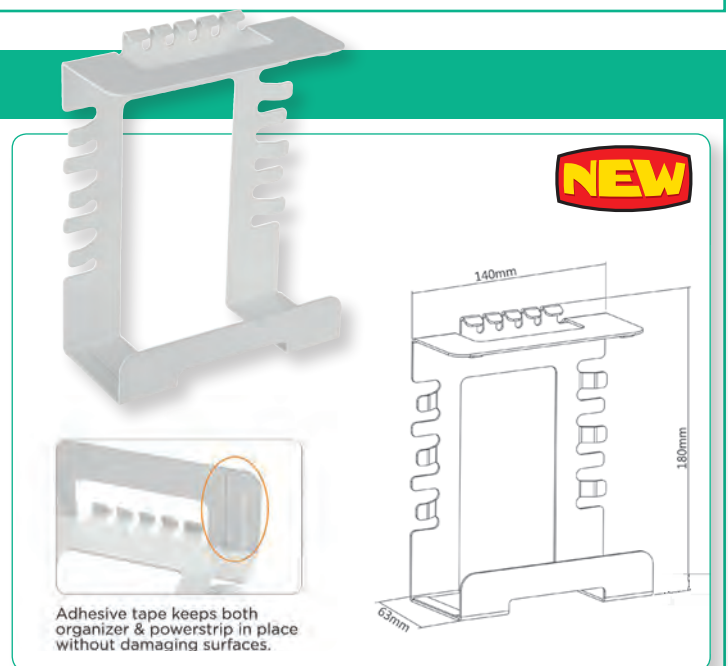

## ROLINE Printer Tables

### 17.01.1085

- Stable metal frame
- Printer shelf and floor level shelf (WxD: 46x39 cm)
- Mobile through 4 wheels, 2 of them are lockable
- Load bearing capacity: up to 30kg
- Colour:  
frame: light grey  
surface: white  
surface border: white
- Dimensions (HxWxD): 38x51x44 cm

**roline**<sup>®</sup>  
Designed for Professionals

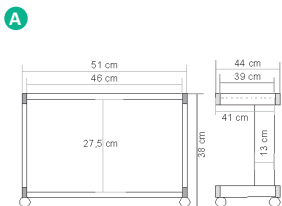

### 17.01.1087

- Stable metal / man-made material frame
- Printer shelf (WxD: 68x50 cm)
- Middle shelf (WxD: 58.5x44 cm)
- Floor level shelf (WxD: 57.5x31.5 cm)
- Mobile through 4 castors, 2 of which are lockable
- Level screws hinders the printer table from tilting on it's side
- Load bearing capacity: up to 30 kg
- Colour:  
frame: light grey  
surface: white  
surface border: grey
- Dimensions: 77.5x68x54 cm

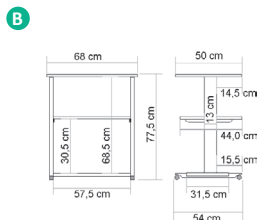

Order-No. – P.U.

ROLINE Mini Printer Table

A 17.01.1085 – 1

ROLINE Printer Table

B 17.01.1087 – 1

## ROLINE Printer Table, up to 80 kg

- Stable metal / plastic frame
- Load bearing capacity: up to 80 kg
- Printer shelf (WxD: 68x50 cm)
- Middle shelf (WxD: 59x44 cm)
- Floor level shelf (WxD: 59x31.5 cm)
- Level screws prevent the printer table from tilting on its side
- Colour:  
frame: light grey  
surface: white  
surface border: grey
- Dimensions (WxHxD): 74x68x55 cm

**roline**<sup>®</sup>  
Designed for Professionals

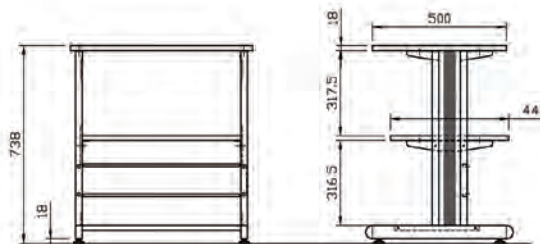

Order-No. – P.U.

ROLINE Printer Table, up to 80 kg

17.01.1089 – 1

## ROLINE PC Standing Workstation

- Stable metal/plastic frame
- Load bearing capacity: up to 40 kg
- Top shelf (WxD: 68 x 50 cm) for monitor etc.
- Slide-out keyboard shelf (WxD: 53.5 x 35 cm) with mouse surface (28 x 23 cm)
- Slide-out shelf (WxD: 53.5 x 35 cm) which can be used for printers
- Floor level shelf (WxD: 57.9 x 31.5 cm)
- Up to 40kg load bearing capacity
- Mobile via 4 wheels, 2 of which can be locked
- Colour:  
frame: light grey  
surface: white  
surface border: grey
- Dimensions (HxWxD): 110 x 68 x 54 cm



**roline**<sup>®</sup>  
Designed for Professionals



Order-No. – P.U.

ROLINE PC Standing Workstation

17.02.1545 – 1

## ROLINE PC Standing Workstation

**Work healthier! A change from sit to stand is good for your spine. With our height adjustable ROLINE PC-Stand-Workplace you can do your work standing.**

- Stable metal/plastic frame
- Load bearing capacity: up to 60 kg
- Top shelf (W x D: 70 x 35.5 cm) for monitor etc.
- Keyboard and mouse shelf (W x D: 70 x 40 cm)
- Printer shelf (W x D: 47.2 x 23 cm)
- Floor level shelf (W x D: 45.5 x 35 cm)
- Mobile via 4 wheels, 2 of which can be locked
- Colour:  
frame: light grey / surface: black / surface border: black
- Dimensions (H x W x D): min. 81 / max. 125 (+12,8 cm) x 70 x 70,5 cm
- Table top thickness 15mm (Melamine)

**The furniture is height adjustable just as you need it and helps to create an ergonomic, healthy workplace by allowing users to sit or stand throughout the day.**

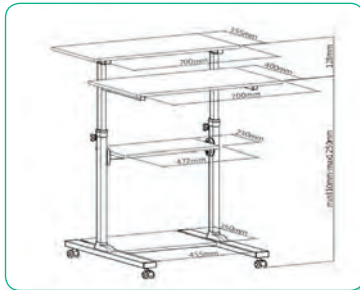

**roline**<sup>®</sup>  
Designed for Professionals

Order-No. – P.U.

ROLINE PC Standing Workstation, black / gray

17.02.1547 – 1

## Lockable PC / Server Workstation

- This PC/server workstation offers a lot of space for the PC, monitor, keyboard and mouse with excellent value for money
- Suitable for desktop, mini or midi PC housings
- With two lockable roller blinds
- Additional storage surface on the top
- 43 cm monitors can be placed without any problems
- Slide-out keyboard shelf (WxD: 53 x 35.2 cm)
- Mobile via 4 wheels, 2 of them can be locked
- Colour:  
Base unit / cabinet: light grey  
Roll top door: white grey
- Load bearing capacity:  
Floor level shelf: max. 60 kg  
Keyboard tabletop: max. 10 kg  
Monitor tabletop: max. 40 kg  
Desk on the top: max. 20 kg
- Dimensions:  
HxWxD: 151.5 x 80 x 60 cm  
Basic unit: 86 x 80 x 60 cm  
Cabinet: 80 x 65.5 x 60 cm

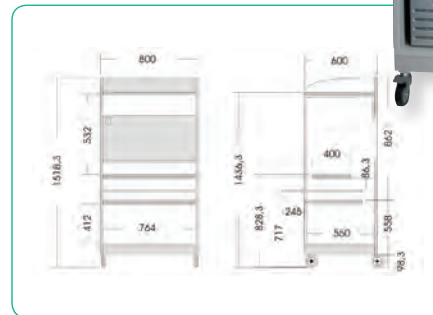

**roline**<sup>®</sup>  
Designed for Professionals

Order-No. – P.U.

Lockable PC / Server Workstation

17.02.2510 – 1

## ROLINE Allround-Cleaner-Aerosol

- Cleaning foam
- Ideal for cleaning printers, monitors, computer cases etc.
- No electrical conduction, antistatic, completely bio-degradable
- Contents: Spray bottle



**roline**<sup>®</sup>  
Designed for Professionals

Order-No. – P.U.

ROLINE Allround-Cleaner-Aerosol

19.03.3000 – 1

## ROLINE Monitor- and Plastic-Cleaner

- 250 ml pump spray bottle
- Efficient and gentle removal of dust and dirt from all plastic, metal and glass surfaces (e.g. printers, keyboards, telephones, etc.)
- Just spray it on a tissue and then polish the surface
- Antistatic, completely bio-degradable
- Ecologically friendly
- Contents: Pump-spray bottle



**roline**<sup>®</sup>  
Designed for Professionals

Order-No. – P.U.

ROLINE Monitor- and Plastic-Cleaner

19.03.3125 – 1

### ROLINE Universal-Cleaning-Tissues

- 100 cleaning tissues for all plastic and metal surfaces
- Ideal for cleaning printers, monitors, PC cases etc (not for TFT Displays and PDAs)
- Antistatic tissues, complete bio-degradable
- Hygienic and fresh smell
- Contents: 100 Cleaning-Tissues

**roline**<sup>®</sup>  
Designed for Professionals



Order-No. – P.U.

ROLINE Universal-Cleaning-Tissues

19.03.3100 – 1

### ROLINE Aerosol Can Air Duster (400 ml)

- For blowing dust and debris from inaccessible areas of electronic equipment (computer keyboards, printers, CD-ROM drives, copiers, fax machines, etc.)
- Variable spray intensity
- Ecologically friendly
- 400 ml aerosol can with spray tube included
- Contents: Aerosol-Can

**roline**<sup>®</sup>  
Designed for Professionals



Order-No. – P.U.

ROLINE Aerosol Can Air Duster (400 ml)

19.03.3110 – 1

### ROLINE Antistatic Foam-Cleaner

- 400ml Cleaning foam
- Ideal for cleaning plastic and coloured surfaces such as tables
- Antistatic, non-abrasive
- Contents: Spray bottle

**roline**<sup>®</sup>  
Designed for Professionals



Order-No. – P.U.

ROLINE Antistatic Foam-Cleaner

19.03.3130 – 1

### ROLINE TFT Cleaner

- Eco-friendly special cleaner for TFT and Laptop monitors, LCDs, PDAs, monitor filters, surfpads and all coated and uncoated glass surfaces (e.g. mirrors, overhead projectors and lenses).
- 250ml pump-spray bottle
  - No alcohol (not flammable), completely bio-degradable
  - Contents: Pump-spray bottle

**roline**<sup>®</sup>  
Designed for Professionals



Order-No. – P.U.

ROLINE TFT Cleaner

19.03.3135 – 1

ROLINE TFT Cleaner with microfiber cloth, 40x40 cm

19.03.3160 – 1

### ROLINE Disinfectant Computer Cleaning Wipes (100 pcs.)

- 100 moist disinfectant cleaning cloths
- For all plastic and metal surfaces (printer, keyboard, CPU, phone, fax (not for TFT screens) etc.)
- For a healthier office environment
- Fast drying, for a streak free shine
- Contents: Tub with 100 pcs.

**Note: Use biocides safely. Always read the label and product information before use.**

**roline**<sup>®</sup>  
Designed for Professionals



Order-No. – P.U.

ROLINE Disinfectant Computer Cleaning Wipes (100 pcs.)

19.03.3185 – 1

### ROLINE PC-Cleaning Set

- This set offers you a complete solution for cleaning your complete office-workplace
- Contents: 1x 125ml ROLINE TFT-Cleaner, 1x keyboard sponge and swab, 1x allround-sponge and 4x tissues „dry“

**roline**<sup>®</sup>  
Designed for Professionals



Order-No. – P.U.

ROLINE PC-Cleaning Set

19.03.3140 – 1





## TV Holders / Furnitures

# 10

TV Wall Holders . . . . .	10.02 – 10.06
TV Mobile Cart . . . . .	10.08 – 10.10
Digital Signage . . . . .	10.07 – 10.08
TV Ceiling Holders . . . . .	10.10
TV Board/Stand / Sideboards . . . . .	10.11
Cable Box . . . . .	10.11

VALUE LCD/Plasma TV Wall Holder, Low Profile

This wall mount allows a very discreet installation of a LCD/Plasma TV, perfect for e.g. a wooden wall.

- Weight capacity: up to 35 kg
- Screen Size: 81 cm up to 139 cm
- Low profile- very small distance to wall 19mm
- Material: Steel
- Max. VESA 400 x 400 mm



Order-No. – P.U.

VALUE LCD/Plasma TV Wall Holder, Low Profile, black

17.99.1202 – 12

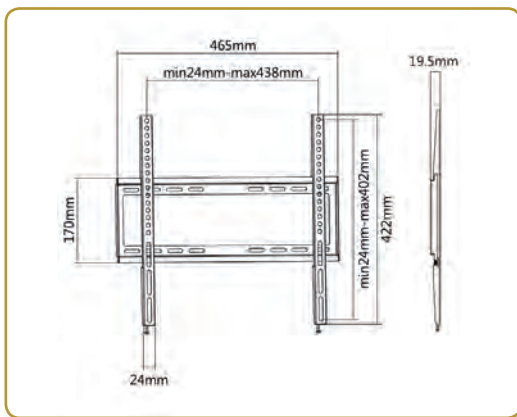

VALUE LCD/Plasma TV Wall Holder, Low Profile

This wall mount allows a very discreet installation of a LCD/Plasma TV, perfect for e.g. a wooden wall.

- Weight capacity: up to 80 kg
- Screen Size: 81 cm up to 152 cm
- Low profile- very small distance to wall
- Material: Steel
- Max. VESA 700 x 500 mm

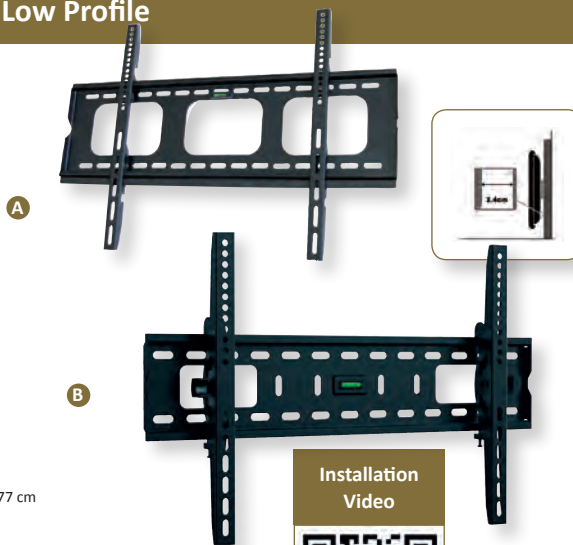

Technical data:	17.99.1214	17.99.1218
Fixing:	wall mount	wall mount
Load capacity:	up to 80 kg	up to 75 kg
Screen size:	81 cm up to 152 cm	93 cm up to 177 cm
Distance monitor to wall:	2.4 cm	8 cm
Tiltable up or down:	-	10°

Installation Video



Order-No. – P.U.

VALUE LCD/Plasma TV Wall Holder, Low Profile

A 17.99.1214 – 5

VALUE LCD/Plasma TV Wall Holder, Tiltable

B 17.99.1218 – 4

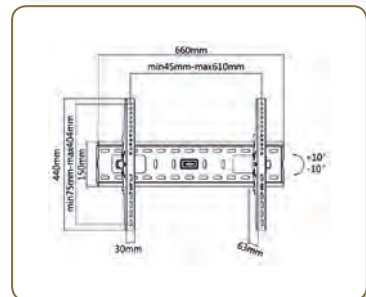
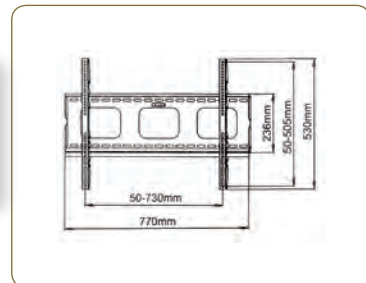

VALUE LCD/Plasma TV Wall Holder, Low Profile

This wall mount allows a very discreet installation of a LCD/Plasma TV, perfect for e.g. a wooden wall.

- Weight capacity: up to 40 kg
- Screen Size: 81 cm up to 139,7 cm
- Low profile- very small distance to wall, 33 mm
- Max. VESA 400 x 400 mm
- Integrated bubble level assures alignment and provides installation instructions
- Innovative quick-release mechanism allows for a quick and easy installation



Installation Video



Order-No. – P.U.

VALUE LCD/Plasma TV Wall Holder, Low Profile, black /silver

17.99.1154 – 10

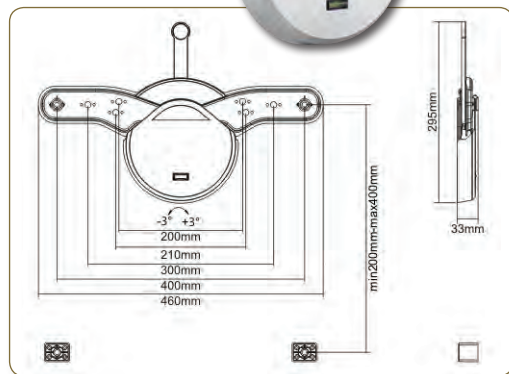

**VALUE LCD/Plasma TV Wall Holder, Low Profile, for Samsung Q Series (Q7 / Q8 / Q9)**

This wall mount allows a very discreet installation of a LCD/Plasma TV, perfect for e.g. a wooden wall.

- Weight capacity: up to 50 kg
- Screen Size: up to 165.1 cm
- Low profile- very small distance to wall, 17- 92 mm
- Integrated bubble level assures alignment and provides installation instructions
- Innovative quick-release mechanism allows for a quick and easy installation

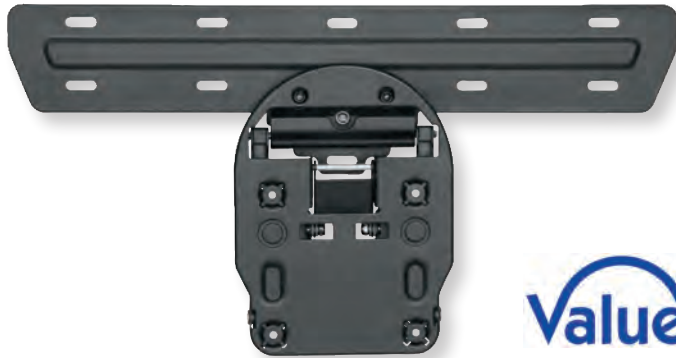

**ZERO Gap Design**  
gains more space and adds a modern look to your house



**Various Positions for Profile Adjustment**  
provides easy access for installation



**Tool-Less Tilting**  
adjusts to any viewing position



**Simple Minimalist Design**



Order-No. – P.U.

VALUE LCD/Plasma TV Wall Holder, Low Profile, for Samsung Q Series (Q7 / Q8 / Q9)

17.99.1166 – 5

**VALUE LCD/TV Wall Mount**

- Mounts a monitor onto a wall
- Integrated cable management system
- Built-in level adjustment
- Swiveling arm offer maximum viewing flexibility (+90° --90°)
- Freely tilting allows easy TV angle adjustment (+5° – 15°)
- Load capacity: up to 35 kg
- Meets VESA 400 x 400 mm
- Arm length: 61 cm
- Contents: supporting arm

Technical data: 17.99.1144  
Fixing: wall mount  
Load capacity: up to 35 kg  
Joints: 4  
Arm length: 61 cm



Order-No. – P.U.

VALUE LCD/TV Wall Mount, 4 Joints

17.99.1144 – 5

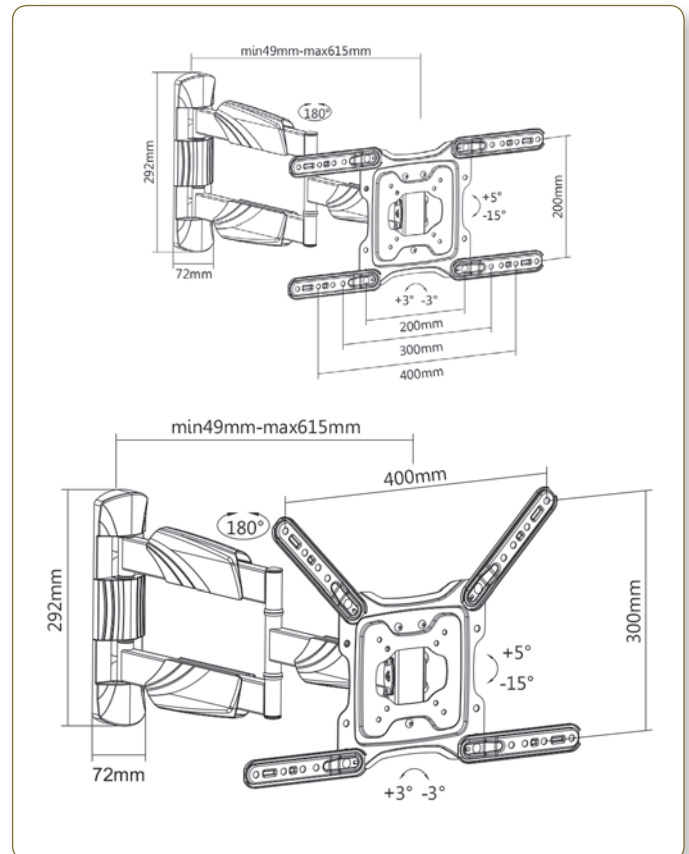





**VALUE LCD Wall Mount Bracket, up to 139.7cm (32" – 55")**

- Provides safe and easy access to most Curved TV's features
- Substantial mount, provides long-lasting use
- Integrated cable management
- Monitor can be tilted downward up to 20°
- Mount your screen neatly to the wall and monitor can be swiveled and rotated
- Fits most displays: 81cm- 139,7cm (32"-55")
- Universal VESA: 400 x 400mm
- Distance to the wall: 515 mm
- Max loading capacity: 35 kg

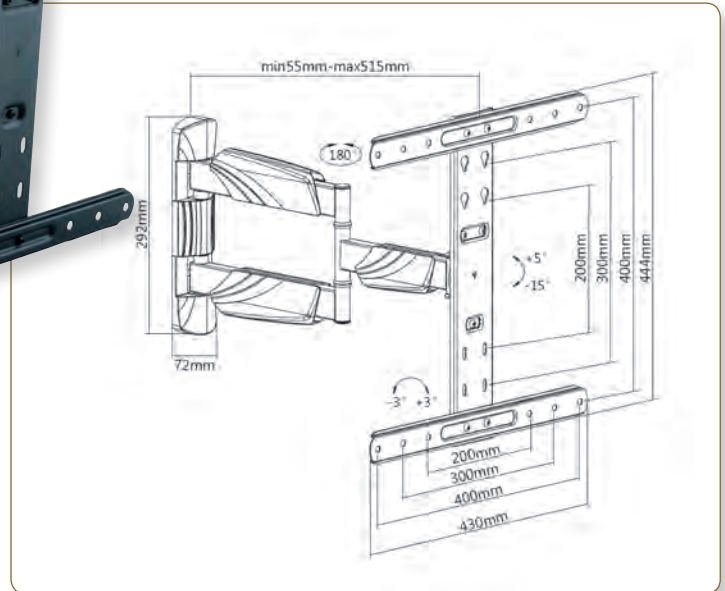
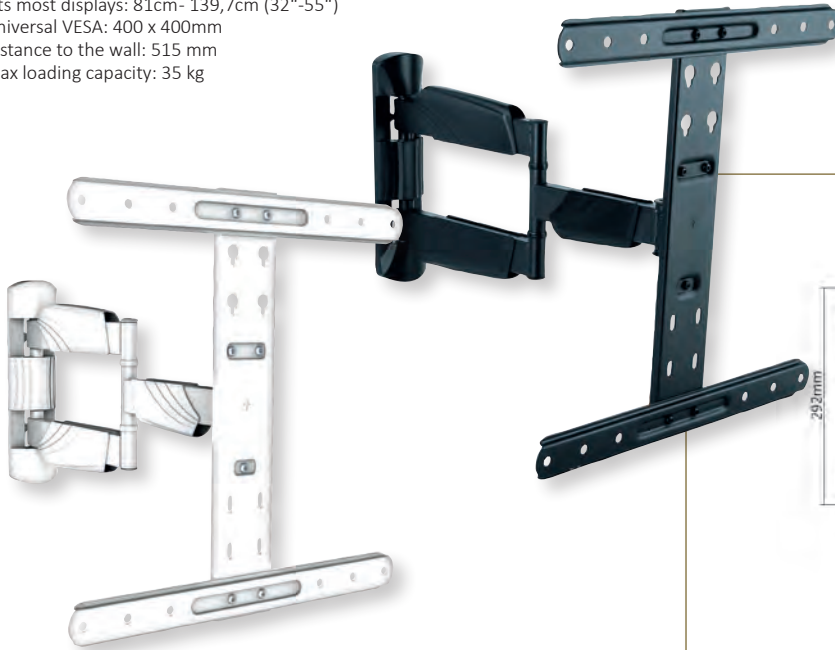

**Order-No. – P.U.**

VALUE LCD Wall Mount Bracket, up to 139.7cm (32" – 55"), black 17.99.1142 – 5

VALUE LCD Wall Mount Bracket, up to 139.7cm (32" – 55"), white 17.99.1149 – 5

**VALUE Solid Articulating Wall Mount TV Holder, up to 177.8cm (37" – 70")**

- Dual-arm full-motion wall mount for TVs (LED, LCD flat panel TVs) up to 177,8cm (37"- 70")
- Max. weight: 35 kg
- This mount extends out 400mm from wall and allows TVs to turn left or right
- Full motion allows maximum flexibility- tilts and swivel your TV for easy viewing from any seat in a room
- Post-installation level adjustment allows the TV to „roll“ up to 3° clockwise and counter-clockwise to ensure it's perfect level
- Integrated cable management system keeps cables organized and protected
- Wide wall plate fits for stud installation

**Technical Data:**

- Material: Steel
- Product weight: 7kg
- Recommended Screen Size: up to 177.8 cm (37"-70")
- Installation: Solid wall, Double Stud
- Max. Load Capacity: 35 kg
- Max.Hole Pattern: 600 x 400mm
- VESA Standard: 200x200, 400x200, 300x300, 400x300, 400x300, 400x300, 600x400
- Max.VESA: 600 x 400
- Tilt: -20°
- Level

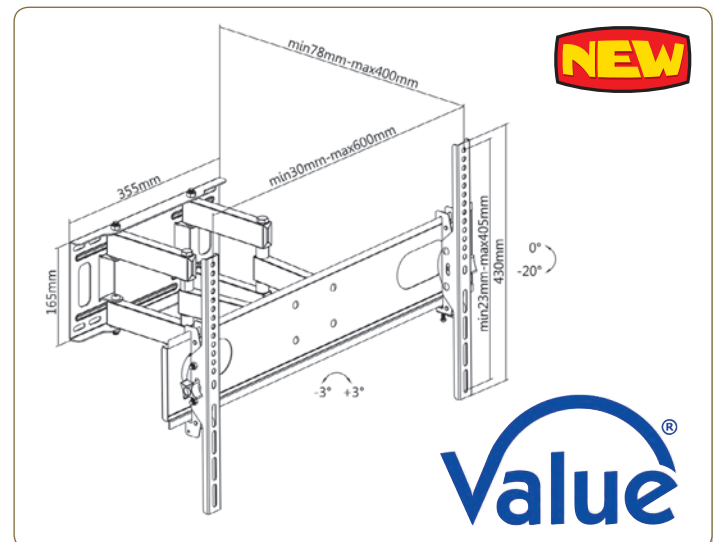

**Order-No. – P.U.**

VALUE Solid Articulating Wall Mount TV Holder, up to 177.8cm (37" – 70") 17.99.1208 – 3

**VALUE Solid Articulating Wall Mount TV Holder, up to 228.6cm (50" – 90")**

- Dual-arm full-motion wall mount for TVs (LED, LCD flat panel TVs) up to 228,6 cm (50"- 90")
- Max. weight: 75 kg
- This mount extends out 635 mm from wall and allows TVs to turn 60° left or right
- Full motion allows maximum flexibility- tilts and swivel your TV for easy viewing from any seat in a room
- Post-installation level adjustment allows the TV to „roll“ up to 3° clockwise and counter-clockwise to ensure it's perfect level
- Integrated cable management system keeps cables organized and protected

**Technical Data:**

- Material: Steel
- Product weight: 12kg
- Recommended Screen Size: 50"- 90" (127 cm- 228,6 cm)
- Installation: Solid wall, Double Stud
- Max. Load Capacity: 75 kg
- VESA Standard: 200x200, 400x200, 300x300, 400x400, 600x400, 800x400, 800x600
- Max.VESA: 800x600
- Tilt:-15°~+5°
- Swivel:-60°~+60°

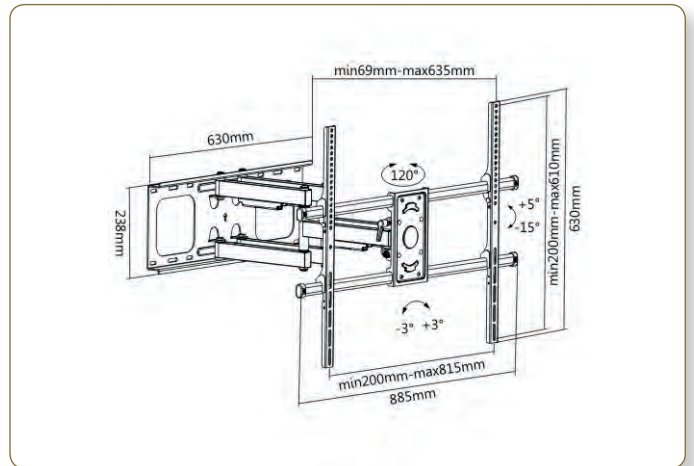

Order-No. – P.U.

VALUE Solid Articulating Wall Mount TV Holder, up to 75kg

17.99.1207 – 2

**VALUE Solid Articulating Wall Mount TV Holder, up to 177.8cm (37" – 70")**

- Dual-arm full-motion wall mount for TVs (LED, LCD flat panel TVs) up to 177,8cm (37"- 70")
- Max. weight: 50kg
- This mount extends out 510mm from wall and allows TVs to turn 60° left or right
- Full motion allows maximum flexibility- tilts and swivel your TV for easy viewing from any seat in a room
- Post-installation level adjustment allows the TV to „roll“ up to 3° clockwise and counter-clockwise to ensure it's perfect level
- Integrated cable management system keeps cables organized and protected
- Wide wall plate fits for 406/450mm stud installation

**Technical Data:**

- Material: Steel
- Product weight: 7 kg
- Recommended Screen Size: up to 177,8cm (37"-70")
- Installation: Solid wall, Double Stud
- Max. Load Capacity: 50kg
- Max.Hole Pattern: 626X400mm
- VESA Standard: 200x200,400x200, 300x300,400x400,600x400
- Max.VESA: 600x400
- Tilt: -20° ~ +10°
- Swivel: -60° ~ +60°
- Level Adjustment: -3° ~ +3°

Installation Video

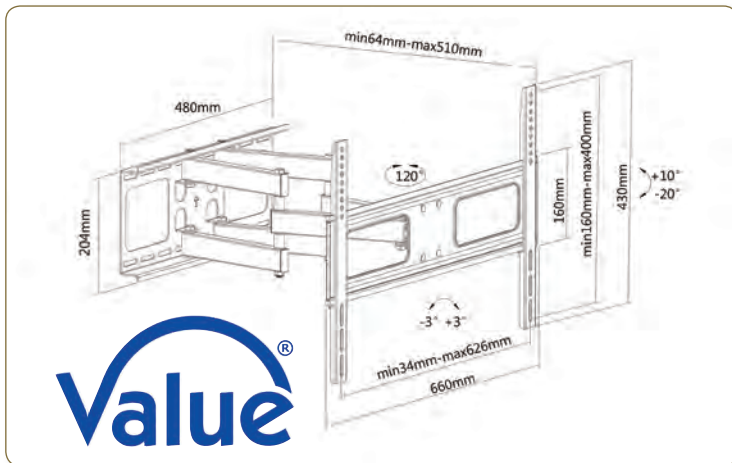

Order-No. – P.U.

VALUE Solid Articulating Wall Mount TV Holder, up to 177.8cm, black

A 17.99.1205 – 2

VALUE Solid Articulating Wall Mount TV Holder, up to 177.8cm, white

B 17.99.1206 – 2







### ROLINE Menu Board Wall Mount Sytem, 3x Displays, up to 127cm

Install a new or expand an existing linear display installation with this Menu Board TV wall mount for up to three monitors (max. 127cm 50") - the adjustments are easily achieved through levels in the holders, so the alignment is as easy and the installation time is as short as it gets!

- Supports maximum VESA 600x400 (VESA: 200x200, 300x200, 300x300, 400x200, 400x300, 400x400, 600x400)
- Versatile use for customer information and communication- directly at the point of sale or point of interest:
  - Display information films on the attached monitors (e.g. at trade fairs, in museums or in shops)
  - Use advertisements for the orientation of visitors (e.g. in conference rooms)
  - Show current offers or menus digitally in your shop

- Heavy quality: the fixing rod is made of light, durable aluminium, the VESA holders are made of solid steel
- Angle of inclination adjustable via steps from -10° to approximately +20°, the orientation can be fixed in the desired position for quick and easy installation
- Suitable for indoor use
- On the back of the monitor holder there is a storage space for e.g. a power supply unit.
- Load capacity up to 50kg
- Dimensions: 2885x440x102mm (WxHxD)

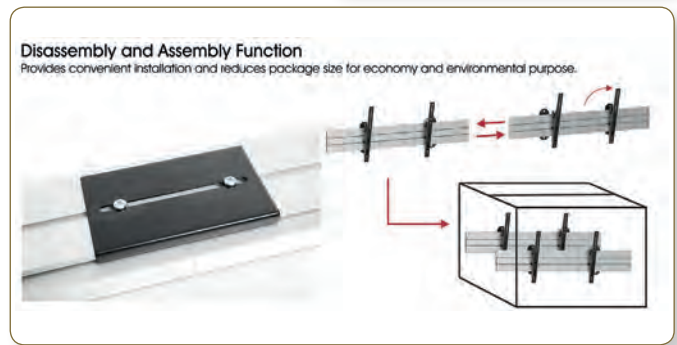
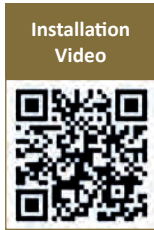
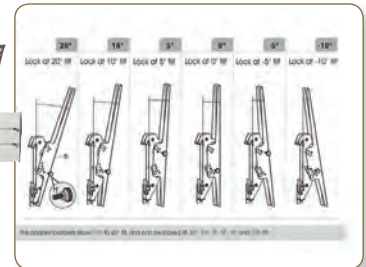

Order-No. - P.U.

ROLINE Menu Board Wall Mount Sytem, 3x Displays, up to 127cm 17.03.1253 - 1

### ROLINE Digital Signage Video Wall Solution



For what types of businesses are these products commonly used?

- Trade Shows & Convention Centers
- Retail Stores- for shoppers to participate in giveaways or learn more about the range of offered products

**Highlights:**

- Aligning of the the displays very quickly
- Lock screw to set position if desired
- TFT Orientation: Vertical
- Universal mount style fits various sizes of most displays with VESA max.600x400 mm
- Push-out open mount providing easy maintainance access
- Max. Weight load capacity: 50 kg
- **The solution consists of two brackets; so you need as for a small video wall (2x 2 monitors) twice this article**

- Colour: black
- Contents: 2x supports

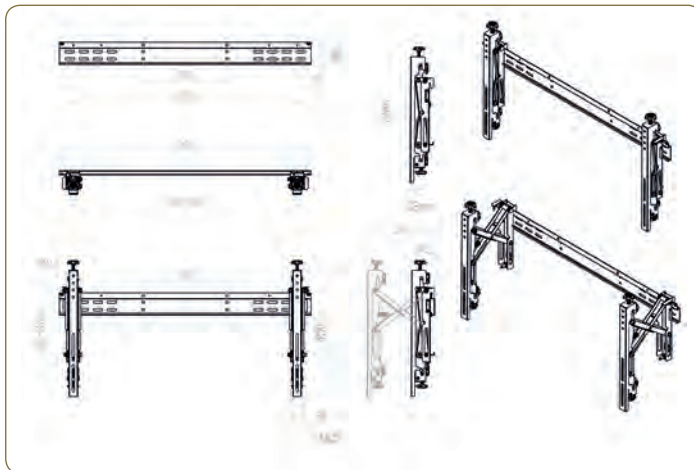

Order-No. - P.U.

ROLINE Digital Signage Video Wall Solution 17.03.1252 - 1

**ROLINE Digital Signage Stand**

- How can a digital signage stand benefit your business? There are a lot of possibilities, and they can be used across a wide variety of settings including retail stores & trade shows. That enables users to take projects and presentations on the road with ease.
- Digital Signage stands turn a tablet into a versatile workstation or customer information center. Pre-load apps and software for customers to use that is tailored to your business.

**For what types of businesses are these products commonly used?**

- Hotels- for guests to check in/out or to request room accommodations
- Restaurants & Food Service Locations- reservation of seating or food order
- Trade Shows & Convention Centers
- Retail Stores- for shoppers to participate in giveaways or learn more about the range of offered products
- Car Dealerships- for customers to see individual features on new models, check in for vehicle maintenance services or queue up to meet with a dealer

- Designed with heavy duty extruded alloy
- Lock screw to set position if desired
- TFT Orientation: Vertical or Horizontal
- Suitable for Indoor Use Only
- Universal mount style fits various sizes of most displays with VESA max.100x100 mm (17.03.1250) and max. 100x200 mm (17.03.1251)
- Cables can go through the tube (only 17.03.1250)
- Max. Weight load capacity: 10kgs
- Colour: silver
- Additional advertising area max. 380 x max. 900 mm (height is individually adjustable) only for 17.03.1251

**REMARK: Display is NOT included**

**Order-No. – P.U.**

ROLINE Digital Signage Stand	A	17.03.1250	- 1
ROLINE Digital Signage Stand, Advertising	B	17.03.1251	- 1

**roline®**  
Designed for Professionals



**VALUE LCD/TV Mobile Cart**

Ideal for applications in conference rooms or class rooms!

- For an easy mobile use of a large LCD monitor or TV
- For fixing LCDs with:
- Handy holders for moving the stand
- Platform for a DVD player or notebook
- Cable channel inside vertical carrier

**Value®**



**Order-No. – P.U.**

VALUE LCD/TV Mobile Cart		17.99.1164	- 1
VALUE LCD/TV Mobile Cart, heavy weight (up to 125kg)		17.99.1165	- 1

**ROLINE LCD/TV Mobile Cart**

Ideal for applications in conference rooms or class rooms!

- For an easy mobile use of a large LCD monitor or TV
- For fixing LCDs with:
- Horizontal: 10-60 cm
- Vertical: 10-40 cm
- Screen size: 82-139 cm
- Load capacity: up to 50 kg
- Adjustable height: 123- 158 cm
- Handy holders for moving the stand
- Platform for a DVD player or notebook (10kg)
- Cable channel inside vertical carrier



**roline®**  
Designed for Professionals

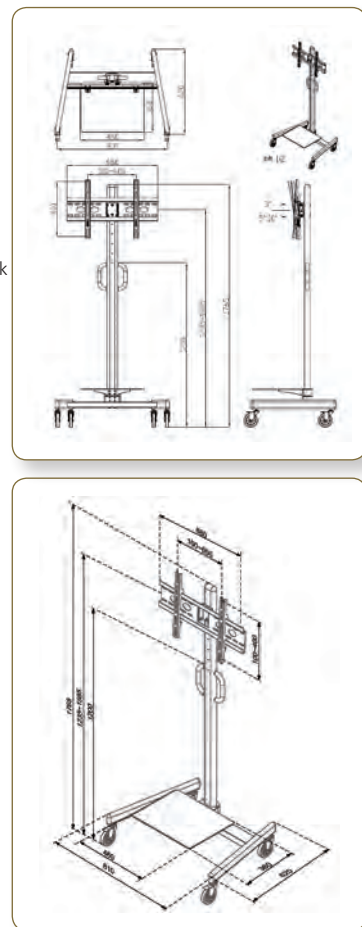

**Order-No. – P.U.**

ROLINE LCD/TV Mobile Cart		17.03.1164	- 1
---------------------------	--	------------	-----

**VALUE LCD/Plasma TV Cart, silver**

Ideal for applications in conference rooms or class rooms!

- For an easy mobile use of a large LCD monitor or flat-screen TV
- For fixing LCDs with screen size: 69- 152 cm (27"- 60")
- Load capacity: up to 50 kg
- Adjustable height: 110 up to 180 cm
- TV can be tilted downward up to 15 degrees
- Platform for e. g. holding a DVD player or notebook (WxD): 498 x 400 mm
- Cables can go through the tube
- Four wheels for easy movement whereof two are lockable

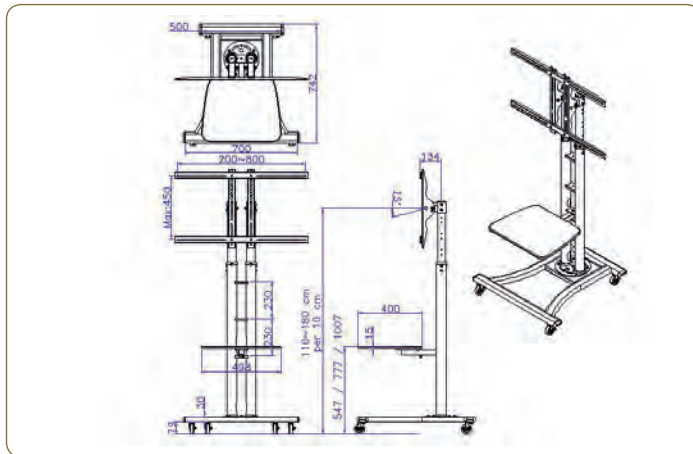

Order-No. – P.U.

VALUE LCD/Plasma TV Cart, silver

17.99.1320 – 1

**ROLINE LCD/TV Mobile Cart, up to 50 kg**



Ideal for applications in conference or class rooms, easily suitable for meetings and presentations!

- Telescopic Height Adjustable TV Cart
- Rotating function of 0°-90° to switch between „landscape“ and „portrait“ mode
- Optional Webcam Mount included in the scope of delivery
- Height adjustable TV mount
- Free-tilting design between +5° and -12° for multiple monitor viewing angles
- Quick-release spring lock adjusts height effortlessly
- Quick assembly shelf assures easy post-intallation
- Cable management keeps everything organized
- Sturdy base with heavy-duty casters
- Supports max. VESA: 600x400
- Suggested screen size: up to 94 cm- 177.8 cm (37"- 70")
- Maximum weight capacity: 50kg

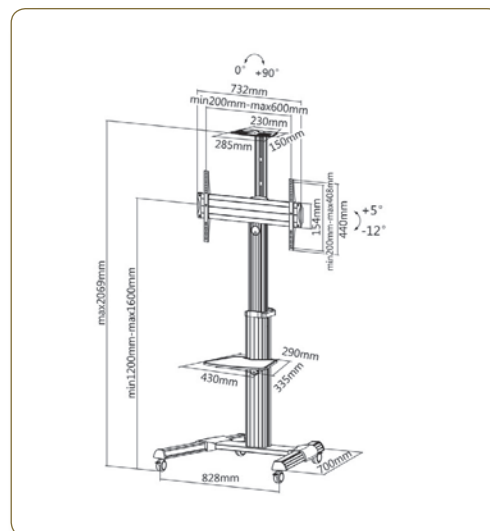

Order-No. – P.U.

ROLINE LCD/TV Mobile Cart, up to 50 kg

17.03.1260 – 1

Installation Video

**roline**<sup>®</sup>  
Designed for Professionals



## ROLINE LCD/TV Mobile Cart, up to 100 kg

MEDICAL  
ENVIRONMENT

Ideal for applications in conference or class rooms, easily suitable for meetings and presentations!

- Telescopic Height Adjustable TV Cart
- Height adjustable TV mount
- Optional Webcam Mount included in the scope of delivery
- Free-tilting design between +5° and -10° for multiple monitor viewing angles
- Quick-release spring lock adjusts height effortlessly
- Quick assembly shelf assures easy post-installation
- Cable management keeps everything organized
- Sturdy base with heavy-duty casters
- Supports max. VESA: 1000x600
- Suggested screen size: up to 152,4 cm - 254 cm (60"-100")
- Maximum weight capacity: 100kg



Order-No. – P.U.

ROLINE LCD/TV Mobile Cart, up to 100 kg

17.03.1261 – 1

**roline**<sup>®</sup>  
Designed for Professionals

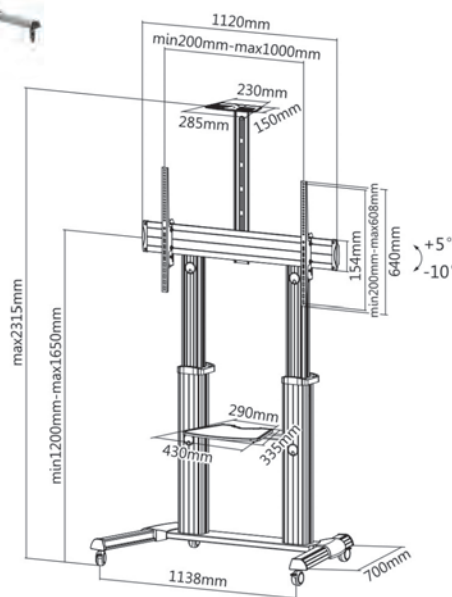
Installation  
Video

## VALUE LCD TV Ceiling Mount

- Firm mounting of a LCD monitor on a ceiling
- Arm length: 64.5- 104.5 cm
- Load capacity: up to 20 kg
- Cables can be layed inside the arm
- LCD monitor can be swiveled and tilted
- Meets VESA 75 x 75 mm, VESA 100 x 100 mm, VESA 100 x 200 mm, VESA 200 x 200 mm
- Contents: Ceiling mount, mounting material, manual

Technical data: 17.99.1107

Fixing: ceiling mount  
Load capacity: up to 20 kg  
Joints: 2  
Arm length: 65 - 104 cm

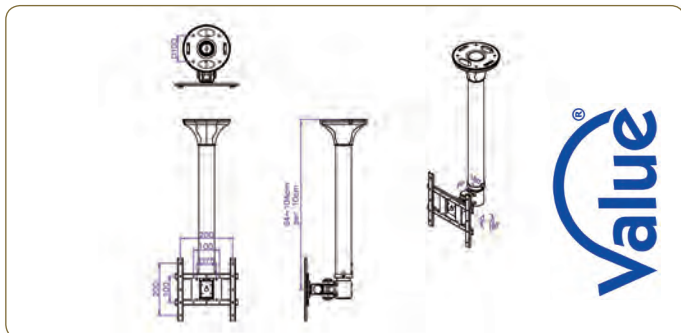

Order-No. – P.U.

VALUE LCD TV Ceiling Mount, 3 Joints

17.99.1107 – 2

## VALUE LCD/TV Ceiling Mount, 50kg

- Ceiling mount for a monitor/TV up to 42"
- Load capacity: up to 50 kg
- Meets VESA 75 x 75, 100 x 100, 100 x 200 ou 200 x 200 mm
- Arm length: 105- 156 cm
- -15° tilt; 360° swivel
- Contents: supporting arm



Order-No. – P.U.

VALUE LCD/TV Ceiling Mount, 50kg

17.99.1217 – 1

**VALUE TV Top Board Stand**

Stylish glass stand for flat-screen TVs.

- Offers space to put a DVD player or HD recorder under it
- For flat-screen TVs up to 20 kg
- 8 mm black silk tempered glass stand
- Dimensions (WxDxH): 63 x 35 x 18 cm

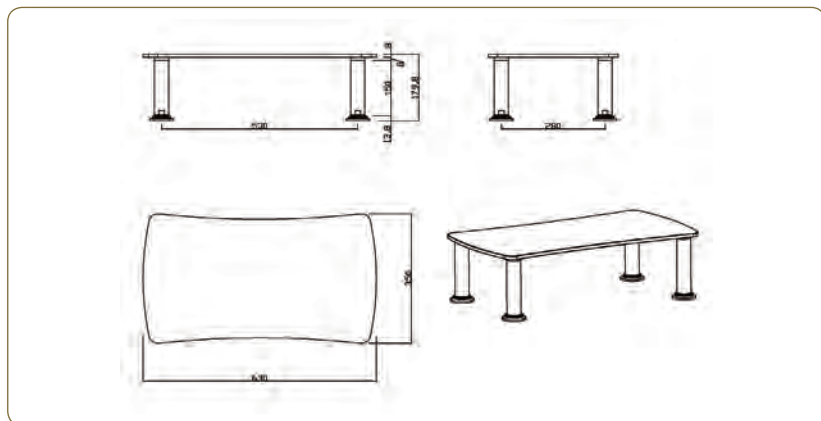

Order-No. – P.U.

VALUE TV Top Board Stand

17.99.1307 – 1

**VALUE Cable Box, small/ large**

- Suitable next to desktops, TV / multi-media systems, etc.
- For an organized desktop/office
- To hide tangled cables / power sockets
- Opening for cable exit on both sides
- Dustproof

- Easy to store
- White plastic box
- Dimensions:  
235 x 115 x 120 mm (small)  
407 x 157 x 133.5 mm (large)



B



A

B



A



Order-No. – P.U.

VALUE Cable Box, small, white

A 19.99.3236 – 8

VALUE Cable Box, large, white

B 19.99.3237 – 4

## VALUE Internal USB Hub

- Offers four SuperSpeed USB 2.0 type A downstream ports
- Can be installed in a free type 3.5 or type 5.25 (by using the optional 5.25 mounting rack) device bay
- LED status indicator for each port
- 4-pin HDD power connector to supply up to 900 mA on each port
- Supported Operating Systems: Windows XP/Vista/7
- Contents: USB hub, USB cable, power cable (4-pin HDD M-F), type 5.25 frame



**Technical data:**  
 PC connection: 1x USB 5-pin Mini  
 Input: 4x USB Type A  
 Dimensions (LxDxH): 101 x 68 x 25 mm  
 Power supply: over special cable (included)



**Order-No. – P.U.**

VALUE Internal USB 2.0 Hub, for Type 3.5/5.25 Bay, 4 Ports, black 14.99.5031 – 10

## ROLINE Switch 25-pin

VALUE switchboxes are designed to be used in non-critical applications where infrequent switching takes place, if it is anticipated that the switches will be used in a critical application our ROLINE range of switchboxes should be used.

- 4 PCs share a serial device or a parallel device, or vice versa
- All connectors DB25 F, connected 1:1

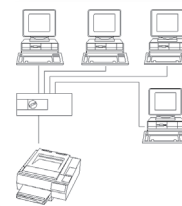

**Order-No. – P.U.**

ROLINE Switch 25-pin, ABCD 14.01.2010 – 20



## ROLINE Auto USB 2.0 Switch

- Enables 4 computers to share one peripheral USB device
- USB 2.0 High Speed (480Mbit/s)
- Hot-pluggable
- Supports auto-switch function for printer only
- Simple port selection via hot key
- LED display
- Bus-powered
- Supports Windows
- Contents: Auto USB switch, manual, cable USB type A/B

**Technical information**  
 Input connections: 4x USB Type B  
 Output connections: 1x USB Type A  
 Dimensions (HxWxD): -

**14.01.2338**



**Order-No. – P.U.**

ROLINE Auto USB 2.0 Switch, 4 Ports 14.01.2338 – 20



## ROLINE USB 2.0 Charging Cable, 3x Micro B

- Charging cable for USB devices with USB Micro B
- To connect three USB devices with USB Micro B to USB Port
- Use with most USB Charging devices
- USB cable with USB Type A to USB devices with USB Micro B
- Only charging, no data transfer
- Color: black
- Length: 0.8m



**Order-No. – P.U.**

ROLINE USB 2.0 Charging Cable, 1x A - 3x Micro B, M/M, 0.8m 11.02.8306 – 10

## ROLINE External Mini SAS Cable

- Cable for using of external RAID casings, libraries or other SAS systems with an internal SAS controller with external connection
- Supports SATA 6.0 Gbit/s (SATA III), SATA 3.0 Gbit/s (SATA II), SATA 1.5 Gbit/s (SATA I)
- With Mini SAS connector on both sides (SFF-8088 Male)
- Connector casing: metal
- Colour: black
- Length: 1.5 m



**Order-No. – P.U.**

ROLINE External Mini SAS Cable, 1.5 m, black 11.03.1588 – 1

## ROLINE Slim HDMI Hi-Speed Cables + Ethernet, Type C/D

- For the connection of e.g. mobile phones, smart phones, PDAs, digital cameras
- Connectors: HDMI Type A M to HDMI Type D (Micro HDMI) M
- Extra slim cable - easy to store and transport and therefore ideal for mobile use
- Quality cable with gold plated contacts for enhanced durability

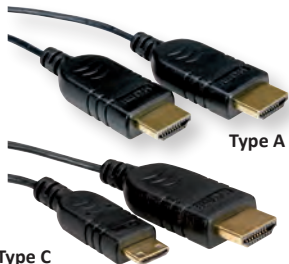

Type C

**Order-No. – P.U.**

ROLINE Slim HDMI High Speed Cable + Ethernet, M/M, 1.2 m 11.04.5632 – 20

ROLINE Slim HDMI High Speed Cable + Ethernet, A - C, M/M, 1.2 m 11.04.5630 – 20

ROLINE Slim HDMI High Speed Cable + Ethernet, A - D, M/M, 1.2 m 11.04.5631 – 20

## VALUE HDMI High Speed Cables + Ethernet

- Extension cable for High Speed HDMI with M/F - connectors
- For extension of existing HDMI cables
- HDMI Ethernet Channel
- Audio Return Channel
- 3D - Defines input/output protocols for major 3D video formats, paving the way for true 3D gaming and 3D home theater applications
- Additional Color Spaces

- Video resolution: 1920 x 1080
- Colour: black



**Order-No. – P.U.**

VALUE HDMI High Speed Cable + Ethernet, M/F, black, 1.0 m 11.99.5511 – 10

VALUE HDMI High Speed Cable + Ethernet, M/F, black, 2.0 m 11.99.5512 – 10

VALUE HDMI High Speed Cable + Ethernet, M/F, black, 3.0 m 11.99.5513 – 10

VALUE HDMI High Speed Cable + Ethernet, M/F, black, 5.0 m 11.99.5515 – 10



**ROLINE USB 2.0 CardReader for Smartphone+Tablet**

- Suitable for all Android Smartphones/ Tablets with a Micro B USB interface which enables OTG function
- Transfer your precious vacation pictures from the memory card of your digital camera on your Android smartphone / tablet using the ROLINE card reader
- Supports USB 2.0
- Card Reader works with multiple media, as e.g. SD (Secure Digital) Card, SDHC, MS (Memory Stick), MS Duo, mini/micro SD
- No adapter required for Micro SD/ M2 Cards
- Supported Operating Systems: Android
- Contents: Card Reader



Order-No. – P.U.

ROLINE USB 2.0 CardReader for Android Smartphone+Tablet 15.08.6252 – 10

**ROLINE Gaming Mouse, optical, USB**

- Super high sensitive 1600/1200/800 cpi (switchable)
- USB connector
- Surface: Black rubber coating
- Suitable for right and left-handed users
- Supported Operating Systems: Windows 2000/XP/Vista/7
- Contents: Mouse



**roline**  
Designed for Professionals

Order-No. – P.U.

ROLINE Gaming Mouse, optical, USB, black 18.01.1084 – 10

**VALUE External Type 3.5 SATA 3.0 Gbit/s HDD Enclosure, with USB 3.0**

- External enclosure for a type 3.5 SATA HDD for connection to a notebook/PC with USB 3.0 port
- Compliant with SuperSpeed USB 3.0, USB 2.0, USB 1.1
- Supports SATA 3.0 Gbit/s, SATA 1.5 Gbit/s
- Compliant with SATA Specification 2.6
- No driver installation required
- Aluminium material for excellent heat dissipation
- Enclosure can be set vertically to save space
- LED indication for power and bus activities
- On/Off switch
- Supported Operating Systems: Windows XP/Server 2003/Vista/7
- Supported HDD capacity: max. 2TB
- Contents: Enclosure, power supply, USB cable (1 m)

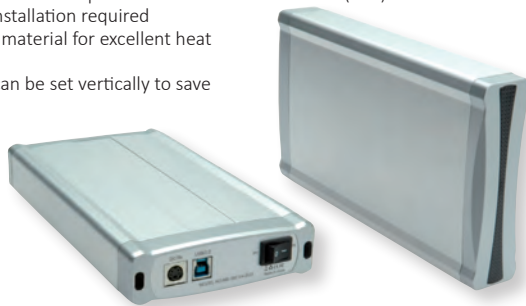

**Value**

Order-No. – P.U.

VALUE External Type 3.5 SATA 3.0 Gbit/s HDD Enclosure, with USB 3.0 16.99.4288 – 5

**ROLINE Bluetooth Sport Headset, waterproof**

- Stylish waterproof sports headset
- Ear-tip design for comfortable wearing
- IP 46
- Sand-proof
- Reduction of noise and wind
- Built-in microphone
- Li-polymer battery (80mAh/3,7VDC) with low voltage reminder LED light
- Talk/Listening time: 4.5 hours
- Standby time: 180 hours
- Colour: black
- Contents: Headset, USB charging cable, manual



**roline**  
Designed for Professionals

Order-No. – P.U.

ROLINE Bluetooth Sport Headset, waterproof 15.08.1354 – 5

**VALUE Headset, dual driver**

- Crystal Clear Stereo Sound
- Dual driver technology for a balanced audio experience
- Ergonomic Comfortable Wearing- fit for both ears in perfect condition
- Technical data:
  - Aluminum alloy housing
  - Frequency Response: 20Hz- 20kHz
  - Driver unit: two drivers in one earpiece: one is diam. 10mm; the other is diam. 7mm
  - Impedance: 16 Ohms
  - Sensitivity: 90dB
  - Connector: 3.5mm audio jack
  - Cord Length: 1.2m
  - Microphone: -42±3dB
- Contents: headset, accessories: 3 sets of silicon cap(S, M, L)

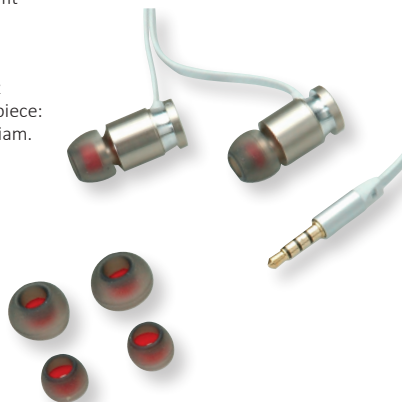

**Value**

Order-No. – P.U.

VALUE Headset, dual driver 15.99.1320 – 10

**VALUE / ROLINE Bluetooth In-Ear Headset**

- Stylish In-Ear headset
- Crystal Clear Stereo Sound
- Ergonomic comfortable wearing- fit for both ears
- Multipoint connection, pair 2 mobile phones at the same time and take or pick up a call from either
- Noise reduction, echo cancellation
- HD voice by high definition small speaker
- LED indicator: red and blue
- Bluetooth specification v3.0
- Multi-Function key to select voice prompt in 5 languages(English, German, French, Spanish, Chinese)
- Normal charging time: 2- 3 hours
- With ear bud, earphone, built-in MIC, volume control function
- Integrated rechargeable battery (80mAh)
- Operating range: 10 meters (Class II)
- Color: black
- Contents: Headset, additional earpiece cable, USB charging cable, manual



**Value**

**roline**  
Designed for Professionals



Order-No. – P.U.

VALUE Bluetooth In-Ear Headset, black 15.99.1321 – 5

ROLINE Bluetooth In-Ear Headset, black 15.08.1321 – 10

## VALUE Bluetooth Headset

- Stereo headset with very good price-performance ratio
- Ideal for multimedia applications
- With integrated microphone
- Connection to PC over 3.5 mm stereo plug or via Bluetooth
- Cable length: approx. 1 m
- Working distance range up to 10m
- Bluetooth Profile Support: HSP, HFP, A2DP, AVRCP
- Power: Polymer lithium battery 5V 400mAh (charging time: 2.5 hours)
- Talk time: = 8 hours; Music time: = 6 hours; Standby time: = 100 hours (approximately specifications)



Order-No. – P.U.

VALUE Bluetooth Headset

15.99.1305 – 24

## ROLINE Bluetooth Speaker, waterproof

- Portable Bluetooth speaker
- IP X6 waterproof (splashing water, to avoid a completely submersed in water functionality)
- Stereo sound, passive radiator for enhanced bass
- Bluetooth 3.0, range up to 10 meters
- Hands-free function and built-in microphone
- Playing music up to 5 hours, charging time 2.5 hours
- Line-in port(AUX-in) for use with music players
- Micro USB charging
- Unique design with portable hook
- Built-in Lithium-Ion battery (1000mAh)
- Speaker diameter: 45mm
- Speaker Impedence: 4 Ohm
- Speaker power output: 2x 3W
- Color: black
- Contents: Headset, audio cable, USB charging cable, manual



Order-No. – P.U.

ROLINE Bluetooth Speaker, waterproof

15.08.0990 – 5

## VALUE Flexible Smartphoneholder with USB Charger

### Practical combination of a Smartphone holder and USB Charging Station

- Smartphone holder with gooseneck
- Suits for various smartphones thanks extendable bracket (width about 5-8cm, height approx 12- 16cm)
- Ball joint allows optimal alignment of the smartphone
- No scratches because of rubberized surfaces
- Easy charging of smartphones and other devices via USB port in the car
- Also suitable for portable navigation devices which needs a USB power supply
- Car plug as the basis
- Two USB outputs, type A Female
- Input voltage: DC 12V- 36V (with surge protection)
- Output voltage: 2x USB 5V / 2.1A



Order-No. – P.U.

VALUE Flexible Smartphoneholder with USB Charger

19.99.1050 – 5

## VALUE Car Smartphoneholder, Air vent fixing

### Practical holder for Smartphones - for many car types suitable thanks to the attachment on the grating

- Suites for various smartphones thanks extendable bracket (width about 5-8cm, height approx 12- 16cm)
- Ball joint allows an optimal alignment of the smartphone
- No scratches because of rubberized surfaces (soft touch finish to protect your smartphone)
- Also suitable as a holder for portable navigation devices (use your smartphone as a navigation system)
- Air vent smartphoneholder for your car
- 360° rotation
- Easy installation
- Compatible e.g. with iPhone 5/6/6plus, Samsung, HTC
- Material: ABS



Order-No. – P.U.

VALUE Car Smartphoneholder, Air vent fixing

19.99.1051 – 5

## ROLINE Sport Set Mount Smartphone Holder

- Easy installation
- Fits for smartphone sizes: from 8,9 cm to 16cm screen size (3.5" - 6.3")
- Universal- snap-on design makes it very helpful under different circumstances: use your smartphone, GPS navigator, etc. during sport, office activities...
- Portable on fitness equipment, bikes- watch videos, listen to music while exercising
- The 4 point connection ensures a stable link and 360° rotation with no risk of accidental release and the extendable sports phone sheath provides firm grip for almost any size smartphone
- 360° Rotational design
- Anti-slip functionality
- Clamp: 95 x 72 x 45mm
- Holder: 115 x 95 x 43mm
- Min-Max Opening: Clamp: 1- 46mm
- Material-Made: plastic, metal and rubber
- Content: Clamp + Sport Phone Holder (Remark: smartphone is not included)



Order-No. – P.U.

ROLINE Sport Set Mount Smartphone Holder

17.03.0031 – 5

## ROLINE Aluminium Stand for Smartphones/Apple Watch

- Stand for Smartphones with additional stand functionality for Apple Watch
- Compatibility with 38mm and 42mm of Apple Watch Sport, Apple Watch
- Place for where the Apple Watch rests is made of a soft, durable TPU material to keep the back of your watch scratch-free
- Rubber mat underneath the stand
- Material: aluminium, rubber bottom
- Colour: silver
- Material: Aluminum
- Dimensions: 95x 124 x 45mm
- Content: Desktop stand (Remark: smartphone is not included)



Order-No. – P.U.

ROLINE Aluminium Stand Smartphones/Apple Watch, silver

17.03.0030 – 10

**ROLINE Universal Tablet Headrest Holder**

- Car headrest holder for iPad 1/2/3/4/ Air/Air2, 8.9"-10.4" Galaxy and other tablets
- Range of headrest pin width: 156mm~186mm
- Suit headrest pins up to 16mm in diameter
- Flexible angle between two legs of 36°~180°
- Adjustable top leg length of 26-64mm
- Freely ±30°tilted silicone feet for holding your iPad perfectly
- 360°rotation allows portrait and landscape viewing
- Easy and secure attachment
- Clamper width:184mm
- Material: steel + plastic



**roline**  
Designed for Professionals

Order-No. – P.U.

ROLINE Universal Tablet Headrest Holder

17.03.0024 – 5

**ROLINE DVI Video Splitter**

- Applications: multimedia, presentations, demos, etc.
- Duplicates DVI Video signals to four DVI Video outputs
- Max. resolution: 1920x1200
- Supports cascading of splitters
- Contents: Splitter, main adapter, manual

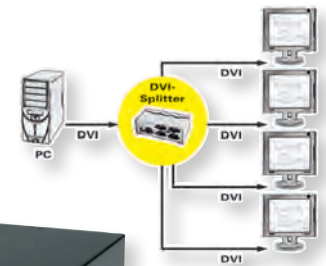

**roline**  
Designed for Professionals

Order-No. – P.U.

ROLINE DVI Video Splitter, 4-way

14.01.3551 – 6

**ROLINE DP to DVI DualLink Converter**

**4K**

**ROLINE quality converter for connecting a DVI dual link monitor to a graphic card with DisplayPort output.**

- Supports DP v.1.2
- DVI output with up to 350 MHz bandwidth
- Supports video resolution up to 4K2K with DVI DualLink
- Supports up to 5.4 GHz / Lane DP signaling
- Input data depth 6/8/10/12 bits
- Compatible with VESA DMT standard
- Contents: Local Unit (RJ-45 F, DVI F) Remote Unit (RJ-45, DVI F), 2x Power Supply Unit, Manual



**roline**  
Designed for Professionals

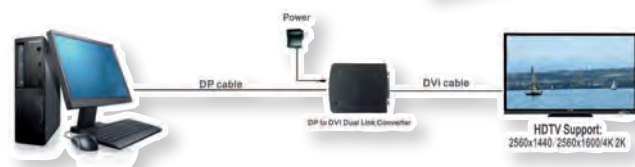

Order-No. – P.U.

ROLINE DP to DVI DualLink Converter

14.01.3425 – 10

**ROLINE 4K HDMI Switch**

**4K**

**3D capable**

**2160p ULTRA HD**

- Shows the Video output of 3/4 HDMI devices like e.g. DVD player, video camera or game console on one monitor
- Supports HDMI High Speed
- Video input can be switched automatically or by button on the switch
- Supports nominal resolution of up to 3840 x 2160 @30Hz (4K2K)
- Supports high-resolution display of up to 480p, 576p, 720p, 1080i, 1080p,

- Supports uncompressed audio such as LPCM
- Supports compressed audio such as DTS Digital, Dolby Digital (including DTS-HD and Dolby True HD)
- No power supply needed
- Colour: Black
- Contents: HDMI switch



**roline**  
Designed for Professionals

Order-No. – P.U.

ROLINE 4K2K HDMI Switch, 4-way

14.01.3576 – 5

**VALUE Wire Crimper / Stripper / Cutter Tool**

- For quick, repetitive stripping and cutting, light weight, compact, cost-effective stripper, simple to operate.
- Stainless steel
- Precision ground stripping holes offer easy, consistent jacket removal
- Strips 8-22 AWG solid and 10-24 AWG stranded conductors
- Multiple functions include plier nose, strippers, cutter, looping holes
- Looping holes and serrated nose for bending, pulling and shaping wires
- Vinyl cushion grip resists slipping

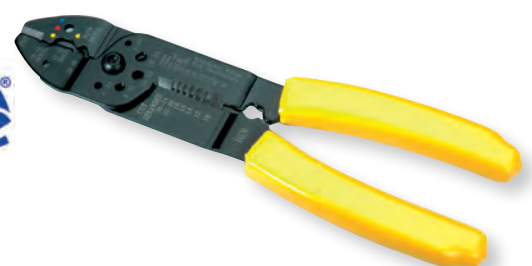

Order-No. – P.U.

VALUE Wire Crimper / Stripper / Cutter Tool

19.06.1022 – 10



## Cutting pliers for coaxial cables

- Cable cutter for coaxial cables
- Blade lock function for better safety and easier storage
- Stable construction
- Metal



Order-No. – P.U.

Cutting pliers for coaxial cables

19.06.1061 – 10

## VALUE Wire Cutter / Stripping Tool

- For quick, repetitive cutting, light weight, compact, cost-effective cutter, simple to operate.
- Stainless steel
- Cuts 10-22 AWG solid conductors
- Long-life spring and low-profile lock for quick, repetitive cutting
- Vinyl cushion grip resists slipping



Value

Order-No. – P.U.

VALUE Wire Cutter / Stripping Tool

19.06.1023 – 10

## Screwdrivers Ratchet

- These precision ratchet screwdriver sets are perfect for technicians, do-it-yourselfer and anyone who needs to carry a useful precision tool to go
- Ideal for repairing glasses, mobiles, electronic & computer or any precision equipment
- Ratchet directions: left/right/0
- The bits are stored inside the ergonomic non-slip handle
- Length: 160 mm



Order-No. – P.U.

Screwdriver 11-in-1 Pop-up Ratchet

A 19.06.1001 – 12

10-in-1 Auto Loading Ratchet Screwdriver Set

B 19.06.1003 – 25

### 19.06.1001:

- Bit magazine lowers by pressing a push button
- 3x Philips bits (PH00, PH0, PH1)
- 3x slotted bits (2 mm, 2.5 mm, 3 mm)
- 5x Torx bits (T6, T7, T8, T9, T10)

### 19.06.1003:

- Pump-action design for easily and quickly auto-loading bits exchange
- Rotatable marked barrel for 6 bits pre-loading and storage
- 3x Philips bits (PH00, PH0, PH1)
- 3x slotted bits (1.5 mm, 2 mm, 3 mm)
- 4x Torx bits (T5, T6, T8, T10)



B

## Screwdriver 15-in-1 Ratchet

- This kit is perfect for technicians, do-it-yourselfer and anyone who needs to carry a useful precision tool to go
- Ideal for repairing glasses, mobiles, electronic & computer or any precision equipment
- The bits are stored in the handle and lower by pressing a push button
- Ratchet directions: left/right/0
- Bits:
  - 3x Philips (PH00, PH0, PH1)
  - 3x slotted (3 mm, 5 mm, 6 mm)

- 2x Torx (T15, T20)
- 1x Adapter 25mm
- 5x piece socket set (nuts 6 / 7 / 8 / 9 / 10mm)
- Length: 165 mm
- Colour: black/green
- Contents: Screwdriver with bit set



Order-No. – P.U.

Screwdriver 15-in-1 Ratchet

19.06.1007 – 12

## VALUE Universal Media Box Holder

- Universal Media Box Mount
- Protective soft cushion holds device securely without scratches
- Simple construction allows easy installation
- Rubber band keeps media box in place and avoids sliding off
- Screw to wall
- Attach to TV wall mount / to the VESA hole of TV
- Hang to the back slot of TV
- Stick on the back of TV
- Material : ABS plastic

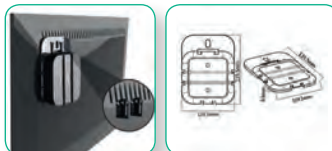

Order-No. – P.U.

VALUE Universal Media Box Holder

17.99.1153 – 30



Value

**ROLINE LCD Monitor Wall Mount Kits**

- Space saving mounting of monitor on Walls
- VESA 75 fixation

**roline**  
Designed for Professionals

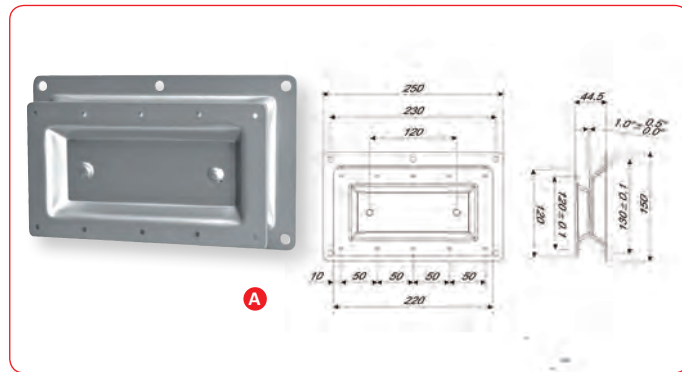

**Technical data:** 17.03.1182 17.03.1183  
Load capacity: 1-35 kg 1-35 kg  
VESA: 200x100 mm 100x100 mm, 200x200 mm

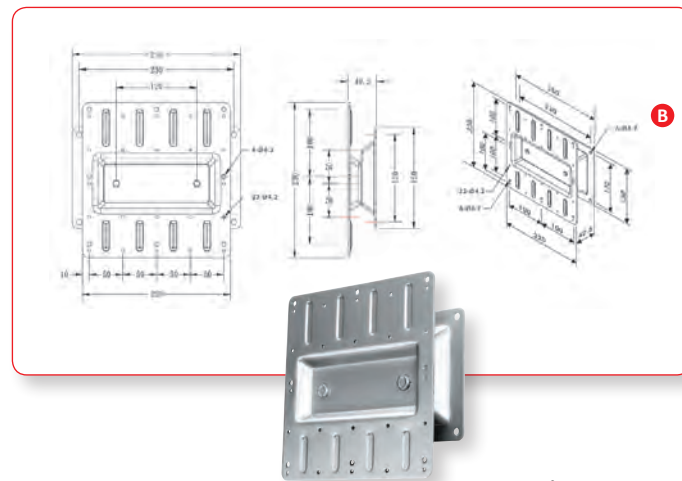

**Order-No. – P.U.**

ROLINE LCD Monitor Wall Mount Kit, -35 kg, VESA 200x100 A 17.03.1182 – 1  
ROLINE LCD Monitor Wall Mount Kit, -35 kg, VESA 200 x 200 and 100 x 100 B 17.03.1183 – 1

**ROLINE LCD Monitor Wall Mount Kit**

- Space saving and solid mounting of a monitor on walls
- Easy to mount with sliding bracket design (2 pieces)- one piece has to be fixed to the wall, the other one has to be screwed with VESA on the monitor
- Monitor has to be mount from the upside into the wall mount
- Meets with VESA 75 (75 x 75 mm) or VESA 100 (100 x 100 mm)
- Load capacity: 8 kg

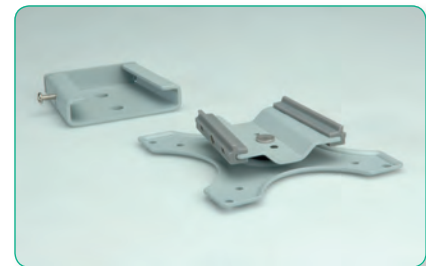

**roline**  
Designed for Professionals

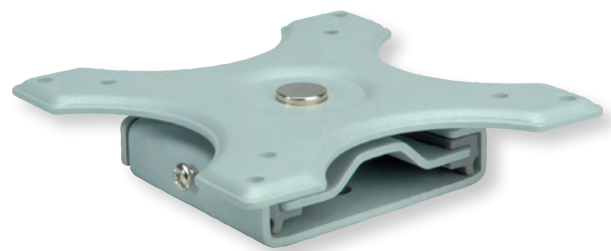

**Order-No. – P.U.**

ROLINE LCD Monitor Wall Mount Kit 17.03.1167 – 30

**VALUE LCD Monitor Arm Gas Spring, Wall Mount**

- LCD monitor wall mount
- Arm length: 490 mm
- Weight capacity: max 4-8 kg
- Meets with VESA 75x75 or 100x100mm
- Monitor can be tilted, swiveled and rotated
- Color: silver
- Monitor can be adjustment: -20° - +45°
- Arm height adjustment: 270mm

**Value**

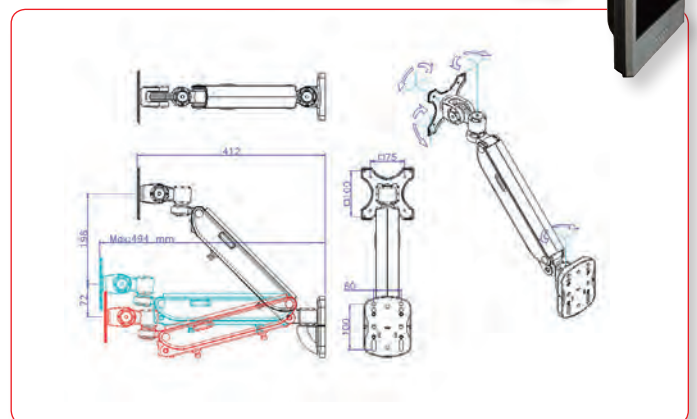
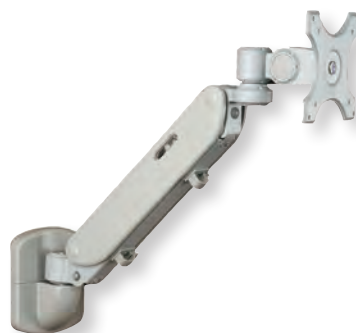

**Order-No. – P.U.**

VALUE LCD Monitor Arm Gas Spring, Wall Mount 17.99.1128 – 2

**VALUE LCD Monitor Wall Mount Kit**

- Integrated bubble level assures easy installation alignment
- Slide-in wall plate provides easy access for attachment and detachment
- Adjustment knob ensures tilt/pan realization (+55° – -35°)
- Swiveling possibility offer maximum viewing flexibility (+90° – -90°)
- In-arm cable clip

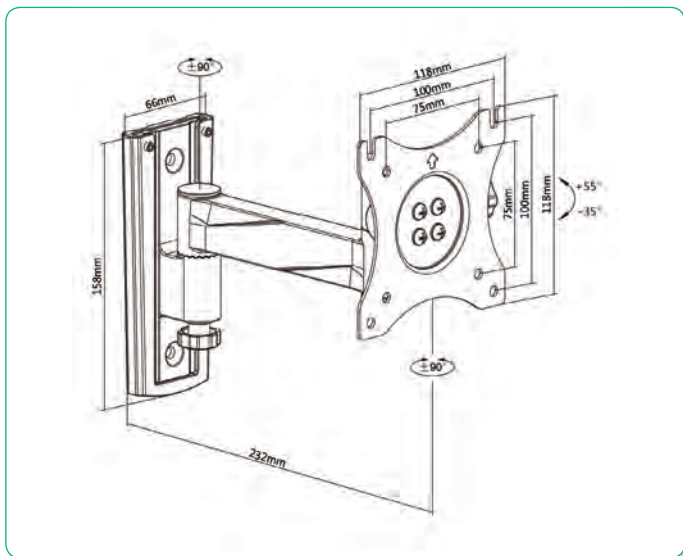

Order-No. – P.U.

VALUE LCD Monitor Wall Mount Kit, 3 Joints

17.99.1131 – 10

**ROLINE LCD/TV Wall Mount**

- Mounts a monitor onto a wall
- Load capacity: up to 50 kg
- Meets VESA 400 x 200 or 600 x 400 mm
- Arm length: 47 cm
- Contents: supporting arm

Technical data: 17.03.1168  
 Fixing: wall mount  
 Load capacity: up to 50 kg  
 Joints: 4  
 Arm length: 47 cm

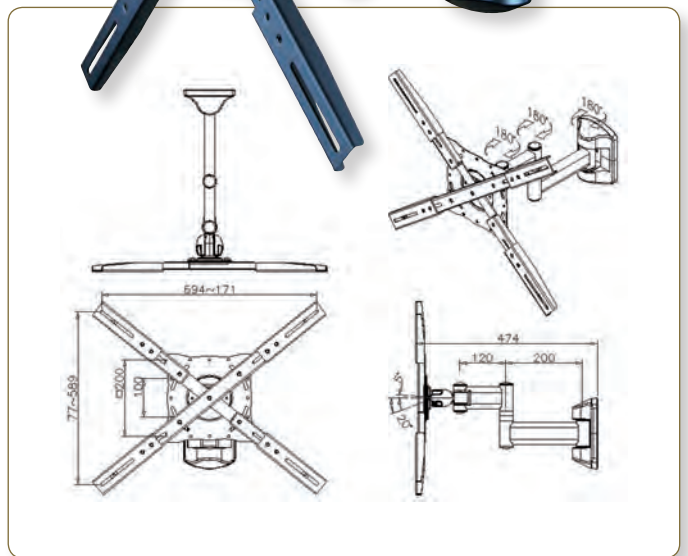

Order-No. – P.U.

ROLINE LCD/TV Wall Mount, 4 Joints

17.03.1168 – 2

**ROLINE LCD Monitor Wall Mount Kit (Slide)**

- Slide-in wall plate provides easy access for attachment and detachment
- 360° rotation allows portrait and landscape viewing
- Pivoting wall mount with pan motion
- Cable management system helps keep cables concealed and organized
- Integrated bubble level assures easy installation alignment

- VESA 75 (75 x 75 mm), VESA 100 (100 x 100 mm) fixation
- Freely tilting allows easy TV angle adjustment (-15° – +15°)
- Swiveling possibility offer maximum viewing flexibility

Technical data: 17.03.1188  
 Fixing: wall mount  
 Load capacity: 1-15 kg  
 Swivel: 180°  
 Tilttable up and down: 15°  
 Arm length: 25 cm



Order-No. – P.U.

ROLINE LCD Monitor Wall Mount Kit (Slide), 4 Joints

17.03.1188 – 5

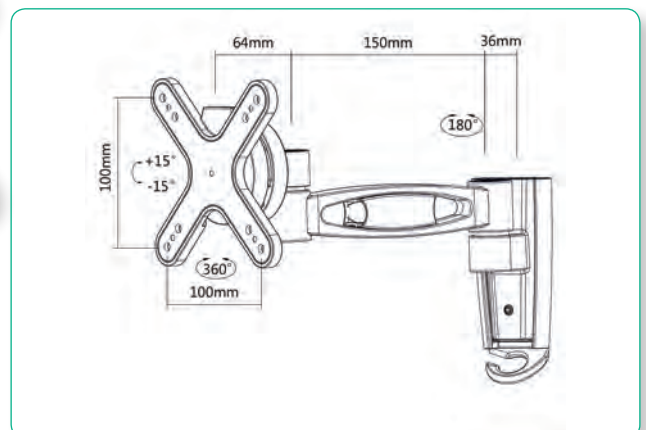



11.01.1xxx	03.13	11.04.5516	03.16	11.99.5521	03.15	12.04.1080	03.10	14.99.326x	02.02	17.03.1253	10.07	19.08.1009	05.02	21.15.0512	01.15	21.99.088x	01.17
11.01.3xxx	03.13	11.04.5518	03.26	11.99.5522	03.16	12.04.1081	03.10	14.99.332x	02.07	17.03.1260	10.09	19.08.101x	03.42	21.15.0515	01.18	21.99.089x	01.16
11.01.4xxx	03.13	11.04.5519	03.16	11.99.5525	03.15	12.04.1082	03.10	14.99.333x	02.06	17.03.1261	10.10	19.08.1022	03.43	21.15.0518	01.15	21.99.090x	01.21
11.01.5xxx	02.05	11.04.5521	03.15	11.99.5526	03.15	12.04.1085	02.11	14.99.334x	02.07	17.03.13xx	09.15	19.08.1028	03.42	21.15.0519	01.18	21.99.091x	01.21
11.01.56xx	03.14	11.04.5522	03.16	11.99.5527	03.16	12.04.1086	02.11	14.99.341x	06.05	17.05.xxxx	09.15	19.08.103x	03.42	21.15.0520	01.15	21.99.095x	01.21
11.01.58xx	03.14	11.04.5525	03.15	11.99.5531	03.17	12.04.1088	03.08	14.99.343x	06.03	17.99.1100	09.16	19.08.1110	03.43	21.15.0521	01.18	21.99.096x	01.22
11.01.59xx	03.13	11.04.5531	03.17	11.99.5532	03.16	12.04.1089	03.08	14.99.344x	03.37	17.99.1102	09.16	19.08.1111	03.43	21.15.0522	01.18	21.99.097x	01.22
11.01.60xx	03.13	11.04.5532	03.16	11.99.5534	03.16	12.04.1091	03.08	14.99.3442	06.14	17.99.1104	09.16	19.08.1118	03.42	21.15.0523	01.18	21.99.099x	01.16
11.01.62xx	03.13	11.04.5535	03.15	11.99.5535	03.15	12.04.1096	03.09	14.99.3451	06.06	17.99.1107	10.10	19.08.15xx	03.42	21.15.0524	01.18	21.99.10xx	01.21
11.01.65xx	03.14	11.04.554x	03.17	11.99.5536	03.16	12.04.1097	02.13	14.99.3452	06.06	17.99.1110	09.03	19.08.325x	05.09	21.15.0525	01.18	21.99.119x	01.06
11.01.66xx	03.14	11.04.5552	03.16	11.99.5537	03.16	12.04.11xx	03.09	14.99.3453	06.06	17.99.1119	09.11	19.08.327x	08.10	21.15.053x	01.18	21.99.119x	01.05
11.01.9xxx	03.13	11.04.5553	03.16	11.99.554x	03.17	12.99.00xx	01.40	14.99.3454	06.06	17.99.1120	09.03	19.11.1024	07.05	21.15.054x	01.18	21.99.1197	01.05
11.02.8307	03.06	11.04.5555	03.15	11.99.5552	03.16	12.99.101x	03.50	14.99.3456	03.49	17.99.1121	09.03	19.11.1025	07.05	21.15.055x	01.18	21.99.12xx	01.23
11.02.8309	03.08	11.04.5556	03.15	11.99.5553	03.16	12.99.103x	06.02	14.99.3459	06.07	17.99.1123	09.03	19.11.1026	07.05	21.15.056x	01.18	21.99.13xx	01.23
11.02.8310	03.04	11.04.5560	03.28	11.99.5555	03.15	12.99.1041	06.03	14.99.346x	06.04	17.99.1125	09.05	19.11.1027	07.06	21.15.059x	01.17	21.99.142x	01.24
11.02.8311	03.06	11.04.5561	03.28	11.99.5556	03.15	12.99.1049	03.46	14.99.348x	06.07	17.99.1126	09.05	19.11.1028	07.06	21.15.066x	01.18	21.99.143x	01.24
11.02.8312	03.08	11.04.5562	03.28	11.99.5557	03.16	12.99.105x	03.46	14.99.349x	06.07	17.99.1129	09.05	19.11.1029	07.05	21.15.07xx	01.20	21.99.144x	01.24
11.02.8313	03.08	11.04.5563	03.28	11.99.5558	03.16	12.99.107x	03.45	14.99.3501	06.08	17.99.1130	09.03	19.11.103x	07.06	21.15.082x	01.24	21.99.145x	01.24
11.02.8314	03.24	11.04.5564	03.28	11.99.556x	03.15	12.99.108x	03.08	14.99.3503	06.08	17.99.1131	09.05	19.11.109x	07.07	21.15.083x	01.24	21.99.146x	01.24
11.02.8317	03.06	11.04.5565	03.28	11.99.5571	03.17	12.99.1100	03.08	14.99.3506	06.09	17.99.1132	09.09	19.10.10xx	07.03	21.15.084x	01.24	21.99.147x	01.24
11.02.8318	03.06	11.04.5566	03.28	11.99.5574	03.17	12.99.1105	01.02	14.99.3507	06.09	17.99.1133	09.09	19.10.11xx	07.02	21.15.0850	01.24	21.99.148x	01.24
11.02.8319	03.24	11.04.5568	03.18	11.99.5575	03.17	12.99.1107	01.02	14.99.352x	06.08	17.99.1134	09.11	19.10.12xx	07.03	21.15.0851	01.30	21.99.149x	01.06
11.02.8321	03.05	11.04.5569	03.18	11.99.5576	03.17	12.99.1108	01.02	14.99.354x	06.10	17.99.1136	09.09	19.10.2xxx	07.02	21.15.0852	01.30	21.99.15xx	01.21
11.02.8322	03.05	11.04.557x	03.16	11.99.5577	03.17	12.99.1109	02.14	14.99.356x	06.12	17.99.1137	09.11	19.10.2xxx	07.02	21.15.0853	01.30	21.99.162x	01.12
11.02.8324	03.05	11.04.5580	03.18	11.99.5578	03.18	12.99.1110	03.08	14.99.357x	06.11	17.99.1139	09.11	19.09.010x	04.07	21.15.0854	01.30	21.99.168x	01.16
11.02.8325	03.05	11.04.5581	03.18	11.99.5579	03.18	12.99.1111	03.08	14.99.358x	06.10	17.99.1140	09.13	19.09.0114	04.07	21.15.0855	01.30	21.99.19xx	01.25
11.02.8326	03.05	11.04.5584	03.18	11.99.558x	03.18	12.99.1115	01.02	14.99.359x	06.13	17.99.1141	09.03	19.09.0115	04.08	21.15.087x	01.30	21.99.300x	01.39
11.02.8327	03.07	11.04.5586	03.18	11.99.559x	03.15	12.99.112x	03.09	14.99.501x	02.11	17.99.1142	10.05	19.09.0116	04.08	21.15.088x	01.17	21.99.304x	01.39
11.02.8329	03.05	11.04.5588	03.17	11.99.5601	03.20	12.99.113x	03.34	14.99.503x	02.10	17.99.1143	10.04	19.09.0117	04.08	21.15.089x	01.16	21.99.3048	01.40
11.02.870x	03.05	11.04.5591	03.18	11.99.5602	03.20	12.99.115x	03.45	14.99.504x	02.13	17.99.1144	10.03	19.09.101x	03.42	21.15.092x	01.22	21.99.3049	01.40
11.02.871x	03.05	11.04.5592	03.18	11.99.5603	03.20	12.99.1160	03.47	15.06.00xx	03.49	17.99.1145	09.10	19.09.1022	03.43	21.15.093x	01.22	21.99.305x	01.39
11.02.872x	03.06	11.04.5593	03.18	11.99.5604	03.20	12.99.1161	03.46	15.06.0500	03.50	17.99.1147	09.10	19.09.1028	03.42	21.15.094x	01.22	21.99.306x	01.39
11.02.873x	03.05	11.04.5594	03.18	11.99.5605	03.20	12.99.1131	03.30	15.06.0501	03.50	17.99.1148	10.04	19.09.103x	07.04	21.15.095x	01.22	21.99.870x	01.41
11.02.875x	03.04	11.04.5595	03.18	11.99.5608	03.22	12.99.3114	03.30	15.06.0502	03.50	17.99.1149	10.05	19.09.104x	07.04	21.15.096x	01.26	21.99.871x	01.41
11.02.8760	03.04	11.04.5595	03.15	11.99.559x	03.15	12.99.3115	03.30	15.06.0503	03.49	17.99.1150	05.09	19.09.105x	05.08	21.15.097x	01.26	21.99.872x	01.41
11.02.8760	03.04	11.04.5596	03.18	11.99.561x	03.22	12.99.3116	03.30	15.06.2113	04.02	17.99.1151	05.09	19.09.1061	05.09	21.15.099x	01.16	21.99.875x	01.42
11.02.8761	03.04	11.04.5598	03.15	11.99.562x	03.20	12.99.3117	03.32	15.06.2117	04.02	17.99.1152	05.09	19.09.1065	05.08	21.15.13xx	01.24	21.99.876x	01.42
11.02.8762	03.04	11.04.5599	03.15	11.99.563x	03.21	12.99.3118	03.32	15.06.2119	04.04	17.99.1153	09.18	19.09.1064	05.08	21.15.14xx	01.24	21.99.877x	01.42
11.02.8763	03.04	11.04.5600	03.20	11.99.568x	03.19	12.99.3119	03.32	15.06.213x	04.03	17.99.1154	10.02	19.09.1065	07.04	21.15.15xx	01.22	21.99.879x	01.43
11.02.8765	03.06	11.04.561x	03.22	11.99.570x	03.17	12.99.312x	03.30	15.06.214x	04.02	17.99.1155	09.09	19.09.1066	07.04	21.15.160x	01.22	25.16.838x	01.37
11.02.877x	03.06	11.04.562x	03.20	11.99.571x	03.17	12.99.313x	03.30	15.06.217x	04.03	17.99.1156	10.04	19.09.1067	07.04	21.15.166x	01.16	25.16.892x	01.38
11.02.878x	03.07	11.04.5634	03.21	11.99.572x	03.17	12.99.314x	03.30	15.06.2192	04.03	17.99.1157	10.04	19.09.1068	07.04	21.15.17xx	01.16	25.16.893x	01.38
11.02.879x	03.24	11.04.5635	03.21	11.99.573x	03.17	12.99.3150	03.30	15.06.2193	04.04	17.99.1158	10.10	19.09.1069	05.08	21.15.185x	01.31	25.16.894x	01.38
11.02.8802	03.24	11.04.5636	03.21	11.99.574x	03.17	12.99.3151	03.30	15.06.2194	04.04	17.99.1159	09.17	19.09.107x	07.04	21.15.186x	01.31	25.16.895x	01.38
11.02.8803	03.24	11.04.5637	03.21	11.99.575x	03.17	12.99.3152	03.30	15.08.130x	06.15	17.99.1160	09.10	19.09.111x	03.42	21.15.188x	01.16	25.16.898x	01.37
11.02.8805	03.24	11.04.5638	03.21	11.99.576x	03.20	12.99.3153	03.32	15.08.135x	06.16	17.99.1161	09.10	19.09.116x	07.10	21.15.21xx	01.26	25.16.899x	01.37
11.02.8808	03.04	11.04.5639	03.26	11.99.577x	03.23	12.99.3154	03.32	15.08.15xx	06.15	17.99.1162	09.10	19.09.117x	07.10	21.15.24xx	01.27	25.16.840x	01.37
11.02.881x	03.04	11.04.5640	03.22	11.99.578x	03.23	12.99.319x	03.12	15.08.624x	04.05	17.99.1163	09.09	19.09.14xx	03.43	21.15.25xx	01.28	25.16.844x	01.38
11.02.882x	03.24	11.04.5641	03.22	11.99.579x	03.23	12.99.32xx	03.34	15.08.6250	04.05	17.99.1164	10.08	19.09.15xx	03.42	21.15.26xx	01.28	25.16.848x	01.37
11.02.883x	03.04	11.04.5644	03.26	11.99.581x	03.21	13.01.333x	08.03	15.08.6257	04.04	17.99.1165	10.08	19.09.2xxx	03.43	21.15.27xx	01.29	25.16.847x	01.37
11.02.8845	03.04	11.04.5645	03.26	11.99.582x	03.33	13.01.334x	08.03	15.08.6258	04.05	17.99.1166	10.03	19.09.30xx	05.10	21.15.28xx	01.29	25.16.849x	01.37
11.02.8849	02.12	11.04.5646	03.26	11.99.583x	03.33	13.01.337x	08.03	15.08.6259	04.05	17.99.1174	09.12	19.09.3230	07.05	21.15.290x	01.28	25.16.849x	01.38
11.02.8867	03.04	11.04.5647	03.26	11.99.584x	03.33	13.01.338x	08.02	15.09.19xx	06.15	17.99.1177	09.18	19.09.3237	09.19	21.15.291x	01.28	25.16.849x	01.38
11.02.8868	03.04	11.04.5648	03.26	11.99.59xx	03.20	13.99.3001	08.02	15.99.2xxx	04.02	17.99.1179	09.19	19.09.3235	08.10	21.15.292x	01.29	25.16.849x	

<b>A</b>	
Adapters	
• Display	6.02 - 6.05
• DisplayPort	3.27, 3.30 - 3.35
• DVI	3.27, 3.30 - 3.35
• Fiber Optic	1.46 - 1.48
• HDD/SSD	4.06 - 4.07
• HDMI	3.27, 3.30 - 3.36, 5.06 - 5.07, 6.02 - 6.03
• Housing	4.06 - 4.08
• Keyboard	3.45
• Mouse	3.45
• PCI, PCI-Express	4.02 - 4.04
• RS232/RS485	3.44 - 3.49
• USB Type C	2.14, 3.33 - 3.36, 3.46 - 3.47, 4.04 - 4.06, 5.02 - 5.06
• USB	5.02 - 5.03
• VGA	3.27, 3.30 - 3.32, 3.34 - 3.35
AOC Fibre cables (HDMI, DisplayPort)	6.07
AT Modem Cables	3.13
AT Printer Cables	3.13
Audio Converters / Extractors	6.14 - 6.15
A/V Audio Video Modules	6.16
<b>B</b>	
Barcode Scanner	4.09
Batteries for UPS	7.02
Boxes for wall mount/flush mount	1.37 - 1.38
<b>C</b>	
Cabinets 19"	1.50
Cable Overview	3.02 - 3.03
Cables	
• Assembly	1.15
• 9-pole / 25-pole	3.13
• Cinch	3.37 - 3.38, 6.15
• Cover/Tunnel	8.10
• DisplayPort	3.20 - 3.23, 3.26
• DVI	3.15 - 3.16, 3.22, 3.26
• Fibre Optic	1.41 - 1.46
• Fibre Optic (HDMI, DisplayPort)	6.07
• FTP	1.15, 1.19, 1.12, 1.25 - 1.26
• HDMI (HD/UHD)	3.16 - 3.20, 3.23, 3.27 - 3.29, 6.05 - 6.07
• Keyboard/Mouse	3.45
• Monitor Connection	3.14 - 3.23, 3.26 - 3.36
• Power Connection/Extension/Supply	3.42 - 3.43, 7.04 - 7.07, 7.09 - 7.10
• Printer	3.13
• RJ-12/RJ-45	3.43 - 3.44
• RS232	3.13, 3.45 - 3.48
• SAS/SATA	3.38 - 3.40
• S/FTP	1.15 - 1.17, 1.20, 1.23 - 1.31
• Toslink	3.38, 6.14
• USB	3.04 - 3.12
• UTP	1.15 - 1.18, 1.21 - 1.22, 1.24 - 1.29
• VGA	3.14 - 3.15
Cable Testers	8.02 - 8.03
Cable Ties/Clips	5.09, 8.10
Cameras Dummies	1.11
Cards	
• CardBus	4.02
• Parallel	4.02
• PCI	4.02
• PCI-Express	4.02 - 4.04
• Serial	4.02
• USB Type C	4.02
Card Readers USB / Smartphone / Tablet	2.14, 4.04 - 4.05, 5.05 - 5.06
Cases	
• Hard Disk Drives	4.06 - 4.07
• Industrial Rack-Mount	4.07 - 4.08
Centronics Cables	3.13, 3.45
Cleaning Sets	9.21 - 9.22
<b>COMPUTER CABLES, CONNECTORS, ADAPTERS</b>	<b>3.02 - 3.38</b>
Connector Casings	3.44
Connectors	
• D-SUB	3.13, 3.44, 3.49, 4.02
• Modular	1.39, 3.44
Converters	
• Fast- / Gigabit Ethernet	1.02, 5.02
• Parallel/Serial	3.45 - 3.50
• RJ-45/Fibre	1.04 - 1.05, 1.09 - 1.10
• RS232/RS485	3.45 - 3.50
• USB/DVI/VGA/HDMI/DP	6.02 - 6.03
• USB/SATA	3.46
• USB/Serial	3.45 - 3.48
Crimping Pliers/Tools	8.04 - 8.10
Crossover Cables, Adapter	1.19
<b>D</b>	
Design Secure UPS	7.03
Device Server	3.49 - 3.50
Docking Station HDD	4.06 - 4.07
Docking Station Notebook	3.36, 5.06 - 5.07
Display Adapters / Cables	New4, 3.14 - 3.23, 3.26 - 3.36
DisplayPort	
• Cables	3.20 - 3.23, 3.26, 6.07
• Extenders	6.05
• KVM	New3, 2.07
Display Stands / Digital Signage	10.08 - 10.10
DVI	
• Adapters	3.27, 3.30 - 3.35
• Cables	3.15 - 3.16
• Extender	6.03
• Video Splitter	6.08 - 6.09
<b>E</b>	
Earphones / Headsets	6.15 - 6.16
EMC Ferrite Cores	3.44
Enclosures HDD	4.06
Ethernet	
• Patch Cords	1.18 - 1.31
• Switches	1.03 - 1.05, 1.07 - 1.09
Extensions	
• Mouse / Keyboard Cables	3.45
• USB	3.04, 3.07 - 3.12
<b>F</b>	
Fast Ethernet	
• Converters	1.02, 1.04
• Switches	1.03 - 1.05
Ferrite Cores	3.44
Field plugs	New2, 1.36
Flat/Slim Patch Cables	1.22, 1.25 - 1.26
FTP Cables	1.15, 1.19, 1.12, 1.25 - 1.26
HDD/SSD Adapters	4.06 - 4.07
FO Adapters	1.46 - 1.48
Fibre Optic Jumper Cables	1.41 - 1.46, New2
Fibre/RJ-45 Converter	1.04 - 1.05
Fibre Optic Accessories	1.46, 8.06
<b>G</b>	
Gender Changers	3.44
Gigabit Ethernet	
• Converters	1.02, 3.36, 5.06 - 5.07
• Switches	1.03 - 1.04, 1.07 - 1.09
<b>H</b>	
Hard Disk	
• Enclosures / Housings	4.06 - 4.07
• Mounting Adapters	4.07
Headphones/Earsets	6.15 - 6.16
HDMI	
• Adapters	3.27, 3.30 - 3.36
• Cables	New3, 3.16 - 3.20, 3.23, 3.27 - 3.29, 6.05 - 6.07
• Extenders	6.04 - 6.05
• Switch	6.10 - 6.13
Holder for iPad / Ebook / Tablet / Smartphones	5.08 - 5.10
Hubs USB	1.02, 2.11 - 2.14
<b>I</b>	
I/O Cards	4.02
Industrial products	New5, 1.07 - 1.10, 4.07 - 4.08
<b>J</b>	
Junction Boxes	1.40
<b>K</b>	
Keyboard	
• Adapters / Cables	3.45
Keypad	4.09
KVM	
• Consoles	1.49, 2.04 - 2.05
• Extension over IP/TP	2.07 - 2.10
• Switch "Desktop"	2.03, 2.06 - 2.07
• Switch 19"	2.03 - 2.05
• Switch LCD	2.04 - 2.05
• Switch „Star“	2.02
Keystones	1.34 - 1.36, 1.38 - 1.40

<b>L</b>	
LAN Cables.....	1.15 - 1.17
LCD Monitor Arms.....	9.04 - 9.13, 9.19
LCD Consoles, KVM.....	1.49, 2.04 - 2.05
Line Secure.....	7.02
Link Cables, USB.....	3.45 - 3.48

<b>M</b>	
Measuring Instruments.....	8.02 - 8.03
Microphones / Headsets.....	6.15 - 6.16
<b>MOBILE COMPUTING.....</b>	<b>5.02 - 5.10</b>
Mobile Racks HDD.....	4.07 - 4.08
Modem Cables.....	3.13
Modular	
• Connectors.....	3.44
• Couplers.....	1.39
Monitor	
• Arms.....	9.04 - 9.13
• Cleaning Tissues.....	9.22
• Connection Cables.....	3.14 - 3.23, 3.26 - 3.29, 3.33
• Power Cables.....	3.42 - 3.43, 7.09 - 7.10
Mouses.....	4.10
• Adapters PS/2, USB.....	3.45
• Cables.....	3.14
• Mouse Pads.....	4.10, 9.02
Mount Boxes.....	1.36 - 1.38
MPO Cabling System.....	1.48
<b>MULTIMEDIA.....</b>	<b>6.02 - 6.16</b>

<b>N</b>	
<b>NETWORK COMPONENTS/CABLES.....</b>	<b>1.02 - 1.50</b>
News Shop.....	New2 - New8
Network	
• Cabinets.....	1.50
• Cameras.....	1.11
• Cable Testers.....	8.02 - 8.03
• Switches.....	1.03 - 1.05, 1.07 - 1.09
• Tools.....	8.04 - 8.10
Notebook	
• Cleaning.....	9.21 - 9.22
• Security Locks.....	5.10
• USB Traveler Kit.....	5.08 - 5.09, 7.07 - 7.08

<b>O</b>	
<b>OFFICE EQUIPMENT / CONSUMABLES.....</b>	<b>9.02 - 9.22</b>
Optical Fibre Patch Cables.....	1.34 - 1.36, 1.38
• Cables OM3.....	1.41
• Cables OM4.....	1.42 - 1.45
• Cables OM5.....	1.43
• Cables OS2.....	1.44 - 1.46

<b>P</b>	
Parallel	
• Cables.....	3.13
• I/O Cards.....	4.02
Patch	
• Panels.....	1.32 - 1.35
• Cables / Cords.....	1.18 - 1.31
PC	
• Stands / Holders.....	9.12 - 9.15
PDU's.....	New6, 7.06
<b>PERIPHERAL DEVICES.....</b>	<b>4.02 - 4.10</b>
PoE	
• Injectors.....	1.06
• Splitters.....	1.07
• Switches.....	1.05 - 1.07
Power	
• Cables.....	3.42 - 3.43, 7.09 - 7.10
• Chargers.....	7.05 - 7.08
Printer	
• Cables.....	3.13
• Switchboxes.....	2.10 - 2.11
• Tables.....	9.20 - 9.21
Pro Secure UPS.....	7.03

<b>R</b>	
RS232	
• Adapters.....	3.48
• Cables.....	3.13
• Converters.....	1.09, 3.46 - 3.50
• Extenders / RS485 Converters.....	3.49

<b>S</b>	
SAS Cables.....	3.38 - 3.40
SATA	
• Cables.....	3.38 - 3.40
• HDD Enclosures / Housings / Mobile Racks.....	4.06 - 4.08
Scanner Barcode.....	4.09
Security Locks.....	5.10
Sell Off.....	A.02 - A.08
Serial Cables.....	3.13
Serial Cards.....	4.02
Service Kits.....	8.04, 8.06 - 8.10
S/FTP Cables.....	1.15 - 1.17, 1.20, 1.23 - 1.31
Splitters.....	6.08 - 6.12
Stand for Smartphones / Tablets.....	5.08 - 5.10
<b>SWITCHBOXES.....</b>	<b>2.02 - 2.14</b>
Switches	
• Fast Ethernet/Gigabit Ethernet.....	1.03 - 1.05, 1.07 - 1.09
• HDMI.....	6.10 - 6.13

<b>T</b>	
Tablet	
• Stand.....	5.09 - 5.10
T-Adapters.....	1.39
<b>TEST, MEASUREMENT, TOOLS.....</b>	<b>8.02 - 8.10</b>
TP Cables Overview.....	1.12 - 1.13
Tool Kits.....	8.04, 8.06 - 8.10
<b>TV HOLDERS / FURNITURES.....</b>	<b>10.02 - 10.11</b>

<b>U</b>	
Universal Power Adapter.....	5.09, 7.07 - 7.08
<b>UPS SYSTEMS / POWER DISTRIBUTION.....</b>	<b>7.02 - 7.10</b>
UPS.....	7.02 - 7.03
USB	
• Adapters.....	3.05, 3.08, 3.12
• Cables.....	3.04 - 3.12, 3.24 - 3.25, 3.33
• Card Readers.....	2.14, 3.36
• Display Adapter.....	3.32, 3.34 - 3.36
• Extenders.....	3.08 - 3.10
• Gender Changers.....	3.44, 5.03
• Hubs.....	2.11 - 2.14, 5.02, 5.05
• Link Cables.....	3.45 - 3.48
• Power Chargers.....	5.08, 7.04 - 7.08
• Switchboxes.....	2.10 - 2.11
UTP Cables.....	1.15 - 1.18, 1.21 - 1.22, 1.24 - 1.29, 5.02

<b>V</b>	
VGA	
• Adapters.....	3.27, 3.30 - 3.32, 3.34 - 3.35
• Cables.....	3.14 - 3.15, 3.33
• Extender over TP.....	6.03
• Extension Cables.....	3.14
Video	
• Extenders.....	6.03 - 6.07
• A/V Modules.....	6.16
• Splitters.....	6.08 - 6.11
• Switches.....	6.10 - 6.13
VESA Adapter.....	9.03

<b>W</b>	
Wall Mounts.....	9.04 - 9.08, 9.11, 10.02 - 10.07
Wall Mount Boxes.....	1.36 - 1.38
Wall Mount Cabinets.....	1.50
Wrist Rests.....	9.02
Wireless HDMI Audio/Video System.....	6.05
Wireless Charger.....	New6
Workstation.....	9.11 - 9.13, 9.18, 9.20 - 9.21

<b>Y</b>	
Y- Power Cables.....	3.43





# General Conditions of Sale and Supply

## 1. General

1.1 A contract is considered to be concluded with a written quotation, an order confirmation or when the goods are despatched and invoiced by SECOMP International. By accepting the delivery, the customer agrees to the conditions of SECOMP International. Divergent conditions have to be stipulated in writing.

1.2 Orders shall only become binding upon SECOMP International after it has issued a written confirmation of order.

1.3 SECOMP International - reserves the right to amend typing errors/mistakes to price lists and technical data at any time.

## 2. Prices

Prices shall be deemed net plus V.A.T., transportation and packaging charges, provided that alternative conditions have not already been agreed. SECOMP International however hereby reserves the right to make price adjustments to cover definite increases in costs for example Goods and Material.

## 3. Delivery period

The delivery period shall be the date in the contract of sale and will be extended should difficulties arise that may have been caused by an act of god such as war, epidemics and among other things storm and tempest.

## 4. Despatch

All deliveries shall be effected for the account and the risk of the customer. Any complaints concerning damage, loss or delay are to be reported to SECOMP International within 8 days of the receipt of the consignment. But complaints concerning any faulty packaging shall be rendered on the same day as the receipt of the consignment.

## 5. Works deliveries

Should the consignment and invoicing be directly affected by the suppliers of SECOMP International, the conditions of sale and supply of that particular supplier shall be valid for customers in res-

pect of that particular contract. In such cases, these present conditions of sale and supply shall have no validity and damage indemnity claims or claims of any other nature cannot be made enforceable against SECOMP International hereunder.

## 6. Return of goods and materials

The return of goods and materials shall require the written permission of SECOMP International and may only be effected if the goods and materials are in re-sellable condition and still in their original packaging, and only then if such are usually maintained in stock by SECOMP International. A copy of the delivery note or the invoice must be enclosed. Returns without either a copy of the delivery note or the invoice will not be accepted. An appropriate surcharge will be applied by SECOMP International on the purchaser to defray the cost of any inconvenience caused.

## 7. Settlement

Invoices are to be settled within 30 days net without any deductions. Purchasers will be charged the usual bank overdraft rate of interest in respect of overdue payments.

## 8. Retention of ownership rights

All goods and materials supplied shall remain the property of SECOMP International until full payment of the debited invoice amount has been received.

## 9. Warranty

SECOMP International will grant a warranty for products for a period of 24 months for the ROLINE brand and 12 months for all others products from the date of delivery in respect of any evidenced faulty workmanship and materials. Should a delivered consignment prove to be contrary to contract upon inspection, the customer shall grant SECOMP International the opportunity hereunder of removing the fault or else the customer may demand replacement. Should the supply or delivery of any improvement or replacement not prove possible, the customer may choose between having the purchase

price reduced or in demanding the contract of sale to be rescinded (conversion).

Damage resulting from natural wear and tear, an act of God or non compliance with the operating instructions shall be excluded from the warranty as well as mechanical interference by the customer or by third parties with products of SECOMP International without its written permission. No liability will be accepted for defects, damage or injury caused due to installation not carried out in accordance with the manufacturer's installation instructions.

## 10. Data Protection

10.1 For a fast and correct handling of your order there will be saved data in our IT – system. The processing of the delivered data is done following the EU-GDPR and the tele-media law.

10.2 In the scope of the credit check and the credit monitoring we are exchanging data with a credit agency.

## 11. Cancellation

Cancellation of orders shall only be possible hereunder with the written approval of SECOMP International. Any costs which have already been incurred or price increases as a result of reduction in amounts ordered shall be for the account of the purchaser. Partial supplies of an order contracted upon call shall be claimed within the agreed supply and delivery periods otherwise SECOMP International may cause the relative consignment and invoice billing therefore to be made.

## 12. Place of jurisdiction

The place of jurisdiction shall be Zürich. Legal relationship hereunder shall be subject to Swiss Law.



## OFFICE

### SECOMP International

Grindelstrasse 6  
8303 Bassersdorf  
Switzerland

PHONE +41 44 511 87 62  
FAX +41 44 511 87 07  
E-MAIL [info@secomp-international.com](mailto:info@secomp-international.com)

[www.secomp-international.com](http://www.secomp-international.com)



## WAREHOUSE

### SECOMP International

Einsteinstrasse 17 - 23  
76275 Ettlingen  
Germany



### SECOMP Germany

Einsteinstrasse 17 - 23  
76275 Ettlingen  
Germany

PHONE +49 7243 383 111  
FAX +49 7243 383 222  
E-MAIL [info@secomp.de](mailto:info@secomp.de)

[www.secomp.de](http://www.secomp.de)



### SECOMP Switzerland

Grindelstrasse 6  
8303 Bassersdorf  
Switzerland

PHONE +41 44 511 87 00  
FAX +41 44 511 87 05  
E-MAIL [info@secomp.ch](mailto:info@secomp.ch)

[www.secomp.ch](http://www.secomp.ch)



### SECOMP France

10, avenue Graham Bell, Bâtiment H Lot B4  
77600 Bussy-Saint-Georges  
France

PHONE +33 164 80 92 30  
FAX +33 164 80 92 40  
E-MAIL [info@secomp.fr](mailto:info@secomp.fr)

[www.secomp.fr](http://www.secomp.fr)



### SECOMP Netherlands

Christiaan Huygensweg 38 H  
3225 LD Hellevoetsluis  
Netherlands

PHONE +31 181 390 030  
FAX +31 181 399 721  
E-MAIL [info@secomp.nl](mailto:info@secomp.nl)

[www.secomp.nl](http://www.secomp.nl)



### SECOMP Czechia

U Vinných sklepů 7  
190 00 Praha 9 - Vysočany  
Czech Republic

PHONE +420 281 861 849  
FAX +420 281 862 729  
E-MAIL [info@secomp.cz](mailto:info@secomp.cz)

[www.secomp.cz](http://www.secomp.cz)