

Programming Guide

ZPL II
ZBI 2
Set-Get-Do
Mirror
WML



ZEBRA

ZEBRA and the stylized Zebra head are trademarks of Zebra Technologies Corporation, registered in many jurisdictions worldwide. All other trademarks are the property of their respective owners.
© 2019 Zebra Technologies Corporation and/or its affiliates. All rights reserved.

Information in this document is subject to change without notice. The software described in this document is furnished under a license agreement or nondisclosure agreement. The software may be used or copied only in accordance with the terms of those agreements.

For further information regarding legal and proprietary statements, please go to:

SOFTWARE: <http://www.zebra.com/linkoslegal>

COPYRIGHTS: <http://www.zebra.com/copyright>

WARRANTY: <http://www.zebra.com/warranty>

END USER LICENSE AGREEMENT: <http://www.zebra.com/eula>

Terms of Use

Proprietary Statement

This manual contains proprietary information of Zebra Technologies Corporation and its subsidiaries (“Zebra Technologies”). It is intended solely for the information and use of parties operating and maintaining the equipment described herein. Such proprietary information may not be used, reproduced, or disclosed to any other parties for any other purpose without the express, written permission of Zebra Technologies.

Product Improvements

Continuous improvement of products is a policy of Zebra Technologies. All specifications and designs are subject to change without notice.

Liability Disclaimer

Zebra Technologies takes steps to ensure that its published Engineering specifications and manuals are correct; however, errors do occur. Zebra Technologies reserves the right to correct any such errors and disclaims liability resulting therefrom.

Limitation of Liability

In no event shall Zebra Technologies or anyone else involved in the creation, production, or delivery of the accompanying product (including hardware and software) be liable for any damages whatsoever (including, without limitation, consequential damages including loss of business profits, business interruption, or loss of business information) arising out of the use of, the results of use of, or inability to use such product, even if Zebra Technologies has been advised of the possibility of such damages. Some jurisdictions do not allow the exclusion or limitation of incidental or consequential damages, so the above limitation or exclusion may not apply to you.

Publication Date

August 26, 2019

Contents

Terms of Use	2
Publication Date	2
Introduction	32
Firmware	32
Who Should Use This Document	32
ZPL Commands	33
How Commands Are Documented	33
Basic ZPL Exercises and Examples	34
Allowed Characters in File Names	44
^A	45
^A@	47
^B0	49
^B1	51
^B2	53
^B3	55
^B4	59
^B5	63
^B7	64
^B8	68
^B9	70
^BA	72
^BB	76
^BC	80
^BD	93
^BE	96
^BF	98
^BI	100
^BJ	102

Contents

^BK	104
^BL	106
^BM	107
^BO	109
^BP	111
^BQ	113
^BR	121
^BS	123
^BT	126
^BU	128
^BX	130
^BY	134
^BZ	135
^CC ~CC	137
^CD ~CD	138
^CF	139
^CI	140
^CM	143
^CN	145
^CO	146
^CP	148
^CT ~CT	149
^CV	150
^CW	152
~DB	154
~DE	156
^DF	157
~DG	158
~DN	160
~DS	161
~DT	162
~DU	163
~DY	164
~EG	168
^FB	169
^FC	171
^FD	172
^FH	173
^FL	175
^FM	177
^FN	180

Contents

^FO	181
^FP	182
^FR	183
^FS	184
^FT	185
^FV	187
^FW	188
^FX	189
^GB	190
^GC	192
^GD	193
^GE	194
^GF	195
^GS	197
~HB	198
~HD	199
^HF	200
^HG	201
^HH	202
~HI	203
~HM	204
~HQ	205
~HS	212
^HT	215
~HU	216
^HV	217
^HW	218
^HY	220
^HZ	221
^ID	223
^IL	225
^IM	226
^IS	227
~JA	229
^JB	230
~JB	231
~JC	232
~JD	233
~JE	234
~JF	235
~JG	236

Contents

^JH	237
^JI	240
~JI	241
^JJ	242
~JL	244
^JM	245
~JN	246
~JO	247
~JP	248
~JQ	249
~JR	250
^JS	251
~JS	252
^JT	253
^JU	254
^JW	255
~JX	256
^JZ	257
~KB	258
^KD	259
^KL	260
^KN	261
^KP	263
^KV	264
^LF	268
^LH	269
^LL	270
^LR	271
^LS	272
^LT	273
^MA	274
^MC	276
^MD	277
^MF	278
^MI	279
^ML	280
^MM	281
^MN	283
^MP	284
^MT	286
^MU	287

Contents

^MW	288
^NC	289
~NC	290
^ND	291
^NI	293
~NR	294
^NS	295
~NT	296
^PA	297
^PF	298
^PH ~PH	299
~PL	300
^PM	301
~PM	302
^PN	303
^PO	304
^PP ~PP	305
^PQ	306
~PR	307
^PR	308
~PS	310
^PW	311
~RO	312
^SC	313
~SD	314
^SE	315
^SF	316
^SI	319
^SL	320
^SN	322
^SO	324
^SP	325
^SQ	326
^SR	328
^SS	329
^ST	330
^SX	331
^SZ	333
~TA	334
^TB	335
^TO	336

Contents

~WC	338
^WD	339
~WQ	341
^XA	347
^XB	348
^XF	349
^XG	350
^XS	351
^XZ	352
^ZZ	353
ZPL RFID Commands	354
RFID Command Overview	355
Printer and Firmware Compatibility	355
^HL or ~HL	363
^HR	365
^RA	373
^RB	374
^RE	376
^RF	377
^RI	381
^RL	382
^RM	384
^RN	385
^RQ	386
^RR	387
^RS	389
^RT	396
^RU	398
~RV	400
^RW	401
^RZ	405
^WF	407
^WT	408
^WV	410
ZPL Wireless Commands	411
^KC	412
^NB	413
^NN	414

Contents

^NP	415
^NT	416
^NW	417
^WA	418
^WE	419
^WL	421
~WL	422
^WP	423
^WR	424
~WR	425
^WS	426
^WX	428
ZBI Commands	436
Introduction to Zebra Basic Interpreter (ZBI)	436
REM	441
CTRL-C	449
DEBUG	451
LET	460
Control and Flow	466
EXIT	471
CLOSE	474
SERVERSOCKET	475
CLIENTSOCKET	476
LOAD	495
DELETE	496
ISERROR	513
ISWARNING	513
CLRERR	515
AUXPORT_GETPIN	519
AUXPORT_RELEASEPIN	519
LCASE\$	520
LTRIM\$	521
RTRIM\$	522
UCASE\$	525
ORD	527
LEN	528
STR\$	529
MIN	530
MOD	531
DATE\$	543

DATE	544
TIME	544
SETVAR	545
SGD Printer Commands	561
Overview	562
Command Structure	562
JSON (JavaScript Object Notation)	564
alerts.add	567
alerts.conditions	569
alerts.configured	570
alerts.destinations	571
alerts.http.authentication.add	572
alerts.http.authentication.entries	574
alerts.http.authentication.remove	575
alerts.http.logging.clear	576
alerts.http.logging.entries	577
alerts.http.logging.max_entries	578
alerts.http.proxy	580
alerts.tracked_settings.clear_log	582
alerts.tracked_settings.log_tracked	583
alerts.tracked_settings.max_log_entries	584
alerts.tracked_sgds.log	585
alerts.tracked_sgds.max_log_entries	586
alerts.tracked_sgds.zbi_notified	587
apl.enable	588
apl.framework_version	589
apl.version	590
appl.link_os_version	591
appl.option_board_version	592
appl.bootblock	593
appl.date	594
appl.name	595
capture.channel1.count	596
capture.channel1.data.mime	597
capture.channel1.data.raw	598
capture.channel1.delimiter	599
capture.channel1.max_length	600
capture.channel1.port	601
CISDFCRC16	602
comm.baud	604

Contents

comm.halt	605
comm.pnp_option	606
comm.type	607
comm.parity	608
comm.stop_bits	609
cradle.comm.baud	610
cradle.comm.handshake	611
cutter.clean_cutter	612
device.allow_firmware_downloads	613
device.applicator.data_ready	614
device.applicator.end_print	615
device.applicator.feed	616
device.applicator.media_out	617
device.applicator.pause	618
device.applicator.reprint	619
device.applicator.rfid_void	620
device.applicator.ribbon_low	621
device.applicator.ribbon_out	622
device.applicator.service_required	623
device.applicator.start_print	624
device.bluetooth_installed	625
device.command_override.active	626
device.command_override.add	627
device.command_override.clear	628
device.command_override.list	629
device.company_contact	630
device.configuration_number	631
device.cpcl_synchronous_mode	632
device.cutter_installed	633
device.download_connection_timeout	634
device.epl_legacy_mode	635
device.feature.bluetooth_le	637
device.feature.mcr	638
device.feature.nfc	639
device.feature.ribbon_cartridge	640
device.feature.802_11ac	641
device.feature.head_element_test	642
device.friendly_name	643
device.frontpanel.feedenabled	644
device.frontpanel.key_press	645
device.frontpanel.line1	647

Contents

device.frontpanel.line2	648
device.frontpanel.xml	649
device.host_identification	650
device.host_status	651
device.idle_display_format	654
device.idle_display_value	655
device.internal_wired_setting_location	656
device.jobs_print	657
device.job_log.total_jobs_logged	658
device.languages	659
device.light.cover_open_brightness	660
device.light.head_open_brightness	661
device.location	662
device.loader_version	663
device.ltu_installed	664
device.orientation	665
device.pause	666
device.pnp_option	667
device.pmcu.revision	668
device.position.accuracy	669
device.position.altitude	670
device.position.latitude	671
device.position.longitude	672
device.print_2key	673
device.print_reprogram_2key	674
device.printhead.test.summary	675
device.printhead.odometer	676
device.printhead.test.detail	677
device.product_name_submodel	678
device.prompted_network_reset	679
device.prompted_default_network	680
device.prompted_reset	681
device.protected_mode	682
device.reset	683
device.restore_defaults	684
device.rewinder_installed	685
device.save_2key	686
device.sensor_select	687
device.sensor_profile	688
device.serial_number.option_board_date	689
device.serial_numbers.control_panel_date	690

Contents

device.serial_numbers.mlb_date	691
device.serial_numbers.processor	692
device.serial_numbers.applicator_option_board_date	693
device.serial_numbers.wired_ethernet_option_board	694
device.serial_numbers.wired_ethernet_option_board_date	695
device.serial_numbers.applicator_option_board	696
device.serial_numbers.cutter	697
device.serial_numbers.cutter_date	698
device.serial_numbers.printhead	699
device.serial_numbers.printhead_date	700
device.serial_numbers.usb_host_option_board_date	701
device.serial_numbers.usb_host_option_board	702
device.serial_numbers.parallel_option_board	703
device.serial_numbers.parallel_option_board_date	704
device.set_clock_to_build_date	705
device.slot_1	706
device.slot_2	707
device.super_host_status	708
device.syslog.clear_log	709
device.syslog.configuration	710
device.syslog.enable	712
device.syslog.entries	713
device.syslog.log_max_file_size	714
device.syslog.save_local_file	715
device.applicator.data_ready_activation	716
device.applicator.error_on_pause	717
device.applicator.start_print_mode	718
device.applicator.voltage	719
device.unique_id	720
device.unpause	721
device.uptime	722
device.user_p1	723
device.user_p2	724
device.user_vars.set_range	725
device.user_vars.create	726
device.xml.enable	728
device.feature.lighted_arrows	729
device.light.ribbon_path_brightness	730
device.light.media_path_brightness	731
display.backlight	732
display.backlight_on_time	733

display.batch_counter	734
display.bluetooth.mac	735
display.calibrate	736
display.language	737
display.load_card	739
display.password.level	740
display.root_wml	741
display.text	742
file.capture_response.destination	743
head.resolution.in_dpi	744
ezpl.head_close_action	745
ezpl.label_length_max	746
ezpl.label_sensor	747
ezpl.manual_calibration	748
ezpl.media_type	749
ezpl.power_up_action	750
ezpl.print_method	751
ezpl.print_width	752
ezpl.reprint_mode	753
ezpl.take_label	754
ezpl.tear_off	755
file.cert.expiration	756
file.cert.supported_curves	757
file.delete	758
file.dir	759
file.dir_format	760
file.type	761
file.run	762
formats.cancel_all	763
head.authenticated	764
head.darkness_switch_enable	765
head.darkness_switch	766
head.element_test	767
head.latch	768
input.capture	769
interface.network.active.arp_interval	770
interface.network.active.cable_type	771
interface.network.active.dhcp_received_host_name	772
interface.network.active.gateway	773
interface.network.active.ip_addr	774
interface.network.active.mac_addr	775

Contents

interface.network.active.mac_raw	776
interface.network.active.netmask	777
interface.network.active.protocol	778
interface.network.active.protocol_error	779
interface.network.active.rx_errors	780
interface.network.active.rx_packets	781
interface.network.active.server_address	782
interface.network.active.speed	783
interface.network.active.tx_errors	784
interface.network.active.tx_packets	785
interface.network.active.wins_addr	786
interface.network.settings_require_reset	787
ip.firewall.whitelist_in	788
ip.https.enable	789
ip.https.port	790
ip.ping_gateway_interval	791
ip.pop3.print_body	792
ip.pop3.print_headers	793
ip.pop3.save_attachments	794
ip.pop3.verbose_headers	795
ip.tls.enable	796
ip.tls.port	797
ip.tls.port_json_config	798
log.reboot.code	799
log.reboot.codes	800
log.reboot.reason	801
log.reboot.report	802
mcr.crypt.enabled	803
mcr.cancel	804
mcr.crypt.key_mgmt	805
mcr.crypt.algorithm	806
mcr.out	807
mcr.revision	808
media.bar_location	809
media.cartridge.darkness	810
media.cartridge.labels_remaining	811
media.cartridge.width	812
media.cartridge.total_label_cnt	813
media.cartridge.speed	814
media.cartridge.length	815
media.cartridge.inserted	816

Contents

media.cartridge.part_number	817
media.cut_now	818
media.darkness_mode	819
media.draft_mode	820
media.dynamic_length_calibration	821
media.feed_skip	822
media.media_low.external	823
media.media_low.warning	824
media.part_number	825
media.present.cut_amount	826
media.present.eject	827
media.present.length_addition	828
media.present.loop_length	829
media.present.loop_length_max	830
media.present.cut_margin	831
media.present.present_timeout	832
media.present.present_type	833
media.printmode	834
media.speed	836
media.serial_number	837
memory.flash_free	838
memory.flash_size	839
memory.ram_free	840
memory.ram_size	841
netmanage.avalanche.agent_addr	842
netmanage.avalanche.available_agent	843
netmanage.avalanche.available_port	844
netmanage.avalanche.encryption_type	845
netmanage.avalanche.interval	846
netmanage.avalanche.interval_update	847
netmanage.avalanche.model_name	848
netmanage.avalanche.set_property	849
netmanage.avalanche.startup_update	850
netmanage.avalanche.tcp_connection_timeout	851
netmanage.avalanche.terminal_id	852
netmanage.avalanche.text_msg.beep	853
netmanage.avalanche.text_msg.display	854
netmanage.avalanche.text_msg.print	855
netmanage.avalanche.udp_timeout	856
netmanage.error_code	857
netmanage.state_code	858

Contents

netmanage.status_code	859
odometer.cut_marker_count	860
odometer.headclean	861
odometer.headnew	862
odometer.label_dot_length	863
odometer.media_marker_count	864
odometer.media_marker_count1	865
odometer.media_marker_count2	866
odometer.retracts_count	867
odometer.rfid.valid_resetable	868
odometer.rfid.void_resetable	869
odometer.total_cuts	870
odometer.total_print_length	871
odometer.total_label_count	872
odometer.user_label_count	873
odometer.user_total_cuts	874
odometer.user_label_count[1 2]	875
odometer.latch_open_count	876
parallel_port.mode	877
parallel_port.present	878
power.average_current	879
power.battery_led_blink_rate	880
power.battery_led_enable	881
power.battery_led_off_duration	882
power.battery_led_on_duration	883
power.battery_type	884
power.dtr_power_off	885
power.energy_star.enable	886
power.energy_star.timeout	887
power.label_queue.shutdown	888
power.power_on_mode	889
power.shutdown	890
power.voltage	891
power.wake.radio	892
power.current	893
power.temperature	894
power.percent_health	895
power.part_number	896
power.sleep.cradle	897
power.remaining_capacity	898
power.cycle_count	899

Contents

print.legacy_compatibility	900
print.tone	901
print.troubleshooting_label_print	902
rfid.adaptive_antenna	903
rfid.antenna_sweep	904
rfid.country_code	905
rfid.enable	906
rfid.error.response	907
rfid.hop_table_version	908
rfid.log.entries	909
rfid.position.program	910
rfid.reader_1.antenna_port	912
rfid.reader_1.power.read	915
rfid.reader_1.power.write	916
rfid.reader_1.power.single_power	917
rfid.reader_1.firmware_version	918
rfid.reader_1.hardware_version	919
rfid.reader_1.model	920
rfid.recipe_version	921
rfid.region_code	922
rfid.tag.calibrate	923
rfid.tag.data	924
rfid.tag.read.content	925
rfid.tag.read.execute	926
rfid.tag.read.result_line1	927
rfid.tag.read.result_line2	928
rfid.tag.read.result_line1_alternate	929
rfid.tag.read.result_line2_alternate	930
rfid.tag.test	931
rfid.tag.test.content	932
rfid.tag.test.execute	933
rfid.tag.test.result_line1	934
rfid.tag.test.result_line2	935
rfid.tag.type	936
rfid.log.enabled	939
rfid.log.clear	940
ribbon.serial_number	941
ribbon.part_number	942
ribbon.cartridge.part_number	943
ribbon.cartridge.length_remaining	944
ribbon.cartridge.length	945

Contents

ribbon.cartridge.authenticated	946
ribbon.cartridge.inserted	947
rtc.timezone	948
rtc.unix_timestamp	950
sensor.battery.in_volts	951
sensor.back_bar.brightness	952
sensor.back_bar.ppr_out_thold	953
sensor.back_bar.cur	954
sensor.cover_open	955
sensor.front_bar.ppr_out_thold	956
sensor.front_bar.cur	957
sensor.front_bar.thold	958
sensor.front_bar.gain	959
sensor.front_bar.brightness	960
sensor.front_bar.offset	961
sensor.back_bar.offset	962
sensor.gap.thold	963
sensor.gap.offset	964
sensor.gap.gain	965
sensor.gap.brightness	966
sensor.head.temp_avg	967
sensor.head.temp_celsius	968
sensor.head.temp	969
sensor.peel.thold	970
sensor.peel.gain	971
sensor.paper_supply	972
sensor.peeler	973
sensor.peel.brightness	974
sensor.width.in_dots	975
sensor.width.cur	976
sensor.self_adjusting_enable	977
usb.device.device_id_string	978
usb.device.device_unique_id	979
usb.device.device_version	980
usb.device.manufacturer_string	981
usb.device.product_id	982
usb.device.product_string	983
usb.device.serial_string	984
usb.device.vendor_id	985
usb.halt	986
usb.host.config_info_to_usb	987

Contents

usb.host.fn_field_data	988
usb.host.fn_last_field	989
usb.host.hid_count	990
usb.host.keyboard_input	991
usb.host.lock_out	992
usb.host.mass_storage_count	993
usb.host.read_list	994
usb.host.read_list_print_delay	995
usb.host.template_list	996
usb.host.template_print_amount	997
usb.host.write_list	998
usb.mirror.appl_path	999
usb.mirror.auto	1000
usb.mirror.enable	1001
usb.mirror.enabled	1002
usb.mirror.error_retry	1003
usb.mirror.feedback.auto	1004
usb.mirror.feedback.odometer	1005
usb.mirror.feedback.path	1006
usb.mirror.fetch	1007
usb.mirror.last_error	1008
usb.mirror.last_time	1009
usb.mirror.path	1010
usb.mirror.reset_delay	1011
usb.mirror.success	1012
usb.mirror.success_time	1013
zbi.control.add_breakpoint	1014
zbi.control.break	1015
zbi.control.clear_breakpoints	1016
zbi.control.delete_breakpoint	1017
zbi.control.line_number	1018
zbi.control.restart	1019
zbi.control.run	1020
zbi.control.step	1021
zbi.control.terminate	1022
zbi.control.variable_name	1023
zbi.control.variable_value	1024
zbi.enable	1025
zbi.key	1026
zbi.last_error	1027
zbi.program_list	1028

zbi.reseller_key	1030
zbi.revision	1031
zbi.running_program_name	1032
zbi.start_info.execute	1033
zbi.start_info.file_name	1034
zbi.start_info.memory_alloc	1035
zbi.state	1036
zpl.calibrate	1037
zpl.format_prefix	1038
zpl.caret	1039
zpl.control_character	1040
zpl.delimiter	1041
zpl.label_length	1042
zpl.left_position	1043
zpl.system_error	1044
zpl.system_status	1046
zpl.zpl_mode	1049
zpl.zpl_override	1050
zpl.relative_darkness	1051
SGD Wired Commands	1052
Overview	1053
Command Structure	1054
external_wired.check	1055
external_wired.ip.addr	1056
external_wired.ip.arp_interval	1057
external_wired.ip.default_addr_enable	1058
external_wired.ip.dhcp.cid_all	1059
external_wired.ip.dhcp.cid_enable	1060
external_wired.ip.dhcp.cid_prefix	1061
external_wired.ip.dhcp.cid_suffix	1062
external_wired.ip.dhcp.cid_type	1063
external_wired.ip.gateway	1064
external_wired.ip.netmask	1065
external_wired.ip.port	1066
external_wired.ip.protocol	1067
external_wired.ip.timeout.enable	1068
external_wired.ip.timeout.value	1069
external_wired.ip.v6.addr	1070
external_wired.ip.v6.gateway	1071
external_wired.ip.v6.prefix_length	1072

Contents

external_wired.mac_addr	1073
external_wired.mac_raw	1074
internal_wired.8021x.password	1075
internal_wired.8021x.peap.validate_server_certificate	1076
internal_wired.8021x.peap.anonymous_identity	1077
internal_wired.8021x.private_key_password	1078
internal_wired.8021x.security	1079
internal_wired.8021x.ttls_tunnel	1080
internal_wired.8021x.username	1081
internal_wired.activity_led	1082
internal_wired.auto_switchover	1083
internal_wired.enable	1084
internal_wired.installed	1085
internal_wired.ip.addr	1086
internal_wired.ip.arp_interval	1087
internal_wired.ip.default_addr_enable	1088
internal_wired.ip.dhcp.arp_verify	1089
internal_wired.ip.dhcp.cache_ip	1090
internal_wired.ip.dhcp.cid_all	1091
internal_wired.ip.dhcp.cid_enable	1092
internal_wired.ip.dhcp.cid_prefix	1093
internal_wired.ip.dhcp.cid_suffix	1094
internal_wired.ip.dhcp.cid_type	1095
internal_wired.ip.dhcp.lease.last_attempt	1096
internal_wired.ip.dhcp.lease.length	1097
internal_wired.ip.dhcp.lease.server	1098
internal_wired.ip.dhcp.lease.time_left	1099
internal_wired.ip.dhcp.option12	1100
internal_wired.ip.dhcp.option12_format	1101
internal_wired.ip.dhcp.option12_value	1102
internal_wired.ip.dhcp.requests_per_session	1103
internal_wired.ip.dns.servers	1104
internal_wired.ip.gateway	1105
internal_wired.ip.netmask	1106
internal_wired.ip.port	1107
internal_wired.ip.port_alternate	1108
internal_wired.ip.port_json_config	1109
internal_wired.ip.protocol	1110
internal_wired.ip.timeout.enable	1111
internal_wired.ip.timeout.value	1112
internal_wired.ip.wins.addr	1113

internal_wired.ip.wins.permanent_source	1114
internal_wired.mac_addr	1115
internal_wired.mac_raw	1116
SGD Wireless Commands	1117
Overview	1118
Command Structure	1119
bluetooth.address	1120
bluetooth.afh_map	1121
bluetooth.afh_map_curr	1122
bluetooth.afh_mode	1123
bluetooth.allow_non_display_numeric_comparison	1124
bluetooth.authentication	1125
bluetooth.bluetooth_pin	1126
bluetooth.clear_bonding_cache	1127
bluetooth.date	1128
bluetooth.discoverable	1129
bluetooth.enable	1130
bluetooth.enable_reconnect	1131
bluetooth.friendly_name	1132
bluetooth.json_config_channel_enable	1133
bluetooth.power_class	1134
bluetooth.le.controller_mode	1135
bluetooth.le.power_class	1136
bluetooth.le.minimum_security	1137
bluetooth.page_scan_window	1138
bluetooth.local_name	1139
bluetooth.minimum_security_mode	1140
bluetooth.radio_auto_baud	1141
bluetooth.radio_version	1142
bluetooth.short_address	1143
bluetooth.version	1144
card.mac_addr	1145
card.inserted	1146
ip.active_network	1147
ip.addr	1148
ip.arp_interval	1149
ip.bootp.enable	1150
ip.dhcp.arp_verify	1151
ip.dhcp.auto_provision_enable	1152
ip.dhcp.cache_ip	1153

ip.dhcp.cid_all	1154
ip.dhcp.cid_enable	1155
ip.dhcp.cid_prefix	1156
ip.dhcp.cid_suffix	1157
ip.dhcp.cid_type	1158
ip.dhcp.cid_value	1159
ip.dhcp.enable	1160
ip.dhcp.lease.last_attempt	1161
ip.dhcp.lease.server	1162
ip.dhcp.lease.time_left	1163
ip.dhcp.ntp.enable	1164
ip.dhcp.ntp.received_servers	1165
ip.dhcp.option12	1166
ip.dhcp.option12_format	1167
ip.dhcp.option12_value	1168
ip.dhcp.request_timeout	1169
ip.dhcp.requests_per_session	1170
ip.dhcp.session_interval	1171
ip.dhcp.user_class_id	1172
ip.dhcp.vendor_class_id	1173
ip.dns.domain	1174
ip.dns.servers	1175
ip.ftp.enable	1176
ip.ftp.execute_file	1177
ip.ftp.request_password	1178
ip.gateway	1179
ip.http.admin_name	1180
ip.http.admin_password	1181
ip.http.custom_link_name	1182
ip.http.custom_link_url	1183
ip.http.enable	1184
ip.http.faq_url	1185
ip.http.port	1186
ip.lpd.enable	1187
ip.mac_raw	1188
ip.mirror.appl_path	1189
ip.mirror.auto	1190
ip.mirror.error_retry	1191
ip.mirror.feedback.auto	1192
ip.mirror.feedback.freq	1193
ip.mirror.feedback.odometer	1194

Contents

ip.mirror.feedback.path	1195
ip.mirror.fetch	1196
ip.mirror.freq	1197
ip.mirror.freq_hours	1198
ip.mirror.interface	1199
ip.mirror.last_error	1200
ip.mirror.last_time	1201
ip.mirror.mode	1202
ip.mirror.password	1203
ip.mirror.path	1204
ip.mirror.reset_delay	1205
ip.mirror.server	1206
ip.mirror.success	1207
ip.mirror.success_time	1208
ip.mirror.username	1209
ip.mirror.version	1210
ip.netmask	1211
ip.ntp.enable	1212
ip.ntp.log	1213
ip.ntp.servers	1214
ip.pop3.enable	1215
ip.pop3.password	1216
ip.pop3.poll	1217
ip.pop3.server_addr	1218
ip.pop3.username	1219
ip.port	1220
ip.port_alternate	1221
ip.port_json_config	1222
ip.port_single_conn	1223
ip.port_single_conn_idle_timeout	1224
ip.primary_network	1225
ip.smtp.domain	1226
ip.smtp.enable	1227
ip.smtp.server_addr	1228
ip.snmp.get_community_name	1229
ip.snmp.set_community_name	1230
ip.snmp.trap_community_name	1231
ip.snmp.enable	1232
ip.tcp.enable	1233
ip.telnet.enable	1234
ip.tcp.nagle_algorithm	1235

Contents

ip.udp.enable	1236
weblink.cloud_connect.enable	1237
weblink.enable	1238
weblink.ip.conn[1 2].authentication.add	1239
weblink.ip.conn[1 2].authentication.entries	1241
weblink.ip.conn[1 2].authentication.remove	1242
weblink.ip.conn[1 2].location	1243
weblink.ip.conn[1 2].num_connections	1244
weblink.ip.conn[1 2].maximum_simultaneous_ connections	1245
weblink.ip.conn[1 2].proxy	1246
weblink.ip.conn[1 2].retry_interval	1248
weblink.ip.conn[1 2].test.location	1249
weblink.ip.conn[1 2].test.retry_interval	1251
weblink.ip.conn[1 2].retry_interval_random_max	1252
weblink.ip.conn[1 2].test.test_on	1253
weblink.logging.clear	1255
weblink.logging.entries	1256
weblink.logging.max_entries	1257
weblink.printer_reset_required	1259
weblink.restore_defaults	1260
weblink.zebra_connector.authentication.add	1261
weblink.zebra_connector.authentication.entries	1262
weblink.zebra_connector.authentication.remove	1263
weblink.zebra_connector.enable	1264
weblink.zebra_connector.proxy	1265
weblink.zebra_connector.version	1267
wlan.11ac.80mhz_enable	1268
wlan.11d.enable	1269
wlan.11n.20mhz_only	1270
wlan.11n.aggregation	1271
wlan.11n.greenfield	1272
wlan.11n.rifs	1273
wlan.11n.short_gi_40mhz	1274
wlan.11n.short_gi_20mhz	1275
wlan.8021x.enable	1276
wlan.8021x.validate_peap_server_certificate	1277
wlan.8021x.peap.anonymous_identity	1278
wlan.8021x.authentication	1279
wlan.8021x.eap.password	1280
wlan.8021x.eap.privkey_password	1281
wlan.8021x.peap.peap_password	1282

Contents

wlan.8021x.peap.privkey_password	1283
wlan.8021x.peap.peap_username	1284
wlan.8021x.eap.username	1285
wlan.active_channels	1286
wlan.adhoc_last_channel	1287
wlan.authenticated	1288
wlan.authentication_error	1289
wlan.available	1290
wlan.allowed_band	1291
wlan.adhocautomode	1292
wlan.adhocchannel	1293
wlan.associated	1294
wlan.auth_type	1295
wlan.band_preference	1296
wlan.bssid	1297
wlan.channel	1298
wlan.channel_mask	1299
wlan.country_code	1301
wlan.current_tx_rate	1302
wlan.enable	1303
wlan.encryption_index	1304
wlan.encryption_key[1 2 3 4]	1305
wlan.encryption_mode	1306
wlan.essid	1307
wlan.firmware_version	1308
wlan.ip.addr	1309
wlan.ip.arp_interval	1310
wlan.ip.default_addr_enable	1311
wlan.ip.dhcp.arp_verify	1312
wlan.ip.dhcp.cache_ip	1313
wlan.ip.dhcp.cid_all	1314
wlan.ip.dhcp.cid_enable	1315
wlan.ip.dhcp.cid_prefix	1316
wlan.ip.dhcp.cid_suffix	1317
wlan.ip.dhcp.cid_type	1318
wlan.ip.dhcp.lease.last_attempt	1319
wlan.ip.dhcp.lease.length	1320
wlan.ip.dhcp.lease.server	1321
wlan.ip.dhcp.lease.time_left	1322
wlan.ip.dhcp.option12	1323
wlan.ip.dhcp.option12_format	1324

Contents

wlan.ip.dhcp.option12_value	1325
wlan.ip.dhcp.request_timeout	1326
wlan.ip.dhcp.requests_per_session	1327
wlan.ip.dhcp.session_interval	1328
wlan.ip.dns.servers	1329
wlan.ip.gateway	1330
wlan.ip.netmask	1331
wlan.ip.port	1332
wlan.ip.port_alternate	1333
wlan.ip.port_json_config	1334
wlan.ip.protocol	1335
wlan.ip.timeout.enable	1336
wlan.ip.timeout.value	1337
wlan.ip.wins.addr	1338
wlan.ip.wins.permanent_source	1339
wlan.keep_alive.enable	1340
wlan.keep_alive.timeout	1341
wlan.kerberos.kdc	1342
wlan.kerberos.mode	1343
wlan.kerberos.password	1344
wlan.kerberos.realm	1345
wlan.kerberos.username	1346
wlan.leap_mode	1347
wlan.leap_password	1348
wlan.leap_username	1349
wlan.mac_addr	1350
wlan.mac_raw	1351
wlan.operating_mode	1352
wlan.password	1353
wlan.permitted_channels	1354
wlan.pmf	1355
wlan.poor_signal_threshold	1356
wlan.preamble	1357
wlan.private_key_password	1358
wlan.region_code	1359
wlan.roam.interchannel_delay	1360
wlan.roam.interval	1361
wlan.roam.max_chan_scan_time	1362
wlan.roam.max_fail	1363
wlan.roam.monitor	1364
wlan.roam.rssi	1365

wlan.roam.signal	1366
wlan.rts_cts_enabled	1367
wlan.security	1368
wlan.signal_noise	1375
wlan.signal_quality	1376
wlan.signal_strength	1377
wlan.station_name	1378
wlan.tx_power	1379
wlan.tx_rate	1380
wlan.user_channel_list	1381
wlan.username	1382
wlan.waveagent.enable	1383
wlan.waveagent.udp_port	1384
wlan.wep.auth_type	1385
wlan.wep.index	1386
wlan.wep.key1	1387
wlan.wep.key2	1388
wlan.wep.key3	1389
wlan.wep.key4	1390
wlan.wpa.psk	1391
wlan.wep.key_format	1392
wlan.wpa.groupkey_ciphersuite	1393
wlan.wpa.pairwise_ciphersuite	1394
wlan.wpa.timecheck	1395
wlan.wpa.wpa_version	1396
Zebra Code Pages	1397
Zebra Code Page 850 — Latin Character Set	1397
Zebra Code Page 1250 — Central and Eastern European Latin Character Set	1399
Zebra Code Page 1252— Latin Character Set	1401
Zebra Code Page 1253 — Modern Greek Character Set	1403
Zebra Code Page 1254 — Turkish Character Set	1405
Zebra Code Page 1255 — Hebrew Character Set	1407
ASCII	1409
Fonts and Bar Codes	1411
Standard Printer Fonts	1411
Scalable Versus Bitmapped Fonts	1414
Bar Codes	1418

Mod 10 and Mod 43 Check Digits	1423
Mod 10 Check Digit	1423
Error Detection Protocol	1425
Introduction	1425
Request Packet Formats from the Host Computer	1426
ZB64 Encoding and Compression	1433
Introduction to B64 and Z64	1433
Field Interactions	1436
Normal Orientation	1436
Rotated Orientation	1437
Real Time Clock	1440
Control Panel Programming	1441
RTC General Information	1443
ZBI Character Set	1452
SGD Command Support	1455
SGDs Supported for Industrial Printers	1455
Mirror	1520
Mirror Overview	1520
Requirements	1522
Creating ZPL Files for Use in the "<update-root>/files" Directory	1526
Wireless Markup Language (WML)	1538
WML Overview	1538
WML Details	1538
Professional Services for WML Content Creation	1540
WML Tags	1540
Troubleshooting Scenarios	1554

Using Weblink	1556
When Should Weblink be Used?	1556
Configuring Weblink	1556
SSL/TLS Certificate Errors	1560
Other Typical Errors	1562
HTTP Messages	1564
HTTP POST Alerts	1566
Configuring Alerts Where the Alert Destination is HTTP POST	1566
How to Parse via PHP	1567
Enabling Logging	1570
Navigating the Log Output	1570
Understanding Errors in the Alerts HTTP Log	1571
Troubleshooting	1571
HTTP Messages	1572
Advanced Techniques	1573
Special Effects for Print Fields	1573
Serialized Data	1573
Variable Data	1573
Stored Formats	1574
Communication Diagnostics Commands	1580
Glossary	1589

Introduction

This guide is the unabridged, alphabetical reference of programming commands supported in the firmware. This includes all ZPL commands and SGD commands.



IMPORTANT: These are important points to note when using ZPL and SGD commands:

- ZPL and SGD commands should be sent to the printer as separate files.
- Certain settings can be controlled by both ZPL and SGD. Configuration changes made in ZPL can affect configuration changes made in SGD.

To contact Zebra or for technical support, visit www.zebra.com/contact.

Firmware

You can find the printer's firmware version by printing a configuration label. For instructions to do so, see your printer's user guide. For firmware upgrades go to: www.zebra.com/firmware.



IMPORTANT: These are important points to note when using a Zebra G-Series printer:

- You can send instructions to the printer using multiple programming languages: EPL, ZPL, or SGD. EPL and ZPL commands configure the printer, print labels, and get device status information. SGD commands set and get configuration details. These three languages can be used without the need to send the printer instructions to switch from one language to another.
- EPL, ZPL, and SGD commands must be sent to the printer as separate files. They cannot be used together in one format, or set of commands. For example, if you send a series of SGD commands to the printer and they are followed by a printable format, this needs to be done using separate files.

Many text editors and word processors can recreate most examples in this guide in ASCII format. However, for other encodings such as Unicode, a text editor such as Microsoft Notepad is needed.

Who Should Use This Document

This Programming Guide is for programmers who are familiar working with programming languages.

ZPL Commands

This section contains the complete alphabetical listing of ZPL II commands.

How Commands Are Documented

Description: The first paragraph(s) provides an explanation of how the command is used, what it is capable of, and any defining characteristics it has.

Format: The format explains how the command is syntactically arranged and what parameters it contains. For example, the **^B8** command prints a EAN-8 bar code. The format of the **^B8** command is: **^B8o,h,f,g**. It is arranged with the caret symbol (^), the command code (**B8**), and the parameters and are replaced with supported values.

Parameters: In the parameters table, if a command has values that can be defined to make its function more specific, these are outlined as parameters.

Still using the **^B8** example, the **h** parameter is defined as:

h = bar code height (in dots)	Values: 1 to 32000 Default: value set by ^BY
---	--

If the command has no parameters – for example **~JA** (Cancel All) – the parameter section is removed, indicating that the format of the command (**~JA**) is acceptable ZPL II code.

Examples: When the command is best clarified in context, an example of the ZPL II code is provided. Text indicating exact code entered is printed in an easily recognizable Courier font. An example of code using the **^B8** command looks like this:

```
^XA
^F050,50
^B8N,100,Y,N
^FD1234567^FS
^XZ
```

Notice that the **^B8** parameter letters have been replaced with real values that apply to the command. In this example **N,100,Y,N** have been entered.

Comments: A Comments section (if used) will show notes that are of value to a programmer, warnings of potential command interactions, or command-specific information that should be taken into consideration. Comments are also included next to parameters if they apply directly to a particular setting.

Basic ZPL Exercises and Examples

The purpose of these exercises is to introduce basic ZPL commands to novice ZPL users.

Make sure this checklist is complete:

- Load the printer with labels that are big enough to give you ample space to work with.
- Print a configuration label.
- Look at the configuration label and make sure that the **LEFT POSITION** is set to **000** and **LABEL TOP** is set to **000**.
- Determine the printer's resolution. It is listed on the configuration label. **8/MM** = 200 dpi, **12/MM** = 300 dpi and **24/MM** = 600 dpi.

Tips

These are some tips when using ZPL:

- Use the DOS text editor to write ZPL files.
- Save the file as a **.txt** file and copy it to the printer from DOS command line.

Before You Begin

Some things that are important to understand before you begin are:

- 200 dpi means the resolution of the printhead is 200 dots per inch. If you program the printer to draw a line 100 dots long that equals a half inch. 100 dots on a 300 dpi printer prints a line 1/3 inch long.
- The home position that all your coordinates are referencing is at the left-hand trailing edge of the label as the label comes out of the printer. (There are some exceptions to this.)

Exercises

The exercises start simple and gradually progress to give you an opportunity to try a variety of commonly used ZPL commands. Not all commands are covered, but this should be a good core of commands to learn. Some commands may not be supported due to the firmware version in your printer.

Exercise 1: Specify a Location for an Entered Name

1. Print your name on the label.
2. Start by printing just your name on the label. Use this format as a model:
3. Send this format to the printer:

```

1 —————> ^XA
2 —————> ^F050,50^ADN,36,20^FDxxxxxxxxxxxx
3 —————> ^FS
4 —————> ^XZ
                                     ↑
                                     5
    
```

1	Every format starts with the ^XA command
2	^FO (field origin) command
3	^FS (field separator) command
4	Every format ends with the ^XZ command
5	^FD (field data) command. Insert your name in place of the xxxxxxxxxxxx shown.

4. When the label prints correctly, alter the first number after the ^FOx. See how that change affects the print position. Alter the second number after the ^FO50,x and see how that the print position.

Font instruction

^ADN

1. Alter the numbers after the ^ADN,x,x command.
 - 18,10 is the smallest size you can make the D font.
 - The first number is the height of the font in dots. The second number is the width in dots.
 - You can use direct multiples up to ten times that size as a maximum.
180,100 is the largest you can make the D font.
 - 25,18 would not be a valid size. The printer rounds to the next recognizable size.
2. Check the font matrices tables for other fonts to try. See [Fonts and Bar Codes on page 1411](#).
3. Try the zero scalable font ^A0N,x,x.
This font is scalable, and you can choose any height and width.

Rotation Commands

1. Change ^ADN to ^ADR, and then ^ADI, and then ^ADB.
See how the print position changes.
2. Add more fields.
3. Add two more fields to print directly under your name using the ^ADN,36,20 font and size:
Your street address
Your city, state, zip

4. You must add two more lines of code that start off with:

```

^XA
^F050,50^ADN,36,20^FDxxxxxxxxxxxx^FS
^F0 (fill in the rest)
^F0 (fill in the rest)
^XZ
    
```

Make sure all these fields print in the same font and size and left side of fields has same vertical alignment.

```

Your name
1200 W Main Street
Anytown, IL 60061
    
```

Special Effects commands

The Graphic Box or ^GB command or is used in some of the special effects commands.

Reverse Printing a Field

Write the following format and send to the printer:

```

^XA
^PR1
^F0100,100
^GB70,70,70,,3^FS
^F0200,100
^GB70,70,70,,3^FS
^F0300,100
^GB70,70,70,,3^FS
^F0400,100
^GB70,70,70,,3^FS
^F0107,110^CF0,70,93
^FR^FDREVERSE^FS
^XZ
    
```

To see the effects, remove:

```
^FR^FDREVERSE^FS
```

To see the effects, try removing one of the ^GB lines of code.

Label Reverse Print

1. Write the following format and send to the printer:

```

^XA^LRY
^F0100,50
^GB195,203,195^FS
^F0180,110^CFG
^FDLABEL^FS
^F0130,170
^FDREVERSE^FS
^XZ
    
```

To see the effects, remove:

```
^GB195,203,195^FS
```

Mirror Image of Label

Write the following format and send to the printer:

```
^XA^PMY  
^F0100,100  
^CFG  
^FDMIRROR^FS  
^F0100,160  
^FDIMAGE^FS  
^XZ
```

To see the effects, in the first line of code change ^PMY to ^PMN.

Print Orientation

Write the following format and send to the printer:

```
^XA^CFD  
^POI  
^LH330,10  
^F050,50  
^FDZEBRA TECHNOLOGIES^FS  
^F050,75  
^FDVernon Hills, IL^FS  
^XZ
```

To see the effects, in the second line of code change ^POI to ^PON.

Exercise 2: Boxes and Lines

Use the address format from <X-refBlue>Exercise .

Add this new line to your existing format:

```
^F050,200^GB200,200,2^FS
```

This prints a box one wide by one inch long and the thickness of the line is 2 dots.

Reposition and resize the square so that it goes around the name and address uniformly.

Print a line by adding:

```
^F050,300^GB400,1,4,^FS
```

This prints a horizontal line two inches wide by 4 dots thick.

Print a vertical line using this code:

```
^F0100,50^GB1,400,4^FS
```

Exercise 3: Bar Codes — ^B3 Code 39 Barcode

Write the following format and send to the printer:

```
^XA
^F050,50^B3N,N,100,Y,N^FD123456^FS
^XZ
```

Try changing each of the parameters in the ^B3 string so you can see the effects.

```
^B3o,e,h,f,g
^BY
```

For valid parameter choices, see [^B3 on page 55](#).

Insert the ^BY command just before the ^B3 to see how the narrow bar width can be altered.

```
^F050,50^BY2^B3..etc ^BYx
```

Acceptable values for x are 1 through 10

Alter the ratio of the narrow to wide bar.

```
^F050,50^BY2,3^B3..etc ^BY2,x
```

Acceptable values for x are 2.1 through 3 in .1 increments

Print out a ^B3 bar code with the interpretation line on top of the bar code and the bar code rotated 90 degrees.

Add a ^PQ just before the ^XZ to print several labels.

```
^PQ4
^XZ
^PR Print rate (in inches per second)
```

Add a ^PR command after the ^XA at the beginning of the format to change the print rate (print speed).

```
^XA
^PR4
```

then try ^PR6. ^PRx acceptable values for x are 2 through 12 (check printer specs)

See how the print speed affects the print quality of the bar code. You may need to increase the printer darkness setting at higher print speeds.

Exercise 4: ^SN — Serial Number Command

Send this format to the printer:

```
^XA
^F0100,100^ADN,36,20^SN001,1,Y^FS
^PQ3
^XZ
```

To vary the **^SNv,n,z** to exercise increment/decrement and leading zeros functions, consult this guide.

If your serial number contains alpha and numeric characters, you can increment or decrement a specific segment of the data even if it is in the middle, as this sample sequence shows:

ABCD1000EFGH, ABCD1001EFGH, ABCD1002EFGH

Send this file to the printer and to see how it increments the serial number. The **^SF** command can also work with alpha characters.

```
^XA
^F0100,100^ADN,36,20^FDABCD1000EFGH^SF%%d%%d%%,10000^FS
^PQ15
^XZ
```

Notice how the field data character position aligns with the **^SF** data string:

^	F	D	A	B	C	D	1	0	0	0	E	F	G	H
^	S	F	%	%	%	%	d	d	d	d	%	%	%	%
										1	0	0	0	0
										2	0	0	0	0
										3	0	0	0	0

And on through...

							1	0	1	4	0	0	0	0
--	--	--	--	--	--	--	---	---	---	---	---	---	---	---

The last label prints **ABCD1014EFGH**.

The **%** is placed in positions that you do not want to increment or decrement, **d** = decimal, **10000** = increment value.

For more details on **^SF**, see [^SF on page 316](#).

Exercise 5: Saving a template to memory. ^IS and image save and image load.

This exercise helps you troubleshoot your code against the errors you see on your labels.

Send this format to the printer:

```

^XA
^F020,30^GB750,1100,4^FS
^F020,30^GB750,200,4^FS
^F020,30^GB750,400,4^FS
^F020,30^GB750,700,4^FS
^F020,226^GB325,204,4^FS
^F030,40^ADN,36,20^FDShip to:^FS
^F030,260^ADN,18,10^FDPart number #^FS
^F0360,260^ADN,18,10^FDDescription:^FS
^F030,750^ADN,36,20^FDFrom:^FS
^ISR:SAMPLE.GRF^FS
^XZ

```

Send this format:

```

^XA
^ILR:SAMPLE.GRF^FS
^F0150,125^ADN,36,20^FDAcme Printing^FS
^F060,330^ADN,36,20^FD14042^FS
^F0400,330^ADN,36,20^FDScrew^FS
^F070,480^BY4^B3N,,200^FD12345678^FS
^F0150,800^ADN,36,20^FDMacks Fabricating^FS
^XZ

```

In this way the template only needs to be sent one time to the printer's memory. Subsequent formats can be sent recalling the template and merging variable data into the template. In this exercise, the file was saved in the printers R: memory, which is volatile.

Exercise 6: ^DF and ^XF — Download format and recall format

Similar concept to ^IS and ^IL command. ^IS and ^IL processes faster in the printer than ^DF and ^XF. This is how the ^DF and ^XF format structure produces a label similar to the ^IS/^IL sample you just tried.

Figure 1 Download and Recall Format

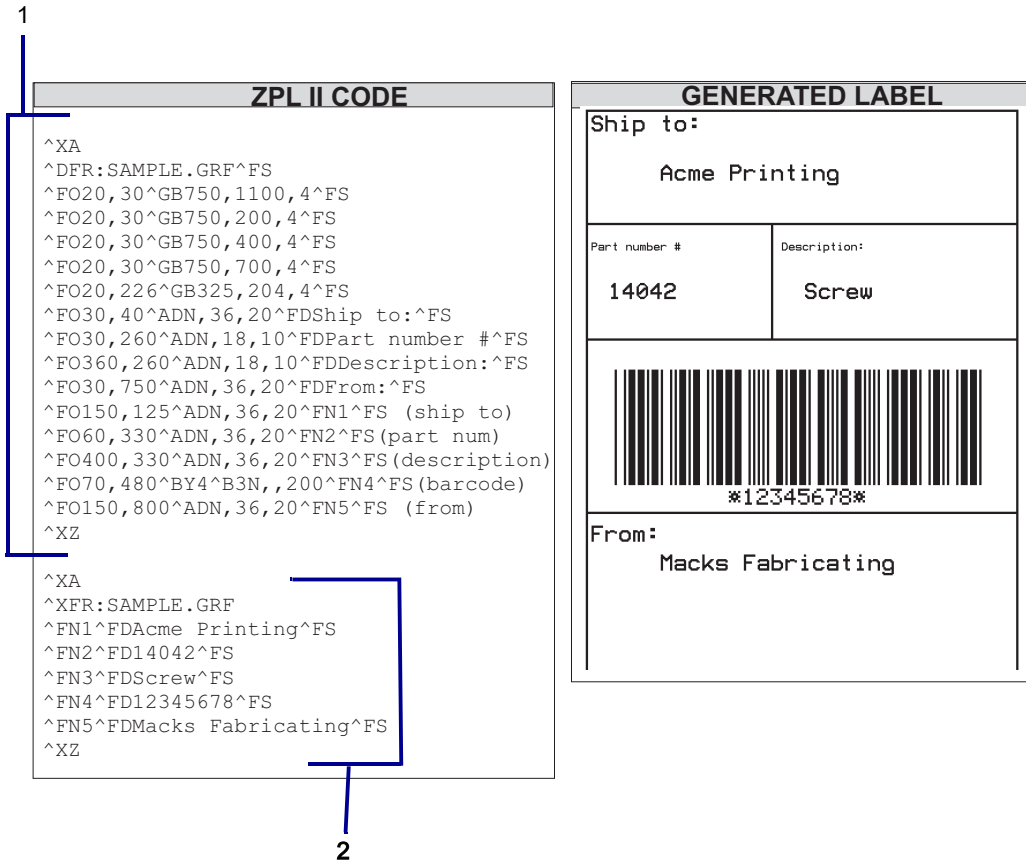

1	Download format code
2	Recall format call that generates the generated label in Figure 1.

Exercise 7: Asian and Unicode Encodings

.14↑

This exercise works on printers with firmware version V60.14, V50.14, or later.

In each of the following examples, the format is saved in the corresponding encoding before being sent down to the printer and the ZPL script was made in Microsoft Notepad, a basic text editor. The characters were inserted from the character map in Windows or typed from the keyboard.

Example: This is an example of using an Asian encoding, such as UHANGUL, with ASCII text. Using the **CI26** command tells the printer to recognize any byte less than 7F as ASCII text and every byte above as the first byte of UHANGUAL encoding:

ZPL II CODE	GENERATED LABEL
<pre> ^XA^CW1, B:ANMDK.TTF ^SEB:UHANGUL.DAT^CI26 ^FO100,100^A1, 50, 50^FDASCII 한국어 ^FS ^XZ </pre>	

Example: This is an example of using the Unicode encoding, UTF-8:

ZPL II CODE	GENERATED LABEL
<pre> ^XA^CW1, ANMDJ.TTF^CI28 ^FO100, 50^A1, 30, 30^FDENGLISH/日本語/한국어/简体中文/繁体中文^FS ^XZ </pre>	

Allowed Characters in File Names

Files on the internal printer drives (R:, E:, etc.) can be created or accessed using several different commands (for example, ^DF, ^XF, ^TO, etc.). The names of the file can contain ONLY the characters shown here.

Shaded areas indicate characters which cannot be used. The command and control characters (normally ^ and ~) cannot be used unless the control characters are changed to something else using the ^CC ~CC ZPL command.

Char.	DEC	OCT	HEX
(sp)	32	0040	0x20
!	33	0041	0x21
"	34	0042	0x22
#	35	0043	0x23
\$	36	0044	0x24
%	37	0045	0x25
&	38	0046	0x26
'	39	0047	0x27
(40	0050	0x28
)	41	0051	0x29
*	42	0052	0x2a
+	43	0053	0x2b
,	44	0054	0x2c
-	45	0055	0x2d
.	46	0056	0x2e
/	47	0057	0x2f
0	48	0060	0x30
1	49	0061	0x31
2	50	0062	0x32
3	51	0063	0x33
4	52	0064	0x34
5	53	0065	0x35
6	54	0066	0x36
7	55	0067	0x37
8	56	0070	0x38
9	57	0071	0x39
:	58	0072	0x3a
;	59	0073	0x3b
<	60	0074	0x3c
=	61	0075	0x3d
>	62	0076	0x3e
?	63	0077	0x3f

Char.	DEC	OCT	HEX
@	64	0100	0x40
A	65	0101	0x41
B	66	0102	0x42
C	67	0103	0x43
D	68	0104	0x44
E	69	0105	0x45
F	70	0106	0x46
G	71	0107	0x47
H	72	0110	0x48
I	73	0111	0x49
J	74	0112	0x4a
K	75	0113	0x4b
L	76	0114	0x4c
M	77	0115	0x4d
N	78	0116	0x4e
O	79	0117	0x4f
P	80	0120	0x50
Q	81	0121	0x51
R	82	0122	0x52
S	83	0123	0x53
T	84	0124	0x54
U	85	0125	0x55
V	86	0126	0x56
W	87	0127	0x57
X	88	0130	0x58
Y	89	0131	0x59
Z	90	0132	0x5a
[91	0133	0x5b
\	92	0134	0x5c
]	93	0135	0x5d
^	94	0136	0x5e
_	95	0137	0x5f

Char.	DEC	OCT	HEX
`	96	0140	0x60
a	97	0141	0x61
b	98	0142	0x62
c	99	0143	0x63
d	100	0144	0x64
e	101	0145	0x65
f	102	0146	0x66
g	103	0147	0x67
h	104	0150	0x68
i	105	0151	0x69
j	106	0152	0x6a
k	107	0153	0x6b
l	108	0154	0x6c
m	109	0155	0x6d
n	110	0156	0x6e
o	111	0157	0x6f
p	112	0160	0x70
q	113	0161	0x71
r	114	0162	0x72
s	115	0163	0x73
t	116	0164	0x74
u	117	0165	0x75
v	118	0166	0x76
w	119	0167	0x77
x	120	0170	0x78
y	121	0171	0x79
z	122	0172	0x7a
{	123	0173	0x7b
	124	0174	0x7c
}	125	0175	0x7d
~	126	0176	0x7e
(del)	127	0177	0x7f

^A**Scalable/Bitmapped Font**

The ^A command specifies the font to use in a text field. ^A designates the font for the current ^FD statement or field. The font specified by ^A is used only once for that ^FD entry. If a value for ^A is not specified again, the default ^CF font is used for the next ^FD entry.

Format: ^Afo,h,w

Parameter	Details
f = font name	<p>Values: A through Z, and 0 to 9</p> <p>Any font in the printer (downloaded, EPROM, stored fonts, fonts A through Z and 0 to 9).</p> <p> IMPORTANT: Parameter f is required. If f is omitted it defaults to the last value of the ^CF command.</p>
o = field orientation	<p>Values:</p> <p>N = normal</p> <p>R = rotated 90 degrees (clockwise)</p> <p>I = inverted 180 degrees</p> <p>B = read from bottom up, 270 degrees</p> <p>Default: the last accepted ^FW value or the ^FW default</p>
h = Character Height (in dots)	<p>Scalable</p> <p>Values: 10 to 32000</p> <p>Default: last accepted ^CF</p> <p>Bitmapped</p> <p>Values: multiples of height from 1 to 10 times the standard height, in increments of 1</p> <p>Default: last accepted ^CF</p>
w = width (in dots)	<p>Scalable</p> <p>Values: 10 to 32000</p> <p>Default: last accepted ^CF</p> <p>Bitmapped</p> <p>Values: multiples of width from 1 to 10 times the standard width, in increments of 1</p> <p>Default: last accepted ^CF</p>

Scalable Font Command

Example: This is an example of a scalable font command:

```

^XA
^F050,50
^A0,32,25
^FDZEBRA^FS
^F050,150
^A0,32,25
^FDPROGRAMMING^FS
^F050,250
^A0,32,25^FDLANGUAGE^FS
^XZ

```

Bitmap Font Command

Example: This is an example of a bitmap font command:

```

^XA
^F050,50
^ADN,36,20
^FDZEBRA^FS
^F050,150
^ADN,36,20
^FDPROGRAMMING^FS
^F050,250
^ADN,36,20^FDLANGUAGE^FS
^XZ

```

Comments Fonts are built using a matrix that defines standard height-to-width ratios. If you specify only the height or width value, the standard matrix for that font automatically determines the other value. If the value is not given or a 0 (zero) is entered, the height or width is determined by the standard font matrix.

.14↑

This command interacts with the justification parameters of `^FO` and `^FT` and with the field direction parameter of `^FP`. For output and examples, see [Field Interactions on page 1436](#).

^A@**Use Font Name to Call Font**

The **^A@** command uses the complete name of a font, rather than the character designation used in **^A**. Once a value for **^A@** is defined, it represents that font until a new font name is specified by **^A@**.

Format: **^A@o,h,w,d:f.x**

Parameter	Details
o = field orientation	<p>Values:</p> <p>N = normal</p> <p>R = rotates 90 degrees (clockwise)</p> <p>I = inverted 180 degrees</p> <p>B = read from bottom up, 270 degrees</p> <p>Default: N or the last ^FW value</p>
h = character height (in dots)	<p>Default:</p> <p>Specifies magnification by w (character width) or the last accepted ^CF value. Uses the base height if none is specified.</p> <ul style="list-style-type: none"> • Scalable The value is the height in dots of the entire character block. Magnification factors are unnecessary, because characters are scaled. • Bitmapped The value is rounded to the nearest integer multiple of the font's base height, then divided by the font's base height to give a magnification nearest limit.
w = width (in dots)	<p>Default: Specifies magnification by h (height) or the last accepted ^CF value. Specifies the base width is used if none is specified.</p> <ul style="list-style-type: none"> • Scalable The value is the width in dots of the entire character block. Magnification factors are unnecessary, because characters are scaled. • Bitmapped The value rounds to the nearest integer multiple of the font's base width, then divided by the font's base width to give a magnification nearest limit.
d = drive location of font	<p>Values: R:, E:, B:, and A:</p> <p>Default: R:</p>
f = font name	<p>Values: any valid font</p> <p>Default: if an invalid or no name is entered, the default set by ^CF is used. If no font has been specified in ^CF, font A is used.</p> <p>The font named carries over on all subsequent ^A@ commands without a font name.</p>

Parameter	Details
<p>x = extension</p> <div style="border: 1px solid blue; padding: 2px; display: inline-block; margin-bottom: 5px;">.14↑</div> <p>.TTE is only supported in firmware version V60.14.x, V50.14.x, or later.</p>	<p>Values:</p> <p>.FNT = font</p> <p>.TTF = TrueType Font</p> <p>.TTE = TrueType Extension</p>

Example: This example identifies the purpose of each line of code for this label:

```

1→ ^XA
2→ ^A2N,50,50,B:CYRI_UB.FNT
3→ ^F0100,100
4→ ^FDZebra Printer Fonts^FS
5→ ^A2N,40,40
6→ ^F0100,150
7→ ^FDThis uses B:CYRI_UB.FNT^FS
8→ ^XZ
    
```

Zebra Printer Fonts
This uses B:CYRI_UB.FNT

1	Starts the label format.
2	Searches non-volatile printer memory (B:) for CYRI_UB.FNT. When the font is found, the ^A@ command sets the print orientation to normal and the character size to 50 dots by 50 dots.
3	Sets the field origin at 100,100.
4	Prints the field data, Zebra Printer Fonts on the label.
5	Calls the font again and character size is decreased to 40 dots by 40 dots.
6	Sets the new field origin at 100,150.
7	Prints the field data, This uses the B:CYRI_UB.FNT on the label.
8	Ends the label format.

For reference, see [Zebra Code Page 850 — Latin Character Set on page 1397](#), [Fonts and Bar Codes on page 1411](#), and [ASCII Code Chart on page 1409](#).

^B0**Aztec Bar Code Parameters**

The **^B0** command creates a two-dimensional matrix symbology made up of square modules arranged around a bulls-eye pattern at the center.



NOTE: The Aztec bar code works with firmware version V60.13.0.11A and V50.13.2 or later.

Format: **^B0a,b,c,d,e,f,g**

Parameters	Details
a = orientation	<p>Values:</p> <p>N = normal</p> <p>R = rotated</p> <p>I = inverted 180 degrees</p> <p>B = read from bottom up, 270 degrees</p> <p>Default: current ^FW value</p>
b = magnification factor	<p>Values: 1 to 10</p> <p>Default:</p> <p>1 on 150 dpi printers</p> <p>2 on 200 dpi printers</p> <p>3 on 300 dpi printers</p> <p>6 on 600 dpi printers</p>
c = extended channel interpretation code indicator	<p>Values:</p> <p>Y = if data contains ECICs</p> <p>N = if data does not contain ECICs</p> <p>Default: N</p>
d = error control and symbol size/type indicator	<p>Values:</p> <p>0 = default error correction level</p> <p>01 to 99 = error correction percentage (minimum)</p> <p>101 to 104 = 1 to 4-layer compact symbol</p> <p>201 to 232 = 1 to 32-layer full-range symbol</p> <p>300 = a simple Aztec "Rune"</p> <p>Default: 0</p>
e = menu symbol indicator	<p>Values:</p> <p>Y = if this symbol is to be a menu (bar code reader initialization) symbol</p> <p>N = if it is not a menu symbol</p> <p>Default: N</p>
f = number of symbols for structured append	<p>Values: 1 through 26</p> <p>Default: 1</p>

ZPL Commands

Parameters	Details
g = optional ID field for structured append	The ID field is a text string with 24-character maximum Default: no ID

Example: This is an example of the **^B0** command:

ZPL II CODE	GENERATED LABEL
<pre>^XA ^BOR,7,N,0,N,1,0 ^FD 7. This is testing label 7^FS ^XZ</pre>	

^B1

Code 11 Bar Code

The **^B1** command produces the Code 11 bar **code**, also known as USD-8 code. In a Code 11 bar code, each character is composed of three bars and two spaces, and the character set includes 10 digits and the hyphen (-).

- **^B1** supports print ratios of 2.0:1 to 3.0:1.
- Field data (**^FD**) is limited to the width (or length, if rotated) of the label.



IMPORTANT: If additional information about this bar code is required, go to www.aimglobal.org.

Format: **^B1o,e,h,f,g**

Parameters	Details
o = orientation	Values: N = normal R = rotated 90 degrees (clockwise) I = inverted 180 degrees B = read from bottom up, 270 degrees Default: <i>current ^FW value</i>
e = check digit	Values: Y = 1 digit N = 2 digits Default: N
h = bar code height (in dots)	Values: 1 to 32000 Default: Value set by ^BY
f = print interpretation line	Values: Y = yes N = no Default: Y
g = print interpretation line above code	Values: Y = yes N = no Default: N

Example: This is an example of the Code 11 bar code:

ZPL II CODE										
<pre style="margin: 0;">^XA ^FO100,100^BY3 ^B1N,N,150,Y,N ^FD123456^FS ^XZ</pre>										

CODE 11 BAR CODE										
										

CODE 11 BAR CODE CHARACTERS										
0	1	2	3	4	5	6	7	8	9	-
Internal Start/Stop Character: △										
<i>When used as a stop character:</i>										
△ is used with 1 check digit										
△ is used with 2 check digits										

^B2

Interleaved 2 of 5 Bar Code

The ^B2 command produces the Interleaved 2 of 5 bar code, a high-density, self-checking, continuous, numeric symbology.

Each data character for the Interleaved 2 of 5 bar code is composed of five elements: five bars or five spaces. Of the five elements, two are wide and three are narrow. The bar code is formed by interleaving characters formed with all spaces into characters formed with all bars.

- ^B2 supports print ratios of 2.0:1 to 3.0:1.
- Field data (^FD) is limited to the width (or length, if rotated) of the label.



IMPORTANT: If additional information about this bar code is required, go to www.aimglobal.org.

Format: ^B2o,h,f,g,e,j

Parameters	Details
o = orientation	Values: N = normal R = rotated 90 degrees (clockwise) I = inverted 180 degrees B = read from bottom up, 270 degrees Default: current ^FW value
h = bar code height (in dots)	Values: 1 to 32000 Default: value set by ^BY
f = print interpretation line	Values: Y = yes N = no Default: Y
g = print interpretation line above code	Values: Y = yes N = no Default: N
e = calculate and print Mod 10 check digit	Values: Y = yes N = no Default: N

Example: This is an example of an Interleaved 2 of 5 bar code:

ZPL II CODE		INTERLEAVED 2 OF 5 BAR CODE							
<pre> ^XA ^FO100,100^BY3 ^B2N,150,Y,N,N ^FD123456^FS ^XZ </pre>	 123456								
INTERLEAVED 2 OF 5 BAR CODE CHARACTERS									
0	1	2	3	4	5	6	7	8	9
Start/Stop (internal)									

Comments: The total number of digits in an Interleaved 2 of 5 bar code must be even. The printer automatically adds a leading 0 (zero) if an odd number of digits is received.

The Interleaved 2 of 5 bar code uses the Mod 10 check-digit scheme for error checking. For more information on Mod 10 check digits, see [Mod 10 Check Digit on page 1423](#).

^B3**Code 39 Bar Code**

The Code 39 bar code is the standard for many industries, including the U.S. Department of Defense. It is one of three symbologies identified in the American National Standards Institute (ANSI) standard MH10.8M-1983. Code 39 is also known as USD-3 Code and 3 of 9 Code.

Each character in a Code 39 bar code is composed of nine elements: five bars, four spaces, and an inter-character gap. Three of the nine elements are wide; the six remaining elements are narrow.

- **^B3** supports print ratios of 2.0:1 to 3.0:1.
- Field data (**^FD**) is limited to the width (or length, if rotated) of the label.
- Code 39 automatically generates the start and stop character (*).
- Asterisk (*) for start and stop character prints in the interpretation line, if the interpretation line is turned on.
- Code 39 is capable of encoding the full 128-character ASCII set.



IMPORTANT: If additional information about this bar code is required, go to www.aimglobal.org.

Format: **^B3o,e,h,f,g**

Parameters	Details
o = orientation	Values: N = normal R = rotated 90 degrees (clockwise) I = inverted 180 degrees B = read from bottom up, 270 degrees Default: current ^FW value
e = Mod-43 check digit	Values: Y = yes N = no Default: N
h = bar code height (in dots)	Values: 1 to 32000 Default: value set by ^BY
f = print interpretation line	Values: Y = yes N = no Default: Y
g = print interpretation line above code	Values: Y = yes N = no Default: N

Example: This is an example of a Code 39 bar code:

ZPL II CODE	CODE 39 BAR CODE
<pre style="margin: 0;">^XA ^FO100,100^BY3 ^B3N,N,100,Y,N ^FD123ABC^FS ^XZ</pre>	 <p style="margin: 0;">*123ABC*</p>

CODE 39 BAR CODE CHARACTERS																									
A	B	C	D	E	F	G	H	I	J	K	L	M	N	O	P	Q	R	S	T	U	V	W	X	Y	Z
						-	.	\$	/	+	%	Space													

Comments: Extended ASCII is a function of the scanner, not of the bar code. Your scanner must have extended ASCII enabled for this feature to work. To enable extended ASCII in the Code 39, you must first encode +\$ in your ^FD statement. To disable extended ASCII, you must encode -\$ in your ^FD statement.

Example: This example encodes a carriage return with line feed into a Code 39 bar code:

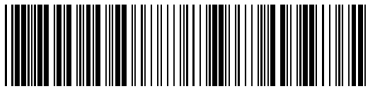
ZPL II CODE	GENERATED LABELS
<pre style="margin: 0;">^XA ^FO20,20 ^B3N,N,100,Y ^FDTEST+\$\$M\$J-\$^FS ^XZ</pre>	 <p style="margin: 0;">*TEST+\$\$M\$J-\$*</p>

Full ASCII Mode for Code 39

Code 39 can generate the full 128-character ASCII set using paired characters as shown in these tables:

ASCII	Code 39	ASCII	Code 39
SOH	\$A	SP	Space
STX	\$B	!	/A
ETX	\$C	"	/B
EOT	\$D	#	/C
ENQ	\$E	\$	/D
ACK	\$F	%	/E
BEL	\$G	&	/F
BS	\$H	'	/G
HT	\$I	(/H
LF	\$J)	/I
VT	\$K	*	/J
FF	\$L	++	/K
CR	\$M	,	/L
SO	\$N	-	-
SI	\$O	.	.
DLE	\$P	/	/O
DC1	\$Q	0	O
DC2	\$R	1	1
DC3	\$S	2	2
DC4	\$T	3	3
NAK	\$U	4	4
SYN	\$V	5	5
ETB	\$W	6	6
CAN	\$X	7	7
EM	\$Y	8	8
SUB	\$Z	9	9
ESC	%A	:	/Z
FS	%B	;	%F
FS	%C	<	%G
RS	%D	=	%H
US	%E	>	%I
		?	%J

ZPL Commands

ASCII	Code 39	ASCII	Code 39
@	%V	'	%W
A	A	a	+A
B	B	b	+B
C	C	c	+C
D	D	d	+D
E	E	e	+E
F	F	f	+F
G	G	g	+G
H	H	h	+H
I	I	l	+I
J	J	j	+J
K	K	k	+K
L	L	l	+L
M	M	m	+M
N	N	n	+N
O	O	o	+O
P	P	p	+P
Q	Q	q	+Q
R	R	r	+R
S	S	s	+S
T	T	t	+T
U	U	u	+U
V	V	v	+V
W	W	w	+W
X	X	x	+X
Y	Y	y	+Y
Z	Z	z	+Z
[%K	{	%P
\	%L		%Q
]	%M	}	%R
^	%N	~	%S
_	%O	DEL	%T, %X

^B4

Code 49 Bar Code

The ^B4 command creates a multi-row, continuous, variable-length symbology capable of encoding the full 128-character ASCII set. It is ideally suited for applications requiring large amounts of data in a small space.

The code consists of two to eight rows. A row consists of a leading quiet zone, four symbol characters encoding eight code characters, a stop pattern, and a trailing quiet zone. A separator bar with a height of one module separates each row. Each symbol character encodes two characters from a set of Code 49 characters.

- ^B4 has a fixed print ratio.
- Rows can be scanned in any order.



IMPORTANT: If additional information about this bar code is required, go to www.aimglobal.org.

Format: ^B4o,h,f,m

Parameters	Details
o = orientation	<p>Values:</p> <p>N = normal</p> <p>R = rotated 90 degrees (clockwise)</p> <p>I = inverted 180 degrees</p> <p>B = read from bottom up, 270 degrees</p> <p>Default: current ^FW value</p>
h = height multiplier of individual rows	<p>Values: 1 to height of label</p> <p>Default: value set by ^BY</p> <p>This number multiplied by the module equals the height of the individual rows in dots. 1 is not a recommended value.</p>
f = print interpretation line	<p>Values:</p> <p>N = no line printed</p> <p>A = print interpretation line above code</p> <p>B = print interpretation line below code</p> <p>Default: N</p> <p>When the field data exceeds two rows, expect the interpretation line to extend beyond the right edge of the bar code symbol.</p>

ZPL Commands

Parameters	Details
m = starting mode	Values: 0 = Regular Alphanumeric Mode 1 = Multiple Read Alphanumeric 2 = Regular Numeric Mode 3 = Group Alphanumeric Mode 4 = Regular Alphanumeric Shift 1 5 = Regular Alphanumeric Shift 2 A = Automatic Mode. The printer determines the starting mode by analyzing the field data. Default: A

Example: This is an example of a Code 49 bar code:

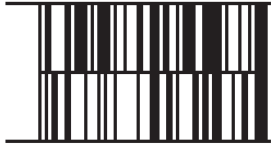
ZPL II CODE	CODE 49 BAR CODE
<pre> ^XA ^FO150,100^BY3 ^B4N,20,A,A ^FD12345ABCDE^FS ^XZ </pre>	<div style="text-align: center;"> <p>12345ABCDE</p>  </div>

ZPL Commands

Field Data Set	Unshifted Character Set	Shift 1 Character Set	Shift 2 Character Set
0	0	,	
1	1	ESC	;
2	2	FS	<
3	3	GS	=
4	4	RS	>
5	5	US	?
6	6	!	@
7	7	"	[
8	8	#	\
9	9	&]
A	A	SOH	a
B	B	STX	b
C	C	ETX	c
D	D	EOT	d
E	E	ENQ	e
F	F	ACK	f
G	G	BEL	g
H	H	BS	h
I	I	HT	i
J	J	LF	j
K	K	VT	k
L	L	FF	l
M	M	CR	m
N	N	SO	n
O	O	SI	o
P	P	DLE	p
Q	Q	DC1	q
R	R	DC2	r
S	S	DC3	s
T	T	DC4	t
U	U	NAK	u
V	V	SYN	v
W	W	ETB	w
X	X	CAN	x
Y	Y	EM	y
Z	Z	SUB	z
-	-	(␣
.	.)	
SPACE	SPACE	Null	DEL
\$	\$	*	{
/	/	,	
++	++	:	}
%	%	reserved	~
< (Shift 1)			
> (Shift 2)			
: (N.A.)			
; (N.A.)			
? (N.A.)			
= (Numeric Shift)			

Code 49 Shift 1 and 2 Character Substitutions

Code 49 Field Data Character Set

The ^FD data sent to the printer when using starting modes 0 to 5 is based on the Code 49 Internal Character Set. This is shown in the first column of the Code 49 table on the previous page. These characters are Code 49 control characters:

: ; < = > ?

Valid field data must be supplied when using modes 0 to 5. Shifted characters are sent as a two-character sequence of a shift character followed by a character in the unshifted character set.

To encode a lowercase **a**, send **a >** (Shift 2) followed by an uppercase **A**. If interpretation line printing is selected, a lowercase **a** prints in the interpretation line. This reflects what the output from the scanner reads. Code 49 uses uppercase alphanumeric characters only.

If an invalid sequence is detected, the Code 49 formatter stops interpreting field data and prints a symbol with the data up to the invalid sequence. These are examples of invalid sequences:

- Terminating numeric mode with any characters other than 0 to 9 or a Numeric Space.
- Starting in Mode 4 (Regular Alphanumeric Shift 1) and the first field data character is not in the Shift 1 set.
- Starting in Mode 5 (Regular Alphanumeric Shift 2) and the first field data character is not in the Shift 2 set.
- Sending Shift 1 followed by a character not in the Shift 1 set.
- Sending Shift 2 followed by a character not in the Shift 2 set.
- Sending two Shift 1 or Shift 2 control characters.

Advantages of Using the Code 49 Automatic Mode

Using the default (Automatic Mode) completely eliminates the need for selecting the starting mode or manually performing character shifts. The Automatic Mode analyzes the incoming ASCII string, determines the proper mode, performs all character shifts, and compacts the data for maximum efficiency.

Numeric Mode is selected or shifted only when five or more continuous digits are found. Numeric packaging provides no space advantage for numeric strings consisting of fewer than eight characters.

^B5**Planet Code bar code**

The **^B5** command is supported in all printers as a resident bar code. Accepted bar code characters are 0-9.

Format: **^B5o,h,f,g**

Parameters	Details
o = orientation code	Values: N = normal R = rotated I = inverted 180 degrees B = read from bottom up, 270 degrees Default: current ^FW value
h = bar code height (in dots)	Values: 1 to 9999 Default: value set by ^BY
f = interpretation line	Values: N = no Y = yes Default: N
g = determines if the interpretation line is printed above the bar code	Values: N = no Y = yes Default: N

Example: This is an example of a Planet Code bar code:

ZPL II CODE	GENERATED LABEL
<pre> ^XA ^FO150,100^BY3 ^B5N,100,Y,N ^FD12345678901^FS ^XZ </pre>	

^B7**PDF417 Bar Code**

The **^B7** command produces the PDF417 bar code, a two-dimensional, multirow, continuous, stacked symbology. PDF417 is capable of encoding over 1,000 characters per bar code. It is ideally suited for applications requiring large amounts of information at the time the bar code is read.

The bar code consists of three to 90 stacked rows. Each row consists of start and stop patterns and symbol characters called *code-words*. A code-word consists of four bars and four spaces. A three code-word minimum is required per row.

The PDF417 bar code is also capable of using the structured append option (**^FM**), which allows you to extend the field data limitations by printing multiple bar codes. For more information on using structured append, see [^FM on page 177](#).

- PDF417 has a fixed print ratio.
- Field data (**^FD**) is limited to 3K of character data.

Format: **^B7o,h,s,c,r,t**

Parameters	Details
o = orientation	<p>Values:</p> <p>N = normal</p> <p>R = rotated 90 degrees (clockwise)</p> <p>I = inverted 180 degrees</p> <p>B = read from bottom up, 270 degrees</p> <p>Default: current ^FW value</p>
h = bar code height for individual rows (in dots)	<p>Values: 1 to height of label</p> <p>Default: value set by ^BY</p> <p>This number multiplied by the module equals the height of the individual rows in dots. If this number is not specified, the overall bar code height, divided by the number of rows, equals the height of the individual rows in dots, where the overall bar code height is defined by the ^BY command. 1 is not a recommended value.</p>
s = security level	<p>Values: 1 to 8 (error detection and correction)</p> <p>Default: 0 (error detection only)</p> <p>This determines the number of error detection and correction code-words to be generated for the symbol. The default level provides only error detection without correction. Increasing the security level adds increasing levels of error correction and increases the symbol size.</p>
c = number of data columns to encode	<p>Values: 1 to 30</p> <p>Default: 1:2 (row-to-column aspect ratio)</p> <p>You can specify the number of code-word columns giving control over the width of the symbol.</p>

Parameters	Details
r = number of rows to encode	<p>Values: 3 to 90</p> <p>Default: 1:2 (row-to-column aspect ratio)</p> <p>You can specify the number of symbol rows giving control over the height of the symbol. For example, with no row or column values entered, 72 code-words would be encoded into a symbol of six columns and 12 rows. Depending on code-words, the aspect ratio is not always exact.</p>
t = truncate right row indicators and stop pattern	<p>Values:</p> <p>N = no truncation</p> <p>Y = perform truncation</p> <p>Default: N</p>

Example: This is an example of a PDF417 bar code:

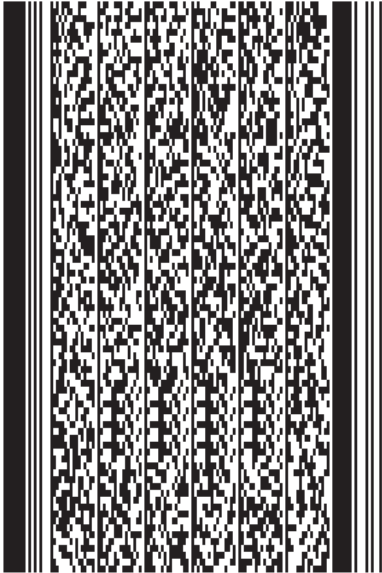
ZPL II CODE	PDF417 BAR CODE
<pre> ^XA ^BY2,3 ^FO10,10^B7N,5,5,,83,N ^FDZebra Technologies Corporation strives to be the expert supplier of innovative solutions to speciality demand labeling and ticketing problems of business and government. We will attract and retain the best people who will understand our customer's needs and provide them with systems, hardware, software, consumables and service offering the best value, high quality, and reliable performance, all delivered in a timely manner. ^FS^XZ </pre>	

Example: This is an example of a PDF417 without and with truncation selected:



PDF417 without Truncation being selected



PDF417 with Truncation being selected

Example: This example shows the ^B7 command used with field hex (^FH) characters:

ZPL II CODE	GENERATED LABEL
<pre> ^XA ^FO50,50^BY3,3.0^B7N,8,5,7,21,N ^FH^FD(>_1E06_1DP12345678_1DQ160 _1D1JUN123456789A2B4C6D8E_1D20LA6-987 _1D21L54321_ZES_1D15KG1155 _1DBSC151208_1D7Q10GT_1E_04^FS ^XZ </pre>	

Comments: Noted in this bulleted list:

- If both columns and rows are specified, their product must be less than 928.
- No symbol is printed if the product of columns and rows is greater than 928.
- No symbol is printed if total code-words are greater than the product of columns and rows.
- Serialization is not allowed with this bar code.
- The truncation feature can be used in situations where label damage is not likely. The right row indicators and stop pattern is reduced to a single module bar width. The difference between a non truncated and a truncated bar code is shown in the previous examples.

Special Considerations for ^BY When Using PDF417

When used with ^B7, the parameters for the ^BY command are:

w = module width (in dots)

Values: 2 to 10

Default: 2

r = ratio

Fixed Value: 3 (ratio has no effect on PDF417)

h = height of bars (in dots)

Values: 1 to 32000

Default: 10

PDF417 uses this only when row height is not specified in the ^B7 h parameter.

Special Considerations for ^FD When Using PDF417

The character set sent to the printer with the ^FD command includes the full ASCII set, except for those characters with special meaning to the printer.

See [Zebra Code Page 850 — Latin Character Set on page 1397](#), [^CC ~CC on page 137](#), and [^CT ~CT on page 149](#).

- CR and LF are also valid characters for all ^FD statements. This scheme is used:

\& = carriage return/line feed

\\ = backslash (\)

- ^CI13 must be selected to print a backslash (\).

^B8

EAN-8 Bar Code

The **^B8** command is the shortened version of the EAN-13 bar code. EAN is an acronym for European Article Numbering. Each character in the EAN-8 bar code is composed of four elements: two bars and two spaces.

- **^B8** supports a fixed ratio.
- Field data (**^FD**) is limited to exactly seven characters. ZPL II automatically pads or truncates on the left with zeros to achieve the required number of characters.
- When using JAN-8 (Japanese Article Numbering), a specialized application of EAN-8, the first two non-zero digits sent to the printer are always 49.



IMPORTANT: If additional information about this bar code is required, go to www.aimglobal.org.

Format: **^B8o,h,f,g**

Parameters	Details
o = orientation	Values: N = normal R = rotated 90 degrees (clockwise) I = inverted 180 degrees B = read from bottom up, 270 degrees Default: current ^FW value
h = bar code height (in dots)	Values: 1 to 32000 Default: value set by ^BY
f = print interpretation line	Values: N = no Y = yes Default: Y
g = print interpretation line above code	Values: N = no Y = yes Default: N

Example: This is an example of an EAN-8 bar code:

ZPL II CODE	
<pre>^XA ^FO100,100^BY3 ^B8N,100,Y,N ^FD1234567^FS ^XZ</pre>	

EAN-8 BAR CODE	
 1234 5670	

EAN-8 BAR CODE CHARACTERS									
0	1	2	3	4	5	6	7	8	9

^B9**UPC-E Bar Code**

The **^B9** command produces a variation of the UPC symbology used for number system 0. It is a shortened version of the UPC-A bar code, where zeros are suppressed, resulting in codes that require less printing space. The 6 dot/mm, 12 dot/mm, and 24 dot/mm printheads produce the UPC and EAN symbologies at 100 percent of their size. However, an 8 dot/mm printhead produces the UPC and EAN symbologies at a magnification factor of 77 percent.

Each character in a UPC-E bar code is composed of four elements: two bars and two spaces. The **^BY** command must be used to specify the width of the narrow bar.

- **^B9** supports a fixed ratio.
- Field data (**^FD**) is limited to exactly 10 characters, requiring a five-digit manufacturer's code and five-digit product code.
- When using the zero-suppressed versions of UPC, you must enter the full 10-character sequence. ZPL II calculates and prints the shortened version.



IMPORTANT: If additional information about this bar code is required, go to www.aimglobal.org.

Format: **^B9,h,f,g,e**

Parameters	Details
o = orientation	Values: N = normal R = rotated 90 degrees (clockwise) I = inverted 180 degrees B = read from bottom up, 270 degrees Default: current ^FW value
h = bar code height (in dots)	Values: 1 to 32000 Default: value set by ^BY
f = print interpretation line	Values: N = no Y = yes Default: Y
g = print interpretation line above code	Values: N = no Y = yes Default: N
e = print check digit	Values: N = no Y = yes Default: Y

Example: This is an example of a UPC-E bar code:

ZPL II CODE	UPC-E BAR CODE								
<pre> ^XA ^FO150,100^BY3 ^B9N,100,Y,N,Y ^FD1230000045^FS ^XZ </pre>									
UPC-E BAR CODE CHARACTERS									
0	1	2	3	4	5	6	7	8	9

Rules for Proper Product Code Numbers

- If the last three digits in the manufacturer's number are 000, 100, or 200, valid product code numbers are 00000 to 00999.
- If the last three digits in the manufacturer's number are 300, 400, 500, 600, 700, 800, or 900, valid product code numbers are 00000 to 00099.
- If the last two digits in the manufacturer's number are 10, 20, 30, 40, 50, 60, 70, 80, or 90, valid product code numbers are 00000 to 00009.
- If the manufacturer's number does not end in zero (0), valid product code numbers are 00005 to 00009.

^BA**Code 93 Bar Code**

The ^BA command creates a variable length, continuous symbology. The Code 93 bar code is used in many of the same applications as Code 39. It uses the full 128-character ASCII set. ZPL II, however, does not support ASCII control codes or escape sequences. It uses the substitute characters shown below.

Control Code	ZPL II Substitute
Ctrl \$	&
Ctrl %	'
Ctrl /	(
Ctrl +)

Each character in the Code 93 bar code is composed of six elements: three bars and three spaces. Although invoked differently, the human-readable interpretation line prints as though the control code has been used.

- ^BA supports a fixed print ratio.
- Field data (^FD) is limited to the width (or length, if rotated) of the label.



IMPORTANT: If additional information about this bar code is required, go to www.aimglobal.org.

Format: ^BAo,h,f,g,e

Parameters	Details
o = orientation	Values: N = normal R = rotated 90 degrees (clockwise) I = inverted 180 degrees B = read from bottom up, 270 degrees Default: current ^FW value
h = bar code height (in dots)	Values: 1 to 32000 Default: value set by ^BY
f = print interpretation line	Values: N = no Y = yes Default: Y
g = print interpretation line above code	Values: N = no Y = yes Default: N

Full ASCII Mode for Code 93

Code 93 can generate the full 128-character ASCII set using paired characters as shown in the following tables.

ASCII	Code 93	ASCII	Code 93
NUL	'U	SP	Space
SOH	&A	!	(A
STX	&B	"	(B
ETX	&C	#	(C
EOT	&D	\$	(D
ENQ	&E	%	(E
ACK	&F	&	(F
BEL	&G	'	(G
BS	&H	((H
HT	&I)	(I
LF	&J	*	(J
VT	&K	++	++
FF	&L	,	(L
CR	&M	-	-
SO	&N	.	.
SI	&O	/	/
DLE	&P	0	O
DC1	&Q	1	1
DC2	&R	2	2
DC3	&S	3	3
DC4	&T	4	4
NAK	&U	5	5
SYN	&V	6	6
ETB	&W	7	7
CAN	&X	8	8
EM	&Y	9	9
SUB	&Z	:	(Z
ESC	'A	:	'F
FS	'B	<	'G
FS	'C	=	'H
RS	'D	>	'I
US	'E	?	'J

ZPL Commands

ASCII	Code 93
@	'V
A	A
B	B
C	C
D	D
E	E
F	F
G	G
H	H
I	I
J	J
K	K
L	L
M	M
N	N
O	O
P	P
Q	Q
R	R
S	S
T	T
U	U
V	V
W	W
X	X
Y	Y
Z	Z
['K
\	'L
]	'M
^	'N
_	'O

ASCII	Code 93
'	'W
a)A
b)B
c)C
d)D
e)E
f)F
g)G
h)H
i)I
j)J
k)K
l)L
m)M
n)N
o)O
p)P
q)Q
r)R
s)S
t)T
u)U
v)V
w)W
x)X
y)Y
z)Z
{	'P
	'Q
}	'R
~	'S
DEL	'T

^BB**CODABLOCK Bar Code**

The **^BB** command produces a two-dimensional, multirow, stacked symbology. It is ideally suited for applications that require large amounts of information.

Depending on the mode selected, the code consists of one to 44 stacked rows. Each row begins and ends with a start and stop pattern.

- CODABLOCK A supports variable print ratios.
- CODABLOCK E and F support only fixed print ratios.



IMPORTANT: If additional information about this bar code is required, go to www.aimglobal.org.

Format: `^BB o , h , s , c , r , m`

Parameters	Details
o = orientation	<p>Values:</p> <p>N = normal</p> <p>R = rotated 90 degrees (clockwise)</p> <p>I = inverted 180 degrees</p> <p>B = read from bottom up, 270 degrees</p> <p>Default: N</p>
h = bar code height for individual rows (in dots)	<p>Values: 2 to 32000</p> <p>Default: 8</p> <p>This number, multiplied by the module, equals the height of the individual row in dots.</p>
s = security level	<p>Values:</p> <p>N = no</p> <p>Y = yes</p> <p>Default: Y</p> <p>Security level determines whether symbol check-sums are generated and added to the symbol. Check sums are never generated for single-row symbols. This can be turned off only if parameter m is set to A.</p>
c = number of characters per row (data columns)	<p>Values: 2 to 62 characters</p> <p>This is used to encode a CODABLOCK symbol. It gives the you control over the width of the symbol.</p>

Parameters	Details
<p>r = number of rows to encode</p>	<p>Values: for CODABLOCK A: 1 to 22 for CODABLOCK E and F: 2 to 4</p> <ul style="list-style-type: none"> • If values for c and r are not specified, a single row is produced. • If a value for r is not specified, and c exceeds the maximum range, a single row equal to the field data length is produced. • If a value for c is not specified, the number of characters per row is derived by dividing the field data by the value of r. • If the s parameter is set to the default of Y, then the checksum characters that are included count as two data characters . <p>For example, if c = 6, r is set to 3 and s is set to N, then up to 18 characters can be used (6 x 3). However, if s is set to Y, then only 16 character can be used.</p> <ul style="list-style-type: none"> • If the data field contains primarily numeric data, fewer than the specified rows might be printed. If the field data contains several shift and code-switch characters, more than the specified number of rows might be printed.
<p>m = mode</p>	<p>Values: A, E, F</p> <p>CODABLOCK A uses the Code 39 character set. CODABLOCK F uses the Code 128 character set. CODABLOCK E uses the Code 128 character set and automatically adds FNC1.</p> <p>Default: F</p>

Example: This is an example of a CODABLOCK bar code:

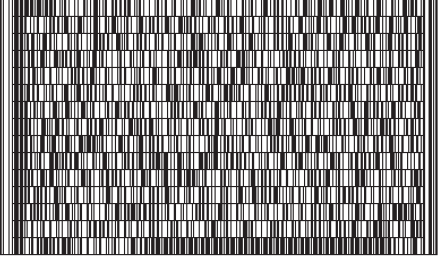
ZPL II CODE	CODABLOCK BAR CODE
<pre data-bbox="318 281 751 905">^XA ^BY2,3 ^FO10,10^BBN,30,,30,44,E ^FDZebra Technologies Corporation strives to be the expert supplier of innovative solutions to speciality demand labeling and ticketing problems of business and government. We will attract and retain the best people who will understand our customer's needs and provide them with systems, hardware, software, consumables and service offering the best value, high quality, and reliable performance, all delivered in a timely manner.^FS ^XZ</pre>	

Special Considerations for the ^BY Command When Using ^BB

The parameters for the ^BY_{w,r,h} command, when used with a ^BB code, are as follows:

w = module width (in dots)

Values: 2 to 10 (CODABLOCK A only)

Default: 2

r = ratio

Fixed Value: 3 (ratio has no effect on CODABLOCK E or F)

h = height of bars (in dots)

Values: 1 to 32,32000

Default: 10

CODABLOCK uses this as the overall symbol height only when the row height is not specified in the ^BB h parameter.

Special Considerations for ^FD Character Set When Using ^BB

The character set sent to the printer depends on the mode selected in parameter m.

CODABLOCK A: CODABLOCK A uses the same character set as Code 39. If any other character is used in the ^FD statement, either no bar code is printed or an error message is printed (if ^CV is active).

CODABLOCK E: The Automatic Mode includes the full ASCII set except for those characters with special meaning to the printer. Function codes or the Code 128 Subset A <nu1> character can be inserted using of the ^FH command.

<fnc1> = 80 hex	<fnc3> = 82 hex
<fnc2> = 81 hex	<fnc4> = 83 hex
<nu1> = 84 hex	

For any other character above 84 hex, either no bar code is printed or an error message is printed (if ^CV is active).

CODABLOCK F: CODABLOCK F uses the full ASCII set, except for those characters with special meaning to the printer. Function codes or the Code 128 Subset A <nu1> character can be inserted using of the ^FH command.

<fnc1> = 80 hex	<fnc3> = 82 hex
<fnc2> = 81 hex	<fnc4> = 83 hex
<nu1> = 84 hex	

^BC**Code 128 Bar Code (Subsets A, B, and C)**

The **^BC** command creates the Code 128 bar code, a high-density, variable length, continuous, alphanumeric symbology. It was designed for complexly encoded product identification.

Code 128 has three subsets of characters. There are 106 encoded printing characters in each set, and each character can have up to three different meanings, depending on the character subset being used. Each Code 128 character consists of six elements: three bars and three spaces.

- **^BC** supports a fixed print ratio.
- Field data (**^FD**) is limited to the width (or length, if rotated) of the label.



IMPORTANT: If additional information about this bar code is required, go to www.aimglobal.org.

Format: **^BCo,h,f,g,e,m**

Parameters	Details
o = orientation	<p>Values:</p> <p>N = normal</p> <p>R = rotated 90 degrees (clockwise)</p> <p>I = inverted 180 degrees</p> <p>B = read from bottom up, 270 degrees</p> <p>Default: current ^FW value</p>
h = bar code height (in dots)	<p>Values: 1 to 32000</p> <p>Default: value set by ^BY</p>
f = print interpretation line	<p>Values: Y (yes) or N (no)</p> <p>Default: Y</p> <p>The interpretation line can be printed in any font by placing the font command before the bar code command.</p>
g = print interpretation line above code	<p>Values: Y (yes) or N (no)</p> <p>Default: N</p>
e = UCC check digit	<p>Values: Y (turns on) or N (turns off)</p> <p>Mod 103 check digit is always there. It cannot be turned on or off. Mod 10 and 103 appear together with e turned on.</p> <p>Default: N</p>

Parameters	Details
<p>m = mode</p>	<p>Values:</p> <p>N = no selected mode</p> <p>U = UCC Case Mode</p> <ul style="list-style-type: none"> • More than 19 digits in ^FD or ^SN are eliminated. • Fewer than 19 digits in ^FD or ^SN add zeros to the right to bring the count to 19. This produces an invalid interpretation line. <p>A = Automatic Mode</p> <p>This analyzes the data sent and automatically determines the best packing method. The full ASCII character set can be used in the ^FD statement — the printer determines when to shift subsets. A string of four or more numeric digits causes an automatic shift to Subset C.</p> <p>D = UCC/EAN Mode (x.11.x and newer firmware)</p> <p>This allows dealing with UCC/EAN with and without chained application identifiers. The code starts in the appropriate subset followed by FNC1 to indicate a UCC/EAN 128 bar code. The printer automatically strips out parentheses and spaces for encoding, but prints them in the human-readable section. The printer automatically determines if a check digit is required, calculate it, and print it. Automatically sizes the human readable.</p> <p>Default: N</p>

Example: This is an example of a Code 128 bar code:

ZPL II CODE	CODE 128 BAR CODE
<pre> ^XA ^FO100,100^BY3 ^BCN,100,Y,N,N ^FD123456^FS ^XZ </pre>	

Code 128 Subsets

The Code 128 character subsets are referred to as Subset A, Subset B, and Subset C. A subset can be selected in these ways:

- A special Invocation Code can be included in the field data (^FD) string associated with that bar code.
- The desired Start Code can be placed at the beginning of the field data. If no Start Code is entered, Subset B are used.

To change subsets within a bar code, place the Invocation Code at the appropriate points within the field data (^FD) string. The new subset stays in effect until changed with the Invocation Code. For example, in Subset C, >7 in the field data changes the Subset to A.

[Table 1](#) shows the Code 128 Invocation Codes and Start Characters for the three subsets.

Table 1 Code 128 Invocation Characters

Invocation Code	Decimal Value	Subset A Character	Subset B Character	Subset C Character
><	62			
>0	30	>	>	
>=	94		~	
>1	95	USQ	DEL	
>2	96	FNC 3	FNC 3	
>3	97	FNC 2	FNC 2	
>4	98	SHIFT	SHIFT	
>5	99	CODE C	CODE C	
>6	100	CODE B	FNC 4	CODE B
>7	101	FNC 4	CODE A	CODE A
>8	102	FNC 1	FNC 1	FNC 1
Start Characters				
>9	103	Start Code A	(Numeric Pairs give Alpha/Numerics)	
>:	104	Start Code B	(Normal Alpha/Numeric)	
>;	105	Start Code C	(All numeric (00 - 99))	

[Table 2](#) shows the character sets for Code 128:

Table 2

Value	Code A	Code B	Code C
0	SP	SP	00
1	!	!	01
2	"	"	02
3	#	#	03
4	\$	\$	04
5	%	%	05
6	&	&	06
7	'	'	07
8	((08
9))	09
10	*	*	10
11	+	+	11
12	,	,	12
13	-	-	13
14	.	.	14
15	/	/	15
16	0	0	16
17	1	1	17
18	2	2	18
19	3	3	19
20	4	4	20
21	5	5	21
22	6	6	22
23	7	7	23
24	8	8	24
25	9	9	25
26	:	:	26
27	;	;	27
28	<	<	28
29	=	=	29
30	>	>	30
31	?	?	31
32	@	@	32
33	A	A	33
34	B	B	34
35	C	C	35
36	D	D	36
37	E	E	37
38	F	F	38
39	G	G	39
40	H	H	40
41	I	I	41
42	J	J	42
43	K	K	43
44	L	L	44
45	M	M	45
46	N	N	46
47	O	O	47
48	P	P	48
49	Q	Q	49
50	R	R	50
51	S	S	51
52	T	T	52
53	U	U	53
54	V	V	54
55	W	W	55
56	X	X	56
57	Y	Y	57
58	Z	Z	58
59	[[59
60	\	\	60
61]]	61
62	^	^	62
63	~	~	63
64	NUL	.	64
65	SOH	a	65
66	STX	b	66
67	ETX	c	67
68	EOT	d	68
69	ENQ	e	69
70	ACK	f	70
71	BEL	g	71
72	BS	h	72
73	HT	i	73
74	LF	j	74
75	VT	k	75
76	FF	l	76
77	CR	m	77
78	SO	n	78
79	SI	o	79
80	DLE	p	80
81	DC1	q	81
82	DC2	r	82
83	DC3	s	83
84	DC4	t	84
85	NAK	u	85
86	SYN	v	86
87	ETB	w	87
88	CAN	x	88
89	EM	y	89
90	SUB	z	90
91	ESC	{	91
92	FS		92
93	GS	}	93
94	RS	~	94
95	US	DEL	95
96	FNC3	FNC3	96
97	FNC2	FNC2	97
98	SHIFT	SHIFT	98
99	Code C	Code C	99
100	Code B	FNC4	Code B
101	FNC4	Code A	Code A
102	FNC1	FNC1	FNC1
103		START (Code A)	
104		START (Code B)	
105		START (Code C)	

Example: Figures A and B are examples of identical bar codes, and Figure C is an example of switching from Subset C to B to A, as follows:

```

^XA
^FO100,75
^BCN,100,Y,N,N
^FDCODE128^FS
^XZ
    
```



CODE128

Figure A: Subset B with no start character

```

^XA
^FO100,75
^BCN,100,Y,N,N
^FD>:CODE128^FS
^XZ
    
```



CODE128

Figure B: Subset B with start character

Example: Because Code 128 Subset B is the most commonly used subset, ZPL II defaults to Subset B if no start character is specified in the data string.

```

^XA
^FO50,50
^BY3^BCN,100,Y,N,N
^FD>;382436>6CODE128>752375152^F
^XZ
    
```



382436CODE128TEST

Figure C: Switching from Subset C to B to A

How ^BC Works Within a ZPL II Script

^XA – the first command starts the label format.

^F0100,75 – the second command sets the field origin at 100 dots across the x-axis and 75 dots down the y-axis from the upper-left corner.

^BCN,100,Y,N,N – the third command calls for a Code 128 bar code to be printed with no rotation (N) and a height of 100 dots. An interpretation line is printed (Y) below the bar code (N). No UCC check digit is used (N).

^FDCODE128^FS (Figure A) **^FD>:CODE128^FS** (Figure B) – the field data command specifies the content of the bar code.

^XZ – the last command ends the field data and indicates the end of the label.

The interpretation line prints below the code with the UCC check digit turned off.

The **^FD** command for Figure A does not specify any subset, so Subset B is used. In Figure B, the **^FD** command specifically calls Subset B with the **>:** Start Code. Although ZPL II defaults to Code B, it is good practice to include the Invocation Codes in the command.

Code 128 – Subset B is programmed directly as ASCII text, except for values greater than 94 decimal and a few special characters that must be programmed using the invocation codes. Those characters are:

^ > ~

Code 128 – Subsets A and C

Code 128, Subsets A and C are programmed in pairs of digits, 00 to 99, in the field data string. For details, see [Table 1 on page 82](#).

In Subset A, each pair of digits results in a single character being encoded in the bar code; in Subset C, characters are printed as entered. Figure E below is an example of Subset A (>9 is the Start Code for Subset A).

Nonintegers programmed as the first character of a digit pair (D2) are ignored. However, nonintegers programmed as the second character of a digit pair (2D) invalidate the entire digit pair, and the pair is ignored. An extra unpaired digit in the field data string just before a code shift is also ignored.

Figure D and Figure E below are examples of Subset C. Notice that the bar codes are identical. In the program code for Figure F, the D is ignored and the 2 is paired with the 4.

```

^XA
^FO100,75^BY3
^BCN,100,Y,N,N
^FD>;382436^FS
^XZ
    
```



Figure D: Subset C with normal data

```

^XA
^FO100,75^BY3
^BCN,100,Y,N,N
^FD>;38D2436^FS
^XZ
    
```



Figure E: Subset C with ignored alpha character

```

^XA
^FO100,75^BY3
^BCN,100,Y,N,N
^FD>935473637171824^FS
^XZ
    
```



Figure F: Subset A

The UCC/EAN-128 Symbology

The symbology specified for the representation of Application Identifier data is UCC/EAN-128, a variant of Code 128, exclusively reserved to EAN International and the Uniform Code Council (UCC).



NOTE: It is not intended to be used for data to be scanned at the point of sales in retail outlets.

UCC/EAN-128 offers several advantages. It is one of the most complete, alphanumeric, one-dimensional symbologies available today. The use of three different character sets (A, B and C), facilitates the encoding of the full 128 ASCII character set. Code 128 is one of the most compact linear bar code symbologies. Character set C enables numeric data to be represented in a double density mode. In this mode, two digits are represented by only one symbol character saving valuable space. The code is concatenated. That means that multiple AIs and their fields may be combined into a single bar code. The code is also very reliable. Code 128 symbols use two independent self-checking features which improves printing and scanning reliability.

UCC/EAN-128 bar codes always contain a special non-data character known as function 1 (FNC 1), which follows the start character of the bar code. It enables scanners and processing software to auto-discriminate between UCC/EAN-128 and other bar code symbologies, and subsequently only process relevant data.

The UCC/EAN-128 bar code is made up of a leading quiet zone, a Code 128 start character A, B, or C, a FNC 1 character, Data (Application Identifier plus data field), a symbol check character, a stop character, and a trailing quiet zone.

UCC/EAN, UCC/128 are a couple of ways you'll hear someone refer to the code. This just indicates that the code is structured as dictated by the application identifiers that are used.

SSCC (Serial Shipping Container Code) formatted following the data structure layout for Application Identifier 00. See [Table 3 on page 90](#). It could be 00 which is the SSCC code. The customer needs to let us know what application identifiers are used for their bar code so we can help them.

There are several ways of writing the code to print the code to Application Identifier '00' structure.

Using N for the mode (m) parameter

This example shows with application identifier 00 structure:

ZPL II CODE	N FOR THE M PARAMETER
<pre> ^XA ^FO90,200^BY4 ^BCN,256,Y,N,Y,N ^FD>;>80012345123451234512^FS ^XZ </pre>	 <p>00123451234512345120</p>

- '>;>8' sets it to subset C, function 1
- '00' is the application identifier followed by '17 characters', the check digit is selected using the 'Y' for the (e) parameter to automatically print the 20th character.
- you are not limited to 19 characters with mode set to N

Using U for the mode (m) parameter

The example shows the application identifier 00 format:

ZPL II CODE	U FOR THE M PARAMETER
<pre> ^XA ^FO90,200 ^BY4^BC,256,Y,N,,U ^FD0012345123451234512^FS ^XZ </pre>	 <p style="font-family: monospace; font-size: small; margin-top: 5px;">00123451234512345120</p>

UCC Case Mode

- Choosing **U** selects UCC Case mode. You will have exactly 19 characters available in **^FD**.
- Subset C using FNC1 values are automatically selected.
- Check digit is automatically inserted.

Using D for the mode (m) parameter

This example shows application identifier 00 format ((x.11.x or later):

ZPL II CODE	D FOR THE M PARAMETER
<pre> ^XA ^FO50,200^BCN,150,Y,N,,D ^FD(00)10084423 7449200940^FS ^XZ </pre>	 <p style="font-family: monospace; font-size: small; margin-top: 5px;">(00) 1 0084423 7449200941</p>

(0 at end of field data is a bogus character that is inserted as a place holder for the check digit the printer will automatically insert.

- Subset C using FNC1 values are automatically selected.
- Parentheses and spaces can be in the field data. '00' application identifier, followed by 17 characters, followed by bogus check digit place holder.
- Check digit is automatically inserted. The printer will automatically calculate the check digit and put it into the bar code and interpretation line.
- The interpretation line will also show the parentheses and spaces but will strip them out from the actual bar code.

Printing the Interpretation Line

This example shows printing the interpretation in a different font with firmware x.11.x or later:

ZPL II CODE	INTERPRETATION LINE
<pre> ^XA ^FO50,200 ^A0N,40,30^BCN,150,Y,N,Y ^FD>;>80012345123451234512^FS ^XZ </pre>	 <p>The interpretation line is printed in a bold, condensed font below the barcode. The text reads: 00123451234512345120</p>

The font command (**^A0N,40,30**) can be added and changed to alter the font and size of the interpretation line.

With firmware version later than x.10.x

- A separate text field needs to be written.
- The interpretation line needs to be turned off.
- **^A0N,50,40** is the font and size selection for the separate text field.
- You have to make sure you enter the correct check digit in the text field.
- Creating a separate text field allows you to format the interpretation line with parentheses and spaces.

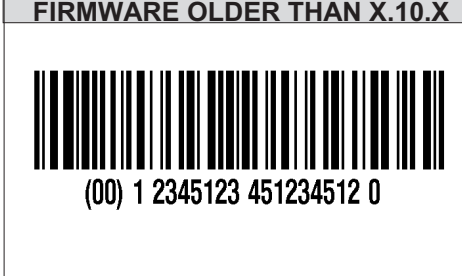
ZPL II CODE	FIRMWARE OLDER THAN X.10.X
<pre> ^XA ^FO25,25 ^BCN,150,N,N,Y ^FD>;>80012345123451234512^FS ^FO100,190 ^A0N,50,40 ^FD(00) 1 2345123 451234512 0^FS ^XZ </pre>	 <p>The interpretation line is printed in a bold, condensed font below the barcode. The text reads: (00) 1 2345123 451234512 0</p>

Application Identifiers — UCC/EAN APPLICATION IDENTIFIER

An Application Identifier is a prefix code used to identify the meaning and the format of the data that follows it (data field).

There are AIs for identification, traceability, dates, quantity, measurements, locations, and many other types of information.

For example, the AI for batch number is 10, and the batch number AI is always followed by an alphanumeric batch code not to exceed 20-characters.

The UCC/EAN Application Identifiers provide an open standard that can be used and understood by all companies in the trading chain, regardless of the company that originally issued the codes.



NOTE: Table 3 is a partial table showing the application identifiers. For more current and complete information, search the Internet for **UCC Application Identifier**.

Table 3 UCC/EAN Application Identifier

Data Content	AI	Plus The Following Data Structure
Serial Shipping Container Code (SSCC)	00	exactly 18 digits
Shipping Container Code	01	exactly 14 digits
Batch Numbers	10	up to 20 alpha numerics
Production Date (YYMMDD)	11	exactly 6 digits
Packaging Date (YYMMDD)	13	exactly 6 digits
Sell By Date (YYMMDD)	15	exactly 6 digits
Expiration Date (YYMMDD)	17	exactly 6 digits
Product Variant	20	exactly 2 digits
Serial Number	21	up to 20 alpha numerics
HIBCC Quantity, Date, Batch and Link	22	up to 29 alpha numerics
Lot Number	23	up to 19 alpha numerics
Quantity Each	30	
Net Weight (Kilograms)	310	exactly 6 digits
Length, Meters	311	exactly 6 digits
Width or Diameter (Meters)	312	exactly 6 digits
Depths (Meters)	313	exactly 6 digits
Area (Sq. Meters)	314	exactly 6 digits
Volume (Liters)	315	exactly 6 digits
Volume (Cubic Meters)	316	exactly 6 digits
Net Weight (Pounds)	320	exactly 6 digits
Customer PO Number	400	up to 29 alpha numerics
Ship To (Deliver To) Location Code using EAN 13 or DUNS Number with leading zeros	410	exactly 13 digits
Plus one digit for length indication. Plus one digit for decimal point indication.		

Table 3 UCC/EAN Application Identifier

Data Content	AI	Plus The Following Data Structure
Bill To (Invoice To) Location Code using EAN 13 or DUNS Number with leading zeros	411	exactly 13 digits
Purchase from	412	exactly 13 digits
Ship To (Deliver To) Postal Code within single postal authority	420	up to 9 alpha numerics
Ship To (Deliver To) Postal Code with 3-digit ISO Country Code Prefix	421	3 digits plus up to 9 alpha numerics
Roll Products - width, length, core diameter, direction and splices	8001	exactly 14 digits
Electronic Serial number for cellular mobile phone	8002	up to 20 alpha numerics
Plus one digit for length indication. Plus one digit for decimal point indication.		

For date fields that only need to indicate a year and month, the day field is set to **00**.

Chaining several application identifiers (firmware x.11.x or later)

The FNC1, which is invoked by >8, is inserted just before the AI's so that the scanners reading the code sees the FNC1 and knows that an AI follows.

Example: This is an example with the mode parameter set to A (automatic):

```
^XA
^BY2,2.5,193
^F033,400
^BCN,,N,N,N,A
^FD>;>80204017773003486100008535>8910001>837252^FS
^FT33,625^AEN,0,0^FD(02)04017773003486(10)0008535(91)0001(37)252^FS
^XZ
```

Example: This is an example with the mode parameter set to U:

```
^XA
^BY3,2.5,193
^F033,200
^BCN,,N,N,N,U
^FD>;>80204017773003486>8100008535>8910001>837252^FS
^FT33,455^A0N,30,30^FD(02)04017773003486(10)0008535(91)0001(37)252^FS
^XZ
```

Example: This is an example with the mode parameter set to D*:

```
^XA
^PON
^LH0,0
^BY2,2.5,145
^F0218,343
^BCB,,Y,N,N,D
^FD(91)0005886>8(10)0000410549>8(99)05^FS
^XZ
```

D* — When trying to print the last Application Identifier with an odd number of characters, a problem existed when printing EAN128 bar codes using Mode D. The problem was fixed in firmware version V60.13.0.6.

^BD**UPS MaxiCode Bar Code**

The **^BD** command creates a two-dimensional, optically read (not scanned) code. This symbology was developed by UPS (United Parcel Service).

Notice that there are no additional parameters for this code and it does not generate an interpretation line. The **^BY** command has no effect on the UPS MaxiCode bar code. However, the **^CV** command can be activated.

Format: **^BD***m,n,t*

Parameters	Details
m = mode	Values: 2 = structured carrier message: numeric postal code (U.S.) 3 = structured carrier message: alphanumeric postal code (non-U.S.) 4 = standard symbol, secretary 5 = full EEC 6 = reader program, secretary Default: 2
n = symbol number	Values: 1 to 8 can be added in a structured document Default: 1
t = total number of symbols	Values: 1 to 8 , representing the total number of symbols in this sequence Default: 1

Example: This is an example of UPS MAXICODE - MODE 2 bar code:

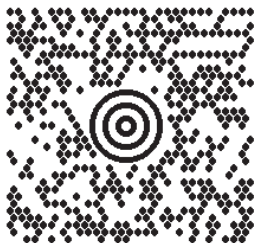
ZPL II CODE	UPS MAXICODE - MODE 2
<pre> ^XA ^FO50,50 ^CVY ^BD^FH^FD001840152382802 [>_1E01_1D961Z00004951_1DUPSN_ 1D_06X610_1D159_1D1234567_1D1/1_ 1D_1DY_1D634 ALPHA DR_ 1DPITTSBURGH_1DPA_1E_04^FS ^FO30,300^A0,30,30^FDMODE2^FS ^XZ </pre>	

Special Considerations for ^FD when Using ^BD

The ^FD statement is divided into two parts: a high priority message (**hpm**) and a low priority message (**lpm**). There are two types of high priority messages. One is for a U.S. Style Postal Code; the other is for a non-U.S. Style Postal Code. The syntax for either of these high priority messages must be exactly as shown or an error message is generated.

Format: ^FD <hpm><lpm>

Parameters	Details
<p><hpm> = high priority message (applicable only in Modes 2 and 3)</p>	<p>Values: 0 to 9, except where noted</p> <p>U.S. Style Postal Code (Mode 2)</p> <p><hpm> = aaabbbccccdddd</p> <p>aaa = three-digit class of service</p> <p>bbb = three-digit country zip code</p> <p>cccc = five-digit zip code</p> <p>dddd = four-digit zip code extension (if none exists, four zeros (0000) must be entered)</p> <p>non-U.S. Style Postal Code (Mode 3)</p> <p><hpm> = aaabbbcccccc</p> <p>aaa = three-digit class of service</p> <p>bbb = three-digit country zip code</p> <p>cccc = six-digit zip code (A through Z or 0 to 9)</p>
<p><lpm> = low priority message (only applicable in Modes 2 and 3)</p>	<p>GS is used to separate fields in a message (0x1D). RS is used to separate format types (0x1E). EOT is the end of transmission characters.</p> <p>Message Header]>RS</p> <p>Transportation Data</p> <p>Format Header01GS96</p> <p>Tracking Number*<tracking number></p> <p>SCAC*GS<SCAC></p> <p>UPS Shipper NumberGS<shipper number></p> <p>Julian Day of PickupGS<day of pickup></p> <p>Shipment ID NumberGS<shipment ID number></p> <p>Package n/xGS<n/x></p> <p>Package WeightGS<weight></p> <p>Address ValidationGS<validation></p> <p>Ship to Street AddressGS<street address></p> <p>Ship to CityGS<city></p> <p>Ship to StateGS<state></p> <p>RSRS</p> <p>End of MessageEOT</p> <p>(* Mandatory Data for UPS)</p>

Comments:

- The formatting of <hpm> and <1pm> apply only when using Modes 2 and 3. Mode 4, for example, takes whatever data is defined in the ^FD command and places it in the symbol.
- UPS requires that certain data be present in a defined manner. When formatting MaxiCode data for UPS, always use uppercase characters. When filling in the *fields* in the <1pm> for UPS, follow the data size and types specified in *Guide to Bar Coding with UPS*.
- If you do not choose a mode, the default is Mode 2. If you use non-U.S. Postal Codes, you probably get an error message (invalid character or message too short). When using non-U.S. codes, use Mode 3.
- ZPL II doesn't automatically change your mode based on the zip code format.
- When using special characters, such as GS, RS, or EOT, use the ^FH command to tell ZPL II to use the hexadecimal value following the underscore character (_).

^BE

EAN-13 Bar Code

The ^BE command is similar to the UPC-A bar code. It is widely used throughout Europe and Japan in the retail marketplace.

The EAN-13 bar code has 12 data characters, one more data character than the UPC-A code. An EAN-13 symbol contains the same number of bars as the UPC-A, but encodes a 13th digit into a parity pattern of the left-hand six digits. This 13th digit, in combination with the 12th digit, represents a country code.

- ^BE supports fixed print ratios.
- Field data (^FD) is limited to exactly 12 characters. ZPL II automatically truncates or pads on the left with zeros to achieve the required number of characters.
- When using JAN-13 (Japanese Article Numbering), a specialized application of EAN-13, the first two non-zero digits sent to the printer must be 49.



NOTE: Use Interleaved 2 of 5 for UCC and EAN 14.



IMPORTANT: If additional information about this bar code is required, go to www.aimglobal.org.

Format: ^BEo,h,f,g

Parameters	Details
o = orientation	Values: N = normal R = rotated 90 degrees (clockwise) I = inverted 180 degrees B = read from bottom up, 270 degrees Default: current ^FW value
h = bar code height (in dots)	Values: 1 to 32000 Default: value set by ^BY
f = print interpretation line	Values: N = no Y = yes Default: Y
g = print interpretation line above code	Values: N = no Y = yes Default: N

Example: This is an example of an EAN-13 bar code:

ZPL II CODE	EAN-13 BAR CODE								
<pre>^XA ^FO100,100^BY3 ^BEN,100,Y,N ^FD12345678^FS ^XZ</pre>	 0 000123 456784								
EAN-13 BAR CODE CHARACTERS									
0	1	2	3	4	5	6	7	8	9

Comments: The EAN-13 bar code uses the Mod 10 check-digit scheme for error checking. For more information on Mod 10, see [Mod 10 Check Digit on page 1423](#).

^BF

MicroPDF417 Bar Code

The ^BF command creates a two-dimensional, multi-row, continuous, stacked symbology identical to PDF417, except it replaces the 17-module-wide start and stop patterns and left/right row indicators with a unique set of 10-module-wide row address patterns. These reduce overall symbol width and allow linear scanning at row heights as low as 2X.

MicroPDF417 is designed for applications with a need for improved area efficiency but without the requirement for PDF417's maximum data capacity. It can be printed only in specific combinations of rows and columns up to a maximum of four data columns by 44 rows.

Field data (^FD) and field hexadecimal (^FH) are limited to:

- 250 7-bit characters
- 150 8-bit characters
- 366 4-bit numeric characters

Format: ^BFo,h,m

Parameters	Details
o = orientation	<p>Values:</p> <p>N = normal</p> <p>R = rotated 90 degrees (clockwise)</p> <p>I = inverted 180 degrees</p> <p>B = read from bottom up, 270 degrees</p> <p>Default: current ^FW value</p>
h = bar code height (in dots)	<p>Values: 1 to 9999</p> <p>Default: value set by ^BY or 10 (if no ^BY value exists).</p>
m = mode	<p>Values: 0 to 33 (see Table 4 on page 99)</p> <p>Default: 0 (see Table 4)</p>

Example: This is an example of a MicroPDF417 bar code:

```

ZPL II CODE

^XA
^FO100,100^BY6
^BFN,8,3
^FDABCDEF GHIJKLMNOPQRSTUVWXYZ^FS
^XZ
    
```



To encode data into a MicroPDF417 bar code, complete these steps:

1. Determine the type of data to be encoded (for example, ASCII characters, numbers, 8-bit data, or a combination).
2. Determine the maximum amount of data to be encoded within the bar code (for example, number of ASCII characters, quantity of numbers, or quantity of 8-bit data characters).
3. Determine the percentage of check digits that are used within the bar code. The higher the percentage of check digits that are used, the more resistant the bar code is to damage — however, the size of the bar code increases.
4. Use [Table 4](#) with the information gathered from the questions above to select the mode of the bar code.

Table 4 MicroPDF417 Mode

Mode (M)	Number of Data Columns	Number of Data Rows	% of Cws for EC	Max Alpha Characters	Max Digits
0	1	11	64	6	8
1	1	14	50	12	17
2	1	17	41	18	26
3	1	20	40	22	32
4	1	24	33	30	44
5	1	28	29	38	55
6	2	8	50	14	20
7	2	11	41	24	35
8	2	14	32	36	52
9	2	17	29	46	67
10	2	20	28	56	82
11	2	23	28	64	93
12	2	26	29	72	105
13	3	6	67	10	14
14	3	8	58	18	26
15	3	10	53	26	38
16	3	12	50	34	49
17	3	15	47	46	67
18	3	20	43	66	96
19	3	26	41	90	132
20	3	32	40	114	167
21	3	38	39	138	202
22	3	44	38	162	237
23	4	6	50	22	32
24	4	8	44	34	49
25	4	10	40	46	67
26	4	12	38	58	85
27	4	15	35	76	111
28	4	20	33	106	155
29	4	26	31	142	208
30	4	32	30	178	261
31	4	38	29	214	313
32	4	44	28	250	366
33	4	4	50	14	20

^BI**Industrial 2 of 5 Bar Codes**

The **^BI** command is a discrete, self-checking, continuous numeric symbology. The Industrial 2 of 5 bar code has been in use the longest of the 2 of 5 family of bar codes. Of that family, the Standard 2 of 5 (**^B1**) and Interleaved 2 of 5 (**^B2**) bar codes are also available in ZPL II.

With Industrial 2 of 5, all of the information is contained in the bars. Two bar widths are employed in this code, the wide bar measuring three times the width of the narrow bar.

- **^BI** supports a print ratio of 2.0:1 to 3.0:1.
- Field data (**^FD**) is limited to the width (or length, if rotated) of the label.



IMPORTANT: If additional information about this bar code is required, go to www.aimglobal.org.

Format: **^BI***o,h,f,g*

Parameters	Details
o = orientation	Values: N = normal R = rotated 90 degrees (clockwise) I = inverted 180 degrees B = read from bottom up, 270 degrees Default: current ^FW value
h = bar code height (in dots)	Values: 1 to 32000 Default: value set by ^BY
f = print interpretation line	Values: N = no Y = yes Default: Y
g = print interpretation line above code	Values: N = no Y = yes Default: N

Example: This is an example of an Industrial 2 of 5 bar code:

ZPL II CODE	
^XA ^FO100,100^BY3 ^BIN,150,Y,N ^FD123456^FS ^XZ	

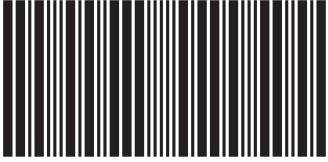
INDUSTRIAL 2 OF 5 BAR CODE	
	
123456	

INDUSTRIAL 2 OF 5 BAR CODE CHARACTERS									
0	1	2	3	4	5	6	7	8	9
Start/Stop (internal)									

^BJ**Standard 2 of 5 Bar Code**

The ^BJ command is a discrete, self-checking, continuous numeric symbology.

With Standard 2 of 5, all of the information is contained in the bars. Two bar widths are employed in this code, the wide bar measuring three times the width of the narrow bar.

- ^BJ supports a print ratio of 2.0:1 to 3.0:1.
- Field data (^FD) is limited to the width (or length, if rotated) of the label.



IMPORTANT: If additional information about this bar code is required, go to www.aimglobal.org.

Format: ^BJo,h,f,g

Parameters	Details
o = orientation	Values: N = normal R = rotated 90 degrees (clockwise) I = inverted 180 degrees B = read from bottom up, 270 degrees Default: current ^FW value
h = bar code height (in dots)	Values: 1 to 32000 Default: value set by ^BY
f = print interpretation line	Values: N = no Y = yes Default: Y
g = print interpretation line above code	Values: N = no Y = yes Default: N

ZPL Commands

Example: This is an example of a Standard 2 of 5 bar code:

ZPL II CODE	
^XA	
^FO100,100^BY3	
^BJN,150,Y,N	
^FD123456^FS	
^XZ	

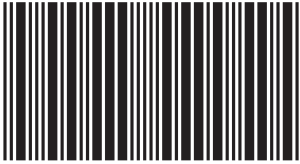
STANDARD 2 OF 5 BAR CODE	
	
123456	

STANDARD 2 OF 5 BAR CODE CHARACTERS									
0	1	2	3	4	5	6	7	8	9
Start/Stop (automatic)									

^BK**ANSI Codabar Bar Code**

The ANSI Codabar bar code is used in a variety of information processing applications such as libraries, the medical industry, and overnight package delivery companies. This bar code is also known as USD-4 code, NW-7, and 2 of 7 code. It was originally developed for retail price labeling.

Each character in this code is composed of seven elements: four bars and three spaces. Codabar bar codes use two character sets, numeric and control (start and stop) characters.

- ^BK supports a print ratio of 2.0:1 to 3.0:1.
- Field data (^FD) is limited to the width (or length, if rotated) of the label.



IMPORTANT: If additional information about this bar code is required, go to www.aimglobal.org.

Format: ^BKo,e,h,f,g,k,l

Parameters	Details
o = orientation	Values: N = normal R = rotated 90 degrees (clockwise) I = inverted 180 degrees B = read from bottom up, 270 degrees Default: current ^FW value
e = check digit	Fixed Value: N
h = bar code height (in dots)	Values: 1 to 32000 Default: value set by ^BY
f = print interpretation line	Values: N = no Y = yes Default: Y
g = print interpretation line above code	Values: N = no Y = yes Default: N
k = designates a start character	Values: A, B, C, D Default: A
l = designates stop character	Values: A, B, C, D Default: A

ZPL Commands

Example: This is an example of an ANSI Codabar bar code:

ZPL II CODE	ANSI CODABAR BAR CODE								
<pre>^XA ^FO100,100^BY3 ^BKN,N,150,Y,N,A,A ^FD123456^FS ^XZ</pre>	<p>A123456A</p>								
ANSI CODABAR BAR CODE CHARACTERS									
0	1	2	3	4	5	6	7	8	9
Control Characters									
- : . \$ / +									
Start/Stop Characters									
A B C D									

^BL

LOGMARS Bar Code

The ^BL command is a special application of Code 39 used by the Department of Defense. LOGMARS is an acronym for Logistics Applications of Automated Marking and Reading Symbols.

- ^BL supports a print ratio of 2.0:1 to 3.0:1.
- Field data (^FD) is limited to the width (or length, if rotated) of the label. Lowercase letters in the ^FD string are converted to the supported uppercase LOGMARS characters.



IMPORTANT: If additional information about this bar code is required, go to www.aimglobal.org.

Format: ^BLo,h,g

Parameters	Details
o = orientation	Values: N = normal R = rotated 90 degrees (clockwise) I = inverted 180 degrees B = read from bottom up, 270 degrees Default: current ^FW value
h = bar code height (in dots)	Values: 1 to 32000 Default: value set by ^BY
g = print interpretation line above code	Values: N = no Y = yes Default: N

Example: This is an example of a LOGMARS bar code:

ZPL II CODE	LOGMARS BAR CODE
<pre> ^XA ^FO100,75^BY3 ^BLN,100,N ^FD12AB^FS ^XZ </pre>	

LOGMARS BAR CODE CHARACTERS																									
		0	1	2	3	4	5	6	7	8	9														
A	B	C	D	E	F	G	H	I	J	K	L	M	N	O	P	Q	R	S	T	U	V	W	X	Y	Z
				-	.	\$	/	+	%																
		SPACE																							

Comments: The LOGMARS bar code produces a mandatory check digit using Mod 43 calculations. For further information on the Mod 43 check digit, see [Mod 10 Check Digit on page 1423](#).

^BM

MSI Bar Code

The ^BM command is a pulse-width modulated, continuous, non-self-checking symbology. It is a variant of the Plessey bar code (^BP).

Each character in the MSI bar code is composed of eight elements: four bars and four adjacent spaces.

- ^BM supports a print ratio of 2.0:1 to 3.0:1.
- For the bar code to be valid, field data (^FD) is limited to 1 to 14 digits when parameter e is B, C, or D. ^FD is limited to 1 to 13 digits when parameter e is A, plus a quiet zone.



IMPORTANT: If additional information about this bar code is required, go to www.aimglobal.org.

Format: ^BMo,e,h,f,g,e2

Parameters	Details
o = orientation	Values: N = normal R = rotated 90 degrees (clockwise) I = inverted 180 degrees B = read from bottom up, 270 degrees Default: current ^FW value
e = check digit selection	Values: A = no check digits B = 1 Mod 10 C = 2 Mod 10 D = 1 Mod 11 and 1 Mod 10 Default: B
h = bar code height (in dots)	Values: 1 to 32000 Default: value set by ^BY
f = print interpretation line	Values: N = no Y = yes Default: Y
g = print interpretation line above code	Values: N = no Y = yes Default: N

ZPL Commands

Parameters	Details
e2 = inserts check digit into the interpretation line	Values: N = no Y = yes Default: N

Example: This is an example of a MSI bar code:

ZPL II CODE	MSI BAR CODE
<pre> ^XA ^FO100,100^BY3 ^BMN,B,100,Y,N,N ^FD123456^FS ^XZ </pre>	 <p style="margin-top: 5px;">123456</p>
MSI BAR CODE CHARACTERS	
<div style="display: flex; justify-content: space-around; width: 100%;"> 1 2 3 4 5 6 7 8 9 </div>	

^B0**Aztec Bar Code Parameters**

The **^B0** command creates a two-dimensional matrix symbology made up of square modules arranged around a bulls-eye pattern at the center.



NOTE: The Aztec bar code works with firmware version V60.13.0.11A and V50.13.2 or later.

Format: **^B0a,b,c,d,e,f,g**

Parameters	Details
a = orientation	Values: N = normal R = rotated I = inverted 180 degrees B = read from bottom up, 270 degrees Default: current ^FW value
b = magnification factor	Values: 1 to 10 Default: 1 on 150 dpi printers 2 on 200 dpi printers 3 on 300 dpi printers 6 on 600 dpi printers
c = extended channel interpretation code indicator	Values: Y = if data contains ECICs N = if data does not contain ECICs. Default: N
d = error control and symbol size/type indicator	Values: 0 = default error correction level 01 to 99 = error correction percentage (minimum) 101 to 104 = 1 to 4-layer compact symbol 201 to 232 = 1 to 32-layer full-range symbol 300 = a simple Aztec "Rune" Default: 0
e = menu symbol indicator	Values: Y = if this symbol is to be a menu (bar code reader initialization) symbol N = if it is not a menu symbol Default: N
f = number of symbols for structured append	Values: 1 through 26 Default: 1

ZPL Commands

Parameters	Details
g = optional ID field for structured append	The ID field is a text string with 24-character maximum Default: no ID

Example: This is an example of the **^B0** command:

ZPL II CODE	GENERATED LABEL
<pre>^XA ^B0R,7,N,0,N,1,0 ^FD 7. This is testing label 7^FS ^XZ</pre>	

^BP

Plessey Bar Code

The ^BP command is a pulse-width modulated, continuous, non-self-checking symbology.

Each character in the Plessey bar code is composed of eight elements: four bars and four adjacent spaces.

- ^BP supports a print ratio of 2.0:1 to 3.0:1.
- Field data (^FD) is limited to the width (or length, if rotated) of the label.



IMPORTANT: If additional information about this bar code is required, go to www.aimglobal.org.

Format: ^BPo,e,h,f,g

Parameters	Details
o = orientation	Values: N = normal R = rotated 90 degrees (clockwise) I = inverted 180 degrees B = read from bottom up, 270 degrees Default: current ^FW value
e = print check digit	Values: N = no Y = yes Default: N
h = bar code height (in dots)	Values: N = no Y = yes Default: N
f = print interpretation line	Values: N = no Y = yes Default: Y
g = print interpretation line above code	Values: N = no Y = yes Default: N

Example: This is an example of a Plessey bar code:

ZPL II CODE	
^XA	
^FO100,100^BY3	
^BPN,N,100,Y,N	
^FD12345^FS	
^XZ	

PLESSEY BAR CODE	
	

PLESSEY BAR CODE CHARACTERS									
0	1	2	3	4	5	6	7	8	9
			A	B	C	D	E	F	

^BQ**QR Code Bar Code**

The **^BQ** command produces a matrix symbology consisting of an array of nominally square modules arranged in an overall square pattern. A unique pattern at three of the symbol's four corners assists in determining bar code size, position, and inclination.

A wide range of symbol sizes is possible, along with four levels of error correction. User-specified module dimensions provide a wide variety of symbol production techniques.

QR Code Model 1 is the original specification, while QR Code Model 2 is an enhanced form of the symbology. Model 2 provides additional features and can be automatically differentiated from Model 1.

Model 2 is the recommended model and should normally be used.

This bar code is printed using field data specified in a subsequent **^FD** string.

Encodable character sets include numeric data, alphanumeric data, 8-bit byte data, and Kanji characters.



IMPORTANT: If additional information about this bar code is required, go to www.aimglobal.org.

Format: **^BQa,b,c,d,e**

Parameters	Details
a = field orientation	Values: normal (^FW has no effect on rotation)
b = model	Values: 1 (original) and 2 (enhanced – recommended) Default: 2
c = magnification factor	Values: 1 to 10 Default: 1 on 150 dpi printers 2 on 200 dpi printers 3 on 300 dpi printers 6 on 600 dpi printers
d = error correction	Values: H = ultra-high reliability level Q = high reliability level M = standard level L = high density level Default: Q = if empty M = invalid values
e = mask value	Values: 0 - 7 Default: 7

Example: This is an example of a QR Code bar code:

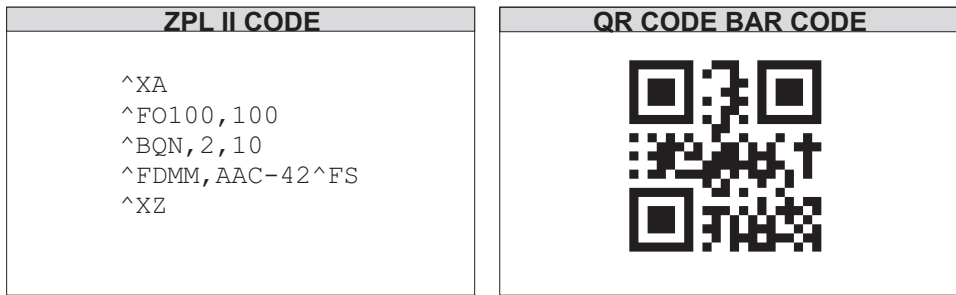

On the pages that follow are specific commands for formatting the ^BQ command with the ^FD statements that contain the information to be coded.

QR Switches (formatted into the ^FD field data)

There are 4 switch fields that are allowed, some with associated parameters and some without. Two of these fields are always present, one is optional, and one's presence depends on the value of another. The switches are always placed in a fixed order. The four switches, in order are:

Mixed mode <D>iiijxx,Optional (note that this switch ends with a comma ",")

Error correction level <H, Q, M, L>Mandatory

Data input <A, M>,Mandatory (note that this switch ends with a comma ",")

Character Mode <N, A, Bdddd, K>Conditional (present if data input is M)

Mixed mode (Optional)

= D - allows mixing of different types of character modes in one code.

ii = code No. – a 2 digit number in the range 01 to 16

Value = subtracted from the Nth number of the divided code (must be two digits).

jj = No. of divisions – a 2 digit number in the range 02 to 16

Number of divisions (must be two digits).

xx = parity data – a 2 digit hexadecimal character in the range 00 to FF

Parity data value is obtained by calculating at the input data (the original input data before divided byte-by-byte through the EX-OR operation).

, = the mixed mode switch, when present, is terminated with a comma

Error correction level (Required)

= H, Q, M, or L

H = ultra-high reliability level

Q = high reliability level

M = standard level (default)

L = high density level

Data input (Required)

= A or M followed by a comma

A = Automatic Input (default). Character Mode is not specified.

Data character string JIS8 unit, Shift JIS. When the input mode is Automatic Input, the binary codes of 0x80 to 0x9F and 0xE0 to 0xFF cannot be set.

M = Manual Input. Character Mode must be specified.

Two types of data input mode exist: Automatic (A) and Manual (M). If A is specified, the character mode does not need to be specified. If M is specified, the character mode must be specified.

Character Mode (Required when data input = M)

= N, A, Bxxxx, or K

N = numeric: digits 0 – 9

A = alphanumeric: digits 0 – 9, upper case letters A – Z, space, and \$%*+-./:) (45 characters)

Bxxxx = 8-bit byte mode. The 'xxxx' is the number of characters and must be exactly 4 decimal digits.

This handles the 8-bit Latin/Kana character set in accordance with JIS X 0201 (character values 0x00 to 0xFF).

K = Kanji — handles only Kanji characters in accordance with the Shift JIS system based on JIS X 0208. This means that all parameters after the character mode K should be 16-bit characters. If there are any 8-bit characters (such as ASCII code), an error occurs.

The data to be encoded follows immediately after the last switch.

Considerations for \wedge F \bar{D} When Using the QR Code:**QR Switches (formatted into the \wedge F \bar{D} field data)****mixed mode <D>**

D = allows mixing of different types of character modes in one code.

code No. <01 16>

Value = subtracted from the Nth number of the divided code (must be two digits).

No. of divisions <02 16>

Number of divisions (must be two digits).

parity data <1 byte>

Parity data value is obtained by calculating at the input data (the original input data before divided byte-by-byte through the EX-OR operation).

error correction level <H, Q, M, L>

H = ultra-high reliability level

Q = high reliability level

M = standard level (default)

L = high density level

character Mode <N, A, B, K>

N = numeric

A = alphanumeric

Bxxxx = 8-bit byte mode. This handles the 8-bit Latin/Kana character set in accordance with JIS X 0201 (character values 0x00 to 0xFF).

xxxx = number of data characters is represented by two bytes of BCD code.

K = Kanji — handles only Kanji characters in accordance with the Shift JIS system based on JIS X 0208. This means that all parameters after the character mode **K** should be 16-bit characters. If there are any 8-bit characters (such as ASCII code), an error occurs.

data character string <Data>

Follows character mode or it is the last switch in the ^FD statement.

data input <A, M>

A = Automatic Input (default). Data character string JIS8 unit, Shift JIS. When the input mode is Automatic Input, the binary codes of 0x80 to 0x9F and 0xE0 to 0xFF cannot be set.

M = Manual Input

Two types of data input mode exist: Automatic (A) and Manual (M). If A is specified, the character mode does not need to be specified. If M is specified, the character mode must be specified.

^FD Field Data (Normal Mode)

Automatic Data Input (A) with Switches

^FD

<error correction level>A,

<data character string>

^FS

QR Code, normal mode with automatic data input.

ZPL II CODE	GENERATED LABEL
<pre> ^XA ^FO20,20^BQ,2,10^FDQA,0123456789ABCD 2D code^FS ^XZ </pre> <div style="text-align: center; margin-top: 10px;"> </div>	

1	Q = error correction level
2	A, = automatic setting
3	data string character

Manual Data Input (M) with Switches

```

^FD
<error correction level>M,
<character mode><data character string>
^FS
    
```

QR Code, normal mode with manual data input:

ZPL II CODE	GENERATED LABEL
<pre> ^XA ^FO20,20^BQ,2,10 ^FDHM,N123456789012345^FS ^XZ </pre>	

1	H = error correction level (ultra-high reliability level)
2	M, = input mode (manual input)
3	N = character mode (numeric data)
4	data character string

QR Code, normal mode with standard reliability and manual data input:

ZPL II CODE	GENERATED LABEL
<pre> ^XA ^FO20,20^BQ,2,10^FDMM, AAC-42^FS ^XZ </pre>	

1	M = error correction level (standard-high reliability level)
2	M, = manual input
3	A = alphanumeric data
4	AC-42 = data character string

^FD Field Data (Mixed Mode – requires more switches)**Automatic Data Input (A) with Switches**

```

^FD
<D><code No.> <No. of divisions> <parity data>,
<error correction level> A,
<data character string>,
<data character string>,
< : >,
<data character string n**>
^FS

```

Manual Data Input (M) with Switches

```

^FD
<code No.> <No. of divisions> <parity data>,
<error correction level> M,
<character mode 1> <data character string 1>,
<character mode 2> <data character string 2>,
< : > < : >,
<character mode n> <data character string n**>
^FS

```

n** up to 200 in mixed mode

QR Code, mixed mode with manual data input:

ZPL II CODE	GENERATED LABEL
<pre> ^XA ^FO,20,20^BQ,2,10 ^FDD03048F,LM,N0123456789,A12AABB,B0006qrcode^FS ^XZ </pre>	

<mixed mode identifier>	D	(mixed)
<code No.>	M	(code number)
<No. of divisions>	D	(divisions)
<parity data>	M	(0x0C)
	‘	
<error correction level>	L	(high-density level)
<input mode>	M	(manual input)
	‘	
<character mode>	N	(numeric data)
<data character string>		0123456789
	‘	
<character mode>	A	(alphanumeric data)
<data character string>		12AABB
	‘	
<character mode>	B	(8-bit byte data)
	0006	(number of bytes)
<data character string>		qrcode

Example: This is an example of QR Code, mixed mode with automatic data input:

```

^XA
^FO20,20^BQ,2,10
^FDD03040C,LA,012345678912AABBqrcode^FS
^XZ
    
```

<mixed mode identifier>	D	D (mixed)
<code No.>	M	03 (code number)
<No. of divisions>	D	04 (divisions)
<parity data>	M	0C (0x0C)
<error correction level>	L	L (high-density level)
<input mode>	A	A (automatic input)
<data character string>		012345678912AABBqrcode

.14↑

For proper functionality, when encoding Kanji characters in **^CI28-30** (Unicode) be sure the **JIS.DAT** table is loaded on the printer and specified.

Example: This is a Unicode example:

ZPL II CODE	GENERATED LABEL
<pre data-bbox="331 390 654 447">^XA^SEE:JIS.DAT^CI28 ^FO20,20^BQ,2,10^FDLM, K月^FS ^XZ</pre>	

^BR**GS1 Databar****(formerly Reduced Space Symbology)**

The **^BR** command is bar code types for space-constrained identification from EAN International and the Uniform Code Council, Inc.

Format: **^BR***a,b,c,d,e,f*

Parameters	Details
a = orientation	Values: N = Normal R = Rotated I = Inverted B = Bottom-up Default: R
b = symbology type in the GS1 DataBar family	Values: 1 = GS1 DataBar Omnidirectional 2 = GS1 DataBar Truncated 3 = GS1 DataBar Stacked 4 = GS1 DataBar Stacked Omnidirectional 5 = GS1 DataBar Limited 6 = GS1 DataBar Expanded 7 = UPC-A 8 = UPC-E 9 = EAN-13 10 = EAN-8 11 = UCC/EAN-128 and CC-A/B 12 = UCC/EAN-128 and CC-C Default: 1
c = magnification factor	Values: 1 to 10 Default: 24 dot = 6 , 12 dot is 3 , 8 dot and lower is 2 12 dot = 6 , > 8 dot is 3 , 8 dot and less is 2
d = separator height	Values: 1 or 2 Default: 1
e = bar code height	The bar code height only affects the linear portion of the bar code. Only UCC/EAN and CC-A/B/C. Values: 1 to 32000 dots Default: 25

ZPL Commands

Parameters	Details
f = the segment width (GS1 DataBar Expanded only)	Values: 2 to 22, even numbers only, in segments per line Default: 22

Example: This is an example of Symbology Type 7 - UPC-A:

ZPL II CODE	GENERATED LABEL
<pre> ^XA ^FO10,10^BRN,7,5,2,100 ^FD12345678901 this is composite info^FS ^XZ </pre>	

Example: This is an example of Symbology Type 1 - GS1 DataBar Omnidirectional:

ZPL II CODE	GENERATED LABEL
<pre> ^XA ^FO10,10^BRN,1,5,2,100 ^FD12345678901 this is composite info^FS ^XZ </pre>	

^BS

UPC/EAN Extensions

The ^BS command is the two-digit and five-digit add-on used primarily by publishers to create bar codes for ISBNs (International Standard Book Numbers). These extensions are handled as separate bar codes.

The ^BS command is designed to be used with the UPC-A bar code (^BU) and the UPC-E bar code (^B9).

- ^BS supports a fixed print ratio.
- Field data (^FD) is limited to exactly two or five characters. ZPL II automatically truncates or pads on the left with zeros to achieve the required number of characters.



IMPORTANT: If additional information about this bar code is required, go to www.aimglobal.org.

Format: ^BS`o,h,f,g`

Parameters	Details
<code>o</code> = orientation	Values: N = normal R = rotated 90 degrees (clockwise) I = inverted 180 degrees B = read from bottom up, 270 degrees Default: current ^FW value
<code>h</code> = bar code height (in dots)	Values: 1 to 32000 Default: value set by ^BY
<code>f</code> = print interpretation line	Values: N = no Y = yes Default: Y
<code>g</code> = print interpretation line above code	Values: N = no Y = yes Default: Y

ZPL Commands

Example: This is an example of a UPC/EAN Two-digit bar code:

ZPL II CODE	UPC/EAN 2-DIGIT BAR CODE
<pre> ^XA ^FO100,100^BY3 ^BSN,100,Y,N ^FD12^FS ^XZ </pre>	 12
UPC/EAN 2-DIGIT BAR CODE CHARACTERS	
0 1 2 3 4 5 6 7 8 9	

Example: This is an example of a UPC/EAN Five-digit bar code:

ZPL II CODE	UPC/EAN 5-DIGIT BAR CODE
<pre> ^XA ^FO100,100^BY3 ^BSN,100,Y,N ^FD12345^FS ^XZ </pre>	 12345
UPC/EAN 5-DIGIT BAR CODE CHARACTERS	
0 1 2 3 4 5 6 7 8 9	

Care should be taken in positioning the UPC/EAN extension with respect to the UPC-A or UPC-E code to ensure the resulting composite code is within the UPC specification.

For UPC codes, with a module width of 2 (default), the field origin offsets for the extension are:

Example: This is an example of a UPC-A:

	Supplement Origin X - Offset	Adjustment Y - Offset
<i>Normal</i>	209 Dots	21 Dots
<i>Rotated</i>	0	209 Dots

Example: This is an example of a UPC-E:

	Supplement Origin X - Offset	Adjustment Y - Offset
<i>Normal</i>	122 Dots	21 Dots
<i>Rotated</i>	0	122 Dots

Additionally, the bar code height for the extension should be 27 dots (0.135 inches) shorter than that of the primary code. A primary UPC code height of 183 dots (0.900 inches) requires an extension height of 155 dots (0.765 inches).

ZPL Commands

Example: This example illustrates how to create a normal UPC-A bar code for the value 700002198 with an extension equal to 04414:

ZPL II CODE	UPC-A BAR CODE WITH EXTENSION
<pre>^XA ^FO100,100^BY3 ^BUN,137 ^FD07000002198^FS ^FO400,121 ^BSN,117 ^FD04414^FS ^XZ</pre>	

^BT**TLC39 Bar Code**

The ^BT bar code is the standard for the TCIF can tag telecommunications equipment.

The TCIF CLEI code, which is the MicroPDF417 bar code, is always four columns. The firmware must determine what mode to use based on the number of characters to be encoded.

Format: ^BT*o,w1,r1,h1,w2,h2*

Parameters	Details
o = orientation	Values: N = normal R = rotated I = inverted B = bottom up
w1 = width of the Code 39 bar code	Values: <i>(in dots):</i> 1 to 10 Default: <i>(600 dpi printers):</i> 4 Default: <i>(200- and 300 dpi printer):</i> 2
r1 = wide to narrow bar width ratio the Code 39 bar code	Values: 2.0 to 3.0(increments of 0.1) Default: 2.0
h1 = height of the Code 39 bar code	Values: <i>(in dots):</i> 1 to 9999 Default: <i>(600 dpi printer):</i> 120 Default: <i>(300 dpi printer):</i> 60 Default: <i>(200 dpi printer):</i> 40
h2 = row height of the MicroPDF417 bar code	Values: <i>(in dots):</i> 1 to 255 Default: <i>(600 dpi printer):</i> 8 Default: <i>(200- and 300 dpi printers):</i> 4
w2 = narrow bar width of the MicroPDF417 bar code	Values: <i>(in dots):</i> 1 to 10 Default: <i>(600 dpi printer):</i> 4 Default: <i>(200- and 300 dpi printers):</i> 2

How to Print TLC39 Bar Code



Example: This is an example on how to print TLC39 bar code. The callouts identify the key components and are followed by a detailed description below:

Use the command defaults to get results that are in compliance with TCIF industry standards; regardless of printhead density.

```

^XA^FO100,100^BT^FD123456,ABCD12345678901234
5551212,888999^FS^XZ
    
```

Callout 1 points to the ECI number '123456'.
 Callout 2 points to the serial number 'ABCD12345678901234'.
 Callout 3 points to the additional data '5551212,888999'.

1	<p>ECI Number. If the seventh character is not a comma, only Code 39 prints. This means if more than 6 digits are present, Code 39 prints for the first six digits (and no Micro-PDF symbol is printed).</p> <ul style="list-style-type: none"> • Must be 6 digits. • Firmware generates invalid character error if the firmware sees anything but 6 digits. • This number is not padded. 				
2	<p>Serial number. The serial number can contain up to 25 characters and is variable length. The serial number is stored in the Micro-PDF symbol. If a comma follows the serial number, then additional data is used below.</p> <ul style="list-style-type: none"> • If present, must be alphanumeric (letters and numbers, no punctuation). <p>This value is used if a comma follows the ECI number.</p>				
3	<p>Additional data. If present, it is used for things such as a country code. Data cannot exceed 150 bytes. This includes serial number commas.</p> <ul style="list-style-type: none"> • Additional data is stored in the Micro-PDF symbol and appended after the serial number. A comma must exist between each maximum of 25 characters in the additional fields. • Additional data fields can contain up to 25 alphanumeric characters per field. <p>The result is:</p> <table border="1" style="width: 100%; border-collapse: collapse;"> <thead> <tr> <th style="text-align: center; background-color: #cccccc;">ZPL II CODE</th> <th style="text-align: center; background-color: #cccccc;">GENERATED LABEL</th> </tr> </thead> <tbody> <tr> <td style="padding: 5px;"> <pre> ^XA^FO100, 100^BT^FD123456, ABCD12345678901234, 5551212, 888999 ^FS^XZ </pre> </td> <td style="text-align: center; padding: 5px;">  </td> </tr> </tbody> </table>	ZPL II CODE	GENERATED LABEL	<pre> ^XA^FO100, 100^BT^FD123456, ABCD12345678901234, 5551212, 888999 ^FS^XZ </pre>	
ZPL II CODE	GENERATED LABEL				
<pre> ^XA^FO100, 100^BT^FD123456, ABCD12345678901234, 5551212, 888999 ^FS^XZ </pre>					

^BU**UPC-A Bar Code**

The **^BU** command produces a fixed length, numeric symbology. It is primarily used in the retail industry for labeling packages. The UPC-A bar code has 11 data characters. The 6 dot/mm, 12 dot/mm, and 24 dot/mm printheads produce the UPC-A bar code (UPC/EAN symbologies) at 100 percent size. However, an 8 dot/mm printhead produces the UPC/EAN symbologies at a magnification factor of 77 percent.

- **^BU** supports a fixed print ratio.
- Field data (**^FD**) is limited to exactly 11 characters. ZPL II automatically truncates or pads on the left with zeros to achieve required number of characters.



IMPORTANT: If additional information about this bar code is required, go to www.aimglobal.org.

Format: **^BU***o,h,f,g,e*

Parameters	Details
o = orientation	Values: N = normal R = rotated 90 degrees (clockwise) I = inverted 180 degrees B = read from bottom up, 270 degrees Default: current ^FW value
h = bar code height (in dots)	Values: 1 to 9999 Default: value set by ^BY
f = print interpretation line	Values: N = no Y = yes Default: Y
g = print interpretation line above code	Values: N = no Y = yes Default: N
e = print check digit	Values: N = no Y = yes Default: Y

The font style of the interpretation line depends on the modulus (width of narrow bar) selected in **^BY**. Zero is not allowed.

- **6 dot/mm printer:** a modulus of 2 dots or greater prints with an OCR-B interpretation line; a modulus of 1 dot prints font A.
- **8 dot/mm printer:** a modulus of 3 dots or greater prints with an OCR-B interpretation line; a modulus of 1 or 2 dots prints font A.
- **12 dot/mm printer:** a modulus of 5 dots or greater prints with an OCR-B interpretation line; a modulus of 1, 2, 3, or 4 dots prints font A.
- **24 dot/mm printer:** a modulus of 9 dots or greater prints with an OCR-B interpretation line; a modulus of 1 to 8 dots prints font A.

Example: This is an example of a UPC-A bar code with extension:

ZPL II CODE	UPC-A BAR CODE WITH EXTENSION
<pre> ^XA ^FO100,100^BY3 ^BUN,137 ^FD07000002198^FS ^FO400,121 ^BSN,117 ^FD04414^FS ^XZ </pre>	

Comments: The UPC-A bar code uses the Mod 10 check digit scheme for error checking. For further information on Mod 10, see [Mod 10 Check Digit on page 1423](#).

^BX**Data Matrix Bar Code**

The **^BX** command creates a two-dimensional matrix symbology made up of square modules arranged within a perimeter finder pattern.

Format: **^BXo,h,s,c,r,f,g,a**

Parameters	Details
o = orientation	<p>Values:</p> <p>N = normal</p> <p>R = rotated 90 degrees (clockwise)</p> <p>I = inverted 180 degrees</p> <p>B = read from bottom up, 270 degrees</p> <p>Default: current ^FW value</p>
h = dimensional height of individual symbol elements	<p>Values: 1 to the width of the label</p> <p>The individual elements are square — this parameter specifies both module and row height. If this parameter is zero (or not given), the h parameter (bar height) in ^BY is used as the approximate symbol height.</p>
s = quality level	<p>Values: 0, 50, 80, 100, 140, 200</p> <p>Default: 0</p> <p><i>Quality</i> refers to the amount of data that is added to the symbol for error correction. The AIM specification refers to it as the ECC value. ECC 50, ECC 80, ECC 100, and ECC 140 use convolution encoding; ECC 200 uses Reed-Solomon encoding. For new applications, ECC 200 is recommended. ECC 000-140 should be used only in closed applications where a single party controls both the production and reading of the symbols and is responsible for overall system performance.</p>
c = columns to encode	<p>Values: 9 to 49</p> <p>Odd values only for quality 0 to 140 (10 to 144); even values only for quality 200.</p> <p>Odd values only for quality 0 to 140 (10 to 144); even values only for quality 200. The number of rows and columns in the symbol is automatically determined. You might want to force the number of rows and columns to a larger value to achieve uniform symbol size. In the current implementation, quality 0 to 140 symbols are square, so the larger of the rows or columns supplied are used to force a symbol to that size. If you attempt to force the data into too small of a symbol, no symbol is printed. If a value greater than 49 is entered, the rows or columns value is set to zero and the size is determined normally. If an even value is entered, it generates INVALID-P (invalid parameter). If a value less than 9 but not 0, or if the data is too large for the forced size, no symbol prints; if ^CV is active, INVALID-L prints.</p>
r = rows to encode	<p>Values: 9 to 49</p>

Parameters	Details
f = format ID (0 to 6) — not used with quality set at 200	<p>Values:</p> <ul style="list-style-type: none"> 1 = field data is numeric + space (0..9,") – No \&" 2 = field data is uppercase alphanumeric + space (A..Z,") – No \&" 3 = field data is uppercase alphanumeric + space, period, comma, dash, and slash (0..9,A..Z,"-"/) 4 = field data is upper-case alphanumeric + space (0..9,A..Z,") – no \&" 5 = field data is full 128 ASCII 7-bit set 6 = field data is full 256 ISO 8-bit set <p>Default: 6</p>
g = escape sequence control character	<p>Values: any character</p> <p>Default: ~ (tilde)</p> <p>This parameter is used only if quality 200 is specified. It is the escape character for embedding special control sequences within the field data.</p> <p>A value must always be specified when using the escape sequence control character. If no value is entered, the command is ignored.</p> <p>The g parameter will continue to be underscore (_) for anyone with firmware version: V60.13.0.12, V60.13.0.12Z, V60.13.0.12B, V60.13.0.12ZB, or later.</p>
a = aspect ratio  The a parameter is only supported in V60.16.5Z and V53.16.5Z or later.	<p>Values:</p> <ul style="list-style-type: none"> 1 = square 2 = rectangular <p>Default: 1</p>

ECC LEVEL	ID = 1	ID = 2	ID = 3	ID = 4	ID = 5	ID = 6
0	596	452	394	413	310	271
50	457	333	291	305	228	200
80	402	293	256	268	201	176
100	300	218	190	200	150	131
140	144	105	91	96	72	63

Maximum Field Sizes

Example: This is an example of a square Data Matrix bar code:

ZPL II CODE	DATA MATRIX BAR CODE
<pre> ^XA ^FO100,100 ^BXN,10,200 ^FDZEBRA TECHNOLOGIES CORPORATION 333 CORPORATE WOODS PARKWAY VERNON HILLS, IL 60061-3109^FS ^XZ </pre>	

Example: This is an example of a rectangle Data Matrix bar code:

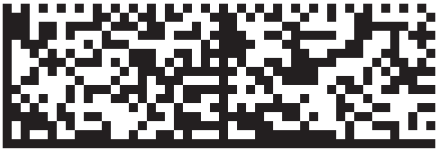
ZPL II CODE	DATA MATRIX BAR CODE
<pre> ^XA ^FO100,100 ^BXN,10,200,,,,,2 ^FDZEBRA TECHNOLOGIES CORPORATION 333 CORPORATE WOODS PARKWAY ^FS ^XZ </pre>	

Effects of ^BY on ^BX

w = **module width** (no effect)

r = **ratio** (no effect)

h = **height of symbol**

If the dimensions of individual symbol elements are not specified in the ^BY command, the height of symbol value is divided by the required rows/columns, rounded, limited to a minimum value of one, and used as the dimensions of individual symbol elements.

Field Data (^FD) for ^BX

Quality 000 to 140

- The |& and || can be used to insert carriage returns, line feeds, and the backslash, similar to the PDF417. Other characters in the control character range can be inserted only by using ^FH. Field data is limited to 596 characters for quality **0** to **140**. Excess field data causes no symbol to print; if ^CV is active, INVALID-L prints. The field data must correspond to a user-specified format ID or no symbol prints; if ^CV is active, INVALID-C prints.
- The maximum field sizes for quality **0** to **140** symbols are shown in the table in the g parameter.

Quality 200

- If more than 3072 bytes are supplied as field data, it is truncated to 3072 bytes. This limits the maximum size of a numeric Data Matrix symbol to less than the 3116 numeric characters that the specification would allow. The maximum alphanumeric capacity is 2335 and the maximum 8-bit byte capacity is 1556.
- If ^FH is used, field hexadecimal processing takes place before the escape sequence processing described below.
- The underscore is the default escape sequence control character for quality 200 field data. A different escape sequence control character can be selected by using parameter g in the ^BX command.

The information that follows applies to firmware version: V60.13.0.12, V60.13.0.12Z, V60.13.0.12B, V60.13.0.12ZB, or later. The input string escape sequences can be embedded in quality 200 field data using the ASCII 95 underscore character (`_`) or the character entered in parameter `g`:

- `_X` is the shift character for control characters (e.g., `_@=NUL`, `_G=BEL`, `_0 is PAD`)
- `_1` to `_3` for FNC characters 1 to 3 (explicit FNC4, upper shift, is not allowed)
- FNC2 (Structured Append) must be followed by nine digits, composed of three-digit numbers with values between 1 and 254, that represent the symbol sequence and file identifier (for example, symbol 3 of 7 with file ID 1001 is represented by `_2214001001`)
- `5NNN` is code page NNN where NNN is a three-digit code page value (for example, Code Page 9 is represented by `_5009`)
- `_dNNN` creates ASCII decimal value NNN for a code word (must be three digits)
- `_` in data is encoded by `__` (two underscores)

The information that follows applies to all other versions of firmware. The input string escape sequences can be embedded in quality 200 field data using the ASCII 7E tilde character (`~`) or the character entered in parameter `g`:

- `~X` is the shift character for control characters (e.g., `~@=NUL`, `~G=BEL`, `~0 is PAD`)
- `~1` to `~3` for FNC characters 1 to 3 (explicit FNC4, upper shift, is not allowed)
- FNC2 (Structured Append) must be followed by nine digits, composed of three-digit numbers with values between 1 and 254, that represent the symbol sequence and file identifier (for example, symbol 3 of 7 with file ID 1001 is represented by `~2214001001`)
- `5NNN` is code page NNN where NNN is a three-digit code page value (for example, Code Page 9 is represented by `~5009`)
- `~dNNN` creates ASCII decimal value NNN for a code word (must be three digits)
- `~` in data is encoded by a `~` (tilde)

^BY**Bar Code Field Default**

The **^BY** command is used to change the default values for the module width (in dots), the wide bar to narrow bar width ratio and the bar code height (in dots). It can be used as often as necessary within a label format.

Format: **^BY***w,r,h*

Parameters	Details
w = module width (in dots)	Values: 1 to 10 Initial Value at Power Up: 2
r = wide bar to narrow bar width ratio	Values: 2.0 to 3.0, in 0.1 increments This parameter has no effect on fixed-ratio bar codes. Default: 3.0
h = bar code height (in dots)	Initial Value at Power Up: 10

For parameter **r**, the actual ratio generated is a function of the number of dots in parameter **w**, module width. See [Table 5](#). Module width and height (**w** and **h**) can be changed at anytime with the **^BY** command, regardless of the symbology selected.

Table 5 Module Width Ratios in Dots

Ratio Selected (r)	Module Width in Dots (w)									
	1	2	3	4	5	6	7	8	9	10
2.0	2:1	2:1	2:1	2:1	2:1	2:1	2:1	2:1	2:1	2:1
2.1	2:1	2:1	2:1	2:1	2:1	2:1	2:1	2:1	2:1	2.1:1
2.2	2:1	2:1	2:1	2:1	2.2:1	2.16:1	2.1:1	2.12:1	2.1:1	2.2:1
2.3	2:1	2:1	2.3:1	2.25:1	2.2:1	2.16:1	2.28:1	2.25:1	2.2:1	2.3:1
2.4	2:1	2:1	2.3:1	2.25:1	2.4:1	2.3:1	2.28:1	2.37:1	2.3:1	2.4:1
2.5	2:1	2.5:1	2.3:1	2.5:1	2.4:1	2.5:1	2.4:1	2.5:1	2.4:1	2.5:1
2.6	2:1	2.5:1	2.3:1	2.5:1	2.6:1	2.5:1	2.57:1	2.5:1	2.5:1	2.6:1
2.7	2:1	2.5:1	2.6:1	2.5:1	2.6:1	2.6:1	2.57:1	2.65:1	2.6:1	2.7:1
2.8	2:1	2.5:1	2.6:1	2.75:1	2.8:1	2.6:1	2.7:1	2.75:1	2.7:1	2.8:1
2.9	2:1	2.5:1	2.6:1	2.75:1	2.8:1	2.8:1	2.85:1	2.87:1	2.8:1	2.9:1
3.0	3:1	3:1	3:1	3:1	3:1	3:1	3:1	3:1	3:1	3:1

Example: Set module width (**w**) to 9 and the ratio (**r**) to 2.4. The width of the narrow bar is 9 dots wide and the wide bar is 9 by 2.4, or 21.6 dots. However, since the printer rounds out to the nearest dot, the wide bar is actually printed at 22 dots. This produces a bar code with a ratio of 2.44 (22 divided by 9). This ratio is as close to 2.4 as possible, since only full dots are printed.

Comments: Once a **^BY** command is entered into a label format, it stays in effect until another **^BY** command is encountered.

^BZ**POSTAL Bar Code**

The POSTAL bar code is used to automate the handling of mail. POSTAL codes use a series of tall and short bars to represent the digits.

- ^BZ supports a print ratio of 2.0:1 to 3.0:1.
- Field data (^FD) is limited to the width (or length, if rotated) of the label and by the bar code specification.



IMPORTANT: If additional information about the POSTAL and PLANET bar code is required, go to www.aimglobal.org, or contact the United States Postal Service <http://pe.usps.gov>. If additional information about the INTELLIGENT MAIL bar code is required, see: <http://ribbs.usps.gov/OneCodeSolution>.

Format: ^BZo,h,f,g,t

Parameters	Details
o = orientation	Values: N = normal R = rotated 90 degrees (clockwise) I = inverted 180 degrees B = read from bottom up, 270 degrees Default: current ^FW value
h = bar code height (in dots)	Values: 1 to 32000 Default: value set by ^BY
f = print interpretation line	Values: N = no Y = yes Default: N
g = print interpretation line above code	Values: N = no Y = yes Default: N
t = Postal code type	Values: 0 = Postnet bar code 1 = Plant Bar Code 2 = Reserved 3 = USPS Intelligent Mail bar code Default: 0

ZPL Commands

Example: This is an example of a POSTNET bar code:

ZPL II CODE	POSTNET BAR CODE								
<pre>^XA ^FO100,100^BY3 ^BZN,40,Y,N ^FD12345^FS ^XZ</pre>	 12345								
POSTNET BAR CODE CHARACTERS									
0	1	2	3	4	5	6	7	8	9

Example: This is an example of a USPS Intelligent Mail bar code:

ZPL II CODE	USPS INTELLIGENT MAIL BAR CODE
<pre>^XA ^FO100,040^BZ,40,,,3 ^FD00123123456123456789^FS ^XZ</pre>	

^CC ~CC

Change Caret

The ^CC command is used to change the format command prefix. The default prefix is the caret (^).

Format: ^CCx or ~CCx

Parameters	Details
x = caret character change	Values: any ASCII character Default: a parameter is required. If a parameter is not entered, the next character received is the new prefix character.

Example: This is an example of how to change the format prefix to / from a ::

```
^XA
^CC/
/XZ
```

The forward slash (/) is set at the new prefix. Note the /XZ ending tag uses the new designated prefix character (/).

Example: This is an example of how to change the format prefix from ~ to a /:

```
~CC/
/XA/JUS/XZ
```

^CD ~CD

Change Delimiter

The ^CD and ~CD commands are used to change the delimiter character. This character is used to separate parameter values associated with several ZPL II commands. The default delimiter is a comma (,).

Format: ^CDa or ~CDa

Parameters	Details
a = delimiter character change	<p>Values: any ASCII character</p> <p>Default: a parameter is required. If a parameter is not entered, the next character received is the new prefix character.</p>

Example: This shows how to change the character delimiter to a semi-colon (;):

```
^XA
^F010,10
^GB10,10,3
^XZ
^XA
^CD;
^F010;10
^GB10;10;3
^XZ
```

To save, the JUS command is required. Here is an example using JUS:

```
~CD;
^XA^JUS^XZ
```

^CF**Change Alphanumeric Default Font**

The ^CF command sets the default font used in your printer. You can use the ^CF command to simplify your programs.

Format: ^CFf,h,w

Parameters	Details
f = specified default font	Values: A through Z and 0 to 9 Initial Value at Power Up: A
h = individual character height (in dots)	Values: 0 to 32000 Initial Value at Power Up: 9
w = individual character width (in dots)	Values: 0 to 32000 Initial Value at Power Up: 5 or last permanent saved value

Parameter **f** specifies the default font for every alphanumeric field. Parameter **h** is the default height for every alphanumeric field, and parameter **w** is the default width value for every alphanumeric field.

The default alphanumeric font is A. If you do not change the alphanumeric default font and do not use any alphanumeric field command (^AF) or enter an invalid font value, any data you specify prints in font A.

Defining only the height or width forces the magnification to be proportional to the parameter defined. If neither value is defined, the last ^CF values given or the default ^CF values for height and width are used.

Example: This is an example of ^CF code and the result of the code:

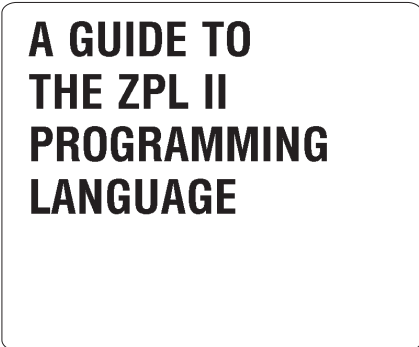
ZPL II CODE	GENERATED LABEL
<pre> ^XA ^CF0,89 ^FO20,50 ^FDA GUIDE TO^FS ^FO20,150 ^FDTHE ZPL II^FS ^FO20,250 ^FDPROGRAMMING^FS ^FO20,350 ^FDLANGUAGE^FS ^XZ </pre>	

Comments: Any font in the printer, including downloaded fonts, EPROM stored fonts, and fonts A through Z and 0 to 9, can also be selected with ^CW.

Parameters	Details
<p>a = desired character set (continued)</p> <p>.14↑ Values 28 to 30 are supported only in firmware version V60.14.x, V50.14.x, or later.</p> <p>.16↑ Values 31 to 36 are supported only in firmware version x.16.x or later.</p>	<ul style="list-style-type: none"> • 17 = Deprecated - UCS-2 Big Endian • 18 to 23 = Reserved • 24 = Single Byte Asian Encodings • 25 = Reserved • 26 = Multibyte Asian Encodings with ASCII Transparency and • 27 = Zebra Code Page 1252 (see page 1401) • 28 = Unicode (UTF-8 encoding) - Unicode Character Set • 29 = Unicode (UTF-16 Big-Endian encoding) - Unicode Character Set • 30 = Unicode (UTF-16 Little-Endian encoding) - Unicode Character Set • 31 = Zebra Code Page 1250 (see page 1399) is supported for scalable fonts, such as Font 0, or a downloaded TrueType font. Bitmapped fonts (including fonts A-H) do not fully support Zebra Code Page 1250. This value is supported only on Zebra G-Series™ printers. • 33 = Code Page 1251 • 34 = Code page 1253 • 35 = Code Page 1254 • 36 = Code Page 1255 <p>Initial Value at Power Up: 0</p>
s1 = source 1 (character output image)	Values: decimals 0 to 255
d1 = destination 1 (character input)	Values: decimals 0 to 255
s2 = source 2 (character output image)	Values: decimals 0 to 255
d2 = destination 2 (character input)	Values: decimals 0 to 255
... = continuation of pattern	Up to 256 source and destination pairs can be entered in this command.
<p>The encoding is controlled by the conversion table (*.DAT). The correct table must be present for the conversion to function. The table generated by ZTools™ is the TrueType fonts internal encoding (Unicode). Shift-JIS encoding converts Shift-JIS to JIS and then looks up the JIS conversion in JIS.DAT. This table must be present for Shift-JIS to function. Supports ASCII transparency for Asian encodings. 7F and less are treated as single byte characters. 80 to FE is treated as the first byte of a 2 byte character 8000 to FEFF in the encoding table for Unicode. The ^CI17 command has been deprecated, along with the ^F8 and ^F16 commands that are required for the ^CI17 command to function. The recommended replacement is the ^CI28-30 commands.</p>	

.14↑

80 to FF could mean quad byte in GB18030. The ^CI26 command can also be used to support the GB 18030 and Big5 HKSCS encodings. The GB 18030 uses the **GB18030.DAT** encoding table and BIG5 HKSCS uses the **BIG5HK.DAT** encoding table.

.14↑

The ^CI17 command has been deprecated, along with the ^F8 and ^F16 commands that are required for the ^CI17 command to function. The recommended replacement is the ^CI28-30 commands.

.14↑

We recommend that a **^CI** command (or Unicode BOM) is included at the beginning of each ZPL script. This is important when ZPL scripts with different encodings are being sent to a single printer. To assist in the interleaving of encoding schemes, the printer maintains two encoding states (**^CI0 - 28** and **^CI29 - 30**). It automatically acknowledges when it should switch encoding states, allowing it to distinguish between encodings, and maintains a **^CI** for each, but endianness is shared.

Example: This example remaps the Euro symbol (21) decimal to the dollar sign value (36) decimal. When the dollar sign character is sent to the printer, the Euro symbol prints:

ZPL II CODE	GENERATED LABEL
<pre> ^XA ^CI0,21,36 ^FO100,200^A0N50,50^FD\$0123^FS ^XZ </pre>	

The font selected determines the shape and resolution of the printed symbol.

International Character Sets

Hex	2	3	4	5	5	5	5	6	7	7	7	7
	3	0	0	B	C	D	E	0	B	C	D	E
CI0	#	0	@	[Φ]	^	'	{		}	~
CI1	#	0	@	⅓	Φ	⅔	^	'	¼	½	¾	~
CI2	£	0	@	[Φ]	^	'	{		}	~
CI3	f	0	\$	[U]	^	'	{	ij	}	~
CI4	#	0	@	Æ	Ø	Å	^	'	æ	ø	å	~
CI5	Ü	0	É	Ä	Ö	À	Ü	é	ä	ö	à	ü
CI6	#	0	\$	Ä	Ö	Ü	^	'	ä	ö	ü	ß
CI7	£	0	à	[ç]	^	'	é	ì	ù	è
CI8	#	0	à	â	ç	ê	î	ô	é	ù	è	û
CI9	£	0	\$	[ç	é	^	ù	à	ò	è	ì
CI10	#	0	\$	i	Ñ	¿	^	'	{	ñ	ç	~
CI11	£	0	É	Ä	Ö	Ü	^	'	ä	ë	ï	ö
CI12	#	0	@	[¥]	^	'	{		}	~
CI13	#	0	@	[\]	^	'	{		}	~



NOTE: **^CI 13** = US keyboard

Comments: The space character cannot be remapped for any font.

^CM**Change Memory Letter Designation**

The ^CM command allows you to reassign a letter designation to the printer's memory devices. If a format already exists, you can reassign the memory device to the corresponding letter without forcing, altering, or recreating the format itself.

Using this command affects every subsequent command that refers to specific memory locations.

Format: ^CMa,b,c,d

Parameters	Details
a = memory alias for B:	Values: B:, E:,R:, A:, and NONE Default: B:
b = memory alias for E:	Values: B:, E:,R:, A:, and NONE Default: E:
c = memory alias for R:	Values: B:, E:,R:, A:, and NONE Default: R:
d = memory alias for A:	Values: B:, E:,R:, A:, and NONE Default: A:
e = multiple alias	Values: M, or no value Default: no value <ul style="list-style-type: none"> • This parameter is supported on Xi4 and ZM400/ZM600 printers using firmware V53.17.7Z or later. • This parameter is supported on G-Series printers using firmware versions v56.17.7Z and v61.17.7Z or later. • This parameter is supported on printers using firmware V60.17.7Z or later.

Comments: Unless the e (multiple alias) parameter is used, when two or more parameters specify the same letter designator, all letter designators are set to their default values.

It is recommended that after entering the ^CM command, ^JUS is entered to save changes to EEPROM. Any duplicate parameters entered will reset the letter designations back to the default.

If any of the parameters are out of specification, the command is ignored.

Example: This example designates letter E: to point to the B: memory device, and the letter B: to point to the E:memory device.

```
^XA
```

```
^CME,B,R,A
```

```
^JUS
```

```
^XZ
```

Example: This example designates that content sent to, or read from the B: or E: memory locations will be sent to or read from the E: memory location.

```
^XA  
^CME,E,R,A,M  
^JUS  
^XZ
```

Example: This example designates that content sent to, or read from the A: or E: memory locations will be sent to or read from the E: memory location.

```
^XA  
^CMB,E,R,E,M  
^JUS  
^XZ
```

Example: This example designates that content sent to, or read from the A:, B: or E: memory locations will be sent to or read from the E: memory location.

```
^XA  
^CME,E,R,E,M  
^JUS  
^XZ
```



NOTE: The last three examples are the only valid uses of the multiple alias parameter.

^CN

Cut Now

The ^CN causes the printer to cycle the media cutter.



IMPORTANT: This command works only when the printer is in Print Mode Kiosk (^MMk). If the printer is not in Print Mode Kiosk, then using this command has no effect. See [^MM on page 281](#).

Supported Devices:

- KR403

Format: ^CNa

a = Cut Mode Override	<p>Values:</p> <p>0 = Use the “kiosk cut amount” setting from ^KV</p> <p>1 = Ignore “kiosk cut amount” from ^KV and do a full cut</p> <p>Default: none</p> <p>The command is ignored if parameters are missing or invalid.</p>

^CO**Cache On**

The **^CO** command is used to change the size of the character cache. By definition, a *character cache* (referred to as cache) is a portion of the DRAM reserved for storing scalable characters. All printers have a default 40K cache that is always turned on. The maximum single character size that can be stored, without changing the size of the cache, is 450 dots by 450 dots.

There are two types of fonts used in Zebra printers: bitmapped and scalable. Letters, numbers, and symbols in a bitmapped font have a fixed size (for example: 10 points, 12 points, 14 points). By comparison, scalable fonts are not fixed in size.

Because their size is fixed, bitmapped fonts can be moved quickly to the label. In contrast, scalable fonts are much slower because each character is built on an as-needed basis before it is moved to the label. By storing scaled characters in a cache, they can be recalled at a much faster speed.

The number of characters that can be stored in the cache depends on two factors: the size of the cache (memory) and the size of the character (in points) being saved. The larger the point size, the more space in the cache it uses. The default cache stores every scalable character that is requested for use on a label. If the same character, with the same rotation and size is used again, it is quickly retrieved from cache.

It is possible that after a while the print cache could become full. Once the cache is full, space for new characters is obtained by eliminating an existing character from the print cache. Existing characters are eliminated by determining how often they have been used. This is done automatically. For example, a 28-point **Q** that was used only once would be a good candidate for elimination from the cache.

Maximum size of a single print cache character is 1500 dots by 1500 dots. This would require a cache of 274K. When the cache is too small for the desired style, smaller characters might appear but larger characters do not. If possible, increase the size of the cache.

Format: **^COa,b,c**

Parameters	Details
a = cache on	Values: N = no Y = yes Default: Y
b = amount of additional memory to be added to cache (in K)	Values: 1 to 9999 Default: 40
c = cache type	Values: 0 = cache buffer (normal fonts) 1 = internal buffer (recommended for Asian fonts) Default: 0

Example: To resize the print cache to 62K, assuming a 22K existing cache:

^COY,40

Example: To resize the print cache to 100K, assuming a 22K existing cache:

^COY,78

Print Cache Performance

For printing large characters, memory added to the cache by the `^C0` command is not physically added to the 22K cache already in the printer. In the second example above, the resulting 100K cache is actually two separate blocks of memory, 22K and 78K.

Because large characters need contiguous blocks of memory, a character requiring a cache of 90K would not be completely stored because neither portion of the 100K cache is big enough. Therefore, if large characters are needed, the `^C0` command should reflect the actual size of the cache you need.

Increasing the size of the cache improves the performance in printing scalable fonts. However, the performance decreases if the size of the cache becomes large and contains too many characters. The performance gained is lost because of the time involved searching the cache for each character.

Comments: The cache can be resized as often as needed. Any characters in the cache when it is resized are lost. Memory used for the cache reduces the space available for label bitmaps, graphic, and fonts.

Some Asian fonts require an internal working buffer that is much larger than the normal cache. Since most fonts do not require this larger buffer, it is now a selectable configuration option. Printing with the Asian fonts greatly reduces the printer memory available for labels, graphics, fonts, formats, and label bitmaps.



NOTE: If you have firmware x.12 or greater this command is not required because the printer firmware automatically expands the size of the character cache as needed.

^CP**Remove Label**

The ^CP command causes the printer to move a printed label out of the presenter area in one of several ways.

Supported Devices:

- KR403

Format: ^CPa

Parameters	Details
<p>a = kiosk present mode</p>	<p>Values:</p> <ul style="list-style-type: none"> 0 = Eject presented page 1 = Retracts presented page 2 = Takes the action defined by c parameter of ^KV command. <p>Default: none</p> <p>The command is ignored if parameters are missing or invalid.</p>

^CT ~CT

Change Tilde

The ^CT and ~CT commands are used to change the control command prefix. The default prefix is the tilde (~).

Format: ^CTa or ~CTa

Parameters	Details
a = change control command character	<p>Values: any ASCII character</p> <p>Default: a parameter is required. If a parameter is not entered, the next character received is the new control command character.</p>

Example: This is an example of how to change the control command prefix from a ^ to a +:

```
^XA
^CT+
^XZ
+HS
```

^CV

Code Validation

The ^CV command acts as a switch to turn the code validation function on and off. When this command is turned on, all bar code data is checked for these error conditions:

- character not in character set
- check-digit incorrect
- data field too long (too many characters)
- data field too short (too few characters)
- parameter string contains incorrect data or missing parameter

When invalid data is detected, an error message and code is printed in reverse image in place of the bar code. The message reads **INVALID - X** where **X** is one of these error codes:

C = character not in character set

E = check-digit incorrect

L = data field too long

S = data field too short

P = parameter string contains incorrect data

(occurs only on select bar codes)

Once turned on, the ^CV command remains active from format to format until turned off by another ^CV command or the printer is turned off. The command is not permanently saved.

Format: ^CVa

Parameters	Details
a = code validation	Values: N = no Y = yes Default: N

ZPL Commands

Example: The examples below show the error labels ^CVY generates when incorrect field data is entered. Compare the letter following **INVALID** – to the listing on the previous page.

ZPL II CODE	GENERATED LABEL
<pre> ^XA ^CVY ^FO50,50 ^BEN,100,Y,N ^FD97823456 890^FS ^XZ </pre>	
<pre> ^XA ^CVY ^FO50,50 ^BEN,100,Y,N ^FD9782345678907^FS ^XZ </pre>	
<pre> ^XA ^CVY ^FO50,50 ^BEN,100,Y,N ^FD97823456789081^FS ^XZ </pre>	
<pre> ^XA ^CVY ^FO50,50 ^BEN,100,Y,N ^FD97823456789^FS ^XZ </pre>	
<pre> ^XA ^CVY ^FO50,50 ^BQN2,3 ^FDHM,BQRCODE-22^FS ^XZ </pre>	

Comments: If more than one error exists, the first error detected is the one displayed.

The ^CV command tests the integrity of the data encoded into the bar code. It is not used for (or to be confused with) testing the scan-integrity of an image or bar code.

^CW

Font Identifier

All built-in fonts are referenced using a one-character identifier. The ^CW command assigns a single alphanumeric character to a font stored in DRAM, memory card, EPROM, or Flash.

If the assigned character is the same as that of a built-in font, the downloaded font is used in place of the built-in font. The new font is printed on the label wherever the format calls for the built-in font. If used in place of a built-in font, the change is in effect only until power is turned off.

If the assigned character is different, the downloaded font is used as an additional font. The assignment remains in effect until a new command is issued or the printer is turned off.

Format: ^CWa,d:o.x

Parameters	Details
a = letter of existing font to be substituted, or new font to be added	Values: A through Z and 0 to 9 Default: a one-character entry is required
d = device to store font in (optional)	Values: R:, E:, B:, and A: Default: R:
o = name of the downloaded font to be substituted for the built-in, or as an additional font	Values: any name up to 8 characters Default: if a name is not specified, UNKNOWN is used
x = extension  .TTE is only supported in firmware version V60.14.x, V50.14.x, or later.	Values: .FNT = Font .TTF = TrueType Font .TTE = TrueType Extension

Example: These examples show how to use:

- MYFONT.FNT stored in DRAM whenever a format calls for Font A:
^XA
^CWA,R:MYFONT.FNT
^XZ
- MYFONT.FNT stored in DRAM additionally as Font Q:
^XA
^CWQ,R:MYFONT.FNT
^XZ
- NEWFONT.FNT stored in DRAM whenever a format calls for font F:
^XA
^CWF,R:NEWFONT.FNT
^XZ

DIRECTORY OF R:*.*	
R:NEWFONT.FNT	65268
R:MYFONT.FNT	65268
582164 BYTES FREE R:	

Label Listing Before Assignment

DIRECTORY OF R:*.*	
F R:NEWFONT.FNT	65268
AQ R:MYFONT.FNT	65268
582164 BYTES FREE R:	

Label Listing After Assignment

~DB**Download Bitmap Font**

The **~DB** command sets the printer to receive a downloaded bitmap font and defines native cell size, baseline, space size, and copyright.

This command consists of two portions, a ZPL II command defining the font and a structured data segment that defines each character of the font.

Format: `~DBd:o,x,a,h,w,base,space,#char,@,data`

Parameters	Details
d = drive to store font	Values: R:, E:, B:, and A: Default: R:
o = name of font	Values: 1 to 8 alphanumeric characters Default: if a name is not specified, UNKNOWN is used
x = extension	Format: .FNT
a = orientation of native font	Fixed Value: normal
h = maximum height of cell (in dots)	Values: 1 to 32000 Default: a value must be specified
w = maximum width of cell (in dots)	Values: 1 to 32000 Default: a value must be specified
base = dots from top of cell to character baseline	Values: 1 to 32000 Default: a value must be specified
space = width of space or non-existent characters	Values: 1 to 32000 Default: a value must be specified
#char = number of characters in font	Values: 1 to 256 (must match the characters being downloaded) Default: a value must be specified
@ = copyright holder	Values: 1 to 63 alphanumeric characters Default: a value must be specified

Parameters	Details
<p>data = structured ASCII data that defines each character in the font</p>	<p>The # symbol signifies character code parameters, which are separated with periods. The character code is from 1 to 4 characters to allow for large international character sets to be downloaded to the printer.</p> <p>The data structure is:</p> <p>#xxx.h.w.x.y.i.data</p> <p>#xxx = character code</p> <p>h = bitmap height (in dot rows)</p> <p>w = bitmap width (in dot rows)</p> <p>x = x-offset (in dots)</p> <p>y = y-offset (in dots)</p> <p>i = typesetting motion displacement (width, including inter character gap of a particular character in the font)</p> <p>data = hexadecimal bitmap description</p>

Example: This is an example of how to use the ~DB command. It shows the first two characters of a font being downloaded to DRAM.

```
~DBR:TIMES.FNT,N,5,24,3,10,2,ZEBRA 1992,
```

```
#0025.5.16.2.5.18.
```

```
00FF
```

```
00FF
```

```
FF00
```

```
FF00
```

```
FFFF
```

```
#0037.4.24.3.6.26.
```

```
00FF00
```

```
0F00F0
```

```
0F00F0
```

```
00FF00
```

~DE

Download Encoding

The standard encoding for TrueType Windows® fonts is always Unicode. The ZPL II field data must be converted from some other encoding to Unicode that the Zebra printer understands. The required translation tables are provided with font packs. Some tables can be downloaded from www.zebra.com.

Format: ~DEd:o.x,s,data

Parameters	Details
d = location of table	Values: R:, E:, B:, and A: Default: R:
o = name of table	Values: any valid name, up to 8 characters Default: if a name is not specified, UNKNOWN is used
x = extension	Format: .DAT
s = table size	Values: the number of memory bytes required to hold the Zebra downloadable format of the font Default: if an incorrect value or no value is entered, the command is ignored
data = data string	Values: a string of ASCII hexadecimal values Default: if no data is entered, the command is ignored

Example: This is an example of how to download the required translation table:
~DER:JIS.DAT,27848,300021213001... (27848 two-digit hexadecimal values)

Comments: For more information on ZTools or ZebraNet Bridge, see the program documentation included with the software.

For assistance with editing or adding mappings to .DAT tables, ZebraNet Bridge includes a .DAT table editor in the font wizard.

Encoding scheme for the data sent to the printer is the second four character and the encoding scheme for the font is the first four characters throughout the .DAT file. The data must be ordered by the second four characters (the encoding table).

Example: This is an example of a .DAT table. The table below the example identifies the elements:

```
~DEE:EXAMPLE.DAT,16,
00310041 ← 1
00320042 ← 2
00330043 ← 3
00340044 ← 4
```

Data must have 0041, 0042, 0043, and 0044 in order. Multiple pairs can be on the same line.

1	Input stream with 0041 will be mapped to 0031. The printer prints "1".
2	Input stream with 0042 will be mapped to 0032. The printer prints "2".
3	Input stream with 0043 will be mapped to 0033. The printer prints "3".
4	Input stream with 0044 will be mapped to 0034. The printer prints "4".

^DF**Download Format**

The **^DF** command saves ZPL II format commands as text strings to be later merged using **^XF** with variable data. The format to be stored might contain field number (**^FN**) commands to be referenced when recalled.

While use of stored formats reduces transmission time, no formatting time is saved—this command saves ZPL II as text strings formatted at print time.

Enter the **^DF** stored format command immediately after the **^XA** command, then enter the format commands to be saved.

Format: **^DFd:o:x**

Parameters	Details
d = device to store image	Values: R:, E:, B:, and A: Default: R:
o = image name	Values: 1 to 16 alphanumeric characters with a file type of 1 to 3 alphanumeric characters separated by a "." Default: if a name is not specified, UNKNOWN is used.
x = extension	Format: .ZPL

For a complete example of the **^DF** and **^XF** command, see [Exercise 6: ^DF and ^XF — Download format and recall format on page 42](#).

Example: This example is generated using the **^XF** command to recall this format:

ZPL II CODE	GENERATED LABEL
<pre> ^XA ^DFR:STOREFMT.ZPL^FS ^FO25,25 ^AD,36,20^FN1^FS ^FO165,25 ^AD,36,20^FN2^FS ^FO25,75 ^AB,22,14^FDBUILT BY^FS ^FO25,125 ^AE,28,15^FN1 ^XZ ^XA ^XFR:STOREFMT.ZPL^FS ^FN1^FDZEBRA^FS ^XZ </pre>	<p>The generated label is a rectangular box with rounded corners. Inside the box, the text is arranged as follows: 'ZEBRA PRINTER' on the top line, 'BUILT BY' on the second line, and 'ZEBRA' on the third line. The text is centered and appears to be in a bold, sans-serif font.</p>

~DG**Download Graphics**

The **~DG** command downloads an ASCII Hex representation of a graphic image. If **.GRF** is not the specified file extension, **.GRF** is automatically appended.

For more saving and loading options when downloading files, see [~DY on page 164](#).

Format: **~DGd:o,x,t,w,data**

Parameters	Details
d = device to store image	Values: R:, E:, B:, and A: Default: R:
o = image name	Values: 1 to 8 alphanumeric characters Default: if a name is not specified, UNKNOWN is used
x = extension	Format: .GRF
t = total number of bytes in graphic	See the formula in the examples below.
w = number of bytes per row	See the formula in the examples below.
data = ASCII hexadecimal string defining image	The data string defines the image and is an ASCII hexadecimal representation of the image. Each character represents a horizontal nibble of four dots.

This is the key for the examples that follow:

- x = width of the graphic in millimeters
- y = height of the graphic in millimeters
- z = dots/mm = print density of the printer being programmed
- 8 = bits/byte

These are some example related to the **~DG** command:

Example: To determine the **t** parameter use this formula:

$$\frac{xz}{8} \times yz = \text{totalbytes}$$

Example: To determine the correct **t** parameter for a graphic 8 mm wide, 16 mm high, and a print density of 8 dots/mm, use this formula:

$$8 \times 128 = 1024$$

$$t = 1024$$

Raise any portion of a byte to the next whole byte.

Example: To determine the **w** parameter (the width in terms of bytes per row) use this formula:

$$\frac{xz}{8} = (\text{totalbytes})/(\text{row})$$

$$w = 8$$

Example: To determine the correct *w* parameter for a graphic 8 mm wide and a print density of 8 dots/mm, use this formula:

$$\frac{8 \times 8}{8} = 8 \text{ bytes}$$

$$w = 8$$

Raise any portion of a byte to the next whole byte.

Parameter *w* is the first value in the *t* calculation.

The data parameter is a string of hexadecimal numbers sent as a representation of the graphic image. Each hexadecimal character represents a horizontal nibble of four dots. For example, if the first four dots of the graphic image are white and the next four black, the dot-by-dot binary code is 00001111. The hexadecimal representation of this binary value is 0F. The entire graphic image is coded in this way, and the complete graphic image is sent as one continuous string of hexadecimal values.

Example: This is an example of using the `~DG` command to load a checkerboard pattern into DRAM. The name used to store the graphic is `SAMPLE.GRF`:

ZPL II CODE	GENERATED LABEL
<pre>~DGR: SAMPLE.GRF,00080,010, FFFFFFFFFFFFFFFFFFFF 8000FFFF0000FFFF0001 8000FFFF0000FFFF0001 8000FFFF0000FFFF0001 FFFF0000FFFF0000FFFF FFFF0000FFFF0000FFFF FFFF0000FFFF0000FFFF FFFFFFFFFFFFFFFFFFFF ^XA ^F020,20^XGR: SAMPLE.GRF,1,1^FS ^XZ</pre>	

Comments: Do not use spaces or periods when naming your graphics. Always use different names for different graphics.

If two graphics with the same name are sent to the printer, the first graphic is erased and replaced by the second graphic.

~DN

Abort Download Graphic

After decoding and printing the number of bytes in parameter **t** of the **~DG** command, the printer returns to normal Print Mode. Graphics Mode can be aborted and normal printer operation resumed by using the **~DN** command.

Format: ~DN

Comments: If you need to stop a graphic from downloading, you should abort the transmission from the host device. To clear the **~DG** command, however, you must send a **~DN** command.

~DS

Download Intellifont (Scalable Font)

The **~DS** command is used to set the printer to receive a downloadable scalable font and defines the size of the font in bytes.

The **~DS** command, and its associated parameters, is the result of converting a vendor-supplied font for use on a Zebra printer. To convert this font use the ZTools utility.

Format: `~DSd:o.x,s,data`

Parameters	Details
d = device to store image	Values: R:, E:, B:, and A: Default: R:
o = image name	Values: 1 to 8 alphanumeric characters Default: if a name is not specified, UNKNOWN is used
x = extension	Fixed Value: .FNT
s = size of font in bytes	Fixed Value: this number is generated by ZTools and should not be changed
data = ASCII hexadecimal string that defines font	Fixed Value: this number is generated by ZTools and should not be changed

Example: This example shows the first three lines of a scalable font that was converted using the ZTools program and is ready to be downloaded to the printer. If necessary, the destination and object name can be changed.

```
~DSB:CGTIMES.FNT,37080,
00FF00FF00FF00FF
FF0AECB28FFF00FF
```

Comments: Downloaded scalable fonts are not checked for integrity. If they are corrupt, they cause unpredictable results at the printer.

14↑

If you are using a TrueType font use these commands: [~DT](#), [~DU](#), and [~DY](#). To determine when to use the noted commands, see [~DT on page 162](#), [~DU on page 163](#), and [~DY on page 164](#).

~DT**Download Bounded TrueType Font**

Use ZTools to convert a TrueType font to a Zebra-downloadable format. that has less than 256 characters in it. To convert a font that has more than 256 characters, see [~DU on page 163](#). ZTools creates a downloadable file that includes a ~DT command. For information on converting and downloading Intellifont information, see [~DS on page 161](#).

Format: ~DTd:o.x,s,data

Parameters	Details
d = font location	Values: R:, E:, B:, and A: Default: R:
o = font name	Values: any valid TrueType name, up to 8 characters Default: if a name is not specified, UNKNOWN is used
x = extension	Fixed Value: .DAT
s = font size	Values: the number of memory bytes required to hold the Zebra-downloadable format of the font Default: if an incorrect value or no value is entered, the command is ignored
data = data string	Values: a string of ASCII hexadecimal values (two hexadecimal digits/byte). The total number of two-digit values must match parameter s . Default: if no data is entered, the command is ignored

Example: This is an example of how to download a true type font:

```
~DTR:FONT,52010,00AF01B0C65E...
```

(52010 two-digit hexadecimal values)

~DU

Download Unbounded TrueType Font

Some international fonts, such as Asian fonts, have more than 256 printable characters. These fonts are supported as *large TrueType fonts* and are downloaded to the printer with the ~DU command. Use ZTools to convert the large TrueType fonts to a Zebra-downloadable format.

The Field Block (^FB) command cannot support the large TrueType fonts.

Format: ~DUd:o.x,s,data

Parameters	Details
d = font location	Values: R:, E:, B:, and A: Default: R:
o = font name	Values: 1 to 8 alphanumeric characters Default: if a name is not specified, UNKNOWN is used
x = extension	Format: .FNT
s = font size	Values: the number of memory bytes required to hold the Zebra-downloadable format of the font Default: if no data is entered, the command is ignored
data = data string	Values: a string of ASCII hexadecimal values (two hexadecimal digits/byte). The total number of two-digit values must match parameter s. Default: if no data is entered, the command is ignored

Example: This is an example of how to download an unbounded true type font:

```
~DUR:KANJI,86753,60CA017B0CE7...
```

(86753 two-digit hexadecimal values)

For similar commands, see [~DS on page 161](#), [~DT on page 162](#), and [~DY on page 164](#).

~DY

Download Objects

The ~DY command downloads to the printer graphic objects or fonts in any supported format. This command can be used in place of ~DG for more saving and loading options. ~DY is the preferred command to download TrueType fonts on printers with firmware later than X.13. It is faster than ~DU. The ~DY command also supports downloading wireless certificate files.



NOTE: When using certificate files, your printer supports:

- Using Privacy Enhanced Mail (PEM) formatted certificate files.
- Using the client certificate and private key as two files, each downloaded separately.
- Using exportable PAC files for EAP-FAST.
- Zebra recommends using Linear style memory devices for storing larger objects.

Format: ~DYd:f,b,x,t,w,data

Parameters	Details
<p>d = file location</p> <p>.15↑ .NRD and .PAC files reside on E: in firmware versions V60.15.x, V50.15.x, or later.</p>	<p>Values: R:, E:, B:, and A:</p> <p>Default: R:</p>
<p>f = file name</p>	<p>Values: 1 to 8 alphanumeric characters</p> <p>Default: if a name is not specified, UNKNOWN is used</p>
<p>b = format downloaded in data field</p> <p>.14↑ .TTE and .TTF are only supported in firmware versions V60.14.x, V50.14.x, or later.</p>	<p>Values:</p> <p>A = uncompressed (ZB64, ASCII)</p> <p>B = uncompressed (.TTE, .TTF, binary)</p> <p>C = AR-compressed (used only by Zebra's BAR-ONE® v5)</p> <p>P = portable network graphic (.PNG) - ZB64 encoded</p> <p>Default: a value must be specified</p>

Parameters	Details
<p>x = extension of stored file</p> <p>.14↑ .TTE and .OTF are only supported in firmware versions V60.14.x, V50.14.x, or later.</p> <p>.15↑ .NRD and .PAC are only supported in firmware versions V60.15.x, V50.15.x, or later.</p>	<p>Values:</p> <p>B = bitmap</p> <p>E = TrueType Extension (.TTE)</p> <p>G = raw bitmap (.GRF)</p> <p>P = store as compressed (.PNG)</p> <p>T = TrueType (.TTF) or OpenType (.OTF)</p> <p>X = Paintbrush (.PCX)</p> <p>NRD = Non Readable File (.NRD)</p> <p>PAC = Protected Access Credential (.PAC)</p> <p>C = User defined menu file (WML)</p> <p>F = User defined webpage file (HTM)</p> <p>H = Printer feedback file (GET)</p> <p>Default: a value other than the accepted values defaults to .GRF</p>
<p>t = total number of bytes in file</p> <p>.14↑ .TTE is only supported in firmware versions V60.14.x, V50.14.x, or later.</p>	<p>Values:</p> <p>.BMP</p> <p style="padding-left: 20px;">This parameter refers to the actual size of the file, not the amount of disk space.</p> <p>.GRF images: the size after decompression into memory</p> <p style="padding-left: 20px;">This parameter refers to the actual size of the file, not the amount of disk space.</p> <p>.PCX</p> <p style="padding-left: 20px;">This parameter refers to the actual size of the file, not the amount of disk space.</p> <p>.PNG images:</p> <p style="padding-left: 20px;">This parameter refers to the actual size of the file, not the amount of disk space.</p> <p>.TTF</p> <p style="padding-left: 20px;">This parameter refers to the actual size of the file, not the amount of disk space.</p> <p>.TTE</p> <p style="padding-left: 20px;">This parameter refers to the actual size of the file, not the amount of disk space.</p>

Parameters	Details
<p>w = total number of bytes per row</p> <p>.14↑ .TTE is only supported in firmware version V60.14.x, V50.14.x, or later.</p> <p>.15↑ .NRD and .PAC files are supported in firmware version V60.15.x, V50.15.x, or later.</p>	<p>Values:</p> <p>.GRF images: number of bytes per row</p> <p>.PNG images: value ignored</p> <p>.TTF images: value ignored</p> <p>.TTE images: value ignored</p> <p>.NRD images: value ignored</p> <p>.PAC images: value ignored</p>
<p>data = data</p>	<p>ASCII hexadecimal encoding, ZB64, or binary data, depending on b.</p> <p>A, P = ASCII hexadecimal or ZB64</p> <p>B, C = binary</p> <p>When binary data is sent, all control prefixes and flow control characters are ignored until the total number of bytes needed for the graphic format is received.</p>



NOTE: When transmitting fonts or graphics, the `~DY` command and the binary content can be sent as two separate data streams. In cases where the `~DY` command and data content are sent separately, the connection to the printer must be maintained until both the command and data content have been sent. If the command and data content are sent separately, the data light on the printer will remain lit until it receives all the data called for in the `~DY` command. The download will be considered complete when the number of bytes called out in the `~DY` command have been received.

For best results, graphic files must be monochrome (black and white) or dithered.

Example: This is an example of how to download a binary TrueType Font file of Size bytes using the name `fontfile.ttf` and storing it to permanent flash memory on the printer:

```
~DYE:FONTFILE.TTF,B,T,SIZE,,
```

These examples show:

- that when the `^IM` command is used with the `^F0` command, the `^IM` command (see [^IM on page 226](#)) moves the `logo.png` file from a storage area to the 0,0 position on the label. This is the ZPL code:

```
^XA
^F00,0^IMR:LOGO.PNG^FS
^XZ
```

- that when the `^IL` command (see [^IL on page 225](#)) is used at the beginning of a label format, it loads a stored image (`logo.png`) of a format and merges it with additional data. It is automatically positioned at the 0,0 position of the label and does not require the `^F0` command. This is the ZPL code:

```
^XA
^ILR:LOGO.PNG
^XZ
```

Comments: For more information on ZB64 encoding and compression, see [ZB64 Encoding and Compression on page 1433](#).

.14↑

These are some important things to know about this command in firmware version V60.14.x, V50.14.x, or later:

- ZebraNet Bridge can be used to download fonts and graphics with this command.
- OpenType tables are only supported when downloading the font with this command
- OpenType fonts (.OTF) are supported if they are downloaded as a TrueType font. In the printer .OTF fonts have the .TTF extension.

~EG

Erase Download Graphics

See [^ID](#) on page 223.

^FB**Field Block**

The **^FB** command allows you to print text into a defined *block type* format. This command formats an **^FD** or **^SN** string into a block of text using the origin, font, and rotation specified for the text string. The **^FB** command also contains an automatic word-wrap function.

Format: **^FB***a,b,c,d,e*

Parameters	Details
a = width of text block line (in dots)	<p>Values: 0 to the width of the label</p> <p>Default: 0</p> <p>If the value is less than font width or not specified, text does not print.</p>
b = maximum number of lines in text block	<p>Values: 1 to 9999</p> <p>Default: 1</p> <p>Text exceeding the maximum number of lines overwrites the last line. Changing the font size automatically increases or decreases the size of the block.</p>
c = add or delete space between lines (in dots)	<p>Values: -9999 to 9999</p> <p>Default: 0</p> <p>Numbers are considered to be positive unless preceded by a minus sign. Positive values add space; negative values delete space.</p>
d = text justification	<p>Values:</p> <ul style="list-style-type: none"> L = left C = center R = right J = justified <p>Default: L</p> <p>If J is used the last line is left-justified.</p>
e = hanging indent (in dots) of the second and remaining lines	<p>Values: 0 to 9999</p> <p>Default: 0</p>

Example: These are examples of how the ^FB command affects field data.

ZPL II CODE	GENERATED LABEL
<pre> ^XA ^CF0,30,30^FO25,50 ^FB250,4,, ^FDFD command that IS\& preceded by an FB \&command. ^FS ^XZ </pre>	<div style="border: 1px solid black; padding: 10px; width: fit-content; margin: auto;"> <p>FD command that IS preceded by an FB command.</p> </div>
<pre> ^XA ^CF0,30,30^FO25,50 ^FDFD command that IS NOT preceded by an FB command.^FS ^XZ </pre>	<div style="border: 1px solid black; padding: 10px; width: fit-content; margin: auto;"> <p>FD command that IS NOT preceded by an FB command.</p> </div>

Comments:

This scheme can be used to facilitate special functions:

- \& = carriage return/line feed
- \(*) = soft hyphen (word break with a dash)
- \\ = backslash (\)

Item 1: ^CI13 must be selected to print a backslash (\).

Item 2: If a soft hyphen escape sequence is placed near the end of a line, the hyphen is printed. If it is not placed near the end of the line, it is ignored.

 (*) = any alphanumeric character

- If a word is too long to print on one line by itself (and no soft hyphen is specified), a hyphen is automatically placed in the word at the right edge of the block. The remainder of the word is on the next line. The position of the hyphen depends on word length, not a syllable boundary. Use a soft hyphen within a word to control where the hyphenation occurs.
- Maximum data-string length is 3K, including control characters, carriage returns, and line feeds.
- Normal carriage returns, line feeds, and *word spaces* at line breaks are discarded.
- When using ^FT (Field Typeset), ^FT uses the baseline origin of the last possible line of text. Increasing the font size causes the text block to increase in size from bottom to top. This could cause a label to print past its top margin.
- When using ^F0 (Field Origin), increasing the font size causes the text block to increase in size from top to bottom.
- ^FS terminates an ^FB command. Each block requires its own ^FB command.

.14↑

While the ^FB command has a text justification parameter that defines the justification of the text within the block, it also interacts with the justification of ^F0 and ^FT that define the justification of the origin.

The ^FB command does not support soft hyphens as a potential line break point. However, soft hyphen characters are always printed as if they were a hyphen.

The ^FB command does not support complex text. For complex text support, use ^TB.

^FC

Field Clock

The ^FC command is used to set the clock-indicators (delimiters) and the clock mode for use with the Real-Time Clock hardware. This command must be included within each label field command string each time the Real-Time Clock values are required within the field.

Format: ^FCa,b,c

Parameters	Details
a = primary clock indicator character	Values: any ASCII character Default: %
b = secondary clock indicator character	Values: any ASCII character Default: none—this value cannot be the same as a or c
c = third clock indicator character	Values: any ASCII character Default: none—this value cannot be the same as a or b

Entering these ZPL commands sets the primary clock indicator to %, the secondary clock indicator to {, and the third clock indicator to #. The results are printed on a label with Primary, Secondary, and Third as field data.

ZPL II CODE	GENERATED LABEL
<pre> ^XA ^FO10,100^A0N,50,50 ^FC%,{,# ^FDPrimary: %m/%d/%y^FS ^FO10,200^A0N,50,50 ^FC%,{,# ^FDSecondary: {m/{d/{y^FS ^FO10,300^A0N,50,50 ^FC%,{,# ^FDThird: #m/#d/#y^FS ^XZ </pre>	<p>The generated label is a rectangular box with a thin border. It contains three lines of text, each in a bold, black, sans-serif font. The first line reads 'Primary: 00/00/00', the second line reads 'Secondary: 01/01/00', and the third line reads 'Third: 01/01/00'. The text is centered within the box.</p>

Comments: The ^FC command is ignored if the Real Time Clock hardware is not present. As of V60.13.0.10, (^SN) functions with (^FC) capabilities.

For more details on the Real Time Clock, see [Real Time Clock on page 1440](#).

^FD

Field Data

The ^FD command defines the data string for a field. The field data can be any printable character except those used as command prefixes (^ and ~).

In RFID printers, it can also be used to specify passwords to write to tags.

Format: ^FDa

Parameters	Details
a = <ul style="list-style-type: none"> data to be printed (all printers), or a password to be written to a RFID tag (rfid printers) 	Values: any data string up to 3072 bytes Default: none—a string of characters must be entered

Comments: The ^ and ~ characters can be printed by changing the prefix characters—see [^CD ~CD on page 138](#) and [^CT ~CT on page 149](#). The new prefix characters cannot be printed.

Characters with codes above 127, or the ^ and ~ characters, can be printed using the ^FH and ^FD commands.

- ^CI13 must be selected to print a backslash (\).

For information on using soft hyphens, see [Comments: on the command on page 170](#).

^FH

Field Hexadecimal Indicator

The ^FH command allows you to enter the hexadecimal value for any character directly into the ^FD statement. The ^FH command must precede each ^FD command that uses hexadecimal in its field.

Within the ^FD statement, the hexadecimal indicator must precede each hexadecimal value. The default hexadecimal indicator is _ (underscore). There must be a minimum of two characters designated to follow the underscore. The a parameter can be added when a different hexadecimal indicator is needed.

This command can be used with any of the commands that have field data (that is ^FD, ^FV (Field Variable), and ^SN (Serialized Data)).

Valid hexadecimal characters are:

0 1 2 3 4 5 6 7 8 9 A B C D E F a b c d e f

Format: ^FH*a*

Parameters	Details
a = hexadecimal indicator	<p>Values: any character except current format and control prefix (^ and ~ by default)</p> <p>Default: _ (underscore)</p>

Example: This is an example of how to enter a hexadecimal value directly into a ^FD statement: This is an example for ascii data using ^CI0.

ZPL II CODE	GENERATED LABEL
<pre>^XA ^FO100,100 ^AD^FH ^FDTilde _7e used for HEX^FS ^XZ</pre>	<pre>Tilde ~ used for HEX</pre>
<pre>^XA ^FO100,100 ^AD^FH\ ^FDTilde \7E used for HEX^FS ^XZ</pre>	<pre>Tilde ~ used for HEX</pre>

Example: These are examples of how ^FH works with UTF-8 and UTF-16BE:

- UTF-8

ZPL II CODE	GENERATED LABEL
<pre>^XA ^CI28 ^LL500 ^FO100,100 ^AA,20,20 ^FH^FDU+00A1 in UTF8 = _C2_A1^FS ^XZ</pre>	<pre>U+00A1 in UTF8 = i</pre>

- UTF-16BE

ZPL II CODE	GENERATED LABEL
<pre data-bbox="285 310 751 478">^XA ^CI29 ^LL500 ^FO100,100 ^AA,20,20 ^FH^FDU+00A1 in UTF16BE = _00_A1^FS ^XZ</pre>	<pre data-bbox="776 310 1240 583">U+00A1 in UTF16BE = i</pre>

^FL

Font Linking

The ^FL command provides the ability to link any TrueType font, including private character fonts, to associated fonts.

If the base font does not have a glyph for the required character, the printer looks to the linked fonts for the glyph. The font links are user-definable. The font linking remains until the link is broken or the printer is turned off. To permanently save the font linking, use the ^JUS command.



NOTE: For assistance in setting up the font links, use the font wizard in ZebraNet Bridge.

Format: ^FL<ext>,<base>,<link>

Parameters	Details
<ext>	<p>This is the fully-qualified filename of the extension. This file name does not accept wildcards.</p> <p>The supported extensions for this parameter are: .TTF and .TTE. The format for this parameter is the memory device followed by the font name with the extension, as follows:</p> <p style="text-align: center;">E:SWISS721.TTF</p>
<base>	<p>This is the filename of the base font(s). The base font can be any of the following types:</p> <p style="text-align: center;">.FNT .TTF or .TTE</p> <p>From these font types you can only link to a .TTF or .TTE.</p> <p>The name of the base font can be expressed as a wild card; doing so will define multiple base fonts. The result will be that all base font files so defined will be linked to the file defined in the <ext> parameter.</p> <p>The filename does not have to match a file that is currently defined on the printer. A specification of *.TTF results in all *.TTF font files loaded on the printer currently or in the future to be linked with the specified <ext> font extension.</p>
<link>	<p>This is an indicator that determines if the extension is to be linked with the base, or unlinked from the base, as follows:</p> <p>Values:</p> <p style="padding-left: 20px;">0 = <ext> is to be unlinked (disassociated) from the file(s) specified in <base></p> <p style="padding-left: 20px;">1 = <ext> is to be linked (associated) with the file(s) specified by <base></p> <p>Default: must be an accepted value or it is ignored</p>

Comments: A font can have up to five fonts linked to it. The printer resident font, 0.FNT is always the last font in the list of font links, but is not included in the five link maximum. It can also be placed anywhere in the font links list.

The default glyph prints when a glyph cannot be found in any of the fonts in the link list. The advanced layout command `^PA` determines if the default glyph is a space character or the default glyph of the base font, which is typically a hollow box.

The list of font links can be printed by using the `^LF` command or retrieved with the `^HT` command.

Example: These examples show the code and output for no font linking and for font linking:

No Font Linking

In the no font linking example, the Swiss721 font does not have the Asian glyphs, which is why Asian glyphs do not print.

ZPL II CODE	GENERATED LABEL
<pre> ^XA^LL1200^CW1,E:SWISS721.TTF^CW2,E:ANMDJ.TTF^CI28^FS ^FO100,100^A0,50,50^FDNO FONT LINKING^FS ^FO100,300^A1,50,50^FDTEST WITH SWISS721^FS ^FO100,400^A1,50,50^FDDRAGONFLY 蜻蜓^FS ^FO100,600^A2,50,50^FDTEST WITH ANMDJ^FS ^FO100,700^A2,50,50^FDDRAGONFLY 蜻蜓^FS ^XZ </pre>	<div style="border: 1px solid black; padding: 10px;"> <p style="text-align: center;">NO FONT LINKING</p> <p style="text-align: center;">TEST WITH SWISS721</p> <p style="text-align: center;">DRAGONFLY</p> <p style="text-align: center;">TEST WITH ANMDJ</p> <p style="text-align: center;">DRAGONFLY 蜻蜓</p> </div>

Font Linking

In the font linking example, this code is sent down to link the `ANMDJ.TTF` font to `SWISS721.TTF` font:

```

^XA
^FLE:ANMDJ.TTF,E:SWISS721.TTF,1^FS
^XZ
                    
```

When the label reprints, the Asian characters are printed using the `ANMDJ.TTF` font, rather than the `SWISS721.TTF` font.

ZPL II CODE	GENERATED LABEL
<pre> ^XA^LL1200^CW1,E:SWISS721.TTF^CW2,E:ANMDJ.TTF^CI28^FS ^FO100,100^A0,50,50^FDFONT LINKING^FS ^FO100,300^A1,50,50^FDTEST WITH SWISS721^FS ^FO100,400^A1,50,50^FDDRAGONFLY 蜻蜓^FS ^FO100,600^A2,50,50^FDTEST WITH ANMDJ^FS ^FO100,700^A2,50,50^FDDRAGONFLY 蜻蜓^FS ^XZ </pre>	<div style="border: 1px solid black; padding: 10px;"> <p style="text-align: center;">FONT LINKING</p> <p style="text-align: center;">TEST WITH SWISS721</p> <p style="text-align: center;">DRAGONFLY 蜻蜓</p> <p style="text-align: center;">TEST WITH ANMDJ</p> <p style="text-align: center;">DRAGONFLY 蜻蜓</p> </div>

^FM

Multiple Field Origin Locations

The ^FM command allows you to control the placement of bar code symbols.

It designates field locations for the PDF417 (^B7) and MicroPDF417 (^BF) bar codes when the structured append capabilities are used. This allows printing multiple bar codes from the same set of text information.

The structured append capability is a way of extending the text printing capacity of both bar codes. If a string extends beyond what the data limitations of the bar code are, it can be printed as a series: 1 of 3, 2 of 3, 3 of 3. Scanners read the information and reconcile it into the original, unsegmented text.

The ^FM command triggers multiple bar code printing on the same label with ^B7 and ^BF only. When used with any other commands, it is ignored.

Format: ^FMx1,y1,x2,y2,...

Parameters	Details
x1 = x-axis location of first symbol (in dots)	<p>Values: 0 to 32000</p> <p>e = exclude this bar code from printing</p> <p>Default: a value must be specified</p>
y1 = y-axis location of first symbol (in dots)	<p>Values: 0 to 32000</p> <p>e = exclude this bar code from printing</p> <p>Default: a value must be specified</p>
x2 = x-axis location of second symbol (in dots)	<p>Values: 0 to 32000</p> <p>e = exclude this bar code from printing</p> <p>Default: a value must be specified</p>
y2 = y-axis location of second symbol (in dots)	<p>Values: 0 to 32000</p> <p>e = exclude this bar code from printing</p> <p>Default: a value must be specified</p>
... = continuation of X,Y pairs	Maximum number of pairs: 60

Example: This example shows you how to generate three bar codes with the text “Zebra Technologies Corporation strives to be...” would need to be repeated seven times, which includes 2870 characters of data (including spaces) between ^FD and ^FS:

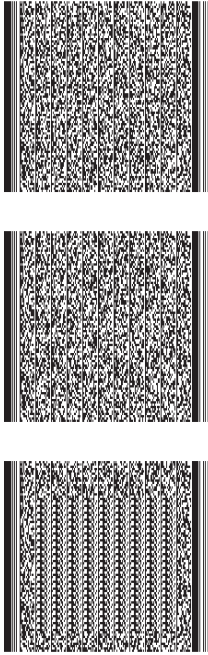
ZPL II CODE	GENERATED LABEL
<pre> ^XA ^FM100,100,100,600,100,1200 ^BY2,3 ^B7N,5,5,9,83,N ^FDZebra Technologies Corporation strives to be the expert supplier of innovative solutions to specialty demand labeling and ticketing problems of business and government. We will attract and retain the best people who will understand our customer's needs and provide them with systems, hardware, software, consumables and service offering the best value, high quality, and reliable performance, all delivered in a timely manner ... ^FS^XZ </pre>	

1

1	The ellipse is not part of the code. It indicates that the text needs to be repeated seven times, as mentioned in the example description.
---	--

Example: This example assumes a maximum of three bar codes, with bar code 2 of 3 omitted:

ZPL II CODE	GENERATED LABEL
<pre> ^XA ^FM100,100,e,e,100,1200 ^BY2,3 ^B7N,5,5,9,83,N ^FDZebra Technologies Corporation strives to be the expert supplier of innovative solutions to specialty demand labeling and ticketing problems of business and government. We will attract and retain the best people who will understand our customer's needs and provide them with systems, hardware, software, consumables and service offering the best value, high quality, and reliable performance, all delivered in a timely manner ... ^FS^XZ </pre>	
<p>1</p>	

Comments: Subsequent bar codes print once the data limitations of the previous bar code have been exceeded. For example, bar code 2 of 3 prints once 1 of 3 has reached the maximum amount of data it can hold. Specifying three fields does not ensure that three bar codes print; enough field data to fill three bar code fields has to be provided.

The number of the x,y pairs can exceed the number of bar codes generated. However, if too few are designated, no symbols print.

^FN

Field Number

The **^FN** command numbers the data fields. This command is used in both **^DF** (Store Format) and **^XF** (Recall Format) commands.

In a stored format, use the **^FN** command where you would normally use the **^FD** (Field Data) command. In recalling the stored format, use **^FN** in conjunction with the **^FD** command.

The optional "a" parameter can be used with the KDU Plus to cause prompts to be displayed on the KDU unit. Also, when the Print on Label link is selected on the Directory page of ZebraLink enabled printers the field prompt displays.

The number of fields and data that can be stored is dependent in the available printer memory.



NOTE: The maximum number of **^FN** commands that can be used depends on the amount of data that is placed in the fields on the label. It is recommended to use 400 or fewer fields.

Format: **^FN#"a"**

Parameters	Details
# = number to be assigned to the field	Values: 0 to 9999 Default: 0
"a" = optional parameter*	Values: 255 alphanumeric characters maximum (a-z,A-Z,1-9 and space) Default: optional parameter
* This parameter is only available on printers with firmware V50.13.2, V53.15.5Z, V60.13.0.1, or later. For a complete example of the ^DF and ^XF command, see Exercise 6: ^DF and ^XF — Download format and recall format on page 42.	

Comments:

- The same **^FN** value can be stored with several different fields.
- If a label format contains a field with **^FN** and **^FD**, the data in that field prints for any other field containing the same **^FN** value.
- For the "a" parameter to function as a prompt the characters used in the "a" parameter must be surrounded by double quotes (see example).

The **^FN1"Name"** would result in "Name" being used as the prompt on the KDU unit.

^FO

Field Origin

The ^FO command sets a field origin, relative to the label home (^LH) position. ^FO sets the upper-left corner of the field area by defining points along the x-axis and y-axis independent of the rotation.

Format: ^FOx,y,z

Parameters	Details
x = x-axis location (in dots)	Values: 0 to 32000 Default: 0
y = y-axis location (in dots)	Values: 0 to 32000 Default: 0
z = justification  The z parameter is only supported in firmware versions V60.14.x, V50.14.x, or later.	Values: 0 = left justification 1 = right justification 2 = auto justification (script dependent) Default: last accepted ^FW value or ^FW default

Comments: If the value entered for the x or y parameter is too high, it could position the field origin completely off the label.

 .14↑

This command interacts with the field direction parameter of ^FP and with the rotation parameter of ^A. For output and examples, see [Field Interactions on page 1436](#).

The auto justification option might cause unexpected results if variable fields or bidirectional text are used with ^FO. For the best results with bidirectional text and/or variable fields, use either the left or right justification option.

^FP

Field Parameter

The ^FP command allows vertical and reverse formatting of the font field, commonly used for printing Asian fonts.

Format: ^FPd,g

Parameters	Details
d = direction	Values: H = horizontal printing (left to right) V = vertical printing (top to bottom) R = reverse printing (right to left) Default: H
g = additional inter-character gap (in dots)	Values: 0 to 9999 Default: 0 if no value is entered

Example: This is an example of how to implement reverse and vertical print:

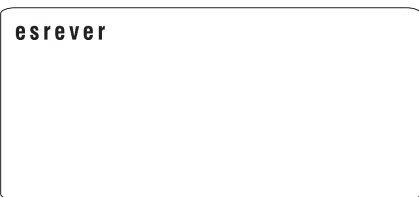
ZPL II CODE	GENERATED LABEL
<pre> ^XA ^FO100,50 ^FPV,10 ^AV ^FDvertical^FS ^XZ </pre>	
<pre> ^XA ^FO350,50 ^FPR,10 ^AV ^FDreverse^FS ^XZ </pre>	

.14↑

For vertical and reverse printing directions, combining semantic clusters are used to place characters.

This command interacts with the justification parameters of ^FO and ^FT and with the rotation parameter of ^A. For output and examples, see [Field Interactions on page 1436](#).

^FR

Field Reverse Print

The ^FR command allows a field to appear as white over black or black over white. When printing a field and the ^FR command has been used, the color of the output is the reverse of its background.

Format: ^FR

Example: In this example, the ^GB command creates areas of black allowing the printing to appear white:

ZPL II CODE	GENERATED LABEL
<pre> ^XA ^PR1 ^FO100,100 ^GB70,70,70,,3^FS ^FO200,100 ^GB70,70,70,,3^FS ^FO300,100 ^GB70,70,70,,3^FS ^FO400,100 ^GB70,70,70,,3^FS ^FO107,110^CF0,70,93 ^FR^FDREVERSE^FS ^XZ </pre>	

Comments: The ^FR command applies to only one field and has to be specified each time. When multiple ^FR commands are going to be used, it might be more convenient to use the ^LR command.

^FS

Field Separator

The **^FS** command denotes the end of the field definition. Alternatively, **^FS** command can also be issued as a single ASCII control code SI (Control-O, hexadecimal 0F).

Format: **^FS**

^FT

Field Typeset

The ^FT command sets the field position, relative to the home position of the label designated by the ^LH command. The typesetting origin of the field is fixed with respect to the contents of the field and does not change with rotation.



NOTE: The ^FT command is capable of concatenation of fields.

Format: ^FTx,y,z



Parameters	Details
x = x-axis location (in dots)	Values: 0 to 32000 Default: position after last formatted text field
y = y-axis location (in dots)	Values: 0 to 32000 Default: position after last formatted text field
z = justification  The z parameter is only supported in firmware version V60.14.x, V50.14.x, or later.	Values: 0 = left justification 1 = right justification 2 = auto justification (script dependent) Default: last accepted ^FW value or ^FW default The auto justification option may cause unexpected results if variable fields or bidirectional text are used with ^FT. For best results with bidirectional text and/or variable fields, use either the left or right justification options.

Table 6 Typeset Justification

Left Justified	Text	For examples, see Field Interactions on page 1436 .
	Bar Codes	Origin is base of bar code, at left edge
	Graphic Boxes	Origin is bottom-left corner of the box
	Images	Origin is bottom-left corner of the image area
Right Justified	Text	For examples, see Field Interactions on page 1436 .
	Bar Codes	Origin is base of bar code, at right edge
	Graphic Boxes	Origin is bottom-right corner of the box
	Images	Origin is bottom-right corner of the image area

Example: This is an example of the ^FT command and concatenation:

ZPL II CODE	GENERATED LABEL
<pre> ^XA ^FT10,200^A0N,30,20^FDACME ^FS ^FT^GS^FDC^FS ^FT^A0N,30,20^FDSummer ^FS ^FT^A0N,60,50^FDClearance ^FS ^FT^A0N,120,100^FDSale ^FS ^XZ </pre>	

When a coordinate is missing, the position following the last formatted field is assumed. This *remembering* simplifies field positioning with respect to other fields. Once the first field is positioned, other fields follow automatically.

There are several instances where using the ^FT command without specifying x and y parameters is not recommended:

- when positioning the first field in a label format
- at any time with the ^FN (Field Number) command
- following an ^SN (Serialization Data) command
- variable data
- bidirectional text

.14↑

The right typeset justified is available only for printers with firmware version V60.14.x, V50.14.x, or later.

This command interacts with the field direction parameters of ^FP and with the rotation parameter of ^A. For output and code examples, see [Field Interactions on page 1436](#).

^FV

Field Variable

^FV replaces the ^FD (field data) command in a label format when the field is variable.

Format: ^FVa

Parameters	Details
a = variable field data to be printed	<p>Values: 0 to 3072 byte string</p> <p>Default: if no data is entered, the command is ignored</p>

Example: This is an example of how to use the ^MC and ^FV command:

ZPL II CODE	GENERATED LABEL
<pre> ^XA ^FO40,40 ^GB300,203,8^FS ^FO55,60^CF0,25 ^FVVARIABLE DATA #1^FS ^FO80,150 ^FDFIXED DATA^FS ^MCN ^XZ </pre>	
<pre> ^XA ^FO55,60^CF0,25 ^FVVARIABLE DATA #2^FS ^MCY ^XZ </pre>	

Comments: ^FV fields are always cleared after the label is printed. ^FD fields are not cleared.

^FW

Field Orientation

The ^FW command sets the default orientation for all command fields that have an orientation (rotation) parameter (and in x.14 sets the default justification for all commands with a justification parameter). Fields can be rotated 0, 90, 180, or 270 degrees clockwise by using this command. In x.14, justification can be left, right, or auto.

The ^FW command affects only fields that follow it. Once you have issued a ^FW command, the setting is retained until you turn off the printer or send a new ^FW command to the printer.

Format: ^Fwr, z

Parameters	Details
r = rotate field	Values: N = normal R = rotated 90 degrees I = inverted 180 degrees B = bottom-up 270 degrees, read from bottom up Initial Value at Power Up: N
z = justification  The z parameter is available only with printers with firmware version V60.14.x, V50.14.x, or later.	Values: 0 = left justification 1 = right justification 2 = auto justification (script dependent) Default: auto for ^TB and left for all other commands

Example: This example shows how ^FW rotation works in conjunction with ^FO. In this example, note that:

- the fields using A0N print the field in normal rotation
- the fields with no rotation indicated (A0) follow the rotation used in the ^FW command (^FWR).

ZPL II CODE	GENERATED LABEL
<pre> ^XA ^FWR ^FO150,90^A0N,25,20^FDZebra Technologies^FS ^FO115,75^A0,25,20^FD0123456789^FS ^FO150,115^A0N,25,20^FD333 Corporate Woods Parkway^FS ^FO400,75^A0,25,20^FDXXXXXXXXXX^FS ^XZ </pre>	

Comments: ^FW affects only the orientation in commands where the rotation parameter has not been specifically set. If a command has a specific rotation parameter, that value is used.

 .141

^FW affects only the justification in commands where the parameter has not been set. If a command has a specific justification parameter that value is used .

^FX

Comment

The ^FX command is useful when you want to add *non-printing* informational comments or statements within a label format. Any data after the ^FX command up to the next caret (^) or tilde (~) command does not have any effect on the label format. Therefore, you should avoid using the caret (^) or tilde (~) commands within the ^FX statement.

Format: ^FXc

Parameters	Details
c = non printing comment	Creates a non-printable comment.

Example: This is an example of how to use the ^FX command effectively:

ZPL II CODE	GENERATED LABEL
<pre> ^XA ^LH100,100^FS ^FXSHIPPING LABEL^FS ^FO10,10^GB470,280,4^FS ^FO10,190^GB470,4,4^FS ^FO10,80^GB240,2,2^FS ^FO250,10^GB2,100,2^FS ^FO250,110^GB226,2,2^FS ^FO250,60^GB226,2,2^FS ^FO156,190^GB2,95,2^FS ^FO312,190^GB2,95,2^FS ^XZ </pre>	

Comments: Correct usage of the ^FX command includes following it with the ^FS command.

^GB

Graphic Box

The **^GB** command is used to draw boxes and lines as part of a label format. Boxes and lines are used to highlight important information, divide labels into distinct areas, or to improve the appearance of a label. The same format command is used for drawing either boxes or lines.

Format: `^GBw,h,t,c,r`

Parameters	Details
w = box width (in dots)	Values: value of t to 32000 Default: value used for thickness (t) or 1
h = box height (in dots)	Values: value of t to 32000 Default: value used for thickness (t) or 1
t = border thickness (in dots)	Values: 1 to 32000 Default: 1
c = line color	Values: B = black W = white Default: B
r = degree of corner-rounding	Values: 0 (no rounding) to 8 (heaviest rounding) Default: 0

For the **w** and **h** parameters, keep in mind that printers have a default of 6, 8, 12, or 24 dots/millimeter. This comes out to 153, 203, 300, or 600 dots per inch. To determine the values for **w** and **h**, calculate the dimensions in millimeters and multiply by 6, 8, 12, or 24.

If the width and height are not specified, you get a solid box with its width and height as specified by value **t**.

The roundness-index is used to determine a rounding-radius for each box. Formula:

$$\text{rounding-radius} = (\text{rounding-index} / 8) * (\text{shorter side} / 2)$$

where the shorter side is the lesser of the width and height (after adjusting for minimum and default values).

Example: Here are a few examples of graphic boxes:

Width: 1.5 inch; Height: 1 inch; Thickness: 10; Color: default; Rounding: default

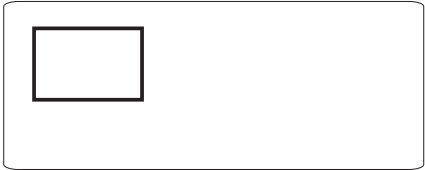
ZPL II CODE	GENERATED LABEL
<pre> ^XA ^FO50,50 ^GB300,200,10^FS ^XZ </pre>	

ZPL Commands

Width: 0 inch; Height: 1 inch; Thickness: 20; Color: default; Rounding: default:

ZPL II CODE	GENERATED LABEL
<pre>^XA ^FO50,50 ^GB0,203,20^FS ^XZ</pre>	

Width: 1 inch; Height: 0 inch; Thickness: 30; Color: default; Rounding: default

ZPL II CODE	GENERATED LABEL
<pre>^XA ^FO50,50 ^GB203,0,20^FS ^XZ</pre>	

Width: 1.5 inch; Height: 1 inch; Thickness: 10; Color: default; Rounding: 5

ZPL II CODE	GENERATED LABEL
<pre>^XA ^FO50,50 ^GB300,200,10,,5^FS ^XZ</pre>	

^GC**Graphic Circle**

The **^GC** command produces a circle on the printed label. The command parameters specify the diameter (width) of the circle, outline thickness, and color. Thickness extends inward from the outline.

Format: **^GC***d,t,c*

Parameters	Details
d = circle diameter (in dots)	Values: 3 to 4095 (larger values are replaced with 4095) Default: 3
t = border thickness (in dots)	Values: 2 to 4095 Default: 1
c = line color	Values: B = black W = white Default: B

Example: This is an example of how to create a circle on the printed label:

ZPL II CODE	GENERATED LABEL
<pre> ^XA ^FO50,50 ^GC250,10,B^FS ^XZ </pre>	

^GD**Graphic Diagonal Line**

The **^GD** command produces a straight diagonal line on a label. This can be used in conjunction with other graphic commands to create a more complex figure.

Format: **^GD***w,h,t,c,o*

Parameters	Details
w = box width (in dots)	Values: 3 to 32000 Default: value of t (thickness) or 3
h = box height (in dots)	Values: 3 to 32000 Default: value of t (thickness) or 3
t = border thickness (in dots)	Values: 1 to 32000 Default: 1
c = line color	Values: B = black W = white Default: B
o = orientation (direction of the diagonal)	Values: R (or /) = right-leaning diagonal L (or \) = left-leaning diagonal Default: R

Example: This is an example of how to create a diagonal line connecting one corner with the opposite corner of a box on a printed label:

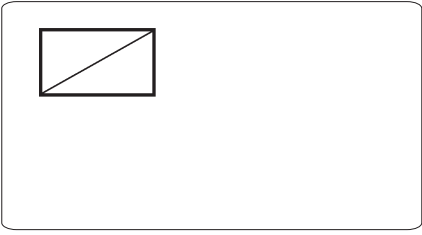
ZPL II CODE	GENERATED LABEL
<pre> ^XA ^FO150,100 ^GB350,203,10^FS ^FO155,110 ^GD330,183,10,,R^FS ^XZ </pre>	

^GE**Graphic Ellipse**

The ^GE command produces an ellipse in the label format.

Format: ^GEw,h,t,c

Parameters	Details
w = ellipse width (in dots)	Values: 3 to 4095 (larger values are replaced with 4095) Default: value used for thickness (t) or 1
h = ellipse height (in dots)	Values: 3 to 4095 Default: value used for thickness (t) or 1
t = border thickness (in dots)	Values: 2 to 4095 Default: 1
c = line color	Values: B = black W = white Default: B

Example: This is an example of how to create a ellipse on a printed label:

ZPL II CODE	GENERATED LABEL
<pre> ^XA ^FO100,100 ^GE300,100,10,B^FS ^XZ </pre>	

^GF**Graphic Field**

The **^GF** command allows you to download graphic field data directly into the printer's bitmap storage area. This command follows the conventions for any other field, meaning a field orientation is included. The graphic field data can be placed at any location within the bitmap space.

Format: **^GFa,b,c,d,data**

Parameters	Details
a = compression type	<p>Values:</p> <p>A = ASCII hexadecimal (follows the format for other download commands)</p> <p>B = binary (data sent after the c parameter is strictly binary)</p> <p>C = compressed binary (data sent after the c parameter is in compressed binary format. The data is compressed on the host side using Zebra's compression algorithm. The data is then decompressed and placed directly into the bitmap.)</p> <p>Default: A</p>
b = binary byte count	<p>Values: 1 to 99999</p> <p>This is the total number of bytes to be transmitted for the total image or the total number of bytes that follow parameter d. For ASCII download, the parameter should match parameter c. Out-of-range values are set to the nearest limit.</p> <p>Default: command is ignored if a value is not specified</p>
c = graphic field count	<p>Values: 1 to 99999</p> <p>This is the total number of bytes comprising the graphic format (width x height), which is sent as parameter d. Count divided by bytes per row gives the number of lines in the image. This number represents the size of the image, not necessarily the size of the data stream (see d).</p> <p>Default: command is ignored if a value is not specified</p>
d = bytes per row	<p>Values: 1 to 99999</p> <p>This is the number of bytes in the downloaded data that comprise one row of the image.</p> <p>Default: command is ignored if a value is not specified</p>
data = data	<p>Values:</p> <p>ASCII hexadecimal data: 00 to FF</p> <p>A string of ASCII hexadecimal numbers, two digits per image byte. CR and LF can be inserted as needed for readability. The number of two-digit number pairs must match the above count. Any numbers sent after count is satisfied are ignored. A comma in the data pads the current line with 00 (white space), minimizing the data sent. ~DN or any caret or tilde character prematurely aborts the download.</p> <p>Binary data: Strictly binary data is sent from the host. All control prefixes are ignored until the total number of bytes needed for the graphic format is sent.</p>

Example: This example downloads 8,000 total bytes of data and places the graphic data at location 100,100 of the bitmap. The data sent to the printer is in ASCII form.

```
^F0100,100^GFA,8000,8000,80,ASCII data
```

Example: This example downloads 8,000 total bytes of data and places the graphic data at location 100,100 of the bitmap. The data sent to the printer is in binary form.

```
^F0100,100^GFB,8000,8000,80,Binary data
```

^GS

Graphic Symbol

The ^GS command enables you to generate the registered trademark, copyright symbol, and other symbols.

Format: ^GS_o,h,w

Parameters	Details
o = field orientation	Values: N = normal R = rotate 90 degrees clockwise I = inverted 180 degrees B = bottom-up, 270 degrees Default: N or last ^FW value
h = character height proportional to width (in dots)	Values: 0 to 32000 Default: last ^CF value
w = character width proportional to height (in dots)	Values: 0 to 32000 Default: last ^CF value

Use the ^GS command followed by ^FD and the appropriate character (A through E) within the field data to generate the desired character:

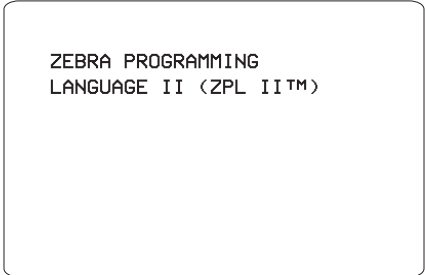
ZPL II CODE	GENERATED LABEL
<pre> ^XA^CFD ^FO50,50 ^FDZEBRA PROGRAMMING^FS ^FO50,75 ^FDLANGUAGE II (ZPL II)^FS ^FO280,75 ^GS^FDC^FS ^XZ </pre>	

A = ® (Registered Trade Mark)

B = © (Copyright)

C = ™ (Trade Mark)

D =  (Underwriters Laboratories approval)

E =  (Canadian Standards Association approval)

~HB

Battery Status

When the ~HB command is sent to the printer, a data string is sent back to the host. The string starts with an <STX> control code sequence and terminates by an <ETX><CR><LF> control code sequence.



NOTE: This command only responds to mobile printers.

Format: ~HB

Parameters

When the printer receives the command, it returns:

<STX>hh.hh,bb.bb,bt<ETX><CR><LF>

<STX>	=	ASCII start-of-text character
hh.hh	=	current head voltage reading in integers
bb.bb	=	current battery voltage reading in integers
bt	=	battery temperature in Celsius
<ETX>	=	ASCII end-of-text character
<CR>	=	ASCII carriage return
<LF>	=	ASCII line feed character

- This command is used for the power-supply battery of the printer and should not be confused with the battery backed-up RAM.
- For a more precise voltage reading, you can use the power.voltage SGD command, which returns a value to the nearest hundredths of a volt (X.XX).

~HD

Head Diagnostic

The ~HD command echoes printer status information that includes the power supply and head temperature using the terminal emulator.

Format: ~HD

Example: This is an example of the ~HD command:

```

Head Temp = 29
Ambient Temp = 00
Head Test = Passed
Darkness Adjust = 23
Print Speed = 2
Slew Speed = 6
Backfeed Speed = 2
Static_pitch_length = 0521
Dynamic_pitch_length = 0540
Max_dynamic_pitch_length = 0540
Min_dynamic_pitch_length = 0537
COMMAND PFX = ~ : FORMAT PFX = ^ : DELIMITER = ,
P30 INTERFACE = None
P31 INTERFACE = None
P32 INTERFACE = Front Panel           Revision 5
P33 INTERFACE = None
P34 INTERFACE = None
P35 INTERFACE = None
Dynamic_top_position = 0008
No ribbon A/D = 0000

```

^HF

Host Format

The ^HF command sends stored formats to the host.

Format: ^HFd,o,x

Parameters	Details
d = device to recall image	Values: R:, E:, B:, and A: Default: R:
o = image name	Values: 1 to 8 alphanumeric characters Default: if a name is not specified, UNKNOWN is used
x = extension	Fixed Value: .ZPL

Example: This example shows the sequence and results.

Using a terminal emulator, you download this code to the printer:

```

^XA
^DFB:FILE1.ZPL
^F0100,100^A0,100
^FDTEST^FS
^XZ

```

Then you send this code to the printer:

```

^XA
^HFB:FILE1.ZPL
^XZ

```

The terminal emulator returns this code:

```

^XA^DFFILE1,
^F0100,100^A0,100^FDTEST^FS
^XZ

```

^HG

Host Graphic

The **^HG** command is used to upload graphics to the host. The graphic image can be stored for future use, or it can be downloaded to any Zebra printer.

Format: ^HGd:o.x

Parameters

- **d** (device location of object)- Values=**R:**, **E:**, **B:**, and **A:**;
 Default= search priority
- **o** (object name)- Values=**R:**, **E:**, **B:**, and **A:**;
 Default =if a name is not specified, UNKNOWN is used
- **x** (**extension**)- **Fixed Value**=**.GRF**

Comments: For more information on uploading graphics, see [^HY on page 220](#).

^HH**Configuration Label Return**

The ^HH command echoes printer configuration back to the host, using a terminal emulator.

Format: ^HH

Example: This is an example of what is returned to the host when ^XA^HH^XZ is sent to the printer:

```

+10          DARKNESS
+000        TEAR OFF
TEAR OFF    PRINT MODE
NON-CONTINUOUS MEDIA TYPE
WEB         SENSOR TYPE
DIRECT-THERMAL PRINT METHOD
050 6/8 MM  PRINT WIDTH
0622       LABEL LENGTH
22.01IN   557MM MAXIMUM LENGTH
9600      BAUD
8 BITS    DATA BITS
NONE      PARITY
XON/XOFF  HOST HANDSHAKE
NONE      PROTOCOL
000       NETWORK ID
NORMAL MODE COMMUNICATIONS
<^> 7EH  CONTROL PREFIX
<^> 5EH  FORMAT PREFIX
<,> 2CH  DELIMITER CHAR
ZPL II    ZPL MODE
NO MOTION MEDIA POWER UP
NO MOTION HEAD CLOSE
DEFAULT   BACKFEED
+000     LABEL TOP
+0000    LEFT POSITION
026      WEB S.
068      MEDIA S.
050      MARK S.
001      MARK MED S.
CS        MODES ENABLED
..        MODES DISABLED
864 8/MM FULL RESOLUTION
U32.10.2 <-  FIRMWARE
U2.2.6.98.A  HARDWARE ID
CUSTOMIZED  CONFIGURATION
1024.....R: RAM
8192.....B: MEMORY CARD
0768.....E: ONBOARD FLASH
NONE      FORMAT CONUERT
NONE      OPTION
05/14/03  RTC DATE
02:23    RTC TIME
DYNAMIC  IP RESOLUTION
ALL      IP PROTOCOL
010.003.005.090 IP ADDRESS
255.255.255.000 SUBNET MASK
010.003.005.001 DEFAULT GATEWAY

```

~HI

Host Identification

The ~HI command is designed to be sent from the host to the Zebra printer to retrieve information. Upon receipt, the printer responds with information on the model, software version, dots-per-millimeter setting, memory size, and any detected options.

Format: ~HI

When the printer receives this command, it returns:

XXXXXX,V1.0.0,dpm,000KB,X

XXXXXX = model of Zebra printer

V1.0.0 = version of software

dpm = dots/mm

6, 8, 12, or 24 dots/mm printheads

000KB = memory

512KB = 1/2 MB

1024KB = 1 MB

2048KB = 2 MB

4096KB = 4 MB

8192KB = 8 MB

x = recognizable options

only options specific to printer are shown (cutter, options, et cetera.)

~HM

Host RAM Status

Sending ~HM to the printer immediately returns a memory status message to the host. Use this command whenever you need to know the printer's RAM status.

When ~HM is sent to the Zebra printer, a line of data containing information on the total amount, maximum amount, and available amount of memory is sent back to the host.

Format: ~HM

Example: This example shows when the ~HM is sent to the printer, a line of data containing three numbers are sent back to the host. Each set of numbers is identified and explained in the table that follows:

1—(1024)—(0780)—(0780)—3

1	The total amount of RAM (in kilobytes) installed in the printer. In this example, the printer has 1024K RAM installed.
2	The maximum amount of RAM (in kilobytes) available to the user. In this example, the printer has a maximum of 780K RAM available.
3	The amount of RAM (in kilobytes) currently available to the user. In this example, there is 780K of RAM in the printer currently available to the user.

Comments: Memory taken up by bitmaps is included in the currently available memory value (due to ^MCN).

Downloading a graphic image, fonts, or saving a bitmap affects only the amount of RAM. The total amount of RAM and maximum amount of RAM does not change after the printer is turned on.

~HQ

Host Query

The ~HQ command group causes the printer to send information back to the host.

Format: ~HQquery-type

Parameter	Details
query-type	<p>For detailed examples of these parameters, see ~HQ Examples on page 207.</p> <p>Values:</p> <ul style="list-style-type: none"> • ES = requests the printer's status - see Table 7 on page 206 and Table 8 on page 207 • HA = hardware address of the internal wired print server • JT = requests a summary of the printer's printhead test results • MA = maintenance alert settings • MI = maintenance information • OD = odometer • PH = printhead life history • PP = printer's Plug and Play string • SN = printer's serial number • UI = USB product ID and BDC release version • <p>Default: must be an accepted value or the command is ignored</p>

Comments: The response to the ~HQ command starts with STX, a CR LF is inserted between each line, and the response ends with ETX.

Table 7 Error Flags (~HQES)

Error Flags	Flag	Group 2	Group 1 (X = Value can be any hexadecimal number [0-9, A-F])							
		Nibbles 16-9	Nibble 8	Nibble 7	Nibble 6	Nibble 5	Nibble 4	Nibble 3	Nibble 2	Nibble 1
No Error	0	00000000	0	0	0	0	0	0	0	0
Error Present	1	00000000	X	X	X	X	X	X	X	X
Printhead Thermistor Open	1	00000000	X	X	X	X	X	2	X	X
Invalid Firmware Config.	1	00000000	X	X	X	X	X	1	X	X
Printhead Detection Error	1	00000000	X	X	X	X	X	X	8	X
Bad Printhead Element	1	00000000	X	X	X	X	X	X	4	X
Motor Over Temperature	1	00000000	X	X	X	X	X	X	2	X
Printhead Over Temperature	1	00000000	X	X	X	X	X	X	1	X
Cutter Fault	1	00000000	X	X	X	X	X	X	X	8
Head Open	1	00000000	X	X	X	X	X	X	X	4
Ribbon Out	1	00000000	X	X	X	X	X	X	X	2
Media Out	1	00000000	X	X	X	X	X	X	X	1
Clear Paper Path Failed	1	00000000	X	X	X	X	8	X	X	X
Paper Feed Error	1	00000000	X	X	X	X	4	X	X	X
Presenter Not Running	1	00000000	X	X	X	X	2	X	X	X
Paper Jam during Retract	1	00000000	X	X	X	X	1	X	X	X
Black Mark not Found	1	00000000	X	X	X	8	X	X	X	X
Black Mark Calabrate Error	1	00000000	X	X	X	4	X	X	X	X
Retract Function timed out	1	00000000	X	X	X	2	X	X	X	X
Paused	1	00000000	X	X	X	1	X	X	X	X

This error flag is supported only on KR403 printers.

Table 8 Warning Flags (~HQES)

Error Flags	Flag	Group 2	Group 1 (X = Value can be any hexadecimal number [0-9, A-F])								
		Nibbles 16-9	Nibble 8	Nibble 7	Nibble 6	Nibble 5	Nibble 4	Nibble 3	Nibble 2	Nibble 1	
No Warning	0	00000000	0	0	0	0	0	0	0	0	0
Warning Present	1	00000000	X	X	X	X	X	X	X	X	X
Paper-near-end Sensor	1	00000000	X	X	X	X	X	X	X	X	8
Replace Printhead	1	00000000	X	X	X	X	X	X	X	X	4
Clean Printhead	1	00000000	X	X	X	X	X	X	X	X	2
Need to Calibrate Media	1	00000000	X	X	X	X	X	X	X	X	1
Sensor 1 (Paper before head)	1	00000000	X	X	X	X	X	X	X	1	X
Sensor 2 (Black mark)	1	00000000	X	X	X	X	X	X	X	2	X
Sensor 3 (Paper after head)	1	00000000	X	X	X	X	X	X	X	4	X
Sensor 4 (loop ready)	1	00000000	X	X	X	X	X	X	X	8	X
Sensor 5 (presenter)	1	00000000	X	X	X	X	X	X	1	X	X
Sensor 6 (retract ready)	1	00000000	X	X	X	X	X	X	2	X	X
Sensor 7 (in retract)	1	00000000	X	X	X	X	X	X	4	X	X
Sensor 8 (at bin)	1	00000000	X	X	X	X	X	X	8	X	X

This error flag is supported only on KR403 printers.

~HQ Examples

This section provides detail examples of all the available parameters.

Example: This example shows how to request the printer's status.

- a. To request the printer's status, type `~HQES`

The printer responds with data similar to this:

```

PRINTER STATUS
ERRORS:          1 00000000 00000005
WARNINGS:        1 00000000 00000002
    
```

In this example, the Printer Status resolves to these conditions:

- The cover/printhead is open (value = 4).
- Media is out or not loaded into the printer (value = 1).
- The printhead needs to be cleaned (value = 2).
- Error nibble 1 is equal to 5 when the error status values are added together (4 + 1).

This illustration identifies the printer status definitions:

ZPL Commands

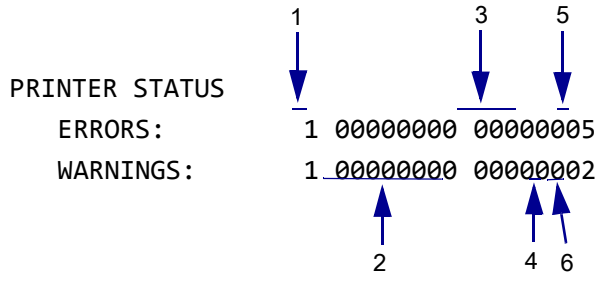

1	Flag
2	Nibble 16-9
3	Nibble 8-4
4	Nibble 3
5	Nibble 2
6	Nibble 1

Example: This example shows how the printer responds when the printer receives the `~HQES` command:

- a. To see how the printer responds, type `~HQES`

The printer responds with data similar to this:

```
PRINTER STATUS
ERRORS: 1 00000000 0000000B
WARNINGS: 0 00000000 00000000
```

In this example, the printer status resolves to the following conditions:

- The cutter has a fault (value = 8).
- Ribbon is out or not loaded into the printer (value = 2).
- Media is out or not loaded into the printer (value = 1).
- Error byte 1 is equal to **B** when the error status values are added together ($8 + 2 + 1 = \text{hexadecimal B}$).

Example: This is an example of how to retrieve the hardware address of the internal wired print server.

- a. To get the hardware address of the internal wired print server, type `~HQHA`

The printer responds with data similar to this:

```
MAC ADDRESS
00:07:4d:2c:e0:7a
```

Example: This is an example of how to request a summary of the printer's printhead test results.

The `^JT` command is used to initiate printhead testing, set the testing interval, and set the element range to be tested. For more details see, [^JT on page 253](#).

- a. To request a summary of the printer's printhead test, type `~HQJT`

The printer responds with data similar to this:

```
PRINT HEAD TEST RESULTS
0,A,0000,0000,0000
```

When the printer has printed enough labels to trigger a printhead test, the initial data changes.

- b. To request a summary of the printer's printhead test, type `~HQJT`

The printer responds with data similar to this:

```
PRINT HEAD TEST RESULTS:
0,A,0015,0367,0000
```

This illustration identifies the printhead test field definitions:

`0,A,0000,0000,0000`

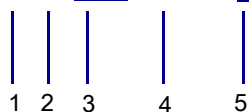

1	Element failure
2	Manual (M) or automatic (A) range
3	First test element
4	Last test element
5	Failure count

Example: This is an example of how to use the maintenance alert query for the `~HQ` command.

- a. To get the current settings, type `~HQMA`

The printer responds with data similar to this:

```
~HQMA
MAINTENANCE ALERT SETTINGS
HEAD REPLACEMENT INTERVAL:      1 km
HEAD REPLACEMENT FREQUENCY:     0 M
HEAD CLEANING INTERVAL:         0 M
HEAD CLEANING FREQUENCY:        0 M
PRINT REPLACEMENT ALERT:        NO
PRINT CLEANING ALERT:           NO
UNITS:                           C
```

Example: This is an example of how to use the maintenance information query for the `~HQ` command.

Note that the message is controlled by the `^MI` command.

- a. To get the current settings, type `~HQMI`

The printer responds with data similar to this:

```
MAINTENANCE ALERT MESSAGES
CLEAN: PLEASE CLEAN PRINT HEAD
REPLACE: PLEASE REPLACE PRINT HEAD
```

Example: This is an example of how to use the odometer query for the `~HQ` command.

Note that the units of measure are controlled by the `^MA` command. Also, if the "Early Warning Maintenance State" is turned "ON" the printer response would also list LAST CLEANED and CURRENT PRINTHEAD LIFE counters.

- a. To get the current settings, type `~HQOD`

The printer responds with data similar to this:

```
PRINT METERS
TOTAL NONRESETTABLE:           8560 "
USER RESETTABLE CNTR1:         9 "
USER RESETTABLE CNTR2:        8560 "
```

The units of measure are set to inches.

- b. To change the units of measure to centimeters, type:

```
^XA^MA,,,C
^XZ
```

The units of measure are set to centimeters.

- c. To check the settings, type `~HQOD`

The printer responds with data similar to this:

```
PRINT METERS
TOTAL NONRESETTABLE:           21744 cm
USER RESETTABLE CNTR1:         24 cm
USER RESETTABLE CNTR2:        21744 cm
```

Example: This is an example of how to use the printhead life query for the `~HQ` command.

Note that the units of measure are controlled by the `^MA` command.

- a. To get the current settings, type `~HQPH`

The printer responds with data similar to this:

```
LAST CLEANED: 257 "
HEAD LIFE HISTORY
#    DISTANCE
1:      257 "
2:     1489 "
3:     7070 "
```

line 1	The current life of the print head.
lines 2–10	Tracks the measurement for each time the print head is changed. (The example only shows lines 2 and 3.)

Example: This is an example of how to request the printer's Plug and Play string.

- a. To request the printer's Plug and Play string, type `~HQPP`

The printer responds with data similar to this:

```
PLUG AND PLAY MESSAGES
MFG: Zebra Technologies
CMD: ZPL
MDL: GX420t
```

Example: This is an example of how to retrieve the printer's serial number.

- a. To get the printer's serial number, type `~HQSN`

The printer responds with data similar to this:

```
SERIAL NUMBER
41A06440023
```

Example: This is an example of how to retrieve the printer's USB product ID and BCD release version.

- a. To get the printer's USB product ID and BCD release version, type `~HQUI`

The printer responds with data similar to this:

```
USB INFORMATION
PID:                                0085
RELEASE VERSION:                    15.01
```

~HS

Host Status Return

When the host sends ~HS to the printer, the printer sends three data strings back. Each string starts with an <STX> control code and is terminated by an <ETX><CR><LF> control code sequence. To avoid confusion, the host prints each string on a separate line.



NOTE: When a ~HS command is sent the printer will not send a response to the host if the printer is in one of these conditions:

- MEDIA OUT
- RIBBON OUT
- HEAD OPEN
- REWINDER FULL
- HEAD OVER-TEMPERATURE

String 1 <STX>aaa,b,c,dddd,eee,f,g,h,iii,j,k,l<ETX><CR><LF>

aaa	=	communication (interface) settings ^a
b	=	paper out flag (1 = paper out)
c	=	pause flag (1 = pause active)
dddd	=	label length (value in number of dots)
eee	=	number of formats in receive buffer
f	=	buffer full flag (1 = receive buffer full)
g	=	communications diagnostic mode flag (1 = diagnostic mode active)
h	=	partial format flag (1 = partial format in progress)
iii	=	unused (always 000)
j	=	corrupt RAM flag (1 = configuration data lost)
k	=	temperature range (1 = under temperature)
l	=	temperature range (1 = over temperature)

This string specifies the printer's baud rate, number of data bits, number of stop bits, parity setting, and type of handshaking. This value is a three-digit decimal representation of an eight-bit binary number. To evaluate this parameter, first convert the decimal number to a binary number.

The nine-digit binary number is read according to this table:

aaa = a ⁸ a ⁷ a ⁶ a ⁵ a ⁴ a ³ a ² a ¹ a ⁰	
a ⁷ = Handshake 0 = Xon/Xoff 1 = DTR	a ⁸ a ² a ¹ a ⁰ = Baud 0 000 = 110 0 001 = 300 0 010 = 600 0 011 = 1200 0 100 = 2400 0 101 = 4800 0 110 = 9600 0 111 = 19200 1 000 = 28800 <i>(available only on certain printer models)</i> 1 001 = 38400 <i>(available only on certain printer models)</i> 1 010 = 57600 <i>(available only on certain printer models)</i> 1 011 = 14400
a ⁶ = Parity Odd/Even 0 = Odd 1 = Even	
a ⁵ = Disable/Enable 0 = Disable 1 = Enable	
a ⁴ = Stop Bits 0 = 2 Bits 1 = 1 Bit	
a ³ = Data Bits 0 = 7 Bits 1 = 8 Bits	

String 2 <STX>mmm,n,o,p,q,r,s,t,uuuuuuuu,v,www<ETX><CR><LF>

- mmm = function settings
- n = unused
- o = head up flag (1 = head in up position)
- p = ribbon out flag (1 = ribbon out)
- q = thermal transfer mode flag (1 = Thermal Transfer Mode selected)
- r = Print Mode
 - 0 = Rewind
 - 1 = Peel-Off
 - 2 = Tear-Off
 - 3 = Cutter
 - 4 = Applicator
 - 5 = Delayed cut
 - 6 = Linerless Peel
 - 7 = Linerless Rewind
 - 8 = Partial Cutter
 - 9 = RFID
 - K = Kiosk
 - S = A = Kiosk CutStream
- s = print width mode
- t = label waiting flag (1 = label waiting in Peel-off Mode)

.141 Values 4 to 5 are supported only in firmware version V60.14.x, V50.14.x, V53.15.x, or later.

This string specifies the printer's media type, sensor profile status, and communication diagnostics status. As in String 1, this is a three-digit decimal representation of an eight-bit binary number. First, convert the decimal number to a binary number. These values are only supported on the ZE500, Xi4, RXi4, ZM400/ZM600, and RZ400/RZ600 printers.

- uuuuuuuu** = labels remaining in batch
- v** = format while printing flag (always 1)
- www** = number of graphic images stored in memory

This string specifies the printer's media type, sensor profile status, and communication diagnostics status. As in String 1, this is a three-digit decimal representation of an eight-bit binary number. First, convert the decimal number to a binary number. These values are only supported on the ZE500, Xi4, RXi4, ZM400/ZM600, and RZ400/RZ600 printers.

The eight-digit binary number is read according to this table:

mmm = m7 m6 m5 m4 m3 m2 m1 m0	
m7 = Media Type 0 = Die-Cut 1 = Continuous	m4 m3 m2 m1 = Unused 0 = Off 1 = On
m6 = Sensor Profile 0 = Off	m0 = Print Mode 0 = Direct Thermal 1 = Thermal Transfer
m5 = Communications Diagnostics 0 = Off 1 = On	

String 3 <STX>xxx,y<ETX><CR><LF>

- y = 0 (static RAM not installed)
- 1 (static RAM installed)

^HT**Host Linked Fonts List****.14↑**

This command is available only for printers with firmware version V60.14.x, V50.14.x, or later.

The ^HT command receives the complete list of font links over a communication port.

The **SWISS.721.TTF** is the base font, **ANMDJ.TTF** is the first linked font, and **MSGOTHIC.TTF** is the second linked font:

ZPL II CODE	DATA RETURNED
^XA ^HT ^XZ	LIST OF FONT LINKS E:SWISS721.TTF E:ANMDJ.TTF E:MSGOTHIC.TTF

This is the code that was used to establish the font links:

```

^XA
^FLE:ANMDJ.TTF,E:SWISS721.TTF,1^FS
^FLE:MSGOTHIC.TTF,E:SWISS721.TTF,1^FS
^XZ

```

~HU

Return ZebraNet Alert Configuration

This command returns the table of configured ZebraNet Alert settings to the host.

Format: ~HU

Example: If the ~HU command is sent to the printer with existing Alert messages set to go to e-mail and SNMP traps, the data returned would look something like the information below. See [^SX on page 331](#) for complete information on the individual parameter settings.

```

B,C,Y,Y,ADMIN@COMPANY.COM,0
J,F,Y,Y,,0
C,F,Y,Y,,0
D,F,Y,Y,,0
E,F,Y,N,,0
F,F,Y,N,,0
H,C,Y,N,ADMIN@COMPANY.COM,0
N,C,Y,Y,ADMIN@COMPANY.COM,0
O,C,Y,Y,ADMIN@COMPANY.COM,0
P,C,Y,Y,ADMIN@COMPANY.COM,0

```



IMPORTANT: If there are no ^SX (alerts) set, the printer will not respond to the ~HU command.

The first line indicates that condition B (ribbon out) is routed to destination C (e-mail address).

The next two characters, Y and Y, indicate that the condition set and condition clear options have been set to yes.

The following entry is the destination that the Alert e-mail should be sent to; in this example it is admin@company.com.

The last figure seen in the first line is 0, which is the port number.

Each line shows the settings for a different Alert condition as defined in the ^SX command.

^HV

Host Verification

Use this command to return data from specified fields, along with an optional ASCII header, to the host computer. You can use this command with any field that has been assigned a number with the ^FN and ^RF commands.

Format: ^HV#,n,h,t,a

Parameters	Details
# = field number specified with another command	The value assigned to this parameter should be the same as the one used in another command. Values: 0 to 9999 Default: 0
n = number of bytes to be returned	Values: 1 to 256 Default: 64
h = header to be returned with the data	Delimiter characters terminate the string. This field is Field Hex (^FH) capable. Values: 0 to 3072 bytes Default: no header
t = termination	This field is Field Hex (^FH) capable. Values: 0 to 3072 characters
a = command applies to	When ^PQ is greater than 1 or if a void label occurs, send one response for a label format or one for every label printed. Values: <ul style="list-style-type: none">• F = Format• L = Label Default: F

The following code:

```
^XA
.
.
.
^FH_^HV0,8,EPC[, ]_0D_0A,L^FS
^PQ2
^XZ
```

Would return data similar to this:

```
EPC[12345678]
EPC[55554444]
```

^HW**Host Directory List**

^HW is used to transmit a directory listing of objects in a specific memory area (storage device) back to the host device. This command returns a formatted ASCII string of object names to the host.

Each object is listed on a line and has a fixed length. The total length of a line is also fixed. Each line listing an object begins with the asterisk (*) followed by a blank space. There are eight spaces for the object name, followed by a period and three spaces for the extension. The extension is followed by two blank spaces, six spaces for the object size, two blank spaces, and three spaces for option flags (reserved for future use). The format looks like this:

```
<STX><CR><LF>
DIR R: <CR><LF>
*Name.ext(2sp.)(6 obj. sz.)(2sp.)(3 option flags)
*Name.ext(2sp.)(6 obj. sz.)(2sp.)(3 option flags)
<CR><LF>
-xxxxxxx bytes free
<CR><LF>
<ETX>
<STX> = start of text
<CR><LR> = carriage return/line feed
<ETX> = end on text
```

The command might be used in a stand-alone file to be issued to the printer at any time. The printer returns the directory listing as soon as possible, based on other tasks it might be performing when the command is received.

This command, like all ^ (caret) commands, is processed in the order that it is received by the printer.

Format: **^Hwd:o.x**

Parameters	Details
d = location to retrieve object listing	Values: R:, E:, B:, A:and Z: Default: R:
o = object name	Values: 1 to 8 alphanumeric characters Default: asterisk (*). A question mark (?) can also be used.
x = extension	Values: any extension conforming to Zebra conventions Default: asterisk (*). A question mark (?) can also be used.
f = format  The f parameter is only supported in firmware version V60.16.0Z and V53.16.0Z or later.	Values: c = column format d = default format Default: d

Example: Listed is an example of the ^HW command to retrieve from information R:

```
^XA  
^HWR:*. *  
^XZ
```

The printer returned this information as the Host Directory Listing: -DIR R:*. *

```
*R:ARIALN1.FNT 49140  
*R:ARIALN2.FNT 49140  
*R:ARIALN3.FNT 49140  
*R:ARIALN4.FNT 49140  
*R:ARIALN.FNT 49140  
*R:ZEBRA.GRF 8420  
-794292 bytes free R:RAM
```

^HY

Upload Graphics

The ^HY command is an extension of the ^HG command. ^HY is used to upload graphic objects from the printer in any supported format.

Format: ^HYd:o.x

Parameters	Details
d = location of object	Values: R:, E:, B:, and A: Default: search priority
o = object name	Values: 1 to 8 alphanumeric characters Default: an object name must be specified
x = extension	Values: G = .GRF (raw bitmap format) P = .PNG (compressed bitmap format) Default: format of stored image

Comments: The image is uploaded in the form of a ~DY command. The data field of the returned ~DY command is always encoded in the ZB64 format.

^HZ**Display Description Information**

The ^HZ command is used for returning printer description information in XML format. The printer returns information on format parameters, object directories, individual object data, and print status information.

Format: ^HZb

Parameters	Details
b = display description to return	<p>Values:</p> <ul style="list-style-type: none"> a = display all information f = display printer format setting information l = display object directory listing information o = display individual object data information r = display printer status information <p>Default: if the value is missing or invalid, the command is ignored</p>

Format: ^HZ0,d:o.x,1

Parameters	Details
d = location of stored object	<p>Values: R:, E:, B:, and A:</p> <p>Default: R:</p>
o = object name	<p>Values: 1 to 8, or 1 to 16 alphanumeric characters based on parameter 1.</p> <p>Default: if a name is not specified, UNKNOWN is used.</p>
x = extension	<p>Supported extensions for objects (parameter o) include:</p> <ul style="list-style-type: none"> .FNT — font .GRF — graphic .PNG — compressed graphic .ZPL — stored format .DAT — encoding table .ZOB — downloadable object .STO — Alert data file
l = long filename support	<p>Values:</p> <p>Y = Yes</p> <p style="padding-left: 20px;">If Y, the object data stores the filename as 16 characters. The data is only compatible with firmware version V60.13.0.5, or later.</p> <p>N = No</p> <p style="padding-left: 20px;">If N, the object data stores the filename as 8 characters. The data is forward and backward compatible with all versions of firmware.</p> <p>Default: N</p>

Example: This example shows the object data information for the object **SAMPLE.GRF** located on **R:**.

^XA

^HZO,R:SAMPLE.GRF

^XZ

^ID

Object Delete

The ^ID command deletes objects, graphics, fonts, and stored formats from storage areas. Objects can be deleted selectively or in groups. This command can be used within a printing format to delete objects before saving new ones, or in a stand-alone format to delete objects.

The image name and extension support the use of the asterisk (*) as a wild card. This allows you to easily delete a selected groups of objects.

Format: ^IDd:o.x

Parameters	Details
d = location of stored object	Values: R:, E:, B:, and A: Default: R:
o = object name	Values: any 1 to 8 character name Default: if a name is not specified, UNKNOWN is used
x = extension	Values: any extension conforming to Zebra conventions Default: .GRF

To delete stored formats from DRAM:

```
^XA
^IDR:*.ZPL^FS
^XZ
```

To delete formats and images named SAMPLE from DRAM, regardless of the extension:

```
^XA
^IDR:SAMPLE.*^FS
^XZ
```

To delete the image **SAMPLE1.GRF** prior to storing **SAMPLE2.GRF**:

```
^XA
^F025,25^AD,18,10
^FDDelete^FS
^F025,45^AD,18,10
^FDthen Save^FS
^IDR:SAMPLE1.GRF^FS
^ISR:SAMPLE2.GRF^FS^XZ
```

In this the * is a wild card, indicating that all objects with the .GRF extension are deleted:

```
^XA
^IDR:*.GRF^FS
^XZ
```

Comments: When an object is deleted from **R:**, the object can no longer be used and memory is available for storage. This applies only to **R:** memory. With the other memory types (**A:**, **B:**, **E:**) the deleted object is no longer available. The memory space recovers when an automatic defragmentation or initialization occurs.

The **^ID** command also frees up the uncompressed version of the object in DRAM.

If the name is specified as ***.ZOB**, all downloaded bar code fonts (or other objects) are deleted.

If the named downloadable object cannot be found in the **R:**, **E:**, **B:**, and **A:** device, the **^ID** command is ignored.

^IL

Image Load

The ^IL command is used at the beginning of a label format to load a stored image of a format and merge it with additional data. The image is always positioned at ^F00,0.



IMPORTANT: See [^IS](#) on page 227.

Using this technique to overlay the image of constant information with variable data greatly increases the throughput of the label format.

Format: ^ILd:o:x

Parameters	Details
d = location of stored object	Values: R:, E:, B:, and A: Default: R:
o = object name	Values: 1 to 8 alphanumeric characters Default: if a name is not specified, UNKNOWN is used
x = extension	Fixed Value: .GRF, .PNG

Example: This example recalls the stored image **SAMPLE2.GRF** from DRAM and overlays it with the additional data. The graphic was stored using the [^IS](#) command. For the stored label format, see the [^IS](#) on page 227 command.

ZPL II CODE	GENERATED LABEL
<pre> ^XA ^ILR:SAMPLE2.GRF^FS ^CFD,36,20 ^FO15,210 ^FD900123^FS ^FO218,210 ^FDLINE 12^FS ^FO15,360^AD ^FDZEBRA THERMAL^FS ^FO15,400^AD ^FDTRANSFER PRINTER^FS ^FO15,540 ^FD54321^FS ^FO220,530 ^FDZ58643^FS ^FO15,670^A0,27,18 ^FDTesting Stored Graphic^FS ^FO15,700^A0,27,18 ^FDLabel Formats!!^FS ^XZ </pre>	

^IM

Image Move

The ^IM command performs a direct move of an image from storage area into the bitmap. The command is identical to the ^XG command (Recall Graphic), except there are no sizing parameters.

Format: ^IMd:o.x

Parameters	Details
d = location of stored object	Values: R:, E:, B:, and A: Default: search priority
o = object name	Values: 1 to 8 alphanumeric characters Default: if a name is not specified, UNKNOWN is used
x = extension	Fixed Value: .GRF, .PNG

Example: This example moves the image **SAMPLE.GRF** from DRAM and prints it in several locations in its original size.

```
^XA
^F0100,100^IMR:SAMPLE.GRF^FS
^F0100,200^IMR:SAMPLE.GRF^FS
^F0100,300^IMR:SAMPLE.GRF^FS
^F0100,400^IMR:SAMPLE.GRF^FS
^F0100,500^IMR:SAMPLE.GRF^FS
^XZ
```

Comments: By using the ^F0 command, the graphic image can be positioned anywhere on the label.

The difference between ^IM and ^XG: ^IM does not have magnification, and therefore might require less formatting time. However, to take advantage of this, the image must be at a 8-, 16-, or 32-bit boundary.

^IS

Image Save

The **^IS** command is used within a label format to save that format as a graphic image, rather than as a ZPL II script. It is typically used toward the end of a script. The saved image can later be recalled with virtually no formatting time and overlaid with variable data to form a complete label.

Using this technique to overlay the image of constant information with the variable data greatly increases the throughput of the label format.



IMPORTANT: See [^IL](#) on page 225.

Format: `^ISd:o.x,p`

Parameters	Details
d = location of stored object	Values: R:, E:, B:, and A: Default: R:
o = object name	Values: 1 to 8 alphanumeric characters Default: if a name is not specified, UNKNOWN is used
x = extension	Values: .GRF or .PNG Default: .GRF
p = print image after storing	Values: N = no Y = yes Default: Y

Example: This is an example of using the ^IS command to save a label format to DRAM. The name used to store the graphic is **SAMPLE2.GRF**.

ZPL II CODE	GENERATED LABEL
<pre> ^XA ^LH10,15^FWN^BY3,3,85^CFD,36 ^GB430,750,4^FS ^FO10,170^GB200,144,2^FS ^FO10,318^GB410,174,2^FS ^FO212,170^GB206,144,2^FS ^FO10,498^GB200,120,2^FSR ^FO212,498^GB209,120,2^FS ^FO4,150^GB422,10,10^FS ^FO135,20^A0,70,60 ^FDZEBRA^FS ^FO80,100^A0,40,30 ^FDTECHNOLOGIES CORP^FS ^FO15,180^CFD,18,10^FS ^FDARTICLE#^FS ^FO218,180 ^FDLOCATION^FS ^FO15,328 ^FDDescription^FS ^FO15,508 ^FDREQ.NO.^FS ^FO220,508 ^FDWORK NUMBER^FS ^FO15,630^AD,36,20 ^FDCOMMENTS:^FS ^ISR:SAMPLE2.GRF,Y ^XZ </pre>	

~JA

Cancel All

The ~JA command cancels all format commands in the buffer. It also cancels any batches that are printing. The printer stops after the current label is finished printing. All internal buffers are cleared of data and the **DATA** LED turn off.

Submitting this command to the printer scans the buffer and deletes only the data before the ~JA in the input buffer — it does not scan the remainder of the buffer for additional ~JA commands.

Format: ~JA

^JB

Initialize Flash Memory

The ^JB command is used to initialize various types of Flash memory available in the Zebra printers.

Format: ^JBa

Parameters	Details
a = device to initialize	<p>Values:</p> <p>A = Option Flash memory</p> <p>B = Flash card (PCMCIA)</p> <p>E = internal Flash memory</p> <p>Default: a device must be specified</p>

Example: This is an example of initializing the different types of flash memory:

^JBA - initializes initial Compact Flash memory when installed in the printer.

^JBB - initializes the optional Flash card when installed in the printer.

^JBE - initializes the optional Flash memory when installed in the printer.



NOTE: Initializing memory can take several minutes. Be sure to allow sufficient time for the initialization to complete before power cycling the printer.

~JB

Reset Optional Memory

The **~JB** command is used for these conditions:

- The **~JB** command must be sent to the printer if the battery supplying power to the battery powered memory card fails and is replaced. A bad battery shows a battery dead condition on the Printer Configuration Label.
- The **~JB** command can also be used to intentionally clear (reinitialize) the **B:** memory card. The card must not be write protected.

Format: ~JB

Comments: If the battery is replaced and this command is not sent to the printer, the memory card cannot function.

~JC

Set Media Sensor Calibration

The ~JC command is used to force a label length measurement and adjust the media and ribbon sensor values.

Format: ~JC

Comments: In Continuous Mode, only the media and ribbon sensors are calibrated.

This command is ignored on the HC100™ printer.

~JD

Enable Communications Diagnostics

The ~JD command initiates Diagnostic Mode, which produces an ASCII printout (using current label length and full width of printer) of all characters received by the printer. This printout includes the ASCII characters, the hexadecimal value, and any communication errors.

Format: ~JD

~JE

Disable Diagnostics

The ~JE command cancels Diagnostic Mode and returns the printer to normal label printing.

Format: ~JE

~JF

Set Battery Condition

There are two low battery voltage levels sensed by the PA/PT400™ printers. When battery voltage goes below the first level, the green LED begins flashing as a warning but printing continues. When this warning occurs, it is recommended to recharge the battery.

As printing continues, a second low voltage level is reached. At this point, both green and orange LEDs flash as a warning, and printing automatically pauses.

When pause on low voltage is active (~JFY) and the battery voltage level falls below the second low voltage level, printing pauses and an error condition is displayed as an indication that the printer should be plugged into the battery charger. By pressing FEED, printing continues on a label-by-label basis, but there is a high risk of losing label format information due to the continued decrease of battery voltage.

When pause on low voltage is not active (~JFN), and the battery voltage level falls below the second low voltage level, printing continues and the orange LED remains off. If the battery voltage continues to decrease, label information could be lost and cause the printer to stop operating. This option should be selected only when the printer is connected to the Car Battery Adapter. From time to time the printer might sense that battery voltage is below the first low voltage level, but due to the continuous recharging of the car battery, further loss of battery voltage is not a concern and printing continues.

If this option is not selected when using the Car Battery Adapter, you might need to press FEED to take the printer out of Pause Mode and print each label.

Format: ~JFp

Parameters	Details
p = pause on low voltage	<p>Values: Y (pause on low voltage) or N (do not pause)</p> <p>N is suggested when the printer is powered by the Car Battery Adapter.</p> <p>Default: Y</p>

~JG

Graphing Sensor Calibration

The ~JG command prints a graph (media sensor profile) of the sensor values.

Format: ~JG

Sending the ~JG command to a printer configured for thermal transfer produces a series of labels resembling this image:

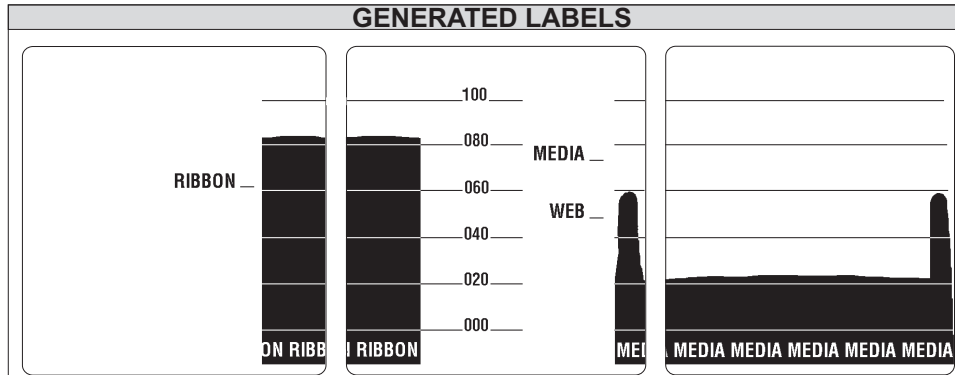

Comments The HC100™ printer does not perform a calibration, but does print a sensor profile label.

^JH**Early Warning Settings**

The **^JH** command configures the early warning messages that appear on the LCD.

- ZE500 series
- *XIII*, *XIII Plus*, Xi4, RXi4
- *PAX3*, *PAX4*
- ZM400, ZM600, RZ400, RZ600
- S4M
- G-Series ("f" parameter only)

Format: ^JHa,b,c,d,e,f,g,h,i,j

Parameter	Details
a = early warning media a = supplies warning (Xi4 and RXi4 printers only)	This parameter is for XIIIPlus, Xi4, RXi4, PAX3, and PAX4 printers only. Values: E = enable D = disable Default: D
b = labels per roll	This parameter is for XIIIPlus, PAX3, and PAX4 printers only. Values: 100 to 9999 Default: 900
c = media replaced	This parameter is for XIIIPlus, PAX3, and PAX4 printers only. Values: Y = yes N = no Default: N

Parameter	Details																						
g = head cleaning interval	<p>Accepted value exceptions: accepted values for <i>XIII</i> printer are 100M through 450M; accepted values for 600 dpi <i>XIII</i> printers are 100M through 150M; accepted values for <i>PAX4</i> series printers are up to 900M by increments of 50M; accepted values for ZM400/ZM600, RZ400/RZ600, and S4M printers are 0M through 450M.</p> <p>Values:</p> <table> <tr> <td>0 = 100M</td> <td>11 = 650M</td> </tr> <tr> <td>1 = 150M</td> <td>12 = 700M</td> </tr> <tr> <td>2 = 200M</td> <td>13 = 750M</td> </tr> <tr> <td>3 = 250M</td> <td>14 = 800M</td> </tr> <tr> <td>4 = 300M</td> <td>15 = 850M</td> </tr> <tr> <td>5 = 350M</td> <td>16 = 900M</td> </tr> <tr> <td>6 = 400M</td> <td></td> </tr> <tr> <td>7 = 450M</td> <td></td> </tr> <tr> <td>8 = 500M</td> <td></td> </tr> <tr> <td>9 = 550M</td> <td></td> </tr> <tr> <td>10 = 600M</td> <td></td> </tr> </table> <p>Default: 1 - for 96XIIIPlus 7 - for all other printers</p>	0 = 100M	11 = 650M	1 = 150M	12 = 700M	2 = 200M	13 = 750M	3 = 250M	14 = 800M	4 = 300M	15 = 850M	5 = 350M	16 = 900M	6 = 400M		7 = 450M		8 = 500M		9 = 550M		10 = 600M	
0 = 100M	11 = 650M																						
1 = 150M	12 = 700M																						
2 = 200M	13 = 750M																						
3 = 250M	14 = 800M																						
4 = 300M	15 = 850M																						
5 = 350M	16 = 900M																						
6 = 400M																							
7 = 450M																							
8 = 500M																							
9 = 550M																							
10 = 600M																							
h = head clean	<p>Values: N = No Y = Yes</p> <p>Default: N</p>																						
i = head life threshold	<p>Values: 0 – 0 in or off 100-3500000 in</p> <p>Default: 1000000</p>																						
j = head replaced	<p>Values: N = no Y = yes</p> <p>Default: N</p>																						

Comments: To permanently save the changes to the ^JH command, send ^XA^JUS^XZ.

^JI**Start ZBI (Zebra BASIC Interpreter)****.16†**

Identifies features that are available in printers with firmware version V60.16.2Z, V53.16.2Z, or later.

^JI works much like the **~JI** command. Both commands are sent to the printer to initialize the Zebra BASIC Interpreter.

In interactive mode, **^JI** can be sent through one of the communication ports (serial, parallel, or Ethernet) to initialize the printer to receive ZBI commands. This command can be sent from one of the Zebra software utilities, such as ZTools, or from a terminal emulation program.

When the command is received, the printer responds by sending a ZBI header back to the console, along with the program version number. This indicates that the interpreter is active.

Format: **^JI**d:o.x,b,c,d

Parameters	Details
d = location of program to run after initialization	Values: R:, E:, B:, and A: Default: location must be specified
o = name of program to run after initialization	Values: any valid program name Default: name must be specified
x = extension of program to run after initialization	Fixed Value: .BAS, .BAE  NOTE: .BAE is only supported in firmware version V60.16.0Z or later
b = console control	Values: Y = console on N = console off Default: Y
c = echoing control	Values: Y = echo on N = echo off Default: Y
d = memory allocation for ZBI *	Values: 20K to 1024K Default: 50K

* This parameter is only available on printers with firmware V60.12.0.x or earlier.

Comments When the printer is turned on, it can receive ZPL II commands and label formats. However, for the printer to recognize ZBI commands and programs, it must be initialized using **^JI** or **~JI**.

Only one ZBI interpreter can be active in the printer at a time. If a second **^JI** or **~JI** command is received while the interpreter is running, the command is ignored.

The interpreter is deactivated by entering one of two commands:

ZPL at the ZBI prompt

~JQ at an active ZPL port

~JI

Start ZBI (Zebra BASIC Interpreter)

.16†

Identifies features that are available in printers with firmware version V60.16.2Z, V53.16.2Z, or later.

~JI works much like the ^JI command. Both commands are sent to the printer to initialize the Zebra BASIC Interpreter.

In interactive mode, ~JI can be sent through one of the communication ports (serial, parallel, or Ethernet) to initialize the printer to receive ZBI commands. This command can be sent from one of the Zebra software utilities, such as ZTools, or from a standard PC program, such as Hyper terminal.

When the command is received, the printer responds by sending a ZBI header back to the console, along with the program version number. This indicates that the interpreter is active.

Format: ~JI

Comments: While receiving commands, the printer echoes the received characters back to the source. This can be toggled on and off with the ZBI ECHO command.

When the printer is turned on, it can receive ZPL II commands and label formats. However, for the printer to recognize ZBI commands and formats, it must be initialized using ^JI or ~JI.

Only one ZBI interpreter can be active in the printer at a time. If a second ~JI or ^JI command is received while the interpreter is running, the command is ignored.

The interpreter is deactivated by entering one of these commands:

ZPL at the ZBI prompt

~JQ at an active ZPL port

^JJ**Set Auxiliary Port**

The ^JJ command allows you to control an online verifier or applicator device.

Format: ^JJa,b,c,d,e,f

Parameters	Details
a = operational mode for auxiliary port	<p>Values:</p> <p>0 = off</p> <p>1 = reprint on error—the printer stops on a label with a verification error. When PAUSE is pressed, the label reprints (if ^JZ is set to reprint). If a bar code is near the upper edge of a label, the label feeds out far enough for the bar code to be verified and then backfeeds to allow the next label to be printed and verified.</p> <p>2 = maximum throughput—the printer stops when a verification error is detected. The printer starts printing the next label while the verifier is still checking the previous label. This mode provides maximum throughput, but does not allow the printer to stop immediately on a label with a verification error.</p> <p>Default: 0</p>
b = application mode	<p>Values:</p> <p>0 = off</p> <p>1 = End Print signal normally high, and low only when the printer is moving the label forward.</p> <p>2 = End Print signal normally low, and high only when the printer is moving the label forward.</p> <p>3 = End Print signal normally high, and low for 20 ms when a label has been printed and positioned.</p> <p>4 = End Print signal normally low, and high for 20 ms when a label has been printed and positioned.</p> <p>Default: 0</p> <p> NOTE:The Set/Get/Do command device.applicator.end_print on page 615 controls the same setting as the b parameter.</p>
c = application mode start signal print	<p>Values:</p> <p>p = Pulse Mode – Start Print signal must be de-asserted before it can be asserted for the next label.</p> <p>1 = Level Mode – Start Print signal does not need to be de-asserted to print the next label. As long as the Start Print signal is low and a label is formatted, a label prints.</p> <p>Default: 0</p>

ZPL Commands

Parameters	Details
d = application label error mode	<p>Values:</p> <p>e = error mode—the printer asserts the <i>Service Required</i> signal (svce_req - pin 10) on the application port, enters into Pause Mode, and displays an error message on the LCD.</p> <p>f = Feed Mode—a blank label prints when the web is not found where expected to sync the printer to the media.</p> <p>Default: f</p>
e = reprint mode	<p>Values:</p> <p>e = enabled—the last label reprints after the signal is asserted. If a label is canceled, the label to be reprinted is also canceled. This mode consumes more memory because the last printed label is not released until it reprints.</p> <p>d = disabled—printer ignores the Reprint signal.</p> <p>Default: d</p>
f = ribbon low mode	<p>Values:</p> <p>e = enabled – printer warning issued when ribbon low.</p> <p>d = disabled – printer warning not issued when ribbon low.</p> <p>Default: e</p>

~JL

Set Label Length

The ~JL command is used to set the label length. Depending on the size of the label, the printer feeds one or more blank labels.

Format: ~JL

^JM

Set Dots per Millimeter

The ^JM command lowers the density of the print—24 dots/mm becomes 12, 12 dots/mm becomes 6, 8 dots/mm becomes 4, and 6 dots/mm becomes 3. ^JM also affects the field origin (^F0) placement on the label (see example below).



When sent to the printer, the ^JM command doubles the format size of the label. Depending on the printhead, normal dot-per-millimeter capabilities for a Zebra printer are 12 dots/mm (304 dots/inch), 8 dots/mm (203 dots/inch) or 6 dots/mm (153 dots/inch).

This command must be entered before the first ^FS command in a format. The effects of ^JM are persistent.

Format: ^JMn

Parameters	Details
n = set dots per millimeter	Values: A = 24 dots/mm, 12 dots/mm, 8 dots/mm or 6 dots/mm B = 12 dots/mm, 6 dots/mm, 4 dots/mm or 3 dots/mm Default: A

Example: This example shows the affects of alternating the dots per millimeter:

ZPL II CODE	GENERATED LABEL
<pre> ^XA ^JMA^FS ^FO100,100 ^B2N,50,Y,N,N ^FD1234567890^FS ^XZ </pre>	
<pre> ^XA ^JMB^FS ^FO100,100 ^B2N,50,Y,N,N ^FD1234567890^FS ^XZ </pre>	

Comments: If ^JMB is used, the UPS MaxiCode bar code becomes out of specification.

~JN

Head Test Fatal

The ~JN command turns on the head test option. When activated, ~JN causes the printer to halt when a head test failure is encountered.

Once an error is encountered the printer remains in error mode until the head test is turned off (~J0) or power is cycled.

Format: ~JN

Comments: If the communications buffer is full, the printer is not able to receive data. In this condition, the ~J0 command is not received by the printer.

~JO

Head Test Non-Fatal

The **~JO** command configures the printer to run the head test with error reporting enabled. When **~JO** is used an error will be displayed and printing will stop if the head test fails. The user can push the PAUSE button on the printer to bypass the error. This command differs from the **~JN** (Head Test Fatal) command in that a power cycle is not required in the event of a head test failure.

~JO is the default print head test condition. This setting is changed when the printer receives a **~JN** (Head Test Fatal) command.

Format: **~JO**

~JP

Pause and Cancel Format

The ~JP command clears the format currently being processed and places the printer into Pause Mode.

The command clears the next format that would print, or the oldest format from the buffer. Each subsequent ~JP command clears the next buffered format until the buffer is empty. The **DATA** indicator turns off when the buffer is empty and no data is being transmitted.

Issuing the ~JP command is identical to using **CANCEL** on the printer, but the printer does not have to be in Pause Mode first.

Format: ~JP

~JQ

Terminate Zebra BASIC Interpreter



Identifies features that are available in printers with firmware version V60.16.2Z, V53.16.2Z, or later.

The **~JQ** command is used when Zebra BASIC Interpreter is active. Sending **~JQ** to the printer terminates the ZBI session.

Format: ~JQ

Comments Entering ZPL at the command prompt also terminates a ZBI session.

~JR

Power On Reset

The ~JR command resets all of the printer's internal software, performs a power-on self-test (POST), clears the buffer and DRAM, and resets communication parameters and default values. Issuing a ~JR command performs the same function as a manual power-on reset.

Format: ~JR

^JS**Sensor Select**

Format: ^JSa



NOTE: This command is ignored on Zebra ZM400/ZM600 and RZ400/RZ600 printers. This command is only for use with the S4M and Z Series printers (with the exception of the ZM400/ZM600/RZ400/RZ600).

Parameters	Details
a = sensor selection	Values: A = auto select R = reflective sensor T = transmissive sensor Default: Z series = A S4M = R

~JS

Change Backfeed Sequence

The **~JS** command is used to control the backfeed sequence. This command can be used on printers with or without built-in cutters. This command is ignored on the HC100™ printer.

These are the primary applications:

- to allow programming of the rest point of the cut edge of continuous media.
- provide immediate backfeed after peel-off when the printer is used in a print/apply application configuration.

This command stays in effect only until the printer is turned off, a new **~JS** command is sent, or the setting is changed on the control panel. When a **~JS** command is encountered, it overrides the current control panel setting for the Backfeed Sequence.

The most common way of eliminating backfeed is to operate in Rewind Mode. Rewind Mode does not backfeed at all. After a label prints, the leading edge of the next label is placed at the print line. This eliminates the need to backfeed and does not introduce a non printable area at the leading edge or bottom of the label. It also does not allow the label to be taken from the printer because it is not fed out from under the printhead.

Running in another mode with backfeed turned off allows the label to be removed and eliminates the time-reduction of the backfeed sequence.

Format: ~JS**b**

Parameters	Details
b = backfeed order in relation to printing	<p>Values:</p> <p>A = 100 percent backfeed after printing and cutting</p> <p>B = 0 percent backfeed after printing and cutting, and 100 percent before printing the next label</p> <p>N = normal — 90 percent backfeed after label is printed</p> <p>0 = off — turn backfeed off completely</p> <p>10 to 90 = percentage value</p> <p>The value entered must be a multiple of 10. Values not divisible by 10 are rounded to the nearest acceptable value. For example, ~JS55 is accepted as 50 percent backfeed.</p> <p>Default: N</p>

Comments: When using a specific value, the difference between the value entered and 100 percent is calculated before the next label is printed. For example, a value of 40 means 40 percent of the backfeed takes place after the label is cut or removed. The remaining 60 percent takes place before the next label is printed.

The value for this command is also reflected in the Backfeed parameter on the printer configuration label.

For **~JSN** — the Backfeed parameter is listed as DEFAULT

For **~JSA** — or 100% the Backfeed parameter is listed as AFTER

For **~JSB** — or 0% the Backfeed parameter is listed as BEFORE

For **~JS10** — 10% of the backfeed takes place after the label is cut or removed. The remaining 90% takes place before the next label is printed.

^JT**Head Test Interval**

The ^JT command allows you to change the printhead test interval from every 100 labels to any desired interval. With the ^JT command, the printer is allowed to run the test after printing a label. When a parameter is defined, the printer runs the test after printing a set amount of labels.

The printer's default head test state is off. Parameters for running the printhead test are defined by the user.

Format: ^JT####,a,b,c

Parameters	Details
#### = four-digit number of labels printed between head tests	Values: 0000 to 9999 If a value greater than 9999 is entered, it is ignored. Default: 0000 (off)
a = manually select range of elements to test	Values: N = no Y = yes Initial Value at Power Up: N
b = first element to check when parameter a is Y	Values: 0 to 9999 Initial Value at Power Up: 0
c = last element to check when parameter a is Y	Values: 0 to 9999 Initial Value at Power Up: 9999

Comments: The ^JT command supports testing a range of print elements. The printer automatically selects the test range by tracking which elements have been used since the previous test.

^JT also turns on Automatic Mode to specify the first and last elements for the head test. This makes it possible to select any specific area of the label or the entire print width.

If the last element selected is greater than the print width selected, the test stops at the selected print width.

Whenever the head test command is received, a head test is performed on the next label unless the count is set to 0 (zero).

^JU**Configuration Update**

The ^JU command sets the active configuration for the printer.

Format: ^JUa

Parameters	Details
<p>a = active configuration</p>	<p>Values:</p> <p>F = reload factory settings</p> <p>N = reload factory network settings</p> <p>These values are lost at power-off if not saved with ^JUS.</p> <p>R = recall last saved settings</p> <p>S = save current settings</p> <p>These values are used at power-on.</p> <p>Default: a value must be specified</p>

^JW

Set Ribbon Tension

^JW sets the ribbon tension for the printer it is sent to.

Format: ^JWt

Parameters	Details
t = tension	Values: L = low M = medium H = high Default: a value must be specified

Comments: ^JW is used only for *PAX* series printers.

~JX

Cancel Current Partially Input Format

The ~JX command cancels a format currently being sent to the printer. It does not affect any formats currently being printed, or any subsequent formats that might be sent.

Format: ~JX

^JZ**Reprint After Error**

The ^JZ command reprints a partially printed label caused by a Ribbon Out, Media Out, or Head Open error condition. The label is reprinted as soon as the error condition is corrected.

This command remains active until another ^JZ command is sent to the printer or the printer is turned off.

Format: ^JZa

Parameters	Details
a = reprint after error	Values: N = no Y = yes Initial Value at Power Up: Y

Comments: ^JZ sets the error mode for the printer. If ^JZ changes, only labels printed after the change are affected.

If the parameter is missing or incorrect, the command is ignored.

~KB

Kill Battery (Battery Discharge Mode)

To maintain performance of the rechargeable battery in the portable printers, the battery must be fully discharged and recharged regularly. The **~KB** command places the printer in battery discharge mode. This allows the battery to be drained without actually printing.

Format: ~KB

Comments: While the printer is in Discharge Mode, the green power LED flashes in groups of three flashes.

Discharge Mode might be terminated by sending a printing format to the printer or by pressing either of the control panel keys.

If the battery charger is plugged into the printer, the battery is automatically recharged once the discharge process is completed.

^KD**Select Date and Time Format (for Real Time Clock)**

The **^KD** command selects the format that the Real-Time Clock's date and time information presents as on a configuration label. This is also displayed on the Printer Idle LCD control panel display, and displayed while setting the date and time.

Format: **^KDa**

Parameters	Details
a = value of date and time format	<p>Values:</p> <ul style="list-style-type: none"> 0 = normal, displays <i>Version Number</i> of firmware 1 = MM/DD/YY (24-hour clock) 2 = MM/DD/YY (12-hour clock) 3 = DD/MM/YY (24-hour clock) 4 = DD/MM/YY (12-hour clock) <p>Default: 0</p>

Comments: If the Real-Time Clock hardware is not present, Display Mode is set to 0 (Version Number).

If Display Mode is set to 0 (Version Number) and the Real-Time Clock hardware is present, the date and time format on the configuration label is presented in format 1.

If Display Mode is set to 0 (Version Number) and the Real-Time Clock hardware is present, the date and time format on the control panel display is presented in format 1.

For more details on select date and time format for the Real Time Clock, see [Real Time Clock on page 1440](#).

^KL**Define Language**

The ^KL command selects the language displayed on the control panel.

Format: ^KL*a*

Parameters	Details
a = language	<p>Values:</p> <ul style="list-style-type: none"> 1 = English 2 = Spanish 3 = French 4 = German 5 = Italian 6 = Norwegian 7 = Portuguese 8 = Swedish 9 = Danish 10 = Spanish2 11 = Dutch 12 = Finnish 13 = Japanese 14 = Korean* 15 = Simplified Chinese* 16 = Traditional Chinese* 17 = Russian* 18 = Polish* 19 = Czech* 20 = Romanian* <p>Default: 1</p>
<p>* These values are only supported on the ZT200 Series, ZE500 Series, Xi4, RXi4, ZM400/ ZM600, and RZ400/RZ600 printers.</p>	

^KN

Define Printer Name

The printer's network name and description can be set using the **^KN** command. **^KN** is designed to make your Zebra printer easy for users to identify. The name the administrator designates is listed on the configuration label and on the Web page generated by the printer.

Format: **^KN**a,b



NOTE: If you issue the command **^KN**, (without the a and b parameters) you are setting the printer name and description to a blank string.

To cause the printer name and printer description settings controlled by the **^KN** command to be saved, you must issue the **^JUS** command.

Parameters	Details
a = printer name	<p>Values: up to 16 alphanumeric characters</p> <p>Default:</p> <ul style="list-style-type: none"> If no printer name is specified in a printer with a MAC address, the printer name will default to "ZBRxxx," where xxx is the last three octets of the MAC address converted into ASCII text. For printers without a MAC address, if a value is not entered, the current stored value is erased. <p>If more than 16 characters are entered, only the first 16 are used.</p>
b = printer description	<p>Values: up to 35 alphanumeric characters</p> <p>Default: if a value is not entered, the current stored value is erased</p> <p>If more than 35 characters are entered, only the first 35 are used.</p> <p>The value of this parameter will be displayed on the printer's web page in parentheses.</p>

Example: This is an example of how to change the printer's network name and description. The sample labels show how a configuration looks before using this command and after using this command:

```
^XA
^KNZebra1,desk_printer
^XZ
```

ZPL Commands

Before using this command:

PRINTER CONFIGURATION	
Zebra Technologies	
ZTC 105SL-200dpi	
+18.....	DARKNESS
-016.....	TEAR OFF
TEAR OFF.....	PRINT MODE
NON-CONTINUOUS.....	MEDIA TYPE
WEB.....	SENSOR TYPE
THERMAL-TRANS.....	PRINT METHOD
101 4/8 MM.....	PRINT WIDTH
1233.....	LABEL LENGTH
7.0IN 177MM.....	MAXIMUM LENGTH
PARALLEL.....	PARALLEL COMM.
RS232.....	SERIAL COMM.
9600.....	BAUD
8 BITS.....	DATA BITS
NONE.....	PARITY
XON/XOFF.....	HOST HANDSHAKE
NONE.....	PROTOCOL
000.....	NETWORK
NORMAL MODE.....	COMM.
<~> 7EH.....	
<^>	

After using this command:

PRINTER CONFIGURATION	
Zebra Technologies	
ZTC 105SL-200dpi	
Zebra1	
desk_printer	
+18.....	DARKNESS
-016.....	TEAR OFF
TEAR OFF.....	PRINT MODE
NON-CONTINUOUS.....	MEDIA TYPE
WEB.....	SENSOR TYPE
THERMAL-TRANS.....	PRINT METHOD
101 4/8 MM.....	PRINT WIDTH
1233.....	LABEL LENGTH
7.0IN 177MM.....	MAXIMUM LENGTH
PARALLEL.....	PARALLEL COMM.
RS232.....	SERIAL COMM.
9600.....	BAUD
8 BITS.....	DATA BITS
NONE.....	PARITY
XON/XOFF.....	HOST HANDSHAKE
NONE.....	PROTOCOL
000.....	NETWORK
NORMAL MODE.....	COMM.
<~> 7EH.....	
<^>	

^KP

Define Password

The ^KP command is used to define the password that must be entered to access the control panel switches and LCD Setup Mode.

Format: ^KP**a**,**b**

Parameters	Details
a = mandatory four-digit password	Values: any four-digit numeric sequence Default: 1234
b = password level	Values: 1, 2, 3, 4 Default: 3 The b parameter applies only to the S4M printers.

Example: This example shows how to set a new control panel password:

^XA

^KP5678

^XZ

Example: This example shows how to set a new control panel password (5678) at a specific password level (level 2) (applicable to the S4M printer only):

^XA

^KP5678,2

^XZ

Comments: If you forget your password, the printer can be returned to a default Setup Mode and the default password 1234 is valid again. Caution should be used, however — this also sets the printer configuration values back to their defaults.

To return the printer to the default factory settings using ZPL, send this:

^XA

^JUF

^XZ

To return the printer to the default factory settings using the control panel keys, see your printer's User Guide for the procedure.

^KV**Kiosk Values**

The ^KV command sets several parameters that affect the printers operation when ^MM is set to K - Kiosk mode

Supported Devices:

- KR403

Format: ^KV**a,b,c,d,e**

Parameters	Details
a = kiosk cut amount	<p>Values:</p> <p>0 = normal cut</p> <p>10-60 = partial cut, value = mm of media left uncut</p> <p>Default: 0</p> <p>This parameter is ignored if it is missing or invalid. The current value of the parameter remains unchanged.</p>
b = kiosk cut margin	<p>Values:</p> <p>2 - 9 = mm of distance</p> <p>Default:</p> <p>9 = mm of distance</p> <p>This parameter is ignored if it is missing or invalid. The current value of the parameter remains unchanged.</p>
c = kiosk present type	<p>Values:</p> <p>0 = Eject page when new page is printed</p> <p>1 = Retract page when new page is printed</p> <p>2 = Do nothing when new page is printed</p> <p>Default: 0</p> <p>This parameter is ignored if it is missing or invalid. The current value of the parameter remains unchanged.</p>
d = kiosk present timeout	<p>Values:</p> <p>0-300 = If label is not taken, retract label when timeout expires. Timeout is in seconds. Zero (0) indicates that there is no timeout. The label will stay presented until removed manually or a new label is printed.</p> <p>Default: 0</p> <p>This parameter is ignored if it is missing or invalid. The current value of the parameter remains unchanged.</p>

Parameters	Details
e = presenter loop length	<p>Values:</p> <p>0 = paper is fed straight through the presenter</p> <p>3-1023 = loop length in mm.</p> <p>Default: 400</p> <p>400= gives a loop of approximately 400mm</p> <p>This parameter is ignored if it is missing or invalid. The current value of the parameter remains unchanged. . If this is greater than loop_length_max (see SGD media.present.loop_length_max) then it will be set equal to loop_length_max.</p>

Kiosk Printing Examples

The following examples demonstrate the use of the ^KV, ^CN, ^PN and ^CP commands with 80mm wide continuous media and the printer set to Kiosk Mode (^MMK).

Example: In this example, the ^KV command is set to the following:

- Cut - Full Cut
- Cut Margin - 9 mm
- Present Type - Eject page when the next page is printed
- Present Timeout - 6 seconds after printing, if the document is not taken, it will be retracted
- Presenter Loop Length - No loop

```

^XA
^MMK
^KV0,9,0,6,0
^F050,50^A0N,50,50^FDZebra Technologies^FS
^CN1
^PN0
^XZ

```



NOTE: The ^CN1 command (Cut Now) is included to ensure that a full cut is done. The ^PN0 (Present Now) command is included to ensure that the media is ejected when the user pulls on the leading edge of the media. In this example, if the user does not pull on the leading edge of the second document, it will be retracted.

Example: This example contains only one change from the Example 1 - the Presenter Loop Length is now 100mm, and two documents will be printed instead of one.

```

^XA
^MMK
^KV0,9,2,6,100
^F050,50^A0N,50,50^FDZebra Technologies^FS
^CN1^PN0
^PQ2
^XZ

```

Example: In this example, two documents will be printed, each one will be ejected from the printer.

```

^XA
^MMK
^KV0,9,2,6,100
^F050,50^A0N,50,50^FDZebra Technologies^FS
^CN1^CP0
^PQ2
^XZ

```

Example: In this example, two documents, with partial cuts, will be printed, and a third document, with a full cut, will be printed.

```

^XA
^MMK
^KV50,9,0,0,0
^F050,50^A0N,50,50^FDPartial Cut^FS
^CN0^PN0
^PQ2
^XZ
^XA
^MMK
^KV0,9,2,6,0
^F050,50^A0N,50,50^FDFull Cut^FS
^CN1^CP0
^XZ

```

Example: In this example, four documents will be printed – three with a partial cut and the fourth with a full cut. Additionally, the document length is set to 406 dots and the Media Tracking mode is set to "Continuous Media, Variable Length". The third document contains fields that are positioned outside of the 406 dot length – however, because the printer is set to "Continuous Media, Variable Length" Media Tracking mode, the printer will automatically adjust the document length to compensate.

```

^XA
^MMK
^LL406
^KV20,9,0,0,0
^F050,50^A0N,50,50^FDPartial Cut^FS
^CN0^PN0
^PQ2
^XZ

^XA
^MMK
^MNV
^KV20,9,0,0,0
^F050,50^A0N,50,50^FDPartial Cut^FS
^F050,150^A0N,50,50^FDPrinting Line 1^FS
^F050,250^A0N,50,50^FDPrinting Line 2^FS
^F050,350^A0N,50,50^FDPrinting Line 3^FS
^F050,450^A0N,50,50^FDPrinting Line 4^FS
^F050,550^A0N,50,50^FDPrinting Line 5^FS
^F050,650^A0N,50,50^FDPrinting Line 6^FS
^F050,750^A0N,50,50^FDPrinting Line 7^FS
^F050,850^A0N,50,50^FDPrinting Line 8^FS
^F050,950^A0N,50,50^FDPrinting Line 9^FS
^F050,1050^A0N,50,50^FDPrinting Line 10^FS
^F050,1150^A0N,50,50^FDPrinting Line 11^FS
^F050,1250^A0N,50,50^FDPrinting Line 12^FS
^F050,1350^A0N,50,50^FDPrinting Line 13^FS
^F050,1450^A0N,50,50^FDPrinting Line 14^FS
^F050,1550^A0N,50,50^FDPrinting Line 15^FS
^CN0^PN0
^XZ

^XA
^MMK
^KV0,9,0,0,0
^F050,50^A0N,50,50^FDFull Cut^FS
^CN0^PN1^CP0
^PQ1
^XZ

```

^LF

List Font Links

.14↑

This command is available only for printers with firmware version V60.14.x, V50.14.x, or later.

The ^LF command prints out a list of the linked fonts.

Example: This example shows that **SWISS721.TTF** is the based font. **ANMDJ.TTF** is the first linked font, and **MSGOTHIC.TTF** is the second linked extension:

ZPL II CODE	GENERATED LABEL
<pre> ^XA ^LF ^XZ </pre>	<pre> LIST OF FONT LINKS E:SWISS721.TTF E:ANMDJ.TTF E:MSGOTHIC.TTF </pre>

This is the code that established the font links:

```

^XA
^FLE:ANMDJ.TTF,E:SWISS721.TTF,1^FS
^FLE:MSGOTHIC.TTF,E:SWISS721.TTF,1^FS
^XZ

```

^LH

Label Home

The ^LH command sets the label home position.

The default home position of a label is the upper-left corner (position 0,0 along the x and y axis). This is the axis reference point for labels. Any area below and to the right of this point is available for printing. The ^LH command changes this reference point. For instance, when working with preprinted labels, use this command to move the reference point below the preprinted area.

This command affects only fields that come after it. It is recommended to use ^LH as one of the first commands in the label format.

Format: ^LHx,y

Parameters	Details
x = x-axis position (in dots)	Values: 0 to 32000 Initial Value at Power Up: 0 or last permanently saved value
y = y-axis position (in dots)	Values: 0 to 32000 Initial Value at Power Up: 0 or last permanently saved value

Depending on the printhead used in your printer, use one of these when figuring the values for x and y:

6 dots = 1 mm, 152 dots = 1 inch

8 dots = 1 mm, 203 dots = 1 inch

11.8 dots = 1 mm, 300 dots = 1 inch

24 dots = 1 mm, 608 dots = 1 inch

Comments: To be compatible with existing printers, this command must come before the first ^FS (Field Separator) command. Once you have issued an ^LH command, the setting is retained until you turn off the printer or send a new ^LH command to the printer.

^LL**Label Length**

The **^LL** command defines the length of the label. This command is necessary when using continuous media (media not divided into separate labels by gaps, spaces, notches, slots, or holes).

To affect the current label and be compatible with existing printers, **^LL** must come before the first **^FS** (Field Separator) command. Once you have issued **^LL**, the setting is retained until you turn off the printer or send a new **^LL** command.

Format: **^LLy**

Parameters	Details
y = y-axis position (in dots)	<p>Values: 1 to 32000, not to exceed the maximum label size.</p> <p>While the printer accepts any value for this parameter, the amount of memory installed determines the maximum length of the label.</p> <p>Default: typically set through the LCD (if applicable), or to the maximum label length capability of the printer.</p>

Comments: These formulas can be used to determine the value of **y**:

For 6 dot/mm printheads... Label length in inches x 152.4 (dots/inch) = **y**

For 8 dot/mm printheads... Label length in inches x 203.2 (dots/inch) = **y**

For 12 dot/mm printheads... Label length in inches x 304.8 (dots/inch) = **y**

For 24 dot/mm printheads... Label length in inches x 609.6 (dots/inch) = **y**

Values for **y** depend on the memory size. If the entered value for **y** exceeds the acceptable limits, the bottom of the label is cut off. The label also shifts down from top to bottom.

If multiple **^LL** commands are issued in the same label format, the last **^LL** command affects the next label unless it is prior to the first **^FS**.

This command is ignored on the HC100™ printer.

^LR

Label Reverse Print

The ^LR command reverses the printing of all fields in the label format. It allows a field to appear as white over black or black over white.

Using the ^LR is identical to placing an ^FR command in all current and subsequent fields.

Format: ^LRa

Parameters	Details
a = reverse print all fields	Values: N = no Y = yes Initial Value at Power Up: N or last permanently saved value

Example: This is an example that shows printing white over black and black over white. The ^GB command is used to create the black background.

ZPL II CODE	GENERATED LABEL
<pre> ^XA^LRY ^FO100,50 ^GB195,203,195^FS ^FO180,110^CFG ^FDLABEL^FS ^FO130,170 ^FDREVERSE^FS ^XZ </pre>	

Comments: The ^LR setting remains active unless turned off by ^LRN or the printer is turned off.



NOTE: ^GB needs to be used together with ^LR.

Only fields following this command are affected.

^LS

Label Shift

The **^LS** command allows for compatibility with Z-130 printer formats that are set for less than full label width. It is used to shift all field positions to the left so the same commands used on a Z-130 or Z-220 Printer can be used on other Zebra printers.

To determine the value for the **^LS** command, use this formula:

Z-130 and Z-220 values for **^LHx + ^F0x**

(distance from edge of label) = printer value for **^LSa**

If the print position is less than 0, set **^LS** to 0.

Format: **^LSa**



IMPORTANT: The ability to save the **^LS** command depends on the version of firmware.

Parameters	Details
a = shift left value (in dots)	Values: -9999 to 9999 Initial Value at Power Up: 0

Comments: When entering positive values, it is not necessary to use the + sign. The value is assumed to be positive unless preceded by a negative sign (-).

To be compatible with existing Zebra printers, this command must come before the first **^FS** (Field Separator) command. Once you have issued an **^LS** command, the setting is retained until you turn off the printer or send a new **^LS** command to the printer.

^LT

Label Top

The ^LT command moves the entire label format a maximum of 120 dot rows up or down from its current position, in relation to the top edge of the label. A negative value moves the format towards the top of the label; a positive value moves the format away from the top of the label.

This command can be used to fine-tune the position of the finished label without having to change any of the existing parameters.



IMPORTANT: For some printer models, it is possible to request a negative value large enough to cause the media to backup into the printer and become unthreaded from the platen. This condition can result in a printer error or unpredictable results.

Format: ^LTx

Parameters	Details
x = label top (in dot rows)	<p>Values:</p> <p>HC100: 0 to 120</p> <p>XiIIIPlus 600dpi: -240 to 240</p> <p>All other Zebra printers: -120 to 120</p> <p>Default: a value must be specified or the command is ignored</p>

Comments: The Accepted Value range for x might be smaller depending on the printer platform.

The Label Top value shown on the front panel of the printer is double the value used in the ZPL format.

The ^LT command does not change the media rest position.

^MA

Set Maintenance Alerts

.15↑

This command is available only for printers with firmware version V60.15.x, V50.15.x, or later.

The ^MA command controls how the printer issues printed maintenance alerts. Maintenance alerts are labels that print with a warning that indicates the printhead needs to be cleaned or changed.

- Xi4, RXi4
- ZM400/ZM600, RZ400/RZ600
- S4M with v53.15.5Z or later
- G-Series



IMPORTANT: ^MA settings do not impact or effect the functionality of the Xi4 Supplies Warning system.

Format: ^MAtype,print,printlabel_threshold,frequency,units

Parameters	Details
type = type of alert	<p>Values:</p> <ul style="list-style-type: none"> • R = head replacement • C = head cleaning <p>Default: This parameter must be specified as R or C for print, printlabel_threshold, and frequency to be saved. However, units will always be set.</p>
print = determines if the alert prints a label	<p>Values:</p> <ul style="list-style-type: none"> • Y = print a label • N = do not print label <p>Default: N</p>
printlabel_threshold = distance where the first alert occurs	<p>Values:</p> <ul style="list-style-type: none"> • R = head replacement (unit of measurement for head is km with a range of 0 to 150 km) • C = clean head with a range of 100 to 2000 meters. • 0 = off (when set to 0, the selected alert is disabled; otherwise it is enabled). <p>Default: R = 50 km (1,968,500 inches) and C = 0 (off).</p>
frequency = distance before reissuing the alert	<p>The unit of measurement is in meters. The range is 0 to 2000. The range for G-Series printers is 0 or 5 to 2000 meters. When set to 0, the alert label is only printed on power-up or when the printer is reset.</p> <p>Default: 0 (print on power-up).</p>

Parameters	Details
units = odometer and printhead maintenance commands	<p>The units parameter reports units of the odometer and printhead maintenance commands, as follows: <code>~HQOD</code>, <code>~HQPH</code>, <code>~WQOD</code>, <code>~WQPH</code>.</p> <p>Values:</p> <ul style="list-style-type: none"> • C = centimeters (displays as: cm) • I = inches (displays as: ") • M = meters (displays as: M) <p>Default: I</p>

Example: This example sets the printed head cleaning message to print after five meters and to repeat every one meter after that until a `~ROC` command is issued.

The Early Warning Maintenance setting must be ON. To enable the maintenance alert system on the G-Series™ printer the `^JH` command is used; on other Zebra printers the front panel can also be used.

1. To set `^MA` to print out a label flagging the need to clean the head, type:

```
^XA^MAC,Y,5,1^XZ
```

When the threshold is met a label will print indicating that the head needs to be clean.

2. For this example, the message on the label looks like this:

PLEASE CLEAN PRINT HEAD

For details resetting the units of measure, see the `~HQ` examples on [page 207](#).

Comments Any values outside the specified range are ignored.

The intent of this command is to cause a label to print when the defined threshold is reached.

^MC

Map Clear

In normal operation, the bitmap is cleared after the format has been printed. The ^MC command is used to retain the current bitmap. This applies to current and subsequent labels until cleared with ^MCY.

Format: ^MCa



IMPORTANT: To produce a label template, ^MC must be used with ^FV.

Parameters	Details
a = map clear	Values: Y (clear bitmap) or N (do not clear bitmap) Initial Value at Power Up: Y

Comments: The ^MC command retains the image of the current label after formatting. It appears in the background of the next label printed.

^MD

Media Darkness

The ^MD command adjusts the darkness relative to the current darkness setting.

Format: ^MDa

Parameters	Details
a = media darkness level	<p>Values: -30 to 30, depending on current value</p> <p>Initial Value at Power Up: 0</p> <p>If no value is entered, this command is ignored.</p>

Example: These examples show setting the printer to different darkness levels:

- If the current value (value on configuration label) is 16, entering the command ^MD-9 decreases the value to 7.
- If the current value (value on configuration label) is 1, entering the command ^MD15 increases the value to 16.
- If the current value (value on configuration label) is 25, entering the command ^MD10 increases only the value to 30, which is the maximum value allowed.

Each ^MD command is treated separately in relation to the current value as printed on the configuration label.



NOTE: On Zebra G-Series™ printers the value set with the ^MD command is persistent across power cycles.



Important: The darkness setting range for the XiIIIPlus, Xi4, and RXi4 is 0 to 30 in increments of 0.1. The firmware is setup so that the ^MD and ~SD commands (ZPL darkness commands) accepts that range of settings.

Example: These are examples of the XiIIIPlus, Xi4, and RXi4 Darkness Setting:

```
^MD8.3
```

```
~SD8.3
```

Example: For example, this is what would happen if two ^MD commands were received:

Assume the current value is 15. An ^MD-6 command is received that changes the current value to 9. Another command, ^MD2, is received. The current value changes to 17.

The two ^MD commands are treated individually in relation to the current value of 15.

Comments: The ~SD command value, if applicable, is added to the ^MD command.

^MF

Media Feed

The ^MF command dictates what happens to the media at power-up and at head-close after the error clears.

Format: ^MFp,h

Parameters	Details
p = feed action at power-up	Values: F = feed to the first web after sensor C = (see ~JC on page 232 definition) L = (see ~JL on page 244 definition) N = no media feed S = short calibration Default: C
h = feed action after closing printhead	Values: F = feed to the first web after sensor C = (see ~JC on page 232 definition) L = (see ~JL on page 244 definition) N = no media feed S = short calibration Default: C

These values are supported only on Xi4, RXi4, XiIIIPlus, PAX, ZM400/ZM600, RZ400/RZ600, and S4M printers.

Comments: It is important to remember that if you choose the **N** setting, the printer assumes that the media and its position relative to the printhead are the same as before power was turned off or the printhead was opened. Use the ^JU command to save changes.

^MI**Set Maintenance Information Message****.15↑**

This command is available only for printers with firmware version V60.15.x, V50.15.x, or later.

The **^MI** command controls the content of maintenance alert messages, which are reminders printed by the printer to instruct the operator to clean or replace the printhead.

Format: **^MI***type*,*message*

Parameters	Details
type = identifies the type of alert	<p>Values:</p> <ul style="list-style-type: none"> • R = head replacement • C = head cleaning <p>Default: R</p>
message = message that prints on the label when a maintenance alert occurs	<p>The maximum length of each message is 63 characters. All characters following the comma and preceding the next tilde (~) or caret (^) define the message string. Commas (,) are not allowed in the message.</p> <p>Default:</p> <ul style="list-style-type: none"> • HEAD CLEANING = please clean printhead • HEAD REPLACEMENT = please replace printhead

Example: This example sets the printhead (head) replacement warning message. Printing of this message is controlled by the **^MA** command.

1. To customize the text of this label, type something like this:

```
^XA^MIR,PRINT HEAD NEEDS REPLACEMENT - CALL EXT 1000^XZ
```

The label prints whatever you program it to say.

2. For this example, the message on the label looks like this:

```
PRINT HEAD NEEDS REPLACEMENT - CALL
EXT 1000
```

^ML

Maximum Label Length

The ^ML command lets you adjust the maximum label length.



NOTE: This command does not apply when in continuous mode.

Format: ^MLa

Parameters	Details
a = maximum label length (in dot rows)	<p>Values: the dpi of the printer multiplied by two, up to the maximum length of label</p> <p>Default: last permanently saved value</p>

Comments: For calibration to work properly, you must set the maximum label length equal to or greater than your actual label length.

This command is ignored on the HC100™ printer

^MM**Print Mode**

Description: The ^MM command determines the action the printer takes after a label or group of labels has printed.



NOTE: Refer to the User Guide for your printer to determine which print modes are supported by your printer.

Format: ^MMa,b

Parameters	Details
a = desired mode	<p>Values:</p> <p>T = Tear-off</p> <p>P = Peel-off (not available on S-300)</p> <p>R = Rewind (depends on printer model)</p> <p>A = Applicator (depends on printer model)</p> <p>C = Cutter (depends on printer model)</p> <p>D = Delayed cutter</p> <p>F = RFID</p> <p>L = Reserved ,</p> <p>U = Reserved ,</p> <p>K = Kiosk</p> <p>Default:</p> <p>The values available for parameter a depend on the printer being used and whether it supports the option.</p> <p>For RFID printers:</p> <p>A = R110PAX4 print engines</p> <p>F = other RFID printers</p>
b = prepeel select	<p>Values:</p> <p>N = no</p> <p>Y = yes</p> <p>Default: N</p> <p>The command is ignored if parameters are missing or invalid. The current value of the command remains unchanged.</p>
<p>This value is not supported on the KR403 or ZD500R printer. This value is supported only on the ZM400 and ZM600 printers. This value is supported only the KR403 printer.</p>	

This list identifies the different modes of operation:

- Tear-off — after printing, the label advances so the web is over the tear bar. The label, with liner attached, can be torn off manually.

- Peel-off — after printing, the label moves forward and activates a Label Available Sensor. Printing stops until the label is manually removed from the printer.
Power Peel – liner automatically rewinds using an optional internal rewind spindle.
Value Peel – liner feeds down the front of the printer and is manually removed.
Prepeel – after each label is manually removed, the printer feeds the next label forward to prepeel a small portion of the label away from the liner material. The printer then backfeeds and prints the label. The prepeel feature assists in the proper peel operation of some media types.
- Rewind — the label and liner are rewound on an (optional) external rewind device. The next label is positioned under the printhead (no backfeed motion).
- Applicator — when used with an application device, the label move far enough forward to be removed by the applicator and applied to an item. This applies only to printers that have applicator ports and that are being used in a print-and-apply system.
- Cutter — after printing, the media feeds forward and is automatically cut into predetermined lengths.
- Delayed cutter — When the printer is in the Delayed Cut PRINT MODE, it will cut the label when it receives the ~JK (Delayed Cut) command. To activate the ~JK command, the printer's PRINT MODE must be set to Delayed Cut and there must be a label waiting to be cut. When the printer is not in the Delayed Cut PRINT MODE, the printer will not cut the label when it receives the ~JK command.



NOTE: Send ~JK in a separate file - it cannot be sent at the end of a set of commands.

The Delayed Cut feature can be activated:

- through PRINT MODE on the printer's control panel
- with a ^MMD command
- RFID — increases throughput time when printing batches of RFID labels by eliminating backfeed between labels.
- Kiosk — after printing, the media is moved in a presentation position, most applications maintain a loop of media in the printer.

Comments: Be sure to select the appropriate value for the print mode being used to avoid unexpected results.

This command is ignored on the HC100™ printer.

^MN**Media Tracking**

This command specifies the media type being used and the black mark offset in dots.

This bulleted list shows the types of media associated with this command:

- Continuous Media – this media has no physical characteristic (such as a web, notch, perforation, black mark) to separate labels. Label length is determined by the ^LL command.
- Continuous Media, variable length – same as Continuous Media, but if portions of the printed label fall outside of the defined label length, the label size will automatically be extended to contain them. This label length extension applies only to the current label. Note that ^MNV still requires the use of the ^LL command to define the initial desired label length.
- Non-continuous Media – this media has some type of physical characteristic (such as web, notch, perforation, black mark) to separate the labels.

Format: ^MNa, b

Parameters	Details
a = media being used	<p>Values:</p> <p>N = continuous media</p> <p>Y = non-continuous media web sensing</p> <p>W = non-continuous media web sensing</p> <p>M = non-continuous media mark sensing</p> <p>A = auto-detects the type of media during calibration</p> <p>V = continuous media, variable length</p> <p>Default: a value must be entered or the command is ignored</p>
b = black mark offset in dots	<p>This sets the expected location of the media mark relative to the point of separation between documents. If set to 0, the media mark is expected to be found at the point of separation. (i.e., the perforation, cut point, etc.)</p> <p>All values are listed in dots. This parameter is ignored unless the a parameter is set to M. If this parameter is missing, the default value is used.</p> <p>Values:</p> <p>-80 to 283 for direct-thermal only printers</p> <p>-240 to 566 for 600 dpi printers</p> <p>-75 to 283 for KR403 printers</p> <p>-120 to 283 for all other printers</p> <p>Default: 0</p>
<p>Provides the same result. This value is not supported on the KR403 printer. This parameter is supported only on G-series printers. This parameter is supported only on the KR403 printer.</p>	

Comments This command is ignored on the HC100™ printer.

^MP

Mode Protection

The ^MP command is used to disable the various mode functions on the control panel. Once disabled, the settings for the particular mode function can no longer be changed and the LED associated with the function does not light.

Because this command has only one parameter, each mode must be disabled with an individual ^MP command.

Format: ^MPa

Parameters	Details
a = mode to protect	<p>Values:</p> <p>D = disable Darkness Mode</p> <p>P = disable Position Mode</p> <p>C = disable Calibration Mode</p> <p>E = enable all modes</p> <p>S = disable all mode saves (modes can be adjusted but values are not saved)</p> <p>W = disable Pause</p> <p>F = disable Feed</p> <p>X = disable Cancel</p> <p>M = disable menu changes</p> <p>Default: a value must be entered or the command is ignored</p>

Example: This example shows the ZPL code that disables modes D and C. It also shows the effects on the configuration label before and after the ZPL code is sent:

```
^XA
^MPD
^MPC
^XZ
```

ZPL Commands

Before

DPCSFXM..... MODES ENABLED
 MODES DISABLED

After

.P.SWFXM..... MODES ENABLED
 D.C..... MODES DISABLED

PRINTER CONFIGURATION	
Zebra Technologies	
ZTC 110X1111Plus-300dpi	
ZBR14629777	
10.2.....	DARKNESS
2 IPS.....	PRINT SPEED
+000.....	TEAR OFF
TEAR OFF.....	TEAR OFF
NON-CONTINUOUS.....	MEDIA TYPE
WEB.....	SENSOR TYPE
THERMAL-TRANS.....	PRINT METHOD
105 08/12 MM.....	PRINT WIDTH
1828.....	LABEL LENGTH
39.0IN 980MM.....	MAXIMUM LENGTH
MEDIA DISABLED.....	EARLY WARNING
MAINT. OFF.....	EARLY WARNING
NOT CONNECTED.....	USB COMM.
910 DIRECTIONAL.....	PARALLEL COMM.
RS232.....	SERIAL COMM.
9600.....	BAUD
8 BITS.....	DATA BITS
NONE.....	PARITY
XON/XOFF.....	HOST HANDSHAKE
NCNE.....	PROTOCOL
000.....	NETWORK ID
NORMAL MODE.....	COMMUNICATIONS
<> 7EH.....	CONTROL PREFIX
<> SEH.....	FORMAT PREFIX
<,> 2CH.....	DELIMITER CHAR
ZPL II.....	ZPL MODE
NO MOTION.....	MEDIA POWER UP
NO MOTION.....	HEAD CLOSE
DEFAULT.....	BRICKFEED
+000.....	LABEL TOP
+0000.....	LEFT POSITION
0000.....	HEAD TEST COUNT
1447.....	HEAD RESISTOR
OFF.....	VERTIFER PORT
OFF.....	APPLICATOR PORT
ENABLED.....	ERROR ON PAUSE
PULSE MODE.....	START PRINT STG
FEED MODE.....	RESYNCH MODE
DISABLED.....	REPRINT MODE
050.....	MEDIA S.
079.....	RIBBON S.
012.....	TAKE LABEL
050.....	MARK S.
000.....	MARK MED S.
079.....	MEDIA LED
039.....	RIBBON LED
028.....	MARK LED
+10.....	LCD ADJUST
DPCSFXM.....	MODES ENABLED
.....	MODES DISABLED
1248 12/PM FULL.....	RESOLUTION
V30.15.12P02 C.....	FIRMWARE
V30 7908B 57.....	HARDWARE ID
CUSTOMIZED.....	CONFIGURATION
NONE.....	COMPACT FLASH
11776k.....	RAM
2048k.....	ONBOARD FLASH
NONE.....	FORMAT CONVERT
005 DISPLAY.....	PSC INTERFACE
001 POWER SUPPLY.....	PSE INTERFACE
FW VERSION.....	TWINAX/COAX ID
11/16/06.....	IDLE DISPLAY
16-10.....	RTC DATE
NONE.....	RTC TIME
NONE.....	ZEBRA NET II
15940 IN.....	RFID READY
15940 IN.....	NONRESET CNTR
15940 IN.....	RESET CNTR1
15940 IN.....	RESET CNTR2
39850 CH.....	NONRESET CNTR
39850 CH.....	RESET CNTR1
39850 CH.....	RESET CNTR2
4207 LABELS.....	NONRESET CNTR
4207 LABELS.....	RESET CNTR1
4207 LABELS.....	RESET CNTR2
gk 36850.0 5 NYS07015.41008.07.VH1..	
2006-06-14 16:30:23	TIME STAMP

FIRMWARE IN THIS PRINTER IS COPYRIGHTED

^MT

Media Type

The ^MT command selects the type of media being used in the printer.

These are the choices for this command:

- Thermal Transfer Media – this media uses a high-carbon black or colored ribbon. The ink on the ribbon is bonded to the media.
- Direct Thermal Media – this media is heat sensitive and requires no ribbon.

Format: ^MTa

Parameters	Details
a = media type used	<p>Values:</p> <p>T = thermal transfer media</p> <p>D = direct thermal media</p> <p>Default: a value must be entered or the command is ignored</p>

Comments This command is ignored on the HC100™ printer.

^MU

Set Units of Measurement

The ^MU command sets the units of measurement the printer uses. ^MU works on a field-by-field basis. Once the mode of units is set, it carries over from field to field until a new mode of units is entered.

^MU also allows for printing at lower resolutions — 600 dpi printers are capable of printing at 300, 200, and 150 dpi; 300 dpi printers are capable of printing at 150 dpi.

Format: ^MUa,b,c

Parameters	Details
a = units	Values: D = dots I = inches M = millimeters Default: D
b = format base in dots per inch	Values: 150, 200, 300 Default: a value must be entered or the command is ignored
c = desired dots-per-inch conversion	Values: 300, 600 Default: a value must be entered or the command is ignored

Example: This is an example of Setting Units:

Assume 8 dot/millimeter (203 dot/inch) printer.

Field based on dots:

```
^MUd^F0100,100^GB1024,128,128^FS
```

Field based on millimeters:

```
^MUm^F012.5,12.5^GB128,16,16^FS
```

Field based on inches:

```
^MUi^F0.493,.493^GB5.044,.631,.631^FS
```

Example: This is an example of Converting dpi Values:

```
^MUd,150,300 Convert a 150 dpi format to a 300 dpi format with a base in dots.
```

```
^MUd,150,600 Convert a 150 dpi format to a 600 dpi format with a base in dots.
```

```
^MUd,200,600 Convert a 200 dpi format to a 600 dpi format with a base in dots:
```

To reset the conversion factor to the original format, enter matching values for parameters b and c:

```
^MUd,150,150
```

```
^MUd,200,200
```

```
^MUd,300,300
```

```
^MUd,600,600
```

Comments: This command should appear at the beginning of the label format to be in proper ZPL II format. To turn the conversion off, enter matching values for parameter b and c.

^MW

Modify Head Cold Warning

The ^MW command allows you to set the head cold warning indicator based on the operating environment.

Format: ^MWa

Parameters	Details
a = enable head cold warning	Values: Y = enable head cold warning N = disable head cold warning



IMPORTANT: When a parameter is not given, the instruction is ignored.

^NC**Select the Primary Network Device**

The ^NC command selects the wired or wireless print server as the primary network device.

Supported Devices:

- Xi4, RXi4
- ZM400/ZM600, RZ400/RZ600

The Xi4, RXi4, ZM400/ZM600, and RZ400/RZ600 printers support the simultaneous installation of an internal, external, and a wireless print server. Even though all three print servers may be installed, only one is connected to the network and is the active print server. [Table 9](#) outlines priorities and identifies which device becomes the active print server when multiple print servers are installed.

Table 9 Effect of Primary Network Setting on Active Print Server

If the Primary Network is set to:	Installed and Connected to a Live Ethernet Network			Then, the Active Print Server will be:
	Internal	External	Wireless	
Wired	X	X	X	Internal
		X	X	External
			X	Wireless
Wireless	X	X	X	Wireless
	X	X		Internal
		X		External

A wireless option board must have an active radio that can properly associate to an access point.

Format: ^NCa

Parameters	Details
a = primary network device	<p>Values:</p> <p>1 = wired primary</p> <p>2 = wireless primary</p> <p>Default: 1</p> <p>must be an accepted value or it is ignored</p>

~NC

Network Connect

The ~NC command is used to connect a particular printer to a network by calling up the printer's network ID number.

Format: ~NC###

Parameters	Details
### = network ID number assigned (must be a three-digit entry)	Values: 001 to 999 Default: 000 (none)

Comments: Use this command at the beginning of any label format to specify which printer on the network is going to be used. Once the printer is established, it continues to be used until it is changed by another ~NC command. This command must be included in the label format to wake up the printer.

The commands ^MW, ~NC, ^NI, ~NR, and ~NT are used only with RS-422/485 printer communications.

^ND**Change Network Settings**

The **^ND** command changes the network settings on supported printers.

For the external wired print server settings, the **^ND** command is the same as the **^NS** command. For the wireless print server settings, the **^ND** command is the same as the **^WI** command.

Format: **^ND***a,b,c,d,e,f,g,h,i,j*

Parameters	Details
a = the device that is being modified	Values: <ul style="list-style-type: none"> • 1 = external wired • 2 = internal wired • 3 = wireless
b = IP resolution	Values: <ul style="list-style-type: none"> • A = All • B = BOOTP • C = DHCP and BOOTP • D = DHCP • G = Gleaning only (Not recommended when the Wireless Print Server or Wireless Plus Print Server is installed.) • R = RARP • P = Permanent Default: A
c = IP address	Values: Any properly formatted IP address in the xxx.xxx.xxx.xxx format.
d = subnet mask	Values: Any properly formatted subnet mask in the xxx.xxx.xxx.xxx format.
e = default gateway	Values: Any properly formatted gateway in the xxx.xxx.xxx.xxx format.
f = WINS server address	Values: Any properly formatted WINS server in the xxx.xxx.xxx.xxx format.
g = connection timeout checking	Values: <ul style="list-style-type: none"> Y = yes N = no Default: Y
h = timeout value	Time, in seconds, before the connection times out. Values: 0 through 9999 Default: 300
i = ARP broadcast interval	Time, in minutes, that the broadcast is sent to update the device's ARP cache. Values: 0 through 30 Default: 0 (no ARP sent)

ZPL Commands

Parameters	Details
j = base raw port number	The port number that the printer should use for its RAW data. Values: 1 through 65535 Default: 9100

^NI**Network ID Number**

The **^NI** command is used to assign a network ID number to the printer. This must be done before the printer can be used in a network.

Format: **^NI###**

Parameters	Details
### = network ID number assigned (must be a three-digit entry)	Values: 001 to 999 Default: 000 (none)

Comments: The last network ID number set is the one recognized by the system.

The commands **~NC**, **^NI**, **~NR**, and **~NT** are used only with RS-485 printer communications.

~NR

Set All Network Printers Transparent

The **~NR** command sets all printers in the network to be transparent, regardless of ID or current mode.

Format: ~NR

Comments: The commands **~NC**, **^NI**, **~NR**, and **~NT** are used only with RS-485 printer communications.

^NS**Change Wired Networking Settings**

Use this command to change the wired print server network settings.

Format: ^NSa,b,c,d,e,f,g,h,i

Parameters	Details
a = IP resolution	<p>Values: A = ALL B = BOOTP C = DHCP AND BOOTP D = DHCP G = GLEANING ONLY R = RARP P = PERMANENT</p> <p>Default: A</p> <p>Use of GLEANING ONLY is not recommended when the Wireless Print Server or Wireless Plus Print Server is installed.</p>
b = IP address	Values: Any properly formatted IP address in the xxx.xxx.xxx.xxx format.
c = subnet mask	Values: Any properly formatted subnet mask in the xxx.xxx.xxx.xxx format.
d = default gateway	Values: Any properly formatted gateway in the xxx.xxx.xxx.xxx format.
e = WINS server address	Values: Any properly formatted WINS server in the xxx.xxx.xxx.xxx format.
f = connection timeout checking	<p>Values: Y = Yes N = No</p> <p>Default: Y</p>
g = timeout value	<p>Time, in seconds, before the connection times out.</p> <p>Values: 0 through 9999</p> <p>Default: 300</p>
h = ARP broadcast interval	<p>Time, in minutes, that the broadcast is sent to update the device's ARP cache.</p> <p>Values: 0 through 30</p> <p>Default: 0 (no ARP sent)</p>
i = base raw port number	<p>The port number that the printer should use for its RAW data.</p> <p>Values: 1 through 65535</p> <p>Default: 9100</p>

Example:

```
^XA
^NSa,192.168.0.1,255.255.255.0,192.168.0.2
^XZ
```

Comments For the Xi4, RXI4, ZM400/ZM600, and RZ400/RZ600 printers, Zebra recommends that you use the ^ND command instead of the ^NS command.

~NT

Set Currently Connected Printer Transparent

The ~NT command sets the currently connected network printer to be transparent.

Format: ~NT

Comments: With Z Series printers, the ~NT command functions the same as the ~NR command. All Z Series printers on a network receive the transmission.

The commands ~NC, ^NI, ~NR, and ~NT are used only with RS-485 printer communications.

^PA**Advanced Text Properties****.14↑**

This command is available only for printers with firmware version V60.14.x, V50.14.x, or later.

The ^PA command is used to configure advanced text layout features.

Format: ^PAa,b,c,d

Parameters	Details
a = default glyph	This determines whether the default glyph is a space character or the default glyph of the base font, which is typically a hollow box. Values: 0 = off (space as default glyph) 1 = on (default glyph of font is used, often a hollow box, but depends on the font.) Default: 0
b = bidirectional text layout	This determines whether the bidirectional text layout is turned on or off. Values: 0 = off 1 = on Default: 0
c = character shaping	This determines whether character shaping is turned on or off. Values: 0 = off 1 = on Default: 0
d = OpenType table support	This determines whether the OpenType support is turned on or off. Values: 0 = off 1 = on Default: 0

^PF

Slew Given Number of Dot Rows

The ^PF command causes the printer to slew labels (move labels at a high speed without printing) a specified number of dot rows from the bottom of the label. This allows faster printing when the bottom portion of a label is blank.

Format: ^PF#

Parameters	Details
# = number of dots rows to slew	Values: 0 to 32000 Default: a value must be entered or the command is ignored

^PH ~PH

Slew to Home Position

The ^PH or ~PH command causes the printer to feed one blank label.

The ~PH command feeds one label after the format currently being printed is done or when the printer is placed in pause.

The ^PH command feeds one blank label after the current format prints.

Format: ^PH or ~PH

~PL

Present Length Addition

The ~PL command adds an additional amount to how far the paper is ejected during a present cycle. A standard amount of 50mm is always added to clear the kiosk wall. This amount is added to that 50mm. The total amount of media ejected when a ^PN is executed, then, is 50mm + ~PL value + ^PN value.

Supported Devices:

- KR403

Format: ^PLa

Parameters	Details
a = additional eject length	<p>Values: 000-255 = additional mm of media to eject</p> <p>Default: 000</p> <p>The command is ignored if parameters are missing or invalid.</p>

^PM

Printing Mirror Image of Label

The ^PM command prints the entire printable area of the label as a mirror image. This command flips the image from left to right.

Format: ^PMa

Parameters	Details
a = print mirror image of entire label	Values: N = no Y = yes Default: N

Example: This is an example of printing a mirror image on a label:

ZPL II CODE	GENERATED LABEL
<pre> ^XA^PMY ^FO100,100 ^CFG ^FDMIRROR^FS ^FO100,160 ^FDIMAGE^FS ^XZ </pre>	

Comments: If the parameter is missing or invalid, the command is ignored. Once entered, the ^PM command remains active until ^PMN is received or the printer is turned off.

~PM

Decommissioning Mode

This command places the printer into the Decommissioning Mode.

Format: ~PMa,b

Parameter	Details
a = printer's serial number	Alphanumeric string. Mandatory parameter.
b = number of times for the flash wipe-out to occur	Optional parameter. Minimum Value = 0 Maximum Value =3 Default Value = 0



NOTE:

- If Decommissioning Mode takes longer than 3 seconds, printers with a screen will display a message while the Decommissioning Mode is in process.
- The serial number specified should match with the serial number of the printer, else the printer does not exit Protected Mode.
- Decommissioning Mode will cause the printer to exit Protected Mode.
- Only use the flash wipe optional parameter if the printer will be resold, recycled, or reused by another group that should not have access to the printer settings data. This may include proprietary fonts, formats, files, or network configuration. A flash wipe does take considerable time, which will vary in length, based on printer model.

RECOMMENDATION: Only use the flash wipe optional parameter if the printer will be resold, recycled, or reused by another group that should not have access to the printer settings data. This may include proprietary fonts, formats, files, or network configuration. A flash wipe takes considerable time, which will vary in length, based on the printer model.

^PN

Present Now

The ^PN command causes the printer to run a Presenter cycle. The parameter defines the amount of media ejected. The total amount of media ejected when a ^PN is executed, then, is 50mm + ~PL value + ^PN value. (See [~PL on page 300](#)).

Supported Devices:

- KR403

Format: ^PNa

Parameters	Details
a = media eject length	<p>Values: 0-255 = additional mm of media to eject</p> <p>Default: none</p> <p>The command is ignored if parameters are missing or invalid.</p>

^PO

Print Orientation

The **^PO** command inverts the label format 180 degrees. The label appears to be printed upside down. If the original label contains commands such as **^LL**, **^LS**, **^LT** and **^PF**, the inverted label output is affected differently.

Format: ^POa

Parameters	Details
a = invert label 180 degrees	Values: N = normal I = invert Default: N

Example: This is an example of printing a label at 180 degrees:

ZPL II CODE	GENERATED LABEL
<pre> ^XA^CFD ^POI ^LH330,10 ^FO50,50 ^FDZEBRA TECHNOLOGIES^FS ^FO50,75 ^FDVernon Hills, IL^FS ^XZ </pre>	

The **^POI** command inverts the x, y coordinates. All image placement is relative to these inverted coordinates. Therefore, a different **^LH** (Label Home) can be used to move the print back onto the label.

Comments: If multiple **^PO** commands are issued in the same label format, only the last command sent to the printer is used.

Once the **^PO** command is sent, the setting is retained until another **^PO** command is received or the printer is turned off.

The **N** value for the a parameter is not supported on the HC100™ printer.

^PP ~PP

Programmable Pause

The **~PP** command stops printing after the current label is complete (if one is printing) and places the printer in Pause Mode.

The **^PP** command is not immediate. Therefore, several labels might print before a pause is performed. This command pauses the printer after the current format prints.

The operation is identical to pressing **PAUSE** on the control panel of the printer. The printer remains paused until **PAUSE** is pressed or a **~PS** (Print Start) command is sent to the printer.

Format: ^PP or ~PP

^PQ**Print Quantity**

The **^PQ** command gives control over several printing operations. It controls the number of labels to print, the number of labels printed before printer pauses, and the number of replications of each serial number.

Format: **^PQq,p,r,o,e**

Parameters	Details
q = total quantity of labels to print	Values: 1 to 99,999,999 Default: 1
p = pause and cut value (labels between pauses)	Values: 1 to 99,999,999 Default: 0 (no pause)
r = replicates of each serial number	Values: 0 to 99,999,999 replicates Default: :0 (no replicates)
o = override pause count	Values: N = no Y = yes Default: N
e = cut on error label (RFID void is an error label)	Values: N = no - if a cutter is installed, a cut will be made after a voided RIFD label ONLY if a cut would be made after the non-voided label and this was the last retry. Y = yes - if a cutter is installed, a cut will be made after ANY voided RFID label. Default: Y

If the **o** parameter is set to **Y**, the printer cuts but does not pause, and the printer does **not** pause after every group count of labels has been printed. With the **o** parameter set to **N** (default), the printer pauses after every group count of labels has been printed.

Example: This example shows the control over print operations:

^PQ50,10,1,Y: This example prints a total of 50 labels with one replicate of each serial number. It prints the total quantity in groups of 10, but does not pause after every group.

^PQ50,10,1,N: This example prints a total of 50 labels with one replicate of each serial number. It prints the total quantity in groups of 10, pausing after every group.

~PR

Applicator Reprint

If the ~PR command is enabled (see [^JJ on page 242](#)), the last label printed reprints, similar to the applicator asserting the Reprint signal on the applicator port. This command is similar to [device.applicator.reprint on page 619](#).

Format: ~PR

Comments: Pressing **PREVIOUS** on the control panel also causes the last label to reprint.

^PR

Print Rate

The ^PR command determines the media and slew speed (feeding a blank label) during printing.

The printer operates with the selected speeds until the setting is reissued or the printer is turned off.

The print speed is application-specific. Because print quality is affected by media, ribbon, printing speeds, and printer operating modes, it is very important to run tests for your applications.



IMPORTANT: Some models go to default print speed when power is turned off.

Format: ^PRp,s,b

Parameters	Details
p = print speed	<p>Values:</p> <p>1 = 25.4 mm/sec. (1 inch/sec.)</p> <p>A or 2 = 50.8 mm/sec. (2 inches/sec.)</p> <p>B or 3 = 76.2 mm/sec. (3 inches/sec.)</p> <p>C or 4 = 101.6 mm/sec. (4 inches/sec.)</p> <p>5 = 127 mm/sec.(5 inches/sec.)</p> <p>D or 6 = 152.4 mm/sec. (6 inches/sec.)</p> <p>7 = 177.8 mm/sec. (7 inches/sec.)</p> <p>E or 8 = 203.2 mm/sec. (8 inches/sec.)</p> <p>9 = 220.5 mm/sec. 9 inches/sec.)</p> <p>10 = 245 mm/sec.(10 inches/sec.)</p> <p>11 = 269.5 mm/sec.(11 inches/sec.)</p> <p>12 = 304.8 mm/sec. 12 inches/sec.)</p> <p>13 = 13 in/sec</p> <p>14 = 14 in/sec</p> <p>Default: A</p>
<p>This value is supported only on the 110Xi4-600dpi, 110XiIIIPlus-600dpi , and RXi printers. This value is supported only on the Xi4 and RXi4 printers.</p>	

ZPL Commands

Parameters	Details
s = slew speed	<p>Values:</p> <p>A or 2 = 50.8 mm/sec. (2 inches/sec.) B or 3 = 76.2 mm/sec. (3 inches/sec.) C or 4 = 101.6 mm/sec. (4 inches/sec.) 5 = 127 mm/sec. 5 inches/sec.) D or 6 = 152.4 mm/sec. (6 inches/sec.) 7 = 177.8 mm/sec. (7 inches/sec.) E or 8 = 203.2 mm/sec. (8 inches/sec.) 9 = 220.5 mm/sec. (9 inches/sec.) 10 = 245 mm/sec. (10 inches/sec.) 11 = 269.5 mm/sec. 11 inches/sec.) 12 = 304.8 mm/sec. 12 inches/sec.) 13 = 13 in/sec 14 = 14 in/sec</p> <p>Default: D</p>
b = backfeed speed	<p>Values:</p> <p>A or 2 = 50.8 mm/sec. (2 inches/sec.) B or 3 = 76.2 mm/sec. (3 inches/sec.) C or 4 = 101.6 mm/sec. (4 inches/sec.) 5 = 127 mm/sec.(5 inches/sec.) D or 6 = 152.4 mm/sec. (6 inches/sec.) 7 = 177.8 mm/sec. (7 inches/sec.) E or 8 = 203.2 mm/sec. (8 inches/sec.) 9 = 220.5 mm/sec. 9 inches/sec.) 10 = 245 mm/sec. 10 inches/sec.) 11 = 269.5 mm/sec. 11 inches/sec.) 12 = 304.8 mm/sec. 12 inches/sec.) 13 = 13 in/sec 14 = 14 in/sec</p> <p>Default: A</p>
<p>This value is supported only on the 110Xi4-600dpi, 110Xi4Plus-600dpi , and RXi printers. This value is supported only on the Xi4 and RXi4 printers.</p>	

Comments: The speed setting for **p**, **s**, and **b** is dependent on the limitations of the printer. If a particular printer is limited to a rate of 6 ips (inches per second), a value of 12 can be entered but the printer performs only at a 6 ips rate. See your printer's User Guide for specifics on performance.

This command is ignored on the HC100 printer.

~PS

Print Start

The **~PS** command causes a printer in Pause Mode to resume printing. The operation is identical to pressing **PAUSE** on the control panel of the printer when the printer is already in Pause Mode.

Format: ~PS

^PW

Print Width

The ^PW command allows you to set the print width.

Format: ^PWa

Parameters	Details
a = label width (in dots)	Values: 2, to the width of the label If the value exceeds the width of the label, the width is set to the label's maximum size. Default: last permanently saved value

Comments This command is ignored on the HC100™ printer.

~R0

Reset Advanced Counters

The ~R0 command resets the advanced counters used by the printer to monitor label generation in inches, centimeters, and number of labels.

Format: ~R0c

Parameters	Details
c = counter number	<p>Values:</p> <p>1 = reset counter 1</p> <p>2 = reset counter 2</p> <p>3 = reset valid RFID label counter</p> <p>4 = reset voided RFID label counter</p> <p>C = reset head cleaned counter</p> <p>R = reset head replaced counter and head cleaned counter</p> <p>Default: a value must be specified or the command is ignored</p>
<p>These values are supported only on Xi4, RXi4, ZM400/ZM600, RZ400/RZ600, S4M, and G-Series printers.</p>	

→ This example shows how the counter portion of the printer configuration labels looks when counter 1 is reset by sending ~R01.

Before

```

→ 296862 IN..... NONRESET CNTR
→ 296862 IN..... RESET CNTR1
→ 296862 IN..... RESET CNTR2
→ 753289 CM..... NONRESET CNTR
→ 753289 CM..... RESET CNTR1
→ 753289 CM..... RESET CNTR2
→ 92928 LABLS..... NONRESET CNTR
→ 92928 LABLS..... RESET CNTR1
→ 92928 LABLS..... RESET CNTR2
    
```

After

```

→ 296876 IN..... NONRESET CNTR
→ 0 IN..... RESET CNTR1
→ 296876 IN..... RESET CNTR2
→ 753323 CM..... NONRESET CNTR
→ 0 CM..... RESET CNTR1
→ 753323 CM..... RESET CNTR2
→ 92930 LABLS..... NONRESET CNTR
→ 0 LABLS..... RESET CNTR1
→ 92930 LABLS..... RESET CNTR2
    
```

^SC**Set Serial Communications**

The ^SC command allows you to change the serial communications parameters you are using.

Format: ^SCa,b,c,d,e,f

Parameters	Details
a = baud rate	Values: 110 ; 300; 600; 1200; 2400; 4800; 9600; 14400; 19200; 28800; 38400; or 57600; 115200 Default: must be specified or the parameter is ignored
b = word length (in data bits)	Values: 7 or 8 Default: must be specified
c = parity	Values: N (none), E (even), or O (odd) Default: must be specified
d = stop bits	Values: 1 or 2 Default: must be specified
e = protocol mode	Values: X = XON/XOFF D = DTR/DSR R = RTS M = DTR/DSR XON/XOFF Default: must be specified
f = Zebra protocol	Values: A = ACK/NAK N = none Z = Zebra Default: must be specified

This value is not supported on Xi4, RXi4, ZM400/ZM600, RZ400/RZ600, and S4M printers.

This parameter is supported only on G-Series printers. Using the DTR/DSR XON/XOFF mode will cause the printer to respond to either DTR/DSR or XON/XOFF, depending on which method is first received from the host device.

Comments: If any of the parameters are missing, out of specification, not supported by a particular printer, or have a ZPL-override DIP switch set, the command is ignored.

A ^JUS command causes the changes in Communications Mode to persist through power-up and software resets.

~SD

Set Darkness

The **~SD** command allows you to set the darkness of printing. **~SD** is the equivalent of the darkness setting parameter on the control panel display.

Format: **~SD##**

Parameters	Details
## = desired darkness setting (two-digit number)	Values: 00 to 30 Default: last permanently saved value



IMPORTANT: The darkness setting range for the XiIIIPlus, Xi4, and RXi4 is 0 to 30 in increments of 0.1. The firmware is setup so that the **^MD** and **~SD** commands (ZPL darkness commands) accept that range of settings.

Example: These are examples of the XiIIIPlus, Xi4, and RXi4 Darkness Setting:

^MD8.3

~SD8.3

Comments: The **^MD** command value, if applicable, is added to the **~SD** command.

^SE**Select Encoding Table**

The **^SE** command is used to select the desired ZPL or ZPL II encoding table.

Format: **^SEd:o.x**

Parameters	Details
d = location of encoding table	Values: R:, E:, B:, and A: Default: R:
o = name of encoding table	Values: 1 to 8 alphanumeric characters Default: a value must be specified
x = extension	Fixed Value: .DAT

The encoding tables are provided with the font card or downloaded in flash with the font. The table appears as **XXXXXX.DAT** in a directory label printed by the ZPL commands.

The most active encoding table is indicated by the ***** on the directory label.

Example:

^XA^WD*:*.*^XZ

^SF**Serialization Field (with a Standard ^FD String)**

The **^SF** command allows you to serialize a standard **^FD** string. The maximum size of the mask and increment string is 3K combined.

.14↑

In firmware version x.14 and later, strings are serialized from the last character in the backing store with regard to the alignment of the mask and increment strings. For combining semantic clusters that do not get incremented, the mask character % needs to be added to the increment string.

Format: **^SF**a,b

Parameters	Details
a = mask string	<p>The mask string sets the serialization scheme. The length of the string mask defines the number of characters (or in firmware version x.14 and later, combining semantic clusters) in the current ^FD string to be serialized. The mask is aligned to the characters (or in firmware version x.14 and later, combining semantic clusters) in the ^FD string starting with the right-most (or in firmware x.14 and later, last) in the backing store position.</p> <p>Mask String placeholders:</p> <p>D or d – Decimal numeric 0–9</p> <p>H or h – Hexadecimal 0–9 plus a-f or A-F</p> <p>O or o – Octal 0–7</p> <p>A or a – Alphabetic A–Z or a–z</p> <p>N or n – Alphanumeric 0–9 plus A–Z or a–z</p> <p>% – Ignore character or skip</p>
b = increment string	<p>The increment string is the value to be added to the field on each label. The default value is equivalent to a decimal value of one. The string is composed of any characters (or in firmware version x.14 and later, combining semantic clusters) defined in the serial string. Invalid characters (or in firmware version x.14 and later, combining semantic clusters) are assumed to be equal to a value of zero in that characters (or in firmware version x.14 and later, combining semantic clusters) position.</p> <p>The increment value for alphabetic strings start with 'A' or 'a' as the zero placeholder. This means to increment an alphabetic character (or in firmware version x.14 and later, combining semantic cluster) by one, a value of 'B' or 'b' must be in the increment string.</p>

For characters that do not get incremented, the % character needs to be added to the increment string.

Example: This is an example of serializing a `^FD` string. The ZPL II code generates three separate labels as seen in Generated Labels:

ZPL II CODE	GENERATED LABELS
<code>^XA</code>	12K
<code>^FO100,100</code>	12F
<code>^CF0,100</code>	12A
<code>^FD12A^SFnnA,F^FS</code>	
<code>^PQ3</code>	
<code>^XZ</code>	

This mask has the first characters (or in firmware version x.14 and later, the first combining semantic clusters) as alphanumeric (`nn = 12`) and the last digit as uppercase alphabetic (A). The decimal value of the increment number is equivalent to 5 (F). The number of labels generated depends on the number specified by the `^PQ` command.

In a similar instance, the `^FD` string could be replaced with either of the `^FD` strings below to generate a series of label, determined by `^PQ`.

Using this ZPL code:

```
^FDBL0000^SFAAddd,1
```

The print sequence on this series of labels is:

```
BL0000, BL0001, ...BL0009, BL0010, ...
BL0099, BL0100, ...BL9999, BM0000...
```

Using this ZPL code:

```
^FDBL00-0^SFAAdd%d,1%1
```

The print sequence on this series of labels is:

```
BL00-0, BL01-1, BL02-2, ...BL09-9,
BL11-0, BL12-1...
```

.14↑

Important notes about masking for firmware version V60.14.x, V50.14.x, or later:

- A single `%` masks an entire combining semantic cluster rather than a single code point.
- The mask string and increment string should be aligned at the last code point in their respective backing stores.
- Control and bidirectional characters do not require a mask and are ignored for serialization purposes.

The following examples show the importance of capitalization and location within the mask.

Example: In this example, the printer cycles with every two printed labels and alternates between H (position 18), and then Z (position 36). With `n` or `N`, the serial number increments from 0 - 9 and `a-z` or `A-Z` (36 positions overall). With each completed cycle, the second cluster (`nn`) increments one position (from 00, 01, 02 ...) per cycle:

ZPL II CODE

```

^XA
^FO100,50^A0N,50,50^FDzzZ^SFnnN,I^FS
^PQ10
^XZ
    
```

GENERATED LABELS

Example: In this example, lower case i increments with a mask string of nnN. Nothing changes because the first cluster (Z) never triggers the second cluster (zz) to change.

ZPL II CODE

```

^XA
^FO100,50^A0N,50,50^FDzzZ^SFnnN,i^FS
^PQ10
^XZ
    
```

GENERATED LABELS

^SI**Set Sensor Intensity****.15↑**

This command is available only for printers with firmware versions V53.15.x or later.

The **^SI** command is used to change the values for the media sensors, which are also set during the media calibration process. The media calibration process is described in your specific printer's user's guide.

Format: **^SIa,b**

Parameters	Details
a = indicates the setting to modify	<p>Values:</p> <p>1 = transmissive sensor brightness setting</p> <p>2 = transmissive sensor baseline setting</p> <p>Default: must be an accepted value or the entire command is ignored</p>
b = the value to use for the sensor being configured	<p>The ranges for this parameter are the same for the accepted values in parameter a.</p> <p>Values: 0 to 196</p> <p>Default: must be an accepted value or the entire command is ignored</p>

^SL

Set Mode and Language (for Real-Time Clock)

The ^SL command is used to specify the Real-Time Clock's mode of operation and language for printing information.

**IMPORTANT:**

- Time is read when the image is created. If the image stays in the queue longer than the specified time the image will be recreated with a new time.
- There are incidents when the same time or a larger space of time may be printed on labels. This is due to the format complexity and print speed.

Format: ^SLa,b

Parameters	Details
a = mode	<p>Values:</p> <p>S = Start Time Mode. This is the time that is read from the Real-Time Clock when label formatting begins (when ^XA is received). The first label has the same time placed on it as the last label.</p> <p>T = Time Now Mode. This is the time that is read from the Real-Time Clock when the label to be printed is placed in print queue. <i>Time Now</i> is similar to a serialized time or date field.</p> <p>Numeric Value = With the Enhanced Real Time Clock (V60.13.0.10 or later) a time accuracy tolerance can be specified. Range = 1 to 999 seconds, 0 = one second tolerance</p> <p>SL30,1 = Accuracy tolerance of 30 seconds and use English.</p> <p>Default: S</p>
These values are only supported on the Xi4, RXi4, ZM400/ZM600, and RZ400/RZ600 printers.	

^SN

Serialization Data

The ^SN command allows the printer to index data fields by a selected increment or decrement value, making the data fields increase or decrease by a specified value each time a label is printed. This can be performed on 100 to 150 fields in a given format and can be performed on both alphanumeric and bar code fields. A maximum of 12 of the right- most integers are subject to indexing.

.13↓

In x.13 and earlier, the first integer found when scanning from right to left starts the indexing portion of the data field.

.14↑

In x.14 and later, the first integer found when scanning from end of the backing store towards the beginning starts the indexing portion of the data field.

.13↓

In x.13 and earlier, if the alphanumeric field to be indexed ends with an alpha character, the data is scanned, character by character, from right to left until a numeric character is encountered. Serialization takes place using the value of the first number found.

.14↑

In x.14 and later, if the backing store of the alphanumeric field to be indexed ends with an alpha character, the data is scanned, character by character, from the end of the backing store until a numeric character is encountered. Serialization takes place using the value of the first number found.

Format: ^SNv,n,z

Parameters	Details
v = starting value	Values: 12-digits maximum for the portion to be indexed Default: 1
n = increment or decrement value	Values: 12-digit maximum Default: 1 To indicate a decrement value, precede the value with a minus (-) sign.
z = add leading zeros (if needed)	Values: N = no Y = yes Default: N

Example: This example shows incrementing by a specified value:

ZPL II CODE	GENERATED LABELS
<pre> ^XA ^FO260,110 ^CFG ^SN001,1,Y^FS ^PQ3 ^XZ </pre> <p><i>Note: The ZPL II code above will generate three separate labels, seen to the right.</i></p>	<div style="border: 1px solid black; padding: 10px; text-align: center; margin-bottom: 10px;">001</div> <div style="border: 1px solid black; padding: 10px; text-align: center; margin-bottom: 10px;">002</div> <div style="border: 1px solid black; padding: 10px; text-align: center;">003</div>

Comments: Incrementing and decrementing takes place for each serial-numbered field when all replicates for each serial number have been printed, as specified in parameter *r* of the **^PQ** (print quality) command.

If, during the course of printing serialized labels, the printer runs out of either paper or ribbon, the first label printed (after the media or ribbon has been replaced and calibration completed) has the same serial number as the *partial* label printed before the *out* condition occurred. This is done in case the last label before the *out* condition did not fully print. This is controlled by the **^JZ** command.

Using Leading Zeros

In the **^SN** command, the *z* parameter determines if leading zeros are printed or suppressed. Depending on which value is used (**Y** = print leading zeros; **N** = do not print leading zeros), the printer either prints or suppresses the leading zeros.

The default value for this parameter is **N** (do not print leading zeros).

Print Leading Zeros

.13↓

In x.13 and earlier, the starting value consists of the right-most consecutive sequence of digits.

.14↑

In x.14 and later, the starting value consists of the first number working backwards in the backing store consecutive sequence of digits.

The width (number of digits in the sequence) is determined by scanning from right to left until the first non-digit (space or alpha character) is encountered. To create a specific width, manually place leading zeros as necessary.

Suppressing Leading Zeros

.13↓

In x.13 and earlier, the starting value consists of the right-most consecutive sequence of digits, including any leading spaces.

.14↑

In x.14 or later, the starting value consists of the first number working backwards in the backing store consecutive sequence of digits, including any leading spaces.

^SO

Set Offset (for Real-Time Clock)

The ^SO command is used to set the secondary and the tertiary offset from the primary Real-Time Clock.



NOTE: For each label only one ^SO2 command can be used. If more than one offset is required, ^SO3 must be used.

Format: ^SOa,b,c,d,e,f,g

Parameters	Details
a = clock set	Values: 2 = secondary 3 = third Default: value must be specified
b = months offset	Values: -32000 to 32000 Default: 0
c = days offset	Values: -32000 to 32000 Default: 0
d = years offset	Values: -32000 to 32000 Default: 0
e = hours offset	Values: -32000 to 32000 Default: 0
f = minutes offset	Values: -32000 to 32000 Default: 0
g = seconds offset	Values: -32000 to 32000 Default: 0

For more detail on set offset, see [Real Time Clock on page 1440](#).

^SP

Start Print

The **^SP** command allows a label to start printing at a specified point before the entire label has been completely formatted. On extremely complex labels, this command can increase the overall throughput of the print.

The command works as follows: Specify the dot row at which the **^SP** command is to begin. This creates a label segment. Once the **^SP** command is processed, all information in that segment prints. During the printing process, all of the commands after the **^SP** continue to be received and processed by the printer.

If the segment after the **^SP** command (or the remainder of the label) is ready for printing, media motion does not stop. If the next segment is not ready, the printer stops mid-label and wait for the next segment to be completed. Precise positioning of the **^SP** command requires a trial-and-error process, as it depends primarily on print speed and label complexity.

The **^SP** command can be effectively used to determine the worst possible print quality. You can determine whether using the **^SP** command is appropriate for the particular application by using this procedure.

If you send the label format up to the first **^SP** command and then wait for printing to stop before sending the next segment, the printed label is a sample of the worst possible print quality. It drops any field that is out of order.

If the procedure above is used, the end of the label format must be:

```
^SP#^FS
```

Comments: ^SPa

Parameters	Details
a = dot row to start printing	Values: 0 to 32000 Default: 0

Example: In this example, a label 800 dot rows in length uses **^SP500**. Segment 1 prints while commands in Segment 2 are being received and formatted.

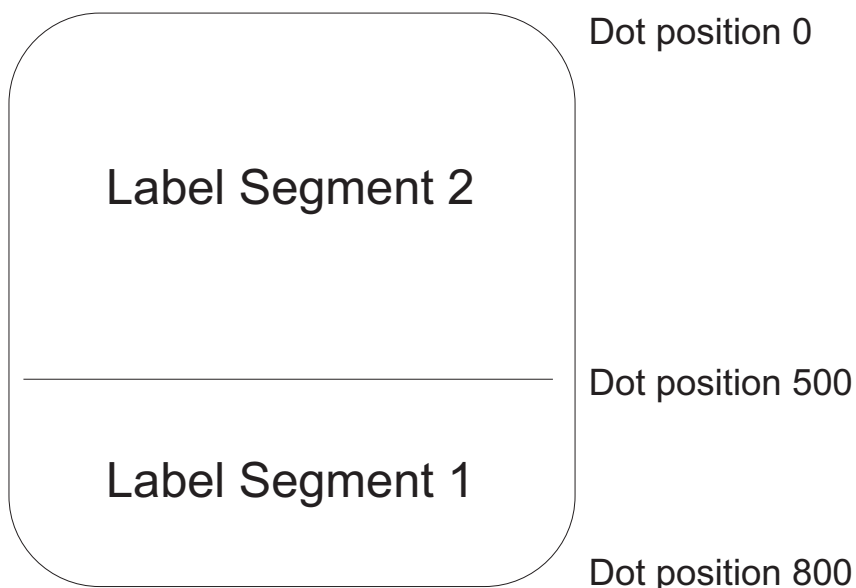

^SQ**Halt ZebraNet Alert**

The **^SQ** command is used to stop the ZebraNet Alert option.

Format: **^SQa,b,c**

Parameters	Details
a = condition type	Values: A = paper out B = ribbon out C = printhead over-temp D = printhead under-temp E = head open F = power supply over-temp G = ribbon-in warning (Direct Thermal Mode) H = rewind full I = cut error J = printer paused K = PQ job completed L = label ready M = head element out N = ZBI (Zebra BASIC Interpreter) runtime error O = ZBI (Zebra BASIC Interpreter) forced error Q = clean printhead R = media low S = ribbon low T = replace head U = battery low V = RFID error (in RFID printers only) W = all errors (in RFID printers only) * = all errors (in non-RFID printers)
b = destination	Values: A = serial port B = parallel port C = e-mail address D = TCP/IP E = UDP/IP F = SNMP trap * = wild card to stop alerts for all destinations

ZPL Commands

Parameters	Details
c = halt messages	Values: Y = halt messages N = start messages Default: Y

^SR

Set Printhead Resistance

The ^SR command allows you to set the printhead resistance.

Format: ^SR####

Parameters	Details
#### = resistance value (four-digit numeric value)	Values: 0488 to 1175 Default: last permanently saved value

Comments: To avoid damaging the printhead, this value should be less than or equal to the value shown on the printhead being used. Setting a higher value could damage the printhead.



NOTE: New printer models automatically set head resistance.

^SS**Set Media Sensors**

The **^SS** command is used to change the values for media, web, ribbon, and label length set during the media calibration process. The media calibration process is described in your specific printer's user's guide.

Format: **^SS**w,m,r,l,m2,r2,a,b,c

Parameters	Details
w = web (3-digit value)	Values: 000 to 100 Default: value shown on the media sensor profile or configuration label
m = media (3-digit value)	Values: 000 to 100 Default: value shown on the media sensor profile or configuration label
r = ribbon (3-digit value)	Values: 000 to 100 Default: value shown on the media sensor profile or configuration label
l = label length (in dots, four-digit value)	Values: 0001 to 32000 Default: value calculated in the calibration process
m2 = intensity of media LED (3-digit value)	Values: 000 to 255 Default: value calculated in the calibration process
r2 = intensity of ribbon LED (3-digit value)	Values: 000 to 255 Default: value calculated in the calibration process
a = mark sensing (3-digit value)	Values: 000 to 100 Default: value calculated in the calibration process
b = mark media sensing (3-digit value)	Values: 000 to 100 Default: value calculated in the calibration process
c = mark LED sensing (3-digit value)	Values: 000 to 255 Default: value calculated in the calibration process

Example: Below is an example of a media sensor profile. Notice the numbers from 000 to 100 and where the words WEB, MEDIA, and RIBBON appear in relation to those numbers. Also notice the black vertical spike. This represents where the printer sensed the transition from media-to-web-to-media.

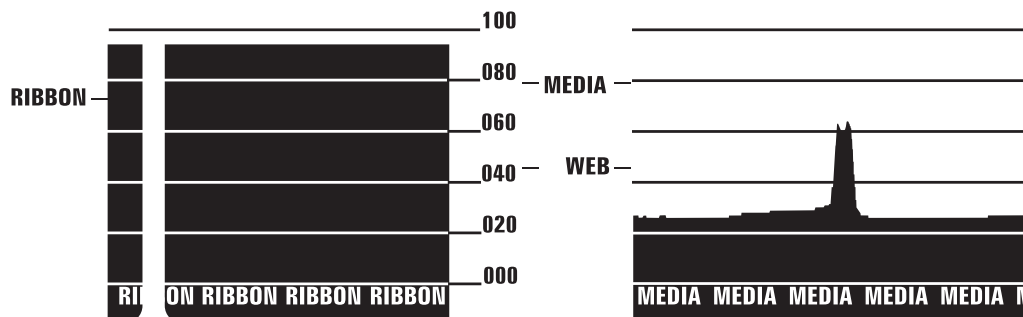

The media and sensor profiles produced vary in appearance from printer to printer.

Comments: The **m2** and **r2** parameters have no effect in Stripe® S-300 and S-500 printers. This command is ignored on the HC100™ printer. Maximum values for parameters depend on which printer platform is being used.

^ST**Set Date and Time (for Real-Time Clock)**

The ^ST command sets the date and time of the Real-Time Clock.

Format: ^STa,b,c,d,e,f,g

Parameters	Details
a = month	Values: 01 to 12 Default: current month
b = day	Values: 01 to 31 Default: current day
c = year	Values: 1998 to 2097 Default: current year
d = hour	Values: 00 to 23 Default: current hour
e = minute	Values: 00 to 59 Default: current minute
f = second	Values: 00 to 59 Default: current second
g = format	Values: A = a.m. P = p.m. M = 24-hour military Default: M

For more details on set date and time, see [Real Time Clock on page 1440](#).

^SX

Set ZebraNet Alert

The ^SX command is used to configure the ZebraNet Alert System.

Format: ^SXa,b,c,d,e,f



NOTE: The values in this table apply to firmware version V48.12.4 or later.

Parameters	Details
a = condition type	<p>Values:</p> <p>A = paper out</p> <p>B = ribbon out</p> <p>C = printhead over-temp</p> <p>D = printhead under-temp</p> <p>E = head open</p> <p>F = power supply over-temp</p> <p>G = ribbon-in warning (Direct Thermal Mode)</p> <p>H = rewind full</p> <p>I = cut error</p> <p>J = printer paused</p> <p>K = PQ job completed</p> <p>L = label ready</p> <p>M = head element out</p> <p>N = ZBI (Zebra BASIC Interpreter) runtime error</p> <p>O = ZBI (Zebra BASIC Interpreter) forced error</p> <p>P = power on</p> <p>Q = clean printhead</p> <p>R = media low</p> <p>S = ribbon low</p> <p>T = replace head</p> <p>U = battery low</p> <p>V = RFID error (in RFID printers only)</p> <p>* = all errors</p> <p>Default: if the parameter is missing or invalid, the command is ignored</p>

Parameters	Details
b = destination for route alert	Values: A = serial port B* = parallel port C = e-mail address D = TCP/IP E = UDP/IP F = SNMP trap Default: If this parameter is missing or invalid, the command is ignored. * Requires bidirectional communication.
c = enable condition set alert to this destination	Values: N = no Y = yes Values: Y or previously configured value
d = enable condition clear alert to this destination	Values: N = no Y = yes Values: N or previously configured value Parameters e and f are sub-options based on destination. If the sub-options are missing or invalid, these parameters are ignored.
e = destination setting	Values: Internet e-mail address (e.g. user@company.com) IP address (for example, 10.1.2.123) SNMP trap IP or IPX addresses
f = port number	Values: TCP port # (0 to 65535) UDP port # (0 to 65535)

Example: This is an example of the different (b) destinations that you can send for the condition type (a):

Serial: ^SXA,A,Y,Y

Parallel: ^SXA,B,Y,Y

E-Mail: ^SXA,C,Y,Y,admin@company.com

TCP: ^SXA,D,Y,Y,123.45.67.89,1234

UDP: ^SXA,E,Y,Y,123.45.67.89,1234

SNMP Trap: ^SXA,F,Y,Y,255.255.255.255

Comments: In the example above for SNMP Trap, entering 255.255.255.255 broadcasts the notification to every SNMP manager on the network. To route the device to a single SNMP manager, enter a specific address (123.45.67.89).

^SZ

Set ZPL Mode

The ^SZ command is used to select the programming language used by the printer. This command gives you the ability to print labels formatted in both ZPL and ZPL II.

This command remains active until another ^SZ command is sent to the printer or the printer is turned off.

Format: ^SZa

Parameters	Details
a = ZPL version	Values: 1 = ZPL 2 = ZPL II Default: 2

Comments: If the parameter is missing or invalid, the command is ignored.

~TA

Tear-off Adjust Position

The ~TA command lets you adjust the rest position of the media after a label is printed, which changes the position at which the label is torn or cut.

Format: ~TA###



IMPORTANT: These are some important facts about this command:

- For 600 dpi printers, the step size doubles.
- If the number of characters is **less than 3**, the command is ignored.

Parameters	Details
### = change in media rest position (3-digit value in dot rows must be used.)	<p>Values: -120 to 120 0 to 120 (on the HC100)</p> <p>Default: last permanent value saved</p>

Comments: If the parameter is missing or invalid, the command is ignored.

^TB

Text Blocks



This command is available only for printers with firmware version V60.14.x, V50.14.x, or later.

Description: The ^TB command prints a text block with defined width and height. The text block has an automatic word-wrap function. If the text exceeds the block height, the text is truncated. This command supports complex text layout features.



NOTE: ^TB is the preferred command for printing fields or blocks of text, instead of ^FB.

Format: ^TBa,b,c

Parameters	Details
a = block rotation	<p>Values:</p> <p>N = normal</p> <p>R = rotate 90 degrees clockwise</p> <p>I = invert 180 degrees</p> <p>B = read from bottom up-270 degrees</p> <p>Default: whatever was specified by the last ^A (which has the default of ^FW)</p>
b = block width in dots	<p>Values:</p> <p>1 to the width of the label in dots</p> <p>Default: 1 dot</p>
c = block height in dots	<p>Values:</p> <p>1 to the length of the label in dots</p> <p>Default: 1 dot</p>

Comments: Facts about the ^TB command:

- Justification of ^TB command comes from ^FO, ^FT, or ^FN command. If no justification is determined then the default is auto justification.
- Data between < and > is processed as an escape sequence; for example, <<> will print < .
- The ^TB command has an automatic word-wrap function. Soft hyphens do not print and are not used as a line break position.

^TO

Transfer Object

The ^TO command is used to copy an object or group of objects from one storage device to another. It is similar to the copy function used in PCs.

Source and destination devices must be supplied and must be different and valid for the action specified. Invalid parameters cause the command to be ignored.

The asterisk (*) can be used as a wild card for object names and extensions. For instance, **ZEBRA.*** or ***.GRF** are acceptable forms for use with the ^TO command.

At least one source parameter (**d**, **o**, or **x**) and one destination parameter (**s**, **o**, or **x**) must be specified. If only ^TO is entered, the command is ignored.

Format: ^TOs:o.x,d:o.x

Parameters	Details
s = source device of stored object	Values: R:, E:, B:, and A: Default: if a drive is not specified, all objects are transferred to the drive set in parameter s
o = stored object name	Values: any existing object conforming to Zebra conventions Default: if a name is not specified, * is used — all objects are selected
x = extension	Values: any extension conforming to Zebra conventions Default: if an extension is not specified, * is used — all extensions are selected
d = destination device of the stored object	Values: R:, E:, B:, and A: Default: a destination must be specified
o = name of the object at destination	Values: up to 8 alphanumeric characters Default: if a name is not specified, the name of the existing object is used
x = extension	Values: any extension conforming to Zebra conventions Default: if an extension is not specified, the extension of the existing object is used

Comments: Parameters **o**, **x**, and **s** support the use of the wild card (*).

If the destination device does not have enough free space to store the object being copied, the command is canceled.

Zebra files (**Z:*.***) cannot be transferred. These files are copyrighted by Zebra Technologies.

Transferring Objects

These are some examples of using the **^TO** command.

Example: To copy the object **ZLOGO .GRF** from DRAM to an optional Memory Card and rename it **ZLOGO1 .GRF**, write the following format:

```
^XA
^TOR:ZLOGO.GRF,B:ZLOGO1.GRF
^XZ
```

Example: To copy the object **SAMPLE .GRF** from an optional Memory Card to DRAM and keep the same name, write this format:

```
^XA
^TOB:SAMPLE.GRF,R:SAMPLE.GRF
^XZ
```

Transferring Multiple Objects

The asterisk (*) can be used to transfer multiple object files (except *.FNT) from DRAM to the Memory Card. For example, assume you have several object files that contain logos. These files are named **LOGO1 .GRF**, **LOGO2 .GRF**, and **LOGO3 .GRF**.

To transfer all these files to the memory card using the name NEW instead of LOGO, place an asterisk after the names NEW and LOGO in the transfer command. This copies all files beginning with LOGO in one command.

```
^XA
^TOR:LOGO*.GRF,B:NEW*.GRF
^XZ
```

During a multiple transfer, if a file is too big to be stored on the memory card, that file is skipped. All remaining files attempt to be transferred. All files that can be stored within the space limitations are transferred, while other files are ignored.

~WC

Print Configuration Label

Description: The ~WC command is used to generate a printer configuration label. The printer configuration label contains information about the printer setup, such as sensor type, network ID, ZPL mode, firmware version, and descriptive data on the **R**:, **E**:, **B**:, and **A**: devices.

Format: ~WC

Comments: This command works only when the printer is idle.

PRINTER CONFIGURATION	
Zebra Technologies	
ZTC Z4MPlus-200 dpi	
140XiIIIplus	
Zebra	
+12.....	DARKNESS
6 IPS.....	PRINT SPEED
+000.....	TEAR OFF
TEAR OFF.....	PRINT MODE
CONTINUOUS.....	MEDIA TYPE
WEB.....	SENSOR TYPE
AUTO SELECT.....	SENSOR SELECT
THERMAL-TRANS.....	PRINT METHOD
101 4/8 MM.....	PRINT WIDTH
2000.....	LABEL LENGTH
39.0IN 988MM.....	MAXIMUM LENGTH
BIDIRECTIONAL.....	PARALLEL COMM.
RS232.....	SERIAL COMM.
9600.....	BAUD
8 BITS.....	DATA BITS
NONE.....	PARITY
XON/XOFF.....	HOST HANDSHAKE
NONE.....	PROTOCOL
000.....	NETWORK ID
NORMAL MODE.....	COMMUNICATIONS
<~> 7EH.....	CONTROL PREFIX
<^> 5EH.....	FORMAT PREFIX
<,> 2CH.....	DELIMITER CHAR
ZPL II.....	ZPL MODE
CALIBRATION.....	MEDIA POWER UP
CALIBRATION.....	HEAD CLOSE
DEFAULT.....	BACKFEED
+000.....	LABEL TOP
+0020.....	LEFT POSITION
DISABLED.....	REPRINT MODE
070.....	WEB S.
070.....	MEDIA S.
072.....	RIBBON S.
100.....	TAKE LABEL
015.....	MEDIA LED
103.....	RIBBON LED
+10.....	LCD ADJUST
DPSWFXM.....	MODES ENABLED
.....	MODES DISABLED
832 8/MM FULL.....	RESOLUTION
V60.14.5Z <-.....	FIRMWARE
V23 ---- 57.....	HARDWARE ID
CUSTOMIZED.....	CONFIGURATION
3584k.....	R: RAM
2048k.....	E: ONBOARD FLASH
NONE.....	FORMAT CONVERT
CUTTER.....	OPTION
FW VERSION.....	IDLE DISPLAY
04/03/07.....	RTC DATE
15:51.....	RTC TIME
NO.....	RFID READY
SELECTED ITEMS.....	PASSWORD LEVEL
GL 47277.04MS050224.79000.04.VH2....	

FIRMWARE IN THIS PRINTER IS COPYRIGHTED

^WD**Print Directory Label**

Description: The ^WD command is used to print a label listing bar codes, objects stored in DRAM, or fonts.

For bar codes, the list shows the name of the bar code. For fonts, the list shows the name of the font, the number to use with ^A command, and size. For objects stored in DRAM, the list shows the name of the object, extension, size, and option flags. All lists are enclosed in a double-line box.

Format: ^WDd:o:x

Parameters	Details
d = source device — optional	Values: R:, E:, B:, A: and Z: Default: R:
o = object name — optional	Values: 1 to 8 alphanumeric characters Default: * The use of a ? (question mark) is also allowed.
x = extension — optional	Values: any extension conforming to Zebra conventions .FNT = font .BAR = bar code .ZPL = stored ZPL format .GRF = GRF graphic .CO = memory cache .DAT = font encoding .BAS = ZBI encrypted program .BAE = ZBI encrypted program .STO = data storage .PNG = PNG graphic * = all objects .TTF = TrueType Font .TTE = True Type Extension Default: * The use of a ? (question mark) is also allowed.

.14↑

.TTF and .TTE are only supported in firmware version V60.14.x, V50.14.x, or later.

Example: To print a label listing all objects in DRAM, enter:

```
^XA
^WDR:*. *
^XZ
```

Example: To print a label listing all resident bar codes, enter:

```
^XA
^WDZ:*.BAR
^XZ
```

Example: To print a label listing all resident fonts, enter:

```
^XA
```

```
^WDZ:*.FNT
```

```
^XZ
```

~WQ

Write Query

Description: The ~WQ command triggers the printer to print a label with odometer, maintenance or alert, and printhead history information.

Format: ~WQquery-type

Parameter	Details
query-type	<p>For detailed examples of these parameters, see ~WQ Examples on page 343.</p> <p>Values:</p> <p>ES = requests the printer's status. For details see, Table 10 on page 341 and Table 11 on page 342.</p> <p>HA = hardware address of the internal wired print server</p> <p>JT = requests a summary of the printer's printhead test results</p> <p>MA = maintenance alert settings</p> <p>MI = maintenance information</p> <p>OD = odometer</p> <p>PH = printhead life history</p> <p>PP = printer's Plug and Play string</p> <p>SN = printer's serial number</p> <p>UI = printer's USB product ID and BCD release version</p> <p>Default: must be an accepted value or the command is ignored</p>

Table 10 Error Flags (~WQES)

Error Flags	Flag	Group 2	Group 1 (X = Value can be any hexadecimal number [0-9, A-F])							
		Nibbles 16-9	Nibble 8	Nibble 7	Nibble 6	Nibble 5	Nibble 4	Nibble 3	Nibble 2	Nibble 1
No Error	0	00000000	0	0	0	0	0	0	0	0
Error Present	1	00000000	X	X	X	X	X	X	X	X
Printhead Thermistor Open	1	00000000	X	X	X	X	X	2	X	X
Invalid Firmware Config.	1	00000000	X	X	X	X	X	1	X	X
Printhead Detection Error	1	00000000	X	X	X	X	X	X	8	X
Bad Printhead Element	1	00000000	X	X	X	X	X	X	4	X
Motor Over Temperature	1	00000000	X	X	X	X	X	X	2	X
Printhead Over Temperature	1	00000000	X	X	X	X	X	X	1	X
Cutter Fault	1	00000000	X	X	X	X	X	X	X	8
Head Open	1	00000000	X	X	X	X	X	X	X	4

This error flag is supported only on KR403 printers.

Table 10 Error Flags (~WQES) (Continued)

Error Flags	Flag	Group 2	Group 1 (X = Value can be any hexadecimal number [0-9, A-F])								
		Nibbles 16-9	Nibble 8	Nibble 7	Nibble 6	Nibble 5	Nibble 4	Nibble 3	Nibble 2	Nibble 1	
Ribbon Out	1	00000000	X	X	X	X	X	X	X	X	2
Media Out	1	00000000	X	X	X	X	X	X	X	X	1
Clear Paper Path Failed	1	00000000	X	X	X	X	8	X	X	X	X
Paper Feed Error	1	00000000	X	X	X	X	4	X	X	X	X
Presenter Not Running	1	00000000	X	X	X	X	2	X	X	X	X
Paper Jam during Retract	1	00000000	X	X	X	X	1	X	X	X	X
Black Mark not Found	1	00000000	X	X	X	8	X	X	X	X	X
Black Mark Calabrate Error	1	00000000	X	X	X	4	X	X	X	X	X
Retract Function timed out	1	00000000	X	X	X	2	X	X	X	X	X
Paused	1	00000000	X	X	X	1	X	X	X	X	X

This error flag is supported only on KR403 printers.

Table 11 Warning Flags (~WQES)

Error Flags	Flag	Group 2	Group 1 (X = Value can be any hexadecimal number [0-9, A-F])								
		Nibbles 16-9	Nibble 8	Nibble 7	Nibble 6	Nibble 5	Nibble 4	Nibble 3	Nibble 2	Nibble 1	
No Warning	0	00000000	0	0	0	0	0	0	0	0	0
Warning Present	1	00000000	X	X	X	X	X	X	X	X	X
Paper-near-end Sensor	1	00000000	X	X	X	X	X	X	X	X	8
Replace Printhead	1	00000000	X	X	X	X	X	X	X	X	4
Clean Printhead	1	00000000	X	X	X	X	X	X	X	X	2
Need to Calibrate Media	1	00000000	X	X	X	X	X	X	X	X	1
Sensor 1 (Paper before head)	1	00000000	X	X	X	X	X	X	X	1	X
Sensor 2 (Black mark)	1	00000000	X	X	X	X	X	X	X	2	X
Sensor 3 (Paper after head)	1	00000000	X	X	X	X	X	X	X	4	X
Sensor 4 (loop ready)	1	00000000	X	X	X	X	X	X	X	8	X
Sensor 5 (presenter)	1	00000000	X	X	X	X	X	1	X	X	X
Sensor 6 (retract ready)	1	00000000	X	X	X	X	X	2	X	X	X
Sensor 7 (in retract)	1	00000000	X	X	X	X	X	4	X	X	X
Sensor 8 (at bin)	1	00000000	X	X	X	X	X	8	X	X	X

This error flag is supported only on KR403 printers.

~WQ Examples

This section provides detailed examples of all the available parameters.

Example: This example shows how to request the printer's status.

1. To request the printer's status, type `~WQES`

A label similar to this prints out:

```

PRINTER STATUS
ERRORS:      1 00000000 00000005
WARNINGS:    1 00000000 00000002
    
```

In this example, the Printer Status resolves to these conditions:

- The cover/printhead is open (value = 4).
- Media is out or not loaded into the printer (value = 1).
- The printhead needs to be cleaned (value = 2).
- Error nibble 1 is equal to 5 when the error status values are added together (4+1).

This illustration identifies the printer status definitions:

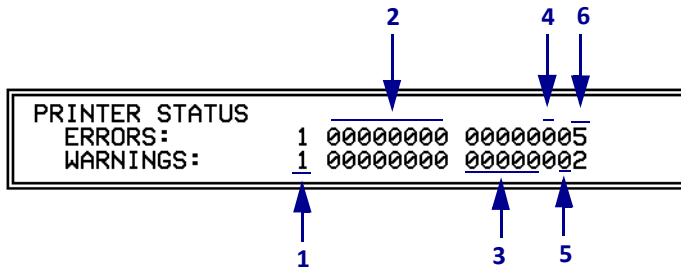

1	Flag
2	Nibble 16-9
3	Nibble 8-4
4	Nibble 3
5	Nibble 2
6	Nibble 1

Example: This example shows how to request the printer's status.

1. To request the printer's status, type `~WQES`

A label similar to this prints out:

```

PRINTER STATUS
ERRORS:      1 00000000 0000000B
WARNINGS:    0 00000000 00000000
    
```

In the example shown above, the Printer Status resolves to the following conditions:

- The cutter has a fault. (value = 8).
- Ribbon is out or not loaded into the printer (value = 2).
- Media is out or not loaded into the printer (value = 1).
- Error byte 1 is equal to **B** when the error status values are added together (8 + 2 + 1 = hexadecimal **B**).

Example: This is an example of how to print the hardware address of the internal wired print server.

1. To print the hardware address of the internal wired print server, type `~WQHA`

A label similar to this prints out:

```

MAC ADDRESS
00:07:4d:2c:e0:7a
    
```

Example: This is an example of how to print a summary of the printer's printhead test results.

The `^JT` command is used to initiate printhead testing, set the testing interval, and set the element range to be tested. For more details see, [^JT on page 253](#).

1. To request a summary of the printer's printhead test, type `~WQJT`

A label similar to this prints out:

```

PRINT HEAD TEST RESULTS
0,A,0000,0000,0000
    
```

When the printer has printed enough labels to trigger a printhead test, the initial data changes.

1. To request a summary of the printer's printhead test, type `~WQJT`

A label similar to this prints out:

```

PRINT HEAD TEST RESULTS
0,A,0015,0367,0000
    
```

This illustration identifies the printhead test field definitions:

```

PRINT HEAD TEST RESULTS
0,A,0000,0000,0000
  ↑  ↑  ↑  ↑  ↑
  1  2  3  4  5
    
```

1	Element failure
2	Manual (M) or automatic (A) range

3	First test element
4	Last test element
5	Failure count

Example: This is an example of how to print the maintenance alert query for the `~WQ` command.

1. To get the current settings, type `~WQMA`

A label similar to this prints out:

```

MAINTENANCE ALERT SETTINGS
HEAD REPLACEMENT INTERVAL:      1 km
HEAD REPLACEMENT FREQUENCY:     0 M
HEAD CLEANING INTERVAL:         0 M
HEAD CLEANING FREQUENCY:        0 M
PRINT REPLACEMENT ALERT:        NO
PRINT CLEANING ALERT:           NO
UNITS:                           C
    
```

Example: This is an example of how to use the odometer query for the `~WQD` command. Note that the units of measure are controlled by the `^MA` command. Also, if the "Early Warning Maintenance State" is turned "ON" the printer response would also list LAST CLEANED and CURRENT PRINTHEAD LIFE counters.

1. To get the current settings, type `~WQOD`

A label similar to this prints out:

```

PRINT METERS
TOTAL NONRESETTABLE:            8560 "
USER RESETTABLE CNTR1:         9 "
USER RESETTABLE CNTR2:         8560 "
    
```

The units of measure are set to inches.

1. To change the units of measure to centimeters, type:

```

^XA^MA,,,,C
^XZ
    
```

The units of measure are set to centimeters.

2. To check the settings, type `~WQOD`.

A label similar to this prints out:

```

PRINT METERS
TOTAL NONRESETTABLE:            21744 cm
USER RESETTABLE CNTR1:         24 cm
USER RESETTABLE CNTR2:         21744 cm
    
```

Example: This is an example of how to print the maintenance information query for the `~WQI` command. Note that the message is controlled by the `^MI` command.

1. To get the current settings, type `~WQMI`

A label similar to this prints out:

```

MAINTENANCE ALERT MESSAGES
CLEAN: PLEASE CLEAN PRINT HEAD
REPLACE: PLEASE REPLACE PRINT HEAD
    
```

Example: This is an example of how to print the printhead life query for the `~WQ` command. Note that the units of measure are controlled by the `^MA` command.

1. To get the current settings, type `~WQPH`

A label similar to this prints out:

```

LAST CLEANED:                257 "
HEAD LIFE HISTORY
#   DISTANCE
1:   257 "
2:   1489 "
3:   7070 "
    
```

1	The current life of the print head.
2	Line items 2 through 10 (the example only shows 2 through 3) tracks the measurement for each time the print head is changed.

Example: This is an example of how to print the printer's Plug and Play string.

1. To print the printer's Plug and Play string, type `~WQPP`

A label similar to this prints out:

```

PLUG AND PLAY MESSAGES
MFG: Zebra Technologies
CMD: ZPL
MDL: Gx420d
    
```

Example: This is an example of how to print the printer's serial number.

1. To get the printer's serial number, type `~WQSN`

A label similar to this prints out:

```

SERIAL NUMBER
30A07070005
    
```

Example: This is an example of how to print the printer's USB product ID and BCD release version.

1. To print the printer's USB product ID and BCD release version, type `~WQUI`

A label similar to this prints out:

```

USB INFORMATION
PID:                0084
RELEASE VERSION:    15.01
    
```

^XA

Start Format

The **^XA** command is used at the beginning of ZPL II code. It is the opening bracket and indicates the start of a new label format. This command is substituted with a single ASCII control character STX (control-B, hexadecimal 02).

Format: **^XA**

Comments: Valid ZPL II format requires that label formats should start with the **^XA** command and end with the **^XZ** command.

^XB

Suppress Backfeed

Description: The ^XB command suppresses forward feed of media to tear-off position depending on the current printer mode. Because no forward feed occurs, a backfeed before printing of the next label is not necessary; this improves throughput. When printing a batch of labels, the last label should not contain this command.

Format: ^XB

^XB in Tear-off Mode

Normal Operation: backfeed, print, and feed to rest

^XB Operation: print (Rewind Mode)

^XB in Peel-off Mode

Normal Operation: backfeed, print, and feed to rest

^XB Operation: print (Rewind Mode)



NOTE: To prevent jamming in cutter mode, ^XB suppresses backfeed and cutting.

^XF

Recall Format

The ^XF command recalls a stored format to be merged with variable data. There can be multiple ^XF commands in one format, and they can be located anywhere within the code.

When recalling a stored format and merging data using the ^FN (Field Number) function, the calling format must contain the ^FN command to merge the data properly.

While using stored formats reduces transmission time, no formatting time is saved. The ZPL II format being recalled is saved as text strings that need to be formatted at print time.

Format: ^XFd:o.x

Parameters	Details
d = source device of stored image	Values: R:, E:, B:, and A: Default: search priority (R:, E:, B:, and A:)
o = name of stored image	Values: 1 to 8 alphanumeric characters Default: if a name is not specified, UNKNOWN is used
x = extension l	Fixed Value: .ZPL

For a complete example of the ^DF and ^XF command, see [Exercise 6: ^DF and ^XF — Download format and recall format on page 42](#).

^XG

Recall Graphic

Description: The ^XG command is used to recall one or more graphic images for printing. This command is used in a label format to merge graphics, such as company logos and piece parts, with text data to form a complete label.

An image can be recalled and resized as many times as needed in each format. Other images and data might be added to the format.

Format: ^XGd:o.x,mx,my

Parameters	Details
d = source device of stored image	Values: R:, E:, B:, and A: Default: search priority (R:, E:, B:, and A:)
o = name of stored image	Values: 1 to 8 alphanumeric characters Default: if a name is not specified, UNKNOWN is used
x = extension l	Fixed Value: .GRF
mx = magnification factor on the x-axis	Values: 1 to 10 Default: 1
my = magnification factor on the y-axis	Values: 1 to 10 Default: 1

Example: This is an example of using the ^XG command to recall the image **SAMPLE.GRF** from DRAM and print it in five different sizes in five different locations on the same label:

```

^XA
^F0100,100^XGR:SAMPLE.GRF,1,1^FS
^F0100,200^XGR:SAMPLE.GRF,2,2^FS
^F0100,300^XGR:SAMPLE.GRF,3,3^FS
^F0100,400^XGR:SAMPLE.GRF,4,4^FS
^F0100,500^XGR:SAMPLE.GRF,5,5^FS
^XZ

```

^XS**Set Dynamic Media Calibration**

Description: The ^XS command controls whether dynamic media calibration is performed to compensate for variations in label length, position, transmissivity, and/or reflectance after a printer is powered-up or the printer has been opened (for example to change or check the media).

Format: ^XSlength,threshold

Parameters	Details
length = dynamic length calibration	Values: Y = enable N = disable Default: Y
threshold = dynamic threshold calibration	Values: Y = enable N = disable Default: Y
gain = dynamic gain calibration (to be in a future implementation)	Values: Y = enable N = disable Default: Y

^XZ

End Format

Description: The ^XZ command is the ending (closing) bracket. It indicates the end of a label format. When this command is received, a label prints. This command can also be issued as a single ASCII control character ETX (Control-C, hexadecimal 03).

Format: ^XZ

Comments: Label formats must start with the ^XA command and end with the ^XZ command to be in valid ZPL II format.

^ZZ**Printer Sleep**

Description: The ^ZZ command places the printer in an idle or shutdown mode.

Format: ^ZZt,b

Parameters	Details
t = number of second (idle time) prior to shutdown	Values: 0 to 999999 – setting 0 disables automatic shutdown Default: last permanently saved value or 0
b = label status at shutdown	Values: Y = indicates to shutdown when labels are still queued N = indicates all labels must be printed before shutting down Default: N

Comments: The ^ZZ command is only valid on the PA400 and PT400 battery-powered printers.

ZPL RFID Commands

This section contains the ZPL II commands for RFID-specific applications.

For additional information, refer to the RFID Programming Guide for your printer. A copy is available at www.zebra.com/manuals.

RFID Command Overview

In addition to reading or encoding RFID tags, the RFID ZPL commands also provide for RFID exception handling, such as setting the number of read/write retries before declaring a transponder defective (set with ^RR, ^RT, and ^WT) or setting the number of labels that will be attempted if an error occurs (set with ^RS).

For example, if an RFID label fails to program correctly or if the transponder cannot be detected, the printer ejects the label and prints VOID across it. The printer will try to print another label with the same data and format for the number of RFID labels specified by the ^RS command. If the problem persists, the printer follows the error handling instructions specified by the ^RS command: the printer may remove the problematic format from the print queue and proceed with the next format (if one exists in the buffer), or it may place the printer in Pause or Error mode.

If a parameter is designated as *not applicable* for a particular printer, any value entered for the parameter will be ignored, but the place holder for the field is required.

Printer and Firmware Compatibility

Before using a particular command, verify that it is compatible with your printer and firmware version. See the following tables:

- [Table 12 on page 355](#)
- [Table 13 on page 357](#)
- [Table 14 on page 359](#)
- [Table 15 on page 361](#)

Table 12 ZD500R Series Printer Command and Firmware Compatibility

Command	Function	ZD500R
		Firmware
		all
^HL or ~HL on page 363	Return RFID Data Log to Host	*
^HR on page 365	Calibrate RFID Tag Position	*
^HV on page 217	Host Verification	*
^RA on page 373	Read AFI or DSFID Byte	—
^RB on page 374	Define EPC Data Structure	*
* = Supported — = Not supported a. Use the ^RF, ^RM, and ^RR commands rather than the ^RT command. b. Use the ^RF, ^RM, ^RR, and ^WV commands rather than the ^WT command.		

Table 12 ZD500R Series Printer Command and Firmware Compatibility

Command	Function	ZD500R
		Firmware
		all
^RE on page 376	Enable/Disable E.A.S. Bit	—
^RF on page 377	Read or Write RFID Format	*
^RI on page 381	Get RFID Tag ID	—
^RL on page 382	Lock/Unlock RFID Tag Memory	*
^RM on page 384	Enable RFID Motion	—
^RN on page 385	Detect Multiple RFID Tags in Encoding Field	—
~RO on page 312	Reset Advanced Counters	*
^RQ on page 386	Quick Write EPC Data and Passwords	—
^RR on page 387	Specify RFID Retries for a Block or Enable Adaptive Antenna Selection	—
^RS on page 389	Set Up RFID Parameters	*
^RT on page 396	Read RFID Tag	—
^RU on page 398	Read Unique RFID Chip Serialization	*
~RV on page 400	Report RFID Encoding Results	—
^RW on page 401	Set RF Power Levels for Read and Write	*
^RZ on page 405	Set RFID Tag Password and Lock Tag	—
<p>* = Supported — = Not supported a. Use the ^RF, ^RM, and ^RR commands rather than the ^RT command. b. Use the ^RF, ^RM, ^RR, and ^WV commands rather than the ^WT command.</p>		

Table 12 ZD500R Series Printer Command and Firmware Compatibility

Command	Function	ZD500R
		Firmware
		all
^WF on page 407	Encode AFI or DSFID Byte	—
^WT on page 408	Write (Encode) Tag	—
^WV on page 410	Verify RFID Encoding Operation	—
* = Supported — = Not supported a. Use the ^RF, ^RM, and ^RR commands rather than the ^RT command. b. Use the ^RF, ^RM, ^RR, and ^WV commands rather than the ^WT command.		

Table 13 RXi Series Printer Command and Firmware Compatibility

Command	Function	R110Xi4	R110Xi HF	R110Xi and R170Xi
		Firmware		
		all	all	all
^HL or ~HL on page 363	Return RFID Data Log to Host	*	*	*
^HR on page 365	Calibrate RFID Tag Position	*	*	*
^RA on page 373	Read AFI or DSFID Byte	—	*	—
^RB on page 374	Define EPC Data Structure	*	*	*
^RE on page 376	Enable/Disable E.A.S. Bit	—	*	—
^RF on page 377	Read or Write RFID Format	*	*	*
^RI on page 381	Get RFID Tag ID	*	*	* (R60.13.0.13ZD or later)
^RL on page 382	Lock/Unlock RFID Tag Memory	—	—	—
* = Supported — = Not supported a. Use the ^RF, ^RM, and ^RR commands rather than the ^RT command. b. Use the ^RF, ^RM, ^RR, and ^WV commands rather than the ^WT command.				

Table 13 RXi Series Printer Command and Firmware Compatibility

Command	Function	R110Xi4	R110Xi HF	R110Xi and R170Xi
		Firmware		
		all	all	all
^RM on page 384	Enable RFID Motion	*	*	*
^RN on page 385	Detect Multiple RFID Tags in Encoding Field	*	*	* (R60.13.0.3 or later)
~RO on page 312	Reset Advanced Counters	*	*	*
^RQ on page 386	Quick Write EPC Data and Passwords	*	—	* (R60.15.7Z or later)
^RR on page 387	Specify RFID Retries for a Block or Enable Adaptive Antenna Selection	*	*	*
^RS on page 389	Set Up RFID Parameters	*	*	*
^RT on page 396	Read RFID Tag	—	* a	* a
^RU on page 398	Read Unique RFID Chip Serialization	—	—	—
~RV on page 400	Report RFID Encoding Results	*	—	*
^RW on page 401	Set RF Power Levels for Read and Write	*	*	*
^RZ on page 405	Set RFID Tag Password and Lock Tag	*	—	*
^WF on page 407	Encode AFI or DSFID Byte	—	*	—
^WT on page 408	Write (Encode) Tag	—	* b	* b
^WV on page 410	Verify RFID Encoding Operation	—	—	*

* = Supported
 — = Not supported
 a. Use the ^RF, ^RM, and ^RR commands rather than the ^RT command.
 b. Use the ^RF, ^RM, ^RR, and ^WV commands rather than the ^WT command.

Table 14 RZ Series and R110PAX4 Printer Command and Firmware Compatibility

Command	Function	RZ400 and RZ600		R110PAX4	
		Firmware			
		V53.17.7Z or later	R53.16.X	R62.X.X	R63.X.X
^HL or ~HL on page 363	Return RFID Data Log to Host	*	*	*	*
^HR on page 365	Calibrate RFID Tag Position	*	*	*	*
^RA on page 373	Read AFI or DSFID Byte	—	—	—	—
^RB on page 374	Define EPC Data Structure	*	*	*	*
^RE on page 376	Enable/Disable E.A.S. Bit	—	—	—	—
^RF on page 377	Read or Write RFID Format	*	*	*	*
^RI on page 381	Get RFID Tag ID	*	*	* (R62.13.0.13ZC or later)	* (R63.13.0.11Z or later)
^RL on page 382	Lock/Unlock RFID Tag Memory	—	—	—	—
^RM on page 384	Enable RFID Motion	*	*	*	*
^RN on page 385	Detect Multiple RFID Tags in Encoding Field	*	*	*	—
~RO on page 312	Reset Advanced Counters	*	*	*	*
^RQ on page 386	Quick Write EPC Data and Passwords	*	*	* (R62.15.7Z or later)	—
^RR on page 387	Specify RFID Retries for a Block or Enable Adaptive Antenna Selection	*	*	*	*

* = Supported
 — = Not supported
 a. Use the ^RF, ^RM, and ^RR commands rather than the ^RT command.
 b. Use the ^RF, ^RM, ^RR, and ^WV commands rather than the ^WT command.
 c. For parameter e, the only accepted value is N for No Action.

Table 14 RZ Series and R110**PAX4** Printer Command and Firmware Compatibility

Command	Function	RZ400 and RZ600		R110PAX4	
		Firmware			
		V53.17.7Z or later	R53.16.X	R62.X.X	R63.X.X
^RS on page 389	Set Up RFID Parameters	*	*	*	*
^RT on page 396	Read RFID Tag	* a	* a	* a	* a
^RU on page 398	Read Unique RFID Chip Serialization	—	—	—	—
~RV on page 400	Report RFID Encoding Results	*	*	*	*
^RW on page 401	Set RF Power Levels for Read and Write	*	*	*	*
^RZ on page 405	Set RFID Tag Password and Lock Tag	*	*	*	*
^WF on page 407	Encode AFI or DSFID Byte	—	—	—	—
^WT on page 408	Write (Encode) Tag	* b	* b	* b	* b
^WV on page 410	Verify RFID Encoding Operation	*	*	*	*

* = Supported
 — = Not supported
 a. Use the ^RF, ^RM, and ^RR commands rather than the ^RT command.
 b. Use the ^RF, ^RM, ^RR, and ^WV commands rather than the ^WT command.
 c. For parameter e, the only accepted value is N for No Action.

Table 15 R4Mplus, RP4T, and R2844-Z Printer Command and Firmware Compatibility

Command	Function	R4Mplus					RP4T	R2844-Z
		Firmware						
		SP994X	SP999X	SP1027X	SP1056X	SP1082X	all	all
^HL or ~HL on page 363	Return RFID Data Log to Host	*	*	*	*	*	*	—
^HR on page 365	Calibrate RFID Tag Position	*	*	*	*	*	*	—
^RA on page 373	Read AFI or DSFID Byte	—	—	—	—	—	—	—
^RB on page 374	Define EPC Data Structure	*	*	*	*	*	*	—
^RE on page 376	Enable/Disable E.A.S. Bit	—	—	—	—	—	—	*
^RF on page 377	Read or Write RFID Format	*	*	*	*	*	*	—
^RI on page 381	Get RFID Tag ID	*	*	*	*	*	*	*
^RL on page 382	Lock/Unlock RFID Tag Memory							
^RM on page 384	Enable RFID Motion	*	*	*	*	*	*	—
^RN on page 385	Detect Multiple RFID Tags in Encoding Field	—	—	—	—	—	*	—
~RO on page 312	Reset Advanced Counters	*	*	*	*	*	*	—
^RQ on page 386	Quick Write EPC Data and Passwords	—	—	—	—	—	*	—
^RR on page 387	Specify RFID Retries for a Block or Enable Adaptive Antenna Selection	*	*	*	*	*	*	—
^RS on page 389	Set Up RFID Parameters	*	*	*	*	*	* c	*
^RT on page 396	Read RFID Tag	* a	* a	* a	* a	* a	* a	*
^RU on page 398	Read Unique RFID Chip Serialization	—	—	—	—	—	—	—

* = Supported
 — = Not supported
 a. Use the ^RF, ^RM, and ^RR commands rather than the ^RT command.
 b. Use the ^RF, ^RM, ^RR, and ^WV commands rather than the ^WT command.
 c. For parameter e, the only accepted value is N for No Action.

Table 15 R4Mplus, RP4T, and R2844-Z Printer Command and Firmware Compatibility

Command	Function	R4Mplus					RP4T	R2844-Z
		Firmware						
		SP994X	SP999X	SP1027X	SP1056X	SP1082X	all	all
~RV on page 400	Report RFID Encoding Results	*	*	*	*	*	*	—
^RW on page 401	Set RF Power Levels for Read and Write	*	*	*	*	*	*	—
^RZ on page 405	Set RFID Tag Password and Lock Tag	*	*	*	*	*	*	—
^WF on page 407	Encode AFI or DSFID Byte	—	—	—	—	—	—	—
^WT on page 408	Write (Encode) Tag	* b	* b	* b	* b	* b	* b	*
^WV on page 410	Verify RFID Encoding Operation	*	*	*	*	*	*	—
<p>* = Supported — = Not supported a. Use the ^RF, ^RM, and ^RR commands rather than the ^RT command. b. Use the ^RF, ^RM, ^RR, and ^WV commands rather than the ^WT command. c. For parameter e, the only accepted value is N for No Action.</p>								

^HL or ~HL

Return RFID Data Log to Host

Description: The printer can log RFID data and store it in the printer's RAM. These commands request that the RFID data log be returned to the host computer. The ~HL command is processed immediately, while the ^HL command is processed after all of the previous formats (^XA ... ^XZ) have been processed.

The firmware version determines the way that these commands function:

- In firmware X.20.16Z and later, for security, logging is disabled by default. The ^HL command clears the current data log and restarts data recording. The ~HL command does not automatically clear the data log.
- In firmware X.20.15Z and earlier, logging is enabled by default. Both commands clear the current data log and restart data recording.

Format: ^HL or ~HL

In the log, RFID data displays in this format:

```
[date&time][RFID operation],[program position],[antenna element],
[read or write power], [RFID status],[data]
```

where

- **[date&time]***
a time stamp for the log entry
* With some older versions of firmware, this parameter does not display.
- **[RFID operation]**
B = a ^RLB command was issued (see [^RLB – Permanently Lock Specified Memory Sections on page 383](#))
E = log file reset
L = lock
M = a ^RLM command was issued (see [^RLM – Lock/Unlock the Specified Memory Bank on page 382](#))
R = read
S = RFID settings
W = write
- **[program position],[antenna element],[read or write power]***
Additional information about the program position, the antenna, and the read or write power follows the RFID operation.

Such as:

```
R, F1, D3, 27, 00000000, DATA
```

where F1 = the program position, D3 = the antenna, and 27 is the write power.

* With some older versions of firmware, these parameters do not display.

- [RFID status]
 - #### or ##### = an RFID error code (See the RFID Programming Guide for your printer for more information on error codes. You can download a copy from www.zebra.com/manuals.)
 - RPWR = read power
 - WPWR = write power
 - ANT = antenna
 - PPOS = program position
 - FFFFFFF (or limited to length FFFF for some printers) = indicates that the log file was reset
- [data]
 - the data read or written

Comments:

- Data is shown in the format specified by the ^RFW command (ASCII, Hex, or EPC).
- If the RFID data log exceeds the maximum size, the following occurs:
 - **In firmware X.20.16Z and later**, when the data log reaches 1500K, one or more older entries are deleted to make room for the newest entry.
 - **In firmware X.20.15Z and earlier**, when the data log reaches 64K, the RFID data log is cleared automatically, and data recording restarts. When this happens, the following appears in the log:
E,FFFFFFF,Logfile automatically reset
- If the printer loses power, the log is lost. If the log results are important to you, retrieve the information frequently.

^HR**Calibrate RFID Tag Position**

Description: Use this command to initiate tag calibration for RFID media. During the tag calibration process (which can take up to 5 minutes on some printers, depending on the type of RFID inlay and the label size) the printer moves the media, reads the tag's TID to determine chip type, calibrates the RFID tag position, and determines the optimal settings for the RFID media being used. Depending on the printer, these settings include the programming position, the antenna element to use, and the read/write power level to use.



IMPORTANT: Consider the following before using this command:

- This command is not supported by all printers or firmware. See [Printer and Firmware Compatibility on page 355](#) for the list of printers and firmware with which you can use this command.
- For the R110Xi4 and ZD500R printers, leave all transponders before and after the tag that is being calibrated. This allows the printer to determine RFID settings which do not encode the adjacent tag. Allow a portion of media to extend out the front of the printer to allow for backfeed during the tag calibration procedure.
- With some printers, you should not perform transponder calibration for RFID media that meets the transponder placement specifications for your printer because doing so will slow the printer's throughput unnecessarily. For more information about tag calibration, refer to the RFID Programming Guide for your printer. A copy of the manual is located on the User CD that came with your printer, or you can download a copy from www.zebra.com/manuals.



Results of the ^HR tag calibration are returned to the host computer. The "run" option in the `rfid.tag.calibrate` SGD command performs the same calibration but does not create a results table.

To restore the printer's default programming position at any time, use the "restore" option in the `rfid.tag.calibrate` SGD command (see [rfid.tag.calibrate on page 923](#)).

Format: ^HRa,b,c,d,e

Parameters	Details
a = start string	This parameter specifies the user text to appear before the results table. Values: any string less than 65 characters Default: start
b = end string	This parameter specifies the user text to appear after the results table. Values: any string less than 65 characters Default: end

Parameters	Details
<p>c = start position</p>	<p>This parameter specifies the start position of the calibration range. All numeric values are in millimeters. Forward or backward designations assume that the label's initial position is with the leading edge at the print line.</p> <p>Values:</p> <ul style="list-style-type: none"> • Forward: F0 to Fxxx (where xxx is the label length in millimeters or 999, whichever is less) The printer feeds the label forward for the specified distance and then begins transponder calibration. • Backward: B0 to B30 (Not valid on the RP4T printer.) The printer backfeeds the label for the specified distance and then begins transponder calibration. Allow at least 1.25 in. (32 mm) of empty media liner to extend out of the front of the printer. <p>Default:</p> <ul style="list-style-type: none"> • For the R110Xi4 and ZD500R: B20 —The printer backfeeds 20 mm before starting transponder calibration. • For the ZT400 with RFID option: B30 —The printer backfeeds 30 mm before starting transponder calibration. • For all other supported printers: F0—The printer moves the media to the start position relative to the leading edge of the label and then performs the RFID tag calibration.
<p>d = end position</p>	<p>This parameter specifies the end position of the calibration range (last program position to check). All numeric values are in millimeters. Forward or backward designations assume that the label's initial position is with the leading edge at the print line.</p> <p>Values:</p> <ul style="list-style-type: none"> • Forward: F0 to Fxxx (where xxx is the label length in millimeters or 999, whichever is less) The printer performs transponder calibration until it reaches the specified end position and then ends the process. • Backward: B0 to B30 (Not valid on the RP4T printer.) The printer performs transponder calibration until it reaches the specified end position and then ends the process. Valid only with a backward start position that is greater than the end position. • A = Automatic (Valid only on the R110Xi4 and ZD500R printers.) The printer automatically ends the transponder calibration process after successfully reading and encoding a consecutive range of 5 mm on the label. The ZD500R also ensures that no other tags can be programmed at the programming position with the calibration-determined power levels. <p>Default:</p> <p>For the R110Xi4 and ZD500R: A</p> <ul style="list-style-type: none"> • For all other supported printers: Label length as shown on the printer configuration label

Parameters	Details
<p>e = antenna and read/write power level detection</p>	<div style="display: flex; align-items: flex-start;">  <div> <p>NOTE:</p> <ul style="list-style-type: none"> This parameter is not valid on all RFID printers. The ZD500R printer has only one antenna, so this parameter applies only to the read/write power level settings. <p>This parameter specifies whether to select the antenna and read/write power levels automatically or manually.</p> <p>Values:</p> <ul style="list-style-type: none"> A = Automatic. The printer automatically scans through the antennas and read/write power during calibration. M = Manual. The printer uses the current antenna and read/write power level settings. <p>Default: A</p> </div> </div>

Example: When the printer is using Absolute mode and the following command is sent to the printer:

```
^XA^HR^XZ
```

the printer starts the transponder calibration and returns a results table such as the following:

```
start
position=195
215, ,
214, ,
213, ,
212, ,
211, ,
210, ,W
209,R,
208, ,
207, ,
206, ,W
205,R,
204, ,
203, ,
202, ,W
201,R,W
200,R,W
199,R,W
198,R,W
197,R,W
196,R,W
195,R,W <---****
194,R,W
193,R,W
192,R,W
191,R,W
190,R,W
189,R,
188, ,
187, ,
186, ,
185, ,
.
.
.
end
```

Each line in the results table appears as:

Row, Read Result, Write Result

where

Row = the dot row where calibration occurred

Read Result = results of calibration (R = read, " " = unable to read)

Write Result = results of calibration (W = write, " " = unable to write)

The optimal programming position is 195. This is identified at the top of the table (**position=195**) and with an arrow (<---****) in the table.

Example: When the printer is using Relative mode and the following command is sent to the printer:

```
^HRstart,end,B20,F42,M
```

the printer starts the tag calibration and returns a results table such as the following:

```
start
position=F0 MM
leading edge
B20, ,
B19, ,
B18, ,
B17, ,
...
B8, ,
B7, ,
B6, ,
B5, ,
B4,R,W
B3,R,W
B2,R,W
B1,R,W
F0,R,W<---**** F0 MM
F1,R,W
F2,R,W
F3,R,W
F4, ,
F5, ,
F6, ,
F7, ,
F8, ,
F9, ,
F10, ,
...
F38, ,
F39, ,
F40, ,
F41, ,
F42, ,
trailing edge
end
```

Each line in the results table appears as:

Row, Read Result, Write Result

where

Row = the position from the leading edge of the label where calibration occurred

Read Result = results of calibration (R = read, " " = unable to read)

Write Result = results of calibration (W = write, " " = unable to write)

The optimal programming position is F0 (program with the leading edge of the label at the print line). This is identified at the top of the table (**position=F0 MM**) and with an the arrow (<---****) in the table.

Example: When the ^HR command is sent to the printer, the printer performs tag calibration and returns a results table such as the following:

```

start
position=B14 MM,A1,18,25
tid information=E200.3414:Alien
leading edge
  Tag 1 ,Tag 2 ,Tag 3 ,Tag 4 ,Tag 5 ,Tag 1 ,Tag 2 ,Tag 3 ,Tag 4 ,Tag 5 ,
EPC,7109 ,BA29 ,6FD0 ,58AE ,9CDE ,7109 ,BA29 ,6FD0 ,58AE ,9CDE ,
B30,A1,12,18,A1,29 ,A1 , ,A1 , ,A1 , ,B1 , ,B1,17,24,B1 , ,B1 , ,B1 , ,
B29,A1,13,18,A1,25 ,A1 , ,A1 , ,A1 , ,B1 , ,B1,14,19,B1 , ,B1 , ,B1 , ,
B28,A1,15,20,A1,23,29,A1 , ,A1 , ,A1 , ,B1 , ,B1,09,15,B1 , ,B1 , ,B1 , ,
B27,A1,17,22,A1,23,29,A1 , ,A1 , ,A1 , ,B1 , ,B1,08,14,B1 , ,B1 , ,B1 , ,
B26,A1,19,25,A1 , ,A1 , ,A1 , ,A1 , ,B1 , ,B1,09,15,B1,28 ,B1 , ,B1 , ,
B25,A1,22,28,A1,22,27,A1 , ,A1 , ,A1 , ,B1 , ,B1,11,18,B1,26 ,B1 , ,B1 , ,
B24,A1,26 ,A1,13,19,A1 , ,A1 , ,A1 , ,B1 , ,B1,15,21,B1,27 ,B1 , ,B1 , ,
B23,A1 , ,A1,08,14,A1 , ,A1 , ,A1 , ,B1 , ,B1,18,24,B1 , ,B1 , ,B1 , ,
B22,A1 , ,A1,05,11,A1 , ,A1 , ,A1 , ,B1 , ,B1,21,28,B1,19,24,B1 , ,B1 , ,
B21,A1 , ,A1,05,11,A1 , ,A1 , ,A1 , ,B1 , ,B1,25 ,B1,11,17,B1 , ,B1 , ,
B20,A1 , ,A1,06,12,A1 , ,A1 , ,A1 , ,B1 , ,B1,30 ,B1,07,13,B1 , ,B1 , ,
B19,A1 , ,A1,08,15,A1 , ,A1 , ,A1 , ,B1 , ,B1 , ,B1,05,11,B1 , ,B1 , ,
B18,A1 , ,A1,15,22,A1 , ,A1 , ,A1 , ,B1 , ,B1 , ,B1,05,10,B1 , ,B1 , ,
B17,A1 , ,A1,22,28,A1 , ,A1 , ,A1 , ,B1 , ,B1 , ,B1,05,11,B1 , ,B1 , ,
B16,A1 , ,A1,16,23,A1 , ,A1 , ,A1 , ,B1 , ,B1 , ,B1,07,13,B1 , ,B1 , ,
B15,A1 , ,A1,13,19,A1 , ,A1 , ,A1 , ,B1 , ,B1 , ,B1,13,20,B1 , ,B1 , ,
B14,A1 , ,A1,12,19,A1 , ,A1 , ,A1 , ,B1 , ,B1 , ,B1,18,23,B1 , ,B1 , ,<---****A1
B13,A1 , ,A1,14,20,A1,24,30,A1 , ,A1 , ,B1 , ,B1 , ,B1,10,16,B1 , ,B1 , ,
B12,A1 , ,A1,15,22,A1,22,29,A1 , ,A1 , ,B1 , ,B1 , ,B1,08,14,B1 , ,B1 , ,
B11,A1 , ,A1,18,25,A1,26 ,A1 , ,A1 , ,B1 , ,B1 , ,B1,08,14,B1 , ,B1 , ,
B10,A1 , ,A1,21,27,A1,26 ,A1 , ,A1 , ,B1 , ,B1 , ,B1,11,17,B1,26 ,B1 , ,
B09,A1 , ,A1,24 ,A1,15,21,A1 , ,A1 , ,B1 , ,B1 , ,B1,14,20,B1,25 ,B1 , ,
B08,A1 , ,A1,28 ,A1,09,15,A1 , ,A1 , ,B1 , ,B1 , ,B1,17,23,B1 , ,B1 , ,
B07,A1 , ,A1 , ,A1,06,11,A1 , ,A1 , ,B1 , ,B1 , ,B1,20,26,B1,27,30,B1 , ,
B06,A1 , ,A1 , ,A1,05,11,A1 , ,A1 , ,B1 , ,B1 , ,B1,24,30,B1,16,19,B1 , ,
B05,A1 , ,A1 , ,A1,05,11,A1 , ,A1 , ,B1 , ,B1 , ,B1,28 ,B1,10,14,B1 , ,
B04,A1 , ,A1 , ,A1,08,14,A1 , ,A1 , ,B1 , ,B1 , ,B1 , ,B1,07,11,B1 , ,
B03,A1 , ,A1 , ,A1,12,18,A1 , ,A1 , ,B1 , ,B1 , ,B1 , ,B1,06,11,B1 , ,
B02,A1 , ,A1 , ,A1,20,26,A1 , ,A1 , ,B1 , ,B1 , ,B1 , ,B1,06,10,B1 , ,
B01,A1 , ,A1 , ,A1,18,24,A1 , ,A1 , ,B1 , ,B1 , ,B1 , ,B1,09,13,B1 , ,
F00,A1 , ,A1 , ,A1,14,21,A1 , ,A1 , ,B1 , ,B1 , ,B1 , ,B1,12,17,B1 , ,
F01,A1 , ,A1 , ,A1,13,19,A1 , ,A1 , ,B1 , ,B1 , ,B1 , ,B1,20,25,B1 , ,
F02,A1 , ,A1 , ,A1,13,19,A1,27 ,A1 , ,B1 , ,B1 , ,B1 , ,B1,16,20,B1 , ,
F03,A1 , ,A1 , ,A1,14,21,A1,26,29,A1 , ,B1 , ,B1 , ,B1 , ,B1,11,16,B1 , ,
F04,A1 , ,A1 , ,A1,17,24,A1,27 ,A1 , ,B1 , ,B1 , ,B1 , ,B1,11,15,B1 , ,
F05,A1 , ,A1 , ,A1,19,26,A1 , ,A1 , ,B1 , ,B1 , ,B1 , ,B1,12,16,B1,25 ,
F06,A1 , ,A1 , ,A1,22,29,A1,23,26,A1 , ,B1 , ,B1 , ,B1 , ,B1,15,18,B1,23,28 ,
F07,A1 , ,A1 , ,A1,26 ,A1,15,19,A1 , ,B1 , ,B1 , ,B1 , ,B1,17,22,B1,23,29 ,
F08,A1 , ,A1 , ,A1 , ,A1,10,14,A1 , ,B1 , ,B1 , ,B1 , ,B1,20,25,B1 , ,
F09,A1 , ,A1 , ,A1 , ,A1,08,12,A1 , ,B1 , ,B1 , ,B1 , ,B1,24,28,B1,21,26 ,
F10,A1 , ,A1 , ,A1 , ,A1,08,11,A1 , ,B1 , ,B1 , ,B1 , ,B1,27 ,B1,13,18 ,
trailing edge
end

```

In the results table, the tags visible to the antenna elements are numbered, and the EPC number that is unique to each tag is displayed.

ZPL RFID Commands

Each line in the results table gives a row number followed by readings associated with RFID tags that are visible at that row. Multiple values on a line indicate that multiple tags were visible. The order of the RFID tags is arbitrary.

[Row],[Antenna Element],[Min Read Power],[Min Write Power], [Antenna Element],[Min Read Power],[Min Write Power] ...

where

- Row = the position from the leading edge of the label where calibration occurred
- Antenna Element = the antenna used (the ZD500R only has A1)
- Minimum Read Power = calibration results (0 – 30) for a tag visible from that row
- Minimum Write Power = calibration results (0 – 30) for the same tag

The read and write power values are left empty (such as A1, , ,) when no tag is found.

In the sample results table for this example, at position B25 (25 mm behind the print line), two RFID tags are visible to the printer at antenna A1. Tag 1 (EPC 7109) can be read at power level 22 and written to at power level 28. Tag 2 (EPC BA29) can be read at power level 22 and written to at power level 27. At that position, Tags 2 and 3 are visible to antenna B1 while Tag 1 is not.

```

    Tag 1   ,Tag 2   ,Tag 3   ,Tag 4   ,Tag 5   ,Tag 1   ,Tag 2   ,Tag 3   ,Tag 4   ,Tag 5   ,
EPC,7109   ,BA29   ,6FD0   ,58AE   ,9CDE   ,7109   ,BA29   ,6FD0   ,58AE   ,9CDE   ,
...
B25,A1,22,28,A1,22,27,A1, , ,A1, , ,A1, , ,B1, , ,B1,11,18,B1,26, ,B1, , ,B1, , ,
B24,A1,26, ,A1,13,19,A1, , ,A1, , ,A1, , ,B1, , ,B1,15,21,B1,27, ,B1, , ,B1, , ,
B23,A1, , ,A1,08,14,A1, , ,A1, , ,A1, , ,B1, , ,B1,18,24,B1, , ,B1, , ,B1, , ,
B22,A1, , ,A1,05,11,A1, , ,A1, , ,A1, , ,B1, , ,B1,21,28,B1,19,24,B1, , ,B1, , ,
B21,A1, , ,A1,05,11,A1, , ,A1, , ,A1, , ,B1, , ,B1,25, ,B1,11,17,B1, , ,B1, , ,
...

```

At position B23, only Tag 2 is visible to antenna A1. Tag 1 is no longer visible.

```

    Tag 1   ,Tag 2   ,Tag 3   ,Tag 4   ,Tag 5   ,Tag 1   ,Tag 2   ,Tag 3   ,Tag 4   ,Tag 5   ,
EPC,7109   ,BA29   ,6FD0   ,58AE   ,9CDE   ,7109   ,BA29   ,6FD0   ,58AE   ,9CDE   ,
...
B25,A1,22,28,A1,22,27,A1, , ,A1, , ,A1, , ,B1, , ,B1,11,18,B1,26, ,B1, , ,B1, , ,
B24,A1,26, ,A1,13,19,A1, , ,A1, , ,A1, , ,B1, , ,B1,15,21,B1,27, ,B1, , ,B1, , ,
B23,A1, , ,A1,08,14,A1, , ,A1, , ,A1, , ,B1, , ,B1,18,24,B1, , ,B1, , ,B1, , ,
B22,A1, , ,A1,05,11,A1, , ,A1, , ,A1, , ,B1, , ,B1,21,28,B1,19,24,B1, , ,B1, , ,
B21,A1, , ,A1,05,11,A1, , ,A1, , ,A1, , ,B1, , ,B1,25, ,B1,11,17,B1, , ,B1, , ,
...

```

At position B13, Tag 3 (EPC 6FD0) becomes visible to antenna A1 and can be read with at power level 24 and written to at power level 30.

```

    Tag 1   ,Tag 2   ,Tag 3   ,Tag 4   ,Tag 5   ,Tag 1   ,Tag 2   ,Tag 3   ,Tag 4   ,Tag 5   ,
EPC,7109   ,BA29   ,6FD0   ,58AE   ,9CDE   ,7109   ,BA29   ,6FD0   ,58AE   ,9CDE   ,
...
B16,A1, , ,A1,16,23,A1, , ,A1, , ,A1, , ,B1, , ,B1, , ,B1,07,13,B1, , ,B1, , ,
B15,A1, , ,A1,13,19,A1, , ,A1, , ,A1, , ,B1, , ,B1, , ,B1,13,20,B1, , ,B1, , ,
B14,A1, , ,A1,12,19,A1, , ,A1, , ,A1, , ,B1, , ,B1, , ,B1,18,23,B1, , ,B1, , ,<---****A1
B13,A1, , ,A1,14,20,A1,24,30,A1, , ,A1, , ,B1, , ,B1, , ,B1,10,16,B1, , ,B1, , ,
...

```

The arrow (<---***) in the table indicates that a valid program position and power levels were found during calibration. The program position is identified at the top of the table as **position=B14 MM** (backfeed 14 millimeters). The optimal antenna element at that position is A1. The optimal read power is 18, and the optimal write power is 25.

```
start
position=B14 MM,A1,18,25
tid information=E200.3414:Alien
leading edge
...
B14,A1, , ,A1,12,19,A1, , ,A1, , ,A1, , ,B1, , ,B1, , ,B1,18,23,B1, , ,B1, , ,<---***)A1
...
```

^RA**Read AFI or DSFID Byte**

Description: Use this command to read the AFI or DSFID byte. The data can be returned to the host via the ^HV command.

Format: ^RA#,f,r,m,b

Parameters	Details
# = field number specified with another command	The value assigned to this parameter should be the same as the one used in the ^RT command. Values: 0 to 9999 Default: 0
f = format	Values: 0 = ASCII 1 = Hexadecimal Default: 0
r = number of retries	Values: 0 to 10 Default: 0
m = motion	Values: 0 = Feed label after writing. 1 = No Feed after writing. Other ZPL may cause a feed. Default: 0
b= type of byte to read	Values: A = AFI byte D = DSFID byte Default: A

Example: This example reads the AFI byte in ASCII format and returns **AFI Byte:x** to the host. The printer will retry the command five times if necessary. A voided label is generated if the read is unsuccessful after these retries. The data read will go into the ^FN1 location of the recalled format.

```
^XA
^F020,120^A0N,60^FN1^FS
^RA1,0,5,0^FS
^HV1,,AFI Byte:^FS
^XZ
```

Example: This example reads the DSFID byte in ASCII format and returns **DSFID Byte:x** to the host. The printer will retry the command three times if necessary. A voided label is generated if the read is unsuccessful after these retries. The data read will go into the ^FN1 location of the recalled format.

```
^XA
^F020,120^A0N,60^FN1^FS
^RA1,0,3,0,D^FS
^HV1,,DSFID Byte:^FS
^XZ
```

^RB**Define EPC Data Structure**

Description: Use this command to define the structure of EPC data, which can be read from or written to an RFID tag. For more information about EPC specifications, refer to the EPC Global web site. All parameters in this command are persistent and will be used in subsequent formats if not provided. The values are initially set to the default values.

RFID tags can have different partitions defined. This command specifies the number of partitions and how many bits are in each partition.

Format: `^RBn,p0,p1,p2, . . . , p15`

Parameters	Details
n = total bit size of the partitions	Specify the number of bits to include in the partitions. Values: 1 to n, where n is the bit size of the tag. Default: 96
p0 . . . p15 = partition sizes	Specify the number of bits to include in the individual partitions. The partition sizes must add up to the bit size specified for the previous parameter. The largest individual partition size is 64 bits. Values: 1 to 64 Default: 1

Example: The following command specifies that there are 96 bits used with three fields. Fields 1, 2, and 3 contain 10, 26, and 60 bits, respectively.

```
^RB96,10,26,60
```

The ZPL code to encode a tag with this format would look like this:

```
^RFW,E^FD1000.67108000.1122921504606846976^FS
```

When the tag is being encoded, the tag stores the data in the following way:

- Field 1 contains **1000**. This value is stored in the first 10 bits
- Field 2 contains **67108000**. This value is stored in the next 26 bits.
- Field 3 contains **1122921504606846976**. This value is stored in the remaining 60 bits.

Example: The following command specifies that there are 64 bits used with eight 8-bit fields.

```
^RB64,8,8,8,8,8,8,8,8^FS
```

The ZPL code to encode a tag with this format would look like this:

```
^RFW,E^FD1.123.160.200.249.6.1.0^FS
```

When writing to the tag, each set of data is written in its respective 8-bit field.

Example: This example uses the SGTIN-96 standard, which defines 96-bit structure in the following way:

	Header	Filter Value	Partition	Company Prefix Index	Item Reference	Serial Number
SGTIN-96	8 bits	3 bits	3 bits	20–40 bits	24 bits	38 bits
	10 (binary value)	8 (decimal capacity)	8 (decimal capacity)	16,383 (decimal capacity)	9 to 1,048,575 (decimal capacity*)	33,554,431 (decimal capacity)

* Capacity of Item Reference field varies with the length of the company prefix.

The ZPL code to encode a tag with this format would look like this:

```

^XA
^RB96,8,3,3,20,24,38^FS
^RFW,E^FD48,1,6,770289,10001025,1^FS
^XZ
    
```

These commands would put

- **48** in the header
- **1** as the filter value
- **6** as the partition (indicates a 20-bit prefix and 24-bit item reference)
- **770289** as the company prefix
- **10001025** as the item reference
- **1** as the serial number

To read this EPC data and print the results on the label, you would use the following code:

```

^XA
^RB96,8,3,3,20,24,38^FS
^F050,50^A0N,40^FN0^FS
^FN0^RFR,E^FS
^XZ
    
```

The resulting label would look like this:

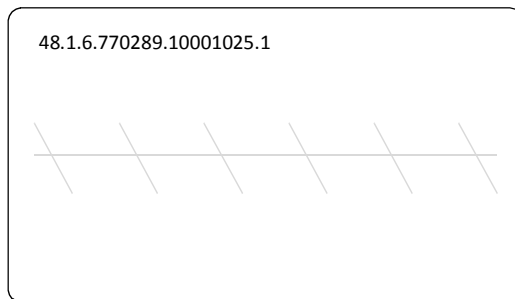

^RE**Enable/Disable E.A.S. Bit**

Description: Use this command to enable or disable the Electronic Article Surveillance (E.A.S.) bit that is available in some ISO15693 tags (such as Philips). This command works only on those ISO15693 transponders and will be ignored if the tag does not support E.A.S.

Format: ^REt,r

Parameters	Details
t = Enable/disable the E.A.S. bit in the ISO15693 transponder	Values: N = Disable E.A.S. Y = Enable E.A.S. Default: N
r = number of retries	Values: 0 to 10 Default: 0

Example: This example enables the E.A.S. bit in the transponder. It will retry the command five times if necessary.

```
^XA
^REy,5
^XZ
```

^RF**Read or Write RFID Format**



Description: Use this command to read or write to (encode) an RFID tag or to specify the access password.

When using this command to read a tag, you may use a field variable to print the tag data on the label or to return the data to the host. For more information on how memory is stored on a Gen 2 tag or for examples that use a field variable, refer to the RFID Programming Guide for your printer. A copy of the manual is located on the User CD that came with your printer, or you can download a copy from <http://www.zebra.com/manuals>.

Format: ^RFo,f,b,n,m

Parameters	Details
o = operation	<p>Specifies the action to be performed.</p> <p>Values:</p> <p>W = write to (encode) the tag</p> <p>L = write with LOCK (if supported by tag type; Gen 2 tag type does not use this locking function)</p> <p>R = read the tag</p> <p>P = read password (Gen 2 tag type only. Not supported on all Gen 2 printers, including the ZD500R printer.)</p> <p>S = specify the access password</p> <p>Default: W</p>
f = format	<p>Values:</p> <p>A = ASCII</p> <p>H = Hexadecimal</p> <p>E = EPC (ensure proper setup with the ^RB command)</p> <p>Default: H</p>

Parameters	Details
<p>b = password OR b = starting block number</p>	<p>For Gen 2 tag type only: What you specify for this parameter depends on what you enter for other parameters.</p> <p> NOTE: When the memory bank parameter is set to E (EPC 96-bit) or A (EPC and Auto adjust PC bits), W and R values are always set to 2.</p> <p>If the Operation parameter value is...</p> <p>W Values: P, which indicates that an access password, a kill password, or both follow in a ^FD command. Each password must be 8 hex characters. If the password is omitted, it is not written. An access password is used in subsequent lock commands in the format. 0 to n, which specifies the 16-bit starting block number, where n is the maximum number of blocks for the bank specified in the memory bank parameter. Default: 0</p> <p>R Values: 0 to n, which specifies the 16-bit starting block number, where n is the maximum number of blocks for the bank specified in the memory bank parameter. Default: 0</p> <p>S This parameter must be P and must be followed by the access password in a ^FD command.</p> <p>For tag types other than Gen 2: Specifies the starting block number. Values: 0 to n, where n is the maximum number of blocks for the tag. Default: 0</p>

Parameters	Details
<p>n = number of bytes to read or write</p>	<p>Specifies the number of bytes to read or write.</p> <p>For high-frequency (HF) printers:</p> <p>Values: 1 to <i>n</i>, where <i>n</i> is the maximum number of bytes for the tag.</p> <p>Default: 1</p> <p>For Gen 2 tag type only:</p> <p>When E or A is specified for the memory bank parameter, this value is not required.</p> <p>Values: 1 to <i>n</i>, where <i>n</i> is the maximum number of bytes for the tag.</p> <p>Default: 1</p> <p>For all other printers and tag types:</p> <p>This parameter applies only when the starting block number is 1.</p> <p>Values: 1 to <i>n</i>, where <i>n</i> is the maximum number of bytes for the tag. For UCODE EPC 1.19, <i>n</i> is 32.</p> <p>Default: 1</p>
<p>m = Gen 2 memory bank</p>	<p> NOTE: This parameter applies to Gen 2 tags only.</p> <p>Specifies the Gen 2 memory bank. For more information about Gen 2 memory, refer to the RFID Programming Guide for your printer.</p> <p>Values:</p> <p>E = EPC 96-bit (When writing data, this parameter performs the operation on Gen 2 bit address 20_h and accesses 12 bytes of the EPC memory bank. When reading data, this parameter reads the amount of data specified in the PC bits on the tag.)</p> <p>A = EPC and Auto adjust PC bits (When writing data, this parameter performs the operation on Gen 2 bit address 20_h of the EPC memory bank and accesses the number of bytes specified in the ^FD. The PC bits will be updated to match the amount of data written to the tag. When reading data, this parameter reads the amount of data specified in the PC bits on the tag.)</p> <p> NOTE: This value is supported only by the ZD500R printer and ZT400 Series and ZT600_Series RFID printers.</p> <p>0 = Reserved</p> <p>1 = EPC</p> <p>2 = TID (Tag ID)</p> <p>3 = User</p> <p>Default: E</p>

Example: This example encodes 96-bit data in ASCII format. (The ^RS command can be omitted for printers that use Gen 2 tag types only.)

```

^XA
^RS8
^RFW,A^FD00 my data^FS
^XZ

```

Example: This example encodes 96-bit EPC data, as specified by the **^RB** command.

```
^XA
^RB96,8,3,3,20,24,38
^RFW,E^FD16,3,5,78742,146165,1234567891^FS
^XZ
```

Example: This example encodes 4 bytes of hexadecimal formatted data, starting in block 3 of Gen 2 EPC bank 1. (The **^RS** command can be omitted for printers that use Gen 2 tag types only.)

```
^XA
^RS8
^RFW,H,3,4,1^FD11112222^FS
^XZ
```

Example: This example reads the extended Gen 2 tag ID (TID), which is not read by the **^RI** command, and returns the results to the host computer. The results are labeled with the header “8-byte Tag ID Data.” (The **^RS** command can be omitted for printers that use Gen 2 tag types only.)

```
^XA
^RS8
^RFR,H,0,8,2^FN1^FS^HV1,,8-byte Tag ID Data:^FS
^XZ
```

Example: This command writes and specifies both the access password (**12345678**) and the kill password (**88887777**) separated by a comma.

```
^RFW,H,P^FD12345678,88887777^FS
```

This command writes the access password only:

```
^RFW,H,P^FD12345678^FS
```

This command writes the kill password only (a comma must be used before it to distinguish it from an access password):

```
^RFW,H,P^FD,88887777^FS
```

See the examples for [^RL on page 382](#) for how this command would be used in a format.

Example: This command writes **1122334455667788** to the bit address 20h of the EPC memory and updates the PC bits bit address 10h to 14h to reflect 8 bytes (4 words) of data.

```
^RFW,H,,A^FD1122334455667788^FS
```

Example: This command specifies the access password for the tag, which will be used in subsequent lock commands in the format. The access password specified must match the one stored on the tag. This command does not write the password to the tag. See the examples for [^RL on page 382](#) for how this command would be used in a format.

```
^RFS,H,P^FD12345678^FS
```

^RI**Get RFID Tag ID**

Description: Use this command to get the unique serial number of the tag and return it in hexadecimal format. The data can be sent back to the host via the **^HV** command.

For Gen 2 tag types, this command returns the 32-bit tag ID (TID) for the tag. If your Gen 2 tag supports TID data beyond 32 bits, see [^RF on page 377](#) to access the TID memory bank.

Format: **^RI***a,b,c,d*

Parameters	Details
a = number to be assigned to the field	Values: 0 to 9999 Default: 0
b = specify data order	 NOTE: This parameter applies only to the R110Xi HF and R2844-Z printers. Values: 0 = Most significant byte first for Tag*It and PicoTag. Least significant byte first for I*code and ISO15693. 1 = Reverse the data order Default: 0
c = number of retries	Values: 0 to 10 Default: 0
d = motion	Values: 0 = Feed label after writing 1 = No Feed after writing (other ZPL commands may cause a feed) Default: 0

Example: This example reads a tag ID, prints it on a label, and sends string **Tag ID:xxxxxxx** to the host. The data read will go into the **^FN0** location of the format. The printer will retry the command five times, if necessary.

```

^XA
^F020,120^A0N,60^FN0^FS
^RI0,,5^FS
^HV0,,Tag ID:^FS
^XZ
  
```

^RL

Lock/Unlock RFID Tag Memory

The ^RL command has two distinct formats and functions:

- **^RLM – Lock/Unlock the Specified Memory Bank**
Locks a password or an entire memory bank in a writeable or unwriteable state. These locks/unlocks can be permanent or reversible.
- **^RLB – Permanently Lock Specified Memory Sections**
Locks blocks of user memory in an unwriteable state.

^RLM – Lock/Unlock the Specified Memory Bank

Description: The ^RLM command locks/unlocks the specified password or memory bank on an RFID tag. You can use this command to do the following:

- lock individual passwords, thereby preventing or allowing subsequent reads or writes of that password
- lock individual memory banks, thereby preventing or allowing subsequent writes to those banks
- Permanently lock (permalock) the lock status for a password or memory bank

Format: ^RLM,k,a,e,u

Parameters	Details
k = kill password function	Values: U = unlock the kill password* L = lock the kill password* O = permanently unlock (Open) the kill password P = permanently lock (Protected) the kill password
a = access password function	Values: U = unlock the access password* L = lock the access password* O = permanently unlock (Open) the access password P = permanently lock (Protected) the access password
e = EPC memory bank function	Values: U = unlock the EPC memory bank* L = lock the EPC memory bank* O = permanently unlock (Open) the EPC memory bank P = permanently lock (Protected) the EPC memory bank
u = USER memory bank function	Values: U = unlock the USER memory bank* L = lock the USER password bank* O = permanently unlock (Open) the USER memory bank P = permanently lock (Protected) the USER memory bank

* The access password must be set to something other than the default of 00000000 to use this value. See the examples for this command for guidance.

^RLB – Permanently Lock Specified Memory Sections

Description: The ^RLB command permanently locks (permalocks) one or more sections (individual sub-portions) in a tag’s user memory. The section sizes for each tag is defined by the tag manufacturer.

Format: ^RLB,s,n

Parameters	Details
s = starting section	Specify the starting section of memory to lock.
n = number of sections	Specify the number of sections to lock.

Example: The following command locks all memory banks using a previously specified access password.

```
^RLM,L,L,L,L^FS
```

Example: The following command locks the user memory banks using a previously specified access password.

```
^RLM,,,L^FS
```

Example: The following command permalocks sections 0 to 4 of user memory using a previously specified access password.

```
^RLB,0,4^FS
```

Example: This code does the following:

- writes 12 bytes to user memory
- writes “12345678” to the access password and “11223344” to the kill password
- permalocks 6 sections of user memory using “12345678” as the access password
- locks the kill and access passwords and permanently unlocks the EPC memory, using “12345678” as the access password

```
^XA
```

```
^RFW,H,0,12,3^FD112233445566778899001122^FS
```

```
^RFW,H,P^FD12345678,11223344^FS
```

```
^RLB,0,6^FS
```

```
^RLM,L,L,0^FS
```

```
^XZ
```

Example: This code does the following:

- writes 12 bytes to user memory
- permalocks 6 sections of user memory using “00000000” as the access password
- permalocks the kill password and access password using “00000000” as the access password

```
^XA
```

```
^RFW,H,0,12,3^FD112233445566778899001122^FS
```

```
^RLB,0,6^FS
```

```
^RLM,P,P^FS
```

```
^XZ
```

^RM

Enable RFID Motion

Description: Use this command to enable or disable RFID motion. By default, labels automatically print at the end of the format. This command allows you to inhibit the label from actually moving when it reaches the program position, which is useful for debugging, setup, and custom applications. This parameter is not persistent (carried over from label to label).

Format: ^RM`e`

Parameters	Details
e = enable	Values: Y = Yes, move the label N = No, do not move the label Default: Y

^RN**Detect Multiple RFID Tags in Encoding Field**

Description: Use this command to enable or disable detection of multiple RFID tags in the encoding field. By default, the printer checks for more than one tag in the field before attempting to read or write. If more than one tag is found, the label over the antenna support is voided, and the **RFID ERR STATUS** parameter on the control panel displays **MULTIPLE TAGS**. To speed up printing and encoding by up to 200 ms, the check may be disabled.



NOTE: This parameter is persistent across labels (carried over from label to label), but is NOT persistent across power cycles.

Format: ^RNe

Parameters	Details
e= enable	<p>Values:</p> <p>Y = Yes, check for multiple tags</p> <p>N = No, do not check for multiple tags</p> <p>Default:</p> <p>Y = Printers with firmware R60.13.0.5 and earlier</p> <p> N = Printers with firmware R60.13.0.7 and later</p> <p>NOTE: If an invalid parameter value is entered, the default value will be used.</p>

^RQ

Quick Write EPC Data and Passwords

Description: Use this command with an Alien Higgs RFID tag and appropriate firmware to write the EPC data, access password, and kill password with one command. Doing so reduces the encoding time.



NOTE: The access password on the tag to be written to must be 00000000 prior to sending this command.

Format: ^RQf,c,o[data]

Parameters	Details
f = format	Values: A = ASCII H = Hexadecimal E = EPC Default: H
c = chip type	Values: 0 (Higgs IC tag) Default: 0
o = option	Values: 0 (write 96-bit EPC) Default: 0
data = the EPC data, access password, and kill password	Use the ^FD command to specify the passwords in the following format: ^FD[EPC],[access],[kill] where: EPC = the EPC data in the format specified by the f parameter. The data should match what would be programmed with the ^RF command. access = an optional access password in hexadecimal format. If this field is left blank, 0x00000000 is written as the access password. kill = an optional kill password in hexadecimal format. If this field is left blank, 0x00000000 is written as the kill password.

Example: This example writes the EPC data to the tag in hexadecimal format. The unspecified access and kill passwords are written as zeroes (0x00000000).

```
^XA^RQ^FD112233445566778899001122^XZ
```

Example: This example writes the EPC data to the tag in hexadecimal format. The access password is written as 0xAAAAAAAA, and the kill password is written as 0xBBBBBBBB.

```
^XA^RQ^FD112233445566778899001122,AAAAAAAA,BBBBBBBB^XZ
```

Example: This example writes the EPC data to the tag in EPC format. The unspecified access and kill passwords are written as zeroes (0x00000000).

```
^XA^RB96,30,30,30,6^RQE^FD1234.5678.9012.12^XZ
```

Example: This example writes the EPC data to the tag in hexadecimal format. The access password is written as 0xAAAAAAAA, and the unspecified kill password is written as zeroes (0x00000000).

```
^XA^RB96,30,30,30,6^RQE^FD1234.5678.9012.12,AAAAAAAA^XZ
```

^RR

Specify RFID Retries for a Block or Enable Adaptive Antenna Selection

Description: Use this command for the following:



- to change the number of times that the printer attempts to read or write to a particular block of a single RFID tag (Not applicable to printers with firmware V75.19.7Z or later.)
- to enable the adaptive antenna element selection feature



NOTE: This command's function is different than the "number of labels" parameter in the ^RS command.

This command is persistent and will be used in subsequent formats if not provided.

Format: ^RRn,a

Parameters	Details
n = number of retries	 <p>NOTE: This parameter does not apply to the ZT400 and ZT600 printers.</p> <p>Values: 0 to 10</p> <p>Default: 6</p>
a = adaptive antenna element selection	 <p>NOTE: This parameter is valid only on R110Xi4, ZT400, and ZT600 printers with a label that is 2 in. (51 mm) or longer.</p> <p>If the printer cannot find RFID tags with the antenna element specified during the number of retries specified (if applicable), the printer may try neighboring antenna elements. If the printer is unsuccessful communicating with the RFID tag after trying the neighboring antenna elements, the printer voids the label.</p>  <p>NOTE: Activating this parameter may slow throughput on damaged or weak RFID tags.</p> <p>Values:</p> <p>0 = None. The printer uses only the current antenna element selection.</p> <p>1 = Neighbors. The printer attempts to read the tag using the antenna elements to the left/right and above/below the current antenna element. The antenna element that is successful is used for all subsequent RFID commands until the next unsuccessful attempt.</p> <p>Default: 0</p>

Example: This example sets the read block retries to 5.

```
^XA
^FN1^RR5^RFR,H^FS
^HV1^FS
^XZ
```

Example: This example sets the write block retries to 2.

```
^XA  
^RR2^RFW,H^FD1234^FS  
^XZ
```

Example: On an R110Xi4 printer, this example sets the write retries to 2 and allows the printer to try neighboring antennas in the event that the current antenna cannot write to the RFID tag.

```
^XA  
^RR2,1^RFW,H^FD1234^FS  
^XZ
```

^RS

Set Up RFID Parameters

Use this command to set up RFID parameters including tag type; programming position; and error handling. In addition to reading or encoding RFID tags, the RFID ZPL commands also provide for RFID exception handling, such as setting the number of read/write retries before declaring a transponder defective (set with **^RR**, **^RT**, and **^WT**) or setting the number of labels that will be attempted if an error occurs (set with **^RS**).

For example, if an RFID label fails to program correctly or if the transponder cannot be detected, the printer ejects the label and prints **VOID** across it. The printer will try to print another label with the same data and format for the number of labels specified (parameter **n**). If the problem persists, the printer follows the error handling instructions specified by the error handling parameter (parameter **e**): the printer may remove the problematic format from the print queue and proceed with the next format (if one exists in the buffer), or it may place the printer in Pause or Error mode.







IMPORTANT: Use care when using this command in combination with **^RT** or **^RF** for reading tag data. Problems can occur if the data read from the tag is going to be printed on the label. Any data read from the tag must be positioned to be printed above the read/write position. Failure to do this will prevent read data from being printed on the label.

Format: **^RS***t,p,v,n,e,a,c,s*

Parameters	Details
t = tag type	<p>Tells the printer/print engine which tag type you are using. If you specify a tag type that is not supported by your printer or firmware, the printer uses its default value. For the supported tag types and defaults, see Table 16 on page 393.</p> <p>Values:</p> <p>UHF Printers</p> <ul style="list-style-type: none"> 0 = None 1 = EPC Class 0 2 = EPC Class 0 Plus 3 = EPC Class 1 64-bit 4 = EPC Class 1 96-bit 5 = UCODE EPC 1.19 6 = Impinj Class 0 Plus 7 = ISO 18000-06A 8 = EPC Class 1, Generation 2 (Gen 2) 9 = ISO 18000-06B <p>HF Printers</p> <p> NOTE: Only the R110X HF printer (firmware version R65.X.X) supports the use of letters for this parameter. All other printers use the numbers.</p> <ul style="list-style-type: none"> A or 0 = None B or 1 = Auto detect (query tag to determine) C or 2 = Tag*It (Texas Instruments Tagit tags) D or 3 = I*code (Phillips Icode tags) E or 4 = Pico Tag (Inside Technology's) F or 5 = ISO 15693 G or 6 = EPC tag (13.56 MHz) H or 7 = UID Tag I or 8 = Mifare UltraLight <p>Default: varies by printer (see Table 16 on page 393)</p>

Parameters	Details
<p>p = read/write position of the tag (programming position)</p>	<p>This parameter sets the read/write position of the tag.</p> <p> IMPORTANT: If a label format specifies a value for the programming position, this value will be used for the programming position for all labels until a new position is specified or until the tag calibration procedure is run.</p> <p>Values:</p> <p>For the ZD500R only:</p> <p>F0 to Fxxx (where xxx is the label length in millimeters or 999, whichever is less) The printer prints the first part of a label until it reaches the specified distance and then begins programming. After programming, the printer prints the remainder of the label.</p> <p>B0 to B30 The printer backfeeds the label for the specified distance and then begins programming. To account for the backfeed, allow empty media liner to extend out of the front of the printer when using a backward programming position.</p> <p>up = move to the next value down = move to the previous value</p> <p>For other RFID printers:</p> <p>Absolute Mode (all firmware versions): xxxx = 0 to label length (in dot rows). Move the media to the specified position xxxx on the label, measured in dot rows from the label top, before encoding. Set to 0 (no movement) if the tag is already in the effective area without moving the media.</p> <p>Relative Mode (firmware versions V53.17.6 and later):</p> <p>F0 to Fxxx (where xxx is the label length in millimeters or 999, whichever is less) The printer prints the first part of a label until it reaches the specified distance and then begins programming. After programming, the printer prints the remainder of the label.</p> <p>B0 to B30 (Does not apply to the RP4T printer.) The printer backfeeds the label for the specified distance and then begins programming. To account for the backfeed, allow empty media liner to extend out of the front of the printer when using a backward programming position.</p> <p>Default:</p> <p>For the R2844-Z and RPAX: 0 (no movement) For printers using V53.17.6, V74.19.6Z, and later: F0 (which moves the leading edge of the label to the print line) For all other printers or firmware: label length minus 1 mm (1/16 in.)</p>
<p>v = length of void printout</p>	<p>Sets the length of the void printout in vertical (Y axis) dot rows.</p> <p>Values: 0 to label length</p> <p>Default: label length</p>

Parameters	Details
n = number of labels to try encoding	<p>The number of labels that will be attempted in case of read/encode failure.</p> <p>Values: 1 to 10</p> <p>Default: 3</p>
e = error handling	<p>If an error persists after the specified number of labels are tried, perform this error handling action.</p> <p>Values:</p> <p>N = No action (printer drops the label format causing the error and moves to the next queued label)</p> <p>P = Place printer in Pause mode (label format stays in the queue until the user cancels)</p> <p>E = Place printer in Error mode (label format stays in the queue until the user cancels)</p> <p>Default: N</p> <p> NOTE: You can set the printer to send an error message to the host for each failure. To enable or disable this unsolicited error message, refer to the ^SX and ^SQ ZPL commands. Use V for the condition type for an RFID error.</p>
a = signals on applicator	<p> NOTE: This parameter applies only to printers that have an applicator board. This parameter does not apply to the R2844-Z. For the R4Mplus, this parameter applies only to printers with firmware version SP994X (R4Mplus European version).</p> <p>Single Signal Mode</p> <p>In this mode, one start print signal starts printing. Then, at the program position (parameter p), the printer automatically stops and encodes the tag. Printing continues, and a single end print signal signifies the completion of the label.</p> <p>Double Signal Mode</p> <p>With RFID, when there is a non-zero program position, the label is logically split into two parts. The first part is printed, the tag encodes, and then the second part prints. If this parameter is set to "D," then the label is split into two and requires both portions of the label to be controlled by the applicator. This means that a start print signal triggers the first portion of the label, and then when the printer reaches the RFID program position (and the motor stops), an end print signal is provided. In this mode, a second start print signal is required to print the rest of the label. When the label is complete, a final end print signal is provided.</p> <p> NOTE: If parameter p is zero, then single signal mode is used (parameter ignored). If p is F0 (or B0) with backfeed-after, then single signal mode is used (parameter ignored).</p> <p>Values:</p> <ul style="list-style-type: none"> • S = single signal • D = double signal (For the R110PAX4, Double mode will work only if the read/write position is changed from the default of zero.) <p>Default: s</p>

Parameters	Details
c = reserved	Not applicable.
s = void print speed	 NOTE: This parameter does not apply to the R2844-Z printer. For the R4Mplus printer, this parameter applies only to printers with firmware version SP994X (R4Mplus European version). If a label is voided, the speed at which “VOID” will be printed across the label. Values: any valid print speed Default: the printer’s maximum print speed

Supported Tag Types Table 16 shows the tag types supported by different RFID printers/print engines and firmware versions. Depending on your country or on the firmware version that you are using, your printer may not support all of the tag types listed. If you specify an unsupported tag type, the printer uses the default value. If a tag type is shown as supported but does not work with your printer, you may need to upgrade the printer’s firmware (see <http://www.zebra.com/firmware>).

Table 16 Supported Tag Types and Default Values

Printer	UHF Printers											HF Printers			
	ZD500R	R110Xi4	R110Xi R170Xi	R110PAX4				R4Mplus			RZ400/ RZ600	R110Xi HF	R2844-Z		
Firmware Version	V74.19.6Z and later	V53.17.7 and later	R60.13.X R60.15.X and later	R62.13.X R62.15.X and later	R63.13.X R63.15.X and later	SP994O, SP999E, SP1027E, SP1082E, and earlier			SP994P, SP999F, SP1027F, SP1082F, and later		SP1056D and earlier SP1056E and later	R53.16.X and later	R65.13.X R65.15.X and later	all	
Tag Type															
UHF Tag Types and Options															
None (no tag type specified)	—	—	*	*	*	*	—	—	—	—	—	—	—	—	—
EPC Class 0	—	—	*	*	*	*	—	—	—	—	—	—	—	—	—
EPC Class 0 Plus	—	—	*	*	*	*	—	—	—	—	—	—	—	—	—
EPC Class 1 64-bit	—	—	*	*	*	*	—	—	—	—	—	—	—	—	—
EPC Class 1 96-bit	—	—	#	*	#	*	—	*	*	*	—	—	—	—	—
UCODE EPC 1.19	—	—	*	*	—	*	#	*	#	*	#	*	—	—	—
			a												
# = Default value * = Accepted value — = Not supported a. Requires R60.13.0.13ZD or later.															

Table 16 Supported Tag Types and Default Values (Continued)

Printer	UHF Printers												HF Printers			
	ZD500R	R110Xi4	R110Xi R170Xi		R110PAX4				R4Mplus				RZ400/ RZ600	R110Xi HF	R2844-Z	
Firmware Version	V74.19.6Z and later	V53.17.7 and later	R60.13.X R60.15.X and later		R62.13.X	R62.15.X and later	R63.13.X	R63.15.X and later	SP994O, SP999E, SP1027E, SP1082E, and earlier	SP994P, SP999F, SP1027F, SP1082F, and later	SP1056D and earlier	SP1056E and later	R53.16.X and later	R65.13.X	R65.15.X and later	all
Tag Type																
Impinj Class 0 Plus	—	—	*	*	*	*	—	—	—	—	—	—	—	—	—	—
ISO 18000-06A	—	—	—	—	*	—	—	*	*	*	—	—	—	—	—	—
EPC Class 1, Generation 2 (Gen 2)	#	#	*	#	*	#	—	#	*	#	*	#	#	—	—	—
ISO 18000-06B	—	—	*	*	*	*	—	*	*	*	*	*	—	—	—	—
HF Tag Types and Options																
Auto-detect the tag type by querying the tag	—	—	—	—	—	—	—	—	—	—	—	—	—	—	—	#
Tag*It (Texas Instruments Tagit tags)	—	—	—	—	—	—	—	—	—	—	—	—	—	—	—	*
I*code (Phillips Icode tags)	—	—	—	—	—	—	—	—	—	—	—	—	—	—	—	*
Pico Tag (Inside Technology's)	—	—	—	—	—	—	—	—	—	—	—	—	—	—	—	*
ISO 15693	—	—	—	—	—	—	—	—	—	—	—	—	—	#	#	*
EPC tag	—	—	—	—	—	—	—	—	—	—	—	—	—	—	—	*
UID Tag	—	—	—	—	—	—	—	—	—	—	—	—	—	—	—	—
Mifare UltraLight	—	—	—	—	—	—	—	—	—	—	—	—	—	*	*	—
# = Default value * = Accepted value — = Not supported a. Requires R60.13.0.13ZD or later.																

Example: The following are examples of Absolute Mode and Relative Mode for the tag position parameter (parameter **p**).

Absolute Mode

1. `^RS,520` sets the encode position at 520 dots from the top edge of the label.
2. `^RS,0` programs the tag without moving the media.

Relative Mode

3. `^RS,F1` sets the encode position 1 mm forward from the leading edge of the label.
4. `^RS,B10` sets the encode position 10 mm backwards from the leading edge of the label.
5. `^RS,F0` sets the encode position at the leading edge of the label.
6. `^RS,B0` sets the encode position at the leading edge of the label.

Example: The following shows the difference between absolute and relative programming positions for the tag position parameter (parameter **p**) with a 6-inch (152-mm, 1216-dot) label length. The end results are that the tag is programmed with the label in the same position.

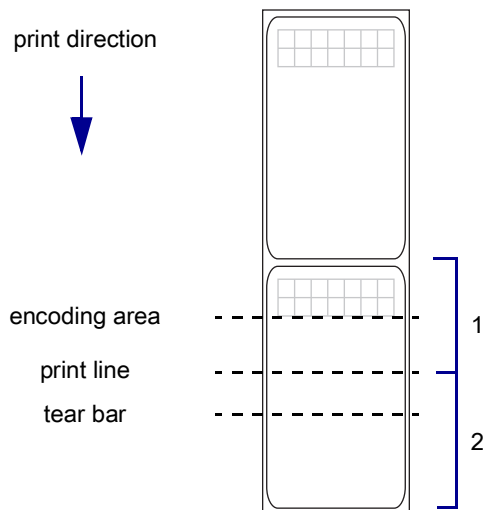

1	<code>^RS,496</code> , Absolute Mode, 496 dots from the top of the label
2	<code>^RS,F90</code> , Relative Mode, 90 mm from the leading edge of the label

^RT**Read RFID Tag**

NOTE: The ^RT command is provided only for backward-compatibility with label formats that were developed for older Zebra RFID printers.

Description: Use this command to tell the printer to read the current RFID tag data. The data can be returned to the host via the ^HV command.

Format: ^RT#,b,n,f,r,m,s

Parameters	Details
# = number to be assigned to the field	<p>Values: 0 to 9999</p> <p>Default: 0</p>
b = starting block number	<p>Values: 0 to <i>n</i>, where <i>n</i> is the maximum number of blocks for the tag.</p> <p>Default: 0</p>
n = number of blocks/bytes to read	<p> NOTE: This parameter does NOT apply to R4Mplus printers with firmware version SP920X (R4Mplus U.S. version).</p> <p>For firmware version SP994X: This parameter applies only when the starting block number (parameter b) is 1.</p> <p>Values: 1 to <i>n</i>, where <i>n</i> is the maximum number of bytes for the tag. For UCODE EPC 1.19, <i>n</i> is 32.</p> <p>For all other supported printers:</p> <p>Values: 1 to <i>n</i>, where <i>n</i> is the maximum number of blocks for the tag type minus the starting block number. For example, if the tag has 8 blocks (starting with block 0) and you start with block 6, <i>n</i> can be 2. This would return block 6 and block 7 information.</p> <p>Default: 1</p>
f = format	<p>Values:</p> <p>0 = ASCII</p> <p>1 = Hexadecimal</p> <p>Default: 0</p>
r = number of retries	<p>Changes the number of times that the printer attempts to read a particular block of a single RFID tag. (Same retry rules as the ^RR command.)</p> <p>Values: 0 to 10</p> <p>Default: 0</p>
m = motion	<p>Enables or disables RFID motion for the current field.</p> <p>Values:</p> <p>0 = Feed label after writing.</p> <p>1 = No feed after writing. Other ZPL may cause a feed.</p> <p>Default: 0</p>

Parameters	Details
s = special mode	 <p>NOTE: This parameter is used only for the printers referenced here.</p> <p>For R4Mplus printers with firmware version SP920X (U.S. version): Specify actions for mismatched checksums. For EPC Class 1 (Alien reader) only. Not applicable for EPC class 0.</p> <p>Default: 0</p> <p>Values: 0 = Do not read if mismatched checksum 1 = Read even if mismatched checksum</p> <p>For R110X/ HF and R2844-Z printers: Specify data order.</p> <p>Default: 0</p> <p>Values: 0 = least significant byte first 1 = most significant byte first</p>

Example: This example reads a tag, prints the data on a label, and sends the string **Tag Data:xxxxxxxx** back to the host. The data read will go into the **^FN1** location of the format. The printer will retry the command five times, if necessary.

```

^XA
^F020,120^A0N,60^FN1^FS
^RT1,,,5^FS
^HV1,,Tag Data:^FS
^XZ

```

Example: This example reads from a tag twice and prints the results on a label.

```

^XA
^F020,120^A0N,60^FN1^FS
^F020,100^A0N,20^FN2^FS
^RT1,7,3,,5^FS
^RT2,3,2,,5^FS
^XZ

```

The first **^RT** command starts at block 7 and reads three blocks of data in ASCII format. The data read will go into the **^FN1** location of the format. The printer will retry the command five times, if necessary.

The second **^RT** command starts at block 2 and reads two blocks of data in ASCII format. The data read will go into the **^FN2** location of the format. The printer will retry the command five times, if necessary.

^RU

Read Unique RFID Chip Serialization

Use this command to read the TID (Tag ID) data from the current chip and format a unique 38-bit serial number, which will be placed in the lower (least significant) 38 bits of the EPC code.

Format: ^RUa,b

Parameters	Details
a = prefix	<p>Specifies the prefix in ASCII Binary</p> <p>Values: Only ASCII characters 1 and 0 are accepted. Maximum of 38 characters.</p> <p>The number of bits in the value specifies the length of the prefix. The prefix is placed as the left-most (most significant) bits in the unique serial number. If nothing is specified, the default value will be used.</p> <p>Default: The MCS prefix is determined by the MDID in the TID of the chip read:</p> <p>100 = EM Micro Impinj = 101 Alien = 110 NXP = 111</p>
b = special character	<p>Special character for serial number inclusion.</p> <p>Values: Any ASCII character other than the current Command character, Control character, Delimiter character, or any of the Real-Time Clock (RTC) characters.</p> <p>Default: #</p>



NOTE: Serial number inclusion:

One of several data elements can be included into any ^FD data string in the same way that Real Time Clock data is included. Use any of the commands below to include a data pattern based on the serial number. These are defined using the default value for the Special Character.

#S = include 38-bit serial number derived from TID in decimal form.

#H = include 38-bit serial number derived from TID in hexadecimal form.

#E = include the entire 96-bit EPC code, including the 38-bit serial number derived from TID in decimal form.

#F = include the entire 96-bit EPC code, including the 38-bit serial number derived from TID in hexadecimal form.

#P = include the entire 96-bit EPC code, but use the tag's preprogrammed, 38-bit SGTIN serial number in decimal form.*

#Q = include the entire 96-bit EPC code, but use the tag's preprogrammed, 38-bit SGTIN serial number in hexadecimal form.*

* If the EPC has been preprogrammed (typically by the manufacturer) with the chip-based RFID serialization scheme, then the serialized data does not have to be written back to the EPC memory, which saves time. **#P** and **#Q** simply format the data that is read from the EPC memory bank.

Example: Read the TID from the tag, create a serial number based on the tag type, write **12<serial number (5 bytes)>000000000000** to the 96-bit EPC field, and print the serial number (in hex format) on the label.

```
^XA
^RU
^F010,10^A0N,50,50^FDSerial Number: #H^FS
^RFW,H^FD12#H^FS
^XZ
```

Example: Read the TID from the tag, create a serial number based on the tag type, write the serial number to the EPC field (lower 38 bits) while maintaining the contents of the rest of the EPC memory, print **Serial Number: <serial number in hex format>** on the label, and return **Serial Number: <serial number in hex format>** to the host. Perform this operation on three label formats.

```
^XA
^RU
^F010,10^A0N,50,50^FN1^FS
^FN1^FDSerial Number: #H^FS
^FH^HV1,24, ,_0D_0A,L^FS
^RFW,H^FD#F^FS
^PQ3
^XZ
```

Example: Read the full EPC (already serialized) from the tag, print **Serial Number: <full EPC in decimal format>** on the label, and return **Serial Number: <full EPC in decimal format>** to the host.

```
^XA
^RU
^F010,10^A0N,50,50^FN1^FS
^FN1^FDSerial Number: #P^FS
^FH^HV1,44, ,_0D_0A,L^FS
^XZ
```

~RV

Report RFID Encoding Results

Description: Use this command to tell the printer to send RFID encoding success or failure results to the host computer after each label format completes.

Format: ~RVa

Parameters	Details
a = enable/disable	Enables or disables the results reporting feature. Values: E = Enable D = Disable Default: D

Example: Assume that the following code is sent and that there is no RFID tag in the field.

```
~RVE
^XA
^RS8,0,,3
^RMY
^RFR,H
^XZ
```

The printer attempts to program a tag three times and then returns the following to the host:

```
_,3_
```

The minus sign indicates that the programming attempt failed entirely and voided three labels.

Example: Assume that the same code is sent and that the first two attempts at programming a tag are unsuccessful. The third attempt succeeds.

```
~RVE
^XA
^RS8,0,,3
^RMY
^RFR,H
^XZ
```

The printer attempts to program a tag three times and then returns the following to the host:

```
_,2_
```

The plus sign indicates that the programming attempt was successful and voided two labels.

^RW

Set RF Power Levels for Read and Write

Use this command to set the RFID read and write power levels if the desired levels are not achieved through RFID tag calibration. If not enough power is applied, the tag may not have sufficient power for programming, and tag data will fail to encode. If too much power is applied, the extra power may cause data communication errors or may cause the wrong tag to be programmed.



NOTE: For Japan, the printer's maximum RFID read and write power are limited to comply with local radio regulations. Any power setting of 24 or higher results in the same output.



NOTE: For the R110Xi4, ZT400, ZT600, and ZD500R printers:

During RFID tag calibration, the printer automatically selects the best read/write power levels and the best antenna element (not applicable to the ZD500R) for the media being used. The R110Xi4 printer may also set the levels during an adaptive antenna sweep. Use the ~HL command (see ^HL or ~HL on page 363) to view the antenna element and power settings being used.

Format: ^RW r , w , a

Parameters	Details
r = read power	<p>This parameter sets the power level to match the desired output as calibrated in the factory.</p> <p>R53.16.3, V53.17.5, and later:</p> <p>Values: 0 to 30</p> <p>Default: 16</p> <p>R60.16.4, R62.16.4, R63.16.4, SP994Q, SP999G, SP1027G, SP1056F, SP1082G, and later:</p> <p>Values: 0 to 30, H (high), M (medium), L (low)</p> <p>Default: L</p> <p>R65.X and older versions of other firmware:</p> <p>Values:</p> <p>H = high</p> <p>M = medium</p> <p>L = low</p> <p>Default: L</p>

Parameters	Details
<p>w = write power</p>	<p> NOTE: This parameter is ignored on the R110Xi HF printer (firmware version R65.X) because read and write powers cannot be specified separately. The printer uses the value that you specified for read power for both the read and write power settings.</p> <p>This parameter sets the power level to match the desired output as calibrated in the factory.</p> <p>R53.16.3, V53.17.5, and later:</p> <p>Values: 0 to 30</p> <p>Default: 16</p> <p>R60.16.4, R62.16.4, R63.16.4, SP994Q, SP999G, SP1027G, SP1056F, SP1082G, and later:</p> <p>Values: 0 to 30, H (high), M (medium), L (low)</p> <p>Default: L</p> <p>Older versions of firmware:</p> <p>Values:</p> <p>H = high</p> <p>M = medium</p> <p>L = low</p> <p>Default: L</p>

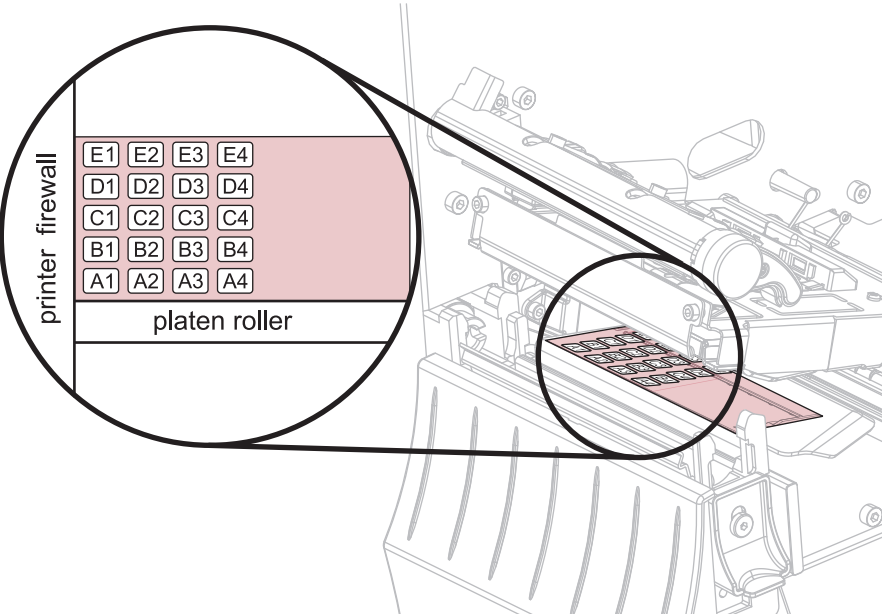
Parameters	Details
<p>a = RFID antenna element selection</p>	<p>ZD500R: This printer only has one antenna element, so the value used is always A1.</p> <p>ZT400 and ZT600: This parameter selects an antenna element from the printer's antenna array.</p> <p>Values: E1, E2, E3, E4 D1, D2, D3, D4 C1, C2, C3, C4 B1, B2, B3, B4 A1, A2, A3, A4</p>  <p>Default: A4</p> <p>(Continued on next page)</p>

Parameters	Details
<p>a = RFID antenna element selection</p>	<p>(Continued from previous page)</p> <p>R110Xi4 (V53.17.5 and later): This parameter selects an antenna element from the printer's antenna array.</p> <p>Values: A1, A2, A3, A4, B1, B2, B3, B4, C1, C2, C3, C4, D2, D3, D4, E2, E3, E4, F2, F3, F4 (combinations D1, E1, and F1 are invalid)</p> <div style="text-align: center;"> </div> <p>Default: A4</p> <p>R110Xi HF (R65.X): This parameter selects the antenna port that provides the best results for reading and writing.</p> <p>Values: 1 = antenna port 1 2 = antenna port 2</p> <p>Default: 1</p>

Example: The following command selects the antenna at row D, column 3 on an R110Xi4 printer:

```
^RW, ,D3
```

Example: The following command sets the read/write power level to Medium and selects antenna 2 on an R110Xi HF printer:

```
^RWM, ,2
```

Example: The following command sets the read and write power levels to High on an R110PAX4 printer:

```
^RWH, H
```

^RZ**Set RFID Tag Password and Lock Tag**

Description: Use this command to define a password for a tag during writing.

With Gen 2 tags, you can lock a tag's memory bank with an access password or define a kill password that can be used to permanently disable the tag. If you do not set access or kill passwords for a tag, the tag ignores any read or write commands that try to use these functions.



NOTE: The printer can set a kill password, but the printer cannot kill a tag.

Format: ^RZp,m,1

Parameters	Details
p = password	<p>This parameter sets a password for the RFID tag.</p> <p>For tag types other than Gen 2: The password is 8 bits. The memory bank and lock style parameters are ignored. The password must be 2 hexadecimal characters long. Values: 00 to FF (hexadecimal) Default: 00</p> <p>For Gen 2 tag type only: Gen 2 tags use a 32-bit password and specify the memory bank and lock style. The password must be 8 hexadecimal characters long. Use ^RF on page 377 to read the passwords. Values: 00000000 to FFFFFFFF (hexadecimal) Default: none</p>
m = memory bank	<p> NOTE: This parameter applies to Gen 2 tags only.</p> <p>This parameter specifies the type of RFID tag password.</p> <p>Values: K = kill password A = access password E = EPC T = tag identifier (TID) U = user Default: none</p>

Parameters	Details
1 = lock style	<div style="display: flex; align-items: flex-start;">  <p>NOTE: This parameter applies to Gen 2 tags only.</p> </div> <p>This parameter specifies the RFID tag password status.</p> <p>Values:</p> <ul style="list-style-type: none"> U = unlocked L = locked O = permanently unlocked (open) P = permanently locked (protected) W = write value (used only for the kill password memory bank) <p>Default: none</p>

Example: On a tag that is not Gen 2, this example encodes 5A as the tag password.

```
^XA
^RZ5A^FS
^XZ
```

Example: On a Gen 2 tag, this example encodes EPC data **112233445566778899001122** to the tag in Hex format, write protects the tag's EPC data with password **1234ABCD**, and leaves the tag's access password unlocked.

```
^XA
^RFW,H^FD112233445566778899001122^FS
^RZ1234ABCD,E,L^FS
^XZ
```

Example: On a Gen 2 tag, this example encodes EPC data **112233445566778899001122** to the tag in Hex format, write protects the tag's EPC data with password **1234ABCD**, and makes the tag's access password unreadable.

```
^XA
^RFW,H^FD112233445566778899001122^FS
^RZ1234ABCD,E,L^FS
^RZ1234ABCD,A,L^FS
^XZ
```

The following code unprotects EPC data **112233445566778899001122** using the password **1234ABCD**, encodes EPC data **newdata** to the tag in ASCII format, and then write protects the tag's new EPC data. The access password and its lock state are not changed, so the access password remains unreadable.

```
^XA
^RZ1234ABCD,E,U^FS
^RFW,A^FDnewdata^FS
^RZ1234ABCD,E,L^FS
^xz
```

Example: This example unlocks the locked access password from the previous example.

```
^XA
^RZ1234ABCD,A,U^FS
^XZ
```

^WF**Encode AFI or DSFID Byte**

Description: Use this command to encode the AFI or DSFID byte to a tag. Error handling is set by the ^RS command.

Format: ^WFr,m,w,f,b

Parameters	Details
r = number of retries	Values: 0 to 10 Default: 0
m = motion	Values: 0 = Feed label after writing. 1 = No Feed after writing. Other ZPL may cause a feed. Default: 0
w = write protect	Values: 0 = Not write protected 1 = Write protect Default: 0
f = data format	Values: 0 = ASCII 1 = Hexadecimal Default: 0
b = type of byte to read	Values: A = AFI byte D = DSFID byte Default: A

Example: This example encodes data "R" (hex 52) as the AFI byte. The printer will try the command up to five times, if necessary.

```
^XA
^WF5^FDR
^XZ
```

Example: This example encodes data hex 66 as the AFI byte. The printer will try the command up to three times, if necessary.

```
^XA
^WF3,,,1^FD66
^XZ
```

Example: This example encodes data hex 77 as the DSFID byte. The printer will try the command up to four times, if necessary.

```
^XA
^WF4,,,1,D^FD77
^XZ
```

^WT**Write (Encode) Tag**

NOTE: The ^WT command is provided only for backward-compatibility with label formats that were developed for older Zebra RFID printers.

Description: Use this command to encode the current RFID tag. Check the amount of data memory available for the tag that you will be using. If you send more data than the memory can hold, the printer truncates the data.

Format: ^WT**b**,**r**,**m**,**w**,**f**,**v**

Parameters	Details
b = block number	Specifies the block number to encode. This parameter is tag-dependent. For most tags, use block 0. For EPC Class 0 Plus, block 0 is EPC data, and block 1 is user data. For the R4Mplus, this parameter does not apply to printers with firmware version SP902X. With other versions of firmware in this printer, you can encode 12 bytes (96 bits) to block 0, but you can encode only the first byte of block 1. Values: 0 to <i>n</i> , where <i>n</i> is the maximum number of blocks for the tag. Default: 0
r = number of retries	Changes the number of times that the printer attempts to encode a particular block of a single RFID tag. (Same function as the ^RR command.) Values: 0 to 10 Default: 0
m = motion	Enables or disables RFID motion. (Same function as the ^RM command.) Values: 0 = Feed label after writing 1 = No feed after writing (other ZPL may cause a feed) Default: 0
w = write protect	Values: 0 = Not write protected 1 = Write protected Default: 0
f = data format	Values: 0 = ASCII 1 = Hexadecimal Default: 0

Parameters	Details
<p>For the R110X/HF: v = reverse the data order</p> <p>For other supported printers: v = verify valid data</p>	<p>Parameter v is not used in the R2844-Z.</p> <p>For the R110X/HF: Reverses the data order.</p> <p>Values: N = Do not reverse the data order (Most significant byte first for Tag*It and PicoTag. Last significant byte first for I*code and ISO 15693) Y = Reverse the data order</p> <p>Default: N</p> <p>For other supported printers: For reliability, some manufacturers encode tags with known data (such as A5A5). This parameter flags whether the preprogrammed data is verified. (Same function as the ^WV command.)</p> <p>Values: N = Do not verify Y = Verify valid data before writing</p> <p>Default: N</p>

Example: This sample encodes data "RFIDRFID" and will try writing up to five times, if necessary.

^XA

^WT,5^FDRFIDRFID^FS

^XZ

^WV

Verify RFID Encoding Operation

Description: Use this command to enable or disable the write verify function. When write verify is enabled, this command verifies the RFID encoding operation to ensure that the tag about to be programmed contains the hex data "A5A5" in the first two bytes. This parameter is not persistent (carried over from label to label).

Format: ^wVe

Parameters	Details
e = enable	Values: Y or N Default: N

ZPL Wireless Commands

This section contains ZPL commands for the Wireless and Wireless Plus print servers.

^KC**Set Client Identifier (Option 61)**

Description: The ^KC command allows the print server to have its own client identifier (CID).

Format: ^KC**a**,**b**,**c**,**d**

Parameters	Details
a = enable or disable	<p>Values:</p> <ul style="list-style-type: none"> 0 = disable (default) 1 = enabled, use MAC address 2 = enabled, ASCII value 3 = enabled, HEX value <p>Default: 0</p>
b = device	<p>Values:</p> <ul style="list-style-type: none"> 0 = all devices 1 = wireless 2 = external wired 3 = internal wired <p>Default: 1</p>
c = prefix (optional)	<p>Values: 11 ASCII characters or 22 hexadecimal values. The prefix can be cleared by defaulting the network settings on the printer.</p>
d = identifier	<p>Values: 60 ASCII characters or 120 hexadecimal values. Minimum field length is 2 bytes. The suffix can be cleared by defaulting the network settings on the printer.</p>
<p>This applies only to the Xi4, RXi4, ZM400, ZM600, RZ400, or RZ600 printers when it is used with the external ZebraNet 10/100 print server using firmware v1.1.5 or later.</p>	

^NB

Search for Wired Print Server during Network Boot

Description: Use this command to tell the printer whether to search for a wired print server at bootup. This command is ignored on the Xi4, RXi4, ZM400, ZM600, RZ400, and RZ600 printers.



NOTE: Only one print server can be installed in the S4M at one time, so this check does not occur.

Table 17 identifies which device becomes the active print server under different conditions.

Table 17 Results of Check for Wired Print Server

If the Check for Wired Print Server is set to:	Installed and Connected to a Live Ethernet Network		Then, the Active Print Server will be:
	Wired	Wireless	
Skip	X	X	Wireless
	X	—	Wired
	—	X	Wireless
Check	X	X	Wired
	X	—	Wired
	—	X	Wireless

A wireless option board must have an active radio that can properly associate to an access point.

Format: ^NBa

Parameters	Details
a = check for wired print server at boot time	<p>Values:</p> <p>c = check</p> <p>s = skip check</p> <p>Default: s</p>

^NN**Set SNMP**

Description: Use this command to set the Simple Network Management Protocol (SNMP) parameters.

Format: ^NNa,b,c,d,e,f

Parameters	Details
a = system name	Same as printer name. Values: Up to 17 alphanumeric characters
b = system contact	Any contact information as desired (such as a name or phrase) Values: Up to 50 alphanumeric characters
c = system location	The printer's model information. Values: Up to 50 alphanumeric characters
d = get community name	Values: Up to 19 alphanumeric characters Default: public
e = set community name	Values: Up to 19 alphanumeric characters Default: public
f = trap community name	Values: Up to 20 alphanumeric characters Default: public

^NP**Set Primary/Secondary Device**

Description: Use this command to specify whether to use the printer's or the print server's LAN/WLAN settings at boot time. The default is to use the printer's settings.

When the printer is set as the primary device, you can set it up using ZPL commands or the Wireless Setup Wizard utility, and any wired print server inserted into the printer will use those settings. The drawbacks to using the printer as primary are:

Any wired print server inserted into the printer will lose its original settings if the printer is set to check for the wired print server and the Primary Device is set to PRINTER (see [^NB on page 413](#)).

Format: ^NP`a`

Parameters	Details
<code>a</code> = device to use as primary	Values: <code>P</code> = printer <code>M</code> = MPS/Printserver Default: <code>P</code>

^NT**Set SMTP**

Description: Use this command to set the Simple Mail Transfer Protocol (SMTP) parameters. This allows you to set the e-mail settings for alerts.

Format: ^NTa,b

Parameters	Details
a = SMTP server address	Values: Any properly formatted server address in the xxx.xxx.xxx.xxx format
b = print server domain	Values: Any properly formatted print server domain name. A domain name is one or more labels separated by a period ("dot"), and a label consists of letters, numbers, and hyphens. An example of a domain name is zebra.com

^NW**Set Web Authentication Timeout Value**

Description: Use this command to set the timeout value for the printer home page. The printer will prompt for the printer password only the first time that certain screens are accessed until 1) the web authentication timeout value is reached (default value is 5 minutes) or 2) the printer is reset. At that time, the printer will prompt for the password again.

Format: ^NWa

Parameters	Details
a = timeout value	<p>The timeout value in minutes for an IP address to be authenticated to the printer web pages.</p> <p>Values: 0 (no secure pages can be accessed without entering the printer password) to 255 minutes</p> <p>Default: 5</p>

^WA**Set Antenna Parameters**

Description: Use this command to set the values for the receive and transmit antenna.

Format: ^WAa,b

Parameters	Details
a = receive antenna	Values: D = diversity L = left R = right Default: D
b = transmit antenna	Values: D = diversity L = left R = right Default: D

^WE

Set WEP Mode

**NOTE:**

- The ^WE command is provided only for backward-compatibility with printers using firmware prior to V50.15.x, V53.15.x, or X60.15.x. For these firmware versions and later, use [^WX on page 428](#) to set the security type and related parameters.
- This command does not apply to printers running Link-OS v6 or later versions.

Use this command to command enable Wired Equivalent Privacy (WEP) mode and set WEP values. WEP is a security protocol for wireless local area networks (WLANs).

Be careful to include the exact number of commas required for this command when setting encryption keys (parameters e through h). A missing or extra comma will cause the keys to be stored in the wrong slots and can prevent the printer from joining the wireless network.

Format

^WEa,b,c,d,e,f,g,h

Parameters	Details
a = encryption mode	Values: OFF 40 = 40-bit encryption 128 = 128-bit encryption Default: OFF
b = encryption index	Tells the printer which encryption key to use. Values: 1 = Key 1 2 = Key 2 3 = Key 3 4 = Key 4 Default: 1
c = authentication type	Values: O (Open System), S (Shared Key) 0 = Open System S = Shared Key Default: 0  NOTE: If you enable Shared Key authentication with Encryption Mode set to OFF , this value resets to 0 (Open).
d = encryption key storage	Values: H (Hex key storage), S (string key storage) H = Hex key storage S = String key storage Default: H

Parameters	Details
e, f, g, h = encryption keys 1 through 4	<p>Values: The actual value for the encryption key</p> <p>The encryption mode affects what can be entered for the encryption keys:</p> <ul style="list-style-type: none"> For 40-bit, encryption keys can be set to any 5 hex pairs or any 10 alphanumeric characters. For 128-bit, encryption keys can be set to any 13 hex pairs or any 26 alphanumeric characters. <p> NOTE: When using hex storage, do not add a leading 0x on the WEP key.</p>

Example: This example sets encryption to 40-bit, activates encryption key 1, and sets encryption key 1 to the string **12345**.

```
^WE40,,,12345
```

In this example, the Encryption Index, Authentication Type, and Encryption Key Storage parameters are left blank with commas as placeholders for the fields. The printer uses the default values for these parameters.

Example: This example sets encryption to 128-bit, activates encryption key 2, and sets encryption keys 1 and 2 to hex values.

```
^WE128,2,,H,12345678901234567890123456,98765432109876543210987654
```

The value for encryption key 1 is stored and can be activated in the future by the following command:

```
^WE128,1
```

Example: This example sets encryption to 128-bit, activates encryption key 4, and sets encryption key 4 to a hex value.

```
^WE128,4,,H,,,98765432109876543210987654
```

Values are not required for encryption keys 1 through 3 when setting encryption key 4. In this example, commas are used as placeholders for the fields for encryption keys 1 through 3.

Any previously stored values for these encryption keys do not change.



IMPORTANT: Make sure that you include the exact number of commas required to get to the slot for encryption key 4 (parameter h).

^WL**Set LEAP Parameters**

NOTE: The ^WL command is provided only for backward-compatibility with printers using firmware prior to V50.15.x or X60.15.x. For these firmware versions and later, use [^WX on page 428](#) to set the security type and related parameters.

Description: Use this command to enable Cisco® Lightweight Extensible Authentication Protocol (LEAP) mode and set parameters. LEAP is user authentication method that is available with some wireless radio cards.

Format: ^WLa,b,c

Parameters	Details
a = mode	Values: OFF, ON Default: OFF
b = user name	Values: Any 1 to 32 alphanumeric including special characters Default: user
c = password	Values: Any 1 to 32 alphanumeric including special characters Default: password

~WL

Print Network Configuration Label

Description: Generates a network configuration label (Figure 2).

Format: ~WL

Figure 2 Network Configuration Label

Wireless Print Server

Network Configuration	
Zebra Technologies ZTC 140xi11IP1us-200dpi ZBR3258042	
NO.....	WIRED PS CHECK?
Printer.....	LOAD LAN FROM?
Wired	
ALL.....	IP PROTOCOL
000.000.000.000.....	IP ADDRESS
000.000.000.000.....	SUBNET MASK
000.000.000.000.....	DEFAULT GATEWAY
000.000.000.000.....	WINS SERVER IP
YES.....	TIMEOUT CHECKING
0300.....	TIMEOUT VALUE
0000.....	ARP INTERVAL
9100.....	BASE RAW PORT
Wireless*	
ALL.....	IP PROTOCOL
010.003.015.034.....	IP ADDRESS
255.255.255.000.....	SUBNET MASK
000.000.000.000.....	DEFAULT GATEWAY
000.000.000.000.....	WINS SERVER IP
YES.....	TIMEOUT CHECKING
0300.....	TIMEOUT VALUE
0000.....	ARP INTERVAL
9100.....	BASE RAW PORT
YES.....	CARD INSERTED
015FH.....	CARD MFG ID
000AH.....	CARD PRODUCT ID
5.02.19.....	CARD FIRMWARE
00062131b6ba.....	MAC ADDRESS
YES.....	DRIVER INSTALLED
INFRASTRUCTURE.....	OPERATING MODE
125.....	ESSID
100.....	TX POWER
ON.....	1 Mb/s
ON.....	2 Mb/s
ON.....	5.5 Mb/s
ON.....	11 Mb/s
11 Mb/s.....	CURRENT TX RATE
DIVERSITY.....	RECEIVE ANTENNA
DIVERSITY.....	XMIT ANTENNA
YES.....	ASSOCIATED
NONE.....	WLAN SECURITY
OPEN.....	WEP TYPE
1.....	WEP INDEX
LONG.....	PREAMBLE
020.....	POOR SIGNAL

FIRMWARE IN THIS PRINTER IS COPYRIGHTED

**Wireless Plus Print Server
and Internal Wireless Plus Print Server**

Xi4, R110Xi4, ZM400, ZM600,
RZ400, RZ600

Network Configuration	
Zebra Technologies PRINTER NAME ZBR2634792	
0.0.0 *.....	OPTION FIRMWARE
Wired.....	PRIMARY NETWORK
NO.....	LOAD FROM EXT?
Internal Wired.....	ACTIVE PRINTSRVR
External Wired	
ALL.....	IP PROTOCOL
000.000.000.000.....	IP ADDRESS
255.255.255.000.....	SUBNET MASK
000.000.000.000.....	DEFAULT GATEWAY
000.000.000.000.....	WINS SERVER IP
YES.....	TIMEOUT CHECKING
300.....	TIMEOUT VALUE
000.....	ARP INTERVAL
9100.....	BASE RAW PORT
Internal Wired*	
ALL.....	IP PROTOCOL
010.003.004.116.....	IP ADDRESS
255.255.255.000.....	SUBNET MASK
010.003.004.001.....	DEFAULT GATEWAY
010.003.001.098.....	WINS SERVER IP
YES.....	TIMEOUT CHECKING
300.....	TIMEOUT VALUE
000.....	ARP INTERVAL
9100.....	BASE RAW PORT
00074d2b4168.....	MAC ADDRESS
Wireless	
ALL.....	IP PROTOCOL
000.000.000.000.....	IP ADDRESS
255.255.255.000.....	SUBNET MASK
000.000.000.000.....	DEFAULT GATEWAY
000.000.000.000.....	WINS SERVER IP
YES.....	TIMEOUT CHECKING
300.....	TIMEOUT VALUE
000.....	ARP INTERVAL
9100.....	BASE RAW PORT
NO.....	CARD INSERTED
0000H.....	CARD MFG ID
0000H.....	CARD PRODUCT ID
000000000000.....	MAC ADDRESS
YES.....	DRIVER INSTALLED
INFRASTRUCTURE.....	OPERATING MODE
125.....	ESSID
100.....	TX POWER
ON.....	1 Mb/s
ON.....	2 Mb/s
ON.....	5.5 Mb/s
ON.....	11 Mb/s
11 Mb/s.....	CURRENT TX RATE
DIVERSITY.....	RECEIVE ANTENNA
DIVERSITY.....	XMIT ANTENNA
OPEN.....	WEP TYPE
NONE.....	WLAN SECURITY
1.....	WEP INDEX
020.....	POOR SIGNAL
LONG.....	PREAMBLE
NO.....	ASSOCIATED
ON.....	PULSE ENABLED
15.....	PULSE RATE
OFF.....	INTL MODE
07FFH.....	CHANNEL MASK

FIRMWARE IN THIS PRINTER IS COPYRIGHTED

**Other Printers/
Print Engines**

Network Configuration	
Zebra Technologies ZTC 105SL-200dpi ZBR12908662	
1.10.1729.....	OPTION FIRMWARE
NO.....	WIRED PS CHECK?
Printer.....	LOAD LAN FROM?
Wired	
ALL.....	IP PROTOCOL
000.000.000.000.....	IP ADDRESS
000.000.000.000.....	SUBNET MASK
000.000.000.000.....	DEFAULT GATEWAY
000.000.000.000.....	WINS SERVER IP
YES.....	TIMEOUT CHECKING
0300.....	TIMEOUT VALUE
0000.....	ARP INTERVAL
9100.....	BASE RAW PORT
Wireless*	
ALL.....	IP PROTOCOL
010.003.015.034.....	IP ADDRESS
255.255.255.000.....	SUBNET MASK
000.000.000.000.....	DEFAULT GATEWAY
000.000.000.000.....	WINS SERVER IP
YES.....	TIMEOUT CHECKING
0300.....	TIMEOUT VALUE
0000.....	ARP INTERVAL
9100.....	BASE RAW PORT
YES.....	CARD INSERTED
015FH.....	CARD MFG ID
000AH.....	CARD PRODUCT ID
5.60.21.....	CARD FIRMWARE
000e84c4f876.....	MAC ADDRESS
YES.....	DRIVER INSTALLED
INFRASTRUCTURE.....	OPERATING MODE
125.....	ESSID
100.....	TX POWER
ON.....	1 Mb/s
ON.....	2 Mb/s
ON.....	5.5 Mb/s
ON.....	11 Mb/s
11 Mb/s.....	CURRENT TX RATE
DIVERSITY.....	RECEIVE ANTENNA
DIVERSITY.....	XMIT ANTENNA
YES.....	ASSOCIATED
NONE.....	WLAN SECURITY
OPEN.....	WEP TYPE
1.....	WEP INDEX
LONG.....	PREAMBLE
020.....	POOR SIGNAL
ON.....	PULSE ENABLED
15.....	PULSE RATE
ON.....	INTL MODE
07FFH.....	CHANNEL MASK

FIRMWARE IN THIS PRINTER IS COPYRIGHTED

^WP**Set Wireless Password**

NOTE: This command does not apply to the S4M.

Description: Use this command to set the four-digit wireless password (not the same as the general printer password). If the wireless password is **0000**, the Wireless and Wireless Plus print servers run in an “unprotected” mode, which means that you do not need to enter the wireless password through the control panel to view or modify wireless settings.

If a wireless password is set, the values for the following parameters will not appear through the control panel until the wireless password is entered:

- MAC Address
- ESSID
- WLAN Security
- WEP Type
- WEP Index
- Reset Network

Format: ^WP a, b

Parameters	Details
a = old wireless password	Values: 0000 through 9999 Default: 0000
b = new wireless password	Values: 0000 through 9999 Default: 0000

^WR**Set Transmit Rate**

Use this command to change the transmission rate for 802.11b wireless print servers.

Format

^WRa,b,c,d,e

Parameters	Details
a = rate 1	Sets the 1 Mb/s transmit rate. Values: Y (On), N (Off)
b = rate 2	Sets the 2 Mb/s transmit rate. Values: Y (On), N (Off)
c = rate 5.5	Sets the 5.5 Mb/s transmit rate. Values: Y (On), N (Off)
d = rate 11	Sets the 11 Mb/s transmit rate. Values: Y (On), N (Off)
e = transmit power	Values: 1, 5, 20, 30, 50, 100



NOTE: This command is not valid for Link-OS printers and is only supported in selected other models.

~WR

Reset Wireless Radio Card and Print Server

Description: Use this command to reinitialize the wireless radio card and the print server (wired or wireless) when the Wireless or Wireless Plus print server is running. The command also causes any wireless radio card in the printer to reassociate to the wireless network.

Format: ~WR

^WS

Set Wireless Radio Card Values

Description: Use this command to set the wireless radio card values for ESSID, Operating Mode, and Card Preamble.

Format: ^WSe,o,p,h,i,j,k

Parameters	Details
e = ESSID value	<p>Values: Any value up to 32 characters, including all ASCII and Extended ASCII characters, including the space character. When this parameter is left blank, the ESSID is not changed.</p> <p>Default: 125</p>
o = operating mode	<p>Values: I (Infrastructure), A (Adhoc)</p> <p>Default: I</p>
p = wireless radio card preamble	<p>Values:</p> <p>L = long</p> <p>S = short</p> <p>Default: L</p>
<div data-bbox="180 989 240 1045" style="float: left; margin-right: 10px;">.15↑</div> h = wireless pulse This parameter is supported in firmware version V60.15.x, V50.15.x, R6x.15.x, R53.15.x, ZSPx, or later.	<p>Adds a pulse to the network traffic generated by the printer. This pulse is necessary with some network configurations to keep the printer online.</p> <p>Values:</p> <p>0 = disabled</p> <p>1 = enabled</p> <p>Default: 1</p>
<div data-bbox="180 1255 240 1312" style="float: left; margin-right: 10px;">.15↑</div> i = wireless pulse interval This parameter is supported in firmware version V60.15.x, V50.15.x, R6x.15.x, R53.15.x, ZSPx, or later.	<p>Sets the interval at which the wireless pulse is sent when the wireless pulse feature is enabled.</p> <p>Values: 5 to 300 seconds</p> <p>Default: 15</p>
<div data-bbox="180 1476 240 1533" style="float: left; margin-right: 10px;">.15↑</div> j = channel mask This parameter is supported in firmware version X60.15.x, V50.15.x, or later.	<p>For commonly used channel masks, see Table 18 on page 427.</p> <p>Values: 4 Hexadecimal digits preceded by "0x" (0x0000 to 0xFFFF)</p> <p>Default: 0x7FF</p>
<div data-bbox="180 1665 240 1722" style="float: left; margin-right: 10px;">.15↑</div> k = international mode This parameter is supported in firmware version X60.15.x, V50.15.x, or later.	<p>In international mode, the printer uses the channel set by the access point.</p> <p>Values: 0 (Disabled), 1 (Enabled)</p> <p>Default: 0</p>

Table 18 Channel Mask Settings

Region	Channel Mask
United States, Canada, Latin America	0x7FF
Europe, Middle East, Africa, other	0x1FFF
Japan	0x3FFF

^WX

Configure Wireless Securities

Use this command to configure the wireless security settings for your printer. Values entered for this command must match what is configured on your WLAN and must be supported by the wireless radio card that you are using.

The ^WX command replaces individual ZPL commands for different security types.

**NOTE:**

When using certificate files, your printer supports:

- Using Privacy Enhanced Mail (PEM) formatted certificate files.
- Using the client certificate and private key as two files, each downloaded separately.
- Using exportable PAC files for EAP-FAST.
- The supporting parameters that are required vary based on the security type that you select. See [Supporting Parameters for Different Security Types on page 432](#) for instructions for each security type.

The values 2, 3 for the security type (a) parameter, b, c, d, e, f, g and h parameters are ignored for printer running Link-OS 6.0 or later versions..





IMPORTANT: When using certificate files, the time on the printer must be set correctly for the websocket connection to succeed, as the time is used in the certificate validation.

Format:

^WXa,[zero or more supporting parameters]

Parameters	Details
a = security type	<p>Enter the two-digit code for the security type that your WLAN uses. For which supporting parameters (b through n) to use with the different security types, see Supporting Parameters for Different Security Types on page 432.</p> <p> NOTE: Configuring the printer for WPA also allows the printer to be used in WPA2 environments.</p> <p>Values: 01 to 15 01 - No wireless security is active 02 = WEP 40-bit 03 = WEP 128-bit 04 = EAP-TLS 05 = EAP-TTLS 06 = EAP-FAST 07 = PEAP 08 = LEAP 09 = WPA PSK (R6x15.x, R53.15.x, ZSPx, and later.) 10 = WPA EAP-TLS 11 = WPA EAP-TTLS 12 = WPA EAP-FAST 13 = WPA PEAP 14 = WPA LEAP 15 = Kerberos Default: 01</p>
b = WEP encryption index*	<p>Specifies which encryption key to use for WEP encryption. A value must be specified if using WEP 40-bit or WEP 128-bit.</p> <p>Values: 1, 2, 3, 4 Default: 1</p>
c = WEP authentication type*	<p>Enables the WEP key authentication type. A value must be specified if using WEP 40-bit or WEP 128-bit.</p> <p>Values: 0 or S 0 = open system S = shared key Default: 0</p>
d = WEP key type*	<p>Specifies the format of the WEP key. A value must be specified if using WEP 40-bit or WEP 128-bit.</p> <p>Values: H or S H = hex key storage S = string key storage Default: S</p>
*Not used for all security types	

Parameters	Details
<p>e,f,g,h = WEP encryption keys 1 through 4*</p>	<p>Specifies the actual values of any WEP encryption keys to be used. A value must be specified for at least one WEP encryption key if you specify 40-bit or 128-bit WEP encryption for the security type.</p> <p> IMPORTANT: Be careful to include the exact number of commas required for this command when setting encryption keys (parameters e through h). A missing or extra comma will cause the keys to be stored in the wrong slots and can prevent the printer from joining the wireless network.</p> <p>The encryption mode affects what can be entered for the encryption keys:</p> <ul style="list-style-type: none"> • For 40-bit, encryption keys can be set to any 5 hex pairs or any 10 alphanumeric characters. • For 128-bit, encryption keys can be set to any 13 hex pairs or any 26 alphanumeric characters. <p> NOTE: When using hex storage, do not add a leading 0x on the WEP key.</p> <p>Values: The actual value for the encryption key Default: None</p>
<ul style="list-style-type: none"> • i = user ID* 	<p>Specifies a user ID for security types that require one. A value must be specified if using the following security types:</p> <ul style="list-style-type: none"> • EAP-TTLS • LEAP • WPA LEAP • PEAP • WPA PEAP • WPA EAP-TTLS • Kerberos <p>Values: The actual value for the user ID. Default: user</p>

*Not used for all security types

Parameters	Details
<ul style="list-style-type: none"> • j = password* 	<p>Specifies a password for security types that require one. A value must be specified if using the following security types:</p> <ul style="list-style-type: none"> • EAP-TTLS • LEAP • WPA LEAP • PEAP • WPA PEAP • WPA EAP-TTLS • Kerberos <p>Values: The actual value for the password. Default: password</p>
<ul style="list-style-type: none"> • k = optional private key password* 	<p>Specifies an optional private key password for security types that require one. A value must be specified if using the following security types:</p> <ul style="list-style-type: none"> • EAP-TLS • EAP-FAST • WPA EAP-TLS • WPA EAP-FAST <p>Values: The actual value for the optional private key. Default: None</p>
<ul style="list-style-type: none"> • l = realm* 	<p>Specifies the realm for security types that require it. A value must be specified if using Kerberos.</p> <p>Values: The actual value for the realm. Default: kerberos</p>
<ul style="list-style-type: none"> • m = Key Distribution Center (KDC)* 	<p>Specifies the KDC for security types that require it. A value must be specified if using Kerberos.</p> <p>Values: The actual value for the KDC. Default: krbtgt"</p>
<ul style="list-style-type: none"> • n = Pre-Shared Key (PSK) value* 	<p>Enter the PSK value. This value is calculated and must be the same for each device on the WLAN. Use ZebraNet Bridge to generate the PSK value. A value must be specified if using WPA PSK.</p> <p> IMPORTANT: Do not enter a pass phrase for this field in this command. To use a pass phrase, use the ZebraNet Bridge Enterprise Wireless Setup Wizard.</p> <p>Values: a minimum of 64 hexadecimal digits Default: None</p>
<p>*Not used for all security types</p>	

Supporting Parameters for Different Security Types

The supporting parameters required for this command vary based on the security type that you select. You should not use all of the supporting parameters each time that you use this command, nor will you use extra commas to separate unused fields. Follow the example and format for your specific security type in this section, substituting your own wireless network data.

Security Type 01: No Wireless Security Active

Format: ^WX01

Example: This example turns off all wireless securities controlled under this command, but it does not reset the printer's wireless settings to their defaults.

```
^XA
^WX01
^JUS^XZ
```

Security Type 02: WEP 40-Bit

Format: ^WX02,b,c,d,e,f,g,h

Example: This example configures the printer for WEP 40-bit encryption using index key 1, open authentication, and a hexadecimal WEP key with a value of "A1B2C3D4F5."

```
^XA
^WX02,1,0,H,A1B2C3D4F5,,,
^JUS
^XZ
```



NOTE: This is no longer valid for Link OS 6 printers.

Security Type 03: WEP 128-Bit

Format: ^WX03,b,c,d,e,f,g,h

Example: This example configures the printer for WEP 128-bit encryption using index key 2, open authentication, and four hexadecimal WEP keys.

```
^XA
^WX03,2,0,H,001122334455667788,112233445566778899,223344556677889900,334455667788990011
^JUS
^XZ
```



NOTE: This command is not valid for printers running Link OS 6 or later versions.

Security Type 04: EAP-TLS

Format: ^WX04,k

Example: This example configures the printer for EAP-TLS authentication with an optional private key password with a value of "private."

```
^XA
^WX04,private
^JUS
^XZ
```

Security Type 05: EAP-TTLS

Format: ^WX05,i,j

Example: This example configures the printer for EAP-TTLS authentication, including a user ID of “user” and a password of “password.”

```
^XA
^WX05,user,password
^JUS
^XZ
```

Security Type 06: EAP-FAST

Format: ^WX06,i,j,k

Example: This example configures the printer for EAP-FAST authentication, including a user ID of “user,” a password of “password,” and an optional private key of “private.”

```
^XA
^WX06,user,password,private
^JUS
^XZ
```

Security Type 07: PEAP

Format: ^WX07,i,j

Example: This example configures the printer for PEAP authentication, including a user ID with a value of “user” and a password with a value of “password.”

```
^XA
^WX07,user,password
^JUS
^XZ
```

Security Type 08: LEAP

Format: ^WX08,i,j

Example: This example configures the printer for LEAP authentication, including a user ID with a value of “user” and a password with a value of “password.”

```
^XA
^WX08,user,password
^JUS
^XZ
```

Security Type 09: WPA PSK



NOTE: Configuring the printer for WPA also allows the printer to be used in WPA2 environments (R6x15.x, R53.15.x, ZSPx, and later.)

Format: ^WX09,n

Example: This example configures the printer for WPA PSK authentication with a PSK value of all zeroes (64 hexadecimal digits).

```
^XA
^WX09,00000000...
```

^JUS
^XZ

Security Type 10: WPA EAP-TLS



NOTE: Configuring the printer for WPA also allows the printer to be used in WPA2 environments.

Format: ^WX10,k

Example: This example configures the printer for WPA EAP-TLS authentication with an optional private key password with a value of “private.”

^XA
^WX10,private
^JUS
^XZ

Security Type 11: WPA EAP-TTLS



NOTE: Configuring the printer for WPA also allows the printer to be used in WPA2 environments.

Format: ^WX11,i,j

Example: This example configures the printer for WPA EAP-TTLS authentication, including a user ID with a value of “user” and a password with a value of “password.”

^XA
^WX11,user,password
^JUS
^XZ

Security Type 12: WPA EAP-FAST



NOTE: Configuring the printer for WPA also allows the printer to be used in WPA2 environments.

Format: ^WX12,i,j,k

Example: This example configures the printer for WPA EAP-FAST authentication, including a user ID of “user,” a password of “password,” and an optional private key of “private.”

^XA
^WX12,user,password,private
^JUS
^XZ

Security Type 13: WPA PEAP



NOTE: Configuring the printer for WPA also allows the printer to be used in WPA2 environments.

Format: ^WX13,i,j

Example: This example configures the printer for WPA PEAP authentication, including a user ID with a value of “user” and a password with a value of “password.”

^XA
^WX13,user,password

^JUS
^XZ

Security Type 14: WPA LEAP



NOTE: Configuring the printer for WPA also allows the printer to be used in WPA2 environments.

Format: ^WX14,i,j

Example: This example configures the printer for WPA LEAP authentication, including a user ID with a value of “user” and a password with a value of “password.”

^XA
^WX14,user,password
^JUS
^XZ

Security Type 15: Kerberos

Format: ^WX15,i,j,l,m

Example: This example configures the printer for Kerberos encryption, including a Kerberos user ID with a value of “user,” a Kerberos password with a value of “password,” a realm of “zebra,” and a KDC of “krbtgt.”

^XA
^WX15,user,password,zebra,krbtgt
^JUS
^XZ

ZBI Commands

This section explains the Zebra Basic Interpreter, its commands, descriptions, formats, and parameters.

Introduction to Zebra Basic Interpreter (ZBI)

What is ZBI and why is it for me?

ZBI is an "on-the-printer" programming language that offers many of the functions found in ANSI BASIC. The ZBI language allows the user to create applications that are run on the printer to manipulate data streams. By using ZBI, it is possible to have the printer perform the same functions that a computer or programmable terminal might otherwise be used for.

With the connectivity options available on Zebra printers, you may not need a separate computer. Simply load a ZBI program on your printers, add them to your network, and let the printers serve as the gateway for moving data.

Here are some of the applications that can be written using ZBI:

- Connect a barcode scanner to the printer. Based on scanned data, reprint tags, verify printed output, and manage a list of items.
- Connect a scale to the printer and print labels, tags, or receipts based on the weight of an item.
- Connect the printer to a PC-based database and send queries from the printer to retrieve or upload data.
- Convert incoming data into the commands that can be used to print a label. This is useful for replacing other brands of printers with new Zebra units.
- Provide fail-over to another printer when the target printer is in an error state.

Printers, ZBI Keys, & ZBI Versions

Information about ZBI 1.x and ZBI 2.x:

ZBI versions 1.0 through 1.5: ZBI 1.x was available on printers with X.10 or higher firmware (such as V48.10.x). To determine if the printer supports ZBI version 1, check the firmware version loaded on the printer. This can be determined by the absence of a "Z" in the firmware version number (for example, firmware V60.13.0.12 supports ZBI version 1, while V60.13.0.12Z does not).

ZBI-Developer can be used to create programs for use on printers that support ZBI version 1.x., however, the features that are only available in ZBI v2.x cannot be used with printers running ZBI v1.x. For example, "on-printer" debugging advanced file encryption and commands added in ZBI 2 are not supported in printers running ZBI 1.x. If you do not have a printer that meets this requirement, contact your reseller.



NOTE: Support for ZBI versions 1.0 through 1.5 is limited to syntax checking only. On-printer debugging is not supported for ZBI versions 1.0 through 1.5.



ZBI versions 2.0 and higher: Printers with firmware versions X.16 or later (for example, V60.16.x and V53.16.x) can support ZBI version 2.0 and later.

These printers can be either ZBI-Ready or ZBI-Enabled, depending on whether or not a ZBI Key file has been loaded on the printer. ZBI Keys can be loaded onto printers during manufacturing or later purchased at www.zebrasoftware.com. A Downloader Utility/ZBI Key Manager software utility is available to assist in the task of sending ZBI Keys to printers.

The ZBI.nrd file is required to be present on the printer for ZBI 2.0 to be enabled. The ZBI Key is stored on the printer's E: memory location with the name ZBI.nrd. The file is persistent. It cannot be deleted even if the printer's memory is initialized. For example, if the ^JB command is used to initialize the location, the ZBI Key file will not be deleted.

When a printer is ZBI-Ready but not ZBI-Enabled, the firmware version will display a "Z" at the end of the version string (for example, V60.16.0Z). Additionally, the printer's configuration label will show that the printer is not ZBI-Enabled.

When a printer is ZBI-Enabled, the firmware version will not display a "Z" at the end of the version string (for example, V60.16.0). Additionally, the printer's configuration label will show that the printer is ZBI-Enabled.



NOTE: Each single ZBI Key can only be used once. When multiple printers are to be ZBI-Enabled, multiple Keys will be needed. The ZBI Key cannot be retrieved from printer to a host system.

Command and Function Reference Format

This section describes how commands and functions are presented in this document.

Command/Function NAME

Describes how the command is used, its capabilities, and its characteristics.

Format The Format section explains how the command is arranged and its parameters. For example, the **AUTONUM** command starts the auto-numbering option. The format for the command is **AUTONUM <A>,**. The <A> and are parameters of this command and are replaced with values determined by the user.

For functions, parameters are enclosed within parentheses and separated by commas, such as **EXTRACT\$(A\$,START\$,STOP\$)**.

Numeric parameters are written as a name, while string parameters are written as a name followed by a dollar sign.

Parameters If a command has parameters that make a command or function more specific, they are listed under this heading. Still using the **AUTONUM** example, the <A> parameter is defined as:

<A> = number used to start the auto-numbering sequence

Return Value (functions only)

The return value is the result of evaluating the function or expression.

Example When a command is best clarified in a programming context, an example of the ZBI code is provided. Text indicating parameters, exact code to be entered, or data returned from the host is printed in the **Courier** font to be easily recognizable.

An example of **PRINT** code is:

```
10 PRINT "HELLO WORLD"
RUN
HELLO WORLD
```

Comments This section is reserved for notes that are of value to a programmer, warnings of potential command interactions, or command-specific information that should be taken into consideration. An example comment could be: This is a program command and must be preceded by a line number.

Function Rules

Functions built into this interpreter can be used in expressions only. The function names are not case sensitive.

If input parameters exist, they are enclosed in parentheses. If no parameters exist, no parentheses are used.

Variables referenced in the functions could be substituted by functions or expressions of the same type. If the function name ends with a \$, it returns a string value. Otherwise, it returns a numeric value.

Section Organization

The sections in this guide are arranged based on programming topics. A brief description of the sections is listed below.

Editing Commands This section describes the commands which are used to manipulate the interpreter and enter programs.

Running and Debugging Outlines the control commands used to run and debug programs.

Base Types and Expressions Fundamental structure for manipulating strings and computing numeric and boolean values.

Control and Flow Commands to conditionally execute code and control the flow of the program

Input and Output Outlines how to communicate with the physical ports, internal ports, and network.

File System Shows how programs and formats can be saved and recalled

Comma Separated Values Identifies how to load and store comma separated data

Events Explains how to capture and trigger internal events in the printer

Systems Contains miscellaneous systems interface functions

String Functions Handles string manipulation

Math Functions Handles mathematical calculations

Array Functions Describes how to search, resize, and query arrays

Time and Date Functions Functions to access the real time clock option

Set/Get/Do Interface Functions to directly interface with the Set/Get/Do system

Example Programs More examples to give a head start in creating your applications

Writing ZBI Programs

There are two main ways to develop ZBI programs. The preferred method is to use the ZBI-Developer application. ZBI-Developer allows you to create and test programs before a printer is even turned on. In addition, many features of this program allow for quicker program creation and more meaningful debugging. ZBI-Developer can be downloaded from the Zebra web site.

An alternate method for developing a program is through a direct connection to the printer using a terminal emulation program.

Editing Commands

This section details the Editing Commands. This section describes the commands which are used to manipulate the interpreter and enter programs. These commands are used while controlling the ZBI environment from a console connection. Here is a quick list of these commands:

NEW – Clears out the program and variables currently in memory

REM and ! – Comment commands

LIST – Lists the program currently in memory

AUTONUM – Automatically generates the next line number

RENUM – Renumbers the program currently in memory

ECHO – Controls whether characters received on the console are echoed back

If you are using ZBI-Developer, the commands that will be most useful are AUTONUM and REM/!.

The following example shows the use of Editing commands from within a console connection.

Preview:

```

NEW
AUTONUM 10,5
10 REM "Hello World" Application
15 PRINT "Hello World" ! comment...
20
LIST
10 REM "Hello World" Application
15 PRINT "Hello World"

NEW
LIST

```

Entered automatically when AUTONUM is used

A blank line stops AUTONUM

Preview when viewed in ZBI-Developer

```

AUTONUM 10,5
REM "Hello World" Application
PRINT "Hello World" ! comment...

```

NEW

This command clears the interpreter's memory, including the line buffer and variables, but not any open ports. Use this command when creating code to restart the coding process or before resending a program from a file to the interpreter.

Format NEW

Parameters N/A

Example This is an example of how to use the NEW command:

```
10 PRINT "Hello World"
RUN
Hello World
```

```
LIST
10 PRINT "Hello World"
```

```
NEW
LIST
```

Comments This is an interactive command that takes effect as soon as it is received by the printer.

REM

A numbered **remark** line starts with REM and includes text in any form after it. This line is ignored by the interpreter.

Format REM <comment>

Parameters The comment string can contain any character and is terminated by a carriage return.

Example This is an example of how to use the REM command:

```
10 REM COMMAND LINES 20-100 PRINT A LABEL
```

Comments Remarks are used for program description and are included as a separate program line. To append a comment to the end of a program line, use the exclamation mark (!).

A useful method to keep comments in a stored file (but not in the printer) is to always start the REM line with the number 1. When all of the lines are sent to the printer, only the last REM line will stay resident in the printer. This will require less RAM for large programs.

Example This is an example of how to re-use the REM command:

```
1 REM MYPROGRAM COPYRIGHT ME Inc. 2008
1 REM While debugging a port may be left open
5 CLOSE ALL
1 REM Open the ports this program will use
10 OPEN #0: NAME: "SER" ! Restart the console
```

! (EXCLAMATION MARK)

The exclamation mark is the marker for adding comments to the end of numbered programming lines. Any text following the ! is ignored when the line or command is processed.

Format !<comment>

Parameters The comment string can contain any character and is terminated by the carriage return.

Example This is an example of how to use the ! (comments) command:

```
10 LET A=10 ! Indicates number of labels to print
```

Comments None

LIST

This command lists the program lines currently in memory.

Format

```
LIST
LIST <A>
LIST <A>-<B>
```

Parameters

default = lists all lines in memory

<A> = line to start listing the program

 = line to stop listing the program. If not specified, only the line at <A> will print.

Example This is an example of how to use the LIST command:

```
1 REM MYPROGRAM COPYRIGHT ME Inc. 2008
1 REM While debugging a port may be left open
5 CLOSE ALL
1 rem Open the ports this program will use
10 OPEN #0: NAME: "SER" ! Restart the console
20 PRINT #0: "Hello World"
LIST
1 REM Open the ports this program will use
5 CLOSE ALL
10 OPEN #0: NAME: "SER" ! Restart the console
20 PRINT #0: "Hello World"

LIST 1
1 REM Open the ports this program will use

LIST 5-10
5 CLOSE ALL
10 OPEN #0: NAME: "SER" ! Restart the console
```

Comments The output of the LIST command may not match exactly what was entered. It is based on how the program lines are stored in memory. Notice that the last comment line the REM is entered in lower case characters. When it is listed, the REM is displayed in uppercase.

This is an interactive command that takes effect as soon as it is received by the printer.

AUTONUM

This command automatically generates sequential program line numbers.

Format AUTONUM <A>,

Parameters

A = the number used to start the auto-numbering sequence

B = the automatic increment between the new line numbers

Example This example shows specifying the starting line number in the increment between new line number. Type the following at the prompt:

```
AUTONUM 10,5
SUB START
PRINT "HELLO WORLD"
GOTO START
```

LIST

Will produce:

```
AUTONUM 10,5
10 SUB START
15 PRINT "HELLO WORLD"
20 GOTO START
```

The three lines are automatically started with the **AUTONUM** parameters; in this case, the first line starts with 10 and each subsequent line increments by 5.

Comments This feature is disabled by overwriting the current line number and entering the desired interactive mode commands, or leaving the line blank.

Use of the **SUB** command allows for **GOTO** and **GOSUB** statements that do not require line numbers in your program.

This is an interactive command that takes effect as soon as it is received by the printer.

RENUM

This command renumbers the lines of the program being edited. **RENUM** can reorganize code when line numbers become over- or under-spaced. The line references following **GOTO** and **GOSUB** statements are renumbered if they are constant numeric values. Renumbering does not occur if the line numbers are outside of the range limits of 1 to 10000.

Format `RENUM <A>, `

Parameters

<A> = the number to start the renumbering sequence

 = the automatic increment between the new line numbers

Example This is an example of how to use the `RENUM` command:

```
LIST
13 LET A=6
15 LET B=10
17 GOTO 13
RENUM 10,5
LIST
10 LET A=6
15 LET B=10
20 GOTO 10
```



NOTE: The target of the `GOTO` command changes from 13 to 10 to reflect the renumbering.

Comments This is an interactive command that takes effect as soon as it is received by the printer.

ECHO

When Console Mode is enabled, this command controls whether the printer echoes the characters back to the communications port. If **ECHO ON** is entered, keystroke results return to the screen. If **ECHO OFF** is entered, keystroke results do not return to the screen.

Format

ECHO ON

ECHO OFF

Parameters

<ON/OFF> = toggles the ECHO command on or off

Example N/A

Comments This can be an interactive command that takes effect as soon as it is received by the printer, or a program command that is preceded by a line number.

Running and Debugging Commands

The following commands were written before the development of the ZBI-Developer application. With that application, and when using ZBI version 1, the following commands are essentially obsolete. However, for those who started developing ZBI applications before ZBI-Developer, the following reference will be helpful.

RUN – Starts executing the program currently in memory at the first line of the program

CTRL-C Sends an end-of-transmission character, **ETX** , to the console to terminate the ZBI program currently running.

RESTART – Starts executing the program currently in memory where it was last stopped

STEP – Executes one line of the program in memory where it was last stopped

DEBUG – This mode controls whether or not the **TRACE** and **BREAK** commands are processed

TRACE – Shows which lines have been executed and which variables have been changed

BREAK – Stops the currently running program

ADDBREAK – Adds a break to an existing line

DELBREAK – Deletes an existing break

ZPL Terminates and exits the ZBI environment.

Example This example shows many of the Running and Debug Commands in practice.

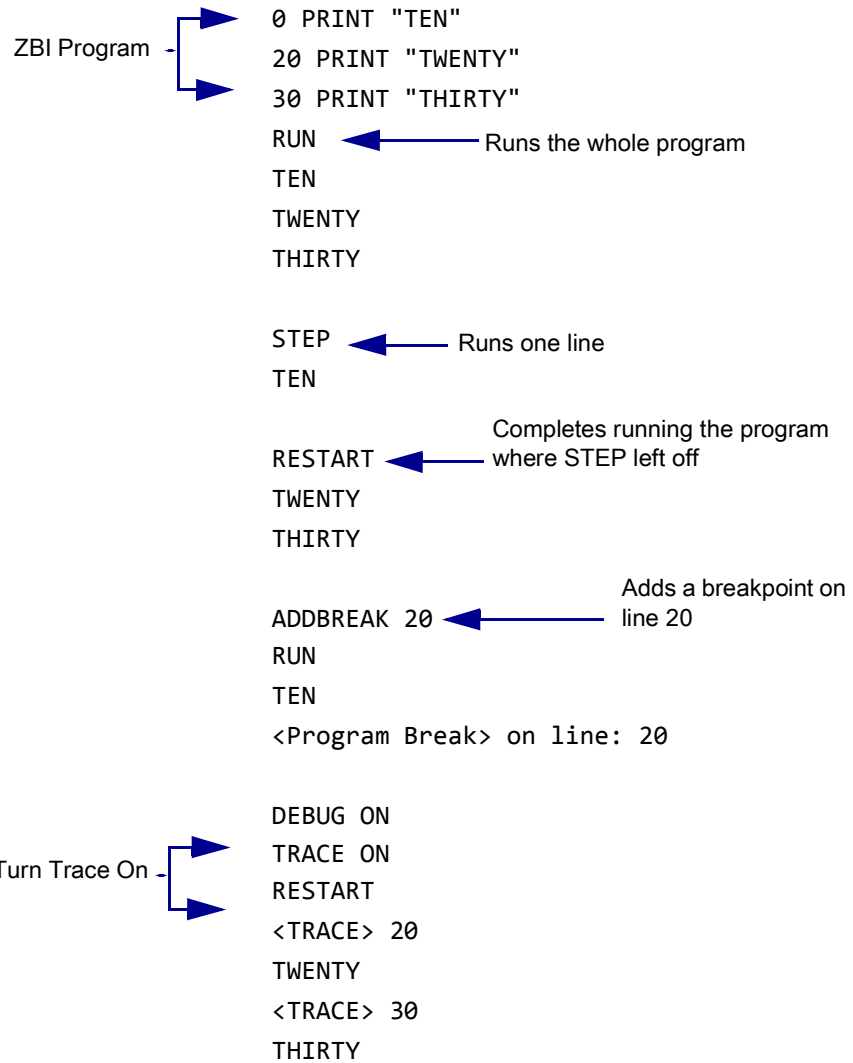

RUN

This command executes the current program, starting with the lowest line number. The interpreter will continue to execute the program lines in order unless a control statement directs the flow to a different point. When a higher line number does not exist or the END command is processed, the RUN command will stop.

Format RUN

Parameters N/A

Example This is an example of how to use the RUN command:

```
10 PRINT "ZBI"
20 PRINT "Programming"
RUN
ZBI
Programming

15 END
RUN
ZBI
```

Comments Ports that are open when the application is activated will remain open after the application has terminated. Variables also remain after the application has terminated.

To execute programs when the printer is powered on, use the ^JI command in the Autoexec.zpl file.

This is an interactive command that takes effect as soon as it is received by the printer.

CTRL-C

Sending an end-of-transmission character, ETX (3 in hex), to the console (port 0) terminates the ZBI program currently running.

Format N/A

Parameters N/A

Example N/A

Comments In most terminal programs, you terminate the program using the Ctrl-C key sequence. Another method is to store an ETX character in a file and have the terminal program send the file to the console port.



NOTE: It is not recommended to use RESTART after using a CTRL-C because a command may have been prematurely interrupted. Restarting will have an undefined result.

RESTART

If a program was halted by a break point or the **BREAK** command, the **RESTART** command can be used to reactivate the program at the point it stopped. **RESTART** functions similar to **RUN**, except the program attempts to restart from the point where it was last terminated. It also works in conjunction with the **STEP** command, picking up where the **STEP** command ended.

Format RESTART

Parameters N/A

Example An example of the **RESTART** command:

```
10 PRINT "TEN"
20 PRINT "TWENTY"
30 PRINT "THIRTY"
RUN
TEN
TWENTY
THIRTY
```

```
STEP
TEN
```

```
RESTART
TWENTY
THIRTY
```

```
ADDBREAK 20
RUN
TEN
```

```
<Program Break> on line: 20
```

```
DEBUG ON
TRACE ON
RESTART
<TRACE> 20
TWENTY
<TRACE> 30
THIRTY
```

Comments If the program has not been run or has finished, **RESTART** runs the program from the beginning. This is an interactive command that takes effect as soon as it is received by the printer.

STEP

If a program was stopped by a **BREAK** command, **STEP** attempts to execute the program one line from where it last ended. If the program has not been run or has been completed, this executes the lowest numbered line.

Format STEP

Parameters N/A

Example This is an example of how to use the **STEP** command:

```
10 PRINT "Hello World"
20 Print "TWENTY"
STEP
Hello World
```

```
STEP
TWENTY
```

Comments This is an interactive command that takes effect as soon as it is received by the printer.

DEBUG

DEBUG enables and disables the **TRACE** and **BREAK** commands.

Format

```
DEBUG ON
DEBUG OFF
```

Parameters

ON = turns the debug mode on enabling the **TRACE** and **BREAK** commands to be processed.

OFF = turns the debug mode off. This disables the **TRACE** mode and causes **BREAK** commands to be ignored.

Example See [TRACE on page 452](#) and [BREAK on page 453](#).

Comments This command has no effect on the processing of break points in ZBI-Developer. It is recommended that you avoid using the **DEBUG** command when writing programs in the ZBI-Developer environment, instead use the Debug capabilities of ZBI-Developer.

TRACE

This command enables you to debug an application by outputting the executed line numbers and changed variables to the console.

Format

```
TRACE ON
TRACE OFF
```

Parameters

<ON/OFF> = controls whether **TRACE** is active (ON) or disabled (OFF).

If **DEBUG** is activated and the **TRACE** command is on, trace details are displayed. When any variables are changed, the new value displays as follows:

```
<TRACE> Variable = New Value
```

Every line processed has its line number printed as follows:

```
<TRACE> Line Number
```

Example An example of **TRACE** command in use:

```
10 LET A=5
20 GOTO 40
30 PRINT "Error"
40 PRINT A
DEBUG ON
TRACE ON
RUN
<TRACE> 10
<TRACE> A=5
<TRACE> 20
<TRACE> 40
5
```

Comments This can be an interactive command that takes effect as soon as it is received by the printer, or a program command that is preceded by a line number.

It is recommended that you avoid using the **TRACE** command when writing programs in the ZBI-Developer environment, instead use the Debug capabilities of ZBI-Developer.

BREAK

This command allows you to stop the program when the program reaches this line.

Format BREAK

Parameters N/A

Example An example of BREAK command in use:

```
10 LET A=5
20 BREAK
30 PRINT A
DEBUG ON
TRACE ON
RUN
<TRACE> 10
<TRACE> A=5
<TRACE> 20
<USER BREAK>
```

Comments This command is available only when the **DEBUG** function has been activated. When **DEBUG** is on, **BREAK** halts processing. **RUN** starts the program from the beginning. **RESTART** allows the program to continue from where it left off.

When using ZBI-Developer, this command will interfere with the debugging operations built into the application.

This is a program command that must be preceded by a line number.

ADDBREAK



Description This command allows you to stop the program when the program reaches a specified line.

Format `ADDBREAK <A>`

Parameters

A = the line number to break on. If the number specified is not in the program, the program will not break.

Example An example of the ADDBREAK command.

```
10 LET A=5
20 PRINT A
ADDBREAK 20
RUN
<PROGRAM BREAK> ON LINE:20
```

```
RESTART
```

```
5
```

Comments This command is available only when the `DEBUG` function has been activated. When `DEBUG` is on, `BREAK` halts processing. `RUN` starts the program from the beginning. `RESTART` allows the program to continue from where it left off.

This is the command used internally by ZBI-Developer when the user right-clicks over a program line and adds a Breakpoint via the "Toggle Breakpoint" selection.

It is the recommended method for setting breakpoints in ZBI.

A maximum of 16 breakpoints can be set in an application.

This is an interactive command that takes effect as soon as it is received by the printer.

DELBREAK



This command allows you to remove existing breakpoints.

Format DELBREAK <A>

Parameters A = the line number from which to remove the break. If 0 is specified, all break points will be removed. If the number specified is not a breakpoint, the command will have no effect.

Example An example of the DELBREAK command:

```
10 LET A=5
20 PRINT A
ADDBREAK 20
DEBUG ON
TRACE ON
RUN
<TRACE> 10
<TRACE> A=5
<PROGRAM BREAK> ON LINE:20
```

```
RESTART
<TRACE> 20
5
```

```
DELBREAK 20
RUN
<TRACE> 10
<TRACE> A=5
<TRACE> 20
5
```

Comments This command is available only when the `DEBUG` function has been activated. When `DEBUG` is on, `BREAK` halts processing, `RUN` starts the program from the beginning, and `RESTART` allows the program to continue where it left off.

This is the command used internally by ZBI-Developer when the user right-clicks over a program line and removes a Breakpoint via the "Toggle Breakpoint" selection.

A maximum of 16 breakpoints can be set in an application.

This is an interactive command that takes effect as soon as it is received by the printer.

ZPL

This command terminates and exits the ZBI environment.

Format ZPL

Parameters N/A

Example An example of the ZPL command.

ZPL

ZBI TERMINATED

Comments This is an interactive command that takes effect as soon as it is received by the printer.

Base Types and Expressions

There are two base types in the ZBI language. These types are Integers and Strings. Integers are whole numbers that contain no fractional part. The range of values for integers is:

-2,147,483,648 to +2,147,483,647

Strings are character arrays. The string length is only limited by the amount of memory in the system (version 2.0 and higher). Each character can have a value between 0 and 255 (version 2.0 and higher).

The use of control characters (0-31) may be difficult to debug based on the handling of control characters in different communications programs. In addition the ETX (3) will terminate a ZBI application when it is received on the console port. Use the CHR\$ function when control characters must be placed into strings.



NOTE: In ZBI version 1.4 and lower, there was a string length limit of 255 characters.

This section is organized as follows:

- Variable Names
- Variable Declarations
- Constants
- Arrays
- Assignment
- Numeric Expressions
- String Concatenation (&)
- Sub-strings
- Boolean Expressions
- Combined Boolean Expressions

Variable Names

To distinguish strings from integers, string variable names must end in a \$. Variable names must start with a letter and can include any sequence of letters, digits, and underscores. Function and command names must not be used as a variable name. Variable names are not case sensitive and are converted to uppercase by the interpreter.

A common mistake is to use a command or function name as a variable. To avoid using these reserved words, ZBI-Developer can be a useful resource. Reserved words are highlighted making it easier to spot this occurrence and thus, saving debugging time.

Valid variable names:

I, J, K, VARNAME, VARSTR\$, MYSTR\$,MY_STR9\$

Invalid Names:

STR\$ = Reserved word

ORD = Reserved word

VAL = Reserved word

W# = Invalid character (#)

9THSTR = Variable can not start with a number

Variable Declarations

ZBI will allow storage of up to 255 variables. If more variables are needed, consider using arrays to store data. The base array will take up one of the 255 variable slots, but it can be declared to allow for many indices.

Variables can be declared explicitly or implicitly. If a variable has not been used before, it will be declared when used. The default value for an integer will be zero and the default value of a string will be an empty string.

Explicit:

```
DECLARE NUMERIC <variable_name>
```

```
DECLARE STRING <variable_name$>
```

If the variable existed before the DECLARE statement, it will be defaulted.

Implicit:

```
LET <variable_name> = NUMERIC EXPRESSION
```

```
LET <variable_name$> = STRING EXPRESSION
```

The Interpreter is limited to 255 variables. If more variables are required, consider using arrays.

Constants

Integers are represented simply by numbers, such as 5, -10, 10000. Do not use commas in integer constants. Strings are enclosed by quotes. If a quote is required in the string, use double quotes, such as "Look here->"<- would result in the string – Look here->"<-.

Arrays

An array is a collection of string or integer values used by a program. Array indices are accessed through parentheses. Array indices start at 1 and end at the length of an array (for example, MyArray(3) returns the value in the third location of the variable array). One- and two-dimensional arrays are allowed. Two-dimensional arrays are referenced with two indices in parentheses, separated by a comma.

Arrays must be allocated through the use of the **DECLARE** command. Arrays can be re-dimensioned by using **DECLARE**, however, this will replace the original array.

Array size is limited only by the size of the memory available.

Format

```
DECLARE STRING <ARRAYNAME$>(<SIZE>)
DECLARE STRING <ARRAYNAME$>(<ROWS>,<COLUMNS>)
DECLARE NUMERIC <ARRAYNAME>(<SIZE>)
DECLARE NUMERIC <ARRAYNAME>(<ROWS>,<COLUMNS>)
```

Parameters

<SIZE> = number of entries in a single dimension array
 <ROWS> = number of rows in a two dimensional array
 <COLUMNS> = number of columns in a two dimensional array

Example An example of ARRAY code is:

```
10 DECLARE STRING INARRAY$(3)
20 FOR I = 1 TO 3
30 PRINT "Name "; I; ": ";
40 INPUT INARRAY$(I)
50 NEXT I
60 PRINT INARRAY$(1); ", "; INARRAY$(2); ", and "; INARRAY$(3);
70 PRINT " went to the park"
RUN
Name 1: Jim
Name 2: Jose
Name 3: Jack
Jim, Jose, and Jack went to the park
```

Comments If you attempt to access an array outside of its allocated bounds, an error will occur.

Assignment

All lines must start with a command. In order to assign a value to a variable, use the LET command. Multiple variables can be placed before the =. The variable types must match the expression type.

The right side of the assignment is always calculated completely before the assignment is made. This allows a variable to be the target and source of the assignment.

When a value is assigned to a string variable with a sub-string qualifier, it replaces the value of the sub-string qualifier. The length of the value of the string variable may change as a result of this replacement.

Example An ASSIGNMENT example:

```
10 LET A=5
20 LET B$="HELLO"
30 LET B$(5:5)=B$
```

LET

The LET command is used to assign value to a specific variable. The expression is evaluated and assigned to each variable in the variable list. See [Assignment on page 460](#).

Format

```
LET <variable> [,<variable>]* = <expression>
```

The variable types must match the expression type or an error message will be displayed.

Error: Poorly formed expression.

When a value is assigned to a string variable with a sub-string qualifier, it replaces the value of the sub-string qualifier. The length of the value of the string variable may change as a result of this replacement.

Parameters N/A

Example This is an example of how to use the LET command:

```
10 LET A$= "1234"
15 LET A$(2:3)= "55" ! A$ NOW = 1554
20 LET A$(2:3)= "" ! A$ NOW = 14

10 LET A$= "1234"
15 LET A$(2:3)= A$(1:2) ! A$ NOW = 1124

10 LET A$= "1234"
15 LET A$(2:1)= "5" ! A$ NOW = 15234
```

Comments This can be an interactive command that takes effect as soon as it is received by the printer, or a program command that is preceded by a line number.

Numeric Expressions

A base numerical expression can be either a constant, variable, or another numerical expression enclosed in parentheses. The five types used (addition, subtraction, multiplication, division, and exponentiation) are listed below. When evaluating an expression exceeding the maximum or minimum values at any point creates an undefined result. (maximum value: 2,147,487,647; minimum value: -2,147,483,648)

Floating point is not supported.

When using division, the number is always rounded down. For example, $5/2=2$. Use **MOD** to determine the remainder.

Format

1. + (addition) Addition expressions use this format:

$\langle A \rangle + \langle B \rangle$

5+2 result = 7

VAL ("25") +2 result =27

2. - (subtraction) Subtraction expressions use this format:

$\langle A \rangle - \langle B \rangle$

5-2 result = 3

VAL ("25") -2 result =23

3. * (multiplication) Multiplication expressions use this format:

$\langle A \rangle * \langle B \rangle$

5*2 result = 10

VAL ("25") *2 result =50

4. / (division) Division expressions use this format:

$\langle A \rangle / \langle B \rangle$

5/2 result = 2

VAL ("25") /2 result =12

5. ^ (exponentiation) Exponentiation expressions use this format:

$\langle A \rangle ^ \langle B \rangle$

5^2 result = 25

VAL ("25") ^2 result =625

Order of Precedence

In mathematics, the order of precedence describes the sequence that items in an expression are processed. All expressions have a predefined order of precedence.

The order of precedence is listed below:

Functions

Parenthetical Expressions ()

^

* and /

+ and -

The * and / have the same precedence, and the + and - have the same precedence. Items with the same order of precedence are processed from left to right.

For example, this expression $5+(8+2)/5$ is processed as $8+2=10$, followed by $10/5=2$, then $5+2$ to give a result of 7.

Functions and parenthetical expressions always have the highest order of precedence, meaning that they are processed first.

String Concatenation (&)

The basic string expression may be either a constant or a variable, and concatenation (&) is supported. Using the concatenation operator (&) adds the second string to the first string.

`<A$> & <B$>`

Example This is an example of how to use the `STRING CONCATENATION (&)` command:

```
10 LET A$= "ZBI-"
20 LET B$= "Programming"
30 LET C$= A$ & B$
40 PRINT C$
RUN
ZBI-Programming
```

Sub-strings

Using a sub-string operator on a string allows a specific portion of the string to be accessed. This portion may be the target of an assignment operation or a reference to a portion of the string. To determine the coordinates of the string portion to be used, count the characters from the beginning to the end of the string, including spaces.

Format

```
LET <STRVAR$>(<A>:<B>)=<C$>
```

```
LET <C$> = <STRVAR$>(<A>:<B>)
```

Parameters

<A> = the position of the first character in the desired string

 = the position of the last character in the desired string.

<STRVAR\$> = base string variable

If the A parameter is less than 1, it is automatically assigned a value of 1. Because the string is calculated starting with 1, the A parameter cannot be less than 1.

If B is greater than the length of the string, it is replaced with the length of the string.

If A is greater than B, a NULL string (""), which points to the location of the smaller of A or the end of the string, is returned. This is used when adding a string in the middle of another string without removing a character.

Example This is an example of a sub-string reference:

```
LET A$="Zebra Quality Printers"
LET B$=A$(1:13)
PRINT B$
Zebra Quality
```

This is an example of a sub-string assignment.

```
LET A$= "1234"
LET A$(2:3)= "55" ! A$ NOW = 1554
LET A$(2:3)= "" ! A$ NOW = 14
```

```
LET A$= "1234"
LET A$(2:3)= A$(1:2) ! A$ NOW = 1124
```

```
LET A$= "1234"
LET A$(2:1)= "5" ! A$ NOW = 15234
```

The best way to think of assignment to a sub-string is as follows: an assignment is like selecting a word, and pasting over the selection with the new string.

Boolean Expressions

A Boolean expression holds 0 (zero) as false and non-zero as true.

Formats

<STRING EXPRESSION> <BOOLEAN COMPARE> <STRING EXPRESSION>
 <NUMERIC EXPRESSION> <BOOLEAN COMPARE> <NUMERIC EXPRESSION>
 NOT(<BOOLEAN EXPRESSION>)

Parameters

<STRING EXPRESSION> = a string variable, string constant or any combination with concatenation

<NUMERIC EXPRESSION> = any mathematical operation

Comments A numeric expression cannot be compared to a string expression.

Numeric expressions can substitute a Boolean expression where a value of 0 (zero) represents false and a non-zero value represents true.

Base Boolean expressions:

1. < (less than)

Expression	Result
1 < 2	true
2 < 2	false
2 < 1	false

2. <= (less than or equal to)

Expression	Result
1 <= 2	true
2 <= 2	true
2 <= 1	false

3. > (greater than)

Expression	Result
1 > 2	false
2 > 2	false
2 > 1	true

4. >= (greater than or equal to)

Expression	Result
1 >= 2	false
2 >= 2	true
2 >= 1	true

5. = (equal to)

Expression	Result
1=2	false
2=2	true
"A"="AA"	false
"A"="A"	true

6. <> (not equal to)

Expression	Result
1<>2	true
2<>2	false
"A"<>"AA"	true
"A"<>"A"	false

Combined Boolean Expressions

AND, OR, and NOT can be used in conjunction with base Boolean expressions to recreate expanded Boolean expressions.

1. NOT — Negate the target expression.

Expression	Result
NOT 1=2	true
NOT 1=1	false

2. AND — Both expressions must be true for a true result.

Expression	Result
1=2 AND 1=2	false
2=2 AND 1=2	false
1=2 AND 2=2	false
2=2 AND 2=2	true

3. OR — If either expression is true, the result will be true.

Expression	Result
1=2 OR 1=2	false
1=2 OR 2=2	true
2=2 OR 1=2	true
2=2 OR 2=2	true

Order of Precedence

The order of precedence is listed below:

Expressions and Functions

Parenthetical expressions ()

<, <=, <>, =, =>, >

NOT, AND, OR

Control and Flow

This section outlines the commands to conditionally execute code and control the flow of the program. Here is a quick list of these commands:

IF Statements Executes or skips a sequence of statements, depending on the value of a Boolean expression.

DO Loops Repeats instructions based on the results of a comparison.

FOR Loops A control flow statement which allows code to be executed iteratively.

GOTO/GOSUB Causes an unconditional jump or transfer of control from one point in a program to another.

SUB Allows you to “substitute” names instead of actual line numbers as the target of **GOSUBS** and **GOTOS**.

EXIT Used to exit the **DO** and **FOR** loops.

END Terminates any program currently running.

IF Statements

If the value of the **<Boolean expression>** in an **IF** statement is true and a program line follows the keyword **THEN**, this program line is executed. If the value of the Boolean expression is false and a program line follows the keyword **ELSE**, this program line is executed. If **ELSE** is not present, then execution continues in sequence, with the line following the **END IF** statement.

Nesting of blocks is permitted, subject to the same nesting constraints as **DO-LOOPS** (no overlapping blocks).

ELSE IF statements are treated as an **ELSE** line followed by an **IF** line, with the exception that the **ELSE IF** shares the **END IF** line of the original **IF** statement.

Format

```
IF <Boolean expression> THEN
  ~~BODY~~
[ELSE IF <Boolean expression> THEN
  ~~BODY~~]*
[ELSE
  ~~BODY~~]
END IF
```

Parameters N/A

Example This is an example of how to use the **IF** statement command:

```
10 IF A$="0" TyHEN
20 PRINT "ZBI IS FUN"
30 ELSE IF A$="1" THEN
40 PRINT "ZBI IS EASY"
50 ELSE IF TIME=1 THEN
60 PRINT "It is one second past midnight"
70 ELSE
80 PRINT "X=0"
90 END IF
```

DO Loops

Processing of the loop is controlled by a **<WHILE/UNTIL>** expression located on the **DO** or **LOOP** line.

Processing a **WHILE** statement is the same on either the **DO** or **LOOP** lines. The Boolean expression is evaluated and if the statement is true, the **LOOP** continues at the line after the **DO** statement. Otherwise, the line after the corresponding **LOOP** is the next line to be processed.

Processing an **UNTIL** statement is the same on either the **DO** or **LOOP** lines. The Boolean expression is evaluated and if the statement is false, the **LOOP** continues at the line after the **DO** statement. Otherwise, the line after the corresponding **LOOP** is the next to be processed.

If **<WHILE/UNTIL>** is on the **LOOP** line, the **BODY** of the loop is executed before the Boolean expression is evaluated.

If neither the **DO** or **LOOP** line has a **<WHILE/UNTIL>** statement, the loop continues indefinitely.

Some notes about **DO-LOOPS**:

- can be nested
- cannot overlap
- have two formats

Format

```
DO [<WHILE/UNTIL> <Boolean expression>]
```

```
~~BODY~~
```

```
LOOP [<WHILE/UNTIL> <Boolean expression>]
```

Example This is an example of how to use the **DO-LOOP** command with the conditional on the **DO** line:

```
10 DO WHILE A$="70"
20 INPUT A$
30 LOOP
```

Example This is an example of how to use the **DO UNTIL LOOP** command with conditional on the **LOOP** line:

```
10 DO
20 INPUT A$
30 LOOP UNTIL A$="EXIT"
```

Comments This is a program command that is preceded by a line number.

FOR Loops

FOR loops are an easy way to iterate through a range of values and run a body of code for each value iterated.

Format

```
FOR <I> = <A> TO <B> [STEP <C>]
  ~~BODY~~
NEXT <I>
```

Parameters

<I> = indicates a numeric variable is used. <I> increments each time through the **FOR-LOOP**.

<A> = the value assigned to <I> the first time through the loop

 = the last value through the loop

<C> = (Optional) the amount <I> increments each time through the loop

Values of **I** for the following situations:

Statement	Result
FOR I=1 TO 10	{1, 2, 3, 4, 5, 6, 7, 8, 9, 10}
FOR I=10 TO 1	{10, 9, 8, 7, 6, 5, 4, 3, 2, 1}
FOR I=1 TO 10 STEP 2	{1, 3, 5, 7, 9}
FOR I=10 TO 1 STEP 2	{10, 8, 6, 4, 2}
FOR I=10 TO 1 STEP 2	{ } FOR LOOP skipped

Example This is an example of how to use the **FOR LOOP** command:

```
10 FOR X=1 TO 10 STEP 1
20 PRINT X; ":ZBI IS FUN"
30 NEXT X
```

Comments **FOR** loops can be nested but cannot overlap. Variables cannot be reused by the nested loops.

GOTO/GOSUB

GOSUB is followed by a line number. The program will attempt to process the line the **GOSUB** command points to rather than the next line of the program. Upon executing the **GOSUB** statement, the interpreter continues running at the line number specified following **GOSUB**. If the line number referenced does not exist, an error will occur.

Before executing the next line, the **GOSUB** command stores the line number of the **GOSUB** line. When the **RETURN** statement is called, the program moves back to the next line following the **GOSUB**.

Executing a **RETURN** statement without a corresponding **GOSUB** statement causes an error.

GOSUB statements can be nested.

GOTO works the same way as **GOSUB** except that no return address will be stored.

Format

```
GOSUB <A>
RETURN
GOTO <A>
```

Parameters <A> = the program location executed immediately after the **GOTO** or **GOSUB**.

Example This is an example of how to use the **GOSUB** command:

```
10 PRINT "Call Subroutine"
20 GOSUB 1000
30 PRINT "Returned from Subroutine"
40 END
1000 PRINT "In Subroutine"
1010 RETURN
```

Example This is an example of how to use the **GOTO** command:

```
10 PRINT "Prepare to Jump!"
20 GOTO 1000
30 PRINT "Jump Missed..."
1000 PRINT "Jump Successful"
1010 END
```

Comments These are program commands and must be preceded by line numbers.

SUB



This command allows you to use names instead of actual line numbers as the target of **GOSUBs** and **GOTOs**. **AUTONUM** can be used at the beginning of a file and there is no need to compute the line number where the jump will go.

Format 10 SUB <A>

Parameters <A> = the integer variable to use as a target for the **GOTO/GOSUB**

Example This is an example of how to use the **SUB** command:

```
AUTONUM 1,1
GOSUB INITCOMM
DO
GOSUB GETINPUT
GOSUB PROCESSINPUT
LOOP
SUB INITCOMM
OPEN #1:NAME "SER"
RETURN
SUB GETINPUT
INPUT #1: A$
RETURN
SUB PROCESSINPUT
PRINT A$
RETURN
```

Comments <A> is a numeric variable. If this variable is changed in the program, any **GOSUB/GOTO** to this variable may fail.

EXIT

This command is used to exit the **DO** and **FOR** loops.

Format

```
EXIT DO
EXIT FOR
```

Parameters The specified loop type is exited. For the **DO** command, the program will continue execution on the line following the next **LOOP**. Likewise for the **FOR** command, the program will continue on the line after the next **NEXT** command.

Example N/A

Comments This is a program command that is preceded by a line number. To be explicit and reduce errors, it is recommended to use **GOTO** instead of **EXIT**.

END

The **END** command terminates any program currently running. When the **END** command is received, the interpreter returns to interpreting commands (>).

Format END

Parameters N/A

Example This is an example of how to use the **END** command:

```
10 PRINT "THIS PROGRAM WILL TERMINATE"  
20 PRINT "WHEN THE END COMMAND IS RECEIVED"  
30 END  
40 PRINT "THIS SHOULD NOT PRINT"  
RUN  
THIS PROGRAM WILL TERMINATE  
WHEN THE END COMMAND IS RECEIVED
```

Comments This is a program command and is preceded by a line number.

Input and Output

This section outlines how to communicate with physical ports, internal ports, and the network.

ZBI allows access to the physical and network connections in the printer. Most ports are, by default, connected to the ZPL processor. When a port is opened in ZBI, the port will be disconnected from ZPL and connected into the interpreter. Depending on the type of connection, there are two methods you may use to start the connection. For the static connections, the **OPEN** command should be used. These are the connections that you open when starting your program and leave open for the duration of your program. For dynamic connections, servers and clients are set up following the "Sockets" model. On servers, the actual connections are started upon successful calls to **ACCEPT**. Below are the available connections that can be made and the preferred accessors.

Available Ports

Port/Connection	ZBI Name	Preferred Access Commands/Functions
Serial	"SER"	OPEN, CLOSE
Parallel	"PAR"	OPEN, CLOSE
USB	"USB"	OPEN, CLOSE
ZPL parser	"ZPL"	OPEN, CLOSE
TCP Server	"TCP", "TCPX"	SERVERSOCKET, SERVERCLOSE, ACCEPT, CLOSE
TCP Client	"TCP"	CLIENTSOCKET, CLOSE
UDP Server	"UDP"	SERVERSOCKET, SERVERCLOSE, ACCEPT, CLOSE
UDP Client	"UDP"	CLIENTSOCKET, CLOSE
Email Sender	"EML"	OPEN, CLOSE
Bluetooth	"BLU"	OPEN, CLOSE

Note: TCPx will not work on PS2 or PS100 print servers.

Creating Connections

Here is a quick list of the commands in this section:

OPEN Opens a port for transmitting and receiving data.

CLOSE Closes specific ports that are in use.

DATAREADY Determines if there is data received on a specified port.

SERVERSOCKET Opens a listening socket for incoming UDP packets or TCP connections.

SERVERCLOSE Closes a listening server socket.

CLIENTSOCKET Creates an outgoing TCP connection or sets up UDP transmissions.

ACCEPT Accepts incoming TCP or UDP connections and assigns a channel for the connection.

OPEN

This command is used to open a port for transmitting and receiving data.

Format OPEN #<CHANNEL>: NAME <PORT\$>

Parameters

<CHANNEL> = a number to use as a handle to the port for all future communications

Values: 0 to 9

Default: a port must be specified

<PORT\$> = port name to open. See [Available Ports on page 473](#).

Example This is an example of how to use the OPEN command:

```
10 OPEN #1: NAME "ZPL"
```

The port being opened no longer allows data to pass directly into its buffer, it disconnects, and the interpreter now controls the data flow.

Data already in the buffer stays in the buffer.

Comments This can be an interactive command that takes effect as soon as it is received by the printer, or a program command that is preceded by a line number.

CLOSE

This command is implemented to close specific ports that are in use. If a port is open on a channel and the CLOSE command is entered, the port closes and returns to communicating with the ZPL buffer.

Format

CLOSE #<A>

CLOSE ALL

Parameters

<A> = Numeric value of port to close

Values: 0 through 9

ALL = closes all open ports and network connections



NOTE: CLOSE ALL will close the console.

Example This example shows the closing of channel 1:

```
10 CLOSE #1
```

Comments This can be an interactive command that takes effect as soon as it is received by the printer, or a program command that is preceded by a line number.

DATAREADY

This function is used to determine if there is data received on a specified port.

Format DATAREADY (A)

Parameters A = the port to check

Returns 1 if there is data, 0 if there is no data.

Example This is an example of how to check if there is a data on a port:

```
10 PRINT DATAREADY(0)
```

```
RUN
```

The result, assuming no data is waiting, is:

```
0
```

Comments If this command follows the **INPUT** command, it may return 1 if the line received was ended with a CRLF. In this case, **INBYTE** can be used to take the LF out of the buffer.

SERVERSOCKET



This function opens a listening socket for incoming UDP packets or TCP connections. It must be used in conjunction with the **ACCEPT** function.

Format SERVERSOCKET (TYPE\$,PORT)

Parameters

TYPE\$ = listens for any of the following communication protocols:

"TCP" = TCP – PORT parameter is ignored. The current port will be used.

"TCPX" = TCP – any open port

"UDP" = UDP – any open port

Returns

NUMERIC = returns the handle of the server upon success.

Example See the examples for [TCP Server on page 489](#) and [UDP Server on page 491](#).

Comments When using **TCPX**, care needs to be taken not to use a port that is already open on the printer. No error message will be returned until the **ACCEPT** function is called.

SERVERCLOSE



This function closes a listening server socket created by SERVERSOCKET.

Format SERVERCLOSE(SOCKET)

Parameters

SOCKET = the socket handle returned from a successful SERVERSOCKET invocation.

Returns Returns a 0 if the socket was already closed or a 1 if the socket was closed successfully.

Example This example shows how to close a listening server socket.

```
10 LET SERVER_HANDLE = SERVERSOCKET("TCPX", 19100)
20 LET SCERR = SERVERCLOSE(SERVER_HANDLE)
```

CLIENTSOCKET



This function creates an outgoing TCP connection or sets up UDP transmissions. Once set up for UDP, packets can be sent by printing to the socket. Packets are sent when the size limit is met or a EOT character is written.

Format CLIENTSOCKET (TYPE\$, IPADDR\$, PORT)

Parameters

TYPE\$ = set to "UDP" or "TCP".

IPADDR\$ = connects to this address.

PORT = connects to this IP port.

Returns The port number assigned to the connection.

Example See the examples for [TCP Server on page 489](#) and [UDP Server on page 491](#).

Comments Multiple communications connections can be made up to the maximum of 10. Each protocol may have a different limit based on the support of the print server used. Test the worst case situation based on your application's needs or use **ONERROR** to recover from failed connection attempts.

ACCEPT



This function will accept incoming TCP or UDP connections and assign a channel for the connection. **SERVERSOCKET** must be used to set up the listening socket before **ACCEPT** can be used.

Format `ACCEPT (SERVER, CLIENT_INFO$)`

Parameters

SERVER = the handle returned by the **SERVERSOCKET** call.

CLIENT_INFO\$ = string variable will have the connecting client's IP address and port separated by a space when using UDP.

Returns The channel number to use to communicate with the client.

Example See the examples for [TCP Server on page 489](#) and [UDP Server on page 491](#).

Comments It is best to poll this function at regular intervals. When there is no connection waiting, this function will trigger an error. Follow this function with the **ON ERROR** command to divert to a section of code that handles an unsuccessful connection.

ACCEPT can be called before closing a previous connection. This allows for processing multiple incoming streams of data. There are limits on the number of simultaneous incoming connections based on the print server model on the printer.

Connection closure can be detected when any input or output command to the port triggers an error. These commands should be followed by an **ON ERROR** statement to send the program into a recovery state and to shutdown the connection cleanly.

Reading and Writing

This manual has detailed various functions to read and write to all of the ports. The following section gives an overview of the commands, functions, and when each should be used.

To start, it is important to understand the term "blocking". In communications code, a function or command is "blocking" if it waits for all of the requested data to be received before it returns.

INPUT (blocking) Reads one line into each string specified.

PRINT (blocking) Simple method to write specified expressions out.

OUTBYTE (blocking) Writes one byte out.

INBYTE (blocking) Reads in one byte.

READ (non-blocking) Reads in all available data up to the maximum amount specified.

WRITE (non-blocking) Writes out as much data as possible up to a maximum specified amount.

SEARCHTO\$ (blocking) Reads in data (does not keep) until a search parameter is found. Non-matching data can be redirected to another port.

INPUT

If the variable is numeric and the value entered cannot be converted to a number, it writes as 0. This operation scans the data from left to right, shifting any number into the variable. It ignores any non-numeric character except the return character, which terminates the input, or Ctrl-C (^C) which terminates the program. The variable can be in string or numeric form.

Format

```
INPUT [<CHANNEL>:] <A$> [,<B$>]*
```

```
INPUT [<CHANNEL>:] <A>[,<B>]*
```

If the [<channel>:] is omitted, the default port, 0, will be used.

Parameters

<CHANNEL> = read data from this port. Default = 0.

<A,B,...,N> = variables to write.

When using multiple variables as targets, a corresponding number of lines are read. String and numeric variables can be intermixed.

Example This is an example of how to use the `INPUT` command:

```
10 OPEN #1: NAME "ZPL"
20 PRINT #1: "~HS"
30 FOR I = 1 TO 3
40 INPUT #1: A$
50 PRINT A$
60 NEXT I
```

In this example, a host status prints to the console after submitting the host status request `~HS` to the ZPL port. The Input/Output command of the ZBI interpreter is limited to the communications ports. File I/O is not supported.

`INPUT` ends processing a line with a `CR` or `LF`. This leads to a tricky situation. There are many ways different systems end a line: `CR`, `CRLF`, `LF`. If the ZBI program only uses `INPUT`, the next execution of the `INPUT` command will remove the extra `LF` or `CR`, in case of `LFCR`. However, if the program instead uses `INBYTE`, `DATAREADY` or the other commands, the extra `LF` will show up on the port. Here's a simple workaround to explicitly look for the `CRLF` that is in use:

```
SEARCHTO(<PORT>,CHR$(13)&CHR$(10),<INSTRING$>)
```



NOTE: The `INPUT` command does not accept control characters or the delete character. If these characters need to be processed, use the `READ` command.

Comments This can be an interactive command that takes effect as soon as it is received by the printer, or a program command that is preceded by a line number.

If an invalid port is specified, **Error: Invalid port** is returned.

Example This shows the input command reading in multiple lines.

```
10 INPUT A$,B,C,D$,E$
```

Five lines would be read in: 3 strings and 2 numbers.

PRINT

This command sends data to the printer to be printed.

Format PRINT [CHANNEL:] <expression> [,or; <expression>]* [;]

Parameters

<CHANNEL> = write data to this port

<expression> = the value to write

The expression can be either a string or a numeric expression.

Using a , to separate expressions adds a space between them.

Using a ; to separate expressions does not put a space between them.

Using a ; at the end of a line ends the print statement without adding a new line (CR/LF).

Example This is an example of how to use the PRINT command:

```
10 LET A$ = "This is an example"
20 LET B$ = "of the PRINT Command."
30 PRINT A$, B$ ! adds a space between expressions
40 PRINT A$; B$ ! no space added
RUN
```

The result is:

This is an example of the PRINT Command.

This is an example of the PRINT Command.

Comments This can be an interactive command that takes effect as soon as it is received by the printer, or a program command that is preceded by a line number.

OUTBYTE

This command outputs a byte to a port.

Format

```
OUTBYTE [<CHANNEL>:] <A>
```

```
OUTBYTE [<CHANNEL>:] <A$>
```

Parameters

<CHANNEL> = sends the byte to this port. Default = 0.

<A> = This is a numeric expression.

Values 0 through 255. If it is not within that range, it is truncated.

<A\$> = This is the string expression. The first character is used. In the case of a NULL string, 0 is sent.

Example This is an example of how to use the `OUTBYTE` command:

```
LET A$="Hello"
```

```
OUTBYTE A$
```

This would only print the H character to the console.

```
OUTBYTE 4
```

This would print the control character `EOT` to the console. See an ASCII table for a list of the control characters.

Comments This can be an interactive command that takes effect as soon as it is received by the printer, or a program command that is preceded by a line number.

INBYTE

This command forces the interpreter to pause until data is available. Use the `DATAREADY` function to determine if there is data on the port.

Format

```
INBYTE [<CHANNEL>:] <A>
INBYTE [<CHANNEL>:] <A$>
```

Parameters

<CHANNEL> = reads from this port. Default = 0.

<A> = integer value is set to the byte received.

<A\$> = A single byte string is created with the byte received. The first character is used. In the case of a NULL string, 0 is sent.

Example This is an example of how to use the `INBYTE` to create an echo program:

```
10 INBYTE A$ !Takes one byte (char) from port #0
20 PRINT A$ !Prints the character to the console
30 GOTO 10
```

In this example, the interpreter pauses until the data is entered, then continues processing. This command enters all bytes in a string or integer, including control codes.

Comments `INBYTE` will block until a byte is received on the specified port. This can be an interactive command that takes effect as soon as it is received by the printer, or a program command that is preceded by a line number.

READ



Description This is a non-blocking input function. It will read in all of the bytes available on the specified port.

Format READ (<CHANNEL>, <A>, <MAXBYTES>)

Parameters

- <CHANNEL> = reads from this port. Default = 0.
- <A\$> = the string where the data will be placed
- <MAXBYTES> = the maximum number of bytes to read

Returns The number of bytes read.

Example This is an example of the READ command:

```

1 CLOSE ALL
2 LET INPORT = CLIENTSOCKET("TCP", "192.168.0.1", 9100)
3 ON ERROR GOTO RECOVERY
4 LET WATERMARK = 5000
5 DO WHILE 1
6 IF LEN(DATA$) < WATERMARK THEN
7 LET BYTESREAD = READ(INPORT, DATA$, 500)
8 ON ERROR GOTO RECOVERY
9 END IF
10 IF (LEN(DATA$) > 0) THEN
11 LET BYTES_WRITTEN = WRITE(INPORT, DATA$, LEN(DATA$))
12 ON ERROR GOTO RECOVERY
13 LET DATA$(1, BYTES_WRITTEN) = ""
14 END IF
15 IF BYTESREAD = 0 AND BYTESWRITTEN = 0 THEN
16 SLEEP 1 ! DON'T BOMBARD IF IDLE
17 END IF
18 LOOP
19 SUB RECOVERY
20 CLOSE #INPORT

```

WRITE



Description This is a non-blocking output function. It will write as many bytes as the output buffer can hold.

Format WRITE (<CHANNEL>, <A>, <BYTES>)

Parameters

<CHANNEL> = reads from this port. Default = 0.

<A\$> = the string to write out.

<MAXBYTES> = The number of bytes to write

Returns The number of bytes written.

Example This is an example of WRITE command:

```

1 CLOSE ALL
2 LET INPORT = CLIENTSOCKET("TCP", "192.168.0.1", 9100)
3 ON ERROR GOTO RECOVERY
4 LET WATERMARK = 5000
5 DO WHILE 1
6 IF LEN(DATA$) < WATERMARK THEN
7 LET BYTESREAD = READ(INPORT, DATA$, 500)
8 ON ERROR GOTO RECOVERY
9 END IF
10 IF (LEN(DATA$) > 0) THEN
11 LET BYTES_WRITTEN = WRITE(INPORT, DATA$, LEN(DATA$))
12 ON ERROR GOTO RECOVERY
13 LET DATA$(1, BYTES_WRITTEN) = ""
14 END IF
15 IF BYTESREAD = 0 AND BYTESWRITTEN = 0 THEN
16 SLEEP 1 ! DON'T BOMBARD IF IDLE
17 END IF
18 LOOP
19 SUB RECOVERY
20 CLOSE #INPORT

```

SEARCHTO\$

This function performs a search until a specified string is found. The string the search yields is displayed.

Format

```
SEARCHTO$(A, B$)
SEARCHTO$(A, B$, C)
SEARCHTO$(A$, B$)
SEARCHTO$(A$, B$, C$)
```

Parameters

A = port number (0 to 9) to which requested data is sent

A\$ = string to search for B\$

B\$ = string variable or string array. If B\$ is an array, this command searches for all non-null strings in the B\$ array.

C = a port in which the input is directed until B\$ is found

C\$ = a string in which the characters in A\$ are directed until B\$ is found

Returns The string found.

Example This example shows how to use **SEARCHTO** to find a string on a port:

```
10 OPEN #1: NAME "SER"
20 LET A$ = SEARCHTO$(1, "^XA")
30 PRINT "FOUND:", A$
```

Example This example shows how to search for an array of strings:

```
10 OPEN #1: NAME "SER"
20 DECLARE STRING FIND$(3)
30 LET FIND$(1) = "ONE"
40 LET FIND$(2) = "TWO"
50 LET FIND$(3) = "THREE"
60 LET A$ = SEARCHTO$(1, FIND$)
70 PRINT "FOUND:", A$
```

Example This example shows unused data routed to a port.

```
10 OPEN #1: NAME "PAR"
20 OPEN #2: NAME "SER"
30 DECLARE STRING FIND$(3)
40 LET FIND$(1) = "ONE"
50 LET FIND$(2) = "TWO"
60 LET FIND$(3) = "THREE"
70 LET A$ = SEARCHTO$(1, FIND$, 2)
80 PRINT "FOUND:", A$
```

Example This example shows how to use **SEARCHTO** to find a string within a string and direct the unused part of the string to another string:

```
10 LET A$ = "The faster you go, the shorter you are - Einstein"  
20 LET B$ = SEARCHTO$(A$, "you", C$)  
30 PRINT "FOUND:", B$  
40 PRINT "DISCARDED:", C$
```

Comments **SEARCHTO** will block (wait) until the search string is found. If you want to be able to run other code while doing something similar, consider using **READ** with **POS**.

When using **SEARCHTO** with ports, it will block (wait) until the search string is found. If you want to be able to run other code while doing something similar, consider using **READ** to place data into a string. That string can be passed to **SEARCHTO** for processing.

Port Usage Examples

Before diving into the syntax of all the commands, let's look at some simple applications using the different features of the communications systems in ZBI.

Physical Ports (Serial, Parallel, USB, Bluetooth®)

Though the types of devices interacting with the printer's ports may vary greatly, internal to the printer, the ports are all handled in the same way. These ports are opened with the ZBI **OPEN** command and closed with the ZBI **CLOSE** command. When one of these ports is opened, it is disconnected from the ZPL parser and any data in the buffer will be redirected to the ZBI environment.

Example In the following example, "SER" could be replaced by "PAR", "USB", or "BLU" depending on the application.

```
10 CLOSE ALL
20 LET INPORT = 1
25 SLEEP 1
30 OPEN #INPORT: NAME "SER"
35 ON ERROR GOTO 25
40 PRINT #INPORT: "Enter your name:";
50 INPUT #INPORT: YOURNAME$
55 ON ERROR GOTO 70
60 PRINT #INPORT: "You entered: "; YOURNAME$
70 CLOSE #INPORT
```

ZPL Parser

To make a ZBI program print, it is necessary to create a connection from the program to the ZPL parser on the printer. The connection will function in the same way as a connection to a physical port, except that the connection will not automatically terminate. The ZPL parser in the printer can handle many incoming connections simultaneously. For example, a ZBI program could take control of the serial port and send label formats to the ZPL parser, while the parallel port (unopened by ZBI) could also be used to send label formats directly into the parser.



NOTE: The ZPL parser will lock onto one port once a format is started (via the **^XA** command). So, in some cases, is it desirable to start and stop your communications to ZPL in one continuous sequence.

Another use of ZBI is to check printer status, while another application prints to another port.

Example Here is how that can be done:

```
10 OPEN #1: NAME "ZPL"
20 PRINT #1: "~HS"
30 FOR I = 1 TO 3
40 INPUT #1: A$
50 PRINT A$
60 NEXT I
```

TCP Client

There are two methods for making a TCP connection to another server. The first method uses the **OPEN** command while the second method uses the **CLIENTSOCKET** method.

CLIENTSOCKET is the preferred method.

Example The following example demonstrates this method:

```
10 CLOSE ALL
20 LET INPORT = CLIENTSOCKET("TCP","192.168.0.1",9100)
40 LET OUTSTR$ = "REQUESTING SERVER NAME";
50 DO WHILE (LEN(OUTSTR$) > 0)
60 LET BYTES_WRITTEN = WRITE(INPORT,OUTSTR$,LEN(OUTSTR$))
70 ON ERROR GOTO RECOVERY
80 LET OUTSTR$ = OUTSTR$(1+BYTES_WRITTEN:LEN(OUTSTR$))
90 LOOP
100 INPUT #INPORT: YOURNAME$
110 PRINT #INPORT: "Server returned: "; YOURNAME$
120 CLOSE #INPORT
130 SUB RECOVERY
140 END
```

TCP Server

Setting up a listening server in the printer can be accomplished with the **SERVERSOCKET** function. To connect to incoming TCP sessions, use the **ACCEPT** function.

When starting the application, call **SERVERSOCKET**. This function will create a handle for this listening server. Check for incoming connections at regular intervals with the **ACCEPT** function. If there are no pending sessions, the **ACCEPT** function will return with an error. Handle the error using the **ON ERROR** command and continue looking for other sessions later.

Depending on how the program is set up, it is possible to handle one or more sessions at a time. If the program is configured to allow only one session, the other connections will remain pending until they are shut down by the requesting client or the ZBI program connects them.

Example Here is an example of the **SERVERSOCKET** and **ACCEPT** commands:

```

10 CLOSE ALL
20 LET SERVER_HANDLE = SERVERSOCKET("TCPX",19100)
30 REM There are no connections yet we are just listening for them
40 REM Lets loop until we get a connection
50 SLEEP 1
60 LET INPORT = ACCEPT(SERVER_HANDLE,CLIENT_INFO$)
70 ON ERROR GOTO 50
80 PRINT #INPORT: "You have successfully connected!"
90 PRINT #INPORT: "Login:";
100 INPUT #INPORT: LOGIN$
110 PRINT #INPORT: "Password:";
120 INPUT #INPORT: PASSWORD$
130 REM We will not be nice and reject the connection
130 PRINT #INPORT: "Login failed"
140 CLOSE #INPORT
150 GOTO 60 ! Go look for the next connection
160 END

```

UDP Client

There are also two methods for making a UDP connection to another server. The first method uses the **OPEN** command, while the second method uses the **CLIENTSOCKET** method. UDP is a one way communication medium, thus, you can only use output commands. Because UDP is connectionless, the output will be queued up until an **EOT** character is written or the maximum packet size is exceeded. Once the **EOT** character is written, the packet is formatted and sent.

With UDP, it is important to be careful about understanding what the network being used will support.

In many cases, there will be a limit to the size of the packet that can be used, typically between 1000 and 1500 bytes, but some networks cut this down into the 500 to 600 byte range. To be safe, keep your packets less than 500 bytes.

UDP does not guarantee transmission. See UDP specifications for more details.

Example Since **CLIENTSOCKET** is the preferred method, an example is shown below.

```

10 CLOSE ALL
20 LET INPORT = CLIENTSOCKET("UDP", "192.168.0.1", 22222)
30 LET EOT$ = CHR$(4)
40 PRINT #INPORT: "Packet #"; I; EOT$;
50 LET I = I + 1
60 SLEEP 1
70 GOTO 40

```

UDP Server

Setting up a listening server in the printer can be accomplished with the **SERVERSOCKET** function. Then, to connect to incoming UDP packets, use the function **ACCEPT**. When starting your application, call **SERVERSOCKET**. This function will create a handle for this listening server. Check for incoming packets at a regular interval with the **ACCEPT** function. If there are no pending sessions, the **ACCEPT** function will return with an error. Just handle the error using the **ON ERROR** command and continue looking for other sessions later. You will need to call **ACCEPT** for each incoming packet. When the accept is successful, all of the data will be available. Call **READ** with a **MAX** string size of 2000 and you will have the whole packet in your string. Close the port and wait for the next packet. You can only read in data using a UDP server.

Example Here is an example of how to set up to receive UDP messages:

```

10 CLOSE ALL
20 LET ZPLPORT = 1
35 OPEN #ZPLPORT: NAME "ZPL"
40 LET SERVER_HANDLE = SERVERSOCKET("UDP",33333)
50 REM There are no connections yet: listening
60 REM Let's loop until we get a connection
70 SLEEP 1
80 LET INPORT = ACCEPT(SERVER_HANDLE,CLIENT_INFO$)
90 IF INPORT = -1 THEN
92 GOTO 70
94 END IF
100 LET PACKET_SIZE = READ(INPORT,PACKET$,2000)
110 PRINT #ZPLPORT: "^XA^F0100,100^A0N,40,40^FDPACKET FROM:";
115 PRINT #ZPLPORT: CLIENT_INFO$; "^FS"
120 PRINT #ZPLPORT: "^F0100,150^A0N,40,40^FDPACKET SIZE:";
125 PRINT #ZPLPORT: PACKET_SIZE; "^FS"
130 PRINT #ZPLPORT: "^F0100,200^A0N,40,40^FDPACKET DATA:";
135 PRINT #ZPLPORT: PACKET$; "^FS^XZ"
140 CLOSE #INPORT
150 GOTO 60 ! go look for the next connection
160 END

```

E-mail

ZBI can be used to enhance the printer's ability to send status via e-mail messages. The process is simple: open the email port "EML", send the recipient list, send the header, and send the body of the message.

The printer can only process a limited number of outgoing email messages at one time. For this reason, error handling should be used when opening the connection to wait for the printer to be ready to send the message. The EOT character is important for delimiting sections of the email message. If it is left out, the message will not be sent properly.

Before the following code will work, the email settings for the print server must be set up. Consult the print server manual to learn how to configure the unit.

Example Here is an example of how to send e-mails:

```

1 REM EOT$ this is used to denote end of transmission
5 LET EOT$ = CHR$(4)

```

```
1 REM Open a connection to the e-mail port and if it errors
1 REM try again until complete
10 OPEN #1: NAME "EML"
15 ON ERROR GOTO 10
1 REM Specify address to send message to then end signal end
1 REM of recipients with EOT$
1 REM To send to multiple addressees separate addressees by
1 REM space
20 PRINT #1: "youraddress@yourdomain.com";EOT$;
1 REM Fill in the message information
30 PRINT #1: "From: HAL"
40 PRINT #1: "To: Dave"
50 PRINT #1: "Subject: A message from HAL"
60 PRINT #1: ""
70 PRINT #1: "Dave, I am sorry I can not let you do that."
80 PRINT #1: i
1 REM Terminate message
90 PRINT #1: "";EOT$
1 REM You must close the port, each open port is only good
1 REM for sending one message
100 CLOSE #1
```

File System

This section shows how programs and formats can be saved and recalled. Here's a quick list of these commands:

STORE Saves the program currently in memory as the specified file name.

LOAD Transfers a program file previously stored in the printer's memory and opens it in the ZBI Program Memory.

DIR With no filter included, prompts the printer to list all of the ZBI programs residing in all printer memory locations.

DELETE Removes a specified file from the printer's memory.

Runtime Access

The following example is a method to store runtime data in the printer memory. The file system in the printer is limited to writing one file at a time. Since only one component of the printer can have write access to the file system, the ZPL parser is the component with this access. For ZBI to use the ZPL parser as a gateway into printer memory, the ZPL comment command (^FX) is used.

Example

```
AUTONUM 1,1
REM ***** TEST FOR SUBROUTINES *****
LET ZPLPORT = 1 OPEN #ZPLPORT: NAME "ZPL"
LET SIZE = 5
LET FILENAME$ = "R:TESTSYS.ZPL"
DECLARE STRING DATAIN$(SIZE)
LET DATAIN$(1) = "ONE"
LET DATAIN$(2) = "TWO"
LET DATAIN$(3) = "THREE"
LET DATAIN$(4) = "FOUR"
LET DATAIN$(5) = "FIVE"
GOSUB STOREDATA
GOSUB GETDATA
FOR I = 1 TO SIZE
IF DATAIN$(I) <> DATAOUT$(I) THEN
PRINT #ZPLPORT: "^XA^FO100,100^A0N,50,50^FDERROR:";
PRINT #ZPLPORT: DATAOUT$(I);"^XZ"
END IF
NEXT I
END
REM **** SUBROUTINE STOREDATA *****
REM INPUT: ZPLPORT, DATAIN$, SIZE, FILENAME$ *****
SUB STOREDATA
PRINT #ZPLPORT: "^XA^DF" & FILENAME$ & "^FS"
PRINT #ZPLPORT: "^FX"; SIZE; "AFS"
FOR I = 1 TO SIZE
PRINT #ZPLPORT: "^FX" & DATAIN$(I) & "AFS"
NEXT I
PRINT #ZPLPORT: "^XZ"
RETURN
REM **** SUBROUTINE GETDATA - *****
REM INPUT: ZPLPORT, FILENAME$ *****
REM ** OUTPUT: DECLARES AND FILLS DATAOUT$ AND FILLS SIZE
SUB GETDATA
PRINT #ZPLPORT: "^XA^HF" & FILENAME$ & "^XZ"
SLEEP 1
LET RESULT$ = ""
```

```
FOR J = 1 TO 25
LET A = READ(ZPLPORT,TEMP$,5000)
LET RESULT$ = RESULT$ & TEMP$
IF POS(RESULT$,"^XZ") <> 0 THEN
EXIT FOR
END IF
SLEEP 1
NEXT J
LET RESULT$(1:POS(RESULT$,"^FX")+2) = ""
LET SIZE = VAL(EXTRACT$(RESULT$,"","^"))
DECLARE STRING DATAOUT$(SIZE)
FOR I = 1 TO SIZE
LET RESULT$(1:POS(RESULT$,"^FX")+2) = ""
LET DATAOUT$(I) = EXTRACT$(RESULT$,"","^")
NEXT I
LET RESULT$ = ""
LET TEMP$ = ""
RETURN
```

STORE

This command saves the program currently in memory as the specified file name. The format listed below is used.

Format STORE <filename\$>

Parameters <filename\$> = the name of the file to be stored. Drive location and file name must be in quotation marks.

Example This is an example of how to use the STORE command:

```
STORE "E:PROGRAM1.BAS"
```

Comments For a file name to be valid, it must conform to the 8.3 Rule: each file must have no more than eight characters in the file name and have a three-character extension. Here the extension is always .BAS (for example, MAXIMUM8.BAS).

This is an interactive command that takes effect as soon as it is received by the printer.

The ZBI-Developer IDE will take care of this for you with the SEND TO option on your program.

LOAD

This command transfers a program file previously stored in the printer's memory and opens it in the ZBI Program Memory.

If the program file does not exist, the ZBI Program Memory is cleared and no program is opened.

Format LOAD <filename\$>

Parameters <filename\$> = the file name to be loaded into memory. Drive location and file name must be in quotation marks. If the drive location is not specified, all drives will be searched.

Example Here are examples of how to use the LOAD command:

```
LOAD "PROGRAM1.BAS"
```

```
LOAD "E:PROGRAM1.BAS"
```

Comments This is an interactive command that takes effect as soon as it is received by the printer.

DIR

This command, with no filter included, prompts the printer to list all of the ZBI programs residing in all printer memory locations.

Including a filter signals the printer to limit the search; including a drive location signals the printer to search in only one location.

Asterisks (*) are used as wild cards. A wild card (*) finds every incidence of a particular request. The example here, `DIR "B:*.BAS"`, signals the printer to search for every file with a `.BAS` extension in B: memory.

Format `DIR [<filter$>]`

Parameters `[<filter$>]` = the name of the file to be accessed (optional). Drive location and file name must be in quotation marks.

Default = `"*:*.*bas"`



IMPORTANT: Quotes must be around what you are doing. This shows you how to use the wildcard (*) to search for all `.BAS` files in B: memory:

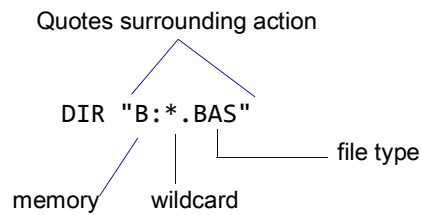

Example N/A

Comments This is an interactive command that takes effect as soon as it is received by the printer.

DELETE

This command removes a specified file from the printer's memory.

Format `DELETE <filename$>`

Parameters `<filename$>` = the name of the file to be deleted. Drive location and filename must be in quotation marks.

Example This is an example of deleting a specified file from printer memory:

```
DELETE "E:PROGRAM1.BAS"
```

Comments This is an interactive command that takes effect as soon as it is received by the printer.

Comma Separated Values (CSV)

Accessing Comma Separated Value (CSV) and Text File Functions

This section describes the functions to access CSV files and ASCII plain-text files. Here is a quick list of these commands:

CSVLOAD Loads the contents of a CSV file in a two dimensional string array.

CSVSTORE Stores the contents of a two dimensional string array in a CSV file.

TXTLOAD Loads the contents of an ASCII plain-text file into a string variable.

TXTSTORE Stores the contents of a string variable in an ASCII plain text file.

CSVLOAD



This function will load the delimited values from a CSV file, defined by **FILENAME\$**, and store them in the two-dimensional array, **DEST\$**.

Format

```
CSVLOAD(DEST$, FILENAME$)
CSVLOAD(DEST$, FILENAME$, DELIM$)
```

Parameters

DEST\$ = two dimensional array that will hold the rows and columns from the CSV file specified by the **FILENAME\$** variable. If there is not enough room in **DEST\$**, or if it has the wrong size, it will be changed to fit the data from the file. The data originally in **DEST\$** will be overwritten.

FILENAME\$ = name of the file to load. Drive location and file name must be in quotation marks. The file extension must be either ".CSV" or ".TXT".

DELIM\$ = optional delimiter that is used in the CSV file instead of a comma. If **DELIM\$** is not provided a comma will be used by default. The delimiter must be a single character that is not a quote, carriage return, or newline.

Returns The number of elements in each row of the CSV file. The function will return 0 if errors were detected in the CSV file, or if the file could not be read.

Example This example shows how to print the values in a CSV file with a comma delimiter.

```
10 DECLARE STRING CSVDB$(1,2)
20 LET FILENAME$ = "E:RECORDS.CSV"
30 LET NUMOFCOLS = CSVLOAD(CSVDB$, FILENAME$)
40 LET NUMOFROWS = ROWSIZE(CSVDB$)
100 FOR I = 1 TO NUMOFROWS STEP 1
110     FOR J = 1 TO NUMOFCOLS STEP 1
120         PRINT CSVDB$(I, J), " ";
200     NEXT J
210     PRINT ""
300 NEXT I
```

Example This example shows how to print the values in a CSV file that uses a '|' as a delimiter.

```
10 DECLARE STRING CSVDB$(1,2)
20 LET FILENAME$ = "E:EMPLOYEE.CSV"
30 LET NUMOFCOLS = CSVLOAD(CSVDB$, FILENAME$, "|")
40 LET NUMOFROWS = ROWSIZE(CSVDB$)
100 FOR I = 1 TO NUMOFROWS STEP 1
110     FOR J = 1 TO NUMOFCOLS STEP 1
120         PRINT CSVDB$(I, J), " ";
200     NEXT J
210     PRINT ""
300 NEXT I
```

Comments The maximum CSV file size supported will vary based upon available RAM within the printer.

CSV File Information

The file format should follow the rules in IETF RFC 4180: <http://tools.ietf.org/html/rfc4180>

The maximum number of columns per row in a CSV file is 256.

Each row must be 2048 characters or less including the delimiter. The carriage return/line feed (CRLF) does not count toward the limit.

Each row in the CSV file must have the same number of elements. If there are any missing elements in the CSV file (indicated by two adjacent commas or a comma at the end of a row), they will be represented as empty strings.

If an element in the CSV file contains a quote, it should be represented as two quotes. Additionally, if an element contains a quote, a new line, a carriage return, or the delimiter character, the element must be within quotes. For example, a value that is used to store a measurement in feet and inches (4' 5") must be formatted as "4' 5"" within the CSV file.

CSVSTORE



This function will store the values of a two dimensional array into a CSV file on the file system. Each element within the array is treated as a single value within the CSV file.

Format

```
CSVSTORE(SRC$, FILENAME$)
CSVSTORE(SRC$, FILENAME$, DELIM$)
```

Parameters

SRC\$ = two dimensional array of strings to be written to a CSV file.

FILENAME\$ = name of the file to store the array contents. Drive location and file name must be in quotation marks. The file extension must be either ".CSV" or ".TXT".

DELIM\$ = optional delimiter that is used in the CSV file instead of a comma. If DELIM\$ is not provided a comma will be used by default. The delimiter must be a single character that is not a quote, carriage return, or newline.

Returns A 0 if there were no errors. A 1 is returned if SRC\$ is not a string array, if the file could not be written, or if SRC\$ contains errors that prevent the file from being stored.

Example This example shows how to convert a comma delimited CSV file into a "^" delimited TXT file and print the contents.

```
10 DECLARE STRING CSVDB$(1,2)
20 LET NUMFCOLS = CSVLOAD(CSVDB$, "E:RECORDS.CSV")
30 LET CSVERROR = CSVSTORE(CSVDB$, "E:NEWREC.TXT", "^")
40 LET NUMFCOLS = CSVLOAD(CSVDB$, "E:NEWREC.TXT", "^")
50 LET NUMFROWS = ROWSIZE(CSVDB$)
100 FOR I = 1 TO NUMFROWS STEP 1
110     FOR J = 1 TO NUMFCOLS STEP 1
120         PRINT CSVDB$(I, J), " ";
200     NEXT J
210     PRINT ""
300 NEXT I
```

Comments The elements of the array should follow the rules in IETF RFC 4180:
<http://tools.ietf.org/html/rfc4180>

There is no limit on the number of columns per row when storing to a CSV file. However, a file stored with rows that exceed the column limit imposed by CSVLOAD will not be loaded by the CSVLOAD function.

There is no limit on the size of a row when stored to a CSV file. However, a file stored with rows that exceed the size limit imposed by CSVLOAD will not be loaded by the CSVLOAD function.

TXTLOAD



This function will read the contents of an ASCII text file into a ZBI string variable.

Format TXTLOAD(DEST\$, FILENAME\$)

Parameters

DEST\$ = string to store the contents of **FILENAME\$**.

FILENAME\$ = name of the file to read. Drive location and file name must be in quotation marks. The file extension must be either ".CSV" or ".TXT".

Returns The number of bytes read from the file. The function will return 0 if the file could not be read.

Example This example shows how to print out the contents of a file.

```
10 LET TXTSIZE = TXTLOAD(TXTDATA$, "E:MYDATA.TXT")
20 PRINT STR$(TXTSIZE), "bytes:", TXTDATA$
```

Comments The data originally in **DEST\$** will be overwritten upon completion of this function.

TXTSTORE



This function will store the contents of a ZBI string in an ASCII text file.

Format TXTSTORE(SRC\$, FILENAME\$)

Parameters

SRC\$ = string to store to **FILENAME\$**.

FILENAME\$ = name of the file to store. Drive location and file name must be in quotation marks. The file extension must be either ".CSV" or ".TXT".

Returns Returns a 0 if there were no errors, otherwise a 1 is returned.

Example This example shows how to append a text file.

```
10 LET TXTSIZE = TXTLOAD(TXTDATA$, "E:MYDATA.TXT")
11 REM Append a date/time stamp to the file
20 LET TXTDATA$ = TXTDATA$ & " " & DATE$ & " " & TIME$
30 LET TXTSIZE = TXTSTORE(TXTDATA$, "E:MYDATA.TXT")
40 PRINT TXTDATA$
```

Events

This section explains how to capture and trigger internal events in the printer. Here's a quick list of these commands:

Available Events A table that correlates a ZBI event with an identification number.

ZBI Key Names Details the names of each printer's front panel buttons, ZBI names, and ZBI event ID.

REGISTEREVENT Sets up the **HANDLEEVENT** function to receive notification when the specified event has occurred.

UNREGISTEREVENT Allows events that are currently set to be captured by the program to no longer be captured.

HANDLEEVENT Once events have been registered, this function is used to see what events have occurred.

TRIGGEREVENT Allows for front panel buttons to be triggered programatically.

There are certain events in the printer that a ZBI 2.0 program can receive. To do this, the program first registers for the event. On a regular basis, call a function to handle events. When an event occurs that the program is registered for, the function will return the event's identification number.

Available Events

ZBI Event ID	ZBI Event
3	menu key
4	pause key
5	feed key
6	cancel key
7	up arrow key
8	plus key
9	minus key
10	enter key
11	setup exit key
12	select key
13	cancel all event
14	config label
15	timer1
16	timer2
17	timer3
18	timer4
19	timer5
20	spare unused
21	previous key
22	next save key

ZBI Commands

ZBI Event ID	ZBI Event
23	calibrate key
24	paper out set
25	paper out clear
26	ribbon out set
27	ribbon out clear
28	head too hot set
29	head too hot clear
30	head cold set
31	head cold clear
32	head open set
33	head open clear
34	supply too hot set
35	supply too hot clear
36	ribbon in set
37	ribbon in clear
38	rewind full set
39	rewind full clear
40	cutter jammed set
41	cutter jammed clear
42	paused set
43	paused clear
44	pq completed set
45	pq completed clear
46	label ready set
47	label ready clear
48	head element bad set
49	head element bad clear
50	basic runtime set
51	basic runtime clear
52	basic forced set
53	basic forced clear
54	power on set
55	power on clear
56	clean printhead set
57	clean printhead clear
58	media low set
59	media low clear
60	ribbon low set
61	ribbon low clear

ZBI Commands

ZBI Event ID	ZBI Event
62	replace head set
63	replace head clear
64	battery low set
65	battery low clear
66	rfid error set
67	rfid error clear
68	any messages set
69	any messages clear
70	auto baud
71	factory default
72	networking default
73	networking factory
74	print width
75	darkness adjust
76	calibrate
77	scroll key
78	soft key 1
79	soft key 2

ZBI Key Names

This section details the names to use for each printer's front panel buttons when creating ZBI 2.0 programs to capture the buttons.

ZT200/ZT400/ZT500/ZT600/ZD500/Qln

ZT2X0	ZT400/ ZT500/ ZT600	ZD500	Qln	ZBI Event ID	ZBI Name
Left Soft button				76	soft key 1
Right Soft Button				77	soft key 2
Plus	Up Arrow			6	plus key
Minus	Down Arrow			7	minus key
Left Arrow				19	previous key
Right Arrow				20	next save key
Setup	OK	Check	OK	10	select key
Pause			no key	2	pause key
Feed				3	feed key
Cancel			no key	4	cancel key

Xi4/RXi4/XiiiPlus/PAX4/105SL/ZE500

XiiiPlus/PAX4/Xi4/RXi4/ ZE500/105SL Plus Front Panel Key	105SL Front Panel Key	ZBI Event ID	ZBI Name
Right Oval	Plus (+)	6	plus key
Left Oval	Minus (-)	7	minus key
Previous		19	previous key
Next/Save		20	next save key
Setup/Exit		9	setup exit key
Pause		2	pause key
Feed		3	feed key
Cancel		4	cancel key
Calibrate		21	calibrate key

HC100

Front Panel Key	ZBI Event ID	ZBI Name
Pause	2	pause key
Feed	3	feed key
Eject		eject key

ZM400/ZM600/RZ400/RZ600/Z4Mplus/Z6Mplus

Front Panel Key	ZBI Event ID	ZBI Name
Feed	3	feed key
Pause	2	pause key
Cancel	4	cancel key
Setup/Exit	9	setup exit key
Select	10	select key
Plus (+)	6	plus key
Minus (-)	7	minus key

S4M

Front Panel Key	ZBI Event ID	ZBI Name
Menu	1	menu key
Enter	8	enter key
Cancel	4	cancel key
Feed	3	feed key
Pause	2	pause key
Left Arrow	4	cancel key
Right Arrow	3	feed key
Up Arrow	5	up arrow key
Down Arrow	2	pause key

G-Series

Front Panel Key	ZBI Event ID	ZBI Name
Feed key	3	Feed key
Select key	10	Select key
Scroll key	75	Scroll key

KR403 / 2824 Plus Series

Front Panel Key	ZBI Event ID	ZBI Name
Feed key	3	Feed key

REGISTEREVENT



Description This function will set up the **HANDLEEVENT** function to receive notification when the specified event has occurred. Events can be registered for one time or until the program is exited.



IMPORTANT: If an event occurs twice or more before the **HANDLEEVENT** function is called, only one event will be received.

Format

REGISTEREVENT(X)

REGISTEREVENT(X,Y)

REGISTEREVENT(X,Y,Z)

Parameters

(X) = This is the ID of the event being registered for.

(Y) = If Y=1: the event happens once; If Y=0: the event stays registered for the duration of the program, or until it is unregistered.

(Z) = For System Events: if Z=0, the event will still be handled by the printer. If Z=1, then only ZBI will receive the event.

For Timer Events: this is the timer interval in mSec. If the interval is less than 0 or greater than 1,000,000,000, it is set to 1000.

Returns The ID of the successfully registered event. If an event was not successfully registered, a -1 is returned.

Example Here is an example of how to use the REGISTEREVENT command:

```

1 REM This example shows how to override the functionality of the feed
1 REM key
1 REM using the event system. After all why waste a label when you
1 REM could put
1 REM valuable information there
AUTONUM 1,1
CLOSE ALL
LET ZPLPORT = 1
OPEN #ZPLPORT: NAME "ZPL"
LET FEEDKEY = 3
LET TMP = REGISTEREVENT(FEEDKEY, 0, 1)
DO WHILE 1 = 1
LET EVT = HANDLEEVENT()
IF EVT = FEEDKEY THEN
GOSUB PRINTINFO
END IF
SLEEP 1
LOOP
REM **** SUBROUTINE PRINTINFO *** expects ZPLPORT ****
SUB PRINTINFO
PRINT #ZPLPORT: "^XA"
PRINT #ZPLPORT: "^F030,30^A0N,50,50^FDZebra Technologies^FS"
PRINT #ZPLPORT: "^F030,85^A0N,35,35^FDwww.zebra.com^FS"
PRINT #ZPLPORT: "^F030,125^A0N,35,35^FDsupport.zebra.com^FS"
PRINT #ZPLPORT: "^F030,165^A0N,35,35^FDFW Version: "
PRINT #ZPLPORT: GETVAR$("appl.name") & "^FS"
PRINT #ZPLPORT: "^F030,205^A0N,35,35^FDPrinter Unique ID:"
PRINT #ZPLPORT: GETVAR$("device.unique_id") & "^FS"
PRINT #ZPLPORT: "^F030,245^A0N,35,35^FDActive Network: "
PRINT #ZPLPORT: GETVAR$("ip.active_network") & "^FS"
PRINT #ZPLPORT: "^F030,285^A0N,35,35^FDZBI Memory Usage: "
PRINT #ZPLPORT: GETVAR$("zbi.start_info.memory_alloc") & "^FS"
PRINT #ZPLPORT: "^F030,325^A0N,35,35^FDOdometer: "
PRINT #ZPLPORT: GETVAR$("odometer.total_print_length") & "^FS"
PRINT #ZPLPORT: "^XZ"

```

Comments None

UNREGISTEREVENT



Description This function allows events that are currently set to be captured by the program to no longer be captured. Once called events will return to the normal method of processing if the REGISTEREVENT function Z parameter was set to 1.

Format UNREGISTEREVENT(X)

Parameters (x) = the ID of the event to stop

Returns 0 if the event is a valid event to unregister. A -1 if the event does not exist.

Example Here is an example of how to use the UNREGISTEREVENT command:

```
AUTONUM 1,1
LET OUTSTR$ = "Processing"
LET LOOPCTR = 200
LET TIMER5 = 17
LET TMP = REGISTEREVENT(TIMER5, 0, 1000)
DO WHILE LOOPCTR > 0
LET EVT = HANDLEEVENT()
IF EVT = TIMER5 THEN
LET A = SETVAR("device.frontpanel.line2",OUTSTR$)
LET OUTSTR$ = OUTSTR$ & "."
IF LEN(OUTSTR$) >16 THEN
LET OUTSTR$ = "Processing"
END IF
END IF
LET LOOPCTR = LOOPCTR - 1
SLEEP 1
LOOP
LET TMP = UNREGISTEREVENT(TIMER5)
LET A = SETVAR("device.frontpanel.line2","")
END
```

Comments None

HANDLEEVENT



Description Once events have been registered, this function is used to see what events have occurred.

Format HANDLEEVENT()

Parameters N/A

Returns The ID of the event that occurred. One event at a time will be returned through this function. The order of the events are based on priority. The priority is based on the ID number of the event, with the exception of the timer events, which have the highest priority.

Example Here are examples of how to use the HANDLEEVENT command:

```
1 REM This example shows how to override the feed key functionality
1 REM using the event system. Why waste a label when you could put
1 REM valuable information there
AUTONUM 1,1
CLOSE ALL
LET ZPLPORT = 1
OPEN #ZPLPORT: NAME "ZPL"
LET FEEDKEY = 3
LET TMP = REGISTEREVENT(FEEDKEY, 0, 1)
DO WHILE 1 = 1
LET EVT = HANDLEEVENT()
IF EVT = FEEDKEY THEN
GOSUB PRINTINFO
END IF
SLEEP 1
LOOP
REM ***** SUBROUTINE PRINTINFO ***
REM *** expects ZPLPORT *****
SUB PRINTINFO
PRINT #ZPLPORT: "^XA"
PRINT #ZPLPORT: "^FO30,30^A0N,50,50";
PRINT #ZPLPORT: "^FDZebra Technologies^FS"
PRINT #ZPLPORT: "^FO30,85^A0N,35,35";
PRINT #ZPLPORT: "^FDwww.zebra.com^FS"
PRINT #ZPLPORT: "^FO30,125^A0N,35,35";
PRINT #ZPLPORT: "^FDsupport.zebra.com^FS"
PRINT #ZPLPORT: "^FO30,165^A0N,35,35";
PRINT #ZPLPORT: "^FDFW Version: ";
PRINT #ZPLPORT: GETVAR$("appl.name") & "^FS"
PRINT #ZPLPORT: "^FO30,205^A0N,35,35";
PRINT #ZPLPORT: "^FDPrinter Unique ID:";
PRINT #ZPLPORT: GETVAR$("device.unique_id") & "^FS"
PRINT #ZPLPORT: "^FO30,245^A0N,35,35";
PRINT #ZPLPORT: "^FDActive Network: ";
PRINT #ZPLPORT: GETVAR$("ip.active_network") & "^FS"
PRINT #ZPLPORT: "^FO30,285^A0N,35,35";
PRINT #ZPLPORT: "^FDZBI Memory Usage: ";
PRINT #ZPLPORT: GETVAR$("zbi.start_info.memory_alloc") & "^FS"
PRINT #ZPLPORT: "^FO30,325^A0N,35,35";
PRINT #ZPLPORT: "^FDOdometer: ";
PRINT #ZPLPORT: GETVAR$("odometer.total_print_length") & "^FS"
PRINT #ZPLPORT: "^XZ"
```

Comments None

TRIGGEREVENT



This function allows for front panel buttons to be triggered programatically.

Format TRIGGEREVENT(X)

Parameters

x = the ID of the event from the possible event list to TRIGGER.

See the following printer tables for events that can be triggered by this command:

- [Xi4/RXi4/XiIIIPlus/PAX4/105SL/ZE500 on page 506](#)
- [105SL Front Panel Key on page 506](#)
- [ZM400/ZM600/RZ400/RZ600/Z4Mplus/Z6Mplus on page 507](#)
- [S4M on page 507](#)

Returns Always returns 0.

Example Here are examples of how to use the TRIGGEREVENT command:

```
1 REM THIS IS AN EXAMPLE OF HOW TO TRIGGER AN EVENT
AUTONUM 1,1
LET PAUSEKEY = 2
DO WHILE 1 = 1
LET A = TRIGGEREVENT(PAUSEKEY)
LET A = SETVAR("device.frontpanel.line2",str$(A))
SLEEP 2
LOOP
```

Comments None

Systems

This section contain miscellaneous systems interface functions. Here's a quick list of these commands:

ISERROR Returns a non-zero value if there is an internal error set in the printer.

ISWARNING Returns a non-zero value if there is an internal warning set in the printer.

SLEEP Specifies the time that the interpreter pauses.

SETERR Sends a message to the printer to set the error flag.

CLRERR Sends a message to the printer to clear the error flag.

ON ERROR Prevents a program from halting in the event of an error.

ISERROR

This function returns a non-zero value if there is an internal error set in the printer. Otherwise, the numeral returned will 0.

Format ISERROR

Parameters N/A

Returns 0 for no errors; 1 if there is an error.

Example Here is an example of the ISERROR command.

```
10 PRINT ISERROR
RUN
0
```

Comments None

ISWARNING

This function returns a non-zero value if there is an internal warning set in the printer. Otherwise, the numeral returned will 0.

Format ISWARNING

Parameters N/A

Returns 0 for no errors; 1 if there is an error.

Example Here is an example of the ISWARNING command.

```
10 PRINT ISWARNING
RUN
0
```

Comments None

SLEEP

This command specifies the time that the interpreter pauses. This command could be sent to the printer after sending a label format to be printed. The interpreter pauses in its processing for the amount of time specified.

Format SLEEP <A>

Parameters <A> = the time in seconds (0 to 500) the interpreter pauses.

Example This is an example of how to use the SLEEP command:

```
10 SLEEP 450
```

Comments If a timer is needed, use the **Event** system. The timer will allow for processing other items, where SLEEP will stop execution of any ZBI commands for the specified SLEEP period.

This is a program command and must be preceded by a line number.

Calling SLEEP with <A> set to zero will force the ZBI task to yield to the rest of the system and allow any pending tasks to run (e.g., pending ZPL commands). If there are no pending tasks, ZBI will sleep for a minimum of 8 milliseconds.

SETERR

This command sends a message to the printer to set the error flag. A logical interpreter flag is triggered in the printer. This error is referenced as a BASIC Forced Error.

Format SETERR

Parameters N/A

Example An example of the SETERR and CLRERR commands.

```
AUTONUM 1,1
OPEN #1:NAME "ZPL"
PRINT #1: "^XA^SXO,A,Y,Y^XZ"
CLOSE #1
FOR I=1 TO 10
SLEEP 5
IF MOD(I,2)=1 THEN
SETERR
ELSE
CLRERR
ENDIF
NEXT I
```

Comments This is a program command and must be preceded by a line number.

CLRERR

This command sends a message to the printer to clear the error flag. A logical interpreter flag is cleared in the printer. This error is referenced as a BASIC Forced Error.

Format 10 CLRERR

Parameters N/A

Example See [SETERR on page 515](#).

Comments This is a program command that is preceded by a line number.

ON ERROR

The **ON ERROR** command can be used to prevent a program from halting in the event of an error. If an error occurs in a previous line during program execution, the **ON ERROR** statement calls the **GOTO** or **GOSUB** statement and allows the program to continue.

Format

```
ON ERROR GOTO <A>
ON ERROR GOSUB <A>
```

Parameters <A> = the destination location in the program should an error be triggered on the previous line.

Example This is an example of how to use the **ON ERROR** command:

```
30 LET A = B/C
40 ON ERROR GOTO 100
...
100 PRINT "DIVIDE BY ZERO OCCURRED"
110 LET A = 0
120 GOTO 50
...
```

See [TCP Server on page 489](#) or [UDP Server on page 491](#).

Comments

If there is no error, this line is ignored.

This is a program command that is preceded by a line number.

Applicator Functions

The printer applicator port option can be controlled in part or completely by ZBI 2. When ZBI takes control of a pin, the printer's built-in applicator functionality will not have access to that pin. This function will allow the printer to perform some of the functionality that a programmable logic controller (PLC) could.

AUXPORT_STEALPIN Takes control of a pin and allows ZBI to perform other actions on the pin.

AUXPORT_SETPIN Sets the output level on an applicator pin.

AUXPORT_GETPIN Retrieves the state of the applicator pin.

AUXPORT_RELEASEPIN Returns a pin controlled by ZBI to normal printer operation.

AUXPORT_STEALPIN



This function will take control of a pin and allow ZBI to perform other actions on the pin.

Format AUXPORT_STEALPIN(x)

Parameters x = perform action on this applicator port pin.

Returns This function returns -1 upon failure and 0 upon success.

Example This is an example of the AUXPORT_STEALPIN command:

```

1 REM Demo applicator to show control of applicator pins
1 REM on the printer
1 REM The application is to create a light pole with an
1 REM external feed button
AUTONUM 1,1
LET RED = 9
LET YELLOW = 10
LET GREEN = 11
LET BUTTON = 4
LET FEED_KEY = 3
LET TMP = AUXPORT_STEALPIN(RED)
LET TMP = AUXPORT_STEALPIN(YELLOW)
LET TMP = AUXPORT_STEALPIN(GREEN)
LET TMP = AUXPORT_STEALPIN(BUTTON)
DO WHILE 1 = 1
SLEEP 1
IF ISERROR = 1 THEN
LET TMP = AUXPORT_SETPIN(RED,1)
LET TMP = AUXPORT_SETPIN(YELLOW,0)
LET TMP = AUXPORT_SETPIN(GREEN,0)
ELSE IF ISWARNING = 1 THEN
LET TMP = AUXPORT_SETPIN(RED,0)
LET TMP = AUXPORT_SETPIN(YELLOW,1)
LET TMP = AUXPORT_SETPIN(GREEN,0)
ELSE
LET TMP = AUXPORT_SETPIN(RED,0)
LET TMP = AUXPORT_SETPIN(YELLOW,0)
LET TMP = AUXPORT_SETPIN(GREEN,1)
END IF
IF AUXPORT_GETPIN(BUTTON) = 1 THEN
LET A = TRIGGEREVENT(FEED_KEY)
END IF
LOOP

```

Comments If this pin is not controlled via ZBI (power pin), this function will return -1.

AUXPORT_SETPIN



This function sets the output level on an applicator pin.

Format AUXPORT_SETPIN(x,y)

Parameters

x = perform action on this applicator port pin.

y = The value to set on the pin (1 = high, 0 = low).

Returns This function returns -1 upon failure and 0 upon success.

Example See [AUXPORT_STEALPIN on page 518](#).

Comments If this pin is not controlled via ZBI (power pin), this function will return -1. See [AUXPORT_STEALPIN on page 518](#).

AUXPORT_GETPIN



Description This function will retrieve the state of the applicator pin.

Format AUXPORT_GETPIN(x)

Parameters x = perform action on this applicator port pin.

Returns This function returns 1 if pin is in high state, 0 in low state, and -1 upon failure.

Example See [AUXPORT_STEALPIN on page 518](#).

Comments If this pin is not controlled via ZBI (power pin), this function will return -1. See [AUXPORT_STEALPIN on page 518](#).

AUXPORT_RELEASEPIN



Description This function returns a pin controlled by ZBI to normal printer operation.

Format AUXPORT_RELEASEPIN(x)

Parameters x = perform action on this applicator port pin.

Returns This function returns -1 upon failure and 0 upon success.

Example This is an example of the `AUXPORT_RELEASEPIN` command:

```
90 LET TMP = AUXPORT_RELEASEPIN(X)
```

Comments If this pin is not controlled via ZBI (power pin), this function will return -1. See [AUXPORT_STEALPIN on page 518](#).

String Functions

This section identifies how to handle string manipulation. Here is a quick list of these commands:

LCASE\$ Converts a string to all lowercase characters.

CHR\$ Takes a value between 0 and 255 and puts that value into a string.

LTRIM\$ Removes leading spaces from a string.

REPEAT\$ Creates multiple copies of a string combined into a new string.

RTRIM\$ Returns a string with trailing spaces removed

SPLIT Splits a string into sub-strings

SPLITCOUNT Returns the number of sub-strings that would be returned by the SPLIT function.

UCASE\$ Converts a string to all uppercase characters

EXTRACT\$ Searches for a string based on a starting and ending string.

ORD Returns the ASCII value of the first character of string A\$.

POS Returns the location of the first occurrence of a search string in the target string.

LEN Returns the length of a string.

LCASE\$

This function will convert a string to all lowercase characters.

Format LCASE\$ (A\$)

Parameters (A\$) = the string that will be converted

Returns The characters in A\$ converted to lowercase.

Example This is an example of how to use the LCASE\$ command.

```
10 LET B$=LCASE$ ("Hello World")
20 PRINT B$
RUN
hello world
```

Comments This will only work on non-accented Latin characters, A-Z.

CHR\$

This function takes a value between 0 and 255 and puts that value into a string.

Format CHR\$(VAL)

Parameters (VAL)= The numeric value of the string character.

Returns A single character string containing the value entered.

Example This is an example of how to use the CHR\$ command to easily put control characters into strings:

```
10 LET NULL$=CHR$(0)
20 LET STX$=CHR$(2)
30 LET ETX$=CHR$(3)
40 LET EOT$=CHR$(4)
```

Comments None

LTRIM\$

This function removes leading spaces from a string.

Format LTRIM\$(A\$)

Parameters (A\$) = the string to convert.

Returns The string in A\$ with no spaces.

Example This is an example of how to use the LTRIM\$(A\$) command:

```
10 LET A$=" Hello"
20 PRINT LTRIM$(A$)
RUN
Hello
```

Comments None

REPEAT\$

This function creates multiple copies of a string combined into a new string.

Format REPEAT\$(A\$,M)

Parameters

A\$ = the base string to duplicate

M = the number of times to duplicate A\$

Returns A string containing M copies of A\$. **Note:** When M=0, an empty string is returned.

Example This is an example of how to use the REPEAT\$(A\$,M) command:

```
10 PRINT REPEAT$("Hello",3)
RUN
HelloHelloHello
```

Comments None

RTRIM\$

This function returns a string with trailing spaces removed.

Format RTRIM\$(A\$)

Parameters (A\$) = the base string

Returns A\$ with trailing spaces removed.

Example This is an example of how to use the RTRIM\$(A\$) command:

```
10 LET A$="Hello "
20 LET B$="World"
30 PRINT A$ & B$
40 PRINT RTRIM$(A$)& B$
RUN
Hello World
HelloWorld
```

Comments None

SPLIT



Description This function allows a string to be split into sub-strings

Format

`SPLIT(DEST$,SOURCE$,DELIMITER$)`

`SPLIT(DEST$,SOURCE$,DELIMITER$,MAXCOUNT)`

Parameters

DEST\$ = the array to populate with the sub-strings created by the split

SOURCE\$ = the string that will be searched for the provided delimiter

DELIMITER\$ = the delimiter string (may be more than one character) to search for

MAXCOUNT = the maximum number of sub-strings the string should be split into. A negative value will return every sub-string created by the split. A value of zero will return empty strings in the array. If not specified, the limit will be the maximum size of the array.

Returns The number of sub-strings placed into the DEST\$ array. If the number of sub-strings is less than the size of DEST\$, the remaining elements of the array will be set to empty strings.

Example This is an example of how to use the `SPLIT` command:

```
1 REM Example - This example show how the SPLIT and SPLITCOUNT
1 REM commands can be
1 REM used to merge a comma separated variable string(CSV)
1 REM into a stored format
AUTONUM 1,1
SLEEP 10
DECLARE STRING TESTDATA$(5)
REM data format = <Format Name>,<VAR 1>,<VAR 2>,....,<VAR N>
LET TESTDATA$(1) = "E:PRICETAG.ZPL,FRED'S OATS,$1.25,C:126789:325,123456789"
LET TESTDATA$(2) = "E:PRICETAG.ZPL,FRED'S OATS,$2.25,C:126789:325,123456789"
LET TESTDATA$(3) = "E:PRICETAG.ZPL,FRED'S OATS,$3.25,C:126789:325,123456789"
LET TESTDATA$(4) = "E:PRICETAG.ZPL,FRED'S OATS,$4.25,C:123489:325,123456789"
LET TESTDATA$(5) = "E:PRICETAG.ZPL,FRED'S OATS,$5.25,C:123459:325,123456789"
LET ZPLPORT = 2
OPEN #ZPLPORT: NAME "ZPL"
FOR T = 1 TO 5
LET DATA$ = TESTDATA$(T)
GOSUB CSVPRINTER
NEXT T
END
REM ***** Subroutine CSVPRINTER, expects DATA$ and ZPLPORT *****
SUB CSVPRINTER
LET CNT = SPLITCOUNT(DATA$, ",")
DECLARE STRING SPLITSTRING$(CNT)
ON ERROR GOTO RECOVERY
LET CNT = SPLIT(SPLITSTRING$,DATA$,",")
PRINT #ZPLPORT: "^XA^XF";SPLITSTRING$(1);"^AFS"
IF CNT >= 2 THEN
FOR I = 2 TO CNT
PRINT #ZPLPORT: "^FN";I-1;"^FD";SPLITSTRING$(I);"^AFS"
NEXT I
END IF
PRINT #ZPLPORT: "^XZ"
SUB RECOVERY
RETURN
```

Example This is an example of how to use the `SPLIT` command:

```

1 REM Example - Shows how the SPLIT and SPLITCOUNT commands can be used to
1 REM merge a comma separated variable string(CSV) into a stored format
AUTONUM 1,1
SLEEP 10
DECLARE STRING TESTDATA$(5)
REM data format = <Format Name>,<VAR 1>,<VAR 2>,...,<VAR N>
LET F$="E:PRICETAG.ZPL"
LET TESTDATA$(1) = F$&","FRED'S ROLLED OATS,$1.25,C:123456789:325,123456789"
LET TESTDATA$(2) = F$&","FRED'S ROLLED OATS,$2.25,C:123456789:325,123456789"
LET TESTDATA$(3) = F$&","FRED'S ROLLED OATS,$3.25,C:123456789:325,123456789"
LET TESTDATA$(4) = F$&","FRED'S ROLLED OATS,$4.25,C:123456789:325,123456789"
LET TESTDATA$(5) = F$&","FRED'S ROLLED OATS,$5.25,C:123456789:325,123456789"
LET ZPLPORT = 2
OPEN #ZPLPORT: NAME "ZPL"
FOR T = 1 TO 5
LET DATA$ = TESTDATA$(T)
GOSUB CSVPRINTER
NEXT T
END
REM ***** Subroutine CSVPRINTER, expects DATA$ and ZPLPORT *****
SUB CSVPRINTER
LET CNT = SPLITCOUNT(DATA$, ",")
DECLARE STRING SPLITSTRING$(CNT)
ON ERROR GOTO RECOVERY
LET CNT = SPLIT(SPLITSTRING$,DATA$,",")
PRINT #ZPLPORT: "^XA^XF";SPLITSTRING$(1);"^FS"
IF CNT >= 2 THEN
FOR I = 2 TO CNT
PRINT #ZPLPORT: "^FN";I-1;"^FD";SPLITSTRING$(I);"^FS"
NEXT I
END IF
PRINT #ZPLPORT: "^XZ"
SUB RECOVERY
RETURN

```

Comments If the delimiter is an empty string, or does not appear in the `SOURCE$` string, the first entry of the array will be the source string and all other elements will be empty strings.

When the `SPLIT` function encounters a delimiter at the beginning or end of the source string, or two delimiters in a row, it populates the corresponding array element with an empty string.

If `MAXCOUNT` is larger than the number of returned sub-strings (N), the last `MAXCOUNT` - N array elements will be empty strings. If `MAXCOUNT` is larger than the destination array or is negative, the size of the array will be used as the `MAXCOUNT`. Therefore, the smallest value among the value of `MAXCOUNT`, the size of the return array, or the number of sub-strings found determines the maximum number of sub-strings that will be returned.

If `MAXCOUNT` is less than the number of delimiters in a string the last string in the array will hold the end of the string starting from where the last delimiter was found. For example, if `SOURCE$ = "one,two,three,four,five"`, `DELIMITER$ = ","`, and `MAXCOUNT = 2`, the output would be two strings: "one" and "two,three,four,five".

If a two dimensional array is provided for `DEST$`, the array will be filled linearly. For example, an array that is 2 x 3 (for example, `DECLARE STRING MYARRAY$(2,3)`) will be filled from (0,0), then (0,1) up to (2,3).

SPLITCOUNT



Description This function returns the number of sub-strings that would be returned by the SPLIT function.

Format SPLITCOUNT(SOURCE\$, DELIMITER\$)

Parameters

SOURCE\$ = the string that will be searched for the provided delimiter.

DELIMITER\$ =5

Returns The number of sub-strings that would be returned by the SPLITCOUNT function.

Example This function shows how to determine the number of sub-strings that the SPLITCOUNT command would produce

```
10 LET CNT = SPLITCOUNT("ONE,,,FOUR,FIVE,,SEVEN,", ",")
20 PRINT "Number of sub-strings returned is", STR$(CNT)
RUN
Number of sub-strings returned is 8
```

Comments None

UCASE\$

This function converts a string to all uppercase characters.

Format UCASE\$(A\$)

Parameters A\$ = the base string to convert

Returns A\$ converted to uppercase.

Example This is an example of how to use the UCASE\$ (A\$) command:

```
10 LET A$="Zebra Technologies"
20 PRINT UCASE$(A$)
RUN
ZEBRA TECHNOLOGIES
```

Example This is an example of how to capitalize a line.

```
10 LET A$="The Cow jUmped Over THE Moon."
20 LET A$=LCASE$(A$)
30 LET A$(1:1)=UCASE$(A$(1:1))
40 PRINT A$
RUN
The cow jumped over the moon.
```

Comments This will only convert non-accented Latin characters, a-z.

EXTRACT\$

This function searches for a string based on a starting and ending string. When these two strings are found, the string between them is returned.



IMPORTANT: If the `EXTRACT$` command encounters a carriage return line feed before encountering the beginning character or the ending character, it returns null.

Format

```
EXTRACT$ (CHANNEL, START$, STOP$)
```

```
EXTRACT$ (A$, START$, STOP$)
```

Parameters

CHANNEL = extracts data from this channel

A\$ = the source string

START\$ = Once this string is found, the extract pulls characters immediately following.

STOP\$ = the extraction stops when this string is found

Example This example shows how to extract the word `Technologies` from this string:
`Zebra,Technologies,Corporation.`

This is what the program looks like to accomplish this:

```
10 LET A$ = "Zebra,Technologies,Corporation,"
20 LET DATA$ = EXTRACT$(A$,"","")
```

Example This example shows how the `EXTRACT$` command works from an open port:

```
10 OPEN #1: NAME "SER"
20 LET DATA$ = EXTRACT$(1,"","")
```

Notice how the quotes are used to show a literal character, in this case a comma.

Example This example shows how the start and stop points are variable; a variable name is used instead of the literal:

```
10 LET B$ = ","
20 LET A$ = "Zebra,Technologies,Corporation"
30 LET DATA$ = EXTRACT$(A$,B$,B$)
40 PRINT DATA$
RUN
Technologies
```

Example This example shows how an empty string can be used to extract from the start of the input string to the end string:

```
10 LET IN$ = "BLAH BLAH <END>"
20 LET B$ = EXTRACT$(IN$, "", "<END>")
30 PRINT B$
RUN
BLAH BLAH
```

Example This example will use an empty string to extract to the end of a line:

```
10 LET IN$ = "BLAH <START> THE DATA"  
20 LET B$ = EXTRACT$(IN$, "<START>", "")  
30 PRINT B$  
RUN  
THE DATA
```

Comments EXTRACT\$ reads in and discards data until the start criteria is met. Then, all data is returned up to the stop criteria.

ORD

This function returns the ASCII value of the first character of string A\$.

Format ORD(A\$)

Parameters A\$ = Input string: only the first character will be used.

Returns The ASCII value of the first character.

Example This is an example of how to use the ORD (A\$) command:

```
10 LET A$="ABC"  
20 PRINT ORD(A$)  
RUN  
65
```

Comments None

POS

This function returns the location of the first occurrence of a search string in the target string. It can be assigned an index.

Format

`POS(A$,B$)`

`POS(A$,B$,M)`

Parameters

A\$ = the target string to search

B\$ = the search string to find in **A\$**

M = The index to start looking for **B\$**. If omitted, the search will start at the beginning of the string. **M** must be greater than zero.

Returns The location of the string. If the string is not found, this will return 0.

Example This is an example of how to use the `POS` command:

```
10 LET A$="Hello World"
```

```
20 LET B$="o"
```

```
30 PRINT POS(A$,B$)
```

```
40 PRINT POS(A$,B$,1)
```

```
50 PRINT POS(A$,B$,6)
```

```
RUN
```

```
5
```

```
5
```

```
8
```

Comments None

LEN

This function returns the length of a string.

Format `LEN(A$)`

Parameters **A\$** = the target string from which to determine the length.

Returns The length of the string.

Example This example identifies the length of a string. Hello World is 11 characters, as follows:

```
10 LET A$="Hello World"
```

```
20 PRINT LEN(A$)
```

```
RUN
```

```
11
```

Comments None

Math Functions

This section identifies how to handle mathematical calculations. Here is a quick list of these commands:

STR\$ Converts a number to a string.

MAX Returns the greater value between two numbers.

MIN Returns the smaller value of two numbers.

MAXNUM returns the largest number permitted by this machine.

MOD Computes the remainder from division.

VAL Evaluates the number represented by a string.

INTTOHEX\$ Takes a numeric value and converts it into a hexadecimal string.

HEXTOINT Converts hexadecimal strings to integers.

STR\$

This function converts a number to a string.

Format STR\$(X)

Parameters X = the number to convert to a string

Returns A string representing X.

Example This is an example of how to use the STR\$(X) command:

```
10 LET A=53
20 PRINT STR$(A)
RUN
53
```

Comments None

MAX

This function returns the greater value between two numbers.

Format MAX(X,Y)

Parameters

X = the first number to compare

Y = the second number to compare

Returns The greater of X or Y.

Example This is an example of how to use the MAX (X, Y) command:

```
10 LET A=-2
20 LET B=1
30 PRINT MAX(A,B)
RUN
1
```

Comments None

MIN

This function returns the smaller value of two numbers.

Format MIN(X,Y)

Parameters

X = the first number to compare

Y = the second number to compare

Returns The smaller of X or Y.

Example This is an example of how to use the MIN (X, Y) command:

```
10 LET A=-2
20 LET B=0
30 PRINT MIN(A,B)
RUN
-2
```

Comments None

MAXNUM

This function returns the largest number permitted by this machine: 2,147,483,647.

Format MAXNUM

Parameters N/A

Returns The largest number that the NUMERIC type can handle (2,147,483,647).

Example This is an example of how to use the MAXNUM command:

```
10 PRINT MAXNUM
RUN
2147483647
```

Comments None

MOD

This function computes the remainder from division. (This is known as the modulus.)

Format MOD(X,Y)

Parameters

x = the value to be modulated (numerator).

y = the base number or divisor (denominator).

Returns The remainder of the division (X/Y).

Example This is an example of how to use the MOD (X, Y) command:

```
10 PRINT MOD(25,10)
20 PRINT MOD(2,1)
30 PRINT MOD(3,2)
40 PRINT MOD(9,2)
50 PRINT MOD(-2,9)
60 PRINT MOD(2,0)
RUN
5
0
1
1
-2
ERROR OCCURRED ON LINE 60:DIVIDE BY ZERO
```

Comments None

VAL

This function evaluates the number represented by a string.

Format VAL(A\$)

Parameters A\$ = This is the input string to pull the number from. Non-numbers are ignored.

Returns The numeric representation of the string.

Example This is an example of how to use the VAL (A\$) command:

```
10 LET A$="123"
```

```
20 LET C=VAL(A$)
```

```
30 PRINT C
```

```
RUN
```

```
123
```

```
PRINT VAL("321A123")
```

```
321123
```

Comments None

INTTOHEX\$



Description This function will take a numeric value and convert it into a hexadecimal string. The range of values for integers is:

-2,147,483,648 to +2,147,483,647

Format INTTOHEX\$(A)

Parameters A = The numeric value to convert.

Returns A string representing the integer in hex.

Example These print statements show the output of the **INTTOHEX\$** function given different values.

```
PRINT INTTOHEX$(1)
```

```
1
```

```
PRINT INTTOHEX$(10)
```

```
A
```

```
PRINT INTTOHEX$(16)
```

```
10
```

```
PRINT INTTOHEX$(20)
```

```
14
```

```
PRINT INTTOHEX$(30)
```

```
1E
```

```
PRINT INTTOHEX$(100)
```

```
64
```

```
PRINT INTTOHEX$(123124)
```

```
1EOF4
```

```
PRINT INTTOHEX$(-5)
```

```
0
```

```
PRINT INTTOHEX$(-99)
```

```
0
```

Comments Negative values will be returned as 0.

HEXTOINT



This function will convert hexadecimal strings to integers.

Format HEXTOINT(A\$)

Parameters A\$ = The hex string to convert.

Returns A integer string computed from the hexadecimal string.

Example These print statements show the output of the `INTTOHEX` function given different values.

```
PRINT HEXTOINT("0")
```

```
0
```

```
PRINT HEXTOINT("A")
```

```
10
```

```
PRINT HEXTOINT("a")
```

```
10
```

```
PRINT HEXTOINT("1A")
```

```
26
```

```
PRINT HEXTOINT("10")
```

```
16
```

```
PRINT HEXTOINT("AaAa")
```

```
43690
```

```
PRINT HEXTOINT("AAAA")
```

```
43690
```

```
PRINT HEXTOINT("-1")
```

```
0
```

```
PRINT HEXTOINT("-A")
```

```
0
```

Comments Negative values will be returned as 0.

Array Functions

This section describes the functions to search, resize, and query arrays.

REDIM Changes the size of an array.

INSERTROW Inserts a new row into an existing array.

DELROW Deletes a new row from an existing array

ROWSIZE Returns the number of rows in an array.

COLUMNSIZE Returns the number of columns in an array.

FIND Searches a string array for an occurrence of a sub-string.

REDIM



This command will change the dimensions of an array.

Format

```
REDIM <ARRAYNAME>(<SIZE>)
REDIM <ARRAYNAME>(<ROWS>,<COLUMNS>)
REDIM <ARRAYNAME$>(<SIZE>)
REDIM <ARRAYNAME$>(<ROWS>,<COLUMNS>)
```

Parameters

- <SIZE> = new number of entries in a single dimension array.
- <ROWS> = new number of rows in a two dimensional array.
- <COLUMNS> = new number of columns in a two dimensional array.

Example This example shows how to change a one dimensional numeric array.

```
10 DECLARE NUMERIC SCORES(3)
20 LET SCORES(1) = 85
30 LET SCORES(2) = 92
40 LET SCORES(3) = 98
50 REDIM SCORES(2) ! Discard the last one
```

Example This example shows how to change a two dimensional string array.

```
10 DECLARE STRING NAMEAGES$(3,2)
20 LET NAMEAGES$(1,1) = "Abraham"
30 LET NAMEAGES$(1,2) = "Lincoln"
40 LET NAMEAGES$(2,1) = "Dwight"
50 LET NAMEAGES$(2,2) = "Eisenhower"
60 LET NAMEAGES$(3,1) = "Theodore"
70 LET NAMEAGES$(3,2) = "Roosevelt"
80 REDIM NAMEAGES$(5,2) ! Make room for more
```

Comments The **REDIM** must have the same number of dimensions as the original declaration of the array.

- If the array has two dimensions, the second array bound cannot change. It must have the same value as the original declaration.
- If **REDIM** makes an array smaller, elements (or rows, for a two dimensional array) at the end of the array are discarded.
- If **REDIM** makes an array larger, elements (or rows) are added at the end of the array, and initialized as they would be with a **DECLARE**.

This can be an interactive command that takes effect as soon as it is received by the printer, or a program command that is preceded by a line number.

INSERTROW



This command will insert a new row into an existing array.

Format INSERTROW (<ARRAYNAME>, <INDEX>)

Parameters

<ARRAYNAME> = array where the row will be inserted

<INDEX> = index of the row in the array that the new row will be inserted before

Example This example shows how to insert a row into the middle of an array.

```
10 DECLARE NUMERIC SCORES(3)
20 LET SCORES(1) = 85
30 LET SCORES(2) = 92
40 LET SCORES(3) = 98
50 INSERTROW(SCORES, 2)
60 LET SCORES(2) = 100
```

Example This example shows how to add a row into the end of an array.

```
10 DECLARE NUMERIC SCORES(3)
20 LET SCORES(1) = 85
30 LET SCORES(2) = 92
40 LET SCORES(3) = 98
50 INSERTROW(SCORES, 4)
60 LET SCORES(4) = 100
```

Comments Inserting a row increases the size of the array by one row, and moves all the rows from **INDEX** to the end of the array up one row, leaving an empty row at position **INDEX**.

INDEX cannot be any larger the number of rows in the array plus one. If the number of rows plus one is provided, the new row will be added to the end of the array.

This can be an interactive command that takes effect as soon as it is received by the printer, or a program command that is preceded by a line number.

DELROW



This command will delete a row from an existing array.

Format DELROW (<ARRAYNAME>, <INDEX>)

Parameters

<ARRAYNAME> = the array where the row will be deleted

<INDEX> = index of the row to delete from the array

Example This example shows how to delete a row from the middle of an array.

```
10 DECLARE NUMERIC SCORES(5)
20 LET SCORES(1) = 85
30 LET SCORES(2) = 92
40 LET SCORES(3) = 98
50 LET SCORES(4) = 45
60 LET SCORES(5) = 100
70 DELROW(SCORES, 4) ! Remove the low score
```

Comments This decreases the size of A by one row, and moves all the rows from INDEX to the end of the array down by one, overwriting the row at position INDEX.

INDEX cannot be any larger the number of rows in the array.

If the array only has one row, that row may not be deleted.

This can be an interactive command that takes effect as soon as it is received by the printer, or a program command that is preceded by a line number.

ROWSIZE



This function will return the number of rows in an array.

Format

```
ROWSIZE(A)
ROWSIZE(A$)
```

Parameters

A = integer array to query for the number of rows.

A\$ = string array to query for the number of rows.

Returns Returns a 0 if the variable is not an array. Returns the number of elements in the array if the array has only one dimension. Returns the size of the first dimension if the array has two dimensions.

Example This example shows how to determine the number of elements in a one dimensional string array.

```
10 DECLARE STRING NAMES$(3)
20 LET NAMES$(1) = "Fred"
30 LET NAMES$(2) = "Wilma"
40 LET NAMES$(3) = "Barney"
50 REDIM NAMES$(4) ! Make room for Betty
60 LET NAMES$(4) = "Betty"
70 LET NUMOFNAMES = ROWSIZE(NAMES$)
80 PRINT NUMOFNAMES
```

Example This example shows how to determine the number of rows in a two dimensional numeric array.

```
10 DECLARE NUMERIC SQROFTWOLOOKUP(3,2)
20 LET SQROFTWOLOOKUP (1,1) = 1
30 LET SQROFTWOLOOKUP (1,2) = 2
40 LET SQROFTWOLOOKUP (2,1) = 2
50 LET SQROFTWOLOOKUP (2,2) = 4
60 LET SQROFTWOLOOKUP (3,1) = 3
70 LET SQROFTWOLOOKUP (3,2) = 8
80 LET NUMOFSQRS = ROWSIZE(SQROFTWOLOOKUP)
90 PRINT NUMOFSQRS
```

COLUMNSIZE



This function will return the number of columns in an array.

Format

COLUMNSIZE(A)

COLUMNSIZE(A\$)

Parameters

A = integer array to query for the number of columns.

A\$ = string array to query for the number of columns.

Returns A 0 if the variable is not an array. Returns 1 if the array has only one dimension. Returns the size of the second dimension if the array has two dimensions.

Example This example shows how to determine the number of elements in a one dimensional string array.

```
10 DECLARE STRING NAMES$(3)
20 LET NAMES$(1) = "Fred"
30 LET NAMES$(2) = "Wilma"
40 LET NAMES$(3) = "Barney"
50 REDIM NAMES$(4) ! Make room for Betty
60 LET NAMES$(4) = "Betty"
70 LET NUMOFCOLS = COLUMNSIZE(NAMES$)
80 PRINT NUMOFCOLS
```

Example This example shows how to determine the number of columns in a two dimensional numeric array.

```
10 DECLARE NUMERIC SQROFTWOLOOKUP(3,2)
20 LET SQROFTWOLOOKUP (1,1) = 1
30 LET SQROFTWOLOOKUP (1,2) = 2
40 LET SQROFTWOLOOKUP (2,1) = 2
50 LET SQROFTWOLOOKUP (2,2) = 4
60 LET SQROFTWOLOOKUP (3,1) = 3
70 LET SQROFTWOLOOKUP (3,2) = 8
80 LET COLCNT = COLUMNSIZE(SQROFTWOLOOKUP)
90 PRINT COLCNT
```

FIND



This function will find an element of a string array that contains an identified search string.

Format

FIND(A\$, B\$)

FIND(A\$, B\$, START)

FIND(A\$, COLUMN, B\$)

FIND(A\$, COLUMN, B\$, START)

Parameters

A\$ = string array to search for B\$.

B\$ = string to search for within A\$.

START = index within a single dimensional array, or row for a two dimensional array, to start the search.

COLUMN = column to isolate search to in a two dimensional array. This must be supplied if A\$ is a two dimensional array.

Returns Returns a 0 if B\$ is not found or if there was an error. Otherwise, returns the index that contains the first occurrence of the string B\$ (the element index for one dimensional arrays, the row for two dimensional arrays).

Example This example shows how to find a string in a one dimensional array.

```
10 DECLARE STRING NAMES$(4)
20 LET NAMES$(1) = "Fred"
30 LET NAMES$(2) = "Wilma"
40 LET NAMES$(3) = "Barney"
50 LET NAMES$(4) = "Betty"
60 LET BARNEYIX = FIND(NAMES$, "Bar")
70 PRINT "Found Barney in element "; STR$(BARNEYIX)
```

Example This example shows how to find a string that occurs more than once in a two dimensional array.

```

10 DECLARE STRING CLOTHING$(5,2)
20 LET TYPECOL      = 1
30 LET MATERIALCOL = 2
40 LET CLOTHING$(1,1) = "Gloves"
50 LET CLOTHING$(1,2) = "Knit"
60 LET CLOTHING$(2,1) = "Pants"
70 LET CLOTHING$(2,2) = "Cotton"
80 LET CLOTHING$(3,1) = "Gloves"
90 LET CLOTHING$(3,2) = "Leather"
100 LET CLOTHING$(4,2) = "Shirts"
110 LET CLOTHING$(4,2) = "Polyester"
120 LET CLOTHING$(5,2) = "Pants"
130 LET CLOTHING$(5,2) = "Denim"
140 LET GLOVEIX = 1
150 DO
160 LET GLOVEIX = FIND(CLOTHING$, TYPECOL, "Gloves", GLOVEIX)
170 IF NOT GLOVEIX = 0 THEN
180 PRINT CLOTHING$(GLOVEIX, MATERIALCOL), "gloves are available"
190 LET GLOVEIX = GLOVEIX + 1
200 END IF
210 LOOP WHILE NOT GLOVEIX = 0

```

Comments COLUMN must be greater than 0.

If START is given, it must be greater than 0.

FIND will match the first occurrence of B\$, even if it is a substring of a string within the A\$ array. For example, "Coat" will be found in both locations 1 and 4.

```

5 DECLARE STRING A$(5)
10 LET A$(1) = "Over Coat"
20 LET A$(2) = "Hat"
30 LET A$(3) = "Jacket"
40 LET A$(4) = "Coat"
50 LET A$(5) = "Boots"

```

If an exact match is needed, FIND should be called until 0 is returned or the item is found and confirmed. To confirm, check the item against the expected item, it should match exactly. See [CSV Program on page 548](#) for an example showing how to do this.

Time and Date Functions

This section describes the functions to access the real time clock option. Here is a quick list of these commands:

DATE\$ Returns the date as a string

TIME\$ Returns the current time in a string.

DATE Gets the current date as a number.

TIME Gets the current time as a number.

DATE\$

This function returns the date as a string.

Format DATE\$

Parameters N/A

Returns The current date in string form YYYYMMDD. If the Real-Time Clock is not installed, an empty string is returned.

Example This is an example of how to use the DATE\$ command:

```
10 PRINT DATE$
RUN
```

The result, assuming the date is January 1, 2003 is:

```
20030101
```

Example This is another example of the DATE\$ command used with the sub-string operator to get the day of the month:

```
10 LET A$=DATE$(7:8)
20 IF A$ <> DATE$(7:8)
30 LET A$=DATE$(7:8)
40 IF A$="01"
50 PRINT "IT IS THE FIRST OF THE MONTH"
60 END IF
70 END IF
80 SLEEP 100
90 GOTO 20
```

Comments None

TIME\$

This function returns the current time in a string.

Format TIME\$

Parameters N/A

Returns This function returns the time of day in format HH:MM:SS (hours:minutes:seconds). If the Real-Time Clock is not installed, an empty string is returned.

Example This is an example of how to use the TIME\$ command:

```
10 PRINT TIME$
RUN
10:00:00
```

DATE

This function gets the current date as a number.

Format DATE

Parameters N/A

Returns This function returns the current date in YYYYDDD format, where YYYY is the year and DDD is the number of days since the beginning of the year. If the Real-Time Clock is not installed, 0 is returned.

Example This example assumes the current date is January 1, 2003:

```
10 PRINT DATE
RUN
2003001
```

TIME

This function gets the current time as a number.

Format TIME

Parameters N/A

Returns This function returns the time past midnight (2400h) in seconds. If the Real-Time Clock is not installed, 0 is returned.

Example This is an example of how to use the TIME command [assuming the time is one minute past midnight]:

```
10 PRINT TIME
RUN
60
```

Set/Get/Do Interactions

The printer's Set/Get/Do data can be directly accessed via ZBI. For a complete listing of what can be accessed, type the following:

```
! U1 getvar "allcv"
```

Here's a quick list of these commands:

SETVAR Allows the direct setting of printer parameters.

GETVAR\$ Retrieves printer parameters.

SETVAR



Description SETVAR allows the direct setting of printer parameters.

Format SETVAR (PARAM\$, VALUE\$)

Parameters

PARAM\$ = The printer parameter to set.

VALUE\$ = the value to set

Returns Parameter dependent.

Example This is an example of the SETVAR command:

```
AUTONUM 1,1
LET OUTSTR$ = "Processing"
LET LOOPCTR = 200
LET TIMER5 = 17
LET TMP = REGISTEREVENT(TIMER5, 0, 1000)
DO WHILE LOOPCTR > 0
LET EVT = HANDLEEVENT()
IF EVT = TIMER5 THEN
LET A = SETVAR("device.frontpanel.line2",OUTSTR$)
LET OUTSTR$ = OUTSTR$ & "."
IF LEN(OUTSTR$) >16 THEN
LET OUTSTR$ = "Processing"
END IF
END IF
LET LOOPCTR = LOOPCTR - 1
SLEEP 1
LOOP
LET TMP = UNREGISTEREVENT(TIMER5)
LET A = SETVAR("device.frontpanel.line2","")
END
```

Comments None

GETVAR\$



This function retrieves printer parameters.

Format GETVAR\$ (PARAM\$)

Parameters

PARAM\$ = the printer parameter to get.

Returns The value of the parameter. Refer to the SGD commands for specific parameters.

Example Example: This is an example of the GETVAR\$ command:

```
AUTONUM 1,1
LET SGDCOUNT = 7
DECLARE STRING SGDQUERY$(2,SGDCOUNT)
LET SGDQUERY$(1,1) = "appl.name"
LET SGDQUERY$(1,2) = "device.printhead.serialnum"
LET SGDQUERY$(1,3) = "internal_wired.ip.addr"
LET SGDQUERY$(1,4) = "internal_wired.ip.netmask"
LET SGDQUERY$(1,5) = "internal_wired.ip.gateway"
LET SGDQUERY$(1,6) = "internal_wired.ip.port"
LET SGDQUERY$(1,7) = "internal_wired.mac_addr"
FOR I = 1 TO SGDCOUNT
LET SGDQUERY$(2,I) = GETVAR$(SGDQUERY$(1,I))
NEXT I
OPEN #1: NAME "ZPL"
PRINT #1: "^XA"
FOR I = 1 TO SGDCOUNT
PRINT #1: "^F050, ";50*I;"^A0N,25,25^FD";SGDQUERY$(1,I);"=";
PRINT #1: SGDQUERY$(2,I);"^FS"
NEXT I
PRINT #1: "^XZ"
```

Comments None

Example Programs

The next section provides example programs of common tasks using ZBI commands. These programs are also available for download at: www.zebra.com/zbi

Array Program

This program prompts a user to enter first a name; when it is entered, it is added to an array of all names entered. The user is then prompted to enter an address, which is then added to an array of all addresses entered. After the user enters a total of five names and addresses, the program uses the arrays to print the entered data on five labels.

Example This is an example of Array

```

1 rem *****
1 rem Zebra Technologies ZBI Sample Program
1 rem
1 rem Professional programming services are available. Please contact
1 rem ZBI-Experts@zebra.com for more information.
1 rem
1 rem This is an example of using arrays to store and use data within 1 rem ZBI.
1 rem *****
1 rem close all ports except for the console
1 rem *****
10 for i = 1 to 9 step 1
20  close #i
30  next i
1 rem *****
1 rem open a port to the print engine
1 rem *****
40 open #1: name "ZPL"
1 rem *****
1 rem create string arrays five elements in size to hold names and
1 rem addresses
1 rem *****
50 declare string name$(5)
60 declare string address$(5)
1 rem *****
1 rem infinite loop to put name and address data from console into
1 rem arrays
1 rem *****
70 do
80 for i = 1 to 5 step 1
90  print "PLEASE ENTER THE NAME"
1 rem *****
1 rem get data from console; input command looks for CRLF
1 rem *****
100  input name$(i)
1 rem *****
1 rem if the user inputs end or END, the program will end
1 rem *****
110  if name$(i) = "END" or name$(i) = "end" then
120    end
130  end if
140  print "PLEASE ENTER THE ADDRESS"
150  input address$(i)
160  if address$(i) = "END" or address$(i) = "end" then
170    end
180  end if
190 next i
200 for index = 1 to 5 step 1 ! For loop To Print data no label
1 rem *****
1 rem semicolon at the end prints with no CRLF

```

```

1 rem *****
210 print #1: "^XA^FO30,30^A0N,30,30^FD"&NAME$(INDEX)&"^FS";
1 rem *****
1 rem ampersand used to concatenate data into strings
1 rem *****
220 print #1: "^FO30,70^A0N,30,30^FD"&ADDRESS$(INDEX)&"^FS^XZ"
230 next index
240 loop ! loops back To Line 60
250 end

```

CSV Program

The following program will initialize and then execute continuously, repeating the same series of operations; process events, read input from the serial port, write any processed data out to the ZPL port, and then process the data read from the serial port.

The program first loads the CSV database E:PRODUCTS.CSV (in PROGRAMINIT subroutine). Then, data read from the serial port is compared against the first column in the database. If an entry is found in the first column of a row (in FINDITEM subroutine), the data for the respective row is inserted into the ZPL format E:PRICELBL.ZPL and printed on a label.

Example This is an example of a CSV program.

```

1 REM SUBROUTINES BELOW....
2 REM
3 REM *****
4 REM      MAIN LOOP - DO NOT MODIFY
5 REM *****
6 REM
7 GOSUB PROGRAMINIT
8 DO WHILE 1 = 1
9 GOSUB PROCESSEVENTS
10 GOSUB GETINPUT
11 GOSUB WRITEOUTPUT
12 GOSUB PROCESSDATA
13 LOOP
14 REM SUBROUTINES BELOW....
15 REM
16 REM *****
17 REM      Program Init
18 REM *****
19 REM
20 SUB PROGRAMINIT
21 LET INPORT = 1
22 LET OUTPORT = 2
23 LET ENDLIN$ = CHR$ ( 13 ) & CHR$ ( 10 )
24 OPEN # INPORT : NAME "SER"
25 OPEN # OUTPORT : NAME "ZPL"
26 DECLARE STRING DATABASE$ ( 1 , 1 )
27 LET COLUMNCOUNT = CSVLOAD ( DATABASE$ , "E:PRODUCTS.CSV" )
28 LET OUTDATA$ = "TABLE WITH " & STR$ ( COLUMNCOUNT ) & " COLUMNS LOADED" & ENDLIN$
29 RETURN
30 REM
31 REM *****
32 REM      Process Events
33 REM *****
34 REM
35 SUB PROCESSEVENTS
36 RETURN
37 REM
38 REM *****
39 REM      Get Input
40 REM
41 REM Writes All Data from the serial port to the string INDATA$

```

ZBI Commands

```
42 REM *****
43 REM
44 SUB GETINPUT
45 IF LEN ( INDATA$ ) < 5000 THEN
46 LET INCOUNT = READ ( INPORT , A$ , 1024 )
47 LET INDATA$ = INDATA$ & A$
48 END IF
49 RETURN
50 REM
51 REM *****
52 REM      Write Output
53 REM
54 REM Writes All Data from the string OUTDATA$ to the ZPL Port
55 REM *****
56 REM
57 SUB WRITEOUTPUT
58 LET OUTCOUNT = WRITE ( OUTPORT , OUTDATA$ , LEN ( OUTDATA$ ) )
59 IF OUTCOUNT > 0 THEN
60 LET OUTDATA$ ( 1 : OUTCOUNT ) = ""
61 END IF
62 RETURN
63 REM
64 REM *****
65 REM      Process Data
66 REM
67 REM Parse the data in the string INDATA$ and write output to OUTDATA$
68 REM *****
69 REM
70 SUB PROCESSDATA
71 IF LEN ( OUTDATA$ ) > 1000 THEN
72 RETURN
73 END IF
74 REM REMOVE ALL LINE FEEDS
75 DO
76 LET LOC = POS ( INDATA$ , CHR$ ( 10 ) )
77 LET INDATA$ ( LOC : LOC ) = ""
78 LOOP WHILE LOC > 0
79 REM COMPLETED LINE FEED REMOVAL
80 LET LOC = POS ( INDATA$ , CHR$ ( 13 ) ) ! Line ends with CR
81 IF LOC > 0 THEN
82 LET INLINE$ = INDATA$ ( 1 : LOC - 1 )
83 LET INDATA$ ( 1 : LOC ) = ""
84 GOSUB FINDITEM
85 IF ROW > 0 THEN
86 LET OUTDATA$ = OUTDATA$ & "^XA^XFE:PRICELBL.ZPL^FS" & ENDLIN$
87 LET OUTDATA$ = OUTDATA$ & "^FN1^FD" & DATABASE$ ( ROW , 1 ) & "^FS" & ENDLIN$
88 LET OUTDATA$ = OUTDATA$ & "^FN2^FD" & DATABASE$ ( ROW , 2 ) & "^FS" & ENDLIN$
89 LET OUTDATA$ = OUTDATA$ & "^FN3^FD" & DATABASE$ ( ROW , 3 ) & "^FS^XZ" & ENDLIN$
90 END IF
91 END IF
92 RETURN
93 REM
94 REM *****
95 REM      Find Item
96 REM
97 REM Search the first column of the database for the exact item requested
98 REM *****
99 REM
100 SUB FINDITEM
101 LET ROW = 0
102 LET EXPECTED$ = INLINE$
103 DO
104 LET FOUNDENTRY$ = ""
105 LET ROW = FIND ( DATABASE$ , 1 , EXPECTED$ , ROW + 1 )
106 IF ROW <> 0 THEN
107 LET FOUNDENTRY$ = DATABASE$ ( ROW , 1 )
```

```

108 END IF
109 LOOP WHILE ( ROW <> 0 AND FOUNDRY$ <> EXPECTED$ )
110 RETURN

```

DPI Conversion Program

This program converts a ZPL format being sent to the printer on the parallel port to 300 dpi (dots per inch) from 200 dpi (dots per inch). This is done by searching for and extracting ZPL commands with resolution-dependent arguments and scaling the arguments for a 300 dpi printer.

Example This is an example of dpi conversion:

```

1 rem *****
1 rem Zebra Technologies ZBI Sample Program
1 rem
1 rem Professional programming services are available. Please contact
1 rem ZBI-Experts@zebra.com for more information.
1 rem
1 rem This is an example of converting a printer from 200 dpi (dots
1 rem per inch
1 rem to 300 dpi. This example covers only some of the ZPL commands
1 rem that
1 rem could be affected by converting from 200 to 300 dpi printing.
1 rem *****
1 rem open the ports for input and output
1 rem *****
10 close #1
20 close #2
30 open #1 : name "PAR"
40 open #2 : name "ZPL"
1 rem *****
1 rem create an array with the search parameters
1 rem *****
50 declare string find$(20)
60 let find$(1) = "^FO"
70 let find$(2) = "^A0"
80 let find$(3) = "^GB"
90 let find$(4) = "^XZ"
100 let find$(5) = "^A@"
110 let find$(6) = "^LL"
120 let find$(7) = "^LH"
130 let find$(8) = "FO"
140 let find$(9) = "A0"
150 let find$(10) = "GB"
160 let find$(11) = "XZ"
170 let find$(12) = "A@"
180 let find$(14) = "LH"
190 let find$(15) = "^BY"
200 let find$(16) = "BY"
210 let find$(17) = "^B3"
220 let find$(18) = "B3"
1 rem *****
1 rem search for the parameters
1 rem *****
300 do
310 let in$ = searchto$(1, find$, 2)
1 rem *****
1 rem once a parameter is found, determine how to handle it
1 rem *****
320 if in$ = "^FO" or in$ = "FO" then
330 gosub 520
340 else if in$ = "^LH" or in$ = "LH" then
350 gosub 520
360 else if in$ = "^A0" or in$ = "A0" then

```

```

370  gosub 700
380  else if in$ = "^A@" or in$ = "A@" then
390  gosub 700
400  else if in$ = "^GB" or in$ = "GB" then
410  gosub 1100
420  else if in$ = "^LL" then
430  gosub 1300
440  else if in$ = "^BY" or in$ = "BY" then
450  gosub 1400
460  else if in$ = "^B3" or in$ = "B3" then
470  gosub 1600
480  else if in$ = "^XZ" then
490  print #2: in$;
500  end if
510 loop
1 rem *****
1 rem convert the ^FO and ^LH commands from 200 to 300 dpi
1 rem *****
520 inbyte #1: a$
530 let a = ord(a$)
540 if a >= 65 then
550  print #2: in$&a$;
560  goto 660
570 end if
580 let x$ = extract$(1, "", ", ")
590 let x2$ = a$&x$
600 let y$ = extract$(1, "", "^")
610 let x = val(x2$)
620 let y = val(y$)
630 let x2 = (x/2)+x
640 let y2 = (y/2)+y
650 print #2: in$; x2; ", "; y2; "^";
660 return
1 rem *****
1 rem convert the ^A0 and ^A@ commands from 200 to 300 dpi
1 rem *****
700 inbyte #1: a$
710 let a = ord(a$)
720 let b = 0
730 let c = 0
740 if a >= 65 then
750  print #2: in$&a$; ", ";
760  let b = 1
770 end if
780 inbyte #1: a$
790 let h$ = extract$(1, "", ", ")
800 if in$ = "^A@" or in$ = "A@" then
810  let c = 1
820  let w$ = extract$(1, "", ", ")
830  let m$ = extract$(1, "", "^")
840 else
850  let w$ = extract$(1, "", "^")
860 end if
870 let h = val(h$)
880 let w = val(w$)
900 let h2 = (h/2) + h
910 let w2 = (w/2) + w
920 if b = 1 then
930  print #2: h2; ", "; w2;
940 else
950  print #2: in$&"N,"; h2; ", "; w2;
960 end if
970 if c = 1 then
980  print #2: ", "; m$;
990 end if
1000 print #2: "^";

```

```

1010 return
1 rem *****
1 rem convert the ^GB command from 200 to 300 dpi
1 rem *****
1020 let w$ = extract$(1, "", ", ")
1030 let h$ = extract$(1, "", ", ")
1040 let t$ = extract$(1, "", ", ^")
1050 let h = val(h$)
1060 let w = val(w$)
1070 let t = val(t$)
1080 let h2 = (h/2)+ h
1090 let w2 = (w/2)+ w
1100 let t2 = (t/2)+ t
1110 print #2: in$; w2; ", "; h2; ", "; t2; "^";
1120 return
1 rem *****
1 rem convert the ^LL command from 200 to 300 dpi
1 rem *****
1300 let l$ = extract$(1, "", ", ^")
1310 let l = VAL(l$)
1320 let l2 = (l/2) + l
1330 print #2: in$; l2; "^";
1340 return
1 rem *****
1 rem convert the ^BY command from 200 to 300 dpi
1 rem *****
1400 inbyte #1: a$
1410 let a = ord(a$)
1420 if a >= 48 and a <= 57 then
1460 let x$ = extract$(1, "", ", ")
1470 let x2$ = a&x$
1480 let x = val(x2$)
1490 let x2 = (x/2) + x
1500 if x2 > 10 then
1510 let x2 = 10
1520 end if
1530 print #2: in$; x2; ", ";
1540 else
1550 print #2: in$; a$;
1560 end if
1570 return
1 rem *****
1 rem convert the ^B3 command from 200 to 300 dpi
1 rem *****
1600 let o$ = extract$(1, "", ", ")
1610 let e$ = extract$(1, "", ", ")
1620 let h$ = extract$(1, "", ", ")
1630 let h = val(h$)
1640 let h2 = (h/2) + h
1650 print #2: in$; o$; ", "; e$; ", "; h2; ", ";
1660 return

```

Email Program

This program sends a simple email message to user@domain.com, assuming a valid email server is set up by identifying the SMTP server on the print server. In order to write email via ZBI, the port written to must be named "EML".

Example This is an example of email

```

1 rem *****
1 rem Zebra Technologies ZBI Sample Program
1 rem
1 rem Professional programming services are available. Please contact
1 rem ZBI-Experts@zebra.com for more information.
1 rem
1 rem This is an example of connecting to an email server to send
1 rem email.
1 rem *****
1 rem EOT$ is the special character used to denote end of transmission
1 rem *****
5 let EOT$ = chr$(4)
1 rem *****
1 rem Open a connection to the email port; if there is an error, try
1 rem again
1 rem *****
10 open #1: name "EML"
15 on error goto 10
1 rem *****
1 rem Specify address to send message to, signal end of recipients
1 rem with EOT$
1 rem Note: To send to multiple addressees, separate addressees with
1 rem a space
1 rem *****
20 print #1: "user@domain.com";EOT$;
1 rem *****
1 rem Fill in the message information
1 rem *****
30 print #1: "From: Sample User"
40 print #1: "To: Recipient"
50 print #1: "Subject: This is a test"
60 print #1: ""
70 print #1: "Hello!"
80 print #1: i
1 rem *****
1 rem Terminate message
1 rem *****
90 print #1: "";EOT$
1 rem *****
1 rem Close the port, since each open port is only good for sending
1 rem one message
1 rem *****
100 close #1
110 sleep 2
120 let i = i + 1
130 goto 10

```

Extraction 1 Program

This program finds and stores data of interest, which in this case is found in a format after the string "DATA = ". The extract command is used to get the data from the input stream, and it is inserted into a simple ZPL format to be printed.

Example This is an example of Extraction 1.

```

1 rem *****
1 rem Zebra Technologies ZBI Sample Program
1 rem
1 rem Professional programming services are available. Please contact
1 rem ZBI-Experts@zebra.com for more information.
1 rem
1 rem This is an example of using ZBI for data extraction.
1 rem There are two methods for doing extraction; this example shows
1 rem data extraction using a string.
1 rem
1 rem The data to extract is as follows:
1 rem START
1 rem DATA = "hello":
1 rem DATA = "goodbye":
1 rem END
1 rem *****
1 rem close ports except console, open channels to parallel and serial
1 rem ports
1 rem *****
05 for i = 1 to 9 step 1
10  close #i
20 next i
30 open #1: name "PAR"
40 open #2: name "ZPL"
1 rem *****
1 rem create string array to hold data
1 rem *****
50 declare string format$(3)
60 let format$(1) = "START"
70 let format$(2) = "END"
80 let format$(3) = "DATA"
1 rem *****
1 rem main program; look for "START" keyword, if found print ^XA to ZPL port
1 rem *****
90 do
100  let begin$ = searchto$(1,format$,2)
110  if begin$ = "START" then
120    print #2: "^XA";
1 rem *****
1 rem if "DATA" keyword is found, get two data strings
1 rem *****
130  else if begin$ = "DATA" then
140    input #1: data_string1$
150    input #1: data_string2$
1 rem *****
1 rem get data from between quotes and print to ZPL port with formatting
1 rem *****
160    let extracted_data1$ = extract$(data_string1$,"""", """"")
170    let extracted_data2$ = extract$(data_string2$,"""", """"")
180    print #2:"^FO30,30^A0N,30,30^FD"&extracted_data1$&"^FS";
190    print #2:"^FO30,70^A0N,30,30^FD"&extracted_data2$&"^FS";
200  else if begin$ = "END" then
210    print #2: "^XZ          "
220  end if
230 loop

```

Extraction 2 Program

This program finds and stores data of interest, which in this case is found in a format after the string "DATA = ". The input command is used to get the data from the input stream, and it is inserted into a simple ZPL format to be printed.

Example This is an example of Extraction 2.

```

1 rem*****
1 rem Zebra Technologies ZBI Sample Program
1 rem
1 rem Professional programming services are available. Please contact
1 rem ZBI-Experts@zebra.com for more information.
1 rem
1 rem This is an example of using ZBI for data extraction.
1 rem There are two methods for doing extraction; this example shows
1 rem data extraction from the port directly.
1 rem
1 rem The data to extract is as follows:
1 rem START
1 rem DATA = "hello":
1 rem DATA = "goodbye":
1 rem END
1 rem*****
1 rem close ports except console, open channels to parallel and serial ports
1 rem*****
05 for i = 1 to 9 step 1
10  close #i
20  next i
30  open #1: name "PAR"
40  open #2: name "ZPL"
1 rem*****
1 rem create string array to hold data
1 rem*****quotes and print to ZPL port with formatting
1 rem*****

50 declare string format$(3)
60 let format$(1) = "START"
70 let format$(2) = "END"
80 let format$(3) = "DATA"
1 rem*****
1 rem main program; look for "START" keyword, if found print ^XA to ZPL port
1 rem*****

90 do
100  let begin$ = searchto$(1, format$, 2)
110  if begin$ = "START" then
120    print #2: "^XA";
1 rem*****
1 rem if "DATA" keyword is found, get two data strings
1 rem*****
130  else if begin$ = "DATA" then
1 rem*****
1 rem get data from between q
140    let extracted_data1$ = extract$(1,"""", """)
150    input #1: junk$
170    let extracted_data2$ = extract$(1,"""", """)
180    print #2:"^FO30,30^A0N,30,30^FD" &extracted_data1$& "^FS";
190    print #2:"^FO30,70^A0N,30,30^FD" &extracted_data2$& "^FS";
200  else if begin$ = "END" then
210    print #2: "^XZ"
220  end if
230 loop

```

Front Panel Control

This example shows how to intercept front panel button presses and write to the display to create a simple menu. The buttons used in this demo are set up for a Z4M/Z6M, ZM400/ZM600, or RZ400/RZ600. This could be reconfigured to work with any other printer.

Example This is an example of front panel control.

```

1 REM This example shows how to override the functionality of the feed key
1 REM and use the front panel display to show a option list
AUTONUM 1,1
REM CLOSE ALL
DECLARE STRING OPTIONS$(5)
FOR I = 1 TO 5
LET OPTIONS$(I) = "Option " & STR$(I)
NEXT I
LET ZPLPORT = 1
OPEN #ZPLPORT: NAME "ZPL"
LET FEEDKEY = 3
LET SELECTKEY = 10
LET PLUSKEY = 6
LET MINUSKEY = 7
LET EXITKEY = 9
LET TMP = REGISTEREVENT(FEEDKEY, 0, 1)
SUB NORMALLOOP
DO WHILE 1 = 1
LET EVT = HANDLEEVENT()
IF EVT = FEEDKEY THEN
LET INDEX = 1
GOSUB REGISTERKEYS
GOSUB SHOWMENU
GOTO FEEDLOOP
END IF
SLEEP 1
LOOP
SUB FEEDLOOP
DO WHILE 1 = 1
LET EVT = HANDLEEVENT()
IF EVT = FEEDKEY THEN
GOSUB RELEASEKEYS
GOSUB HIDEMENU
GOTO NORMALLOOP
ELSE IF EVT = SELECTKEY THEN
GOSUB HANDLEOPTION
ELSE IF EVT = PLUSKEY THEN
LET INDEX = INDEX + 1
IF INDEX > 5 THEN
LET INDEX = 1
END IF
GOSUB SHOWMENU
ELSE IF EVT = MINUSKEY THEN
LET INDEX = INDEX - 1
IF INDEX < 1 THEN
LET INDEX = 5
END IF
GOSUB SHOWMENU
ELSE IF EVT = EXITKEY THEN
GOSUB RELEASEKEYS
GOSUB HIDEMENU
GOTO NORMALLOOP
END IF
SLEEP 1
LOOP
REM ***** SUBROUTINE SHOWMENU ***

```



```
SUB SHOWMENU
LET LINE1$ = "FEED DISPLAY"
LET LINE2$ = OPTIONS$(INDEX)
GOSUB UPDATEDISPLAY
RETURN
REM ***** SUBROUTINE HIDEMENU ***
SUB HIDEMENU
LET LINE1$ = ""
LET LINE2$ = ""
GOSUB UPDATEDISPLAY
RETURN
SUB UPDATEDISPLAY
LET A = SETVAR("device.frontpanel.line1",LINE1$)
LET A = SETVAR("device.frontpanel.line2",LINE2$)
RETURN
SUB REGISTERKEYS
LET TMP = REGISTEREVENT(SELECTKEY, 0, 1)
LET TMP = REGISTEREVENT(PLUSKEY, 0, 1)
LET TMP = REGISTEREVENT(MINUSKEY, 0, 1)
LET TMP = REGISTEREVENT(EXITKEY, 0, 1)
RETURN
SUB RELEASEKEYS
LET TMP = UNREGISTEREVENT(SELECTKEY)
LET TMP = UNREGISTEREVENT(PLUSKEY)
LET TMP = UNREGISTEREVENT(MINUSKEY)
LET TMP = UNREGISTEREVENT(EXITKEY)
RETURN
SUB HANDLEOPTION
PRINT #ZPLPORT: "^XA^FO100,100^A0N,100,100^FD"; OPTIONS$(INDEX);"^XZ"
RETURN
```

Recall Program

This program searches for a ZPL format named "FORMAT.ZPL" that is already saved in printer memory. If the format is found, a number within the format is extracted and shown on the console. The user is then prompted to enter a new number, which is then substituted into the format.

Example This is an example of Recall.zpl

```

1 rem *****
1 rem Zebra Technologies ZBI Sample Program
1 rem
1 rem Professional programming services are available. Please contact
1 rem ZBI-Experts@zebra.com for more information.
1 rem
1 rem This is an example of recalling a ZPL format and extracting data
1 rem from it.
1 rem *****
1 rem close ports except console, open ZPL port and declare search
1 rem array
1 rem *****
10 for i = 1 to 9 step 1 ! Close all ports
20  close #i
30 next i
40 let zplport = 2
50 open #zplport: name "ZPL"
60 declare string search_zpl$(2)
70 let search_zpl$(1) = chr$(03)
80 let search_zpl$(2) = "FORMAT.ZPL"
1 rem *****
1 rem main program; look for format to recall on printer
1 rem *****
90 do
100 print #zplport: "^XA^HWE:*ZPL^FS^XZ"
110  let present = 0
115 let find$ = ""
120 do until find$ = chr$(03)
130  let find$ = searchto$(zplport, search_zpl$)
140  if find$ = "FORMAT.ZPL" then
150    let present = 1 ! format is present
160  end if
170 loop

1 rem *****
1 rem if format is not found, create a format and set data value to
1 rem 000
1 rem *****
180 if present = 0 then
190  print #zplport:"^XA^DFE:FORMAT.ZPL^FS";
200  print #zplport:"^FX000^FS^XZ"
210  let counter$ = "000"
1 rem *****
1 rem if format is found, extract the data from ^FX field
1 rem *****
220 else
230  print #zplport:"^XA^HFE:FORMAT.ZPL^FS^XZ"
240  let stop$ = searchto$(zplport, "^FX")
250  let counter$ = extract$(zplport, "", "^FS")
260  let stop$ = searchto$(zplport, "^XZ")
270 end if
1 rem *****
1 rem print current data value, prompt user to replace data
1 rem *****
280 print ""
290 print "Current number in format is " & counter$
300 print "Please enter new number (type EXIT to end) ";

```

```

310 input new_counter$
320 if new_counter$ = "EXIT" then
330   print "Program ending"
340   end
350 else
360   print #zplport:"^XA^DFE:FORMAT.ZPL^FS";
370   print #zplport:"^FX" & new_counter$ & "^FS^XZ"
380 end if
390 loop

```

Scale Program

This program reads data from a scale connected to the serial port by sending a "W" to the scale and waiting for a weight to be returned. When the weight is received, it is inserted into a simple label format and printed.

Example This is an example of Scale

```

1 rem *****
1 rem Zebra Technologies ZBI Sample Program
1 rem
1 rem Professional programming services are available. Please contact
1 rem ZBI-Experts@zebra.com for more information.
1 rem
1 rem This is an example of using ZBI to read scale data from the
1 rem serial port.
1 rem *****
1 rem close all ports except console, open channels to parallel and
1 rem serial ports
1 rem *****
05 for i = 1 to 9 step 1
10  close #i
20  next i
30  open # 2 : name "SER"
40  open # 1 : name "ZPL"
1 rem *****
1 rem main program; send serial port a 'W' in order to get a weight
1 rem *****
50 do
60 do
70   sleep 1 ! sleep so scale is not bombarded with incoming
1 rem data
80   print # 2 : "W" ; ! semicolon ends sent W without a CRLF
1 rem *****
1 rem get response from scale; note that input requires a CRLF to be
1 rem entered
1 rem *****
90   input # 2 : a$
100  if a$ = "EXIT" then! back door exit - if EXIT is received, ZBI ends
110   close # 2
120   print #1: "^XZ"
130   close #1
140   end
150   end if

1 rem *****
1 rem loop until valid weight is received, then print on label
1 rem *****
160 loop while pos ( a$ , "000.00" ) = 1 or pos ( a$ , "?" ) = 1
170 print # 1 : "~SD25^XA^FS";
180 print # 1 : "^LH0,0^FS";
190 print # 1 : "^FO56,47^A0N,69,58^FDThis weighs^FS";
1 rem *****
1 rem print weight on label; & character concatenates strings

```

```
1 rem *****
200 print # 1 : "^FO56,150^A0N,69,58^FD" & A$ & " lbs^FS";
210 print # 1 : "^PQ1,0,0,N";
220 print # 1 : "^XZ"
1 rem *****
1 rem loop until weight is off scale, then repeat for next item
1 rem weighed
1 rem *****
230 do
240   print # 2 : "W" ;
250   input # 2 : A$
260   loop until pos(A$ , "000.00") = 1 or pos(A$ , "?") = 1
270 loop
```

SGD Printer Commands

This chapter provides a high-level overview of printer setting Set / Get / Do (SGD) commands. For printer support of these SGD commands, see [SGD Command Support on page 1455](#).

.15†

SGD commands are available in printers with the following firmware versions or later:

- V66.17.4Z or later
- V61.15.xZ or later
- V60.16.2Z or later
- V60.15.xZ or later
- V50.15.xZ or later
- V56.15.xZ or later
- V53.16.x or later
- V53.15.2Z or later
- R53.16.3Z or later
- R60.15.8Z or later
- R62.15.8Z or later
- R63.15.8Z or later
- R65.15.8Z or later



IMPORTANT:: These are important points to note when using ZPL and SGD commands:

- SGD commands are case-sensitive.
- ZPL and SGD commands should be sent to the printer as separate files.
- Certain settings can be controlled by both ZPL and SGD. Configuration changes made in ZPL can affect configuration changes made in SGD.
- Changes made with one command type (ZPL or SGD) will affect the data returned to the host in response to both ZPL and getvar commands. The command type (ZPL or SGD) that was sent last determines the current setting.
- Some RF cards do not support all of the SGD commands.



IMPORTANT: These are important points to note when using a Zebra G-Series printer:

- You can send instructions to the printer using multiple programming languages: EPL, ZPL, or SGD. EPL and ZPL commands configure the printer, print labels, and get device status information. SGD commands set and get configuration details. These three languages can be used without the need to send the printer instructions to switch from one language to another.
- EPL, ZPL, and SGD commands must be sent to the printer as separate files. They cannot be used together in one format, or set of commands. For example, if you send a series of SGD commands to the printer and they are followed by a printable format, this needs to be done using separate files.

Overview

This section describes how and why to use the Set / Get / Do (SGD) commands. It also provides an example of a typical command structure.

SGD commands are commands that allow you to configure all printers with firmware versions V60.15.xZ, V50.15.xZ, V61.15.xZ, V56.15.xZ, V53.15.xZ, or later. The printer performs the specified function immediately after receiving the command. The commands are:

- setvar
- getvar
- do



IMPORTANT:: SGD commands must be terminated by a carriage return or a space and line feed, and the command, attributes, and values must be specified in lower case.

setvar Command

Setvar commands:

- are used to configure printer settings to specific values by setting them in the printer
- must be terminated by a space character or a CR/ LF (0x0D, 0x0A)

getvar Command

Getvar commands:

- are used to get the current value of the printer settings
- must be terminated by a space character or CR/LF (0x0D, 0x0A)

The printer responds with the printer setting of “?” if:

- the printer setting does not exist (usually due to incorrect spelling of the printer setting)
- it has not been configured yet

do Command

Do commands:

- are used to instruct the printer to perform predefined actions
- must be terminated by a space character or a CR/LF (0x0D, 0x0A)

Some Do commands require additional settings which must be enclosed in double quotes.

Command Structure

It is important to understand the structure of the command and its components. A command structure illustration is provided for each command in this guide.

This is an example of a command structure illustration:

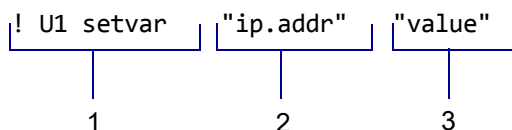

1	Command—always preceded with an exclamation point (!) and must be specified in lower case. A space resides between the !and U1 and between U1 and the command (setvar or getvar).
2	Attribute—always in double quotes and must be specified in lower case.
3	Chosen value—always in double quotes. Only applicable for setvar and do.

This command must be terminated by a space character or a CR/ LF (0x0D, 0x0A).

How to Send Multiple SGD Commands

For any getvar, setvar, or do command, if you issue the syntax without the "1" and use the END command followed by a space, multiple SGD commands are sent simultaneously.

This syntax shows how you can send multiple getvar commands:

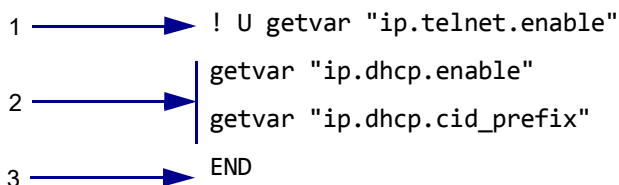

1	The command portion of the string does not use the "1" after the "! U".
2	Commands issued after the first command do not require the "! U".
3	The string of commands is terminated by the word "END" with a space after the word, and by a carriage return/ line feed.

JSON (JavaScript Object Notation)

JSON (JavaScript Object Notation) is an open standard format that uses human- and machine-readable text for device management. It transmits data objects consisting of elements as attribute–value pairs.

You can use JSON as an alternative to using the SGD (Set-Get-Do) mechanism when reading or writing parameters on QLn and iMZ mobile printers. JSON is a popular open standard for exchanging data objects and is well suited to this task.

The main settings channel for JSON is TCP port 9200, but other ports can be used. JSON commands are processed when received. Up to eight connections are allowed, and all connected ports are active, and the JSON commands will work while the printer is printing.

The port used for JSON can be changed or disabled using [ip.port_json_config on page 1222](#).



NOTE: JSON is available on all communications ports, unless **line_print** is enabled, in which case you must use the main TCP JSON port, 9200. If you connect to port 9200, the printer **ONLY** accepts JSON commands. CPCL, SGD, ZPL, and other command languages are not supported.

Configuring JSON Usage for Communications

All JSON commands should follow the JSON specification for escaping, spacing, etc. All JSON commands are prefixed by `{}`. Refer to <http://www.json.org/> for full details on JSON formatting.

By enclosing a variable's value in curly braces, it indicates that the value is an object. Inside the object, you can declare any number of properties using a **"name": "value"** pairing, separated by colons. Multiple pairings are separated by commas.

Use the SGD variable name in the JSON command structure. To configure JSON usage for communication, refer to the following examples.

Getvar using JSON

To do a getvar in SGD you use the format:

```
! U1 getvar "sgd.name"
! U1 getvar "ip.port"
! U1 getvar "device.location"
```

To get a variable value using JSON:

```
{}{ "sgd.name":null} returns { "sgd.name":"value" }
(){ "ip.port":null} returns { "ip.port":"9100" }
(){ "device.location":null} returns { "device.location":"my desk" }
```

You can get several values as follows:

```
{}{ "device.friendly_name":null, "device.company_name":null,
"device.company_contact":null, "device.location":null }
```

The response is:

```
{ "device.friendly_name":"XXQLJ120900310",
"device.company_name":"Zebra Technologies",
"device.company_contact":"123-555-1212",
"device.location":"My Desk" }
```

Setvar using JSON

To do a setvar in SGD you use the format:

```
! U1 getvar "sgd.name" "value"
! U1 getvar "ip.port" "9200"
! U1 setvar "device.location" "my desk"
```

To set a variable value using JSON:

```
{{"sgd.name":"value"} sets the variable value to "value"
{{"ip.port":"1234"} sets the variable value to "1234"
{{"device.location":"my desk"} sets the variable value to "my desk"
```



NOTE: When you set an SGD value, it will return the value that was set, or the old value if the set failed. If:

```
{{"sgd.name":"new_value"} fails, the variable value remains "old_value"
```

To set several values at once:

```
{{"device.friendly_name":"XXQLJ120900310",
"device.company_contact":"123-555-1212", "device.location":"My Desk"}}
```

The response is:

```
{"device.friendly_name":"XXQLJ120900310",
"device.company_contact":"123-555-1212", "device.location":"My Desk"}
```

Get an SGD Branch

You can retrieve all branch values by specifying the branch.

```
{{"bluetooth":null} returns all SGDs in branch and their values.
```

Get an allvalues Report

You can request an **allvalues** report with just the values for all settings with characteristics. This will return all SGDs and their values.

```
{{"allvalues":
{"ip.port":"6101", "ip.port_alternate":"9100", "ip.sgd_json_port":"9200",
...
}}
```

Get an allconfig Report

You can request an allconfig report using JSON, and it will return all settings with characteristics.

To get all SGDs and their values along with various other information including defaults:

```
{{"allconfig":null}
```



NOTE: For the "allconfig" response, it will start with

```
{"allconfig":{
```

and end with
 }}

If you do an **allconfig**, you can get the setting attributes for all settings as follows:

```
{ "allconfig": { "ip.port": { "value": "6101", "type": "integer", "range": "0-65535", "clone": true, "archive": true, "access": "RW" }, "ip.port_alterate": { "value": "9100", "type": "integer", "range": "0-65535", "clone": true, "archive": true, "access": "RW" }, "ip.sgd_json_port": { "value": "9200", "type": "integer", "range": "0-65535", "clone": true, "archive": true, "access": "RW" }, another setting, ... the last setting }
```

where:

- **"value"** = indicates the current value stored in the setting.
- **"type"** = indicates the type of value. Possible values are integer, enum, bool, string, double, ipv4-address, ipv6-address.
- **"range"** = indicates the range of a setting. For strings this is the range of the string length. For enums it is the possible enum values.
- **"clone"** = indicates if it is safe to store this setting and apply it to another link-os printer.
- **"archive"** = indicates if it is safe to store this setting and apply it to same link-os printer at a later time.
- **"access"** = indicates if the setting is RW (read/write), R (read-only), or W (write-only).

If you do an **allconfig**, you can get the setting attributes for all settings as follows:

```
{ } { "allconfig": null }
```

For the values used above it returns these entries:

```
"device.friendly_name": { "value": "XXQLJ120900310", "type": "string", "range": "0-17", "clone": false, "archive": true, "access": "RW" }, "device.company_contact": { "value": "123-555-1212", "type": "string", "range": "0-128", "clone": true, "archive": true, "access": "RW" }, "device.location": { "value": "my desk", "type": "string", "range": "0-128", "clone": true, "archive": true, "access": "RW" },
```

alerts.add

This command is used to configure the ZebraNet Alert System. It allows Zebra software to add new alerts without having to use the ZPL `^SX` command. This allows software to configure printers which do not have ZPL on them, and it provides the software with a single way in for configuring alerts. It also allows the software to configure alerts via local ports such as USB and serial.

The format is similar to the `^SX` command. It can delete the alert when both the set and clear flags are set to **FALSE**.

Setvar

This command instructs the printer to add the new alert with the configuration specified in the comma delimited list.

To configure the ZebraNet Alert system:

```
! U1 setvar "alerts.add" "[condition],[destination],[set],
[clear],[destination_address],[port],[quelling],[SGD_name]"
```

Parameters

- The alert condition. This can be any of the values returned from [alerts.conditions on page 569](#).
- The alert destination type. This can be any of the value returned from [alerts.destinations on page 571](#).
- On Set - Set to Y if the alert should be sent when the event is set
- On Clear - Set to Y if the alert should be sent when the event is cleared
- Destination address - applies to TCP,UDP,EMAIL,SNMP, SDK, and HTTP POST destination types. The maximum length of this address is 255 characters.
- Port - Applies to TCP and UDP types
- Quelling - When set to "Y" it prevents the alert from being sent. "N" is the default.

SGD Name - the name of the SGD command to be added. This is valid only when the alert condition is SGD_SET.

Values

Defined via [alerts.conditions on page 569](#): PAPER OUT, RIBBON OUT, HEAD TOO HOT, HEAD COLD, HEAD OPEN, SUPPLY TOO HOT, RIBBON IN, REWIND, CUTTER JAM, MED, PRINTER PAUSED, PQ JOB COMPLETED, LABEL READY, HEAD ELEMENT BAD, BASIC RUNTIME, BASIC FORCED, POWER ON, CLEAN PRINTHEAD, MEDIA LOW, RIBBON LOW, REPLACE HEAD, BATTERY LOW, RFID ERROR, ALL MESSAGES, COLD START, SGD SET

Default

NA

Do

This command has the same functionality as the **setvar**.

To configure the ZebraNet Alert system:

```
! U1 do "alerts.add" "[condition],[destination],[set],
[clear],[destination_address],[port],[quelling],[SGD_name]"
```

Example

This example shows a "Paper Out" alert sent via the serial port, with no destination address specified.

```
! U1 setvar "alerts.add" "PAPER OUT,SERIAL,Y,N,,0,,,"
```



NOTES:

- For printer support, see [SGD Command Support on page 1455](#).
- For details on SGD command structure, see [Command Structure on page 562](#).

alerts.conditions

This command lists the available conditions that can be specified in the first parameter of the `alerts.add` SGD. See [alerts.add on page 567](#) for information on the various parameters.

Getvar

To retrieve the list of available alert conditions for the printer:

```
! U1 getvar "alerts.conditions"
```

Values

PAPER OUT, RIBBON OUT, HEAD TOO HOT, HEAD COLD, HEAD OPEN, SUPPLY TOO HOT, RIBBON IN, REWIND, CUTTER JAM, MED, PRINTER PAUSED, PQ JOB COMPLETED, LABEL READY, HEAD ELEMENT BAD, BASIC RUNTIME, BASIC FORCED, POWER ON, CLEAN PRINTHEAD, MEDIA LOW, RIBBON LOW, REPLACE HEAD, BATTERY LOW, RFID ERROR, ALL MESSAGES, COLD START, SGD SET

Default

""



NOTES:

- For printer support, see [SGD Command Support on page 1455](#).
- For details on SGD command structure, see [Command Structure on page 562](#).

alerts.configured

This command creates a list of all the alerts that are configured on the printer. The alerts are delimited by the '|' character.

Writing to this SGD will clear out the old alerts and setup the new ones.

Setvar

To create the list of alerts configured on the printer:

```
! U1 setvar "alerts.configured" "<a '|' delimited list of configured alerts>"
```

Values

A list of alerts to be setup on the printer. See `alerts.add` for the format of the individual alerts.

Default

```
"COLD START,SNMP,Y,N,255.255.255.255,162,N"
```

Getvar

To retrieve the currently configured alerts on the printer:

```
! U1 getvar "alerts.configured"
```



NOTES:

- For printer support, see [SGD Command Support on page 1455](#).
- For details on SGD command structure, see [Command Structure on page 562](#).

alerts.destinations

This command lists the available destinations that can be specified in the first parameter of the `alerts.add` SGD. See the [alerts.add on page 567](#) for information on the various parameters.

Getvar

To return a list of available alert destinations:

```
! U1 getvar "alerts.destinations"
```

Values

SERIAL, PARALLEL, E-MAIL, TCP, UDP, SNMP, USB, HTTP-POST, BLUETOOTH, SDK

Default

NA



NOTES:

- For printer support, see [SGD Command Support on page 1455](#).
- For details on SGD command structure, see [Command Structure on page 562](#).

alerts.http.authentication.add

This command allows the user to add a single server/username/password triplet into the list of authentication entries.

When the printer attempts to connect to the URL in the HTTP POST alert, the server may require HTTP authentication (such as digest, basic, DNS, etc.). There may be multiple authentication requests along the route to the destination (for example, a local server first requires HTTP authentication as well as on the remote server). For each HTTP authentication request received while attempting to connect, the printer will enumerate the authentication entries and attempt to satisfy the request with the username/password pair provided for the respective server. The server name in the entry is what determines which username/password pair should be used for which authentication request. Both DNS names and IP addresses are acceptable.

The server, username, and password are separated by a single space (not a tab or other white space character). The server name is the only required field. If no username is supplied, but a password is, there must be two spaces between the server and the password fields. If there is a username but no password, or simply just the servername, no space is required at the end of the entry.

Setvar

To add server/username/password triplet into the list of authentication entries:

```
! U1 setvar "alerts.http.authentication.add" "servername[ username][ password]"
```

Values

Maximum string of 2048 characters.

Default

NA

Do

This command has the same settings as the `setvar`.

To add server/username/password triplet into the list of authentication entries:

```
! U1 do "alerts.http.authentication.add" "servername[ username][ password]"
```

Values

Maximum string of 2048 characters.

Default

NA

Examples

Example 1

A username and a password is supplied:

```
! U1 setvar "alerts.http.authentication.add" "my.server.lan johndoe password"
```

Example 2

No password is supplied:

```
! U1 setvar "alerts.http.authentication.add" "my.server.lan johndoe"
```

Example 3

No username is supplied (note the double space):

```
! U1 setvar "alerts.http.authentication.add" "my.server.lan  password"
```

Example 4

No username or password is supplied:

```
! U1 setvar "alerts.http.authentication.add" "my.server.lan"
```



NOTES:

- For printer support, see [SGD Command Support on page 1455](#).
- For details on SGD command structure, see [Command Structure on page 562](#).
- For details on HTTP POST, see [HTTP POST Alerts on page 1566](#).

alerts.http.authentication.entries

This command lists the server names added to the authentication entries list via `alerts.http.authentication.add`.

Only the server names will be shown; the username and passwords will not be shown. The server names are separated by a `\r\n` so that each shows up on its own line and is easier to read.

Getvar

To return the server names added to the authentication entry list:

```
! U1 getvar "alerts.http.authentication.entries"
```

Values

A list of server names.

Default

NA



NOTES:

- For printer support, see [SGD Command Support on page 1455](#).
- For details on SGD command structure, see [Command Structure on page 562](#).
- For details on HTTP POST, see [HTTP POST Alerts on page 1566](#).

alerts.http.authentication.remove

This command allows the user to remove a single server/username/password triplet from the list of authentication entries. To remove an entry, only the server name is supplied, and the entire entry will be removed. If an invalid entry is supplied no action is taken.

Note that the list of authentication triplets will be updated (and saved over a reset) but this SGD is just a command and doesn't have state. Therefore the persistent and restore defaults do not apply. The internal list that this command removes from, however, is persistent and defaultable (defaults to an empty list).

Setvar

To remove a server/username/password triplet from the list of authentication entries:

```
! U1 setvar "alerts.http.authentication.remove" "servername"
```

Value

Maximum string of 2048 characters

Default

NA

Do

This command has the same settings as the **setvar**.

To remove a server/username/password triplet from the list of authentication entries:

```
! U1 do "alerts.http.authentication.remove" "servername"
```

Value

Maximum string of 2048 characters

Default

NA

Example

A username and a password is supplied

```
! U1 setvar "alerts.http.authentication.remove" "my.server.lan"
```



NOTES:

- For printer support, see [SGD Command Support on page 1455](#).
- For details on SGD command structure, see [Command Structure on page 562](#).
- For details on HTTP POST, see [HTTP POST Alerts on page 1566](#).

alerts.http.logging.clear

This command clears the weblink alerts log entries. It does not disable logging. Setting this command to any value, including an empty string, will clear the weblink log entries.

Setvar

To clear the weblink alerts log entries:

```
! U1 setvar "alerts.http.logging.clear" "value"
```

Values

Any string value, including an empty string.

Default

NA

Do

To clear the weblink alerts log entries:

```
! U1 do "alerts.http.logging.clear" "value"
```

Values

Any string value, including an empty string.

Default

NA

Example

This example clears the log entries with an empty string value.

```
! U1 setvar "alerts.http.logging.clear" ""
```



NOTES:

- For printer support, see [SGD Command Support on page 1455](#).
- For details on SGD command structure, see [Command Structure on page 562](#).
- For details on HTTP POST, see [HTTP POST Alerts on page 1566](#).

alerts.http.logging.entries

This command returns the N number of entries in the http log, where N has a maximum value that is set by `alerts.http.logging.max_entries`.

The alerts http log is a collection of events related to sending HTTP POST messages. The log entries range anywhere from general status to errors that prevented a successful connection. Each log entry contains a timestamp for when it was logged by the system. The newest events will appear at the bottom of the list.

Getvar

To return the number of entries in the HTTP log:

```
! U1 getvar "alerts.http.logging.entries"
```

Values

NA

Default

NA

Example

This example shows the result from `alerts.http.logging.entries`:

```
[01-03-2013 12:48:59.964] [http] Connected to 10.3.4.58 (10.3.4.58) port 80
[01-03-2013 12:48:59.978] [http] HTTP/1.1 100 Continue
[01-03-2013 12:49:01.999] [http] Closing connection
```



NOTES:

- For printer support, see [SGD Command Support on page 1455](#).
- For details on SGD command structure, see [Command Structure on page 562](#).
- For details on HTTP POST, see [HTTP POST Alerts on page 1566](#).

alerts.http.logging.max_entries

This command specifies the maximum number of individual log entries that will be stored in the `alert.http.logging.entries` command.



IMPORTANT:: Changes to this command are immediate and may result in some log entries being lost. If there are N log entries currently in the log, the user sets the `max_entries` to M, where M is less than N, the oldest (N-M) log entries will be removed.

Setvar

To set the maximum number of log entries that will be stored:

```
! U1 getvar "alerts.http.logging.max_entries" "value"
```

Values

0 - 10000

Setting the value to 0 disables logging.

Default

"0"

Getvar

To return the setting for the maximum number of log entries that will be stored:

```
! U1 getvar "alerts.http.logging.max_entries"
```

Do

To set the maximum number of log entries that will be stored:

```
! U1 do "alerts.http.logging.max_entries" "value"
```

Values

0 - 10000

Setting the value to 0 disables logging.

Default

"0"

Example

In this example, `alert.http.logging.max_entries` is then set to 2.

```
[01-03-2013 12:48:59.964] [http] Connected to 10.3.4.58 (10.3.4.58) port 80
```

```
[01-03-2013 12:48:59.978] [http] HTTP/1.1 100 Continue
```

```
[01-03-2013 12:49:01.999] [http] Closing connection
```

When it is set to 2

[01-03-2013 12:48:59.978] [http] HTTP/1.1 100 Continue

[01-03-2013 12:49:01.999] [http] Closing connection



NOTES:

- For printer support, see [SGD Command Support on page 1455](#).
- For details on SGD command structure, see [Command Structure on page 562](#).
- For details on HTTP POST, see [HTTP POST Alerts on page 1566](#).

alerts.http.proxy

This command assigns the URL of the proxy for any HTTP POST alerts. The proxy server protocol, port, domain, username, and password are all encoded into the URL via the format outlined in RFC2396 (<http://www.ietf.org/rfc/rfc2396.txt>).

The username and password must avoid the invalid characters listed in RFC2396 (e.g. ':', '@', '/', etc). If an invalid character must be used it needs to be escaped using '%' as described in RFC2396.

When the setting is changed, the next HTTP POST alert will use the new value.

Setvar

To assign the proxy URL for HTTP POST alerts:

```
! U1 setvar "alerts.http.proxy" "http://username:password@mydomain.com:3128/"
```

Values

Any valid URL up to 2048 characters

URL format expected: **http://[user:pass@]domain[:port]/[path]**

Default

- The user:pass, port, and path are all optional.
- The default port is 1080.
- The default is to omit the username and password.

Getvar

To retrieve the proxy URL for HTTP POST alerts:

```
! U1 getvar "alerts.http.proxy"
```

Do

To assign the proxy URL for HTTP POST alerts:

```
! U1 do "alerts.http.proxy" "http://username:password@mydomain.com:3128/"
```

Values

Any valid URL up to 2048 characters

URL format expected: **http://[user:pass@]domain[:port]/[path]**

Default

- The user:pass, port, and path are all optional.
- The default port is 1080.
- The default is to omit the username and password.

Example

Examples of how to connect to various proxy servers:

`http://username:password@mydomain.com:3128/`

`http://mydomain.com/`



NOTES:

- For printer support, see [SGD Command Support on page 1455](#).
- For details on SGD command structure, see [Command Structure on page 562](#).
- For details on HTTP POST, see [HTTP POST Alerts on page 1566](#).

alerts.tracked_settings.clear_log

This command clears the `alerts.tracked_settings.log`. Setting this command to any value, including an empty string, will clear the `tracked_sgds` log entries.

Setvar

To clear the `tracked_sgds` log entries:

```
! U1 setvar "alerts.tracked_settings.clear_log" "value"
```

Values

Any string value, including an empty string.

Default

NA

Do

To clear the `tracked_sgds` log entries:

```
! U1 do "alerts.tracked_settings.clear_log" "value"
```

Values

Any string value, including an empty string.

Default

NA

Example

This example clears the log entries with an empty string value.

```
! U1 setvar "alerts.tracked_settings.clear_log" ""
```



NOTES:

- For printer support, see [SGD Command Support on page 1455](#).
- For details on SGD command structure, see [Command Structure on page 562](#).

alerts.tracked_settings.log_tracked

This command creates a comma-delimited list of settings for which sets should be logged.

Setvar

To set the list of settings for which sets should be logged:

```
! U1 setvar "alerts.tracked_settings.log_tracked" "settings.name1,settings.name2..."
```

Values

Settings with commas between names.

Default

""

Getvar

To return a comma-delimited lists of settings being logged:

```
! U1 getvar "alerts.tracked_settings.log_tracked"
```

Do

To set the list of settings for which sets should be logged:

```
! U1 do "alerts.tracked_settings.log_tracked" "settings.name1,settings.name2..."
```

Values

Settings with commas between names.

Default

""



NOTES:

- For printer support, see [SGD Command Support on page 1455](#).
- For details on SGD command structure, see [Command Structure on page 562](#).

alerts.tracked_settings.max_log_entries

Sets or retrieves the maximum number of entries to be shown in the `alerts.tracked_settings.log`.

Setvar

To set the maximum number of entries:

```
! U1 setvar "alerts.tracked_settings.max_log_entries" "value"  
! U1 do "alerts.tracked_settings.max_log_entries" "value"
```

Values

0 - 10000

Default

100

Getvar

To retrieve the maximum number of entries :

```
! U1 getvar "alerts.tracked_settings.max_log_entries"
```



NOTES:

- For printer support, see [SGD Command Support on page 1455](#).
- For details on SGD command structure, see [Command Structure on page 562](#).

alerts.tracked_sgds.log

This command reports the log of the settings listed in `alerts.tracked_settings.log_tracked`. The log entries will be fully JSON compliant.

Getvar

To retrieve the current log:

```
! U1 getvar "alerts.tracked_sgds.log"
```

Example

Sending `! U1 getvar "alerts.tracked_settings.log"` returns:

```
:[{"settingsName":"newValue","timestamp"
:"06-24-2012 19:51:28.641"}]" for 1 entry or
"[{"settingsName":"newValue","timestamp"
:"06-24-2012
19:51:28.641"},\r\n{"settingsName2":"newValue2","timestamp":"06-24-2012
19:51:30.641"}]" for 2 entries.
```

When the log is empty, the result will be: ""



NOTES:

- For printer support, see [SGD Command Support on page 1455](#).
- For details on SGD command structure, see [Command Structure on page 562](#).

alerts.tracked_sgds.max_log_entries

This command sets the maximum number of entries to be shown in `alerts.tracked_settings.log`.

Setvar

To set the maximum number of alert log entries that will be stored:

```
! U1 setvar "alerts.tracked_sgds.max_log_entries" "value"
```

Values

0 - 10000

Default

"100"

Setting the value to 0 disables logging.

Getvar

To return the setting for the maximum number of alert log entries that will be stored:

```
! U1 getvar "alerts.tracked_sgds.max_log_entries"
```

Do

To set the maximum number of alert log entries that will be stored:

```
! U1 setvar "alerts.tracked_sgds.max_log_entries" "value"
```

Values

0 - 10000

Default

"100"

Setting the value to 0 disables logging.

Example

This example sets the maximum log entries to 50.

```
! U1 setvar "alerts.tracked_sgds.max_log_entries" "50"
```



NOTES:

- For printer support, see [SGD Command Support on page 1455](#).
- For details on SGD command structure, see [Command Structure on page 562](#).

alerts.tracked_sgds.zbi_notified

This command provides a comma-delimited list of settings for which ZBI should be notified when the value is set.

Setvar

To set the list of the settings for which ZBI will be notified when the setting is set:

```
! U1 setvar "alerts.tracked_settings.zbi_notified"
"settings.name1,settings.name2,etc."
```

Values

A comma delimited list of settings names.

Default

""

Getvar

To retrieve the list of the settings for which ZBI will be notified when the value is set:

```
U1 getvar "alerts.tracked_settings.zbi_notified"
```

Do

To set the list of the settings for which ZBI will be notified when the setting is set:

```
! U1 setvar "alerts.tracked_settings.zbi_notified"
"settings.name1,settings.name2,etc."
```

Values

A comma delimited list of settings names.

Default

""



NOTES:

- For printer support, see [SGD Command Support on page 1455](#).
- For details on SGD command structure, see [Command Structure on page 562](#).

apl.enable

The setvar enables or disables a Virtual Device. The getvar returns the currently enabled Virtual Device.

Setvar

To enable or disable a virtual device:

```
! U1 setvar "apl.enable" "value"
```

Values

none, apl-d, apl-i, apl-e, apl-l, apl-m, apl-mi, apl-o, apl-t

Default

NA

Example

```
! U1 setvar "apl.enable" "apl-o"
```

Getvar

To return the currently enabled Virtual Device:

```
! U1 getvar "apl.enable"
```



NOTES:

- For printer support, see [SGD Command Support on page 1455](#).
- For details on SGD command structure, see [Command Structure on page 562](#).

apl.framework_version

Returns the revision number of the Virtual Device framework.

Getvar

To return the revision number of the Virtual Device framework:

```
! U1 getvar "apl.framework_version"
```



NOTES:

- For printer support, see [SGD Command Support on page 1455](#).
- For details on SGD command structure, see [Command Structure on page 562](#).

apl.version

This command returns the revision number of the Virtual Device system.

Getvar

To display the revision number of the Virtual Device system:

```
! U1 getvar "apl.version"
```



NOTES:

- For printer support, see [SGD Command Support on page 1455](#).
- For details on SGD command structure, see [Command Structure on page 562](#).

appl.link_os_version

This command lists the version of the Link-OS™ feature set that is supported by the printer.

Getvar

To retrieve the Link-OS™ version of the printer:

```
! U1 getvar "appl.link_os_version"
```

Example

In this example, the `getvar` command returns version 1.0 of Link-OS™ .

```
! U1 getvar "appl.link_os_version"
```

returns

```
1.0
```



NOTES:

- For printer support, see [SGD Command Support on page 1455](#).
- For details on SGD command structure, see [Command Structure on page 562](#).

appl.option_board_version

This command returns the version number of the firmware running on the wireless option board. For printer support, see [SGD Command Support on page 1455](#).

Getvar

To return the version number of the firmware running on the wireless option board:

```
! U1 getvar "appl.option_board_version"
```

Example

This command returns the version number of the firmware running on the wireless option board.

```
! U1 getvar "appl.option_board_version"  
"0.0.0 *"
```



NOTES:

- For details on SGD command structure, see [Command Structure on page 562](#).

appl.bootblock

This command refers to the bootblock version. On the configuration label, the bootblock number is identified as the hardware ID. For printer support, see [SGD Command Support on page 1455](#).

Getvar

To return the bootblock version number that appears on the configuration label:

```
! U1 getvar "appl.bootblock"
```

Example

In this example, the `getvar` returns the bootblock version number.

```
! U1 getvar "appl.bootblock"
```

NOTES:

For details on SGD command structure, see [Command Structure on page 562](#).

appl.date

This command refers to the date the firmware was created. For printer support, see [SGD Command Support on page 1455](#).

Getvar

To respond with the date the firmware was created in the mm/dd/yy format:

```
! U1 getvar "appl.date"
```

Example

In this example, the `getvar` returns the date the firmware was created.

```
! U1 getvar "appl.date"
```

Result: "01/29/10"



NOTES:

For details on SGD command structure, see [Command Structure on page 562](#).

appl.name

This command refers to the printer's firmware version. For printer support, see [SGD Command Support on page 1455](#).

Getvar

To return the printer's firmware version:

```
! U1 getvar "appl.name"
```

Example

In this example, the `getvar` returns the printer's firmware version.

```
! U1 getvar "appl.name"
```



NOTE

For details on SGD command structure, see [Command Structure on page 562](#).

capture.channel1.count

This command indicates the number of times that `capture.channel1.delimiter` was seen on the port specified in `capture.channel1.port`. Additionally, it indicates how many times `capture.channel1.data.raw` has been updated with user data as well as the number of times we reached the `capture.channel1.max_length`.

This will be shown in the HZA response under the capture data section.

Getvar

To return the number of times that `capture.channel1.delimiter` was seen on the port specified in `capture.channel1.port`:

```
! U1 getvar "capture.count"
```



NOTES:

- For printer support, see [SGD Command Support on page 1455](#).
- For details on SGD command structure, see [Command Structure on page 562](#).

capture.channel1.data.mime

This command provides a view to the data captured on the port specified by `capture.channel1.port` in a mime/base64 encoded format.

Getvar

To retrieve the data captured on the port specified by `capture.channel1.port`:

```
! U1 getvar "capture.channel1.data.mime"
```

Result

Data in mime-encoded format.



NOTES:

- For printer support, see [SGD Command Support on page 1455](#).
- For details on SGD command structure, see [Command Structure on page 562](#).

capture.channel1.data.raw

This command retrieves the user data captured off of the port specified in `capture.channel1.port`.

Any binary zeros in the capture.data stream will be replaced with the escaped representation of NULL ("`\000`"). The delimiter data is not stored as part of the captured data.

This will be shown in the HZA output within capture data section.

Getvar

To retrieve the user data captured off of the port specified in `capture.channel1.port`:

```
! U1 getvar "capture.channel1.data.raw"
```



NOTES:

- For printer support, see [SGD Command Support on page 1455](#).
- For details on SGD command structure, see [Command Structure on page 562](#).

capture.channel1.delimiter

This command stores the delimiter used to partition data received on the port specified by `capture.channel1.port` and stored in `capture.channel1.data.raw` and `capture.channel1.data.mime`.

This will be reported in the data capture section of the HZA response.

Setvar

To set the delimiter used to partition data received on the `capture.channel1.port`:

```
! U1 setvar "capture.channel1.delimiter" "delimiter"
```

Values

Any character set up to a maximum of 64 characters in length.

Binary data can be used in the delimiter. To do this enter a `'\'` and then the 3 digit octal value of the character. `"\\\" = '\'` in some tools, so to get `\002` you may need to enter `"\\002"`. Escaped octal characters count as a single character and not 4 (e.g. a delimiter of `"\001\000\002"` is 3 characters, not 12)

Default

```
"\012"
```

Getvar

To retrieve the delimiter:

```
! U1 getvar "capture.channel1.delimiter"
```

Example

Binary data can be used in the delimiter. To do this enter a `'\'` and then the 3 digit octal value of the character. Note: `"\\\" = '\'` in some tools, so to get `\002` you may need to enter `"\\002"`.

```
"\000" = NULL (single character)
```

```
"end\015\012\000" = 'e'+ 'n'+ 'd'+ '\r'+ '\n'+ NULL (total of 6 characters)
```



NOTES:

- For printer support, see [SGD Command Support on page 1455](#).
- For details on SGD command structure, see [Command Structure on page 562](#).

capture.channel1.max_length

This command sets a length indicating when to copy captured data to the data SGD if the delimiter has not been seen yet.

If the delimiter and the max_length are reached at the same time, the delimiter will not be part of the captured data. If only part of the delimiter has been received, then the part of the delimiter we have received, will be part of the capture data.

When the max_length is changed, any data currently in the buffer will be thrown away, and the new value of max_length will be used.

The Capture Port shall be defaulted to 1000 bytes by any mechanism (including ^JUF, ^JUN, ^JUA, and device.restore_defaults).

Setvar

To instruct the printer to set a default data capture length:

```
! U1 setvar "capture.channel1.max_length" "value"
```

Values

1-3000

Default

"1000"

Getvar

To retrieve the default data capture length:

```
! U1 getvar "capture.channel1.max_length"
```



NOTES:

- For printer support, see [SGD Command Support on page 1455](#).
- For details on SGD command structure, see [Command Structure on page 562](#).

capture.channel1.port

This command determines the port that should be monitored for user data. This allows the user to attach an external device, such as a keyboard or barcode scanner, and have input captured into the `capture.channel1.data.raw` command. Once the data is in the SGD they can use it as they would any other SGD (this includes functionality that allows users to be sent an alert when an SGD value changes).

The data received on the specified port will be read until the value in `capture.channel1.delimiter` is seen, at which point the data received until (but not including) the delimiter will be stored in `capture.channel1.data.raw`.

For the port specified in `capture.channel1.port`, no data will be sent to any of the parsers on that port. All data received is assumed to be user input that is to be placed in `capture.channel1.data.raw`. To disable the data capture functionality, set `capture.channel1.port` to "off"

The delimiter will not be stored in `capture.channel1.data.raw`.

The port will be shown in the data capture portion of the HZA response.

The capture port shall be defaulted to "off" by any mechanism (including ^JUF, ^JUA, and `device.restore_defaults`).

Setvar

To set the port to be monitored for user data:

```
! U1 setvar "capture.channel1.port" "value"
```

Values

- **off** = no data is stored in `capture.channel1.data.raw` and all data is sent to the parsers - normal operation
- **serial** = Data is read off the serial port. No data sent to the parsers on this port.
- **usb** = Data is read off the usb port. No data sent to the parsers on this port.
- **bt** = Data is read off the Bluetooth[®] port. No data sent to the parsers on this port.
- **usb_host** = not yet supported. reserved for when usb host is implemented.

Default

"off"

Getvar

To retrieve the printer's current port being monitored for user data:

```
! U1 getvar "capture.channel1.port"
```

Example

This example sets the command value to "off", preventing it from capturing data.

```
! U1 setvar "capture.channel1.port" "off"
```



NOTES:

- For printer support, see [SGD Command Support on page 1455](#).
- For details on SGD command structure, see [Command Structure on page 562](#).

CISDFCRC16

Download Files

The **CISDFCRC16** command downloads supported files types to the printer.



NOTE: When using certificate files, your printer supports:

- a. Using Privacy Enhanced Mail (PEM) formatted certificate files.
- b. Using the client certificate and private key as two files, each downloaded separately.

Using exportable PAC files for EAP-FAST.



IMPORTANT: When using certificate files, the time on the printer must be set correctly for the websocket connection to succeed, as the time is used in the certificate validation. Each line should be terminated with a CR/LF.

Type

```
! CISDFCRC16
<crc>
<filename>
<size>
<checksum>
<data>
```

Parameters	Details
• <crc> = CRC value	Values: a four digit CRC value in hexadecimal. If 0000 is entered, then the CRC validation is ignored. For examples, see below.
• <filename> = file name	Values: file name that is stored on the printer's file system. An extension must be specified. Files must be saved to the E: drive.
• <size> = file size	Values: an eight digit file size specified in hexadecimal which indicates the number of bytes in the <data> section.
• <checksum> = checksum value	Values: a four digit checksum value in hexadecimal. If 0000 is entered, then the CRC validation is ignored. The checksum value is calculated using the sum of the bytes in the <data> section. For examples, see below.
• <data> = data	Values: Binary data saved on the printer's file system as <filename> . Number of bytes in this field must match the <size> parameter.



NOTE: This command can be used in place of the **~DG** and **~DY** command for more saving and loading options. **~DY** is the preferred command to download TrueType fonts on printers with firmware later than X.13. The **CISDFCRC16** command also supports downloading wireless certificate files

	<p>This example shows the CISDFCRC16 command used to download a private key file (privkey.nrd) to the printer. The different sections of the command are on separate lines.</p> <pre> ! CISDFCRC16 BA0B privkey.nrd 0000037B E3AF -----BEGIN RSA PRIVATE KEY----- MIICXgIBAAKBgQDQXu/E9YuG1ScfWQepZa8Qe/1mJRpmk8oPhPVvam/4M5/WaWQp 3/p1f8J17/hDH8fFq5Dnx3/tHaU7A4SK08GeghX5hnp/mt4tuQEvSxkCrcgS1puz z5db07ThhuzxYClnr7uiXPvSRXawgWDPas+0q/6gHeUSXtA0EofuIyv7wIDAQAB AoGBAJPNf3wn6wT5pE59DJIyakRiLmkt1wK0zv0bJfgS7i2Yv1EbeAy9PnPe3vKG Bovm6A+oi2/qTSTLUTiFc7QHxJPVxLmRiHmbf1Q8j+VJKGtpwt8EY/Px+HSM2HAP jqd+Im0IiE9RQPsxWQH9Uaauf6n15gIfMF74BIPsVzFXLFfxAKEA6zSrCKCycE/P 14cjZibnLiWxdL3U3I9eWuhmIS37RB6UJFBCWUPwr26H1HzOKqhOUMbFf5h0mvkZ gciN9A8kxwJBAOLK7Gyorre8iK9IMMwc70IJc7H8pH1y/N20tyaC1XuPfqz0H4PH w2W2m3BhZ7ggHJLLiiFVF+Hr5X7cibFD05kCQQDFe51HSzXHWxvViN/N+0gL1RYk Q0cisTW1+n8VyLe5wDr+Km0q6eytq44mvIuWAW6QH/TfZxBIynICKFQX4UctAkAm P80iAkz9RfnTfhxjp7S35poxoYdodPU6tLAK+ZnhrfDSYJXUFuPYirSqfnMMtbW7 +EICnyRZAP0CqVU7pUm5AkEAnH206dKvUvwOEX+CscVATRrejKLCeJ+6YZWqid9X 0XGJgrHNXGpDtQiVSGM59p0XnHTZJYjvVNdNOMnhg333nQ== -----END RSA PRIVATE KEY----- </pre>
---	--

	<p>These are examples of CRC and checksum values:</p> <p style="text-align: center;">CRC example</p> <p>The value of the <code><crc></code> field is calculated the CRC-16 for the contents of a specified file using the CRC16-CCITT polynomial which is $x^{16} + x^{12} + x^5 + 1$. It is calculated using an initial CRC of 0x0000.</p> <p style="text-align: center;">checksum example</p> <p>Given 4 bytes of data : 0x25, 0x62, 0x3F, 0x52:</p> <ol style="list-style-type: none"> 1. Adding all bytes together gives 0x118. 2. Drop the carry nibble to get 0x18. 3. Get the two's complement of the 0x18 to get 0xE8. <p style="text-align: center;">This is the checksum byte.</p>
---	--



NOTES:

- For details on SGD command structure, see [Command Structure on page 562](#).
- For printer support, see [SGD Command Support on page 1455](#).

comm.baud

This command refers to the printer's comm (cable) baud rate. For printer support, see [SGD Command Support on page 1455](#).

Once the printer's communication port parameters have been changed, the host terminal must also be configured to match the new printer settings before the host can communicate again.

Setvar

To instruct the printer to change the baud rate:

```
! U1 setvar "comm.baud" "value"
```

Values

- "9600"
- "19200"
- "38400"
- "57600"
- "115200"

Default

```
"19200"
```

Getvar

To instruct the printer to respond with the currently set printer baud rate:

```
! U1 getvar "comm.baud"
```

Examples

In this example, the `getvar` retrieves the current baud rate.

```
! U1 getvar "comm.baud"
```

This `setvar` example sets the communications baud rate to 19200 BPS.

```
! U1 setvar "comm.baud" "19200"
```



NOTES:

For details on SGD command structure, see [Command Structure on page 562](#).

comm.halt

This command halts all communications to the serial port if an error condition occurs.

Setvar

To instruct the printer to halt communication to the printer:

```
! U1 setvar "comm.halt" "value"
```

Values

- "yes"
- "no"

Default

"yes"

Getvar

To return the current value:

```
! U1 getvar "comm.halt"
```

Values

- "yes"
- "no"

Example

This setvar example sets the value set to "yes".

```
! U1 setvar "comm.halt" "yes"
```



NOTES:

- For printer support, see [SGD Command Support on page 1455](#).
- For details on SGD command structure, see [Command Structure on page 562](#).

comm.pnp_option

The `comm.pnp_option` command configures the RS-232 Serial Port Plug and Play setting on the printer. For printer support, see [SGD Command Support on page 1455](#).

Setvar

To instruct the printer to change the `comm.pnp_option` setting:

```
! U1 setvar "comm.pnp_option" "value"
```

Values

- "off" = sets the printer to not attempt Plug and Play via serial at startup
- "on" = sets the printer to attempt Plug and Play via serial at startup

Default

"off"

Getvar

To return the current setting for the `comm.pnp_option` setting:

```
! U1 getvar "comm.pnp_option"
```

Example

In this example, the `setvar` sets the serial port communications state to "on".

```
! U1 setvar "comm.pnp_option" "on"
```

When the `setvar` value is set to "on", the `getvar` result is "on".



NOTES:

- Not all Operating Systems and computer hardware support Plug and Play over RS-232 Serial port connections.
- For details on SGD command structure, see [Command Structure on page 562](#).

comm.type

This printer setting determines the behavior of the serial port interface. It selects one of three serial communication states: DTE, DCE or Autodetect. For printer support, see [SGD Command Support on page 1455](#).

Setvar

To instruct the printer to change the serial port interface type:

```
! U1 setvar "comm.type" "value"
```

Values

- "auto" = Autodetect
- "dte" = Force DTE (Tx on pin 2)
- "dce" = Force DCE (Rx on pin 2)

Default

"auto"

Getvar

To instruct the printer to respond with the current serial port interface type:

```
! U1 getvar "comm.type"
```

Examples

In this example, the `getvar` retrieves the serial port communications state.

```
! U1 getvar "comm.type"
```

This `setvar` example sets the communications port state to Autodetect.

```
! U1 setvar "comm.type" "auto"
```



NOTES:

For details on SGD command structure, see [Command Structure on page 562](#).

comm.parity

This command sets the printer's communication parity. For printer support, see [SGD Command Support on page 1455](#).

Once the printer's communication port parameters have been changed, the host terminal must also be configured to match the new printer settings before the host can communicate again.

Setvar

To instruct the printer to set the communication port parity:

```
! U1 setvar "comm.parity" "value"
```

Values

- "N" — None
- "E" — Even
- "O" — Odd

Getvar

To instruct the printer to respond with the currently set printer parity:

```
! U1 getvar "comm.parity"
```

Examples

In this example, the `getvar` retrieves the currently set printer parity.

```
! U1 getvar "comm.parity"
```

This `setvar` example sets the parity to None.

```
! U1 setvar "comm.parity" "N"
```



NOTE:

- For details on SGD command structure, see [Command Structure on page 562](#).

comm.stop_bits

This command refers to the printers's communication port stop bits. For printer support, see [SGD Command Support on page 1455](#).

Once the printer's communication port parameters have been changed, the host terminal must also be configured to match the new printer settings before the host can communicate again.

Setvar

To instruct the printer to configure the comm.port stop bit value:

```
! U1 setvar "comm.stop_bits" "value"
```

Values

- "1"
- "2"

Default

"1"

Getvar

To instruct the printer to respond with the currently set stop bit value:

```
! U1 getvar "comm.stop_bits"
```

Example

In this example, the `getvar` retrieves the currently set stop bit value.

```
! U1 getvar "comm.stop_bits"
```

This `setvar` example configures the comm.port for 1 stop bit.

```
! U1 setvar "comm.stop_bits" "1"
```



NOTES:

For details on SGD command structure, see [Command Structure on page 562](#).

cradle.comm.baud

Sets or retrieves the cradle serial USB port baud rate.

Setvar

To set the cradle serial USB port baud rate:

```
! U1 setvar "cradle.comm.baud" "value"
```

Value

300,1200,2400,4800,9600,19200,38400,57600,115200,230400,460800,921600

Default

"115200"

Getvar

To return the cradle serial USB port baud rate:

```
! U1 getvar "cradle.comm.baud"
```



NOTES:

- For printer support, see [SGD Command Support on page 1455](#).
- For details on SGD command structure, see [Command Structure on page 562](#).

cradle.comm.handshake

Sets or retrieves the cradle serial USB port handshake mode.

Setvar

To set the cradle serial USB port handshake mode:

```
! U1 setvar "cradle.comm.handshake" "value"
```

Values

- "rts/cts" = use hardware handshake via the request-to-send/clear-to-send pins
- "xon/xoff" = use software handshake
- "none" = no flow control

Default

"rts/cts"

Getvar

To retrieve the cradle serial USB port handshake mode:

```
! U1 getvar "cradle.comm.handshake"
```



NOTES:

- For printer support, see [SGD Command Support on page 1455](#).
- For details on SGD command structure, see [Command Structure on page 562](#).

cutter.clean_cutter

This command determines if the clean cutter option is enabled or disabled. For printer support, see [SGD Command Support on page 1455](#).

Setvar

To instruct the printer to set the clean cutter option:

```
! U1 setvar "cutter.clean_cutter"
```

Values

- "on" = turns on clean cutter
- "off" = turns off clean cutter

Default

"on"

Getvar

To retrieve the status of the clean cutter option:

```
! U1 getvar "cutter.clean_cutter"
```

Example

This **setvar** example shows the value set to "on".

```
! U1 setvar "cutter.clean_cutter" "on"
```

When the setvar value is set to "on", the **getvar** result is "on".



NOTES:

For details on SGD command structure, see [Command Structure on page 562](#).

device.allow_firmware_downloads

This command sets if the firmware downloads are allowed or not.

Setvar

To set the command:

```
! U1 setvar "device.allow_firmware_downloads" "value"
```

Values

"yes" = allow firmware downloads

"no" = does not allow firmware downloads

Default Value

"yes"

Getvar

To view the current setting:

```
! U1 getvar "device.allow_firmware_downloads"
```

Example

This setvar example sets the firmware downloads feature to "no".

```
! U1 setvar "device.allow_firmware_downloads" "no"
```



NOTES:

- For printer support, see [SGD Command Support on page 1455](#).
- For details on SGD command structure, see [Command Structure on page 562](#).

device.applicator.data_ready

This command will specify if a "high" or "low" value is required for the applicator to indicate it is ready to receive data.

Setvar

To set the value:

```
! U1 setvar "device.applicator.data_ready" "value"
```

Values

high, low

Default

low

Getvar

To instruct the printer to respond with the currently set value:

```
! U1 getvar "device.applicator.data_ready"
```



NOTES:

- For printer support, see [SGD Command Support on page 1455](#).
- For details on SGD command structure, see [Command Structure on page 562](#).

device.applicator.end_print

This command allows you to control an online verifier or applicator device. This command is similar to the `b` parameter for [^JJ on page 242](#).

Setvar

To set the value for the applicator port mode:

```
! U1 setvar "device.applicator.end_print" "value"
```

Values

- **off**
- **1** = End Print signal normally high, and low only when the printer is moving the label forward.
- **2** = End Print signal normally low, and high only when the printer is moving the label forward.
- **3** = End Print signal normally high, and low for 20 ms when a label has been printed and positioned.
- **4** = End Print signal normally low, and high for 20 ms when a label has been printed and positioned.

Default

off

Getvar

To instruct the printer to respond with the currently set value:

```
! U1 getvar "device.applicator.end_print"
```



NOTES:

- For printer support, see [SGD Command Support on page 1455](#).
- For details on SGD command structure, see [Command Structure on page 562](#).

device.applicator.feed

This command will specify if a "high" or "low" value is required for an applicator to feed media.

Setvar

To set the value:

```
! U1 setvar "device.applicator.feed" "value"
```

Values

high, low

Default

low

Getvar

To instruct the printer to respond with the currently set value:

```
! U1 getvar "device.applicator.feed"
```



NOTES:

- For printer support, see [SGD Command Support on page 1455](#).
- For details on SGD command structure, see [Command Structure on page 562](#).

device.applicator.media_out

This command will specify if a "high" or "low" value is required for an applicator to indicate that the media has run out.

Setvar

To set the value:

```
! U1 setvar "device.applicator.media_out" "value"
```

Values

high, low

Default

low

Getvar

To instruct the printer to respond with the currently set value:

```
! U1 getvar "device.applicator.media_out"
```



NOTES:

- For printer support, see [SGD Command Support on page 1455](#).
- For details on SGD command structure, see [Command Structure on page 562](#).

device.applicator.pause

This command will specify if a "high" or "low" value is required for an applicator to pause printing.

Setvar

To set the value:

```
! U1 setvar "device.applicator.pause" "value"
```

Values

high, low

Default

low

Getvar

To instruct the printer to respond with the currently set value:

```
! U1 getvar "device.applicator.pause"
```



NOTES:

- For printer support, see [SGD Command Support on page 1455](#).
- For details on SGD command structure, see [Command Structure on page 562](#).

device.applicator.reprint

This command will specify if a "high" or "low" value is required for an applicator to reprint a label. This command is similar to [~PR on page 307](#).

Setvar

To set the value:

```
! U1 setvar "device.applicator.reprint" "value"
```

Values

high, low

Default

low

Getvar

To instruct the printer to respond with the currently set value:

```
! U1 getvar "device.applicator.reprint"
```



NOTES:

- For printer support, see [SGD Command Support on page 1455](#).
- For details on SGD command structure, see [Command Structure on page 562](#).

device.applicator.rfid_void

This command will specify if a "high" or "low" value is used for the RFID void signal, which occurs when an RFID label is voided by the printer.

Setvar

To set the value:

```
! U1 setvar "device.applicator.rfid_void" "value"
```

Values

high, low

Default

low

Getvar

To instruct the printer to respond with the currently set value:

```
! U1 getvar "device.applicator.rfid_void"
```



NOTES:

- For printer support, see [SGD Command Support on page 1455](#).
- For details on SGD command structure, see [Command Structure on page 562](#).

device.applicator.ribbon_low

This command will specify if a "high" or "low" value is required for an applicator to indicate that the ribbon is running out.

Setvar

To set the value:

```
! U1 setvar "device.applicator.ribbon_low" "value"
```

Values

high, low

Default

high

Getvar

To instruct the printer to respond with the currently set value:

```
! U1 getvar "device.applicator.ribbon_low"
```



NOTES:

- For printer support, see [SGD Command Support on page 1455](#).
- For details on SGD command structure, see [Command Structure on page 562](#).

device.applicator.ribbon_out

This command will specify if a "high" or "low" value is required for an applicator to indicate that the ribbon has run out.

Setvar

To set the value:

```
! U1 setvar "device.applicator.ribbon_out"
```

Values

high, low

Default

low

Getvar

To instruct the printer to respond with the currently set value:

```
! U1 getvar "device.applicator.ribbon_out"
```



NOTES:

- For printer support, see [SGD Command Support on page 1455](#).
- For details on SGD command structure, see [Command Structure on page 562](#).

device.applicator.service_required

This command will specify if a "high" or "low" value is required for an applicator to indicate that maintenance is required.

Setvar

To set the value:

```
! U1 setvar "device.applicator.service_required" "value"
```

Values

high, low

Default

low

Getvar

To instruct the printer to respond with the currently set value:

```
! U1 getvar "device.applicator.service_required"
```



NOTES:

- For printer support, see [SGD Command Support on page 1455](#).
- For details on SGD command structure, see [Command Structure on page 562](#).

device.applicator.start_print

This command will specify if a "high" or "low" value is required for an applicator to start printing.

Setvar

To set the value:

```
! U1 setvar "device.applicator.start_print" "value"
```

Values

high, low

Default

low

Getvar

To instruct the printer to respond with the currently set value:

```
! U1 getvar "device.applicator.start_print"
```



NOTES:

- For printer support, see [SGD Command Support on page 1455](#).
- For details on SGD command structure, see [Command Structure on page 562](#).

device.bluetooth_installed

Determines if there is a Bluetooth radio installed in the printer.

Getvar

To return if the Bluetooth radio is installed in the printer or not:

```
! U1 getvar "device.bluetooth_installed"
```

Result

- "yes" = a Bluetooth radio is installed in the printer.
- "no" = no Bluetooth radio is installed.



NOTES:

- For printer support, see [SGD Command Support on page 1455](#).
- For details on SGD command structure, see [Command Structure on page 562](#).

device.command_override.active

This command enables or disables the `device.command_override` function. When enabled, the printer will ignore the list of commands previously specified using the `device.command_override.add`. Use of this command does not modify the list.

Setvar

To turn on/off the `device.command_override` function:

```
! U1 setvar "device.command_override.active" "value"
```

Values

- **yes** = active
- **no** = inactive

Default

yes

Getvar

To return the active/inactive state of `device.command_override` command:

```
! U1 getvar "device.command_override.active"
```

Result

- yes = active
- no = inactive

Default

yes

Example

```
! U1 setvar "device.command_override.active" "yes"
! U1 setvar "device.command_override.active" "no"
```



NOTES:

- For printer support, see [SGD Command Support on page 1455](#).
- For details on SGD command structure, see [Command Structure on page 562](#).

device.command_override.add

This command adds a specified command to the list of commands that will be ignored by the printer. The list is saved when the printer is powered off. The list is not cleared when the printer is defaulted.

- If there are items in the list and the `device.command_override.active` is set to "yes", then the config label will show **ACTIVE COMMAND OVERRIDE**.
- If there are no items in the list or `device.command_override.active` is set to "no", then the config label will show **INACTIVE COMMAND OVERRIDE**.

Setvar

- To instruct the printer to add a specified command to the list of override commands:

```
! U1 setvar "device.command_override.add" "command"
```

Values

any ZPL or Set/Get/Do command

Default

- NA

Example

When specifying a ZPL command, the command must be preceded by the current format or control prefix character (e.g. ^ or ~). Multiple commands must be declared with its own setvar declaration.

```
! U1 setvar "device.command_override.add" "^MN"
! U1 setvar "device.command_override.add" "^PR"
! U1 setvar "device.command_override.add" "comm.baud"
! U1 setvar "device.command_override.add" "device.reset"
```

The following example would **NOT** be valid.

```
! U1 setvar "device.command_override.add" "~HI,~HS,^MN"
```

and would have to be re-sent as

```
! U1 setvar "device.command_override.add" "~HI"
! U1 setvar "device.command_override.add" "~HS"
! U1 setvar "device.command_override.add" "^MN"
```

You can not add `"device.command_override.clear"` to the list of accepted override commands.



NOTES:

- For printer support, see [SGD Command Support on page 1455](#).
- For details on SGD command structure, see [Command Structure on page 562](#).

device.command_override.clear

This command clears all commands from the command override list.

Setvar

To clear the list of override commands specified in device.command_override.list:

```
! U1 setvar "device.command_override.clear" "value"
```

Values

NA

Default

NA



NOTES:

- For printer support, see [SGD Command Support on page 1455](#).
- For details on SGD command structure, see [Command Structure on page 562](#).

device.command_override.list

This command returns to the host a list of the current set of commands that the printer will ignore.

Getvar

To print a comma-delimited list of override commands:

```
! U1 getvar "device.command_override.list"
```

Values

NA

Default

NA



NOTES:

- For printer support, see [SGD Command Support on page 1455](#).
- For details on SGD command structure, see [Command Structure on page 562](#).

device.company_contact

This command sets the company contact information, which can be accessed from the server/sysinfo.htm webpage.

Setvar

To set the company contact information:

```
! U1 setvar "device.company_contact" "value"
```

Values

Any string up to 128 characters in length

Result

""

Getvar

To return the current company contact information:

```
! U1 getvar "device.company_contact"
```

Example

This `setvar` example shows the value set to **"Zebra"**.

```
! U1 setvar "device.company_contact" "Zebra"
```



NOTES:

- For printer support, see [SGD Command Support on page 1455](#).
- For details on SGD command structure, see [Command Structure on page 562](#).

device.configuration_number

Returns the current SKU number of the printer.

Getvar

To return the device configuration number:

```
! U1 getvar "device.configuration_number"
```



NOTES:

- For printer support, see [SGD Command Support on page 1455](#).
- For details on SGD command structure, see [Command Structure on page 562](#).

device.cpcl_synchronous_mode

This command enables/disables CPCL synchronous mode. When the printer is in sync mode, parsing will "lock" while printing is going on, allowing behavior similar to that of the legacy SH3 mobile printers.

Setvar

To turn on or off the `device.cpcl_synchronous_mode`:

```
! U1 setvar "evice.cpcl_synchronous_mode" "value"
```

Values

- on = puts the printer in CPCL synchronous mode
- off = puts the printer in default mode

Default

off

Getvar

To return the current value of the setting:

```
! U1 getvar "evice.cpcl_synchronous_mode"
```

Example

Consider issuing a label immediately followed by an SGD request. When sync mode is "**off**", the SGD will be returned nearly immediately after submitting the label. When sync mode is "**on**", the SGD will be returned after the label has printed.

```
! U1 setvar "evice.cpcl_synchronous_mode" "on"
```

```
! U1 setvar "evice.cpcl_synchronous_mode" "off"
```



NOTES:

- For printer support, see [SGD Command Support on page 1455](#).
- For details on SGD command structure, see [Command Structure on page 562](#).

device.cutter_installed

This command reports if a cutter unit is installed.

Getvar

To check if a cutter is installed:

```
! U1 getvar "device.cutter_installed"
```

Values

Yes or No

Default

No



NOTES:

- For printer support, see [SGD Command Support on page 1455](#).
- For details on SGD command structure, see [Command Structure on page 562](#).

device.download_connection_timeout

This command instructs the printer to abort a firmware download if the printer fails to receive any download data in the set amount of seconds. If the set amount of seconds is exceeded, the download will be aborted, and the printer automatically restarts. This command prevents the printer from being locked into the downloading state, if the communication to the host is interrupted. For printer support, see [SGD Command Support on page 1455](#).

Setvar

To instruct the printer to abort a firmware download if the printer fails to receive any download data in the set amount of seconds:

```
! U1 setvar "device.download_connection_timeout" "value"
```

Values

"0" through "65535"

Default

"0" ("0" disables this feature)

Getvar

To retrieve the connection time out value (in seconds):

```
! U1 getvar "device.download_connection_timeout"
```

Example

This **setvar** example shows the value set to "0".

```
! U1 setvar "device.download_connection_timeout" "0"
```

When the **setvar** value is set to "0", the **getvar** result is "0".



NOTES:

For details on SGD command structure, see [Command Structure on page 562](#).

device.ep1_legacy_mode

This command places the printer in a 2824/2844 compatibility mode for vertical registration.

Setvar

To instruct the printer to change the `ep1_legacy_mode` setting:

```
! U1 setvar "device.ep1_legacy_mode" "value"
```

Values

- **off** = `ep1_legacy_mode` not active
 - **registration** = EPL legacy registration mode on
 - **print orientation** = EPL legacy print orientation mode on
- all** = all EPL legacy modes on

Default

"off"

Getvar

To return the current setting value for the `device.ep1_legacy_mode` setting:

```
! U1 getvar "device.ep1_legacy_mode"
```

Example

This `setvar` example shows the value set to `"registration"`.

```
! U1 setvar "device.ep1_legacy_mode" "registration"
```

This `setvar` example shows the value set to `"print_orientation"`.

```
! U1 setvar "device.ep1_legacy_mode" "print_orientation"
```

This `getvar` example shows the response when the value was set to `"registration"` and `"print_orientation"`.

```
! U1 getvar "device.ep1_legacy_mode"
"registration, print_orientation"
```

This `getvar` example shows the response when value was set to `"all"`

```
! U1 getvar "device.ep1_legacy_mode"
"all"
```

Example

This `setvar` example shows the value set to `"registration"`.

```
! U1 setvar "device.ep1_legacy_mode" "registration"
```

This `setvar` example shows the value set to `"print_orientation"`.

```
! U1 setvar "device.ep1_legacy_mode" "print_orientation"
```

This `getvar` example shows the response when the value was set to `"registration"` and `"print_orientation"`.

```
! U1 getvar "device.ep1_legacy_mode"
"registration, print_orientation"
```

This `getvar` example shows the response when value was set to `"all"`

```
! U1 getvar "device.ep1_legacy_mode"
"all"
```



NOTES:

- This setting is not defaulted as part of a factory default (`^JUF` or `^default`). The setting is persistent across a power cycle or rest (`~JR` or `device.reset`).
- When setting the "registration" mode, the `"print_orientation"` mode is not changed. Likewise, when setting the `"print_orientation"` mode, the `"registration"` mode is not changed. Using `"off"` or `"all"` changes all modes.

Print Orientation Mode



NOTE: When the printer is powered on, the print orientation defaults to `^PON` (EPL ZB mode). The print orientation setting is not saved across power cycles. This is different than TLP2844, LP2844, TLP2824, LP2824, and TLP3842 printers. Those printers have a default of ZB (ZPL `^PON` mode) and the print orientation setting is saved across power cycles. To make the printer have the print orientation behavior of the TLP2844, LP2844, TLP2824, LP2824, and TLP3842 printers, set the `ep1_legacy_mode` to `"print_orientation"`.

Registration Mode



NOTE: When printing labels using EPL commands, printing starts 1mm from the top edge of the label (from the gap). This is known as the "no print zone". When printing in ZT mode, the "no print zone" starts at the gap on the leading edge of the label. When printing in ZB mode, the "no print zone" starts from the gap on the trailing edge of the label. In the TLP2844, LP2844, TLP2824, LP2824, and TLP3842 printers, the distance from gap to start of print (the "no print zone") is not always 1mm.

The table below shows the nominal distance.

Distance from Edge of Label to First Print Line (No Print Zone)			
Legacy Printer Model	New Printer Model	ZT Mode	ZB Mode
LP2844	GX420, GK420 (direct thermal)	1.9 mm	0.0 mm
TLP2844	GX420, GK420 (thermal transfer)	0.4 mm	1.6 mm
TLP3842	GX430 (thermal transfer)	0.0 mm	1.2 mm
LP2824	LP 2824 Plus (direct thermal)	1.5 mm	0.4 mm
TLP2824	TLP 2824 Plus (thermal transfer)	0.1 mm	1.8 mm

- Setting `ep1_legacy_mode` to `"registration"` selects the distance shown in the table.
- Setting `ep1_legacy_mode` to `"off"` selects a no print zone distance of 1mm.

device.feature.bluetooth_le

Indicates whether or not the printer supports Bluetooth LE.

Getvar

To return if the printer supports Bluetooth LE:

```
! U1 getvar "device.feature.bluetooth_le"
```

Values

- **"present"** = a Bluetooth LE radio is installed
- **"not present"** = no Bluetooth LE radio is installed
- **"not available"** = Bluetooth LE radio is not available on this printer



NOTES:

- For printer support, see [SGD Command Support on page 1455](#).
- For details on SGD command structure, see [Command Structure on page 562](#).

device.feature.mcr

Indicates if the magnetic card reader is installed and available.

Getvar

To return if the magnetic card reader is installed and available:

```
! U1 getvar "device.feature.mcr"
```

Values

- **"not available"** = the magnetic card reader is not available on the printer
- **"not present"** = the magnetic card reader is available but not installed
- **"present"** = the magnetic card reader is both available and installed on the printer

Default

NA



NOTES:

- For printer support, see [SGD Command Support on page 1455](#).
- For details on SGD command structure, see [Command Structure on page 562](#).

device.feature.nfc

Indicates if the printer supports the optional Active Near Field Communication (NFC) feature, and if it is currently installed.

Getvar

To see if the printer supports the optional Active Near Field Communication (NFC) feature, and if it is currently installed:

```
! U1 getvar "device.feature.nfc"
```

Values

- **"not available"** = active NFC is not supported.
- **"not present"** = active NFC is supported, but no reader is installed.
- **"present"** = active NFC is supported with a reader is installed.

Default

NA



NOTES:

- For printer support, see [SGD Command Support on page 1455](#).
- For details on SGD command structure, see [Command Structure on page 562](#).

device.feature.ribbon_cartridge

Indicates if the printer can accept a ribbon cartridge, and if so, if one is installed.

Getvar

To return if a ribbon cartridge is installed or not:

```
! U1 getvar "device.feature.ribbon_cartridge"
```

Result

"not available" - the ribbon cartridge is not available on the platform

"not present" - the printer is capable of accepting a ribbon cartridge, but one is not currently installed

"present" - a ribbon cartridge is installed



NOTES:

- For printer support, see [SGD Command Support on page 1455](#).
- For details on SGD command structure, see [Command Structure on page 562](#).

device.feature.802_11ac

This command returns information on the 802.11AC radio status.

Getvar

To return the current setting:

```
! U1 getvar "device.feature.802_11ac"
```

Result

"not present" = if the printer model supports an 802.11ac option but the printer does not have the feature installed.
"not available" = if the printer model does not support an 802.11ac feature option.
"present" = if the printer has an 802.11ac radio installed.



NOTES:

- For printer support, see [SGD Command Support on page 1455](#).
- For details on SGD command structure, see [Command Structure on page 562](#).

device.feature.head_element_test

This command retrieves the head element test status on the printer.

Getvar

To return the head element test feature availability:

```
! U1 getvar "device.feature.head_element_test"
```

Result

"present"	=	head test is present on the printer
"not present"	=	head test is not present on the printer but is available on the platform
"not available"	=	head test is not available on the platform



NOTES:

- For printer support, see [SGD Command Support on page 1455](#).
- For details on SGD command structure, see [Command Structure on page 562](#).

device.friendly_name

This command shows the name assigned to the printer. For printer support, see [SGD Command Support on page 1455](#).

Setvar

To set the printer's name:

```
! U1 setvar "device.friendly_name" "value"
```

Default

"xxxxxxxxxx" ("xxxxxxxxxx" represents the main logic board serial number)

Getvar

To retrieve the name assigned to the printer:

```
! U1 getvar "device.friendly_name"
```

Example

This **setvar** example shows the value set to "xxxxxxxxxx".

```
! U1 setvar "device.friendly_name" "xxxxxxxxxx"
```

When the **setvar** value is set to "xxxxxxxxxx", the **getvar** result is "xxxxxxxxxx".



NOTES:

For details on SGD command structure, see [Command Structure on page 562](#).

device.frontpanel.feedenabled

This command can be used to enable or disable the **FEED** key or any other key on the printer. For printer support, see [SGD Command Support on page 1455](#).

Setvar

To instruct the printer to change the **front_panel.feedenabled** setting:

```
! U1 setvar "device.frontpanel.feedenabled"
```

Values

- "yes" = Front Panel keys are enabled
- "no" = Front Panel keys are disabled

Default

- "no" = for GX420s printers
- "yes" = all supported printers except GX420s

Power On Default

- "no" = for GX420s printers
- "yes" = all supported printers except GX420s

Getvar

To retrieve the current setting for the **front_panel.feedenable** command:

```
! U1 getvar "device.frontpanel.feedenabled"
```

Example

In this example, the **setvar** sets the value to "no".

```
! U1 setvar "device.frontpanel.feedenabled" "no"
```



NOTES:

- On GX420 printers with an LCD display, there is a **SCROLL** and **SELECT** key in addition to the **FEED** key. Both the **SCROLL** and **SELECT** keys are enabled or disabled when the **FEED** key is enabled or disabled using this command.
- On power up, for model GX420s printer, the command value is set to "no". For all other printers, on power up, the command value is set to "yes".
- For details on SGD command structure, see [Command Structure on page 562](#).

device.frontpanel.key_press

This command instructs the printer to press a button on the front panel. For printer support, see [SGD Command Support on page 1455](#).

Setvar

To instruct the printer to press a button on the front panel:

```
! U1 setvar "device.frontpanel.key_press"
```

Values

The values vary per printer, as follows:

ZM400, Z4M/Z6M, and RZ400/RZ600:

- "A" = Pause
- "B" = Feed
- "C" = Cancel
- "D" = Setup/Exit
- "E" = Minus
- "F" = Select
- "G" = Plus

XiIIIplus:

- "A" = Pause
- "B" = Feed
- "C" = Cancel
- "D" = Setup/Exit
- "E" = Previous
- "F" = Next/Save
- "G" = Minus
- "H" = Plus
- "I" = Calibrate

S4M:

- "A" = Pause
- "B" = Feed
- "C" = Up Arrow
- "D" = Cancel
- "E" = Menu
- "F" = Enter

Xi4, RXi4:

- "A" = Pause

- "B" = Feed
- "C" = Cancel
- "D" = Setup/Exit
- "E" = Previous
- "F" = Next/Save
- "G" = Minus
- "H" = Plus
- "I" = Calibrate

Example

This `setvar` example shows the value set to "A".

```
! U1 setvar "device.frontpanel.key_press" "A"
```



NOTES:

For details on SGD command structure, see [Command Structure on page 562](#).

device.frontpanel.line1

This command overrides the content that is shown on the first line of the front panel when the printer is showing the idle display. Use of the `getvar` function is dependent on first using the `setvar` function. For example, to have the first line of the idle display to show HELLO, you must first send a `setvar` command; then a `getvar` command can be sent to retrieve the value HELLO. For printer support, see [SGD Command Support on page 1455](#). For details on the supported character set, see [ZBI Character Set on page 1452](#).

Setvar

To instruct the printer to set the content that is shown on line one of the front panel:

```
! U1 setvar "device.frontpanel.line1" "value"
```

Values

The maximum amount of alphanumeric ASCII characters available for line 1 on the printer's front panel

Default

""

Getvar

To retrieves the content that is shown on line one of the front panel:

```
! U1 getvar "device.frontpanel.line1"
```

Example

This `setvar` example shows the value set to "sample line 1".

```
! U1 setvar "device.frontpanel.line1" "sample line 1"
```

When the `setvar` value is set to "sample line 1", the `getvar` result is "sample line 1".



NOTES:

For details on SGD command structure, see [Command Structure on page 573](#).

device.frontpanel.line2

This command overrides the content that is shown on the second line of the front panel when the printer is showing the idle display. Use of the `getvar` function is dependent on using the `setvar` function. For example, to have the second line of the idle display show HELLO, you must first send a `setvar` command; then a `getvar` command can be sent to retrieve the value HELLO. For printer support, see [SGD Command Support on page 1455](#). For details on the supported character set, see [ZBI Character Set on page 1452](#).

Setvar

To instruct the printer to set the content that shows on line two of the front panel:

```
! U1 setvar "device.frontpanel.line2" "value"
```

Values

The maximum amount of alphanumeric ASCII characters available for line two on the printer's front panel.

Default

```
""
```

Getvar

To retrieve the content that shows on line two of the front panel:

```
! U1 getvar "device.frontpanel.line2"
```

Example

This `setvar` example shows the value set to "sample line 2".

```
! U1 setvar "device.frontpanel.line2" "sample line 2"
```

When the `setvar` value is set to "sample line 2", the `getvar` result is "sample line 2".



NOTES:

For details on SGD command structure, see [Command Structure on page 562](#).

device.frontpanel.xml

This command retrieves the current content of the front panel in an XML format. For printer support, see [SGD Command Support on page 1455](#).

Getvar

To retrieve the file that determines the representation of the front panel:

```
! U1 getvar "device.frontpanel.xml"
```

Example

In this example, the `getvar` shows the status of the LEDs and the two lines of the front panel in XML formatted text. The text below is formatted for easy reading. When you use this command the response will not contain line feeds.

```
! U1 getvar "device.frontpanel.xml"
<FRONT-PANEL>
<LCD>
<LINE1>PRINTER READY</LINE1>
<LINE2>V53.16.0</LINE2>
</LCD>
<LEDS>
<PAUSE-LED>STEADY-OFF</PAUSE-LED>
<DATA-LED>STEADY-OFF</DATA-LED>
<ERROR-LED>STEADY-OFF</ERROR-LED>
</LEDS>
</FRONT-PANEL>
```



NOTES:

For details on SGD command structure, see [Command Structure on page 562](#).

device.host_identification

This command is designed to be sent from the host to the Zebra printer to retrieve information. Upon receipt, the printer responds with information on the model, software version, dots-per-millimeter setting, memory size, and any detected options.

This command is equivalent to the `~HI` ZPL command.

Getvar

To display information about the printer:

```
! U1 getvar "device.host_identification"
```

Result

```
XXXXXX,V1.0.0,dpm,000KB,X
```

Values

XXXXXX = model of Zebra printer

V1.0.0 = version of software

dpm = dots/mm

6, 8, 12, or 24 dots/mm printheads

000KB = memory

512KB = 1/2 MB

1024KB = 1 MB

2048KB = 2 MB

4096KB = 4 MB

8192KB = 8 MB

x = recognizable options

only options specific to printer are shown (cutter, options, et cetera.)



NOTES:

- For printer support, see [SGD Command Support on page 1455](#).
- For details on SGD command structure, see [Command Structure on page 562](#).

device.host_status

When this command is sent to the printer, the printer sends three data strings back. To avoid confusion, the host prints each string on a separate line.

This command is similar to the `~HS ZPL` command.

The response for this SGD command does not include the `STX` at the beginning of each data line and does not include the `ETX` at the end of each data line as found in the `~HS` response. Additionally, the first and second response lines for the SGD command contain a `CR/LF` at the end of each line.



NOTE: When the command is sent, the printer will not send a response to the host if the printer is in one of these conditions:

- a. MEDIA OUT
- b. RIBBON OUT
- c. HEAD OPEN
- d. REWINDER FULL
- e. HEAD OVER-TEMPERATURE

Getvar

To return the current setting value:

```
! U1 getvar "device.host_status"
```

Result

Three strings, each on their own line.

```
"aaa,b,c,dddd,eee,f,g,h,iii,j,k,l  
mmm,n,o,p,q,r,s,t,uuuuuuuu,v,www  
xxxx,y"
```

See definitions for String 1, String 2, and String 3 below.

String 1

```
"aaa,b,c,dddd,eee,f,g,h,iii,j,k,l"
```

The nine-digit binary number is read according to this table:

- | | | |
|-------------|---|---|
| aaa | = | communication (interface) settings ^a |
| b | = | paper out flag (1 = paper out) |
| c | = | pause flag (1 = pause active) |
| dddd | = | label length (value in number of dots) |
| eee | = | number of formats in receive buffer |
| f | = | buffer full flag (1 = receive buffer full) |
| g | = | communications diagnostic mode flag
(1 = diagnostic mode active) |
| h | = | partial format flag (1 = partial format in progress) |

- c. This string specifies the printer's baud rate, number of data bits, number of stop bits, parity setting, and type of handshaking. This value is a three-digit decimal representation of an eight-bit binary number. To evaluate this parameter, first convert the decimal number to a binary number.

aaa = a ⁸ a ⁷ a ⁶ a ⁵ a ⁴ a ³ a ² a ¹ a ⁰	
a ⁷ = Handshake 0 = Xon/Xoff 1 = DTR	a ⁸ a ² a ¹ a ⁰ = Baud 0 000 = 110 0 001 = 300 0 010 = 600 0 011 = 1200 0 100 = 2400 0 101 = 4800 0 110 = 9600 0 111 = 19200 1 000 = 28800 <i>(available only on certain printer models)</i> 1 001 = 38400 <i>(available only on certain printer models)</i> 1 010 = 57600 <i>(available only on certain printer models)</i> 1 011 = 14400
a ⁶ = Parity Odd/Even 0 = Odd 1 = Even	
a ⁵ = Disable/Enable 0 = Disable 1 = Enable	
a ⁴ = Stop Bits 0 = 2 Bits 1 = 1 Bit	
a ³ = Data Bits 0 = 7 Bits 1 = 8 Bits	

String 2

"mmm,n,o,p,q,r,s,t,uuuuuuu,v,www"

- mmm = function settings ^b
- n = unused
- o = head up flag (1 = head in up position)
- p = ribbon out flag (1 = ribbon out)
- q = thermal transfer mode flag (1 = Thermal Transfer Mode selected)
- r = Print Mode
 - 0 = Rewind
 - 1 = Peel-Off
 - 2 = Tear-Off
 - 3 = Cutter
 - 4 = Applicator
 - 5 = Delayed cut
 - 6 = Reserved ^c
 - 7 = Reserved ^c
 - 8 = Reserved ^c
 - 9 = RFID
- s = print width mode
- t = label waiting flag (1 = label waiting in Peel-off Mode)
- uuuuuuu = labels remaining in batch
- v = *format while printing* flag (always 1)
- www = number of graphic images stored in memory



Values 4 to 5 are only supported in firmware version V60.14.x, V50.14.x, V53.15.x, or later.

d. This string specifies the printer's media type, sensor profile status, and communication diagnostics status. As in String 1, this is a three-digit decimal representation of an eight-bit binary number. First, convert the decimal number to a binary number.
e. These values are only supported on the Xi4, RXi4, ZM400/ZM600, RZ400/RZ600, and ZT200 Series printers.

The eight-digit binary number is read according to this table:

mmm = m7 m6 m5 m4 m3 m2 m1 m0							
m7 = Media Type 0 = Die-Cut 1 = Continuous				m4 m3 m2 m1 = Unused 0 = Off 1 = On			
m6 = Sensor Profile 0 = Off				m0 = Print Mode 0 = Direct Thermal 1 = Thermal Transfer			
m5 = Communications Diagnostics 0 = Off 1 = On							

String 3 "xxxx,y"

- XXXX password (printers running Link-OS v5.3 or earlier versions)
- 0000 = password. (printers running Link-OS 6 or later versions)
- y = 0 (static RAM not installed)
- = 1 (static RAM installed)



NOTES:

- For printer support, see [SGD Command Support on page 1455](#).
- For details on SGD command structure, see [Command Structure on page 562](#).

device.idle_display_format

Retrieves and sets the front panel's idle display format.

Setvar

To set the front panel's idle display format:

```
! U1 setvar "device.idle_display_format" "value"
```

Values

`fw-version, ip-address, mm/dd/yy-24-hr, mm/dd/yy-12-hr, dd/mm/yy-24-hr, dd/mm/yy-12-hr`

Default

`"fw-version"` (firmware version)

Getvar

To retrieve the front panel's idle display format:

```
! U1 getvar "device.idle_display_format"
```

Result

`fw-version, ip-address, mm/dd/yy-24-hr, mm/dd/yy-12-hr, dd/mm/yy-24-hr, dd/mm/yy-12-h`



NOTES:

- For printer support, see [SGD Command Support on page 1455](#).
- For details on SGD command structure, see [Command Structure on page 562](#).

2762

device.idle_display_value

Returns the printer's current front panel idle display information.

Getvar

To return the printer current front panel idle display information:

```
! U1 getvar "device.idle_display_value"
```

Result

A firmware version, the printer's IP address, or the date.



NOTES:

- For printer support, see [SGD Command Support on page 1455](#).
- For details on SGD command structure, see [Command Structure on page 562](#).

device.internal_wired_setting_location

This command identifies the location from where internal_wired network specific settings should be retrieved.

Setvar

To specify the location from where internal_wired network specific settings should be retrieved:

```
! U1 setvar "device.internal_wired_setting_location" "value"
```

Values

- "network card"
- "printer"

"printer" is the only valid option for the QLn series and ZD500 series printers.

Default

"network_card"

Getvar

To display the location where internal_wired network specific settings are retrieved from:

```
! U1 getvar "device.internal_wired_setting_location"
```

"printer" is the only valid getvar option for the QLn series and ZD500 series printers.



NOTES:

For details on SGD command structure, see [Command Structure on page 562](#).

For printer support, see [SGD Command Support on page 1455](#).

device.jobs_print

This command identifies the number of jobs to be printed. For printer support, see [SGD Command Support on page 1455](#).

Getvar

To retrieve the number of jobs to be printed:

```
! U1 getvar "device.jobs_print"
```

Example

In this example, the `getvar` retrieves the jobs currently being printed or last printed.

```
! U1 getvar "device.jobs_print"  
"1"
```



NOTES:

For details on SGD command structure, see [Command Structure on page 562](#).

device.job_log.total_jobs_logged

This command returns the total number of jobs logged, which is used on the "server/joblog.htm" webpage.

Getvar

To return the current setting value:

```
! U1 getvar "device.job_log.total_jobs"
```



NOTES:

- The value resets to 0 after a power cycle.
- For printer support, see [SGD Command Support on page 1455](#).
- For details on SGD command structure, see [Command Structure on page 562](#).

device.languages

This command identifies the programming language that the printer is currently using.

Setvar

To set the printer to the required programming language:

```
! U1 setvar "device.languages" "value"
```

Values

- "ep1" = Eltron Programming Language
- "ep1_zp1" = Eltron Programming Language and Zebra Programming Language
- "zp1" = Zebra Programming Language
- "hybrid_xml_zp1" = XML and ZPL Programming Languages
- "ap1-d" = Virtual Device-D (only Link-OS printers)
- "ap1-t" = Virtual Device-T (only desktop and table top printers with Link-OS)
- "ap1-e" = Virtual Device-E (only mobile printers with Link-OS)
- "ap1-o" = Virtual Device-O (only mobile printers with Link-OS)
- "ap1-i" = Virtual Device-I (only Link-OS printers)



IMPORTANT: Not all values are accepted on all printers.

Use the `! U1 getvar "allcv"` command to see the range of values that your printer supports. Values other than those listed may be available depending on the firmware version being used.



NOTE: "zp1" and "hybrid_xml_zp1" are equivalent. When the setvar is set to "zp1", the getvar result will always be "hybrid_xml_zp1".

Default

```
"ep1_zp1"
```

Getvar

To retrieve the programming language that the printer is currently using:

```
! U1 getvar "device.languages"
```

Example

This `setvar` example sets the programming language to "hybrid_xml_zp1" using the shorter value of "zp1".

```
! U1 setvar "device.languages" "zp1"
```



NOTES:

- For printer support, see [SGD Command Support on page 1455](#).
- For details on SGD command structure, see [Command Structure on page 562](#).

device.light.cover_open_brightness

This command sets the brightness level for the Cover Open light.

Setvar

To set the brightness level for the cover open LEDs:

```
! U1 setvar "device.light.cover_open_brightness" "value"
```

Values

- "high" = the LEDs display at maximum brightness when the cover is open
- "medium" = the LEDs display at medium brightness when the cover is open
- "low" = the LEDs display at lowest brightness when the cover is open
- "off" = the LEDs remain off at all times

Default

"high"

Getvar

To retrieve the current brightness level setting for the cover open LEDs:

```
! U1 getvar "device.light.cover_open_brightness"
```

Example

This `setvar` example shows the value set to "low".

```
! U1 setvar "device.light.cover_open_brightness" "low"
```



NOTES:

- For printer support, see [SGD Command Support on page 1455](#).
- For details on SGD command structure, see [Command Structure on page 562](#).

device.light.head_open_brightness

This command sets the brightness level for the Head Open light.

Setvar

To set the brightness level for the head open LEDs:

```
! U1 setvar "device.light.head_open_brightness" "value"
```

Values

- "high" = the LEDs display at maximum brightness when the head is open
- "medium" = the LEDs display at medium brightness when the head is open
- "low" = the LEDs display at lowest brightness when the head is open
- "off" = the LEDs remains off at all times

Default

"high"

Getvar

To retrieve the current brightness level setting for the head open LEDs:

```
! U1 getvar "device.light.head_open_brightness"
```

Example

This `setvar` example shows the value set to "medium".

```
! U1 setvar "device.light.head_open_brightness" "medium"
```



NOTES:

- For printer support, see [SGD Command Support on page 1455](#).
- For details on SGD command structure, see [Command Structure on page 562](#).

device.location

Sets the system location, which is used on the "server/sysinfo.htm" webpage.

Setvar

To set the system location:

```
! U1 setvar "device.location" "value"
```

Values

Any ASCII string up to 128 characters.

Default

"" (empty string)

Getvar

To retrieve the system location:

```
! U1 getvar "device.location"
```



NOTES:

- For printer support, see [SGD Command Support on page 1455](#).
- For details on SGD command structure, see [Command Structure on page 562](#).

device.loader_version

This command returns the device loader version.

Getvar

To have the printer return the loader version:

```
! U1 getvar "device.loader_version"
```

Example

In this getvar example, the printer returns with the loader version number.

```
! U1 getvar "device.loader_version"
```



NOTES:

- For printer support, see [SGD Command Support on page 1455](#).
- For details on SGD command structure, see [Command Structure on page 562](#).

device.ltu_installed

This command checks to see if a Liner Take-Up unit is installed.

Getvar

To check if the Liner Take-Up unit is installed or not:

```
! U1 getvar "device.ltu_installed"
```

Values

- Yes
- No

Default

No



NOTES:

- For printer support, see [SGD Command Support on page 1455](#).
- For details on SGD command structure, see [Command Structure on page 562](#).

device.orientation

This printer setting determines the installation orientation of the KR403 printer, either horizontal or vertical. It is intended for use only by the system integrator. Modification by an end user can result in unexpected printer behaviour.

Setvar

To instruct the printer to change the presenter loop length:

```
! U1 setvar "device.orientation" "value"
```

Values

- 0 = printer is installed horizontally
- 1 = is installed vertically

Default

0 = printer is installed horizontally (original factory default only, value will not change when defaulting the printer with ^JUF)

Getvar

To instruct the printer to respond with the currently set presenter loop length:

```
! U1 getvar "device.orientation"
```



NOTES:

For details on SGD command structure, see [Command Structure on page 562](#).

device.pause

This command stops printing after the current label is complete (if one is printing) and places the printer in Pause Mode.

This command is equivalent to `~PP`.

Setvar

To stop printing and set the printer in Pause Mode:

```
! U1 SETVAR "device.pause" ""
```

Values

NA

Default

NA

Do

To stop printing and set the printer in Pause Mode:

```
! U1 DO "device.pause" ""
```

Values

NA

Default

NA



NOTES:

- For printer support, see [SGD Command Support on page 1455](#).
- For details on SGD command structure, see [Command Structure on page 562](#).

device.pnp_option

This command defines the type of Plug and Play response that is sent by the printer after the printer is started. The printer must be restarted for a new PNP string to be reported. For printer support, see [SGD Command Support on page 1455](#).

Setvar

To instruct the printer to select the desired Plug and Play response option:

```
! U1 setvar "device.pnp_option" "value"
```

Values

- "ep1" = Eltron Programming Language
- "zp1" = Zebra Programming Language

Default

```
"zp1"
```

Getvar

To retrieve the Plug and Play option setting:

```
! U1 getvar "device.pnp_option"
```

Example

This **setvar** example shows the value set to "zp1".

```
! U1 setvar "device.pnp_option" "ep1"
```

When the **setvar** value is set to "ep1", the **getvar** result is "ep1".



NOTES:

- For GT800 printers only: when the printer's Plug and Play string is set to EPL, the KDU Plus displays **'ONNECTION - EPL Printer (DTE)** even when set to ZPL Forms mode. This behavior only affects the display, not the functionality.
- For details on SGD command structure, see [Command Structure on page 562](#).

device.pmcu.revision

Retrieves the Power Micro-Controller Unit's (PMCU) current revision number.

Getvar

To retrieve the power micro-controller unit's (PMCU) current revision number:

```
! U1 getvar "device.pmcu.revision"
```



NOTES:

- For printer support, see [SGD Command Support on page 1455](#).
- For details on SGD command structure, see [Command Structure on page 562](#).

device.position.accuracy

This printer setting retrieves/sets the accuracy of the geographic position values.

The units of the value depend upon the location provider that was used to determine the geographic coordinates. Usually, this is specified as a radius, in meters, of confidence around the location coordinates. Often, the radius represents a radius of 68% confidence that the true location lies within the circle, representing one standard deviation.

These settings hold the value to which they are set, within the range restrictions. The printer does not perform any calculations, nor associate any meaning such as “meters” or “feet” to the values. The values can be determined by a number of methods, including an Android® or iOS® application communicating with the printer using the smart phone’s geolocation device.

Setvar

To set the accuracy of the geographic position values:

```
! U1 setvar "device.position.accuracy" "value"
```

Values

A decimal number with 6 decimal places, e.g. **25.370000**. The value is saved as a double precision floating point number.

- Minimum: 0
- Maximum: 406700000

Getvar

To retrieve the accuracy of the geographic position values:

```
! U1 getvar "device.position.accuracy"
```

Example

```
! U1 setvar "device.position.accuracy" "25.37"
```



NOTES:

For details on SGD command structure, see [Command Structure on page 562](#).

device.position.altitude

This printer setting retrieves the altitude above sea level.

The value is in meters above sea level. A positive number indicates a position above sea level. A negative number indicates a position below sea level. The position of sea level depends upon the system used to provide a nominal sea level reference position. This is often the World Geodetic System WGS 84 standard but depends upon the location provider.

Setvar

To set the altitude of the printer above sea level:

```
! U1 setvar "device.position.altitude" "value"
```

Values

A decimal number with 6 decimal places, e.g. 305.100000

The value is saved as a double precision floating point number.

- Minimum: **-10000**
- Maximum: **406700000**

Getvar

To retrieve the altitude above sea level:

```
! U1 getvar "device.position.altitude"
```

Example

```
! U1 setvar "device.position.altitude" "305.1"
```



NOTES:

- For details on SGD command structure, see [Command Structure on page 562](#).

device.position.latitude

This printer setting retrieves/sets the geographic latitudinal position.

Setvar

To set the latitude position of the printer:

```
! U1 setvar "device.position.latitude" "value"
```

Values

The value is in decimal degrees from **0.0** to **+/-90.0**.

Default

0.0

Getvar

To retrieve the latitude position of the printer:

```
! U1 getvar "device.position.latitude"
```

Values

The value is returned with 6 decimal places. A value of **0.000001** degree is on the order of 0.1 meter of distance on the earth's surface. (The correspondence between degrees and length on the earth's surface varies because the earth is an irregular ellipsoid.)

Example

```
! U1 setvar "device.position.latitude" "6.123456"
```



NOTES:

For details on SGD command structure, see [Command Structure on page 562](#).

device.position.longitude

This printer setting retrieves/sets the geographic longitudinal position.

Setvar

To set the longitudinal position of the printer:

```
! U1 setvar "device.position.longitude" "value"
```

Values

The value is in decimal degrees from **0.0** to **+/-180.0**.

The value is saved as a double precision floating point number.

Default

0.0

Getvar

To retrieve the longitudinal position of the printer:

```
! U1 getvar "device.position.longitude"
```

Values

The value is returned with 6 decimal places. A value of 0.000001 degree is on the order of no more than 0.1 meter of distance on the earth's surface. (The correspondence between degrees and length on the earth's surface varies from approximately 0.1 meter at the equator to 0.0 at the poles.)

Example

```
! U1 setvar "device.position.longitude" "25.123456"
```



NOTES:

For details on SGD command structure, see [Command Structure on page 562](#).

device.print_2key

Causes the printer to print the mobile configuration report (commonly known as a 2key report).

Setvar

To cause the printer to print the mobile configuration report:

```
! U1 setvar "device.print_2key" ""
```

The set value is ignored.

Do

To cause the printer to print the mobile configuration report:

```
! U1 do "device.print_2key"
```



NOTES:

- For printer support, see [SGD Command Support on page 1455](#).
- For details on SGD command structure, see [Command Structure on page 562](#).

device.print_reprogram_2key

This command determines whether the printer will print a configuration label or 2key report after the printer restarts following a firmware update.

When set to "off" the printer will not print the configuration label or 2key report after the printer is updated.

Setvar

To set whether a two-key report is printed or not:

```
! U1 setvar "device.print_reprogram_2key" "value"
```

Values

- "yes"
- "no"

Default

"no"

Getvar

To retrieve the current setting for processing two-key report after printer firmware is reprogrammed:

```
! U1 getvar "device.print_reprogram_2key"
```

Result

- yes
- no

Example

This example disables printing of the two-key report after printer firmware is reprogrammed.

```
! U1 setvar "device.print_reprogram_2key" "no"
```



NOTES:

- For printer support, see [SGD Command Support on page 1455](#).
- For details on SGD command structure, see [Command Structure on page 562](#).

device.printhead.test.summary

This command retrieves a summary of the printer's printhead test results. This command mimics the results of the ~HQJT ZPL command output.

Getvar

To get the summary of the printer's printhead test results:

```
! U1 getvar "device.printhead.test.summary"
```

Result

A string in the format of A, B, C, D, E. Here:

A = number Element Failure;

B = Manual (M) or automatic (A) range;

C = first test element;

D = last test element;

E = failure count.



NOTES:

- The command will return a response for all LOS printers. However only printers that support the head test will display valid values. For all unsupported printers, C and D above will always be 0.
- For printer support, see [SGD Command Support on page 1455](#).
- For details on SGD command structure, see [Command Structure on page 562](#).

device.printhead.odometer

This command returns the current contents of the odometer. This value is the total number of dots printed over the life of the printhead.

Getvar

To return the current contents of the odometer:

```
! U1 getvar "device.printhead.odometer"
```



NOTES:

- For printer support, see [SGD Command Support on page 1455](#).
- For details on SGD command structure, see [Command Structure on page 562](#).

device.printhead.test.detail

This command returns the results of the last printhead test for the resistance values. This command is not reported in the ALLCV.

Getvar

To get the summary of the printer's printhead test details:

```
! U1 getvar "device.printhead.test.detail"
```

Result

A comma separated string as given below. Although the content below is shown on individual lines, it is displayed as one line of comma separated values.

- Current Date (as reported by rtc.date),
- Current Time (as reported by rtc.time),
- Odometer Value in cm (as reported by "odometer.total_print_length"),
- Part Number of the Printhead,
- Serial Number of the Printhead,
- Resistance profile of each Printhead element



NOTES:

- The command will return a response for all Link-OS printers. However only printers that support the head test will display valid values. For all unsupported printers, the result is "Test Not Run".
- For printer support, see [SGD Command Support on page 1455](#).
- For details on SGD command structure, see [Command Structure on page 562](#).

device.product_name_submodel

Retrieves the product name submodel, which is derived from the Printer Configuration Code (PCC, also known as the SKU).

Getvar

To retrieve the product name submodel:

```
! U1 getvar "device.product_name_submodel"
```

Result

- "hc" = QLn Healthcare printers
- "none" = QLn Standard printers and all other printers



NOTES:

- For printer support, see [SGD Command Support on page 1455](#).
- For details on SGD command structure, see [Command Structure on page 562](#).

device.prompted_network_reset

Reinitializes the wireless radio card and the print server (wired or wireless) when the Wireless or Wireless Plus print server is running. The command also causes any wireless radio card in the printer to re-associate to the wireless network.

This command is equivalent to the [~WR on page 425](#) command.

Setvar

To set the device prompted reset:

```
! U1 setvar "device.prompted_network_reset" "value"
```

Values

- "yes" = causes the network to reset
- "no" = no changes to the network



NOTES:

- For printer support, see [SGD Command Support on page 1455](#).
- For details on SGD command structure, see [Command Structure on page 562](#).

device.prompted_default_network

This command enables or disables the default device network settings.

Setvar

To enable or disable the device default network settings:

```
! U1 setvar "device.prompted_default_network" "value"
```

Values

"Y" = default the network settings

"N" = Do not default the network settings



NOTES:

- For printer support, see [SGD Command Support on page 1455](#).
- For details on SGD command structure, see [Command Structure on page 562](#).

device.prompted_reset

This command enables the device prompted reset.

Setvar

To enable or disable the device prompted reset:

```
! U1 setvar "device.prompted_reset" "value"
```

Values

"Y" = reset the printer

"N" = do not reset the printer



NOTES:

- For printer support, see [SGD Command Support on page 1455](#).
- For details on SGD command structure, see [Command Structure on page 562](#).

device.protected_mode

This command retrieves information on the protected mode feature settings.

It returns "off" if protected mode is currently disabled or "on" if protected mode is currently enabled. Protected mode is enabled if a non-empty protected mode password for the administrator user has been set.

Getvar

To retrieve the radio firmware version:

```
! U1 getvar "device.protected_mode"
```

Result

"off" = protected mode is off.

"on" = protected mode is on.

Default Value

"off"



NOTES:

- For printer support, see [SGD Command Support on page 1455](#).
- For details on SGD command structure, see [Command Structure on page 562](#).

device.reset

This command instructs the printer to perform a soft reset. For printer support, see [SGD Command Support on page 1455](#).

Setvar

To instruct the printer to perform a soft reset:

```
! U1 setvar "device.reset" ""
```

Example

In this example, the `setvar` performs a soft reset.

```
! U1 setvar "device.reset" ""
```



NOTES:

For details on SGD command structure, see [Command Structure on page 562](#).

device.restore_defaults

This command restores to the default of all settings within the specified SGD branch. For printer support, see [SGD Command Support on page 1455](#).

Setvar

To restore the default of all settings within the specified branch:

```
! U1 setvar "device.restore_defaults" "value"
```

Values

- "ip" = default all parameters in the IP branch
- "wlan" = default all parameters in the wlan branch
- "internal_wired" = default all parameters in the internal wired branch

Do

To restore the default of all settings within the specified branch:

```
! U1 do "device.restore_defaults" "value"
```

Values

- "ip" = default all parameters in the ip branch
- "wlan" = default all parameters in the wlan branch
- "internal_wired" = default all parameters in the internal wired branch

Example

These **do** and **setvar** examples restore the network card's wlan parameters to their default values.

```
! U1 do "device.restore_defaults" "wlan"
! U1 setvar "device.restore_defaults" "wlan"
```



NOTES:

For details on SGD command structure, see [Command Structure on page 562](#).

device.rewinder_installed

Determines if a rewind option is installed on the printer.

The Rewind Option is not the same as the Liner Take-Up Option.

Getvar

To determine if a rewind option is installed or not:

```
! U1 getvar "device.rewinder_installed"
```

Result

- "yes" = a rewind option is installed
- "no" = no rewind option installed



NOTES:

- For printer support, see [SGD Command Support on page 1455](#).
- For details on SGD command structure, see [Command Structure on page 562](#).

device.save_2key

Sets or retrieves the current device.save_2key setting.

The two-key report is a configuration listing originally used on legacy mobile printers.

Setvar

To set the current device.save_2key setting:

```
! U1 setvar "device.save_2key" "value"
```

Values

- **"on"** = Two-key diagnostics reports will be saved to Flash memory whenever a two-key report is printed. The file will be named 2KEY.TXT.
- **"off"** = Two-key reports will not be saved to Flash memory.
- **"now"** = This choice can be used to generate a two-key diagnostics report on demand and save it to Flash memory (save only, does not print). This choice does not alter the **"on"/"off"** state of this SGD.

Default

"on"

Getvar

To retrieve the current device.save_2key setting:

```
! U1 getvar "device.save_2key"
```

Example

This example instructs the printer to generate a two-key diagnostics report and save it to Flash memory.

```
! U1 setvar "device.save_2key" "now"
```



NOTES:

- For printer support, see [SGD Command Support on page 1455](#).
- For details on SGD command structure, see [Command Structure on page 562](#).

device.sensor_select

Determines which media sensor will be used.

This command is similar to the ^JS ZPL command.

Setvar

To determine which media sensor will be used:

```
! U1 setvar "device.sensor_select" "value"
```

Values

- "reflective"
- "transmissive"
- "reflective"

Getvar

To retrieve which media sensor is used:

```
! U1 getvar "device.sensor_select"
```



NOTES:

- For printer support, see [SGD Command Support on page 1455](#).
- For details on SGD command structure, see [Command Structure on page 562](#).

device.sensor_profile

This command sets the printer's sensor profile output destination.

Setvar

To set the sensor profile of the printer:

```
! U1 setvar "device.sensor_profile" "value"
```

Values

"print"	=	forces all subsequent ~jg output to be printed on media.
"store"	=	forces all subsequent ~jg output to be stored on the E drive.
"usb_host"	=	forces all subsequent ~jg output to be stored on a USB Stick. If the sensor profile value of "usb_host" is selected and a USB Stick is not inserted at the time, then the ~jg is issued. An Acknowledged Alert is displayed on printers that support an LCD. If the Sensor Profile value of "usb_host" is selected and a USB Stick is not inserted at the time, then the ~jg is issued and the printer does not support an LCD, then the error is ignored.
"reply"	=	forces all subsequent ~jg output to be returned to the host on the same port that the command is issued.
"display"	=	forces all subsequent ~jg output to be stored on the LCD. If the Sensor Profile value of "display" is selected and the printer does not have at least a 240x128 pixel display, then the setting is ignored. The UI SRS defines the actual content to be displayed if the "display" option is selected.

If a valid setting is not specified, then the sensor profile command is ignored.

Default Value

"print"

Getvar

To return the sensor profile values:

```
! U1 getvar "device.sensor_profile"
```



NOTES:

- For printer support, see [SGD Command Support on page 1455](#).
- For details on SGD command structure, see [Command Structure on page 562](#).

device.serial_number.option_board_date

Returns the date the option board was made.

This command is functional only on printers that had their option board manufacturing date programmed when they were created. Older printers that do not have the option board creation date programmed will return a "?" or empty string.

Getvar

To return the date the option board was made:

```
! U1 getvar "device.serial_number.option_board_date"
```

Result

a date in mm/dd/yyyy format.



NOTES:

- For printer support, see [SGD Command Support on page 1455](#).
- For details on SGD command structure, see [Command Structure on page 562](#).

device.serial_numbers.control_panel_date

Returns the date the control panel was made.



NOTES: This command is functional only on printers that had their control panel manufacturing date programmed when they were created. Older printers that do not have the control panel creation date programmed will return a "?" or empty string.

Getvar

To return the date the control panel was made:

```
! U1 getvar "device.serial_numbers.control_panel_date"
```

Result

a date in mm/dd/yyyy format.



NOTES:

- For printer support, see [SGD Command Support on page 1455](#).
- For details on SGD command structure, see [Command Structure on page 562](#).

device.serial_numbers.mlb_date

Returns the date the main logic board (MLB) was made.



NOTE: This command is functional only on printers that had their MLB manufacturing date programmed when they were created. Older printers that do not have the MLB creation date programmed will return a "?" or empty string.

Getvar

To return the date the main logic board (MLB) was made:

```
! U1 getvar "device.serial_numbers.mlb_date"
```

Result

a date in mm/dd/yyyy format.



NOTES:

- For printer support, see [SGD Command Support on page 1455](#).
- For details on SGD command structure, see [Command Structure on page 562](#).

device.serial_numbers.processor

Returns the unique main processor ID.

Getvar

To have the printer return the current setting value:

```
! U1 getvar "device.serial_numbers.processor"
```



NOTES:

- For printer support, see [SGD Command Support on page 1455](#).
- For details on SGD command structure, see [Command Structure on page 562](#).

device.serial_numbers.applicator_option_board_date

This command retrieves the applicator option board date.

For printers that do not store this value, the printer returns an empty string.

Getvar

To return the current setting:

```
! U1 getvar "device.serial_numbers.applicator_option_board_date"
```

Example

In this example, the printer reports the application option boards date.

```
! U1 getvar "device.serial_numbers.applicator_option_board_date"  
"12/31/2014"
```



NOTES:

- For printer support, see [SGD Command Support on page 1455](#).
- For details on SGD command structure, see [Command Structure on page 562](#).

device.serial_numbers.wired_ethernet_option_board

This command retrieves the serial number of the wired Ethernet option board if it is installed in the printer. For printers that do not store this value, the printer returns an empty string.

Getvar

To return the current setting:

```
! U1 GETVAR "device.serial_numbers.wired_ethernet_option_board"
```



NOTES:

- For printer support, see [SGD Command Support on page 1455](#).
- For details on SGD command structure, see [Command Structure on page 562](#).

device.serial_numbers.wired_ethernet_option_board_date

This command retrieves the Ethernet option board date.

For printers that do not store this value, the printer returns an empty string.

Getvar

To return the current setting:

```
! U1 getvar "device.serial_numbers.ethernet_option_board_date"
```

Example

In this example, the getvar returns the current date of the Ethernet option board.

```
! U1 getvar "device.serial_numbers.ethernet_option_board_date"  
"12/31/2014"
```



NOTES:

- For printer support, see [SGD Command Support on page 1455](#).
- For details on SGD command structure, see [Command Structure on page 562](#).

device.serial_numbers.applicator_option_board

This command retrieves the serial number of the applicator option board if it is installed in the printer. For printers that do not store this value, the printer returns an empty string.

Getvar

To return the current setting:

```
! U1 GETVAR "device.serial_numbers.applicator_option_board"
```



NOTES:

- For printer support, see [SGD Command Support on page 1455](#).
- For details on SGD command structure, see [Command Structure on page 562](#).

device.serial_numbers.cutter

This command returns the serial number of the cutter, if installed.

For printers that do not store this value, the printer returns an empty string.

Getvar

To return the serial number of the cutter board:

```
! U1 getvar "device.serial_numbers.cutter"
```

Result

A hexadecimal representation of the control panel serial number.

Example

In this example, the getvar returns the serial number of the cutter board.

```
! U1 getvar "device.serial_numbers.cutter" "0123456789ABCDEF"
```



NOTES:

- For printer support, see [SGD Command Support on page 1455](#).
- For details on SGD command structure, see [Command Structure on page 562](#).

device.serial_numbers.cutter_date

This command returns the cutter date. For printers that do not store this value, the printer returns an empty string.

Getvar

To return the manufacturing date of the cutter board:

```
! U1 getvar "device.serial_numbers.cutter_date"
```

Example

In this example, the getvar returns the manufacturing date of the cutter board.

```
! U1 getvar "device.serial_numbers.cutter_date" "12/31/2014"
```



NOTES:

- For printer support, see [SGD Command Support on page 1455](#).
- For details on SGD command structure, see [Command Structure on page 562](#).

device.serial_numbers.printhead

This command returns the serial number field of the printhead that is installed in the printer.

Getvar

To return the serial number field of the printhead that is installed in the printer:

```
! U1 getvar "device.serial_numbers.printhead"
```



NOTES:

- For printer support, see [SGD Command Support on page 1455](#).
- For details on SGD command structure, see [Command Structure on page 562](#).

device.serial_numbers.printhead_date

This command retrieves the printhead date. For printers that do not store this value, the printer returns an empty string.

Getvar

To return the printhead date:

```
! U1 getvar "device.serial_numbers.printhead_date"
```

Example

In this example, the getvar returns the manufacturing date of the printhead.

```
! U1 getvar "device.serial_numbers.printhead_date" "12/31/2014"
```



NOTES:

- For printer support, see [SGD Command Support on page 1455](#).
- For details on SGD command structure, see [Command Structure on page 562](#).

device.serial_numbers.usb_host_option_board_date

This command retrieves the USB Host option board date.

For printers that do not store this value, the printer returns an empty string.

Getvar

To return the usb host option board date:

```
! U1 getvar "device.serial_numbers.usb_host_option_board_date"
```

Example

In this example, the getvar returns the manufacturing date of the usb host option board.

```
! U1 getvar "device.serial_numbers.usb_host_option_board_date" "12/31/2014"
```



NOTES:

- For printer support, see [SGD Command Support on page 1455](#).
- For details on SGD command structure, see [Command Structure on page 562](#).

device.serial_numbers.usb_host_option_board

This command retrieves the serial number of the usb host option board. For printers that do not store this value, the printer returns an empty string.

Getvar

To return the usb host option board serial number:

```
! U1 getvar "device.serial_numbers.usb_host_option_board"
```



NOTES:

- For printer support, see [SGD Command Support on page 1455](#).
- For details on SGD command structure, see [Command Structure on page 562](#).

device.serial_numbers.parallel_option_board

This command retrieves the serial number of the parallel port option board. For printers that do not store this value, the printer returns an empty string.

Getvar

To return the parallel port option board serial number:

```
! U1 getvar "device.serial_numbers.parallel_option_board"
```



NOTES:

- For printer support, see [SGD Command Support on page 1455](#).
- For details on SGD command structure, see [Command Structure on page 562](#).

device.serial_numbers.parallel_option_board_date

This command retrieves the parallel port option board date.

For printers that do not store this value, the printer returns an empty string.

Getvar

To return the parallel option board date:

```
! U1 getvar "device.serial_numbers.parallel_option_board_date"
```

Example

In this example, the getvar returns the manufacturing date of the parallel port option board.

```
! U1 getvar "device.serial_numbers.parallel_option_board_date"  
"12/31/2014"
```



NOTES:

- For printer support, see [SGD Command Support on page 1455](#).
- For details on SGD command structure, see [Command Structure on page 562](#).

device.set_clock_to_build_date

Enables or disables a lower bound of the firmware build date for the rtc.date SGD.

If enabled, when the printer powers up and it finds an RTC date earlier than the firmware build date, it will set the RTC date to the firmware build date.

Setvar

To enable or disable a lower bound of the firmware build date for the rtc.date SGD:

```
! U1 setvar "device.set_clock_to_build_date" "value"
```

Values

- "enabled"
- "disabled"

Default

"enabled"

Getvar

To retrieve the firmware build date for the rtc.date SGD:

```
! U1 getvar "device.set_clock_to_build_date"
```



NOTES:

- For printer support, see [SGD Command Support on page 1455](#).
- For details on SGD command structure, see [Command Structure on page 562](#).

device.slot_1

This command retrieves the type of board installed in the bottom slot of a ZT400 series printer, or in the single expansion slot of a ZT200 series printer.

Getvar

To retrieve the type of board installed in the bottom slot of a ZT400 series printer:

```
! U1 getvar "device.slot_1"
```

Values

- "empty" = no board installed
- "parallel" = a parallel communications board is installed
- "wired" = a wired PrintServer board is installed
- "wireless" = a wireless PrintServer board is installed



NOTES:

- For printer support, see [SGD Command Support on page 1455](#).
- For details on SGD command structure, see [Command Structure on page 562](#).

device.slot_2

This command retrieves the type of board installed in the bottom slot of a ZT400 series printer.

Getvar

To retrieve the type of board installed in the bottom slot:

```
! U1 getvar "device.slot_2"
```

Values

- "empty" = no board installed
- "parallel" = a parallel communications board is installed
- "wired" = a wired PrintServer board is installed
- "wireless" = a wireless PrintServer board is installed



NOTES:

- For printer support, see [SGD Command Support on page 1455](#).
- For details on SGD command structure, see [Command Structure on page 562](#).

device.super_host_status

This command returns printer description information in XML format. The printer returns information on format parameters, object directories, individual object data, and print status information.

This command is equivalent to the ^HZA ZPL command.

Getvar

To return printer description information in XML format:

```
! U1 getvar "device.super_host_status"
```

Result

Information on format parameters, object directories, individual object data, and print status information.



NOTES:

- For printer support, see [SGD Command Support on page 1455](#).
- For details on SGD command structure, see [Command Structure on page 562](#).

device.syslog.clear_log

This setting clears the local syslog.entries SGD. Any log messages previously sent to an ip address are not changed.

Setvar

To clear the local syslog file:

```
! U1 setvar "device.syslog.clear_log" ""
```

Values

NA

Default

NA

Do

To clear the local syslog file:

```
! U1 do "device.syslog.clear_log" ""
```

Values

NA

Default

NA



NOTES:

- For printer support, see [SGD Command Support on page 1455](#).
- For details on SGD command structure, see [Command Structure on page 562](#).

device.syslog.configuration

This setting specifies the location for the syslog messages to be recorded. The location may be either on the printer, or a syslog server IP address.

Setvar

To specify the location for the syslog messages to be recorded:

```
! U1 setvar "device.syslog.configuration" "value"
```

Values

A list of configuration entries, limited to 1000 characters. Entries must be in the form of "**severity,destination**" and delimited with a semi-colon.

SEVERITY - The severity levels, in decreasing severity order, are:

```
emerg
alert
crit
err
warning
notice
info
debug
```

When you specify the severity level, the lowest specified severity and all severity levels above it will be recorded. For example, if you specify **debug**, you will get all severity level reports. If you specify **crit**, you will get only **crit**, **alert**, and **emerg** severity reports.

DESTINATION - "**local**" or a syslog server IP address

When configuring the local syslog report, the first local entry is used and duplicate requests to local are ignored.

To configure remote syslog messages you will first need a syslog server to accept them.

Default

```
""
```

Getvar

To retrieve the configuration string setting:

```
! U1 getvar "device.syslog.configuration"
```

Example

Example 1

This example has emergency syslog messages being sent to an IP location, debug (and all higher severity) syslog messages to another IP address, and critical and higher syslog messages to local storage (either a file or SGD).

```
! U1 setvar "device.syslog.configuration"
"emerg,128.168.0.1;debug,192.168.0.2;crit,local;"
```

Example 2

This example will only report emergency syslog messages to the local file, and ignore the duplicate location request for critical and higher reports.

```
! U1 setvar "device.syslog.configuration" "emerg,local;crit,local;"
```

Example 3

This is an example of a syslog report stored at E:SYSLOG.TXT. Note that device.syslog.save_local_file must be enabled.

```
Feb 17 14:28:17: [Power][Informational][0X14] Power On
Feb 17 14:28:19: [Print][Informational][0XF] PQ Job Completed
Feb 17 14:28:20: [Print][Informational][0XF] PQ Job Completed
Feb 17 14:28:20: [Weblink][Informational][0X1005] Weblink disabled
Feb 17 14:28:34: [Network][Notice][0X1C] Cold Start
```

Example 4

This is an example of a syslog report from a syslog server application monitoring an IP address.

Received	Source IP	Source Name	Facility	Severity	Timestamp	Tag	Origin	Message
3/17/2014 4:13:59.590 PM	3.5.62	18j131600029	local 0	Notice	Feb 09 19:42:33	[Print][Notice][0XE]		Printer Unpaused
3/17/2014 4:13:57.365 PM	3.5.62	18j131600029	local 0	Notice	Feb 09 19:42:31	[Print][Notice][0X8]		Head Closed
3/17/2014 4:13:56.237 PM	3.5.62	18j131600029	local 0	Warning	Feb 09 19:42:30	[Print][Warning][0XA]		Ribbon In
3/17/2014 4:13:56.230 PM	3.5.62	18j131600029	local 0	Notice	Feb 09 19:42:30	[Print][Notice][0XD]		Printer Paused
3/17/2014 4:13:56.224 PM	3.5.62	18j131600029	local 0	Error	Feb 09 19:42:30	[Print][Error][0X7]		Head Open



NOTES:

- For printer support, see [SGD Command Support on page 1455](#).
- For details on SGD command structure, see [Command Structure on page 562](#).

device.syslog.enable

This printer setting enables syslog messages.

The destination of syslog messages is specified in [device.syslog.configuration on page 710](#).

Setvar

To enable or disable syslog:

```
! U1 setvar "device.syslog.enable" "value"
```

Values

- "on"
- "off"

Default

"off"

Getvar

To retrieve if the syslog is enabled:

```
! U1 getvar "device.syslog.enable"
```

Example

This `setvar` example shows the value set to "on".

```
! U1 setvar "device.syslog.enable" "on"
```



NOTES:

- For printer support, see [SGD Command Support on page 1455](#).
- For details on SGD command structure, see [Command Structure on page 562](#).

device.syslog.entries

This printer setting displays previously sent syslog messages. If there are no previously sent syslog messages, an empty string is returned.

The destination of syslog messages is specified in `device.syslog.configuration`.

Getvar

To display previously sent syslog messages:

```
! U1 getvar "device.syslog.entries"
```

The format of each syslog message includes the printer feature, the severity level, the unique message code, and the unique English message. This allows for more advanced systems administrators to filter particular messages of interest. Syslog currently supports unique messages for most printer alerts, WebLink, and some USB Host messages.

Example

This `getvar` example shows the value of the syslog file.

```
! U1 getvar "device.syslog.entries"
```

returns

```
Feb 17 14:28:17: [Power][Informational][0X14] Power On
Feb 17 14:28:19: [Print][Informational][0XF] PQ Job Completed
Feb 17 14:28:20: [Print][Informational][0XF] PQ Job Completed
Feb 17 14:28:20: [Weblink][Informational][0X1005] Weblink disabled
Feb 17 14:28:34: [Network][Notice][0X1C] Cold Start
```



NOTES:

- For printer support, see [SGD Command Support on page 1455](#).
- For details on SGD command structure, see [Command Structure on page 562](#).

device.syslog.log_max_file_size

This printer setting specifies the maximum size of the local syslog file.

Setvar

To set the maximum syslog file size to the specified value:

```
! U1 setvar "device.syslog.log_max_file_size" "value"
```

Values

A numerical value between 10000 and 400000

Default

```
"10000"
```

Getvar

To return the maximum allowed size of the syslog file:

```
! U1 getvar "device.syslog.log_max_file_size"
```

Example

This `setvar` example shows the value set to `"200000"`.

```
! U1 setvar "device.syslog.log_max_file_size" "200000"
```



NOTES:

- For printer support, see [SGD Command Support on page 1455](#).
- For details on SGD command structure, see [Command Structure on page 562](#).

device.syslog.save_local_file

This command saves the contents of the local syslog to E:SYSLOG.TXT.

The local destination must be specified in [device.syslog.configuration](#).

Setvar

To specify whether to save the contents of the local syslog file to E:SYSLOG.TXT:

```
! U1 setvar "device.syslog.save_local_file" "value"
```

Values

- "yes" = the local syslog is saved to E:SYSLOG.TXT
- "no" = the local syslog is not saved

Default

"no"

Getvar

To display the setting for saving the local syslog file to E:SYSLOG.TXT:

```
! U1 getvar "device.syslog.save_local_file"
```

Example

This **setvar** example shows the value set to "yes".

```
! U1 setvar "device.syslog.save_local_file" "yes"
```



NOTES:

- For printer support, see [SGD Command Support on page 1455](#).
- For details on SGD command structure, see [Command Structure on page 562](#).

device.applicator.data_ready_activation

Sets whether the applicator port DATA READY signal is asserted for all formats, or only for printing formats.

Setvar

To set whether the applicator port DATA READY signal is asserted for all formats, or only for printing formats:

```
! U1 setvar "device.applicator.data_ready_activation" "value"
```

Values

- "print" = indicates the data ready signal is activated on printing labels only.
- "format" = indicates the data ready signal is activated on all formats.

Default

"format"

Getvar

To return the data ready activation value:

```
! U1 getvar "device.applicator.data_ready_activation"
```

Result

"print"

Example

The setvar example shows the data ready signal activated on printing labels only.

```
! U1 setvar "device.applicator.data_ready_activation" "print"
```



NOTES:

- For printer support, see [SGD Command Support on page 1455](#).
- For details on SGD command structure, see [Command Structure on page 562](#).

device.applicator.error_on_pause

Sets whether device applicator errors will be displayed.

Setvar

To set whether device applicator errors will be displayed:

```
! U1 setvar "device.applicator.error_on_pause" "value"
```

Values

"enabled" = device applicator errors will be displayed, and SERVICE REQUIRED will be asserted.

"disabled" = device applicator errors will not be displayed.

Default

"enabled"

Example

```
! U1 setvar "device.applicator.error_on_pause" "enabled"
```

Getvar

To return the current setting value:

```
! U1 setvar "device.applicator.error_on_pause" "enabled"
```



NOTES:

- For printer support, see [SGD Command Support on page 1455](#).
- For details on SGD command structure, see [Command Structure on page 562](#).

device.applicator.start_print_mode

Selects the applicator port START PRINT mode of operation.

Setvar

To select the start print mode of operation:

```
! U1 setvar "device.applicator.start_print_mode" "value"
```

Values

- "level" = the Start Print signal does not need to be de-asserted to print the next label. As long as the Start Print signal is low and a label is formatted, a label prints.
- "pulse" = the Start Print signal must be de-asserted before it can be asserted for the next label

Default

"pulse"

Getvar

To retrieve the current setting value:

```
! U1 getvar "device.applicator.start_print_mode"
```

Result

"level"

Example

In the setvar example below, the "level" start print mode of operation is set.

```
! U1 setvar "device.applicator.start_print_mode" "level"
```



NOTES:

- For printer support, see [SGD Command Support on page 1455](#).
- For details on SGD command structure, see [Command Structure on page 562](#).

device.applicator.voltage

Sets the output voltage of the applicator board. The value will not take effect until a reboot.

Setvar

To set the output voltage of the applicator board:

```
! U1 setvar "device.applicator.voltage" "value"
```

Values

- "0" = off
- "5" = 5V
- "24" = 24V

Default

"disabled"

Getvar

To retrieve the current setting value:

```
! U1 getvar "device.applicator.voltage"
```

Result

"5"

Example

In the setvar example below, the output voltage of the applicator board is set to "5".

```
! U1 setvar "device.applicator.voltage" "5"
```



NOTES:

- For printer support, see [SGD Command Support on page 1455](#).
- For details on SGD command structure, see [Command Structure on page 562](#).

device.unique_id

This command retrieves the printer identifier. For printer support, see [SGD Command Support on page 1455](#).

Getvar

To retrieve the established printer identifier:

```
! U1 getvar "device.unique_id"
```

Example

In this example, assuming the printer's unique ID is 12345, the `getvar` shows "12345".

```
! U1 getvar "device.unique_id"
```



NOTES:

- For details on SGD command structure, see [Command Structure on page 562](#).

device.unpause

This command causes a printer in Pause Mode to resume printing. The operation is identical to pressing **PAUSE** on the control panel of the printer when the printer is already in Pause Mode.

This command is equivalent to **~PS**.

Setvar

To cause the printer in the pause mode to resume printing:

```
! U1 SETVAR "device.pause" ""
```

Values

NA

Default

NA

Do

To cause the printer in the pause mode to resume printing:

```
! U1 DO "device.pause" ""
```

Values

NA

Default

NA



NOTES:

- For printer support, see [SGD Command Support on page 1455](#).
- For details on SGD command structure, see [Command Structure on page 562](#).

device.uptime

This command identifies the amount of time the printer has been powered on. The string format is: xx days, xx hours, xx minutes, and xx seconds. For printer support, see [SGD Command Support on page 1455](#).

Getvar

To retrieve the amount of time the print has been powered on:

```
! U1 getvar "device.uptime"
```

Example

In this example, the `getvar` retrieves the amount of time the printer has been turned on.

```
! U1 getvar "device.uptime"  
"00 days 02 hours 45 mins 30 secs"
```



NOTES:

For details on SGD command structure, see [Command Structure on page 562](#).

device.user_p1

This command saves and retrieves user specified values. For printer support, see [SGD Command Support on page 1455](#).

Setvar

To instruct the printer to set user parameters:

```
! U1 setvar "device.user_p1" "value"
```

Values

alphanumeric text string (1 - 20)

Default

""

Getvar

To retrieve user specified parameters:

```
! U1 getvar "device.user_p1"
```

Example

This `setvar` example shows the value set to "test".

```
! U1 setvar "device.user_p1" "test"
```

When the `setvar` value is set to "test", the `getvar` result is "test".



NOTES:

For details on SGD command structure, see [Command Structure on page 562](#).

device.user_p2

This command saves and retrieves user specified values. For printer support, see [SGD Command Support on page 1455](#).

Setvar

To instruct the printer to set user parameters:

```
! U1 setvar "device.user_p2" "value"
```

Values

alphanumeric text string (1 - 20)

Default

""

Getvar

To save and retrieve user specified parameters:

```
! U1 getvar "device.user_p2"
```

Example

This **setvar** example shows the value set to **"test"**.

```
! U1 setvar "device.user_p2" "test"
```

When the **setvar** value is set to **"test"**, the **getvar** result is **"test"**.



NOTES:

For details on SGD command structure, see [Command Structure on page 562](#).

device.user_vars.set_range

This command compliments the `device.user_vars.create` command, allowing a user to change the range of a user-created SGD variable. It has a similar syntax to `device.user_vars.create` with the exception that no default is specified.

Setvar

To change the range of a user-created variable:

```
! U1 setvar "device.user_vars.set_range" "name:type:range"
```

Values

- **name** = the name of the SGD to modify
- **type** = Must be the same type for 'name' as when it was created
- **range** = x-y (for all but UPDOWNCHOICES and CHOICES) or a,b,c,d (for CHOICES and UPDOWNCHOICES)
- If no range is specified then it will delete whatever range is currently specified.

Default

NA

Example

This example modifies my_var to:

```
device.user_vars.my_var : b , Choices: a,b,c,d,e
```

```
! U1 setvar "device.user_vars.set_range" "my_var:CHOICES:a,b,c,d,e"
```



NOTES:

- For printer support, see [SGD Command Support on page 1455](#).
- For details on SGD command structure, see [Command Structure on page 562](#).

device.user_vars.create

This command creates a user variable with the specified name, type, range, and default value. The root SGD location for user variables is "device.user_vars".

Setvar

To instruct the printer to create a user variable with the specified parameters:

```
! U1 setvar "device.user_vars.create" "name:type:range:defaultValue"
```

Values

- **name** = the name of the SGD to appear in device.user_vars. The name can be anything from 1 to 64 printable ASCII characters. Any '.' within the name will be replaced with '_'. (e.g. "john.doe" will be changed to "john_doe"). The name must be unique in the device.user_vars branch or it will not be created. The name will be converted to lower case.
- **type** = one of STRING, INTEGER, DOUBLE, CHOICES, UPDOWNCHOICES, UPDOWNINTEGER, UPDOWNDOUBLE. The type must be one of these types or the variable will not be created.
 - STRING - For strings the range indicates the min/max length of the data that can be stored. If the range is left blank, the default range is a string length of 0-1024. There is no maximum string length, however, if large data is placed into the variables the user should be aware that system memory and performance will be affected. Strings larger than available system memory will not be stored. Values should attempt to stay around, or below, 5K.
 - INTEGER/UPDOWNINTEGER - For integers the range can be any number expressed by a 32-bit integer, signed or unsigned. If the range is left blank then a range of -32768 to 32767 will be used.
 - DOUBLE/UPDOWNDOUBLE - A double can be any value within the range of +/-1.7e308. If the range is left blank then a range of -32768.0 to 32767.0 will be used.
 - CHOICES/UPDOWNCHOICES - Choices must be specified in a comma delimited list. The range cannot be blank if the type is CHOICES or UPDOWNCHOICES.
- **range** = Expressed as x-y. The range of a variable depends upon the type. Some types will create default ranges, while others will fail to be created if the range is invalid or not specified.
- **default** = the default value for the variable. The value must fall within the range specified or the variable will not be created. If the type is INTEGER, UPDOWNINTEGER, DOUBLE, UPDOWNDOUBLE the default value will be 0 if not specified. For STRING the default value will be an empty string if it is not specified. CHOICES and UPDOWNCHOICES must have a default value and it must be one of the choices within the specified range.

All four parts of the creation string must be present (some can be empty) meaning that there must be three delimiter characters (':') present. There is no error shown or indicated otherwise when the variable is not created for some reason. If the variable is not created one of the rules listed above has been violated.

Any user variables will be deleted from the device.user_vars branch on a power cycle (they won't be recreated on the next power up).

Defaulting the user_vars branch will restore the consumers back to their defaulted values and will not remove them from the user_vars branch.

Example

To create a user variable named **userVar1** that is an integer with a minimum of 1, a maximum of 10, and a default/initial value of 5, issue this command:

```
! U1 setvar "device.user_vars.create" "userVar1:INTEGER:1-10:5"
```

After issuing the above “create” command the **device.user_vars.userVar1** SGD will be present in an ALLCV response.

After issuing the above “create” command the **device.user_vars.userVar1** SGD may be set via:

```
! U1 setvar "device.user_vars.userVar1" "2"
```

After issuing the above “create” command the “device.user_vars.userVar1” SGD may be retrieved via:

```
! U1 getvar "device.user_vars.userVar1"
```



NOTES:

- For printer support, see [SGD Command Support on page 1455](#).
- For details on SGD command structure, see [Command Structure on page 562](#).

device.xml.enable

This command enables and disables language parsing support for XML. When enabled (on), the printer will parse both ZPL and XML. When disabled (off), the printer will not parse XML data. For printer support, see [SGD Command Support on page 1455](#).

Setvar

To instruct the printer to disable or enable the language parsing support for XML:

```
! U1 getvar "device.xml.enable" "value"
```

Values

- "on" = enables language parsing support for XML
- "off" = disables language parsing support for XML

Default

on

Getvar

To enable and disable language parsing support for XML:

```
! U1 getvar "device.xml.enable"
```

Example

This **setvar** example shows the language parsing support for XML set to "on".

```
! U1 setvar "device.xml.enable" "on"
```

When the **setvar** value is set to "on", the **getvar** result is language parsing support for XML set to "on".



NOTES:

For details on SGD command structure, see [Command Structure on page 562](#).

device.feature.lighted_arrows

Indicates if the Lighted Arrows hardware is installed.

Getvar

To retrieve if the Lighted Arrow hardware is installed or not:

```
! U1 getvar "device.feature.lighted_arrows"
```

Result

- "not available" = lights are not available for this printer
- "present" = lights are installed
- "not present" = lights are not installed



NOTES:

- For printer support, see [SGD Command Support on page 1455](#).
- For details on SGD command structure, see [Command Structure on page 562](#).

device.light.ribbon_path_brightness

Sets the brightness level for the ribbon path LED.

Setvar

To set the brightness level for the ribbon path LED:

```
! U1 setvar "device.light.ribbon_path_brightness" "value"
```

Values

- "off"
- "low"
- "medium"
- "high"

Default

"high"

Example

```
! U1 setvar "device.light.ribbon_path_brightness" "low"
```

Getvar

To retrieve the current setting value:

```
! U1 getvar "device.light.ribbon_path_brightness"
```

Result

"low"



NOTES:

- For printer support, see [SGD Command Support on page 1455](#).
- For details on SGD command structure, see [Command Structure on page 562](#).

device.light.media_path_brightness

Sets the brightness level for the media path LED.

Setvar

To set the brightness level for the media path LED:

```
! U1 setvar "device.light.media_path_brightness" "value"
```

Values

- "off"
- "low"
- "medium"
- "high"

Default

"high"

Example

```
! U1 setvar "device.light.media_path_brightness" "low"
```

Getvar

To retrieve the current setting value:

```
! U1 getvar "device.light.media_path_brightness"
```

Result

"low"



NOTES:

- For printer support, see [SGD Command Support on page 1455](#).
- For details on SGD command structure, see [Command Structure on page 562](#).

display.backlight

This parameter determines if the printer display backlight will be active. Valid only on printers with a display installed.

Setvar

To instruct the printer to turn on or off the backlight display:

```
! U1 setvar "display.backlight" "value"
```

Values

on, off

Default

on

Getvar

To return if the display backlight is on or off:

```
! U1 getvar "display.backlight"
```

Example

This example sets the backlight display to "on".

```
! U1 setvar "display.backlight" "on"
```



NOTES:

- For printer support, see [SGD Command Support on page 1455](#).
- For details on SGD command structure, see [Command Structure on page 562](#).

display.backlight_on_time

This command sets the amount of time before the backlight turns off. Valid only on printers with a display installed.

Setvar

To set the display length in seconds:

```
! U1 setvar "display.backlight_on_time" "time"
```

Values

0-8191

Default

0

If the value is set to 0, the backlight will remain on.

Getvar

To return the display length in seconds:

```
! U1 getvar "display.backlight_on_time"
```

Example

This **setvar** example shows the value set to one minute (60 seconds).

```
! U1 setvar "display.backlight_on_time" "60"
```



NOTES:

- For printer support, see [SGD Command Support on page 1455](#).
- For details on SGD command structure, see [Command Structure on page 562](#).

display.batch_counter

Sets whether batch counters will be displayed on the printer's control panel.

Setvar

To set whether batch counters will be displayed on the printer's control panel:

```
! U1 setvar "display.batch_counter" "value"
```

Values

- "enabled" = batch counters will be displayed
- "disabled" = batch counters will not be displayed

Default

"disabled"

Example

```
! U1 setvar "display.batch_counter" "enabled"
```

Getvar

To retrieve the current setting value:

```
! U1 getvar "display.batch_counter"
```

Result

"enabled"



NOTES:

- For printer support, see [SGD Command Support on page 1455](#).
- For details on SGD command structure, see [Command Structure on page 562](#).

display.bluetooth.mac

This command enables or disables the bluetooth MAC address display on printers.

Setvar

To set the command:

```
! U1 setvar "display.bluetooth.mac" "on"
```

Values

"off" = BT Mac address is not displayed

"on" = BT Mac Address is displayed

Default Value

"off"

Example

In this example, the setvar turns on the bluetooth MAC address display:

```
! U1 setvar "display.bluetooth.mac" "on"
```

Getvar

To view the current bluetooth MAC address display setting:

```
! U1 getvar "display.bluetooth.mac"
```



NOTES:

- For printer support, see [SGD Command Support on page 1455](#).
- For details on SGD command structure, see [Command Structure on page 562](#).

display.calibrate

This command initiates the UI screen calibration if the user cannot enter the UI screen calibration from the menu.

Setvar

To set the command:

```
! U1 setvar "display.calibrate" ""
```

Values

NA

Do

To initiate the UI screen calibration:

```
! U1 do "display.calibrate" ""
```

Values

NA



NOTES:

- This command only works for printers with a touch display.
- For printer support, see [SGD Command Support on page 1455](#).
- For details on SGD command structure, see [Command Structure on page 562](#).

display.language

This command sets the display language for the control panel. This is equivalent to the ^KL ZPL command.

Setvar

To set the display language for the front panel:

```
! U1 setvar "display.language" "language"
```

Values

- "english"
- "spanish"
- "french"
- "german"
- "italian"
- "norwegian"
- "portuguese"
- "swedish"
- "danish"
- "spanish2" (*same as Spanish*)
- "dutch"
- "finnish"
- "japanese"
- "korean"
- "simplified chinese"
- "traditional chinese"
- "russian"
- "polish"
- "czech"
- "romanian"

Default

"english"

Getvar

To return the currently set display language:

```
! U1 getvar "display.language"
```

Example

This `setvar` example shows the value set to `"dutch"`.

```
! U1 setvar "dsplay.language" "dutch"
```



NOTES:

- For printer support, see [SGD Command Support on page 1455](#).
- For details on SGD command structure, see [Command Structure on page 562](#).

display.load_card

This command loads a specific card from a WML file.

Setvar

To load a specific card from a WML file:

```
! U1 setvar "display.load_card" "value"
```

Values

A valid WML filename and card within the WML filename.

The card name is case sensitive.

Example

```
! U1 setvar "display.load_card" "BLUETOOTH.WML#bluetooth2"
```



NOTES:

- For printer support, see [SGD Command Support on page 1455](#).
- For details on SGD command structure, see [Command Structure on page 562](#).

display.password.level

Controls when to display the password WML card on the LCD display.

Setvar

To control when to display the password WML card on the LCD display:

```
! U1 setvar "display.password.level" "value"
```

Values

- **"all"** - The user will always be prompted to enter a password when a field is to be modified.
- **"none"** - The user will not be prompted to enter a password on the LCD display.
- **"selected"** - The user will be prompted to enter a password only if the WML card contains a password ="on" attribute and the user attempts to change a setting.

Default

- **"selected"** - QLn420, QLn320 Healthcare, and QLn220 Healthcare
- **"none"** - all other platforms

Getvar

To retrieve the current setting value:

```
! U1 getvar "display.password.level"
```



NOTES:

- For printer support, see [SGD Command Support on page 1455](#).
- For details on SGD command structure, see [Command Structure on page 562](#).

display.root_wml

This command specifies which control file is first processed by the printer's front panel.

Setvar

To specify which control file is first processed by the printer's front panel:

```
! U1 setvar "display.root_wml" "value"
```

Values

Any file name with a maximum of 128 characters in length.

Default

- **Z:INDEX420.WML** for the QLn420 printers
- **Z:INDEX320.WML** for the QLn220 and QLn320 printers
- **Z:INDEX.WML** for all other printers

If the value is "" on power-up, then **Z:INDEX.WML** is used.

Getvar

To retrieve the current setting value:

```
! U1 getvar "display.root_wml"
```



NOTES:

- For printer support, see [SGD Command Support on page 1455](#).
- For details on SGD command structure, see [Command Structure on page 562](#).

display.text

This command retrieves the text data that is being used on the printer's LCD. For printer support, see [SGD Command Support on page 1455](#).

Getvar

To retrieve the text data that appears on the printer's LCD:

```
! U1 getvar "display.text"
```

Example

In this example, the `getvar` displays text content that appears on the printer's LCD.

```
! U1 getvar "display.text"  
"PRINTER READY V60.16.4Z"
```



NOTES:

For details on SGD command structure, see [Command Structure on page 562](#).

file.capture_response.destination

Sets whether batch counters will be displayed on the printer's control panel.

Setvar

To set whether batch counters will be displayed on the printer's control panel:

- "printer_file" = captured files will be written to the printer's memory
- "usb_file" = captured files will be written to a USB storage device

Default

"printer_file"

Example

```
! U1 setvar "file.capture_response.destination" "usb_file"
```

Getvar

To retrieve the current setting value:

```
! U1 getvar "file.capture_response.destination"
```

Result

"usb_file"



NOTES:

- For printer support, see [SGD Command Support on page 1455](#).
- For details on SGD command structure, see [Command Structure on page 562](#).

head.resolution.in_dpi

Returns the resolution of the print head in dots per inch as an integer.

Getvar

To return the resolution of the print head in dots per inch:

```
! U1 getvar "head.resolution.in_dpi"
```

Values

'203', '300', or '600'



NOTES:

- For printer support, see [SGD Command Support on page 1455](#).
- For details on SGD command structure, see [Command Structure on page 562](#).

ezpl.head_close_action

This command sets what happens to the media after the printhead is closed and the printer is taken out of pause.

This command is similar to the `^MF ZPL` command.

Setvar

To instruct the printer on which action to perform when the printhead is closed:

```
! U1 setvar "ezpl.head_close_action" "value"
```

Values

- `"feed"` = feed to the first web after sensor
- `"calibrate"` = is used to force a label length measurement and adjust the media and ribbon sensor values.
- `"length"` = is used to set the label length. Depending on the size of the label, the printer feeds one or more blank labels.
- `"no motion"` = no media feed
- `"short cal"` = short calibration

Default

```
"calibrate"
```

Getvar

To return the current set of action to be performed when the printhead is closed:

```
! U1 getvar "ezpl.head_close_action"
```

Example

This `setvar` example sets the calibration method to short calibration.

```
! U1 setvar "ezpl.head_close_action" "short cal"
```



NOTES:

- For printer support, see [SGD Command Support on page 1455](#).
- For details on SGD command structure, see [Command Structure on page 562](#).

ezpl.label_length_max

This command sets the maximum label length in inches.

This command is equivalent to the ^ML ZPL command.

Setvar

To set the maximum label length in inches:

```
! U1 setvar "ezpl.label_length_max" "value"
```

Values

1.0 to 39.0

Default

"39"

Getvar

To retrieve the current maximum label length setting in inches:

```
! U1 getvar "ezpl.label_length_max"
```

Example

This example sets the label length to 6.2 inches.

```
! U1 setvar ezpl.label_length_max" "6.2"
```

```
! U1 setvar ezpl.label_length_max" "14"
```

Values can be expressed to one decimal place.



NOTES:

- For printer support, see [SGD Command Support on page 1455](#).
- For details on SGD command structure, see [Command Structure on page 562](#).

ezpl.label_sensor

This command sets the paper out threshold value.

Setvar

To set the paper out threshold value:

```
! U1 setvar "ezpl.label_sensor" "value"
```

Values

"0" to "255", integer values only

Default

"70"

Getvar

To retrieve the currently set paper out threshold value:

```
! U1 getvar "ezpl.label_sensor"
```

Example

This `setvar` example shows the value set to 50.

```
! U1 setvar "ezpl.label_sensor" "50"
```



NOTES:

- For printer support, see [SGD Command Support on page 1455](#).
- For details on SGD command structure, see [Command Structure on page 562](#).

ezpl.manual_calibration

This command initiates a manual calibration sequence.

Setvar

To instruct the printer to initiate a manual calibration:

```
! U1 setvar "ezpl.manual_calibration" ""
```

Values

NA

Default

NA

Do

To instruct the printer to initiate a manual calibration:

```
! U1 do "ezpl.manual_calibration" ""
```

Values

NA

Default

NA



NOTES:

- For printer support, see [SGD Command Support on page 1455](#).
- For details on SGD command structure, see [Command Structure on page 562](#).

ezpl.media_type

This command specifies the media type being used.

This command is similar to the `^MN ZPL` command.

Setvar

To set the media type used in the printer:

```
! U1 setvar "ezpl.media_type" "value"
```

Values

- "continuous"
- "gap/notch"
- "mark"

Default

"gap/notch"

To return the current media type setting:

```
! U1 getvar "ezpl.media_type"
```

Example

This `setvar` example sets the media type to "continuous".

```
! U1 setvar "ezpl.media_type" "continuous"
```



NOTES:

- For printer support, see [SGD Command Support on page 1455](#).
- For details on SGD command structure, see [Command Structure on page 562](#).

ezpl.power_up_action

This command sets what happens to the media when the printer is powered on.

This command is similar to the `^MF ZPL` command.

Setvar

To set the media motion and calibration setting at printer power up:

```
! U1 setvar "ezpl.power_up_action" "value"
```

Values

- "calibrate"
- "feed"
- "length"
- "no motion"
- "short cal"

Default

"calibrate"

Getvar

To return the current power up media motion and calibration settings:

```
! U1 getvar "ezpl.power_up_action"
```

Example

This `setvar` example sets the power up calibration setting to "length".

```
! U1 setvar "ezpl.power_up_action" "length"
```



NOTES:

- For printer support, see [SGD Command Support on page 1455](#).
- For details on SGD command structure, see [Command Structure on page 562](#).

ezpl.print_method

This command sets the print method.

This command is similar to `^MT`.

Setvar

To set the print method:

```
! U1 setvar "ezpl.print_method" "value"
```

Values

- "thermal trans"
- "direct thermal"

Default

"thermal trans"

Getvar

To retrieve the current print method setting:

```
! U1 getvar "ezpl.print_method"
```

Example

This `setvar` example sets the print method to "direct thermal".

```
! U1 setvar ezpl.print_method" "direct thermal"
```



NOTES:

- For printer support, see [SGD Command Support on page 1455](#).
- For details on SGD command structure, see [Command Structure on page 562](#).

ezpl.print_width

This command sets the print width of the label.

Setvar

To set the print width:

```
! U1 setvar "ezpl.print_width" "value"
```

Values

any printhead width

Default

the width of the printhead

Getvar

To retrieve the current print width setting:

```
! U1 getvar "ezpl.print_width"
```

Example

This `setvar` example sets the print width value to 3.

```
! U1 setvar "ezpl.print_width" "3"
```



NOTES:

- For printer support, see [SGD Command Support on page 1455](#).
- For details on SGD command structure, see [Command Structure on page 562](#).

ezpl.reprint_mode

This command turns on/off the reprint mode.

Setvar

To instruct the printer to turn on or off reprint mode:

```
! U1 setvar "ezpl.reprint_mode" "value"
```

Values

- "on"
- "off"

Default

"off"

Getvar

To retrieves the current setting for reprint mode:

```
! U1 getvar "ezpl.reprint_mode"
```

Example

This `setvar` example turns reprint mode on.

```
! U1 setvar "ezpl.reprint_mode" "on"
```



NOTES:

- For printer support, see [SGD Command Support on page 1455](#).
- For details on SGD command structure, see [Command Structure on page 562](#).

ezpl.take_label

This command sets the take label position.

Setvar

To set the take label position:

```
! U1 setvar "ezpl.take_label" "value"
```

Values

"0" to "255"

Default

"50"

Getvar

To retrieve the take label position:

```
U! getvar "ezpl.take_label"
```

Example

This example sets the take label position to 175.

```
! U1 setvar "ezpl.take_label" "175"
```



NOTES:

- For printer support, see [SGD Command Support on page 1455](#).
- For details on SGD command structure, see [Command Structure on page 562](#).

ezpl.tear_off

This command retrieves the tear-off position.

Setvar

To set the tear-off position:

```
! U1 setvar "ezpl.tear_off" "value"
```

Values

"-120" to "120"

Default

"0"

Getvar

To retrieve the currently set tear-off position:

```
! U1 getvar "ezpl.tear_off"
```

Example

This `setvar` example sets the tear-off value to 110.

```
! U1 setvar "ezpl.tear_off" "110"
```



NOTES:

- For printer support, see [SGD Command Support on page 1455](#).
- For details on SGD command structure, see [Command Structure on page 562](#).

file.cert.expiration

This command retrieves the certificate expiration information.

Getvar

To return the file expiration certificate information:

```
! U1 getvar "file.cert.expiration"
```

Result

A file with the service name, file name and date of expiration for every certificate in use.

Example

In this example, the getvar command returns the certificate expiration information for each communication service (SHA1, WLAN, TLS, WebLink, etc).

```
! U1 getvar "file.cert.expiration"
[{"service":"SHA1","file":"SHA1_DEVICE","end_date":"2027-07-09"},
{"service":"SHA2","file":"SHA2_DEVICE","end_date":"2037-11-22"},
{"service":"WLAN","file":"CERTCLN.NRD","end_date":"2019-06-22"},
{"service":"WIRED","file":null,"end_date":null},
{"service":"WEBLINK1","file":"WEBLINK1_CERT.NRD","end_date":"2096-01-02"},
{"service":"WEBLINK2","file":null,"end_date":null},
{"service":"TLSRAW","file":null,"end_date":null},
{"service":"HTTPS","file":"HTTPS_CERT.NRD","end_date":"2020-03-14"}]
```

In the example above, the command returns the service name, file name and date of expiration for every certificate in use. The expiration date is in the YYYY-MM-DD format. The certificates that are not provided by the user are listed as SHA_2 or SHA_1 DEVICE as they are available in the Zebra certificate directory. The printer returns the certificate file information even for not enabled services. If a certificate is not in use for a particular service, the command returns a null value.



NOTES:

- This command is not displayed in an ALLCV or JSON allconfig as per the SW request as the JSON SGD is not compatible with the SDK.
- The command only works with certificate files in use by a service. This command does not work with CA, KEY, CSR, or any other files.
- For printer support, see [SGD Command Support on page 1455](#).
- For details on SGD command structure, see [Command Structure on page 562](#).

file.cert.supported_curves

This command retrieves a list of supported elliptical curves for certificates.

Getvar

To return the list of supported elliptical curves:

```
! U1 getvar "file.cert.supported_curves"
```

Result

A comma delimited list of curve names from OpenSSL that the printer supports for certificates and encryption in general.



NOTES:

- For printer support, see [SGD Command Support on page 1455](#).
- For details on SGD command structure, see [Command Structure on page 562](#).

file.delete

This command instructs the printer to delete specified files. For printer support, see [SGD Command Support on page 1455](#).

Do

To instruct the printer to delete specified files:

```
! U1 do "file.delete" "value"
```

Values

file name



NOTE: Be sure to always specify the memory location.

Example

This **do** example shows the specified file to delete.

```
! U1 do "file.delete" "e:abcd.zpl"
```



NOTES:

For details on SGD command structure, see [Command Structure on page 562](#).

file.dir

This command displays a directory listing on the same port the command was received. For printer support, see [SGD Command Support on page 1455](#).

Setvar

To set the directory name from which to retrieve files:

```
! U1 setvar "file.dir" "value"
```

Values

directory letter

Be sure to always specify the memory location.

Getvar

To retrieve a directory listing of the specified directory:

```
! U1 getvar "file.dir"
```

Be sure to always specify the memory location.

Do

To set the directory name from which to retrieve files:

```
! U1 do "file.dir" "value"
```

Values

directory letter

Be sure to always specify the memory location.

Example

This **do** example shows the directory listing of the specified directory.

```
! U1 do "file.dir" "R:"
- DIR R:*. *
- 11172192 bytes free R: RAM
```



NOTES:

For details on SGD command structure, see [Command Structure on page 562](#).

file.dir_format

This command controls the output format of the `file.dir` Set/Get/Do command.

Setvar

To set the output format:

```
! U1 setvar "file.dir_format" "value"
```

Values

- "cpcl"
- "zpl"

Getvar

To retrieves the current setting for the output format:

```
! U1 getvar "file.dir_format"
```

Result

- "cpcl"
- "zpl"

Do

To set the output format:

```
! U1 do "file.dir_format" "value"
```

Values

- "cpcl"
- "zpl"

Example

This do example sets the directory format to CPCL.

```
! U1 do "file.dir_format" "cpcl"
```



NOTES:

- For printer support, see [SGD Command Support on page 1455](#).
- For details on SGD command structure, see [Command Structure on page 562](#).

file.type

This command displays the contents of the specified file.

Setvar

To instruct the printer to display the content of a file:

```
! U1 setvar "file.type" "value"
```

The contents are displayed on the same port as the command was received.

Values

the drive letter, file name, file extension, such as **R:TEST.ZPL**

Be sure to always specify the memory location.

Do

To display the content of a specified file:

```
! U1 do "file.type" "value"
```

Values

the drive letter, file name, file extension, such as **R:TEST.ZPL**

Be sure to always specify the memory location.

Example

This **setvar** example shows the value set to **"R:TEST.ZPL"**.

```
! U1 setvar "file.type" "R:TEST.ZPL"
```

When the **setvar** value is set to **"R:TEST.ZPL"**, the contents of the file **TEST.ZPL** located on the **R:** drive will be displayed.



NOTES:

- For details on SGD command structure, see [Command Structure on page 562](#).
- For printer support, see [SGD Command Support on page 1455](#).

file.run

This command instructs the printer to send a specified file to the parser.

Setvar

To instruct the printer to send a specified file to the parser:

```
! U1 setvar "file.run" "values"
```

Values

drive:filename.extension

Be sure to always specify the memory location.

Do

To instruct the printer to send a specified file to the parser:

```
! U1 do "file.run" "value"
```

Values

drive:filename.extension

Be sure to always specify the memory location.

Example

This `setvar` example will send the file "text.zpl" stored in RAM to the parser.

```
! U1 setvar "file.run" "R:text.zpl"
```



NOTES:

- For details on SGD command structure, see [Command Structure on page 562](#).
- For printer support, see [SGD Command Support on page 1455](#).

formats.cancel_all

The ~JA command cancels all format commands in the buffer. It also cancels any batches that are printing. This command is equivalent to the ~JA ZPL command.

Setvar

To cancel all format commands in the buffer:

```
! U1 setvar "formats.cancel_all" ""
```

Values

NA

Default

NA

Do

To cancel all format commands in the buffer:

```
! U1 do "formats.cancel_all" ""
```



NOTES:

- For details on SGD command structure, see [Command Structure on page 562](#).
- For printer support, see [SGD Command Support on page 1455](#).

head.authenticated

This command reports if the printhead is authenticated.

Getvar

To return the current state of the authenticated printhead:

```
! U1 getvar "head.authenticated"
```

Result

"yes" = printhead has passed printhead authentication

"no" = printhead has failed printhead authentication

Example

In the example below, the getvar returns the current state of the authenticated printhead.

```
! U1 getvar "head.authenticated" "yes"
```



NOTES:

- For printer support, see [SGD Command Support on page 1455](#).
- For details on SGD command structure, see [Command Structure on page 562](#).

head.darkness_switch_enable

Enables the darkness switch on desktop printers.

Setvar

To enable or disable the darkness switch:

```
! U1 setvar "head.darkness_switch_enable" "value"
```

Values

- "on" = enables the darkness switch
- "off" = disables the darkness switch

Default

"on"

Getvar

To retrieve the current setting value:

```
! U1 getvar "head.darkness_switch_enable"
```



NOTES:

- For printer support, see [SGD Command Support on page 1455](#).
- For details on SGD command structure, see [Command Structure on page 562](#).

head.darkness_switch

Indicates the value to which the darkness switch is set on the printer.

Getvar

To return which darkness switch is set on the printer:

```
! U1 getvar "head.darkness_switch"
```

Values

(looking at the switch from the rear of the printer)

"**low**" = darkness switch is on the left

"**medium**" = darkness switch is in the middle

"**high**" = darkness switch is on the right



NOTES:

- For printer support, see [SGD Command Support on page 1455](#).
- For details on SGD command structure, see [Command Structure on page 562](#).

head.element_test

This command will cause the printer to immediately run the head test on all printhead elements. The command can also display the result of the last head element test.

Do

To run the head test on all printhead elements:

```
! U1 do "head.element_test" ""
```

Getvar

To display the result of the last head element test:

```
! U1 getvar "head.element_test"
```

Values

The possible getvar responses include:

"Head Elements OK" - All head elements passed the test.

"n, n..." - a comma-separated list of elements that failed the test.

"Initialization Failed" - the test could not start.

"Failed to Attach" - the test could not start.

"Please Run Test" - default response if there are no results to display.

"In Progress" - The element test has been started but not completed yet.

Default

"Please Run Test"

Example

This example shows a single element that failed the test.

```
"86"
```

This example shows a list of elements that failed the test.

```
"75,309,456,778,779"
```



NOTES:

- For printer support, see [SGD Command Support on page 1455](#).
- For details on SGD command structure, see [Command Structure on page 562](#).

head.latch

This command identifies if the printhead is open or closed. For printer support, see [SGD Command Support on page 1455](#).

Getvar

To retrieve the status of the printhead, open or closed:

```
! U1 getvar "head.latch"
```

Values

"ok" = closed

"open" = open

Example

In this example, the `getvar` retrieves the status of the print head.

```
! U1 getvar "head.latch"  
"ok"
```



NOTES:

For details on SGD command structure, see [Command Structure on page 562](#).

input.capture

This parameter allows capturing input data in diagnostics mode. Input capture has three modes: "print", "run", and "off". The "print" and "run" modes can be used to examine data received by the printer.

When in "print" mode the printer will save incoming data to files named "in???.dmp", where ??? is a number between 001 to 999. The printer will then print the text and hexadecimal representation of data bytes received instead of printing the formatted labels which that data might represent. When in "run" mode the printer will save captured incoming data to files as above, but will otherwise run the incoming data/commands normally.

The capture files should be deleted from printer memory after retrieving them. Leaving the printer in "print" or "run" mode and not deleting the capture files will reduce the printer's available flash memory.

The "off" mode is the printer's normal operating mode. Cycling power will also return the printer to "off" mode.



Setvar

NOTE: This command does not capture a network packet trace.

To set the directory name from which to retrieve files:

```
! U1 setvar "input.capture" "value"
```

Values

"print"

"run"

"off"

Getvar

To retrieve the current `input.capture` setting value:

```
! U1 getvar "input.capture"
```



NOTES:

- For printer support, see [SGD Command Support on page 1455](#).
- For details on SGD command structure, see [Command Structure on page 562](#).

interface.network.active.arp_interval

This command changes the arp interval.

Setvar

To retrieve the gateway address of the active print server:

```
! U1 setvar "interface.network.active.arp_interval" "value"
```

Values

integer values from "0" to "30"

Default

"0"

Getvar

To retrieve the current arp interval setting, shown in minutes:

```
! U1 getvar "interface.network.active.arp_interval"
```

Example

In this example, the `setvar` changes the arp interval to three minutes.

```
! U1 setvar "interface.network.active.arp_interval" "3"
```



NOTES:

- For printer support, see [SGD Command Support on page 1455](#).
- For details on SGD command structure, see [Command Structure on page 562](#).

interface.network.active.cable_type

This command returns the cable type of the active network, either 10/100BaseT, Wireless 802.11b/g, or Wireless 802.11n.



Getvar

NOTE: This command will only give a valid response once an IP address has been established.

To retrieve the current cable type of the active network:

```
! U1 getvar "interface.network.active.cable_type"
```

Values

- "10/100BaseT"
- "Wireless 802.11b/g"
- "Wireless 802.11n"

Default

NA



NOTES:

- For printer support, see [SGD Command Support on page 1455](#).
- For details on SGD command structure, see [Command Structure on page 562](#).

interface.network.active.dhcp_received_host_name

This command reports the Host Name as assigned by the DHCP Server. If one is not assigned, or DHCP is not used, then the field will be blank.



Getvar

NOTE: This command will only give a valid response once an IP address has been established.

To report the host name:

```
! U1 getvar "interface.network.active.dhcp_received_host_name"
```

Example

```
! U1 getvar "interface.network.active.dhcp_received_host_name"
```

Result

```
"Zebra Printer on shelf 2112"
```



NOTES:

- For printer support, see [SGD Command Support on page 1455](#).
- For details on SGD command structure, see [Command Structure on page 562](#).

interface.network.active.gateway

This command retrieves the gateway address of the active print server. Getvar

To retrieve the gateway address of the active print server:

```
! U1 getvar "interface.network.active.gateway"
```

Example

In this example, the `getvar` retrieves the gateway address of the active print server.

```
! U1 getvar "interface.network.active.gateway"  
"10.3.5.1"
```



NOTES:

- For printer support, see [SGD Command Support on page 1455](#).
- For details on SGD command structure, see [Command Structure on page 562](#).

interface.network.active.ip_addr

This command retrieves the IP address of the active print server.

Getvar

To retrieve the IP address of the active print server:

```
! U1 getvar "interface.network.active.ip_addr"
```

Example

In this example, the `getvar` retrieves the IP address of the active print server.

```
! U1 getvar "interface.network.active.ip_addr"  
"10.3.5.92"
```



NOTES:

- For details on SGD command structure, see [Command Structure on page 562](#).
- For printer support, see [SGD Command Support on page 1455](#).

interface.network.active.mac_addr

This command retrieves the MAC address of the active print server. For printer support, see [SGD Command Support on page 1455](#).

Getvar

To retrieve the MAC address of the active print server:

```
! U1 getvar "interface.network.active.mac_addr"
```

Example

In this example, the `getvar` retrieves the MAC address of the active print server.

```
! U1 getvar "interface.network.active.mac_addr"  
"00:07:4d:24:08:ff"
```



NOTES:

For details on SGD command structure, see [Command Structure on page 562](#).

interface.network.active.mac_raw

This command identifies the RAW MAC address of the active print server. The raw mac address is the mac address without the colons (":").

Getvar

To retrieve the RAW MAC address of the active print server:

```
! U1 getvar "interface.network.active.mac_raw"
```

Example

In this example, the `getvar` retrieves the RAW MAC address of the active print server.

```
! U1 getvar "interface.network.active.mac_raw"  
"00074d2408ff"
```



NOTES:

- For details on SGD command structure, see [Command Structure on page 562](#).
- For printer support, see [SGD Command Support on page 1455](#).

interface.network.active.netmask

This command retrieves the netmask of the active print server.

Getvar

To retrieve the netmask of the active print server:

```
! U1 getvar "interface.network.active.netmask"
```

Example

In this example, the `getvar` retrieves the netmask of the active print server.

```
! U1 getvar "interface.network.active.netmask"  
"255.255.255.0"
```



NOTES:

- For details on SGD command structure, see [Command Structure on page 562](#).
- For printer support, see [SGD Command Support on page 1455](#).

interface.network.active.protocol

This command retrieves IP protocol of the active print server. For printer support, see [SGD Command Support on page 1455](#).

Getvar

To retrieve the IP protocol of the active print server:

```
! U1 getvar "interface.network.active.protocol"
```



NOTES:

For details on SGD command structure, see [Command Structure on page 562](#).

interface.network.active.protocol_error

This command returns the last error reported by the active print server.

Getvar

To return the last error reported by the active print server:

```
! U1 getvar "interface.network.active.protocol_error"
```



NOTES:

- For printer support, see [SGD Command Support on page 1455](#).
- For details on SGD command structure, see [Command Structure on page 562](#).

interface.network.active.rx_errors

This command returns the current number of packet receive errors on the active network interface.

Getvar

To return the current number of packet receive errors:

```
! U1 getvar "interface.network.active.rx_errors"
```

Result

The current number of errors.



NOTES:

- For printer support, see [SGD Command Support on page 1455](#).
- For details on SGD command structure, see [Command Structure on page 562](#).

interface.network.active.rx_packets

This command returns the number of packets received on the active network interface since the last power cycle.

Getvar

To return the number of packets received on the active network interface since the last power cycle:

```
! U1 getvar "interface.network.active.rx_packets"
```

Result

An integer.



NOTES:

- For printer support, see [SGD Command Support on page 1455](#).
- For details on SGD command structure, see [Command Structure on page 562](#).

interface.network.active.server_address

This command returns the network IP address of the server that provided the printer's IP address.

Getvar

To return the network IP address of the server providing the printer's IP address:

```
! U1 getvar "interface.network.server_address"
```

Result

an IP address



NOTES:

- For printer support, see [SGD Command Support on page 1455](#).
- For details on SGD command structure, see [Command Structure on page 562](#).

interface.network.active.speed

This command returns the speed in megabits per second of the active print server network since the last power cycle.

Getvar

To return the active print server network speed since the last power cycle:

```
! U1 getvar "interface.network.active.speed"
```

Result

A number indicating megabits/second



NOTES:

- For printer support, see [SGD Command Support on page 1455](#).
- For details on SGD command structure, see [Command Structure on page 562](#).

interface.network.active.tx_errors

This command returns the number of packet transmit errors on the active print server network since the last power cycle.

Getvar

To return the number of packet transmit errors on the active print server network since the last power cycle:

```
! U1 getvar "interface.network.active.tx_errors"
```

Result

An integer number



NOTES:

- For printer support, see [SGD Command Support on page 1455](#).
- For details on SGD command structure, see [Command Structure on page 562](#).

interface.network.active.tx_packets

This command returns the number of packets transmitted on the active print server network since the last power cycle.

Getvar

To return the number of packets transmitted on the active print server network since the last power cycle:

```
! U1 getvar "interface.network.active.tx_packets"
```

Result

A number.



NOTES:

- For printer support, see [SGD Command Support on page 1455](#).
- For details on SGD command structure, see [Command Structure on page 562](#).

interface.network.active.wins_addr

This command sets and retrieves the active WINS address.

Setvar

To set the WINS address of the active print server:

```
! U1 setvar "interface.network.active.wins_addr" "value"
```

Values

```
"0.0.0.0" - "255.255.255.255"
```

Getvar

To retrieve the WINS address of the active print server:

```
! U1 getvar "interface.network.active.wins_addr"
```

Result

```
a WINS address
```

Example

In this example, the `setvar` sets the Wins address of the active print server.

```
! U1 setvar "interface.network.active.wins_addr" "10.3.5.120"
```



NOTES:

- For printer support, see [SGD Command Support on page 1455](#).
- For details on SGD command structure, see [Command Structure on page 562](#).

interface.network.settings_require_reset

Displays whether or not the network system has to be reset for a new configuration setting to take effect.

Getvar

To display whether or not the network system has to be reset for a new configuration setting to take effect:

```
! U1 getvar "interface.network.settings_require_reset"
```

Values

"no" = no settings have been changed that require a reset to take effect.

"yes" = one or more settings has been changed that requires a reset to take effect



NOTES:

- For printer support, see [SGD Command Support on page 1455](#).
- For details on SGD command structure, see [Command Structure on page 562](#).

ip.firewall.whitelist_in

Returns a comma-separated list of IP addresses and/or IP address ranges that will be allowed to communicate with the printer. If the list is empty then the firewall will be disabled.

Setvar

To set the command:

```
! U1 setvar "ip.firewall.whitelist_in" "value"
```

Values:

The value is a string of up to 256 alphanumeric characters.

Default:

""

Examples

Single IP address:

```
! U1 setvar "ip.firewall.whitelist_in" "192.168.1.20"
```

Multiple IP addresses:

```
! U1 setvar "ip.firewall.whitelist_in" "192.168.1.20,192.168.100.21"
```

IP address ranges:

```
! U1 setvar "ip.firewall.whitelist_in" "192.168.1.20-192.168.1.100"
```

IP ranges and Single/Multiple IPs

```
"ip.firewall.whitelist_in" "192.168.1.20-192.168.1.40, 192.168.1.50, 192.168.1.75"
```

Getvar

To have the printer return the current setting value:

```
! U1 getvar "ip.firewall.whitelist_in"
```



NOTES:

- For printer support, see [SGD Command Support on page 1498](#).
- For details on SGD command structure, see [Command Structure on page 572](#).

ip.https.enable

Enables/disables the HTTPS web connections.



IMPORTANT: A network or printer reset is required for this setting to take effect.

Setvar

To set the command:

```
! U1 setvar "ip.https.enable" "value"
```

Values:

- off = disables HTTPS protocol
- on = enables HTTPS protocol

Default:

"on"

Getvar

To have the printer return the current setting value:

```
! U1 getvar "ip.https.enable"
```



NOTES:

- For printer support, see [SGD Command Support on page 1455](#).
- For details on SGD command structure, see [Command Structure on page 562](#).

ip.https.port

Sets the port that will listen for HTTPS connections.

Setvar

To set the command:

```
! U1 setvar "ip.https.port" "value"
```

Values:

Any valid https port from 0-65535.

Default:

"443"

Getvar

To have the printer return the current setting value:

```
! U1 getvar "ip.https.port"
```



NOTES:

- For printer support, see [SGD Command Support on page 1455](#).
- For details on SGD command structure, see [Command Structure on page 562](#).

ip.ping_gateway_interval

Determines the interval in minutes at which to send ICMP PING packets to the default gateway.

Setvar

To set the command:

```
! U1 setvar "ip.ping_gateway_interval" "value"
```

Values:

The value is an integer from 0-30.

0 — disabled

Default:

"0"

Getvar

To have the printer return the current setting value:

```
! U1 getvar "ip.ping_gateway_interval"
```



NOTES:

- For printer support, see [SGD Command Support on page 1455](#).
- For details on SGD command structure, see [Command Structure on page 562](#).

ip.pop3.print_body

Determines if the email body will be printed when the email is retrieved via POP3. This only applies if ip.pop3.enable is set to "on".

Setvar

To set the command:

```
! U1 setvar "ip.pop3.print_body" "value"
```

Values:

- on
- off

Default:

"off"

Getvar

To have the printer return the current setting value:

```
! U1 getvar "ip.pop3.print_body"
```



NOTES:

- For printer support, see [SGD Command Support on page 1455](#).
- For details on SGD command structure, see [Command Structure on page 562](#).

ip.pop3.print_headers

Determines if the email header will be printed when the email is retrieved via POP3. This only applies if ip.pop3.enable is set to "on".

Setvar

To set the command:

```
! U1 setvar "ip.pop3.print_headers" "value"
```

Values:

- on
- off

Default:

"off"

Getvar

To have the printer return the current setting value:

```
! U1 getvar "ip.pop3.print_headers"
```



NOTES:

- For printer support, see [SGD Command Support on page 1455](#).
- For details on SGD command structure, see [Command Structure on page 562](#).

ip.pop3.save_attachments

Determines if the email attachments are to be saved to the flash file system when the email is retrieved via POP3. This only applies if ip.pop3.enable is set to "on".

Setvar

To set the command:

```
! U1 setvar "ip.pop3.save_attachments" "value"
```

Values:

- on
- off

Default:

"on"

Getvar

To have the printer return the current setting value:

```
! U1 getvar "ip.pop3.save_attachments"
```



NOTES:

- For printer support, see [SGD Command Support on page 1455](#).
- For details on SGD command structure, see [Command Structure on page 562](#).

ip.pop3.verbose_headers

Instructs the printer to respond with the POP3 verbose header value.

Setvar

To set the command:

```
! U1 setvar "ip.pop3.verbose_headers" "value"
```

Values:

- on
- off

Default:

"off"

Getvar

To have the printer return the current setting value:

```
! U1 getvar "ip.pop3.verbose_headers"
```



NOTES:

- For printer support, see [SGD Command Support on page 1455](#).
- For details on SGD command structure, see [Command Structure on page 562](#).

ip.tls.enable

Enables the TLS connections to the encrypted channels on the printer specified by `ip.tls.port` and `ip.tls.port_json_config`.

Setvar

To set the command:

```
! U1 setvar "ip.tls.enable" "value"
```

Values:

- on
- off

Default:

"on"

Getvar

To have the printer return the current setting value:

```
! U1 getvar "ip.tls.enable"
```

Example

This example disables the TLS port.

```
! U1 setvar "ip.tls.enable" "off"
```



NOTES:

- For printer support, see [SGD Command Support on page 1455](#).
- For details on SGD command structure, see [Command Structure on page 562](#).

ip.tls.port

Sets the port number to which encrypted connections can be made to communicate with the printing channel.

Setvar

To set the command:

```
! U1 setvar "ip.tls.port" "value"
```

Values:

Any valid https port from 0-65535.

Default:

"9143"

Getvar

To have the printer return the current setting value:

```
! U1 getvar "ip.tls.port"
```



NOTES:

- For printer support, see [SGD Command Support on page 1455](#).
- For details on SGD command structure, see [Command Structure on page 562](#).

ip.tls.port_json_config

Sets the port number used to create an encrypted connection to the JSON configuration channel.

Setvar

To set the command:

```
! U1 setvar "ip.tls.port_json_config" "value"
```

Values:

Any valid https port from 0-65535.

Default:

```
"9243"
```

Getvar

To have the printer return the current setting value:

```
! U1 getvar "ip.tls.port_json_config"
```



NOTES:

- For printer support, see [SGD Command Support on page 1455](#).
- For details on SGD command structure, see [Command Structure on page 562](#).

log.reboot.code

Causes the printer to return a one-character value which indicates the reason for the last printer reboot.

Getvar

To return a one-character value which indicates the reason for the last printer reboot:

```
! U1 getvar "log.reboot.code"
```

Result

A one-character code indicating the reason for the reboot.

Values

- "0" - Other
- "1" - device.reset command
- "2" - Mirror reset – new files
- "3" - DTR off
- "4" - Low-battery timeout
- "5" - Low-battery shutdown
- "6" - power.shutdown command
- "7" - Idle timeout
- "8" - Printer OS update
- "9" - Reserved
- "a" - Reserved
- "b" - Off key
- "f" - No data

Example

```
! U1 getvar "log.reboot.code"
```

4

The result indicates that the device rebooted because the battery timed out.



NOTES:

- For printer support, see [SGD Command Support on page 1455](#).
- For details on SGD command structure, see [Command Structure on page 562](#).

log.reboot.codes

Causes the printer to return a list of one-character values which indicates the reasons for the last 32 printer reboots.

Getvar

To return with the reboot codes:

```
! U1 getvar "log.reboot.codes"
```

Result

A string of one-character codes indicating the reason for the reboots. A total of 32 reboot events are stored; if less than 32 reboots have occurred, "f" is stored in any unpopulated event slot, indicating **"no data"** for that event.

Values

- "0" - Other
- "1" - device.reset command
- "2" - Mirror reset – new files
- "3" - DTR off
- "4" - Low-battery timeout
- "5" - Low-battery shutdown
- "6" - power.shutdown command
- "7" - Idle timeout
- "8" - Printer OS update
- "9" - Reserved
- "a" - Reserved
- "b" - Power Switch / Off Key
- "f" - No data

Example

```
! U1 getvar "log.reboot.codes"
"bb338bbbbbbbbb3bbbbbbbbb1bb"
```



NOTES:

- For printer support, see [SGD Command Support on page 1455](#).
- For details on SGD command structure, see [Command Structure on page 562](#).

log.reboot.reason

Returns the reason for the last printer reboot, based on the `log.reboot.code`.

Getvar

To return the reason for the last printer reboot, based on the `log.reboot.code`:

```
! U1 getvar "log.reboot.reason"
```

Result

The reason for the last reboot.

Values

"Other"
 "device.reset command"
 "Mirror reset – new files"
 "DTR off"
 "Low-battery timeout"
 "Low-battery shutdown"
 "power.shutdown command"
 "Idle timeout"
 "New OS reprogramming"
 "Unknown-1"
 "Unknown-2"
 "Off key"
 "No data"



NOTES:

- For printer support, see [SGD Command Support on page 1455](#).
- For details on SGD command structure, see [Command Structure on page 562](#).

log.reboot.report

Causes the printer to return a list of values which indicate the reasons for the last 32 printer reboots.

Getvar

To return a list of values which indicate the reasons for the last 32 printer reboots:

```
! U1 getvar "log.reboot.report"
```

Result

The recorded reboot reasons as a list, starting with the most recent reboot reason first. A total of 32 reboot events are stored; if less than 32 reboots have occurred, "f" is stored in any unpopulated event slot, indicating "no data" for that event.

Values

```
"Other"
"device.reset command"
"Mirror reset - new files"
"DTR off"
"Low-battery timeout"
"Low-battery shutdown"
"power.shutdown command"
"Idle timeout"
"New OS reprogramming"
"Unknown-1"
"Unknown-2"
"Off key"
"No data"
```

Example

```
! U1 getvar "log.reboot.report"
```

A list of 32 codes, in a carriage-return delimited list:

```
"Off key
Off key
Off key
.
.
.
No data
"
```



NOTES:

- For printer support, see [SGD Command Support on page 1455](#).
- For details on SGD command structure, see [Command Structure on page 562](#).

mcr.crypt.enabled

Retrieves the MCR encryption-enabled status.

Getvar

To retrieve the MCR encryption-enabled status:

```
! U1 getvar "mcr.crypt.enabled"
```

Values

"off" = mcr encryption is not enabled

"on" = mcr encryption is enabled



NOTES:

- For printer support, see [SGD Command Support on page 1455](#).
- For details on SGD command structure, see [Command Structure on page 562](#).

mcr.cancel

Cancels the magnetic card read operation currently in progress.

Setvar

To cancel the magnetic card read operation currently in progress:

```
! U1 setvar "mcr.cancel" ""
```

Values

No value needs to be specified.

Default

NA



NOTES:

- For printer support, see [SGD Command Support on page 1455](#).
- For details on SGD command structure, see [Command Structure on page 562](#).

mcr.crypt.key_mgmt

Retrieves the MCR encryption key management algorithm for a fixed key or DUKPT (Derived Unique Key Per Transaction). The return value applies only if "mcr.crypt.enabled" is "on".

Getvar

To retrieve the MCR encryption key management algorithm for a fixed key or DUKPT:

```
! U1 getvar "mcr.crypt.key_mgmt"
```

Values

"" = fixed key algorithm

"dukpt" = derived unique key per transaction

Default

N/A



NOTES:

- For printer support, see [SGD Command Support on page 1455](#).
- For details on SGD command structure, see [Command Structure on page 562](#).

mcr.crypt.algorithm

Retrieves the MCR encryption algorithm. The return value applies only if "mcr.crypt.enabled" is "on".

Getvar

To retrieve the MCR encryption algorithm:

```
! U1 getvar "mcr.crypt.algorithm"
```

Values

```
""  
"3des"  
"aes"
```

Default

N/A



NOTES:

- For printer support, see [SGD Command Support on page 1455](#).
- For details on SGD command structure, see [Command Structure on page 562](#).

mcr.out

Specifies the communication port which MCR (Mag Card Reader) output is sent to.

Setvar

To specify the communication port which MCR (Mag Card Reader) output is sent to:

```
! U1 setvar "mcr.out" "value"
```

Values

"active" = the data is sent out over the same port that the command was received on.

If "multiple" is specified in the option string of the `mcr.enable` command, data will continue to be sent to the port defined by this command.

"alert" = the data will be forwarded as a weblink alert.

Default

"active"



NOTES:

- For printer support, see [SGD Command Support on page 1455](#).
- For details on SGD command structure, see [Command Structure on page 562](#).

mcr.revision

Returns the revision of the MCR (magnetic card reader).

Getvar

To return the revision of the MCR (magnetic card reader):

```
! U1 getvar "mcr.revision"
```

Result

```
"ID TECH TM3 SecureHead RS232 Reader V 5.14"
```



NOTES:

- For printer support, see [SGD Command Support on page 1455](#).
- For details on SGD command structure, see [Command Structure on page 562](#).

media.bar_location

Allows the user to configure the printer to look for a black mark bar on the front or back of the media.



Setvar

NOTE: This command works only with printers that have a front media sensor.

To configure the printer's black bar location:

```
! U1 setvar "media.bar_location" "value"
```

Values

- front = use media with bars on the front.
- back = use media with bars on the back

Options available by printer:

iMZ220, iMZ320, QLn220, QLn320, QLn420, ZR318, ZR328 = **"front"**

ZQ310, ZQ320, ZQ510, ZQ520 = **"front"**, **"back"**

All other printers = **"back"**

Default

- iMZ220, iMZ320, QLn220, QLn320, QLn420, ZR318, ZR328 = **"front"**
- ZQ310, ZQ320 with optional back bar sensor = **"back"**
- ZQ310, ZQ320 with no back bar sensor = **"front"**

All other printers = **"back"**

Getvar

To return the current setting value:

```
! U1 getvar "media.bar_location"
```



NOTES:

- For printer support, see [SGD Command Support on page 1455](#).
- For details on SGD command structure, see [Command Structure on page 562](#).

media.cartridge.darkness

This command returns the recommended print darkness setting to be used with the media cartridge currently installed in the printer.

Getvar

To return the recommended print darkness setting for the printer:

```
! U1 getvar "media.cartridge.darkness"
```

Result

"0" to "300"

"0"= no cartridge installed



NOTES:

- For printer support, see [SGD Command Support on page 1455](#).
- For details on SGD command structure, see [Command Structure on page 562](#).

media.cartridge.labels_remaining

This command returns the number of labels which remain in the cartridge.

Getvar

To return the number of remaining labels:

```
! U1 getvar "media.cartridge.labels_remaining"
```

Result

An integer ≥ 0 .

"no" = cartridge is not inserted or printer does not support this command.

Example

In this example, the getvar returns the number of print labels that is remaining in the cartridge.

```
! U1 getvar "media.cartridge.labels_remaining" "10"
```



NOTE:

- For printer support, see [SGD Command Support on page 1455](#).
- For details on SGD command structure, see [Command Structure on page 562](#).

media.cartridge.width

This command returns the width of the media cartridge installed in the printer.

Getvar

To fetch the width of the media cartridge:

```
! U1 getvar "media.cartridge.width"
```

Result

A numeric value specified in dots.

"0"= cartridge not installed

Example

In the example below, the getvar returns with the width of the media cartridge in dots.

```
! U1 getvar "media.cartridge.width" "300"
```



NOTES:

- For printer support, see [SGD Command Support on page 1455](#).
- For details on SGD command structure, see [Command Structure on page 562](#).

media.cartridge.total_label_cnt

This command returns the total number of labels that is initially available in the cartridge.

Getvar

To return the total number of labels initially available in the cartridge:

```
! U1 getvar "media.cartridge.total_label_cnt"
```

Result

The value depends on the length of the label and other factors. It typically ranges from 100-300 labels.

"0"= cartridge not installed

Example

In this example, the getvar returns with the total label count available in the cartridge.

```
! U1 getvar "media.cartridge.total_label_cnt" "100"
```



NOTES:

- For printer support, see [SGD Command Support on page 1455](#).
- For details on SGD command structure, see [Command Structure on page 562](#).

media.cartridge.speed

This command fetches the print speed for the media cartridge.

Getvar

To get the print speed for the cartridge:

```
! U1 getvar "media.cartridge.speed"
```

Result

"0" = cartridge not installed

"2"

"4"

Currently, the only cartridge speeds supported are "2" and "4".



NOTES:

- For printer support, see [SGD Command Support on page 1455](#).
- For details on SGD command structure, see [Command Structure on page 562](#).

media.cartridge.length

This command fetches the initial label length of the media cartridge installed in the printer.

Getvar

To fetch the length of the media cartridge:

```
! U1 getvar "media.cartridge.length"
```

Result

A numeric value specified in dots.

"0" = no cartridge installed

Example

In the example below, the getvar returns with the width of the media cartridge in dots.

```
! U1 getvar "media.cartridge.length" "300"
```



NOTES:

- For printer support, see [SGD Command Support on page 1455](#).
- For details on SGD command structure, see [Command Structure on page 562](#).

media.cartridge.inserted

This command verifies if the media cartridge is inserted or not.

Getvar

To view if the media cartridge is inserted or not

```
! U1 getvar "media.cartridge.inserted"
```

Result

```
"yes" = cartridge is inserted  
"no"  = cartridge is not inserted  
      =
```

Example

In this example, the getvar returns with the information that the media cartridge is inserted.

```
! U1 getvar "media.cartridge.inserted" "yes"
```



NOTES:

- For printer support, see [SGD Command Support on page 1455](#).
- For details on SGD command structure, see [Command Structure on page 562](#).

media.cartridge.part_number

This command returns the part number of the media cartridge installed in the printer.

Getvar

To get the part number of the media cartridge:

```
! U1 getvar "media.cartridge.part_number"
```

Result

0 to 16 character string

"" = no cartridge installed

Example

In this example, the getvar returns with the part number of the media cartridge.

```
! U1 getvar "media.cartridge.part_number" "100127132K"
```



NOTES:

- For printer support, see [SGD Command Support on page 1455](#).
- For details on SGD command structure, see [Command Structure on page 562](#).

media.cut_now

This command instructs the printer cycle the media cutter. If the printer is in Print Mode Kiosk (media.printmode "K") then the cutter will execute a cut based on the value of media.present.cut_amount – either a normal cut or a partial cut. If the printer is not in Print Mode Kiosk (media.printmode "K"), this command does nothing. See [media.present.cut_amount on page 826](#).

Setvar

To instruct the printer to cycle the media cutter:

```
! U1 setvar "media.cut_now" ""
```



NOTE: See [media.present.cut_amount on page 826](#).

Do

To instruct the printer to cycle the media cutter:

```
! U1 do "media.cut_now" ""
```



NOTES:

- For printer support, see [SGD Command Support on page 1455](#).
- For details on SGD command structure, see [Command Structure on page 562](#).

media.darkness_mode

This command instructs the printer to set the darkness mode.

Setvar

To set the darkness mode:

```
! U1 setvar "media.darkness_mode" "value"
```

Values

- "cartridge" = cartridge mode (no changes allowed)
- "user" = user mode (Darkness is set by the user, and the cartridge value is ignored. This value is used for all cartridges inserted in the printer).
- "relative" = relative mode (the specified darkness value is added to the cartridge default value)

Default

"cartridge"

Example

This setvar example shows the darkness mode set to "cartridge".

```
! U1 setvar "media.darkness_mode" "cartridge"
```



NOTES:

- For printer support, see [SGD Command Support on page 1455](#).
- For details on SGD command structure, see [Command Structure on page 562](#).

media.draft_mode

This command puts the printer into draft mode setting.



NOTE:

Setting the printer to draft mode may result in poorer print quality depending on print speed, label configurations, etc.

Setvar

To set the value:

```
! U1 setvar "media.draft_mode" "value"
```

Values

enabled = faster ramp (acceleration) speed

disabled = normal ramp (acceleration) speed

Default

disabled

Getvar

To respond with the currently set value:

```
! U1 getvar "media.draft_mode"
```



NOTES:

- For printer support, see [SGD Command Support on page 1455](#).
- For details on SGD command structure, see [Command Structure on page 562](#).

media.dynamic_length_calibration

This command enables or disables the dynamic length calibration. This is identical to the first parameter of the ^XS command - Dynamic Length Calibration.

Setvar

To enable or disable the dynamic length calibration:

```
U1 setvar "media.dynamic_length_calibration" "value"
```

Values

"on" = dynamic length calibration is enabled.

"off" = dynamic length calibration is disabled.

Default Value

- "on" = ZDxxx printers
- "off" = ZTxxx printers

Getvar

To return the current setting:

```
! U1 getvar "media.dynamic_length_calibration"
```

Example

In this example, the getvar returns the current setting of the dynamic length calibration.

```
U1 setvar "media.dynamic_length_calibration" "on"
```



NOTES:

- For printer support, see [SGD Command Support on page 1455](#).
- For details on SGD command structure, see [Command Structure on page 562](#).

media.feed_skip

This command only applies to labels created with CPCL commands. It controls the same setting as the second parameter of the CPCL SETFF command.

Setvar

To set the printer's feed skip length:

```
! U1 setvar "media.feed_skip" "value"
```

Values

a numeric value from 0 to 50

Default

5 - for QLn and ZQ series printers

35 - for iMZ and ZR series printers

Getvar

To return the current setting value:

```
! U1 getvar "media.feed_skip"
```

Result

a numeric value from 0 to 50.



NOTES:

- For printer support, see [SGD Command Support on page 1455](#).
- For details on SGD command structure, see [Command Structure on page 562](#).

media.media_low.external

This printer setting gets the status of the external media_low warning. For printer support, see [SGD Command Support on page 1455](#).

Getvar

To instruct the printer to respond with the currently set media print mode:

```
! U1 getvar "media.media_low.external"
```

Values

0 = Paper present at sensor position

1 = No paper present



NOTES:

- The status of the sensor is sampled every time the printout is cut. If three succeeding samples show "no paper", the status reply changes to 1. This is to prevent a false alarm if the side of the paper roll is not clean. If the current status of the sensor is required, use `~HQES` and extract the paper near-end sensor bit.
- For details on SGD command structure, see [Command Structure on page 562](#).

media.media_low.warning

This command retrieves the value of, or enables or disables the Supplies Warning system. For printer support, see [SGD Command Support on page 1455](#).

Setvar

To enable or disable the Supplies Warning System:

```
! U1 setvar "media.media_low.warning" "value"
```

Values

"disabled" = not active

"enabled" = active

Default

"disabled"

Getvar

To retrieve the setting for the Supplies Warning system:

```
! U1 getvar "media.media_low.warning"
```

Example

This `setvar` example disables the Supplies Warning system.

```
! U1 setvar "media.media_low.warning" "disabled"
```

This `setvar` example enables the Supplies Warning system.

```
! U1 setvar "media.media_low.warning" "enabled"
```



NOTES:

For details on SGD command structure, see [Command Structure on page 562](#).

media.part_number

Sets the media's part number.

Setvar

To set the media's part number:

```
! U1 setvar "media.part_number" "value"
```

Values

an alpha-numeric string between 0 and 64 characters

Default

NA

Example

```
! U1 setvar "media.part_number" "123AB987"
```

Getvar

To return the current setting value:

```
! U1 getvar "media.part_number"
```

Result

```
"123AB987"
```



NOTES:

- For printer support, see [SGD Command Support on page 1455](#).
- For details on SGD command structure, see [Command Structure on page 562](#).

media.present.cut_amount

This printer setting determines the type of cut made by the printer cutter (normal or partial) and, if partial, the length of the partial cut on each side, in mm.

Setvar

To instruct the printer to change the media cut amount:

```
! U1 setvar "media.present.cut_amount" "value"
```

Values

0 = normal cut

10-60 = partial cut, value = mm of media left uncut

Getvar

To respond with the currently set media cut amount:

```
! U1 getvar "media.present.cut_amount"
```



NOTES:

- For details on SGD command structure, see [Command Structure on page 562](#).
- For printer support, see [SGD Command Support on page 1455](#).

media.present.eject

This command instructs the printer to eject the document through the presenter module. The value is the amount to eject, in mm. The value of [media.present.length_addition](#) gets added to the value to determine the total length of media ejected.

Command	Details
<ul style="list-style-type: none"> setvar 	<p>This command instructs the printer to eject the document through the presenter module.</p> <p>Format: <code>! U1 setvar "media.present.eject" "value"</code></p> <p>Values: 0 - 255 = amount of media to eject in mm</p> <p> NOTE: See media.present.length_addition on page 828.</p>
<ul style="list-style-type: none"> do 	<p>This command instructs the printer to eject the document through the presenter module.</p> <p>Format: <code>! U1 do "media.present.eject" "value"</code></p>



NOTES:

- For printer support, see [SGD Command Support on page 1455](#).
- For details on SGD command structure, see [Command Structure on page 562](#).

media.present.length_addition

This printer setting adds an additional amount to how far the paper is ejected during a present cycle. A standard amount of 50mm is always added to clear the kiosk wall. This amount is added to that 50mm. The total amount of media ejected this command is executed, then, is 50mm + media.present.length_addition + media.present.eject.

Command	Details
<ul style="list-style-type: none"> setvar 	<p>This command instructs the printer to change the media present length addition.</p> <p>Format: ! U1 setvar "media.present.length_addition" "value"</p> <p>Values: 0-255 = additional mm of media to eject</p>
<ul style="list-style-type: none"> getvar 	<p>This command instructs the printer to respond with the currently set media present length addition.</p> <p>Format: ! U1 getvar "media.present.length_addition"</p>



NOTES:

- For printer support, see [SGD Command Support on page 1455](#).
- For details on SGD command structure, see [Command Structure on page 562](#).

media.present.loop_length

This printer setting determines the length of the presenter loop. If `loop_length` is greater than `loop_length_max` (see `media.present.loop_length_max`) then it will be set equal to `loop_length_max`. For printer support, see [SGD Command Support on page 1455](#).

Command	Details
<ul style="list-style-type: none"> • <code>setvar</code> 	<p>This command instructs the printer to change the presenter loop length.</p> <p>Format:</p> <pre>! U1 setvar "media.present.loop_length" "value"</pre> <p>Values:</p> <p>0 = paper is fed straight through the presenter</p> <p>3-1023 = loop length in mm.</p> <p>Default:</p> <p>400 = gives a loop of approximately 400mm</p>
<ul style="list-style-type: none"> • <code>getvar</code> 	<p>This command instructs the printer to respond with the currently set presenter loop length.</p> <p>Format: <code>! U1 getvar "media.present.loop_length"</code></p>



NOTES:

For details on SGD command structure, see [Command Structure on page 562](#).

media.present.loop_length_max

This printer setting determines the maximum allowed length of the presenter loop.

Command	Details
setvar	<p>This command instructs the printer to change the presenter loop length.</p> <p>Format:</p> <pre>! U1 setvar "media.present.loop_length_max" "value"</pre> <p>Values:</p> <p>0 = paper is fed straight through the presenter</p> <p>3-1023 = loop length in mm.</p> <p>Default:</p> <p>400 = gives a loop of approximately 400mm</p>
getvar	<p>This command instructs the printer to respond with the currently set presenter loop length.</p> <p>Format:</p> <pre>! U1 getvar "media.present.loop_length_max"</pre>



NOTES:

- For printer support, see [SGD Command Support on page 1455](#).
- For details on SGD command structure, see [Command Structure on page 562](#).

media.present.cut_margin

This printer setting determines the margin between the cutter and the printhead.

Command	Details
<ul style="list-style-type: none"> setvar 	<p>This command instructs the printer to change the media cut amount.</p> <p>Format: ! U1 setvar "media.present.cut_margin" "value"</p> <p>Values: 2 - 9 = mm of distance</p> <p>Default: 9 = mm of distance</p>
<ul style="list-style-type: none"> getvar 	<p>This command instructs the printer to respond with the currently set media cut margin amount.</p> <p>Format: ! U1 getvar "media.present.cut_margin"</p>



NOTES:

- For printer support, see [SGD Command Support on page 1455](#).
- For details on SGD command structure, see [Command Structure on page 562](#).

media.present.present_timeout

This printer setting determines how long the printer will wait after a present event to clear the label. See ^KV ZPL command.

Command	Details
<ul style="list-style-type: none"> setvar 	<p>This command instructs the printer to change the presenter function mode.</p> <p>Format: ! U1 setvar "media.present.present_timeout" "value"</p> <p>Values: 0 - 300 = If label is not taken, retract label when timeout expires. Timeout is in seconds. Zero (0) indicates that there is no timeout. The label will stay presented until removed manually or a new label is printed.</p>
<ul style="list-style-type: none"> getvar 	<p>This command instructs the printer to respond with the currently set presenter function mode.</p> <p>Format: ! U1 getvar "media.present.present_timeout"</p>



NOTES:

- For printer support, see [SGD Command Support on page 1455](#).
- For details on SGD command structure, see [Command Structure on page 562](#).

media.present.present_type

This printer setting determines the way that the printer performs a present command. See ^KV ZPL command.

Command	Details
<ul style="list-style-type: none"> setvar 	<p>This command instructs the printer to change the presenter function mode.</p> <p>Format: ! U1 setvar "media.present.present_type" "value"</p> <p>Values:</p> <ul style="list-style-type: none"> 0 = Eject page when new page is printed 1 = Retract page when new page is printed 2 = Do nothing when new page is printed
<ul style="list-style-type: none"> getvar 	<p>This command instructs the printer to respond with the currently set presenter function mode.</p> <p>Format: ! U1 getvar "media.present.present_type"</p>



NOTES:

- For printer support, see [SGD Command Support on page 1455](#).
- For details on SGD command structure, see [Command Structure on page 562](#).

media.printmode

This printer setting determines the action the printer takes after a label or group of labels has printed. This command is equivalent to [^MM on page 281](#).

Commands	Details
<ul style="list-style-type: none"> setvar 	<p>This command instructs the printer to change the media print mode.</p> <p>Format: <code>! U1 setvar "media.printmode" "value"</code></p> <p>Values:</p> <p>"T" = Tear-off ^f</p> <p>"P" = Peel-off (not available on S-300) ^{f, g}</p> <p>"R" = Rewind (depends on printer model)</p> <p>"A" = Applicator (depends on printer model) ^f</p> <p>"C" = Cutter (depends on printer model) ^g</p> <p>"D" = Delayed cutter ^{f, g}</p> <p>"F" = RFID ^{f, g}</p> <p>"L" = Linerless Peel ^{g, h}</p> <p>"U" = Linerless Rewind ^{g, h}</p> <p>"K" = Kiosk ⁱ</p> <p>"V" = Linerless Tear ^g</p> <p>"S" = Stream ^j</p>
<ul style="list-style-type: none"> getvar 	<p>This command instructs the printer to respond with the the currently set media print mode.</p> <p>Format: <code>! U1 getvar "media.printmode"</code></p>
<p>f. This value is not supported on the KR403 printer.</p> <p>g. This value is not supported on tthe ZE500 printer.</p> <p>h. This value is supported only on the ZM400/ZM600 and RZ400/RZ600 printers.</p> <p>i. This value is supported only on the KR403 printer.</p> <p>j. This value is supported only on the ZE500 printer.</p>	

Example

This **setvar** example shows the value set to "T".

```
! U1 setvar "media.printmode" "T"
```

What the **setvar** value is set to is the **getvar** result. In this example, the **getvar** result is "tear off".

For more details on how each **setvar** value relates to the **getvar** responses, see [Table 19 on page 835](#).



NOTES:

- For printer support, see [SGD Command Support on page 1455](#).
- For details on SGD command structure, see [Command Structure on page 562](#).

Table 19 Setvar / Getvar Relation

If the setvar is set to ...	Then the getvar response and control panel display is ...
"T"	TEAR OFF
"p"	PEEL OFF
"R"	REWIND
"A"	APPLICATOR
"C"	CUTTER
"D"	DELAYED CUT
"L"	RESERVED
"U"	RESERVED
"K"	KIOSK

media.speed

This command specifies media print speed in inches per second (ips).

Commands	Details
<ul style="list-style-type: none"> setvar 	<p>This command instructs the printer to set the media print speed.</p> <p>Format: <code>! U1 setvar "media.speed" "value"</code></p> <p>Values: 2-12 ips</p> <p>"up" = increments the printer speed by one unit</p> <p>"down" = decrements the speed by one unit</p> <p>Default: "2"</p>
<ul style="list-style-type: none"> getvar 	<p>This command retrieves the currently set media print speed.</p> <p>Format: <code>! U1 getvar "media.speed"</code></p>

Example

This **setvar** example shows the value set to "2".

```
! U1 setvar "media.speed" "2"
```

When the **setvar** value is set to "2", the **getvar** result is "2".

This **setvar** example shows the value set to "up".

```
! U1 setvar "media.speed" "up"
```

If the current print speed is 2: When the **setvar** value is set to "up", the **getvar** result is "3".

This **setvar** example shows the value set to "down".

```
! U1 setvar "media.speed" "down"
```

If the current print speed is 2: When the **setvar** value is set to "down", the **getvar** result is "1".



NOTES:

- For printer support, see [SGD Command Support on page 1455](#).
- For details on SGD command structure, see [Command Structure on page 562](#).

media.serial_number

Sets the media's serial number.

Commands	Details
<ul style="list-style-type: none"> setvar 	<p>Format: ! U1 setvar "media.serial_number" "value"</p> <p>Values: an alpha-numeric string between 0 and 64 characters</p> <p>Default: NA</p> <p>! U1 setvar "media.serial_number" "A34567BC6789"</p>
<ul style="list-style-type: none"> getvar 	<p>Format: ! U1 getvar "media.serial_number"</p> <p>Result: "A34567BC6789"</p>



NOTES:

- For printer support, see [SGD Command Support on page 1455](#).
- For details on SGD command structure, see [Command Structure on page 562](#).

memory.flash_free

This parameter returns the amount of available Flash memory.

Commands	Details
• <code>getvar</code>	Format: <code>! U1 getvar "memory.flash_free"</code>



NOTES:

- For printer support, see [SGD Command Support on page 1455](#).
- For details on SGD command structure, see [Command Structure on page 562](#).

memory.flash_size

This parameter returns the total amount of Flash memory.

Getvar

To return the current setting value:

```
! U1 getvar "memory.flash_size"
```



NOTES:

- For printer support, see [SGD Command Support on page 1455](#).
- For details on SGD command structure, see [Command Structure on page 562](#).

memory.ram_free

This parameter returns the amount available Random Access Memory (RAM).

Getvar

To return the current setting value:

```
! U1 getvar "memory.ram_free"
```



NOTES:

- For printer support, see [SGD Command Support on page 1455](#).
- For details on SGD command structure, see [Command Structure on page 562](#).

memory.ram_size

This parameter returns the total amount of Random Access Memory (RAM).

Getvar

To return the RAM size:

```
! U1 getvar "memory.ram_size"
```



NOTES:

- For printer support, see [SGD Command Support on page 1455](#).
- For details on SGD command structure, see [Command Structure on page 562](#).

netmanage.avalanche.agent_addr

This parameter obtains or changes the Network Management agent IP address.

Setvar

To set the Network Management Agent IP address:

```
! U1 setvar "netmanage.avalanche.agent_addr" "value"
```

Values

any valid IP address

Default

```
"0.0.0.0"
```

Getvar

To retrieve the current Network Management IP address:

```
! U1 getvar "netmanage.avalanche.agent_addr"
```

Example

```
! U1 setvar "netmanage.avalanche.agent_addr" "10.14.2.200"
```



NOTES:

- For printer support, see [SGD Command Support on page 1455](#).
- For details on SGD command structure, see [Command Structure on page 562](#).

netmanage.avalanche.available_agent

This command returns the current IP address of the remote agent found during the Agent Discovery Phase.

Getvar

To obtain the IP address of the remote agent found during the Agent Discovery Phase:

```
! U1 getvar "netmanage.avalanche.available_agent"
```

Result

An IP address

Example

```
! U1 getvar "netmanage.avalanche.available_agent"  
"10.3.4.128"
```



NOTES:

- For printer support, see [SGD Command Support on page 1455](#).
- For details on SGD command structure, see [Command Structure on page 562](#).

netmanage.avalanche.available_port

This command returns the available port of the remote agent found during the Agent Discovery Phase.

Setvar

To set the available port of the remote agent found during the Agent Discovery Phase:

```
! U1 setvar "netmanage.avalanche.available_port" "value"
```

Values

"0" to "65535"

Default

"0"

Getvar

To retrieve the current port setting of the remote agent found during the Agent Discovery Phase:

```
! U1 getvar "netmanage.avalanche.available_port"
```

Example

```
U1 setvar "netmanage.avalanche.available_port" "1800"
```



NOTES:

- For printer support, see [SGD Command Support on page 1455](#).
- For details on SGD command structure, see [Command Structure on page 562](#).

netmanage.avalanche.encryption_type

This parameter sets and gets the Network Management Encryption type to be used.

Setvar

To set the Network Management Encryption type to be used:

```
! U1 setvar "netmanage.avalanche.encryption_type" "value"
```

Values

"0" = None

"1" = Limburger

"2" = AES128S

Default

"0"

Getvar

To retrieve the currently set Network Management Encryption type:

```
! U1 getvar "netmanage.avalanche.encryption_type"
```

Example

This example sets the value to Limburger (1) encryption type.

```
! U1 getvar "netmanage.avalanche.encryption_type" "1"
```



NOTES:

- For printer support, see [SGD Command Support on page 1455](#).
- For details on SGD command structure, see [Command Structure on page 562](#).

netmanage.avalanche.interval

This parameter obtains or sets the Network Management Update Interval time stored in the printer. Time is measured in milliseconds (e.g., a setting of "2000" equals 2 seconds).

Setvar

To set the Network Management Update Interval:

```
! U1 setvar "netmanage.avalanche.interval" "value"
```

Values

any integer value from "0" to "4294967295" (*4,294,967,295 milliseconds*)

Default

"0"

Getvar

To retrieve the current Network Management Update Interval:

```
! U1 getvar "netmanage.avalanche.interval"
```

Example

This example sets the interval value to 3 seconds.

```
! U1 setvar "netmanage.avalanche.interval" "3000"
```



NOTES:

- For printer support, see [SGD Command Support on page 1455](#).
- For details on SGD command structure, see [Command Structure on page 562](#).

netmanage.avalanche.interval_update

This parameter turns on or off the Network Management Update Interval. This command is related to [netmanage.avalanche.interval](#) on page 846.

Setvar

To turn on or off the network management interval update:

```
! U1 setvar "netmanage.avalanche.interval_update" "value"
```

Values

"off"

"on"

Default

"off"

Getvar

To retrieve the current network management interval update setting:

```
! U1 getvar "netmanage.avalanche.interval_update"
```

Example

This example sets the device's Network Management Interval Update setting to "on".

```
! U1 setvar "netmanage.avalanche.interval_update" "on"
```



NOTES:

- For printer support, see [SGD Command Support](#) on page 1455.
- For details on SGD command structure, see [Command Structure](#) on page 562.

netmanage.avalanche.model_name

This command obtains or sets the current Network Management Device Model Name stored in the printer.

Setvar

To set the current Network Management Device model name:

```
! U1 setvar "netmanage.avalanche.model_name" "value"
```

Values

a string up to 31 characters in length.

Default

NA

Getvar

To retrieve the current Network Management Device model name:

```
! U1 getvar "netmanage.avalanche.model_name"
```

Example

```
! U1 setvar "netmanage.avalanche.model_name" "ZT230"
```



NOTES:

- For printer support, see [SGD Command Support on page 1455](#).
- For details on SGD command structure, see [Command Structure on page 562](#).

netmanage.avalanche.set_property

This parameter sets Network Management Device Side Property (custom).

Setvar

To set the Network Management Device Side Property (custom):

```
! U1 setvar "netmanage.avalanche.set_property" "value"
```

Values

A string in the format of "AAAA=XXXXXXXX"

Getvar

To retrieve the current Network Management Device Side Property value:

```
! U1 getvar "netmanage.avalanche.set_property"
```

Example

This example will be viewed as a property under the general property tree in avalanche console.

```
! U1 setvar netmanage.avalanche.set_property" "ZebraLocation=VH"
```

This example will be viewed as a property under the Zebra tree in avalanche console.

```
! U1 setvar netmanage.avalanche.set_property" "Zebra.Location=VH"
```



NOTES:

- For printer support, see [SGD Command Support on page 1455](#).
- For details on SGD command structure, see [Command Structure on page 562](#).

netmanage.avalanche.startup_update

This parameter sets and retrieves the Network Management Start Up Update setting.

Setvar

To set the device's Network Management Start Up Update setting:

```
! U1 setvar "netmanage.avalanche.startup_update" "value"
```

Values

"off"

"on"

Default

"off"

Getvar

To retrieve the device's current Network Management Start Up Update setting:

```
! U1 getvar "netmanage.avalanche.startup_update"
```

Example

```
! U1 setvar "netmanage.avalanche.startup_update" "on"
```



NOTES:

- For printer support, see [SGD Command Support on page 1455](#).
- For details on SGD command structure, see [Command Structure on page 562](#).

netmanage.avalanche.tcp_connection_timeout

This command sets the Network Management Timeout used for establishing a TCP connection to an Agent. Time is set in milliseconds.

Setvar

To set the Network Management Timeout used for establishing a TCP connection to an Agent:

```
! U1 setvar "netmanage.avalanche.tcp_connection_timeout" "value"
```

Values

any integer value from "0" to "4294967295" (*4,294,967,295 milliseconds*)

Default

"0"

Getvar

To retrieve the current Network Management Timeout used for establishing a TCP connection to an Agent:

```
! U1 getvar "netmanage.avalanche.tcp_connection_timeout"
```

Values

any integer value from "0" to "4294967295" (*4,294,967,295 milliseconds*)

Default

"0"

Getvar

To retrieve the current Network Management Timeout used for establishing a TCP connection to an Agent:

```
! U1 getvar "netmanage.avalanche.tcp_connection_timeout"
```

Example

This examples sets the connection timeout to 2000 milliseconds (2 seconds).

```
! U1 setvar "netmanage.avalanche.tcp_connection_timeout" "2000"
```



NOTES:

- For printer support, see [SGD Command Support on page 1455](#).
- For details on SGD command structure, see [Command Structure on page 562](#).

netmanage.avalanche.terminal_id

Sets or retrieves the Terminal ID of the Avalanche server. This value is typically assigned by the Avalanche server.

Setvar

To set the Terminal ID of the Avalanche server:

```
! U1 setvar "netmanage.avalanche.terminal_id" "value"
```

Values

```
"0" - "402653183"
```

Default

```
"0"
```

Getvar

To return the current setting value:

```
! U1 getvar "netmanage.avalanche.terminal_id"
```



NOTES:

- For printer support, see [SGD Command Support on page 1455](#).
- For details on SGD command structure, see [Command Structure on page 562](#).

netmanage.avalanche.text_msg.beep

This parameter sets and gets Network Management Text Message Beep enable setting.

Setvar

To set the Network Management Text Message Beep enable setting:

```
! U1 setvar "netmanage.avalanche.text_msg.beep" "value"
```

Values

"off"

"on"

Default

"off"

Getvar

To retrieve the Network Management Text Message Beep enable setting:

```
! U1 getvar "netmanage.avalanche.text_msg.beep"
```

Example

```
! U1 setvar "netmanage.avalanche.text_msg.beep" "on"
```



NOTES:

- For printer support, see [SGD Command Support on page 1455](#).
- For details on SGD command structure, see [Command Structure on page 562](#).

netmanage.avalanche.text_msg.display

This command turns on and off the Network Management Text Message Display setting.

Setvar

To retrieve the device's Network Management Text Message Display enable setting:

```
! U1 setvar "netmanage.avalanche.text_msg.display" "value"
```

Values

"off"

"on"

Default

"off"

Getvar

To return the current Network Management Text Message Display enable setting:

```
! U1 getvar "netmanage.avalanche.text_msg.display"
```

Example

```
! U1 setvar "netmanage.avalanche.text_msg.display" "on"
```



NOTES:

- For printer support, see [SGD Command Support on page 1455](#).
- For details on SGD command structure, see [Command Structure on page 562](#).

netmanage.avalanche.text_msg.print

This command turns on and off the Network Management Text Message Print setting.

Setvar

To set the device's Network Management Text Message Print enable setting:

```
! U1 setvar "netmanage.avalanche.text_msg.print" "value"
```

Values

"off"

"on"

Default

"off"

Getvar

To return the current Network Management Text Message Print enable setting:

```
! U1 getvar "netmanage.avalanche.text_msg.print"
```

Example

```
! U1 setvar "netmanage.avalanche.text_msg.print" "on"
```



NOTES:

- For printer support, see [SGD Command Support on page 1455](#).
- For details on SGD command structure, see [Command Structure on page 562](#).

netmanage.avalanche.udp_timeout

This command sets the device's Network Management UDP timeout. Time is set in milliseconds.

Setvar

To set the device's Network Management UDP timeout:

```
! U1 setvar "netmanage.avalanche.udp_timeout" "value"
```

Values

any integer value from "0" to "4294967295" (*4,294,967,295 milliseconds*)

Default

"0"

Getvar

To return the current Network Management UDP timeout setting:

```
! U1 getvar "netmanage.avalanche.udp_timeout"
```

Example

This example sets the timeout value to .4 seconds (400 milliseconds).

```
! U1 setvar "netmanage.avalanche.udp_timeout" "400"
```



NOTES:

- For printer support, see [SGD Command Support on page 1455](#).
- For details on SGD command structure, see [Command Structure on page 562](#).

netmanage.error_code

This parameter refers to Avalanche client error code.

Getvar

To return the current setting value:

```
! U1 getvar "netmanage.error_code"
```

Result

"0"



NOTES:

- For printer support, see [SGD Command Support on page 1455](#).
- For details on SGD command structure, see [Command Structure on page 562](#).

netmanage.state_code

This parameter refers to Avalanche client state code.

Getvar

To return the Avalanche client state code:

```
! U1 getvar "netmanage.state_code"
```

Result

```
"0"
```



NOTES:

- For printer support, see [SGD Command Support on page 1455](#).
- For details on SGD command structure, see [Command Structure on page 562](#).

netmanage.status_code

This parameter refers to Avalanche client status code.

Getvar

To return the Avalanche client status code:

```
! U1 getvar "netmanage.status_code"
```

Result

"0"



NOTES:

- For printer support, see [SGD Command Support on page 1455](#).
- For details on SGD command structure, see [Command Structure on page 562](#).

odometer.cut_marker_count

Returns the number of cuts incurred by the cutter or resets the counter to "0". This command tracks the same events as [odometer.total_cuts](#), which cannot be reset.

Setvar

To set the number of cuts incurred by the cutter:

```
! U1 setvar "odometer.cut_marker_count" "value"
```

Values

"0" - resets the counter to 0

Getvar

To return the current setting value:

```
! U1 getvar "odometer.cut_marker_count"
```

Result

an integer value of "0" or greater.



NOTES:

- For printer support, see [SGD Command Support on page 1455](#).
- For details on SGD command structure, see [Command Structure on page 562](#).

odometer.headclean

This printer setting refers to the head clean odometer count. This counter tracks how many inches and centimeters have passed through the printer since the head was last cleaned.

Setvar

To reset the head clean counter:

```
! U1 setvar "odometer.headclean" "value"
```

Values

"0" = reset the head clean counter

Default

must be an accepted value or it is ignored

Getvar

To retrieve the values for the head clean counter:

```
! U1 getvar "odometer.headclean"
```

Example

This example shows how to get the odometer head clean, how to reset it, and how to confirm the settings changed.

To see the current settings, type:

```
! U1 getvar "odometer.headclean"
```

Something similar to this is shown:

```
"1489 INCHES, 3784 CENTIMETERS"
```

To reset the these values to 0, type:

```
! U1 setvar "odometer.headclean" "0"
```

To confirm this settings were reset, type:

```
! U1 getvar "odometer.headclean"
```

If the resetting was successful, this is shown:

```
"0 INCHES, 0 CENTIMETERS"
```



NOTES:

- For printer support, see [SGD Command Support on page 1455](#).
- For details on SGD command structure, see [Command Structure on page 562](#).

odometer.headnew

This printer setting refers to the head replaced odometer count. This counter tracks how many inches and centimeter passed through the printer since the head was last replaced.

Setvar

To instruct the printer to reset the head new counter:

```
! U1 setvar "odometer.headnew" "value"
```

Values

"0" = resets the head new counter

Default

must be an accepted value or it is ignored

Getvar

To instruct the printer to retrieve the values for the head new counter:

```
! U1 getvar "odometer.headnew"
```

Example

This example shows how to get the odometer head new, how to reset it, and how to confirm the settings changed:

To see the current settings, type:

```
! U1 getvar "odometer.headnew"
```

Something similar to this is shown:

```
"1489 INCHES, 3784 CENTIMETERS"
```

To reset the these values to 0, type:

```
! U1 setvar "odometer.headnew" "0"
```

To confirm this settings were reset, type:

```
! U1 getvar "odometer.headnew"
```

If the resetting was successful, this is shown:

```
"0 INCHES, 0 CENTIMETERS"
```



NOTES:

- For printer support, see [SGD Command Support on page 1455](#).
- For details on SGD command structure, see [Command Structure on page 562](#).

odometer.label_dot_length

This command returns the length of the last label printed or fed (in dots).

Getvar

To return the length of the last label printed or fed (in dots):

```
! U1 getvar "odometer.label_dot_length"
```

Example

This is an example of how to reset the length using the ^LL command and how to use the getvar to confirm the change. For the ^LL command to work the printer must be in continuous mode.

To change the odometer label dot length, type:

```
^XA
```

```
^LL500
```

```
^XZ
```

To get the current odometer label dot length, type:

```
! U1 getvar "odometer.label_dot_length"
```

Something similar to this is shown:

```
"500"
```



NOTES:

- For printer support, see [SGD Command Support on page 1455](#).
- For details on SGD command structure, see [Command Structure on page 562](#).

odometer.media_marker_count

This command refers to the non-resettable media marker count. The media marker counter keeps track of how many labels have passed through the printer by counting the bar sense marks on the back of the media or the gap in gap media. Labels are counted whether or not they have been printed.

Setvar

To set the non-resettable media marker count:

```
! U1 setvar "odometer.media_marker_count" "value"
```

Values

"0" to "4294967295"

Default

"0"

Getvar

To return the current setting value:

```
! U1 getvar "odometer.media_marker_count"
```

Result

"105"



NOTES:

- For printer support, see [SGD Command Support on page 1455](#).
- For details on SGD command structure, see [Command Structure on page 562](#).

odometer.media_marker_count1

This printer setting refers to the value of the first (count1) user resettable counter. The user resettable counters track how much media has passed through the printer in both inches or centimeters.

Setvar

To reset the first user resettable counter:

```
! U1 setvar "odometer.media_marker_count1" "value"
```

Values

"0" = reset the counter

Default

must be an accepted value or it is ignored

Getvar

To return the current value of the first (count1) user resettable counter in both inches and centimeters:

```
! U1 getvar "odometer.media_marker_count1"
```

Example

This example shows how to get the first user resettable counter, how to reset it, and how to confirm the settings have changed:

To see the current settings, type:

```
! U1 getvar "odometer.media_marker_count1"
```

Something similar to this is shown:

```
"8516 INCHES, 21632 CENTIMETERS"
```

To reset the these values to 0, type:

```
! U1 setvar "odometer.media_marker_count1" "0"
```

To confirm these settings were reset, type:

```
! U1 getvar "odometer.media_marker_count1"
```

If the resetting was successful, this is shown:

```
"0 INCHES, 0 CENTIMETERS"
```



NOTES:

- For printer support, see [SGD Command Support on page 1455](#).
- For details on SGD command structure, see [Command Structure on page 562](#).

odometer.media_marker_count2

This printer setting refers to the value of the second (count2) user resettable counter. The user resettable counters track how much media has passed through the printer in both inches or centimeters.

Setvar

To reset the second user resettable counter:

```
! U1 setvar "odometer.media_marker_count2" "value"
```

Values

"0" = reset the counter

Default

must be an accepted value or it is ignored

Getvar

To return the current value of the second (count2) user resettable counter in both inches and centimeters:

```
! U1 getvar "odometer.media_marker_count2"
```

Example

This example shows how to get the second user resettable counter, how to reset it, and how to confirm the settings have changed:

To see the current settings, type:

```
! U1 getvar "odometer.media_marker_count2"
```

Something similar to this is shown:

```
"8516 INCHES, 21632 CENTIMETERS"
```

To reset these values to 0, type:

```
! U1 setvar "odometer.media_marker_count2" "0"
```

To confirm these settings were reset, type:

```
! U1 getvar "odometer.media_marker_count2"
```

If the resetting was successful, this is shown:

```
"0 INCHES, 0 CENTIMETERS"
```



NOTES:

- For printer support, see [SGD Command Support on page 1455](#).
- For details on SGD command structure, see [Command Structure on page 562](#).

odometer.retracts_count

This printer value records the number of times a label has been retracted since the last time the counter has been reset.

Setvar

To reset the current count of retractions:

```
! U1 setvar "odometer.retracts_count" "value"
```

Values

0 = reset the counter

Default

none

Getvar

To respond with the current number of retractions that have happened since the last time the counter was reset:

```
! U1 getvar "odometer.retracts_count"
```



NOTES:

- For printer support, see [SGD Command Support on page 1455](#).
- For details on SGD command structure, see [Command Structure on page 562](#).

odometer.rfid.valid_resettable

This command resets the RFID valid label counter to zero.

Setvar

To set the RFID valid counter to zero:

```
! U1 setvar "odometer.rfid.valid_resettable" "value"
```

Values

(ZD500R only) "0"

(other RFID printers) "reset"

Getvar

To respond with the current RFID valid counter value:

```
! U1 getvar "odometer.rfid.valid_resettable"
```

Example

This `setvar` example shows how the counter portion of the printer configuration labels looks when the RFID valid counter is reset by sending:

ZD500R only:

```
! U1 setvar "odometer.rfid.valid_resettable" "0"
```

Other RFID printers:

```
! U1 setvar "odometer.rfid.valid_resettable" "reset"
```

Before

```
TM:M6E MICRO..... RFID READER
20.00.00.01..... RFID HW VERSION
01.01.00.EA..... RFID FW VERSION
USA/CANADA..... RFID REGION CODE
USA/CANADA..... RFID COUNTRY CODE
RFID OK..... RFID ERR STATUS
16..... RFID READ PWR
16..... RFID WRITE PWR
F0..... PROG. POSITION
507..... RFID VALID CTR
4..... RFID VOID CTR
```

After

```
TM:M6E MICRO..... RFID READER
20.00.00.01..... RFID HW VERSION
01.01.00.EA..... RFID FW VERSION
USA/CANADA..... RFID REGION CODE
USA/CANADA..... RFID COUNTRY CODE
RFID OK..... RFID ERR STATUS
16..... RFID READ PWR
16..... RFID WRITE PWR
F0..... PROG. POSITION
0..... RFID VALID CTR
4..... RFID VOID CTR
```



NOTES:

- For printer support, see [SGD Command Support on page 1455](#).
- For details on SGD command structure, see [Command Structure on page 562](#).

odometer.rfid.void_resetable

This command resets the RFID void label counter to zero.

Setvar

To set the RFID void counter to zero:

```
! U1 setvar "odometer.rfid.void_resetable" "value"
```

Values

(ZD500R only) "0"

(other RFID printers) "reset"

Getvar

To respond with the current RFID void counter value:

```
! U1 getvar "odometer.rfid.void_resetable"
```

Example

This `setvar` example shows how the counter portion of the printer configuration labels looks when the RFID void counter is reset by sending:

ZD500R only:

```
! U1 setvar "odometer.rfid.valid_resetable" "0"
```

Other RFID printers:

```
! U1 setvar "odometer.rfid.valid_resetable" "reset"
```

Before

TM:M6E MICRO.....	RFID READER
20.00.00.01.....	RFID HW VERSION
01.01.00.EA.....	RFID FW VERSION
USA/CANADA.....	RFID REGION CODE
USA/CANADA.....	RFID COUNTRY CODE
RFID OK.....	RFID ERR STATUS
16.....	RFID READ PWR
16.....	RFID WRITE PWR
F0.....	PROG. POSITION
507.....	RFID VALID CTR
4.....	RFID VOID CTR

After

TM:M6E MICRO.....	RFID READER
20.00.00.01.....	RFID HW VERSION
01.01.00.EA.....	RFID FW VERSION
USA/CANADA.....	RFID REGION CODE
USA/CANADA.....	RFID COUNTRY CODE
RFID OK.....	RFID ERR STATUS
16.....	RFID READ PWR
16.....	RFID WRITE PWR
F0.....	PROG. POSITION
507.....	RFID VALID CTR
0.....	RFID VOID CTR



NOTES:

- For printer support, see [SGD Command Support on page 1455](#).
- For details on SGD command structure, see [Command Structure on page 562](#).

odometer.total_cuts

Displays the total number of cuts incurred by the cutter.

Getvar

To return the current setting value:

```
! U1 getvar "odometer.total_cuts"
```

Values

an integer



NOTES:

- For printer support, see [SGD Command Support on page 1455](#).
- For details on SGD command structure, see [Command Structure on page 562](#).

odometer.total_print_length

This command returns the total length of all media movement over the life of the printer.



Getvar

NOTE: The number returned includes all media movement including backfeeds.

To return the current setting value:

```
! U1 getvar "odometer.total_print_length"
```

Default

0

Example

To get the total length of media printed to date:

```
! U1 getvar "odometer.total_print_length"  
(sample) "8560 INCHES, 21744 CENTIMETERS"
```



NOTES:

- For printer support, see [SGD Command Support on page 1455](#).
- For details on SGD command structure, see [Command Structure on page 562](#).

odometer.total_label_count

This command returns the total number of labels printed over the life of the printer.



NOTE: The number returned does not include form feeds or calibration labels.

Getvar

To return the current setting value:

```
! U1 getvar "odometer.total_label_count"
```

Example

To get the total number of labels printed to date:

```
! U1 getvar "odometer.total_label_count"  
(sample) "31084"
```



NOTES:

- For printer support, see [SGD Command Support on page 1455](#).
- For details on SGD command structure, see [Command Structure on page 562](#).

odometer.user_label_count

Returns the number of labels printed since the last odometer set command.

Setvar

To set the user label count:

```
! U1 setvar "odometer.user_label_count" "value"
```

Values

0 to 65000

Related ZPL Commands

~R0 1

Getvar

To return the current setting value:

```
! U1 getvar "odometer.user_label_count"
```

Values

0 to 65000

Example

To get the total number of labels printed to date:

```
! U1 getvar "odometer.user_label_count"
```

(sample) "7544"



NOTES:

- For printer support, see [SGD Command Support on page 1455](#).
- For details on SGD command structure, see [Command Structure on page 562](#).

odometer.user_total_cuts

This command sets the number of cuts incurred by the cutter. This is the resettable version of the `odometer.total_cuts` SGD.

Setvar

To set the number of cuts incurred by the cutter:

```
! U1 setvar "odometer.user_total_cuts" "0"
```

Values

"0" = reset the cut counter.

Getvar

To return the current number of cuts since the last time the cut counter was reset:

```
! U1 getvar "odometer.user_total_cuts"
```

Result

"0" to "n"

Here "n" is an integer



NOTES:

- For printer support, see [SGD Command Support on page 1455](#).
- For details on SGD command structure, see [Command Structure on page 562](#).

odometer.user_label_count[1|2]

Returns the number of labels printed since the last reset of each resettable odometer.

Setvar

To resets the counter value to 0:

```
! U1 setvar "odometer.user_label_count1" "value"
! U1 setvar "odometer.user_label_count2" "value"
```

Values

0

Related ZPL Commands

~R0

Getvar

To return the current setting value:

```
! U1 getvar "odometer.user_label_count1"
! U1 getvar "odometer.user_label_count2"
```

Values

0 to 4294967295

Related ZPL Commands

~R0

Example

To get the total number of labels printed on to date:

```
! U1 getvar "odometer.user_label_count1"
(sample) "164"
```



NOTES:

- For printer support, see [SGD Command Support on page 1455](#).
- For details on SGD command structure, see [Command Structure on page 562](#).

odometer.latch_open_count

Returns the number of times the latch for the printhead has been opened.

Setvar

To return the number of times the latch for the printhead has been opened:

```
! U1 setvar "odometer.latch_open_count" "value"
```

Values

0 to 4294967295

Getvar

To return the number of times the latch for the printhead has been opened:

```
! U1 getvar "odometer.latch_open_count"
```



NOTES:

- For printer support, see [SGD Command Support on page 1455](#).
- For details on SGD command structure, see [Command Structure on page 562](#).

parallel_port.mode

This command sets the mode type for the parallel port.

Setvar

To set the mode type for the parallel port:

```
! U1 setvar "parallel_port.mode" "value"
```

Values

"bidirectional"

"unidirectional"

Default

"bidirectional"

Getvar

To retrieve the current mode type setting for the parallel port:

```
! U1 getvar "parallel_port.mode"
```

Example

```
! U1 setvar "parallel_port.mode" "bidirectional"
```



NOTES:

- For printer support, see [SGD Command Support on page 1455](#).
- For details on SGD command structure, see [Command Structure on page 562](#).

parallel_port.present

This command reports if there is a parallel port in the printer.

Getvar

To report if there is a parallel port in the printer:

```
! U1 getvar "parallel_port.present"
```

Result

"present"

"not installed"



NOTES:

- For printer support, see [SGD Command Support on page 1455](#).
- For details on SGD command structure, see [Command Structure on page 562](#).

power.average_current

Returns the battery pack average current value for mA for printers supporting Power Precision Plus batteries.

Getvar

To return the current value of the setting:

```
! U1 getvar "power.average_current"
```

Values

any integer value



NOTES:

- For printer support, see [SGD Command Support on page 1455](#).
- For details on SGD command structure, see [Command Structure on page 562](#).

power.battery_led_blink_rate

Sets the Extended Smart Battery LED blink rate. The rate is set in multiples of 0.5 seconds.

Setvar

To set the Extended Smart Battery LED blink rate:

```
! U1 setvar "power.battery_led_blink_rate" "value"
```

Values

a number from 0 to 127. The rate is set in multiples of 0.5 seconds.

Default

"2"

Getvar

To return the current setting value:

```
! U1 getvar "power.battery_led_blink_rate"
```

Result

a number from 0 to 127. The rate is set in multiples of 0.5 seconds.

Example

The rate is set in multiples of 0.5 seconds.

To achieve an On time of 1 second, and Off time of 4.5 seconds one would use the following configuration:

On Duration = 2 ($2 * 0.5 = 1$ second) (xref power.battery_led_on_duration)

Off Duration = 9 ($9 * 0.5 = 4.5$ seconds) (xref power.battery_led_off_duration)

Blink Rate = 2 ($2 * 0.5 = 1$ second)



NOTES:

- For printer support, see [SGD Command Support on page 1455](#).
- For details on SGD command structure, see [Command Structure on page 562](#).

power.battery_led_enable

This command will enable or disable the illumination of the Extended Smart battery LED when one or more of the `power.battery` thresholds have been reached.

Setvar

To enable or disable the illumination of the Extended Smart battery LED when one or more of the `power.battery` thresholds have been reached:

```
! U1 setvar "power.battery_led_enable" "value"
```

Values

"on" = enables the Extended Smart battery LED

"off" = disables the Extended Smart battery LED

Default

"on"

Getvar

To return the current setting value:

```
! U1 getvar "power.battery_led_enable"
```



NOTES:

- For printer support, see [SGD Command Support on page 1455](#).
- For details on SGD command structure, see [Command Structure on page 562](#).

power.battery_led_off_duration

Sets the Extended Smart Battery Led Off duration. The rate is set in multiples of 0.5 seconds.

Setvar

To set the Extended Smart Battery Led Off duration:

```
! U1 setvar "power.battery_led_off_duration" "value"
```

Values

A number between 0 and 255. The rate is set in multiples of 0.5 seconds.

Default

"9"

Getvar

To return the current setting value:

```
! U1 getvar "power.battery_led_off_duration"
```



NOTES:

- For printer support, see [SGD Command Support on page 1455](#).
- For details on SGD command structure, see [Command Structure on page 562](#).

power.battery_led_on_duration

Sets the Extended Smart Battery Led On duration. The rate is set in multiples of 0.5 seconds.

Setvar

To set the Extended Smart Battery Led On duration:

```
! U1 setvar "power.battery_led_on_duration" "value"
```

Values

A number between 0 and 255. The rate is set in multiples of 0.5 seconds.

Default

"2"

Getvar

To return the current setting value:

```
! U1 getvar "power.battery_led_on_duration"
```



NOTES:

- For printer support, see [SGD Command Support on page 1455](#).
- For details on SGD command structure, see [Command Structure on page 562](#).

power.battery_type

This command retrieves the battery type installed in the printer.

Getvar

To get the type of battery installed in the printer:

```
! U1 getvar "power.battery_type"
```

Default Value

"unmanaged"

Result

"sb"	= smart battery
"ppp"	= power precision plus
"none"	= no battery
"unmanaged"	= legacy unmanaged battery

Example

In the example below, the getvar retrieves the battery type installed in the printer.

```
! U1 getvar "power.battery_type" "sb"
```



NOTES:

- QLn and ZQ5 are not capable of authenticating a Power Precision Plus battery so these printers will report "sb" only.
- For printer support, see [SGD Command Support on page 1455](#).
- For details on SGD command structure, see [Command Structure on page 562](#).

power.dtr_power_off

This command refers to the remote printer power control, and is used for power management. When Data Terminal Ready (DTR) is enabled the printer can be powered on and off via the Data Set Ready (DSR) signal. When DTR power off is enabled, a low to high transition will cause the printer to turn ON and a high to low transition will cause the printer to turn OFF.



NOTE: The inactivity time-out is disabled while DSR is active.

Setvar

To turn DTR power on or off:

```
! U1 setvar "power.dtr_power_off" "value"
```

Values

"off"

"on"

Default

"on"

Getvar

To retrieve the current DTR power-off setting:

```
! U1 getvar "power.dtr_power_off"
```

Example

```
! U1 setvar "power.dtr_power_off" "off"
```



NOTES:

- For printer support, see [SGD Command Support on page 1455](#).
- For details on SGD command structure, see [Command Structure on page 562](#).

power.energy_star.enable

Enables the EnergyStar functionality. For more information on Energy Star, see <http://www.energystar.gov>.

Setvar

To enable or disable the EnergyStar functionality:

```
! U1 setvar "power.energy_star.enable" "value"
```

Values

"on" = enables the EnergyStar functionality

"off" = disables the EnergyStar functionality

Getvar

To return the current setting value:

```
! U1 getvar "power.energy_star.enable"
```



NOTES:

- For printer support, see [SGD Command Support on page 1455](#).
- For details on SGD command structure, see [Command Structure on page 562](#).

power.energy_star.timeout

Sets the amount of idle time before EnergyStar mode is invoked. The time is specified in seconds. For more information on Energy Star, see <http://www.energystar.gov>.

Setvar

To set the amount of idle time before EnergyStar mode is invoked:

```
! U1 setvar "power.energy_star.timeout" "value"
```

Values

180 to 65535

Default

"180"

Getvar

To return the current setting value:

```
! U1 getvar "power.energy_star.timeout"
```

Example

This `setvar` example shows the value set to "260".

```
! U1 setvar "power.energy_star.timeout" "260"
```

The `setvar` value is the `getvar` result. In this example, the `getvar` result is "260".



NOTES:

- For printer support, see [SGD Command Support on page 1455](#).
- For details on SGD command structure, see [Command Structure on page 562](#).

power.label_queue.shutdown

Specifies if the printer should wait to shut down until all labels in its internal queue have been printed.

Setvar

To specify the label queue shutdown time:

```
! U1 setvar "power.label_queue.shutdown" "value"
```

Values

"yes" = printer will wait to shut down until all labels in its internal queue have been printed

"no" = printer will not wait to shut down until all labels in its internal queue have been printed

Default

"no"

Getvar

To return the current setting value:

```
! U1 getvar "power.label_queue.shutdown"
```



NOTES:

- For printer support, see [SGD Command Support on page 1455](#).
- For details on SGD command structure, see [Command Structure on page 562](#).

power.power_on_mode

Indicates if the printer will power on automatically when power is applied, i.e., when the power supply is plugged in.

Getvar

To return the current setting value:

```
! U1 getvar "power.power_on_mode"
```

Values

"**auto**" = jumper is present on option card, which makes the printer power on automatically when power is applied

"**manual**" = jumper is not present on option card or the option card doesn't support auto-power on, so the printer will power on only when the user presses the power button.

"**not available**" = not an option on the printer.

Default

"on"



NOTE:

- For printer support, see [SGD Command Support on page 1455](#).
- For details on SGD command structure, see [Command Structure on page 562](#).

power.shutdown

Instructs the printer to shut down.

Do

To shut down the printer:

```
! U1 do "power.shutdown" ""
```



NOTES:

- For printer support, see [SGD Command Support on page 1455](#).
- For details on SGD command structure, see [Command Structure on page 562](#).

power.voltage

This command returns the current battery voltage.

Getvar

To return the current setting:

```
! U1 getvar "power.voltage"
```

Result

Current voltage reading in integers



NOTES:

- For printer support, see [SGD Command Support on page 1455](#).
- For details on SGD command structure, see [Command Structure on page 562](#).

power.wake.radio

This command is used to enable or disable the power wake feature on printers that are radio (WLAN, BT Classic, and BTLE) enabled. The radio must be enabled to support waking on that interface. i.e. wlan.enable must be set to "yes" to support the wake feature on WLAN.

Setvar

To enable or disable the power wake setting:

```
! U1 setvar "power.wake.radio" "values"
```

Values

"on", "off"	=	ZQ6
"on", "off"	=	ZQ3
"on"	=	ZQ3 with BT Classic/BTLE radio installed (BT Only - UART)
"off"	=	ZQ5 with WLAN/BT Classic radio installed
"on"	=	ZQ5 with BT Classic/BTLE radio installed (BT Only - UART)
"on", "off"	=	ZD4xx, ZD6xx with WLAN/BT Classic/BTLE installed
"off"	=	ZD4xx, ZD6xx with BTLE only radio or no radio installed

Default Value

"on"

Getvar

To return the current setting:

```
! U1 getvar "power.wake.radio"
```



NOTES:

- For printer support, see [SGD Command Support on page 1455](#).
- For details on SGD command structure, see [Command Structure on page 562](#).

power.current

This command returns the battery pack instantaneous current value in mA for printers supporting Power Precision Plus batteries.

Positive values indicate charging current, whereas negative values indicate discharge current.

Getvar

To return the battery pack instantaneous current value:

```
! U1 getvar "power.current"
```

Result

```
"-32768" to "32767" mA
```

Example

In the example below, the getvar returns the battery pack instantaneous current value.

```
! U1 getvar "power.current" "5643 mA"
```



NOTES:

- For printer support, see [SGD Command Support on page 1455](#).
- For details on SGD command structure, see [Command Structure on page 562](#).

power.temperature

Returns the current battery temperature in degrees Celsius for printers that support a Power Precision Plus and Smart Batteries.

Getvar

To get the Power Precision battery temperature in Celsius:

```
! U1 getvar "power.temperature"
```

Example

In the example below, the getvar returns the current battery temperature in Celsius.

```
! U1 getvar "power.temperature" "25.40 C"
```



NOTES:

- For printer support, see [SGD Command Support on page 1455](#).
- For details on SGD command structure, see [Command Structure on page 562](#).

power.percent_health

This command returns the percent health that is read from the fuel gauge for printers that support a Power Precision Plus battery. The battery health is expressed as a percentage of design capacity.

Getvar

To get the Power Precision battery health percentage:

```
! U1 getvar "power.percent_health"
```

Result

"0" to "100"

Example

In the example below, the getvar returns the Power Precision battery health percentage.

```
! U1 getvar "power.percent_health" "90"
```



NOTES:

- For printer support, see [SGD Command Support on page 1455](#).
- For details on SGD command structure, see [Command Structure on page 562](#).

power.part_number

Returns the battery part number for printers that support Power Precision Plus batteries.

Getvar

To get the Power Precision battery part number:

```
! U1 getvar "power.part_number"
```

Result

<=10 digit string

Example

In the example below, the getvar returns the battery part number for Power Precision battery printers.

```
! U1 getvar "power.part_number" "0123456789"
```



NOTES:

- For printer support, see [SGD Command Support on page 1455](#).
- For details on SGD command structure, see [Command Structure on page 562](#).

power.sleep.cradle

This command enables or disables the sleep timeout feature while the printer is docked in the cradle. In the ZQ5 printer, the sleep timeout in the cradle is enabled by default. In the ZQ3 and ZQ6 printers, the sleep timeout in the cradle feature is disabled by default. This is done so as to manage the printer not having the Wake on BT, Wake on WLAN, and Wake feature on Ethernet support.

The command only affects the sleep timeout in cradle. If the user presses the power button, then the printer can still go to sleep, regardless of the setting.

Setvar

To set the command:

```
! U1 setvar "power.sleep.cradle" "values"
```

Values

"enabled" = the power.sleep.timeout is honored while the printer is docked in a cradle.

"disabled" = the power.sleep.timeout is disabled while the printer is docked in a cradle.

Default Value

"disabled" = ZQ3, ZQ6

"enabled" = ZQ5

Getvar

To return the current setting:

```
! U1 getvar "power.sleep.cradle"
```

Example

In the example below, the getvar returns the current setting of the sleep timeout in cradle feature.

```
! U1 getvar "power.sleep.cradle" "enabled"
```



NOTES:

- For printer support, see [SGD Command Support on page 1455](#).
- For details on SGD command structure, see [Command Structure on page 562](#).

power.remaining_capacity

This command returns the remaining capacity of the battery in milliamp hours (mAh).

Getvar

To return the remaining battery capacity:

```
! U1 getvar "power.remaining_capacity"
```

Result

```
"0 mAh" to "65535 mAh"
```

Example

In the example below, the getvar returns the remaining battery capacity of "1846 mAh".

```
! U1 getvar "power.remaining_capacity" "1846 mAh"
```



NOTES:

- For printer support, see [SGD Command Support on page 1455](#).
- For details on SGD command structure, see [Command Structure on page 562](#).

power.cycle_count

This command returns the number of charge cycles the battery has performed. A cycle is defined as a discharge of 80% of the pack's full charge capacity plus the concatenated partial charges that add to 80% of the pack's full charge capacity.

Getvar

To return the number of charge cycles:

```
! U1 getvar "power.cycle_count"
```

Example

In the example below, the getvar returns the number of charge cycles the battery has performed.

```
! U1 getvar "power.cycle_count" "77"
```



NOTES:

- For printer support, see [SGD Command Support on page 1455](#).
- For details on SGD command structure, see [Command Structure on page 562](#).

print.legacy_compatibility

This command turns off or on the legacy compatibility print quality.

Setvar

To enable or disable the legacy compatibility print quality:

```
! U1 setvar "print.legacy_compatibility" "value"
```

Values

"on" = use legacy QLn print quality tables. Applicable to ZQ610 and ZQ620 printers only. Not supported on ZQ630.

"off" = use ZQ6 print quality tables.

Default Value

"off"

Getvar

To return the current setting value:

```
! U1 getvar "print.legacy_compatibility"
```



NOTES:

- For printer support, see [SGD Command Support on page 1455](#).
- For details on SGD command structure, see [Command Structure on page 562](#).

print.tone

This command specifies the printer darkness.

Setvar

To set the darkness and relative darkness:

```
! U1 setvar "print.tone" "value"
```

Values

"0.0" to "30.0" = darkness

"-0.1" to "-30.0" and "+0.1" to "+30.0" = incremental adjustments

Default

"4.0"

Getvar

To retrieve the printer's current darkness setting:

```
! U1 getvar "print.tone"
```

Example

This `setvar` example shows the value set to "4.0".

```
! U1 setvar "print.tone" "4.0"
```

When the `setvar` value is set to "4.0", the `getvar` result is "4.0".



NOTES:

- For printer support, see [SGD Command Support on page 1455](#).
- For details on SGD command structure, see [Command Structure on page 562](#).

print.troubleshooting_label_print

Sets whether batch counters will be displayed on the printer's control panel.

Setvar

To set whether batch counters will be displayed on the printer's control panel:

```
! U1 setvar "print.troubleshooting_label_print" "value"
```

Values

"enabled" = batch counters will be displayed

"disabled" = batch counters will not be displayed

Default

"disabled"

Getvar

To return the current setting value:

```
! U1 getvar "print.troubleshooting_label_print"
```

Result

"enabled"



NOTES:

- For printer support, see [SGD Command Support on page 1455](#).
- For details on SGD command structure, see [Command Structure on page 562](#).

rfid.adaptive_antenna

This command enables or disables adaptive antenna selection.

If the printer cannot find RFID tags with the antenna element specified during the number of retries specified (if applicable), the printer may try neighboring antenna elements. If the printer is unsuccessful communicating with the RFID tag after trying the neighboring antenna elements, the printer voids the label.

Setvar

To enable or disable the adaptive antenna feature:

```
! U1 setvar "rfid.adaptive_antenna" "value"
```

Values

- **none** = The printer uses only the current antenna element selection.
- **neighbors** = The printer attempts to read the tag using the antenna elements to the left/right and above/below the current antenna. The antenna element that is successful is used for all subsequent RFID commands until the next unsuccessful attempt.

Default

none



NOTES:

- This command is valid only on R110Xi4 and ZT400 printers with a label that is 2 in. (51 mm) or longer. Activating this feature may slow throughput on damaged or weak RFID tags
- This feature does not apply to ZD500R printers, which always use an antenna element value of A1. The label length must be 2 in. (51 mm) or greater. Activating this feature may slow throughput on damaged or weak RFID tags.

Getvar

To retrieve the current adaptive antenna setting:

```
! U1 getvar "rfid.adaptive_antenna"
```



NOTES:

- For printer support, see [SGD Command Support on page 1455](#).
- For details on SGD command structure, see [Command Structure on page 562](#).

rfid.antenna_sweep

This command enables/disables the antenna sweep feature.

If the RFID media loaded in the printer is known to be in range of an antenna at the **F0** programming position, you can avoid RFID calibration by using the RFID antenna sweep feature. With this feature enabled, when the first RFID format is sent after a printer powerup or printhead close, the printer scans through the antennas to find the optimal antenna element.

Setvar

To enable or disable the antenna sweep feature:

```
! U1 setvar "rfid.antenna_sweep" "value"
```

Values

on, off

Default

on



NOTES:

- This command is valid only on R110Xi4 and ZT400 printers with a label that is 2 in. (51 mm) or longer and when using a program position of F0.
- This feature does not apply to ZD500R printers, which always use an antenna element value of A1.
- The label length must be 2 in. (51 mm) or greater, and the programming position must be F0.

Getvar

To retrieve the current antenna sweep setting:

```
! U1 getvar "rfid.adaptive_antenna"
```



NOTES:

- For printer support, see [SGD Command Support on page 1455](#).
- For details on SGD command structure, see [Command Structure on page 562](#).

rfid.country_code

This command sets or returns the RFID reader country code. The country code is restricted based on the region code assigned to the reader and, in some instances, cannot be modified. You can check the countries available for your region through the control panel menu items on your printer.

Setvar

To set the RFID reader's current country code

```
! U1 setvar "rfid.country_code" "value"
```

Values

The country code choices available will vary depending on the region for which your printer is configured.

Getvar

To retrieve the RFID reader's current country code:

```
! U1 getvar "rfid.country_code"
```

Example

In this example, the `setvar` sets the country code to USA/Canada.

```
! U1 setvar "rfid.country_code" "usa/canada"
```



NOTES:

- For printer support, see [SGD Command Support on page 1455](#).
- For details on SGD command structure, see [Command Structure on page 562](#).

rfid.enable

This command instructs an RFID printer to enable or disable RFID functionality. You must restart the printer for the command to take effect.



NOTE: When this function is set to "on," changes are made to normal printer functionality. Loading printer defaults does NOT:

- Default the sensor select setting
- Default media tracking sensor settings
- Default label length
- Perform an auto calibration

Setvar

To enable or disable RFID functionality:

```
! U1 setvar "rfid.enable" "value"
```

Values

on = enables RFID functionality

off = disables RFID functionality

Default

on



NOTES:

- For printer support, see [SGD Command Support on page 1455](#).
- For details on SGD command structure, see [Command Structure on page 562](#).

rfid.error.response

This command can be used to retrieve the RFID status, including any error codes or messages.

Getvar

To retrieve any active RFID error messages:

```
! U1 getvar "rfid.error.response"
```

Example

This `getvar` example shows responses that you may get in different situations:

```
! U1 getvar "rfid.error.response"
```

If no RFID tag is present, you get the following response:

```
NO TAG FOUND
```

If an RFID tag is present and there are no errors, you get the following response:

```
RFID OK
```



NOTES:

- For printer support, see [SGD Command Support on page 1455](#).
- For details on SGD command structure, see [Command Structure on page 562](#).

rfid.hop_table_version

This command retrieves the RFID reader's hop table version.

Getvar

To retrieve the RFID reader's hop table version:

```
! U1 getvar "rfid.hop_table_version"
```



NOTES:

- For printer support, see [SGD Command Support on page 1455](#).
- For details on SGD command structure, see [Command Structure on page 562](#).

rfid.log.entries

This command returns the RFID host log. This command is equivalent to the ^HL and ~HL command. Host logs are not displayed during an ALLCV.

Getvar

To get the RFID host logs:

```
! U1 getvar "rfid.log.entries"
```

Result

```
[0x02]<start>
Nov-13-2017 23:31:30,R,F0,A1,16,00000000,E200905962180075209038CD
...
<end>[0x03]
```

- In this example, "..." can be more entries.
- [0x02] and [0x03] are the STX and ETX binary characters.



NOTES:

- For printer support, see [SGD Command Support on page 1455](#).
- For details on SGD command structure, see [Command Structure on page 562](#).

rfid.position.program

This command sets the read/write position of the RFID tag (programming position).



IMPORTANT: If this command is used to specify a value for the programming position, this value will be used for the programming position for all labels until a new position is specified or until the tag calibration procedure is run.

Setvar

This command instructs the printer to set the read/write position of the RFID tag.

```
! U1 setvar "rfid.position.program" "value"
```

Values

For the ZD500R only:

- **F0** to **Fxxx** (where **xxx** is the label length in millimeters or **999**, whichever is less)
The printer prints the first part of a label until it reaches the specified distance and then begins programming. After programming, the printer prints the remainder of the label.
- **B0** to **B30**
The printer backfeeds the label for the specified distance and then begins programming. To account for the backfeed, allow empty media liner to extend out of the front of the printer when using a backward programming position.
- **up** = move to the next value
- **down** = move to the previous value

For other RFID printers:

Absolute Mode (all firmware versions):

- **xxxx** = **0** to label length (in dot rows). Move the media to the specified position **xxxx** on the label, measured in dot rows from the label top, before encoding. Set to **0** (no movement) if the tag is already in the effective area without moving the media.

Relative Mode (firmware versions V53.17.6 and later):

- **F0** to **Fxxx** (where **xxx** is the label length in millimeters or **999**, whichever is less)
The printer prints the first part of a label until it reaches the specified distance and then begins programming. After programming, the printer prints the remainder of the label.
- **B0** to **B30** (Does not apply to the RP4T printer.)
The printer backfeeds the label for the specified distance and then begins programming. To account for the backfeed, allow empty media liner to extend out of the front of the printer when using a backward programming position.

Default

- *For the R2844-Z and RPAX:* **0** (no movement)
- *For printers using V53.17.7 and Later:* **F0** (which moves the leading edge of the label to the print line)
- *For all other printers or firmware:* label length minus 1 mm (1/16 in.)

Getvar

This command instructs the printer to respond with the current programming position.

```
! U1 getvar "rfid.position.program"
```

Example

This example shows the programming position being set at 15 mm from the leading edge of the label.

```
! U1 setvar "rfid.position.program" "F15"
```

When the `setvar` value is set to "F15", the `getvar` result is F15.



NOTES:

- For printer support, see [SGD Command Support on page 1455](#).
- For details on SGD command structure, see [Command Structure on page 562](#).

rfid.reader_1.antenna_port

This command specifies the RFID antenna to be used for RFID operation.



NOTE: Some printers automatically select the best antenna element and read/write power levels for the media during RFID transponder calibration. Ty may also set the levels during an adaptive antenna sweep. Use the `~HL` command (see [^HL or ~HL on page 363](#)) to view the antenna element and power settings being used.

Default

Setvar

Sets the antenna port.

```
! U1 setvar "rfid.reader_1.antenna_port" "value"
```

ZD500R:

This printer only has one antenna element, so the value used is always **A1**.

Default

A1

ZT400

This parameter selects an antenna element from the printer's antenna array.

Values

E1, E2, E3, E4

D1, D2, D3, D4

C1, C2, C3, C4

B1, B2, B3, B4

A1, A2, A3, A4

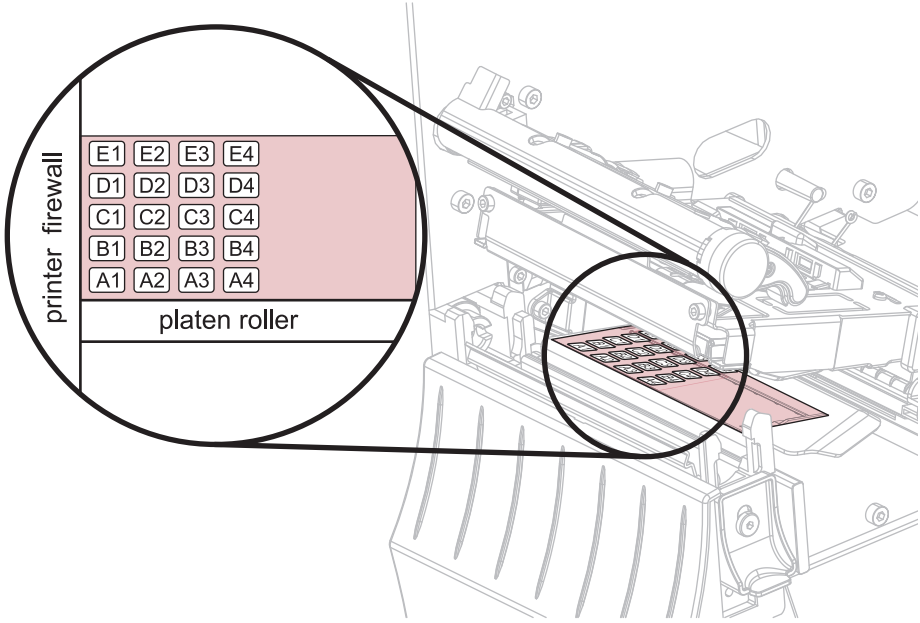

Default

A4

R110Xi4 (V53.17.5 and later):

Values

a two-digit antenna value:

A1, A2, A3, A4, B1, B2, B3, B4, C1, C2, C3, C4, D2, D3, D4, E2, E3, E4, F2, F3, F4 (combinations D1, E1, and F1 are invalid)

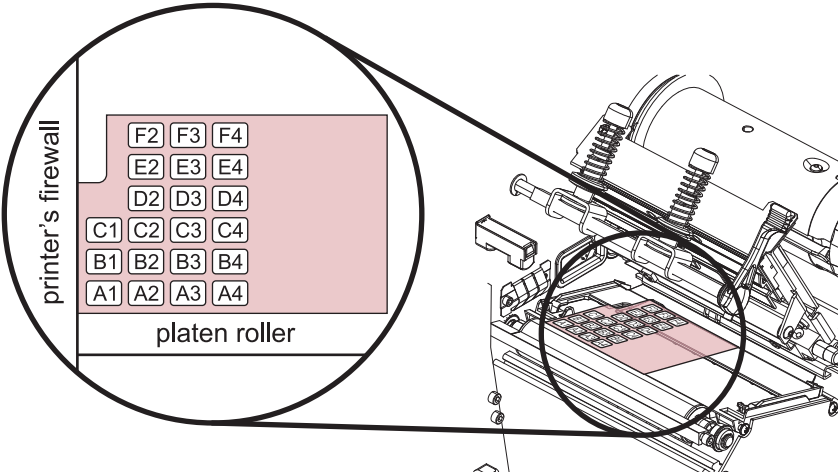

Default

A4

R110xi HF (R65.X):

Values

1 = antenna port 1

2 = antenna port 2

Default

1

Getvar

Retrieves the current antenna port.

```
! U1 getvar "rfid.reader_1.antenna_port"
```

Example

This `setvar` example shows the selection of antenna port D3.

```
! U1 setvar "rfid.reader_1.antenna_port" "D3"
```

When the `setvar` value is set to "D3", the `getvar` result is "D3".



NOTES:

- For printer support, see [SGD Command Support on page 1455](#).
- For details on SGD command structure, see [Command Structure on page 562](#).

rfid.reader_1.power.read

This command sets the RFID reader power level for reading RFID tags.



NOTES: The R110Xi4 printer automatically selects the best antenna element and read/write power levels for the media during RFID transponder calibration. It may also set the levels during an adaptive antenna sweep. Use the ~HL command (see ^HL or ~HL on page 363) to view the antenna element and power settings being used.

Commands	Details			
<ul style="list-style-type: none"> setvar 	<p>This command instructs the printer to set the antenna's read power level. Format: ! U1 setvar "rfid.reader_1.power.read" "value"</p> <table border="0" data-bbox="285 646 1333 1398"> <tr> <td data-bbox="285 646 812 1398"> <p>R53.16.3Z: Values: 0 to 30 Default: 16</p> <p>RP4T (all firmware versions), R53.16.4Z, V53.17.7, V74.19.6Z, and later: Values: • 0 to 30 • up = increase the current value by 1 • down = decrease the current value by 1 Default: "16"</p> </td> <td data-bbox="812 646 1333 1398"> <p>R60.16.x, R62.16.x, R63.16.x, R65.16.x, SP994Q, SP999G, SP1027G, SP1056F, SP1082G, and later: Values: • 0 to 30 • high • medium • low Default: low</p> <p>Older firmware: Values: • high • medium • low Default: low</p> </td> </tr> </table>		<p>R53.16.3Z: Values: 0 to 30 Default: 16</p> <p>RP4T (all firmware versions), R53.16.4Z, V53.17.7, V74.19.6Z, and later: Values: • 0 to 30 • up = increase the current value by 1 • down = decrease the current value by 1 Default: "16"</p>	<p>R60.16.x, R62.16.x, R63.16.x, R65.16.x, SP994Q, SP999G, SP1027G, SP1056F, SP1082G, and later: Values: • 0 to 30 • high • medium • low Default: low</p> <p>Older firmware: Values: • high • medium • low Default: low</p>
<p>R53.16.3Z: Values: 0 to 30 Default: 16</p> <p>RP4T (all firmware versions), R53.16.4Z, V53.17.7, V74.19.6Z, and later: Values: • 0 to 30 • up = increase the current value by 1 • down = decrease the current value by 1 Default: "16"</p>	<p>R60.16.x, R62.16.x, R63.16.x, R65.16.x, SP994Q, SP999G, SP1027G, SP1056F, SP1082G, and later: Values: • 0 to 30 • high • medium • low Default: low</p> <p>Older firmware: Values: • high • medium • low Default: low</p>			
<ul style="list-style-type: none"> getvar 	<p>Retrieves the antenna's current read power level. Format: ! U1 getvar "rfid.reader_1.power.read"</p>			

Example

This **setvar** example sets the antenna to power setting 16 for reading RFID tags.

```
! U1 setvar "rfid.reader_1.power.read" "16"
```

When the **setvar** value is set to "16", the **getvar** result is 16.



NOTES:

- For printer support, see [SGD Command Support on page 1455](#).
- For details on SGD command structure, see [Command Structure on page 562](#).

rfid.reader_1.power.write

Use this command to set the RFID write power levels if the desired levels are not achieved through RFID tag calibration. If not enough power is applied, the tag may not have sufficient power for programming, and tag data will fail to encode. If too much power is applied, the extra power may cause data communication errors or may cause the wrong tag to be programmed.



NOTES:

- The R110Xi4 printer automatically selects the best antenna element and read/write power levels for the media during RFID transponder calibration. It may also set the levels during an adaptive antenna sweep. Use the ~HL command (see ^HL or ~HL on page 363) to view the antenna element and power settings being used.
- This parameter is ignored on the R110Xi HF printer because read and write powers cannot be specified separately. See rfid.reader_1.power.single_power on page 917 to set the power level for the R110Xi HF printer.

Commands	Details	
<ul style="list-style-type: none"> • setvar 	This command instructs the printer to set the antenna's read power level. Format: ! U1 setvar "rfid.reader_1.power.read" "value"	
	R53.16.3Z: Values: 0 to 30 Default: 16 RP4T (all firmware versions), R53.16.4Z, V53.17.7, V74.19.6Z, and later: Values: <ul style="list-style-type: none"> • 0 to 30 • up = increase the current value by 1 • down = decrease the current value by 1 Default: "16"	R60.16.x, R62.16.x, R63.16.x, R65.16.x, SP994Q, SP999G, SP1027G, SP1056F, SP1082G, and later: Values: <ul style="list-style-type: none"> • 0 to 30 • high • medium • low Default: low Older firmware: Values: high, medium, low Default: low
<ul style="list-style-type: none"> • getvar 	Retrieves the antenna's current write power level. Format: ! U1 getvar "rfid.reader_1.power.write"	

Example

This **setvar** example sets the antenna to power setting 16 for writing to RFID tags.

```
! U1 setvar "rfid.reader_1.power.write" "16"
```

When the **setvar** value is set to "16", the **getvar** result is 16.



NOTES:

- For printer support, see [SGD Command Support on page 1455](#).
- For details on SGD command structure, see [Command Structure on page 562](#).

rfid.reader_1.power.single_power

This command sets the RFID reader power level for reading and writing to RFID tags for readers with a single power level.



NOTE: This command applies only to the R110*x*i HF printer, firmware version R65.*x*.

Setvar

To set the power level for reading and writing:

```
! U1 setvar "rfid.reader_1.power.single_power" "value"
```

Values

high

medium

low

Default

low

Getvar

To respond with the current power level:

```
! U1 getvar "rfid.reader_1.power.single_power"
```

This **setvar** example sets the antenna to high power for writing to RFID tags.

Example

```
! U1 setvar "rfid.reader_1.power.single_power" "high"
```

When the **setvar** value is set to "high", the **getvar** result is "high".



NOTES:

- For printer support, see [SGD Command Support on page 1455](#).
- For details on SGD command structure, see [Command Structure on page 562](#).

rfid.reader_1.firmware_version

This command returns the RFID reader firmware version.

Getvar

To return the RFID reader firmware version:

```
! U1 getvar "rfid.reader_1.firmware_version"
```

Example

This example shows responses that you get in different situations:

```
! U1 getvar "rfid.reader_1.firmware_version"
```

If an RFID reader is present and connected, you get the firmware version in the following format:

```
xx.xx.xx.xx
```

If there is no RFID reader or if the reader is not connected correctly, the response is blank.



NOTES:

- For printer support, see [SGD Command Support on page 1455](#).
- For details on SGD command structure, see [Command Structure on page 562](#).

rfid.reader_1.hardware_version

This command returns the RFID reader hardware version.

Getvar

To return the RFID reader hardware version:

```
! U1 getvar "rfid.reader_1.hardware_version"
```

Example

This example shows responses that you get in different situations:

```
! U1 getvar "rfid.reader_1.hardware_version"
```

If an RFID reader is present and connected, you get the hardware version in the following format:

```
xx.xx.xx.xx
```

If there is no RFID reader or if the reader is not connected correctly, the response is blank.



NOTES:

- For printer support, see [SGD Command Support on page 1455](#).
- For details on SGD command structure, see [Command Structure on page 562](#).

rfid.reader_1.model

This command returns the printer's RFID reader model number. Possible values are as follows:

- M6E MICRO

Getvar

To return the printer's RFID reader model number:

```
! U1 getvar "rfid.reader_1.model"
```



NOTES:

- For printer support, see [SGD Command Support on page 1455](#).
- For details on SGD command structure, see [Command Structure on page 562](#).

rfid.recipe_version

The RFID recipe file controls how the printer manages RFID tag encoding, according to the type of tag in use.

This command returns the version number of the RFID recipe file currently in use. The RFID recipe file is named RFIDRCPE.XML. The default location for this file is Z:RFIDRCPE.XML. If a file using the same name is stored in the E: memory location, it will be used instead of the file stored in the Z: memory location.

Getvar

To return the version number of the RFID recipe file currently in use:

```
! U1 getvar "rfid.recipe_version"
```



NOTES:

- For printer support, see [SGD Command Support on page 1455](#).
- For details on SGD command structure, see [Command Structure on page 562](#).

rfid.region_code

This command returns the region code assigned to the printer's RFID device.

Getvar

To retrieve the RFID region code:

```
! U1 getvar "rfid.region_code"
```

Values

- not available
- usa/canada
- japan
- rest of world



NOTES:

- For printer support, see [SGD Command Support on page 1455](#).
- For details on SGD command structure, see [Command Structure on page 562](#).

rfid.tag.calibrate

Use this command to initiate tag calibration for RFID media. During the process, the printer moves the media, calibrates the RFID tag position, and determines the optimal settings for the RFID media being used. Depending on the printer, these settings include the programming position, the antenna element to use, and the read/write power level to use.



NOTES:

For more information about RFID tag calibration, refer to the *RFID Programming Guide* for your printer. A copy is available online at <http://www.zebra.com/manuals>.

Setvar

To initiate tag calibration for RFID media:

```
! U1 setvar "rfid.tag.calibrate" "value"
```

Values

restore

run

Example

This `setvar` example restores the programming position back to the printer's default value.

```
! U1 setvar "rfid.tag.calibrate" "restore"
```

This `setvar` example performs RFID tag calibration.

```
! U1 setvar "rfid.tag.calibrate" "run"
```



NOTES:

- For printer support, see [SGD Command Support on page 1455](#).
- For details on SGD command structure, see [Command Structure on page 562](#).

rfid.tag.data

This command tells the RFID reader to attempt to read a tag over the RFID antenna, even if the printhead is open. Results are returned to the host.

Before running this command, position an RFID label over the printer's RFID antenna.

For more information about this option and for the location of the RFID antenna, refer to the *RFID Programming Guide* for your printer. A copy is available online at <http://www.zebra.com/manuals>.

Commands	Details
<ul style="list-style-type: none"> <code>getvar</code> 	This command instructs the printer to respond with the current tag's data. Format: <code>! U1 getvar "rfid.tag.data"</code>

Example

This `getvar` example gets the current tag's data, assuming that an RFID label with data "0123456789ABCDEF12345678" is in place over the antenna.

```
! U1 setvar "rfid.tag.data"
```

This `getvar` example gets the current tag's data, assuming that no tag data can be read or that no tag is present.

```
! U1 setvar "rfid.tag.data"
```



NOTES:

- For printer support, see [SGD Command Support on page 1455](#).
- For details on SGD command structure, see [Command Structure on page 562](#).

rfid.tag.read.content

This command instructs the printer which data to read from the tag with the `rfid.tag.read.execute` command. (See [rfid.tag.read.execute](#) on page 926.)

Setvar

To instruct the printer which data to read from the tag with the `rfid.tag.read.execute` command:

```
! U1 setvar "rfid.tag.read.content" "value"
```

Values

- `epc` = reads the EPC data based on the EPC size specified in the RFID tag's protocol bits, up to 160 bits
- `tid information` = reads the first 32 bits of the TID (Tag ID)
- `password status` = reads the tag's access and kill passwords
- `protocol bits` = reads the protocol bits from the EPC memory banks and converts that value to the EPC size
- `memory bank sizes` = reads the EPC, TID, and user memory banks sizes
- `up` = sets the command to the previous test
- `down` = sets the command to the next test

Default

`epc`

Getvar

To retrieve the current setting:

```
! U1 getvar "rfid.tag.read.content"
```



NOTES:

- For printer support, see [SGD Command Support](#) on page 1455.
- For details on SGD command structure, see [Command Structure](#) on page 562.

rfid.tag.read.execute

This command reads the data specified by the `rfid.tag.read.content` command. (See [rfid.tag.read.content](#) on page 925.)

Setvar

To read the specified data:

```
! U1 setvar "rfid.tag.read.execute"
```



NOTES:

- For printer support, see [SGD Command Support](#) on page 1455.
- For details on SGD command structure, see [Command Structure](#) on page 562.

rfid.tag.read.result_line1

This command reports the results of the `rfid.tag.read.execute` command.

Getvar

To retrieve the results of the `rfid.tag.read.execute` command:

```
! U1 getvar "rfid.tag.read.result_line1"
```



NOTES:

- For printer support, see [SGD Command Support on page 1455](#).
- For details on SGD command structure, see [Command Structure on page 562](#).

rfid.tag.read.result_line2

This command reports the results of the `rfid.tag.read.execute` command.

Getvar

To retrieve the results of the `rfid.tag.read.execute` command:

```
! U1 setvar "rfid.tag.read.result_line2"
```



NOTES:

- For printer support, see [SGD Command Support on page 1455](#).
- For details on SGD command structure, see [Command Structure on page 562](#).

rfid.tag.read.result_line1_alternate

This command reports the results of the `rfid.tag.read.execute` command.

Getvar

To retrieve the results of the `rfid.tag.read.execute` command:

```
! U1 setvar "rfid.tag.read.result_line1_alternate"
```



NOTES:

- For printer support, see [SGD Command Support on page 1455](#).
- For details on SGD command structure, see [Command Structure on page 562](#).

rfid.tag.read.result_line2_alternate

This command reports the results of the `rfid.tag.read.execute` command.

Getvar

To retrieve the results of the `rfid.tag.read.execute` command:

```
! U1 getvar "rfid.tag.read.result_line2_alternate"
```



NOTES:

- For printer support, see [SGD Command Support on page 1455](#).
- For details on SGD command structure, see [Command Structure on page 562](#).

rfid.tag.test

This command performs an RFID test. In the RFID test, the printer attempts to read and write to a transponder that you place over the RFID antenna. Results are displayed on the printer's control panel display. For more information about the RFID antenna location, refer to the *RFID Programming Guide* for your printer. A copy is available online at <http://www.zebra.com/manuals>.

In the slow version of the RFID test, the printer first displays the hardware version, the reader firmware version, and the program position.



NOTE: This command is valid only on RP4T printers.

Setvar

To set the programming position:

```
! U1 setvar "rfid.tag.test" "value"
```

Values

quick

slow

Example

This `setvar` example performs a quick RFID test, which shows a pass or fail message.

```
! U1 setvar "rfid.tag.test" "quick"
```

This `setvar` example performs a slow RFID test, which shows the success or failure of each read or write tag operation.

```
! U1 setvar "rfid.tag.test" "slow"
```



NOTES:

- For printer support, see [SGD Command Support on page 1455](#).
- For details on SGD command structure, see [Command Structure on page 562](#).

rfid.tag.test.content

This command instructs the printer which test to perform on the tag with the `rfid.tag.test.execute` command. (See [rfid.tag.test.execute](#) on page 933.)

Setvar

To instruct the printer which test to perform on the tag with the `rfid.tag.test.execute` command:

```
! U1 setvar "rfid.tag.test.content" "value"
```

Values

- **quick** = performs a read EPC test and a write EPC test (using random data)
- **read** = performs a read EPC test
- **write** = performs a write EPC test (using random data)
- **up** = sets the command to the previous test
- **down** = sets the command to the next test

Default

`quick`

Getvar

To retrieve the current setting:

```
! U1 getvar "rfid.tag.test.content"
```



NOTES:

- For printer support, see [SGD Command Support](#) on page 1455.
- For details on SGD command structure, see [Command Structure](#) on page 562.

rfid.tag.test.execute

This command tests the data specified by the `rfid.tag.test.content` command. (See [rfid.tag.test.content on page 932.](#))

Setvar

To test the specified data:

```
! U1 setvar "rfid.tag.test.execute"
```



NOTES:

- For printer support, see [SGD Command Support on page 1455.](#)
- For details on SGD command structure, see [Command Structure on page 562.](#)

rfid.tag.test.result_line1

This command reports the results of the `rfid.tag.test.execute` command.

Getvar

To retrieve the results of the `rfid.tag.test.execute` command:

```
! U1 setvar "rfid.tag.test.result_line1"
```



NOTES:

- For printer support, see [SGD Command Support on page 1455](#).
- For details on SGD command structure, see [Command Structure on page 562](#).

rfid.tag.test.result_line2

This command reports the results of the `rfid.tag.test.execute` command.

Getvar

To retrieve the results of the `rfid.tag.test.execute` command:

```
! U1 setvar "rfid.tag.test.result_line2"
```



NOTES:

- For printer support, see [SGD Command Support on page 1455](#).
- For details on SGD command structure, see [Command Structure on page 562](#).

rfid.tag.type

This command sets the reader's RFID tag type.

Setvar

To set the reader's tag type:

```
! U1 setvar "rfid.tag.type" "value"
```

Values

UHF Printers

none = None

class0 = EPC Class 0

class0+ = EPC Class 0 Plus

class1_64bit = EPC Class 1 64-bit

class1_96bit = EPC Class 1 96-bit

ucode_epc_1_19 = UCODE EPC 1.19

class0+_impinj = Impinj Class 0 Plus

ISO18000A = ISO 18000-06A

gen2 = EPC Class 1, Generation 2 (Gen 2)

ISO18000B = ISO 18000-06B

HF Printers

none = None

detect = Auto detect (query tag to determine)

tagit = Tag*It (Texas Instruments Tagit tags)

icode = I*code (Phillips Icode tags)

pico = Pico Tag (Inside Technology's)

ISO15693 = ISO 15693

EPC = EPC tag (13.56 MHz)

UIC = UID Tag

mifare_ultralight = Mifare UltraLight

Getvar

To respond with the reader's current tag type:

```
! U1 getvar "rfid.tag.type"
```

Example

This **setvar** example shows the reader's tag type being set to Gen 2.

```
! U1 setvar "rfid.tag.type" "gen2"
```

Supported Tag Types Table 20 shows the tag types supported by different RFID printers/print engines and firmware versions. Depending on your country or on the firmware version that you are using, your printer may not support all of the tag types listed. If you specify an unsupported tag type, the printer uses the default value. If a tag type is shown as supported but does not work with your printer, you may need to upgrade the printer's firmware (see <http://www.zebra.com/firmware>).

Table 20 Supported Tag Types and Default Values

Printer	UHF Printers												HF Printers						
	R110Xi4	R110 R170		R110 4				R4Mplus			RZ400/ RZ600	R110 Xi HF	R2844-Z						
Firmware Version	V53.17.7 and later	R60.13.	R60.15. and later		R62.13.	R62.15. and later		R63.13.	R63.15. and later		SP994O, SP999E, SP1027E, SP1082E, and earlier	SP994P, SP999F, SP1027F, SP1082F, and later	SP1056D and earlier	SP1056E and later	R53.16. and later	R65.13 X	R65.15 X and later	all	
Tag Type																			
UHF Tag Types and Options																			
• None (no tag type specified)	—	*	*	*	*	—	—	—	—	—	—	—	—	—	—	—	—	—	—
• EPC Class 0	—	*	*	*	*	—	—	—	—	—	—	—	—	—	—	—	—	—	—
• EPC Class 0 Plus	—	*	*	*	*	—	—	—	—	—	—	—	—	—	—	—	—	—	—
• EPC Class 1 64-bit	—	*	*	*	*	—	—	—	—	—	—	—	—	—	—	—	—	—	—
• EPC Class 1 96-bit	—	#	*	#	*	—	*	*	*	—	—	—	—	—	—	—	—	—	—
• UCODE EPC 1.19	—	* a	*	—	*	#	*	#	*	#	*	—	—	—	—	—	—	—	—
• Impinj Class 0 Plus	—	*	*	*	*	—	—	—	—	—	—	—	—	—	—	—	—	—	—
• ISO 18000-06A	—	—	—	*	—	—	*	*	*	—	—	—	—	—	—	—	—	—	—
• EPC Class 1, Generation 2 (Gen 2)	#	*	#	*	#	—	#	*	#	*	#	#	—	—	—	—	—	—	—
• ISO 18000-06B	—	*	*	*	*	—	*	*	*	*	*	*	—	—	—	—	—	—	—
HF Tag Types and Options																			
• Auto-detect the tag type by querying the tag	—	—	—	—	—	—	—	—	—	—	—	—	—	—	—	—	—	—	#
• Tag*It (Texas Instruments Tagit tags)	—	—	—	—	—	—	—	—	—	—	—	—	—	—	—	—	—	—	*
• I*code (Phillips Icode tags)	—	—	—	—	—	—	—	—	—	—	—	—	—	—	—	—	—	—	*

= Default value * = Accepted value — = Not supported
a. Requires R60.13.0.13ZD or later.

Table 20 Supported Tag Types and Default Values (Continued)

Printer	UHF Printers											HF Printers						
	R110Xi4	R110 R170		R110 4				R4Mplus			RZ400/ RZ600	R111 Xi HF	R2844-Z					
Firmware Version	V53.17.7 and later	R60.13.	R60.15. and later		R62.13.	R62.15. and later		R63.13.	R63.15. and later		SP994O, SP999E, SP1027E, SP1082E, and earlier	SP994P, SP999F, SP1027F, SP1082F, and later	SP1056D and earlier	SP1056E and later	R53.16. and later	R65.13 X	R65.15 X and later	all
Tag Type																		
• Pico Tag (Inside Technology's)	—	—	—	—	—	—	—	—	—	—	—	—	—	—	—	—	—	*
• ISO 15693	—	—	—	—	—	—	—	—	—	—	—	—	—	—	—	#	#	*
• EPC tag	—	—	—	—	—	—	—	—	—	—	—	—	—	—	—	—	—	*
• UID Tag	—	—	—	—	—	—	—	—	—	—	—	—	—	—	—	—	—	—
• Mifare UltraLight	—	—	—	—	—	—	—	—	—	—	—	—	—	—	—	*	*	—
# = Default value * = Accepted value — = Not supported a. Requires R60.13.0.13ZD or later.																		

rfid.log.enabled

This command enables or disables the RFID host log.

Setvar

To set the command:

```
! U1 setvar "rfid.log.enabled" "value"
```

Values

"yes" = enables the RFID host log

"no" = disables the RFID host log

Default

"no"

Example

In this example, the setvar enables the RFID host log.

```
! U1 setvar "rfid.log.enabled" "yes"
```

Getvar

To view the current setting value:

```
! U1 getvar "rfid.log.enabled"
```



NOTES:

- For printer support, see [SGD Command Support on page 1455](#).
- For details on SGD command structure, see [Command Structure on page 562](#).

rfid.log.clear

This command clears the RFID host log.

Setvar

To set the command:

```
! U1 setvar "rfid.log.clear" ""
```

Values

NA

Do

To clear the RFID host logs:

```
! U1 do "rfid.log.clear" ""
```

Values

NA



NOTES:

- For printer support, see [SGD Command Support on page 1455](#).
- For details on SGD command structure, see [Command Structure on page 562](#).

ribbon.serial_number

Sets the ribbon's part number.

Setvar

To set the ribbon's part number:

```
! U1 setvar "ribbon.serial_number" "value"
```

Values

an alpha-numeric string between 0 and 64 characters

Default

NA

Example

```
! U1 setvar "ribbon.serial_number" "A34567BC6789"
```

Getvar

To return the current setting value:

```
! U1 getvar "ribbon.serial_number"
```

Result

```
"A34567BC6789"
```



NOTES:

- For printer support, see [SGD Command Support on page 1455](#).
- For details on SGD command structure, see [Command Structure on page 562](#).

ribbon.part_number

Sets the ribbon's part number.

Setvar

To set the ribbon's part number:

```
! U1 setvar "ribbon.part_number" "value"
```

Values

an alpha-numeric string between 0 and 64 characters.

Default

NA

Example

```
! U1 setvar "ribbon.part_number" "123AB987"
```

Getvar

To return the current setting value:

```
! U1 getvar "ribbon.part_number"
```

Result

```
"123AB987"
```



NOTES:

- For printer support, see [SGD Command Support on page 1455](#).
- For details on SGD command structure, see [Command Structure on page 562](#).

ribbon.cartridge.part_number

This command retrieves the part number of the ribbon cartridge installed in the printer. There is a 12 character max for the size of string returned since the cartridge allows for 10 character part numbers.

If a ribbon cartridge is not installed, or if the ribbon cartridge option is not present, then the command returns an empty string.

Getvar

To return the part number of the ribbon cartridge:

```
! U1 getvar "ribbon.cartridge.part_number"
```

Result

"value" <= 12 characters

"" = ribbon cartridge is not installed or not available

Example

In this example, the getvar returns the part number of the ribbon cartridge.

```
! U1 getvar "ribbon.cartridge.part_number" "123456789A"
```



NOTES:

- For printer support, see [SGD Command Support on page 1455](#).
- For details on SGD command structure, see [Command Structure on page 562](#).

ribbon.cartridge.length_remaining

This command retrieves the length of ribbon remaining on the cartridge. This is specified in meters.

If a cartridge is not installed, the printer returns "0". If the cartridge option is not available in the printer, then the printer returns an empty string.

Getvar

To return the length of ribbon remaining on the cartridge:

```
! U1 getvar "ribbon.cartridge.length_remaining"
```

Result

"0" to "74" meters

"0" = cartridge not installed

"" = cartridge is not available



NOTES:

- For printer support, see [SGD Command Support on page 1455](#).
- For details on SGD command structure, see [Command Structure on page 562](#).

ribbon.cartridge.length

This command returns the original length of the ribbon cartridge installed in the printer. This is specified in meters. If a ribbon cartridge is not installed, then the printer returns "0". If the ribbon cartridge option is not present, then the command returns an empty string.

Getvar

To return the current setting:

```
! U1 getvar "ribbon.cartridge.length"
```

Result

"0" = cartridge is not installed

"" = cartridge option is not present

Example

In this example, the getvar returns the original length of the ribbon cartridge.

```
! U1 getvar "ribbon.cartridge.length" "100"
```



NOTES:

- For printer support, see [SGD Command Support on page 1455](#).
- For details on SGD command structure, see [Command Structure on page 562](#).

ribbon.cartridge.authenticated

This command returns the printer cartridge authentication status. The setting gets updated every time an authentication occurs (power up, head close, or any other time).

If a ribbon cartridge is not installed, then the printer returns "not installed". If the ribbon cartridge option is not present, then the command returns an empty string.

Getvar

To return the printer cartridge authentication status:

```
! U1 getvar "ribbon.cartridge.authenticated"
```

Result

"yes"	=	the cartridge installed is authenticated
"no"	=	the cartridge installed is not authenticated
	=	
"not installed"	=	printer supports ribbon cartridge, but it is not installed (initial condition prior to authentication)
"" (empty string)	=	printer does not support ribbon cartridge

Example

In this example, the getvar returns that the cartridge is authenticated.

```
! U1 getvar "ribbon.cartridge.authenticated" "yes"
```



NOTES:

- For printer support, see [SGD Command Support on page 1455](#).
- For details on SGD command structure, see [Command Structure on page 562](#).

ribbon.cartridge.inserted

This command returns if the ribbon cartridge is inserted or not. The command is hidden in an ALLCV.

Getvar

To return if the cartridge is inserted or not:

```
! U1 getvar "ribbon.cartridge.inserted"
```

Result

"yes" = the cartridge is inserted

"no" = the cartridge is not inserted or the cartridge mechanism does not exist, but the cartridge mechanism is an option on this printer platform



NOTES:

- For printer support, see [SGD Command Support on page 1455](#).
- For details on SGD command structure, see [Command Structure on page 562](#).

rtc.timezone

Specifies the POSIX-compliant time zone string. This string includes the following:

- the time zone character specifier
- the offset from UTC
- daylight savings time adjustment
- when to go on and off of daylight savings time (if it pertains to the timezone).

Setvar

To set the POSIX-compliant time zone string:

```
! U1 setvar "rtc.timezone" "value"
```

Values

www.iana.org/time-zones This site is updated periodically to reflect changes made by political bodies to time zone boundaries, UTC offsets, and daylight-saving rules.

Getvar

To return the current setting value:

```
! U1 getvar "rtc.timezone"
```

Example

If you live in New York in the United States, in the Eastern time zone, your `setvar` string may look like:

```
! U1 setvar "rtc.timezone" "EST5EDT4,M3.2.0/02:00:00,M11.1.0/02:00:00"
```

The "`value`" string can be translated as follows:

EST5 (Eastern Standard Time; 5 hours off UTC), **EDT4** (Eastern Daylight Time; 4 hours off UTC), running from 2AM (`/02`; fully qualified: `/02:00:00`) from the second Sunday in March (**M3.2.0/02**) through 2AM (`/02`; fully qualified: `/02:00:00`) on the first Sunday in November (**M11.1.0/02**).

M indicates the Month follows, followed by the two-digit month, the week (**1** is the first week in which the specified weekday occurs, and **5** indicates the last week of the month with that weekday) and the weekday (**0** is Sunday). The time starts with a slash, and unspecified trailing fields default to zero.

Other examples for locations in the United States:

- US Central:
! U1 setvar "rtc.timezone" "CST6CDT5,M3.2.0/02,M11.1.0/02"
- US Mountain:
! U1 setvar "rtc.timezone" "MST7MDT6,M3.2.0/02,M11.1.0/02"
- US Pacific:
! U1 setvar "rtc.timezone" "PST8PDT7,M3.2.0/02,M11.1.0/02"
- US Alaska:
! U1 setvar "rtc.timezone" "AST9ADT8,M3.2.0/02,M11.1.0/02"
- US Hawaii:
! U1 setvar "rtc.timezone" "HST10"

**NOTES:**

- For printer support, see [SGD Command Support on page 1455](#).
- For details on SGD command structure, see [Command Structure on page 562](#).

rtc.unix_timestamp

This command sets or gets the printer time based on the Unix Epoch (UTC) number of seconds since January 1 1970.

Setvar

To set the command:

```
! U1 setvar "rtc.unix_timestamp" "123123"
```

Values

0 to 0xFFFFFFFF

Getvar

To get the current printer time in seconds since 1970:

```
! U1 getvar "rtc.unix_timestamp"
```



NOTES:

- For printer support, see [SGD Command Support on page 1455](#).
- For details on SGD command structure, see [Command Structure on page 562](#).

sensor.battery.in_volts

This command retrieves information on the battery current in volts.

Getvar

To return the current setting:

```
! U1 getvar "sensor.battery.in_volts"
```

Result

"0.0" to "12.0" volts

Example

In the getvar example below, the battery current volt reading of "7.6" is returned.

```
! U1 getvar "sensor.battery.in_volts" "7.6"
```



NOTES:

- For printer support, see [SGD Command Support on page 1455](#).
- For details on SGD command structure, see [Command Structure on page 562](#).

sensor.back_bar.brightness

This command retrieves the current back bar sensor brightness level.

Getvar

To return the back bar sensor brightness level:

```
! U1 getvar "sensor.back_bar.brightness"
```

Example

In the example below, the getvar retrieves the back bar sensor brightness level of "10".

```
! U1 getvar "sensor.back_bar.brightness" "10"
```



NOTES:

- For printer support, see [SGD Command Support on page 1455](#).
- For details on SGD command structure, see [Command Structure on page 562](#).

sensor.back_bar.ppr_out_thold

This command retrieves the current back bar sensor paper out threshold value.

Getvar

To return the current sensor back bar paper out threshold value:

```
! U1 getvar "sensor.back_bar.ppr_out_thold"
```

Example

In the getvar example below, the current sensor back bar threshold value of "**10**" is returned.

```
! U1 getvar "sensor.back_bar.ppr_out_thold" "10"
```



NOTES:

- For printer support, see [SGD Command Support on page 1455](#).
- For details on SGD command structure, see [Command Structure on page 562](#).

sensor.back_bar.cur

This command retrieves the current back bar sensor value.

Getvar

To return the current back bar sensor value:

```
! U1 getvar "sensor.back_bar.cur"
```

Result

"0" to "255"

Example

In the getvar example below, the current sensor back bar value of "10" is returned.

```
! U1 getvar "sensor.back_bar.ppr_out_thold" "10"
```



NOTES:

- For printer support, see [SGD Command Support on page 1455](#).
- For details on SGD command structure, see [Command Structure on page 562](#).

sensor.cover_open

This printer setting determines if the printer media cover is open.

Getvar

To display if the printer cover is open or not:

```
! U1 getvar "sensor.cover_open"
```

Values

- "yes" = the printer cover is open
- "no" = the printer cover is closed



NOTES:

- For printer support, see [SGD Command Support on page 1455](#).
- For details on SGD command structure, see [Command Structure on page 562](#).

sensor.front_bar.ppr_out_thold

This command retrieves the current paper out threshold level of the front bar sensor of the printer.

Getvar

To return the current paper out threshold level:

```
! U1 getvar "sensor.front_bar.paper_out_threshold"
```

Example

In the getvar example below, the paper out threshold value of "**10**" is returned.

```
! U1 getvar "sensor.front_bar.paper_out_threshold" "10"
```



NOTES:

- For printer support, see [SGD Command Support on page 1455](#).
- For details on SGD command structure, see [Command Structure on page 562](#).

sensor.front_bar.cur

This command retrieves the current front bar sensor value.

Getvar

To return the current front bar sensor value:

```
! U1 getvar "sensor.front_bar.cur"
```

Result

"0" to "255"

Example

In the getvar example below, the front bar sensor value of "10" is returned.

```
! U1 getvar ! U1 getvar "sensor.front_bar.cur""10"
```



NOTES:

- For printer support, see [SGD Command Support on page 1455](#).
- For details on SGD command structure, see [Command Structure on page 562](#).

sensor.front_bar.thold

This command retrieves the current front bar sensor threshold value.

Getvar

To return the current front bar sensor threshold value:

```
! U1 getvar "sensor.front_bar.thold"
```

Example

In the getvar example below, the current front bar sensor threshold value of "4" is returned.

```
! U1 getvar "sensor.front_bar.thold" "4"
```



NOTES:

- For printer support, see [SGD Command Support on page 1455](#).
- For details on SGD command structure, see [Command Structure on page 562](#).

sensor.front_bar.gain

This command retrieves the current front bar sensor gain level.

Getvar

To return the current front bar sensor gain level:

```
! U1 getvar "sensor.front_bar.gain"
```

Example

In the getvar example below, the front bar sensor gain level of "10" is returned.

```
! U1 getvar "sensor.front_bar.gain" "10"
```



NOTES:

- For printer support, see [SGD Command Support on page 1455](#).
- For details on SGD command structure, see [Command Structure on page 562](#).

sensor.front_bar.brightness

This command retrieves the current front bar sensor brightness.

Getvar

To return the current front bar sensor brightness:

```
! U1 getvar "sensor.front_bar.brightness"
```

Example

In the getvar example below, the front bar sensor brightness level of "**10**" is returned.

```
! U1 getvar "sensor.front_bar.brightness" "10"
```



NOTES:

- For printer support, see [SGD Command Support on page 1455](#).
- For details on SGD command structure, see [Command Structure on page 562](#).

sensor.front_bar.offset

This command retrieves the current front bar sensor offset value.

Getvar

To return the current front bar sensor offset value:

```
! U1 getvar "sensor.front_bar.offset"
```

Example

In the getvar example below, the front bar sensor offset value of "10" is returned.

```
! U1 getvar "sensor.front_bar.offset" "10"
```



NOTES:

- For printer support, see [SGD Command Support on page 1455](#).
- For details on SGD command structure, see [Command Structure on page 562](#).

sensor.back_bar.offset

This command retrieves the current back bar sensor offset value.

Getvar

To return the current setting:

```
! U1 getvar "sensor.back_bar.offset"
```

Example

In the example below, the getvar retrieves the back bar sensor offset value of "**10**".

```
! U1 getvar "sensor.back_bar.offset" "10"
```



NOTES:

- For printer support, see [SGD Command Support on page 1455](#).
- For details on SGD command structure, see [Command Structure on page 562](#).

sensor.gap.thold

This command retrieves the current gap sensor threshold level.

Getvar

To return the current gap sensor threshold level:

```
! U1 getvar "sensor.gap.thold"
```

Example

In the example below, the getvar retrieves the current gap sensor threshold value of "10".

```
! U1 getvar "sensor.gap.thold" "10"
```



NOTES:

- For printer support, see [SGD Command Support on page 1455](#).
- For details on SGD command structure, see [Command Structure on page 562](#).

sensor.gap.offset

This command retrieves the current gap sensor offset value.

Getvar

To return the current gap sensor offset value:

```
! U1 getvar "sensor.gap.offset"
```

Example

In the example below, the getvar retrieves the current gap sensor offset value of "10".

```
! U1 getvar "sensor.gap.offset" "10"
```



NOTES:

- For printer support, see [SGD Command Support on page 1455](#).
- For details on SGD command structure, see [Command Structure on page 562](#).

sensor.gap.gain

This command retrieves the current gap sensor gain level.

Getvar

To return the current gap sensor gain level:

```
! U1 getvar "sensor.gap.gain"
```

Example

In the example below, the getvar retrieves the current gap sensor gain level of "10".

```
! U1 getvar "sensor.gap.gain" "10"
```



NOTES:

- For printer support, see [SGD Command Support on page 1455](#).
- For details on SGD command structure, see [Command Structure on page 562](#).

sensor.gap.brightness

This command retrieves the current gap sensor brightness level.

Getvar

To return the current gap sensor brightness level:

```
! U1 getvar "sensor.gap.brightness"
```

Example

In the example below, the getvar retrieves the current gap sensor brightness level of "10".

```
! U1 getvar "sensor.gap.brightness" "10"
```



NOTES:

- For printer support, see [SGD Command Support on page 1455](#).
- For details on SGD command structure, see [Command Structure on page 562](#).

sensor.head.temp_avg

This command retrieves the current average head temperature in Celsius.

Getvar

To return the current average head temperature:

```
! U1 getvar "sensor.head.temp_avg"
```

Result

-32768 to 32767 Celsius

Example

In the getvar example below, the head temperature average of "32" Celsius is returned.

```
! U1 getvar "sensor.head.temp_avg" "32"
```



NOTES:

- For printer support, see [SGD Command Support on page 1455](#).
- For details on SGD command structure, see [Command Structure on page 562](#).

sensor.head.temp_celsius

This command retrieves the current head temperature in Celsius.

Getvar

To return the current average head temperature:

```
! U1 getvar "sensor.head.temp_celsius"
```

Result

-32768 to 32767 Celsius

Example

In the getvar example below, the head temperature average of "0" is returned.

```
! U1 getvar "sensor.head.temp_celsius" "0"
```



NOTES:

- For printer support, see [SGD Command Support on page 1455](#).
- For details on SGD command structure, see [Command Structure on page 562](#).

sensor.head.temp

This command retrieves the current head temperature of the printer.

Getvar

To return the current average head temperature:

```
! U1 getvar "sensor.head.temp"
```

Result

-32768 to 32767 Celsius

Example

In the getvar example below, the head temperature average of "32" is returned.

```
! U1 getvar "sensor.head.temp" "32"
```



NOTES:

- For printer support, see [SGD Command Support on page 1455](#).
- For details on SGD command structure, see [Command Structure on page 562](#).

sensor.peel.thold

This command retrieves the current peel sensor threshold level.

Getvar

To return the current peel sensor threshold level:

```
! U1 getvar "sensor.peel.thold"
```

Example

In the example below, the getvar retrieves the current peel threshold level of "5".

```
! U1 getvar "sensor.peel.thold" "5"
```



NOTES:

- For printer support, see [SGD Command Support on page 1455](#).
- For details on SGD command structure, see [Command Structure on page 562](#).

sensor.peel.gain

This command retrieves the current peel sensor gain level.

Getvar

To return the current peel sensor gain level:

```
! U1 getvar "sensor.peel.gain"
```

Example

In the example below, the getvar retrieves the current peel gain level of "2".

```
! U1 getvar "sensor.peel.gain" "2"
```



NOTES:

- For printer support, see [SGD Command Support on page 1455](#).
- For details on SGD command structure, see [Command Structure on page 562](#).

sensor.paper_supply

Returns current paper supply status.

Getvar

To return the current paper supply status:

```
! U1 getvar "sensor.paper_supply"
```

Result

- "ok" = printer has paper.
- "out" = printer is out of paper.



NOTES:

- For printer support, see [SGD Command Support on page 1455](#).
- For details on SGD command structure, see [Command Structure on page 562](#).

sensor.peeler

Obtains current peeler sensor status.

Getvar

To retrieve the current peeler sensor status:

```
! U1 getvar "sensor.peeler"
```

Result

- "clear": the last printed item has been removed, or there are no items waiting to be removed.
- "not clear": last printed item has not yet been removed.



NOTES:

- For printer support, see [SGD Command Support on page 1455](#).
- For details on SGD command structure, see [Command Structure on page 562](#).

sensor.peel.brightness

This command returns the current peel sensor brightness level.

Getvar

To return the current peel sensor brightness level:

```
! U1 getvar "sensor.peel.brightness"
```

Example

In the example below, the getvar returns the current peel sensor brightness level of "2".

```
! U1 getvar "sensor.peel.brightness" "2"
```



NOTES:

- For printer support, see [SGD Command Support on page 1455](#).
- For details on SGD command structure, see [Command Structure on page 562](#).

sensor.width.in_dots

This command retrieves the current width sensor value in dots.

Getvar

To return the current width sensor value in dots:

```
! U1 getvar "sensor.width.in_dots"
```

Example

In the example below, the getvar retrieves the current width sensor value that is "200" dpi.

```
! U1 getvar "sensor.width.in_dots" "200"
```



NOTES:

- For printer support, see [SGD Command Support on page 1455](#).
- For details on SGD command structure, see [Command Structure on page 562](#).

sensor.width.cur

This command retrieves the current width sensor value.

Getvar

To return the current width sensor value:

```
! U1 getvar "sensor.width.cur"
```

Result

"0" to "255"

Example

In the example below, the getvar retrieves the current width sensor value.

```
! U1 getvar "sensor.width.cur" "5"
```



NOTES:

- For printer support, see [SGD Command Support on page 1455](#).
- For details on SGD command structure, see [Command Structure on page 562](#).

sensor.self_adjusting_enable

Enables the self-adjusting gap sensor.

Setvar

To enable the self-adjusting gap sensor:

```
! U1 setvar "sensor.self_adjusting_enable" "value"
```

Values

- "yes" = enables the self-adjusting gap sensor and disables the traditional gap sensor
- "no" = disables the self-adjusting gap sensor and enables the traditional gap sensor

Getvar

To retrieve the self-adjusting gap sensor:

```
! U1 getvar "sensor.self_adjusting_enable"
```

Example

This `setvar` example shows the value set to "yes".

```
! U1 setvar "sensor.self_adjusting_enable" "yes"
```

The `setvar` value is the `getvar` result. In this example, the `getvar` result is "yes".



NOTES:

- For printer support, see [SGD Command Support on page 1455](#).
- For details on SGD command structure, see [Command Structure on page 562](#).

usb.device.device_id_string

This command retrieves the manufacturer assigned IEEE1284 Device Identification string for USB devices.

Getvar

To retrieve the device ID string:

```
! U1 getvar "usb.device.device_id_string"
```

Example

```
! U1 getvar "usb.device.device_id_string"
```

Result

```
"MANUFACTURER:Zebra Technologies ;COMMAND SET:ZPL;MODEL:ZTC ZT220-200dpi  
ZPL;CLASS:PRINTER;OPTIONS:XML;"
```



NOTES:

- For printer support, see [SGD Command Support on page 1455](#).
- For details on SGD command structure, see [Command Structure on page 562](#).

usb.device.device_unique_id

This command sets the USB Unique Device ID setting. The identifier that makes any printer unique is set by the `usb.device.serial_string` command which is reported to the USB driver.

By default `usb.device.serial_string` reports the printer's serial number. If `usb.device_unique_id` is set to `"off"` the printer will report the `usb.device.serial_string` parameter as its product family (e.g. ZT230, etc).

When subsequent printers of the same model, with `usb.device_unique_id` parameter to `"off"`, are connected via USB, the host computer will not treat them as a new Plug and Play events, nor require new driver installations.

Setvar

To set the current USB Unique Device Id setting:

```
! U1 setvar "usb.device.device_unique_id" "value"
```

Values

- `"off"`
- `"on"`

Default

`"on"`

Getvar

To return the current USB Unique Device Id setting stored in the printer:

```
! U1 getvar "usb.device.device_unique_id"
```

Example

```
! U1 setvar "usb.device.device_unique_id" "off"
```



NOTES:

- For printer support, see [SGD Command Support on page 1455](#).
- For details on SGD command structure, see [Command Structure on page 562](#).

usb.device.device_version

This command returns the version of the USB device being queried.

Commands	Details
<ul style="list-style-type: none"> <code>getvar</code> 	This command instructs the printer to respond with the printer's USB version. Format: <code>! U1 getvar "usb.device.device_version"</code>

Example

```
! U1 getvar "usb.device.device_version"
"1.1"
```



NOTES:

- For printer support, see [SGD Command Support on page 1455](#).
- For details on SGD command structure, see [Command Structure on page 562](#).

usb.device.manufacturer_string

This command retrieves the USB device manufacturer's name.

Getvar

To respond with the manufacturer name:

```
! U1 getvar "usb.device.manufacturer_string"
```

Example

```
! U1 getvar "usb.device.manufacturer_string"  
"Zebra Technologies"
```



NOTES:

- For printer support, see [SGD Command Support on page 1455](#).
- For details on SGD command structure, see [Command Structure on page 562](#).

usb.device.product_id

This command retrieves the Product Identification number that a manufacturer assigned to a particular product. This number, along with the Vendor ID, allows a USB host to distinguish between devices.

Getvar

To retrieve the product ID:

```
! U1 getvar "usb.device.product_id"
```

Example

```
! U1 getvar "usb.device.product_id"  
"003D"
```



NOTES:

- For printer support, see [SGD Command Support on page 1455](#).
- For details on SGD command structure, see [Command Structure on page 562](#).

usb.device.product_string

This command returns the manufacturer-assigned string describing a particular USB product.

Getvar

To instruct the printer to respond with the product string description:

```
! U1 getvar "usb.device.product_string"
```

Example

Issuing the command on a ZT210 printer:

```
! U1 getvar "usb.device.product_string"  
"ZT210"
```

Issuing the command on a QLn320 printer:

```
! U1 getvar "usb.device.product_string"  
"ZTC QLn320-203dpi CPCL"
```



NOTES:

- For firmware V68.19.0 and V72.19.0, the return value was changed to the longer name, which is the same as the USB PID. The QLnXXX is replaced by the printer model and number for each printer.
- For printer support, see [SGD Command Support on page 1455](#).
- For details on SGD command structure, see [Command Structure on page 562](#).

usb.device.serial_string

This command returns the manufacturer-assigned serial number for a particular USB product.

Getvar

To return the printer's serial number:

```
! U1 getvar "usb.device.serial_string"
```

Example

```
! U1 getvar "usb.device.serial_string"  
"ABC1234567890"
```



NOTES:

- For printer support, see [SGD Command Support on page 1455](#).
- For details on SGD command structure, see [Command Structure on page 562](#).

usb.device.vendor_id

This command returns the Vendor Identification number that the USB-IF organization has assigned to a manufacturer. This number, along with the Product ID, allows a USB host to distinguish between devices.

Getvar

To retrieve the vendor ID of the device:

```
! U1 getvar "usb.device.vendor_id"
```

Example

```
! U1 getvar "usb.device.vendor_id"  
"0a5f"
```



NOTES:

- For printer support, see [SGD Command Support on page 1455](#).
- For details on SGD command structure, see [Command Structure on page 562](#).

usb.halt

This command controls whether the printer allows communication over the USB port when the printer is in an error condition.

Setvar

To control whether the printer allows communication over the USB port when the printer is in an error condition:

```
! U1 setvar "usb.halt" "value"
```

Values

- "yes"
- "no"

Default

"no"

Getvar

To return the current "usb.halt" setting stored in the printer:

```
! U1 getvar "usb.halt"
```

Example

```
! U1 setvar "usb.halt" "yes"
```



NOTES:

- For printer support, see [SGD Command Support on page 1455](#).
- For details on SGD command structure, see [Command Structure on page 562](#).

usb.host.config_info_to_usb

This command is used by WML to save the ^HH output files to the USB thumb drive. The file names are written in the CONFIGxxx.TXT format, where xxx ranges from 1 to 999.

Setvar

To enable or disable saving the ^HH output to the USB thumb drive:

```
! U1 setvar "usb.host.config_info_to_usb" "values"
```

Values

"yes" = ^HH output is saved

"no" = No action is taken

Example

In the setvar example below, the ^HH output file is saved to the USB thumb drive.

```
! U1 setvar "usb.host.config_info_to_usb" "yes"
```



NOTES:

- For printer support, see [SGD Command Support on page 1455](#).
- For details on SGD command structure, see [Command Structure on page 562](#).

usb.host.fn_field_data

This command is used to collect a user's response to a presented ^FN prompt.



IMPORTANT: This command is used only in the context of the on-printer Print Station application. Altering the use of this command in the WML can make the Print Station application non-functional. It is recommended changes to portions of this portion of the menu system be done by Zebra Professional Services team.

Setvar

To collect a user's response to a presented ^FN prompt:

```
! U1 setvar "usb.host.fn_field_data" "value"
```

Values

the text entered by the user via a USB Human Interface Device (HID) keyboard

Default

"NULL"

Getvar

To retrieve the current setting value:

```
! U1 getvar "usb.host.fn_field_data"
```

Result

One of the following:

- NULL
- the current user response to an ^FN prompt



NOTES:

- For printer support, see [SGD Command Support on page 1455](#).
- For details on SGD command structure, see [Command Structure on page 562](#).

usb.host.fn_last_field

This command is intended for use by WML code to control the presentation of ^FN fields contained within a template file that resides on the E:/ drive and has an extension of .ZPL.

Getvar

To return the current setting value:

```
! U1 getvar "usb.host.fn_last_field"
```

Result

YES or NO



NOTES:

- For printer support, see [SGD Command Support on page 1455](#).
- For details on SGD command structure, see [Command Structure on page 562](#).

usb.host.hid_count

This command displays the number of USB Human Interface Devices (HIDs) connected to the printer. Refer to <http://www.usb.org> for further details on USB device types.

Getvar

To retrieve the number of USB HIDs connected to the printer:

```
! U1 getvar "usb.host.hid_count"
```

Result

When no devices are attached:

```
! U1 getvar "usb.host.hid_count"  
"0"
```



NOTES:

- For printer support, see [SGD Command Support on page 1455](#).
- For details on SGD command structure, see [Command Structure on page 562](#).

usb.host.keyboard_input

This command enables/disables USB keyboard input to the printer, affecting the Print Station user menu item.

Setvar

To enable or disable USB keyboard input to the printer:

```
! U1 setvar "usb.host.keyboard_input"
```

Values

- "on"—keyboard input is supported.
- "off"—keyboard input is not supported

Default

on

Getvar

To retrieve the current setting value:

```
! U1 getvar "usb.host.keyboard_input"
```



NOTES:

- For printer support, see [SGD Command Support on page 1455](#).
- For details on SGD command structure, see [Command Structure on page 562](#).

usb.host.lock_out

This command enables/disables the USB host port.

Setvar

To enable or disable the USB port:

```
! U1 setvar "usb.host.lock_out" "value"
```

Values

- "on"—the USB host port is enabled.
- "off"—the USB host port is disabled.

Default

"on"

Getvar

To return the current setting value:

```
! U1 getvar "usb.host.lock_out"
```



NOTES:

- For printer support, see [SGD Command Support on page 1455](#).
- For details on SGD command structure, see [Command Structure on page 562](#).

usb.host.mass_storage_count

This command displays the number of USB mass storage devices connected to the printer. Only the first USB mass storage device found will be mounted and accessible.

Getvar

To retrieve the current setting value:

```
! U1 getvar "usb.host.mass_storage_count"
```



NOTES:

- For printer support, see [SGD Command Support on page 1455](#).
- For details on SGD command structure, see [Command Structure on page 562](#).

usb.host.read_list

This command scans the mounted usb mass storage device for non-user-restricted files and displays the files in a list.

Setvar

To scan the mounted usb mass storage device for non-user-restricted files and displays the files in a list:

```
! U1 setvar "usb.host.read_list" "value"
```

Values

- **"fill_store"**—The printer creates a list of all of the top-level files that are readable on a connected mass storage device. (.ZPL and .XML files)
- **"store"**—The printer copies the current file (the file listed on the display) or all eligible files if **SELECT ALL** is displayed from the USB mass storage device to the printer's **E:** drive.



NOTE: Store does an exact byte-for-byte copy of the file being stored. ZPL files that are transferred to the printer using the "store" command are NOT prepared to be used with a recall format command (^XF). See XREF Character Substitution (in Mirror) for the modifications necessary to prepare a ZPL file for use with ^XF. If the ZPL file contains a ^DF, the appropriate way to place it on the printer's memory is to use the **"print"** command, below.

- **"fill_print"**—The printer analyzes the content of the USB mass storage device and creates a list of files that may be printed. (.ZPL files only)
- **"print"**—The printer prints the current file (the file listed on the display) or all eligible files if **SELECT ALL** is displayed.
- **"clear"** -

Getvar

To return the current setting value:

```
! U1 getvar "usb.host.read_list"
```

Result

the current file in the list or **NONE**

Example

```
! U1 getvar "usb.host.read_list"
One of the following:
```

- The current file in the list.
- **NONE** if there are no files on the USB mass storage device.



NOTES:

- For printer support, see [SGD Command Support on page 1455](#).
- For details on SGD command structure, see [Command Structure on page 562](#).

usb.host.read_list_print_delay

This command specifies a number of milliseconds for the printer to wait before processing the next file when “SELECT ALL” is chosen on the **USB PRINT FILES** user menu.

Setvar

To specify the print delay time in milliseconds:

```
! U1 setvar "usb.host.read_list_print_delay"
```

Values

0 to 65535

Default

"0"

Getvar

To return the current setting value:

```
! U1 getvar "usb.host.read_list_print_delay"
```



NOTES:

- For printer support, see [SGD Command Support on page 1455](#).
- For details on SGD command structure, see [Command Structure on page 562](#).

usb.host.template_list

This command is used by WML to support selecting `.ZPL` template files resident on the `E:/` drive.

Setvar

To list the `*.ZPL` files from the E drive:

```
! U1 getvar "usb.host.template_list"
```

Values

- `"fill"`—The printer analyzes the contents of its `E:/` drive and creates a list of the template files with a `.ZPL` extension.
- `"up"`—moves to the previous file in the list
- `"down"`—moves to the next file in the list

Default

`"on"`

Getvar

- To return the current setting value:

```
! U1 getvar "usb.host.template_list"
```

Result

One of the following:

- **UNINITIALIZED**
- **IN PROGRESS**
- **NONE** (if no `.ZPL` files reside on the `E:/` drive)

the current `.ZPL` file



NOTES:

- For printer support, see [SGD Command Support on page 1455](#).
- For details on SGD command structure, see [Command Structure on page 562](#).

usb.host.template_print_amount

This command is used by WML to control the number of template-type labels to print.

Setvar

To control the number of template-type labels to print:

```
! U1 setvar "usb.host.template_print_amount" "value"
```

Values

- 1 to 99999
- "up" - moves to the previous file in the list
- "down" - moves to the next file in the list

Default

"1" which will change based on the contents of the selected template file

Getvar

To retrieve the current setting value:

```
! U1 getvar "usb.host.template_print_amount"
```

Result

the current value



NOTES:

- For printer support, see [SGD Command Support on page 1455](#).
- For details on SGD command structure, see [Command Structure on page 562](#).

usb.host.write_list

This command scans the E: flash drive for non-user-restricted files and displays the files in a list.

Setvar

To scan the E: flash drive for non-user-restricted files and displays the files in a list:

```
! U1 setvar "usb.host.write_list" "value"
```

Values

- **"fill_store"**—The printer analyzes the contents of its E: drive and creates a list of files that may be copied to a USB mass storage device connected to the printer.
- **"store"**—The printer copies the current file (the file listed on the display) or all eligible files if **SELECT ALL** is displayed to the USB mass storage device.
- **"up"**
- **"down"**

Default

"on"

Getvar

To return the current setting value:

```
! U1 getvar "usb.host.write_list"
```

Result

One of the following:

The current file in the list.

- **NONE** if there are no files on the printer's E: drive.
- **READONLY** if the USB mass storage device is read-only.



NOTES:

- For printer support, see [SGD Command Support on page 1455](#).
- For details on SGD command structure, see [Command Structure on page 562](#).

usb.mirror.appl_path

This command specifies the path to the location on a USB device from which Mirror files are retrieved. If no path is specified, then the path is `zebra/app1`.

Setvar

To specify the path to the location on a USB device from which Mirror files are retrieved:

```
! U1 setvar "usb.mirror.appl_path" "path"
```

Values

a valid path up to 255 characters

Default

```
"zebra/app1"
```

Getvar

To retrieve the current setting value:

```
! U1 getvar "usb.mirror.appl_path"
```



NOTES:

- For printer support, see [SGD Command Support on page 1455](#).
- For details on SGD command structure, see [Command Structure on page 562](#).

usb.mirror.auto

This command determines if mirroring happens automatically when a USB device is inserted in the printer. To use this function, the setting for `usb.mirror.enable` must be "on".

Setvar

To set the automatic mirroring of a USB device:

```
! U1 setvar "usb.mirror.auto" "value"
```

Values

- "on"—mirroring occurs automatically when the USB device is inserted and `usb.mirror.enable` is on.
- "off"—mirroring does not occur automatically when the USB device is inserted.
- "prompt"—the printer gives you the option to start or abort a mirroring process.

Getvar

To return the current setting value:

```
! U1 getvar "usb.mirror.auto"
```



NOTES:

- For printer support, see [SGD Command Support on page 1455](#).
- For details on SGD command structure, see [Command Structure on page 562](#).

usb.mirror.enable

This command enables or disables the ability to perform mirroring of a USB device.

Setvar

To enable or disable the USB device mirroring ability:

```
! U1 setvar "usb.mirror.enable" "value"
```

Values

- "on"—mirroring is enabled
- "off"—mirroring is disabled

Default

"on"

Getvar

To retrieve the current setting value:

```
! U1 getvar "usb.mirror.enable"
```



NOTES:

- For printer support, see [SGD Command Support on page 1455](#).
- For details on SGD command structure, see [Command Structure on page 562](#).

usb.mirror.enabled

Enables or disables the ability to perform mirroring using a USB device memory stick.

Setvar

To set the command:

```
! U1 setvar "usb.mirror.enabled" "value"
```

Values

- **on** — mirroring is enabled
- **off** — mirroring is disabled

Default

on

Getvar

To have the printer return the current setting value:

```
! U1 getvar "usb.mirror.enabled"
```



NOTES:

- For printer support, see [SGD Command Support on page 1455](#).
- For details on SGD command structure, see [Command Structure on page 562](#).

usb.mirror.error_retry

This command specifies the number of times that the USB mirror operation will be repeated if the process fails.

Setvar

To specify the number of times that the USB mirror operation will be repeated:

```
! U1 setvar "usb.mirror.error_retry" "value"
```

Values

0 to 65535

Default

"0"

Getvar

To retrieve the current setting value:

```
! U1 getvar "usb.mirror.error_retry"
```



NOTES:

- For printer support, see [SGD Command Support on page 1455](#).
- For details on SGD command structure, see [Command Structure on page 562](#).

usb.mirror.feedback.auto

This command determines if a feedback file is written to the USB device connected to the printer after mirroring.

Setvar

To specify if the feedback file is written to the USB device or not:

```
! U1 setvar "usb.mirror.feedback.auto" "value"
```

Values

- "on"—a feedback file is written to the USB device connected to the printer.
- "off"—a feedback file is not written to the USB device connected to the printer.

Getvar

To return the current setting value:

```
! U1 getvar "usb.mirror.feedback.auto"
```



NOTES:

- For printer support, see [SGD Command Support on page 1455](#).
- For details on SGD command structure, see [Command Structure on page 562](#).

usb.mirror.feedback.odometer

This command instructs the printer to set or retrieve the `usb.mirror.feedback.odometer` value.

Setvar

To set the `usb.mirror.feedback.odometer` value:

```
! U1 setvar "usb.mirror.feedback.odometer" "value"
```

Values

0 to 65535

Default

"0"

Example

This example sets the counter to 0, which resets the counter.

```
! U1 setvar "usb.mirror.feedback.odometer" "0"
```

Getvar

To retrieve the `usb.mirror.feedback.odometer` value:

```
! U1 getvar "usb.mirror.feedback.odometer"
```



NOTES:

- For printer support, see [SGD Command Support on page 1455](#).
- For details on SGD command structure, see [Command Structure on page 562](#).

usb.mirror.feedback.path

This command specifies where the feedback file is stored on the USB drive connected to the printer.

Setvar

To specify the path of the feedback file stored on the USB drive:

```
! U1 setvar "usb.mirror.feedback.path" "value"
```

Values

a valid path up to 255 characters



NOTE:

The path must exist on the USB drive before the printer can write files to it.

Default

```
"zebra/feedback"
```

Getvar

To return the current setting value:

```
! U1 getvar "usb.mirror.feedback.path"
```



NOTES:

- For printer support, see [SGD Command Support on page 1455](#).
- For details on SGD command structure, see [Command Structure on page 562](#).

usb.mirror.fetch

This command immediately initiates a USB mirroring operation. To use this function, the setting for `usb.mirror.enable` must be "on".

Do

To initiate a USB mirroring operation:

```
! U1 do "usb.mirror.fetch"
```



NOTES:

- For printer support, see [SGD Command Support on page 1455](#).
- For details on SGD command structure, see [Command Structure on page 562](#).

usb.mirror.last_error

This command returns the last USB mirroring error string. If there are no errors, the result is "No Error".

Getvar

To return the last USB mirroring error string:

```
! U1 getvar "usb.mirror.last_error"
```



NOTES:

- For printer support, see [SGD Command Support on page 1455](#).
- For details on SGD command structure, see [Command Structure on page 562](#).

usb.mirror.last_time

This command returns the date and time of the last USB mirroring operation. The date and time reported are from the printer's clock.

Getvar

To return the date and time of the last USB mirroring operation:

```
! U1 getvar "usb.mirror.last_time"
```

Result

```
02 18 2015 11:10:09 (mm dd yyyy hh:mm:ss)
```



NOTES:

- For printer support, see [SGD Command Support on page 1455](#).
- For details on SGD command structure, see [Command Structure on page 562](#).

usb.mirror.path

This command specifies the root directory on the connected USB drive. The root directory contains the subdirectories from which files are retrieved during the mirror operation. If no path is specified, then the path is `/zebra`.

The standard subdirectories to use are:

- "`<update-root>`"/`appl`
- "`<update-root>`"/`files`
- "`<update-root>`"/`commands`
- "`<feedback-root>`"

See [How Mirror Works on page 1524](#) for a comprehensive overview of mirroring.

Setvar

To specify the root directory on the connected USB drive:
`! U1 setvar "usb.mirror.appl_path" "path"`

Values

a valid path up to 255 characters

Default

`"zebra"`

Getvar

To retrieve the current setting:

`! U1 getvar "usb.mirror.path"`



NOTES:

- For printer support, see [SGD Command Support on page 1455](#).
- For details on SGD command structure, see [Command Structure on page 562](#).

usb.mirror.reset_delay

This command specifies a number of seconds for the printer to wait after it loads the last of the files in the `/commands` directory during mirroring.

Setvar

To specify the USB mirror reset delay time:

```
! U1 setvar "usb.mirror.reset_delay"
```

Values

0 to 900

Default

"5"

Getvar

To return the current setting value:

```
! U1 getvar "usb.mirror.reset_delay"
```



NOTES:

- For printer support, see [SGD Command Support on page 1455](#).
- For details on SGD command structure, see [Command Structure on page 562](#).

usb.mirror.success

This command returns the last USB mirroring event status string.

Getvar

To return the last USB mirroring event status string:

```
! U1 getvar "usb.mirror.success"
```

Values

- **yes** (indicates that the mirroring operation was successful)
- **no** (indicates that the mirroring operation was not successful)



NOTES:

- For printer support, see [SGD Command Support on page 1455](#).
- For details on SGD command structure, see [Command Structure on page 562](#).

usb.mirror.success_time

This command returns the date and time of the last successful USB mirroring operation. The date and time reported are from the printer's clock.

Getvar

To return the date and time of the last successful USB mirroring operation:

```
! U1 getvar "usb.mirror.success_time.fm"
```

Result

```
02 18 2015 11:10:09 (mm dd yyyy hh:mm:ss)
```



NOTES:

- For printer support, see [SGD Command Support on page 1455](#).
- For details on SGD command structure, see [Command Structure on page 562](#).

zbi.control.add_breakpoint

This command instructs the printer to set a ZBI program break point. For printer support, see [SGD Command Support on page 1455](#).

Setvar

To instruct the printer to set a ZBI program break point:

```
! U1 setvar "zbi.control.add_breakpoint" "value"
```

Values

Any line number of the program currently being debugged.

Example

This `setvar` example shows setting the breakpoint at line "30".

```
! U1 setvar "zbi.control.add_breakpoint" "30"
```



NOTE:

For details on SGD command structure, see [Command Structure on page 562](#).

zbi.control.break

This command breaks the execution of the ZBI 2.0 program that is currently running. For printer support, see [SGD Command Support on page 1455](#).

Setvar

To break the execution of the ZBI program that is currently running:

```
! U1 setvar "zbi.control.break" ""
```

Values

```
""
```

Example

This `setvar` example shows the value set to "".

```
! U1 setvar "zbi.control.break" ""
```



NOTES:

For details on SGD command structure, see [Command Structure on page 562](#).

zbi.control.clear_breakpoints

This command deletes all breakpoints in the current ZBI 2.0 program. For printer support, see [SGD Command Support on page 1455](#).

Setvar

To instruct the printer to delete all breakpoints:

```
! U1 setvar "zbi.control.clear_breakpoints" ""
```

Values

```
""
```

Example

This `setvar` example shows the value set to "".

```
! U1 setvar "zbi.control.clear_breakpoints" ""
```



NOTE:

For details on SGD command structure, see [Command Structure on page 562](#).

zbi.control.delete_breakpoint

This command deletes a breakpoint in the current ZBI 2.0 program. For printer support, see [SGD Command Support on page 1455](#).

Setvar

To instruct the printer to delete the breakpoint at the line indicated by the value parameter:

```
! U1 setvar "zbi.control.delete_breakpoint" "value"
```

Values

You can use the same value as `add_breakpoint`.

Example

This `setvar` example shows the breakpoint set to "30".

```
! U1 setvar "zbi.control.delete_breakpoint" "30"
```



NOTE:

For details on SGD command structure, see [Command Structure on page 562](#).

zbi.control.line_number

This command gives you control and information about which line of a stopped ZBI 2.0 program is being executed. For printer support, see [SGD Command Support on page 1455](#).

Setvar

To sets which line of the current ZBI 2.0 program should be executed:

```
! U1 setvar "zbi.control.line_number" "value"
```

Values

Any line number of the currently stopped ZBI program.

Default

"0"

Getvar

To return the line number that is currently being executed in the ZBI 2.0 program:

```
! U1 getvar "zbi.control.line_number"
```

Example

This **setvar** example shows the value parameter set to "30".

```
! U1 setvar "zbi.control.line_number" "30"
```

When the **setvar** value is set to "30", the **getvar** result is "30".



NOTE:

For details on SGD command structure, see [Command Structure on page 562](#).

zbi.control.restart

This command restarts a ZBI 2.0 program that is currently stopped. For printer support, see [SGD Command Support on page 1455](#).

Setvar

To restart a ZBI 2.0 program that is currently stopped:

```
! U1 setvar "zbi.control.restart" "value"
```

Values

""

Example

This `setvar` example shows the value set to "".

```
! U1 setvar "zbi.control.restart" ""
```



NOTE:

For details on SGD command structure, see [Command Structure on page 562](#).

zbi.control.run

This command runs the current ZBI 2.0 program that is loaded in the interpreter. For printer support, see [SGD Command Support on page 1455](#).

Setvar

To run the ZBI 2.0 program that is loaded in the interpreter:

```
! U1 setvar "zbi.control.run" ""
```

Values

```
""
```

Example

This `setvar` example shows the value set to "".

```
! U1 setvar "zbi.control.run" ""
```



NOTE:

For details on SGD command structure, see [Command Structure on page 562](#).

zbi.control.step

This command restarts the execution of the currently stopped ZBI 2.0 program for one line. For printer support, see [SGD Command Support on page 1455](#).

Setvar

To instruct the printer to restart the execution of the currently stopped ZBI 2.0 program for one line:

```
! U1 setvar "zbi.control.step" ""
```

Values

""

Default

""

Example

This `setvar` example shows the value set to "".

```
! U1 setvar "zbi.control.step" ""
```

When the `setvar` value is set to "".



NOTE:

For details on SGD command structure, see [Command Structure on page 562](#).

zbi.control.terminate

This command instructs the ZBI 2.0 program to terminate and shuts down the interpreter. For printer support, see [SGD Command Support on page 1455](#).

Setvar

To instruct the ZBI 2.0 program to terminate and shuts down the interpreter:

```
! U1 setvar "zbi.control.terminate" "value"
```

Values

```
""
```

Example

This `setvar` example shows the value set to "".

```
! U1 setvar "zbi.control.terminate" ""
```



NOTE:

For details on SGD command structure, see [Command Structure on page 562](#).

zbi.control.variable_name

This command sets the name of the variable that is to be read or modified through `variable_value`. For printer support, see [SGD Command Support on page 1455](#).

Setvar

To set the variable that is to show on the front panel:

```
! U1 setvar "zbi.control.variable_name" "value"
```

Values

Any ZBI variable in the program that is currently being debugged.

Default

""

Getvar

To retrieve the variable value that is to show on the front panel:

```
! U1 getvar "zbi.control.variable_name"
```

Example

This `setvar` example shows the value set to "MYVAR\$".

```
! U1 setvar "zbi.control.variable_name" "MYVAR$"
```

When the `setvar` value is set to "MYVAR\$", the `getvar` result is "MYVAR\$".



NOTES:

For details on SGD command structure, see [Command Structure on page 562](#).

zbi.control.variable_value

This command identifies the variable name. For printer support, see [SGD Command Support on page 1455](#).

Setvar

To set a value to the variable referenced by a `variable_name`:

```
! U1 setvar "zbi.control.variable_value" "value"
```

Values

A string or integer that is dependent on the variable type in `variable_name`.

Default

The current value of the variable referenced via `variable_name`

Getvar

To retrieve the variable name that is loaded into the `variable_name`:

```
! U1 getvar "zbi.control.variable_value"
```

Example

This `setvar` example shows the value set to "Hello World".

```
! U1 setvar "zbi.control.variable_value" "Hello World"
```

When the `setvar` value is set to "Hello World", the `getvar` result is "Hello World".



NOTES:

For details on SGD command structure, see [Command Structure on page 562](#).

zbi.enable

This command enables ZBI on the printer.

Setvar

To set the command:

```
! U1 setvar "zbi.enable" "value"
```

Values

- on
- off

Default:

"on"

Getvar

To have the printer return the current setting value:

```
! U1 getvar "zbi.enable"
```



NOTES:

- For printer support, see [SGD Command Support on page 1455](#).
- For details on SGD command structure, see [Command Structure on page 562](#).

zbi.key

This command identifies if the ZBI 2.0 option is enabled or disabled on the printer. For printer support, see [SGD Command Support on page 1455](#).

Getvar

To retrieve the status of the ZBI 2.0 option on the printer:

```
! U1 getvar "zbi.key"
```

Example

In this example, the `getvar` shows the status of ZBI on the printer.

```
! U1 getvar "zbi.key"  
"ENABLED"
```



NOTES:

For details on SGD command structure, see [Command Structure on page 562](#).

zbi.last_error

This command identifies the last error that the ZBI 2.0 interpreter encountered.

Getvar

To show the last error that the ZBI 2.0 interpreter encountered:

```
! U1 getvar "zbi.last_error"
```

Example

This example demonstrates how to make the ZBI 2.0 interpreter return the last error it encountered.

```
! U1 getvar "zbi.last_error"
```



NOTES:

- For details on SGD command structure, see [Command Structure on page 562](#).
- For printer support, see [SGD Command Support on page 1455](#).

zbi.program_list

This SGD is intended to be used on WML pages. Its purpose is to support displaying the name of each ZBI program file contained on the E: drive.



IMPORTANT: A specific sequence required to get an accurate listing of files. See the example below.

Setvar

To display the program list:

```
! U1 setvar "zbi.program_list" "value"
```

Values

- "fill" = initializes the device (first step)
- "up" = gets the previous file in the list
- "down" = gets the next file in the list
- "execute" = executes the currently specified zbi file (as determined by the getvar command)

Default

- "none"

Example

A specific sequence of commands is required to get an accurate listing of files.

Initialize the device by issuing:

```
! U1 setvar "zbi.program_list" "fill"
```

To get the first file, issue:

```
! U1 getvar "zbi.program_list"
```

This will return the current filename in the list of zbi files present on the E: drive. If the response returned is "none" you have reached the end of the list.

To get the next filename in the list, issue:

```
! U1 setvar "zbi.program_list" "up"
```

To get the previous filename in the list, issue:

```
! U1 setvar "zbi.program_list" "down"
```

To execute the current zbi filename, i.e. the one returned by a getvar, issue:

```
! U1 setvar "zbi.program_list" "execute"
```

Getvar

To return the current setting value:

```
! U1 getvar "zbi.program_list"
```



NOTES:

- For device support, see [SGD Command Support on page 1455](#).
- For details on SGD command structure, see [Command Structure on page 562](#).

zbi.reseller_key

This command allows programs that are encrypted with this key in ZBI- Developer to run. For printer support, see [SGD Command Support on page 1455](#).

Setvar

To allow programs that are encrypted with this key in ZBI developer to run:

```
! U1 setvar "zbi.reseller_key" "value"
```

Values

Any valid encryption key provided by ZBI Developer.

Example

This `setvar` example shows the value set to "abc123".

```
! U1 setvar "zbi.reseller_key" "abc123".
```



NOTE:

For details on SGD command structure, see [Command Structure on page 562](#).

zbi.revision

This command identifies the current ZBI version. For printer support, see [SGD Command Support on page 1455](#).

Getvar

To retrieve the current ZBI version:

```
! U1 getvar "zbi.revision"
```

Example

In this example, the `getvar` shows the current ZBI version.

```
! U1 getvar "zbi.revision"
```



NOTE:

For details on SGD command structure, see [Command Structure on page 562](#).

zbi.running_program_name

This command identifies the name of the ZBI 2.0 program that is currently running. For printer support, see [SGD Command Support on page 1455](#).

Getvar

To retrieve the name of the currently running ZBI 2.0 program:

```
! U1 getvar "zbi.running_program_name"
```

Example

In this example, the `getvar` command causes the printer to respond that the program `choices.bas` is currently running.

```
! U1 getvar "zbi.running_program_name"  
"CHOICES.BAS"
```



NOTE:

For details on SGD command structure, see [Command Structure on page 562](#).

zbi.start_info.execute

This command instructs the ZBI 2.0 environment to execute the program listed in the file_name. For printer support, see [SGD Command Support on page 1455](#).

Setvar

To instruct the ZBI 2.0 environment to execute the program listed in the file_name:

```
! U1 setvar "zbi.start_info.execute"
```

Example

This setvar example executes the "choices.bas" program.

```
! U1 setvar "zbi.start_info.execute" "choices.bas"
```



NOTE:

For details on SGD command structure, see [Command Structure on page 562](#).

zbi.start_info.file_name

This command prepares a program to run when the `zbi.start_info.execute` command is used. This command does not run the program. For printer support, see [SGD Command Support on page 1455](#).

Setvar

To prepare a ZBI 2.0 program to be executed using the `zbi.start_info.execute` command:

```
! U1 setvar "zbi.start_info.file_name" "value"
```

Values

a file name or path of a basic program

Getvar

To return the file path and file name of a ZBI 2.0 program to run using the `zbi.start_info.execute` command:

```
! U1 getvar "zbi.start_info.file_name"
```

Default

The last program run. If nothing has been run, `*:\.BAZ`.

Example

This `setvar` example shows the value set to `"E:PROGRAM1.BAS"`.

```
! U1 setvar "zbi.start_info.file_name" "E:PROGRAM1.BAS"
```

When the `setvar` value is set to `"E:PROGRAM1.BAS"`, the `getvar` result is `"E:PROGRAM1.BAS"`.



NOTE:

For details on SGD command structure, see [Command Structure on page 562](#).

zbi.start_info.memory_alloc

This command identifies the amount of memory currently in use in a ZBI 2.0 program. For printer support, see [SGD Command Support on page 1455](#).

Getvar

To show the amount of memory currently in use in bytes:

```
! U1 getvar "zbi.start_info.memory_alloc"
```

Example

In this example, the `getvar` shows the amount of memory currently in use.

```
! U1 getvar "zbi.start_info.memory_alloc"  
"17203"
```



NOTE:

For details on SGD command structure, see [Command Structure on page 562](#).

zbi.state

This command shows the current state of the ZBI 2.0 program. For printer support, see [SGD Command Support on page 1455](#).

Getvar

To retrieve the current state of ZBI:

```
! U1 getvar "zbi.state"
```

Values

- "running" = ZBI Interpreter is active and running a program
- "off" = ZBI Interpreter is inactive
- "stopped" = ZBI Interpreter is active but not executing a program

Example

In this example, the `getvar` shows that state of ZBI.

```
! U1 getvar "zbi.state"  
"running"
```



NOTE:

For details on SGD command structure, see [Command Structure on page 562](#).

zpl.calibrate

This command measures the media label length that is installed in the printer. It then sets the "zpl.label_length" parameter to the detected media label length.

Do

To calibrate to the media installed in the printer:

```
! U1 do "zpl.calibrate" ""
```

Values

NA



NOTES:

- For printer support, see [SGD Command Support on page 1455](#).
- For details on SGD command structure, see [Command Structure on page 562](#).

zpl.format_prefix

This command sets or returns the format character to the character corresponding to the Ascii Hex value xx. This command is similar to the ^CC and ~CC commands.

Setvar

To set the format character to the character corresponding to the Ascii Hex value xx:

```
! U1 setvar "zpl.format_prefix" "xx"
```

Values

"xx" = "00-FF", "00-ff", "up","down"

- Specifying the up or down will increment or decrement the current value.
- Note that the increment/decrement will skip over conflicting values.
- Conflicting values for zpl.format_prefix are zpl.command_prefix, a zpl.delimiter

Getvar

To return the current value of the format character:

```
! U1 getvar "zpl.format_prefix"
```

Result

^ (5E)



NOTES:

- For printer support, see [SGD Command Support on page 1455](#).
- For details on SGD command structure, see [Command Structure on page 562](#).

zpl.caret

This command is used to change the format command prefix for ZPL commands. The default prefix is the caret (^)

This command is equivalent to the ~CC and ^CC ZPL commands.

Setvar

To set the command prefix:

```
! U1 setvar "zpl.caret" "value"
```

Values

any ASCII character

Default

"^"

Getvar

To retrieve the current format command prefix:

```
! U1 getvar "zpl.caret"
```

Example

This `setvar` example changes the format prefix to a forward slash "/"

```
! U1 setvar "zpl.caret" "/"
```



NOTE:

- For printer support, see [SGD Command Support on page 1455](#).
- For details on SGD command structure, see [Command Structure on page 562](#).

zpl.control_character

This command is used to change the control command prefix. The default prefix is the tilde (~).
This command is equivalent to the ^CT and ~CT commands.

Setvar

To change the control character:

```
! U1 setvar "zpl.control_character" "value"
```

Values

ASCII values for the desired character "**00-FF,00-ff,up,down**"
See [ASCII Code Chart on page 1409](#).

Default

"7E" (tilde)

Getvar

To return the currently set control character:

```
! U1 getvar "zpl.control_character"
```

Example

This example sets the value set to "+".

```
! U1 setvar "zpl.control_characater" "2b"
```



NOTES:

- For printer support, see [SGD Command Support on page 1455](#).
- For details on SGD command structure, see [Command Structure on page 562](#).

zpl.delimiter

This command is used to change the delimiter character for ZPL commands. The default delimiter character is the comma (,).

Related Commands: ^CD and ~CD commands.

Setvar

To change the delimiter character for ZPL commands:

```
! U1 setvar "zpl.delimiter" "value"
```

Values

HEX values for the desired character "**00-FF,00-ff,up,down**"
See [ASCII Code Chart on page 1409](#).

Default

"2C" (comma)

Getvar

To return the currently set delimiter character:

```
! U1 getvar "zpl.delimiter"
```

Example

This example changes the delimiter to a semi-colon (;).

```
! U1 setvar "zpl.delimiter" "3B"
```



NOTES:

- For printer support, see [SGD Command Support on page 1455](#).
- For details on SGD command structure, see [Command Structure on page 562](#).

zpl.label_length

This command defines the length of the label. This command is necessary when using continuous media (media that is not divided into separate labels by gaps, spaces, notches, slots, or holes).

This command is equivalent to the ^LL command.

Setvar

To set the label length:

```
! U1 setvar "zpl.label_length" "value"
```

Values

1 to 32000, (in dots) not to exceed the maximum label length.

While the printer accepts any value for this parameter, the amount of memory installed determines the maximum length of the label.

Getvar

To return the current label length setting:

```
! U1 getvar "zpl.label_length"
```

Comments

These formulas can be used to determine the value of y:

For 6 dot/mm printheads...	Label length in inches x 152.4 (dots/inch) = y
For 8 dot/mm printheads...	Label length in inches x 203.2 (dots/inch) = y
For 12 dot/mm printheads...	Label length in inches x 304.8 (dots/inch) = y
For 24 dot/mm printheads...	Label length in inches x 609.6 (dots/inch) = y

Values for y depend on the memory size. If the entered value for y exceeds the acceptable limits, the bottom of the label is cut off. The label also shifts down from top to bottom.

Example

```
! U1 setvar zpl.label_length" "1281"
```



NOTES:

- For printer support, see [SGD Command Support on page 1455](#).
- For details on SGD command structure, see [Command Structure on page 562](#).

zpl.left_position

This command sets the label's left margin offset in dots.

Related Command: ^LS

Setvar

To set the label left margin offset in dots:

```
! U1 setvar "zpl.left_position" "value"
```

Values

"-9999 to 9999"

Default

"0"

Getvar

To retrieve the currently set left margin offset for the label:

```
! U1 getvar "zpl.left_position"
```

Example

```
! U1 setvar "zpl.left_position" "100"
```



NOTES:

- For printer support, see [SGD Command Support on page 1455](#).
- For details on SGD command structure, see [Command Structure on page 562](#).

zpl.system_error

This command returns the system error flags.

This command is equivalent to the error recording of ~HQES.

Getvar

To return the state of the system error flags:

```
! U1 getvar "zpl.system_error"
```

Result

```
0,0,00000000,00000000
(flag, error flag, Group 2, Group 1)
```

Example

This example shows how to request the printer's status.

To request the printer's status, type `! U1 getvar "zpl.system_error"`

The printer responds with data similar to this: `"1,1,00000000,00000004"`

In this example, the Printer Status resolves to these conditions:

- The printer is in Pause (value = 1)
- The Error Flag is 0 if there are no errors (i.e. Group 2 and Group 1 are all 0s), and 1 if there are any errors.

The cover/printhead is open (value = 4).



NOTES:

- For printer support, see [SGD Command Support on page 1455](#).
- For details on SGD command structure, see [Command Structure on page 562](#).

Table 21 Error Flags (~HQES)

Error Flags	Flag	Group 2	Group 1 (X = Value can be any hexadecimal number [0-9, A-F])							
		Nibbles 6-9	Nibble 8	Nibble 7	Nibble 6	Nibble 5	Nibble 4	Nibble 3	Nibble 2	Nibble 1
No Error	0	00000000 0	0	0	0	0	0	0	0	0
Error Present	1	00000000 0	X	X	X	X	X	X	X	X
Printhead Thermistor Open	1	00000000 0	X	X	X	X	X	2	X	X
Invalid Firmware Config.	1	00000000 0	X	X	X	X	X	1	X	X
Printhead Detection Error	1	00000000 0	X	X	X	X	X	X	8	X

k. This error flag is supported only on KR403 printers.

Table 21 Error Flags (~HQES)

Error Flags	Flag	Group 2	Group 1 (X = Value can be any hexadecimal number [0-9, A-F])								
		Nibbles1 6-9	Nibbl e8	Nibbl e7	Nibbl e6	Nibbl e5	Nibbl e4	Nibbl e3	Nibbl e2	Nibbl e1	
Bad Printhead Element	1	0000000 0	X	X	X	X	X	X	X	4	X
Motor Over Temperature	1	0000000 0	X	X	X	X	X	X	X	2	X
Printhead Over Temperature	1	0000000 0	X	X	X	X	X	X	X	1	X
Cutter Fault	1	0000000 0	X	X	X	X	X	X	X	X	8
Head Open	1	0000000 0	X	X	X	X	X	X	X	X	4
Ribbon Out	1	0000000 0	X	X	X	X	X	X	X	X	2
Media Out	1	0000000 0	X	X	X	X	X	X	X	X	1
Clear Paper Path Failed ^k	1 ^k	0000000 0	X	X	X	X	8 ^k	X	X	X	X
Paper Feed Error ^k	1 ^k	0000000 0	X	X	X	X	4 ^k	X	X	X	X
Presenter Not Running ^k	1 ^k	0000000 0	X	X	X	X	2 ^k	X	X	X	X
Paper Jam during Retract ^k	1 ^k	0000000 0	X	X	X	X	1 ^k	X	X	X	X
Black Mark not Found ^k	1 ^k	0000000 0	X	X	X	8 ^k	X	X	X	X	X
Black Mark Calabrate Error ^k	1 ^k	0000000 0	X	X	X	4 ^k	X	X	X	X	X
Retract Function timed out ^k	1 ^k	0000000 0	X	X	X	2 ^k	X	X	X	X	X
Paused ^k	1 ^k	0000000 0	X	X	X	1 ^k	X	X	X	X	X

^k. This error flag is supported only on KR403 printers.

zpl.system_status

This command returns the errors and warnings of the system.

This command is equivalent to all data reported by the ~HQES ZPL command.

Getvar

To return the system error and warning flags:

```
! U1 getvar "zpl.system_status"
```

Result

```
0,0,00000000,00000000,0,00000000,00000000
(flag, error flag, group 2, group 1, warning flag, group 2, group 1)
```

Example

This example shows how to request the printer's status.

- a. To request the printer's status, type `! U1 getvar "zpl.system_status"`

The printer responds with data similar to this:

```
"1,1,00000000,00000004,0,00000000,00000000"
```

In this example, the Printer Status resolves to these conditions:

- The printer is in Pause (value = 1)
- The Error Flag is 0 if there are no errors (i.e. Group 2 and Group 1 are all 0s), and 1 if there are any errors (non-zero).
- The cover/printhead is open (value = 4).

The Warning Flag is 0 if there are no warnings (i.e. Group 2 and Group 1 are all 0s), and 1 if there are any errors (non-zero).



NOTES:

- For printer support, see [SGD Command Support on page 1455](#).
- For details on SGD command structure, see [Command Structure on page 562](#).

Table 22 Error Flags (~HQES)

Error Flags	Fla 9	Group 2	Group 1 (X = Value can be any hexadecimal number [0-9, A-F])							
		Nibbl 6-9	Nibbl e8	Nibbl e7	Nibbl e6	Nibbl e5	Nibbl e4	Nibbl e3	Nibbl e2	Nibbl e1
No Error	0	0000000 0	0	0	0	0	0	0	0	0
Error Present	1	0000000 0	X	X	X	X	X	X	X	X
Printhead Thermistor Open	1	0000000 0	X	X	X	X	X	2	X	X

i. This error flag is supported only on KR403 printers.

Table 22 Error Flags (~HQES)

Error Flags	Flag	Group 2	Group 1 (X = Value can be any hexadecimal number [0-9, A-F])							
		Nibbles16-9	Nibble8	Nibble7	Nibble6	Nibble5	Nibble4	Nibble3	Nibble2	Nibble1
Invalid Firmware Config.	1	00000000	X	X	X	X	X	1	X	X
Printhead Detection Error	1	00000000	X	X	X	X	X	X	8	X
Bad Printhead Element	1	00000000	X	X	X	X	X	X	4	X
Motor Over Temperature	1	00000000	X	X	X	X	X	X	2	X
Printhead Over Temperature	1	00000000	X	X	X	X	X	X	1	X
Cutter Fault	1	00000000	X	X	X	X	X	X	X	8
Head Open	1	00000000	X	X	X	X	X	X	X	4
Ribbon Out	1	00000000	X	X	X	X	X	X	X	2
Media Out	1	00000000	X	X	X	X	X	X	X	1
Clear Paper Path Failed ¹	1 ¹	00000000	X	X	X	X	8 ¹	X	X	X
Paper Feed Error ¹	1 ¹	00000000	X	X	X	X	4 ¹	X	X	X
Presenter Not Running ¹	1 ¹	00000000	X	X	X	X	2 ¹	X	X	X
Paper Jam during Retract ¹	1 ¹	00000000	X	X	X	X	1 ¹	X	X	X
Black Mark not Found ¹	1 ¹	00000000	X	X	X	8 ¹	X	X	X	X
Black Mark Calabrate Error ¹	1 ¹	00000000	X	X	X	4 ¹	X	X	X	X
Retract Function timed out ¹	1 ¹	00000000	X	X	X	2 ¹	X	X	X	X
Paused ¹	1 ¹	00000000	X	X	X	1 ¹	X	X	X	X

¹ This error flag is supported only on KR403 printers.

Table 23 Warning Flags (~HQES)

Error Flags	Flag	Group 2	Group 1 (X = Value can be any hexadecimal number [0-9, A-F])							
		Nibbles16-9	Nibble8	Nibble7	Nibble6	Nibble5	Nibble4	Nibble3	Nibble2	Nibble1
No Warning	0	00000000	0	0	0	0	0	0	0	0
Warning Present	1	00000000	X	X	X	X	X	X	X	X
Paper-near-end Sensor ^m	1 ^m	00000000	X	X	X	X	X	X	X	8 ^m
Replace Printhead	1	00000000	X	X	X	X	X	X	X	4
Clean Printhead	1	00000000	X	X	X	X	X	X	X	2
Need to Calibrate Media	1	00000000	X	X	X	X	X	X	X	1
Sensor 1 (Paper before head) ^m	1 ^m	00000000	X	X	X	X	X	X	1 ^m	X
Sensor 2 (Black mark) ^m	1 ^m	00000000	X	X	X	X	X	X	2 ^m	X
Sensor 3 (Paper after head) ^m	1 ^m	00000000	X	X	X	X	X	X	4 ^m	X
Sensor 4 (loop ready) ^m	1 ^m	00000000	X	X	X	X	X	X	8 ^m	X
Sensor 5 (presenter) ^m	1 ^m	00000000	X	X	X	X	X	1 ^m	X	X
Sensor 6 (retract ready) ^m	1 ^m	00000000	X	X	X	X	X	2 ^m	X	X
Sensor 7 (in retract) ^m	1 ^m	00000000	X	X	X	X	X	4 ^m	X	X
Sensor 8 (at bin) ^m	1 ^m	00000000	X	X	X	X	X	8 ^m	X	X

^m. This error flag is supported only on KR403 printers.

zpl.zpl_mode

This command sets the ZPL mode to ZPL II or ZPL.

Setvar

To set the printer ZPL mode:

```
! U1 setvar "zpl.zpl_mode" "value"
```

Values

- "zpl"
- "zpl II"

Default

```
"zpl II"
```

Getvar

To return the current ZPL mode setting:

```
! U1 getvar "zpl.zpl_mode"
```

Example

This `setvar` example sets the ZPL mode to ZPL.

```
! U1 setvar "zpl.system_status" "zpl"
```



NOTES:

- For printer support, see [SGD Command Support on page 1455](#).
- For details on SGD command structure, see [Command Structure on page 562](#).

zpl.zpl_override

Enable this menu item to prevent the following ZPL commands from changing the printer's current settings:

- ^MM (print mode)
- ^MT (Direct Thermal or Thermal Transfer print method)
- ^MN (media type - non-continuous or continuous)

When this menu item is disabled, these commands override the printer's settings.

Setvar

To set the override status to the specified value:

```
! U1 setvar "zpl.zpl_override" "value"
```

Values

- "disabled" = allows override
- "enabled" = prevents ZPL commands from overriding printer settings.

Default

"disabled"

Example

This example enables `zpl.zpl_override`, which prevents ^MM, ^MT, and ^MN from making changes to the current printer settings.

```
! U1 setvar "zpl.zpl_override" "enabled"
```



NOTES:

- For printer support, see [SGD Command Support on page 1455](#).
- For details on SGD command structure, see [Command Structure on page 562](#).

zpl.relative_darkness

Changes the relative darkness for ZPL labels. This command is similar to the ZPL `^MD` command.



IMPORTANT: This value is saved permanently on Desktop printers, but it is not saved permanently on Industrial or Mobile.

Setvar

To set the relative darkness for ZPL labels:

```
! U1 setvar "zpl.relative_darkness" "value"
```

Values

"" to "300"

Default

"0"

Getvar

To return the current setting value:

```
! U1 getvar "relative_darkness"
```

Example

These examples show setting the printer to different darkness levels:

- If the current value shown on the configuration label is "16", using a `zpl.relative_darkness` command of "-90" decreases the value to "7.0".
- If the current value shown on the configuration label is "1", using a `zpl.relative_darkness` command of "153" increases the value to "16.3".
- If the current value shown on the configuration label is "25", using a `zpl.relative_darkness` command of "105" increases the value to "30.0", which is the maximum value allowed.

Each `zpl.relative_darkness` command is treated separately in relation to the current value as printed on the configuration label.



NOTES:

- For printer support, see [SGD Command Support on page 1455](#).
- For details on SGD command structure, see [Command Structure on page 562](#).

SGD Wired Commands

This chapter provides a high-level overview of the wired Set / Get / Do (SGD) commands. For printer support of these SGD commands, see [SGD Command Support on page 1455](#).

.15†

SGD commands are available in printers with the following firmware versions or later:

- V54
- V66
- V68
- V72
- V73
- V74
- V75
- V76
- V78
- V79
- V60.16.2Z or later
- V60.15.xZ or later
- V50.15.xZ or later
- V61.15.xZ or later
- V56.15.xZ or later
- V53.16.x or later
- V53.15.2Z or later
- R53.16.3Z or later
- R60.15.8Z or later
- R62.15.8Z or later
- R63.15.8Z or later
- R65.15.8Z or later



IMPORTANT: These are important points to note when using ZPL and SGD commands:

- SGD commands are case-sensitive.
- ZPL and SGD commands should be sent to the printer as separate files.
- Certain settings can be controlled by both ZPL and SGD. Configuration changes made in ZPL can affect configuration changes made in SGD.
- Changes made with one command type (ZPL or SGD) will affect the data returned to the host in response to both ZPL and getvar commands. The command type (ZPL or SGD) that was sent last determines the current setting.
- Some RF cards do not support all of the SGD commands.



IMPORTANT: These are important points to note when using a Zebra G-Series printer:

- You can send instructions to the printer using multiple programming languages: EPL, ZPL, or SGD. EPL and ZPL commands configure the printer, print labels, and get device status information. SGD commands set and get configuration details. These three languages can be used without the need to send the printer instructions to switch from one language to another.
- EPL, ZPL, and SGD commands must be sent to the printer as separate files. They cannot be used together in one format, or set of commands. For example, if you send a series of SGD commands to the printer and they are followed by a printable format, this needs to be done using separate files.

Overview

This section describes how and why to use the Set / Get / Do (SGD) commands. It also provides an example of a typical command structure.



NOTE: SGD commands must be terminated by a carriage return or a space and line feed.

SGD commands are commands that allow you to configure all printers with firmware version V60.15.x, V50.15.x, V61.15.x, V56.15.x, V53.15.xZ, or later. The printer performs the specified function immediately after receiving the command. The commands are:

- `setvar`
- `getvar`
- `do`

setvar Command

Setvar commands:

- are used to configure printer settings to specific values by setting them in the printer
- must be terminated by a space character or a CR/ LF (0x0D, 0x0A)



IMPORTANT: The setvar command and attributes must be specified in lower case.

getvar Command

Getvar commands:

- are used to get the current value of the printer settings
- must be terminated by a space character or CR/LF (0x0D, 0x0A)

The printer responds with the printer setting of “?” if:

- the printer setting does not exist (usually due to incorrect spelling of the printer setting)
- it has not been configured yet



IMPORTANT: The printer settings and attributes must be specified in lower case.

do Command

Do commands:

- are used to instruct the printer to perform predefined actions
- must be terminated by a space character or a CR/LF (0x0D, 0x0A)

Some **Do** commands require additional settings which must be enclosed in double quotes.



IMPORTANT: The values must be specified in lower case.

Command Structure

It is important to understand the structure of the command and its components. A command structure illustration is provided for each command in this guide.

This is an example of a command structure illustration:

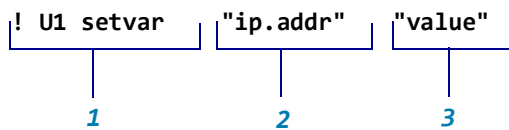

1	Command—always preceded with an exclamation point (!) and must be specified in lower case. A space resides between the ! and U1 and between U1 and the command (setvar or getvar).
2	Attribute—always in double quotes and must be specified in lower case.
3	Chosen value—always in double quotes. Only applicable for setvar and do .

This command must be terminated by a space character or a CR/ LF (0x0D, 0x0A).

How to Send Multiple SGD Commands

For any **getvar**, **setvar**, or **do** command, if you issue the syntax without the "1" and use the **END** command followed by a space, multiple SGD commands are sent simultaneously.

This syntax shows how you can send multiple **getvar** commands:

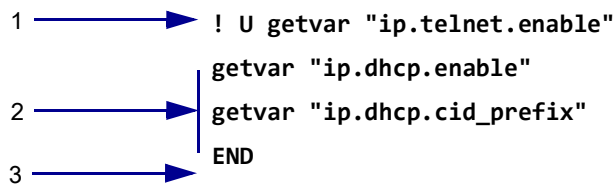

1	The command portion of the string does not use the "1" after the "! U".
2	Commands issued after the first command do not require the "! U".
3	The string of commands is terminated by the word "END" with a space after the word, and by a carriage return/ line feed.

external_wired.check

This command controls whether to check for external print server during the network interface search.

Setvar

To instruct the printer to set the network interface search:

```
! U1 setvar "external_wired.check" "value"
```

Values

- "on" = turn on external wired network interface search
- "off" = turn off external wired network interface search

Default

- "on" = If wireless option board is not installed
- "off" = If wireless option board is installed

Getvar

To retrieve the status of the network interface search:

```
! U1 getvar "external_wired.check"
```

Example

This **setvar** example shows the value set to "off".

```
! U1 setvar "external_wired.check" "off"
```

When the **setvar** value is set to "off", the **getvar** result is "off".



NOTES:

- For printer support, see [SGD Command Support on page 1455](#).
- For details on SGD command structure, see [Command Structure on page 562](#).

external_wired.ip.addr

This command allows you to get or set the external wired print servers's IP address.



IMPORTANT: For a set IP address to take affect, the IP protocol must be set to permanent and the print server must be reset.

Setvar

To instruct the printer to change its current external wired print server IP address upon powering the printer on:

```
! U1 setvar "external_wired.ip.addr" "value"
```

Values

any valid IP address

Default

"0.0.0.0"

Getvar*

To respond with the current external wired print server IP address:

```
! U1 getvar "external_wired.ip.addr"
```

* On SEH print server models PS102-Z or the PS105-Z, only the getvar command is supported.



NOTE: The setvar value of this command can be affected by the `external_wired.ip.dhcp.enable` command.

Example

This setvar example shows the value set to "**10.14.4.235**".

```
! U1 setvar "external_wired.ip.addr" "10.14.4.235"
```

What the setvar value is set to is the getvar result. In this example, the getvar result is "**10.14.4.235**".



NOTES:

- For printer support, see [SGD Command Support on page 1455](#).
- For details on SGD command structure, see [Command Structure on page 562](#).

external_wired.ip.arp_interval

This print server setting allows you to specify the ARP (Address Resolution Protocol) interval or the ARP cache time out for the external wired print server.

Setvar

To instruct the printer to change the ARP interval or the ARP cache time out for the external wired print server:

```
! U1 setvar "external_wired.ip.arp_interval" "value"
```

Values

0 - 30

Default

"0"

Getvar*

To instruct the printer to respond with the ARP interval or the ARP cache time out value for the external wired print server:

```
! U1 getvar "external_wired.ip.arp_interval"
```

* On SEH print server models PS102-Z or the PS105-Z, only the getvar command is supported.

Example

This `setvar` example shows the value set to "0".

```
! U1 setvar "external_wired.ip.arp_interval" "0"
```

What the `setvar` value is set to is the `getvar` result. In this example, the `getvar` result is "0".



NOTES:

- For printer support, see [SGD Command Support on page 1455](#).
- For details on SGD command structure, see [Command Structure on page 562](#).

external_wired.ip.default_addr_enable

This command allows you to default the external wired print server's IP address.



IMPORTANT: For a set IP address to take affect, the IP protocol must be set to permanent and the print server must be reset.

Setvar

To instruct the printer to use it's default address:

```
! U1 setvar "external_wired.ip.default_addr_enable" "value"
```

If no address is provided through DHCP or BOOTP. If you do not assign an IP address after 2 minutes, the 10/100 Internal PS defaults to IP address 192.168.254.254.

Values

- "on" = enabled
- "off" = disabled

Default

"on"

Getvar*

To instruct the printer to show the status of the setting of external wired print server's default IP address feature:

```
! U1 getvar "external_wired.ip.default_addr_enable"
```

* On SEH print server models PS102-Z or the PS105-Z, only the getvar command is supported.

Example

This **setvar** example shows the value set to "on".

```
! U1 setvar "external_wired.ip.default_addr_enable" "on"
```

What the **setvar** value is set to is the **getvar** result. In this example, the **getvar** result is "on".



NOTES:

- For printer support, see [SGD Command Support on page 1455](#).
- For details on SGD command structure, see [Command Structure on page 562](#).

external_wired.ip.dhcp.cid_all

This printer setting defines the entire client identifier (DHCP option 61) if DHCP is enabled on the external print server and "external_wired.ip.dhcp.cid_type" is set to "0", or "2". The MAC address is used if the type is set to "1".

Setvar

To instruct the printer to change the client identifier prefix and suffix of the external wired print server:

```
! U1 setvar "external_wired.ip.dhcp.cid_all" "value"
```

Values

A maximum length of 60 characters if the CID type is ASCII, or 120 characters if the CID type is hexadecimal.

Default

""

Getvar*

To instruct the printer to respond with the client identifier prefix and suffix of the external wired print server:

```
! U1 getvar "external_wired.ip.dhcp.cid_all"
```

* On SEH print server models PS102-Z or the PS105-Z, only the getvar command is supported.

Example

This **setvar** example shows the value set to "printer".

```
! U1 setvar "external_wired.ip.dhcp.cid_all" "printer"
```

What the **setvar** value is set to is the **getvar** result. In this example, the **getvar** result is "printer".



NOTES:

- For printer support, see [SGD Command Support on page 1455](#).
- For details on SGD command structure, see [Command Structure on page 562](#).

external_wired.ip.dhcp.cid_enable

This command determines if DHCP (option 61) on the external wired print server is turned on or off.

Setvar

To instruct the printer to set the status of the client identifier of the external wired print server:

```
! U1 setvar "external_wired.ip.dhcp.cid_enable" "value"
```

Values

- "off" = client identifier is turned off
- "on" = client identifier is turned on

Default

"off"

Getvar*

To instruct the printer to respond with the status of the client identifier of the external wired print server:

```
! U1 getvar "external_wired.ip.dhcp.cid_enable"
```

* On SEH print server models PS102-Z or the PS105-Z, only the getvar command is supported.

Example

This **setvar** example shows the value set to "off".

```
! U1 setvar "external_wired.ip.dhcp.cid_enable" "off"
```

What the **setvar** value is set to is the **getvar** result. In this example, the **getvar** result is "off".



NOTES:

- For printer support, see [SGD Command Support on page 1455](#).
- For details on SGD command structure, see [Command Structure on page 562](#).

external_wired.ip.dhcp.cid_prefix

This printer setting defines the prefix to be prepended to the DHCP client identifier (option 61) when DHCP is enabled on the external wired print server and "external_wired.ip.dhcp.cid_type" is set to "0" or "2".

Setvar

To instructs the printer to change the CID prefix of the external wired print server:

```
! U1 setvar "external_wired.ip.dhcp.cid_prefix" "value"
```

Values

Any text string up to 10 characters if the CID type is ASCII, or 20 characters if the CID type is hexadecimal.

Default

""

Getvar*

To instruct the printer to respond with the client identifier prefix of the external wired print server:

```
! U1 getvar "external_wired.ip.dhcp.cid_prefix"
```

* On SEH print server models PS102-Z or the PS105-Z, only the getvar command is supported.

Example

This **setvar** example shows the value set to "PRT001".

```
! U1 setvar "external_wired.ip.dhcp.cid_prefix" "PRT001"
```

What the **setvar** value is set to is the **getvar** result. In this example, the **getvar** result is "PRT001".



NOTES:

- For printer support, see [SGD Command Support on page 1455](#).
- For details on SGD command structure, see [Command Structure on page 562](#).

external_wired.ip.dhcp.cid_suffix

This printer setting defines the unique suffix to be used as the client identifier (DHCP option 61) if DHCP is enabled repeated on the external wired print server and [external_wired.ip.dhcp.cid_type on page 1063](#) is set to "0" or "2", not "1".

Setvar

To instruct the printer to change the client identifier suffix value:

```
! U1 setvar "external_wired.ip.dhcp.cid_suffix" "value"
```

Values

The maximum length of a value allowed is 60 ASCII characters when the CID type is ASCII, or 120 hexadecimal values when the CID type is hexadecimal.

Default

""

Getvar*

To instruct the printer to respond with the client identifier suffix on the external wired print server:

```
! U1 getvar "external_wired.ip.dhcp.cid_suffix"
```

* On SEH print server models PS102-Z or the PS105-Z, only the getvar command is supported.

Example

This `setvar` example shows setting the suffix to `printer`.

```
! U1 setvar "external_wired.ip.dhcp.cid_suffix" "printer"
```

What the `setvar` value is set to is the `getvar` result. In this example, the `getvar` result is `printer`.



NOTES:

- For printer support, see [SGD Command Support on page 1455](#).
- For details on SGD command structure, see [Command Structure on page 562](#).

external_wired.ip.dhcp.cid_type

This printer setting defines the type of client identifier (DHCP option 61) that will be sent if DHCP is enabled on the external wired print server. A value of "1" means the type of "Ethernet" and the printer's MAC address will be used. A value of "0" or "2" means the client identifier sent will be "external_wired.ip.dhcp.cid_prefix" concatenated with "external_wired.ip.dhcp.cid_suffix".

Setvar

To instruct the printer to enable "synthetic" Client Identifier for the external wired print server:

```
! U1 setvar "external_wired.ip.dhcp.cid_type" "value"
```

Values

- "0" = ASCII string
- "1" = wired print server's MAC address
- "2" = HEX value

Default

"1"

Getvar*

To instruct the printer to respond with the client identifier type for the external wired print server:

```
! U1 getvar "external_wired.ip.dhcp.cid_type"
```

* On SEH print server models PS102-Z or the PS105-Z, only the getvar command is supported.

Example

This `setvar` example shows the value set to "1".

```
! U1 setvar "external_wired.ip.dhcp.cid_type" "1"
```

When the `setvar` value is set to "1", the `getvar` result is "1".



NOTES:

- For printer support, see [SGD Command Support on page 1455](#).
- For details on SGD command structure, see [Command Structure on page 562](#).

external_wired.ip.gateway

This command instructs the printer to change the external wired print server's gateway address.



IMPORTANT: This setting refers to the gateway address. A set value is ignored if the IP protocol is not set to permanent.

Setvar

To instruct the printer to change the external wired printer server's gateway address:

```
! U1 setvar "external_wired.ip.gateway" "value"
```

Values

Any valid gateway address

Default

"0.0.0.0"

Getvar*

To instruct the printer to respond with the external wired printer server's gateway address:

```
! U1 getvar "external_wired.ip.gateway"
```

* On SEH print server models PS102-Z or the PS105-Z, only the getvar command is supported.

Example

This `setvar` example shows the value set to "**10.3.5.1**".

```
! U1 setvar "external_wired.ip.gateway" "10.3.5.1"
```

When the `setvar` value is set to "**10.3.5.1**", the `getvar` result is "**10.3.5.1**".



NOTES:

- For printer support, see [SGD Command Support on page 1455](#).
- For details on SGD command structure, see [Command Structure on page 562](#).

external_wired.ip.netmask

This setting refers to the external wired print server's subnet mask address. This value is ignored if the IP protocol is not set to permanent.

Setvar

To instruct the printer to change the external wired print servers subnet mask:

```
! U1 setvar "external_wired.ip.netmask" "value"
```

Values

Any valid subnet mask.

Default

```
"255.255.255.0"
```

Getvar*

To instruct the printer to respond with the external wired print server's subnet mask:

```
! U1 getvar "external_wired.ip.netmask"
```

* On SEH print server models PS102-Z or the PS105-Z, only the getvar command is supported.

Example

This `setvar` example shows the value set to `"255.255.255.0"`.

```
! U1 setvar "external_wired.ip.netmask" "255.255.255.0"
```

When the `setvar` value is set to `"255.255.255.0"`, the `getvar` result is `"255.255.255.0"`.



NOTES:

- For printer support, see [SGD Command Support on page 1455](#).
- For details on SGD command structure, see [Command Structure on page 562](#).

external_wired.ip.port

This printer setting refers to the external wired print server's port number that the TCP print service is listening on. Normal TCP communications from the host should be directed to this port.

Setvar

To instruct the printer to set the external wired print server's TCP/UDP port number:

```
! U1 setvar "external_wired.ip.port" "value"
```

Values

1 - 65535 (excluding any ports currently used by other services, such as 21, 23, 80, and 515).

Default

"9100"

Getvar*

To instruct the printer to respond with the external wired printer server's TCP/UDP port number:

```
! U1 getvar "external_wired.ip.port"
```

* On SEH print server models PS102-Z or the PS105-Z, only the getvar command is supported.

Example

This `setvar` example shows the value set to "9100".

```
! U1 setvar "external_wired.ip.port" "9100"
```

When the `setvar` value is set to "9100", the `getvar` result is "9100".



NOTES:

- For printer support, see [SGD Command Support on page 1455](#).
- For details on SGD command structure, see [Command Structure on page 562](#).

external_wired.ip.protocol

This command configures the IP addressing method used by the external wired print server.

Setvar

To instruct the printer to configure the IP addressing method used by the external wired print server:

```
! U1 setvar "external_wired.ip.protocol" "value"
```

Values

- "bootp" = uses the standard bootp addressing method to obtain an IP address and configuration
- "dhcp" = uses the standard dhcp addressing method to obtain an IP address and configuration for a server specified period of time
- "rarp" = uses the standard rarp addressing method to obtain an IP address
- "glean" = uses the IP address from a PING packet that is sent to its hardware address (unicast address)
- "permanent" = uses static values assigned through other commands
- "all" = tries all of the dynamic addressing methods, not permanent, to obtain an IP address

Default

"all"

Getvar*

To return the IP addressing method used by the external print server:

```
! U1 getvar "external_wired.ip.protocol"
```

* On SEH print server models PS102-Z or the PS105-Z, only the getvar command is supported.

Example

In this example, the `setvar` result is the current programming language that the printer is using.

```
! U1 setvar "external_wired.ip.protocol" "bootp"
```

What the `setvar` value is set to is the `getvar` result. In this example, the `getvar` result is "bootp".



NOTES:

- For printer support, see [SGD Command Support on page 1455](#).
- For details on SGD command structure, see [Command Structure on page 562](#).

external_wired.ip.timeout.enable

This network setting refers to enabling the connection timeout on the external wired 10/100 print server. For this to take effect, the print server must be reset.

Setvar

To instruct the printer to enable or disable the timeout checking on the external wired print server:

```
! U1 setvar "external_wired.ip.timeout.enable" "value"
```

Values

- "off" = turns off the connection checking
- "on" = turns on the connection checking

Default

"on"

Getvar*

To instruct the printer to return whether the timeout checking is enabled on the external wired print server:

```
! U1 getvar "external_wired.ip.timeout.enable"
```

* On SEH print server models PS102-Z or the PS105-Z, only the getvar command is supported.

Example

This **setvar** example shows the value set to "on".

```
! U1 setvar "external_wired.ip.timeout.enable" "on"
```

When the **setvar** value is set to "on", the **getvar** result is "on".



NOTES:

- For printer support, see [SGD Command Support on page 1455](#).
- For details on SGD command structure, see [Command Structure on page 562](#).

external_wired.ip.timeout.value

This network setting refers to the number of seconds before the connection times out for the external wired print server.

Setvar

To instructs the printer to set the time of the external wired print server, in seconds, before the connection times out:

```
! U1 setvar "external_wired.ip.timeout.value" "value"
```

Values

"1" through "3600"

Default

"300"

Getvar*

To instruct the printer to respond with the time of the external wired print server, in seconds, before the connection times out:

```
! U1 getvar "external_wired.ip.timeout.value"
```

* On SEH print server models PS102-Z or the PS105-Z, only the getvar command is supported.

Example

This `setvar` example shows the value set to "300".

```
! U1 setvar "external_wired.ip.timeout.value" "300"
```

When the `setvar` value is set to "300", the `getvar` result is "300".



NOTES:

- For printer support, see [SGD Command Support on page 1455](#).
- For details on SGD command structure, see [Command Structure on page 562](#).

external_wired.ip.v6.addr

This command retrieves the IPv6 address of the SEH wired print server. This command is only supported on SEH print server models PS105-Z and PS102-Z with firmware version V60.16.5Z or V53.16.5Z and later.

Getvar

To retrieve the IPv6 address of the SEH wired print server:

```
! U1 getvar "external_wired.ip.v6.addr"
```

Values

8 group of four hexadecimal digits with a colon delimiter

character set = A-F or 0-9 (39-character maximum)

- SEH print server model PS105-Z with firmware version V60.16.5Z or V53.16.5Z and later.
- SEH print server model PS102-Z with firmware version V60.16.5Z or V53.16.5Z and later.

Example

In this example, the `getvar` returns the IPv6 address of the wired print server.

```
! U1 getvar "external_wired.ip.v6.addr"
```



NOTES:

- For printer support, see [SGD Command Support on page 1455](#).
- For details on SGD command structure, see [Command Structure on page 562](#).

external_wired.ip.v6.gateway

This command retrieves the IPv6 gateway of the SEH wired print server.

Getvar

To retrieve the IPv6 gateway of the SEH wired print server:

```
! U1 getvar "external_wired.ip.v6.gateway"
```

Values

8 group of four hexadecimal digits with a colon delimiter

character set = A-F or 0-9 (39-character maximum)

- SEH print server model PS105-Z with firmware version V60.16.5Z or V53.16.5Z and later.
- SEH print server model PS102-Z with firmware version V60.16.5Z or V53.16.5Z and later.

Example

In this example, the `getvar` returns the IPv6 gateway of the wired print server.

```
! U1 getvar "external_wired.ip.v6.gateway"
```



NOTES:

- For printer support, see [SGD Command Support on page 1455](#).
- For details on SGD command structure, see [Command Structure on page 562](#).

external_wired.ip.v6.prefix_length

This command retrieves the IPv6 address prefix length of the SEH wired print server.

Getvar

To retrieve the IPv6 address prefix length of the SEH wired print server:

```
! U1 getvar "external_wired.ip.v6.prefix_length"
```

Values

character set = 0-9 (3-character maximum)

- SEH print server model PS105-Z with firmware version V60.16.5Z or V53.16.5Z and later.
- SEH print server model PS102-Z with firmware version V60.16.5Z or V53.16.5Z and later.

Example

In this example, the `getvar` returns the IPv6 address prefix length of the wired print server.

```
! U1 getvar "external_wired.ip.v6.prefix_length"
```



NOTES:

- For printer support, see [SGD Command Support on page 1455](#).
- For details on SGD command structure, see [Command Structure on page 562](#).

external_wired.mac_addr

This command retrieves the MAC address of the external wired print server.

Getvar

To instruct the printer to respond with the MAC address of the external wired print server:

```
! U1 getvar "external_wired.mac_addr"
```

Example

In this example, the `getvar` result is the MAC address of the external wired print server.

```
! U1 getvar "external_wired.mac_addr"
```



NOTES:

- For printer support, see [SGD Command Support on page 1455](#).
- For details on SGD command structure, see [Command Structure on page 562](#).

external_wired.mac_raw

This command specifies the RAW MAC address of the external print server. The raw mac address is the mac address without the colons (":").

Getvar

To retrieve the RAW MAC address of the external print server:

```
! U1 getvar "external_wired.mac_raw"
```

Example

In this example, the `getvar` retrieves the RAW MAC address of the external print server.

```
! U1 getvar "external_wired.mac_raw"  
"00074d2408ff"
```



NOTES:

- For printer support, see [SGD Command Support on page 1455](#).
- For details on SGD command structure, see [Command Structure on page 562](#).

internal_wired.8021x.password

Sets the password to be used for authentication with the wired network.

Setvar

To set the command:

```
! U1 setvar "internal_wired.8021x.password" "value"
```

Values

The value is a string of up to 32 ASCII characters.



NOTES:

- For printer support, see [SGD Command Support on page 1455](#).
- For details on SGD command structure, see [Command Structure on page 562](#).

internal_wired.8021x.peap.validate_server_certificate

When using PEAP, this command determines if the printer requires the server certificate to be signed by a CA in Zebra's CA chain of trust.

Setvar

To set the command:

```
! U1 setvar "internal_wired.8021x.peap.validate_server_certificate" "value"
```

Values:

- on
- off

Default:

"on"

Getvar

To have the printer return the current setting value:

```
! U1 getvar "internal_wired.8021x.peap.validate_server_certificate"
```



NOTES:

- For printer support, see [SGD Command Support on page 1455](#).
- For details on SGD command structure, see [Command Structure on page 562](#).

internal_wired.8021x.peap.anonymous_identity

Sets the phase 1 ID name when authenticating with the wired network.

Setvar

To set the command:

```
! U1 setvar "internal_wired.8021x.peap.anonymous_identity" "value"
```

Values:

The value is a string of up to 32 ASCII characters.

Default:

""

Getvar

To confirm the command is set:

```
! U1 getvar "internal_wired.8021x.peap.anonymous_identity"
```



NOTES:

- For printer support, see [SGD Command Support on page 1455](#).
- For details on SGD command structure, see [Command Structure on page 562](#).

internal_wired.8021x.private_key_password

Sets the private key password for encryption in the certificate file.

Setvar

To set the command:

```
! U1 setvar "internal_wired.8021x.private_key_password" "value"
```

Values:

The value is a string of up to 32 ASCII characters.

Default:

""

Getvar

To have the printer return the current setting value:

```
! U1 getvar "internal_wired.8021x.private_key_password"
```



NOTES:

- For printer support, see [SGD Command Support on page 1455](#).
- For details on SGD command structure, see [Command Structure on page 562](#).

internal_wired.8021x.security

Returns the security type used for the wired network.

Setvar

To set the command:

```
! U1 setvar "internal_wired.8021x.security" "none"
```

Values:

- none
- peap
- eap-tls
- eap-ttls

Default:

"none"

Getvar

To have the printer return the current setting value:

```
! U1 getvar "internal_wired.8021x.security"
```



NOTES:

- For printer support, see [SGD Command Support on page 1455](#).
- For details on SGD command structure, see [Command Structure on page 562](#).

internal_wired.8021x.ttls_tunnel

Sets the TTLS tunnel protocol to use in the authentication process.

Setvar

To set the command:

```
! U1 setvar "internal_wired.8021x.ttls_tunnel" "value"
```

Values:

- pap
- chap
- mschap
- mschapv2

Default:

"mschapv2"

Getvar

To have the printer return the current setting value:

```
! U1 getvar "internal_wired.8021x.ttls_tunnel"
```



NOTES:

- For printer support, see [SGD Command Support on page 1455](#).
- For details on SGD command structure, see [Command Structure on page 562](#).

internal_wired.8021x.username

Sets the user name to use for authentication with the wired network.

Setvar

To set the command:

```
! U1 setvar "internal_wired.8021x.username" "value"
```

Values:

The value is a string of up to 32 ASCII characters.

Default:

""

Getvar

To have the printer return the current setting value:

```
! U1 getvar "internal_wired.8021x.username"
```

The value is a string of up to 32 ASCII characters.



NOTES:

- For printer support, see [SGD Command Support on page 1455](#).
- For details on SGD command structure, see [Command Structure on page 562](#).

internal_wired.activity_led

Controls whether the Ethernet activity LED will blink or be solid when there is link.

Setvar

To set the Ethernet activity LED value:

```
! U1 setvar "internal_wired.activity_led" "value"
```

Values

- "blink" = the LED will blink
- "solid" = the LED will be solid

Default

"blink"

Getvar

To return the current setting value:

```
! U1 getvar "internal_wired.activity_led"
```



NOTES:

- For printer support, see [SGD Command Support on page 1455](#).
- For details on SGD command structure, see [Command Structure on page 562](#).

internal_wired.auto_switchover

This command instructs the printer to switch from wireless to the internal wired print server when an Ethernet cable is plugged into the printer and the printer detects an active data link.

Setvar

To configure switches between the wireless and wired interfaces:

```
! U1 setvar "internal_wired.auto_switchover" "value"
```

Values

- "on" = switchover enabled
- "off" = switchover disabled

Default

"off"

Getvar

To retrieve the current automatic switchover value:

```
! U1 getvar "internal_wired.auto_switchover"
```

Example

This `setvar` example shows the value set to "off".

```
! U1 setvar "internal_wired.auto_switchover" "off"
```

When the `setvar` value is set to "off", the `getvar` result is "off".



IMPORTANT: For this command to work, be sure:

- you are using a ZM400/ZM600 or RZ400/RZ600 printer with both the internal 10/100 wired print server and wireless option board installed
- the value for this command is set to "on" (switchover enabled)
- the printer is currently communicating to the network through a wireless connection
- a Ethernet cable is plugged into the ZM400/ZM600 or RZ400/RZ600 printer and the printer recognizes a data link connection

When the above conditions exist and an active Ethernet cable is plugged into an internal wired print server, the printer will detect the wired data link and automatically switch to the wired interface. The printer will automatically switch back to the wireless interface when the Ethernet cable is disconnected.



NOTES:

- For printer support, see [SGD Command Support on page 1455](#).
- For details on SGD command structure, see [Command Structure on page 562](#).

internal_wired.enable

Enables or disables the wired network interface.



IMPORTANT: A network or printer reset is required for this setting to take effect.

Setvar

To set the command:

```
! U1 setvar "internal_wired.enable" "value"
```

Values:

- on
- off

Default:

"on"

Getvar

To have the printer return the current setting value:

```
! U1 getvar "internal_wired.enable"
```



NOTES:

- For printer support, see [SGD Command Support on page 1455](#).
- For details on SGD command structure, see [Command Structure on page 562](#).

internal_wired.installed

Returns if the wired option is installed in the printer.

Getvar

To return if the wired option is installed in the printer:

```
! U1 getvar "internal_wired.installed"
```

Values

"yes" = the wired print server is installed

"no" = the wired print server is not installed



NOTES:

- For printer support, see [SGD Command Support on page 1455](#).
- For details on SGD command structure, see [Command Structure on page 562](#).

internal_wired.ip.addr

This command allows you to get or set the internal wired print servers's IP address.



NOTE: For a set IP address to take affect, the IP protocol must be set to permanent and the print server must be reset.

Setvar

To instruct the printer to change its current internal wired print server IP address upon powering the printer on:

```
! U1 setvar "internal_wired.ip.addr" "value"
```

Values

any valid IP address

Default

"0.0.0.0"

Getvar

To respond with the current internal wired print server IP address:

```
! U1 getvar "internal_wired.ip.addr"
```



NOTE: The `setvar` value of this command can be affected by the `internal_wired.ip.dhcp.enable` command.

Example

This `setvar` example shows the value set to "**10.14.4.235**".

```
! U1 setvar "internal_wired.ip.addr" "10.14.4.235"
```

What the `setvar` value is set to is the `getvar` result. In this example, the `getvar` result is "**10.14.4.235**".



NOTES:

- For printer support, see [SGD Command Support on page 1455](#).
- For details on SGD command structure, see [Command Structure on page 562](#).

internal_wired.ip.arp_interval

This print server setting allows you to specify the ARP (Address Resolution Protocol) interval or the ARP cache time out for the internal wired print server.

Setvar

To instruct the printer to change the ARP interval or the ARP cache time out for the internal wired print server:

```
! U1 setvar "internal_wired.ip.arp_interval" "value"
```

Values

0 - 30

Default

"0"

Getvar

To instruct the printer to respond with the ARP interval or the ARP cache time out value for the internal wired print server:

```
! U1 getvar "internal_wired.ip.arp_interval"
```

Example

This **setvar** example shows the value set to "0".

```
! U1 setvar "internal_wired.ip.arp_interval" "0"
```

What the **setvar** value is set to is the **getvar** result. In this example, the **getvar** result is "0".



NOTES:

- For printer support, see [SGD Command Support on page 1455](#).
- For details on SGD command structure, see [Command Structure on page 562](#).

internal_wired.ip.default_addr_enable

This command allows you to default the internal wired print server's IP address.



IMPORTANT

For a set IP address to take effect, the IP protocol must be set to permanent and the print server must be reset.

Setvar

To tell the printer to use its default address:

```
! U1 setvar "internal_wired.ip.default_addr_enable" "value"
```

Values

- "on" = enabled
- "off" = disabled

Default

"on"

Getvar

To instruct the printer to show the status of the setting of internal wired print server's default IP address feature:

```
! U1 getvar "internal_wired.ip.default_addr_enable"
```

Example

This `setvar` example shows the value set to "on".

```
! U1 setvar "internal_wired.ip.default_addr_enable" "on"
```

What the `setvar` value is set to is the `getvar` result. In this example, the `getvar` result is "on".



NOTES:

- For printer support, see [SGD Command Support on page 1455](#).
- For details on SGD command structure, see [Command Structure on page 562](#).

internal_wired.ip.dhcp.arp_verify

This command controls whether the internal wired print server will send an ARP response after receiving an IP address via DHCP.

Setvar

To control whether the internal wired print server will send an ARP response after receiving an IP address via DHCP:

```
! U1 setvar "internal_wired.ip.dhcp.arp_verify" "value"
```

Values

"off" = ARP response will not be sent.

"on" = ARP response will be sent.

Default

"off" for mobile Link-OS printers

"on" for desktop and industrial printers

Getvar

To return the current setting value:

```
! U1 getvar "internal_wired.ip.dhcp.arp_verify"
```



NOTES:

- For printer support, see [SGD Command Support on page 1455](#).
- For details on SGD command structure, see [Command Structure on page 562](#).

internal_wired.ip.dhcp.cache_ip

This command enables or disables the IP cache on the internal wired print server.

Setvar

To set the status of the IP cache:

```
! U1 setvar "internal_wired.ip.dhcp.cache_ip" "value"
```

Values

- "on" = enabled
- "off" = disabled

Default

"off"

Getvar

To retrieve the status of the IP cache on the internal wired print server:

```
! U1 getvar "internal_wired.ip.dhcp.cache_ip"
```

Example

This `setvar` example shows the value set to "off".

```
! U1 setvar "internal_wired.ip.dhcp.cache_ip" "off"
```

When the `setvar` value is set to "off", the `getvar` result is "off".



NOTES:

- For printer support, see [SGD Command Support on page 1455](#).
- For details on SGD command structure, see [Command Structure on page 562](#).

internal_wired.ip.dhcp.cid_all

This printer setting defines the entire client identifier (DHCP option 61) if DHCP is enabled on the internal print server and "internal_wired.ip.dhcp.cid_type" is set to "0", or "2". The MAC address is used if the type is set to "1".

Setvar

To instruct the printer to change the client identifier prefix and suffix of the internal wired print server:

```
! U1 setvar "internal_wired.ip.dhcp.cid_all" "value"
```

The prefix gets cleared and the suffix contains the entire client identifier.

Values

A maximum length of 60 characters if the CID type is ASCII, or 120 characters if the CID type is hexadecimal.

Default

""

Getvar

To instruct the printer to respond with the client identifier prefix and suffix of the internal wired print server:

```
! U1 getvar "internal_wired.ip.dhcp.cid_all"
```

Example

This **setvar** example shows the value set to "printer".

```
! U1 setvar "internal_wired.ip.dhcp.cid_all" "printer"
```

What the **setvar** value is set to is the **getvar** result. In this example, the **getvar** result is "printer".



NOTES:

- For printer support, see [SGD Command Support on page 1455](#).
- For details on SGD command structure, see [Command Structure on page 562](#).

internal_wired.ip.dhcp.cid_enable

This command determines if DHCP (option 61) is turned on or off of the internal wired print server.

Setvar

To instruct the printer to set the status of the client identifier of the internal wired print server:

```
! U1 setvar "internal_wired.ip.dhcp.cid_enable" "value"
```

Values

- "off" = client identifier is turned off
- "on" = client identifier is turned on

Default

"off"

Getvar

To instruct the printer to respond with the status of the client identifier of the internal wired print server:

```
! U1 getvar "internal_wired.ip.dhcp.cid_enable"
```

Example

This `setvar` example shows the value set to "off".

```
! U1 setvar "internal_wired.ip.dhcp.cid_enable" "off"
```

What the `setvar` value is set to is the `getvar` result. In this example, the `getvar` result is "off".



NOTES:

- For printer support, see [SGD Command Support on page 1455](#).
- For details on SGD command structure, see [Command Structure on page 562](#).

internal_wired.ip.dhcp.cid_prefix

This printer setting defines the prefix to be prepended to the DHCP client identifier (option 61) when DHCP is enabled on the internal wired print server and "internal_wired.ip.dhcp.cid_type" is set to "0" or "2".

Setvar

To instruct the printer to change the CID prefix of the internal wired print server:

```
! U1 setvar "internal_wired.ip.dhcp.cid_prefix" "value"
```

Values

Any text string up to 10 characters if the CID type is ASCII, or 20 characters if the CID type is hexadecimal.

Default

""

Getvar

To instruct the printer to respond with the client identifier prefix of the internal wired print server:

```
! U1 getvar "internal_wired.ip.dhcp.cid_prefix"
```

Example

This **setvar** example shows the value set to "PRT001".

```
! U1 setvar "internal_wired.ip.dhcp.cid_prefix" "PRT001"
```

What the **setvar** value is set to is the **getvar** result. In this example, the **getvar** result is "PRT001".



NOTES:

- For printer support, see [SGD Command Support on page 1455](#).
- For details on SGD command structure, see [Command Structure on page 562](#).

internal_wired.ip.dhcp.cid_suffix

This printer setting defines the unique suffix to be used as the client identifier (DHCP option 61) if DHCP is enabled on the internal wired 10/100 print server and "`internal_wired.ip.dhcp.cid_type`" is set to "0" or "2".

Setvar

To instruct the printer to change the client identifier suffix value of the internal wired 10/100 print server:

```
! U1 setvar "internal_wired.ip.dhcp.cid_suffix" "value"
```

Values

The maximum length of a value allowed is 60 ASCII characters when the CID type is ASCII, or 120 hexadecimal values when the CID type is hexadecimal.

Default

""

Getvar

To instruct the printer to respond with the client identifier suffix of the internal wired 10/100 print server:

```
! U1 getvar "internal_wired.ip.dhcp.cid_suffix"
```

Example

This `setvar` example shows the value set to `printer`.

```
! U1 setvar "internal_wired.ip.dhcp.cid_suffix" "printer"
```

What the `setvar` value is set to is the `getvar` result. In this example, the `getvar` result is `printer`.



NOTES:

- For printer support, see [SGD Command Support on page 1455](#).
- For details on SGD command structure, see [Command Structure on page 562](#).

internal_wired.ip.dhcp.cid_type

This printer setting defines the type of client identifier (DHCP option 61) that will be sent if DHCP is enabled on the internal wired print server. A value of "1" means the type of "Ethernet" and the printer's MAC address will be used. A value of "0" or "2" means the client identifier sent will be "internal_wired.ip.dhcp.cid_prefix" concatenated with "internal_wired.ip.dhcp.cid_suffix".

Setvar

To instruct the printer to enable "synthetic" Client Identifier for the internal wired print server:

```
! U1 setvar "internal_wired.ip.dhcp.cid_type" "value"
```

Values

- "0" = ASCII string
- "1" = wired print server's MAC address
- "2" = HEX value

Getvar

To instruct the printer to respond with the client identifier type for the internal wired print server:

```
! U1 getvar "internal_wired.ip.dhcp.cid_type"
```

Example

This `setvar` example shows the value set to "1".

```
! U1 setvar "internal_wired.ip.dhcp.cid_type" "1"
```

When the `setvar` value is set to "1", the `getvar` result is "1".



NOTES:

- For printer support, see [SGD Command Support on page 1455](#).
- For details on SGD command structure, see [Command Structure on page 562](#).

internal_wired.ip.dhcp.lease.last_attempt

This command retrieves the last time a DHCP request was sent from the internal wired print server.

Getvar

To retrieve the last time a DHCP request was sent from the internal wired print server:

```
! U1 getvar "internal_wired.ip.dhcp.lease.last_attempt"
```

Example

In this example, the `getvar` retrieves the last time a DHCP request was sent to the internal wired print server.

```
! U1 getvar "internal_wired.ip.dhcp.lease.last_attempt"
```



NOTES:

- For printer support, see [SGD Command Support on page 1455](#).
- For details on SGD command structure, see [Command Structure on page 562](#).

internal_wired.ip.dhcp.lease.length

This command retrieves the original length (in seconds) of the DHCP lease on the internal wired print server.

Getvar

To retrieve the original length (in seconds) of the DHCP lease on the internal wired print server:

```
! U1 getvar "internal_wired.ip.dhcp.lease.length"
```

Example

In this example, the `getvar` returns the original length of the DHCP lease on the internal wired print server.

```
! U1 getvar "internal_wired.ip.dhcp.lease.length"  
"691200"
```



NOTES:

- For printer support, see [SGD Command Support on page 1455](#).
- For details on SGD command structure, see [Command Structure on page 562](#).

internal_wired.ip.dhcp.lease.server

This command retrieves the address of the server that provided the DHCP lease on the internal wired print server.

Getvar

To retrieve the address of the server that provided the DHCP lease on the internal wired print server:

```
! U1 getvar "internal_wired.ip.dhcp.lease.server"
```

Example

In this example, the `getvar` retrieves the address of the server that provided the DHCP lease on the internal wired print server.

```
! U1 getvar "internal_wired.ip.dhcp.lease.server"  
"10.3.1.98"
```



NOTES:

- For printer support, see [SGD Command Support on page 1455](#).
- For details on SGD command structure, see [Command Structure on page 562](#).

internal_wired.ip.dhcp.lease.time_left

This command retrieves the time (in seconds) left in the current DHCP lease on the internal wired print server.

Getvar

To retrieve the time (in seconds) left in the current DHCP lease on the internal wired print server:

```
! U1 getvar "internal_wired.ip.dhcp.lease.time_left"
```

Example

In this example, the `getvar` retrieves the time left in the current DHCP lease on the wired internal print server.

```
! U1 getvar "internal_wired.ip.dhcp.lease.time_left"  
"10.3.1.98"
```



NOTES:

- For printer support, see [SGD Command Support on page 1455](#).
- For details on SGD command structure, see [Command Structure on page 562](#).

internal_wired.ip.dhcp.option12

This command specifies if the DHCP option 12 (host name) is on or off in the discovery packet that is sent from the internal wired print server.

Setvar

To instruct the printer to set the DHCP option 12 (host name) in the discovery packet of the internal wired print server:

```
! U1 setvar "internal_wired.ip.dhcp.option12" "value"
```

Values

- "on" = turns on option 12
- "off" = turns off option 12

Default

"on"

Getvar

To retrieve the status of the DHCP option 12 (host name) in the discovery packet of the internal wired print server:

```
! U1 getvar "internal_wired.ip.dhcp.option12"
```

Example

This **setvar** example shows the value set to "on".

```
! U1 setvar "internal_wired.ip.dhcp.option12" "on"
```

When the **setvar** value is set to "on", the **getvar** result is "on".



NOTES:

- For printer support, see [SGD Command Support on page 1455](#).
- For details on SGD command structure, see [Command Structure on page 562](#).

internal_wired.ip.dhcp.option12_format

This command specifies the value which will be used for option 12 (host name) to be used in the DHCP discovery packet of the internal wired print server.

Setvar

To instruct the printer to set value which will be used for option 12 (host name) to be used in the DHCP discovery packet of the internal wired print server:

```
! U1 setvar "internal_wired.ip.dhcp.option12_format" "value"
```

Values

0 to 109 alphanumeric characters

Default

""

Getvar

To retrieve the value which will be used for option 12 (host name) to be used in the DHCP discovery packet of the internal wired print server:

```
! U1 getvar "internal_wired.ip.dhcp.option12_format"
```

Example

This **setvar** example shows configuring the `internal_wired.ip.dhcp.option12_format` to the value contained in the `device.friendly_name`.

It is necessary to surround the SGD entry to be used as source for the data with the `<` and `>` characters.

```
! U1 setvar "internal_wired.ip.dhcp.option12_format" "<device.friendly_name>"
```

To further explain, if the above command was issued and the value currently stored in the `device.friendly_name` parameter was "ShipPrinter", then the response to following command would be "ShipPrinter":

```
! U1 getvar "internal_wired.ip.dhcp.option12_value"
```



NOTES:

- For printer support, see [SGD Command Support on page 1455](#).
- For details on SGD command structure, see [Command Structure on page 562](#).

internal_wired.ip.dhcp.option12_value

This command retrieves the actual value which will be used in the discovery packet of the internal wired print server.

Getvar

To retrieve the actual value which will be used in the discovery packet of the internal wired print server:

```
! U1 getvar "internal_wired.ip.dhcp.option12_value"
```

Example

This **setvar** example shows configuring the `internal_wired.ip.dhcp.option12_format` to the value contained in the `device.friendly_name`.

It is necessary to surround the SGD entry to be used as source for the data with the `<` and `>` characters.

```
! U1 setvar "internal_wired.ip.dhcp.option12_format" "<device.friendly_name>"
```

To further explain, if the above command was issued and the value currently stored in the `device.friendly_name` parameter was "ShipPrinter", then the response to following command would be "ShipPrinter":

```
! U1 getvar "internal_wired.ip.dhcp.option12_value"
```



NOTES:

- For printer support, see [SGD Command Support on page 1455](#).
- For details on SGD command structure, see [Command Structure on page 562](#).

internal_wired.ip.dhcp.requests_per_session

This command retrieves the maximum amount of DHCP discover requests for a single DHCP session on the internal wired print server.

Setvar

To instruct the printer to set the maximum amount of DHCP discover requests for a single DHCP session on the internal wired print server:

```
! U1 setvar "internal_wired.ip.dhcp.requests_per_session" "value"
```

Values

1-10

Default

"2"

Getvar

To retrieve the currently set maximum amount of DHCP discover requests for a single DHCP session on the internal wired print server:

```
! U1 getvar "internal_wired.ip.dhcp.requests_per_session"
```

Example

This **setvar** example shows the value set to "2".

```
! U1 setvar "internal_wired.ip.dhcp.requests_per_session" "2"
```

When the **setvar** value is set to "2", the **getvar** result is "2".



NOTES:

- For printer support, see [SGD Command Support on page 1455](#).
- For details on SGD command structure, see [Command Structure on page 562](#).

internal_wired.ip.dns.servers

This command retrieves a space delimited list of the domain name servers from an internal wired print server.

Getvar

To retrieve a list of space delimited DNS internal wired print servers:

```
! U1 getvar "internal_wired.ip.dns.servers"
```



NOTES:

- For printer support, see [SGD Command Support on page 1455](#).
- For details on SGD command structure, see [Command Structure on page 562](#).

internal_wired.ip.gateway

This command instructs the printer to change the internal wired print servers gateway address.



IMPORTANT: This setting refers to the gateway address. A set value is ignored if the IP protocol is not set to permanent.

Setvar

To instruct the printer to change the internal wired printer servers gateway address:

```
! U1 setvar "internal_wired.ip.gateway" "value"
```

Values

Any valid gateway address

Default

"0.0.0.0"

Getvar

To instruct the printer to respond with the internal wired printer servers gateway address:

```
! U1 getvar "internal_wired.ip.gateway"
```

Example

This **setvar** example shows the value set to "**10.3.5.1**".

```
! U1 setvar "internal_wired.ip.gateway" "10.3.5.1"
```

When the **setvar** value is set to "**10.3.5.1**", the **getvar** result is "**10.3.5.1**".



NOTES:

- For printer support, see [SGD Command Support on page 1455](#).
- For details on SGD command structure, see [Command Structure on page 562](#).

internal_wired.ip.netmask

This setting refers to the internal wired print server's subnet mask address. This value is ignored if the IP protocol is not set to permanent.

Setvar

To instruct the printer to change the internal wired print servers subnet mask:

```
! U1 setvar "internal_wired.ip.netmask" "value"
```

Values

Any valid subnet mask.

Default

```
"255.255.255.0"
```

Getvar

To instruct the printer to respond with internal wired print servers subnet mask:

```
! U1 getvar "internal_wired.ip.netmask"
```

Example

This `setvar` example shows the value set to "255.255.255.0".

```
! U1 setvar "internal_wired.ip.netmask" "255.255.255.0"
```

When the `setvar` value is set to "255.255.255.0", the `getvar` result is "255.255.255.0".



NOTES:

- For printer support, see [SGD Command Support on page 1455](#).
- For details on SGD command structure, see [Command Structure on page 562](#).

internal_wired.ip.port

This printer setting refers to the internal wired print servers port number that the TCP print service is listening on. Normal TCP communications from the host should be directed to this port.

Setvar

To instruct the printer to set the internal wired print servers TCP/UDP port number:

```
! U1 setvar "internal_wired.ip.port" "value"
```

Values

1 - 65535 (excluding any ports currently used by other services, such as 21, 23, 80, and 515).

Default

"9100"

Getvar

To instruct the printer to respond with the internal wired printer servers TCP/UDP port number:

```
! U1 getvar "internal_wired.ip.port"
```

Example

This **setvar** example shows the value set to **"9100"**.

```
! U1 setvar "internal_wired.ip.port" "9100"
```

When the **setvar** value is set to **"9100"**, the **getvar** result is **"9100"**.



NOTES:

- For printer support, see [SGD Command Support on page 1455](#).
- For details on SGD command structure, see [Command Structure on page 562](#).

internal_wired.ip.port_alternate

This command sets the port number of the alternate port.



NOTE: Print servers supporting this command will monitor both the primary port and the alternate port for connections at the same time.

Setvar

To set the alternate port for the print server:

```
! U1 setvar "internal_wired.ip.port_alternate" "value"
```

Values

Any valid TCP port address.

Default

"9100"

Getvar

To return the current alternate port setting:

```
! U1 setvar "internal_wired.ip.port_alternate"
```

Values

The current port setting.



NOTES:

- For printer support, see [SGD Command Support on page 1455](#).
- For details on SGD command structure, see [Command Structure on page 562](#).

internal_wired.ip.port_json_config

This command determines the TCP port number to listen on for JSON configuration packets.

Setvar

To set the TCP port number to listen on for JSON configuration packets:

```
! U1 setvar "internal_wired.ip.port_json_config" "value"
```

Values

- 0 = disable the port
- 1-65535 = Port number to listen on.

Ports that are already in use or the standard network ports are invalid values.

Default

```
"9200"
```

Getvar

To retrieve the port number:

```
! U1 getvar "internal_wired.ip.port_json_config"
```

Example

This example sets the port value to listen on as 1234.

```
! U1 setvar "internal_wired.ip.port_json_config" "1234"
```



NOTES:

- For printer support, see [SGD Command Support on page 1455](#).
- For details on SGD command structure, see [Command Structure on page 562](#).

internal_wired.ip.protocol

This command configures the IP addressing method used by the internal wired print server.

Setvar

To instruct the printer to configure the IP addressing method used by the internal wired print server:

```
! U1 setvar "internal_wired.ip.protocol" "value"
```

Values

- **"bootp"** = uses the standard bootp addressing method to obtain an IP address and configuration
- **"dhcp"** = uses the standard dhcp addressing method to obtain an IP address and configuration for a server specified period of time
- **"rarp"** = uses the standard rarp addressing method to obtain an IP address
- **"glean"** = uses the IP address from a PING packet that is sent to its hardware address (unicast address)
- **"permanent"** = uses static values assigned through other commands
- **"all"** = tries all of the dynamic addressing methods, not permanent, to obtain an IP address

Default

```
"all"
```

Getvar

To return the IP addressing method used by the internal wired print server:

```
! U1 getvar "internal_wired.ip.protocol"
```

Example

In this example, the **setvar** result is the current programming language that the printer is using.

```
! U1 setvar "internal_wired.ip.protocol" "bootp"
```

What the **setvar** value is set to is the **getvar** result. In this example, the **getvar** result is **"bootp"**.



NOTES:

- For printer support, see [SGD Command Support on page 1455](#).
- For details on SGD command structure, see [Command Structure on page 562](#).

internal_wired.ip.timeout.enable

This network setting refers to enabling the connection timeout on the internal wired print server. For this to take effect, the print server must be reset.

Setvar

To instruct the printer to enable or disable the timeout checking on the internal wired print server:

```
! U1 setvar "internal_wired.ip.timeout.enable" "value"
```

Values

- "off" = turns off the connection checking
- "on" = turns on the connection checking

Default

"on"

Getvar

To instruct the printer to return whether the timeout checking is enabled on the internal wired print server:

```
! U1 getvar "internal_wired.ip.timeout.enable"
```

Example

This `setvar` example shows the value set to "on".

```
! U1 setvar "internal_wired.ip.timeout.enable" "on"
```

When the `setvar` value is set to "on", the `getvar` result is "on".



NOTES:

- For printer support, see [SGD Command Support on page 1455](#).
- For details on SGD command structure, see [Command Structure on page 562](#).

internal_wired.ip.timeout.value

This network setting refers to the number of seconds before the connection times out for the internal wired print server. For this to take effect, the print server must be reset.

Setvar

To instruct the printer to set the time of the internal wired print server, in seconds, before the connection times out:

```
! U1 setvar "internal_wired.ip.timeout.value" "value"
```

Values

"1" through "3600"

Default

"300"

Getvar

To instruct the printer to respond with the time of the internal wired print server, in seconds, before the connection times out:

```
! U1 getvar "internal_wired.ip.timeout.value"
```

Example

This `setvar` example shows the value set to "300".

```
! U1 setvar "internal_wired.ip.timeout.value" "300"
```

When the `setvar` value is set to "300", the `getvar` result is "300".



NOTES:

- For printer support, see [SGD Command Support on page 1455](#).
- For details on SGD command structure, see [Command Structure on page 562](#).

internal_wired.ip.wins.addr

Sets or returns the current WINS server address. If WinsAddressing is DHCP, then this will automatically be filled by the DHCP server.

Setvar

To set the current WINS server address:

```
! U1 setvar "internal_wired.ip.wins.addr" "value"
```

Values

a valid WINS IP address.

Default

```
"0.0.0.0"
```

Getvar

To return the WINS server address:

```
! U1 getvar "internal_wired.ip.wins.addr"
```

Result

the current WINS server address



NOTES:

- For printer support, see [SGD Command Support on page 1455](#).
- For details on SGD command structure, see [Command Structure on page 562](#).

internal_wired.ip.wins.permanent_source

Specifies if the WINS address will be permanent or set via DHCP.

Setvar

To specify if the WINS address will be permanent or set via DHCP:

```
! U1 setvar "internal_wired.ip.wins.permanent_source" "value"
```

Values

- "off" = use DHCP-assigned WINS address
- "on" = use currently stored WINS address

The WINS address can be set using the `interface.network.active.wins_address` command.

Default

"off"

Getvar

To return the current setting value:

```
! U1 getvar "internal_wired.ip.wins.permanent_source"
```



NOTES:

- For printer support, see [SGD Command Support on page 1455](#).
- For details on SGD command structure, see [Command Structure on page 562](#).

internal_wired.mac_addr

This command retrieves the MAC address of the internal wired print server.

Getvar

To instruct the printer to respond with the MAC address of the internal wired print server:

```
! U1 getvar "internal_wired.mac_addr"
```

Example

In this example, the `getvar` result is the MAC address of the internal wired print server.

```
! U1 getvar "internal_wired.mac_addr"
```



NOTES:

- For printer support, see [SGD Command Support on page 1455](#).
- For details on SGD command structure, see [Command Structure on page 562](#).

internal_wired.mac_raw

This command identifies the RAW MAC address of the internal wired print server. The raw mac address is the mac address without the colons (":").

Getvar

To retrieve the RAW MAC address of the internal wired print server:

```
! U1 getvar "internal_wired.mac_raw"
```

Example

In this example, the `getvar` retrieves the RAW MAC address of the internal wired print server.

```
! U1 getvar "internal_wired.mac_raw"
```



NOTES:

- For printer support, see [SGD Command Support on page 1455](#).
- For details on SGD command structure, see [Command Structure on page 562](#).

SGD Wireless Commands

This chapter provides a high-level overview of the wireless Set / Get / Do (SGD) commands and details on each SGD command. For printer support of these SGD commands, see [SGD Command Support on page 1455](#).

.15†

SGD commands are available in printers with the following firmware versions or later:

- V60.16.2Z or later
- V60.15.xZ or later
- V50.15.xZ or later
- V61.15.xZ or later
- V56.15.xZ or later
- V53.16.x or later
- V53.15.2Z or later
- R53.16.3Z or later
- R60.15.8Z or later
- R62.15.8Z or later
- R63.15.8Z or later
- R65.15.8Z or later



NOTE: The commands listed in this chapter are for use with the Wireless Print Server and Wireless Plus Print Server, when used with firmware version V60.15.x, V50.15.x, or later.



IMPORTANT: These are important points to note when using ZPL and SGD commands:

- SGD commands are case-sensitive.
- ZPL and SGD commands should be sent to the printer as separate files.
- Certain settings can be controlled by both ZPL and SGD. Configuration changes made in ZPL can affect configuration changes made in SGD.
- Changes made with one command type (ZPL or SGD) will affect the data returned to the host in response to both ZPL and getvar commands. The command type (ZPL or SGD) that was sent last determines the current setting.
- Some RF cards do not support all of the SGD commands.



IMPORTANT: These are important points to note when using a Zebra G-Series printer:

- You can send instructions to the printer using multiple programming languages: EPL, ZPL, or SGD. EPL and ZPL commands configure the printer, print labels, and get device status information. SGD commands set and get configuration details. These three languages can be used without the need to send the printer instructions to switch from one language to another.

- EPL, ZPL, and SGD commands must be sent to the printer as separate files. They cannot be used together in one format, or set of commands. For example, if you send a series of SGD commands to the printer and they are followed by a printable format, this needs to be done using separate files.

Overview

This section describes how and why to use the Set / Get / Do (SGD) commands. It also provides an example of a typical command structure.



NOTE: SGD commands must be terminated by a carriage return or a space and line feed.

SGD commands are commands that allow you to configure all printers with firmware version V60.15.x, V50.15.x, V61.15.x, V56.15.x, V53.15.xZ, or later. The printer performs the specified function immediately after receiving the command. The commands are:

- **setvar**
- **getvar**
- **do**

setvar Command

Setvar commands:

- are used to configure printer settings to specific values by setting them in the printer
- must be terminated by a space character or a CR/ LF (0x0D, 0x0A)



IMPORTANT: The setvar command and attributes must be specified in lower case.

getvar Command

Getvar commands:

- are used to get the current value of the printer settings
- must be terminated by a space character or CR/LF (0x0D, 0x0A)

The printer responds with the printer setting of “?” if:

- the printer setting does not exist (usually due to incorrect spelling of the printer setting)
- it has not been configured yet



IMPORTANT: The printer settings and attributes must be specified in lower case.

do Command

Do commands:

- are used to instruct the printer to perform predefined actions
- must be terminated by a space character or a CR/LF (0x0D, 0x0A)

Some **Do** commands require additional settings which must be enclosed in double quotes.



IMPORTANT: The values must be specified in lower case.

Command Structure

It is important to understand the structure of the command and its components. A command structure illustration is provided for each command in this guide.

This is an example of a command structure illustration:

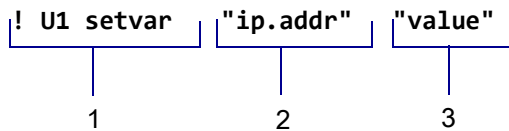

1	Command—always preceded with an exclamation point (!) and must be specified in lower case. A space resides between the ! and U1 and between U1 and the command (setvar or getvar).
2	Attribute—always in double quotes and must be specified in lower case.
3	Chosen value—always in double quotes. Only applicable for setvar and do .



IMPORTANT: This command must be terminated by a space character or a CR/ LF (0x0D, 0x0A).

How to Send Multiple SGD Commands

For any **getvar**, **setvar**, or **do** command, if you issue the syntax without the "1" and use the END command followed by a space, multiple SGD commands are sent simultaneously.

This syntax shows how you can send multiple **getvar** commands:

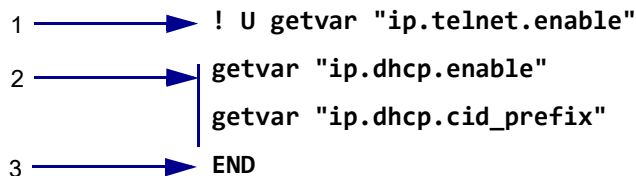

1	The command portion of the string does not use the "1" after the "! U".
2	Commands issued after the first command do not require the "! U".
3	The string of commands is terminated by the word "END" with a space after the word, and by a carriage return/ line feed.

bluetooth.address

This command returns the printer's Bluetooth device address.

Getvar

To retrieve the printer's Bluetooth address:

```
! U1 getvar "bluetooth.address"
```

Example

In this example, the `getvar` command causes the printer to return the printer's Bluetooth address.

```
! U1 getvar "bluetooth.address"
```



NOTES:

- For printer support, see [SGD Command Support on page 1455](#).
- For details on SGD command structure, see [Command Structure on page 562](#).

bluetooth.afh_map

Sets or retrieves the default AFH (adaptive frequency hopping) channel map (Bluetooth radios 1.2 and later); 20 bytes.

Setvar

To selectively enables or disables individual Bluetooth channels for use when AFH mode is set to "on":

```
! U1 setvar "bluetooth.afh_map" "value"
```

Values

20-byte string of hexadecimal characters

Default

```
"7FFFFFFFFFFFFFFFFFFFFF"
```

Getvar

To retrieve default AFH channel map:

```
! U1 getvar "bluetooth.afh_map"
```

Example

This **setvar** example shows the value set to "7FFFFFFFFFFFFFFFFFFFFF".

```
! U1 setvar "bluetooth.afh_map" "7FFFFFFFFFFFFFFFFFFFFF"
```

What the **setvar** value is set to is the **getvar** result. In this example, the **getvar** result is "7FFFFFFFFFFFFFFFFFFFFF".



NOTES:

- For printer support, see [SGD Command Support on page 1455](#).
- For details on SGD command structure, see [Command Structure on page 562](#).

bluetooth.afh_map_curr

This command retrieves the current AFH (adaptive frequency hopping) channel map (Bluetooth radios 1.2 and later).

Getvar

To retrieve the current AFH channel map:

```
! U1 getvar "bluetooth.afh_map_curr"
```

Example

In this example, the `getvar` command causes the printer to retrieve the current AFH channel map.

```
! U1 getvar "bluetooth.afh_map_curr"
```



NOTES:

- For printer support, see [SGD Command Support on page 1455](#).
- For details on SGD command structure, see [Command Structure on page 562](#).

bluetooth.afh_mode

This command sets or retrieves AFH (adaptive frequency hopping) mode setting (Bluetooth radios 1.2 and later).

Setvar

To enable or disable AFH mode:

```
! U1 setvar "bluetooth.afh_mode" "value"
```

Values

- "on" = enables AFH mode
- "off" = disables AFH mode

Default

"off"

Getvar

To retrieve the current setting of the AFH mode:

```
! U1 getvar "bluetooth.afh_mode"
```

Example

This `setvar` example shows the value set to "on".

```
! U1 setvar "bluetooth.afh_mode" "on"
```

What the `setvar` value is set to is the `getvar` result. In this example, the `getvar` result is "on".



NOTES:

- For printer support, see [SGD Command Support on page 1455](#).
- For details on SGD command structure, see [Command Structure on page 562](#).

bluetooth.allow_non_display_numeric_comparison

This command allows the user to enable or disable a numeric comparison connection for printers without a display and also enables or disables displaying the pass key.



NOTE: This is an unsupported command for printers with display.

Setvar

To set the numeric comparison connection:

```
! U1 setvar "device.allow_non_display_numeric_comparison" "value"
```

Values

"off"	=	does not allow pass key connection for non display printers.
"print"	=	prints and accepts the pass key on non display printers (Man in the Middle protection).
"no print"	=	accepts but does not print the pass key for non display printer (no Man in the Middle protection).

Default Value

"print"

Getvar

To return the current setting value:

```
! U1 getvar "device.allow_non_display_numeric_comparison"
```



NOTES:

- For printer support, see [SGD Command Support on page 1455](#).
- For details on SGD command structure, see [Command Structure on page 562](#).

bluetooth.authentication

This command sets or retrieves Bluetooth authentication mode and works in combination with the `bluetooth.bluetooth_pin`.

Setvar

To enable or disable Bluetooth authentication:

```
! U1 setvar "bluetooth.authentication" "value"
```

Values

- "off" = disables authentication (can connect to master device without PIN)
- "setpin" = enables authentication (requires PIN or passkey to connect to a master device)

Default

"off"

Getvar

To retrieve the current Bluetooth authentication mode:

```
! U1 getvar "bluetooth.authentication"
```

Example

This `setvar` example shows the value set to "setpin".

```
! U1 setvar "bluetooth.authentication" "setpin"
```

What the `setvar` value is set to is the `getvar` result. In this example, the `getvar` result is "setpin".



NOTES:

- For printer support, see [SGD Command Support on page 1455](#).
- For details on SGD command structure, see [Command Structure on page 562](#).

bluetooth.bluetooth_pin

This command is used to connect to the printer only when the command `bluetooth.authentication` is set to `setpin`.

Setvar

To set the Bluetooth pin value:

```
! U1 setvar "bluetooth.bluetooth_pin" "value"
```

Values

Any text string up to 10 characters

Default

""

Getvar

To retrieve the current Bluetooth pin:

```
! U1 getvar "bluetooth.bluetooth_pin"
```

Example

This `setvar` example shows the value set to `"1234567890"`.

```
! U1 setvar "bluetooth.bluetooth_pin" "1234567890"
```

What the `setvar` value is set to is the `getvar` result. In this example, the `getvar` result is `"1234567890"`.



NOTES:

- For printer support, see [SGD Command Support on page 1455](#).
- For details on SGD command structure, see [Command Structure on page 562](#).

bluetooth.clear_bonding_cache

Deletes all information related to previous Bluetooth pairing events from the printer.

Do

To delete all information related to previous Bluetooth pairing events from the printer:

```
! U1 do "bluetooth.clear_bonding_cache"
```

Values

NA

Default

NA



NOTES:

- For printer support, see [SGD Command Support on page 1455](#).
- For details on SGD command structure, see [Command Structure on page 562](#).

bluetooth.date

This command shows the release date of the Bluetooth module.

Getvar

To show the release date of the Bluetooth module:

```
! U1 getvar "bluetooth.date"
```

Example

In this example, the `getvar` command returns the release date of the Bluetooth module.

```
! U1 getvar "bluetooth.date"
```



NOTES:

- For printer support, see [SGD Command Support on page 1455](#).
- For details on SGD command structure, see [Command Structure on page 562](#).

bluetooth.discoverable

This command enables or disables the Bluetooth discoverable mode.

Setvar

To enable or disable the Bluetooth discoverable mode:

```
! U1 setvar "bluetooth.discoverable" "value"
```

Values

"on" = enables Bluetooth discoverable mode

"off" = disables Bluetooth discoverable mode

Default

"on" (For Printers running Link-OS v5.3 or earlier versions)

"off" (For Printers running Link-OS 6 or later versions)

Getvar

To retrieve the current Bluetooth discoverable mode:

```
! U1 getvar "bluetooth.discoverable"
```

Example

This `setvar` example shows the value set to "on".

```
! U1 setvar "bluetooth.discoverable" "on"
```

What the `setvar` value is set to is the `getvar` result. In this example, the `getvar` result is "on".



NOTES:

- For printer support, see [SGD Command Support on page 1455](#).
- For details on SGD command structure, see [Command Structure on page 562](#).

bluetooth.enable

This command enables or disables the Bluetooth radio.

Setvar

To enable or disable the Bluetooth radio:

```
! U1 setvar "bluetooth.enable"
```

Values

- "on" = enables the Bluetooth radio
- "off" = disables the Bluetooth radio

Default

"on"

Getvar

To retrieve the current status of the Bluetooth radio:

```
! U1 getvar "bluetooth.enable"
```

Example

This `setvar` example shows the value set to "on".

```
! U1 setvar "bluetooth.enable" "on"
```

What the `setvar` value is set to is the `getvar` result. In this example, the `getvar` result is "on".



NOTES:

- For printer support, see [SGD Command Support on page 1455](#).
- For details on SGD command structure, see [Command Structure on page 562](#).

bluetooth.enable_reconnect

Enables the Bluetooth reconnect feature required by iOS devices.

Setvar

To enable or disable the Bluetooth reconnect feature:

```
! U1 setvar "bluetooth.enable_reconnect" "value"
```

Values

- "off" = disables the command
- "iOS_only" = enables the command to work with iOS devices only

Getvar

To return the current setting value:

```
! U1 getvar "bluetooth.enable_reconnect"
```



NOTES:

- For printer support, see [SGD Command Support on page 1455](#).
- For details on SGD command structure, see [Command Structure on page 562](#).

bluetooth.friendly_name

This command sets the friendly name, which is used during service discovery. For changes to take effect, you must power cycle the printer or issue the `device.reset` command. If `bluetooth.friendly_name` is not set by you, it will default to the printer serial number.

Setvar

To set the Bluetooth discoverable mode:

```
! U1 setvar "bluetooth.friendly_name" "value"
```

Values

Any text string up to 17 characters

Getvar

To retrieve the current Bluetooth discoverable mode:

```
! U1 getvar "bluetooth.friendly_name"
```

Example

This `setvar` example shows the value set to `"1234567"`.

```
! U1 setvar "bluetooth.friendly_name" "1234567"
```

What the `setvar` value is set to is the `getvar` result. In this example, the `getvar` result is `"1234567"`.



NOTES:

- For printer support, see [SGD Command Support on page 1455](#).
- For details on SGD command structure, see [Command Structure on page 562](#).

bluetooth.json_config_channel_enable

Enables or disables the Bluetooth JSON configuration channel. Changes to this command setting only take effect when the printer is reset or power cycled.



NOTE: The JSON config channel will stop being advertised when there is no connection to the JSON channel and there is no connection on the main SPP channel.



IMPORTANT: All Bluetooth devices must first make an SPP connection before being able to make the JSON channel connection to a printer.

Setvar

To enable or disable the Bluetooth JSON configuration channel:

```
! U1 setvar "bluetooth.json_config_channel_enable" "value"
```

Values

- "on" - the channel is advertised and available for use only when the main serial port protocol (SPP) channel is connected.
- "off" - the channel is not advertised or available for use.

Default

"on"

Example

```
! U1 setvar "bluetooth.json_config_channel_enable" "off"
```

Getvar

To return the current setting value:

```
! U1 getvar "bluetooth.json_config_channel_enable"
```



NOTES:

- For printer support, see [SGD Command Support on page 1455](#).
- For details on SGD command structure, see [Command Structure on page 562](#).

bluetooth.power_class

This command sets the maximum transmit power level of the Bluetooth radio.

If the Bluetooth radio is configured for "1", then the maximum power level of the radio is 20 dBm. If the radio is configured for "2", then the maximum power level of the radio is 4 dBm.

Setvar

To set the bluetooth power class value for the printer:

```
! U1 setvar "bluetooth.power_class" "value"
```

Values

- "1" = iMZ220, iMZ320, ZD500, ZQ610, ZQ620, ZQ630, ZR658, ZR668, ZT210, ZT220, ZT410, ZT411, ZT420, ZT421, ZT510, ZT610, ZT620
- "2" = iMZ220, iMZ320, ZD500, ZQ610, ZQ620, ZQ630, ZR658, ZR668, ZT210, ZT220, ZT410, ZT411, ZT420, ZT421, ZT510, ZT610, ZT620
- "3" = ZT510, ZT610, ZT620

Default Value

- "2" = ZQ610, ZQ620, ZQ630, ZR658, ZR668, iMZ220 Non-Sdio radio, iMZ320 Non-Sdio radio, ZT410 Non-Sdio Radio, ZT411 Non-Sdio Radio, ZT420 Non-Sdio Radio, ZT510 8887 Sdio Radio, ZT620 Non-Sdio Radio
- "1" = ZT620 8787 Sdio Radio, ZT610 8787 Sdio Radio, ZT421 8787 Sdio Radio, ZT420 8787 Sdio Radio, ZT410 Sdio Radio, ZD500 8787 Sdio Radio

Getvar

To return the current setting:

```
! U1 getvar "bluetooth.power_class"
```



NOTES:

- Not all radios support a 20 dBm power output. A radio that supports a transmit power level above 4 dBm but less than 20 dBm is sometimes referred to as "Class 1.5". This is not a standard term defined by the Bluetooth SIG.
- For printer support, see [SGD Command Support on page 1455](#).
- For details on SGD command structure, see [Command Structure on page 562](#).

bluetooth.le.controller_mode

For printers that support both Bluetooth Classic and Bluetooth Low-Energy mode, this command controls the mode of operation.

Setvar

To control the mode of operation:

```
! U1 setvar "bluetooth.le.controller_mode" "value"
```

Values

- **"both"** = the Bluetooth radio operates in both low energy and classic mode
- **"le"** = the Bluetooth radio operates in low energy mode
- **"classic"** = the Bluetooth radio operates in the classic mode

Default

"both"

Getvar

To return the current setting value:

```
! U1 getvar "bluetooth.le.controller_mode"
```



NOTES:

- For printer support, see [SGD Command Support on page 1455](#).
- For details on SGD command structure, see [Command Structure on page 562](#).

bluetooth.le.power_class

This command sets the maximum transmit power level of the Bluetooth low energy radio.

Setvar

To set the power class value of the bluetooth low energy printers:

```
! U1 setvar "bluetooth.le.power_class" "value"
```

Values

The values varies printer to printer as given below.

"1" = ZQ610, ZQ620, ZQ630, ZR658, ZR668, ZT510, ZT610, ZT620

"2" = ZQ610, ZQ620, ZQ630, ZR658, ZR668, ZT510, ZT610, ZT620

"3" = ZT510, ZT610, ZT620

Default Value

The default values varies printer to printer as given below.

"2" = ZQ610, ZQ620, ZQ630, ZR658, ZR668

"3" = ZT510, ZT610, ZT620

Getvar

To return the current setting:

```
! U1 getvar "bluetooth.le.power_class"
```



NOTES:

- For printer support, see [SGD Command Support on page 1455](#).
- For details on SGD command structure, see [Command Structure on page 562](#).

bluetooth.le.minimum_security

Determines the minimum device-level security settings the printer will use to connect for Bluetooth Low-Energy (LE) connections.

Setvar

To set the device-level security settings the printer will use to connect for Bluetooth Low-Energy (LE) connections:

```
! U1 setvar "bluetooth.le.minimum_security" "value"
```

Values

- **"none"** = security is not required unless the particular Bluetooth LE service or characteristic being accessed requires security.
For all other choices, all services will require pairing and apply some form of security.
- **"unauth_key_signing"** = (un)authenticated pairing and signing keys are required
- **"auth_key_signing"** = authenticated pairing and signing keys are required.
- **"unauth_key_encrypt"** = (un)authenticated pairing and encryption are required.
- **"auth_key_encrypt"** = authenticated pairing and encryption are required.

Default

"none" - if the printer has a Bluetooth LE radio.

If the printer does not have a Bluetooth LE radio installed, there is no default value.

Getvar

To return the current setting value:

```
! U1 getvar "bluetooth.le.minimum_security"
```

If the printer does not have a Bluetooth LE radio installed, the printer will return an empty string.



NOTES:

- For printer support, see [SGD Command Support on page 1455](#).
- For details on SGD command structure, see [Command Structure on page 562](#).

bluetooth.page_scan_window

This command sets the page scan window timing. It can be either 15 or 60 ms. 60 ms is the default value.

Setvar

To set the page scan window timing:

```
! U1 setvar "bluetooth.page_scan_window" "value"
```

Values

"15"

"60"

Default Value

"60"

Getvar

To view the current setting:

```
! U1 getvar "bluetooth.page_scan_window"
```



NOTES:

- For printer support, see [SGD Command Support on page 1455](#).
- For details on SGD command structure, see [Command Structure on page 562](#).

bluetooth.local_name

This command retrieves the local name that is provided during service discovery.

Getvar

To retrieve the local name that is provided during service discovery:

```
! U1 getvar "bluetooth.local_name"
```

Example

In this example, the `getvar` command returns the local name that is provided during service discovery.

```
! U1 getvar "bluetooth.local_name"
```



NOTES:

- For printer support, see [SGD Command Support on page 1455](#).
- For details on SGD command structure, see [Command Structure on page 562](#).

bluetooth.minimum_security_mode

This printer setting parameter sets the Bluetooth Minimum Security mode. Minimum Security Mode provides for three levels of security, depending on the printer radio version and printer firmware: "1", "2", and "3".



IMPORTANT: This feature is available in printers with Bluetooth® radio version 2.0 or higher.

Setvar

To set the Bluetooth Minimum Security mode:

```
! U1 setvar "bluetooth.minimum_security_mode" "value"
```

Values

"1" = Security mode 1 - the printer will:

- be discoverable
- not require a PIN to connect to

"2" = the printer will:

- switch to bluetooth.authentication = "setpin"
(Connecting device must provide the printer's bluetooth.bluetooth_pin),
- switch to Bluetooth.encryption = "on", and
- use existing Bluetooth.discoverable setting

"3" = Link Level Enforced Security - the printer will:

- switch to bluetooth.authentication = "setpin"
(Connecting device must provide the printer's bluetooth.bluetooth_pin)
- switch to bluetooth.encryption = "on"
- switch to bluetooth.discoverable = "off"
- only connect to devices which use Link Level Enforced Security

Default

"1"

Getvar

To retrieve the current Bluetooth Minimum Security Mode:

```
! U1 getvar "bluetooth.minimum_security_mode"
```

Example

This `setvar` example shows the value set to "2".

```
! U1 setvar "bluetooth.minimum_security_mode" "2"
```



NOTES:

- For printer support, see [SGD Command Support on page 1455](#).
- For details on SGD command structure, see [Command Structure on page 562](#).

bluetooth.radio_auto_baud

This command retrieves the Bluetooth radio data rate.

Getvar

To retrieve Bluetooth radio data rate:

```
! U1 getvar "bluetooth.radio_auto_baud"
```

Example

In this example, the `getvar` retrieves the short Bluetooth address.

```
! U1 getvar "bluetooth.radio_auto_baud"
```



NOTES:

- For printer support, see [SGD Command Support on page 1455](#).
- For details on SGD command structure, see [Command Structure on page 562](#).

bluetooth.radio_version

This command returns the version of the currently installed Bluetooth radio.

Getvar

To return the version of the currently installed Bluetooth radio:

```
! U1 getvar "bluetooth.radio_version"
```

Example

In this example, the `getvar` command returns the currently installed Bluetooth radio.

```
! U1 getvar "bluetooth.radio_version"
```



NOTES:

- For printer support, see [SGD Command Support on page 1455](#).
- For details on SGD command structure, see [Command Structure on page 562](#).

bluetooth.short_address

This command shortens the Bluetooth address by removing the colons (":").

Getvar

To retrieve the shortened Bluetooth address:

```
! U1 getvar "bluetooth.short_address"
```

Example

In this example, the `getvar` retrieves the short Bluetooth address.

```
! U1 getvar "bluetooth.short_address"
```



NOTES:

- For printer support, see [SGD Command Support on page 1455](#).
- For details on SGD command structure, see [Command Structure on page 562](#).

bluetooth.version

This command returns the Bluetooth library version number.

Getvar

To return the Bluetooth library version number:

```
! U1 getvar "bluetooth.version"
```

Example

In this example, the `getvar` command returns the Bluetooth library version number.

```
! U1 getvar "bluetooth.version"
```



NOTES:

- For printer support, see [SGD Command Support on page 1455](#).
- For details on SGD command structure, see [Command Structure on page 562](#).

card.mac_addr

This command retrieves the MAC address of the wireless radio card.

Getvar

To instruct the printer to respond with the MAC address:

```
! U1 getvar "card.mac_addr"
```

Example

In this example, the `getvar` result is the MAC address for the wireless radio card.

```
! U1 getvar "card.mac_addr"
```



NOTES:

- For printer support, see [SGD Command Support on page 1455](#).
- For details on SGD command structure, see [Command Structure on page 562](#).

card.inserted

This command indicates whether the wireless radio card is or is not inserted.

Getvar

To instruct the printer to respond with the wireless radio card status. It's inserted or it's not inserted:

```
! U1 getvar "card.inserted"
```

Example

In this example, the `getvar` result is `"Inserted"`.

```
! U1 getvar "card.inserted"
```



NOTES:

- For printer support, see [SGD Command Support on page 1455](#).
- For details on SGD command structure, see [Command Structure on page 562](#).

ip.active_network

This command displays if the printer is actively connected to wireless, external wired, or internal wired.

Getvar

To return the current active network the printer is connected to:

```
! U1 getvar "ip.active_network"
```

The Printer Response table below details on the potential return values.

Example

In this example, the `getvar` will return the current active network the printer is connected to.

```
! U1 getvar "ip.active_network"
```



NOTES:

- For printer support, see [SGD Command Support on page 1455](#).
- For details on SGD command structure, see [Command Structure on page 562](#).

Table 24 Printer Response

Return Values	Details
"internal wired"	This is the return value when an internal wired device is detected.
"wireless"	This is the return value when a wireless device is detected.
"external wired"	This is the return value when an external wired device is detected.
"unknown"	This is the return value: <ul style="list-style-type: none"> • if the printer has not established a network connection on any of the devices • if you don't have any of the network devices plugged in • if the printer is still trying to establish a connection (i.e. on wireless it is going through the association process).

ip.addr

This command allows you to get or set the printer's IP address.



IMPORTANT: For a set IP address to take affect, the IP protocol must be set to permanent and the print server must be reset.

Setvar

To instruct the printer to change its current IP address upon powering the printer on:

```
! U1 setvar "ip.addr" "value"
```

Values

any valid IP address

Default

"0.0.0.0"

Getvar

To instruct the printer to respond with its current IP address:

```
! U1 getvar "ip.addr"
```



NOTE: The `setvar` value of this command can be affected by the `ip.dhcp.enable` command.

Example

This `setvar` example shows the value set to "**10.14.4.235**".

```
! U1 setvar "ip.addr" "10.14.4.235"
```

What the `setvar` value is set to is the `getvar` result. In this example, the `getvar` result is "**10.14.4.235**".



NOTES:

- For printer support, see [SGD Command Support on page 1455](#).
- For details on SGD command structure, see [Command Structure on page 562](#).

ip.arp_interval

This printer setting allows you to specify the ARP (Address Resolution Protocol) interval or the ARP cache time out.

Setvar

To instruct the printer to change the ARP interval or the ARP cache time out:

```
! U1 setvar "ip.arp_interval" "value"
```

Values

0 - 30

Default

"0"

Getvar

To instruct the printer to respond with the ARP interval or the ARP cache time out value in seconds:

```
! U1 getvar "ip.arp_interval"
```

Example

This **setvar** example shows the value set to "0".

```
! U1 setvar "ip.arp_interval" "0"
```

What the **setvar** value is set to is the **getvar** result. In this example, the **getvar** result is "0".



NOTES:

- For printer support, see [SGD Command Support on page 1455](#).
- For details on SGD command structure, see [Command Structure on page 562](#).

ip.bootp.enable

This printer setting turns BOOTP on or off. BOOTP is a method for acquiring an IP address, netmask, and gateway automatically on printer power-up. It requires a BOOTP server on the local network.



NOTE: If you are using static IP addressing, the IP protocol must be set to permanent.

Setvar

To instruct the printer to turn BOOTP on or off:

```
! U1 setvar "ip.bootp.enable" "value"
```

Values

- "off" = printer does not use BOOTP to get the IP address
- "on" = printer uses BOOTP to get the IP address

Default

"on"

Getvar

To instructs the printer to respond with the current BOOTP setting:

```
! U1 getvar "ip.bootp.enable"
```

Example

This **setvar** example shows the value set to "on".

```
! U1 setvar "ip.bootp.enable" "on"
```

When the **setvar** value is set to "on", the **getvar** result is "on".



NOTES:

- For printer support, see [SGD Command Support on page 1455](#).
- For details on SGD command structure, see [Command Structure on page 562](#).

ip.dhcp.arp_verify

This command configures the print server to send out an ARP request during the DHCP address negotiation. This is used to verify if the IP address received from the DHCP server is in use.

- If an ARP reply is received, a DHCP DECLINE message is sent to the DHCP server telling it that the received address cannot be used and then the normal DHCP procedure is restarted.
- If no ARP reply is received the DHCP address is used.

Setvar

To instruct the printer to turn on ARP verify:

```
! U1 setvar "ip.dhcp.arp_verify" "value"
```

Values

- "on"
- "off"

Default

"off"

Getvar

To return whether the printer will send the ARP request during the DHCP negotiation:

```
! U1 getvar "ip.dhcp.arp_verify"
```

Example

This `setvar` example shows the value set to "on".

```
! U1 setvar "ip.dhcp.arp_verify" "on"
```



NOTES:

- For printer support, see [SGD Command Support on page 1455](#).
- For details on SGD command structure, see [Command Structure on page 562](#).

ip.dhcp.auto_provision_enable

This command prepares the printer to receive Weblink settings from the DHCP server. These settings are used to allow the printer to connect to on-premise or web-based servers.

If DHCP receives option 43 in the format of "**10642 <auto provision code> < auto provision settings>**" and the Client is not already configured, the client will use the configuration to connect to the server.

Using this feature requires configuring your DHCP server to send option 43 information during address assignment. The feature allows the printer to obtain the settings used to control Cloud Connect weblink connections or Mirror events as part of receiving a DHCP assigned IP address. This requires that DHCP option 60 is not empty and that `ip.dhcp.auto_provision_enable` is set to "on".

The package of Cloud Connect/weblink information sent from the DHCP server in the Option 43 response can include the:

- Server address
- Authentication server name
- User name and password for proxy logins

The package of Mirror information sent from the DHCP server in the Option 43 packet can include the:

- Server address
- Mirror path
- Mirror feedback path
- Mirror appl path
- Mirror mode

Setvar

To enable or disable the DHCP auto provision feature of the printer:

```
! U1 setvar "ip.dhcp.auto_provision_enable" "value"
```

Values

- "on" = enabled
- "off" = disabled

Default

"off"

Getvar

To retrieve the current value of on or off for the DHCP auto provision feature:

```
! U1 getvar "ip.dhcp.auto_provision_enable"
```



NOTES:

- For printer support, see [SGD Command Support on page 1455](#).
- For details on SGD command structure, see [Command Structure on page 562](#).

ip.dhcp.cache_ip

This command enables or disables the IP caching.

Setvar

To set the status of the IP cache:

```
! U1 setvar "ip.dhcp.cache_ip" "value"
```

Values

- "on" = enabled
- "off" = disabled

Default

"off"

Getvar

To retrieve the status of the IP cache:

```
! U1 getvar "ip.dhcp.cache_ip"
```

Example

This `setvar` example shows the value set to "off".

```
! U1 setvar "ip.dhcp.cache_ip" "off"
```

When the `setvar` value is set to "off", the `getvar` result is "off".



NOTES:

- For printer support, see [SGD Command Support on page 1455](#).
- For details on SGD command structure, see [Command Structure on page 562](#).

ip.dhcp.cid_all

This printer setting defines the entire client identifier (DHCP option 61) if the DHCP is enabled and "ip.dhcp.cid_type" is set to "0", or "2". The MAC address is used if the type is set to "1".

Setvar

To instruct the printer to change the CID prefix and suffix:

```
! U1 setvar "ip.dhcp.cid_all" "value"
```

Values

A maximum length of 60 characters if the CID type is ASCII, or 120 characters if the CID type is hexadecimal.

Default

""

Getvar

To instruct the printer to respond with the client identifier prefix and suffix:

```
! U1 getvar "ip.dhcp.cid_all"
```

Example

This **setvar** example shows the value set to "printer".

```
! U1 setvar "ip.dhcp.cid_all" "printer"
```

What the **setvar** value is set to is the **getvar** result. In this example, the **getvar** result is "printer".



NOTES:

- For printer support, see [SGD Command Support on page 1455](#).
- For details on SGD command structure, see [Command Structure on page 562](#).

ip.dhcp.cid_enable

This command determines if DHCP (option 61) is turned on or off.

Setvar

To set the status of the client identifier:

```
! U1 setvar "ip.dhcp.cid_enable" "value"
```

Values

- "off" = client identifier is turned off
- "on" = client identifier is turned on

Default

"off"

Getvar

To return the current setting value:

```
! U1 getvar "ip.dhcp.cid_enable"
```

Example

This `setvar` example shows the value set to "off".

```
! U1 setvar "ip.dhcp.cid_enable" "off"
```

What the `setvar` value is set to is the `getvar` result. In this example, the `getvar` result is "off".



NOTES:

- For printer support, see [SGD Command Support on page 1455](#).
- For details on SGD command structure, see [Command Structure on page 562](#).

ip.dhcp.cid_prefix

This printer setting defines the prefix to be prepended to the DHCP client identifier (option 61) when DHCP is enabled and "ip.dhcp.cid_type" is set to "0" or "2".

Setvar

To instruct the printer to change the CID prefix:

```
! U1 setvar "ip.dhcp.cid_prefix" "value"
```

Values

Any text string up to 10 characters if the CID type is ASCII, or 20 characters if the CID type is hexadecimal.

Default

""

Getvar

To instruct the printer to respond with the client identifier prefix:

```
! U1 getvar "ip.dhcp.cid_prefix"
```

Example

This **setvar** example sets the value to "ZEB".

```
! U1 setvar "ip.dhcp.cid_prefix" "ZEB"
```

What the **setvar** value is set to is the **getvar** result. In this example, the **getvar** result is "ZEB".

The next time the printer sends a DHCP request, if **ip.dhcp.cid_type** is "0", the client identifier sent will be prefixed with the string "ZEB". For example, if **ip.dhcp.cid_value** is "PRT001", the actual client identifier sent will be "ZEBPRT001".



NOTES:

- For printer support, see [SGD Command Support on page 1455](#).
- For details on SGD command structure, see [Command Structure on page 562](#).

ip.dhcp.cid_suffix

This printer setting defines the unique suffix to be used as the client identifier (DHCP option 61) if DHCP is enabled and "ip.dhcp.cid_type" is set to "0" or "2".

Setvar

To instruct the printer to change the CID value:

```
! U1 setvar "ip.dhcp.cid_suffix" "value"
```

Values

The maximum length of a value allowed is 60 ASCII characters when the CID type is ASCII, or 120 hexadecimal values when the CID type is hexadecimal.

Default

""

Getvar

To instruct the printer to respond with the client identifier suffix:

```
! U1 getvar "ip.dhcp.cid_suffix"
```

Example

This **setvar** example shows the value set to "printer".

```
! U1 setvar "ip.dhcp.cid_suffix" "printer"
```

What the **setvar** value is set to is the **getvar** result. In this example, the **getvar** result is "printer".



NOTES:

- For printer support, see [SGD Command Support on page 1455](#).
- For details on SGD command structure, see [Command Structure on page 562](#).

ip.dhcp.cid_type

This printer setting defines the type of client identifier (DHCP option 61) that will be sent if DHCP is enabled. A value of "1" means the type of "Ethernet" and the printer's MAC address will be used. A value of "0" or "2" means the client identifier sent will be "ip.dhcp.cid_prefix" concatenated with "ip.dhcp.cid_suffix".

Setvar

To instruct the printer to set the Client Identifier type:

```
! U1 setvar "ip.dhcp.cid_type" "value"
```

Values

- "0" = ASCII string
- "1" = wireless radio card's MAC address
- "2" = HEX value

Default

"1"

Getvar

To instruct the printer to respond with the client identifier type:

```
! U1 getvar "ip.dhcp.cid_type"
```

Example

This **setvar** example shows the value set to "1".

```
! U1 setvar "ip.dhcp.cid_type" "1"
```

When the **setvar** value is set to "1", the **getvar** result is "1".



NOTES:

- For printer support, see [SGD Command Support on page 1455](#).
- For details on SGD command structure, see [Command Structure on page 562](#).

ip.dhcp.cid_value

This parameter defines the unique value to be used as the client identifier (option 61) if DHCP is enabled and "ip.dhcp.cid_type" is "1".



NOTE: This parameter is only applicable if [ip.dhcp.cid_enable](#) is set to "on".

Setvar

To instruct the printer to change the CID value:

```
! U1 setvar "ip.dhcp.cid_value" "value"
```

Values

Any text string up to 20 characters in length.

Default

If [ip.dhcp.cid_type](#) is set to:

- "0" — the default is the printer's friendly name (see [device.friendly_name](#) on page 643).
- "1" — the default is the printer's MAC address.

Getvar

To instruct the printer to respond with the client identifier value:

```
! U1 getvar "ip.dhcp.cid_value"
```

Example

This `setvar` example changes the cid value to "PRT001".

```
! U1 setvar "ip.dhcp.cid_value" "PRT001"
```

The next time the printer sends a DHCP request, if [ip.dhcp.cid_type](#) is "0", the client identifier sent will be [ip.dhcp.cid_prefix](#) plus "PRT001". For example, if [ip.dhcp.cid_prefix](#) is "ZEB", the actual client identifier sent will be "ZEBPRT001".



NOTES:

- For specific product support, see [SGD Command Support](#) on page 1455.
- For details on command structure, see [Command Structure](#) on page 562.

ip.dhcp.enable

This printer setting turns DHCP on or off. DHCP is a method for acquiring an IP address, netmask, and gateway automatically on printer power-up. It requires a DHCP server on the local network.



NOTE: If you are using static IP addressing, the IP protocol must be set to permanent.

Setvar

To instruct the printer to turn DHCP on or off:

```
! U1 setvar "ip.dhcp.enable" "value"
```

Values

- "off" = printer does not use DHCP to get the IP address
- "on" = printer uses DHCP to get the IP address

Default

"on"

Getvar

To instruct the printer to respond with the DHCP status:

```
! U1 getvar "ip.dhcp.enable"
```

Example

This **setvar** example shows the value set to "on".

```
! U1 setvar "ip.dhcp.enable" "on"
```

When the **setvar** value is set to "on", the **getvar** result is "on".



NOTES:

- For printer support, see [SGD Command Support on page 1455](#).
- For details on SGD command structure, see [Command Structure on page 562](#).

ip.dhcp.lease.last_attempt

This command retrieves the time from the DHCP server of when the last DHCP request was sent.

Getvar

To retrieve the last time a DHCP request was sent:

```
! U1 getvar "ip.dhcp.lease.last_attempt"
```

Example

In this example, the `getvar` retrieves the last time a DHCP request was sent to the wireless print server.

```
! U1 getvar "ip.dhcp.lease.last_attempt"
```



NOTES:

- For printer support, see [SGD Command Support on page 1455](#).
- For details on SGD command structure, see [Command Structure on page 562](#).

ip.dhcp.lease.server

This command retrieves the address of the server that provided the DHCP lease on the wireless print server.

Getvar

To retrieve the address of the server that provided the DHCP lease on the wireless print server:

```
! U1 getvar "ip.dhcp.lease.server"
```

Example

In this example, the `getvar` retrieves the server that provided the DHCP lease on the wireless print server.

```
! U1 getvar "ip.dhcp.lease.server"  
"10.3.5.1"
```



NOTES:

- For printer support, see [SGD Command Support on page 1455](#).
- For details on SGD command structure, see [Command Structure on page 562](#).

ip.dhcp.lease.time_left

This command retrieves the time left in the current DHCP lease on the wireless print server.

Getvar

To **retrieve** the time left in the current DHCP lease on the wireless print server:

```
! U1 getvar "ip.dhcp.lease.time_left"
```

Example

In this example, the **getvar** retrieves the time left in the current DHCP lease on the wireless print server.

```
! U1 getvar "ip.dhcp.lease.time_left"  
"1192518"
```



NOTES:

- For printer support, see [SGD Command Support on page 1455](#).
- For details on SGD command structure, see [Command Structure on page 562](#).

ip.dhcp.ntp.enable

This command controls whether or not the printer retrieves the address of a Network Time Protocol (NTP) server during DHCP address assignment.

Setvar

To set whether or not the printer retrieves the address of a Network Time Protocol (NTP) server during DHCP address assignment:

```
! U1 setvar "ip.dhcp.ntp.enable" "value"
```

Values

- "off" = does not request the NTP server address
- "on" = requests the NTP server address

Default

"off"

Getvar

To return the current setting value:

```
! U1 getvar "ip.dhcp.ntp.enable"
```



NOTES:

- For printer support, see [SGD Command Support on page 1455](#).
- For details on SGD command structure, see [Command Structure on page 562](#).

ip.dhcp.ntp.received_servers

Returns the list of Network Time Protocol (NTP) server IP Addresses received via DHCP.

Getvar

To return the current setting value:

```
! U1 getvar "ip.dhcp.ntp.received_servers"
```

Values

A comma-separated list of IP address. The maximum number of servers listed will be three (3).

Default

""

Example

```
"10.4.3.24,172.30.16.52"
```



NOTES:

- For printer support, see [SGD Command Support on page 1455](#).
- For details on SGD command structure, see [Command Structure on page 562](#).

ip.dhcp.option12

This command specifies if the DHCP option 12 (host name) is on or off in the discovery packet that is sent from the wireless print server.

Setvar

To instructs the printer to set the DHCP option 12 (host name) in the discovery packet that is sent from the wireless print server:

```
! U1 setvar "ip.dhcp.option12" "value"
```

Values

- "on" = turns on option 12
- "off" = turns off option 12

Default

"on"

Getvar

To retrieve the status of the DHCP option 12 (host name) in the discovery packet that is sent from the wireless print server:

```
! U1 getvar "ip.dhcp.option12"
```

Example

This `setvar` example shows the value set to "on".

```
! U1 setvar "ip.dhcp.option12" "on"
```

When the `setvar` value is set to "on", the `getvar` result is "on".



NOTES:

- For printer support, see [SGD Command Support on page 1455](#).
- For details on SGD command structure, see [Command Structure on page 562](#).

ip.dhcp.option12_format

This command specifies the value which will be used for option 12 (host name) to be used in the DHCP discovery packet of the wireless print server.

Setvar

To instruct the printer to set the value which will be used for option 12 (host name) to be used in the DHCP discovery packet of the wireless print server:

```
! U1 setvar "ip.dhcp.option12_format" "value"
```

Values

string

Default

""

Getvar

To retrieve the value which will be used for option 12 (host name) to be used in the DHCP discovery packet of the wireless print server:

```
! U1 getvar "ip.dhcp.option12_format"
```

Example

This **setvar** example shows configuring the ip.dhcp.option12_format to the value contained in the device.friendly_name.

It is necessary to surround the SGD entry to be used as source for the data with the < and > characters.

```
! U1 setvar "ip.dhcp.option12_format" "<device.friendly_name>"
```

To further explain, if the above command was issued and the value currently stored in the device.friendly_name parameter was "ShipPrinter", then the response to following command would be "ShipPrinter":

```
! U1 getvar "ip.dhcp.option12_value"
```



NOTES:

- For printer support, see [SGD Command Support on page 1455](#).
- For details on SGD command structure, see [Command Structure on page 562](#).

ip.dhcp.option12_value

This command retrieves the actual value which will be used in the discovery packet of the wireless print server.

Getvar

To retrieve the actual value which will be used in the discovery packet of the wireless print server:

```
! U1 getvar "ip.dhcp.option12_value"
```

Example

This **setvar** example shows configuring the ip.dhcp.option12_format to the value contained in the device.friendly_name.

It is necessary to surround the SGD entry to be used as source for the data with the < and > characters.

```
! U1 setvar "ip.dhcp.option12_format" "<device.friendly_name>"
```

To further explain, if the above command was issued and the value currently stored in the device.friendly_name parameter was "ShipPrinter", then the response to following command would be "ShipPrinter":

```
! U1 getvar "ip.dhcp.option12_value"
```



NOTES:

- For printer support, see [SGD Command Support on page 1455](#).
- For details on SGD command structure, see [Command Structure on page 562](#).

ip.dhcp.request_timeout

This command retrieves the maximum amount of time (in seconds) for a DHCP discovery requests on the wireless print server.

Setvar

To set the amount of time (in seconds) to wait before timing out a DHCP discovery request:

```
! U1 setvar "ip.dhcp.request_timeout" "value"
```

Values

"2" through "30"

Default

"2"

Getvar

To retrieve the currently set the amount of time (in seconds) to wait before timing out a DHCP discovery request:

```
! U1 getvar "ip.dhcp.request_timeout"
```

Example

This **setvar** example shows the value set to "2".

```
! U1 setvar "ip.dhcp.request_timeout" "2"
```

When the **setvar** value is set to "2", the **getvar** result is "2".



NOTES:

- For printer support, see [SGD Command Support on page 1455](#).
- For details on SGD command structure, see [Command Structure on page 562](#).

ip.dhcp.requests_per_session

This command retrieves the maximum amount of DHCP discovery requests for a single DHCP session on the wireless print server.

Setvar

To set the maximum amount of DHCP discovery requests for a single DHCP session on the wireless print server:

```
! U1 setvar "ip.dhcp.requests_per_session" "value"
```

Values

"1" through "10"

Default

"2"

Getvar

To retrieve the currently set maximum amount of DHCP discovery requests for a single DHCP session on the wireless print server:

```
! U1 getvar "ip.dhcp.requests_per_session"
```

Example

This **setvar** example shows the value set to "2".

```
! U1 setvar "ip.dhcp.requests_per_session" "2"
```

When the **setvar** value is set to "2", the **getvar** result is "2".



NOTES:

- For printer support, see [SGD Command Support on page 1455](#).
- For details on SGD command structure, see [Command Structure on page 562](#).

ip.dhcp.session_interval

This command configures the time interval (in seconds) before a new DHCP session is started on the wireless print server.

Setvar

To set the DHCP session time out value (in seconds):

```
! U1 setvar "ip.dhcp.session_interval" "value"
```

Values

"0" through "60"

Default

"10"

Getvar

To retrieve the current DHCP session time out value (in seconds):

```
! U1 getvar "ip.dhcp.session_interval"
```

Example

This **setvar** example shows the value set to "**10**".

```
! U1 setvar "ip.dhcp.session_interval" "10"
```

When the **setvar** value is set to "**10**", the **getvar** result is "**10**".



NOTES:

- For printer support, see [SGD Command Support on page 1455](#).
- For details on SGD command structure, see [Command Structure on page 562](#).

ip.dhcp.user_class_id

This command sets or retrieves the current DHCP class ID setting.

Setvar

To set the current DHCP class ID setting:

```
! U1 setvar "ip.dhcp.user_class_id" "value"
```

Values

any class ID string,

Default

""

Getvar

To retrieve the current DHCP class ID setting:

```
! U1 getvar "ip.dhcp.user_class_id"
```

Result

the current DHCP class ID setting.



NOTES:

- For printer support, see [SGD Command Support on page 1455](#).
- For details on SGD command structure, see [Command Structure on page 562](#).

ip.dhcp.vendor_class_id

This command configures the DHCP vendor class ID setting.

Setvar

To set the DHCP vendor class ID setting:

```
! U1 setvar "ip.dhcp.vendor_class_id" "value"
```

Values

Max string length of 64.

This command builds a string using the following values:

```
(device.company_name) (device.product_name)-(head.resolution.in_dpi)  
(device.pnp_option)
```

Default

The default varies by printer.

Getvar

To retrieve the current DHCP vendor class ID setting:

```
! U1 getvar "ip.dhcp.vendor_class_id"
```



NOTES:

- For printer support, see [SGD Command Support on page 1455](#).
- For details on SGD command structure, see [Command Structure on page 562](#)

ip.dns.domain

This command identifies the network domain of the wireless print server.

Getvar

To retrieve the network domain of the wireless print server:

```
! U1 getvar "ip.dns.domain"
```

Example

In this example, the **getvar** retrieves the network domain of the wireless print server.

```
! U1 getvar "ip.dns.domain"
```



NOTES:

- For printer support, see [SGD Command Support on page 1455](#).
- For details on SGD command structure, see [Command Structure on page 562](#).

ip.dns.servers

This command retrieves a space delimited list of the domain name servers from a wireless print server.

Getvar

To retrieve a list of space delimited DNS wireless print servers

```
! U1 getvar "ip.dns.servers"
```

Example

In this example, the **getvar** retrieves a list of space delimited DNS wireless print servers.

```
! U1 getvar "ip.dns.servers"
```



NOTES:

- For printer support, see [SGD Command Support on page 1455](#).
- For details on SGD command structure, see [Command Structure on page 562](#).

ip.ftp.enable

This printer setting refers to the FTP protocol setting. This command tells the printer to turn FTP on or off.

Setvar

To turn FTP on or off:

```
! U1 setvar "ip.ftp.enable" "value"
```

Values

"off" = disables FTP

"on" = enables FTP

Default

"on"

Getvar

To respond with the FTP status:

```
! U1 getvar "ip.ftp.enable"
```

Example

This **setvar** example shows the FTP status set to "on".

```
! U1 setvar "ip.ftp.enable" "on"
```

When the **setvar** value is set to "on", the **getvar** result is that the FTP status is "on".



NOTES:

- For printer support, see [SGD Command Support on page 1455](#).
- For details on SGD command structure, see [Command Structure on page 562](#).

ip.ftp.execute_file

This command setting controls the printers' ability to process or not process commands received via the FTP protocol using the printers ZPL engine.

Setvar

To turn FTP processing ability on or off:

```
! U1 setvar "ip.ftp.execute_file" "value"
```

Values

"off" = disables the printer's ability to process FTP commands

"on" = enables the printer's ability to process FTP commands

Default

"on"

Getvar

To respond with the FTP processing ability status:

```
! U1 getvar "ip.ftp.execute_file"
```

Example

This **setvar** example shows the FTP processing ability set to "on".

```
! U1 setvar "ip.ftp.execute_file" "on"
```



NOTES:

- For printer support, see [SGD Command Support on page 1455](#).
- For details on SGD command structure, see [Command Structure on page 562](#).

ip.ftp.request_password

This command controls whether the ftp client will prompt the user to enter a password at the beginning of an ftp session.

Setvar

To turn on or off the ftp session password request:

```
! U1 setvar "ip.ftp.request_password" "value"
```

Values

"no"

"yes"

Default

"no"

Getvar

To return whether the ftp client is set to prompt the user for a password at the start of an ftp session:

```
! U1 getvar "ip.ftp.request_password"
```



NOTES:

- For printer support, see [SGD Command Support on page 1455](#).
- For details on SGD command structure, see [Command Structure on page 562](#).

ip.gateway

This command instructs the printer to change the gateway address.



IMPORTANT: This setting refers to the gateway address. A set value is ignored if the IP protocol is not set to permanent.

Setvar

To change the gateway address:

```
! U1 setvar "ip.gateway" "value"
```

Values

Any valid gateway address

Default

"0.0.0.0"

Getvar

To respond with the gateway address:

```
! U1 getvar "ip.gateway"
```

Example

This **setvar** example shows the value set to "**10.3.5.1**".

```
! U1 setvar "ip.gateway" "10.3.5.1"
```

When the **setvar** value is set to "**10.3.5.1**", the **getvar** result is "**10.3.5.1**".



NOTES:

- For printer support, see [SGD Command Support on page 1455](#).
- For details on SGD command structure, see [Command Structure on page 562](#).

ip.http.admin_name

This command sets the name to be used for authentication on the print server web pages.

Setvar

To set the admin user name to the specified value:

```
! U1 setvar "ip.http.admin_name" "value"
```

Values

a string with a maximum of 25 characters

Default

```
"admin"
```

Getvar

To respond with the admin user name:

```
! U1 getvar "ip.http.admin_name"
```

Example

This **setvar** example shows the value set to **"useradmin101"**.

```
! U1 setvar "ip.http.admin_name" "useradmin101"
```



NOTES:

- For printer support, see [SGD Command Support on page 1455](#).
- For details on SGD command structure, see [Command Structure on page 562](#).

ip.http.admin_password

This command sets the password to be used for authentication on the print server web pages.

Setvar

To set print server web page password:

```
! U1 setvar "ip.http.admin_password" "value"
```

Values

a string, maximum 25 characters

Default

1234

Getvar

To respond with the print server web page password:

```
! U1 getvar "ip.http.admin_password"
```

Example

This **setvar** example shows the value set to "**P@ssword101**".

```
! U1 setvar "ip.http.admin_password" "P@ssword101"
```



NOTES:

- For printer support, see [SGD Command Support on page 1455](#).
- For details on SGD command structure, see [Command Structure on page 562](#).

ip.http.custom_link_name

This command creates a custom link below the FAQ link on the print server settings page. Use [ip.http.custom_link_url on page 1183](#) to define the URL for your link name.

Setvar

To set the custom link name:

```
! U1 setvar "ip.http.custom_link_name" "value"
```

Values

Any string, maximum of 25 characters

Default

""

Getvar

To respond with the custom link name

```
! U1 getvar "ip.http.custom_link_name"
```

Example

This `setvar` example shows the value set to `"Click Here for Info"`.

```
! U1 setvar "ip.http.custom_link_name" "Click Here for Info"
```



NOTES:

- For printer support, see [SGD Command Support on page 1455](#).
- For details on SGD command structure, see [Command Structure on page 562](#).

ip.http.custom_link_url

This command creates a custom link on the printer web page for the printer's URL. Use [ip.http.custom_link_name on page 1182](#) to define the text that will display for your link.

Setvar

To change the custom URL:

```
! U1 setvar "ip.http.custom_link_url" "value"
```

Values

A string of 64 characters or less

Default

""

Getvar

To respond with the custom URL:

```
! U1 getvar "ip.http.custom_link_url"
```

Example

```
! U1 setvar "ip.http.custom_link_url" "http://www.zebra.com/sdk"
```



NOTES:

- For printer support, see [SGD Command Support on page 1455](#).
- For details on SGD command structure, see [Command Structure on page 562](#).

ip.http.enable

This printer setting refers to the HTTP protocol/web server setting.

Setvar

To change HTTP to on or off:

```
! U1 setvar "ip.http.enable" "value"
```

Values

"off" = disables HTTP protocol

"on" = enables HTTP protocol

Default

"on"

Getvar

To respond with the HTTP status:

```
! U1 getvar "ip.http.enable"
```

Example

This **setvar** example shows the value set to "on".

```
! U1 setvar "ip.http.enable" "on"
```

When the **setvar** value is set to "on", the **getvar** result is "on".



NOTES:

- For printer support, see [SGD Command Support on page 1455](#).
- For details on SGD command structure, see [Command Structure on page 562](#).

ip.http.faq_url

This command sets the FAQ URL displayed on the printer web pages.

Setvar

To change the FAQ URL:

```
! U1 setvar "ip.http.faq_url" "value"
```

Values

A string of 64 characters or less.

Default

""

Getvar

To respond with the current FAQ URL:

```
! U1 getvar "ip.http.faq_url"
```

Example

```
! U1 getvar "ip.http.faq_url"
```



NOTES:

- For printer support, see [SGD Command Support on page 1455](#).
- For details on SGD command structure, see [Command Structure on page 562](#).

ip.http.port

This command sets the port number at which the printer web pages will be served.

Setvar

To change the port setting for the printer web pages:

```
! U1 setvar "ip.http.port" "value"
```

Values

"0" to "65535"

Default

"80"

Getvar

To respond with the current port setting for the printer web pages:

```
! U1 getvar "ip.http.port"
```

Example

This **setvar** example shows the value set to **"8080"**.

```
! U1 setvar "ip.http.enable" "8080"
```



NOTES:

- For printer support, see [SGD Command Support on page 1455](#).
- For details on SGD command structure, see [Command Structure on page 562](#).

ip.lpd.enable

This printer setting refers to the LPD (Line Printer Daemon) protocol setting.



IMPORTANT: LPD communications from the host should be directed to port 515.

Setvar

To turn LPD on or off:

```
! U1 setvar "ip.lpd.enable" "value"
```

Values

"off" = disables LPD protocol

"on" = enables LPD protocol

Default

"on"

Getvar

To respond with the LPD status:

```
! U1 getvar "ip.lpd.enable"
```

Example

This **setvar** example shows the value set to "on".

```
! U1 setvar "ip.lpd.enable" "on"
```

When the **setvar** value is set to "on", the **getvar** result is "on".



NOTES:

- For printer support, see [SGD Command Support on page 1455](#).
- For details on SGD command structure, see [Command Structure on page 562](#).

ip.mac_raw

This command specifies the RAW MAC address of the wireless print server. The raw mac address is the mac address without the colons (":").

Getvar

To retrieve the RAW MAC address of the wireless print server:

```
! U1 getvar "ip.mac_raw"
```

Example

In this example, the `getvar` retrieves the RAW MAC address of the wireless print server.

```
! U1 getvar "ip.mac_raw"
```



NOTES:

- For printer support, see [SGD Command Support on page 1455](#).
- For details on SGD command structure, see [Command Structure on page 562](#).

ip.mirror.appl_path



This command overrides the default location of the mirror application path ("appl" in "ip.mirror.path"). If the SGD is empty, the default path is used. If an error occurs retrieving application from path (i.e. path not found or application not there), the default path is NOT used. This path must be fully defined in relation to the mirror server root and is not relative to [ip.mirror.path](#).

Setvar

To set the path to the application on the mirror server:

```
! U1 setvar "ip.mirror.appl_path" "values"
```

Values

A valid application path (location)

Default

""

Getvar

To retrieve the path to the application on the mirror server:

```
! U1 getvar "ip.mirror.appl_path"
```

Example

If the default value is used, the application would be copied from `"ip.mirror.path"\appl`

If you send `! U1 setvar "ip.mirror.appl_path" "program\current"` and `"ip.mirror.path"` has the value `"c:\mirror"`, then the application would be copied from `c:\mirror\program\current`.



NOTES:

- For printer support, see [SGD Command Support on page 1455](#).
- For details on SGD command structure, see [Command Structure on page 562](#).

ip.mirror.auto



This command enables the ability to automatically perform a mirror update (fetch) command on power up.

Setvar

To perform a mirror update (fetch) command when the printer is turned on using the interval that is set for "ip.mirror.freq" or "ip.mirror.freq_hours":

```
! U1 setvar "ip.mirror.auto" "values"
```

Values

- "on" = turns on the auto mirroring feature
- "off" = turns off the auto mirroring feature

Default

"off"

Getvar

To report whether the printer will perform a mirror update (fetch) automatically on power up:

```
! U1 getvar "ip.mirror.auto"
```

Example

This **setvar** example shows the value set to "off".

```
! U1 setvar "ip.mirror.auto" "off"
```

When the **setvar** value is set to "off", the **getvar** result is "off".



NOTES:

- For printer support, see [SGD Command Support on page 1455](#).
- For details on SGD command structure, see [Command Structure on page 562](#).

ip.mirror.error_retry



This command identifies how many times mirroring is retried when an error occurs.

Setvar

To set the required times that mirroring retries when an error occurs:

```
! U1 setvar "ip.mirror.error_retry" "value"
```

Getvar

To return the current setting value:

```
! U1 getvar "ip.mirror.error_retry"
```

Example

This **setvar** example shows the value set to "0".

```
! U1 setvar "ip.mirror.error_retry" "0"
```

When the **setvar** value is set to "0", the **getvar** result is "0"



NOTES:

- For printer support, see [SGD Command Support on page 1455](#).
- For details on SGD command structure, see [Command Structure on page 562](#).

ip.mirror.feedback.auto



This command identifies if a feedback file is pushed to the mirroring server by the printer when a mirroring update (fetch) is complete.

Setvar

To set the mirror feedback feature to on or off:

```
! U1 setvar "ip.mirror.feedback.auto" "value"
```

Values

"on" = turns on mirror feedback

"off" = turns off mirror feedback

Default

"off"

Getvar

To return the current setting value:

```
! U1 getvar "ip.mirror.feedback.auto"
```

Example

This **setvar** example shows the value set to "off".

```
! U1 setvar "ip.mirror.feedback.auto" "off"
```

When the **setvar** value is set to "off", the **getvar** result is "off".



NOTES:

- For printer support, see [SGD Command Support on page 1455](#).
- For details on SGD command structure, see [Command Structure on page 562](#).

ip.mirror.feedback.freq



This command specifies the time interval (in minutes) between performing feedback file uploads.

Setvar

To set the number of minutes to wait between feedback file uploads:

```
! U1 setvar "ip.mirror.feedback.freq" "value"
```

Values

numeric value (0 - 65535)

Default

"0"

Getvar

To retrieve the number of minutes set to wait between feedback file uploads:

```
! U1 getvar "ip.mirror.feedback.freq"
```

Example

This **setvar** example shows the value set to "0".

```
! U1 setvar "ip.mirror.feedback.freq" "0"
```

When the **setvar** value is set to "0", the **getvar** result is "0".



NOTES:

- For printer support, see [SGD Command Support on page 1455](#).
- For details on SGD command structure, see [Command Structure on page 562](#).

ip.mirror.feedback.odometer



This command instructs the printer to set the mirror feedback odometer.

Setvar

To set the odometer counter:

```
! U1 setvar "ip.mirror.feedback.odometer" "values"
```

Values

numeric value between 0 and 4294967295

Default

"0"

Getvar

To retrieve the mirror feedback odometer value:

```
! U1 getvar "ip.mirror.feedback.odometer"
```

Example

This **setvar** example shows the value set to "0".

```
! U1 setvar "ip.mirror.feedback.odometer" "0"
```

When the **setvar** value is set to "0", the **getvar** result is "0".



NOTES:

- For printer support, see [SGD Command Support on page 1455](#).
- For details on SGD command structure, see [Command Structure on page 562](#).

ip.mirror.feedback.path



This command identifies where the feedback file is stored on the mirroring server.

Setvar

To set the path on the mirroring server that stores the feedback file:

```
! U1 setvar "ip.mirror.feedback.path" "value"
```

Values

alphanumeric text (1 to 50 characters)

Default

"Zebra/feedback"

Getvar

To retrieve the path on the mirroring sever that the printer is currently using to store the feedback file:

```
! U1 getvar "ip.mirror.feedback.path"
```

Example

This **setvar** example shows the value set to "**Zebra/feedback**".

```
! U1 setvar "ip.mirror.feedback.path" "Zebra/feedback"
```

When the **setvar** value is set to "**Zebra/feedback**", the **getvar** result is "**Zebra/feedback**".



NOTES:

- For printer support, see [SGD Command Support on page 1455](#).
- For details on SGD command structure, see [Command Structure on page 562](#).

ip.mirror.fetch



This command forces a mirroring update sequence.

Setvar

To force a mirroring update sequence:

```
! U1 setvar "ip.mirror.fetch" ""
```

Do

To force a mirroring update sequence:

```
! U1 do "ip.mirror.fetch" ""
```

Example

This **setvar** example forces a mirroring update sequence.

```
! U1 setvar "ip.mirror.fetch" ""
```



NOTES:

- For printer support, see [SGD Command Support on page 1455](#).
- For details on SGD command structure, see [Command Structure on page 562](#).

ip.mirror.freq



This command defines the frequency of mirroring updates (in minutes).

Setvar

To set the mirror frequency:

```
! U1 setvar "ip.mirror.freq" "value"
```

Values

"0" through "65535" (minutes)

Default

"0" (disables this feature)



IMPORTANT: When the "ip.mirror.freq" is set to a low value (other than zero) the printer will spend a lot of time performing the mirroring process.

Getvar

To retrieve the number of minutes to wait before performing another mirror update:

```
! U1 getvar "ip.mirror.freq"
```

Example

This **setvar** example shows the value set to "**1000**".

```
! U1 setvar "ip.mirror.freq" "1000"
```

When the **setvar** value is set to "**1000**", the **getvar** result is "**1000**" and mirroring will be attempted every 1000 minutes.



NOTES:

- For printer support, see [SGD Command Support on page 1455](#).
- For details on SGD command structure, see [Command Structure on page 562](#).

ip.mirror.freq_hours



This command defines the frequency of mirroring updates (in hours).

Setvar

To set the frequency of mirroring updates (in hours):

```
! U1 setvar "ip.mirror.freq_hours" "values"
```

Values

"0" through "100"

Default

"0" (disables this feature)

Getvar

To retrieve the frequency of mirroring updates (in hours) that the printer is currently using:

```
! U1 getvar "ip.mirror.freq_hours"
```

Example

This **setvar** example shows the value set to "8".

```
! U1 setvar "ip.mirror.freq_hours" "8"
```

When the **setvar** value is set to "8", the **getvar** result is "8" and mirroring will be attempted every 8 hours.



NOTES:

- For printer support, see [SGD Command Support on page 1455](#).
- For details on SGD command structure, see [Command Structure on page 562](#).

ip.mirror.interface

Determines the interface over which Mirror will operate.

Setvar

To set the interface over which Mirror will operate:

```
! U1 setvar "ip.mirror.interface" "value"
```

Values

"both" = internal or external wired and WLAN

"wired" = internal or external wired

"wireless" = WLAN

Default

"both"

Getvar

To return the current setting value:

```
! U1 getvar "ip.mirror.interface"
```



NOTES:

- For printer support, see [SGD Command Support on page 1455](#).
- For details on SGD command structure, see [Command Structure on page 562](#).

ip.mirror.last_error



This command retrieves the last error encountered during a mirroring operation.

Getvar

To retrieve the error code of the last mirroring update (fetch):

```
! U1 getvar "ip.mirror.last_error"
```

Example

In this example, the **getvar** retrieves the error code of the last mirroring update.

```
! U1 getvar "ip.mirror.last_error"
```



NOTES:

- For printer support, see [SGD Command Support on page 1455](#).
- For details on SGD command structure, see [Command Structure on page 562](#).

ip.mirror.last_time



This command retrieves the timestamp, in seconds, of the last time the system attempted a mirror update (fetch).

Getvar

To retrieve the timestamp, in seconds, of the last time the system attempted a mirror update (fetch):

```
! U1 getvar "ip.mirror.last_time"
```

Example

In this example, the **getvar** retrieves the timestamp, in seconds, of the last time the system attempted a mirror update.

```
! U1 getvar "ip.mirror.last_time"
```



NOTES:

- For printer support, see [SGD Command Support on page 1455](#).
- For details on SGD command structure, see [Command Structure on page 562](#).

ip.mirror.mode



This command sets the protocol used to perform mirror tasks.

Setvar

To sets the protocol for mirror tasks:

```
! U1 setvar "ip.mirror.mode" "values"
```

Values

ftp = FTP protocol will be used to perform mirror tasks

sftp = SFTP protocol will be used to perform mirror tasks

Getvar

To retrieve the path to the application on the mirror server:

```
! U1 getvar "ip.mirror.mode"
```



NOTES:

- For printer support, see [SGD Command Support on page 1455](#).
- For details on SGD command structure, see [Command Structure on page 562](#).

ip.mirror.password



Setvar

This command specifies the user password on the mirroring server assigned for mirroring updates (fetch).

To specify a password for mirroring updates (fetch):

```
! U1 setvar "ip.mirror.password" "value"
```

Values

alphanumeric text string (1 to 20 characters)

Default

"password"

Getvar

To retrieve the user password the printer is currently using for mirroring updates (fetch):

```
! U1 getvar "ip.mirror.password"
```

Example

This **setvar** example shows the value set to "**password**".

```
! U1 setvar "ip.mirror.password" "password"
```

When the **setvar** value is set to "**password**", the **getvar** result is "*". For security purposes, the printer does not return password information.



NOTES:

- For printer support, see [SGD Command Support on page 1455](#).
- For details on SGD command structure, see [Command Structure on page 562](#).

ip.mirror.path



This command identifies the base path on the FTP server where the mirror directory resides.

Setvar

To set the base path on the FTP server where the mirror directory resides:

```
! U1 setvar "ip.mirror.path" "value"
```

Values

alphanumeric text string (1 to 50 characters)

Default

"zebra"

Getvar

To retrieve the base path of the FTP server where the mirror directory resides:

```
! U1 getvar "ip.mirror.path"
```

Example

This **setvar** example shows the value set to "**zebra**".

```
! U1 setvar "ip.mirror.path" "zebra"
```

When the **setvar** value is set to "**zebra**", the **getvar** result is "**zebra**".



NOTES:

- For printer support, see [SGD Command Support on page 1455](#).
- For details on SGD command structure, see [Command Structure on page 562](#).

ip.mirror.reset_delay



This command specifies the number of seconds between when the printer receives the last byte of the last file from the `/commands` directory and when the printer resets during a mirror event.

Setvar

To set the number of seconds between when the printer receives the last byte of the last file from the `/commands` directory and when the printer resets during a mirror event:

```
! U1 setvar "ip.mirror.reset_delay" "value"
```

Values

0 - 900 (seconds)

Default

"5"



NOTE: The default setting for the `ip.mirror.reset_delay` command is 5 seconds; in some cases it may be necessary to use a longer delay to allow for full processing of longer or more complex files.

Getvar

To retrieve the number of seconds between when the printer receives the last byte of the last file from the `/commands` directory and when the printer resets during a mirror event:

```
! U1 getvar "ip.mirror.reset_delay"
```

Example

This `setvar` example shows the value set to `"10"`.

```
! U1 setvar "ip.mirror.reset_delay" "10"
```

When the `setvar` value is set to `"10"`, the `getvar` result is `"10"`.



NOTES:

- For printer support, see [SGD Command Support on page 1455](#).
- For details on SGD command structure, see [Command Structure on page 562](#).

ip.mirror.server



This command identifies the IP address of the mirroring server.

Setvar

To set the IP address of the mirroring server:

```
! U1 setvar "ip.mirror.server" "value"
```

Values

a valid IP address

Default

```
"127.0.0.1"
```

Getvar

To retrieve the IP address of the mirroring server:

```
! U1 getvar "ip.mirror.server"
```

Example

This **setvar** example shows the value set to "**10.3.1.1**".

```
! U1 setvar "ip.mirror.server" "10.3.1.1"
```

When the **setvar** value is set to "**10.3.1.1**", the **getvar** result is "**10.3.1.1**".



NOTES:

- For printer support, see [SGD Command Support on page 1455](#).
- For details on SGD command structure, see [Command Structure on page 562](#).

ip.mirror.success



This command reports the success or failure of the last mirroring update (fetch).

Getvar

To retrieve the success or failure of the last mirroring update (fetch):

```
! U1 getvar "ip.mirror.success"
```

Values

"yes" = successful

"no" = unsuccessful

Example

In this example, the `getvar` retrieves the success or failure of the last mirroring update (fetch).

```
! U1 getvar "ip.mirror.success"
```



NOTES:

- For printer support, see [SGD Command Support on page 1455](#).
- For details on SGD command structure, see [Command Structure on page 562](#).

ip.mirror.success_time



This command provides the timestamp, in seconds, of the last time the system successfully completed a mirror update (fetch).

Getvar

To retrieve the timestamp, in seconds, of the last time the system successfully completed a mirror update (fetch):

```
! U1 getvar "ip.mirror.success_time"
```

Example

In this example, the `getvar` retrieves the timestamp of the last time the system successfully completed a mirror update.

```
! U1 getvar "ip.mirror.success_time"
```



NOTES:

- For printer support, see [SGD Command Support on page 1455](#).
- For details on SGD command structure, see [Command Structure on page 562](#).

ip.mirror.username



This command specifies the user name on the mirroring server assigned for mirroring updates (fetch).

Setvar

To set a specific user name for mirroring updates (fetch):

```
! U1 setvar "ip.mirror.username" "value"
```

Values

alphanumeric text string (1 to 20 characters)

Default

"user"

Getvar

To retrieve the user name the printer is currently using for mirroring updates (fetch):

```
! U1 getvar "ip.mirror.username"
```

Example

This **setvar** example shows the value set to **"user"**.

```
! U1 setvar "ip.mirror.username" "user"
```

When the **setvar** value is set to **"user"**, the **getvar** result is **"user"**.



NOTES:

- For printer support, see [SGD Command Support on page 1455](#).
- For details on SGD command structure, see [Command Structure on page 562](#).

ip.mirror.version



This command retrieves the mirror code build date.

Getvar

To retrieve the mirror code build date:

```
! U1 getvar "ip.mirror.version"
```

Example

In this example, the **getvar** retrieves the mirror code build date.

```
! U1 getvar "ip.mirror.version"
```



NOTES:

- For printer support, see [SGD Command Support on page 1455](#).
- For details on SGD command structure, see [Command Structure on page 562](#).

ip.netmask

This setting refers to the subnet mask address. This value is ignored if the IP protocol is not set to permanent.

Setvar

To instruct the printer to change the subnet mask:

```
! U1 setvar "ip.netmask" "value"
```

Values

Any valid subnet mask.

Default

```
"255.255.255.0"
```

Getvar

To respond with the subnet mask value:

```
! U1 getvar "ip.netmask"
```

Example

This **setvar** example shows the value set to "255.255.255.0".

```
! U1 setvar "ip.netmask" "255.255.255.0"
```

When the **setvar** value is set to "255.255.255.0", the **getvar** result is "255.255.255.0".



NOTES:

- For printer support, see [SGD Command Support on page 1455](#).
- For details on SGD command structure, see [Command Structure on page 562](#).

ip.ntp.enable

Enables or disables the Network Time Protocol (NTP) feature.

Setvar

To enable or disable the Network Time Protocol (NTP) feature:

```
! U1 setvar "ip.ntp.enable" "value"
```

Values

"on" = enabled

"off" = disabled

Default

"off"

Getvar

To return the current setting value:

```
! U1 getvar "ip.ntp.enable"
```



NOTES:

- For printer support, see [SGD Command Support on page 1455](#).
- For details on SGD command structure, see [Command Structure on page 562](#).

ip.ntp.log

Retrieves the Network Time Protocol (NTP) status and error log. If NTP is not running this will return "**File Not Found**" for the error log.

Getvar

To retrieve the Network Time Protocol (NTP) status and error log:

```
! U1 getvar "ip.ntp.log"
```

Default

"File Not Found"



NOTES:

- For printer support, see [SGD Command Support on page 1455](#).
- For details on SGD command structure, see [Command Structure on page 562](#).

ip.ntp.servers

Sets the list of NTP (Network Time Protocol) servers which the printer will use to set the time.

Setvar

To set the list of NTP (Network Time Protocol) servers which the printer will use to set the time:

```
! U1 setvar "ip.ntp.servers" "value"
```

Values

A comma delimited string of server name(s) or ip address(es), with a length of 0-1024 characters.

Default

""

Example

```
! U1 setvar "ip.ntp.servers" "0.us.pool.ntp.org,10.3.17.124"
```

Getvar

To retrieve the current setting value:

```
! U1 getvar "ip.ntp.servers"
```

Result

A comma delimited string of server name(s) or ip address(es).



NOTES:

- For printer support, see [SGD Command Support on page 1455](#).
- For details on SGD command structure, see [Command Structure on page 562](#).

ip.pop3.enable

This printer setting determines if the printer queries a POP3 mailbox for mail.

Setvar

To turn POP3 on or off:

```
! U1 setvar "ip.pop3.enable" "value"
```

Values

"off" = disables POP3

"on" = enables POP3

Default

"on"

Getvar

To respond with the POP3 status:

```
! U1 getvar "ip.pop3.enable"
```

Example

This **setvar** example shows the value set to "on".

```
! U1 setvar "ip.pop3.enable" "on"
```

When the **setvar** value is set to "on", the **getvar** result is "on".



NOTES:

- For printer support, see [SGD Command Support on page 1455](#).
- For details on SGD command structure, see [Command Structure on page 562](#).

ip.pop3.password

This printer setting refers to the POP3 mailbox password. This only applies if "**ip.pop3.enable**" is set to on.

Setvar

To change the POP3 password:

```
! U1 setvar "ip.pop3.password" "value"
```

Values

A maximum of 20 alphanumeric characters

Default

" "

Getvar

To respond with the POP3 password:

```
! U1 getvar "ip.pop3.password"
```

For protection a single "*" prints.

Example

This **setvar** example shows the value set to "**password**".

```
! U1 setvar "ip.pop3.password" "password"
```

When the **setvar** value is set to "**password**", the **getvar** result is "*".



NOTES:

- For printer support, see [SGD Command Support on page 1455](#).
- For details on SGD command structure, see [Command Structure on page 562](#).

ip.pop3.poll

This printer setting refers to how frequent (in seconds) the printer queries a POP3 mailbox for new mail. This only applies if the "**ip.pop3.enable**" is set to on.

Setvar

To change the POP3 poll interval:

```
! U1 setvar "ip.pop3.poll" "value"
```

A value of "**0**" causes the printer to only query the POP3 mailbox one time, on printer power up, or following a network reset.

Values

"0" through "65535"

Default

"0"



NOTE: A poll value of less than thirty seconds is not recommended. The printer is unresponsive for several seconds when polling for email depending on data transfer time from the server to the printer.

Getvar

To respond with the POP3 poll frequency (in seconds):

```
! U1 getvar "ip.pop3.poll"
```

Example

This **setvar** example shows the value set to "**0**".

```
! U1 setvar "ip.pop3.poll" "0"
```

When the **setvar** value is set to "**0**", the **getvar** result is "**0**".



NOTES:

- For printer support, see [SGD Command Support on page 1455](#).
- For details on SGD command structure, see [Command Structure on page 562](#).

ip.pop3.server_addr

This printer setting refers to the POP3 server IP address that the printer contacts when checking for new mail. This only applies if "**ip.pop3.enable**" is set to on.

Setvar

To change the POP3 server address:

```
! U1 setvar "ip.pop3.server_addr" "value"
```

Values

Any valid POP3 server address

Default

```
"0.0.0.0"
```

Getvar

To respond with the POP3 server address:

```
! U1 getvar "ip.pop3.server_addr"
```



NOTES:

- For printer support, see [SGD Command Support on page 1455](#).
- For details on SGD command structure, see [Command Structure on page 562](#).

ip.pop3.username

This printer setting refers to the POP3 user name. This only applies if the "**ip.pop3.enable**" is set to on.

Setvar

To change the POP3 user name:

```
! U1 setvar "ip.pop3.username" "value"
```

Values

A maximum of 20 alphanumeric characters

Default

" "

Getvar

To respond with the POP3 user name:

```
! U1 getvar "ip.pop3.username"
```

Example

This **setvar** example shows the value set to "**user**".

```
! U1 setvar "ip.pop3.username" "user"
```

When the **setvar** value is set to "**user**", the **getvar** result is "**user**".



NOTES:

- For printer support, see [SGD Command Support on page 1455](#).
- For details on SGD command structure, see [Command Structure on page 562](#).

ip.port

This printer setting refers to the port number that the TCP print service is listening on. Normal TCP communications from the host should be directed to this port.

Setvar

To set the TCP/UDP port number:

```
! U1 setvar "ip.port" "value"
```

Values

1 - 65535 (excluding any ports currently used by other services, such as 21, 23, 80, and 515).

Default

"9100"

Getvar

To respond with the TCP/UDP port number:

```
! U1 getvar "ip.port"
```

Example

This **setvar** example shows the value set to "9100".

```
! U1 setvar "ip.port" "9100"
```

When the **setvar** value is set to "9100", the **getvar** result is "9100".



NOTES:

- For printer support, see [SGD Command Support on page 1455](#).
- For details on SGD command structure, see [Command Structure on page 562](#).

ip.port_altername

This command sets the port number of the alternate port.



NOTE: Print servers supporting this command will monitor both the primary port and the alternate port for connections at the same time.

Setvar

To set the alternate port for the print server:

```
! U1 setvar "ip.port_altername" "value"
```

Values

Any valid TCP port address.

Default

"9100"

Getvar

To return the current alternate port setting:

```
! U1 getvar "ip.port_altername"
```

Values

The current port setting.

Example

This **setvar** example shows the value set to "**6101**".

```
U1 setvar "ip.port_altername" "6101"
```



NOTES:

- For printer support, see [SGD Command Support on page 1455](#).
- For details on SGD command structure, see [Command Structure on page 562](#).

ip.port_json_config

This printer setting refers to the port number that the TCP print service is listening on for JSON configuration packets. JSON TCP communications from the host should be directed to this port.

Setvar

To set the JSON TCP port number:

```
! U1 setvar "ip.port_json_config" "value"
```

Values

0 = Disable the port

1 - 65535 (excluding any ports currently used by other services, such as 21, 23, 80, and 515).

Default

"9200"

Getvar

To respond with the JSON TCP port number:

```
! U1 getvar "ip.port_json_config"
```

Example

This **setvar** example shows the value set to **"9200"**.

```
! U1 setvar "ip.port_json_config" "9200"
```

When the **setvar** value is set to **"9200"**, the **getvar** result is **"9200"**.



NOTES:

- For printer support, see [SGD Command Support on page 1455](#).
- For details on SGD command structure, see [Command Structure on page 562](#).

ip.port_single_conn

This command configures the port number for the single connection IP port. The single-connection IP port allows only one connection at a time.

See "[ip.port_single_conn_idle_timeout](#)" for additional information.

Setvar

To configure the port number for the single connection IP port:

```
! U1 setvar "ip.port_single_conn" "value"
```

Values

A number between 1 and 65535. This number specifies the port.

Default

"9300"

Getvar

To return the current setting value:

```
! U1 getvar "ip.port_single_conn"
```

Result

A port number between 1 and 65535.



NOTES:

- For printer support, see [SGD Command Support on page 1455](#).
- For details on SGD command structure, see [Command Structure on page 562](#).

ip.port_single_conn_idle_timeout

Sets the amount of time that must elapse with no activity for the single-connection IP port to be considered in the idle state.

When the port is idle and a new connection is requested, the currently open connection will be closed and a new connection will be opened. If the port is not in the idle state, the current connection will be maintained and the connection request will be refused with an error response.

Setvar

To set the single connection timeout time:

```
! U1 setvar "ip.port_single_conn_idle_timeout" "value"
```

Values

A number between 1 and 65535. The value is in seconds. If the value is 0, the port will be considered to be in the idle state.

Default

"180"

Getvar

To return the current setting value:

```
! U1 getvar "ip.port_single_conn_idle_timeout"
```

Result

A number between 1 and 65535. The value is in seconds. If the value is 0, the port will be considered to be in the idle state.



NOTES:

- For printer support, see [SGD Command Support on page 1455](#).
- For details on SGD command structure, see [Command Structure on page 562](#).

ip.primary_network

This command allows you to set the primary network to either wired or wireless.

Setvar

To set the primary network device:

```
! U1 setvar "ip.primary_network" "value"
```

Values

1 = wired

2 = wireless

Default

"1"

Getvar

To respond with the name of the current primary network device:

```
! U1 getvar "ip.primary_network"
```

Example

This **setvar** example shows the value set to "1".

```
! U1 setvar "ip.primary_network" "1"
```

What the **setvar** value is set to is the **getvar** result. In this example, the **getvar** result is "1".



NOTES:

- For printer support, see [SGD Command Support on page 1455](#).
- For details on SGD command structure, see [Command Structure on page 562](#).

ip.smtp.domain

This printer setting refers to the domain name used by the printer in sending email with respect to the SMTP server.

Setvar

To change the SMTP domain name:

```
! U1 setvar "ip.smtp.domain" "value"
```

Values

A maximum of 24 alphanumeric characters

Default

"ZBRPrintServer"

Getvar

To return the SMTP domain name:

```
! U1 getvar "ip.smtp.domain"
```

Example

This **setvar** example shows the value set to **"ZBRPrintServer.com"**.

```
! U1 setvar "ip.smtp.domain" "ZBRPrintServer.com"
```

When the **setvar** value is set to **"ZBRPrintServer.com"**, the **getvar** result is **"ZBRPrintServer.com"**.



NOTES:

- For printer support, see [SGD Command Support on page 1455](#).
- For details on SGD command structure, see [Command Structure on page 562](#).

ip.smtp.enable

This printer setting refers to the SMTP protocol.

Setvar

To turn SMTP on or off:

```
! U1 setvar "ip.smtp.enable" "value"
```

Values

"off" = disables SMTP

"on" = enables SMTP

Default

"on"

Getvar

To return the SMTP status:

```
! U1 getvar "ip.smtp.enable"
```

Example

This **setvar** example shows the value set to "on".

```
! U1 setvar "ip.smtp.enable" "on"
```

When the **setvar** value is set to "on", the **getvar** result is "on".



NOTES:

- For printer support, see [SGD Command Support on page 1455](#).
- For details on SGD command structure, see [Command Structure on page 562](#).

ip.smtp.server_addr

This printer setting refers to the IP address of the SMTP server used for sending email.

Setvar

To change the SMTP server address:

```
! U1 setvar "ip.smtp.server_addr" "value"
```

Values

Any valid IP address.

Default

0.0.0.0

Getvar

To respond with the current SMTP server address:

```
! U1 getvar "ip.smtp.server_addr"
```

Example

This **setvar** example shows the value set to **10.10.10.10**.

```
! U1 setvar "ip.smtp.server_addr" "10.10.10.10"
```

When the **setvar** value is set to **"10.10.10.10"**, the **getvar** result is **"10.10.10.10"**.



NOTES:

- For printer support, see [SGD Command Support on page 1455](#).
- For details on SGD command structure, see [Command Structure on page 562](#).

ip.snmp.get_community_name

This printer setting is used when making SNMP queries. The SNMP client must supply the get community name that matches the printer's get community name in order to query any SNMP data.

Setvar

To set the SNMP get community name string:

```
! U1 setvar "ip.snmp.get_community_name" "value"
```

Values

A maximum of 19 alphanumeric characters.

Default

"public"

Getvar

To get the SNMP get community name string:

```
! U1 getvar "ip.snmp.get_community_name"
```

For protection a single "*" prints.

Example

This **setvar** example shows the value set to **"public"**.

```
! U1 setvar "ip.snmp.get_community_name" "public"
```

When the **setvar** value is set to **"public"**, the **getvar** result is **"*"**.



NOTES:

- For printer support, see [SGD Command Support on page 1455](#).
- For details on SGD command structure, see [Command Structure on page 562](#).

ip.snmp.set_community_name

This printer setting is used when changing SNMP data remotely. To alter any SNMP data, the SNMP client must supply the set community name that matches the printer's set community name.

Setvar

To set the SNMP set community name string:

```
! U1 setvar "ip.snmp.set_community_name" "value"
```

Values

A maximum of 19 alphanumeric characters

Default

"public"

Getvar

To return the printer's SNMP set community name string:

```
! U1 getvar "ip.snmp.set_community_name"
```

For protection a single "*" returns.

Example

This **setvar** example shows the value set to **"public"**.

```
! U1 setvar "ip.snmp.set_community_name" "public"
```

When the **setvar** value is set to **"public"**, the **getvar** result is **"*"**.



NOTES:

- For printer support, see [SGD Command Support on page 1455](#).
- For details on SGD command structure, see [Command Structure on page 562](#).

ip.snmp.trap_community_name

This command sets the SNMP Trap Community name of the print server.

Setvar

To set the SNMP trap community name:

```
! U1 setvar "ip.snmp.get_community_name" "value"
```

Values

A maximum of 20 alphanumeric characters.

Default

"public"

Getvar

To get the SNMP trap community name:

```
! U1 getvar "ip.snmp.trap_community_name"
```

Example

```
! U1 setvar "ip.snmp.trap_community_name" "public"
```



NOTES:

- For printer support, see [SGD Command Support on page 1455](#).
- For details on SGD command structure, see [Command Structure on page 562](#).

ip.snmp.enable

This printer setting refers to the SNMP protocol.

Setvar

To enable or disable the SNMP protocol:

```
! U1 setvar "ip.snmp.enable" "value"
```

Values

"on" = enable the SNMP protocol

"off" = disable the SNMP protocol

Default

"on"

Getvar

To respond with the SNMP status:

```
! U1 getvar "ip.snmp.enable"
```

Example

This **setvar** example shows the value set to "on".

```
! U1 setvar "ip.snmp.enable" "on"
```

When the **setvar** value is set to "on", the **getvar** result is "on".



NOTES:

- For printer support, see [SGD Command Support on page 1455](#).
- For details on SGD command structure, see [Command Structure on page 562](#).

ip.tcp.enable

This printer setting refers to the TCP socket protocol.

Setvar

To turn the TCP on or off:

```
! U1 setvar "ip.tcp.enable" "value"
```

Values

"off" = disables TCP protocol

"on" = enables TCP protocol

Default

"on"

Getvar

To respond with the TCP status:

```
! U1 getvar "ip.tcp.enable"
```

Example

This **setvar** example shows the value set to "on".

```
! U1 setvar "ip.tcp.enable" "on"
```

When the **setvar** value is set to "on", the **getvar** result is "on".



NOTES:

- For printer support, see [SGD Command Support on page 1455](#).
- For details on SGD command structure, see [Command Structure on page 562](#).

ip.telnet.enable

Use this command to set the TELNET (port 23) protocol. This command is not supported in printers running Link-OS 6 or later versions.

Setvar

To instruct the printer to turn TELNET on or off:

```
! U1 setvar "ip.telnet.enable" "value"
```

Value

"off" = disables telnet protocol

"on" = enables telnet protocol

Default

"on"

Getvar

To instruct the printer to respond with the TELNET status:

```
! U1 getvar "ip.telnet.enable"
```

Example

This **setvar** example shows the value set to "on".

```
! U1 setvar "ip.telnet.enable" "on"
```

When the **setvar** value is set to "on", the **getvar** result is "on".



NOTES:

- For printer support, see [SGD Command Support on page 1455](#).
- For details on SGD command structure, see [Command Structure on page 562](#).

ip.tcp.nagle_algorithm

Enables or disables the use of the Nagle algorithm on TCP connections.

Setvar

To enable or disable the use of the Nagle algorithm on TCP connections:

```
! U1 setvar "ip.tcp.nagle_algorithm" "value"
```

Values

"enabled" = allows the use of the Nagle algorithm

"disabled" = disables use of the Nagle algorithm

Default

"enabled"

Getvar

To return the current setting value:

```
! U1 getvar "ip.tcp.nagle_algorithm"
```



NOTES:

- For printer support, see [SGD Command Support on page 1455](#).
- For details on SGD command structure, see [Command Structure on page 562](#).

ip.udp.enable

This printer setting refers to the UDP socket protocol.

Setvar

To turn UDP on or off:

```
! U1 setvar "ip.udp.enable" "value"
```

Values

"off" = disables UDP protocol

"on" = enables UDP protocol

Default

"off"

Getvar

To respond with the UDP status:

```
! U1 getvar "ip.udp.enable"
```

Example

This **setvar** example shows the value set to "on".

```
! U1 setvar "ip.udp.enable" "on"
```

When the **setvar** value is set to "on", the **getvar** result is "on".



NOTES:

- For printer support, see [SGD Command Support on page 1455](#).
- For details on SGD command structure, see [Command Structure on page 562](#).

weblink.cloud_connect.enable

Enables the CloudConnect menu feature.

Setvar

To set the command:

```
! U1 setvar "weblink.cloud_connect.enable" "value"
```

Values:

- true — CloudConnect menu is enabled
- false — CloudConnect menu is disabled

Default:

```
"true"
```

Getvar

To have the printer return the current setting value:

```
! U1 getvar "weblink.cloud_connect.enable"
```



NOTES:

- For printer support, see [SGD Command Support on page 1455](#).
- For details on SGD command structure, see [Command Structure on page 562](#).

weblink.enable

This command indicates if one or more of the weblink connections are active.

If there is more than one connection under the weblink branch (for example, **weblink.ip.conn1**) and if any of the **.location** values are set, then this SGD will be set to **"on"**. If all connections are disabled (all connection **.location** values set to **""**), then this value will be set to **"off"**.

^JUF, **^JUS**, **^JUN**, **^JUA**, and **device.restore_defaults** do not have any affect on this setting.

Getvar

To indicate if one or more of the weblink connections are active:

```
! U1 getvar "weblink.enable"
```

Result

- "yes" = if any of the **.location** values are set
- "off" = if all connections are disabled



NOTES:

- For printer support, see [SGD Command Support on page 1455](#).
- For details on SGD command structure, see [Command Structure on page 562](#).

weblink.ip.conn[1|2].authentication.add

This command allows the user to add a single server/username/password triplet into the list of authentication entries.

When the printer attempts to connect to the server (url specified in **weblink.ip.conn[1|2].location**) the server may require HTTP authentication (e.g. digest, basic, DNS, etc.). There may be multiple authentication requests along the route to the destination (e.g. a local server first requires HTTP authentication as well as on the remote server).

For each HTTP authentication request received while attempting to connect, the printer will enumerate the authentication entries and attempt to satisfy the request with the username/password pair provided for the respective server. The server name in the entry is what determines which username/password pair should be used for which authentication request. Both DNS names and IP addresses are acceptable. The server, username, and password are separated by a single space (not a tab or other white space character). The server name is the only required field. If no username is supplied, but a password is, there must be two spaces between the server and the password fields. If there is a username but no password, or simply just the servername, no space is required at the end of the entry.

If the command is changed when the connection is enabled (**weblink.enable** is set to "on"), it will not take effect until the connection is disabled, and then re-enabled.



NOTE: This setting only be changed when `weblink.enable` is set to "off".

`^JUF`, `^JUS`, `^JUN`, `^JUA`, and `device.restore_defaults` do not have any affect on this setting.

Setvar

To add a single server/username/password triplet to the list of authentication entries:

```
! U1 setvar "weblink.ip.conn1.authentication.add" "servername[ username][ password]"
! U1 setvar "weblink.ip.conn2.authentication.add" "servername[ username][ password]"
```

Values

servername [username][password] has a maximum length of 2048 characters

Default

NA

Example

In this example, a username and a password is supplied:

```
! U1 setvar "weblink.ip.conn1.authentication.add" "my.server.lan johndoe password"
```

In this example, no password is supplied

```
! U1 setvar "weblink.ip.conn1.authentication.add" "my.server.lan johndoe"
```

In this example, no username is supplied (note the double space)

```
! U1 setvar "weblink.ip.conn1.authentication.add" "my.server.lan password"
```

In this example, no username or password is supplied

```
! U1 setvar "weblink.ip.conn1.authentication.add" "my.server.lan"
```

**NOTES:**

- For printer support, see [SGD Command Support on page 1455](#).
- For details on SGD command structure, see [Command Structure on page 562](#).

weblink.ip.conn[1|2].authentication.entries

This command lists the server names added to the authentication entries list.

Only the server names will be shown. The username and passwords will not be shown. The server names are separated by a `\r\n` so that each shows up on its own line.

`^JUF`, `^JUS`, `^JUN`, `^JUA`, and `device.restore_defaults` do not have any affect on this setting.

Getvar

To list the server names for the specified connection:

```
! U1 getvar "weblink.ip.conn1.authentication.entries"
```

```
! U1 getvar "weblink.ip.conn2.authentication.entries"
```



NOTES:

- For printer support, see [SGD Command Support on page 1455](#).
- For details on SGD command structure, see [Command Structure on page 562](#).

weblink.ip.conn[1|2].authentication.remove

This command allows the user to remove a single server/username/password triplet from the list of authentication entries.

To remove an entry only the server name is supplied. If an invalid entry is supplied no action is taken. If the SGD is changed when the connection is enabled (**weblink.ip.conn[1|2].enable**), it will not take effect until the connection is disabled, and then re-enabled. It is therefore recommended that this setting only be changed when **weblink.ip.conn[1|2].enable** is set to "off".

^JUF, ^JUS, ^JUN, ^JUA, and **device.restore_defaults** do not have any affect on this setting.

Setvar

To remove a single server/username/password triplet from the list of authenticaiton entries:

```
! U1 setvar "weblink.ip.conn1.authentication.remove" "servername"
! U1 setvar "weblink.ip.conn2.authentication.remove" "servername"
```

Values

servername has a maximum length of string is 2048 characters.

Default

NA

Example

In this example, a username and a password is supplied

```
! U1 setvar "weblink.ip.conn1.authentication.remove"
"my.server.lan"
```



NOTES:

- For printer support, see [SGD Command Support on page 1455](#).
- For details on SGD command structure, see [Command Structure on page 562](#).

weblink.ip.conn[1|2].location

This command assigns the URL of the server for this connection. The URL must follow the URL rules for the HTTP[S] protocol outlined in RFC2396 (<http://www.ietf.org/rfc/rfc2396.txt>).

The setting will not take effect until the printer is reset. Changing this setting will set `weblink.printer_reset_required` to **"yes"**.

`^JUF`, `^JUS`, `^JUN`, `^JUA`, and `device.restore_defaults` do not have any affect on this setting.

Setvar

To set the server URL for the specified connection:

```
! U1 setvar "weblink.ip.conn1.location" "value"
! U1 setvar "weblink.ip.conn2.location" "value"
```

Values

any HTTPS URL up to 2048 characters

Default

""

Getvar

To return the server URL currently assigned to the connection:

```
! U1 getvar "weblink.ip.conn1.location"
! U1 getvar "weblink.ip.conn2.location"
```

Example

```
! U1 setvar "weblink.ip.conn2.location"
"https://my.linkos.server.com:8080/link/os"
```



NOTES:

- For printer support, see [SGD Command Support on page 1455](#).
- For details on SGD command structure, see [Command Structure on page 562](#).

weblink.ip.conn[1|2].num_connections

This command reports the number of established connections on conn1 and conn2. Once the connection is established, this number will be incremented. When a channel is closed or the connection times out, the number is decremented.

Getvar

To retrieve the number of active connections on conn1 and conn2:

```
! U1 getvar "weblink.ip.conn1.num_connections"  
! U1 getvar "weblink.ip.conn2.num_connections"
```



NOTES:

- For printer support, see [SGD Command Support on page 1455](#).
- For details on SGD command structure, see [Command Structure on page 562](#).

weblink.ip.conn[1|2].maximum_simultaneous_connections

This command indicates the maximum number of simultaneous connections that can be initiated by the printer.

Via the main connection (the original connection initiated by the printer to the remote server), the remote server can request that additional connections from the printer be initiated (e.g. a connection that supports only JSON SGDs, one that behaves similar to the RAW TCP port).

The server is free to request as many as it thinks it needs, but the printer will prevent more than N number of connections, where N is the value of this command.

^JUF, ^JUS, ^JUN, ^JUA, and `device.restore_defaults` do not have any affect on this setting.

Setvar

To set the maximum number of connections:

```
! U1 setvar "weblink.ip.conn1.maximum_simultaneous_connections" "value"
```

```
! U1 setvar "weblink.ip.conn2.maximum_simultaneous_connections" "value"
```

Values

Any integer from 1-100

Default

"10"

Getvar

To retrieve the maximum set number of connections:

```
! U1 getvar "weblink.ip.conn1.maximum_simultaneous_connections"
```

```
! U1 getvar "weblink.ip.conn2.maximum_simultaneous_connections"
```

Example

This example sets the conn1 maximum connections to 3.

```
! U1 setvar "weblink.ip.conn1.maximum_simultaneous_connections" "3"
```



NOTES:

- For printer support, see [SGD Command Support on page 1455](#).
- For details on SGD command structure, see [Command Structure on page 562](#).

weblink.ip.conn[1|2].proxy

This command assigns the URL of the proxy for the connection.

The proxy server protocol, port, domain, username, and password are all encoded into the URL via the format outlined in RFC2396 (<http://www.ietf.org/rfc/rfc2396.txt>).

The username and password must avoid the invalid characters listed in RFC2396 (e.g. ':', '@', '/', etc). If an invalid character must be used it needs to be escaped using '%' as described in RFC2396.

^JUF, ^JUS, ^JUN, ^JUA, and `device.restore_defaults` do not have any affect on this setting.

Setvar

To assign the URL of the connection proxy:

```
! U1 setvar "weblink.ip.conn1.proxy" "url"
! U1 setvar "weblink.ip.conn2.proxy" "url"
```

Values

- Any valid URL up to 2048 characters
- Expected URL format: [http|https]://[user:pass@]domain[:port]/[path]
- The URL will need to be built according to the server/proxy environment the printer is running within.

Default

""

- The user:pass, port, and path are all optional.
- The default scheme must be either **HTTPS** or **HTTP**. The default is **HTTP**.
- The default port is 1080.
- The default is to omit the username and password.

Getvar

To retrieve the URL of the connection proxy:

```
! U1 getvar "weblink.ip.conn1.proxy"
! U1 getvar "weblink.ip.conn2.proxy"
```

Do

To assign the URL of the connection proxy:

```
! U1 do "weblink.ip.conn1.proxy" "url"
! U1 do "weblink.ip.conn2.proxy" "url"
```

Values

- Any valid URL up to 2048 characters
- Expected URL format: [http|https]://[user:pass@]domain[:port]/[path]
- The URL will need to be built according to the server/proxy environment the printer is running within.

Default

""

- The user:pass, port, and path are all optional.
- The default scheme must be either **HTTPS** or **HTTP**. The default is **HTTP**.
- The default port is 1080.
- The default is to omit the username and password.

Example

Examples of how to connect to various proxy servers:

`http://username:password@mydomain.com:3128/`

`http://mydomain.com/`



NOTES:

- For printer support, see [SGD Command Support on page 1455](#).
- For details on SGD command structure, see [Command Structure on page 562](#).

weblink.ip.conn[1|2].retry_interval

This command sets the number of seconds between attempts to connect to the server URL provided in `weblink.ip.conn1.location`. If an attempt is unsuccessful or the connection is lost, the printer will wait '`retry_interval`' seconds before attempting to connect again.

`^JUF`, `^JUS`, `^JUN`, `^JUA`, and `device.restore_defaults` do not have any affect on this setting.

Setvar

To set the number of seconds to wait before attempting to reconnect to the server:

```
! U1 setvar "weblink.ip.conn1.retry_interval" "value"
! U1 setvar "weblink.ip.conn2.retry_interval" "value"
```

Values

1 - 600

Default

"10"

Getvar

To return the number of seconds to wait between connection attempts:

```
! U1 getvar "weblink.ip.conn1.retry_interval"
! U1 getvar "weblink.ip.conn2.retry_interval"
```

Do

To set the number of seconds to wait before attempting to reconnect to the server:

```
! U1 do "weblink.ip.conn1.retry_interval" "value"
! U1 do "weblink.ip.conn2.retry_interval" "value"
```

Values

1 - 600

Default

"10"



NOTES:

- For printer support, see [SGD Command Support on page 1455](#).
- For details on SGD command structure, see [Command Structure on page 562](#).

weblink.ip.conn[1|2].test.location

This command holds the URL for testing a connection to the internet. This is meant to assist users in debugging their printer's connection to remote servers when there are issues with the main weblink connection (conn1 or conn2).

The URL must follow the URL rules for the HTTP[S] protocol outlined in RFC2396 (<http://www.ietf.org/rfc/rfc2396.txt>).

^JUF, ^JUS, ^JUN, ^JUA, and `device.restore_defaults` do not have any affect on this setting.

Setvar

To set the URL to hold for testing a connection:

```
! U1 setvar "weblink.ip.conn1.test.location" "url"
! U1 setvar "weblink.ip.conn2.test.location" "url"
```

Values

Any HTTPS URL up to 2048 characters

Default

"http://www.zebra.com/apps/linktest"

Getvar

To retrieve the printer's test connection URL:

```
! U1 getvar "weblink.ip.conn1.test.location"
! U1 getvar "weblink.ip.conn2.test.location"
```

Do

To set the URL to hold for testing a connection:

```
! U1 do "weblink.ip.conn1.test.location" "url"
! U1 do "weblink.ip.conn2.test.location" "url"
```

Values

Any HTTPS URL up to 2048 characters

Default

"http://www.zebra.com/apps/linktest"

Example

The test connection can assist the user in several ways/scenarios:

1. If the `test.test_on` value is set to "failure", any time the main weblink (`conn[1|2].location`) connection fails to connect then the `test.location` URL will be used. In this situation, an attempt will be made to contact the remote URL in `test.location`, using authentication and proxy configuration that is specified by the main connection.

2. If the `test.test_on` value is set to "**interval**" an attempt will be made to contact the remote URL in `test.location` every `test.retry_interval` seconds, using authentication and proxy configuration that is specified by the main connection.
3. If the `test.test_on` value is set to "**both**", then scenario 1 and 2 will both occur. This is useful for users who will use an HTTP connection to move through their firewall - and thereafter frequently refresh the connection to indicate to their firewall that there is still activity for the purpose of keeping the connection alive.



NOTES:

- For printer support, see [SGD Command Support on page 1455](#).
- For details on SGD command structure, see [Command Structure on page 562](#).

weblink.ip.conn[1|2].test.retry_interval

This command determines how often, in seconds, a connection to the test.location URL should be attempted. This setting is only applicable when the `test.test_on` SGD is set to `"interval"` or `"both"`.

`^JUF`, `^JUS`, `^JUN`, `^JUA`, and `device.restore_defaults` do not have any affect on this setting.

Setvar

To set the interval for how often a connection to the test.location URL should be attempted:

```
! U1 setvar "weblink.ip.conn1.test.retry_interval" "value"
! U1 setvar "weblink.ip.conn2.test.retry_interval" "value"
```

Values

0-1800 (in seconds, providing 0 second - 30 minute interval)

Default

"900"

Getvar

To retrieve the retry interval:

```
! U1 getvar "weblink.ip.conn1.test.retry_interval"
! U1 getvar "weblink.ip.conn2.test.retry_interval"
```

Do

To set the interval for how often a connection to the test.location URL should be attempted:

```
! U1 do "weblink.ip.conn1.test.retry_interval" "value"
! U1 do "weblink.ip.conn2.test.retry_interval" "value"
```

Values

0-1800 (in seconds, providing 0 second - 30 minute interval)

Default

"900"



NOTES:

- For printer support, see [SGD Command Support on page 1455](#).
- For details on SGD command structure, see [Command Structure on page 562](#).

weblink.ip.conn[1|2].retry_interval_random_max

Specifies the maximum random wait time in seconds for weblink connection retries.

^JUF, ^JUS, ^JUN, ^JUA, and `device.restore_defaults` do not have any affect on this setting.

Setvar

To set the command:

```
! U1 setvar "weblink.ip.conn[1|2].retry_interval_random_max" "value"
```

Values

- 0-600

Default

"120"

Examples

```
! U1 setvar "weblink.ip.conn[1].retry_interval_random_max" "120"  
! U1 setvar "weblink.ip.conn[2].retry_interval_random_max" "60"
```

Getvar

To have the printer return the current setting value:

```
! U1 getvar "weblink.ip.conn[1|2].retry_interval_random_max"
```



NOTES:

- For printer support, see [SGD Command Support on page 1455](#).
- For details on SGD command structure, see [Command Structure on page 562](#).

weblink.ip.conn[1|2].test.test_on

This command determines when the test connection should be attempted. This assists in debugging the printer's connection to remote servers when there are issues with the main weblink connection (conn1 or conn2).

^JUF, ^JUS, ^JUN, ^JUA, and `device.restore_defaults` do not have any affect on this setting.

Setvar

To indicate when the test connection should be attempted:

```
! U1 setvar "weblink.ip.conn1.test.test_on" "value"
! U1 setvar "weblink.ip.conn2.test.test_on" "value"
```

Values

`off, failure, interval, both`

Default

`"failure"`

Getvar

To retrieve the test connection setting:

```
! U1 getvar "weblink.ip.conn1.test.test_on"
! U1 getvar "weblink.ip.conn2.test.test_on"
```

Do

To set when the test connection should be attempted:

```
! U1 do "weblink.ip.conn1.test.test_on" "value"
! U1 do "weblink.ip.conn2.test.test_on" "value"
```

Values

`off, failure, interval, both`

Default

`"failure"`

Example

The test connection can assist the user is several ways/scenarios:

4. If the `test.test_on` value is set to `"failure"`, any time the main weblink (`conn[1|2].location`) connection fails to connect then the `test.location` URL will be used. An attempt will be made to contact the remote URL in `test.location`, using authentication and proxy configuration that is specified by the main connection.

5. If the `test.test_on` value is set to "**interval**" an attempt will be made to contact the remote URL in `test.location` every `test.retry_interval` seconds, using authentication and proxy configuration that is specified by the main connection.
6. If the `test.test_on` value is set to "**both**", then scenario 1 and 2 will both occur. This is useful for users who will use an HTTP connection to move through their firewall - and thereafter frequently refresh the connection to indicate to their firewall that there is still activity for the purpose of keeping the connection alive.



NOTES:

- For printer support, see [SGD Command Support on page 1455](#).
- For details on SGD command structure, see [Command Structure on page 562](#).

weblink.logging.clear

This command clears the weblink log. Setting this value to anything will clear it, including an empty string. ^JUF, ^JUS, ^JUN, ^JUA, and `device.restore_defaults` do not have any affect on this setting.

Setvar

To clear the weblink log entries:

```
! U1 setvar "weblink.logging.clear" "value"
```

Values

Any string value, including an empty string.

Default

NA

Do

To clear the weblink log entries:

```
! U1 do "weblink.logging.clear" "value"
```

Values

Any string value, including an empty string.

Default

NA

Example

This example clears the weblink log entries with an empty string value.

```
! U1 setvar "weblink.logging.clear" ""
```



NOTES:

- For printer support, see [SGD Command Support on page 1455](#).
- For details on SGD command structure, see [Command Structure on page 562](#).

weblink.logging.entries

This command returns the N number of entries in the weblink log, where N has a maximum value that is set by `weblink.logging.max_entries`.

The weblink log is a collection of events related to connecting to a remote Link-OS™ server. The log entries range anywhere from general status to errors that prevented a successful connection. The log contains entries from all connections and are labeled so that it is clear which log entries are for which connection. Each log entry also contains a timestamp for when it was logged by the system. The newest events will appear at the bottom of the list.

^JUF, ^JUS, ^JUN, ^JUA, and `device.restore_defaults` do not have any affect on this setting.

Getvar

To return a lists of entries in the weblink log:

```
! U1 getvar "weblink.logging.entries"
```

Values

NA

Default

""

Example

This example shows the result from `weblink.logging.entries`:

```
[01-04-2013 08:40:45.655] [conn1.1] HTTP/1.1 404 Not Found
[01-04-2013 08:40:45.659] [conn1.1] Received HTTP code 404 from proxy after CONNECT
[01-04-2013 08:40:45.660] [conn1.1] Closing connection
[01-04-2013 08:40:45.662] [conn1.1] Failed to connect (SP = 0, CU = 0, UW = 0, AC = 0, PC = 0)
```



NOTES:

- For printer support, see [SGD Command Support on page 1455](#).
- For details on SGD command structure, see [Command Structure on page 562](#).

weblink.logging.max_entries

This command specifies the maximum number of individual log entries that will be stored in the `weblink.logging.entries` command.



IMPORTANT: Changes to this command are immediate and may result in some log entries being lost. If there are N log entries currently in the log, the user sets the `max_entries` to M, where M is less than N, the oldest (N-M) log entries will be removed.

`^JUF`, `^JUS`, `^JUN`, `^JUA`, and `device.restore_defaults` do not have any affect on this setting.

Setvar

To set the maximum number of log entries that will be stored:

```
! U1 setvar "weblink.logging.max_entries" "value"
```

Values

0 - 10000

Setting the value to 0 disables logging.

Default

"0"

Getvar

To return the setting for the maximum number of log entries that will be stored:

```
! U1 getvar "weblink.logging.max_entries"
```

Do

To set the maximum number of log entries that will be stored:

```
! U1 getvar "weblink.logging.max_entries"
```

Values

0 - 10000

Setting the value to 0 disables logging.

Default

"0"

Example

In this example, `weblink.logging.max_entries` is set to 3:

```
[01-04-2013 08:40:45.659] [conn1.1] Received HTTP code 404 from proxy after CONNECT
```

```
[01-04-2013 08:40:45.660] [conn1.1] Closing connection
```

```
[01-04-2013 08:40:45.662] [conn1.1] Failed to connect (SP = 0, CU = 0, UW = 0, AC = 0, PC = 0)
```

In this example, **weblink.logging.max_entries** is set to 2:
weblink.logging.entries becomes:

[01-04-2013 08:40:45.660] [conn1.1] Closing connection

[01-04-2013 08:40:45.662] [conn1.1] Failed to connect (SP = 0, CU = 0, UW = 0, AC = 0, PC = 0)



NOTES:

- For printer support, see [SGD Command Support on page 1455](#).
- For details on SGD command structure, see [Command Structure on page 562](#).

weblink.printer_reset_required

This command retrieves a "yes" or "no" value indicating whether any of the weblink settings have been modified.

^JUF, ^JUS, ^JUN, ^JUA, and `device.restore_defaults` do not have any affect on this setting.

Getvar

To retrieve whether any of the weblink settings are modified:

```
! U1 getvar "weblink.printer_reset_required"
```

Values

"yes" or "no"

Default

"no"



NOTES:

- For printer support, see [SGD Command Support on page 1455](#).
- For details on SGD command structure, see [Command Structure on page 562](#).

weblink.restore_defaults

This command defaults, and saves, the weblink branch settings. Any value, including an empty string, will default the weblink branch settings.



NOTE:The entire weblink branch of settings will be defaulted and the settings are saved; however, the weblink connections will not use the new settings until the printer is restarted (e.g. the `weblink.printer_reset_required` SGD will be "yes" after a default).

`^JUF`, `^JUS`, `^JUN`, `^JUA`, and `device.restore_defaults` do not have any affect on this setting.

Setvar

To default the weblink branch settings:

```
! U1 setvar "weblink.restore_defaults" "value"
```

Values

Any value, including an empty string, will default the branch

Default

NA

Do

To default the weblink branch settings:

```
! U1 do "weblink.restore_defaults" "value"
```

Values

Any value, including an empty string, will default the branch

Default

NA

Example

These all default the branch:

```
! U1 setvar "weblink.restore_defaults" ""
! U1 setvar "weblink.restore_defaults" "foo"
! U1 do "weblink.restore_defaults" ""
! U1 do "weblink.restore_defaults" "foo"
```



NOTES:

- For printer support, see [SGD Command Support on page 1455](#).
- For details on SGD command structure, see [Command Structure on page 562](#).

weblink.zebra_connector.authentication.add

This command allows the user to add a single server/username/password triplet into the list of authentication entries.

When the printer attempts to connect to the Zebra Printer Connector, the local server may require HTTP authentication (e.g. digest, basic, DNS, etc.). There may be multiple authentication requests along the route to the destination (e.g. a local server first requires HTTP authentication as well as on the remote server).

For each HTTP authentication request received while attempting to connect, the printer will enumerate the authentication entries and attempt to satisfy the request with the username/password pair provided for the respective server. The server name in the entry is what determines which username/password pair should be used for which authentication request. Both DNS names and IP addresses are acceptable. The server, username, and password are separated by a single space (not a tab or other white space character). The server name is the only required field. If no username is supplied, but a password is, there must be two spaces between the server and the password fields. If there is a username but no password, or simply just the servername, no space is required at the end of the entry.

If the command is changed while the Visibility Agent is enabled, it will not take effect until the connection is disabled, and then re-enabled.



IMPORTANT: This setting can only be changed when `weblink.zebra_connector.enable` is set to "off".

`^JUF`, `^JUS`, `^JUN`, `^JUA`, and `device.restore_defaults` do not have any affect on this setting.

Setvar

To allow the user to add a single server/username/password triplet into the list of authentication entries:

```
! U1 setvar "weblink.zebra_connector.authentication.add" "server username password"
```

Values

- "server" = an IP address or a DNS name
- "username" = user name on this server
- "password" = password for this username on this server

Default

```
""
```

Result

```
! U1 setvar "weblink.zebra_connector.authentication.add"
"10.3.5.70 jsmith LedZepR0cks!"
```



NOTES:

- For printer support, see [SGD Command Support on page 1455](#).
- For details on SGD command structure, see [Command Structure on page 562](#).

weblink.zebra_connector.authentication.entries

This command lists the server names added to the authentication entries list.

Only the server names will be shown. The username and passwords will not be shown. The server names are separated by a `\r\n` so that each shows up on its own line.

`^JUF`, `^JUS`, `^JUN`, `^JUA`, and `device.restore_defaults` do not have any affect on this setting.

Getvar

To list the server names added to the authentication entries list:

```
! U1 getvar "weblink.zebra_connector.authentication.entries"
```

Result

Returns the list of servers with authentication entries. It does not return the username or passwords for those servers.

Default

""



NOTES:

- For printer support, see [SGD Command Support on page 1455](#).
- For details on SGD command structure, see [Command Structure on page 562](#).

weblink.zebra_connector.authentication.remove

Removes a single server/username/password triplet from the list of authentication entries.

To remove an entry only the server name is supplied, however the entire entry will be removed. If an invalid entry is supplied no action is taken.

^JUF, ^JUS, ^JUN, ^JUA, and `device.restore_defaults` do not have any affect on this setting.

Setvar

To remove a single server/username/password triplet from the list of authentication entries:

```
! U1 setvar "weblink.zebra_connector.authentication.remove" "server"
```

Values

"server" = an IP address or a DNS name of the server to remove

Default

NA

Example

```
! U1 setvar "weblink.zebra_connector.authentication.remove" "10.3.5.70"
```



NOTES:

- For printer support, see [SGD Command Support on page 1455](#).
- For details on SGD command structure, see [Command Structure on page 562](#).

weblink.zebra_connector.enable

Enables the Visibility Agent feature.

Setvar

To enable or disable the Visibility Agent feature:

```
! U1 setvar "weblink.zebra_connector.enable" "value"
```

Values

- "on" = enables Visibility Agent
- "off" = disables Visibility Agent

Default

"on"

Example

```
! U1 setvar "weblink.zebra_connector.enable" "enable"
```

Getvar

To return the current setting value:

```
! U1 getvar "weblink.zebra_connector.enable"
```

Result

"on" or "off"



NOTES:

- For printer support, see [SGD Command Support on page 1455](#).
- For details on SGD command structure, see [Command Structure on page 562](#).

weblink.zebra_connector.proxy

This command assigns the URL for the proxy used to connect to the Zebra connector.

The proxy server protocol, port, domain, username, and password are all encoded into the URL via the format outlined in RFC2396 (<http://www.ietf.org/rfc/rfc2396.txt>).

The username and password must avoid the invalid characters listed in RFC2396 (e.g. ':', '@', '/', etc). If an invalid character must be used it needs to be escaped using '%' as described in RFC2396.

^JUF, ^JUS, ^JUN, ^JUA, and `device.restore_defaults` do not have any affect on this setting.

Setvar

To assign the URL for the proxy used to connect to the Zebra connector:

```
! U1 setvar "weblink.zebra_connector.proxy" "url"
```

Values

Any valid URL up to 2048 characters

Expected URL format: [http|https]://[user:pass@]domain[:port]/[path]

The URL will need to be built according to the server/proxy environment the printer is running where

- "user" = username
- "password" = password
- "host" = either the hostname or IP address
- "port" = port number
- "other" = anything else needed in the path

Default

""

- The user:pass, port, and path are all optional.
- The default scheme must be either **HTTPS** or **HTTP**. The default is **HTTP**.
- The default port is 1080.

The default is to omit the username and password.

Example

```
! U1 setvar "weblink.zebra_connector.proxy"
"https://user:pass@my.internal.proxy:7840/init"
```

Getvar

To return the current setting value:

```
! U1 getvar "weblink.zebra_connector.proxy"
```

Result

```
"https://user:pass@my.internal.proxy:7840/init"
```



NOTES:

- For printer support, see [SGD Command Support on page 1455](#).
- For details on SGD command structure, see [Command Structure on page 562](#).

weblink.zebra_connector.version

Displays the current version of the Zebra Connector.

Getvar

To display the current version of the Zebra connector:
! U1 getvar "weblink.zebra_connector.version"

Values

A version number in the form of xx.yy.

Default

""

Example

```
! U1 getvar "weblink.zebra_connector.version" "0.04"
```



NOTE:

- For printer support, see [SGD Command Support on page 1455](#).
- For details on SGD command structure, see [Command Structure on page 562](#).

wlan.11ac.80mhz_enable

Enables the 80MHz wide channel support for the 802.11AC radio.

Setvar

To enable or disable the 80MHz wide channel support for the 802.11 AC radio:

```
! U1 setvar "wlan.11ac.80mhz_enable" "value"
```

Values

- "on" = enables the 80MHz wide channel support
- "off" = disables the 80MHz wide channel support

Default

"on"

Getvar

To return the current setting value:

```
! U1 getvar "wlan.11ac.80mhz_enable"
```



NOTES:

- For printer support, see [SGD Command Support on page 1455](#).
- For details on SGD command structure, see [Command Structure on page 562](#).

wlan.11d.enable

Allows the client to automatically configure themselves to their local regulatory domain. **Setvar**

To set the command:

```
! U1 setvar "wlan.11d.enable" "value"
```

Values:

- off
- on

Default:

"off"

Getvar

To have the printer return the current setting value:

```
! U1 getvar "wlan.11d.enable"
```



NOTES:

- For specific product support, see [SGD Command Support on page 1455](#).
- For details on command structure, see [Command Structure on page 562](#).

wlan.11n.20mhz_only

This command forces 20 MHz operation only in printers with 802.11n radios.

Setvar

To force 20 MHz operation only in printers with 802.11n radios:

```
! U1 setvar "wlan.11n.20mhz_only" "value"
```

Values

- "on"
- "off"

Default

"off"

Getvar

To return the current setting for 20 MHz operation only:

```
! U1 getvar "wlan.11n.20mhz_only"
```

Example

```
U1 setvar "wlan.11n.20mhz_only" "on"
```



NOTES:

- For printer support, see [SGD Command Support on page 1455](#).
- For details on SGD command structure, see [Command Structure on page 562](#).

wlan.11n.aggregation

This command enable or disables Aggregation MAC Service Data Unit (A-MSDU) in 802.11n radio communications.

Setvar

To enable or disable A-MSDU in 802.11n radio communications:

```
! U1 setvar "wlan.11n.aggregation" "value"
```

Values

- "on"
- "off"

Default

"off"

Getvar

To return the current setting for A-MSDU:

```
! U1 getvar "wlan.11n.aggregation"
```

Example

```
! U1 setvar "wlan.11n.aggregation" "on"
```



NOTES:

- For printer support, see [SGD Command Support on page 1455](#).
- For details on SGD command structure, see [Command Structure on page 562](#).

wlan.11n.greenfield

This command will enable or disable greenfield mode in 802.11n radio communications.

Setvar

To enable or disable the greenfield mode:

```
! U1 setvar "wlan.11n.greenfield" "value"
```

Values

- "on"
- "off"

Default

"off"

Getvar

To return the current setting for greenfield mode:

```
! U1 getvar "wlan.11n.greenfield"
```

Example

```
U1 setvar "wlan.11n.greenfield" "on"
```



NOTES:

- For printer support, see [SGD Command Support on page 1455](#).
- For details on SGD command structure, see [Command Structure on page 562](#).

wlan.11n.rifs

This command enable/disables Reduced Interframe Space (RIFS) in 802.11n radio communications.

Setvar

To enable or disable RIFS in 802.11n:

```
! U1 setvar "wlan.11n.rifs" "value"
```

Values

- "on"
- "off"

Default

"off"

Getvar

To return the current setting for RIFS:

```
! U1 getvar "wlan.11n.rifs"
```

Example

```
U1 setvar "wlan.11n.rifs" "on"
```



NOTES:

- For printer support, see [SGD Command Support on page 1455](#).
- For details on SGD command structure, see [Command Structure on page 562](#).

wlan.11n.short_gi_40mhz

This command enables/disables short Guard Interval in 40 mhz mode.

Setvar

To enable or disable short Guard Interval in 40 mhz mode:

```
! U1 setvar "wlan.11n.short_gi_40mhz" "value"
```

Values

- "on"
- "off"

Default

"off"

Getvar

To return the current setting for short Guard Interval 40mhz operation:

```
! U1 getvar "wlan.11n.short_gi_40mhz"
```

Example

```
U1 setvar "wlan.11n.short_gi_40mhz" "on"
```



NOTES:

- For specific product support, see [SGD Command Support on page 1455](#).
- For details on command structure, see [Command Structure on page 562](#).

wlan.11n.short_gi_20mhz

This command enables/disables short Guard Interval (GI) in 20 mhz mode.

Setvar

To enable or disable short Guard Interval in 20 mhz mode:

```
! U1 setvar "wlan.11n.short_gi_20mhz" "value"
```

Values

- "on"
- "off"

Default

"off"

Getvar

To return the current setting value:

```
! U1 getvar "wlan.11n.short_gi_20mhz"
```

Example

```
U1 setvar "wlan.11n.short_gi_20mhz" "on"
```



NOTES:

- For specific product support, see [SGD Command Support on page 1455](#).
- For details on command structure, see [Command Structure on page 562](#).

wlan.8021x.enable

Enables or disables the 802.1x security protocol, with the option to set it to WPA security protocol.

Setvar

To set the command:

```
! U1 setvar "wlan.8021x.enable" "value"
```

Values:

- **off** — 802.1x security protocol is disabled.
- **on** — 802.1x security protocol is enabled.
- **wpa** — 802.1x security protocol is enabled and uses WPA.

Default:

off

Getvar

To have the printer return the current setting value:

```
! U1 getvar "wlan.8021x.enable"
```



NOTES:

- For printer support, see [SGD Command Support on page 1455](#).
- For details on SGD command structure, see [Command Structure on page 562](#).

wlan.8021x.validate_peap_server_certificate

This command determines if the printer will validate the PEAP server certificate.

Setvar

To determine if the printer will validate the PEAP server certificate:

```
! U1 setvar "wlan.8021x.validate_peap_server_certificate" "value"
```

Values

- "on"
- "off"

Default

"on"

Getvar

To return the current setting:

```
! U1 getvar "wlan.8021x.validate_peap_server_certificate"
```

Example

```
! U1 setvar "wlan.8021x.validate_peap_server_certificate"
```



IMPORTANT: When using certificate files, the time on the printer must be set correctly for the websocket connection to succeed, as the time is used in the certificate validation.



NOTES:

- For printer support, see [SGD Command Support on page 1455](#).
- For details on SGD command structure, see [Command Structure on page 562](#).

wlan.8021x.peap.anonymous_identity

This command is used to specify the phase 1 ID when using PEAP to authenticate with the wireless network.

Setvar

To specify the phase 1 ID to be used during peap authentication:

```
! U1 setvar "wlan.8021x.peap.anonymous_identity" "<value>"
```

Values

"<value>"<= 32 characters

Default Value

""

Getvar

To retrieve the current value:

```
! U1 getvar "wlan.8021x.peap.anonymous_identity"
```



NOTES:

- For printer support, see [SGD Command Support on page 1455](#).
- For details on SGD command structure, see [Command Structure on page 562](#).

wlan.8021x.authentication

Sets the authentication type used in the 802.1x security protocol.

Setvar

To set the authentication type:

```
! U1 setvar "wlan.8021x.authentication" "value"
```

Values

"psk"	=	Pre-Shared Key
"leap"	=	Lightweight Extensible Authentication Protocol
"eap-tls"	=	EAP-Transport Layer Security
"peap"	=	Protected Extensible Authentication Protocol
"ttls"	=	Tunneled Transport Layer Security
"fast"	=	Flexible Authentication via Secure Tunneling

Default Value

"psk"

Getvar

To return the current setting value:

```
! U1 getvar "wlan.8021x.authentication"
```



NOTES:

- For printer support, see [SGD Command Support on page 1455](#).
- For details on SGD command structure, see [Command Structure on page 562](#).

wlan.8021x.eap.password

Sets the EAP authentication password.

Setvar

To set the EAP authentication password:

```
! U1 setvar "wlan.8021x.eap.password" "password"
```

Values

<=32 characters representing the EAP password.

Default Value

"password"

Getvar

To return the current setting value:

```
! U1 getvar "wlan.8021x.eap.password"
```

Result

"*"

Password is not readable. Printer reports "*" in response to this command.



NOTES:

- For printer support, see [SGD Command Support on page 1455](#).
- For details on SGD command structure, see [Command Structure on page 562](#).

wlan.8021x.eap.privkey_password

Sets the EAP private key password to the specified password.

Setvar

To set the EAP private key password:

```
! U1 setvar "wlan.8021x.eap.privkey_password" "password"
```

Values

<=32 characters representing the EAP private key password.

Default Value

""

Getvar

To return the current setting value:

```
! U1 getvar "wlan.8021x.eap.privkey_password"
```

Result

""

Printer always retrieves "" regardless of the length of the stored EAP authentication private key password, and does not reveal the actual password.



NOTES:

- For printer support, see [SGD Command Support on page 1455](#).
- For details on SGD command structure, see [Command Structure on page 562](#).

wlan.8021x.peap.peap_password

Sets the password associated with the PEAP authentication protocol.

Setvar

To set the PEAP password:

```
! U1 setvar "wlan.8021x.peap.peap_password" "password"
```

Values

<=32 characters representing the PEAP password.

Default Value

"password"

Getvar

To return the current setting value:

```
! U1 setvar "wlan.8021x.peap.peap_password"
```

Result

"*"

Printer reports one "*" regardless of the length of the stored PEAP authentication password, and does not reveal the actual password.



NOTES:

- For printer support, see [SGD Command Support on page 1455](#).
- For details on SGD command structure, see [Command Structure on page 562](#).

wlan.8021x.peap.privkey_password

Sets or returns the PEAP authentication private key password.

Setvar

To set the PEAP authentication password:

```
! U1 setvar "wlan.8021x.peap.privkey_password" "password"
```

Values

<=32 characters representing the PEAP private key password.

Default Value

""

Getvar

To return the current setting value:

```
! U1 getvar "wlan.8021x.peap.privkey_password"
```

Result

"*"

Printer reports one "*" regardless of the length of the stored PEAP private key password, and does not reveal the actual password.



NOTES:

- For printer support, see [SGD Command Support on page 1455](#).
- For details on SGD command structure, see [Command Structure on page 562](#).

wlan.8021x.peap.peap_username

Sets the user name associated with the PEAP authentication protocol.

Setvar

To set the user name associated with the PEAP authentication protocol:

```
! U1 getvar "wlan.8021x.peap.peap_username" "username"
```

Values

<=32 characters representing the PEAP username.

Default Value

"username"

Getvar

To return the current setting value:

```
! U1 getvar "wlan.8021x.peap.peap_username"
```

Result

"username"



NOTES:

- For printer support, see [SGD Command Support on page 1455](#).
- For details on SGD command structure, see [Command Structure on page 562](#).

wlan.8021x.eap.username

Sets or returns the user name associated with the EAP authentication protocol.

Setvar

To set the EAP user name:

```
! U1 getvar "wlan.8021x.eap.username" "username"
```

Values

<=32 characters representing the EAP username.

Default Value

"username"

Getvar

To return the current setting value:

```
! U1 getvar "wlan.8021x.eap.username"
```

Result

"username"



NOTES:

- For printer support, see [SGD Command Support on page 1455](#).
- For details on SGD command structure, see [Command Structure on page 562](#).

wlan.active_channels

This command returns list of current active channels defined by [wlan.allowed_band on page 1291](#) and [wlan.user_channel_list on page 1381](#).

Getvar

To return the list of current active channels:

```
! U1 getvar "wlan.active_channels"
```

Result

One or more of the following channels:

```
1,2,3,4,5,6,7,8,9,10,11,36,40,44,48,52,56,60,64,100,104,108,  
112,116,132,136,140,149,153,157,161,165,all
```



NOTES:

- For printer support, see [SGD Command Support on page 1455](#).
- For details on SGD command structure, see [Command Structure on page 562](#).

wlan.adhoc_last_channel

Reports the last channel used for WiFi ad hoc communication.

Getvar

To return the last channel used for WiFi ad hoc communication:

```
! U1 getvar "wlan.adhoc_last_channel"
```

Values

a numeric value between 1-11

Default

"1"



NOTES:

- For printer support, see [SGD Command Support on page 1455](#).
- For details on SGD command structure, see [Command Structure on page 562](#).

wlan.authenticated

Returns the authentication state of the wireless interface.

Getvar

To return the authentication state of the wireless interface:

```
! U1 getvar "wlan.authenticated"
```

Values

- "yes" = the printer wlan connection has been authenticated
- "no" = the printer wlan connection has not been authenticated



NOTES:

- For printer support, see [SGD Command Support on page 1455](#).
- For details on SGD command structure, see [Command Structure on page 562](#).

wlan.authentication_error

Reports the last error that occurred during the WLAN authentication process.

Getvar

To report the last error that occurred during the WLAN authentication process:

```
! U1 getvar "wlan.authentication_error"
```

Values

- **"none"** = the authentication was successful.
- **"timed out"** = the authentication did not succeed in the allotted time.



NOTES:

- For printer support, see [SGD Command Support on page 1455](#).
- For details on SGD command structure, see [Command Structure on page 562](#).

wlan.available

Determines if a WLAN radio has been installed in the printer.

Getvar

To determine if a WLAN radio has been installed in the printer:

```
! U1 getvar "wlan.available"
```

Values

- "yes" = a WLAN radio is installed
- "no" = a WLAN radio is installed



NOTES:

- For printer support, see [SGD Command Support on page 1455](#).
- For details on SGD command structure, see [Command Structure on page 562](#).

wlan.allowed_band

This command provides a method to restrict the 802.11n radio to either the 2.4 GHz or 5 GHz band.

Use this option when it is beneficial to have the radio use only one frequency band. Setting the 802.11n radio to one band will reduce roaming and radio association times since the radio will not scan as many channels.

Setvar

To restrict the 802.11n radio to either the 2.4 GHz or 5 GHz band:

```
! U1 setvar "wlan.allowed_band" "value"
```

Values

```
"2.4, 5, all"
```

Default

```
"all"
```

If both bands are desired, use **"all"**

Getvar

To return the current setting for allowed bands:

```
! U1 getvar "wlan.allowed_band"
```

Example

This example sets the allowed band to only the 2.4 GHz band.

```
U1 setvar "wlan.allowed_band" "2.4"
```



NOTES:

- For printer support, see [SGD Command Support on page 1455](#).
- For details on SGD command structure, see [Command Structure on page 562](#).

wlan.adhocautomode

This printer setting refers to enabling or disabling the adhoc auto mode.

Setvar

To instruct the printer to set the adhoc auto mode:

```
! U1 setvar "wlan.adhocautomode" "value"
```

Values

- "on" = adhoc auto mode enabled
- "off" = adhoc auto mode disabled

Default

"off"

Getvar

To instruct the printer to respond with the adhoc auto mode status:

```
! U1 getvar "wlan.adhocautomode"
```

Example

This **setvar** example shows the value set to "on".

```
! U1 setvar "wlan.adhocautomode" "on"
```

When the **setvar** value is set to "on", the **getvar** result is "on".



NOTES:

- For printer support, see [SGD Command Support on page 1455](#).
- For details on SGD command structure, see [Command Structure on page 562](#).

wlan.adhocchannel

This printer setting refers to specifying the wireless channel for adhoc channel.

Setvar

To set the printer's wireless channel for adhoc channel mode:

```
! U1 setvar "wlan.adhocchannel" "value"
```

Values

Decimal value between 1 and 16 inclusive

Default

"1"

Getvar

To respond with the printer's wireless channel for adhoc channel mode:

```
! U1 getvar "wlan.adhocchannel"
```

Example

This **setvar** example shows the value set to "1".

```
! U1 setvar "wlan.adhocchannel" "1"
```

When the **setvar** value is set to "1", the **getvar** result is "1".



NOTES:

- For printer support, see [SGD Command Support on page 1455](#).
- For details on SGD command structure, see [Command Structure on page 562](#).

wlan.associated

This command refers to if the printer is or is not associated with an access point (AP).

Getvar

To instruct the printer to respond with yes or no, which identifies if it is associated with the AP:

```
! U1 getvar "wlan.associated"
```

Example

In this example, the `getvar` result is "yes".

```
! U1 getvar "wlan.associated"
```



NOTES:

- For printer support, see [SGD Command Support on page 1455](#).
- For details on SGD command structure, see [Command Structure on page 562](#).

wlan.auth_type

This parameter selects the authentication service to be used between the printer and the Access Point. Open System and Shared Key are the two types of authentication services.

Setvar

To instruct the printer to set the authentication type to the specified value:

```
! U1 setvar "wlan.auth_type" "value"
```

Values

- "open"
- "shared"

Default

"open"

Getvar

To instruct the printer to retrieve the current authentication type:

```
! U1 getvar "wlan.auth_type"
```

Example

This example instructs the printer to set the authentication type to Shared Key.

```
! U1 setvar "wlan.auth_type" "shared"
```

The authentication type will be set to Shared Key after power cycle.



NOTES:

- For printer support, see [SGD Command Support on page 1455](#).
- For details on SGD command structure, see [Command Structure on page 562](#).

wlan.band_preference

This command sets a preferred band to connect with via wifi.

Setvar

To specify the wlan band preference:

```
! U1 getvar "wlan.band_preference" "none"
```

Values

- "2.4"
- "5"
- "none"

Default Value

"none"

Getvar

To return the current wlan band preference value:

```
! U1 getvar "wlan.band_preference"
```

Example

In the setvar example below, the wlan band preference is set to "5".

```
! U1 getvar "wlan.band_preference" "5"
```



NOTES:

- For printer support, see [SGD Command Support on page 1455](#).
- For details on SGD command structure, see [Command Structure on page 562](#).

wlan.bssid

This command returns the MAC address of the access point (AP) with which the printer is associated.

Getvar

To retrieve the MAC address of the access point (AP):

```
! U1 getvar "wlan.bssid"
```

Example

In this example, the `getvar` result is the MAC address of the access point.

```
! U1 getvar "wlan.bssid"
```



NOTES:

- For printer support, see [SGD Command Support on page 1455](#).
- For details on SGD command structure, see [Command Structure on page 562](#).

wlan.channel

This command retrieves the current WI-FI channel the printer is using.

Getvar

To retrieve the current WI-FI channel the printer is using:

```
! U1 getvar "wlan.channel"
```

Example

In this example, the `getvar` retrieves the current WI-FI channel the printer is using.

```
! U1 getvar "wlan.channel"
```



NOTES:

- For printer support, see [SGD Command Support on page 1455](#).
- For details on SGD command structure, see [Command Structure on page 562](#).

wlan.channel_mask

This command specifies the wireless channel masks for enabling and disabling various channels. This controls which b/g radio channels can be used by the radio for network connections.

The value for this command is a bit field where a 0 disables a channel and a 1 enables the channel. Starting from the right, bit 0 is for channel 1, bit 1 for channel 2, etc. This can be used to limit the channels scanned for networks, which may slightly improve connection and roaming speed. It also used to ensure compliance with the regulatory domains of your location.

Commonly Used Channel Mask Settings		
Region	Channels	Channel Mask
United States, Canada, Latin America	1 - 11	0x7FF
Europe, Middle East, Africa, other	1 - 13	0x1FFF
Japan	1 - 14	0x3FFF



NOTES: This command is not supported by all radios. Ensure the channel masks are set in accordance with the regulatory domains of your country.

Setvar

To instruct the printer to set the wireless channel mask value:

```
! U1 setvar "wlan.channel_mask" "value"
```

Values

"0x0000" to "0xFFFF" (4 hexadecimal digits preceded by "0x")

Default

"0x7FF"

Getvar

To instruct the printer to set the wireless channel mask value:

```
! U1 getvar "wlan.channel_mask"
```

Example

Example 1

This `setvar` example shows the value set to "0x7FF" for common North American channels.

```
! U1 setvar "wlan.channel_mask" "0x7FF"
```

Example 2

This `setvar` example sets the channel mask to use only channels 1,6,11.

```
! U1 setvar "wlan.channel_mask" "0x421"
```

Only channels 1, 6, and 11 will be used by the radio.



NOTES:

- For printer support, see [SGD Command Support on page 1455](#).
- For details on SGD command structure, see [Command Structure on page 562](#).

wlan.country_code

This command defines the regulatory country for which the radio is currently configured.

Setvar

To set the country code for which the radio is to be configured:

```
! U1 setvar "wlan.country_code" "value"
```



IMPORTANT: The list of country codes is specific to each printer and depends on the printer model and its wireless radio configuration. The list is subject to change, addition, or deletion with any firmware update, at any time, without notice.

To determine the country codes available on your printer, issue the `! U1 getvar "wlan"` command to return all commands related to WLAN settings. Locate the `wlan.country_code` command in the results and view the country codes available for your printer.

Getvar

To retrieve the country code for which the radio is currently configured:

```
! U1 getvar "wlan.country_code"
```

Example

In this example, the `setvar` sets the country code to USA/Canada.

```
! U1 setvar "wlan.country_code" "usa/canada"
```



NOTES:

- For printer support, see [SGD Command Support on page 1455](#).
- For details on SGD command structure, see [Command Structure on page 562](#).

wlan.current_tx_rate

This command retrieves the transmission rate of the wireless print server.

Getvar

To retrieve the current transmit rate of the wireless print server:

```
! U1 getvar "wlan.current_tx_rate"
```

Example

In this example, the **getvar** retrieves the transmission rate of the wireless print server.

```
! U1 getvar "wlan.current_tx_rate"
```



NOTES:

- For printer support, see [SGD Command Support on page 1455](#).
- For details on SGD command structure, see [Command Structure on page 562](#).

wlan.enable

This parameter can be used to enable or disable printer's Wireless LAN functionality.

Setvar

To enable or disable printer's Wireless LAN functionality:

```
! U1 setvar "wlan.enable" "value"
```

Values

- "on" = Wireless LAN functionality is enabled
- "off" = Wireless LAN functionality is disabled

Default

"off"

Getvar

To return the current setting value:

```
! U1 getvar "wlan.enable"
```



NOTES:

- For printer support, see [SGD Command Support on page 1455](#).
- For details on SGD command structure, see [Command Structure on page 562](#).

wlan.encryption_index

This parameter refers to the WEP (Wired Equivalent Privacy) encryption key index. It determines which one of the four encryption keys is to be used by the client (printer).

Setvar

To set the encryption key index to the specified value:

```
! U1 setvar "wlan.encryption_index" "value"
```

Values

- "1"
- "2"
- "3"
- "4"

Default

"1"

Getvar

To retrieve the current encryption key setting:

```
! U1 getvar "wlan.encryption_index"
```

Example

In this example, the `setvar` command instructs the printer to set the encryption key index to 1.

```
! U1 setvar "encryption_index" "1"
```



NOTES:

- For printer support, see [SGD Command Support on page 1455](#).
- For details on SGD command structure, see [Command Structure on page 562](#).

wlan.encryption_key[1|2|3|4]

These parameters refer to the first, second, third, and fourth indexed WEP encryption keys. The WEP encryption keys are hexadecimal strings that are either 10 or 26 characters long depending on the encryption method (40-bit or 128 bit). The keys should match the wireless network WEP encryption keys.

Setvar

To set the encryption key value:

```
! U1 setvar "wlan.encryption_key[1|2|3|4]" "value"
```

Values

10 hexadecimal characters for 40-bit encryption and 26 hexadecimal characters for 128-bit encryption.

Default

All zeroes (10 or 26, depending on encryption setting)

Getvar

To instruct the printer respond with the encryption key value:

```
! U1 getvar "wlan.encryption_key1"
```

Examples

Example 1

In these examples, the **getvar** results assume that the printer is using 40-bit encryption with the default settings.

```
! U1 getvar "wlan.encryption_key1"
! U1 getvar "wlan.encryption_key2"
! U1 getvar "wlan.encryption_key3"
! U1 getvar "wlan.encryption_key4"
```

Results for each key: "0000000000"

Example 2

In these examples, the **setvar** command instructs the printer to set the encryption key value. This example assumes that the printer is using 40-bit encryption.

```
! U1 setvar "wlan.encryption_key1" "A1B2C3D4F5"
! U1 setvar "wlan.encryption_key2" "G1H2J3K4L5"
! U1 setvar "wlan.encryption_key3" "M1N2P3Q4R5"
! U1 setvar "wlan.encryption_key4" "S1T2V3W4X5"
```



NOTES:

- For printer support, see [SGD Command Support on page 1455](#).
- For details on SGD command structure, see [Command Structure on page 562](#).

wlan.encryption_mode

This parameter refers to WEP (Wired Equivalent Privacy) encryption. This parameter enables and disables the printer's WEP encryption. When using WEP encryption make sure that the encryption key matches the wireless network WEP encryption key.

Setvar

To instruct the printer to turn the LEAP mode "on" or "off":

```
! U1 setvar "wlan.encryption_mode" "value"
```

Values

- "off"
- "40-bit"
- "128-bit"

Default

"off"

Getvar

To return the type of encryption that is currently being used by the printer:

```
! U1 getvar "wlan.encryption_mode"
```

Examples

Example 1

This example instructs the printer to set encryption to 40-bit.

```
! U1 setvar "wlan.encryption_mode" "40-bit"
```

Example 2

This example instructs the printer to turn encryption off.

```
! U1 setvar "wlan.encryption_mode" "off"
```



NOTES:

- For printer support, see [SGD Command Support on page 1455](#).
- For details on SGD command structure, see [Command Structure on page 562](#).

wlan.essid

This printer setting refers to the printer's stored ESSID.

Setvar

To instruct the printer to change the ESSID:

```
! U1 setvar "wlan.essid" "value"
```

Values

32 character alphanumeric string

Default

"125" (Printers running Link-OS v5.3 or earlier versions)

"" (For Printers running Link-OS 6 or later versions)

Getvar

To instruct the printer to respond with the stored ESSID value:

```
! U1 getvar "wlan.essid"
```

Example

This setvar example shows the value set to "125".

```
! U1 setvar "wlan.essid" "125"
```

When the setvar value is set to "125", the getvar result is "125".



NOTES:

- For Link-OS Firmware earlier than 6.0, setting ESSID to "" allows the printer to attempt to connect to an AP with any ESSID. For Link-OS Firmware of 6.0 or later, setting ESSID to "" means that the printer will not attempt a WiFi connection.
- For printer support, see [SGD Command Support on page 1455](#).
- For details on SGD command structure, see [Command Structure on page 562](#).

wlan.firmware_version

This command refers to the firmware version of the wireless radio card.

Getvar

To instruct the printer to respond with the current version of the wireless radio card firmware:

```
! U1 getvar "wlan.firmware_version"
```

Example

In this example, the `getvar` result is the version of Symbol 4137 card (for example, "F3.91-69").

```
! U1 getvar "wlan.firmware_version"
```



NOTES:

- For printer support, see [SGD Command Support on page 1455](#).
- For details on SGD command structure, see [Command Structure on page 562](#).

wlan.ip.addr

This command allows you to get or set the wireless print servers IP address.



IMPORTANT: For a set IP address to take affect, the IP protocol must be set to permanent and the print server must be reset.

Setvar

To instruct the printer to change its current wireless print server IP address upon powering the printer on:

```
! U1 setvar "wlan.ip.addr" "value"
```

Values

any valid IP address

Default

"0.0.0.0"

Getvar

To respond with the current wireless print server IP address:

```
! U1 getvar "wlan.ip.addr"
```

Example

This **setvar** example shows the value set to "**10.14.4.235**".

```
! U1 setvar "wlan.ip.addr" "10.14.4.235"
```

What the **setvar** value is set to is the **getvar** result. In this example, the **getvar** result is "**10.14.4.235**".



NOTES:

- For printer support, see [SGD Command Support on page 1455](#).
- For details on SGD command structure, see [Command Structure on page 562](#).

wlan.ip.arp_interval

This print server setting allows you to specify the ARP (Address Resolution Protocol) interval or the ARP cache time out for the wireless print server.

Setvar

To instruct the printer to respond with the ARP interval or the ARP cache time out value for the wireless print server:

```
! U1 setvar "wlan.ip.arp_interval" "value"
```

Values

0 to 30 seconds

Default

"0"

Getvar

To respond with the ARP interval or the ARP cache time out value (in seconds) for the wireless print server:

```
! U1 getvar "wlan.ip.arp_interval"
```

Example

This `setvar` example shows the value set to "0".

```
! U1 setvar "wlan.ip.arp_interval" "0"
```

What the `setvar` value is set to is the `getvar` result. In this example, the `getvar` result is "0".



NOTES

- For printer support, see [SGD Command Support on page 1455](#).
- For details on SGD command structure, see [Command Structure on page 562](#).

wlan.ip.default_addr_enable



This command allows you to default the wireless print server's IP address.

IMPORTANT: For a set IP address to take affect, the IP protocol must be set to permanent and the print server must be reset.

Setvar

To enable or disable te printer to use its default IP address, if no address is provided through DHCP or BOOTP:

```
! U1 setvar "wlan.ip.default_addr_enable" "value"
```

If you do not assign an IP address after 2 minutes, the 10/100 Internal PS defaults to IP address 192.168.254.254.

Values

- "on" = enabled
- "off" = disabled

Default

"on"

Getvar

To instruct the printer to show the status of the setting of the wireless print server's default IP address feature:

```
! U1 getvar "wlan.ip.default_addr_enable"
```

Example

This `setvar` example shows the value set to "on".

```
! U1 setvar "wlan.ip.default_addr_enable" "on"
```

What the `setvar` value is set to is the `getvar` result. In this example, the `getvar` result is "on".



NOTES

- For printer support, see [SGD Command Support on page 1455](#).
- For details on SGD command structure, see [Command Structure on page 562](#).

wlan.ip.dhcp.arp_verify

Specifies whether an ARP broadcast will be sent out to verify that the IP address received from the DHCP server is not already in use.

Setvar

To set the ARP broadcast feature:

```
! U1 setvar "wlan.ip.dhcp.arp_verify" "value"
```

Values

- **"on"** = an ARP broadcast will be sent out
- **"off"** = and ARP broadcast will not be sent out

Default

- **"on"** = an ARP broadcast will be sent out
- **"off"** = and ARP broadcast will not be sent out

Getvar

To return the current setting value:

```
! U1 getvar "wlan.ip.dhcp.arp_verify"
```



NOTES:

- For printer support, see [SGD Command Support on page 1455](#).
- For details on SGD command structure, see [Command Structure on page 562](#).

wlan.ip.dhcp.cache_ip

This command enables or disables the IP cache of the wireless print server.

Setvar

To set the status of the IP cache:

```
! U1 setvar "ip.dhcp.cache_ip" "value"
```

Values

- "on" = enabled
- "off" = disabled

Default

"off"

Getvar

To retrieve the status of the IP cache:

```
! U1 getvar "wlan.ip.dhcp.cache_ip"
```

Example

This `setvar` example shows the value set to "off".

```
! U1 setvar "wlan.ip.dhcp.cache_ip" "off"
```

When the `setvar` value is set to "off", the `getvar` result is "off".



NOTES:

- For printer support, see [SGD Command Support on page 1455](#).
- For details on SGD command structure, see [Command Structure on page 562](#).

wlan.ip.dhcp.cid_all

This printer setting defines the entire client identifier (DHCP option 61) if DHCP is enabled on the wireless print server and "wlan.ip.dhcp.cid_type" is set to "0", or "2". The MAC address is used if the type is set to "1".

Setvar

To change the client identifier prefix and suffix of the wireless print server:

```
! U1 setvar "wlan.ip.dhcp.cid_all" "value"
```

Values

A maximum length of 60 characters if the CID type is ASCII, or 120 characters if the CID type is hexadecimal.

Default

""

Getvar

To instruct the printer to respond with the client identifier prefix and suffix of the wireless print server:

```
! U1 getvar "wlan.ip.dhcp.cid_all"
```

Example

This **setvar** example shows the value set to "printer".

```
! U1 setvar "wlan.ip.dhcp.cid_all" "printer"
```

What the **setvar** value is set to is the **getvar** result. In this example, the **getvar** result is "printer".



NOTES

- For printer support, see [SGD Command Support on page 1455](#).
- For details on SGD command structure, see [Command Structure on page 562](#).

wlan.ip.dhcp.cid_enable

This command determines if DHCP (option 61) is turned on or off of the wireless print server.

Setvar

To instruct the printer to set the status of the client identifier of the wireless print server:

```
! U1 setvar "wlan.ip.dhcp.cid_enable" "value"
```

Values

- "off" = client identifier is turned off
- "on" = client identifier is turned on

Default

"off"

Getvar

To instruct the printer to respond with the status of the client identifier of the wireless print server:

```
! U1 getvar "wlan.ip.dhcp.cid_enable"
```

Example

This `setvar` example shows the value set to "off".

```
! U1 setvar "wlan.ip.dhcp.cid_enable" "off"
```

What the `setvar` value is set to is the `getvar` result. In this example, the `getvar` result is "off".



NOTES:

- For printer support, see [SGD Command Support on page 1455](#).
- For details on SGD command structure, see [Command Structure on page 562](#).

wlan.ip.dhcp.cid_prefix

This printer setting defines the prefix to be prepended to the DHCP client identifier (option 61) when DHCP is enabled on the wireless print server and "wlan.ip.dhcp.cid_type" is set to "0" or "2".

Setvar

To instruct the printer to change the CID prefix of the wireless print server:

```
! U1 setvar "wlan.ip.dhcp.cid_prefix" "value"
```

Values

Any text string up to 10 characters if the CID type is ASCII, or 20 characters if the CID type is hexadecimal.

Default

""

Getvar

To instruct the printer to respond with the client identifier prefix of the wireless print server:

```
! U1 getvar "wlan.ip.dhcp.cid_prefix"
```

Example

This **setvar** example shows the value set to "PRT001".

```
! U1 setvar "wlan.ip.dhcp.cid_prefix" "PRT001"
```

What the **setvar** value is set to is the **getvar** result. In this example, the **getvar** result is "PRT001".



NOTES:

- For printer support, see [SGD Command Support on page 1455](#).
- For details on SGD command structure, see [Command Structure on page 562](#).

wlan.ip.dhcp.cid_suffix

This printer setting defines the unique suffix to be used as the client identifier (DHCP option 61) if DHCP is enabled on the wireless print server and "wlan.ip.dhcp.cid_type" is set to "0" or "2".

Setvar

To instruct the printer to change the client identifier suffix value on the wireless print server:

```
! U1 setvar "wlan.ip.dhcp.cid_suffix" "value"
```

Values

The maximum length of a value allowed is 60 ASCII characters when the CID type is ASCII, or 120 hexadecimal values when the CID type is hexadecimal.

Default

""

Getvar

To instruct the printer to respond with the client identifier suffix on the wireless print server:

```
! U1 getvar "wlan.ip.dhcp.cid_suffix"
```

Example

This **setvar** example shows the value set to "printer".

```
! U1 setvar "wlan.ip.dhcp.cid_suffix" "printer"
```

What the **setvar** value is set to is the **getvar** result. In this example, the **getvar** result is "printer".

wlan.ip.dhcp.cid_type

This printer setting defines the type of client identifier (DHCP option 61) that will be sent if DHCP is enabled on the wireless print server. A value of "1" means the type of "Ethernet" and the printer's MAC address will be used. A value of "0" or "2" means the client identifier sent will be "wlan.ip.dhcp.cid_prefix" concatenated with "wlan.ip.dhcp.cid_suffix".

Setvar

To instruct the printer to enable "synthetic" client identifier for the wireless print server:

```
! U1 setvar "wlan.ip.dhcp.cid_type" "value"
```

Values

- "0" = ASCII string
- "1" = wireless radio card's MAC address
- "2" = HEX value

Default

"1"

Getvar

To instruct the printer to respond with the client identifier type for the wireless print server:

```
! U1 getvar "wlan.ip.dhcp.cid_type"
```

Example

This **setvar** example shows the value set to "1".

```
! U1 setvar "wlan.ip.dhcp.cid_type" "1"
```

What the **setvar** value is set to is the **getvar** result. In this example, the **getvar** result is "1".



NOTES:

- For printer support, see [SGD Command Support on page 1455](#).
- For details on SGD command structure, see [Command Structure on page 562](#).

wlan.ip.dhcp.lease.last_attempt

This command retrieves the last time a DHCP request was sent from the wireless print server.

Getvar

To retrieve the last time a DHCP request was sent from the wireless print server:

```
! U1 getvar "wlan.ip.dhcp.lease.last_attempt"
```

Example

In this example, the `getvar` retrieves the last time a DHCP request was sent from the wireless print server.

```
! U1 getvar "wlan.ip.dhcp.lease.last_attempt"
```



NOTES:

- For printer support, see [SGD Command Support on page 1455](#).
- For details on SGD command structure, see [Command Structure on page 562](#).

wlan.ip.dhcp.lease.length

This command retrieves the original length (in seconds) of the DHCP lease on the wireless print server.

Getvar

To retrieve the original length (in seconds) of the DHCP lease on the wireless print server:

```
! U1 getvar "wlan.ip.dhcp.lease.length"
```

Example

This command retrieves the original length of the DHCP lease on the wireless print server.

```
! U1 getvar "wlan.ip.dhcp.lease.length"
```



NOTES:

- For printer support, see [SGD Command Support on page 1455](#).
- For details on SGD command structure, see [Command Structure on page 562](#).

wlan.ip.dhcp.lease.server

This command retrieves the address of the print server that provided the DHCP lease on the wireless print server.

Getvar

To retrieve the address of the print server that provided the DHCP lease on the wireless print server:

```
! U1 getvar "wlan.ip.dhcp.lease.server"
```

Example

In this example, the `getvar` retrieves the server that provided the DHCP lease on the wireless print server.

```
! U1 getvar "wlan.ip.dhcp.lease.server"
```



NOTES:

- For printer support, see [SGD Command Support on page 1455](#).
- For details on SGD command structure, see [Command Structure on page 562](#).

wlan.ip.dhcp.lease.time_left

This command retrieves the time (in seconds) left in the current DHCP lease on the wireless print server.

Getvar

To retrieve the time (in seconds) left in the current DHCP lease on the wireless print server:

```
! U1 getvar "wlan.ip.dhcp.lease.time_left"
```

Example

In this example, the `getvar` retrieves the time left in the current DHCP lease on the wireless print server.

```
! U1 getvar "wlan.ip.dhcp.lease.time_left"
```



NOTES:

- For printer support, see [SGD Command Support on page 1455](#).
- For details on SGD command structure, see [Command Structure on page 562](#).

wlan.ip.dhcp.option12

This command specifies if the DHCP option 12 (host name) is on or off in the discovery packet that is sent from the wireless print server.

Setvar

To enable or disable the DHCP option 12:

```
! U1 setvar "wlan.ip.dhcp.option12" "value"
```

Values

- "on" = turns on option 12
- "off" = turns off option 12

Default

"on"

Getvar

To return the current setting value:

```
! U1 getvar "wlan.ip.dhcp.option12"
```

Example

This `setvar` example shows the value set to "on".

```
! U1 setvar "wlan.ip.dhcp.option12" "on"
```

When the `setvar` value is set to "on", the `getvar` result is "on".



NOTES:

- For printer support, see [SGD Command Support on page 1455](#).
- For details on SGD command structure, see [Command Structure on page 562](#).

wlan.ip.dhcp.option12_format

This command specifies the format of the option 12 value to be used in the discovery packet of the wireless print server.

Setvar

To set the format of option 12 value to be used in the discovery packet of the wireless print server:

```
! U1 setvar "wlan.ip.dhcp.option12_format" "value"
```

Values

string

Default

""

Getvar

To retrieve the format of option 12 value to be used in the discovery packet of the wireless print server:

```
! U1 getvar "wlan.ip.dhcp.option12_format"
```

Example

This **setvar** example shows configuring the `wlan.ip.dhcp.option12_format` to the value contained in the `device.friendly_name`.

It is necessary to surround the SGD entry to be used as source for the data with the `<` and `>` characters.

```
! U1 setvar "wlan.ip.dhcp.option12_format" "<device.friendly_name>"
```

To further explain, if the above command was issued and the value currently stored in the `device.friendly_name` parameter was "ShipPrinter", then the response to the following command would be "ShipPrinter":

```
! U1 getvar "wlan.ip.dhcp.option12_value"
```



NOTES:

- For printer support, see [SGD Command Support on page 1455](#).
- For details on SGD command structure, see [Command Structure on page 562](#).

wlan.ip.dhcp.option12_value

This command retrieves the actual value which will be used in the discovery packet of the wireless print server.

Getvar

To return the actual value which will be used in the discovery packet of the wireless print server:

```
! U1 getvar "wlan.ip.dhcp.option12_value"
```

Example

This **setvar** example shows configuring the wlan.ip.dhcp.option12_format to the value contained in the device.friendly_name.

It is necessary to surround the SGD entry to be used as source for the data with the < and > characters.

```
! U1 setvar "wlan.ip.dhcp.option12_format" "<device.friendly_name>"
```

To further explain, if the above command was issued and the value currently stored in the device.friendly_name parameter was "ShipPrinter", then the response to following command would be "ShipPrinter":

```
! U1 getvar "wlan.ip.dhcp.option12_value"
```



NOTES:

- For printer support, see [SGD Command Support on page 1455](#).
- For details on SGD command structure, see [Command Structure on page 562](#).

wlan.ip.dhcp.request_timeout

This command sets the maximum time (in seconds) to wait for a response to a DHCP discovery request on the wireless print server.

Setvar

To set the maximum time (in seconds) to wait for a response to a DHCP discovery request on the wireless print server:

```
! U1 setvar "wlan.ip.dhcp.request_timeout" "value"
```

Values

"2" through "30"

Default

"2"

Getvar

To retrieve the maximum time (in seconds) to wait for a response to a DHCP discovery request on the wireless print server:

```
! U1 getvar "wlan.ip.dhcp.request_timeout"
```

Example

This **setvar** example shows the value set to "2".

```
! U1 setvar "wlan.ip.dhcp.request_timeout" "2"
```

When the **setvar** value is set to "2", the **getvar** result is "2".



NOTES:

- For printer support, see [SGD Command Support on page 1455](#).
- For details on SGD command structure, see [Command Structure on page 562](#).

wlan.ip.dhcp.requests_per_session

This command retrieves the maximum amount of DHCP discover requests for a single DHCP session on the wireless print server.

Setvar

To set the maximum amount of DHCP discover requests for a single DHCP session on the wireless print server:

```
! U1 setvar "wlan.ip.dhcp.requests_per_session" "value"
```

Values

"1" through "10"

Default

"2"

Getvar

To retrieve the currently set maximum amount of DHCP discover requests for a single DHCP session on the wireless print server:

```
! U1 getvar "wlan.ip.dhcp.requests_per_session"
```

Example

This **setvar** example shows the value set to "2".

```
! U1 setvar "wlan.ip.dhcp.requests_per_session" "2"
```

When the **setvar** value is set to "2", the **getvar** result is "2".



NOTES:

- For printer support, see [SGD Command Support on page 1455](#).
- For details on SGD command structure, see [Command Structure on page 562](#).

wlan.ip.dhcp.session_interval

This command retrieves how long it will take for a DHCP session to time out before a new DHCP session begins on the wireless print server.

Setvar

To set the DHCP session time out:

```
! U1 setvar "wlan.ip.dhcp.session_interval" "value"
```

Values

"0" through "60"

Default

"10"

Getvar

To return the current setting value:

```
! U1 getvar "wlan.ip.dhcp.session_interval"
```

Example

This **setvar** example shows the value set to "10".

```
! U1 setvar "wlan.ip.dhcp.session_interval" "10"
```

When the **setvar** value is set to "10", the **getvar** result is "10".



NOTES:

- For printer support, see [SGD Command Support on page 1455](#).
- For details on SGD command structure, see [Command Structure on page 562](#).

wlan.ip.dns.servers

This command retrieves a space delimited list of the domain name servers from a wlan print server.

Getvar

To retrieve a list of space delimited DNS wlan print servers:

```
! U1 getvar "wlan.ip.dns.servers"
```



NOTES:

- For printer support, see [SGD Command Support on page 1455](#).
- For details on SGD command structure, see [Command Structure on page 562](#).

wlan.ip.gateway

This command instructs the printer to change the wireless print server's gateway address.



IMPORTANT: This setting refers to the gateway address. A set value is ignored if the IP protocol is not set to permanent.

Setvar

To change the wireless printer server's gateway address:

```
! U1 setvar "wlan.ip.gateway" "value"
```

Values

Any valid gateway address

Default

```
"0.0.0.0"
```

Getvar

To respond with the wireless printer server's gateway address:

```
! U1 getvar "wlan.ip.gateway"
```

Example

This `setvar` example shows the value set to `"10.3.5.1"`.

```
! U1 setvar "wlan.ip.gateway" "10.3.5.1"
```

When the `setvar` value is set to `"10.3.5.1"`, the `getvar` result is `"10.3.5.1"`.



NOTES:

- For printer support, see [SGD Command Support on page 1455](#).
- For details on SGD command structure, see [Command Structure on page 562](#).

wlan.ip.netmask

This setting refers to the wireless print server's subnet mask address. This value is ignored if the IP protocol is not set to permanent.

Setvar

To change the wireless print servers subnet mask:

```
! U1 setvar "wlan.ip.netmask" "value"
```

Values

Any valid subnet mask.

Default

```
"255.255.255.0"
```

Getvar

To return the current setting value:

```
! U1 getvar "wlan.ip.netmask"
```

Example

This `setvar` example shows the value set to `"255.255.255.0"`.

```
! U1 setvar "wlan.ip.netmask" "255.255.255.0"
```

When the `setvar` value is set to `"255.255.255.0"`, the `getvar` result is `"255.255.255.0"`



NOTES:

- For printer support, see [SGD Command Support on page 1455](#).
- For details on SGD command structure, see [Command Structure on page 562](#).

wlan.ip.port

This printer setting refers to the wireless print server's port number that the TCP print service is listening on. Normal TCP communications from the host should be directed to this port.

Setvar

To set the wireless print server's TCP/UDP port number:

```
! U1 setvar "wlan.ip.port" "value"
```

Values

1 - 65535 (excluding any ports currently used by other services, such as 21, 23, 80, and 515).

Default

"9100"

Getvar

To respond with the wireless printer server's TCP/UDP port number:

```
! U1 getvar "wlan.ip.port"
```

Example

This `setvar` example shows the value set to "9100".

```
! U1 setvar "wlan.ip.port" "9100"
```

When the `setvar` value is set to "9100", the `getvar` result is "9100".



NOTES:

- For printer support, see [SGD Command Support on page 1455](#).
- For details on SGD command structure, see [Command Structure on page 562](#).

wlan.ip.port_alternate

This command sets the port number of the alternate wlan port.



Print servers supporting this command will monitor both the primary port and the alternate port for connections at the same time.

Setvar

To set the alternate wlan port for the print server:

```
U1 setvar "wlan.ip.port_alternate" "6101"
```

Values

Any valid TCP port address

Default

9100

Getvar

To return the current alternate wlan port setting:

```
! U1 getvar "wlan.ip.port_alternate"
```

Values

The current port setting.

Examples

Example 1

This setvar example shows the value set to **"6101"**.

```
U1 setvar "wlan.ip.port_alternate" "6101"
```

Example 2

This setvar example sets the channel mask to use only channels 1,6,11.

```
! U1 setvar "wlan.channel_mask" "0x421"
```

Only channels 1, 6, and 11 will be used by the radio.



NOTES:

- For printer support, see [SGD Command Support on page 1455](#).
- For details on SGD command structure, see [Command Structure on page 562](#).

wlan.ip.port_json_config

This command determines the TCP port number to listen on for JSON configuration packets.

Setvar

To determine the TCP port number on which to listen for JSON configuration packets:

```
! U1 setvar "wlan.ip.port_json_config" "value"
```

Values

Any valid port number except ports already in use or the standard network ports.

0 = disable the port

1-65535 = port number to listen on.

Default

"9200"

Getvar

To retrieve the TCP port number which is listening for JSON configuration packets:

```
! U1 getvar "wlan.ip.port_json_config"
```

Example

In this example, the getvar command causes the printer to get the TCP port number which is listening for JSON configuration packets.

```
! U1 getvar "wlan.ip.port_json_config"
```

In this example, the getvar command causes the printer to get the TCP port number which is listening for JSON configuration packets.

```
! U1 getvar "wlan.ip.port_json_config"
```



NOTES:

- For printer support, see [SGD Command Support on page 1455](#).
- For details on SGD command structure, see [Command Structure on page 562](#).

wlan.ip.protocol

This command configures the IP addressing method used by the wireless print server.

Setvar

To configure the IP addressing method used by the wireless print server:

```
! U1 setvar "wlan.ip.protocol" "value"
```

Values

- **"bootp"** = uses the standard bootp addressing method to obtain an IP address and configuration
- **"dhcp"** = uses the standard dhcp addressing method to obtain an IP address and configuration for a server specified period of time
- **"rarp"** = uses the standard rarp addressing method to obtain an IP address
- **"glean only"** = uses the IP address from a PING packet that is sent to its hardware address (unicast address)
- **"permanent"** = uses static values assigned through other commands
- **"all"** = tries all of the dynamic addressing methods, not permanent, to obtain an IP address

Default

```
"all"
```

Getvar

To return the value of the currently selected IP protocol used by the wireless print server:

```
! U1 getvar "wlan.ip.protocol"
```

Example

In this example, the **setvar** result is the current programming language that the printer is using.

```
! U1 setvar "wlan.ip.protocol" "bootp"
```

What the **setvar** value is set to is the **getvar** result. In this example, the **getvar** result is **"bootp"**.



NOTES:

- For printer support, see [SGD Command Support on page 1455](#).
- For details on SGD command structure, see [Command Structure on page 562](#).

wlan.ip.timeout.enable

Use this command to enable the connection timeout on the wireless print server. For this to take effect, the print server must be reset.

Setvar

To enable or disable the timeout checking on the wireless print server:

```
! U1 setvar "wlan.ip.timeout.enable" "value"
```

Values

"off" = turns off the connection checking

"on" = turns on the connection checking

Default

"on"

Getvar

To return whether the timeout checking is enabled on the wireless print server:

```
! U1 getvar "wlan.ip.timeout.enable"
```

Example

This **setvar** example shows the value set to "on".

```
! U1 setvar "wlan.ip.timeout.enable" "on"
```

When the **setvar** value is set to "on", the **getvar** result is "on".



NOTES:

- For printer support, see [SGD Command Support on page 1455](#).
- For details on SGD command structure, see [Command Structure on page 562](#).

wlan.ip.timeout.value

This network setting refers to the number of seconds before the connection times out for the wireless print server. For this to take effect, the print server must be reset.

Setvar

To set the time value of the wireless print server:

```
! U1 setvar "wlan.ip.timeout.value" "value"
```

Values

"1" through "3600"

Default

"300"

Getvar

To respond with the current setting value:

```
! U1 getvar "wlan.ip.timeout.value"
```

Example

This **setvar** example shows the value set to "300".

```
! U1 setvar "wlan.ip.timeout.value" "300"
```

When the **setvar** value is set to "300", the **getvar** result is "300".



NOTES:

- For printer support, see [SGD Command Support on page 1455](#).
- For details on SGD command structure, see [Command Structure on page 562](#).

wlan.ip.wins.addr

Specifies the WINS server address. If WINS Addressing is done via DHCP, then this value will automatically be filled by the DHCP server.

Setvar

To set the WINS server address:

```
! U1 setvar "wlan.ip.wins.addr" "value"
```

Values

a valid IP address

Default

```
"0.0.0.0"
```

Getvar

To return the current setting value:

```
! U1 getvar "wlan.ip.wins.addr"
```



NOTES:

- For printer support, see [SGD Command Support on page 1455](#).
- For details on SGD command structure, see [Command Structure on page 562](#).

wlan.ip.wins.permanent_source

Specifies if the source of the WINS address is DHCP or if it is set manually.

Setvar

To set the source of the WINS address:

```
! U1 setvar "wlan.ip.wins.permanent_source" "value"
```

Values

"off": Use DHCP assigned WINS address

"on": Use manually set WINS address (set via `wlan.ip.wins.addr`)

Default

"off"

Getvar

To return the current setting value:

```
! U1 getvar "wlan.ip.wins.permanent_source"
```



NOTES:

- For printer support, see [SGD Command Support on page 1455](#).
- For details on SGD command structure, see [Command Structure on page 562](#).

wlan.keep_alive.enable

This setting controls the printers ability to send a LSAP (link service access point) packet to the access point on a user controllable interval. This feature is included to accommodate access points that require a regular confirmation that wireless clients are still active.

Setvar

To enable or disable the keep alive printer setting:

```
! U1 setvar "wlan.keep_alive.enable" "value"
```

Values

"on" = turns on keep_alive

"off" = turns off keep_alive

Default

"on"

Getvar

To return with the current value of the `wlan.keep_alive.enable` setting:

```
! U1 getvar "wlan.keep_alive.enable"
```

Example

This `setvar` example shows the value set to "on".

```
! U1 setvar "wlan.keep_alive.enable" "on"
```

When the `setvar` value is set to "on", the `getvar` result is "on"



NOTES:

- For printer support, see [SGD Command Support on page 1455](#).
- For details on SGD command structure, see [Command Structure on page 562](#).

wlan.keep_alive.timeout

This printer setting manages the interval at which the LSAP (link service access point) packet is sent.

Setvar

To configure the frequency at which the printer sends the `wlan.keep_alive` packet:

```
! U1 setvar "wlan.keep_alive.timeout" "value"
```

Values

5 to 300 seconds

Default

"15"

Getvar

To respond with the `wlan.keep_alive.timeout` interval value:

```
! U1 getvar "wlan.keep_alive.timeout"
```

Example

This `setvar` example shows the value set to "15".

```
! U1 setvar "wlan.keep_alive.timeout" "15"
```

When the `setvar` value is set to "15", the `getvar` result is "15".



NOTES:

- For printer support, see [SGD Command Support on page 1455](#).
- For details on SGD command structure, see [Command Structure on page 562](#).

wlan.kerberos.kdc

This printer setting refers to the Kerberos Key Distribution Center (KDC). The KDC is a trusted server which maintains a database with account information for all security principals (users) for a particular site or administrative domain (realm).

Setvar

To change the Kerberos KDC:

```
! U1 setvar "wlan.kerberos.kdc" "value"
```

Values

0-32 ASCII characters

Default

"krbtgt"

Getvar

To respond with the current Kerberos KDC:

```
! U1 getvar "wlan.kerberos.kdc"
```

Example

This **setvar** example shows the value set to "**krbtgt**".

```
! U1 setvar "wlan.kerberos.kdc" "krbtgt"
```

When the **setvar** value is set to "**krbtgt**", the **getvar** result is "**krbtgt**".



NOTES:

- For printer support, see [SGD Command Support on page 1455](#).
- For details on SGD command structure, see [Command Structure on page 562](#).

wlan.kerberos.mode

This printer setting refers to the Kerberos network authentication protocol. Kerberos provides secure mutual authentication for a wireless client through a Symbol Access Point, based on user information stored on a Kerberos KDC (Key Distribution Center) server.

Setvar

To enable or disable the Kerberos mode:

```
! U1 setvar "wlan.kerberos.mode" "values"
```

Values

"off" = disables Kerberos mode

"on" = enables Kerberos mode

Default

"off"

Getvar

To respond with the current Kerberos mode:

```
! U1 getvar "wlan.kerberos.mode"
```

Example

This **setvar** example shows the value set to "on".

```
! U1 setvar "wlan.kerberos.mode" "on"
```

When the **setvar** value is set to "on", the **getvar** result is "on".



NOTES:

- For printer support, see [SGD Command Support on page 1455](#).
- For details on SGD command structure, see [Command Structure on page 562](#).

wlan.kerberos.password

This printer setting refers to the Kerberos password. The password must correspond to a user profile established on the Kerberos KDC server in use.

Setvar

To set the Kerberos password:

```
! U1 setvar "wlan.kerberos.password" "value"
```

Values

0-32 alphanumeric characters

Default

"password"

Getvar

To respond with the current Kerberos password:

```
! U1 getvar "wlan.kerberos.password"
```

For protection a single "*" prints.

Example

This **setvar** example shows the value set to "password".

```
! U1 setvar "wlan.kerberos.password" "password"
```

When the **setvar** value is set to "password", the **getvar** result is "*".



NOTES:

- For printer support, see [SGD Command Support on page 1455](#).
- For details on SGD command structure, see [Command Structure on page 562](#).

wlan.kerberos.realm

This printer setting refers to the Kerberos realm, an administrative domain with its own Kerberos server (KDC).



IMPORTANT: If you are using a Windows 2000 Server the realm must be all upper-case. For details, see example below.

Setvar

To change the Kerberos realm:

```
! U1 setvar "wlan.kerberos.realm" "value"
```

Values

0-64 alphanumeric characters

Default

"kerberos"

Getvar

To respond with the current Kerberos realm:

```
! U1 getvar "wlan.kerberos.realm"
```

Example

This **setvar** example shows the value set to "zebra".

```
! U1 setvar "wlan.kerberos.realm" "zebra"
```

When the **setvar** value is set to "zebra", the **getvar** result is "zebra".

This **setvar** example shows the value set to "ZEBRA" on a Windows 2000 server.

```
! U1 setvar "wlan.kerberos.realm" "ZEBRA"
```

When the **setvar** value is set to "ZEBRA", the **getvar** result is "ZEBRA".



NOTES:

- For printer support, see [SGD Command Support on page 1455](#).
- For details on SGD command structure, see [Command Structure on page 562](#).

wlan.kerberos.username

This printer setting refers to the Kerberos user name. The user name must correspond to a user profile established on the Kerberos KDC server in use.

Setvar

To change the Kerberos user name:

```
! U1 setvar "wlan.kerberos.username" "value"
```

Values

0-32 alphanumeric characters

Default

"user"

Getvar

To respond with the current Kerberos user name:

```
! U1 getvar "wlan.kerberos.username"
```

Example

This **setvar** example shows the value set to **"user"**.

```
! U1 setvar "wlan.kerberos.username" "user"
```

When the **setvar** value is set to **"user"**, the **getvar** result is **"user"**.



NOTES:

- For printer support, see [SGD Command Support on page 1455](#).
- For details on SGD command structure, see [Command Structure on page 562](#).

wlan.leap_mode

This printer setting refers to Cisco LEAP (Lightweight Extensible Authentication Protocol). LEAP provides secure mutual authentication for a wireless client through a Cisco Aironet Access Point, based on user information stored on a backend RADIUS (Remote Authentication in Dial-Up User Service) /AAA (Authentication, Authorization, and Accounting) server.



NOTE:

- This command is only supported on printers using firmware Vxx.18.xx or earlier.
- This command is not supported on units with a Frequency Hopping Spread Spectrum (FHSS) radio.

Setvar

To turn the LEAP mode **"on"** or **"off"**:

```
! U1 setvar "wlan.leap_mode" "values"
```

Values

"off" = disables LEAP mode

"on" = enables LEAP mode

Default

"off"

Getvar

To respond with the LEAP mode:

```
! U1 getvar "wlan.leap_mode"
```

Example

This setvar example shows the value set to "on".

```
! U1 setvar "wlan.leap_mode" "on"
```

When the setvar value is set to "on", the getvar result is "on".



NOTE:

- For printer support, see [SGD Command Support on page 1455](#).
- For details on SGD command structure, see [Command Structure on page 562](#).

wlan.leap_password

This printer setting refers to the LEAP password. The password must correspond to a user profile established on the RADIUS/AAA server in use.



NOTE: This parameter is not supported on units with a Frequency Hopping Spread Spectrum (FHSS) radio.

Commands	Details
<ul style="list-style-type: none"> setvar 	<p>This command instructs the printer to change the LEAP password.</p> <p>Format: ! U1 setvar "wlan.leap_password" "values"</p> <p>Values: 0-32 ASCII characters</p> <p>Default: "password"</p>
<ul style="list-style-type: none"> getvar 	<p>This command instructs the printer to respond with the LEAP password.</p> <p>Format: ! U1 getvar "wlan.leap_password"</p> <p>For protection a single "*" prints.</p>

Example

This setvar example shows the value set to "password".

```
! U1 setvar "wlan.leap_password" "password"
```

When the setvar value is set to "password", the getvar result is "*".



NOTE:

- For printer support, see [SGD Command Support on page 1455](#).
- For details on SGD command structure, see [Command Structure on page 562](#).

wlan.leap_username

This printer setting refers to the LEAP user name. The user name must correspond to a user profile established on the RADIUS/AAA server in use.



NOTE: This parameter is not supported on units with a Frequency Hopping Spread Spectrum (FHSS) radio.

Setvar

To change the LEAP user name:

```
! U1 setvar "wlan.leap_username" "values"
```

Values

0-32 alphanumeric ASCII characters.

Default

"user"

Getvar

To respond with the LEAP user name:

```
! U1 getvar "wlan.leap_username"
```

Example

This setvar example shows the value set to "user".

```
! U1 setvar "wlan.leap_username" "user"
```

When the setvar value is set to "user", the getvar result is "user".



NOTE:

- For printer support, see [SGD Command Support on page 1455](#).
- For details on SGD command structure, see [Command Structure on page 562](#).

wlan.mac_addr

This command retrieves the MAC address of the wireless print server.

Getvar

To respond with the MAC address of the wireless print server:

```
! U1 getvar "wlan.mac_addr"
```

Example

In this example, the `getvar` result is the MAC address for the wireless print server.

```
! U1 getvar "wlan.mac_addr"
```



NOTE:

- For printer support, see [SGD Command Support on page 1455](#).
- For details on SGD command structure, see [Command Structure on page 562](#).

wlan.mac_raw

This command specifies the RAW MAC address of the wireless print server. The raw mac address is the mac address without the colons (":").

Getvar

To retrieve the RAW MAC address of the wireless print server:

```
! U1 getvar "wlan.mac_raw"
```

Example

In this example, the `getvar` retrieves the RAW MAC address of the wireless print server.

```
! U1 getvar "wlan.mac_raw"
```



NOTE:

- For printer support, see [SGD Command Support on page 1455](#).
- For details on SGD command structure, see [Command Structure on page 562](#).

wlan.operating_mode

This printer setting refers to the network operating mode. Infrastructure mode means that the printer will try to associate with an access point. Ad hoc mode means that the printer will try to associate with a device other than an access point and join a standalone network.

To use "ad hoc" mode configure the printer as follows:

- Set the ESSID to the new network's ESSID.
- Turn off the DHCP and assign an IP Address to the printer.
- Set the subnet mask on the printer to the new network's subnet mask.
- Change the operating mode on the printer to "ad hoc".

Setvar

To set the network operating mode:

```
! U1 setvar "wlan.operating_mode" "value"
```

Values

"adhoc" = printer will try to associate with a network device

"infrastructure" = printer will try to associate with an access point

Getvar

To respond with the network-mode value:

```
! U1 getvar "wlan.operating_mode"
```

Example

This setvar example shows the value set to "infrastructure".

```
! U1 setvar "wlan.operating_mode" "infrastructure"
```

When the setvar value is set to "infrastructure", the getvar result is "infrastructure".



NOTE:

- For printer support, see [SGD Command Support on page 1455](#).
- For details on SGD command structure, see [Command Structure on page 562](#).

wlan.password

This printer setting refers to the generic password that is used by the wireless securities that need a password.



IMPORTANT: Kerberos has its own password field.

Setvar

To set a generic password for the wireless securities that need a password:

```
! U1 setvar "wlan.password" "value"
```

Values

A maximum of 32 alphanumeric characters.

Default

"password"

Getvar

To respond with a generic password for wireless securities:

```
! U1 getvar "wlan.password"
```

For protection a single "*" prints.

Example

This setvar example shows the value set to "password".

```
! U1 setvar "wlan.password" "password"
```

When the setvar value is set to "password", the getvar result is "*".



NOTE:

- For printer support, see [SGD Command Support on page 1455](#).
- For details on SGD command structure, see [Command Structure on page 562](#).

wlan.permitted_channels

This command returns the list of permitted channels.

Getvar

To return the list of permitted channels within the defined country or region:

```
! U1 getvar "wlan.permitted_channels"
```

Result

One or more of the following channels:

1,2,3,4,5,6,7,8,9,10,11,36,40,44,48,52,56,60,64,100,104,108,
112,116,132,136,140



NOTES:

- For printer support, see [SGD Command Support on page 1455](#).
- For details on SGD command structure, see [Command Structure on page 562](#).

wlan.pmf

This command allows the user to configure the 802.11 Protected Management Frame settings. This is only applicable for printers having the 802.11ac radio feature.

Setvar

To configure the protected management feature setting:

```
! U1 setvar "wlan.pmf" "value"
```

Values

"disabled" = Protected Management Frame is disabled

"enabled" = Protected Management Frame is enabled

"required" = Printer must support PMF.

Default Value

"enabled"

Getvar

To return the current setting value:

```
! U1 getvar "wlan.pmf"
```



NOTES:

- For printer support, see [SGD Command Support on page 1455](#).
- For details on SGD command structure, see [Command Structure on page 562](#).

wlan.poor_signal_threshold

Sets or returns the poor signal threshold value. The poor signal threshold is a percentage of the signal strength.

Commands	Details
<ul style="list-style-type: none"> setvar 	Format: <code>! U1 setvar "wlan.poor_signal_threshold" "value"</code> Values: 0-100 Default: "0"
<ul style="list-style-type: none"> getvar 	Format: <code>! U1 getvar "wlan.poor_signal_threshold"</code>



NOTES:

- For printer support, see [SGD Command Support on page 1455](#).
- For details on SGD command structure, see [Command Structure on page 562](#).

wlan.preamble

This printer setting selects the radio preamble length to be used.

Commands	Details
<ul style="list-style-type: none"> setvar 	<p>This command instructs the printer to set the preamble length.</p> <p>Format: <code>! U1 setvar "wlan.preamble" "value"</code></p> <p>Values:</p> <ul style="list-style-type: none"> <code>"long"</code> = enables long preamble <code>"short"</code> = enables short preamble <p>Default: <code>"long"</code></p>
<ul style="list-style-type: none"> getvar 	<p>This command instructs the printer to respond with the current preamble length.</p> <p>Format: <code>! U1 getvar "wlan.preamble"</code></p>

Example

This **setvar** example shows the value set to `"long"`.

```
! U1 setvar "wlan.preamble" "long"
```

When the **setvar** value is set to `"long"`, the **getvar** result is `"long"`.



NOTES:

- For printer support, see [SGD Command Support on page 1455](#).
- For details on SGD command structure, see [Command Structure on page 562](#).

wlan.private_key_password

This printer setting allows the setting of the optional private key password.

Commands	Details
<ul style="list-style-type: none"> setvar 	<p>This command instructs the printer to set the private key password.</p> <p>Format: <code>! U1 setvar "wlan.private_key_password" "value"</code></p> <p>Values: A maximum of 32 alphanumeric characters</p> <p>Default: ""</p>
<ul style="list-style-type: none"> getvar 	<p>This command instructs the printer to respond with the value of the private key password.</p> <p>Format: <code>! U1 getvar "wlan.private_key_password"</code></p> <p>For protection a single "*" prints.</p>

Example

This **setvar** example shows the value set to "**password**".

```
! U1 setvar "wlan.private_key_password" "password"
```

When the **setvar** value is set to "**password**", the **getvar** result is "*".



NOTES:

- For printer support, see [SGD Command Support on page 1455](#).
- For details on SGD command structure, see [Command Structure on page 562](#).

wlan.region_code

This command defines the regulatory country for which the radio is currently configured.

Commands	Details
<ul style="list-style-type: none"> setvar 	<p>This command sets the region code for which the radio is to be configured.</p> <pre>! U1 setvar "wlan.region_code" "value"</pre> <p>Values:</p> <ul style="list-style-type: none"> not available usa/canada japan rest of world
<ul style="list-style-type: none"> getvar 	<p>This command retrieves the region code for which the radio is currently configured.</p> <pre>! U1 getvar "wlan.country_code"</pre>



NOTE:

- For printer support, see [SGD Command Support on page 1455](#).
- For details on SGD command structure, see [Command Structure on page 562](#).

wlan.roam.interchannel_delay

This command sets how long of a delay before scanning the next channel when roaming.

Commands	Details
<ul style="list-style-type: none"> setvar 	<p>This command sets how long of a delay before scanning the next channel when roaming. The values are in milliseconds.</p> <p>Format: <code>! U1 setvar "wlan.roam.interchannel_delay" "value"</code></p> <p>Values: 0 to 30000</p> <p>Default: "400"</p>
<ul style="list-style-type: none"> getvar 	<p>This command retrieves the current set delay time before scanning the next channel when roaming.</p> <p>Format: <code>! U1 getvar "wlan.roam.interchannel_delay"</code></p>

Example

This **setvar** example shows the value set to "400".

```
! U1 setvar "wlan.roam.interchannel_delay" "400"
```

The **getvar** result returns the current **setvar** value. In this example, the **getvar** result is "400".



NOTES:

- For printer support, see [SGD Command Support on page 1455](#).
- For details on SGD command structure, see [Command Structure on page 562](#).

wlan.roam.interval

This printer setting refers to specifying the wireless roam interval.

Commands	Details
<ul style="list-style-type: none"> setvar 	<p>This command instructs the printer to set the wireless roam interval.</p> <p>Format: <code>! U1 setvar "wlan.roam.interval" "value"</code></p> <p>Values: Decimal values between 5 and 255 inclusive</p> <p>Default: "20"</p>
<ul style="list-style-type: none"> getvar 	<p>This command instructs the printer to respond with the specified roam interval.</p> <p>Format: <code>! U1 getvar "wlan.roam.interval"</code></p>

Example

This **setvar** example shows the value set to "20".

```
! U1 setvar "wlan.roam.interval" "20"
```

When the **setvar** value is set to "20", the **getvar** result is "20".



NOTES:

- For printer support, see [SGD Command Support on page 1455](#).
- For details on SGD command structure, see [Command Structure on page 562](#).

wlan.roam.max_chan_scan_time

This command sets how long the radio waits on a channel looking for probe responses.

Commands	Details
<ul style="list-style-type: none"> setvar 	<p>This command sets how long the radio waits on a channel looking for probe responses. The values are in milliseconds.</p> <p>Format: ! U1 setvar "wlan.roam.max_chan_scan_time" "value"</p> <p>Values: 10 to 500</p> <p>Default: "100"</p>
<ul style="list-style-type: none"> getvar 	<p>This command retrieves the current setting for how long the radio waits on a channel looking for probe responses.</p> <p>Format: ! U1 getvar "wlan.roam.max_chan_scan_time"</p>

Example

This **setvar** example shows the value set to "**100**".

```
! U1 setvar "wlan.roam.max_chan_scan_time" "100"
```

The **getvar** result returns the current **setvar** value. In this example, the **getvar** result is "**100**".



NOTES:

- For printer support, see [SGD Command Support on page 1455](#).
- For details on SGD command structure, see [Command Structure on page 562](#).

wlan.roam.max_fail

This command determines the number of consecutive tx packet failures, at which point the radio should start its roaming algorithm.

Commands	Details
<ul style="list-style-type: none"> setvar 	<p>This command sets the max_fail threshold value.</p> <p>Format: <code>! U1 setvar "wlan.roam.max_fail" "value"</code></p> <p>Values: 2 to 75 inclusive</p> <p>Default: 10</p>
<ul style="list-style-type: none"> getvar 	<p>This command returns the number for the max_fail threshold.</p> <p>Format: <code>! U1 getvar "wlan.roam.max_fail"</code></p>

Example

In this example, the **setvar** sets the max_fail threshold value to 30 packets.

```
! U1 setvar "wlan.roam.max_fail" "30"
```



NOTES:

- For printer support, see [SGD Command Support on page 1455](#).
- For details on SGD command structure, see [Command Structure on page 562](#).

wlan.roam.monitor

This command sets the wireless LAN roam monitoring event messages.

Setvar

To instruct the printer to turn off or print the roam event messages:

```
! U1 setvar "wlan.roam.monitor" "value"
```

Values

"off"	=	roam monitor event messages are turned off
"print"	=	roam monitor event messages are printed.
"serial"	=	roam monitor event messages are output to the serial port.
"file"	=	roam monitor event messages are stored in the roam.log file on the E: drive.

Default Value

"off"

Getvar

To return the current setting value:

```
! U1 getvar "wlan.roam.monitor"
```



NOTES:

- For printer support, see [SGD Command Support on page 1455](#).
- For details on SGD command structure, see [Command Structure on page 562](#).

wlan.roam.rssi

This command allows you to specify the absolute value of the negative dBm for the RSSI threshold, which is the point at which the radio will start the roaming algorithm.

Commands	Details
<ul style="list-style-type: none"> setvar 	<p>This command sets the RSSI threshold value.</p> <p>Format: <code>! U1 setvar "wlan.roam.rssi" "value"</code></p> <p>Values: 60 to 125</p> <p>Default: 74</p>
<ul style="list-style-type: none"> getvar 	<p>This command retrieves the absolute value of the negative dBm for the RSSI threshold.</p> <p>Format: <code>! U1 getvar "wlan.roam.rssi"</code></p>

Example

In this example, the **setvar** sets the RSSI threshold value to -80 dBm.

```
! U1 setvar "wlan.roam.rssi" "80"
```



NOTES:

- For printer support, see [SGD Command Support on page 1455](#).
- For details on SGD command structure, see [Command Structure on page 562](#).

wlan.roam.signal

This printer setting refers to specifying the wireless roam signal.

Setvar

To set the wireless roam signal:

```
! U1 setvar "wlan.roam.signal" "value"
```

Values

Decimal values between 1 and 75 inclusive.

Default

"50"

Getvar

To respond with the specified wireless roam signal:

```
! U1 getvar "wlan.roam.signal"
```

Example

This **setvar** example shows the value set to "50".

```
! U1 setvar "wlan.roam.signal" "50"
```

When the **setvar** value is set to "50", the **getvar** result is "50".



NOTES:

- For printer support, see [SGD Command Support on page 1455](#).
- For details on SGD command structure, see [Command Structure on page 562](#).

wlan.rts_cts_enabled

Enables the RTS/CTS HT protection frames when configuring a WLAN connection, preventing interference with other nearby 802.11 signals. If the protection frames are not enabled, the WLAN radio will use CTS-to-self.

Commands	Details
<ul style="list-style-type: none"> • setvar 	Format: ! U1 setvar "wlan.rts_cts_enabled" "value" Values: on, off Default: off
<ul style="list-style-type: none"> • getvar 	Format: ! U1 getvar "wlan.rts_cts_enabled" Values: on, off



NOTES:

- For printer support, see [SGD Command Support on page 1455](#).
- For details on SGD command structure, see [Command Structure on page 562](#).

wlan.security

This printer setting allows you to specify both the wireless encryption type and authentication type in one command.



NOTE: The supporting parameters that are required vary based on the security type that you select. See [Supporting SGDs for Different Security Types on page 1369](#) for instructions for each security type.

When using certificate files, Zebra printers support:

- using Privacy Enhanced Mail (PEM) formatted certificate files.
- using the client certificate and private key as two files, each downloaded separately.
- using exportable PAC files for EAP-FAST.

These certificate files can only be sent using ZPL, not SGD. The ZPL command to use when sending these certificate files is the `~DY` command.

Configuring the printer for WPA also allows the printer to be used in WPA2 environments.



IMPORTANT: When using certificate files, the time on the printer must be set correctly for the websocket connection to succeed, as the time is used in the certificate validation.

Setvar

To set the wireless security value:

```
! U1 setvar "wlan.security" "value"
```

Values

- "1" = No wireless security or "none"
- "2" = WEP 40-bit or "wep 40-bit"
- "3" = WEP 128-bit or "wep 128-bit"
- "4" = EAP-TLS or "eap-tls"
- "5" = EAP-TTLS or "eap-ttls"
- "6" = EAP-FAST or "eap-fast"
- "7" = PEAP or "peap"
- "8" = LEAP or "leap"
- "9" = WPA PSK or "wpa psk" (Key rotation for WPA2 PSK is supported in firmware versions V53.15.8Z , V60.15.8Z, and later.)
- "10" = WPA EAP-TLS or "wpa eap-tls"
- "11" = WPA EAP-TTLS or "wpa eap-ttls"
- "12" = WPA EAP-FAST or "wpa eap-fast"
- "13" = WPA PEAP or "wpa peap"
- "14" = WPA LEAP or "wpa leap"
- "15" = Kerberos or "kerberos"

Default

"1"

Getvar

To return the name and not the type:

```
! U1 getvar "wlan.security" "value"
```

If an invalid security mode is entered the printer returns Invalid Mode.

Examples

This **setvar** example shows the value set to "1".

```
! U1 setvar "wlan.security" "1"
```

When the **setvar** value is set to "1", the **getvar** result is "none".



NOTES:

- For printer support, see [SGD Command Support on page 1455](#).
- For details on SGD command structure, see [Command Structure on page 562](#).

The supporting SGD commands required for **wlan.security** vary based on the security type that you select. You must send the additional commands for your printer to be able to work on your wireless network. Follow the example and format for your specific security type in this section, substituting your own wireless network data.

Supporting SGDs for Different Security Types

Security Type 1: No Wireless Security Active

Additional parameters that need to be set: none

Example

This example turns off all wireless securities controlled under this command, but it does not reset the printer's wireless settings to their defaults.

```
! U1 setvar "wlan.security" "1"
```

Security Type 2: WEP 40-Bit

Additional parameters that need to be set and the SGD commands to use:

- WEP encryption index (see [wlan.wep.index on page 1386](#))
- WEP authentication type (see [wlan.wep.auth_type on page 1385](#))
- WEP key type (see [wlan.wep.key_format on page 1395](#))
- the actual values of any WEP encryption keys to be used (see [wlan.wep.key1 on page 1387](#), [wlan.wep.key2 on page 1388](#), [wlan.wep.key3 on page 1389](#), or [wlan.wep.key4 on page 1390](#))

Example

This example configures the printer for WEP 40-bit encryption using index key 1, open authentication, and a hexadecimal WEP key with a value of "A1B2C3D4F5."

```
! U1 setvar "wlan.security" "2"
! U1 setvar "wlan.wep.index" "1"
! U1 setvar "wlan.wep.auth_type" "open"
! U1 setvar "wlan.wep.key_format" "hex"
! U1 setvar "wlan.wep.key1" "A1B2C3D4F5"
```

Security Type 3: WEP 128-Bit

Additional parameters that need to be set and the SGD commands to use:

- WEP encryption index (see [wlan.wep.index on page 1386](#))
- WEP authentication type (see [wlan.wep.auth_type on page 1385](#))
- WEP key type (see [wlan.wep.key_format on page 1395](#))
- the actual values of any WEP encryption keys to be used (see [wlan.wep.key1 on page 1387](#), [wlan.wep.key2 on page 1388](#), [wlan.wep.key3 on page 1389](#), or [wlan.wep.key4 on page 1390](#))

Example

This example configures the printer for WEP 128-bit encryption using index key 2, open authentication, and four hexadecimal WEP keys.

```
! U1 setvar "wlan.security" "3"
! U1 setvar "wlan.wep.index" "2"
! U1 setvar "wlan.wep.auth_type" "open"
! U1 setvar "wlan.wep.key_format" "hex"
! U1 setvar "wlan.wep.key1" "001122334455667788"
! U1 setvar "wlan.wep.key2" "112233445566778899"
! U1 setvar "wlan.wep.key3" "223344556677889900"
! U1 setvar "wlan.wep.key4" "334455667788990011"
```

Security Type 4: EAP-TLS

Additional parameters that need to be set and the SGD commands to use:

- optional private key password (see [wlan.private_key_password on page 1358](#))

Example

This example configures the printer for EAP-TLS authentication with an optional private key password with a value of "private."

```
! U1 setvar "wlan.security" "4"
! U1 setvar "wlan.private_key_password" "private"
```

Security Type 5: EAP-TTLS

Additional parameters that need to be set and the SGD commands to use:

- user ID (see [wlan.username on page 1382](#))
- password (see [wlan.password on page 1353](#))

Example

with a value of “**user**” and a password with a value of “**password.**”

```
! U1 setvar "wlan.security" "5"
! U1 setvar "wlan.username" "user"
! U1 setvar "wlan.password" "password"
```

Security Type 6: EAP-FAST

Additional parameters that need to be set and the SGD commands to use:

- user ID (see [wlan.username on page 1382](#))
- password (see [wlan.password on page 1353](#))
- optional private key password (see [wlan.private_key_password on page 1358](#))

Example

This example configures the printer for EAP-FAST authentication, including a user ID of “**user,**” a password of “**password,**” and an optional private key of “**private.**”

```
! U1 setvar "wlan.security" "6"
! U1 setvar "wlan.username" "user"
! U1 setvar "wlan.password" "password"
! U1 setvar "wlan.private_key_password" "private"
```

Security Type 7: PEAP

Additional parameters that need to be set and the SGD commands to use:

- user ID (see [wlan.username on page 1382](#))
- password (see [wlan.password on page 1353](#))

Example

This example configures the printer for PEAP authentication, including a user ID with a value of “**user**” and a password with a value of “**password.**”

```
! U1 setvar "wlan.security" "7"
! U1 setvar "wlan.username" "user"
! U1 setvar "wlan.password" "password"
```

Security Type 8: LEAP

Additional parameters that need to be set and the SGD commands to use:

- user ID (see [wlan.username on page 1382](#))
- password (see [wlan.password on page 1353](#))

Example

This example configures the printer for LEAP authentication, including a user ID with a value of “**user**” and a password with a value of “**password**.”

```
! U1 setvar "wlan.security" "8"
! U1 setvar "wlan.username" "user"
! U1 setvar "wlan.password" "password"
```

Security Type 9: WPA PSK



NOTE: Configuring the printer for WPA also allows the printer to be used in WPA2 environments. Key rotation for WPA2 PSK is supported in firmware version 60.15.8Z and later and in firmware version 53.15.8Z and later.

Additional parameters that need to be set and the SGD commands to use:

- Pre-Shared Key (PSK) value (see [wlan.wpa.psk on page 1391](#))

Example

This example configures the printer for WPA PSK authentication with a PSK value of all zeroes (64 hexadecimal digits).

```
! U1 setvar "wlan.security" "9"
! U1 setvar "wlan.wpa.psk" "00000000..."
```

Security Type 10: WPA EAP-TLS



NOTE: Configuring the printer for WPA also allows the printer to be used in WPA2 environments.

Additional parameters that need to be set and the SGD commands to use:

- optional private key password (see [wlan.private_key_password on page 1358](#))

Example

This example configures the printer for WPA EAP-TLS authentication with an optional private key password with a value of “**private**.”

```
! U1 setvar "wlan.security" "10"
! U1 setvar "wlan.private_key_password" "private"
```

Security Type 11: WPA EAP-TTLS



NOTE: Configuring the printer for WPA also allows the printer to be used in WPA2 environments.

Additional parameters that need to be set and the SGD commands to use:

- user ID (see [wlan.username on page 1382](#))
- password (see [wlan.password on page 1353](#))

Example

This example configures the printer for WPA EAP-TTLS authentication, including a user ID with a value of “**user**” and a password with a value of “**password**.”

```
! U1 setvar "wlan.security" "11"
! U1 setvar "wlan.username" "user"
! U1 setvar "wlan.password" "password"
```

Security Type 12: WPA EAP-FAST



NOTE: Configuring the printer for WPA also allows the printer to be used in WPA2 environments.

Additional parameters that need to be set and the SGD commands to use:

- user ID (see [wlan.username on page 1382](#))
- password (see [wlan.password on page 1353](#))
- optional private key password (see [wlan.private_key_password on page 1358](#))

Example

This example configures the printer for WPA EAP-FAST authentication, including a user ID of “**user**,” a password of “**password**,” and an optional private key of “**private**.”

```
! U1 setvar "wlan.security" "12"
! U1 setvar "wlan.username" "user"
! U1 setvar "wlan.password" "password"
! U1 setvar "wlan.private_key_password" "private"
```

Security Type 13: WPA PEAP



NOTE: Configuring the printer for WPA also allows the printer to be used in WPA2 environments.

Additional parameters that need to be set and the SGD commands to use:

- user ID (see [wlan.username on page 1382](#))
- password (see [wlan.password on page 1353](#))

Example

This example configures the printer for WPA PEAP authentication, including a user ID with a value of “**user**” and a password with a value of “**password**.”

```
! U1 setvar "wlan.security" "13"
! U1 setvar "wlan.username" "user"
! U1 setvar "wlan.password" "password"
```

Security Type 14: WPA LEAP



NOTE: Configuring the printer for WPA also allows the printer to be used in WPA2 environments.

Additional parameters that need to be set and the SGD commands to use:

- user ID (see [wlan.username on page 1382](#))
- password (see [wlan.password on page 1353](#))

Example

This example configures the printer for WPA LEAP authentication, including a user ID with a value of “**user**” and a password with a value of “**password**.”

```
! U1 setvar "wlan.security" "14"  
! U1 setvar "wlan.username" "user"  
! U1 setvar "wlan.password" "password"
```

Security Type 15: Kerberos

Additional parameters that need to be set and the SGD commands to use:

- Kerberos user ID (see [wlan.kerberos.username on page 1346](#))
- Kerberos password (see [wlan.kerberos.password on page 1344](#))
- realm (see [wlan.kerberos.realm on page 1345](#))
- Key Distribution Center (KDC) (see [wlan.kerberos.kdc on page 1342](#))

Example

This example configures the printer for Kerberos encryption, including a Kerberos user ID with a value of “**user**,” a Kerberos password with a value of “**password**,” a realm of “**zebra**,” and a KDC of “**krbtgt**.”

```
! U1 setvar "wlan.security" "15"  
! U1 setvar "wlan.kerberos.username" "user"  
! U1 setvar "wlan.kerberos.password" "password"  
! U1 setvar "wlan.kerberos.realm" "zebra"  
! U1 setvar "wlan.kerberos.kdc" "krbtgt"
```

wlan.signal_noise

This command returns the signal noise on the wireless network. Values above 40% represent a very significant noise, and radio communication is not reliable.

Getvar

To return the current signal noise on the wireless network:

```
! U1 getvar "wlan.signal_noise"
```

Example

In this example, the getvar result is the current signal_noise value.

```
! U1 getvar "wlan.signal_noise"
```



NOTES:

- For printer support, see [SGD Command Support on page 1455](#).
- For details on SGD command structure, see [Command Structure on page 562](#).

wlan.signal_quality

This command instructs the printer to return the current signal quality of the wireless network. Values below 40% represent a very poor signal quality, and radio communication is not reliable.

Getvar

To return the current signal quality of the wireless network:

```
! U1 getvar "wlan.signal_quality"
```

Example

In this example, the getvar result is the current signal_quality value.

```
! U1 getvar "wlan.signal_quality"
```



NOTES:

- For printer support, see [SGD Command Support on page 1455](#).
- For details on SGD command structure, see [Command Structure on page 562](#).

wlan.signal_strength

This command returns the signal strength of the connection to the access point as a percentage value between zero (not connected) and 100 (strongest signal). Values below 40% represent a very poor signal and radio communication is not reliable.

Getvar

To respond with the current signal strength:

```
! U1 getvar "wlan.signal_strength"
```

Example

In this example, the getvar result is "93".

```
! U1 getvar "wlan.signal_strength"
```



NOTES:

- For printer support, see [SGD Command Support on page 1455](#).
- For details on SGD command structure, see [Command Structure on page 562](#).

wlan.station_name

This printer setting refers to the station name.

Setvar

To set the station name:

```
! U1 setvar "wlan.station_name" "value"
```

Values

A maximum of 32 alphanumeric characters

Default

"ZEBRA"

Getvar

To respond with the station name value:

```
! U1 getvar "wlan.station_name"
```

Example

This **setvar** example shows the value set to "ZEBRA".

```
! U1 setvar "wlan.station_name" "ZEBRA"
```

When the **setvar** value is set to "ZEBRA", the **getvar** result is "ZEBRA".



NOTES:

- For printer support, see [SGD Command Support on page 1455](#).
- For details on SGD command structure, see [Command Structure on page 562](#).

wlan.tx_power

Use this command to specify the wireless transmit power.

Setvar

To set the wireless transmit power:

```
! U1 setvar "wlan.tx_power" "value"
```

Values

Decimal values of 1, 5, 20, 30, 50, 100

Default

"100"

Getvar

To return with the wireless transmit power value:

```
! U1 getvar "wlan.tx_power"
```

Example

This `setvar` example shows the value set to "100".

```
! U1 setvar "wlan.tx_power" "100"
```

When the `setvar` value is set to "100", the `getvar` result is "100".



NOTES:

- This command is not valid for Link-OS printers, and is supported only in selected other models.
- For printer support, see [SGD Command Support on page 1455](#).
- For details on SGD command structure, see [Command Structure on page 562](#).

wlan.tx_rate

Use this command to specify the wireless transmit rate.

Setvar

To set the wireless transmit rate:

```
! U1 setvar "wlan.tx_rate" "value"
```

Values

1, 2, 5.5, 11, all

Default

"all"

Getvar

To respond with the wireless transmit rate:

```
! U1 getvar "wlan.tx_rate"
```

Example

This `setvar` example shows the value set to "all".

```
! U1 setvar "wlan.tx_rate" "all"
```

When the `setvar` value is set to "all", the `getvar` result is "all".



NOTES:

- This command is not valid for Link-OS printers, and is supported in selected other models.
- For printer support, see [SGD Command Support on page 1455](#).
- For details on SGD command structure, see [Command Structure on page 562](#).

wlan.user_channel_list

This command sets the list of available channels.

Setvar

To set the list of available channels:

```
! U1 setvar "wlan.user_channel_list" "value"
```

Values

One or more of the following:

1, 2, 3, 4, 5, 6, 7, 8, 9, 10, 11, 36, 40, 44, 48, 52, 56, 60, 64, 100, 104, 108, 112, 116, 132, 136, 140, 149, 153, 157, 161, 165, all

Default

"all"

Getvar

To retrieve the currently set list of available channels:

```
! U1 getvar wlan.user_channel_list"
```

Example

This example sets the available channel list to channels 1-9.

```
! U1 setvar "wlan.user_channel_list" "1,2,3,4,5,6,7,8,9"
```



NOTES:

- For printer support, see [SGD Command Support on page 1455](#).
- For details on SGD command structure, see [Command Structure on page 562](#).

wlan.username

This printer setting refers to the generic user name that is used by the wireless securities that need a user name.



IMPORTANT: Kerberos has its own user name field.

Setvar

To set a generic user name for wireless securities that need a user name:

```
! U1 setvar "wlan.username" "value"
```

Values

A maximum of 32 alphanumeric characters

Default

"user"

Getvar

To respond with a generic user name for the wireless securities that need a user name:

```
! U1 getvar "wlan.username"
```

Example

This **setvar** example shows the value set to "user".

```
! U1 setvar "wlan.username" "user"
```

When the **setvar** value is set to "user", the **getvar** result is "user".



NOTES:

- For printer support, see [SGD Command Support on page 1455](#).
- For details on SGD command structure, see [Command Structure on page 562](#).

wlan.waveagent.enable

This command enables/disables the internal agent for support of Veriwave's WaveDeploy system. WaveDeploy is a software product used for performing network site surveys.

Setvar

To enable or disable internal agent support for waveagent:

```
! U1 setvar "wlan.waveagent.enable" "value"
```

Values

"off"

"on"

Default

"off"

Getvar

To respond with the current waveagent support status:

```
! U1 getvar "wlan.waveagent.enable"
```

Example

```
! U1 setvar "wlan.waveagent.enable" "on"
```



NOTES:

- For printer support, see [SGD Command Support on page 1455](#).
- For details on SGD command structure, see [Command Structure on page 562](#).

wlan.waveagent.udp_port

This command specifies the UDP port number used by WaveAgent.

Setvar

To specify the port to be used by WaveAgent:

```
! U1 setvar "wlan.waveagent.udp_port" "value"
```

Values

"1" to "64000"

Default

"18100"

Getvar

To respond with the current port setting for WaveAgent:

```
! U1 getvar "wlan.waveagent.udp_port"
```

Example

This **setvar** example shows the value set to "on".

```
! U1 setvar "wlan.waveagent.udp_port" "21000"
```



NOTES:

- For printer support, see [SGD Command Support on page 1455](#).
- For details on SGD command structure, see [Command Structure on page 562](#).

wlan.wep.auth_type

For the WEP security type, this printer setting selects the authentication type to be used between the printer and the access point. The authentication types are open system and shared key.



NOTE: This command is not supported for printers running Link-OS 6 or later versions.

Setvar

To set the WEP authentication type:

```
! U1 setvar "wlan.wep.auth_type" "value"
```

Values

"open" = enables the open authentication type

"shared" = enables the shared authentication type

Getvar

To retrieve the current WEP authentication type:

```
! U1 getvar "wlan.wep.auth_type"
```

Example

This **setvar** example shows the value set to "open".

```
! U1 setvar "wlan.wep.auth_type" "open"
```

When the **setvar** value is set to "open", the **getvar** result is "open".



NOTES:

- For printer support, see [SGD Command Support on page 1455](#).
- For details on SGD command structure, see [Command Structure on page 562](#).

wlan.wep.index

This command sets the WEP (Wired Equivalent Privacy) encryption key index. This printer setting determines which one of the four encryption keys is to be used by the client (printer).



NOTE: This command is not supported for printers running Link-OS 6 or later versions.

Setvar

To set the encryption key index:

```
! U1 setvar "wlan.wep.index" "value"
```

Values

"1" = enables encryption key 1

"2" = enables encryption key 2

"3" = enables encryption key 3

"4" = enables encryption key 4

Default

"1"

Getvar

To respond with the encryption key index:

```
! U1 getvar "wlan.wep.index"
```

Example

This **setvar** example shows the value set to "1".

```
! U1 setvar "wlan.wep.index" "1"
```

When the **setvar** value is set to "1", the **getvar** result is "1".



NOTES:

- For printer support, see [SGD Command Support on page 1455](#).
- For details on SGD command structure, see [Command Structure on page 562](#).

wlan.wep.key1

Use this command to set the first indexed WEP encryption key. The WEP encryption key is a hexadecimal or string value. This key should match the wireless network WEP encryption key 1.



NOTE: This command is not supported for printers running Link-OS 6 or later versions.

Setvar

To set the encryption key:

```
! U1 setvar "wlan.wep.key1" "value"
```

Values

- 10 hexadecimal characters for 40-bit encryption
- 26 hexadecimal characters for 128-bit encryption

Default

All zeros

Getvar

To instruct the printer to respond with the encryption key:

```
! U1 getvar "wlan.wep.key1"
```

For protection a single "*" prints.

Example

This `setvar` example shows the value set to "A1B2C3D4F5".

```
! U1 setvar "wlan.wep.key1" "A1B2C3D4F5"
```

When the `setvar` value is set to "A1B2C3D4F5", the `getvar` result is "*".



NOTES:

- For printer support, see [SGD Command Support on page 1455](#).
- For details on SGD command structure, see [Command Structure on page 562](#).

wlan.wep.key2

Use this command to set the second indexed WEP encryption key. The WEP encryption key is a hexadecimal string value. This key should match the wireless network WEP encryption key 2.



NOTE: This command is not supported for printers running Link-OS 6 or later versions.

Setvar

To set the encryption key:

```
! U1 setvar "wlan.wep.key2" "value"
```

Values

- 10 hexadecimal characters for 40-bit encryption
- 26 hexadecimal characters for 128-bit encryption

Default

All zeros

Getvar

To instruct the printer to respond with the encryption key:

```
! U1 getvar "wlan.wep.key2"
```

For protection a single "*" prints.

Example

This `setvar` example shows the value set to "A1B2C3D4F5".

```
! U1 setvar "wlan.wep.key2" "A1B2C3D4F5"
```

When the `setvar` value is set to "A1B2C3D4F5", the `getvar` result is "*".



NOTES:

- For printer support, see [SGD Command Support on page 1455](#).
- For details on SGD command structure, see [Command Structure on page 562](#).

wlan.wep.key3

Use this command to set the third indexed WEP encryption key. The WEP encryption key is a hexadecimal string value. This key should match the wireless network WEP encryption key 3



NOTE: This command is not supported for printers running Link-OS 6 or later versions.

Setvar

To set the encryption key:

```
! U1 setvar "wlan.wep.key3" "value"
```

Values

- 10 hexadecimal characters for 40-bit encryption
- 26 hexadecimal characters for 128-bit encryption

Default

All zeros

Getvar

To instruct the printer to respond with the encryption key:

```
! U1 getvar "wlan.wep.key3"
```

For protection a single "*" prints.

Example

This **setvar** example shows the value set to "A1B2C3D4F5".

```
! U1 setvar "wlan.wep.key3" "A1B2C3D4F5"
```

When the **setvar** value is set to "A1B2C3D4F5", the **getvar** result is "*".



NOTES:

- For printer support, see [SGD Command Support on page 1455](#).
- For details on SGD command structure, see [Command Structure on page 562](#).

wlan.wep.key4

Use this command to set the fourth indexed WEP encryption key. The WEP encryption key is a hexadecimal string value. This key should match the wireless network WEP encryption key 4.



Setvar

NOTE: This command is not supported for printers running Link OS 6 or later versions.

To set the encryption key:

```
! U1 setvar "wlan.wep.key4" "value"
```

Values

10 hexadecimal characters for 40-bit encryption

26 hexadecimal characters for 128-bit encryption

Default

All zeros

Getvar

To respond with the encryption key:

```
! U1 getvar "wlan.wep.key4"
```

For protection a single "*" prints.

Example

This `setvar` example shows the value set to "A1B2C3D4F5".

```
! U1 setvar "wlan.wep.key4" "A1B2C3D4F5"
```

When the `setvar` value is set to "A1B2C3D4F5", the `getvar` result is "*".



NOTES:

- For printer support, see [SGD Command Support on page 1455](#).
- For details on SGD command structure, see [Command Structure on page 562](#).

wlan.wpa.psk

This printer setting specifies the pre-shared key (PSK) value to use when the WPA authentication is set to PSK.

Setvar

To set the pre-shared key:

```
! U1 setvar "wlan.wpa.psk" "value"
```

Values

64 hexadecimal digits

Default

64 zeros (00000000...)

Getvar

To return the pre-shared key value:

```
! U1 getvar "wlan.wpa.psk"
```

For protection a single "*" prints.

Example

This **setvar** example shows the value set to "00000000...".

```
! U1 setvar "wlan.wpa.psk" "00000000..."
```

When the **setvar** value is set to "00000000...", the **getvar** result is "*".



NOTES:

- For printer support, see [SGD Command Support on page 1455](#).
- For details on SGD command structure, see [Command Structure on page 562](#).

wlan.wep.key_format

This printer setting specifies the format for the WEP key.

This command is disabled for Link OS 6 printers and later versions.



Setvar

NOTE: This printer setting should proceed any of the `wep.key` settings if you select a non-default value.

To set the WEP key format:

```
! U1 setvar "wlan.wep.key_format" "value"
```

Values

"`ascii`" = WEP key is set by ASCII string

"`hex`" = WEP key is a Hex string

Default

"`hex`"

Getvar

To respond with the WEP key format:

```
! U1 getvar "wep.key_format"
```

Example

This `setvar` example shows the value set to "`ascii`".

```
! U1 setvar "wlan.wep.key_format" "ascii"
```

When the `setvar` value is set to "`ascii`", the `getvar` result is "`ascii`".



NOTES:

- For printer support, see [SGD Command Support on page 1455](#).
- For details on SGD command structure, see [Command Structure on page 562](#).

wlan.wpa.groupkey_ciphersuite

This command returns the encryption method currently used for unicast packets.

Getvar

To return the current encryption method value:

```
! U1 getvar "wlan.wpa.groupkey_ciphersuite"
```

Result

"NONE"	=	No encryption being used.
"WEP40"	=	WEP40 encryption being used.
"TKIP"	=	TKIP encryption being used.
"AES"	=	AES being used.
"WEP104"	=	WEP104 encryption being used.
"WPA2"	=	WEP104 encryption being used.
""	=	Reported if printer is not yet associated with the wireless LAN.



NOTES:

- For printer support, see [SGD Command Support on page 1455](#).
- For details on SGD command structure, see [Command Structure on page 562](#).

wlan.wpa.pairwise_ciphersuite

This command returns the encryption method currently used for unicast packets.

Getvar

To return the value of the current encryption methods:

```
! U1 getvar "wlan.wpa.pairwise_ciphersuite"
```

Result

"NONE"	=	No encryption being used.
"WEP40"	=	WEP40 encryption being used.
"TKIP"	=	TKIP encryption being used
"AES"	=	AES being used.
"WEP104"	=	WEP104 encryption being used.
"WPA2"	=	WPA2 encryption being used.
""	=	Reported if printer is not yet associated with the wireless LAN.



NOTES:

- For printer support, see [SGD Command Support on page 1455](#).
- For details on SGD command structure, see [Command Structure on page 562](#).

wlan.wpa.timecheck

Allows the user to disable the certificate timestamp check that is performed during a WPA TLS handshake.

Setvar

To enable or disable the certificate timestamp check that is performed during a WPA TLS handshake:

```
! U1 setvar "wlan.wpa.timecheck" "value"
```

Values

"yes" = the timecheck during the handshake will be performed

"no" = the timecheck during the handshake will not be performed

Default

"yes"

Getvar

To return the current setting value:

```
! U1 getvar "wlan.wpa.timecheck"
```



NOTES:

- For printer support, see [SGD Command Support on page 1455](#).
- For details on SGD command structure, see [Command Structure on page 562](#).

wlan.wpa.wpa_version

Returns the currently active WPA version.

Getvar

To return the currently active WPA version:

```
! U1 getvar "wlan.wpa.wpa_version"
```

Values

"WPA": WPA being used.

"WPA2": WPA2 being used.

"": Reported if wireless LAN is not connected or WPA is not enabled.



NOTES:

- For printer support, see [SGD Command Support on page 1455](#).
- For details on SGD command structure, see [Command Structure on page 562](#).

Zebra Code Pages

Zebra Code Page 850 — Latin Character Set

This is the Zebra Code Page 850:



NOTE: For hex 5C, a cent sign prints for all printer resident fonts. A backslash prints for downloaded fonts.

CHR	HEX	DEC	CHR	HEX	DEC	CHR	HEX	DEC	CHR	HEX	DEC	CHR	HEX	DEC	CHR	HEX	DEC	CHR	HEX	DEC
	20	32	0	30	48	@	40	64	P	50	80	'	60	96	p	70	112	Ç	80	128
!	21	33	1	31	49	A	41	65	Q	51	81	a	61	97	q	71	113	ü	81	129
"	22	34	2	32	50	B	42	66	R	52	82	b	62	98	r	72	114	é	82	130
#	23	35	3	33	51	C	43	67	S	53	83	c	63	99	s	73	115	â	83	131
\$	24	36	4	34	52	D	44	68	T	54	84	d	64	100	t	74	116	ä	84	132
%	25	37	5	35	53	E	45	69	U	55	85	e	65	101	u	75	117	à	85	133
&	26	38	6	36	54	F	46	70	V	56	86	f	66	102	v	76	118	å	86	134
'	27	39	7	37	55	G	47	71	W	57	87	g	67	103	w	77	119	ç	87	135
(28	40	8	38	56	H	48	72	X	58	88	h	68	104	x	78	120	ê	88	136
)	29	41	9	39	57	I	49	73	Y	59	89	i	69	105	y	79	121	ë	89	137
*	2a	42	:	3a	58	J	4a	74	Z	5a	90	j	6a	106	z	7a	122	è	8a	138
+	2b	43	;	3b	59	K	4b	75	[5b	91	k	6b	107	{	7b	123	ï	8b	139
,	2c	44	<	3c	60	L	4c	76	¢	5c	92	l	6c	108		7c	124	î	8c	140
-	2d	45	=	3d	61	M	4d	77]	5d	93	m	6d	109	}	7d	125	ì	8d	141
.	2e	46	>	3e	62	N	4e	78	^	5e	94	n	6e	110	~	7e	126	Ä	8e	142
/	2f	47	?	3f	63	O	4f	79	_	5f	95	o	6f	111	␣	7f	127	Å	8f	143

Zebra Code Pages

CHR	HEX	DEC	CHR	HEX	DEC	CHR	HEX	DEC	CHR	HEX	DEC	CHR	HEX	DEC	CHR	HEX	DEC	CHR	HEX	DEC
É	90	144	á	a0	160	☐	b0	176	└	c0	192	ö	d0	208	Ó	e0	224	·	f0	240
æ	91	145	í	a1	161	☒	b1	177	┘	c1	193	Đ	d1	209	β	e1	225	±	f1	241
Æ	92	146	ó	a2	162	☒	b2	178	┘	c2	194	È	d2	210	Ö	e2	226	=	f2	242
ô	93	147	ú	a3	163		b3	179	┘	c3	195	Ë	d3	211	Ò	e3	227	¾	f3	243
ö	94	148	ñ	a4	164	┘	b4	180	—	c4	196	È	d4	212	õ	e4	228	¶	f4	244
ò	95	149	Ñ	a5	165	Á	b5	181	+	c5	197	ı	d5	213	Õ	e5	229	§	f5	245
û	96	150	ª	a6	166	Â	b6	182	ã	c6	198	İ	d6	214	μ	e6	230	÷	f6	246
ù	97	151	º	a7	167	À	b7	183	Ä	c7	199	İ	d7	215	þ	e7	231	¸	f7	247
ÿ	98	152	¿	a8	168	©	b8	184	└	c8	200	İ	d8	216	þ	e8	232	°	f8	248
Ö	99	153	®	a9	169	≡	b9	185	┘	c9	201	┘	d9	217	Ú	e9	233	"	f9	249
Ü	9a	154	¬	aa	170		ba	186	┘	ca	202	┘	da	218	Û	ea	234	·	fa	250
ø	9b	155	½	ab	171	┘	bb	187	┘	cb	203	■	db	219	Ü	eb	235	1	fb	251
£	9c	156	¼	ac	172	┘	bc	188	┘	cc	204	■	dc	220	ý	ec	236	3	fc	252
Ø	9d	157	ı	ad	173	©	bd	189	=	cd	205		dd	221	Ý	ed	237	2	fd	253
×	9e	158	«	ae	174	¥	be	190	≡	ce	206	ı	de	222	-	ee	238	■	fe	254
f	9f	159	»	af	175	┘	bf	191	ä	cf	207	■	df	223	'	ef	239		ff	255

Zebra Code Page 1250 — Central and Eastern European Latin Character Set

This is the Zebra Code Page 1250 that supports scalable/downloaded TTF fonts:



Font 0 (zero) was used to display this chart.

CHR	HEX	DEC	CHR	HEX	DEC	CHR	HEX	DEC	CHR	HEX	DEC	CHR	HEX	DEC	CHR	HEX	DEC			
	20	32	0	30	48	@	40	64	P	50	80	'	60	96	p	70	112	€	80	128
!	21	33	1	31	49	A	41	65	Q	51	81	a	61	97	q	71	113		81	129
"	22	34	2	32	50	B	42	66	R	52	82	b	62	98	r	72	114	,	82	130
#	23	35	3	33	51	C	43	67	S	53	83	c	63	99	s	73	115		83	131
\$	24	36	4	34	52	D	44	68	T	54	84	d	64	100	t	74	116	,	84	132
%	25	37	5	35	53	E	45	69	U	55	85	e	65	101	u	75	117	...	85	133
&	26	38	6	36	54	F	46	70	V	56	86	f	66	102	v	76	118	†	86	134
'	27	39	7	37	55	G	47	71	W	57	87	g	67	103	w	77	119	‡	87	135
(28	40	8	38	56	H	48	72	X	58	88	h	68	104	x	78	120		88	136
)	29	41	9	39	57	I	49	73	Y	59	89	i	69	105	y	79	121	‰	89	137
*	2a	42	:	3a	58	J	4a	74	Z	5a	90	j	6a	106	z	7a	122	Š	8a	138
+	2b	43	;	3b	59	K	4b	75	[5b	91	k	6b	107	{	7b	123	◀	8b	139
,	2c	44	<	3c	60	L	4c	76	\	5c	92	l	6c	108		7c	124	Š	8c	140
-	2d	45	=	3d	61	M	4d	77]	5d	93	m	6d	109	}	7d	125	Ť	8d	141
.	2e	46	>	3e	62	N	4e	78	^	5e	94	n	6e	110	~	7e	126	Ž	8e	142
/	2f	47	?	3f	63	O	4f	79	_	5f	95	o	6f	111		7f	127	Ž	8f	143

Zebra Code Pages

CHR	HEX	DEC	CHR	HEX	DEC	CHR	HEX	DEC	CHR	HEX	DEC	CHR	HEX	DEC	CHR	HEX	DEC	CHR	HEX	DEC
	90	144		a0	160	°	b0	176	Ŕ	c0	192	Đ	d0	208	í	e0	224	đ	f0	240
‘	91	145	˘	a1	161	±	b1	177	Á	c1	193	Ŋ	d1	209	á	e1	225	í	f1	241
’	92	146	˘	a2	162	˘	b2	178	Ā	c2	194	Ŋ	d2	210	â	e2	226	ň	f2	242
“	93	147	Ł	a3	163	†	b3	179	Ā	c3	195	Ó	d3	211	ă	e3	227	ó	f3	243
”	94	148	Ǻ	a4	164	’	b4	180	Ā	c4	196	Ô	d4	212	ă	e4	228	ô	f4	244
•	95	149	Ą	a5	165	μ	b5	181	Ĺ	c5	197	Õ	d5	213	í	e5	229	õ	f5	245
—	96	150		a6	166	¶	b6	182	Ć	c6	198	Ö	d6	214	ć	e6	230	ö	f6	246
—	97	151	§	a7	167	•	b7	183	Ç	c7	199	×	d7	215	ç	e7	231	÷	f7	247
	98	152	”	a8	168	˘	b8	184	Č	c8	200	Ř	d8	216	č	e8	232	ř	f8	248
™	99	153	©	a9	169	ą	b9	185	É	c9	201	Ů	d9	217	é	e9	233	ů	f9	249
š	9a	154	§	aa	170	ş	ba	186	Ę	ca	202	Ú	da	218	ę	ea	234	ú	fa	250
›	9b	155	«	ab	171	»	bb	187	Ě	cb	203	Ů	db	219	ě	eb	235	ů	fb	251
ś	9c	156	¬	ac	172	Ĺ	bc	188	Ě	cc	204	Ů	dc	220	ě	ec	236	ů	fc	252
ť	9d	157	-	ad	173	”	bd	189	Í	cd	205	Ý	dd	221	í	ed	237	ý	fd	253
ž	9e	158	®	ae	174	Ĺ	be	190	Ī	ce	206	Ť	de	222	î	ee	238	ť	fe	254
ž	9f	159	Ž	af	175	ž	bf	191	Ď	cf	207	ß	df	223	đ	ef	239	˘	ff	255

Zebra Code Page 1252— Latin Character Set

This is the Zebra Code Page 1252:

CHR	HEX	DEC	CHR	HEX	DEC	CHR	HEX	DEC	CHR	HEX	DEC	CHR	HEX	DEC	CHR	HEX	DEC			
	20	32	0	30	48	@	40	64	P	50	80	`	60	96	p	70	112	€	80	128
!	21	33	1	31	49	A	41	65	Q	51	81	a	61	97	q	71	113		81	129
"	22	34	2	32	50	B	42	66	R	52	82	b	62	98	r	72	114	,	82	130
#	23	35	3	33	51	C	43	67	S	53	83	c	63	99	s	73	115	f	83	131
\$	24	36	4	34	52	D	44	68	T	54	84	d	64	100	t	74	116	„	84	132
%	25	37	5	35	53	E	45	69	U	55	85	e	65	101	u	75	117	...	85	133
&	26	38	6	36	54	F	46	70	V	56	86	f	66	102	v	76	118	†	86	134
'	27	39	7	37	55	G	47	71	W	57	87	g	67	103	w	77	119	‡	87	135
(28	40	8	38	56	H	48	72	X	58	88	h	68	104	x	78	120	^	88	136
)	29	41	9	39	57	I	49	73	Y	59	89	i	69	105	y	79	121	‰	89	137
*	2a	42	:	3a	58	J	4a	74	Z	5a	90	j	6a	106	z	7a	122	Š	8a	138
+	2b	43	;	3b	59	K	4b	75	[5b	91	k	6b	107	{	7b	123	<	8b	139
,	2c	44	<	3c	60	L	4c	76	\	5c	92	l	6c	108		7c	124	Œ	8c	140
-	2d	45	=	3d	61	M	4d	77]	5d	93	m	6d	109	}	7d	125		8d	141
.	2e	46	>	3e	62	N	4e	78	^	5e	94	n	6e	110	~	7e	126	Ž	8e	142
/	2f	47	?	3f	63	O	4f	79	_	5f	95	o	6f	111		7f	127		8f	143

Zebra Code Pages

CHR	HEX	DEC	CHR	HEX	DEC	CHR	HEX	DEC	CHR	HEX	DEC	CHR	HEX	DEC	CHR	HEX	DEC			
	90	144		a0	160	°	b0	176	À	c0	192	Ð	d0	208	à	e0	224	ö	f0	240
‘	91	145	í	a1	161	±	b1	177	Á	c1	193	Ñ	d1	209	á	e1	225	ñ	f1	241
’	92	146	¢	a2	162	²	b2	178	Â	c2	194	Ò	d2	210	â	e2	226	ò	f2	242
“	93	147	£	a3	163	³	b3	179	Ã	c3	195	Ó	d3	211	ã	e3	227	ó	f3	243
”	94	148	¤	a4	164	´	b4	180	Ä	c4	196	Ô	d4	212	ä	e4	228	ô	f4	244
•	95	149	¥	a5	165	µ	b5	181	Å	c5	197	Õ	d5	213	å	e5	229	õ	f5	245
–	96	150		a6	166	¶	b6	182	Æ	c6	198	Ö	d6	214	æ	e6	230	ö	f6	246
—	97	151	§	a7	167	·	b7	183	Ç	c7	199	×	d7	215	ç	e7	231	÷	f7	247
~	98	152	¨	a8	168	¸	b8	184	È	c8	200	Ø	d8	216	è	e8	232	ø	f8	248
™	99	153	©	a9	169	¹	b9	185	É	c9	201	Ù	d9	217	é	e9	233	ù	f9	249
š	9a	154	à	aa	170	º	ba	186	Ê	ca	202	Ú	da	218	ê	ea	234	ú	fa	250
›	9b	155	«	ab	171	»	bb	187	Ë	cb	203	Û	db	219	ë	eb	235	û	fb	251
œ	9c	156	¬	ac	172	¼	bc	188	Ì	cc	204	Ü	dc	220	ì	ec	236	ü	fc	252
	9d	157	-	ad	173	½	bd	189	Í	cd	205	Ý	dd	221	í	ed	237	ý	fd	253
ž	9e	158	®	ae	174	¾	be	190	Î	ce	206	Þ	de	222	î	ee	238	þ	fe	254
ÿ	9f	159	¯	af	175	¿	bf	191	Ï	cf	207	ß	df	223	ï	ef	239	ÿ	ff	255

Zebra Code Page 1253 — Modern Greek Character Set

This is the Zebra Code Page 1253:

CHR	HEX	DEC	CHR	HEX	DEC	CHR	HEX	DEC	CHR	HEX	DEC	CHR	HEX	DEC	CHR	HEX	DEC	CHR	HEX	DEC			
0	0		1	1		20	32		0	30	48	@	40	64	P	50	80	'	60	96	p	70	112
2	2		3	3		!	21	33	1	31	49	A	41	65	Q	51	81	a	61	97	q	71	113
4	4		5	5		"	22	34	2	32	50	B	42	66	R	52	82	b	62	98	r	72	114
6	6		7	7		#	23	35	3	33	51	C	43	67	S	53	83	c	63	99	s	73	115
8	8		9	9		\$	24	36	4	34	52	D	44	68	T	54	84	d	64	100	t	74	116
a	10		b	11		%	25	37	5	35	53	E	45	69	U	55	85	e	65	101	u	75	117
c	12		d	13		&	26	38	6	36	54	F	46	70	V	56	86	f	66	102	v	76	118
e	14		f	15		'	27	39	7	37	55	G	47	71	W	57	87	g	67	103	w	77	119
10	16		11	17		(28	40	8	38	56	H	48	72	X	58	88	h	68	104	x	78	120
12	18		13	19)	29	41	9	39	57	I	49	73	Y	59	89	i	69	105	y	79	121
14	20		15	21		*	2a	42	:	3a	58	J	4a	74	Z	5a	90	j	6a	106	z	7a	122
16	22		17	23		+	2b	43	;	3b	59	K	4b	75	[5b	91	k	6b	107	{	7b	123
18	24		19	25		,	2c	44	<	3c	60	L	4c	76	\	5c	92	l	6c	108		7c	124
1a	26		1b	27		-	2d	45	=	3d	61	M	4d	77]	5d	93	m	6d	109	}	7d	125
1c	28		1d	29		.	2e	46	>	3e	62	N	4e	78	^	5e	94	n	6e	110	~	7e	126
1e	30		1f	31		/	2f	47	?	3f	63	O	4f	79	_	5f	95	o	6f	111		7f	127

Zebra Code Pages

CHRHEXDEC			CHRHEXDEC			CHRHEXDEC			CHRHEXDEC			CHRHEXDEC			CHRHEXDEC			CHRHEXDEC					
€	80	128		90	144	€	a0	160	°	b0	176	ı	c0	192	π	d0	208	ü	e0	224	π	f0	240
	81	129	'	91	145	™	a1	161	±	b1	177	A	c1	193	P	d1	209	ä	e1	225	ρ	f1	241
,	82	130	'	92	146	À	a2	162	²	b2	178	B	c2	194		d2	210	ß	e2	226	ç	f2	242
f	83	131	"	93	147	£	a3	163	³	b3	179	Γ	c3	195	Σ	d3	211	γ	e3	227	σ	f3	243
,	84	132	"	94	148	α	a4	164	'	b4	180	Δ	c4	196	Τ	d4	212	δ	e4	228	τ	f4	244
...	85	133	'	95	149	¥	a5	165	μ	b5	181	E	c5	197	Υ	d5	213	ε	e5	229	υ	f5	245
†	86	134	-	96	150		a6	166	¶	b6	182	Z	c6	198	Φ	d6	214	ζ	e6	230	φ	f6	246
‡	87	135	-	97	151	\$	a7	167	'	b7	183	H	c7	199	X	d7	215	η	e7	231	χ	f7	247
	88	136		98	152	™	a8	168	È	b8	184	Θ	c8	200	Ψ	d8	216	θ	e8	232	ψ	f8	248
0/0	89	137	™	99	153	©	a9	169	Ë	b9	185	I	c9	201	Ω	d9	217	ι	e9	233	ω	f9	249
	8a	138		9a	154		aa	170	Ì	ba	186	K	ca	202	ı	da	218	κ	ea	234	ı	fa	250
'	8b	139	'	9b	155	"	ab	171	"	bb	187	Λ	cb	203	Υ	db	219	λ	eb	235	υ	fb	251
	8c	140		9c	156	⌋	ac	172	Ò	bc	188	M	cc	204	ά	dc	220	μ	ec	236	ό	fc	252
	8d	141		9d	157	'	ad	173	½	bd	189	N	cd	205	έ	dd	221	ν	ed	237	ύ	fd	253
	8e	142		9e	158	®	ae	174	Υ	be	190	Ξ	ce	206	ή	de	222	ξ	ee	238	ώ	fe	254
	8f	143		9f	159	-	af	175	Ω	bf	191	Ο	cf	207	ı	df	223	ο	ef	239		ff	255

Zebra Code Page 1254 — Turkish Character Set

This is the Zebra Code Page 1254:

CHR	HEX	DEC	CHR	HEX	DEC	CHR	HEX	DEC	CHR	HEX	DEC	CHR	HEX	DEC	CHR	HEX	DEC	CHR	HEX	DEC			
0	0		1	1		20	32		0	30	48	@	40	64	P	50	80	'	60	96	p	70	112
2	2		3	3		!	21	33	1	31	49	A	41	65	Q	51	81	a	61	97	q	71	113
4	4		5	5		"	22	34	2	32	50	B	42	66	R	52	82	b	62	98	r	72	114
6	6		7	7		#	23	35	3	33	51	C	43	67	S	53	83	c	63	99	s	73	115
8	8		9	9		\$	24	36	4	34	52	D	44	68	T	54	84	d	64	100	t	74	116
a	10		b	11		%	25	37	5	35	53	E	45	69	U	55	85	e	65	101	u	75	117
c	12		d	13		&	26	38	6	36	54	F	46	70	V	56	86	f	66	102	v	76	118
e	14		f	15		'	27	39	7	37	55	G	47	71	W	57	87	g	67	103	w	77	119
10	16		11	17		(28	40	8	38	56	H	48	72	X	58	88	h	68	104	x	78	120
12	18		13	19)	29	41	9	39	57	I	49	73	Y	59	89	i	69	105	y	79	121
14	20		15	21		*	2a	42	:	3a	58	J	4a	74	Z	5a	90	j	6a	106	z	7a	122
16	22		17	23		+	2b	43	;	3b	59	K	4b	75	[5b	91	k	6b	107	{	7b	123
18	24		19	25		,	2c	44	<	3c	60	L	4c	76	\	5c	92	l	6c	108		7c	124
1a	26		1b	27		-	2d	45	=	3d	61	M	4d	77]	5d	93	m	6d	109	}	7d	125
1c	28		1d	29		.	2e	46	>	3e	62	N	4e	78	^	5e	94	n	6e	110	~	7e	126
1e	30		1f	31		/	2f	47	?	3f	63	O	4f	79	_	5f	95	o	6f	111		7f	127

Zebra Code Pages

CHRHEXDEC			CHRHEXDEC			CHRHEXDEC			CHRHEXDEC			CHRHEXDEC			CHRHEXDEC			CHRHEXDEC					
€	80	128		90	144		a0	160	°	b0	176	À	c0	192	Ĝ	d0	208	à	e0	224	ğ	f0	240
	81	129	‘	91	145	ı	a1	161	±	b1	177	Á	c1	193	Ñ	d1	209	á	e1	225	ñ	f1	241
,	82	130	’	92	146	ç	a2	162	²	b2	178	Â	c2	194	Ò	d2	210	â	e2	226	ó	f2	242
/	83	131	“	93	147	£	a3	163	³	b3	179	Ã	c3	195	Ó	d3	211	ã	e3	227	ô	f3	243
„	84	132	”	94	148	¤	a4	164	´	b4	180	Ä	c4	196	Ô	d4	212	ä	e4	228	õ	f4	244
...	85	133	•	95	149	¥	a5	165	µ	b5	181	Å	c5	197	Õ	d5	213	å	e5	229	ö	f5	245
†	86	134	–	96	150		a6	166	¶	b6	182	Æ	c6	198	Ö	d6	214	æ	e6	230	ø	f6	246
‡	87	135	—	97	151	§	a7	167	·	b7	183	Ç	c7	199	×	d7	215	ç	e7	231	÷	f7	247
^	88	136	~	98	152	”	a8	168	¸	b8	184	È	c8	200	Ø	d8	216	è	e8	232	ø	f8	248
%	89	137	™	99	153	©	a9	169	¹	b9	185	É	c9	201	Ù	d9	217	é	e9	233	ù	f9	249
§	8a	138	§	9a	154	ª	aa	170	º	ba	186	Ê	ca	202	Ú	da	218	ê	ea	234	ú	fa	250
‘	8b	139	’	9b	155	«	ab	171	»	bb	187	Ë	cb	203	Û	db	219	ë	eb	235	û	fb	251
Œ	8c	140	œ	9c	156	¬	ac	172	¼	bc	188	Ì	cc	204	Ü	dc	220	ì	ec	236	ü	fc	252
	8d	141		9d	157	•	ad	173	½	bd	189	Í	cd	205	İ	dd	221	í	ed	237	ı	fd	253
	8e	142		9e	158	®	ae	174	¾	be	190	Î	ce	206	Ş	de	222	î	ee	238	ş	fe	254
	8f	143	ÿ	9f	159		af	175	¿	bf	191	Ï	cf	207	ß	df	223	ï	ef	239	ÿ	ff	255

Zebra Code Page 1255 — Hebrew Character Set

This is the Zebra Code Page 1255:

CHRHEXDEC		CHRHEXDEC		CHRHEXDEC		CHRHEXDEC		CHRHEXDEC		CHRHEXDEC		CHRHEXDEC			
0	0	1	1	20	32	0	30	48	@	40	64	P	50	80	
'	60	96	p	70	112	2	2	3	3	!	21	33	1	31	49
A	41	65	Q	51	81	a	61	97	q	71	113	4	4	5	5
"	22	34	2	32	50	B	42	66	R	52	82	b	62	98	
r	72	114	6	6	7	7	#	23	35	3	33	51	C	43	67
S	53	83	c	63	99	s	73	115	8	8	9	9	\$	24	36
4	34	52	D	44	68	T	54	84	d	64	100	t	74	116	
a	10	b	11	%	25	37	5	35	53	E	45	69	U	55	85
e	65	101	u	75	117	6	36	54	F	46	70	V	56	86	
f	66	102	v	76	118	7	37	55	G	47	71	W	57	87	
g	67	103	w	77	119	10	16	11	17	(28	40	8	38	56
H	48	72	X	58	88	h	68	104	x	78	120	12	18	13	19
)	29	41	9	39	57	I	49	73	Y	59	89	i	69	105	
y	79	121	14	20	15	21	*	2a	42	:	3a	58	J	4a	74
Z	5a	90	j	6a	106	z	7a	122	16	22	17	23	+	2b	43
;	3b	59	K	4b	75	[5b	91	k	6b	107	{	7b	123	
L	4c	76	\	5c	92	l	6c	108		7c	124	18	24	19	25
,	2c	44	<	3c	60	M	4c	77]	5d	93	m	6d	109	
}	7d	125	1a	26	1b	27	-	2d	45	=	3d	61	N	4e	78
^	5e	94	n	6e	110	~	7e	126	1c	28	1d	29	.	2e	46
>	3e	62	1e	30	1f	31	/	2f	47	?	3f	63	O	4f	79
_	5f	95	o	6f	111		7f	127							

Zebra Code Pages

CHR	HEX	DEC	CHR	HEX	DEC	CHR	HEX	DEC	CHR	HEX	DEC	CHR	HEX	DEC	CHR	HEX	DEC	CHR	HEX	DEC			
€	80	128		90	144		a0	160	°	b0	176	.	c0	192		d0	208	κ	e0	224	ı	f0	240
	81	129	'	91	145	ı	a1	161	±	b1	177	..	c1	193		d1	209	ı	e1	225	ı	f1	241
,	82	130	'	92	146	ı	a2	162	²	b2	178	..	c2	194		d2	210	λ	e2	226	ı	f2	242
f	83	131	"	93	147	ı	a3	163	³	b3	179	..	c3	195	:	d3	211	ı	e3	227	ı	f3	243
„	84	132	"	94	148	ı	a4	164		b4	180	.	c4	196	ı	d4	212	ı	e4	228	ı	f4	244
...	85	133	'	95	149	ı	a5	165	μ	b5	181	..	c5	197	ı	d5	213	ı	e5	229	ı	f5	245
†	86	134	-	96	150		a6	166	ı	b6	182	.	c6	198	"	d6	214	ı	e6	230	ı	f6	246
‡	87	135	-	97	151	ı	a7	167	'	b7	183	.	c7	199	'	d7	215	ı	e7	231	ı	f7	247
^	88	136	~	98	152	"	a8	168	.	b8	184	.	c8	200	"	d8	216	ı	e8	232	ı	f8	248
0/00	89	137	™	99	153	©	a9	169	ı	b9	185		c9	201		d9	217	'	e9	233	ı	f9	249
	8a	138		9a	154	×	aa	170	÷	ba	186		ca	202		da	218	ı	ea	234	ı	fa	250
'	8b	139	'	9b	155	“	ab	171	”	bb	187	..	cb	203		db	219	ı	eb	235		fb	251
	8c	140		9c	156	ı	ac	172	¼	bc	188	.	cc	204		dc	220	ı	ec	236		fc	252
	8d	141		9d	157	'	ad	173	½	bd	189	.	cd	205		dd	221	ı	ed	237		fd	253
	8e	142		9e	158	®	ae	174	¾	be	190	'	ce	206		de	222	ı	ee	238		fe	254
	8f	143		9f	159		af	175	ı	bf	191	'	cf	207		df	223	ı	ef	239		ff	255

ASCII

This section shows the American Standard Code for Information Interchange (ASCII) code used by Zebra printers.

Shaded areas in [Table 25](#) indicate characters not recommended for command prefix, format prefix, or delimiter characters.

Table 25 ASCII Code Chart

HEX	Character	HEX	Character	HEX	Character	HEX	Character
00	NUL	20	Space	40	@	60	`
01	SOH	21	!	41	A	61	a
02	STX	22	"	42	B	62	b
03	ETX	23	#	43	C	63	c
04	EOT	24	\$	44	D	64	d
05	ENQ	25	%	45	E	65	e
06	ACK	26	&	46	F	66	f
07	BEL	27	'	47	G	67	g
08	BS	28	(48	H	68	h
09	HT	29)	49	I	69	i
0A	LF	2A	*	4A	J	6A	j
0B	VT	2B	+	4B	K	6B	k
0C	FF	2C	,	4C	L	6C	l
0D	CR	2D	-	4D	M	6D	m
0E	SO	2E	.	4E	N	6E	n
0F	SI	2F	/	4F	O	6F	o
10	DLE	30	0	50	P	70	p
11	DC1	31	1	51	Q	71	q
12	DC2	32	2	52	R	72	r
13	DC3	33	3	53	S	73	s
14	DC4	34	4	54	T	74	t
15	NAK	35	5	55	U	75	u
16	SYN	36	6	56	V	76	v

Table 25 ASCII Code Chart (Continued)

HEX	Character	HEX	Character	HEX	Character	HEX	Character
17	ETB	37	7	57	W	77	w
18	CAN	38	8	58	X	78	x
19	EM	39	9	59	Y	79	y
1A	SUB	3A	:	5A	Z	7A	z
1B	ESC	3B	;	5B	[7B	{
1C	FS	3C	<	5C	\	7C	
1D	GS	3D	=	5D]	7D	}
1E	RS	3E	>	5E	^	7E	~
1F	US	3F	?	5F	_	7F	DEL

Fonts and Bar Codes

This section provides information about different fonts (type faces) and bar codes that can be used with the printer.

Standard Printer Fonts

Most Zebra printers come standard with 15 bitmapped fonts and one scalable font, see [Figure 80](#). Additional downloadable bitmapped and scalable fonts are also available. Character size and density (how dark it appears) depend on the density of the printhead and the media used.

Figure 80 Examples of the Standard Printer Fonts

FONT A -- ABCDwxyz 12345
FONT B -- ABCDXYZ 12345 UPPER CASE ONLY
FONT D -- ABCDwxyz 12345
FONT E -- (OCR-B) ABCDwxyz 12345
FONT F -- ABCDwxyz 12345
FONT G -- **AByz 12**
FONT H -- (OCR-A) UPPER CASE ONLY
zero — FONT O -- (Scaleable) ABCDwxyz 12345
FONT GS -- ® © ™ ⓘ Accessed with the ^GS command.
FONT P -- ABCDwxyz 12345
FONT Q -- ABCDwxyz 12345
FONT R -- ABCDwxyz 12345
FONT S -- ABCDwxyz 12345
FONT T -- ABCDwxyz 12345
FONT U -- ABCDwxyz 12345
FONT V -- ABCDwxyz 12345

To use one of these fonts, you must either use the change alphanumeric default font command (^CF) or specify an alphanumeric field command (^A).

The standard Zebra character set is Code 850 for character values greater than 20 HEX. There are six HEX character values below 20 HEX that are also recognized. [Figure 81](#) shows how these character values are printed.



NOTE: Unidentified characters should default to a space.

Figure 81 Recognized HEX Values below 20 HEX

A HEX	1a	will print a	0 (numeric)
A HEX	1b	will print a	⅓
A HEX	1c	will print a	⅔
A HEX	1d	will print a	U
A HEX	1e	will print a	ij
A HEX	1f	will print a	\

Proportional and Fixed Spacing

Proportional spacing is different than fixed spacing. In Table 26, the intercharacter gap (ICG), the space between characters, is constant for fonts A through H, which means that the spacing between all characters is the same. For example, the spacing between the letters MW is the same as between the letters IE.

Figure 82 is an example of fixed space fonts:

Figure 82 Fixed Space Fonts Proportion

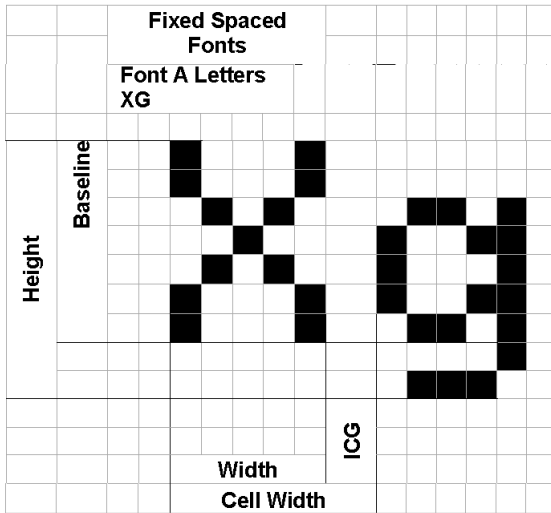

The baseline is the imaginary line on which the bottom (base) of all characters (except any descenders) rest. The area between the baseline and the bottom of the matrix is used for any character “descenders.” Baseline numbers define where the baseline is located in relationship to the top of the matrix. For example, the baseline for font “E” is 23 dots down from the top of the matrix.

Table 26 Intercharacter Gap and Baseline Parameters

Font	H x W (in dots)	Type	Intercharacter Gap (in dots)	Baseline (in dots)
A	9 x 5	U-L-D	1	7
B	11 x 7	U	2	11
C,D	18 x 10	U-L-D	2	14
E	28 x 15	OCR-B	5	23
F	26 x 13	U-L-D	3	21
G	60 x 40	U-L-D	8	48
H	21 x 13	OCR-A	6	21
GS	24 x 24	SYMBOL	PROPORTIONAL	3 x HEIGHT/4
0	DEFAULT: 15 x 12		PROPORTIONAL	3 x HEIGHT/4

Scalable Versus Bitmapped Fonts

For scalable fonts, setting the height and width equally produces characters that appear the most balanced. Balanced characters are pleasing to the eye because actual height and width are approximately equal to each other. This is achieved through the use of a smooth-scaling algorithm in the printer.

For bitmapped fonts, this balancing is built into the font. In actuality, the height of a bitmap font is slightly larger than the width. Bitmap fonts are always at the maximum size of the character's cell.

Scalable Fonts

All dot parameters used in the commands to create scalable fonts are translated into a point size because scalable fonts are measured in point sizes, not dots. To determine how many dots to enter to obtain a particular point size, use the following formula. The actual point size will be an approximate value.

$$\text{Dots} = \frac{(\text{Point size}) \times (\text{Dots per inch of Printer})}{72}$$

- For printers using a 6 dot/mm printhead the "dots per inch of printer" value is 152.4
- For printers using a 8 dot/mm printhead the "dots per inch of printer" value is 203.2
- For printers using a 12 dot/mm printhead the "dots per inch of printer" value is 304.8
- For printers using a 24 dot/mm printhead the "dots per inch of printer" value is 609.6

The actual height and width of the character in dots will vary, depending on the font style and the particular character. Therefore, some characters will be smaller and some will be larger than the actual dot size requested. The baselines for all scalable fonts are calculated against the dot size of the cell. The baseline is 3/4 down from the top of the cell. For example, if the size of the cell is 80 dots, the baseline will be 60 dots (3/4) down from the top of the cell.

For more information concerning fonts and related commands, see [~DB on page 154](#) and [~DS on page 161](#).

Bitmapped Fonts

Internal bitmapped fonts can be magnified from 1 to 10 times their normal (default) size. The magnification factor is in whole numbers. Therefore, if the normal size of a bitmapped font is 9 dots high and 5 dots wide, a magnification factor of 3 would produce a character of 27 dots high and 15 dots wide. Height and width can be magnified independently.

Magnification Factor

The font commands contain parameters for entering the height and width of printed characters. The values are always entered in dots. When entering these values for bitmapped fonts, use the following formula:

$$\text{Base Height} \times \text{Magnification Factor} = \text{Height Parameter Value}$$

The same principle applies when calculating width.

Example:

Base height = 9 dots

Base width = 5 dots

To magnify a bitmapped character with the above specifics 3 times its size:

Height parameter = 27 [9 x 3]

Width parameter = 15 [5 x 3]

Changing Bitmapped Font Size

Alphanumeric field command (^A) parameters h and w control the magnification and, therefore, the ultimate size of the font. The parameter is specified in dots, but ZPL II actually uses an integer multiplier times the original height/width of the font. For example, if you specify

`^AD,54`

you get characters three times their normal size (54 dots high), but if you specify

`^AD,52`

you receive the same result, not characters 52 dots high.

Defining only the height or width of a bitmapped font forces the magnification to be proportional to the parameter defined. If neither is defined, the ^CF height and width are used. For example, if the height is twice the standard height, the width will be twice the standard width.

If a ^CF command, with height and width parameters defined, is used to set the first font, any ^A commands (to select a different font) that follow must have the height and width parameter filled in.

If this is not done, the newly selected font will be magnified using values for the ^CF height and width parameters. This is an example of what happens:.

ZPL II CODE	GENERATED LABEL
<pre> ^XA^LL1800 ^FO50,50^CFD,26,10^FDZEBRA....^FS ^FO50,100^FD"Bar Code, Bar None"^FS ^FO50,200^AA^FDZEBRA....^FS ^FO50,250^FD"Bar Code, Bar None"^FS ^XZ </pre>	<div style="border: 1px solid black; padding: 10px; margin: 10px;"> <pre> ZEBRA.... "Bar Code, Bar None" ZEBRA.... "Bar Code, Bar None" </pre> </div>

Font Matrices

Type Key U = Uppercase, L = Lowercase, D = Descenders

Table 27 6 dot/mm Printhead

Font	Matrix	Type	Character Size			
	HxW (in dots)		HxW (in in.)	Char./in.	HxW (in mm)	Char. /mm
A	9 x 5	U-L-D	0.059 x 0.039	25.4	1.50 x 0.99	1.01
B	11 x 7	U	0.072 x 0.059	16.9	1.82 x 1.50	0.066
C, D	18 x 10	U-L-D	0.118 x 0.079	12.7	2.99 x 2.00	0.05
E	21 x 10	OCR-B	0.138 x 0.085	11.7	3.50 x 2.16	0.46
F	26 x 13	U-L-D	0.170 x 0.105	9.53	4.32 x 2.67	0.37
G	60 x 40	U-L-D	0.394 x 0.315	3.18	10.0 x 8.00	0.125
H	17 x 11	OCR-A	0.111 x 0.098	10.2	2.81 x 2.48	0.40
GS	24 x 24	SYMBOL	0.157 x 0.157	6.35	3.98 x 3.98	0.251
0	Default: 15 x 12					

Table 28 8 dot/mm (203 dpi) Printhead

Font	Matrix	Type	Character Size			
	HxW (in dots)		HxW (in in.)	Char./in.	HxW (in mm)	Char. /mm
A	9 X 5	U-L-D	0.044 x 0.030	33.3	1.12 x 0.76	1.31
B	11 X 7	U	0.054 x 0.044	22.7	1.37 x 1.12	0.89
C, D	18 X 10	U-L-D	0.089 x 0.059	16.9	2.26 x 1.12	0.66
E	28 x 15	OCR-B	0.138 x 0.098	10.2	3.50 x 2.49	0.40
F	26 x 13	U-L-D	0.128 x 0.079	12.7	3.25 x 2.00	0.50
G	60 x 40	U-L-D	0.295 x 0.197	4.2	7.49 x 5.00	0.167
H	21 x 13	OCR-A	0.103 x 0.093	10.8	2.61 x 2.36	0.423
GS	24 x 24	SYMBOL	0.118 x 0.118	8.5	2.99 x 2.99	0.334
P	20 x 18	U-L-D	0.098 x 0.089	N/A	2.50 x 2.25	N/A
Q	28 x 24	U-L-D	0.138 x 0.118	N/A	3.50 x 3.00	N/A
R	35 x 31	U-L-D	0.172 x 0.153	N/A	4.38 x 3.88	N/A
S	40 x 35	U-L-D	0.197 x 0.172	N/A	5.00 x 4.38	N/A
T	48 x 42	U-L-D	0.236 x 0.207	N/A	6.00 x 5.25	N/A
U	59 x 53	U-L-D	0.290 x 0.261	N/A	7.38 x 6.63	N/A
V	80 x 71	U-L-D	0.394 x 0.349	N/A	10.00 x 8.88	N/A
0	Default: 15 x 12	U-L-D	Scalable		Scalable	

Fonts and Bar Codes

Table 29 12 dot/mm (300 dpi) Printhead

Font	Matrix	Type	Character Size			
	HxW (in dots)		HxW (in in.)	Char./in.	HxW (in mm)	Char. /mm
A	9 X 5	U-L-D	0.030 x 0.020	50.8	0.75 x 0.50	2.02
B	11 X 7	U	0.036 x 0.030	33.8	0.91 x 0.75	1.32
C, D	18 X 10	U-L-D	0.059 x 0.040	25.4	1.50 x 1.00	1.00
E	42 x 20	OCR-B	0.138 x 0.085	23.4	1.75 x 1.08	0.92
F	26 x 13	U-L-D	0.085 x 0.053	19.06	2.16 x 1.34	0.74
G	60 x 40	U-L-D	0.197 x 0.158	6.36	5.00 x 4.00	0.25
H	34 x 22	OCR-A	0.111 x 0.098	10.20	2.81 x 2.48	0.40
GS	24 x 24	SYMBOL	0.079 x 0.079	12.70	1.99 x 1.99	0.52
P	20 x 18	U-L-D	0.067 x 0.060	N/A	1.69 x 1.52	N/A
Q	28 x 24	U-L-D	0.093 x 0.080	N/A	2.37 x 2.03	N/A
R	35 x 31	U-L-D	0.117 x 0.103	N/A	2.96 x 2.62	N/A
S	40 x 35	U-L-D	0.133 x 0.177	N/A	3.39 x 2.96	N/A
T	48 x 42	U-L-D	0.160 x 0.140	N/A	4.06 x 3.56	N/A
U	59 x 53	U-L-D	0.197 x 0.177	N/A	5.00 x 4.49	N/A
V	80 x 71	U-L-D	0.267 x 0.237	N/A	6.77 x 6.01	N/A
0	Default: 15 x 12	U-L-D	Scalable		Scalable	

Table 30 24 dot/mm (600 dpi) Printhead

Font	Matrix	Type	Character Size			
	HxW (in dots)		HxW (in in.)	Char./in.	HxW (in mm)	Char. /mm
A	9 X 5	U-L-D	0.015 x 0.010	100.00	0.38 x 0.25	4.00
B	11 X 7	U	0.018 x 0.015	66.66	0.46 x 0.38	2.60
C, D	18 X 10	U-L-D	0.030 x 0.020	50.00	0.77 x 0.51	2.0
E	42 x 20	OCR-B	0.137 x 0.087	11.54	3.47 x 2.20	0.45
F	26 x 13	U-L-D	0.043 x 0.027	37.5	1.10 x 0.68	1.50
G	60 x 40	U-L-D	0.100 x 0.080	12.50	2.54 x 2.04	0.50
H	34 x 22	OCR-A	0.100 x 0.093	10.71	2.54 x 2.37	0.42
GS	24 x 24	SYMBOL	0.040 x 0.040	25.00	1.02 x 1.02	1.00
P	20 x 18	U-L-D	0.067 x 0.060	N/A	1.69 x 1.52	N/A
Q	28 x 24	U-L-D	0.093 x 0.080	N/A	2.37 x 2.03	N/A
R	35 x 31	U-L-D	0.117 x 0.103	N/A	2.96 x 2.62	N/A
S	40 x 35	U-L-D	0.133 x 0.117	N/A	3.39 x 2.96	N/A
T	48 x 42	U-L-D	0.160 x 0.140	N/A	4.06 x 3.56	N/A

Table 30 24 dot/mm (600 dpi) Printhead (Continued)

Font	Matrix	Type	Character Size			
	HxW (in dots)		HxW (in in.)	Char./in.	HxW (in mm)	Char. /mm
U	59 x 53	U-L-D	0.197 x 0.177	N/A	5.00 x 4.49	N/A
V	80 x 71	U-L-D	0.267 x 0.237	N/A	6.77 x 6.01	N/A
0	Default: 15 x 12	U-L-D	Scalable		Scalable	

Bar Codes

Every bar code contains data made up of a sequence of light spaces and dark bars that represent letters, numbers, or other graphic characters. The usable characters differ among the various kinds of bar codes. Each bar code section in the [ZPL Commands on page 33](#) provides a table of applicable characters. Start and stop characters and check digits are used by many, but not all, bar codes. These will be indicated in the specific bar code explanations.

Zebra printers can print the following kinds of bar codes:

<p>Bar code modulus “X” dimensions</p> <ul style="list-style-type: none"> • Picket fence (non-rotated) orientation: <ul style="list-style-type: none"> • 203 dpi = 0.0049 in. mil to 0.049 in. • 300 dpi = 0.0033 in. mil to 0.033 in. • Ladder (rotated) orientation: <ul style="list-style-type: none"> • 203 dpi = 0.0049 in. mil to 0.049 in. • 300 dpi = 0.0039 in. mil to 0.039 in. 	<p>Linear bar codes</p> <ul style="list-style-type: none"> • Codabar • Code 11 • Code 39 • Code 93 • Code 128 with subsets A/B C and UCC Case Codes • ISBT-128 • UPC-A • UPC-E • EAN-8 • EAN-13 • UPC and EAN 2 or 5 digit extensions • Planet Code • Plessey • Postnet • Standard 2 of 5 • Industrial 2 of 5 • Interleaved 2 of 5 • LOGMARS • MSI • GS1 DataBar Omnidirectional
<p>Two-dimensional bar codes</p> <ul style="list-style-type: none"> • Aztec • Code 49 • Maxi Code • TLC39 • PDF-417 • QR Code • Codablock • DataMatrix • Micro-PDF417 	
<p>Bar code ratios</p> <ul style="list-style-type: none"> • 2:1 • 7:3 • 5:2 • 3:1 	

Basic Format for Bar Codes

The basic format for bar codes is quiet zone, start character, data, check digit, stop character, and quiet zone. Not all bar codes require each of these elements.

Every bar code requires a quiet zone. A quiet zone (sometimes called a “clear area”) is an area adjacent to the machine-readable symbols that ensure proper reading (decoding) of the symbols. No printing is permissible within this area. Preprinted characters, borders, and background color are acceptable if they are invisible to the reading device; these are used in some applications but restrict the type of reading device that can be used. The size of the quiet zone depends on the size of bar widths (usually 10 times the width of the narrow bar).

Figure 83 Quiet Zone in a Bar Code



Bar Code Field Instructions

To create a bar code, a bar code field command must be contained in the label format. [Table 31](#) shows the bar code field commands. The number in brackets denotes the print ratio. Each command produces a unique bar code.



IMPORTANT: (*) for Fixed Printing Ratio means that the ratio between the width of the bars in the code is a fixed standard and cannot be changed.

As another reference to the bar code field commands ratio, see [Table 5 on page 134](#).

Table 31 Bar Code Field Commands

ZPL Command	Command Description	Ratio
^B0	Aztec Bar Code Parameters	[Fixed]
^B1	Code 11 (USD-8)	[2.0 - 3.0]
^B2	Interleaved 2 of 5	[2.0 - 3.0]
^B3	Code 39 (USD-3 and 3 of 9)	[2.0 - 3.0]
^B4	Code 49 (*)	[Fixed]
^B5	Planet Code Bar Code	[Fixed]
^B7	PDF417 (*)	[Fixed]
^B8	EAN-8 (*)	[Fixed]
^B9	UPC-E	[Fixed]

Table 31 Bar Code Field Commands (Continued)

ZPL Command	Command Description	Ratio
^BA	Code 93 (USS-93)(*)	[Fixed]
^BB	CODABLOCK A, E, F (*)	[Fixed]
^BC	Code 128 (USD-6) (*)	[Fixed]
^BD	UPS MaxiCode (*)	[Fixed]
^BE	EAN-13	[Fixed]
^BF	Micro-PDF417	[Fixed]
^BI	Industrial 2 of 5	[2.0 - 3.0]
^BJ	Standard 2 of 5	[2.0 - 3.0]
^BK	ANSI Codabar (USD-4 and 2 of 7)	[2.0 - 3.0]
^BL	LOGMARS	[2.0 - 3.0]
^BM	MSI	[2.0 - 3.0]
^BO	Aztec Bar Code Parameters	[Fixed]
^BP	Plessey	[2.0 - 3.0]
^BQ	QR Code (*)	[Fixed]
^BR	GS1 Databar (formerly RSS)	[Fixed]
^BS	UPC/EAN Extensions (*)	[Fixed]
^BU	UPC-A (*)	[Fixed]
^BX	Data Matrix (*)	[Fixed]
^BZ	PostNet (*), USPS Intelligent Mail, and Planet bar codes	[Fixed]

Additionally, each bar code field command can be issued with a definition parameter string. The parameter string defines field rotation, height, and interpretation line status for all bar codes. For some bar codes, the parameter string also sets a check digit, start character, and/or stop character. Use the definition parameter string to command the printer to print bar codes of appropriate heights and densities that conform to the specifications of the application.

The use of the parameter string is optional because all parameters have default values. If the default values for all of the bar code parameters suit the application, then only the bar code command needs to be entered.

Parameters in bar code field commands are “position specific.” If a value (other than the default value) is manually entered for one parameter the ZPL II delimiter character (a comma) must be used to mark the position of the preceding parameters in the string.

To change just the third parameter, enter two commas and then the value for the third parameter. The default values will be automatically used for the first and second parameters.

Bar Code Command Groups

Bar code commands are organized into four groups. Each group represents a type of bar code. [Table 32](#) through [Table 35](#) identify the groups and the bar codes they contain:

Table 32 Numeric Only Bar Codes

ZPL Command	Command Description
^B0	Aztec Bar Code Parameters
^B1	Code 11
^B5	Planet Code Bar Code
^BI	Industrial 2 of 5
^BJ	Standard 2 of 5
^BK	ANSI Codabar (or NW-7)
^BM	MSI
^B0	Aztec Bar Code Parameters
^BP	Plessey
^BZ	PostNet (*), USPS Intelligent Mail, and Planet bar codes

Table 33 Retail Labeling Bar Codes

ZPL Command	Command Description
^B0	Aztec Bar Code Parameters
^B8	EAN-8
^B9	UPC-E
^BE	EAN-13
^B0	Aztec Bar Code Parameters
^BS	UPC/EAN extensions
^BU	UPC-A

Table 34 Alphanumeric Bar Codes

ZPL Command	Command Description
^B0	Aztec Bar Code Parameters
^B3	Code 39
^BA	Code 93
^BC	Code 128
^BL	LOGMARS
^B0	Aztec Bar Code Parameters

Table 35 Two-Dimensional Bar Codes

ZPL Command	Command Description
^B0	Aztec Bar Code Parameters
^B4	Code 49
^B7	PDF417
^BB	CODABLOCK
^BD	UPS MaxiCode
^BF	MicroPDF417
^BQ	QR Code
^B0	Aztec Bar Code Parameters
^BR	GS1 Databar (formerly RSS)
^BT	TLC39
^BX	Data Matrix

Mod 10 and Mod 43 Check Digits

This section provides information about Mod 10 and Mod 43 check digits.

Mod 10 Check Digit

The calculations for determining the Mod 10 Check Digit character are as follows:

1. Start at the first position and add the value of every other position together.

$$0 + 2 + 4 + 6 + 8 + 0 = 20$$

2. The result of Step 1 is multiplied by 3.

$$20 \times 3 = 60$$

3. Start at the second position and add the value of every other position together.

$$1 + 3 + 5 + 7 + 9 = 25$$

4. The results of steps 2 and 3 are added together.

$$60 + 25 = 85$$

5. The check character (12th character) is the smallest number which, when added to the result in step 4, produces a multiple of 10.

$$85 + X = 90 \text{ (next higher multiple of 10)}$$

$$X = 5 \text{ Check Character}$$

This bar code illustrates the above example. The digit on the right (5) is the check digit.



Mod 43 Check Digit

The calculations for determining the Mod 43 check Digit character are as follows:

Each character in the Code 39 character set has a specific value, as follows:

0=0	B=11	M=22	X=33
1=1	C=12	N=23	Y=34
2=2	D=13	O=24	Z=35
3=3	E=14	P=25	- =36
4=4	F=15	Q=26	. = 37
5=5	G=16	R=27	Space=38
6=6	H=17	S=28	\$=39
7=7	I=18	T=29	/=40
8=8	J=19	U=30	+ =41
9=9	K=20	V=31	%=42
A=10	L=21	W=32	

Example Data string 2345ABCDE/

1. Add the sum of all the character values in the data string. Using the chart above, the sum of the character values is as follows:

$$1 + 2 + 3 + 4 + 5 + 10 + 11 + 12 + 13 + 14 + 40 = 115$$

2. Divide the total by 43. Keep track of the remainder.

$$115/43 = 2 \text{ Remainder is } 29$$

3. The “check digit” is the character that corresponds to the value of the remainder.

$$\text{Remainder} = 29$$

29 is the value for the letter T.

T is the check digit.

Below is a bar code that illustrates the example. The character on the right, T, is the check digit.

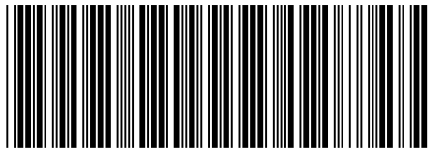

^F0125.100^B3N,Y,150,Y,N^FD12345ABCDE/^FS

Error Detection Protocol

This section explains the Zebra protocol that has been supplanted in TCP/IP based applications because of the error detection compatibility inherent in the TCP/IP protocol.

Introduction

There are many instances when it is vitally important that the information sent to the Zebra printer is received completely Error-Free. ZPL II supports an error detection protocol called Zebra Packet Response Protocol to meet this need.



NOTE: This protocol only works when using serial interface. It does not function when using parallel interface.

What is a Protocol?

A protocol is a precisely defined set of rules. In the case of data communications, a Protocol defines how data is transmitted, received, and acknowledged between two devices.

The sole purpose of the Packet Response Protocol is to ensure that the information sent from a Host computer to the Zebra printer is received accurately. Remember, the protocol cannot insure the accuracy of the data that is actually sent from the Host computer. The commands and data needed to make a label (ZPL II Format) are encapsulated within the information sent from the Host computer.

How Protocols Work

The basic unit of data transfer in the Packet Response Protocol is called a "Transaction." A Transaction is a two-way communication procedure that consists of information being sent from the Host computer to the Zebra printer, and the printer sending back a response to the Host computer. This response is an indication that the Zebra printer has either accepted or rejected the information sent from the Host computer.

Information is sent in the form of "Packets." Packets sent from the Host computer are called Request Packets.

When a Request Packet is received, the Zebra printer analyzes the information in the Packet. If the Request Packet is accepted, the Zebra printer will send a positive response back to the Host computer. The Host computer can then send the next Request Packet. If the information is rejected, the Zebra printer will send a negative response back to the Host computer. The Host computer then sends the same Request Packet again.

The Zebra Packet Response Protocol can be used in both single-printer applications, where there is only one Zebra printer connected to the Host computer, and multi-drop systems in which several Zebra printers are connected to the same Host computer.

Request Packet Formats from the Host Computer

The first part of each data transfer Transaction is the sending of a Request Packet by the Host computer. The Request Packet contains a fixed length “Header” block and a variable length “Data” block. Each Packet sent from the Host computer to the Zebra printer must always use the following format.

The Request Packet Header Block is comprised of five fixed-length fields. The Request Packet Data Block is comprised of four fixed-length fields and one variable-length field. These fields are defined as follows.

Header Block					Data Block				
SOH	DST. Z-ID	SRC. Z-ID	TYPE	SEQ. #	STX	FORMAT	EXT	CRC	EOT
1	3	3	1	1	1	≤1024	1	2	1

Header Block Fields

- **SOH** (start of header character)

The Zebra printer interprets this character as the beginning of a new Request Packet. The ASCII Control Code character SOH (01H) is used as the Start of Header Character.

- **DST. Z-ID** (destination Zebra-ID)

This is the three-digit ASCII I.D. number used to identify which Zebra printer is to receive the Request Packet. The Zebra printer compares this number to the Network ID number assigned to it during Printer Configuration. The Zebra printer will act on the Request Packet only if these numbers match.

- **SRC. Z-ID** (source Zebra-ID)

This is a three-digit ASCII number used to identify the Host computer. This number is determined by the user.

- **TYPE** (packet type)

This field is used to define the type of Request Packet being sent by the Host. Only two characters are valid in this field:

- ‘P’ indicates a Print Request Packet
- ‘I’ indicates an Initialize Request Packet

Most of the Packets sent by the Host to the Zebra printer will be of the ‘P’ variety, requesting a label to be printed.

The ‘I’ character tells the Zebra printer to initialize the packet sequence numbering. It is required in the first packet of a new printing session, after starting up the Host computer or the Zebra printer.

- **SEQ. #** (the sequence number of the request packet)

This block contains a single digit number used to denote the current Transaction Number. The Host computer must increment this number by “1” for each new Request/Response Transaction pair, i.e. 0, 1, 2,..., 9. The numbers repeat after every 10 Transactions.

Data Block Fields

- **STX** (Start of Text)

The Zebra printer interprets this character as the beginning of the variable-length Data Format portion of the Request Packet. The ASCII Control Code character STX (02H) is used as the Start of Text Character.

- **DATA FORMAT** (Label Information)

A variable-length portion of the Request Packet that contains the complete or partial ZPL II label format, or partial data string (such as a downloaded graphic).

This field can contain from 0 to 1024 characters. If the Format of a label is longer than 1024 characters, the Data Format fields from consecutive packets will be concatenated together in the printer's Receive Data Buffer as if they were sent as one long direct transmission.

Special consideration has been given to the possible requirement to include ASCII Control Characters (values less than 20H) in the Data Format portion of a Request Packet. Characters such as EOT (04H), STX (02H), SOH (01H), and ETX (03H), are part of the Error Detection Protocol and could interrupt normal communication procedures if received at the wrong time.

- **ETX** (End of Text)

The Zebra printer interprets this character as the end of the variable length Data Format portion of the Request Packet. The ASCII Control Code character ETX (03H) is used as the End of Text Character.

- **CRC** (Cyclic Redundancy Check)

The CRC is a 2 character field. A Cyclic Redundancy Check is a type of error checking used to maintain the validity and integrity of the information transmitted between the Host computer and the Zebra printer. This Protocol uses the 16-bit CCITT method of producing a CRC.

The CRC is a two-byte value derived from the contents of the packet between, but not including, the SOH character and the CRC code itself. The Zebra printer will calculate a CRC of the Request Packet received and compare the value with the CRC Value in this field. The CRC of the Request Packet must match the CRC calculated by the Zebra printer in order for the Request Packet to be valid.

- **EOT** (End of Transmission)

The Zebra printer interprets this character as the end of the Request Packet. The ASCII Control Code character EOT (04H) is used as the End of Transmission Character.

Response From the Zebra Printer

When the Zebra printer receives the EOT character, it will begin acting on the Request Packet received. The printer will compare certain characters and numeric values within the received Request Packet and send a response back to the Host computer.

Zebra Packet Response

The Packet Response protocol provides the highest degree of error checking and is well suited to the Host-Multiple Printer application. The Response Packet from the Zebra printer will always use the following format.

The Request Packet Header Block is comprised of five fixed-length fields. The Request Packet Data Block is comprised of four fixed-length fields and one variable-length field. These fields are defined as follows.

Header Block					Data Block				
SOH	DST. Z-ID	SRC. Z-ID	TYPE	SEQ. #	STX	FORMAT	EXT	CRC	EOT
1	3	3	1	1	1	≤1024	1	2	1

Header Block Fields

- **SOH** (Start of Header Character)

The Zebra printer sends this character as the beginning of a new Response Packet. The ASCII Control Code character SOH (01H) is used as the Start of Header Character.

- **DST. Z-ID** (Destination Zebra-ID)

This is the same three-digit ASCII number used to identify the Host Computer that was contained in the SRC. Z-ID field of the Request Packet that initiated this Response Packet. The Host compares this number to its known value to insure it is the proper destination.

- **SRC. Z-ID** (Source Zebra-ID)

This is the three character ASCII Network I.D. of the Zebra printer that is sending the Response Packet.

- **TYPE** (Packet Type)

This block is used to define the type of Response Packet being sent to the Host. Only three characters are valid in this field.

- 'A' This is a Positive Acknowledgment to the Host computer. It indicates that the Request Packet was received without a CRC error. The Host computer may send the next Request Packet.
- 'N' This is the Negative Acknowledgment to the Host computer. It indicates that an error was detected in the packet sent from the Host computer. The Host computer must retransmit the same Request Packet again.
- 'S' This character indicates that the Response Packet contains the Zebra Printer Status requested by a ~HS (Host Status) command received from the Host.
- **SEQ. #** (Used to denote the current message sequence number)

This number is identical to the message sequence number in the Request Packet. It denotes the message sequence number to which the Response Packet is replying.

Data Block Fields

- **STX** (Start of Text)

The Zebra printer sends this character as the beginning of the variable length Data Format portion of the Response Packet. The ASCII Control Code character STX (02H) is used as the Start of Text Character.
- **DATA FORMAT** (Label Information)

The 'variable length' portion of the Response Packet. If the Packet Type field in the Response Header contains an 'A' or an 'N', no data will appear in this field. If the Packet Type field contains an 'S', this field will contain the Printer Status Message.
- **ETX** (End of Text)

The Zebra printer sends this character as the end of the variable length Data Format portion of the Request Packet. The ASCII Control Code character ETX (03H) is used as the End of Text Character.
- **CRC** (Cyclic Redundancy Check)

This is the CRC of the Response Packet as calculated by the Zebra printer. This Cyclic Redundancy Check maintains the validity and integrity of the information transmitted between the Zebra printer and the Host computer.

This CRC is a two Byte value derived from the contents of the packet between, but not including, the SOH character and the CRC code itself. The Host computer will calculate a CRC of the received Response Packet and compare it to the CRC value in this field. The CRC of the Response Packet must match the CRC calculated by the Host computer in order for the Response Packet to be valid.
- **EOT** (End of Transmission)

The Zebra printer sends this character as the end of the Response Packet. The ASCII Control Code character EOT (04H) is used as the End of Transmission Character.

Disguising Control Code Characters

There may be occasions when ASCII Control Codes (00H - 19H) must be included as part of the Data Format block of a Request Packet. To eliminate any problems, these characters must be disguised so that the communication protocol does not act on them.

This procedure must be used to disguise each Control Code.

- A SUB (1AH) character must precede each Control Code placed in the Data Format block.
- The value of 40H must be added to the Hex value of the Control Code.
- The ASCII Character corresponding to the total value produced in step 2 must be entered in the Data Format right after the SUB character.

The Zebra printer automatically converts the modified control character back to its correct value by discarding the SUB (1AH) character and subtracting 40H from the next character.

To include a DLE (10H) character in the Data Format block:

1. Enter a SUB (1AH) character into the Data Format.
2. Add 40H to the DLE value of 10H for a resulting value of 50H.
3. Enter the ASCII character "P" (50H) in the Data Format after the SUB character.



NOTE: This technique is counted as two characters of the 1024 allowed in the Data Format block.

Rules for Transactions

- Every Transaction is independent of every other Transaction and can only be initiated by the Host computer.
- A valid Response Packet must be received by the Host computer to complete a Transaction before the next Request Packet is sent.
- If an error is encountered during a Transaction, the entire Transaction (i.e., Request Packet and Response Packet) must be repeated.
- The Zebra printer does not provide for system time-outs and has no responsibility for insuring that its Response Packets are received by the Host computer.
- The Host computer must provide time-outs for all of the Transactions and insure that communication continues.
- If any part of a Transaction is lost or received incorrectly, it is the responsibility of the Host computer to retry the whole Transaction.

Error Detection Protocol Application

The following are the basic requirements for setting up the Zebra printer to use the Error Detection Protocol.

Activating the Protocol Protocol is a front panel selection, or can be done with the ZPL command `^SC`.

Setting Up Communications Insure that the Host computer and the Zebra printer are characterized with the same communication parameters; i.e., Parity, Baud Rate, etc. The communications must be set up for 8 data bits.

Setting the Printer ID Number The Protocol uses the printer's Network ID number to insure communication with the proper unit. The Network ID is programmed into the printer by sending the printer a `^NI` (Network ID Number) command or done through the front panel.

If there is only one printer connected to the Host computer, the Network ID number should be set to all zeros (default).

If there is more than one printer, such as in a broadcast or multi-drop environment, each printer should be assigned its own unique ID number. Printers in this environment, with an ID of all zeros, will receive ALL label formats regardless of the actual printer ID number in the DST. Z-ID block of the Request Packet.

Error Conditions and System Faults

Restarting a Transmission If a break in communication occurs, the Host must restart the transmission of the current label format with an Initialization Request Packet. The Zebra printer will not respond to Request Packets sent out of sequence. However, the Zebra printer will respond to an Initialization Request Packet and restart its internal counting with the sequence number of the Request Packet.

CRC Error Conditions and Responses A CRC error condition can be detected when the printer receives a Request Packet or when the Host computer receives a Response Packet. The following list defines these errors and how the Host computer should respond to them.

Error	Response
The CRC calculated by the Zebra printer does not match the one received as part of the Request Packet.	The Zebra printer will return a Negative Acknowledgment Response Packet. The Host computer should retry the same Transaction with the same Sequence Number.
The CRC calculated by the Host computer does not match the one received as part of the Response Packet.	The Host computer should retry the same Transaction with the same Sequence Number.

Time-Out Error Conditions and Responses

There are certain conditions at the Zebra printer that might cause the Host computer to time-out while processing a Transaction. The following list illustrates these conditions and how the Host computer should respond to them.

Error	Response
A Request Packet from the Host computer is not received by the Zebra printer.	The Host computer times out and resends the Request Packet of the same Transaction with the same Sequence Number.
A Request Packet from the Host computer is partially received by the Zebra printer.	The Host computer times out and resends the Request Packet of the same Transaction with the same Sequence Number.
A Response Packet from the Zebra printer is not received by the Host computer.	The Host computer times out and resends the Request Packet of the same Transaction with the same Sequence Number.
A Response Packet from the Zebra printer is partially received by the Host computer.	The Host computer times out and resends the Request Packet of the same Transaction with the same Sequence Number.

How the Zebra Printer Processes a Request Packet

The following describes the steps taken at the Zebra printer to process a Request Packet.

1. The Zebra printer looks for a SOH (Start of Header) character. As soon as it finds one, it places the SOH and all the data after it into its Receive Data Buffer. This process continues until the printer receives an EOT (End of Transmission) character.



NOTE: If a second SOH is received before an EOT is detected, the contents of the Receive Buffer will be discarded. All of the data after the second SOH will be placed in the Receive Data Buffer.

2. After detecting the EOT, the printer checks for the following:

- * The DST. Z-ID matches the printer's Network I.D.



NOTE: If the Network ID at the printer is all zeros, the printer will accept all Request Packets regardless of the DST. Z-ID received. If a Request Packet is received with the DST. Z-ID all zeros, it is accepted by all printers regardless of their Network ID setting.

- *The Data Format begins with STX and ends with ETX.

- *The Sequence Number has not been used before.

If the check is satisfactory, proceed to Step 3 on the following page.

If any part of the check is unsatisfactory, the printer discards the data in its Receive Data Buffer and waits for another SOH. No response is sent to the computer.

Exceptions

It is possible that the printer will send a response to the host that the host does not receive. Therefore, the host will send the same request packet to the printer again. If this happens, the printer will not use the data if it already used it before. However, the printer will send a response back to the host.

The printer calculates the CRC and compares it with the one received in the Request Packet. If the CRC is valid, the printer sends a Positive Response Packet to the Host computer. It then transfers the 'Variable Length' data from the Receive Buffer to its memory for processing. If the CRC does not match, and the printer is set up to return a Negative Response Packet, the following will take place:

1. The printer assumes that the DST. Z-ID, SRC. Z-ID, and Sequence Number are correct and that the error was in the variable data.
2. The same DST. Z-ID, printers SRC. Z-ID, and Sequence Number will be returned back to the host in the Negative Response Packet.
3. If the assumption in (a) is incorrect, the Host computer can time-out and retransmit the original Request Packet.

How the Zebra Printer Responds to Host Status

If a ~HS (Host Status) command is received by the Zebra printer, the printer will send back an acknowledgment for the receipt of the packet. It then sends an additional packet that includes the Host Status information in the Variable Length portion of the packet.

ZB64 Encoding and Compression

This section describes the Base 64 MIME (ZB64) encoding and compression. This is the same type of MIME encoding that is used in e-mail.

For more information on ZB64 Encoding and Compression, contact your Reseller or Zebra Representative.

Introduction to B64 and Z64

The first encoding, known as B64, encodes the data using the MIME Base64 scheme. Base64 is used to encode e-mail attachments and is specifically designed to address communications path limitations, such as control characters and 7-bit data links. It encodes the data using only the printable ASCII characters:

A B C D E F G H I J K L M N O P Q R S T U V W X Y Z
a b c d e f g h i j k l m n o p q r s t u v w x y z
0 1 2 3 4 5 6 7 8 9 + / =

With the use of ZPL, this has the added benefit of avoiding the caret (^) and tilde (~) characters. Base64 encodes six bits to the byte, for an expansion of 33 percent over the un-enclosed data. This is much better than the 100 percent expansion given by the existing ASCII hexadecimal encoding.

The second encoding, known as Z64, first compresses the data using the LZ77 algorithm to reduce its size. (This algorithm is used by the PKWARE® compression program PKZIP™ and is integral to the PNG graphics format.) The compressed data is then encoded using the MIME Base64 scheme as described above.

A CRC is calculated across the Base64-encoded data. If the CRC-check fails or the download is aborted, the object can be invalidated by the printer.

The robust encodings can be piggybacked on the existing download commands with full backward compatibility. This is done by prefacing the new encodings with a header that uniquely identifies them. The download routines in the printer firmware can key-off the header to determine whether the data is in the old ASCII hexadecimal encoding or one of the new encodings. This allows existing downloadable objects to be used in their present format, while new objects can be created using the same download commands with the new encodings for increased integrity and reduced download times.

For easy reference, B64 and Z64 are referred to as ZB64. In any reference to the ZB64 encoding, assume that both Base64-only (B64) and LZ77/Base64 (Z64) encodings are accepted.

The following is an example of an existing download command using the new encoding:

```
~DTARIAL,59494,:Z64:H4sICMB8+DMAC0FSSUFML1RURgDsmnd8VEW7x5+ZOedsyibZNNJhlyWhbEJIwYSwJ
DGNkmwghJIgJYEEehQIPsggKAjEAiIiVaSoIJYNBAKIGGxUBVUUCGU0JQSC0WFnPvbe+SF18+9H+8f973X+3
Jm93umzzNznvnNSSFGRJ6ARAVZvXK7XDaXLYtIR5B7ontuZPQ824I5RKIa6ew+aba8+pU1rVDZiciv
```

[multiple lines deleted]

```
/O6DU5wZ7ie2+g4xzDPwCpwm3nqw2GAPcdc1xF4fIP66jHjncmKvKzh/ZUNCx19/QQx2HXHYB4m/PkQcdCdx2
G7OYt+mszkMh4iZxoiFvkh89BFipo87kwD/Bf/d0cycAAEA:a1b2
```

The parameters are identical to the existing ~DT command:

Parameter	Details
o = font name	<p>Values: any valid TrueType name, up to 8 characters</p> <p>Default: if a name is not specified, UNKNOWN is used</p> <p>In this example, Arial is the specified font.</p>
s = font size	<p>Values: the number of memory bytes required to hold the Zebra-downloadable format of the font</p> <p>Default: if an incorrect value or no value is entered, the command is ignored</p> <p>In this example, 59494 is the size.</p> <p>To maintain compatibility with the existing ASCII hexadecimal encoding, this field must contain the size of the un-enclosed and uncompressed object — the number of bytes that are finally placed into the printer's memory, not the number of bytes downloaded.</p>
data = data string	<p>Values: a string of ASCII hexadecimal values (two hexadecimal digits/byte). The total number of two-digit values must match parameter <i>s</i>.</p> <p>Default: if no data is entered, the command is ignored</p> <p>Everything following the size field is data. The new encoding imposes a header with a unique signature. The new encoding must start with the characters :B64: (data encoded in Base-64 only) or :Z64: (data compressed with LZ77, then encoded in Base-64) followed by the encoded data.</p> <p>After the data is presented, another colon (:) and four hexadecimal digits comprise the CRC. The Base64 standard allows new-line characters (carriage returns and line feeds) to be inserted into the encoded data for clarity. These characters are ignored by the printer.</p>

When downloading graphics, the colon is used in the current ASCII hexadecimal encoding indicate "repeat the previous dot row." Since this shorthand is invalid for the first character of data (no previous dot row has been downloaded), it is safe for the printer to detect the leading colon character as the lead-in for the new encodings.

B64 and Z64 Encoding

These download encodings, B64 and Z64, are created as drop-in replacements for the existing ASCII hexadecimal encoding.

B64 encoding do the following:

- Encode the compressed data using the MIME Base64 algorithm.
- Calculate a CRC across the encoded data.
- Add a unique header to differentiate the new format from the existing ASCII hex encoding.

Z64 encoding do the following:

- Compress the data using the LZ77 algorithm.
- Encode the compressed data using the MIME Base64 algorithm.
- Calculate a CRC across the encoded data.
- Add a unique header to differentiate the new format from the existing ASCII hexadecimal encoding.

The data field have this format:

`:id:encoded_data:crc`

Parameter	Details
<code>:id</code>	the identifying string B64 or Z64
<code>:iencoded_data</code>	data to download, compressed with LZ77 (if the id parameter is set to Z64) and encoded with Base64.
<code>:crc</code>	four hexadecimal digits representing the CRC calculated over the <code>:encoded_data</code> field.

The printer calculates a CRC across the received data bytes and compare this to the CRC in the header. A CRC mismatch is treated as an aborted download.

The B64 and Z64 encodings can be used in place of the ASCII hexadecimal encoding in any download command. The commands are:

- ~DB – Download Bitmap Font
- ~DE – Download Encoding
- ~DG – Download Graphic
- ~DL – Download Unicode Bitmap Font
- ~DS – Download Scalable Font
- ~DT – Download TrueType Font
- ~DU – Download Unbounded TrueType Font
- ^GF – Graphic Field (with compression type set to “ASCII hex”)

The ~DB (Download Bitmap Font) command can use the new encodings in place of the ASCII hexadecimal encoding in data sub-fields. Each character is encoded individually. However, for small amounts of data, the identifying B64 or Z64 header and trailing CRC may negate any gains made by using the new format.

For backward compatibility, the ^HG (Host Graphic) command uses the ASCII hexadecimal encoding. It does not use the new encodings.

Field Interactions

This section provides you with examples that show how commands interact with various justification parameters. These charts are designed so that you can identify the location of the field origin and interactions between the rotation, formatting and justification commands.

Normal Orientation

	^FPH	^FPV	^FPR
^FO Left Justified	┌ABCDE	┌A B C D E	EDCBA┐
^FT Left Justified	┌ABCDE	┌A B C D E	EDCBA┐
^FO Right Justified	ABCDE┐	A┐ B C D E	EDCBA

Field Interactions

	^FPH	^FPV	^FPR
^FT Right Justified	ABCDE	A B C D E	EDCBA

Rotated Orientation

	^FPH	^FPV	^FPR
^FO Left Justified	A B C D E	A B C D E	EDCBA
^FT Left Justified	A B C D E	A B C D E	EDCBA
^FO Right Justified	A B C D E	A B C D E	EDCBA
^FT Right Justified	A B C D E	A B C D E	EDCBA

Bottom Up Orientation

	^FPH	^FPV	^FPR
^FO Left Justified	ABCDE	A B C D E	EDCBA
^FT Left Justified	ABCDE	A B C D E	EDCBA
^FO Right Justified	ABCDE	A B C D E	EDCBA
^FT Right Justified	ABCDE	A B C D E	EDCBA

Inverted Orientation

	^FPH	^FPV	^FPR
^FO Left Justified	ABCDE+	A B C D E+	EDCBA+
^FT Left Justified	ABCDE+	A B C D E+	EDCBA
^FO Right Justified	ABCDE+	A B C D E+	EDCBA+
^FT Right Justified	ABCDE+	A B C D E+	EDCBA

Real Time Clock

This appendix contains the information needed to install, program, and operate the Real Time Clock (RTC) option. This hardware option is available as either a factory-installed or field-installable option in specific printer products manufactured and sold by Zebra Technologies Corporation.

The Real Time Clock option is currently available for following printers, and requires that the firmware version shown is installed on that printer.

Supported Zebra Printer and Print Engine Models		Requires this Firmware Version or Later
105SL printers that meet any one of the following criteria: <ul style="list-style-type: none"> • if the printer was manufactured after April 2006 • if the RTC Date and the RTC Time fields are printed on the configuration label • if the RTC Date and the RTC Time appear on the LCD display 		60.13.0.13Z
DA402 & T402 printers		32.8.4
LP2844-Z, TPL2844-Z, and TPL3844-Z printers		45.10.x
PAX Series print engines	170PAX2 print engines	29.9.x or 31.9.x
	110PAX3 print engines using Standard Font	34.10.x
	110PAX3 print engines using TT Font	49.10.x
	116PAX3 print engines using TT Font	35.10.x
	170PAX3 print engines using Standard Font	37.10.x
	170PAX3 print engines using TT Font	38.10.x
	110PAX4 and 170PAX4 print engines	60.13.0.12
S4M printers (field-installable kit)		50.13.x
S600 printers		27.10.3
Xi Series printers	90XiII, 140XiII, 170XiII & 220XiII printers	18.9.x
	90XiIII, 96XiIII, 140XiIII, 170XiIII, and 220XiIII printers	33.10.0
	90XiIIIPlus, 96XiIIIPlus, 140XiIIIPlus, 170XiIIIPlus, and 220XiIIIPlus printers	60.13.0.12
Z4Mplus and Z6Mplus printers		60.13.0.12
ZM400/ZM600/RZ400/RZ600 printers		53.15.xZ

Control Panel Programming

New parameters for the Real Time Clock have been added to the Control Panel Configuration. These parameters are located immediately following the **FORMAT CONVERT** prompt. Refer to the printer/print engine User Guide for complete configuration information.

- X.9.x firmware added the parameters to Xill printers and 170PAX/170PAX2 print engines.
- X.10.x firmware added the parameters to Xill printers and PAX3 print engines.
- X.13.x firmware added the parameters to XillPlus printers, PAX4 print engines.
- X.13.0.13Z firmware added the parameters to 105SL printers.

Real Time Clock Parameters

The parameters listed on the following pages are added to the Control Panel Configuration prompts only when both the Real Time Clock hardware option and the appropriate version of firmware are installed:

- X.9.x or later firmware installed in the Xill series printers or the 170PAX/170PAX2 series print engines.
- X.10.x or later firmware installed in the Xill series printers or the PAX3 series print engines.
- X.13.0.13Z or later firmware installed in the 105SL printers
- X.13.x or later firmware installed in the XillPlus series printers, the PAX4 series print engines, or the S4M printers.

The RTC ZPL II commands apply to all printers/print engines with the Real Time Clock hardware option and proper firmware.

Idle Display

Selects the printer/print engine Idle Display format and the method of displaying the time/date information. This parameter also affects the Configuration Label printout and the **RTC DATE** and **RTC TIME** formats.

Selections

- FW VERSION
- MM/DD/YY 24HR
- MM/DD/YY 12HR
- DD/MM/YY 24HR
- DD/MM/YY 12HR

If FW VERSION is selected, the format on the Configuration Label and on the RTC DATE and RTC TIME parameters is MM/DD/YY 24HR.

RTC Date

Allows entry of the RTC date in the format selected by the **IDLE DISPLAY** parameter.



NOTE: The RTC parameters are password-protected. Refer to your printer's user guide for specific instructions on accessing and modifying printer parameters.

Printer Model	Action
PAX Series print engines, Xi Series printers, and 105SL printers	<ol style="list-style-type: none"> 1. Use the LEFT oval key to select the position to be adjusted 2. Then, use the RIGHT oval key to select the correct value for that position.
Z4Mplus and Z6Mplus printers	<ol style="list-style-type: none"> 1. Press SELECT to select the parameter. 2. Use the MINUS (-) key to select the position to be adjusted 3. Then, use the PLUS (+) key to select the correct value for that position. 4. Press SELECT to accept any changes and deselect the parameter.
S4M printer	<ol style="list-style-type: none"> 1. Press ENTER. The printer displays the current RTC date. 2. Modify the values as follows: <ul style="list-style-type: none"> • Press the right arrow to move to the next digit position. • To increase the value, press the up arrow. • To decrease the value, press the down arrow. 3. Press ENTER to accept the value shown.



NOTE: Invalid dates, such as 2/30/1999, may be entered, but they will not be saved.

RTC Time

Allows entry of the RTC time in the format selected by the **IDLE DISPLAY** parameter.



NOTE: The RTC parameters are password-protected. Refer to your printer's user guide for specific instructions on accessing and modifying printer parameters.

Printer Model	Action
PAX Series print engines, Xi Series printers, and 105SL printers	<ol style="list-style-type: none"> 1. Use the LEFT oval key to select the position to be adjusted 2. Use the RIGHT oval key to select the correct value for that position.
Z4Mplus and Z6Mplus printers	<ol style="list-style-type: none"> 1. Press SELECT to select the parameter. 2. Use the MINUS (-) key to select the position to be adjusted. 3. Use the PLUS (+) key to select the correct value for that position. 4. Press SELECT to accept any changes and deselect the parameter.
S4M printer	<ol style="list-style-type: none"> 1. Press ENTER. The printer displays the current RTC date. 2. Modify the values as follows: <ul style="list-style-type: none"> • Press the right arrow to move to the next digit position. • To increase the value, press the up arrow. • To decrease the value, press the down arrow. 3. Press ENTER to accept the value shown.

RTC General Information

The Real Time Clock commands are only applicable if the Real Time Clock option is installed in the printer. For those printers with an LCD control panel display, additional control panel configuration parameters are also included.

The ZPL II Field Clock **^FC** command is used to specify the clock-indicator character for the primary, secondary, and third clocks. This command must be included within each label field command string whenever the date or time clock values are required within the field. No date or time clock information can be printed in a label field unless this command is included. The **^FC** command can now be combined with the **^SN** command in V60.13.0.10 and later.

A clock-indicator can be any printable character except the ZPL II Format Prefix, Control Prefix, or Delimiter characters. The default value for the primary clock-indicator is the percent sign **%**. The secondary and third clock-indicators have no defaults and must be specified in order for that clock to be used.

The Field Data **^FD** command has been expanded to recognize the clock-indicators and associated command characters, and to replace them during the printing process with the corresponding time or date parameter. For example, if the primary clock-indicator is the percent sign **%**, then during printing, the character sequence **%H** in the **^FD** statement would be replaced by the 2-digit current hour.



NOTE: If the Real Time Clock is not installed, or the **^FC** command has not preceded the **^FD** statement, no replacement would occur. In this case, the characters **%H** would print as text on the label.

The name of the day of the week, the name of the month, and the AM or PM designation can also be inserted in place of a specific clock-indicator/command character sequence. See [Table 36](#) for the list of command characters and their functions.

Table 36 Command Characters

Command Character	Function
%a	is replaced by the abbreviated weekday name
%A	is replaced by the weekday name
%b	is replaced by the abbreviated month name
%B	is replaced by the month name
%d	is replaced by the day of the month number, 01 to 31
%H	is replaced by the hour of the day (military), 00 to 23
%I	is replaced by the hour of the day (civilian), 01 to 12
%j	is replaced by the day of the year, 001 to 366
%m	is replaced by the month number, 01 to 12
%M	is replaced by the minute, 00 to 59
%p	is replaced by the AM or PM designation
%S	is replaced by the seconds, 00 to 59
%U	is replaced by the week# of the year, 00 to 53, Sunday is 1st day*
%W	is replaced by the week# of the year, 00 to 53, Monday is 1st day**
%w	is replaced by the day# of the week, 00 (Sunday) to 06 (Saturday)
%y	is replaced by the 2 digits of the year, 00 to 99
%Y	is replaced by the full 4 digit year number—where% is the specified clock-indicator character

*. %U establishes Sunday as the first day of the year.

**.%W establishes Monday as the first day of the year.

The Set Offset **^S0** command permits the printing of specific times and dates relative to the primary clock. The secondary (or third) clock is enabled when secondary (or third) offsets are entered using this command. The secondary (or third) clock time and date are determined by adding the offsets to the current clock reading.

One **^S0** command is required to set the secondary offset; an additional **^S0** command is required for a third offset. The offsets remain until changed or until the printer is either powered down or reset.



NOTE: Only dates from January 1, 1998 to December 31, 2097 are supported. Setting the offsets to values that result in dates outside this range is not recommended and may have unexpected results.

The Set Mode/Language (see **^SL** on page 320) command is used to select the language the days of the week and the months are printed in. This command also sets the printing mode, which can be **S** for START TIME, **T** for TIME NOW, or a Numeric Value for the time accuracy. In START TIME mode, the time printed on the label is the time that is read from the Real Time Clock when the label formatting begins (when the **^XA** command is received by the printer). In TIME NOW mode, the time printed on the label is the time that is read from the Real Time Clock when the label is placed in the queue to be printed. In Numeric Value mode, a time accuracy tolerance can be specified.

First Day of the Week Affects Calendar Week

The %U and %W commands set the first day of the week. The week numbering starts at the beginning of the year with Week 01 representing the **first full week** of the year. Any day(s) before that established first day of the week are part of the Week 00. The following examples show how setting different days as the first day of the week affect the calendar week.



IMPORTANT: The %U and %W commands determine the numbering for all weeks in the year.

January, 2005 with Week 00

Set Sunday as the first day of the week using the %U command. In this example, notice that Saturday, January 1st is Week 00 and Sunday, January 2nd begins Week 01.

	Sun	Mon	Tue	Wed	Thu	Fri	Sat	
							1	← Week 00
First Day of the Week →	2	3	4	5	6	7	8	← Week 01
	9	10	11	12	13	14	15	
	16	17	18	19	20	21	22	
	23	24	25	26	27	28	29	
	30	31						

January, 2005 with Week 00

Set Monday as the first day of the week using the %W command. In this example, notice that Saturday, January 1st **and** Sunday, January 2nd are Week 00 and Monday, January 3rd begins Week 01.

	Mon	Tue	Wed	Thu	Fri	Sat	Sun	
						1	2	← Week 00
First Day of the Week →	3	4	5	6	7	8	9	← Week 01
	10	11	12	13	14	15	16	
	17	18	19	20	21	22	23	
	24	25	26	27	28	29	30	
	31							

January, 2006 without Week 00

Set Sunday as the first day of the week using the %U command. Since 2006 begins on a Sunday, there is no Week 00 in this example.

	Sun	Mon	Tue	Wed	Thu	Fri	Sat	
	No Week 00							
First Day of the Week →	1	2	3	4	5	6	7	← Week 01
	8	9	10	11	12	13	14	
	15	16	17	18	19	20	21	
	22	23	24	25	26	27	28	
	29	30	31					

January, 2006 with Week 00

Set Monday as the first day of the week using the %W command. In this example, Saturday, January 1st is Week 00 and Sunday, January 2nd begins Week 01.

	Mon	Tue	Wed	Thu	Fri	Sat	Sun
							1
First Day of the Week →	2	3	4	5	6	7	8
	9	10	11	12	13	14	15
	16	17	18	19	20	21	22
	23	24	25	26	27	28	29
	30	31					

← Week 00

← Week 01

Time and Date Precision

As of V60.13.0.1 firmware, the ^C0 command is now ignored. While the S4M printer has a lower firmware version number (V50.x), its firmware was recently released and follows the rule to ignore the ^C0 command.

The time and date placed in a label field is determined at the time the label bitmap is created by the printer (start time mode). If a batch of labels is formatted, the date and time will be the same for all labels in the batch. If the printer is paused during the printing process and remains in that state for a period of time, when printing resumes, the time and date will still be the same as when the batch was first started.

If more precise time and date stamps are required on versions prior to V60, follow the process below. For versions after V60, use the Numeric Value mode as shown in [^SL on page 320](#).

Cycle the printer/print engine power Off (O) and On (I) to clear the memory before performing the steps below.

1. Print a Memory Usage Label (^XA^WD* : * . * ^XZ) and note the following value:
Available RAM (in BYTES) (A) _____

2. Print a Configuration Label and note these values:
Printer "Print Width" (in DOTS) (B) _____
Label Length (in DOTS) (C) _____

3. Determine the desired maximum number of queued labels with the same Time and Date value. (D) _____



NOTE: Increasing the number of queued labels will improve throughput performance, but Real Time Clock values will be less accurate. Two is usually a good compromise.

4. Substitute the values for B through D from the previous page into the following formula:
The "label queue" memory required (in BYTES) (E) _____
(B x C x D)/8 =

5. Substitute the values for A and E into the following formula:

The ^CO command memory required (in KBYTES)
 $(A-E)/1024)-5=$

(F) _____



NOTE: If the value of (F) is less than zero, then no ^CO command is needed. If the value of (F) is greater than zero, use the integer portion in the ^CO command.

Available RAM (A) = 71478 BYTES

Print Width (B) = 832 DOTS

Label Length (C) = 1000 DOTS

Max Labels Queued (D) = 2

Then —

The label queue memory required (E) =

$(B \times C \times D)/8 = 208000$ BYTES

And —

The ^CO command memory required (F) =

$(71478-208000)/1024)-5=489.87$ KBYTES

Therefore, the correct ^CO command string to add to the label format would be:

`^XA^COY,489^XZ`

This command string will cause 489 KBYTES to be set aside as Font Memory and make it unavailable as label format memory. The memory remaining will only allow two labels to be formatted at one time, and the time and date will be more precise for those two labels.

ZPL II Samples

The ZPL II scripts shown on this page establish the initial settings for the date and time clock. The script below then references these settings to provide the output shown in [Figure 84 on page 1449](#).

Setting the date and time for the Real Time Clock only needs to be done once. The date and time are maintained by an on-board battery when the printer is reset or the printer is turned Off (O).

To set the date and time to April 23, 2005 at 2:30pm, the following command string should be sent to the printer:

```
^XA
^ST04,23,2005,02,30,0,P^FS
^XZ
```

To initialize the Real Time Clock and set up two offset values (offset #2 set to 3 months and 1 hour in the future, offset #3 set to 1 year in the past), the following command sequence should be sent to the printer:

```
^XA
^SL
^S02,3,0,0,1,0,0^FS
^S03,0,0,-1,0,0,0^FS
^XZ
```

The above ZPL II scripts initialize the RTC date and time and must be sent to a printer to provide proper date and time parameters for the ZPL II script below.

The following ZPL II script illustrates the various methods of printing the date and time initialized in the script above within separate fields on continuous media. [Figure 84 on page 1449](#) illustrates the printout of this script on a label.

For the below example, the ^FC command delimiters are:

```
% Primary clock indicator
{ Secondary clock indicator
# Third clock indicator
```

```
^XA
^LL175
^F010,025^AD^FC%,{,#^FD1: Mil: %H:%M:%S Civ: %I:%M:%S %p^FS
^F010,050^AD^FC%,{,#^FD2: Mil: {H:{M:{S Civ: {I:{M:{S {p^FS
^F010,075^AD^FC%,{,#^FD3: Mil: #H:#M:#S Civ: #I:#M:#S #p^FS
^F010,100^AD^FC%,{,#^FD1: On %A, %B %d
, %Y (%a, %m/%d/%y, %d %b %Y).^FS
^F010,125^AD^FC%,{,#^FD2: On {A, {B {d, {Y (
{a, {m/{d/{y, {d {b {Y).^FS
^F010,150^AD^FC%,{,#^FD3: On #A, #B #d, #Y (
#a, #m/#d/#y, #d #b #Y).^FS
^XZ
```

Figure 84 Printed Result of the Above ZPL II Script

1: Mil: 14:30:00 Civ: 02:30:00 PM
2: Mil: 15:30:00 Civ: 03:30:00 PM
3: Mil: 14:30:00 Civ: 02:30:00 PM
1: On Wed, April 23, 2005 (Fri, 04/23/05, 23 Apr 2005)
2: On Saturday, July 23, 2005 (Sat, 07/23/05, 23 Jul 2005)
3: On Friday, April 23, 2004 (Fri, 04/23/04, 23 Apr 2004)

The following are examples of the time stamp using the **^SL1** and **^SL5** at 2 ips and 10 ips for the Enhanced Real Time Clock (V60.13.0.10 and later).



NOTE: They show the variation of time due to print speed and label complexity.

```
^XA  
^SL1^FS  
^F0187,184^A0N,101,121^FC%^FD%H:%M:%S^FS  
^PQ10  
^XZ
```

Figure 85 Example of ^SL1, 2 ips and 10 ips

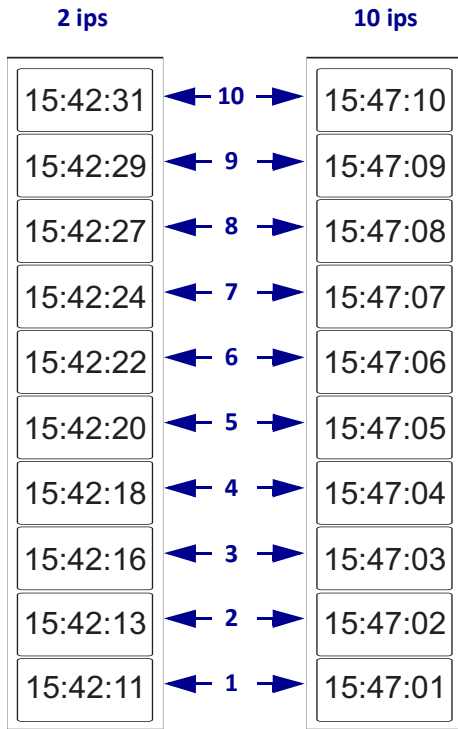

1	Label 1
2	Label 2
3	Label 3
4	Label 4
5	Label 5

6	Label 6
7	Label 7
8	Label 8
9	Label 9
10	Label 10

^XA

^SL5^FS

^F0187,184^A0N,101,121^FC%^FD%H:%M:%S^FS

^PQ10

^XZ

Figure 86 Example of ^SL5, 2 ips and 10 ips

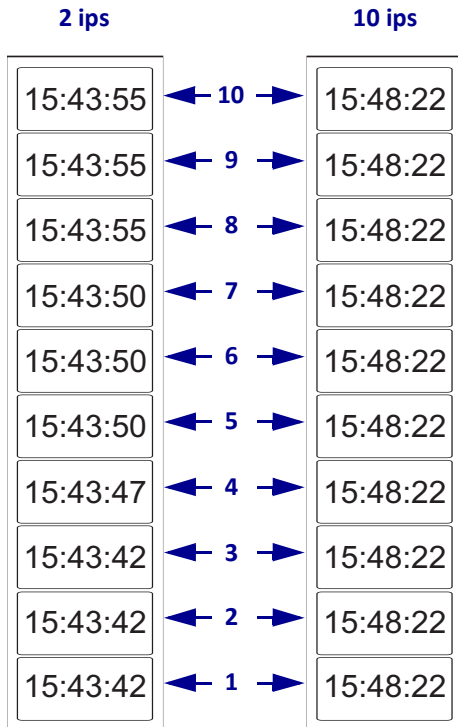

1	Label 1
2	Label 2
3	Label 3
4	Label 4
5	Label 5

6	Label 6
7	Label 7
8	Label 8
9	Label 9
10	Label 10

ZBI Character Set

This section provides you with the set of characters that are supported on the front panel of the following Zebra printers with ZBI 2.0: XiiiPlus, 105SL, Z4M/Z6M, ZM400/ZM600, RZ400/RZ600, PAX4 and S4M when V60.16.0Z or V53.16.0Z, or later firmware are loaded. These characters can be used in ZBI programs to display content on the LCD.

ZBI Character Set

These are the supported characters for these Zebra printers:

- XiIIIPlus
- 105SL
- Z4M/Z6M
- PAX4
- S4M

Char. code

	0	0	0	0	0	0	0	1	1	1	1	1	1
	0	0	0	1	1	1	1	0	0	1	1	1	1
	0	1	1	0	0	1	1	1	1	0	0	1	1
	0	0	1	0	1	0	1	0	1	0	1	0	1
xxxx0000			0	0	P	`	P		-	9	≡	α	∅
xxxx0001		!	1	A	Q	a	q	。	ア	チ	△	△	∅
xxxx0010		"	2	B	R	b	r	「	イ	ツ	×	β	θ
xxxx0011		#	3	C	S	c	s	」	ウ	テ	ε	ε	∞
xxxx0100		\$	4	D	T	d	t	、	エ	ト	μ	μ	Ω
xxxx0101		%	5	E	U	e	u	・	オ	ナ	1	∅	Ü
xxxx0110		&	6	F	V	f	v	ヲ	カ	ニ	ヨ	ρ	Σ
xxxx0111		'	7	G	W	g	w	ア	キ	ヌ	ラ	q	π
xxxx1000		<	8	H	X	h	x	イ	ク	ネ	リ	∫	∞
xxxx1001		>	9	I	Y	i	y	ウ	ツ	ル	”	∫	∅
xxxx1010		*	:	J	Z	j	z	エ	コ	∅	レ	i	∫
xxxx1011		+	;	K	[k	[オ	サ	ヒ	∅	*	∫
xxxx1100		,	<	L	¥	l	∫	カ	シ	フ	フ	∅	∫
xxxx1101		-	=	M]	m	∫	ユ	ヌ	∅	∫	∫	∅
xxxx1110		.	>	N	^	n	∫	ヨ	セ	ホ	∅	∫	∅
xxxx1111		/	?	∅	_	∅	∫	ツ	∫	∫	∫	∅	■

ZBI Character Set

These are the supported characters for these Zebra printers:

- ZM400/ZM600
- RZ400/RZ600
- Xi4
- RXi4

space 0020	" 0022	% 0025	& 0026	(0028) 0029	+ 002B	- 002D	. 002E	/ 002F
0 0030	1 0031	2 0032	3 0033	4 0034	6 0035	7 0037	8 0038	9 0039	: 003A
> 003E	? 003F	A 0041	B 0042	C 0043	D 0044	E 0045	F 0046	G 0047	H 0048
I 0049	J 004A	K 004B	L 004C	M 004D	N 004E	O 004F	P 0050	Q 0051	R 0052
S 0053	T 0054	U 0055	V 0056	W 0057	X 0058	Y 0059	Z 005A	_ 005F	

SGD Command Support

This appendix provides you with details identifying which SGD commands can be used with different printers.

SGDs Supported for Industrial Printers

This table provides details of the list of SGDs supported for Industrial Printers.

Command Name	Industrial						
	105SL	110Xi4 140Xi4 170Xi4 220Xi4	ZM400 ZM600	ZT210 ZT220 ZT230	ZT410 ZT420	ZT510	ZT610 ZT620
alerts.add				X	X	X	X
alerts.conditions				X	X	X	X
alerts.configured				X	X	X	X
alerts.destinations				X	X	X	X
alerts.http.authentication.add				X	X	X	X
alerts.http.authentication.entries				X	X	X	X
alerts.http.authentication.remove				X	X	X	X
alerts.http.logging.clear				X	X	X	X
alerts.http.logging.entries				X	X	X	X
alerts.http.logging.max_entries				X	X	X	X
alerts.http.proxy				X	X	X	X
alerts.tracked_settings.clear_log				X	X	X	X
alerts.tracked_settings.log_tracked				X	X	X	X
alerts.tracked_settings.max_log_entries				X	X	X	X
alerts.tracked_settings.zbi_notified				X	X	X	X
apl.enable				X	X	X	X
apl.framework_version				X	X	X	X
apl.version				X	X	X	X
appl.bootblock	X	X	X	X	X	X	X
appl.date	X	X	X	X	X	X	X
appl.link_os_version				X	X	X	X
appl.name	X	X	X	X	X	X	X

An X indicates that the SGD is supported for the particular device.
This table indicates support based on the most recent Link-OS system release.

SGD Command Support

Command Name	Industrial						
	105SL	110Xi4 140Xi4 170Xi4 220Xi4	ZM400 ZM600	ZT210 ZT220 ZT230	ZT410 ZT420	ZT510	ZT610 ZT620
bluetooth.address					X	X	X
bluetooth.authentication							
bluetooth.bluetooth_pin					X	X	X
bluetooth.clear_bonding_cache					X	X	X
bluetooth.discoverable				X	X	X	X
bluetooth.enable					X	X	X
bluetooth.enable_reconnect					X	X	X
bluetooth.friendly_name				X	X	X	X
bluetooth.json_config_channel_enable					X	X	X
bluetooth.le.controller_mode						X	X
bluetooth.le.minimum_security						X	X
bluetooth.le.power_class						X	X
bluetooth.local_name					X	X	X
bluetooth.minimum_security_mode					X	X	X
bluetooth.page_scan_window					X	X	X
bluetooth.radio_version					X	X	X
bluetooth.short_address					X	X	X
bluetooth.version					X	X	X
capture.channel1.count				X	X	X	X
capture.channel1.data.mime				X	X	X	X
capture.channel1.data.raw				X	X	X	X
capture.channel1.delimiter				X	X	X	X
capture.channel1.max_length				X	X	X	X
capture.channel1.port				X	X	X	X
comm.baud	X	X	X	X	X	X	X
comm.halt							
comm.parity	X	X	X	X	X	X	X
comm.stop_bits	X	X		X	X	X	X
comm.type							
cradle.comm.baud							
cradle.comm.handshake							
cutter.clean_cutter	X	X	X	X	X	X	X
device.allow_firmware_downloads				X	X	X	X
device.applicator.data_ready							X
device.applicator.data_ready_activation							X
device.applicator.end_print							X
device.applicator.error_on_pause							X
device.applicator.feed							X

An X indicates that the SGD is supported for the particular device.
This table indicates support based on the most recent Link-OS system release.

SGD Command Support

Command Name	Industrial						
	105SL	110Xi4 140Xi4 170Xi4 220Xi4	ZM400 ZM600	ZT210 ZT220 ZT230	ZT410 ZT420	ZT510	ZT610 ZT620
device.applicator.media_out						X	X
device.applicator.pause						X	X
device.applicator.reprint						X	X
device.applicator.rfid_void						X	X
device.applicator.ribbon_low						X	X
device.applicator.ribbon_out						X	X
device.applicator.service_required						X	X
device.applicator.start_print							X
device.applicator.start_print_mode							X
device.applicator.voltage							X
device.bluetooth_installed					X	X	X
device.command_override.active				X	X	X	X
device.command_override.add				X	X	X	X
device.command_override.clear				X	X	X	X
device.command_override.list				X	X	X	X
device.company_contact				X	X	X	X
device.configuration_number							X
device.cpcl_synchronous_mode				X	X	X	X
device.cutter_installed				X	X	X	X
device.download_connection_timeout	X	X	X	X	X	X	X
device.download_interactive_mode							
device.epi_legacy_mode				X	X	X	X
device.feature.802_11ac				X	X	X	X
device.feature.bluetooth_le					X	X	X
device.feature.head_element_test					X	X	X
device.feature.lighted_arrows				X	X	X	X
device.feature.mcr				X	X	X	X
device.feature.nfc				X	X	X	X
device.feature.ribbon_cartridge				X	X		X
device.friendly_name	X	X	X	X	X	X	X
device.frontpanel.key_press				X	X	X	X
device.frontpanel.line1	X	X	X	X	X	X	X
device.frontpanel.line2	X	X	X	X	X	X	X
device.frontpanel.wml_menus	X	X	X				
device.frontpanel.xml	X	X	X	X	X	X	X
device.host_identification				X	X	X	X
device.host_status				X	X	X	X
device.idle_display_format				X	X	X	X

An X indicates that the SGD is supported for the particular device.
This table indicates support based on the most recent Link-OS system release.

SGD Command Support

Command Name	Industrial						
	105SL	110Xi4 140Xi4 170Xi4 220Xi4	ZM400 ZM600	ZT210 ZT220 ZT230	ZT410 ZT420	ZT510	ZT610 ZT620
device.idle_display_value				X	X	X	X
device.internal_wired_setting_location				X	X	X	X
device.job_log.total_jobs				X	X	X	X
device.jobs_print	X	X	X	X	X	X	X
device.languages	X	X	X	X	X	X	X
device.light.cover_open_brightness					X	X	X
device.light.head_open_brightness					X		
device.light.media_path_brightness						X	X
device.light.ribbon_path_brightness						X	X
device.ltu_installed				X	X	X	X
device.pause				X	X	X	X
device.pmcu.revision						X	X
device.pnp_option	X	X	X	X	X	X	X
device.position.accuracy				X	X	X	X
device.position.altitude				X	X	X	X
device.position.latitude				X	X	X	X
device.position.longitude				X	X	X	X
device.print_2key							
device.print_reprogram_2key				X	X	X	X
device.printhead.odometer						X	X
device.printhead.resolution				X	X	X	X
device.printhead.test.summary							
device.product_name_submodel				X	X	X	X
device.reset				X	X	X	X
device.restore_defaults				X	X	X	X
device.rewinder_installed				X	X	X	X
device.save_2key							
device.sensor_profile				X	X	X	X
device.sensor_select				X	X	X	X
device.serial_numbers.applicator_option_board						X	X
device.serial_numbers.applicator_option_board_date							X
device.serial_numbers.control_panel_date				X	X	X	X
device.serial_numbers.cutter				X	X	X	X
device.serial_numbers.cutter_date				X	X	X	X
device.serial_numbers.mlb_date				X	X	X	X
device.serial_numbers.parallel_option_board						X	X
device.serial_numbers.parallel_option_board_date							X
device.serial_numbers.printhead				X	X	X	X

An X indicates that the SGD is supported for the particular device.
 This table indicates support based on the most recent Link-OS system release.

SGD Command Support

Command Name	Industrial						
	105SL	110Xi4 140Xi4 170Xi4 220Xi4	ZM400 ZM600	ZT210 ZT220 ZT230	ZT410 ZT420	ZT510	ZT610 ZT620
device.serial_numbers.printhead_date				X	X	X	X
device.serial_numbers.usb_host_option_board						X	X
device.serial_numbers.usb_host_option_board_date						X	X
device.serial_numbers.wired_ethernet_option_board				X	X	X	X
device.serial_numbers.wired_ethernet_option_board_date							X
device.set_clock_to_build_date				X	X		X
device.slot_1				X	X	X	X
device.slot_2					X	X	X
device.super_host_status				X	X	X	X
device.syslog.clear_log				X	X	X	X
device.syslog.configuration				X	X	X	X
device.syslog.enable				X	X	X	X
device.syslog.entries				X	X	X	X
device.syslog.log_max_file_size				X	X	X	X
device.syslog.save_local_file				X	X	X	X
device.unique_id	X	X	X	X	X	X	X
device.unpause				X	X	X	X
device.uptime	X	X	X	X	X	X	X
device.user_p1	X	X	X	X	X	X	X
device.user_p2	X	X	X	X	X	X	X
device.user_vars.create				X	X	X	X
device.user_vars.set_range				X	X	X	X
device.xml.enable	X	X	X	X	X	X	X
display.backlight				X	X	X	X
display.backlight_on_time				X	X	X	X
display.batch_counter				X	X	X	X
display.bluetooth.mac							
display.language				X	X	X	X
display.load_card				X	X	X	X
display.password.level				X	X	X	X
display.root_wml				X	X	X	X
display.status_bar_suppress				X	X	X	X
display.suppress_all_alerts				X	X	X	X
display.text	X	X	X		X	X	X
external_wired.check	X	X	X				
external_wired.ip.addr	X	X	X				
external_wired.ip.arp_interval	X	X	X				

An X indicates that the SGD is supported for the particular device.
This table indicates support based on the most recent Link-OS system release.

SGD Command Support

Command Name	Industrial						
	105SL	110Xi4 140Xi4 170Xi4 220Xi4	ZM400 ZM600	ZT210 ZT220 ZT230	ZT410 ZT420	ZT510	ZT610 ZT620
external_wired.ip.default_addr_enable	X	X	X				
external_wired.ip.gateway	X	X	X				
external_wired.ip.netmask	X	X	X				
external_wired.ip.port	X	X	X				
external_wired.ip.protocol	X	X	X				
external_wired.ip.timeout.enable	X	X	X				
external_wired.ip.timeout.value	X	X	X				
external_wired.ip.v6.addr	X	X	X				
external_wired.ip.v6.gateway	X	X	X				
external_wired.ip.v6.prefix_length	X	X	X				
external_wired.mac_addr	X	X	X				
external_wired.mac_raw	X	X	X	X	X	X	X
ezpl.head_close_action				X	X	X	X
ezpl.label_length_max				X	X	X	X
ezpl.label_sensor				X	X	X	X
ezpl.manual_calibration				X	X	X	X
ezpl.media_type				X	X	X	X
ezpl.power_up_action				X	X	X	X
ezpl.print_method				X	X	X	X
ezpl.print_width				X	X	X	X
ezpl.reprint_mode				X	X	X	X
ezpl.restore_defaults				X	X	X	X
ezpl.take_label				X	X	X	X
ezpl.tear_off				X	X	X	X
file.capture_response.destination				X	X	X	X
file.cert.expiration				X	X	X	X
file.cert.supported_curves				X	X	X	X
file.delete				X	X	X	X
file.dir	X	X	X	X	X	X	X
file.dir_format				X	X	X	X
file.run				X	X	X	X
file.type				X	X	X	X
formats.cancel_all				X	X	X	X
head.authenticated						X	X
head.darkness_switch							
head.darkness_switch_enable							
head.element_test							
head.latch	X	X	X	X	X	X	X

An X indicates that the SGD is supported for the particular device.
This table indicates support based on the most recent Link-OS system release.

SGD Command Support

Command Name	Industrial						
	105SL	110Xi4 140Xi4 170Xi4 220Xi4	ZM400 ZM600	ZT210 ZT220 ZT230	ZT410 ZT420	ZT510	ZT610 ZT620
head.resolution.in_dpi				X	X	X	X
input.capture				X	X	X	X
interface.network.active.arp_interval				X	X	X	X
interface.network.active.cable_type				X	X	X	X
interface.network.active.dhcp_received_host_name				X	X	X	X
interface.network.active.gateway	X	X	X	X	X	X	X
interface.network.active.ip_addr	X	X	X	X	X	X	X
interface.network.active.mac_addr	X	X	X	X	X	X	X
interface.network.active.mac_raw	X	X	X	X	X	X	X
interface.network.active.netmask	X	X	X	X	X	X	X
interface.network.active.printserver	X	X	X	X	X	X	X
interface.network.active.protocol	X	X	X	X	X	X	X
interface.network.active.protocol_error				X	X	X	X
interface.network.active.rx_errors				X	X	X	X
interface.network.active.rx_packets				X	X	X	X
interface.network.active.server_address				X	X	X	X
interface.network.active.speed				X	X	X	X
interface.network.active.tx_errors				X	X	X	X
interface.network.active.tx_packets				X	X	X	X
interface.network.active.wins_addr				X	X	X	X
interface.network.settings_require_reset				X	X	X	X
internal_wired.8021x.password				X	X		X
internal_wired.8021x.peap.anonymous_identity				X	X	X	X
internal_wired.8021x.peap.validate_server_certificate				X	X	X	X
internal_wired.8021x.security				X	X		X
internal_wired.8021x.ttls_tunnel				X	X	X	X
internal_wired.8021x.username				X	X		X
internal_wired.activity_led				X	X	X	X
internal_wired.auto_switchover	X	X	X	X	X	X	X
internal_wired.enable				X	X		X
internal_wired.installed				X	X	X	X
internal_wired.ip.addr	X	X	X	X	X	X	X
internal_wired.ip.arp_interval	X	X	X	X	X	X	X
internal_wired.ip.default_addr_enable	X	X	X	X	X	X	X
internal_wired.ip.dhcp.arp_verify				X	X	X	X
internal_wired.ip.dhcp.cache_ip	X	X	X	X	X	X	X
internal_wired.ip.dhcp.cid_all	X	X	X	X	X	X	X
internal_wired.ip.dhcp.cid_enable	X	X	X	X	X	X	X

An X indicates that the SGD is supported for the particular device.
This table indicates support based on the most recent Link-OS system release.

SGD Command Support

Command Name	Industrial						
	105SL	110Xi4 140Xi4 170Xi4 220Xi4	ZM400 ZM600	ZT210 ZT220 ZT230	ZT410 ZT420	ZT510	ZT610 ZT620
internal_wired.ip.dhcp.cid_prefix	X	X	X	X	X	X	X
internal_wired.ip.dhcp.cid_suffix	X	X	X	X	X	X	X
internal_wired.ip.dhcp.cid_type	X	X	X	X	X	X	X
internal_wired.ip.dhcp.lease.last_attempt	X	X	X	X	X	X	X
internal_wired.ip.dhcp.lease.length	X	X	X	X	X	X	X
internal_wired.ip.dhcp.lease.server	X	X	X	X	X	X	X
internal_wired.ip.dhcp.lease.time_left	X	X	X	X	X	X	X
internal_wired.ip.dhcp.option12	X	X	X	X	X	X	X
internal_wired.ip.dhcp.option12_format	X	X	X	X	X	X	X
internal_wired.ip.dhcp.option12_value	X	X	X	X	X	X	X
internal_wired.ip.dhcp.requests_per_session	X	X	X	X	X	X	X
internal_wired.ip.dns.servers				X	X	X	X
internal_wired.ip.gateway	X	X	X	X	X	X	X
internal_wired.ip.netmask	X	X	X	X	X	X	X
internal_wired.ip.port	X	X	X	X	X	X	X
internal_wired.ip.port_alternate				X	X	X	X
internal_wired.ip.port_json_config				X	X	X	X
internal_wired.ip.protocol	X	X	X	X	X	X	X
internal_wired.ip.timeout.enable	X	X	X	X	X	X	X
internal_wired.ip.timeout.value	X	X	X	X	X	X	X
internal_wired.ip.wins.addr	X	X	X	X	X	X	X
internal_wired.ip.wins.permanent_source	X	X	X	X	X	X	X
internal_wired.mac_addr	X	X	X	X	X	X	X
internal_wired.mac_raw	X	X	X	X	X	X	X
ip.active_network	X	X	X	X	X	X	X
ip.addr	X	X	X	X	X	X	X
ip.arp_interval	X	X	X	X	X	X	X
ip.bootp.enable	X	X	X	X	X	X	X
ip.dhcp.arp_verify				X	X	X	X
ip.dhcp.auto_provision_enable				X	X	X	X
ip.dhcp.cache_ip	X	X	X	X	X	X	X
ip.dhcp.cid_all	X	X	X	X	X	X	X
ip.dhcp.cid_enable	X	X	X	X	X	X	X
ip.dhcp.cid_prefix	X	X	X	X	X	X	X
ip.dhcp.cid_suffix	X	X	X	X	X	X	X
ip.dhcp.cid_type	X	X	X	X	X	X	X
ip.dhcp.cid_value	X	X	X	X	X	X	X
ip.dhcp.enable	X	X	X	X	X	X	X

An X indicates that the SGD is supported for the particular device.
This table indicates support based on the most recent Link-OS system release.

SGD Command Support

Command Name	Industrial						
	105SL	110Xi4 140Xi4 170Xi4 220Xi4	ZM400 ZM600	ZT210 ZT220 ZT230	ZT410 ZT420	ZT510	ZT610 ZT620
ip.dhcp.lease.last_attempt	X	X	X	X	X	X	X
ip.dhcp.lease.server	X	X	X	X	X	X	X
ip.dhcp.lease.time_left	X	X	X	X	X	X	X
ip.dhcp.ntp.enable				X	X	X	X
ip.dhcp.ntp.received_servers				X	X	X	X
ip.dhcp.option12	X	X	X	X	X	X	X
ip.dhcp.option12_format	X	X	X	X	X	X	X
ip.dhcp.option12_value	X	X	X	X	X	X	X
ip.dhcp.request_timeout	X	X	X	X	X	X	X
ip.dhcp.requests_per_session	X	X	X	X	X	X	X
ip.dhcp.session_interval	X	X	X	X	X	X	X
ip.dhcp.user_class_id				X	X	X	X
ip.dhcp.vendor_class_id				X	X	X	X
ip.dns.servers	X	X	X	X	X	X	X
ip.firewall.whitelist_in				X	X	X	X
ip.ftp.enable	X	X	X	X	X	X	X
ip.ftp.execute_file	X	X	X	X	X	X	X
ip.ftp.request_password				X	X	X	X
ip.gateway	X	X	X	X	X	X	X
ip.http.admin_name				X	X	X	X
ip.http.admin_password				X	X	X	X
ip.http.custom_link_name				X	X	X	X
ip.http.custom_link_url				X	X	X	X
ip.http.enable	X	X	X	X	X	X	X
ip.http.faq_url				X	X	X	X
ip.http.port				X	X	X	X
ip.https.enable				X	X	X	X
ip.https.port				X	X	X	X
ip.lpd.enable	X	X	X	X	X	X	X
ip.mirror.appl_path				X	X	X	X
ip.mirror.auto	X	X	X	X	X	X	X
ip.mirror.error_retry	X	X	X	X	X	X	X
ip.mirror.feedback.auto	X	X	X	X	X	X	X
ip.mirror.feedback.freq	X	X	X	X	X	X	X
ip.mirror.feedback.odometer	X	X	X	X	X	X	X
ip.mirror.feedback.path	X	X	X	X	X	X	X
ip.mirror.fetch				X	X	X	X
ip.mirror.freq	X	X	X	X	X	X	X

An X indicates that the SGD is supported for the particular device.
This table indicates support based on the most recent Link-OS system release.

SGD Command Support

Command Name	Industrial						
	105SL	110Xi4 140Xi4 170Xi4 220Xi4	ZM400 ZM600	ZT210 ZT220 ZT230	ZT410 ZT420	ZT510	ZT610 ZT620
ip.mirror.freq_hours	X	X	X	X	X	X	X
ip.mirror.interface				X	X	X	X
ip.mirror.last_error	X	X	X	X	X	X	X
ip.mirror.last_time	X	X	X	X	X	X	X
ip.mirror.mode				X	X	X	X
ip.mirror.password	X	X	X	X	X	X	X
ip.mirror.path	X	X	X	X	X	X	X
ip.mirror.reset_delay				X	X	X	X
ip.mirror.server	X	X	X	X	X	X	X
ip.mirror.success	X	X	X	X	X	X	X
ip.mirror.success_time	X	X	X	X	X	X	X
ip.mirror.username	X	X	X	X	X	X	X
ip.mirror.version	X	X	X	X	X	X	X
ip.netmask	X	X	X	X	X	X	X
ip.ntp.enable				X	X	X	X
ip.ntp.log				X	X	X	X
ip.ntp.servers				X	X	X	X
ip.ping_gateway_interval				X	X	X	X
ip.ping_remote				X	X	X	X
ip.pop3.enable	X	X	X	X	X	X	X
ip.pop3.password	X	X	X	X	X	X	X
ip.pop3.poll	X	X	X	X	X	X	X
ip.pop3.print_body				X	X	X	X
ip.pop3.print_headers				X	X	X	X
ip.pop3.save_attachments				X	X	X	X
ip.pop3.server_addr	X	X	X	X	X	X	X
ip.pop3.username	X	X	X	X	X	X	X
ip.pop3.verbose_headers				X	X	X	X
ip.port	X	X	X	X	X	X	X
ip.port_alternate				X	X	X	X
ip.port_json_config				X	X	X	X
ip.port_single_conn				X	X	X	X
ip.port_single_conn_idle_timeout				X	X	X	X
ip.primary_network	X	X	X	X	X	X	X
ip.smtp.domain	X	X	X	X	X	X	X
ip.smtp.enable	X	X	X	X	X	X	X
ip.smtp.server_addr	X	X	X	X	X	X	X
ip.snmp.enable	X	X	X	X	X	X	X

An X indicates that the SGD is supported for the particular device.
This table indicates support based on the most recent Link-OS system release.

SGD Command Support

Command Name	Industrial						
	105SL	110Xi4 140Xi4 170Xi4 220Xi4	ZM400 ZM600	ZT210 ZT220 ZT230	ZT410 ZT420	ZT510	ZT610 ZT620
ip.snmp.get_community_name				X	X	X	X
ip.snmp.set_community_name				X	X	X	X
ip.snmp.trap_community_name				X	X	X	X
ip.tcp.enable	X	X	X	X	X	X	X
ip.tcp.nagle_algorithm				X	X	X	X
ip.telnet.enable	X	X	X	X	X	X	X
ip.tls.enable				X	X	X	X
ip.tls.port				X	X	X	X
ip.tls.port_json_config				X	X	X	X
ip.udp.enable	X	X	X	X	X	X	X
log.reboot.code				X	X	X	X
log.reboot.codes				X	X	X	X
log.reboot.reason				X	X	X	X
log.reboot.report				X	X	X	X
mcr.cancel							
mcr.crypt.algorithm							
mcr.crypt.enabled							
mcr.crypt.key_mgmt							
mcr.out							
mcr.query							
mcr.revision							
media.bar_location				X	X	X	X
media.cartridge.darkness							
media.cartridge.inserted							
media.cartridge.labels_remaining							
media.cartridge.length							
media.cartridge.part_number							
media.cartridge.serial_number							
media.cartridge.speed							
media.cartridge.total_label_cnt							
media.cartridge.width							
media.cut_now				X	X	X	X
media.darkness_mode	X	X	X				
media.draft_mode							
media.dynamic_length_calibration				X	X	X	X
media.feed_skip							
media.media_low.external							
media.media_low.warning	X	X	X				

An X indicates that the SGD is supported for the particular device.
 This table indicates support based on the most recent Link-OS system release.

SGD Command Support

Command Name	Industrial						
	105SL	110Xi4 140Xi4 170Xi4 220Xi4	ZM400 ZM600	ZT210 ZT220 ZT230	ZT410 ZT420	ZT510	ZT610 ZT620
media.part_number				X	X	X	X
media.present.cut_amount							
media.present.cut_margin							
media.present.eject							
media.present.length_addition							
media.present.loop_length							
media.present.loop_length_max							
media.present.present_timeout							
media.present.present_type							
media.printmode	X	X	X	X	X	X	X
media.serial_number				X	X	X	X
media.speed	X	X	X	X	X	X	X
memory.flash_free	X	X	X	X	X	X	X
memory.flash_size	X	X	X	X	X	X	X
memory.ram_free	X	X	X	X	X	X	X
memory.ram_size	X	X	X	X	X	X	X
memory.types	X	X	X				
netmanage.avalanche.agent_addr				X	X	X	X
netmanage.avalanche.available_agent				X	X	X	X
netmanage.avalanche.available_port				X	X	X	X
netmanage.avalanche.encryption_type				X	X	X	X
netmanage.avalanche.interval				X	X	X	X
netmanage.avalanche.interval_update				X	X	X	X
netmanage.avalanche.model_name				X	X	X	X
netmanage.avalanche.set_property				X	X	X	X
netmanage.avalanche.startup_update				X	X	X	X
netmanage.avalanche.tcp_connection_timeout				X	X	X	X
netmanage.avalanche.terminal_id				X	X	X	X
netmanage.avalanche.text_msg.beep				X	X	X	X
netmanage.avalanche.text_msg.display				X	X	X	X
netmanage.avalanche.text_msg.print				X	X	X	X
netmanage.avalanche.udp_timeout				X	X	X	X
netmanage.error_code	X	X	X	X	X	X	X
netmanage.state_code	X	X	X	X	X	X	X
netmanage.status_code	X	X	X	X	X	X	X
odometer.headclean				X	X	X	X
odometer.headnew				X	X	X	X
odometer.label_dot_length	X	X	X	X	X	X	X

An X indicates that the SGD is supported for the particular device.
 This table indicates support based on the most recent Link-OS system release.

SGD Command Support

Command Name	Industrial						
	105SL	110Xi4 140Xi4 170Xi4 220Xi4	ZM400 ZM600	ZT210 ZT220 ZT230	ZT410 ZT420	ZT510	ZT610 ZT620
odometer.latch_open_count				X	X	X	X
odometer.media_marker_count	X	X	X	X	X	X	X
odometer.media_marker_count1	X	X	X	X	X	X	X
odometer.media_marker_count2	X	X	X	X	X	X	X
odometer.retracts_count							
odometer.rfid.valid_resetable					X	X	X
odometer.rfid.void_resetable					X	X	X
odometer.total_cuts				X	X	X	X
odometer.total_label_count				X	X	X	X
odometer.total_print_length	X	X	X	X	X	X	X
odometer.user_label_count				X	X	X	X
odometer.user_label_count1				X	X	X	X
odometer.user_label_count2				X	X	X	X
odometer.user_total_cuts				X	X	X	X
power.average_current				X	X		
power.battery_led_blink_rate							
power.battery_led_enable							
power.battery_led_off_duration							
power.battery_led_on_duration							
power.battery_replacement_cyclecount_threshold							
power.battery_type							
power.current							
power.cycle_count							
power.dtr_power_off				X	X	X	X
power.energy_star.enable						X	X
power.energy_star.timeout						X	X
power.label_queue.shutdown							
power.part_number							
power.percent_health							
power.power_on_mode							
power.remaining_capacity							
power.sleep.cradle							
power.temperature							
power.voltage							
power.wake.radio							
print.legacy_compatibility							X
print.tone	X	X	X	X	X	X	X
print.troubleshooting_label_print						X	X

An X indicates that the SGD is supported for the particular device.
This table indicates support based on the most recent Link-OS system release.

SGD Command Support

Command Name	Industrial						
	105SL	110Xi4 140Xi4 170Xi4 220Xi4	ZM400 ZM600	ZT210 ZT220 ZT230	ZT410 ZT420	ZT510	ZT610 ZT620
rfid.adaptive_antenna					X	X	X
rfid.antenna_sweep					X	X	X
rfid.country_code					X	X	X
rfid.enable					X	X	X
rfid.error.response					X	X	X
rfid.hop_table_version					X	X	X
rfid.log.clear					X		
rfid.log.enabled					X		
rfid.log.entries					X		
rfid.position.program					X	X	X
rfid.reader_1.antenna_port					X	X	X
rfid.reader_1.firmware_version					X	X	X
rfid.reader_1.hardware_version					X	X	X
rfid.reader_1.model					X	X	X
rfid.reader_1.power.read					X	X	X
rfid.reader_1.power.write					X	X	X
rfid.recipe_version					X	X	X
rfid.region_code					X	X	X
rfid.tag.calibrate					X	X	X
rfid.tag.read.content					X	X	X
rfid.tag.read.execute					X	X	X
rfid.tag.read.result_line1					X	X	X
rfid.tag.read.result_line1_alternate					X	X	X
rfid.tag.read.result_line2					X	X	X
rfid.tag.read.result_line2_alternate					X	X	X
rfid.tag.result_line1							
rfid.tag.test.content					X	X	X
rfid.tag.test.execute					X	X	X
rfid.tag.test.result_line1					X	X	X
rfid.tag.test.result_line2					X	X	X
ribbon.cartridge.authenticated							
ribbon.cartridge.inserted							
ribbon.cartridge.length							
ribbon.cartridge.length_remaining							
ribbon.cartridge.part_number							
rtc.timezone				X	X	X	X
rtc.unix_timestamp				X			
sensor.back_bar.brightness						X	X

An X indicates that the SGD is supported for the particular device.
This table indicates support based on the most recent Link-OS system release.

SGD Command Support

Command Name	Industrial						
	105SL	110Xi4 140Xi4 170Xi4 220Xi4	ZM400 ZM600	ZT210 ZT220 ZT230	ZT410 ZT420	ZT510	ZT610 ZT620
sensor.back_bar.cur				X	X	X	X
sensor.back_bar.gain						X	X
sensor.back_bar.offset					X	X	X
sensor.back_bar.ppr_out_thold				X	X	X	X
sensor.back_bar.thold				X	X	X	X
sensor.battery.in_volts							
sensor.cover_open					X	X	X
sensor.front_bar.brightness				X	X		
sensor.front_bar.cur				X	X		
sensor.front_bar.gain				X	X		
sensor.front_bar.offset				X	X		
sensor.front_bar.ppr_out_thold				X	X		
sensor.front_bar.thold				X	X		
sensor.gap.brightness							
sensor.gap.cur				X	X	X	X
sensor.gap.gain							
sensor.gap.offset							
sensor.gap.thold				X	X	X	X
sensor.head.temp				X	X	X	X
sensor.head.temp_avg				X	X	X	X
sensor.head.temp_celsius				X	X	X	X
sensor.peel.brightness							
sensor.peel.cur				X	X	X	X
sensor.peel.gain							
sensor.peel.thold				X	X		
sensor.peeler				X	X	X	X
sensor.width.cur							
sensor.width.in_dots							
usb.device.device_id_string				X	X	X	X
usb.device.device_unique_id				X	X	X	X
usb.device.device_version				X	X	X	X
usb.device.manufacturer_string				X	X	X	X
usb.device.product_id				X	X	X	X
usb.device.product_string				X	X	X	X
usb.device.serial_string				X	X	X	X
usb.device.vendor_id				X	X	X	X
usb.halt							
usb.host.config_info_to_usb						X	X

An X indicates that the SGD is supported for the particular device.
This table indicates support based on the most recent Link-OS system release.

SGD Command Support

Command Name	Industrial						
	105SL	110Xi4 140Xi4 170Xi4 220Xi4	ZM400 ZM600	ZT210 ZT220 ZT230	ZT410 ZT420	ZT510	ZT610 ZT620
usb.host.fn_field_data					X	X	X
usb.host.fn_last_field					X	X	X
usb.host.hid_count					X	X	X
usb.host.keyboard_input					X	X	X
usb.host.lock_out					X	X	X
usb.host.mass_storage_count					X	X	X
usb.host.read_list					X	X	X
usb.host.read_list_print_delay					X	X	X
usb.host.template_list					X	X	X
usb.host.template_print_amount					X	X	X
usb.host.write_list					X	X	X
usb.mirror.appl_path					X	X	X
usb.mirror.auto					X	X	X
usb.mirror.enable					X	X	X
usb.mirror.error_retry					X	X	X
usb.mirror.feedback.auto					X	X	X
usb.mirror.feedback.odometer					X	X	X
usb.mirror.feedback.path					X	X	X
usb.mirror.fetch					X	X	X
usb.mirror.last_error					X	X	X
usb.mirror.last_time					X	X	X
usb.mirror.path					X	X	X
usb.mirror.reset_delay					X	X	X
usb.mirror.success					X	X	X
usb.mirror.success_time					X	X	X
weblink.cloud_connect.enable				X	X	X	X
weblink.enable				X	X	X	X
weblink.ip.conn1.authentication.add				X	X	X	X
weblink.ip.conn1.authentication.entries				X	X	X	X
weblink.ip.conn1.authentication.remove				X	X	X	X
weblink.ip.conn1.location				X	X	X	X
weblink.ip.conn1.maximum_simultaneous_connections				X	X	X	X
weblink.ip.conn1.num_connections				X	X	X	X
weblink.ip.conn1.proxy				X	X	X	X
weblink.ip.conn1.retry_interval				X	X	X	X
weblink.ip.conn1.retry_interval_random_max					X		X
weblink.ip.conn1.test.location				X	X	X	X
weblink.ip.conn1.test.retry_interval				X	X	X	X

An X indicates that the SGD is supported for the particular device.
This table indicates support based on the most recent Link-OS system release.

SGD Command Support

Command Name	Industrial						
	105SL	110Xi4 140Xi4 170Xi4 220Xi4	ZM400 ZM600	ZT210 ZT220 ZT230	ZT410 ZT420	ZT510	ZT610 ZT620
weblink.ip.conn1.test.test_on				X	X	X	X
weblink.ip.conn2.authentication.add				X	X	X	X
weblink.ip.conn2.authentication.entries				X	X	X	X
weblink.ip.conn2.authentication.remove				X	X	X	X
weblink.ip.conn2.location				X	X	X	X
weblink.ip.conn2.maximum_simultaneous_connections				X	X	X	X
weblink.ip.conn2.num_connections				X	X	X	X
weblink.ip.conn2.proxy				X	X	X	X
weblink.ip.conn2.retry_interval				X	X	X	X
weblink.ip.conn2.retry_interval_random_max					X		X
weblink.ip.conn2.test.location				X	X	X	X
weblink.ip.conn2.test.retry_interval				X	X	X	X
weblink.ip.conn2.test.test_on				X	X	X	X
weblink.logging.clear				X	X	X	X
weblink.logging.entries				X	X	X	X
weblink.logging.max_entries				X	X	X	X
weblink.printer_reset_required				X	X	X	X
weblink.restore_defaults				X	X	X	X
weblink.zebra_connector.authentication.add				X	X	X	X
weblink.zebra_connector.authentication.entries				X	X	X	X
weblink.zebra_connector.authentication.remove				X	X	X	X
weblink.zebra_connector.enable				X	X	X	X
weblink.zebra_connector.proxy				X	X	X	X
weblink.zebra_connector.version				X	X	X	X
wlan.11ac.80mhz_enable							X
wlan.11d.enable				X	X	X	X
wlan.11n.20mhz_only				X	X	X	X
wlan.11n.greenfield				X	X	X	X
wlan.11n.rifs				X	X	X	X
wlan.11n.short_gi_20mhz				X	X	X	X
wlan.11n.short_gi_40mhz				X	X	X	X
wlan.8021x.authentication	X	X	X	X	X	X	X
wlan.8021x.eap.password				X	X	X	X
wlan.8021x.eap.privkey_password				X	X	X	X
wlan.8021x.eap.username	X	X	X	X	X	X	X
wlan.8021x.enable	X	X	X	X	X	X	X
wlan.8021x.peap.anonymous_identity				X	X		X
wlan.8021x.peap.peap_password				X	X	X	X

An X indicates that the SGD is supported for the particular device.
This table indicates support based on the most recent Link-OS system release.

SGD Command Support

Command Name	Industrial						
	105SL	110Xi4 140Xi4 170Xi4 220Xi4	ZM400 ZM600	ZT210 ZT220 ZT230	ZT410 ZT420	ZT510	ZT610 ZT620
wlan.8021x.peap.peap_username	X	X	X	X	X	X	X
wlan.8021x.peap.privkey_password				X	X	X	X
wlan.8021x.ttls_tunnel				X	X	X	X
wlan.active_channels				X	X	X	X
wlan.adhoc_last_channel							
wlan.adhocautomode	X	X	X	X	X	X	X
wlan.adhocchannel	X	X	X	X	X	X	X
wlan.allowed_band				X	X	X	X
wlan.associated	X	X	X	X	X	X	X
wlan.auth_type	X	X	X	X	X	X	X
wlan.authenticated				X	X	X	X
wlan.authentication_error				X	X	X	X
wlan.available				X	X	X	X
wlan.band_preference				X	X	X	X
wlan.bssid	X	X	X	X	X	X	X
wlan.channel	X	X	X	X	X	X	X
wlan.channel_mask				X	X	X	X
wlan.country_code				X	X	X	X
wlan.current_tx_rate	X	X	X	X	X	X	X
wlan.enable				X	X	X	X
wlan.encryption_index	X	X	X				
wlan.encryption_key1							
wlan.encryption_key2							
wlan.encryption_key3							
wlan.encryption_key4							
wlan.encryption_mode	X	X	X				
wlan.essid	X	X	X	X	X	X	X
wlan.firmware_version	X	X	X	X	X	X	X
wlan.ip.addr	X	X	X	X	X	X	X
wlan.ip.arp_interval	X	X	X	X	X	X	X
wlan.ip.default_addr_enable	X	X	X	X	X	X	X
wlan.ip.dhcp.arp_verify				X	X	X	X
wlan.ip.dhcp.cache_ip	X	X	X	X	X	X	X
wlan.ip.dhcp.cid_all				X	X	X	X
wlan.ip.dhcp.cid_enable	X	X	X	X	X	X	X
wlan.ip.dhcp.cid_prefix				X	X	X	X
wlan.ip.dhcp.cid_suffix				X	X	X	X
wlan.ip.dhcp.cid_type	X	X	X	X	X	X	X

An X indicates that the SGD is supported for the particular device.
This table indicates support based on the most recent Link-OS system release.

SGD Command Support

Command Name	Industrial						
	105SL	110Xi4 140Xi4 170Xi4 220Xi4	ZM400 ZM600	ZT210 ZT220 ZT230	ZT410 ZT420	ZT510	ZT610 ZT620
wlan.ip.dhcp.lease.last_attempt	X	X	X	X	X	X	X
wlan.ip.dhcp.lease.length	X	X	X	X	X	X	X
wlan.ip.dhcp.lease.server	X	X	X	X	X	X	X
wlan.ip.dhcp.lease.time_left	X	X	X	X	X	X	X
wlan.ip.dhcp.option12	X	X	X	X	X	X	X
wlan.ip.dhcp.option12_format	X	X	X	X	X	X	X
wlan.ip.dhcp.option12_value				X	X	X	X
wlan.ip.dhcp.request_timeout	X	X	X	X	X	X	X
wlan.ip.dhcp.requests_per_session	X	X	X	X	X	X	X
wlan.ip.dhcp.session_interval	X	X	X	X	X	X	X
wlan.ip.dns.domain				X	X	X	X
wlan.ip.dns.servers				X	X	X	X
wlan.ip.gateway	X	X	X	X	X	X	X
wlan.ip.netmask	X	X	X	X	X	X	X
wlan.ip.port	X	X	X	X	X	X	X
wlan.ip.port_alterate				X	X	X	X
wlan.ip.port_json_config				X	X	X	X
wlan.ip.protocol	X	X	X	X	X	X	X
wlan.ip.timeout.enable	X	X	X	X	X	X	X
wlan.ip.timeout.value	X	X	X	X	X	X	X
wlan.ip.wins.addr	X	X	X	X	X	X	X
wlan.ip.wins.permanent_source	X	X	X	X	X	X	X
wlan.keep_alive.enable	X	X	X	X	X	X	X
wlan.keep_alive.timeout	X	X	X	X	X	X	X
wlan.kerberos.kdc	X	X	X				
wlan.kerberos.mode	X	X	X				
wlan.kerberos.password	X	X	X				
wlan.kerberos.realm	X	X	X				
wlan.kerberos.username	X	X	X				
wlan.leap_mode	X	X	X	X	X	X	X
wlan.leap_password				X	X	X	X
wlan.leap_username	X	X	X	X	X	X	X
wlan.mac_addr	X	X	X	X	X	X	X
wlan.mac_raw	X	X	X	X	X	X	X
wlan.operating_mode	X	X	X	X	X	X	X
wlan.password				X	X	X	X
wlan.permitted_channels				X	X	X	X
wlan.pmf				X	X	X	X

An X indicates that the SGD is supported for the particular device.
This table indicates support based on the most recent Link-OS system release.

SGD Command Support

Command Name	Industrial						
	105SL	110Xi4 140Xi4 170Xi4 220Xi4	ZM400 ZM600	ZT210 ZT220 ZT230	ZT410 ZT420	ZT510	ZT610 ZT620
wlan.poor_signal_threshold				X	X	X	X
wlan.preamble	X	X	X	X	X	X	X
wlan.private_key_password				X	X	X	X
wlan.region_code				X	X	X	X
wlan.roam.interchannel_delay				X	X	X	X
wlan.roam.interval	X	X	X	X	X	X	X
wlan.roam.max_chan_scan_time				X	X	X	X
wlan.roam.max_fail				X	X	X	X
wlan.roam.monitor				X	X	X	X
wlan.roam.rssi				X	X	X	X
wlan.roam.signal	X	X	X	X	X	X	X
wlan.rts_cts_enabled				X	X		
wlan.scrambler							
wlan.secure_ssid				X	X	X	X
wlan.security				X	X	X	X
wlan.signal_noise	X	X	X				
wlan.signal_quality	X	X	X				
wlan.signal_strength	X	X	X	X	X	X	X
wlan.station_name	X	X	X	X	X	X	X
wlan.tx_power	X	X	X				
wlan.tx_rate	X	X	X				
wlan.user_channel_list				X	X	X	X
wlan.username	X	X	X	X	X	X	X
wlan.waveagent.enable				X	X	X	X
wlan.waveagent.udp_port				X	X	X	X
wlan.wep.auth_type	X	X	X				
wlan.wep.index	X	X	X				
wlan.wep.key_format	X	X	X				
wlan.wep.key1							
wlan.wep.key2							
wlan.wep.key3							
wlan.wep.key4							
wlan.wpa.groupkey_ciphersuite				X	X	X	X
wlan.wpa.pairwise_ciphersuite				X	X	X	X
wlan.wpa.psk				X	X	X	X
wlan.wpa.timecheck				X	X	X	X
wlan.wpa.wpa_version				X	X	X	X
zbi.control.add_breakpoint				X	X	X	X

An X indicates that the SGD is supported for the particular device.
This table indicates support based on the most recent Link-OS system release.

SGD Command Support

Command Name	Industrial						
	105SL	110Xi4 140Xi4 170Xi4 220Xi4	ZM400 ZM600	ZT210 ZT220 ZT230	ZT410 ZT420	ZT510	ZT610 ZT620
zbi.control.break				X	X	X	X
zbi.control.clear_breakpoints				X	X	X	X
zbi.control.delete_breakpoint				X	X	X	X
zbi.control.line_number				X	X	X	X
zbi.control.restart				X	X	X	X
zbi.control.run				X	X	X	X
zbi.control.step				X	X	X	X
zbi.control.terminate				X	X	X	X
zbi.control.variable_name				X	X	X	X
zbi.control.variable_value				X	X	X	X
zbi.enable				X	X	X	X
zbi.key	X	X	X	X	X	X	X
zbi.last_error				X	X	X	X
zbi.program_list				X	X	X	X
zbi.reseller_key				X	X	X	X
zbi.revision	X	X	X	X	X	X	X
zbi.running_program_name				X	X	X	X
zbi.start_info.execute				X	X	X	X
zbi.start_info.file_name				X	X	X	X
zbi.start_info.memory_alloc				X	X	X	X
zbi.state	X	X	X	X	X	X	X
zpl.calibrate				X	X	X	X
zpl.command_prefix				X	X	X	X
zpl.format_prefix				X	X	X	X
zpl.label_length	X	X		X	X	X	X
zpl.left_position				X	X	X	X
zpl.relative_darkness				X	X	X	X
zpl.system_error				X	X	X	X
zpl.system_status				X	X	X	X
zpl.zpl_mode				X	X	X	X
zpl.zpl_override							

An X indicates that the SGD is supported for the particular device.
 This table indicates support based on the most recent Link-OS system release.

SGDs Supported for Desktop Printers

This table provides details of the list of SGDs supported for Desktop Printers.

Command Name	Desktop									
	GK420	GK888t	GT800	GX420d	HC100	ZD220 ZD230	ZD410 ZD420	ZD500 ZD510	ZD620	ZD888
alerts.add						X	X	X	X	X
alerts.conditions						X	X	X	X	X
alerts.configured						X	X	X	X	X
alerts.destinations						X	X	X	X	X
alerts.http.authentication.add						X	X	X	X	X
alerts.http.authentication.entries						X	X	X	X	X
alerts.http.authentication.remove						X	X	X	X	X
alerts.http.logging.clear						X	X	X	X	X
alerts.http.logging.entries						X	X	X	X	X
alerts.http.logging.max_entries						X	X	X	X	X
alerts.http.proxy						X	X	X	X	X
alerts.tracked_settings.clear_log						X	X	X	X	X
alerts.tracked_settings.log_tracked						X	X	X	X	X
alerts.tracked_settings.max_log_entries						X	X	X	X	X
alerts.tracked_settings.zbi_notified						X	X	X	X	X
apl.enable						X	X	X	X	X
apl.framework_version						X	X	X	X	X
apl.version						X	X	X	X	X
appl.bootblock	X	X	X	X	X	X	X	X	X	X
appl.date	X	X	X	X	X	X	X	X	X	X
appl.link_os_version						X	X	X	X	X
appl.name	X	X	X		X	X	X	X	X	X
bluetooth.address				X		X	X	X	X	X
bluetooth.authentication				X						
bluetooth.bluetooth_pin						X	X	X	X	X
bluetooth.clear_bonding_cache						X	X	X	X	X
bluetooth.discoverable				X		X	X	X	X	X
bluetooth.enable				X		X	X	X	X	X
bluetooth.enable_reconnect						X	X	X	X	X
bluetooth.friendly_name				X		X	X	X	X	X
bluetooth.json_config_channel_enable						X	X	X	X	X
bluetooth.le.controller_mode						X	X		X	X
bluetooth.le.minimum_security						X	X		X	X

An X indicates that the SGD is supported for the particular device.
This table indicates support based on the most recent Link-OS system release.

SGD Command Support

Command Name	Desktop									
	GK420	GK888t	GT800	GX420d	HC100	ZD220 ZD230	ZD410 ZD420	ZD500 ZD510	ZD620	ZD888
bluetooth.le.power_class										
bluetooth.local_name				X		X	X	X	X	X
bluetooth.minimum_security_mode						X	X	X	X	X
bluetooth.page_scan_window						X	X	X	X	X
bluetooth.radio_version				X		X	X	X	X	X
bluetooth.short_address				X		X	X	X	X	X
bluetooth.version				X		X	X	X	X	X
capture.channel1.count						X	X	X	X	X
capture.channel1.data.mime						X	X	X	X	X
capture.channel1.data.raw						X	X	X	X	X
capture.channel1.delimiter						X	X	X	X	X
capture.channel1.max_length						X	X	X	X	X
capture.channel1.port						X	X	X	X	X
comm.baud	X	X	X	X	X	X	X	X	X	X
comm.halt										
comm.parity	X	X	X	X	X	X	X	X	X	X
comm.stop_bits	X	X	X		X	X	X	X	X	X
comm.type						X	X	X	X	X
cradle.comm.baud										
cradle.comm.handshake										
cutter.clean_cutter	X	X	X	X	X	X	X	X	X	X
device.allow_firmware_downloads						X	X	X	X	X
device.applicator.data_ready										
device.applicator.data_ready_activation										
device.applicator.end_print										
device.applicator.error_on_pause										
device.applicator.feed										
device.applicator.media_out										
device.applicator.pause										
device.applicator.reprint										
device.applicator.rfid_void										
device.applicator.ribbon_low										
device.applicator.ribbon_out										
device.applicator.service_required										
device.applicator.start_print										

An X indicates that the SGD is supported for the particular device.
 This table indicates support based on the most recent Link-OS system release.

SGD Command Support

Command Name	Desktop									
	GK420	GK888t	GT800	GX420d	HC100	ZD220 ZD230	ZD410 ZD420	ZD500 ZD510	ZD620	ZD888
device.applicator.start_print_mode										
device.applicator.voltage										
device.bluetooth_installed						X	X	X	X	X
device.command_override.active						X	X	X	X	X
device.command_override.add						X	X	X	X	X
device.command_override.clear						X	X	X	X	X
device.command_override.list						X	X	X	X	X
device.company_contact						X	X	X	X	X
device.configuration_number						X	X		X	X
device.cpcl_synchronous_mode						X	X	X	X	X
device.cutter_installed						X	X	X	X	X
device.download_connection_timeout	X	X	X	X	X	X	X	X	X	X
device.download_interactive_mode						X				
device.epi_legacy_mode						X	X	X	X	X
device.feature.802_11ac						X	X	X	X	X
device.feature.bluetooth_le						X	X	X	X	X
device.feature.head_element_test						X	X	X	X	X
device.feature.lighted_arrows						X	X	X	X	X
device.feature.mcr						X	X	X	X	X
device.feature.nfc						X	X	X	X	X
device.feature.ribbon_cartridge						X	X	X	X	X
device.friendly_name	X	X	X	X	X	X	X	X	X	X
device.frontpanel.key_press						X	X	X	X	X
device.frontpanel.line1	X	X		X		X	X	X	X	X
device.frontpanel.line2	X	X		X		X	X	X	X	X
device.frontpanel.xml	X	X	X	X	X	X	X	X	X	X
device.host_identification						X	X	X	X	X
device.host_status						X	X	X	X	X
device.idle_display_format						X	X	X	X	X
device.idle_display_value						X	X	X	X	X
device.internal_wired_setting_location						X	X	X	X	X
device.job_log.total_jobs						X	X	X	X	X
device.jobs_print	X	X	X	X	X	X	X	X	X	X
device.languages	X	X	X	X	X	X	X	X	X	X
device.light.cover_open_brightness										

An X indicates that the SGD is supported for the particular device.
 This table indicates support based on the most recent Link-OS system release.

SGD Command Support

Command Name	Desktop									
	GK420	GK888t	GT800	GX420d	HC100	ZD220 ZD230	ZD410 ZD420	ZD500 ZD510	ZD620	ZD888
device.light.head_open_brightness										
device.light.media_path_brightness										
device.light.ribbon_path_brightness										
device.locked						X	X		X	X
device.ltu_installed										
device.pause						X	X	X	X	X
device.pmcu.revision						X	X		X	X
device.pnp_option	X	X	X	X	X	X	X	X	X	X
device.position.accuracy						X	X	X	X	X
device.position.altitude						X	X	X	X	X
device.position.latitude						X	X	X	X	X
device.position.longitude						X	X	X	X	X
device.print_2key										
device.print_reprogram_2key						X	X	X	X	X
device.printhead.odometer										
device.printhead.resolution						X	X	X	X	X
device.printhead.test.summary										
device.product_name_submodel						X	X	X	X	X
device.reset						X	X	X	X	X
device.restore_defaults						X	X	X	X	X
device.rewinder_installed										
device.save_2key										
device.sensor_profile							X	X	X	
device.sensor_select						X	X	X	X	X
device.serial_numbers.applicator_option_board										
device.serial_numbers.applicator_option_board_date										
device.serial_numbers.control_panel_date						X	X	X	X	X
device.serial_numbers.cutter						X	X	X	X	X
device.serial_numbers.cutter_date						X	X	X	X	X
device.serial_numbers.mlb_date						X	X	X	X	X
device.serial_numbers.parallel_option_board										
device.serial_numbers.parallel_option_board_date										
device.serial_numbers.printhead										
device.serial_numbers.printhead_date										
device.serial_numbers.usb_host_option_board										

An X indicates that the SGD is supported for the particular device.
 This table indicates support based on the most recent Link-OS system release.

SGD Command Support

Command Name	Desktop									
	GK420	GK888t	GT800	GX420d	HC100	ZD220 ZD230	ZD410 ZD420	ZD500 ZD510	ZD620	ZD888
device.serial_numbers.usb_host_option_board_date										
device.serial_numbers.wired_ethernet_option_board										
device.serial_numbers.wired_ethernet_option_board_date										
device.set_clock_to_build_date						X	X	X	X	X
device.slot_1						X	X		X	X
device.slot_2										
device.super_host_status						X	X	X	X	X
device.syslog.clear_log						X	X	X	X	X
device.syslog.configuration						X	X	X	X	X
device.syslog.enable						X	X	X	X	X
device.syslog.entries						X	X	X	X	X
device.syslog.log_max_file_size						X	X	X	X	X
device.syslog.save_local_file						X	X	X	X	X
device.unique_id	X	X	X	X	X	X	X	X	X	X
device.unpause						X	X	X	X	X
device.uptime	X	X	X	X	X	X	X	X	X	X
device.user_p1	X	X	X	X	X	X	X	X	X	X
device.user_p2	X	X	X	X	X	X	X	X	X	X
device.user_vars.create						X	X	X	X	X
device.user_vars.set_range						X	X	X	X	X
device.xml.enable	X	X	X	X	X	X	X	X	X	X
display.backlight						X	X	X	X	X
display.backlight_on_time						X	X	X	X	X
display.batch_counter								X		
display.bluetooth.mac										
display.language						X	X	X	X	X
display.load_card								X		
display.password.level								X		
display.root_wml								X		
display.text	X	X	X	X						
external_wired.check	X	X	X	X	X					
external_wired.ip.addr	X	X	X	X	X					
external_wired.ip.arp_interval	X	X	X	X	X					
external_wired.ip.default_addr_enable	X	X	X	X	X					
external_wired.ip.gateway	X	X	X	X	X					

An X indicates that the SGD is supported for the particular device.
This table indicates support based on the most recent Link-OS system release.

SGD Command Support

Command Name	Desktop									
	GK420	GK888t	GT800	GX420d	HC100	ZD220 ZD230	ZD410 ZD420	ZD500 ZD510	ZD620	ZD888
external_wired.ip.netmask	X	X	X	X	X					
external_wired.ip.port	X	X	X	X	X					
external_wired.ip.protocol	X	X	X	X	X					
external_wired.ip.timeout.enable	X	X	X	X	X					
external_wired.ip.timeout.value	X	X	X	X	X					
external_wired.ip.v6.addr	X	X	X							
external_wired.ip.v6.gateway	X	X	X							
external_wired.ip.v6.prefix_length	X	X	X							
external_wired.mac_addr	X	X	X	X	X					
external_wired.mac_raw	X	X	X	X	X	X	X	X	X	X
ezpl.head_close_action						X	X	X	X	X
ezpl.label_length_max						X	X	X	X	X
ezpl.label_sensor						X	X	X	X	X
ezpl.manual_calibration						X	X	X	X	X
ezpl.media_type						X	X	X	X	X
ezpl.power_up_action						X	X	X	X	X
ezpl.print_method						X	X	X	X	X
ezpl.print_width						X	X	X	X	X
ezpl.reprint_mode						X	X	X	X	X
ezpl.restore_defaults						X	X	X	X	X
ezpl.take_label						X	X	X	X	X
ezpl.tear_off						X	X	X	X	X
file.capture_response.destination						X	X	X	X	X
file.cert.expiration							X	X	X	
file.cert.supported_curves							X	X	X	
file.delete						X	X	X	X	X
file.dir	X	X	X		X	X	X	X	X	X
file.dir_format						X	X	X	X	X
file.run						X	X	X	X	X
file.type						X	X	X	X	X
formats.cancel_all						X	X	X	X	X
head.authenticated										
head.darkness_switch						X	X		X	X
head.darkness_switch_enable						X	X		X	X
head.element_test										

An X indicates that the SGD is supported for the particular device.
 This table indicates support based on the most recent Link-OS system release.

SGD Command Support

Command Name	Desktop									
	GK420	GK888t	GT800	GX420d	HC100	ZD220 ZD230	ZD410 ZD420	ZD500 ZD510	ZD620	ZD888
head.latch	X	X	X	X	X	X	X	X	X	X
head.resolution.in_dpi						X	X	X	X	X
input.capture						X	X	X	X	X
interface.network.active.arp_interval						X	X	X	X	X
interface.network.active.cable_type						X	X	X	X	X
interface.network.active.dhcp_received_host_name						X	X	X	X	X
interface.network.active.gateway	X	X	X	X	X	X	X	X	X	X
interface.network.active.ip_addr	X	X	X	X	X	X	X	X	X	X
interface.network.active.mac_addr	X	X	X	X	X	X	X	X	X	X
interface.network.active.mac_raw	X	X	X	X	X	X	X	X	X	X
interface.network.active.netmask	X	X	X	X	X	X	X	X	X	X
interface.network.active.printserver	X	X	X	X	X	X	X	X	X	X
interface.network.active.protocol	X	X	X	X	X	X	X	X	X	X
interface.network.active.protocol_error						X	X	X	X	X
interface.network.active.rx_errors						X	X	X	X	X
interface.network.active.rx_packets						X	X	X	X	X
interface.network.active.server_address						X	X	X	X	X
interface.network.active.speed						X	X	X	X	X
interface.network.active.tx_errors						X	X	X	X	X
interface.network.active.tx_packets						X	X	X	X	X
interface.network.active.wins_addr						X	X	X	X	X
interface.network.settings_require_reset						X	X	X	X	X
internal_wired.8021x.password						X	X	X	X	X
internal_wired.8021x.peap.anonymous_identity						X	X	X	X	X
internal_wired.8021x.peap.validate_server_certificate						X	X	X	X	X
internal_wired.8021x.security								X		
internal_wired.8021x.ttls_tunnel						X	X	X	X	X
internal_wired.8021x.username						X	X	X	X	X
internal_wired.activity_led						X	X	X	X	X
internal_wired.auto_switchover	X	X	X	X	X	X	X	X	X	X
internal_wired.enable								X		
internal_wired.installed						X	X	X	X	X
internal_wired.ip.addr	X	X	X	X	X	X	X	X	X	X
internal_wired.ip.arp_interval	X	X	X	X	X	X	X	X	X	X
internal_wired.ip.default_addr_enable	X	X	X	X	X	X	X	X	X	X

An X indicates that the SGD is supported for the particular device.
 This table indicates support based on the most recent Link-OS system release.

SGD Command Support

Command Name	Desktop									
	GK420	GK888t	GT800	GX420d	HC100	ZD220 ZD230	ZD410 ZD420	ZD500 ZD510	ZD620	ZD888
internal_wired.ip.dhcp.arp_verify						X	X	X	X	X
internal_wired.ip.dhcp.cache_ip	X	X	X	X	X	X	X	X	X	X
internal_wired.ip.dhcp.cid_all	X	X	X	X	X	X	X	X	X	X
internal_wired.ip.dhcp.cid_enable	X	X	X	X	X	X	X	X	X	X
internal_wired.ip.dhcp.cid_prefix	X	X	X	X	X	X	X	X	X	X
internal_wired.ip.dhcp.cid_suffix	X	X	X	X	X	X	X	X	X	X
internal_wired.ip.dhcp.cid_type	X	X	X	X	X	X	X	X	X	X
internal_wired.ip.dhcp.lease.last_attempt	X	X	X	X	X	X	X	X	X	X
internal_wired.ip.dhcp.lease.length	X	X	X	X	X	X	X	X	X	X
internal_wired.ip.dhcp.lease.server	X	X	X	X	X	X	X	X	X	X
internal_wired.ip.dhcp.lease.time_left	X	X	X	X	X	X	X	X	X	X
internal_wired.ip.dhcp.option12	X	X	X	X	X	X	X	X	X	X
internal_wired.ip.dhcp.option12_format	X	X	X	X	X	X	X	X	X	X
internal_wired.ip.dhcp.option12_value	X	X	X	X	X	X	X	X	X	X
internal_wired.ip.dhcp.requests_per_session	X	X	X	X	X	X	X	X	X	X
internal_wired.ip.dns.servers						X	X	X	X	X
internal_wired.ip.gateway	X	X	X	X	X	X	X	X	X	X
internal_wired.ip.netmask	X	X	X	X	X	X	X	X	X	X
internal_wired.ip.port	X	X	X	X	X	X	X	X	X	X
internal_wired.ip.port_alternate						X	X	X	X	X
internal_wired.ip.port_json_config						X	X	X	X	X
internal_wired.ip.protocol	X	X	X	X	X	X	X	X	X	X
internal_wired.ip.timeout.enable	X	X	X	X	X	X	X	X	X	X
internal_wired.ip.timeout.value	X	X	X	X	X	X	X	X	X	X
internal_wired.ip.wins.addr	X	X	X	X	X	X	X	X	X	X
internal_wired.ip.wins.permanent_source	X	X	X	X	X	X	X	X	X	X
internal_wired.mac_addr	X	X	X	X	X	X	X	X	X	X
internal_wired.mac_raw	X	X	X	X	X	X	X	X	X	X
ip.active_network	X	X	X	X	X	X	X	X	X	X
ip.addr	X	X	X	X	X	X	X	X	X	X
ip.arp_interval	X	X	X	X	X	X	X	X	X	X
ip.bootp.enable	X	X	X	X	X	X	X	X	X	X
ip.dhcp.arp_verify						X	X	X	X	X
ip.dhcp.auto_provision_enable						X	X	X	X	X
ip.dhcp.cache_ip	X	X	X	X	X	X	X	X	X	X

An X indicates that the SGD is supported for the particular device.
 This table indicates support based on the most recent Link-OS system release.

SGD Command Support

Command Name	Desktop									
	GK420	GK888t	GT800	GX420d	HC100	ZD220 ZD230	ZD410 ZD420	ZD500 ZD510	ZD620	ZD888
ip.dhcp.cid_all	X	X	X	X	X	X	X	X	X	X
ip.dhcp.cid_enable	X	X	X	X	X	X	X	X	X	X
ip.dhcp.cid_prefix	X	X	X	X	X	X	X	X	X	X
ip.dhcp.cid_suffix	X	X	X	X	X	X	X	X	X	X
ip.dhcp.cid_type	X	X	X	X	X	X	X	X	X	X
ip.dhcp.cid_value	X	X	X	X	X	X	X	X	X	X
ip.dhcp.enable	X	X	X	X	X	X	X	X	X	X
ip.dhcp.lease.last_attempt	X	X	X	X	X	X	X	X	X	X
ip.dhcp.lease.server	X	X	X	X	X	X	X	X	X	X
ip.dhcp.lease.time_left	X	X	X	X	X	X	X	X	X	X
ip.dhcp.ntp.enable						X	X	X	X	X
ip.dhcp.ntp.received_servers						X	X	X	X	X
ip.dhcp.option12	X	X	X	X	X	X	X	X	X	X
ip.dhcp.option12_format	X	X	X	X	X	X	X	X	X	X
ip.dhcp.option12_value	X	X	X	X	X	X	X	X	X	X
ip.dhcp.request_timeout	X	X	X	X	X	X	X	X	X	X
ip.dhcp.requests_per_session	X	X	X	X	X	X	X	X	X	X
ip.dhcp.session_interval	X	X	X	X	X	X	X	X	X	X
ip.dhcp.user_class_id						X	X	X	X	X
ip.dhcp.vendor_class_id						X	X	X	X	X
ip.dns.servers	X	X	X	X	X	X	X	X	X	X
ip.firewall.whitelist_in						X	X	X	X	X
ip.ftp.enable	X	X	X	X	X	X	X	X	X	X
ip.ftp.execute_file	X	X	X	X	X	X	X	X	X	X
ip.ftp.request_password						X	X	X	X	X
ip.gateway	X	X	X	X	X	X	X	X	X	X
ip.http.admin_name						X	X	X	X	X
ip.http.admin_password						X	X	X	X	X
ip.http.custom_link_name						X	X	X	X	X
ip.http.custom_link_url						X	X	X	X	X
ip.http.enable	X	X	X	X	X	X	X	X	X	X
ip.http.faq_url						X	X	X	X	X
ip.http.port						X	X	X	X	X
ip.https.enable						X	X	X	X	X
ip.https.port						X	X	X	X	X

An X indicates that the SGD is supported for the particular device.
This table indicates support based on the most recent Link-OS system release.

SGD Command Support

Command Name	Desktop									
	GK420	GK888t	GT800	GX420d	HC100	ZD220 ZD230	ZD410 ZD420	ZD500 ZD510	ZD620	ZD888
ip.lpd.enable	X	X	X	X	X	X	X	X	X	X
ip.mirror.appl_path						X	X	X	X	X
ip.mirror.auto	X	X	X	X	X	X	X	X	X	X
ip.mirror.error_retry	X	X	X	X	X	X	X	X	X	X
ip.mirror.feedback.auto	X	X	X	X	X	X	X	X	X	X
ip.mirror.feedback.freq	X	X	X	X	X	X	X	X	X	X
ip.mirror.feedback.odometer	X	X	X	X	X	X	X	X	X	X
ip.mirror.feedback.path	X	X	X	X	X	X	X	X	X	X
ip.mirror.fetch						X	X	X	X	X
ip.mirror.freq	X	X	X	X	X	X	X	X	X	X
ip.mirror.freq_hours	X	X	X	X	X	X	X	X	X	X
ip.mirror.interface						X	X	X	X	X
ip.mirror.last_error	X	X	X	X	X	X	X	X	X	X
ip.mirror.last_time	X	X	X	X	X	X	X	X	X	X
ip.mirror.mode						X	X	X	X	X
ip.mirror.password	X	X	X	X		X	X	X	X	X
ip.mirror.path	X	X	X	X	X	X	X	X	X	X
ip.mirror.reset_delay						X	X	X	X	X
ip.mirror.server	X	X	X	X	X	X	X	X	X	X
ip.mirror.success	X	X	X	X	X	X	X	X	X	X
ip.mirror.success_time	X	X	X	X	X	X	X	X	X	X
ip.mirror.username	X	X	X	X	X	X	X	X	X	X
ip.mirror.version	X	X	X	X	X	X	X	X	X	X
ip.netmask	X	X	X	X	X	X	X	X	X	X
ip.ntp.enable						X	X	X	X	X
ip.ntp.log						X	X	X	X	X
ip.ntp.servers						X	X	X	X	X
ip.ping_gateway_interval						X	X	X	X	X
ip.ping_remote						X	X	X	X	X
ip.pop3.enable	X	X	X	X	X	X	X	X	X	X
ip.pop3.password	X	X	X	X		X	X	X	X	X
ip.pop3.poll	X	X	X	X	X	X	X	X	X	X
ip.pop3.print_body						X	X	X	X	X
ip.pop3.print_headers						X	X	X	X	X
ip.pop3.save_attachments						X	X	X	X	X

An X indicates that the SGD is supported for the particular device.
 This table indicates support based on the most recent Link-OS system release.

SGD Command Support

Command Name	Desktop									
	GK420	GK888t	GT800	GX420d	HC100	ZD220 ZD230	ZD410 ZD420	ZD500 ZD510	ZD620	ZD888
ip.pop3.server_addr	X	X	X	X	X	X	X	X	X	X
ip.pop3.username	X	X	X	X	X	X	X	X	X	X
ip.pop3.verbose_headers						X	X	X	X	X
ip.port	X	X	X	X	X	X	X	X	X	X
ip.port_alternate						X	X	X	X	X
ip.port_json_config						X	X	X	X	X
ip.port_single_conn						X	X	X	X	X
ip.port_single_conn_idle_timeout						X	X	X	X	X
ip.primary_network	X	X	X	X	X	X	X	X	X	X
ip.smtp.domain	X	X	X	X	X	X	X	X	X	X
ip.smtp.enable	X	X	X	X	X	X	X	X	X	X
ip.smtp.server_addr	X	X	X	X	X	X	X	X	X	X
ip.snmp.enable	X	X	X	X	X	X	X	X	X	X
ip.snmp.get_community_name						X	X	X	X	X
ip.snmp.set_community_name						X	X	X	X	X
ip.snmp.trap_community_name						X	X	X	X	X
ip.tcp.enable	X	X	X	X	X	X	X	X	X	X
ip.tcp.nagle_algorithm						X	X	X	X	X
ip.telnet.enable	X	X	X	X	X	X	X	X	X	X
ip.tls.enable						X	X	X	X	X
ip.tls.port						X	X	X	X	X
ip.tls.port_json_config						X	X	X	X	X
ip.udp.enable	X	X	X	X	X	X	X	X	X	X
log.reboot.code						X	X	X	X	X
log.reboot.codes						X	X	X	X	X
log.reboot.reason						X	X	X	X	X
log.reboot.report						X	X	X	X	X
mcr.cancel										
mcr.crypt.algorithm										
mcr.crypt.enabled										
mcr.crypt.key_mgmt										
mcr.out										
mcr.query										
mcr.revision										
media.bar_location						X	X	X	X	X

An X indicates that the SGD is supported for the particular device.
 This table indicates support based on the most recent Link-OS system release.

SGD Command Support

Command Name	Desktop									
	GK420	GK888t	GT800	GX420d	HC100	ZD220 ZD230	ZD410 ZD420	ZD500 ZD510	ZD620	ZD888
media.cartridge.darkness										
media.cartridge.inserted										
media.cartridge.labels_remaining										
media.cartridge.length										
media.cartridge.part_number					X					
media.cartridge.serial_number										
media.cartridge.speed					X					
media.cartridge.total_label_cnt										
media.cartridge.width										
media.cut_now						X	X	X	X	X
media.darkness_mode	X	X	X	X	X					
media.draft_mode										
media.dynamic_length_calibration						X	X	X	X	X
media.feed_skip										
media.media_low.external										
media.media_low.warning	X	X		X	X					
media.part_number						X	X	X	X	X
media.present.cut_amount										
media.present.cut_margin										
media.present.eject										
media.present.length_addition										
media.present.loop_length										
media.present.loop_length_max										
media.present.present_timeout										
media.present.present_type										
media.printmode	X	X	X	X	X	X	X	X	X	X
media.serial_number						X	X	X	X	X
media.speed	X	X	X	X	X	X	X	X	X	X
memory.flash_free	X	X	X	X	X	X	X	X	X	X
memory.flash_size	X	X	X	X	X	X	X	X	X	X
memory.ram_free	X	X	X	X	X	X	X	X	X	X
memory.ram_size	X	X	X	X	X	X	X	X	X	X
memory.types	X	X	X	X	X					
netmanage.avalanche.agent_addr						X	X	X	X	X
netmanage.avalanche.available_agent						X	X	X	X	X

An X indicates that the SGD is supported for the particular device.
 This table indicates support based on the most recent Link-OS system release.

SGD Command Support

Command Name	Desktop									
	GK420	GK888t	GT800	GX420d	HC100	ZD220 ZD230	ZD410 ZD420	ZD500 ZD510	ZD620	ZD888
netmanage.avalanche.available_port						X	X	X	X	X
netmanage.avalanche.encryption_type						X	X	X	X	X
netmanage.avalanche.interval						X	X	X	X	X
netmanage.avalanche.interval_update						X	X	X	X	X
netmanage.avalanche.model_name						X	X	X	X	X
netmanage.avalanche.set_property						X	X	X	X	X
netmanage.avalanche.startup_update						X	X	X	X	X
netmanage.avalanche.tcp_connection_timeout						X	X	X	X	X
netmanage.avalanche.terminal_id						X	X	X	X	X
netmanage.avalanche.text_msg.beep						X	X	X	X	X
netmanage.avalanche.text_msg.display						X	X	X	X	X
netmanage.avalanche.text_msg.print						X	X	X	X	X
netmanage.avalanche.udp_timeout						X	X	X	X	X
netmanage.error_code	X	X	X	X	X	X	X	X	X	X
netmanage.state_code	X	X	X	X	X	X	X	X	X	X
netmanage.status_code	X	X	X	X	X	X	X	X	X	X
odometer.headclean						X	X	X	X	X
odometer.headnew						X	X	X	X	X
odometer.label_dot_length	X	X	X	X	X	X	X	X	X	X
odometer.latch_open_count						X	X	X	X	X
odometer.media_marker_count	X	X	X	X	X	X	X	X	X	X
odometer.media_marker_count1	X	X	X	X	X	X	X	X	X	X
odometer.media_marker_count2	X	X	X	X	X	X	X	X	X	X
odometer.retracts_count										
odometer.rfid.valid_resetable								X		
odometer.rfid.void_resetable								X		
odometer.total_cuts						X	X	X	X	X
odometer.total_label_count						X	X	X	X	X
odometer.total_print_length	X	X	X	X	X	X	X	X	X	X
odometer.user_label_count						X	X	X	X	X
odometer.user_label_count1						X	X	X	X	X
odometer.user_label_count2						X	X	X	X	X
odometer.user_total_cuts						X	X	X	X	X
power.average_current						X	X	X	X	X
power.battery_led_blink_rate										

An X indicates that the SGD is supported for the particular device.
 This table indicates support based on the most recent Link-OS system release.

SGD Command Support

Command Name	Desktop									
	GK420	GK888t	GT800	GX420d	HC100	ZD220 ZD230	ZD410 ZD420	ZD500 ZD510	ZD620	ZD888
power.battery_led_enable										
power.battery_led_off_duration										
power.battery_led_on_duration										
power.battery_replacement_cyclecount_threshold										
power.battery_type										
power.current										
power.cycle_count										
power.dtr_power_off										
power.energy_star.enable										
power.energy_star.timeout										
power.label_queue.shutdown										
power.part_number										
power.percent_health										
power.power_on_mode						X	X		X	X
power.remaining_capacity										
power.sleep.cradle										
power.temperature										
power.voltage										
power.wake.radio						X	X		X	X
print.legacy_compatibility										
print.tone	X	X	X	X	X	X	X	X	X	X
print.troubleshooting_label_print										
rfid.adaptive_antenna								X		
rfid.antenna_sweep								X		
rfid.country_code								X		
rfid.enable								X		
rfid.error.response								X		
rfid.hop_table_version								X		
rfid.log.clear								X		
rfid.log.enabled								X		
rfid.log.entries								X		
rfid.position.program								X		
rfid.reader_1.antenna_port								X		
rfid.reader_1.firmware_version								X		
rfid.reader_1.hardware_version								X		

An X indicates that the SGD is supported for the particular device.
 This table indicates support based on the most recent Link-OS system release.

SGD Command Support

Command Name	Desktop									
	GK420	GK888t	GT800	GX420d	HC100	ZD220 ZD230	ZD410 ZD420	ZD500 ZD510	ZD620	ZD888
rfid.reader_1.model								X		
rfid.reader_1.power.read								X		
rfid.reader_1.power.write								X		
rfid.recipe_version								X		
rfid.region_code								X		
rfid.tag.calibrate								X		
rfid.tag.read.content								X		
rfid.tag.read.execute								X		
rfid.tag.read.result_line1								X		
rfid.tag.read.result_line1_alternate								X		
rfid.tag.read.result_line2								X		
rfid.tag.read.result_line2_alternate								X		
rfid.tag.result_line1										
rfid.tag.test.content								X		
rfid.tag.test.execute								X		
rfid.tag.test.result_line1								X		
rfid.tag.test.result_line2								X		
ribbon.cartridge.authenticateda						X	X		X	X
ribbon.cartridge.inserteda						X	X		X	X
ribbon.cartridge.length ^a						X	X		X	X
ribbon.cartridge.length_remaining ^a						X	X		X	X
ribbon.cartridge.part_number ^a						X	X		X	X
rtc.timezone						X	X	X	X	X
rtc.unix_timestamp										
sensor.back_bar.brightness										
sensor.back_bar.cur						X	X	X	X	X
sensor.back_bar.gain										
sensor.back_bar.offset										
sensor.back_bar.ppr_out_thold						X	X	X	X	X
sensor.back_bar.thold						X	X	X	X	X
sensor.battery.in_volts										
sensor.cover_open										
sensor.front_bar.brightness										
sensor.front_bar.cur										
sensor.front_bar.gain										

An X indicates that the SGD is supported for the particular device.
 This table indicates support based on the most recent Link-OS system release.

SGD Command Support

Command Name	Desktop									
	GK420	GK888t	GT800	GX420d	HC100	ZD220 ZD230	ZD410 ZD420	ZD500 ZD510	ZD620	ZD888
sensor.front_bar.offset										
sensor.front_bar.ppr_out_thold										
sensor.front_bar.thold										
sensor.gap.brightness										
sensor.gap.cur						X	X	X	X	X
sensor.gap.gain										
sensor.gap.offset										
sensor.gap.thold						X	X	X	X	X
sensor.head.temp						X	X	X	X	X
sensor.head.temp_avg						X	X	X	X	X
sensor.head.temp_celsius						X	X	X	X	X
sensor.peel.brightness										
sensor.peel.cur						X	X	X	X	X
sensor.peel.gain										
sensor.peel.thold						X	X	X	X	X
sensor.peeler						X	X	X	X	X
sensor.width.cur										
sensor.width.in_dots										
usb.device.device_id_string						X	X	X	X	X
usb.device.device_unique_id						X	X	X	X	X
usb.device.device_version						X	X	X	X	X
usb.device.manufacturer_string						X	X	X	X	X
usb.device.product_id						X	X	X	X	X
usb.device.product_string						X	X	X	X	X
usb.device.serial_string						X	X	X	X	X
usb.device.vendor_id						X	X	X	X	X
usb.halt							X			
usb.host.config_info_to_usb									X	
usb.host.fn_field_data										
usb.host.fn_last_field										
usb.host.hid_count						X	X		X	X
usb.host.keyboard_input										
usb.host.lock_out						X	X		X	X
usb.host.mass_storage_count						X	X		X	X
usb.host.read_list						X	X		X	X

An X indicates that the SGD is supported for the particular device.
 This table indicates support based on the most recent Link-OS system release.

SGD Command Support

Command Name	Desktop									
	GK420	GK888t	GT800	GX420d	HC100	ZD220 ZD230	ZD410 ZD420	ZD500 ZD510	ZD620	ZD888
usb.host.read_list_print_delay						X	X		X	X
usb.host.template_list										
usb.host.template_print_amount										
usb.host.write_list						X	X		X	X
usb.mirror.appl_path						X	X		X	X
usb.mirror.auto						X	X		X	X
usb.mirror.enable						X	X		X	X
usb.mirror.error_retry						X	X		X	X
usb.mirror.feedback.auto						X	X		X	X
usb.mirror.feedback.odometer						X	X		X	X
usb.mirror.feedback.path						X	X		X	X
usb.mirror.fetch						X	X		X	X
usb.mirror.last_error						X	X		X	X
usb.mirror.last_time						X	X		X	X
usb.mirror.path						X	X		X	X
usb.mirror.reset_delay						X	X		X	X
usb.mirror.success						X	X		X	X
usb.mirror.success_time						X	X		X	X
weblink.cloud_connect.enable						X	X	X	X	X
weblink.enable						X	X	X	X	X
weblink.ip.conn1.authentication.add						X	X	X	X	X
weblink.ip.conn1.authentication.entries						X	X	X	X	X
weblink.ip.conn1.authentication.remove						X	X	X	X	X
weblink.ip.conn1.location						X	X	X	X	X
weblink.ip.conn1.maximum_simultaneous_connections						X	X	X	X	X
weblink.ip.conn1.num_connections						X	X	X	X	X
weblink.ip.conn1.proxy						X	X	X	X	X
weblink.ip.conn1.retry_interval						X	X	X	X	X
weblink.ip.conn1.retry_interval_random_max								X		
weblink.ip.conn1.test.location						X	X	X	X	X
weblink.ip.conn1.test.retry_interval						X	X	X	X	X
weblink.ip.conn1.test.test_on						X	X	X	X	X
weblink.ip.conn2.authentication.add						X	X	X	X	X
weblink.ip.conn2.authentication.entries						X	X	X	X	X
weblink.ip.conn2.authentication.remove						X	X	X	X	X

An X indicates that the SGD is supported for the particular device.
 This table indicates support based on the most recent Link-OS system release.

SGD Command Support

Command Name	Desktop									
	GK420	GK888t	GT800	GX420d	HC100	ZD220 ZD230	ZD410 ZD420	ZD500 ZD510	ZD620	ZD888
weblink.ip.conn2.location						X	X	X	X	X
weblink.ip.conn2.maximum_simultaneous_connections						X	X	X	X	X
weblink.ip.conn2.num_connections						X	X	X	X	X
weblink.ip.conn2.proxy						X	X	X	X	X
weblink.ip.conn2.retry_interval						X	X	X	X	X
weblink.ip.conn2.retry_interval_random_max								X		
weblink.ip.conn2.test.location						X	X	X	X	X
weblink.ip.conn2.test.retry_interval						X	X	X	X	X
weblink.ip.conn2.test.test_on						X	X	X	X	X
weblink.logging.clear						X	X	X	X	X
weblink.logging.entries						X	X	X	X	X
weblink.logging.max_entries						X	X	X	X	X
weblink.printer_reset_required						X	X	X	X	X
weblink.restore_defaults						X	X	X	X	X
weblink.zebra_connector.authentication.add						X	X	X	X	X
weblink.zebra_connector.authentication.entries						X	X	X	X	X
weblink.zebra_connector.authentication.remove						X	X	X	X	X
weblink.zebra_connector.enable						X	X	X	X	X
weblink.zebra_connector.proxy						X	X	X	X	X
weblink.zebra_connector.version						X	X	X	X	X
wlan.11ac.80mhz_enable						X	X		X	X
wlan.11d.enable						X	X	X	X	X
wlan.11n.20mhz_only						X	X	X	X	X
wlan.11n.greenfield						X	X	X	X	X
wlan.11n.rifs						X	X	X	X	X
wlan.11n.short_gi_20mhz						X	X	X	X	X
wlan.11n.short_gi_40mhz						X	X	X	X	X
wlan.8021x.authentication	X	X	X	X	X	X	X	X	X	X
wlan.8021x.eap.password						X	X	X	X	X
wlan.8021x.eap.privkey_password						X	X	X	X	X
wlan.8021x.eap.username	X	X	X	X	X	X	X	X	X	X
wlan.8021x.enable	X	X	X	X	X	X	X	X	X	X
wlan.8021x.peap.anonymous_identity						X		X		X
wlan.8021x.peap.peap_password						X	X	X	X	X
wlan.8021x.peap.peap_username	X	X	X	X	X	X	X	X	X	X

An X indicates that the SGD is supported for the particular device.
 This table indicates support based on the most recent Link-OS system release.

SGD Command Support

Command Name	Desktop									
	GK420	GK888t	GT800	GX420d	HC100	ZD220 ZD230	ZD410 ZD420	ZD500 ZD510	ZD620	ZD888
wlan.8021x.peap.privkey_password						X	X	X	X	X
wlan.active_channels						X	X	X	X	X
wlan.adhoc_last_channel										
wlan.adhocautomode	X	X	X	X	X	X	X	X	X	X
wlan.adhocchannel	X	X	X	X	X	X	X	X	X	X
wlan.allowed_band						X	X	X	X	X
wlan.associated	X	X	X	X	X	X	X	X	X	X
wlan.auth_type	X	X	X	X	X	X	X	X	X	X
wlan.authenticated						X	X	X	X	X
wlan.authentication_error						X	X	X	X	X
wlan.available						X	X	X	X	X
wlan.band_preference						X	X	X	X	X
wlan.bssid	X	X	X	X	X	X	X	X	X	X
wlan.channel	X	X	X	X	X	X	X	X	X	X
wlan.channel_mask						X	X	X	X	X
wlan.country_code						X	X	X	X	X
wlan.current_tx_rate	X	X	X	X	X	X	X	X	X	X
wlan.enable						X	X	X	X	X
wlan.encryption_index	X	X	X	X	X		X			
wlan.encryption_key1							X			
wlan.encryption_key2							X			
wlan.encryption_key3							X			
wlan.encryption_key4							X			
wlan.encryption_mode	X	X	X	X	X		X			
wlan.essid	X	X	X	X	X	X	X	X	X	X
wlan.firmware_version	X	X	X	X	X	X	X	X	X	X
wlan.ip.addr	X	X	X	X	X	X	X	X	X	X
wlan.ip.arp_interval	X	X	X	X	X	X	X	X	X	X
wlan.ip.default_addr_enable	X	X	X	X	X	X	X	X	X	X
wlan.ip.dhcp.arp_verify						X	X	X	X	X
wlan.ip.dhcp.cache_ip	X	X	X	X	X	X	X	X	X	X
wlan.ip.dhcp.cid_all						X	X	X	X	X
wlan.ip.dhcp.cid_enable	X	X	X	X	X	X	X	X	X	X
wlan.ip.dhcp.cid_prefix						X	X	X	X	X
wlan.ip.dhcp.cid_suffix						X	X	X	X	X

An X indicates that the SGD is supported for the particular device.
This table indicates support based on the most recent Link-OS system release.

SGD Command Support

Command Name	Desktop									
	GK420	GK888t	GT800	GX420d	HC100	ZD220 ZD230	ZD410 ZD420	ZD500 ZD510	ZD620	ZD888
wlan.ip.dhcp.cid_type	X	X	X	X	X	X	X	X	X	X
wlan.ip.dhcp.lease.last_attempt	X	X	X	X	X	X	X	X	X	X
wlan.ip.dhcp.lease.length	X	X	X	X	X	X	X	X	X	X
wlan.ip.dhcp.lease.server	X	X	X	X	X	X	X	X	X	X
wlan.ip.dhcp.lease.time_left	X	X	X	X	X	X	X	X	X	X
wlan.ip.dhcp.option12	X	X	X	X	X	X	X	X	X	X
wlan.ip.dhcp.option12_format	X	X	X	X	X	X	X	X	X	X
wlan.ip.dhcp.option12_value						X	X	X	X	X
wlan.ip.dhcp.request_timeout	X	X	X	X	X	X	X	X	X	X
wlan.ip.dhcp.requests_per_session	X	X	X	X	X	X	X	X	X	X
wlan.ip.dhcp.session_interval	X	X	X	X	X	X	X	X	X	X
wlan.ip.dns.domain						X	X	X	X	X
wlan.ip.dns.servers						X	X	X	X	X
wlan.ip.gateway	X	X	X	X	X	X	X	X	X	X
wlan.ip.netmask	X	X	X	X	X	X	X	X	X	X
wlan.ip.port	X	X	X	X	X	X	X	X	X	X
wlan.ip.port_alternate						X	X	X	X	X
wlan.ip.port_json_config						X	X	X	X	X
wlan.ip.protocol	X	X	X	X	X	X	X	X	X	X
wlan.ip.timeout.enable	X	X	X	X	X	X	X	X	X	X
wlan.ip.timeout.value	X	X	X	X	X	X	X	X	X	X
wlan.ip.wins.addr	X	X	X	X	X	X	X	X	X	X
wlan.ip.wins.permanent_source	X	X	X	X	X	X	X	X	X	X
wlan.keep_alive.enable	X	X	X	X	X	X	X	X	X	X
wlan.keep_alive.timeout	X	X	X	X	X	X	X	X	X	X
wlan.kerberos.kdc	X	X	X	X	X					
wlan.kerberos.mode	X	X	X	X	X					
wlan.kerberos.password	X	X	X		X					
wlan.kerberos.realm	X	X	X	X	X					
wlan.kerberos.username	X	X	X	X	X					
wlan.leap_mode	X	X	X	X	X	X	X	X	X	X
wlan.leap_password						X	X	X	X	X
wlan.leap_username	X	X	X	X	X	X	X	X	X	X
wlan.mac_addr	X	X	X	X	X	X	X	X	X	X
wlan.mac_raw	X	X	X	X	X	X	X	X	X	X

An X indicates that the SGD is supported for the particular device.
 This table indicates support based on the most recent Link-OS system release.

SGD Command Support

Command Name	Desktop									
	GK420	GK888t	GT800	GX420d	HC100	ZD220 ZD230	ZD410 ZD420	ZD500 ZD510	ZD620	ZD888
wlan.operating_mode	X	X	X	X	X	X	X	X	X	X
wlan.password						X	X	X	X	X
wlan.permitted_channels						X	X	X	X	X
wlan.pmf						X	X	X	X	X
wlan.poor_signal_threshold						X	X	X	X	X
wlan.preamble	X	X	X	X	X	X	X	X	X	X
wlan.private_key_password						X	X	X	X	X
wlan.region_code						X	X	X	X	X
wlan.roam.interchannel_delay						X	X	X	X	X
wlan.roam.interval	X	X	X	X	X	X	X	X	X	X
wlan.roam.max_chan_scan_time						X	X	X	X	X
wlan.roam.max_fail						X	X	X	X	X
wlan.roam.monitor						X	X	X	X	X
wlan.roam.rssi						X	X	X	X	X
wlan.roam.signal	X	X	X	X	X	X	X	X	X	X
wlan.rts_cts_enabled						X	X	X	X	X
wlan.secure_ssid						X	X	X	X	X
wlan.security						X	X	X	X	X
wlan.signal_noise	X	X	X	X						
wlan.signal_quality	X	X	X	X						
wlan.signal_strength	X	X	X	X	X	X	X	X	X	X
wlan.station_name	X	X	X	X	X	X	X	X	X	X
wlan.tx_power	X	X	X	X	X					
wlan.tx_rate	X	X	X	X	X					
wlan.user_channel_list						X	X	X	X	X
wlan.username	X	X	X	X	X	X	X	X	X	X
wlan.waveagent.enable						X	X	X	X	X
wlan.waveagent.udp_port						X	X	X	X	X
wlan.wep.auth_type	X	X	X	X	X		X			
wlan.wep.index	X	X	X	X	X		X			
wlan.wep.key_format	X	X	X	X	X		X			
wlan.wep.key1							X			
wlan.wep.key2							X			
wlan.wep.key3							X			
wlan.wep.key4							X			

An X indicates that the SGD is supported for the particular device.
 This table indicates support based on the most recent Link-OS system release.

SGD Command Support

Command Name	Desktop									
	GK420	GK888t	GT800	GX420d	HC100	ZD220 ZD230	ZD410 ZD420	ZD500 ZD510	ZD620	ZD888
wlan.wpa.groupkey_ciphersuite						X	X	X	X	X
wlan.wpa.pairwise_ciphersuite						X	X	X	X	X
wlan.wpa.psk						X	X	X	X	X
wlan.wpa.timecheck						X	X	X	X	X
wlan.wpa.wpa_version						X	X	X	X	X
zbi.control.add_breakpoint						X	X	X	X	X
zbi.control.break						X	X	X	X	X
zbi.control.clear_breakpoints						X	X	X	X	X
zbi.control.delete_breakpoint						X	X	X	X	X
zbi.control.line_number						X	X	X	X	X
zbi.control.restart						X	X	X	X	X
zbi.control.run						X	X	X	X	X
zbi.control.step						X	X	X	X	X
zbi.control.terminate						X	X	X	X	X
zbi.control.variable_name						X	X	X	X	X
zbi.control.variable_value						X	X	X	X	X
zbi.enable						X	X	X	X	X
zbi.key	X	X	X	X	X	X	X	X	X	X
zbi.last_error						X	X	X	X	X
zbi.program_list						X	X	X	X	X
zbi.reseller_key						X	X	X	X	X
zbi.revision	X	X	X	X	X	X	X	X	X	X
zbi.running_program_name						X	X	X	X	X
zbi.start_info.execute						X	X	X	X	X
zbi.start_info.file_name						X	X	X	X	X
zbi.start_info.memory_alloc						X	X	X	X	X
zbi.state	X	X	X	X	X	X	X	X	X	X
zpl.calibrate						X	X	X	X	X
zpl.command_prefix						X	X	X	X	X
zpl.format_prefix						X	X	X	X	X
zpl.label_length	X	X	X		X	X	X	X	X	X
zpl.left_position						X	X	X	X	X
zpl.relative_darkness						X	X	X	X	X
zpl.system_error						X	X	X	X	X
zpl.system_status						X	X	X	X	X

An X indicates that the SGD is supported for the particular device.
 This table indicates support based on the most recent Link-OS system release.

SGD Command Support

Command Name	Desktop									
	GK420	GK888t	GT800	GX420d	HC100	ZD220 ZD230	ZD410 ZD420	ZD500 ZD510	ZD620	ZD888
zpl.zpl_mode						X	X	X	X	X
zpl.zpl_override										

An X indicates that the SGD is supported for the particular device.
 This table indicates support based on the most recent Link-OS system release.

- a. This command is only valid for ZD420C.

SGDs Supported for Mobile Printers

This table provides details of the list of SGDs supported for Mobile Printers.

Command Name	Mobile									
	IMZ220 IMZ320	KR403	QLn220 QLn320 QLn420	ZQ112 ZQ120 ZQ220	ZQ310 ZQ320	ZQ510 ZQ520	ZQ610 ZQ620 ZQ630	ZR138	ZR318 ZR328 ZR338	ZR628 ZR638 ZR658 ZR668
alerts.add	X		X		X	X	X		X	
alerts.conditions ^a	X		X		X	X	X		X	X
alerts.configured	X		X		X	X	X		X	X
alerts.destinations	X		X		X	X	X		X	X
alerts.http.authentication.add	X		X		X	X	X		X	X
alerts.http.authentication.entries	X		X		X	X	X		X	X
alerts.http.authentication.remove	X		X		X	X	X		X	X
alerts.http.logging.clear	X		X		X	X	X		X	X
alerts.http.logging.entries	X		X		X	X	X		X	X
alerts.http.logging.max_entries	X		X		X	X	X		X	X
alerts.http.proxy	X		X		X	X	X		X	X
alerts.tracked_settings.clear_log	X		X		X	X	X		X	X
alerts.tracked_settings.log_tracked	X		X		X	X	X		X	X
alerts.tracked_settings.max_log_entries	X		X		X	X	X		X	X
alerts.tracked_settings.zbi_notified	X		X		X	X	X		X	X
apl.enable	X		X		X	X	X		X	X
apl.framework_version	X		X		X	X	X		X	X
apl.version	X		X		X	X	X		X	X
appl.bootblock	X	X	X	X	X	X	X	X	X	X
appl.date	X	X	X	X	X	X	X	X	X	X
appl.link_os_version	X		X		X	X	X		X	X
appl.name	X	X	X	X	X	X	X	X	X	X
bluetooth.address	X		X	X	X	X	X	X	X	X
bluetooth.authentication										
bluetooth.bluetooth_pin	X		X	X	X	X	X	X	X	X
bluetooth.clear_bonding_cache	X		X	X	X	X	X	X	X	X
bluetooth.discoverable	X		X	X	X	X	X	X	X	X
bluetooth.enable	X		X	X	X	X	X	X	X	X
bluetooth.enable_reconnect	X		X	X	X	X	X	X	X	X
bluetooth.friendly_name	X		X	X	X	X	X	X	X	X
bluetooth.json_config_channel_enable	X		X		X	X	X		X	X
bluetooth.le.controller_mode						X	X		X	X
bluetooth.le.minimum_security						X				
bluetooth.le.power_class ^a							X			
bluetooth.local_name	X		X	X	X	X	X	X	X	X

An X indicates that the SGD is supported for the particular device.
This table indicates support based on the most recent Link-OS system release.

SGD Command Support

Command Name	Mobile									
	iMZ220 iMZ320	KR403	QLn220 QLn320 QLn420	ZQ112 ZQ120 ZQ220	ZQ310 ZQ320	ZQ510 ZQ520	ZQ610 ZQ620 ZQ630	ZR138	ZR318 ZR328 ZR338	ZR628 ZR638 ZR658 ZR668
bluetooth.minimum_security_mode	X		X	X	X	X	X	X	X	X
bluetooth.page_scan_window	X		X	X	X	X	X	X	X	X
bluetooth.radio_version	X		X	X	X	X	X	X	X	X
bluetooth.short_address	X		X	X	X	X	X	X	X	X
bluetooth.version	X		X	X	X	X	X	X	X	X
capture.channel1.count	X		X		X	X	X		X	X
capture.channel1.data.mime	X		X		X	X	X		X	X
capture.channel1.data.raw	X		X		X	X	X		X	X
capture.channel1.delimiter	X		X		X	X	X		X	X
capture.channel1.max_length	X		X		X	X	X		X	X
capture.channel1.port	X		X		X	X	X		X	X
comm.baud		X	X				X			X
comm.halt			X				X			X
comm.parity		X	X				X			X
comm.stop_bits		X	X				X			X
comm.type										
cradle.comm.baud						X				
cradle.comm.handshake						X				
cutter.clean_cutter		X								
device.allow_firmware_downloads	X		X	X	X	X	X	X		
device.applicator.data_ready										
device.applicator.data_ready_activation										
device.applicator.end_print										
device.applicator.error_on_pause										
device.applicator.feed										
device.applicator.media_out										
device.applicator.pause										
device.applicator.reprint										
device.applicator.rfid_void										
device.applicator.ribbon_low										
device.applicator.ribbon_out										
device.applicator.service_required										
device.applicator.start_print										
device.applicator.start_print_mode										
device.applicator.supplies_low_selection										
device.applicator.voltage										
device.bluetooth_installed	X		X		X	X	X		X	X
device.command_override.active	X		X		X	X	X		X	X

An X indicates that the SGD is supported for the particular device.
 This table indicates support based on the most recent Link-OS system release.

SGD Command Support

Command Name	Mobile									
	iMZ220 iMZ320	KR403	QLn220 QLn320 QLn420	ZQ112 ZQ120 ZQ220	ZQ310 ZQ320	ZQ510 ZQ520	ZQ610 ZQ620 ZQ630	ZR138	ZR318 ZR328 ZR338	ZR628 ZR638 ZR658 ZR668
device.command_override.add	X		X		X	X	X		X	X
device.command_override.clear	X		X		X	X	X		X	X
device.command_override.list	X		X		X	X	X		X	X
device.company_contact	X		X		X	X	X		X	X
device.configuration_number	X		X		X	X	X		X	
device.cpcl_synchronous_mode	X		X		X	X	X		X	X
device.cutter_installed	X		X		X	X	X		X	X
device.download_connection_timeout	X	X	X		X	X	X		X	X
device.download_interactive_mode										
device.epl_legacy_mode ^a	X		X		X	X	X		X	
device.feature.802_11ac ^a	X		X		X	X	X		X	
device.feature.bluetooth_le ^a	X		X		X	X	X		X	
device.feature.head_element_test ^a	X		X		X	X	X		X	
device.feature.lighted_arrows ^a	X		X		X	X	X		X	
device.feature.mcr	X		X		X	X	X		X	X
device.feature.nfc	X		X		X	X	X		X	X
device.feature.ribbon_cartridge	X		X		X	X	X		X	X
device.friendly_name	X	X	X	X	X	X	X	X	X	X
device.frontpanel.key_press			X			X	X			X
device.frontpanel.line1		X	X				X			X
device.frontpanel.line2		X	X				X			X
device.frontpanel.xml		X	X			X	X			X
device.host_identification	X		X		X	X	X		X	X
device.host_status	X		X		X	X	X		X	X
device.idle_display_format			X			X	X			X
device.idle_display_value			X			X	X			X
device.internal_wired_setting_location			X				X			X
device.job_log.total_jobs	X		X		X	X	X		X	X
device.jobs_print ^a	X	X	X	X	X	X	X	X	X	
device.languages	X	X	X	X	X	X	X	X	X	X
device.light.cover_open_brightness										
device.light.head_open_brightness										
device.light.media_path_brightness										
device.light.ribbon_path_brightness										
device.locked										
device.ltu_installed	X		X		X	X	X		X	X
device.pause	X		X		X	X	X		X	X
device.pmcu.revision ^a						X	X			

An X indicates that the SGD is supported for the particular device.
 This table indicates support based on the most recent Link-OS system release.

SGD Command Support

Command Name	Mobile									
	iMZ220 iMZ320	KR403	QLn220 QLn320 QLn420	ZQ112 ZQ120 ZQ220	ZQ310 ZQ320	ZQ510 ZQ520	ZQ610 ZQ620 ZQ630	ZR138	ZR318 ZR328 ZR338	ZR628 ZR638 ZR658 ZR668
device.pnp_option	X	X	X		X	X	X		X	X
device.position.accuracy	X		X		X	X	X		X	X
device.position.altitude	X		X		X	X	X		X	X
device.position.latitude	X		X		X	X	X		X	X
device.position.longitude	X		X		X	X	X		X	X
device.print_2key	X		X		X	X	X		X	X
device.print_reprogram_2key	X		X		X	X	X		X	X
device.printhead.odometer										
device.printhead.resolution	X		X		X	X	X		X	X
device.printhead.test.summary										
device.product_name_submodel	X		X		X	X	X		X	X
device.reset	X		X	X	X	X	X	X	X	X
device.restore_defaults	X		X	X	X	X	X	X	X	X
device.rewinder_installed	X		X		X	X	X		X	X
device.save_2key	X		X	X	X	X	X	X	X	X
device.sensor_profile	X		X		X	X	X		X	X
device.sensor_select ^a							X			
device.serial_numbers.applicator_option_board										
device.serial_numbers.applicator_option_board_date										
device.serial_numbers.control_panel_date ^a	X		X		X	X	X		X	
device.serial_numbers.cutter ^a	X		X		X	X	X		X	
device.serial_numbers.cutter_date ^a	X		X		X	X	X		X	
device.serial_numbers.mlb_date	X		X		X	X	X		X	
device.serial_numbers.option_board	X		X		X	X	X		X	X
device.serial_numbers.option_board_date ^a	X		X		X	X	X		X	
device.serial_numbers.parallel_option_board										
device.serial_numbers.parallel_option_board_date										
device.serial_numbers.printhead										
device.serial_numbers.printhead_date										
device.serial_numbers.usb_host_option_board										
device.serial_numbers.usb_host_option_board_date										
device.serial_numbers.wired_ethernet_option_board										
device.serial_numbers.wired_ethernet_option_board_date										
device.set_clock_to_build_date ^a	X		X				X			
device.slot_1										
device.slot_2										
device.super_host_status ^a	X				X		X		X	

An X indicates that the SGD is supported for the particular device.
This table indicates support based on the most recent Link-OS system release.

SGD Command Support

Command Name	Mobile									
	iMZ220 iMZ320	KR403	QLn220 QLn320 QLn420	ZQ112 ZQ120 ZQ220	ZQ310 ZQ320	ZQ510 ZQ520	ZQ610 ZQ620 ZQ630	ZR138	ZR318 ZR328 ZR338	ZR628 ZR638 ZR658 ZR668
device.syslog.clear_log	X		X		X	X	X		X	X
device.syslog.configuration	X		X		X	X	X		X	X
device.syslog.enable	X		X		X	X	X		X	X
device.syslog.entries ^a	X		X		X	X	X		X	
device.syslog.log_max_file_size	X		X		X	X	X		X	X
device.syslog.save_local_file	X		X		X	X	X		X	X
device.unique_id	X	X	X		X	X	X		X	X
device.unpause	X		X		X	X	X		X	X
device.uptime	X	X	X	X	X	X	X	X	X	X
device.user_p1	X	X	X	X	X	X	X	X	X	X
device.user_p2	X	X	X	X	X	X	X	X	X	X
device.user_vars.create	X		X		X	X	X		X	X
device.user_vars.set_range	X		X		X	X	X		X	X
device.xml.enable	X	X	X		X	X	X		X	X
display.backlight			X			X	X			X
display.backlight_on_time			X			X	X			X
display.batch_counter ^a			X			X	X			
display.bluetooth.mac				X				X		
display.language			X	X		X	X	X		X
display.load_card ^a			X				X			
display.password.level ^a			X				X			
display.root_wml			X				X			X
display.text		X	X			X	X			X
external_wired.check		X								
external_wired.ip.addr		X								
external_wired.ip.arp_interval		X								
external_wired.ip.default_addr_enable		X								
external_wired.ip.gateway		X								
external_wired.ip.netmask		X								
external_wired.ip.port		X								
external_wired.ip.protocol		X								
external_wired.ip.timeout.enable		X								
external_wired.ip.timeout.value		X								
external_wired.ip.v6.addr										
external_wired.ip.v6.gateway										
external_wired.ip.v6.prefix_length										
external_wired.mac_addr		X								
external_wired.mac_raw		X								

An X indicates that the SGD is supported for the particular device.
 This table indicates support based on the most recent Link-OS system release.

SGD Command Support

Command Name	Mobile									
	iMZ220 iMZ320	KR403	QLn220 QLn320 QLn420	ZQ112 ZQ120 ZQ220	ZQ310 ZQ320	ZQ510 ZQ520	ZQ610 ZQ620 ZQ630	ZR138	ZR318 ZR328 ZR338	ZR628 ZR638 ZR658 ZR668
ezpl.head_close_action	X		X	X	X	X	X	X	X	X
ezpl.label_length_max	X		X		X	X	X		X	X
ezpl.label_sensor	X		X		X	X	X		X	X
ezpl.manual_calibration	X		X		X	X	X		X	X
ezpl.media_type	X		X		X	X	X		X	X
ezpl.power_up_action	X		X	X	X	X	X	X	X	X
ezpl.print_method	X		X		X	X	X		X	X
ezpl.print_width	X		X		X	X	X		X	X
ezpl.reprint_mode	X		X		X	X	X		X	X
ezpl.restore_defaults	X		X		X	X	X		X	X
ezpl.take_label	X		X		X	X	X		X	X
ezpl.tear_off	X		X		X	X	X		X	X
file.capture_response.destination ^a	X		X		X	X	X		X	
file.capture_response.end ^a	X		X		X	X	X		X	
file.cert.expiration					X	X	X			
file.cert.supported_curves ^a					X	X	X		X	
file.delete	X		X	X	X	X	X	X	X	X
file.dir	X		X	X	X	X	X	X	X	X
file.dir_format	X		X		X	X	X		X	X
file.run	X		X	X	X	X	X	X	X	X
file.type	X		X	X	X	X	X	X	X	X
formats.cancel_all	X		X		X	X	X		X	X
head.authenticated										
head.darkness_switch										
head.darkness_switch_enable										
head.element_test						X	X			X
head.latch	X	X	X	X	X	X	X	X	X	X
head.resolution.in_dpi ^a	X		X		X	X	X		X	
input.capture	X		X	X	X	X	X	X	X	X
interface.network.active.arp_interval	X		X		X	X	X		X	X
interface.network.active.cable_type	X		X		X	X	X		X	X
interface.network.active.dhcp_received_host_name	X		X		X	X	X		X	X
interface.network.active.gateway	X	X	X		X	X	X		X	X
interface.network.active.ip_addr	X	X	X		X	X	X		X	X
interface.network.active.mac_addr	X	X	X		X	X	X		X	X
interface.network.active.mac_raw	X	X	X		X	X	X		X	X
interface.network.active.netmask	X	X	X		X	X	X		X	X
interface.network.active.printserver	X	X	X		X	X	X		X	X

An X indicates that the SGD is supported for the particular device.
 This table indicates support based on the most recent Link-OS system release.

SGD Command Support

Command Name	Mobile									
	iMZ220 iMZ320	KR403	QLn220 QLn320 QLn420	ZQ112 ZQ120 ZQ220	ZQ310 ZQ320	ZQ510 ZQ520	ZQ610 ZQ620 ZQ630	ZR138	ZR318 ZR328 ZR338	ZR628 ZR638 ZR658 ZR668
interface.network.active.protocol	X	X	X		X	X	X		X	X
interface.network.active.protocol_error	X		X		X	X	X		X	X
interface.network.active.rx_errors	X		X		X	X	X		X	X
interface.network.active.rx_packets	X		X		X	X	X		X	X
interface.network.active.server_address	X		X		X	X	X		X	X
interface.network.active.speed	X		X		X	X	X		X	X
interface.network.active.tx_errors	X		X		X	X	X		X	X
interface.network.active.tx_packets	X		X		X	X	X		X	X
interface.network.active.wins_addr	X		X		X	X	X		X	X
interface.network.settings_require_reset	X		X		X	X	X		X	X
internal_wired.8021x.password ^a			X				X			
internal_wired.8021x.peap.anonymous_identity ^a			X				X			
internal_wired.8021x.peap.validate_server_certificate ^a			X				X			
internal_wired.8021x.security ^a			X				X			
internal_wired.8021x.ttls_tunnel ^a			X				X			
internal_wired.8021x.username ^a			X				X			
internal_wired.activity_led			X				X			X
internal_wired.auto_switchover	X	X	X		X	X	X		X	X
internal_wired.enable ^a			X				X			
internal_wired.installed	X		X		X	X	X		X	X
internal_wired.ip.addr	X	X	X		X	X	X		X	X
internal_wired.ip.arp_interval	X	X	X		X	X	X		X	X
internal_wired.ip.default_addr_enable	X	X	X		X	X	X		X	X
internal_wired.ip.dhcp.arp_verify	X		X		X	X	X		X	X
internal_wired.ip.dhcp.cache_ip	X	X	X		X	X	X		X	X
internal_wired.ip.dhcp.cid_all		X	X				X			X
internal_wired.ip.dhcp.cid_enable	X	X	X		X	X	X		X	X
internal_wired.ip.dhcp.cid_prefix		X	X				X			X
internal_wired.ip.dhcp.cid_suffix		X	X				X			X
internal_wired.ip.dhcp.cid_type	X	X	X		X	X	X		X	X
internal_wired.ip.dhcp.lease.last_attempt	X	X	X		X	X	X		X	X
internal_wired.ip.dhcp.lease.length	X	X	X		X	X	X		X	X
internal_wired.ip.dhcp.lease.server	X	X	X		X	X	X		X	X
internal_wired.ip.dhcp.lease.time_left	X	X	X		X	X	X		X	X
internal_wired.ip.dhcp.option12	X	X	X		X	X	X		X	X
internal_wired.ip.dhcp.option12_format	X	X	X		X	X	X		X	X
internal_wired.ip.dhcp.option12_value		X	X				X			X
internal_wired.ip.dhcp.requests_per_session	X	X	X		X	X	X		X	X

An X indicates that the SGD is supported for the particular device.
 This table indicates support based on the most recent Link-OS system release.

SGD Command Support

Command Name	Mobile									
	iMZ220 iMZ320	KR403	QLn220 QLn320 QLn420	ZQ112 ZQ120 ZQ220	ZQ310 ZQ320	ZQ510 ZQ520	ZQ610 ZQ620 ZQ630	ZR138	ZR318 ZR328 ZR338	ZR628 ZR638 ZR658 ZR668
internal_wired.ip.dns.servers			X				X			X
internal_wired.ip.gateway	X	X	X		X	X	X		X	X
internal_wired.ip.netmask	X	X	X		X	X	X		X	X
internal_wired.ip.port	X	X	X		X	X	X		X	X
internal_wired.ip.port_alternate	X		X		X	X	X		X	X
internal_wired.ip.port_json_config			X				X			X
internal_wired.ip.protocol	X	X	X		X	X	X		X	X
internal_wired.ip.timeout.enable	X	X	X		X	X	X		X	X
internal_wired.ip.timeout.value	X	X	X		X	X	X		X	X
internal_wired.ip.wins.addr	X	X	X		X	X	X		X	X
internal_wired.ip.wins.permanent_source	X	X	X		X	X	X		X	X
ip.active_network	X	X	X		X	X	X		X	X
ip.addr	X		X		X	X	X		X	X
ip.arp_interval	X		X		X	X	X		X	X
ip.bootp.enable	X		X		X	X	X		X	X
ip.dhcp.arp_verify	X		X		X	X	X		X	X
ip.dhcp.auto_provision_enable	X		X		X	X	X		X	X
ip.dhcp.cache_ip	X		X		X	X	X		X	X
ip.dhcp.cid_all	X		X		X	X	X		X	X
ip.dhcp.cid_enable	X		X		X	X	X		X	X
ip.dhcp.cid_prefix	X		X		X	X	X		X	X
ip.dhcp.cid_suffix	X		X		X	X	X		X	X
ip.dhcp.cid_type	X		X		X	X	X		X	X
ip.dhcp.cid_value	X		X		X	X	X		X	X
ip.dhcp.enable	X		X		X	X	X		X	X
ip.dhcp.lease.last_attempt	X		X		X	X	X		X	X
ip.dhcp.lease.server	X		X		X	X	X		X	X
ip.dhcp.lease.time_left	X		X		X	X	X		X	X
ip.dhcp.ntp.enable	X		X		X	X	X		X	X
ip.dhcp.ntp.received_servers	X		X		X	X	X		X	X
ip.dhcp.option12	X		X		X	X	X		X	X
ip.dhcp.option12_format	X		X		X	X	X		X	X
ip.dhcp.option12_value	X		X		X	X	X		X	X
ip.dhcp.request_timeout	X		X		X	X	X		X	X
ip.dhcp.requests_per_session	X		X		X	X	X		X	X
ip.dhcp.session_interval	X		X		X	X	X		X	X
ip.dhcp.user_class_id	X		X		X	X	X		X	X
ip.dhcp.vendor_class_id	X		X		X	X	X		X	X

An X indicates that the SGD is supported for the particular device.
 This table indicates support based on the most recent Link-OS system release.

SGD Command Support

Command Name	Mobile									
	iMZ220 iMZ320	KR403	QLn220 QLn320 QLn420	ZQ112 ZQ120 ZQ220	ZQ310 ZQ320	ZQ510 ZQ520	ZQ610 ZQ620 ZQ630	ZR138	ZR318 ZR328 ZR338	ZR628 ZR638 ZR658 ZR668
ip.dns.servers	X	X	X		X	X	X		X	X
ip.firewall.whitelist_in ^a	X		X		X	X	X			
ip.ftp.enable	X	X	X		X	X	X		X	X
ip.ftp.execute_file	X	X	X		X	X	X		X	X
ip.ftp.request_password	X		X		X	X	X		X	X
ip.gateway	X		X		X	X	X		X	X
ip.http.admin_name	X		X		X	X	X		X	X
ip.http.admin_password	X		X		X	X	X		X	X
ip.http.custom_link_name	X		X		X	X	X		X	X
ip.http.custom_link_url	X		X		X	X	X		X	X
ip.http.enable	X	X	X		X	X	X		X	X
ip.http.faq_url	X		X		X	X	X		X	X
ip.http.port	X		X		X	X	X		X	X
ip.https.enable ^a	X		X		X	X	X			
ip.https.port ^a	X		X		X	X	X			
ip.lpd.enable	X	X	X		X	X	X		X	X
ip.mirror.appl_path	X		X		X	X	X		X	X
ip.mirror.auto	X	X	X		X	X	X		X	X
ip.mirror.error_retry	X	X	X		X	X	X		X	X
ip.mirror.feedback.auto	X	X	X		X	X	X		X	X
ip.mirror.feedback.freq	X	X	X		X	X	X		X	X
ip.mirror.feedback.odometer	X	X	X		X	X	X		X	X
ip.mirror.feedback.path	X	X	X		X	X	X		X	X
ip.mirror.fetch	X		X		X	X	X		X	X
ip.mirror.freq	X	X	X		X	X	X		X	X
ip.mirror.freq_hours	X	X	X		X	X	X		X	X
ip.mirror.interface	X		X		X	X	X		X	X
ip.mirror.last_error	X	X	X		X	X	X		X	X
ip.mirror.last_time	X	X	X		X	X	X		X	X
ip.mirror.mode	X		X		X	X	X		X	X
ip.mirror.password	X		X		X	X	X		X	X
ip.mirror.path	X	X	X		X	X	X		X	X
ip.mirror.reset_delay	X		X		X	X	X		X	X
ip.mirror.server	X	X	X		X	X	X		X	X
ip.mirror.success	X	X	X		X	X	X		X	X
ip.mirror.success_time	X	X	X		X	X	X		X	X
ip.mirror.username	X	X	X		X	X	X		X	X
ip.mirror.version	X	X	X		X	X	X		X	X

An X indicates that the SGD is supported for the particular device.
 This table indicates support based on the most recent Link-OS system release.

SGD Command Support

Command Name	Mobile									
	iMZ220 iMZ320	KR403	QLn220 QLn320 QLn420	ZQ112 ZQ120 ZQ220	ZQ310 ZQ320	ZQ510 ZQ520	ZQ610 ZQ620 ZQ630	ZR138	ZR318 ZR328 ZR338	ZR628 ZR638 ZR658 ZR668
ip.netmask	X		X		X	X	X		X	X
ip.ntp.enable	X		X		X	X	X		X	X
ip.ntp.log	X		X		X	X	X		X	X
ip.ntp.servers	X		X		X	X	X		X	X
ip.ping_gateway_interval	X		X		X	X	X		X	X
ip.ping_remote	X		X		X	X	X		X	X
ip.pop3.enable	X	X	X		X	X	X		X	X
ip.pop3.password	X		X		X	X	X		X	X
ip.pop3.poll	X	X	X		X	X	X		X	X
ip.pop3.print_body	X		X		X	X	X		X	X
ip.pop3.print_headers	X		X		X	X	X		X	X
ip.pop3.save_attachments	X		X		X	X	X		X	X
ip.pop3.server_addr	X	X	X		X	X	X		X	X
ip.pop3.username	X	X	X		X	X	X		X	X
ip.pop3.verbose_headers	X		X		X	X	X		X	X
ip.port	X		X		X	X	X		X	X
ip.port_alternate	X		X		X	X	X		X	X
ip.port_json_config	X		X		X	X	X		X	X
ip.port_single_conn	X		X		X	X	X		X	X
ip.port_single_conn_idle_timeout	X		X		X	X	X		X	X
ip.primary_network	X	X	X		X	X	X		X	X
ip.smtp.domain	X	X	X		X	X	X		X	X
ip.smtp.enable	X	X	X		X	X	X		X	X
ip.smtp.server_addr	X	X	X		X	X	X		X	X
ip.snmp.enable	X	X	X		X	X	X		X	X
ip.snmp.get_community_name	X		X		X	X	X		X	X
ip.snmp.set_community_name	X		X		X	X	X		X	X
ip.snmp.trap_community_name	X		X		X	X	X		X	X
ip.tcp.enable	X	X	X		X	X	X		X	X
ip.tcp.nagle_algorithm	X		X		X	X	X		X	X
ip.telnet.enable ^a	X	X	X		X	X	X		X	X
ip.tls.enable ^a	X		X		X	X	X			
ip.tls.port ^a	X		X		X	X	X			
ip.tls.port_json_config ^a	X		X		X	X	X			
ip.udp.enable	X	X	X		X	X	X		X	X
log.reboot.code	X		X	X	X	X	X	X	X	X
log.reboot.codes	X		X	X	X	X	X	X	X	X
log.reboot.reason	X		X	X	X	X	X	X	X	X

An X indicates that the SGD is supported for the particular device.
 This table indicates support based on the most recent Link-OS system release.

SGD Command Support

Command Name	Mobile									
	iMZ220 iMZ320	KR403	QLn220 QLn320 QLn420	ZQ112 ZQ120 ZQ220	ZQ310 ZQ320	ZQ510 ZQ520	ZQ610 ZQ620 ZQ630	ZR138	ZR318 ZR328 ZR338	ZR628 ZR638 ZR658 ZR668
log.reboot.report	X		X	X	X	X	X	X	X	X
mcr.cancel						X				
mcr.crypt.algorithm						X				
mcr.crypt.enabled						X				
mcr.crypt.key_mgmt						X				
mcr.out						X				
mcr.query						X				
mcr.revision						X				
media.bar_location ^a	X		X	X	X	X	X	X	X	
media.cartridge.darkness										
media.cartridge.inserted										
media.cartridge.labels_remaining										
media.cartridge.length										
media.cartridge.part_number										
media.cartridge.serial_number										
media.cartridge.speed										
media.cartridge.total_label_cnt										
media.cartridge.width										
media.cut_now										
media.darkness_mode		X								
media.draft_mode ^a	X		X		X	X	X		X	
media.dynamic_length_calibration										
media.feed_skip	X		X		X	X	X		X	X
media.media_low.external		X								
media.media_low.warning		X								
media.part_number ^a	X		X		X	X	X		X	
media.present.cut_amount		X								
media.present.cut_margin		X								
media.present.eject		X								
media.present.length_addition		X								
media.present.loop_length		X								
media.present.loop_length_max		X								
media.present.present_timeout		X								
media.present.present_type		X								
media.printmode	X	X	X		X	X	X		X	X
media.serial_number ^a	X		X		X	X	X		X	
media.speed	X	X	X		X	X	X		X	X
memory.flash_free	X	X	X	X	X	X	X	X	X	X

An X indicates that the SGD is supported for the particular device.
 This table indicates support based on the most recent Link-OS system release.

SGD Command Support

Command Name	Mobile									
	iMZ220 iMZ320	KR403	QLn220 QLn320 QLn420	ZQ112 ZQ120 ZQ220	ZQ310 ZQ320	ZQ510 ZQ520	ZQ610 ZQ620 ZQ630	ZR138	ZR318 ZR328 ZR338	ZR628 ZR638 ZR658 ZR668
memory.flash_size	X	X	X	X	X	X	X	X	X	X
memory.ram_free	X	X	X	X	X	X	X	X	X	X
memory.ram_size	X	X	X	X	X	X	X	X	X	X
memory.types		X								
netmanage.avalanche.agent_addr	X		X		X	X	X		X	X
netmanage.avalanche.available_agent	X		X		X	X	X		X	X
netmanage.avalanche.available_port	X		X		X	X	X		X	X
netmanage.avalanche.encryption_type	X		X		X	X	X		X	X
netmanage.avalanche.interval	X		X		X	X	X		X	X
netmanage.avalanche.interval_update	X		X		X	X	X		X	X
netmanage.avalanche.model_name	X		X		X	X	X		X	X
netmanage.avalanche.set_property	X		X		X	X	X		X	X
netmanage.avalanche.startup_update	X		X		X	X	X		X	X
netmanage.avalanche.tcp_connection_timeout	X		X		X	X	X		X	X
netmanage.avalanche.terminal_id	X		X		X	X	X		X	X
netmanage.avalanche.text_msg.beep	X		X		X	X	X		X	X
netmanage.avalanche.text_msg.display	X		X		X	X	X		X	X
netmanage.avalanche.text_msg.print	X		X		X	X	X		X	X
netmanage.avalanche.udp_timeout	X		X		X	X	X		X	X
netmanage.error_code	X	X	X		X	X	X		X	X
netmanage.state_code	X	X	X		X	X	X		X	X
netmanage.status_code	X	X	X		X	X	X		X	X
odometer.headclean	X		X		X	X	X		X	X
odometer.headnew	X		X		X	X	X		X	X
odometer.label_dot_length	X	X	X	X	X	X	X	X	X	X
odometer.latch_open_count	X		X	X	X	X	X	X	X	X
odometer.media_marker_count	X	X	X	X	X	X	X	X	X	X
odometer.media_marker_count1	X	X	X		X	X	X		X	X
odometer.media_marker_count2	X	X	X		X	X	X		X	X
odometer.retracts_count		X								
odometer.rfid.valid_resettable										
odometer.rfid.void_resettable										
odometer.total_cuts										
odometer.total_label_count	X		X	X	X	X	X	X	X	X
odometer.total_print_length	X	X	X	X	X	X	X	X	X	X
odometer.user_label_count	X		X	X	X	X	X	X	X	X
odometer.user_label_count1	X		X		X	X	X		X	X
odometer.user_label_count2	X		X		X	X	X		X	X

An X indicates that the SGD is supported for the particular device.
 This table indicates support based on the most recent Link-OS system release.

SGD Command Support

Command Name	Mobile									
	iMZ220 iMZ320	KR403	QLn220 QLn320 QLn420	ZQ112 ZQ120 ZQ220	ZQ310 ZQ320	ZQ510 ZQ520	ZQ610 ZQ620 ZQ630	ZR138	ZR318 ZR328 ZR338	ZR628 ZR638 ZR658 ZR668
odometer.user_total_cuts										
power.average_current	X		X		X	X	X		X	X
power.battery_led_blink_rate ^a			X			X	X			
power.battery_led_enable ^a			X			X	X			
power.battery_led_off_duration ^a			X			X	X			
power.battery_led_on_duration ^a			X			X	X			
power.battery_replacement_cyclecount_threshold ^a			X			X	X			
power.battery_replacement_stateofcharge_threshold ^a			X			X	X			
power.battery_type ^a	X		X		X	X	X			
power.current ^a					X		X		X	
power.cycle_count			X		X	X	X		X	X
power.dtr_power_off	X		X		X	X	X		X	X
power.energy_star.enable										
power.energy_star.timeout										
power.label_queue.shutdown	X		X		X	X	X		X	X
power.part_number ^a					X		X		X	
power.percent_health ^a					X		X		X	
power.power_on_mode										
power.remaining_capacity ^a					X		X		X	
power.serial_number			X		X	X	X		X	X
power.sleep.cradle						X	X			X
power.temperature ^a			X		X		X		X	
power.voltage	X		X	X	X	X	X	X	X	X
power.wake.radio						X	X		X	X
print.legacy_compatibility ^a							X			
print.tone	X	X	X	X	X	X	X	X	X	X
print.troubleshooting_label_print ^a							X			
rfid.adaptive_antenna										
rfid.antenna_sweep										
rfid.country_code										
rfid.enable										
rfid.error.response										
rfid.hop_table_version										
rfid.log.clear										
rfid.log.enabled										
rfid.log.entries										
rfid.position.program										
rfid.reader_1.antenna_port										

An X indicates that the SGD is supported for the particular device.
 This table indicates support based on the most recent Link-OS system release.

SGD Command Support

Command Name	Mobile									
	iMZ220 iMZ320	KR403	QLn220 QLn320 QLn420	ZQ112 ZQ120 ZQ220	ZQ310 ZQ320	ZQ510 ZQ520	ZQ610 ZQ620 ZQ630	ZR138	ZR318 ZR328 ZR338	ZR628 ZR638 ZR658 ZR668
rfid.reader_1.firmware_version										
rfid.reader_1.hardware_version										
rfid.reader_1.model										
rfid.reader_1.power.read										
rfid.reader_1.power.write										
rfid.recipe_version										
rfid.region_code										
rfid.tag.calibrate										
rfid.tag.read.content										
rfid.tag.read.execute										
rfid.tag.read.result_line1										
rfid.tag.read.result_line1_alternate										
rfid.tag.read.result_line2										
rfid.tag.read.result_line2_alternate										
rfid.tag.result_line1										
rfid.tag.test.content										
rfid.tag.test.execute										
rfid.tag.test.result_line1										
rfid.tag.test.result_line2										
ribbon.cartridge.authenticated										
ribbon.cartridge.inserted										
ribbon.cartridge.length										
ribbon.cartridge.length_remaining										
ribbon.cartridge.part_number										
rtc.timezone	X		X		X	X	X		X	X
rtc.unix_timestamp										
sensor.back_bar.brightness ^a	X		X			X	X			
sensor.back_bar.cur ^a	X		X		X	X	X			
sensor.back_bar.gain ^a	X		X			X	X			
sensor.back_bar.offset ^a	X		X			X	X			
sensor.back_bar.ppr_out_thold ^a	X		X		X	X	X			
sensor.back_bar.thold ^a	X		X		X	X	X			
sensor.battery.in_volts ^a	X		X			X	X			
sensor.cover_open										
sensor.front_bar.brightness	X									
sensor.front_bar.cur	X									
sensor.front_bar.gain	X									
sensor.front_bar.offset	X									

An X indicates that the SGD is supported for the particular device.
 This table indicates support based on the most recent Link-OS system release.

SGD Command Support

Command Name	Mobile									
	iMZ220 iMZ320	KR403	QLn220 QLn320 QLn420	ZQ112 ZQ120 ZQ220	ZQ310 ZQ320	ZQ510 ZQ520	ZQ610 ZQ620 ZQ630	ZR138	ZR318 ZR328 ZR338	ZR628 ZR638 ZR658 ZR668
sensor.front_bar.ppr_out_thold	X									
sensor.front_bar.thold	X									
sensor.gap.brightness ^a	X		X			X	X			
sensor.gap.cur ^a	X		X		X	X	X			
sensor.gap.gain ^a	X		X				X			
sensor.gap.offset ^a	X		X			X	X			
sensor.gap.thold ^a	X		X		X	X	X			
sensor.head.temp ^a	X		X		X	X	X			
sensor.head.temp_avg ^a	X		X		X	X	X			
sensor.head.temp_celsius ^a	X		X		X	X	X			
sensor.peel.brightness ^a	X		X			X	X			
sensor.peel.cur ^a	X		X		X	X	X			
sensor.peel.gain ^a	X		X			X	X			
sensor.peel.thold	X		X		X	X	X		X	X
sensor.peeler	X		X		X	X	X		X	X
sensor.width.cur ^a	X		X		X	X	X		X	
sensor.width.in_dots ^a	X		X		X	X	X		X	
test.enable										
test.newdemo										
testdemo.enable										
usb.device.device_id_string	X		X	X	X	X	X	X	X	X
usb.device.device_unique_id	X		X	X	X	X	X	X	X	X
usb.device.device_version	X		X	X	X	X	X	X	X	X
usb.device.manufacturer_string	X		X	X	X	X	X	X	X	X
usb.device.product_id	X		X	X	X	X	X	X	X	X
usb.device.product_string	X		X	X	X	X	X	X	X	X
usb.device.serial_string	X		X	X	X	X	X	X	X	X
usb.device.vendor_id	X		X	X	X	X	X	X	X	X
usb.halt ^b	X		X		X				X	X
usb.host.config_info_to_usb										
usb.host.fn_field_data										
usb.host.fn_last_field										
usb.host.hid_count						X				
usb.host.keyboard_input										
usb.host.lock_out						X				
usb.host.mass_storage_count						X				
usb.host.read_list										
usb.host.read_list_print_delay										

An X indicates that the SGD is supported for the particular device.
 This table indicates support based on the most recent Link-OS system release.

SGD Command Support

Command Name	Mobile									
	iMZ220 iMZ320	KR403	QLn220 QLn320 QLn420	ZQ112 ZQ120 ZQ220	ZQ310 ZQ320	ZQ510 ZQ520	ZQ610 ZQ620 ZQ630	ZR138	ZR318 ZR328 ZR338	ZR628 ZR638 ZR658 ZR668
usb.host.template_list										
usb.host.template_print_amount										
usb.host.write_list										
usb.mirror.appl_path						X				
usb.mirror.auto						X				
usb.mirror.enable						X				
usb.mirror.error_retry						X				
usb.mirror.feedback.auto						X				
usb.mirror.feedback.odometer						X				
usb.mirror.feedback.path						X				
usb.mirror.fetch						X				
usb.mirror.last_error						X				
usb.mirror.last_time						X				
usb.mirror.path						X				
usb.mirror.reset_delay						X				
usb.mirror.success						X				
usb.mirror.success_time						X				
weblink.cloud_connect.enable	X		X		X	X	X		X	X
weblink.enable	X		X		X	X	X		X	X
weblink.ip.conn1.authentication.add	X		X		X	X	X		X	X
weblink.ip.conn1.authentication.entries	X		X		X	X	X		X	X
weblink.ip.conn1.authentication.remove	X		X		X	X	X		X	X
weblink.ip.conn1.location	X		X		X	X	X		X	X
weblink.ip.conn1.maximum_simultaneous_connections	X		X		X	X	X		X	X
weblink.ip.conn1.num_connections	X		X		X	X	X		X	X
weblink.ip.conn1.proxy	X		X		X	X	X		X	X
weblink.ip.conn1.retry_interval	X		X		X	X	X		X	X
weblink.ip.conn1.retry_interval_random_max ^a	X		X			X	X			
weblink.ip.conn1.test.location	X		X		X	X	X		X	X
weblink.ip.conn1.test.retry_interval	X		X		X	X	X		X	X
weblink.ip.conn1.test.test_on	X		X		X	X	X		X	X
weblink.ip.conn2.authentication.add	X		X		X	X	X		X	X
weblink.ip.conn2.authentication.entries	X		X		X	X	X		X	X
weblink.ip.conn2.authentication.remove	X		X		X	X	X		X	X
weblink.ip.conn2.location	X		X		X	X	X		X	X
weblink.ip.conn2.maximum_simultaneous_connections	X		X		X	X	X		X	X
weblink.ip.conn2.num_connections	X		X		X	X	X		X	X
weblink.ip.conn2.proxy	X		X		X	X	X		X	X

An X indicates that the SGD is supported for the particular device.
 This table indicates support based on the most recent Link-OS system release.

SGD Command Support

Command Name	Mobile									
	iMZ220 iMZ320	KR403	QLn220 QLn320 QLn420	ZQ112 ZQ120 ZQ220	ZQ310 ZQ320	ZQ510 ZQ520	ZQ610 ZQ620 ZQ630	ZR138	ZR318 ZR328 ZR338	ZR628 ZR638 ZR658 ZR668
weblink.ip.conn2.retry_interval	X		X		X	X	X		X	X
weblink.ip.conn2.retry_interval_random_max ^a	X		X			X	X			
weblink.ip.conn2.test.location	X		X		X	X	X		X	X
weblink.ip.conn2.test.retry_interval	X		X		X	X	X		X	X
weblink.ip.conn2.test.test_on	X		X		X	X	X		X	X
weblink.logging.clear	X		X		X	X	X		X	X
weblink.logging.entries	X		X		X	X	X		X	X
weblink.logging.max_entries	X		X		X	X	X		X	X
weblink.printer_reset_required	X		X		X	X	X		X	X
weblink.restore_defaults	X		X		X	X	X		X	X
weblink.zebra_connector.authentication.add	X		X		X	X	X		X	X
weblink.zebra_connector.authentication.entries	X		X		X	X	X		X	X
weblink.zebra_connector.authentication.remove	X		X		X	X	X		X	X
weblink.zebra_connector.enable	X		X		X	X	X		X	X
weblink.zebra_connector.proxy	X		X		X	X	X		X	X
weblink.zebra_connector.version	X		X		X	X	X		X	X
wlan.11ac.80mhz_enable ^a							X			
wlan.11d.enable	X		X		X	X	X		X	X
wlan.11n.20mhz_only	X		X		X	X	X		X	X
wlan.11n.greenfield	X		X		X	X	X		X	X
wlan.11n.rifs	X		X		X	X	X		X	X
wlan.11n.short_gi_20mhz	X		X		X	X	X		X	X
wlan.11n.short_gi_40mhz	X		X		X	X	X		X	X
wlan.8021x.authentication	X	X	X		X	X	X		X	X
wlan.8021x.eap.password	X		X		X	X	X		X	X
wlan.8021x.eap.privkey_password	X		X		X	X	X		X	X
wlan.8021x.eap.username	X	X	X		X	X	X		X	X
wlan.8021x.enable	X	X	X		X	X	X		X	X
wlan.8021x.peap.anonymous_identity ^a	X		X			X	X			
wlan.8021x.peap.peap_password	X		X		X	X	X		X	X
wlan.8021x.peap.peap_username	X	X	X		X	X	X		X	X
wlan.8021x.peap.privkey_password	X		X		X	X	X		X	X
wlan.active_channels	X		X		X	X	X		X	X
wlan.adhoc_last_channel										
wlan.adhocautomode	X	X	X		X	X	X		X	X
wlan.adhocchannel	X	X	X		X	X	X		X	X
wlan.allowed_band	X		X		X	X	X		X	X
wlan.associated	X	X	X		X	X	X		X	X

An X indicates that the SGD is supported for the particular device.
 This table indicates support based on the most recent Link-OS system release.

SGD Command Support

Command Name	Mobile									
	iMZ220 iMZ320	KR403	QLn220 QLn320 QLn420	ZQ112 ZQ120 ZQ220	ZQ310 ZQ320	ZQ510 ZQ520	ZQ610 ZQ620 ZQ630	ZR138	ZR318 ZR328 ZR338	ZR628 ZR638 ZR658 ZR668
wlan.auth_type	X	X	X		X	X			X	X
wlan.authenticated	X		X		X	X	X		X	X
wlan.authentication_error	X		X		X	X	X		X	X
wlan.available	X		X		X	X	X		X	X
wlan.band_preference			X		X	X	X			
wlan.bssid	X	X	X		X	X	X		X	X
wlan.channel	X	X	X		X	X	X		X	X
wlan.channel_mask	X		X		X	X	X		X	X
wlan.country_code	X		X		X	X	X		X	X
wlan.current_tx_rate	X	X	X		X	X	X		X	X
wlan.enable	X		X		X	X	X		X	X
wlan.encryption_index		X							X	X
wlan.encryption_key1									X	X
wlan.encryption_key2									X	X
wlan.encryption_key3									X	X
wlan.encryption_key4									X	X
wlan.encryption_mode		X							X	X
wlan.essid	X	X	X		X	X	X		X	X
wlan.firmware_version	X	X	X		X	X	X		X	X
wlan.ip.addr	X	X	X		X	X	X		X	X
wlan.ip.arp_interval	X	X	X		X	X	X		X	X
wlan.ip.default_addr_enable	X	X	X		X	X	X		X	X
wlan.ip.dhcp.arp_verify	X		X		X	X	X		X	X
wlan.ip.dhcp.cache_ip	X	X	X		X	X	X		X	X
wlan.ip.dhcp.cid_all	X		X		X	X	X		X	X
wlan.ip.dhcp.cid_enable	X	X	X		X	X	X		X	X
wlan.ip.dhcp.cid_prefix	X		X		X	X	X		X	X
wlan.ip.dhcp.cid_suffix	X		X		X	X	X		X	X
wlan.ip.dhcp.cid_type	X	X	X		X	X	X		X	X
wlan.ip.dhcp.lease.last_attempt	X	X	X		X	X	X		X	X
wlan.ip.dhcp.lease.length	X	X	X		X	X	X		X	X
wlan.ip.dhcp.lease.server	X	X	X		X	X	X		X	X
wlan.ip.dhcp.lease.time_left	X	X	X		X	X	X		X	X
wlan.ip.dhcp.option12	X	X	X		X	X	X		X	X
wlan.ip.dhcp.option12_format	X	X	X		X	X	X		X	X
wlan.ip.dhcp.option12_value	X		X		X	X	X		X	X
wlan.ip.dhcp.request_timeout	X	X	X		X	X	X		X	X
wlan.ip.dhcp.requests_per_session	X	X	X		X	X	X		X	X

An X indicates that the SGD is supported for the particular device.
 This table indicates support based on the most recent Link-OS system release.

SGD Command Support

Command Name	Mobile									
	iMZ220 iMZ320	KR403	QLn220 QLn320 QLn420	ZQ112 ZQ120 ZQ220	ZQ310 ZQ320	ZQ510 ZQ520	ZQ610 ZQ620 ZQ630	ZR138	ZR318 ZR328 ZR338	ZR628 ZR638 ZR658 ZR668
wlan.ip.dhcp.session_interval	X	X	X		X	X	X		X	X
wlan.ip.dns.domain	X		X		X	X	X		X	X
wlan.ip.dns.servers	X		X		X	X	X		X	X
wlan.ip.gateway	X	X	X		X	X	X		X	X
wlan.ip.netmask	X	X	X		X	X	X		X	X
wlan.ip.port	X	X	X		X	X	X		X	X
wlan.ip.port_alternate	X		X		X	X	X		X	X
wlan.ip.port_json_config	X		X		X	X	X		X	X
wlan.ip.protocol	X	X	X		X	X	X		X	X
wlan.ip.timeout.enable	X	X	X		X	X	X		X	X
wlan.ip.timeout.value	X	X	X		X	X	X		X	X
wlan.ip.wins.addr	X	X	X		X	X	X		X	X
wlan.ip.wins.permanent_source	X	X	X		X	X	X		X	X
wlan.keep_alive.enable	X	X	X		X	X	X		X	X
wlan.keep_alive.timeout	X	X	X		X	X	X		X	X
wlan.kerberos.kdc		X								
wlan.kerberos.mode		X								
wlan.kerberos.password										
wlan.kerberos.realm		X								
wlan.kerberos.username		X								
wlan.leap_mode	X	X	X		X	X	X		X	X
wlan.leap_password	X		X		X	X	X		X	X
wlan.leap_username	X	X	X		X	X	X		X	X
wlan.mac_addr	X	X	X		X	X	X		X	X
wlan.mac_raw	X	X	X		X	X	X		X	X
wlan.operating_mode	X	X	X		X	X	X		X	X
wlan.password	X		X		X	X	X		X	X
wlan.permitted_channels	X		X		X	X	X		X	X
wlan.pmf ^a	X		X		X	X	X		X	
wlan.poor_signal_threshold ^a	X		X		X	X	X		X	
wlan.power_save	X		X		X	X	X		X	X
wlan.preamble	X	X	X		X	X	X		X	X
wlan.private_key_password	X		X		X	X	X		X	X
wlan.region_code	X		X		X	X	X		X	X
wlan.roam.interchannel_delay	X		X		X	X	X		X	X
wlan.roam.interval	X	X	X		X	X	X		X	X
wlan.roam.max_chan_scan_time	X		X		X	X	X		X	X
wlan.roam.max_fail	X		X		X	X	X		X	X

An X indicates that the SGD is supported for the particular device.
 This table indicates support based on the most recent Link-OS system release.

SGD Command Support

Command Name	Mobile									
	iMZ220 iMZ320	KR403	QLn220 QLn320 QLn420	ZQ112 ZQ120 ZQ220	ZQ310 ZQ320	ZQ510 ZQ520	ZQ610 ZQ620 ZQ630	ZR138	ZR318 ZR328 ZR338	ZR628 ZR638 ZR658 ZR668
wlan.roam.monitor	X		X		X	X	X		X	X
wlan.roam.rssi	X		X		X	X	X		X	X
wlan.roam.signal	X	X	X		X	X	X		X	X
wlan.rts_cts_enabled	X		X		X	X	X		X	X
wlan.secure_ssid	X		X		X	X	X		X	X
wlan.security	X		X		X	X	X		X	X
wlan.signal_noise		X								
wlan.signal_quality		X								
wlan.signal_strength	X	X	X		X	X	X		X	X
wlan.station_name	X	X	X		X	X	X		X	X
wlan.tx_power		X								
wlan.tx_rate		X								
wlan.user_channel_list	X		X		X	X	X		X	X
wlan.username	X	X	X		X	X	X		X	X
wlan.waveagent.enable	X		X		X	X	X		X	X
wlan.waveagent.udp_port	X		X		X	X	X		X	X
wlan.wep.auth_type ^b		X							X	X
wlan.wep.index ^b		X							X	X
wlan.wep.key_format ^b		X							X	X
wlan.wep.key1 ^b									X	X
wlan.wep.key2 ^b									X	X
wlan.wep.key3 ^b									X	X
wlan.wep.key4a									X	X
wlan.wpa.groupkey_ciphersuite	X		X		X	X	X		X	X
wlan.wpa.pairwise_ciphersuite	X		X		X	X	X		X	X
wlan.wpa.psk	X		X		X	X	X		X	X
wlan.wpa.timecheck ^a	X		X		X	X	X		X	
wlan.wpa.wpa_version	X		X		X	X	X		X	X
zbi.control.add_breakpoint	X		X		X	X	X		X	X
zbi.control.break	X		X		X	X	X		X	X
zbi.control.clear_breakpoints	X		X		X	X	X		X	X
zbi.control.delete_breakpoint	X		X		X	X	X		X	X
zbi.control.line_number	X		X		X	X	X		X	X
zbi.control.restart	X		X		X	X	X		X	X
zbi.control.run	X		X		X	X	X		X	X
zbi.control.step	X		X		X	X	X		X	X
zbi.control.terminate	X		X		X	X	X		X	X
zbi.control.variable_name	X		X		X	X	X		X	X

An X indicates that the SGD is supported for the particular device.
 This table indicates support based on the most recent Link-OS system release.

SGD Command Support

Command Name	Mobile									
	iMZ220 iMZ320	KR403	QLn220 QLn320 QLn420	ZQ112 ZQ120 ZQ220	ZQ310 ZQ320	ZQ510 ZQ520	ZQ610 ZQ620 ZQ630	ZR138	ZR318 ZR328 ZR338	ZR628 ZR638 ZR658 ZR668
zbi.control.variable_value	X		X		X	X	X		X	X
zbi.enable ^a	X		X		X	X	X			
zbi.key	X	X	X		X	X	X		X	X
zbi.last_error	X		X		X	X	X		X	X
zbi.program_list	X		X		X	X	X		X	X
zbi.reseller_key	X		X		X	X	X		X	X
zbi.revision	X	X	X		X	X	X		X	X
zbi.running_program_name	X		X		X	X	X		X	X
zbi.start_info.execute	X		X		X	X	X		X	X
zbi.start_info.file_name	X		X		X	X	X		X	X
zbi.start_info.memory_alloc	X		X		X	X	X		X	X
zbi.state	X	X	X		X	X	X		X	X
zpl.calibrate	X		X		X	X	X		X	X
zpl.command_prefix	X		X		X	X	X		X	X
zpl.format_prefix	X		X		X	X	X		X	X
zpl.label_length	X	X	X		X	X	X		X	X
zpl.left_position	X		X		X	X	X		X	X
zpl.relative_darkness ^a	X		X		X	X	X		X	
zpl.system_error	X		X		X	X	X		X	X
zpl.system_status	X		X		X	X	X		X	X
zpl.zpl_mode	X		X		X	X	X		X	X
zpl.zpl_override										

An X indicates that the SGD is supported for the particular device.
 This table indicates support based on the most recent Link-OS system release.

a. This command is not supported for ZR668.

Mirror

This section provides an overview of Mirror, details on how to use it, and configuration examples.

Mirror Overview

Mirror is a feature that gives you the ability to:

- Centrally manage and monitor the deployment of your Zebra printers
- Centrally configure and maintain your Zebra printers through remote updates
- Remotely monitor printer updates - via the "Feedback" feature

There are several Set/Get/Do (SGD) commands that are used to configure and initiate Mirror. For details see, [Mirror Printer Configuration on page 1529](#).

Benefits

When using Mirror, updating the configuration and firmware on the printer is remotely managed from a centralized FTP server. Configurations can be uniformly deployed to individual printers or to groups of printers. Unique Configurations can also be targeted to printers as needed.

Through the "Feedback" feature, Administrators can easily log and monitor configuration updates on a printer-by-printer basis.

Typical uses of Mirror include:

- configuring printers as they are first received
- performing scheduled maintenance updates, sending firmware, fonts, graphics and other objects to the printer as needed
- changing printer Configurations in order to move printers from one role to another

[Figure 87](#) provides an illustration of Mirroring.

Figure 87 Mirror Illustration

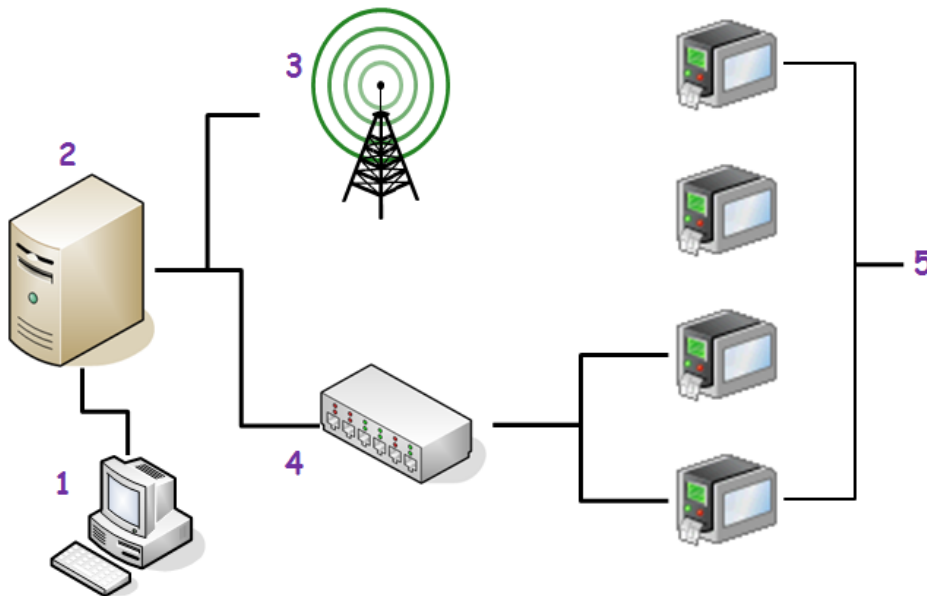

1	Workstation — sends SGD commands to the printer to configure it for Mirror use.
2	FTP Server — Stores configuration files and responds to Mirror requests from the printer. Receives and stores “Feedback” content.
3	Access Point — wireless network infrastructure
4	Hub — wired network infrastructure
5	Zebra Printer(s) — Configured using SGD commands. Sends Mirror requests to the FTP server to receive files. Transmits “Feedback” content to the FTP server to log Mirror event transactions and resulting printer settings.

Professional Services for Mirror Configuration

Zebra offers a Professional Services group that can help with the configuring the Mirror feature. To inquire about Zebra's Professional Services, contact your Zebra account representative.

Requirements

These are the requirements for Mirror:

- Zebra printer loaded with Mirror capable firmware and Print Server. For details, see [Supported Printers Table on page 1522](#).
- FTP server (with UNIX-style directory listings), configured with the following directories:
 - "**<update-root>/app1**" - This directory is used for printer firmware updates. During an update operation, the printer will first check the "**<update-root>/app1**" directory for new printer firmware
 - "**<update-root>/files**" - This directory is used for printer-resident files. Files in this directory will be stored locally on the printer's file system. Files are not processed by the printer; they are only stored.
 - "**<update-root>/commands**" - This directory is used for a limited number of printer executable commands. The contents of files in this directory will be sent to the printer's command interpreter for execution.
 - "**<feedback-root>**" - This optional directory is used to receive Mirror feedback content from the printer. The content sent to this directory is defined by the "**feedback.get**" template file stored on the printer.
- A client account (user name and password) on the FTP server for the printer to use.
- A Terminal Emulation program, used to send SGD commands to the printer to configure Mirror.

Supported Printers and Print Server Types

These are the Zebra printers, firmware versions, and Zebra print servers that support Mirror.

Printer	Firmware	Print Servers
ZT400	V75.19.7Z (or later)	<ul style="list-style-type: none"> • ZebraNet a/b/g/n Print Server • Internal Wireless Plus • Wireless Plus
ZE500	V53.17.15Z (or later)	<ul style="list-style-type: none"> • ZebraNet b/g Print Server • Internal Wireless Plus • Wireless Plus
ZT200	V72.18.2Z (or later)	<ul style="list-style-type: none"> • ZebraNet a/b/g/n Print Server • Internal Wireless Plus • Wireless Plus
105SLPlus	V53.17.15Z (or later)	<ul style="list-style-type: none"> • ZebraNet b/g Print Server • Internal Wireless Plus • Wireless Plus
Xi4™ series	V53.17.5Z (or later)	<ul style="list-style-type: none"> • Internal, Integrated 10/100 IPV4 wired • Internal Wireless Plus

Mirror

XIIIPlus™ series	V60.17.5Z (or later)	<ul style="list-style-type: none"> • Internal Wireless Plus • Wireless Plus
105SL™	V60.17.5Z (or later)	<ul style="list-style-type: none"> • Internal Wireless Plus • Wireless Plus
PAX4™	V60.17.5Z (or later)	<ul style="list-style-type: none"> • Internal Wireless Plus • Wireless Plus
ZM400™	V53.17.5Z (or later)	<ul style="list-style-type: none"> • Internal 10/100 wired • Internal Wireless Plus • Wireless Plus
ZM600™	V53.17.5Z (or later)	<ul style="list-style-type: none"> • Internal 10/100 wired • Internal Wireless Plus • Wireless Plus
S4M™	V53.17.5Z (or later)	<ul style="list-style-type: none"> • Internal Wireless Plus • Wireless Plus
G™ -series	V56.17.5Z V61.17.5Z (or later)	<ul style="list-style-type: none"> • Internal 10/100 wired • Internal Wireless Plus • Wireless Plus
LP 2824 Plus TLP 2824 Plus	V61.17.3Z (or later)	<ul style="list-style-type: none"> • Internal 10/100 wired • Internal Wireless Plus • Wireless Plus



NOTE: Print Servers connected to the parallel port, either externally or internally, are not supported for Mirror use.

How Mirror Works

Mirror utilizes a network connection and FTP communications to perform remote updates and feedback operations. At printer startup and/or at regular intervals, the printer will establish a FTP connection back to a central FTP server and check for updates. During an update operation, the printer will check for updated files in specific directories at the FTP server.

These are the specific FTP server directories that will be checked:

- "**<update-root>/appl**" - This directory is used for printer firmware updates. During an update operation, the printer will first check the "**<update-root>/appl**" directory for new printer firmware
- "**<update-root>/files**" - This directory is used for printer-resident files. Files in this directory will be stored locally on the printer's file system. Files are not processed by the printer; they are only stored.
- "**<update-root>/commands**" - This directory is used for a limited number of printer executable commands. The contents of files in this directory will be sent to the printer's command interpreter for execution.
- "**<feedback-root>**" - This optional directory is used to receive Mirror feedback content from the printer. The content sent to this directory is defined by the "feedback.get" template file stored on the printer.



NOTE: "**<update-root>**" refers to the value of the "**ip.mirror.path**" configuration parameter.

Files in the **<update-root>/files** directory should not have download headers in them. They should be in the exact format they will be in when stored on the printer's file system. Examples of download headers are: **~DY**, **~DG**, **! CISDFCRC16** or **~DF**.



IMPORTANT: When the printer is in the Mirror process:

- It is unavailable for other tasks.
- The LCD will indicate that it is performing a Mirror function, showing when the printer is downloading firmware and the names of the object files as they are transferred to the printer.

Mirror Process Summary

The Mirror process follows a specific series of steps:

1. After power-up, the printer will first check the **<update-root>/appl** directory on the FTP server for new printer firmware and update the printer if necessary
2. If the printer did not find new firmware to download, it will then check in the **<update-root>/files** and **<update-root>/commands** directories for updated files - and download them as needed.
3. As a final Mirror step, the printer can perform an optional Feedback operation, transmitting a file of user-defined printer configuration information to **<feedback-root>** directory on the FTP server.
4. Finally, if any files or commands were downloaded during **Step 2:**, the printer will automatically reset itself.

Mirror Process Details

The following items are important to be aware of when configuring the FTP server to support Firmware updated via Mirror.

- Firmware files must be named using the following format: **<firmware version>.zpl**, where **<firmware version>** is the exact Firmware revision contained in the file. For example, for Firmware version “V53.17.5Z”, the filename stored on the FTP server must be “V53.17.5Z.ZPL”. If the file name and Firmware version do not match, the update will not succeed.
- The firmware filename stored on the FTP server is not case sensitive. This means that “V53.17.5Z.ZPL” and “v53.17.5Z.zpl” will be processed in the exact same way.
- The **/app1** directory can contain only one (1) file at a time. If there is more than 1 file in this directory, the printer will not download anything and will skip the firmware update.

During a Mirror event, the printer will use **<firmware version>** part of the filename contained in the **/app1** directory on the FTP server to check if the Firmware stored on the FTP server is different than the firmware the printer is currently using. If the **<firmware version>** part of the Firmware file name in the **/app1** directory on the FTP server does not exactly match the printer's Firmware version, the file on the FTP server will be downloaded and used to update the printer. Once the printer is updated with the new Firmware, the printer will reset and being using the new Firmware.



NOTE: Performing the Firmware update first is important because it is possible that the files or commands to be downloaded via Mirror will be dependent on the new firmware.

After the printer has completed the Firmware portion of an update operation, it will check the "**<update-root>/files**" directory and "**<update-root>/commands**" directory (in that order) for updated files that need to be retrieved. If a file exists on the FTP server and the server timestamp for the file does not match the printer's archived timestamp for the file, the printer will re-download the file and update its timestamp info. Files that are on the Mirror FTP server but not currently present on the printer will be sent to the printer. The supported file types are the standard files supported on ZPL printers.

If any files are downloaded during this portion of an update operation, the printer will reboot after the file downloads have completed. At this point, the update operation is complete.



IMPORTANT:

- Files in the **<update-root>/files** directory should not have download headers in them. They should be in the exact format they will be in when stored on the printer's file system. Examples of download headers are: **~DY**, **~DG**, **! CISDFCRC16** or **~DF**.
- ZPL files in the **<update-root>/files** directory must use the printers internal characters for the Format Command Prefix (^), Delimiter Character (,) and Control Command Character (~). This means that the caret (^) should be replaced with a HEX 1E, the comma (,) should be replaced with a HEX 1F and the tilde (~) should be replaced with a HEX 10.

After an update operation is complete, a printer will perform a feedback operation, if configured to do so. During a feedback operation, the printer will open its feedback template file (named **feedback.get**), populate it based on its contents, and upload the resulting contents file to the FTP server, in the "**<feedback-root>**" directory.



NOTE: "**<feedback-root>**" refers to the value of the "**ip.mirror.feedback.path**" configuration parameter

Creating ZPL Files for Use in the "`<update-root>/files`" Directory

When creating ZPL formats that will be stored in the "`<update-root>/files`" directory it is necessary to edit the files using the following guidelines:

1. Files must contain only one format. This means that if a file contains multiple `^XA` and `^XZ` commands, those sections of the file must be split into separate formats, or combined as one format.
2. The characters used for the Format Command Prefix (^), Delimiter Character (,) and Control Command Characters (~) must be substituted for their Hexadecimal equivalents.
3. The `^XA` and `^XZ` commands must be removed from the formats.
4. The `^DF` command should be removed.

One Format per File

Files must contain only one format. This means that if a file contains multiple `^XA` and `^XZ` commands, those sections of the file must be split into separate formats, or combined as one format. For example, if a ZPL file contains both an initialization string and a format, the two sections must be either split into two files, or combined into one format.

For example, given the following formats:

```
^XA
^LT0^MNW^MTT^PON^PMN^LH0,0^JMA^PR2,2^LRN^CI0
^XZ
^XA
^F020,100^IME:ZEBRA.BMP^FS
^A@N,75,75,TT0003M_.TTF
^F020,400^FDZebra Technologies^FS
^XZ
```

The following file should be created, which includes all of the command in one file:

```
^XA
^LT0^MNW^MTT^PON^PMN^LH0,0^JMA^PR2,2^LRN^CI0
^F020,100^IME:ZEBRA.BMP^FS
^A@N,75,75,TT0003M_.TTF
^F020,400^FDZebra Technologies^FS
^XZ
```

Character Substitution

The characters used for the Format Command Prefix (^), Delimiter Character (,) and Control Command Characters (~) must be substituted for their Hexadecimal equivalents. During normal operation, this is how the printer works with ZPL formats. For example, when a ZPL format is sent to the printer via a telnet, RS-232 or Ethernet connection and stored for later use, it automatically processes the file and makes these character substitutions.

When ZPL formats are sent to the printer from the "`<update-root>/files`" directory they are stored on the printers memory, but not processed. For this reason, it is necessary to preprocess the files so that they are ready for use.

The following character substitutions must be made to files sent from the "<update-root>/files" directory:

Original Character	Substitute Character
Command Prefix The default is the Caret (^)	HEX 1E
Delimiter Prefix The default is the comma (,)	HEX 1F
Control Prefix The default is the tilde (~)	HEX 10

For example, given the following format:

```

^XA
^F020,100^IME:ZEBRA.BMP^FS
^A@N,75,75,TT0003M_.TTF
^F020,400^FDZebra Technologies^FS
^XZ

```

It would be necessary to replace the ^ characters with a HEX 1E and the , characters with a HEX 1F. This can be done using a Text Editor. See [Example Files on page 1528](#) for more information.

Removing the ^XA and ^XZ commands

Additionally, the ^XA and ^XZ commands should be removed from the format. The printer will automatically add these commands back in to process the file. See [Example Files on page 1528](#) for more information.

Removing the ^DF command

In some cases, you might have been using files that contain the ^DF command. The purpose of the ^DF command is to instruct the printer to store everything that comes after it in a ZPL file. For example, you might have a file that contains the following:

```

^XA
^DFE:STOREFMT.ZPL^FS
^F025,25^AD,36,20^FN1^FS
^F0165,25^AD,36,20^FN2^FS
^F025,75^AB,22,14^FDBUILT BY^FS
^F025,125^AE,28,15^FN1
^XZ

```

The purpose of the above format - when sent to a printer - would be to store a file called "STOREFMT" to the E memory location on the printer. In production, the goal would be to recall and print the "STOREFMT" file using the following ZPL commands:

```

^XA
^XFE:STOREFMT.ZPL^FS
^FN1^FDZEBRA^FS
^FN2^FDPRINTER^FS
^XZ

```

When this is done using Mirror, the format being sent to the printer must be altered. The line with the ^DF command must be removed - this is because the Mirror process is taking care of storing the format to the E memory location. In this scenario, the original format would be edited to look like this:

```
^F025,25^AD,36,20^FN1^FS
^F0165,25^AD,36,20^FN2^FS
^F025,75^AB,22,14^FDBUILT BY^FS
^F025,125^AE,28,15^FN1
```

The character substitution described above must also be done on the file before it is stored in the "<update-root>/files" directory.

The "reca11" format - using the ^XFE:STOREFMT.ZPL command - does not need to be altered or edited. It can be used as it was previously.

Example Files

Example of files that have already been altered in the manner described above are available as "Mirror File Examples" at www.zebra.com.

To see an example file, right-click the paper-clip icon and select **Open File** or **Save Embedded File to Disk**.

File Naming Recommendations

- Files in the "<update-root>/files" directory and "<update-root>/commands" directory should not have the same name.
- Files in the "<update-root>/files" should not contain multiple label formats. If you need to Mirror multiple formats, the recommended method is to split the formats into separate files.

Command Use Recommendations

- Files in the "<update-root>/commands" directory should use only SGD commands or the following ZPL commands:
 - ~CC
 - ~CD
 - ~CT
 - ~JA
 - ~JL
 - ~JS
 - ~JX
 - ~RO
- Do not add a device.reset SGD command to the end of a file in the "<update-root>/commands" directory. Mirror will reset itself automatically after performing an update, so there is no need for this command.

Configuration

This section provides detail on the configuring the printer and FTP server for Mirror.

Mirror FTP Server Configuration

For a Zebra printer to successfully use Mirror, the Mirror FTP server must have the following:

- A client account (user name and password) for the printer to use
- A root (base) directory for Mirror updates. This root directory must have the following subdirectories:
 - /appl
 - /files
 - /commands
- A Mirror feedback folder (optional)



IMPORTANT: The printer's FTP user account must have the necessary permissions to read/write files in the update and feedback root directories. The `/appl`, `/files`, and `/commands` subdirectories are read only; the Mirror feedback folder is read/write. If these permissions are not properly set, the Mirror update and feedback processes will be unsuccessful.

Mirror Printer Configuration

The following SGD commands are used to configure Mirror on the printer:

• ip.mirror.auto on page 1190	• ip.mirror.last_error on page 1200
• ip.mirror.error_retry on page 1191	• ip.mirror.last_time on page 1201
• ip.mirror.feedback.auto on page 1192	• ip.mirror.password on page 1203
• ip.mirror.feedback.freq on page 1193	• ip.mirror.path on page 1204
• ip.mirror.feedback.odometer on page 1194	• ip.mirror.reset_delay on page 1205
• ip.mirror.feedback.path on page 1195	• ip.mirror.server on page 1206
• ip.mirror.fetch on page 1196	• ip.mirror.success on page 1207
• ip.mirror.freq on page 1197	• ip.mirror.success_time on page 1208
• ip.mirror.freq_hours on page 1198	• ip.mirror.username on page 1209
	• ip.mirror.version on page 1210

The Feedback.get File

The Feedback feature is one of the key benefits of the Mirror process. During a Mirror operation, the printer can upload a file to the FTP Server that contains information about the configuration of the printer. This information can then be leveraged by the Administrator to monitor the printer's setup. Using the Feedback feature is optional.

The "**feedback.get**" file is a template file stored on the printer. It controls what content is uploaded to the "**<feedback-root>**" directory on the FTP server. The directory on the FTP server where the printer will send Feedback content to is controlled by the "**ip.mirror.feedback.path**" command.

Within the feedback.get file it is possible to leverage SGD commands to insert current printer status and configuration strings into the file. This feature can help make the Feedback file on the FTP server more unique and useful to the Administrator.

Additionally, the first line of the feedback.get file is used to control the name of the file that will be uploaded and stored on the FTP server.

For example, if first line of the "**feedback.get**" file was:

```
"zebra.<wlan.mac_raw>.<ip.mirror.feedback.odometer>"
```

That line would be evaluated by the printer and used as the Feedback destination file name to create on the FTP server.

Using the example above, if the MAC address of the wireless print server was "00a0f8ae56d7" and the Feedback odometer was currently at "33", the Feedback file created the FTP server would be named:

```
"zebra.00a0f8ae56d7.33.txt"
```

The "feedback.get" file can be sent to the printer using the **!CISDFCRC16** command. For additional information, see [CISDFCRC16 on page 602](#).



NOTE: The first line of the feedback.get file is not included when the Feedback data is written to FTP server.

Example Feedback.get file

Here is an example of a "feedback.get" file and its resulting uploaded file:

```
zebra.<wlan.mac_raw>.<ip.mirror.feedback.odometer>
```

```
Application Name = <appl.name>
```

```
Serial Number = <device.friendly_name>
```

```
Mirror Success = <ip.mirror.success>
```

```
Mirror Auto = <ip.mirror.auto>
```

```
Mirror Path = <ip.mirror.path>
```

```
Mirror Last Update = <ip.mirror.success_time>
```

```
Bootp Enable = <ip.bootp.enable>
```

```
DHCP Enable = <ip.dhcp.enable>
```

```
Data Port = <ip.port>
```

```
Associated AP = <wlan.bssid>
```

```
RF ESSID = <wlan.essid>
```

```
RF Firmware = <wlan.firmware_version>
```

```
RF Signal Strength = <wlan.signal_strength>
```

```
RF Channel Mask = <wlan.channel_mask>
```

```
Label Length = <odometer.total_print_length>
```

```
Print Length = <odometer.label_dot_length>
```

When this file is processed by the printer and uploaded to the FTP server, the resulting upload file on the FTP server would contain data similar to this:

Application Name = V53.17.2Z

Serial Number = ZBR123456

Mirror Success = Yes

Mirror Auto = on

Mirror Path = /update-root/ZM400/

Mirror Last Update = 12345678

Bootp Enable = on

DHCP Enable = on

Data Port = 9100

Associated AP = 124

RF ESSID = MyEssid

RF Firmware = 5.2.1

RF Signal Strength = 98

RF Channel Mask = FF

Label Length = 100

Print Length = 200

How to Set Up and Use Mirror

This section provides multiple scenarios which include specific examples that demonstrate how to set up and use Mirror.

Scenario One

In this scenario, the printer is configured to perform a Mirror update operation ("`ip.mirror.auto = on`") and feedback operation ("`ip.mirror.feedback.auto = on`") every time the printer restarts. On startup, after a network connection has been established, the printer will attempt to make a FTP connection to the server address 10.14.5.133, using the "user name" and "password" of the printer.

If the connection is successful, the printer will attempt to perform an update operation using the root directory "`/all_printers/s4m/role1`". After the update operation is complete, the printer will attempt a Feedback operation, uploading the resulting Feedback file to the "`/all_feedback`" directory on the server.

Using the command set in the example below, the printer will not attempt any *periodic* Mirror Update or Feedback operations. It will only perform Mirror operations on startup or when explicitly instructed to using the "`ip.mirror.fetch`" command.



NOTE: If a file starts with "/" it signifies the base directory of that file system. If a file is contained in the user's account, they do not start with a "/" .

This example shows a Mirror configuration command set. Each line item of the command set is identified with a number. For details on each line item, see the table below.

```

10  ! U1 SETVAR "ip.mirror.auto" "on"
20  ! U1 SETVAR "ip.mirror.username" "printer"
30  ! U1 SETVAR "ip.mirror.password" "printer"
40  ! U1 SETVAR "ip.mirror.server" "10.14.5.133"
50  ! U1 SETVAR "ip.mirror.path" "/all_printers/s4m/role1"
60  ! U1 SETVAR "ip.mirror.feedback.auto" "on"
70  ! U1 SETVAR "ip.mirror.feedback.path" "/all_feedback"
80  ! U1 SETVAR "ip.mirror.feedback.freq" "0"

```

10	Configures the printer to perform a Mirror Update operation at power-up.
20	Configures the FTP Server "user name" for the printer to use
30	Configures the FTP Server "password" for the printer to use
40	Configures the FTP server address the printer should make a FTP connection to.
50	If the FTP connection is successful, the printer should attempt to perform an Update operation using this root directory.
60	Configures a printer to automatically perform a Mirror Feedback operation at start-up.
70	Configures the printer to upload the resulting Feedback file to the designated directory on the server.
80	Configures a printer to repeat the Feedback operation zero times.

Scenario Two

In this scenario, the printer is configured to not perform a Mirror Update function at start-up. It is configured to perform a Mirror Feedback operation at start-up and thereafter at every 60 minutes.

When the 60 minutes elapses, the printer will attempt to make a FTP connection to the server address 10.14.5.133. If the FTP connection is successful, the printer will attempt a Feedback operation, uploading the resulting Feedback file to the "/all_feedback" directory on the server. After the initial Feedback operation, subsequent Feedback operations will occur at an interval of 60 minutes.



IMPORTANT: Using the command set in the example below, for the printer to attempt any Mirror Update operation unless the "`ip.mirror.fetch`" command is sent to the printer.

This example shows a Mirror configuration command set. Each line item of the command set is identified with a number. For details on each line item, see the table below.

```

10 ! U1 SETVAR "ip.mirror.auto" "off"
20 ! U1 SETVAR "ip.mirror.username" "printer"
30 ! U1 SETVAR "ip.mirror.password" "printer"
40 ! U1 SETVAR "ip.mirror.server" "10.14.5.133"
50 ! U1 SETVAR "ip.mirror.path" "/all_printers/s4m/role1"
60 ! U1 SETVAR "ip.mirror.feedback.auto" "on"
70 ! U1 SETVAR "ip.mirror.feedback.path" "/all_feedback"
80 ! U1 SETVAR "ip.mirror.feedback.freq" "60"

```

10	Configures the printer to not perform a Mirror Update operation at start-up
20	Configures the FTP Server "user name" for the printer to use
30	Configures the FTP Server "password" for the printer to use
40	Configures the FTP server address the printer should make a FTP connection to.
50	If the FTP connection is successful, the printer should attempt to perform an Update operation using this root directory.
60	Configures a printer to automatically perform a Mirror Feedback operation at start-up.
70	Configures the printer to upload the resulting Feedback file to the designated directory on the server.
80	Configures the printer to attempt a Feedback operation every 60 minutes.

Troubleshooting

If a Mirror process completes unsuccessfully, troubleshooting information can be retrieved by sending this command to the printer:

```
! U1 GETVAR "ip.mirror.last_error"
```

[Table 37](#) lists possible printer responses, an explanation of each, and resolutions. [Supported Printers Table 38 on page 1537](#) provides problem scenarios and solutions.



IMPORTANT: A mirror path can have up to 50 characters.

Table 37 Printer Response Troubleshooting

Printer Response	Explanation	Resolution
"connection failed"	The network connection to the Mirror FTP server failed while attempting to perform a printer update.	<ul style="list-style-type: none"> • Check the user name, password, and server address for the Mirror FTP server and ensure that these values are set correctly in the printer. • Ensure that the user name assigned to the printer has the proper permission to log into the Mirror FTP server. • Check that the printer has a successful network connection and is able to send and receive network data.
"Failed to get File: [filename]"	During an update operation, the printer's attempt to retrieve the file [filename] failed.	<ul style="list-style-type: none"> • Ensure that the printer's network connection has not been interrupted. If it has, re-establish network connectivity and retry the update. • Check the server's access permissions for the user name assigned to the printer. Make sure the user name is granted access to read [filename] from the server.
"feedback connection failed"	The network connection to the Mirror FTP server failed while attempting to send printer feedback.	<ul style="list-style-type: none"> • Check the user name, password, and server address for the Mirror FTP server and ensure that these values are set correctly in the printer. • Ensure that the user name assigned to the printer have the proper permission to log into the Mirror FTP server. • Check that the printer has a successful network connection and is able to send and receive network data.

Table 37 Printer Response Troubleshooting (Continued)

Printer Response	Explanation	Resolution
"Failed getting file to parser : [filename]"	During an update operation, the printer's attempt to retrieve a file [filename] in the <mirror_path>/app1 directory failed.	<ul style="list-style-type: none"> • Ensure that the printer's network connection has not been interrupted. If it has, re-establish network connectivity and retry the update. • Check the server's access permissions for the user name assigned to the printer. Make sure the user name is granted access to read [filename] from the server.
"Failed to send feedback file: <feedback_path>/<feedback_filename>"	During a feedback operation, the printer's attempt to store the feedback file in the <feedback_path> directory failed.	<ul style="list-style-type: none"> • Ensure that the printer's network connection has not been interrupted. If it has, re-establish network connectivity and retry the update. • Check the server's access permissions for the user name assigned to the printer. Make sure the user name is granted access to write to the <feedback_path> directory. • Ensure that the <feedback_path> directory exists on the remote server.
"Too many files in the firmware download directory"	The Mirror FTP server has more than one file in the <mirror_path>/app1 directory.	Ensure that there is only one (1) firmware file in the <mirror_path>/app1 directory.

Table 38 Problem Scenario Troubleshooting

Problem Scenario	Solution
I performed a Mirror Update and now my printer is continuously reprogramming.	<p>Ensure that the name of the firmware file in <code><mirror_path>/app1</code> matches the version of firmware contained in that file.</p> <p>For firmware version V53.17.2Z, the name of the file in the <code><mirror_path>/app1</code> directory must be <code>V53.17.2Z.ZPL</code> to prevent the continuous reprogramming cycle.</p>
Every time a Mirror Update is run, a file is fetched even though no changes have been made to the files on the server.	<ul style="list-style-type: none"> • Check the names of the files in the <code><mirror_path>/files</code> and <code><mirror_path>/commands</code> directories. If the names are longer than 16 characters (minus extensions), then the printer will truncate them to 16 characters when downloading. If two filenames truncate to the same 16 characters, the printer will not be able to tell the difference between them and will re-download one of the two files during every update operation. • Check the names of the files in the <code><mirror_path>/files</code> and <code><mirror_path>/commands</code> directories. If any of the names are the same, then the printer will not be able to tell the difference. Therefore it will get the one in the files directory, update the timestamp file, and then it will get the one in the commands directory and update the timestamp file. Then, the next time through the one in the files directory will have a different timestamp, so it will get that file again and then check the commands directory, and so on. • Check the server's access permissions for the user name assigned to the printer. Make sure the user name is granted access to read all files in the <code><mirror_path>/files</code> and <code><mirror_path>/commands</code> directories.
The printer is continually rebooting.	<ul style="list-style-type: none"> • Check the <code>/commands</code> directory. If a <code>file.delete</code> command resides, then you need to remove <code>file.delete</code> or modify your script.

Wireless Markup Language (WML)

Wireless Markup Language (WML) offers a text-based method of designing a menu structure for the display screen of selected printers. By leveraging Set/Get/Do (SGD) and files containing Zebra Programming Language (ZPL) commands, customized menus can be created.

WML Overview

Wireless Markup Language (WML) offers a text-based method of designing customized menus on the LCD front panel of selected printers. By leveraging Set-Get-Do (SGD) and Zebra Programming Language (ZPL) commands, menus that feature both display and command features can be created. The WML “card” structure makes it possible to link from one menu screen to another, creating menus that are as many levels “deep” as desired or reduced to only those options needed by the printer operator.

For details on SGD commands, see [This chapter provides a high-level overview of printer setting Set / Get / Do \(SGD\) commands. For printer support of these SGD commands, see SGD Command Support on page 1503. on page 561.](#) For details on ZPL commands, see [ZPL Commands on page 33.](#)

WML Details

A WML file is made up of tags, which are similar to HTML tags. For a list of the supported WML tags, see [WML Tags on page 1540.](#)

Using WML on the printer is dependent on the presence of a single `index.wml` file, stored in the printer's E: memory. The `index.wml` file can contain one or more “cards”, with each card defining the content of a single menu. Everything within the card tag (`<card>` `</card>`) constitutes one complete front panel menu. Cards can also contain hyperlinks to other menus. If the `index.wml` has three cards, with links between the cards, that means there are three front panel menus. It is also possible to create multiple `.wml` files, with links between them and the `index.wml` file. In cases where multiple `.wml` files are used, it is recommended that each file should be structured to provide a link back to the main menu as described in the `index.wml` card.



NOTE: Only one `index.wml` file can reside on a printer at any time

WML defined menus can use Set-Get-Do (SGD) commands to retrieve or set printer settings. For example, a menu might display the printer's current baud rate, while also offering other potential baud rate settings for the printer selection. In more advanced uses, WML defined menus can cause ZPL command files, stored in the printer E: memory, to be injected into the printers command engine – where they will be read in and acted upon. In this use, the ZPL command file files are known as `.nrd` files.

For example, a WML defined menu could call an .nrd file that contains a customized set of printer configuration commands. In this way, different profiles can be created for the printer - making it possible for the printer operator to select the appropriate configuration profile needed for the task the printer is being used in.

An important concept to consider is that the WML menu completely defines what is displayed on the printers screen. If an item is not included in the WML menu definition it will not be displayed to the user.



NOTE: The `index.wml` file must reside on the printer's **E:** drive for the WML menu to display. If the `index.wml` file is on a drive other than **E:**, then the standard front panel menus display. 3



NOTE: When a WML menu is resident on the printer, the standard menu system can be easily be accessed by holding down the Cancel and Setup/Exit buttons (on the ZM400) or the Cancel and Setup/Exit buttons (on Xi4) or the Select button (on GX) on the front panel while the printer powers up. Hold the buttons down until the PRINT READY message displays on the front panel. To return to the WML defined menu, reset the printer again.3

Supported Printers

WML is supported on the following printers, using the indicated firmware. The buttons on the printers' front panel that are used for Navigating WML defined menus are noted.



NOTE: When a WML defined menu is in use, the stripes pattern found at the top of selected printers is not displayed.

Table 39 WML-Supported Printers

Printer	Firmware	Number of "lines" available	Menu Navigation Buttons	Keys to Access Standard Menu System
105SLPlus	V53.17.15Z (or later)	5	Select + (PLUS) - (MINUS)	Hold down CANCEL & SETUP/EXIT during power-up
Xi4 series	V53.17.5Z (or later)	5	Select + (PLUS) - (MINUS)	Hold down CANCEL & SETUP/EXIT during power-up
ZE500	V53.17.15Z (or later)	5	Select + (PLUS) - (MINUS)	Hold down CANCEL & SETUP/EXIT during power-up
ZM400	V53.17.5Z (or later)	5	Select + (PLUS) - (MINUS)	Hold down CANCEL & SETUP/EXIT during power-up
ZM600	V53.17.5Z (or later)	5	NEXT/SAVE + (PLUS) - (MINUS)	Hold down CANCEL & SETUP/EXIT during power-up
G series	V56.17.5Z (or later)	4	SELECT SCROLL	Hold down SELECT during power-up

Professional Services for WML Content Creation

Zebra offers a Professional Services group that can help with the creation of WML content. To inquire about Zebra's Professional Services, contact your Zebra account representative.

WML Tags

Table 1 shows the WML tags and tag parameters that can be used to create a menu system. As with other tag-based languages, such as HTML and XML, ending tags should be used to indicate the end of a structure. An example of an ending tag would be `</wml>`, which indicates the end of a WML script.



IMPORTANT: Using end tags is required to create well formed and functional WML scripts.

Table 40 WML Tag Descriptions

<code><wml> </wml></code>	indicates the beginning/end of the WML script
<code><display> </display></code>	indicates the beginning/end of the content to display on-screen
<code><card> </card></code>	indicates the beginning/end of a card
<code><p> </p></code>	indicates the beginning/end of a Paragraph
<code>
</code>	Line break
<code>Menu</code>	Hyperlink to another card
<code><timer value="xx"> </timer></code>	Controls display timer in 10 th of a second increments
<code>" ontimer="#main"</code>	Controls action to take at timer end
<code>alerts="on"</code>	Controls display of on-screen alerts
<code>\$(command.command)</code>	\$ executes a SGD "get" command
<code><do><setvar></do></code>	Controls execution of do and setvar commands

Using WML

This section provides you with the necessary steps to prepare and transmit WML content to the printer. There are two methods to send WML content to the printer - via the FTP protocol or using the "CISDFCRC16" command. Both methods are detailed below.



IMPORTANT: The & (ampersand) character should not be used within the body of any Paragraph tag (<p>). If an ampersand is present within the body of a Paragraph tag, a WML-based menu may not function as expected.

The ampersand character should NEVER be used within a paragraph tag for any of the printer's soft keys (P1, P2, etc.); doing so can render the menu inoperable.

Create a Sample index.wml File:

1. Open a text editor.
2. Type (or copy/paste) the following text:

```
<wml>
<display>
<card>
<p>Hello World!!</p>
</card>
</display>
</wml>
```

Save this file with this name: *index.wml*.

Prepare the Printer to Receive WML Content via FTP:

WML files – and any .nrd files used by a WML menu structure – must be stored in the printers E: memory location. While the files are first being transmitted to the printer, they should not be processed by the printers ZPL formatting engine. This can be done by configuring the SGD settings "ip.ftp.enable" and "ip.ftp.execute_file".

The "ip.ftp.enable" setting allows the printer to receive content via the FTP protocol. The "ip.ftp.execute_file" setting controls the printers' ability to process or not process commands received via the FTP protocol using the printers ZPL engine. By default, both settings are enabled.

Set "ip.ftp.enable" to "on" and "ip.ftp.execute_file" to "off".

To do this, send these commands to the printer:

```
! U1 setvar "ip.ftp.enable" "on"
! U1 setvar "ip.ftp.execute_file" "off"
```

1. To confirm these commands are correctly set, send the getvar command to check the settings. To do this, send these commands to the printer:

```
! U1 getvar "ip.ftp.enable"
! U1 getvar "ip.ftp.execute_file"
```

If a terminal emulation program is being used, the following response should be returned from the printer.

```
"on""off"
```



NOTE: Only printers using the Internal 10/100 wired or Internal Wireless Plus & Wireless Plus print server can use the `! U1 setvar "ip.ftp.execute_file" "off"` command. For other print servers, use the "CISDFCRC16" command method detailed below.

Send WML Content to the Printer via FTP

Go to a command prompt.

At the command line prompt, type `"ftp xxx.xxx.xxx.xxx"`, where `xxx.xxx.xxx.xxx` is the IP Address of the printer. For example, if the IP Address of the printer is 10.3.5.34, the command would be:

```
ftp 10.3.5.34
```

1. Press Enter to connect to the printer.
2. Press Enter to log in to the printer.
3. At the FTP prompt, type `"put index.wml"` and press Enter. The `index.wml` file will be transferred to the printer's E: memory.
4. Type `"quit"` to disconnect from the printer and exit FTP.
5. Power cycle the printer.

Once the printer completes the power cycle the display should look similar to this:



For additional `index.wml` examples, see [WML Examples on page 1546](#).



NOTE: When a WML menu is resident on the printer, the standard menu system can be easily be accessed by holding down the Cancel and Setup/Exit buttons (on the ZM400) or the Cancel and Setup/Exit buttons (on Xi4) or the Select button (on GX) on the front panel while the printer powers up. Hold the buttons down until the PRINT READY message displays on the front panel. To return to the WML defined menu, reset the printer again.



IMPORTANT: When using the `"ip.ftp.execute_file"` command, be sure to reset the command back to `"on"` for use in production processes. If the setting is left in the `"off"` configuration, when label formats or firmware are sent to the printer via FTP they will not be processed as intended – and the E: memory location can quickly become full.

Resetting the "ip.ftp.execute_file" setting

1. To reset the `"ip.ftp.execute_file"` setting to the default state, send the following command to the printer.

```
! U1 setvar "ip.ftp.execute_file" "on"
```

Sending WML Content to the Printer via the CISDFCRC16 Command:

WML files – and any .nrd files used by a WML menu structure – must be stored in the printers E: memory location. While the files are first being transmitted to the printer, they should not be processed by the printers ZPL formatting engine. This can be done by using the CISDFCRC16 command. This command allows content to be written directly to the E: memory location, without being processed by the printers ZPL formatting engine. By using the CISDFCRC16 command, WML content can be transmitted to the printer via the Serial, USB or Parallel ports.

For additional information on the CISDFCRC16 command, see [page XX](#).

1. To send the sample index.wml shown earlier, send the following commands to the printer:

```
! CISDFCRC16
0000
INDEX.WML
0000004E
0000
<wml>
<display>
<card>
<p>Hello World!!</p>
</card>
</display>
</wml>
```

2. Power cycle the printer.

Once the printer completes the power cycle the display should look similar to this:

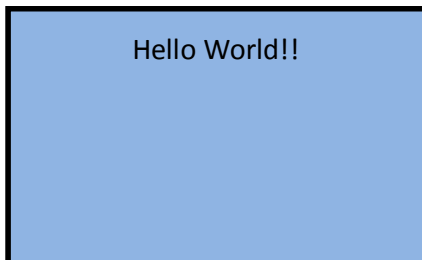

For additional index.wml examples, see [WML Examples on page 1546](#).



NOTE: When a WML menu is resident on the printer, the standard menu system can be easily be accessed by holding down the Cancel and Setup/Exit buttons (on the ZM400) or Cancel and Setup/Exit buttons (on Xi4) on the front panel while the printer powers up. Hold the buttons down until the PRINT READY message displays on the front panel. To return to the WML defined menu, reset the printer again.

Retrieving WML Content from the Printer using the file.type Command:

It is possible to retrieve .wml file content from the printer using the "file.type" SGD command. To do this, open a terminal emulation connection to the printer and issue the command. For example, to retrieve the contents of the INDEX.WML file, use the following command:

```
! U1 setvar "file.type" "E:INDEX.WML"
```



NOTE: The file.type command is case sensitive – if the file is stored on the printer as INDEX.WML, the command must use that same case. Additionally, you should note that .nrd files are treated as confidential – they cannot be retrieved from the printer.

Using .nrd Files from WML Menus

It is possible to have a WML menu send the contents of a ZPL or SGD file to the printer to be processed. In this way, the WML menu can leverage complex command scripts in response to the user pressing a single button on the printer. One possible use for this capability would be to create a series of "profile" files that contain all the settings necessary to reconfigure the printer for different uses.

The command files are known as ".nrd" files and are stored directly on the printers E: memory location. The .nrd files can be created using a standard text editor and sent to the printer via FTP or using the CISDFCRC16 command. Files should have an ".nrd" extension.

Removing WML or .nrd Files from the Printer using the file.delete Command:

It is possible to remove .wml files from the printer using the file.delete SGD command. To do this, open a terminal emulation connection to the printer and issue the command. For example, to remove the INDEX.WML file, use the following command:

```
! U1 do "file.delete" "E:INDEX.WML"
```

WML Examples

The examples shown below “build” from a simple, display-only, WML menu to a more complex interactive example that uses .nrd files containing ZPL commands. In the initial examples, all lines are explained in detail, in the later examples only the new concepts are covered in detail.

Indenting is used in the examples below to improve readability, it is not necessary in actual use.

Example 1

This example shows a basic WML menu structure that uses only fixed text. The content below shows the WML script plus numbered callouts and a table that identify the function of each of the WML tags.

```

1 → <wml>
2 → <display>
3 →   <card>
4 →     <p>Hello World!!</p>
5 →   </card>
6 → </display>
7 → </wml>

```

1	Beginning of the WML file.
2	Beginning of the content to be displayed.
3	The <code><card></code> tag begins the definition of this menu.
4	The <code><p></code> beings a paragraph, here displaying Hello World! The <code></p></code> ends the paragraph
5	The <code></card></code> tag ends the definition of this menu.
6	End of the content to be displayed.
7	End of the WML file.

In use, this WML menu looks similar to this:

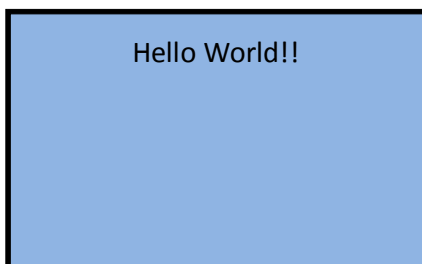

Example 2

This example demonstrates a WML menu structure that uses fixed text, plus two SGD commands to display the current printer settings for the Baud rate and ESSID settings on the printer.

```

1 → <wml>
2 → <display>
3 →   <card>
4 →     <p>Baud: $(comm.baud)</p>
5 →     <br/>
6 →     <p>AP: $(wlan.essid)</p>
7 →   </card>
8 → </display>
9 → </wml>

```

1	Beginning of the WML file.
2	Beginning of the content to be displayed.
3	The <code><card></code> tag begins the definition of this menu.
4	The <code><p></code> begins a paragraph. 'Baud:' displays the text Baud: \$(comm.baud) retrieves and displays the printers' current baud rate. The <code></p></code> ends the paragraph.
5	A line break
6	The <code><p></code> begins a paragraph. "AP:" displays the text AP: \$(wlan.essid) retrieves and displays the printers' current ESSID setting. The <code></p></code> ends the paragraph.
7	The <code></card></code> tag ends the definition of this menu.
8	End of the content to be displayed.
9	End of the WML file

In use, this WML menu looks similar to this:

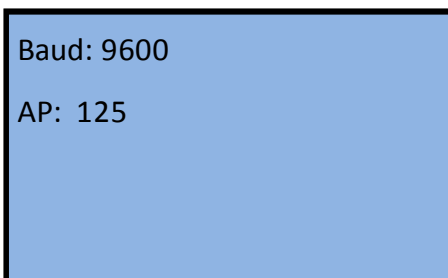

Example 3

This example demonstrates a WML menu structure with two menus. Fixed text and SGD commands are used to display the current printer settings for the Baud rate and ESSID settings on menu one and the Firmware version and ZBI State on menu two. Through use of the 'timer' setting, the menu will automatically return to a defined WML card if no buttons are pressed after a set time period. The menu is configured to allow printer alerts (such as HEAD OPEN) to be displayed.

```

1→ <wml>
2→ <display>
3→   <card id="main" title="" ontimer="#main" alerts="on">
4→   <timer value="50"></timer>
5→   <p>Baud: $(comm.baud)</p>
6→   <br/>
7→   <p>AP: $(wlan.essid)</p>
8→   <p> </p><br/>
9→   <p> </p><br/>
10→  <p> <a href="#system">Firmware</a></p>
11→  </card>
12→  <card id="system" title="" ontimer="#main" alerts="on">
13→  <timer value="50"></timer>
14→  <p>Firmware:</p><br/>
15→  <p>$(appl.name)</p><br/>
16→  <p>ZBI State:</p><br/>
17→  <p>$(zbi.key)</p><br/>
18→  <p> <a href="#main">Main</a></p>
19→  </card>
20→ </display>
21→ </wml>

```

3	<card id="main" - defines the card's id - "main". title="" - defines the title (not displayed on screen). ontimer="#main" - defines the WML card to display when the timer runs out. alerts="on"> - enables the alerts display feature.
4	<timer value="50"></timer> - sets the timer to 50 (in 10 th of a second increments).
10	<p> Firmware</p> - defines a link to the "system" card.
12	<card id="system" - defines the card's id - "system". title="" - defines the title (not displayed on screen). ontimer="#main" - defines the WML card to display when the timer runs out. alerts="on"> - enables the alerts display feature.
13	<timer value="50"></timer> - sets the timer to 50 (in 10 th of a second increments).
18	<p> Main</p> - defines a link to the "main" card.

In use, these two WML menus look similar to this:

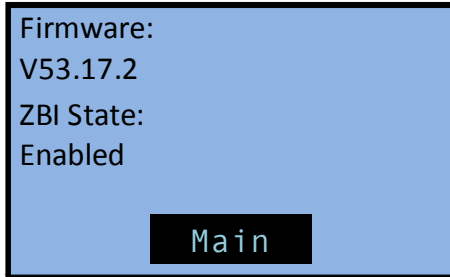
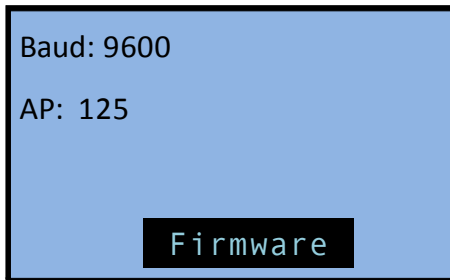

NOTE: GX series printers can display four lines of text. If you are using a GX series printer, remove one line of text from each “card” to use this example.

Example 4

This example demonstrates a WML menu structure that creates two menu screens and a link to a command file – “config.nrd” – that contains a ZPL command that will cause the unit to print a configuration label.

```

1→ <wml>
2→ <display>
3→   <card id="main" title="" ontimer="#main" alerts="on">
4→     <timer value="50"></timer>
5→     <p>Baud: $(comm.baud)</p>
6→     <br/>
7→     <p>AP: $(wlan.essid)</p>
8→     <p> </p><br/>
9→     <p> </p><br/>
10→    <p> <a href="#system">Firmware</a></p>
11→  </card>
12→  <card id="system" title="" ontimer="#main" alerts="on">
13→    <timer value="50"></timer>
14→    <p>Firmware:</p><br/>
15→    <p>$(appl.name)</p><br/>
16→    <p>ZBI State:</p><br/>
17→    <p>$(zbi.key)</p><br/>
18→    <p><a href="#main">Main</a>
19→    <a href="#config">Config</a></p>
20→  </card>
21→  <card id="config" title="" ontimer="#main" alerts="on">
22→    <timer value="50"></timer>
23→    <p>Printing </p><br/>
24→    <p> Config Label...</p><br/>
25→    <p></p><br/>
26→    <p>Please wait...</p><br/>
27→    <setvar name="file.run" value="e:config.nrd"/>
28→  </card>
29→ </display>
30→ </wml>

```

18	<p>Main
19	Config</p>
27	<ul style="list-style-type: none"> • Defines two links, positioned next to each other - to the "main" and "config" WML cards
	<setvar name="file.run" value="e:config.nrd"/>
	<ul style="list-style-type: none"> • Defines that the SGD command "file.run" should be used on the "e:config.nrd" file. • In this instance, the "e:config.nrd" file contains a single ZPL command - "~wc"

In use, these WML menus look similar to this:

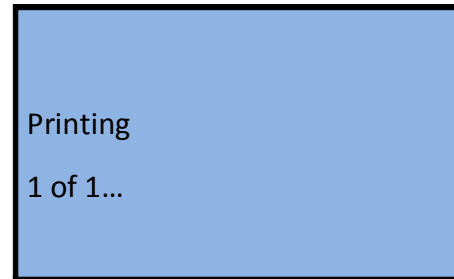
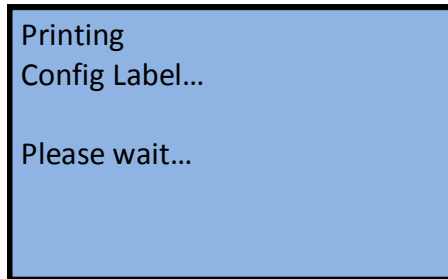
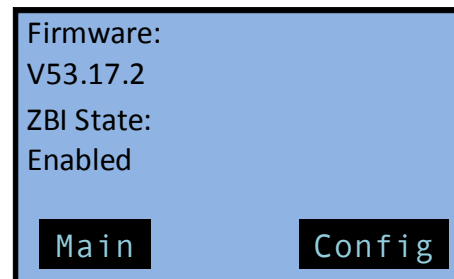
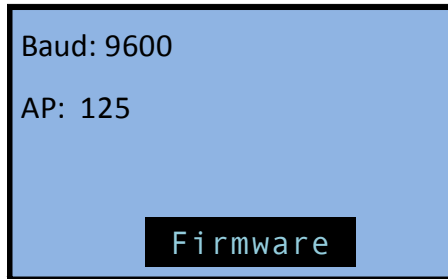

NOTE: GX series printers can display four lines of text. If you are using a GX series printer, remove one line of text from each “card” to use this example.

Example 5

This example demonstrates a WML menu structure with three cards. The "darkness" card leverages WML and the SGD "print.tone" command to allow the user to both view and configure a setting.

```

1→ <wml>
2→ <display>
3→   <card id="main" title="" ontimer="#main" alerts="on">
4→     <timer value="50"></timer>
5→     <p>Baud: $(comm.baud)</p>
6→     <br/>
7→     <p>AP: $(wlan.essid)</p>
8→     <p> </p><br/>
9→     <p> </p><br/>
10→    <p>   <a href="#system">Firmware</a></p>
11→  </card>
12→  <card id="system" title="" ontimer="#main" alerts="on">
13→    <timer value="50"></timer>
14→    <p>Firmware:</p><br/>
15→    <p>$(appl.name)</p><br/>
16→    <p>ZBI State:</p><br/>
17→    <p>$(zbi.key)</p><br/>
18→    <p><a href="#main">Main</a> <a href="#darkness">Darkness</a></p>
19→  </card>
20→  <card id="darkness" title="" ontimer="#main" alerts="on">
21→    <timer value="50"></timer>
22→    <p>Current: $(print.tone)</p><br/>
23→    <p>Change: </p><do type="accept" label="Up"><setvar name="print.tone"
24→      value="+1.0"/></do><br/>
25→    <p>Change: </p><do type="accept" label="Down"><setvar name="print.tone"
26→      value="-1.0"/></do><br/>
27→    <p> </p><br/>
28→    <p><a href="#main">Main</a> <a href="#config">Config</a></p>
29→  </card>
30→  <card id="config" title="" ontimer="#main" alerts="on">
31→    <timer value="50"></timer>
32→    <p>Printing </p><br/>
33→    <p> Config Label...</p><br/>
34→    <p></p><br/>
35→    <p>Please wait...</p><br/>
36→    <setvar name="file.run" value="e:config.nrd"/>
37→  </card>
38→ </display>
39→ </wml>

```

23	<p><code><p>Change: </p></code></p> <ul style="list-style-type: none"> • Defines the fixed text "Change: " <pre style="margin-left: 20px;"><code><do type="accept" label="Up"><setvar name="print.tone" value="+1.0"/></do>
</code></pre> • Defines selecting the word "Up" as equal to sending the value "+1.0" for the SGD command "print.tone". In this case, this increases the setting by 1.0.
24	<p><code><p>Change: </p></code></p> <ul style="list-style-type: none"> • Defines the fixed text "Change: " <pre style="margin-left: 20px;"><code>do type="accept" label="Down"><setvar name="print.tone" value="-1.0"/></do>
</code></pre> • Defines selecting the word "Down" as equal to sending the value "-1.0" for the SGD command "print.tone". In this case, this decreases the setting by 1.0.

In use, these WML menus look similar to this:

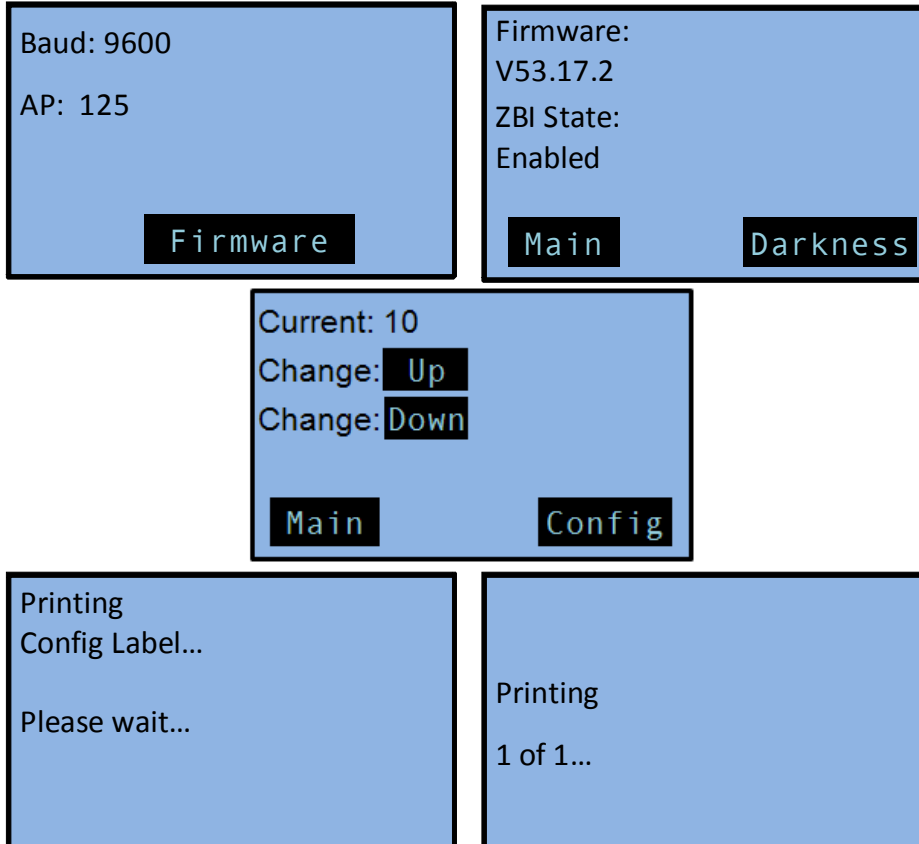

NOTE: GX series printers can display four lines of text. If you are using a GX series printer, remove one line of text from each "card" to use this example.

Troubleshooting Scenarios

Problem Scenario	Corrective Actions
<p>I loaded a WML menu structure on the printer, but the Factory menu structure is displaying.</p>	<ul style="list-style-type: none"> • "The WML files may have syntax errors. Reconfirm that the correct syntax has been used. When creating WML files it is recommended to start with a simple structure, validate that it's functional and build additional content onto the "known good" example • "Power cycle the printer and watch the start-up sequence - if a "WML ERROR" message displays during the start-up, the index.wml file has a syntax error that needs to be corrected. • "The index.wml file may not have been successfully transferred to the printer. Use a terminal emulation program and the following command to retrieve the index.wml file to the PC for examination: ! U1 setvar "file.type" "E:INDEX.WML" • "The index.wml file may not be present in the E: memory location. Validate that the file is present and correctly named. • "Confirm that straight quotes were used in all instances where the quote character was used (use the " character - not " or ?). SGD commands require the use of the straight quote. • "Confirm that the "WML Menu Cancel" buttons, (Setup and Cancel or Cancel and Setup/Exit or Select) were not held down during start up. These actions will cause the standard menu to display
<p>Some characters in the menu are cut off or some lines are not displaying at all.</p>	<ul style="list-style-type: none"> • Characters that extend past the width of the display are truncated, reposition the field as needed. • Check that you have not exceeded that maximum number of lines the display allows (5 lines on ZM and Xi4 series units, 4 lines on the GX series).
<p>My WML menu structure is displaying, but one of the "cards" is not displaying or is unreachable.</p>	<ul style="list-style-type: none"> • The missing "card" may not have been linked to from any of the visible "cards". Review you WML content to ensure that the correct links exist. • The WML files may have syntax errors, reconfirm that the correct syntax has been used. When creating WML files it is recommended to start with a simple structure, validate that it's functional and build additional content onto a known good example. • If the missing card content is contained in a separate .wml file, confirm that the necessary .wml files have been transferred to the printer.
<p>My WML menu structure uses SGD commands to display current settings, but the settings are not displaying.</p>	<ul style="list-style-type: none"> • Validate that the correct syntax was used for the SGD command. • Check the manual page for the command being used. Confirm that the command is supported by the printer & firmware. Use a terminal emulation program to send just the command being used to validate it functions outside the WML menu structure. • Confirm that straight quotes were used in all instances where the quote character was used (use the " character – not " or "). SGD commands require the use of the straight quote. • Characters that extend past the width of the display are truncated, reposition the field as needed. • Check that you have not exceeded that maximum number of lines the display allows (5 on ZM and Xi4 series units).

Problem Scenario	Corrective Actions
<p>My WML menu structure used SGD commands to allow the user to alter printer settings, but the settings are not getting changed as expected.</p>	<ul style="list-style-type: none"> • Validate that the value being used in the <code>value=</code> parameter of the <code><do></code> tag is supported by the SGD command. • Validate that the correct syntax was used for the SGD command. • Check the manual page for the command being used. Confirm that the command is supported by the printer & firmware. Use a terminal emulation program to send just the command being used to validate it functions outside the WML menu structure. • Confirm that straight quotes were used in all instances where the quote character was used (use the " character – not " or ?). SGD commands require the use of the straight quote.
<p>My WML menu structure uses .nrd files to send commands to the printers ZPL or SGD engine, but the commands don't seem to be getting sent when the user selects the on-screen link for the action.</p>	<ul style="list-style-type: none"> • Confirm that the .nrd files are present in E: memory and named as expected. Resend or rename the files if necessary. • Confirm that the WML menu structure is using the correct file name(s). • Confirm that the commands in the files work as expected, independently of the WML menu or .nrd file. • Validate that ZPL and SGD commands have not been interlaced.
<p>I am using the CISDFCRC16 command to transfer files, but the files are either not being transferred to the printer or are showing up with a zero (0) byte size.</p>	<ul style="list-style-type: none"> • Confirm that the Hexadecimal value used for the File Size parameter is correct. This value must be an eight digit file size specified in hexadecimal which indicates the number of bytes in the <code><data></code> section of the command. See the full manual page on the CISDFCRC16 command for additional details. • Validate that the CRC and Checksum parameters are correct (using the "0000" value for these parameters is recommended). • Confirm that the WML file name and extension are in upper case characters. • Confirm that the exclamation mark (!) was included before the command name ("! CISDFCRC16").

Using Weblink

Weblink is a feature of Zebra Link-OS™ printers. Using a secure connection, the Weblink feature allows the printer to directly connect to an internet based server, for the purpose of either sending information to the server or receiving from the server. Weblink can transport data securely through a firewall.

When Should Weblink be Used?

Weblink can transport any information related to device management, transactional data and information to be processed at a later time. It can be used as part of an overall cost reduction solution that leverages web technologies.

Typically, an application called a 'servlet' is created and run on the internet based server, waiting for printers to connect and interact with the servlet. These servlet applications can provide a variety of functions – from sending operating system updates to the printer, to receiving data from the printer and, in turn, using that data to trigger events in other systems.

For example, a solution could be created that would feature the printer consuming data from a Bluetooth® scanner connected to the printer – with that scanned data then being sent from the printer to the internet-based servlet. The servlet would then seek out additional details related to the scanned data, format a document, and then send it to the printer for printing.

Configuring Weblink

When any Weblink setting (with the exception of the logging settings) is adjusted either via SNMP, SGD, or JSON it is required that the printer be reset before the new value takes effect. The `weblink.printer_reset_required` setting will be set to "yes" if there are any settings that have been modified that require a printer reset.

Basic Configuration

To determine how much configuration is necessary the following questions should be considered:

1. Is the remote server the printer is attempting to connect to outside the corporate firewall?
2. Does the firewall require a username and password to access the remote server?
3. Does the printer require a proxy server to access the remote server?

4. Does the firewall permit HTTPS connections initially or does the printer need to connect via HTTP first?

If the answer to any of these questions is 'yes', then more than the basic configuration may be necessary. Depending upon the network environment that the printer is in, accessing the remote server may only require that a few settings be set.

The minimum requirement is that the URL for the remote server be set. For simplicity, assume that only conn1 is being used (this is the typical scenario). See also [Difference Between Conn1 and Conn2 on page 1559](#).

To configure the printer to connect to the remote server:

- i. Set `weblink.ip.conn1.location` to the URL of the remote server.

The URL must conform to the standards described in RFC3986 (<http://www.ietf.org/rfc/rfc3986.txt>). For example, if the remote servlet's full URL is

```
https://www.examplecorpinc.com/zebra/weblink/
```

Configure the location setting as follows:

```
! U1 setvar "weblink.ip.conn1.location"  
"https://www.examplecorpinc.com/zebra/weblink/"
```

- ii. Reset the printer.

When the printer has an IP address, it will attempt to connect to the remote server. In the event that the remote server does not indicate that the printer has connected, logging may need to be enabled in order to determine the failure.

When a Proxy Server is Part of the Network Configuration

If a proxy server must be used to access the remote server, the printer's proxy setting must be set to connect to the server. There are typically four properties associated with a proxy server:

- The proxy server scheme: **HTTP** or **HTTPS**
- The proxy server address
- The proxy server port (optional)
- The username and password for the proxy (optional)

To supply the address of the proxy server (assuming a default port and no username/password), configure the proxy setting as follows:

```
! U1 setvar "weblink.ip.conn1.proxy" "https://my.internal.proxy/"
```

In this scenario the proxy address is `my.internal.proxy` and the scheme is **HTTPS**. The default port (1080) will be used. No username or password will be used to authenticate with the proxy.

To specify an alternate port configure the proxy as follows:

```
! U1 setvar "weblink.ip.conn1.proxy" "https://my.internal.proxy:3128/"
```

To specify a username and password configure the proxy as follows:

```
! U1 setvar "weblink.ip.conn1.proxy" "https://user:pass@my.internal.proxy/"
```

The proxy username, password, and the rest of the URL must follow the rules specified in RFC3986 (<http://www.ietf.org/rfc/rfc3986.txt>).

When HTTP Authentication is Necessary

Use this configuration when, for example, a firewall requires a username and/or password.

It may be necessary to specify a username and password to various routers and servers along the path to the remote server. Typically when using a browser to access the server the authentication request will be presented in the form of a dialog window that asks for the username and password.

Since the printer's connection to the remote server is headless and non-interactive, the Weblink configuration allows a user to enter in a server name/username/password triplet. The triplet will be used in the event that the printer is presented with an authentication request (for example, this typically is requested via the **HTTP/1.1 401 Unauthorized** request).

To specify authentication credentials, issue the following:

```
! U1 setvar "weblink.ip.conn1.authentication.add" "servername.com username password"
```

In this scenario the server requesting authentication is `servername.com`. The username and password to be supplied are 'username' and 'password'. The server name can be either a DNS name or an IP address. The username and password cannot be retrieved from SGD, SNMP, or JSON once added. Only the server name will be returned.

More than one set of authentication triplets can be added. The printer will only use the credentials as they are needed. In other words, the printer will only use the credentials for `servername.com` if it receives a **HTTP/1.1 401 Unauthorized** request from `servername.com`.

To see what authentication triplets are specified issue:

```
! U1 getvar "weblink.ip.conn1.authentication.entries"
```

To remove authentication credentials issue the following:

```
! U1 setvar "weblink.ip.conn1.authentication.remove" "servername.com"
```

Additional Firewall Configuration

Some firewalls do not allow the first connection attempt for a device to be HTTPS or require new connections periodically to keep the initial connections intact. The weblink test branch was provided to address issues that typically arise because the printer is an unattended device.

To configure the printer to attempt an HTTP connection anytime the HTTPS connection drops :

```
! U1 setvar "weblink.ip.conn1.test.location"
"http://www.zebra.com/apps/linktest"
! U1 setvar "weblink.ip.conn1.test.test_on" "failure"
```

The `weblink.ip.conn1.test.location` can be any valid HTTP address. The default uses a link provided by Zebra that exists for no other purpose than to help developers test their connections to the internet. Setting `weblink.ip.conn1.test.test_on` to `interval` or `both` will force the printer to attempt a connection to the URL in location every `weblink.ip.conn1.test.retry_interval` seconds (default is 900 seconds/15 minutes).

To configure the printer to try an HTTP connection periodically, independent of the HTTPS success:

```
! U1 setvar "weblink.ip.conn1.test.location"
"http://www.zebra.com/apps/linktest"
! U1 setvar "weblink.ip.conn1.test.test_on" "interval"
! U1 setvar "weblink.ip.conn1.test.retry_interval" "900"
```

Difference Between Conn1 and Conn2

The printer has the ability to connect to two different servers. Connection 1 (conn1) and Connection 2 (conn2) are identical in every way in terms of their configuration. It is expected that conn2 will typically be left unmodified unless a user has an alternate server that they wish to use to configure the printer.

A typical scenario in which both connections would be used is if a user wishes to have the printer connect to both a configuration server and a data source.

Enable Logging

If your printer has trouble connecting, you may wish to enable logging. By default logging is not enabled in order to reduce the amount of memory consumed when the Weblink feature is enabled. It is recommended that once the Weblink feature is configured properly and is performing as expected that the logging be disabled or that a very small (less than 100) number of logging entries be permitted.

To enable logging, `weblink.logging.max_entries` needs to be modified. By default it is set to 0, which indicates that no messages are logged. When attempting to troubleshoot connection issues it is recommended that `max_entries` be set to at least 100 entries. Setting `max_entries` to 100 means that the 100 newest logging entries will be present in `weblink.logging.entries` as older entries are discarded once the maximum number of entries is reached.

```
! U1 setvar "weblink.logging.max_entries" "100"
```

The logging settings are atypical to the Weblink settings as they do not require the printer to be reset before taking effect. This does not mean that previous logging message that would have been logged will appear when the `max_entries` setting is changed from 0 to a greater value. It means that any new logging messages will be logged from that point forward.

Issue the following command to clear any log entries currently in the `weblink.logging.entries` buffer.

```
! U1 do "weblink.logging.clear" ""
```

Navigating the Log Output

The log will contain useful information, even in the scenario where the printer successfully connects to the remote server. This section explains how to read the log and highlights some of the key entries that will help to determine if the connection was successful.

A typical log entry looks as follows:

```
[12-04-2012 14:57:10.625] [conn1.1] Attempting connection to
https://www.examplecorpinc.com/zebra/weblink/
```

The first column is the date and time that the event occurred. The format of the date and time matches the format of `rtc.date` and `rtc.time`. The time, however, also includes the milliseconds to aid in troubleshooting network latency concerns.



NOTE: For printers that do not have a battery to store the Real Time Clock (RTC) value, the date will be restored to the default value upon a power cycle. The default value depends upon how the `rtc.date` SGD is managed. If it has never been set then it will default to the firmware build date (the value in `app1.date`). Otherwise, the value in `rtc.date` will default to the value that it was last set to. This does not mean the value of the `rtc.date` when it was power cycled. It means that when a user sets `rtc.date` that becomes the new default value.

If the printer has a battery then the `rtc.date` is never default and continues to track the date as expected.

The second column indicates the connection name and channel that the entries are associated with. The connection name will match the weblink branch that was configured with the respective URL (for example, conn1 or conn2). The channel number indicates which channel on the respective connection the entries corresponds to.





NOTE: Channels are additional connections that are requested by the server when the server needs to perform a specific operation that cannot be done on the channel(s) currently open. Typically only the RAW channel is open which operates similar to the RAW TCP port. It is typical to see two channels opened, the main channel and the RAW channel.





The third column is the actual message that contains information about what occurred in the printer at the corresponding time in column one. In the above example the printer was initiating the connection to the URL specified in `weblink.ip.conn1.location`.

Review the section titled [SSL/TLS Certificate Errors on page 1560](#) to understand what it means when certain logging messages/errors appear in the log.

SSL/TLS Certificate Errors

Secure connections to the remote server present the opportunity for several errors when attempting to connect. The errors typically involve the certificates used when connecting via SSL or TLS. This section highlights some of the most common issues involving the certificates.

Error	Cause / Solution
<p>"SSL certificate problem: self signed certificate in certificate chain"</p>	<p>One of the situations that prevent a successful connection is not having the correct Certificate Authority certificates installed on the remote server. Zebra requires that the Zebra Root Certificate Authority and the Zebra Subordinate Certificate Authority be installed on the remote server. This error typically indicates that only one of the Zebra Certificate Authority certificates is installed on the remote server.</p> <p> IMPORTANT: When using certificate files, the time on the printer must be set correctly for the websocket connection to succeed, as the time is used in the certificate validation.</p>
<p>"SSL certificate problem: unable to get local issuer certificate"</p>	<p>One of the situations that prevent a successful connection is not having the correct Certificate Authority certificates installed on the remote server. Zebra requires that the Zebra Root Certificate Authority and the Zebra Subordinate Certificate Authority be installed on the remote server. This error typically indicates that neither of the Zebra Certificate Authority certificates are installed on the remote server.</p> <p> IMPORTANT: When using certificate files, the time on the printer must be set correctly for the websocket connection to succeed, as the time is used in the certificate validation.</p>

Error	Cause / Solution
<p>"SSL certificate problem: certificate has expired"</p>	<p>This error indicates that the remote server's certificate has expired. This is typically an indication that the printer's date and/or time are incorrect as the Zebra certificates are typically issued for long durations. Check that <code>rtc.date</code> and <code>rtc.time</code> are set correctly.</p> <p> NOTE: For printers that do not have a battery to store the Real Time Clock (RTC) value, the date will be restored to the default value upon a power cycle. The default value depends upon how the <code>rtc.date</code> SGD is managed. If it has never been set then it will default to the firmware build date (the value in <code>app1.date</code>). Otherwise, the value in <code>rtc.date</code> will default to the value that it was last set to. This does not mean the value of the <code>rtc.date</code> when it was power cycled. It means that when a user sets <code>rtc.date</code> that becomes the new default value.</p> <p>If the printer has a battery then the <code>rtc.date</code> is never default and continues to track the date as expected.</p> <p> IMPORTANT: When using certificate files, the time on the printer must be set correctly for the websocket connection to succeed, as the time is used in the certificate validation.</p>
<p>"SSL certificate problem: certificate is not yet valid"</p>	<p>This error indicates that the remote server's certificate was incorrectly issued or that the printer's date and/or time are incorrect. Check that the printer's date and time (<code>rtc.date</code> and <code>rtc.time</code>) are set correctly and that the certificate's start and expiration date are valid.</p> <p> NOTE: For printers that do not have a battery to store the Real Time Clock (RTC) value, the date will be restored to the default value upon a power cycle. The default value depends upon how the <code>rtc.date</code> SGD is managed. If it has never been set then it will default to the firmware build date (the value in <code>app1.date</code>). Otherwise, the value in <code>rtc.date</code> will default to the value that it was last set to. This does not mean the value of the <code>rtc.date</code> when it was power cycled. It means that when a user sets <code>rtc.date</code> that becomes the new default value.</p> <p>If the printer has a battery then the <code>rtc.date</code> is never default and continues to track the date as expected.</p>
<p>"subjectAltName does not match 1.2.3.4"</p> <p>"SSL certificate subject name 'examplecorpinc.com' does not match target host name '1.2.3.4'"</p>	<p>Part of the certificate validation process involves making sure that the remote server is who it claims to be. A certificate can be created to validate against several aliases/DNS names. Typically the certificate will not contain the IP address of the server as IP addresses are subject to change. When specifying the remote server's URL via <code>weblink.ip.conn1.location</code> be sure to specify one of the DNS aliases listed in the certificate. The valid names will be listed either under the Common Name (CN) field and/or the subjectAltName (SAN or Subject Alternate Name) field within the certificate. For example, the certificate may have the CN set to <code>'examplecorpinc'</code> and the SAN set to <code>'examplecorpinc.com'</code> or <code>'alias.for.examplecorpinc.com'</code>. Any of the CN or SAN names can be used, but, as the IP address is not listed in the CN or SAN it cannot. It is not recommended that the IP address be part of the SAN if a DNS name is available to avoid connection issues that may arise due to subnet change or DHCP lease expirations, etc.</p> <p> IMPORTANT: When using certificate files, the time on the printer must be set correctly for the websocket connection to succeed, as the time is used in the certificate validation.</p>

Error	Cause / Solution
"Unknown SSL protocol error in connection to ..."	When this message is seen it means that the remote server's SSL/TLS configuration is incorrect. Refer to Troubleshooting on page 1563 to ensure the server and printer are both configured correctly.
I do not see any of these errors, but the printer still does not connect.	Refer to Troubleshooting on page 1563 to ensure the server and printer are both configured correctly.

Other Typical Errors

While SSL/TLS connection errors are the most common, there are issues that can arise that prevent a successful connection. This section highlights the most common issues.

Error	Cause / Solution
"Read failed with an unexpected error"	<p>This message typically indicates that connection to the remote server was lost. The connection can either be lost due to the server powering off or resetting, the firewall or proxy server shutting down the connection, or because the remote server gracefully requests that the connection be discontinued.</p> <p> NOTE: After 60 seconds of inactivity on the connection the printer will attempt to contact the server via a TCP Keepalive. If the connection is still present the server will respond and the connection will remain open. After 10 successive failed attempts to contact the remote the printer will assume the connection is severed and close the connection. The printer will resume it's attempt to connect to the remote server so that when the server comes back online the printer will re-establish communication.</p>
"Failed to connect (SP = #, CI = #, UW = #, AC = #, PC = #)"	<p>If this error is seen one or more of the '#' values will be set to 0. This is an indication of an incorrect configuration of the remote server. Ensure that the remote server is setup according to the Servlet configuration in the Zebra Link-OS SDK documentation.</p> <p>This typically indicates an incorrect version of the remote Application Server (for example, Apache/Tomcat version may be incorrect). If this issue persists contact Zebra Technical Support.. Provide the output of the following command (ensure that logging is enabled and that this error appears within the entries).</p> <pre>! U1 getvar "weblink"</pre>

Troubleshooting

Whenever troubleshooting a connection issue, the following questions should be answered to ensure the configuration is correct.

1. Is the printer connected correctly via Wireless or Ethernet?
2. Does the printer have a valid IP address?
3. Can I ping the printer's IP address from a device on the same network as the printer?
4. Is the remote server URL in `weblink.ip.conn1.location` correct and does it point to the remote server that is configured for weblink functionality?
5. Can you connect to the location defined in the `weblink.ip.conn1.location` setting via a browser?
6. Is the remote server I am attempting to connect to outside the corporate firewall?
7. Can the URL specified in `weblink.ip.conn1.test.location` be accessed?
If this is the case, talk with your administrator about altering restrictions for accessing HTTPS connections.
8. Does the firewall require a username and password to access the remote server?
9. Do I require a proxy server to access the remote server?
10. Is the proxy server port the default (1080) or another port (for example, 3128 for the Linux Squid proxy)?



NOTE: If using the Linux Proxy Server Squid, and you are having trouble connecting, note that it may be configured to:

- disallow POST messages
- only operate in HTTP/1.0 mode 3
- disallow SSL connections.

Refer to your Linux Squid documentation for complete details.

11. Does the firewall permit HTTPS connections initially or do I need to connect via HTTP first?
12. Is the remote server configured to use SSL v3.0 or TLS 1.0?
TLS1.0 is recommended, but SSL v3.0 is also supported. Versions prior to SSL v3.0 and later than TLS v1.0 are not currently supported.
13. Are the Zebra Certificate Authority Certificates correctly installed on the remote server?
14. Was the server's certificate issued by Zebra and is it signed by the Zebra Certificate Authority?
15. Has the server's certificate expired?
16. Is the printer's date and time within the issue and expired period of the server's certificate?
17. Does the value in `weblink.ip.conn1.location` match either the Common Name or one of the names listed in the Subject Alternate Name of the remote server's certificate?
18. Is the proxy server configured correctly and does the respective proxy server allow HTTPS connections via the HTTP CONNECT method?
19. Are there any HTTP authentication attempts when trying to connect that fail?
20. Are there any HTTP/1.1 4xx messages in the log?

If your connection issues persist and the solutions in this document do not help, contact Zebra Tech Support and provide the output of the following command. Ensure that logging is enabled and that the error(s) appear within the entries)

```
! U1 getvar "weblink"
```

HTTP Messages

Message	Cause / Solution
HTTP/1.1 100 Continue	This indicates that the server and printer have begun communicating and is often seen in place of HTTP/1.1 200 OK.
HTTP/1.1 101 Switching Protocols	This indicates that the basic connection to the server worked and the protocol is being switched to a more efficient protocol for data transfer.
HTTP/1.1 200 OK	This indicates that an HTTP GET or HTTP POST was successful.
HTTP/1.1 30x Moved/Redirect/etc	This indicates that the URL specified has moved or that the firewall redirected the printer to another location (typically this is done to authenticate a user in a transparent proxy configuration).
HTTP/1.1 401 Unauthorized	This indicates that the printer either needs to authenticate with the server or failed to authenticate with the remote server (or server/router along the route to the server).
HTTP/1.1 403 Forbidden	This typically means that the authentication was provided and valid, however, the user does not have access to the requested resource.
HTTP/1.1 404 Not Found	This indicates that the remote URL provided points to an invalid location on the server. This does indicate, however, that the server name is valid. Just the path after the domain name is invalid.

HTTP POST Alerts

Link-OS printers can issue alerts to a web server that is listening for HTTP POST requests. The advantage of an HTTP POST alert over the other destinations available (for example, TCP, UDP, SNMP) is that HTTP is firewall friendly.

Configuring Alerts Where the Alert Destination is HTTP POST

Any setting in the `alerts.http` branch that is set will take effect for any HTTP POST alerts that occur from that point forward. A printer reset is not required for the settings to take effect.

If the server is configured to accept and process HTTP POST messages either via a CGI script or a server-side script such as PHP or ASP then the alert can be forwarded to that server from the printer. The printer will send the alert using the multipart/form-data Content-Type. This allows any type of data, including binary data, to be sent via the POST.

The POST will support two variables within the body of the POST:

- `alertMsg` – This is the alert details and the content follows the format of a standard alert when it is issued over one of the other alert destinations (for example, serial, USB, TCP, etc.).
- `uniqueId` – The unique id of the printer. This matches the value in `device.unique_id`.

The HTTP POST request will look as follows (sent when the printer was paused)

```
POST /http_post/alert.php HTTP/1.1
Host: 10.3.4.58
Accept: */*
Connection: close
Content-Length: 281
Expect: 100-continue
Content-Type: multipart/form-data; boundary=-----350c75835f46

-----350c75835f46
Content-Disposition: form-data; name="alertMsg"

ALERT%3A%20PRINTER%20PAUSED
-----350c75835f46
Content-Disposition: form-data; name="uniqueId"

XXQLJ120900310
-----350c75835f46--
```



IMPORTANT: The message is using HTTP/1.1 and therefore HTTP/1.1 header fields. This is important because some older proxy servers do not handle these fields gracefully and may block the **POST** message.

It is important to note that the message is using HTTP/1.1 and therefore HTTP/1.1 header fields. This is important because some older proxy servers do not handle these fields gracefully and may block the POST message.

How to Parse via PHP

The following example shows how to parse the POST message. It does not, however, show how to use this information on other pages, store the results in a database, report this to another device on the domain, etc. The response in this example will be sent back to the printer, but it will be ignored by the printer. If you wish to see the response you can use a packet sniffing tool such as Wireshark.

```
<?php

    $alertMsg = urldecode($_POST["alertMsg"]);
    if (preg_match("/(\w+(\s+\w+)?):\s+(((SGD SET)\s+([\w\d\.\_]+)\s+\->\s+(.+))|([\w|\s]+))/", $alertMsg, $matches)== 1) {

        $alertType = $matches[1];

        if ($matches[5] === "SGD SET") {
            $alertCondition = $matches[5];
            $alertSgdName = htmlspecialchars($matches[6]);
            $alertSgdData = htmlspecialchars($matches[7]);
        } else {
            $alertCondition = $matches[3];
        }
    }

    echo "<H1>Alert Received</H1><br/>\r\n";
    echo "<h2>Original Message = $alertMsg</h2><br/>\r\n";
    echo "<h2>Alert Type = $alertType</h2><br/>\r\n";
    echo "<h2>Alert Condition = $alertCondition</h2><br/>\r\n";
    echo "<h2>SGD Name = $alertSgdName</h2><br/>\r\n";
    echo "<h2>SGD Value = $alertSgdData</h2><br/>\r\n";
?>
```

Basic Configuration

To determine how much configuration is necessary, consider the following questions:

- Is the remote server that the printer is attempting to connect to outside of the corporate firewall?
- Does the firewall require a username and password to access the remote server?
- Does the printer require a proxy server to access the remote server?

If the answer to any of these questions is 'yes', then more than the basic configuration may be necessary. Depending upon the network environment that the printer is in access the remote server may only require that a few settings be set.

To configure an alert to be sent via HTTP POST to a remote server , issue the following command:

```
! U1 setvar "alerts.add" "PRINTER PAUSED,HTTP POST,Y,Y,
http://www.examplecorpinc.com/alerts.php,0,N,"
```

The above command will issue an HTTP POST alert to the remote server (<http://www.examplecorpinc.com/alerts.php>) when the printer is paused or un-paused.

- The first parameter indicates the condition to monitor. A list of available alert conditions can be viewed by issuing:

```
! U1 getvar "alerts.conditions"
```

- The second parameter indicates the alert destination. For the purposes of this section HTTP-POST is the preferred destination. A list of available alert destinations can be viewed by issuing:

```
! U1 getvar "alerts.destinations"
```

- The third and fourth parameters are 'Send on Set' and 'Send on Clear', respectively. They can be either "Y" for monitor the alert or "N" for don't monitor the alert. If both are set to "N" then the alert will not be added or it will be deleted if the alert already existed. To view which alerts already exist issue:

```
! U1 getvar "alerts.configured"
```

- The fifth parameter holds the URL for the server that will be sent the HTTP POST. It holds a maximum of 255 characters for the URL and it must conform to the URI standards described in RFC3986 (<http://www.ietf.org/rfc/rfc3986.txt>).
- The sixth parameter should be set to 0 for HTTP POST alerts.
- The seventh parameter and eighth parameter will not be covered in this section and should be set as indicated in the description above. See the SGD documentation for details on these two parameters.

When a Proxy Server is Part of the Network Configuration

If a proxy server must be used to access the remote server the printer's proxy setting must be set to point to the server. There are typically four properties associated with a proxy server.

- The proxy server scheme: **HTTP** is the only supported scheme
- The proxy server address
- The proxy server port (optional)
- The username and password for the proxy (optional)

To supply the address of the proxy server, assuming a default port and no username/password, configure the proxy setting as follows:

```
! U1 setvar "alerts.http.proxy" "http://my.internal.proxy/"
```

In this scenario, the proxy address is **my.internal.proxy** and the scheme is **HTTP**. The default port (1080) will be used. No username or password will be used to authenticate with the proxy.

To specify an alternate port, configure the proxy as follows

```
! U1 setvar "alerts.http.proxy" "http://my.internal.proxy:3128/"
```

To specify a username and password, configure the proxy as follows:

```
! U1 setvar "alerts.http.proxy" "http://user:pass@my.internal.proxy/"
```

The proxy username, password, and the rest of the URL must follow the rules specified in RFC3986 (<http://www.ietf.org/rfc/rfc3986.txt>).

When HTTP Authentication is Necessary

Use this configuration when, for example, a firewall requires a username and/or password.

It may be necessary to specify a username and password to various routers and servers along the path to the remote server. Typically when using a browser to access the server the authentication request will be presented in the form of a dialog window that asks for the username and password.

Because the printer's connection to the remote server is headless and non-interactive, the alert http configuration allows a user to enter in a server name, username, password triplet. The triplet will be used in the event that the printer is presented with an authentication request (for example, this typically is requested via the HTTP/1.1 401 Unauthorized request).

To specify authentication credentials issue the following:

```
! U1 setvar "alerts.http.authentication.add" "servername.com username password"
```

In this scenario the server requesting authentication is **servername.com**. The username and password to be supplied are 'username' and 'password'. The server name can be either a DNS name or an IP address. The username and password cannot be retrieved from SGD, SNMP, or JSON once added. Only the server name will be returned.

More than one set of authentication triplets can be added. The printer will only use the credentials as they are needed. In other words, the printer will only use the credentials for **servername.com** if it receives a HTTP/1.1 401 Unauthorized request from **servername.com**.

To see what authentication triplets are specified issue:

```
! U1 getvar "alerts.http.authentication.entries"
```

To remove authentication credentials issue the following:

```
! U1 setvar "alerts.http.authentication.remove" "servername.com"
```

Enabling Logging

If your printer has trouble connecting, you may wish to enable logging. By default, logging is not enabled in order to reduce the amount of memory consumed when the HTTP alert feature is enabled. It is recommended that once the alert HTTP feature is configured properly and is performing as expected that the logging be disabled or that a very small (less than 100) number of logging entries be permitted.

To enable logging, `alerts.http.logging.max_entries` needs to be modified. By default it is set to 0, which indicates that no messages are logged. When attempting to troubleshoot connection issues it is recommended that `max_entries` be set to at least 100 entries. Setting `max_entries` to 100 means that the 100 newest logging entries will be present in `alerts.http.logging.entries` as older entries are discarded once the maximum number of entries is reached.

```
! U1 setvar "alerts.http.logging.max_entries" "100"
```

The logging settings do not require the printer to be reset before taking effect. This does not mean that previous logging message that would have been logged will appear when the `max_entries` setting is changed from 0 to a greater value. It means that any new logging messages will be logged from that point forward.

Issue the following command to clear any log entries currently in the `alerts.http.logging.entries` buffer.

```
! U1 do "alerts.http.logging.clear" ""
```

Navigating the Log Output

The log can contain much information, even in the scenario where the printer successfully connects to the remote server. This section explains how to read the log and highlights some of the key entries that will help to determine if the connection was successful.

A typical log entry looks as follows:

```
[12-04-2012 14:57:10.625] [http] Attempting connection to
http://www.examplecorpinc.com/alerts.php
```

The first column is the date and time that the event occurred. The format of the date and time matches the format of `rtc.date` and `rtc.time`. The time, however, also includes the milliseconds to aid in troubleshooting network latency concerns.

The second column indicates the connection name, which is currently always set to `'http'`.

The third column is the actual message that contains information about what occurred in the printer at the corresponding time in column one. In the above example the printer was attempting to POST the alert to the connection to the URL specified in the configured alert.

Review [Understanding Errors in the Alerts HTTP Log on page 1571](#) to understand what it means when certain logging messages/errors appear in the log.

Understanding Errors in the Alerts HTTP Log

Error	Cause / Solution
Couldn't connect to host	<p>This could mean any number of things occurred that prevented the printer from connecting. This message is always present when the connection to the remote failed and is typically accompanied by an HTTP Response Code. See HTTP Messages on page 1572 for the possible HTTP Response Codes and their meaning.</p> <p>If this issue persists contact Zebra Technical Support and provide the output of the following command (ensure that logging is enabled and that this error appears within the entries).</p> <pre>! U1 getvar "alerts"</pre>

Troubleshooting

Whenever troubleshooting a connection issue, the following questions should be answered to ensure the configuration is correct.

1. Is the printer connected correctly via Wireless or Ethernet?
2. Does the printer have a valid IP address?
3. Can I ping the printer's IP address from a device on the same network as the printer?
4. Is the remote server URL listed in the output of the `alerts.configured` SGD or `~HU` command output correct, and is the URL of a server iserver that is configured to accept HTTP POST requests?
5. Can you connect to the URL via a browser?
6. Is the remote server I am attempting to connect to outside the corporate firewall?
7. Does the firewall require a username and password to access the remote server?
8. Does the printer require a proxy server to access the remote server?
9. Is the proxy server port the default (1080) or another port?
10. Is the proxy server configured to allow HTTP POST messages?
11. Is the proxy server HTTP 1.1 compliant and does it allow HTTP 100 Continue messages?

For example, the Squid Proxy Server versions before v3.2 do not fully support HTTP 1.1 requests and may block any HTTP POST attempts from the printer.



NOTE: If using the Linux Proxy Server Squid, and you are having trouble connecting, note that it may be configured to:

- disallow POST messages
- only operate in HTTP/1.0 mode 3
- disallow SSL connections.

Refer to your Linux Squid documentation for complete details.

12. Are there any HTTP authentication attempts when trying to connect that fail?

Are there any HTTP/1.1 4xx messages in the log?

If your connection issues persist and the solutions in this document do not help, contact Zebra Technical Support.. See [Contacts on page 44](#) and provide the output of the following command (ensure that logging is enabled and that this error appears within the entries).

```
! U1 getvar "alerts"
```

HTTP Messages

Message	Cause / Solution
HTTP/1.1 100 Continue	This indicates that the server and printer have begun communicating and is often seen in place of HTTP/1.1 200 OK.
HTTP/1.1 200 OK	This indicates that the HTTP POST was successful.
HTTP/1.1 30x Moved/Redirect/etc	This indicates that the URL specified has moved or that the firewall redirected the printer to another location (typically this is done to authenticate a user in a transparent proxy configuration).
HTTP/1.1 401 Unauthorized	This indicates that the printer either needs to authenticate with the server or failed to authenticate with the remote server (or server/router along the route to the server).
HTTP/1.1 403 Forbidden	This typically means that the authentication was provided and valid, however, the user does not have access to the requested resource.
HTTP/1.1 404 Not Found	This indicates that the remote URL provided points to an invalid location on the server. This does indicate, however, that the server name is valid. Just the path after the domain name is invalid.

Advanced Techniques

This section presents information and commands for using advanced techniques, such as special effects, serialized data fields, control commands, program delimiters, communications, and memory cards.

Special Effects for Print Fields

Reverse Printing a Field The **^FR** (Field Reverse Print) command allows a field to appear as white over black or black over white. When printing a field, the **^FR** command indicates that it will print the field the opposite of its background color.

Reverse Printing a Label The **^LR** (Label Reverse Print) command reverses the printing of all fields in the label format. It allows a field to appear as white over black or black over white. **^LR** functions like **^FR**, but it applies to all fields in a label. The **^LR** command remains active until turned off.

Printing a Mirror Image The **^PM** (Print Mirror Image of Label) command prints the entire printable area of the label as a mirror image. This command flips the image from left to right.

Printing a Label Inverted 180 Degrees The **^P0** (Print Orientation) command inverts the label format 180 degrees. In essence, the label is printed upside down.

Serialized Data

The **^SN** (Serialization Data) command allows the printer to index data fields by a selected increment or decrement value (that is, make the data fields increase or decrease by a specified value) each time a label is printed. This can be performed on up to 100 to 150 fields in a given format and can be performed on both alphanumeric and bar code fields. A maximum of 12 of the right-most integers are subject to indexing. The first integer found when scanning from right to left starts the indexing portion of the data field.

If the alphanumeric field to be indexed ends with an alpha character, the data will be scanned, character-by-character, from right to left until a numeric character is encountered. Serialization will take place using the value of the first number found.

Variable Data

To increase throughput, you can set up a program that uses variable data fields. Then, instead of formatting the whole label each time a label is printed, the printer will have to format only the changed data field. To use this capability, you must use the **^MC** and **^FV** commands.

Stored Formats

You can create formats and save them in the printers memory. A stored format can then be recalled and merged with downloaded data to form a complete label. This process saves data transmission time but not formatting time.

To create a format, complete these steps:

1. Design the label.
2. Replace variable data fields with field numbers.
3. Allocate space for the size of the field.
4. Give the format a name.
5. Save the format on the printer to a memory location (R, E, B, A).

You can store multiple formats on the printer, limited only by available memory. If you try to save a format that would overload memory you can confirm that the format has been successfully stored on the printer by printing the LIST FORMATS from the front panel, or by using the ^HW command to return the directory listing to the host. For details see, [^HW on page 218](#).

If the power is turned off, all stored formats in volatile memory (R:) will be lost.

Initialize/Erased Stored Formats

Stored formats can be selectively erased using the ^ID command.

Download Format Command

The ^DF (Download Format) command saves the ZPL II format commands as text strings to be later merged using ^XF with variable data. The format to be stored may contain Field Number (^FN) commands to be referenced when recalled.

While use of stored formats will reduce transmission time, no formatting time is saved since this command saves the ZPL II as text strings which need to be formatted at print time.

Field Number Command

The ^FN (Field Number) command is used to number the data fields. This command is used in both Store Format and Recall Format operations.

When storing a format, the ^FN command is used where you would normally use the ^FD (Field Data) command. When recalling the stored format, use ^FN in conjunction with the ^FD (Field Data) command.

Recall Stored Format Command

The ^XF (Recall Format) command recalls a stored format to be merged with variable data. There can be multiple ^XF commands and they can be located anywhere in the label format.

When recalling a stored format and merging data utilizing the ^FN (Field Number) function, the calling format must contain the ^FN command to properly merge the data.

While use of stored formats will reduce transmission time, no formatting time is saved because the format being recalled was saved as text strings that need to be formatted at print time.

These are examples of using stored format:

Advanced Techniques

Working with Stored Format commands involves designing and saving a stored format, then recalling and merging the format with some variable data.

The following is an example of how to use the various Stored Format commands. First, enter the following format and send it to the printer. Notice that no label is printed. (DATA Indicator went On and Off.)

<pre>^XA^DFFORMAT^FS ^LH30,30 ^BY2,3,100 ^FO120,100^CFD^FN1^FA9^FS ^FO120,160^B3^FN2^FA6^FS ^XZ</pre>	
---	--

Second, enter the following format and send it to the printer. The label shown will be printed.

<pre>^XA^XFFORMAT^FS ^FN1^FDLABEL ONE^FS ^FN2^FDAAA001^FS ^XZ</pre>	<p style="text-align: center;">LABEL ONE</p>  <p style="text-align: center;">*AAA001*</p>
---	--

Control Commands

Control commands may be sent from the host at any time to elicit an immediate response from the printer. Control commands may be sent in a group or separately.

A control command is acted upon when received to perform a variety of actions, such as:

- clearing the memory
- physical action
- a combination of the above such as feeding a label and calculating and storing its length.

The basic format for using all of the control commands is:

~(2-letter command)

For example: ~DG

Test and Setup Commands

The following commands, presented in alphabetical order, are used to test various elements of the printer and its status.

Table 41 Test and Setup Commands

Command	Function
~HM (Memory Status)	Sending this command to the printer immediately returns a memory status message to host. Use this command whenever you need to know the status of the memory.
~HS (Host Status)	Sending this command to the printer immediately returns a three-line printer status message to the host. Use this command whenever you need to know the status of the printer.
~JR (Power On Reset)	This command resets all of the printer's internal software, performs a power-on self-test, clears the buffer and DRAM, and resets communication parameters and default values. ~JR performs the same function as a manual power-on reset.
~JN (Head Test Fatal)	This command resets the printhead element error override, acting as a toggle for ~J0. The printer then goes into fault status (turns head indicator on steadily) if any subsequent execution of the printing element test detects bad printing elements. This command is only functional on certain printer platforms.
~J0 (Head Test Non-Fatal)	This command overrides a failure of head element status check and allows printing to continue. The override is canceled when the printer is turned off or receives a ~JR or ~JN command. The printhead test will not produce an error if the ~J0 override is active. This command is only functional on certain printer platforms.
^JT (Head Test Interval)	This command lets you change the printhead test interval from 100 to any desired interval. The printer automatically performs an internal printhead element test, which occurs every 100 labels. This takes place during formatting which minimizes a delay in printing. Therefore, the test may be performed while the printer is in PAUSE. This command is only functional on certain printer platforms.
~WC (Print Configuration Label)	The ~WC command is used to generate a printer configuration label. The printer configuration label contains information about the printer setup, such as sensor type, network ID, ZPL mode, firmware version, and descriptive data on the R:, E:, B:, and A: devices.
~HQ (Host Query)	The ~HQ command group causes the printer to send information back to the host.

Calibration and Media Feed Commands

The following commands, presented in alphabetical order, are used to perform various media and ribbon calibrations and also set the media feed mode for the printer.

Command	Function
~JC (Set Media Sensor Calibration)	Forces a label length measurement and recalibrates the media and ribbon sensors.  NOTE: In continuous mode, only the media and ribbon sensors are recalibrated.
~JG (Graphing Sensor Calibration)	Forces a label length measurement, recalibrates the media and ribbon sensors, and prints a graph (media sensor profile) of the sensor values.
~JL (Set Label Length)	Sets the label length. Depending on the size of the label, the printer will feed one or more blank labels.
^MF (Media Feed)	Dictates what happens to the media at power up and after an error is cleared.

Cancel/Clear Commands

The following command controls the contents of the Zebra input buffer.

Command	Function
~JA (Cancel All)	Cancels all format commands in the buffer. It also cancels any batches that may be printing. The printer stops printing after the current label (if one is printing) is finished printing. All internal buffers are cleared of data. The DATA LED turns off.

Printer Control Commands

The following commands control various printer operations:

Command	Function
^PF (Slew Given Number of Dot Rows)	Causes the printer to slew labels (move labels at a high speed without printing) a specified number of dot rows, at the bottom of the label. This allows faster printing when the bottom portion of a label is blank.
~PH or ^PH (Slew to Home Position)	Causes the printer to feed one blank label. <ul style="list-style-type: none"> The ~PH command feeds one label after the format currently being printing is done or when the printer is placed in pause. The ^PH command feeds one blank label after the format it is in prints.
~PP (Programmable Pause)	Stops printing after the current label is printed (if one is printing) and places the printer in the Pause mode. The operation is identical to pressing the PAUSE button on the front panel of the printer. The printer will remain paused until the PAUSE button is pressed or a ~PS command is sent to the printer.
^PP (Programmable Pause)	This command pauses the printer after the format it is in prints. Because this command is not executed immediately, several labels may be printed before the printer is paused. The operation is identical to pressing the PAUSE button on the front panel of the printer. The printer will remain paused until the PAUSE button is pressed or a ~PS command is sent to the printer.

Command	Function
^PQ (Print Quantity)	This command gives control over several printing operations. It controls the number of labels to print, the number of labels printed before the printer pauses, and the number of replications of each serial number.
^PR (Print Rate)	<p>Determines the media speed during printing and the slew speed (feeding a blank label). The printer will operate with the selected speeds until the setting is resent in a subsequent format or the printer is turned off.</p> <p>Limitations of Higher Print Speeds</p> <p>Print speed is application specific. Because print quality is affected by media and ribbon, printing speeds, and printer operating modes, it is very important to run tests for your applications.</p> <ul style="list-style-type: none"> • With high print speeds, use thermal transfer mode only. • Horizontal bar codes with a minimum x dimension of 5 mil may be printed at print speeds of 2 in. (51mm) per second. • Rotated bar codes are limited to a minimum x dimension of 10 mil (modulus 2) at higher print speeds. At x dimension of 5 mil (modulus 1), they may be printed at 2 in. per second. • At high print speeds, Font A at a magnification of 1 is not recommended; all other fonts are acceptable.
~PS (Print Start)	Causes a printer in the Pause mode to resume printing. The operation is identical to pressing the PAUSE button on the front panel of the printer when the printer is already in the Pause mode.

Set Dots/Millimeter

Command	Function
^JM (Set Dots/Millimeter)	<p>Changes the number of dots printed per millimeter. Depending on the printhead, normal dots per millimeter on a Zebra printer are the following:</p> <ul style="list-style-type: none"> • 24 dots/mm (609.6 dots/inch) • 12 dots/mm (304.8 dots/inch) • 8 dots/mm (203.2 dots/inch) • 6 dots/mm (152.4 dots/inch) <p>In some applications, these high densities are not required. For these applications, a lower density of 4 dots/mm (102 dots/inch) or 3 dots/mm (77 dots/inch) can be selected. If used, this command must be entered before the first ^FS command.</p>

Host Status Commands

Table 42 Host Status Commands

Command	Function
~HI (Host Identification)	<p>This command is designed to be sent from the Host to the Zebra printer to find out the type of Zebra printer. Upon receipt, the Zebra printer will respond to the Host with a character string that gives information about the printer such as the version of firmware, dots per inch, memory, and printer options.</p>
^SP (Start Print)	<p>This command allows a label to start printing at a specified point before the entire label has been completely formatted. On extremely complex labels, this command can increase the overall throughput of the printer.</p> <p>The command works as follows: you specify the dot row at which the ^SP command is to take affect. This then creates a label 'segment.' Once the ^SP command is processed, all information in that segment will be printed. During the printing process, all of the commands after the ^SP will continue to be received and processed by the printer.</p> <p>If the segment after the ^SP command (or the remainder of the label) is ready for printing, media motion does not stop. If the next segment is not ready, the printer will stop "mid-label" and wait for the next segment to be completed. Precise positioning of the ^SP command is somewhat of a trial-and-error process as it depends primarily on print speed and label complexity.</p> <p>The ^SP command can be effectively used to determine the worst-case print quality. You can determine if using the ^SP command is appropriate for the particular application by using the following procedure. If you send the label format up to the first ^SP command and then wait for printing to stop before sending the next segment, the printed label will be a sample of the worst case print quality. It will also drop any field that is out of order.</p>
~WC (Print Configuration Label)	<p>This command is used to generate a printer configuration label. This command only works when the printer is idle.</p>
~WL Print Network Configuration Label	<p>This command is used to generate a network configuration label. This command only works when the printer is idle.</p>

Changing Delimiters and Command Prefixes



IMPORTANT: The delimiters used in the incoming ZPL script must match the delimiters set on the printer. If you change the delimiters on the printer, any ZPL script that uses the default delimiters will not work.

For some applications, you may need to change the ZPL II default delimiter (,) the format command default prefix (^), and/or the control command default prefix (~). Any ASCII character may be set as the delimiter.

You might change these characters if you are using a hand-held terminal that does not have a comma to enter the ZPL II commands, if you are working with a mainframe that has trouble processing the caret, or if you find some other character(s) easier to use.

Reasons to set an alternate delimiter include, but are not limited to:

- you are using a hand-held terminal that does not have a comma to enter the ZPL II commands;
- you are working with a host system that does not easily output the default delimiter (for example, AS/400)
- you find some other character(s) easier to use.

Communication Diagnostics Commands

Zebra printers support communication diagnostics through both hardware and software control. You can use these diagnostics to troubleshoot programs.

Command	Function
~JD (Enable Communications Diagnostics)	Initiates a diagnostic mode that produces an ASCII printout (using current label length and full width of printer) of all characters received by the printer. This printout includes the ASCII Characters, the HEX value and any communication errors.
~JE (Disable Diagnostics)	Cancel the diagnostic mode and returns the printer to normal label printing.

Graphic Commands

In addition to text and bar codes, multiple types of graphics can be printed on a Zebra printer:

- boxes and lines (^GB), circles (^GC), diagonal lines (^GD), and ellipses (^GE)
- ZPL II label formats saved as graphics images
- graphic images in Hexadecimal format
- graphic symbols (^GS)

Table 43 Boxes, Lines, Circles, Diagonal Lines, and Ellipses

Command	Function
^GB (Graphic Box)	The ^GB command is used to draw boxes and lines as part of a label format. Boxes and lines are used to highlight important information, divide labels into distinct areas, or to improve the appearance of a label. The same format command is used for drawing either boxes or lines.
^GC (Graphic Circle)	The ^GC command produces a circle on the printed label. The command parameters specify the diameter (width) of the circle, outline thickness, and color. Thickness extends inward from the outline.
^GD (Graphic Diagonal Line)	The ^GC command produces a circle on the printed label. The command parameters specify the diameter (width) of the circle, outline thickness, and color. Thickness extends inward from the outline.
^GE (Graphic Ellipse)	The ^GE command produces an ellipse in the label format.
^GS (Graphic Symbol)	The ^GS command enables you to generate the registered trademark, copyright symbol, and other symbols.

These label formats can also be stored as graphic images and data can be merged with them at print time. Additionally, ZPL II will permit the printing of graphic images from other sources that have been created in (or converted to) hexadecimal (HEX) format. Such graphic images can come from a variety of sources, including CAD programs, draw and paint programs, and scanned images.

Image Move

The ^IM (Image Move) command performs a direct move of an image from a storage area into the bitmap. The command is identical to the Recall Graphic command except that there are no sizing parameters.

Working with Label Formats as Graphics

The ^IS (Image Save) and ^IL (Image Load) commands are used to save a ZPL label format (including text and/or bar codes) in the printer's DRAM, FLASH, or PCMCIA as a special graphic image. The ^IS (Image Save) and ^IL (Image Load) commands are used to save a ZPL label format (including text and/or bar codes) in the printer's DRAM, FLASH, PCMCIA, or battery backed up SRAM, as a special graphic image. This increases the throughput of a series of similar but not identical labels.

Instead of formatting each individual label completely, store the constant fields as an image (known as creating a template). Then, in subsequent label formats, commands are issued to recall that graphic image format and merge it with variable data.

Working with Hex Graphic Images

ZPL II can be used to save graphic images in HEX format in DRAM, FLASH, or PCMCIA, depending on the type of memory installed in your printer. ZPL II can be used to save graphic images in HEX format in DRAM, FLASH, PCMCIA, or battery backed up SRAM, depending on the type of memory installed in your printer. The image might be created using a CAD program, a draw or paint program, or a scanner. These images can then be printed on the label. Graphic images may be created using a program that creates files in the .PCX format. These files must then be converted to ZPL II graphic format .GRF (pure hexadecimal data without headers or other extraneous information) for use as part of a label format.

You can use ZebraDesigner or ZebraNet Bridge Enterprise to convert the .PCX graphic format into the pure hexadecimal .GRF graphic format. Hexadecimal data may also be directly input as part of a ZPL II program. Manually preparing a string of HEX code is possible but usually impractical.

Alternative Data Compression Scheme for ~DG and ~DB Commands

There is an alternative data compression scheme recognized by the Zebra printer. This scheme further reduces the actual number of data bytes and the amount of time required to download graphic images and bitmapped fonts with the ~DG and ~DB commands.

The following represent the repeat counts 1, 2, 3, 4, 5, ..., 19 on a subsequent Hexadecimal value. Values start with G since 0 through 9 and A through F are already used for HEX values.)

G	H	I	J	K	L	M	N	O	P	Q	R	S	T	U	V	W	X	Y
1	2	3	4	5	6	7	8	9	10	11	12	13	14	15	16	17	18	19

These numbers represent the repeat counts 20, 40, 60, 80,...400 on a subsequent hexadecimal value.

g	h	i	j	k	l	m	n	o	p	q
20	40	60	80	100	120	140	160	180	200	220
r	s	t	u	v	w	x	y	z		
240	260	280	300	320	340	360	380	400		

Sending **M6** to the printer is identical to sending the following hexadecimal data:

```
6666666
```

The M has the value of 7. Therefore **M6** sends seven (7) hexadecimal 6's.

Sending **hB** to the printer is identical to sending the following hexadecimal data:

```
BBBBBBBBBBBBBBBBBBBBBBBBBBBBBBBBBBBBBBBB
```

The h has a value of 40. Therefore, **hB** sends 40 Hexadecimal B's.

Repeat Values Several repeat values can be used together to achieve any desired value.

Several repeat values can be used together to achieve any value desired. **vMB** or **MvB** will send 327 hexadecimal B's to the printer.

- a comma (,) fills the line, to the right, with zeros (0) until the specified line byte is filled.
- an exclamation mark (!) fills the line, to the right, with ones (1) until the specified line byte is filled.
- a colon (:) denotes repetition of the previous line.

Recalling a Hexadecimal Graphic Image

The `^XG` (Recall Graphic) command is used to recall one or more graphic images for printing. This command is used in a label format to merge pictures such as company logos and piece parts, with text data to form a complete label.

An image may be recalled and resized as many times per format as needed. Other images and data may be added to the format.

Reducing Download Time of Graphic Images

There is a method of reducing the actual number of data bytes sent to the printer when using the `~DG` command.

If the HEX string ends in an even number of zeros (0's), a single comma (,) can be substituted for ALL of the zeros. If the HEX string ends in an odd number of zeros, one zero and a single comma is required. The exclamation mark (!) and the colon (:) described under [Repeat Values on page 1582](#) can also be used.



NOTE: The text rows in your editor may not be the same as the dot rows used by ZPL II. The editor may word wrap or truncate the dot rows. ZPL II ignores the end of a text line (carriage returns and line feed characters).

Transferring Object Between Storage Devices

The `^T0` (Transfer Object) command is used to copy an object or group of objects from one storage device to another. It is quite similar to the copy function used in personal computers.

Source and destination devices must be supplied and must be different and valid for the action specified. Invalid parameters will cause the command to be ignored.

There are no defaults associated with this command. However, the asterisk (*) may be used as a wild card for Object names and extensions. For instance, `ZEBRA.*` or `*.GRF` would be acceptable forms for use with `^T0` command.

The Asterisk (*) can be used to transfer multiple object files (except *.FNT) from the DRAM to the Memory Card. For example, you have several object files that contain logos. These files are named `LOGO1.GRF`, `LOGO2.GRF`, and `LOGO3.GRF`.

You want to transfer all of these files to the Memory Card using the name NEW instead of LOGO. By placing an Asterisk (*) after both LOGO and NEW in the transfer command, you can copy all of these files with one command. The format for this would be as follows:

```
^XA
^TOR:LOGO*.GRF,B:NEW*.GRF
^XZ
```



NOTE: If, during a multiple transfer, a file is too big to be stored on the Memory Card, it will be skipped. All remaining files will be checked to see if they can be stored. Those that can be stored, will be stored.

Deleting Graphics from Memory

The **^ID** (Item Delete) command deletes objects, images, fonts, and formats from storage areas selectively or in groups. This command can be used within a printing format to delete objects just prior to saving new ones or can be in a stand-alone type format simply to delete objects.

The object name and extension support the use of the asterisk (*) as a wildcard. This allows for easy deletion of selected groups of objects.

The following are various examples of using the **^ID** command.

To delete just stored formats from DRAM:

```
^XA^IDR:*.ZPL^XZ
```

To delete formats and images named SAMPLE from DRAM regardless of the extension:

```
^XA^IDR:SAMPLE.*^XZ
```

To delete the image SAMPLE1.GRF prior to storing SAMPLE2.GRF:

```
^XA
^F025,25^AD,18,10^FDDelete^FS
^F025,45^AD,18,10^FDthen Save^FS
^IDR:SAMPLE1.GRF^FS
^ISR:SAMPLE2.GRF^FS
^XZ
```

To delete everything from DRAM:

```
^XA^IDR:*. *^XZ
```

Defining and Using the AUTOEXEC.ZPL Function

An **AUTOEXEC.ZPL** file function is supported by the printer. It functions in much the same way as the **AUTOEXEC.BAT** file in MS-DOS. The **AUTOEXEC.ZPL** file function can be used for setting up various parameters at the time the printer is powered up (such as **^COY**, **^LL**, **^CWf**). The function can also be recalled at any time after power up.

This file must initially be in the extra EPROM, FLASH, or PCMCIA memory. When the printer is powered on, it looks to the extra memory site for the stored format called **AUTOEXEC.ZPL**. If found, the contents of the file are automatically executed as a stored format.

This is an example of an **autoexe.zpl** file:

```
^XA
^DFE:AUTOEXEC.ZPL^FS
^SEE:JIS.DAT^FS
^CW1,E:ANMDJ.TTF^FS
^XZ
```

Memory, Flash Cards, and Font Cards

Zebra printers come with a variety of memory device, including DRAM, EPROM, PCMCIA, Flash, socket Flash, and battery backed-up RAM.



NOTE: Not all memory options are available on all printers.

Most Zebra printers allow you to print a printer configuration label, which will show the letter designation assigned to your printer memory options. For printer models that do not support this feature, use [Table 44](#) to see how the memory IDs are assigned. Memory IDs default to these values when the printer is reset to factory defaults.

Table 44 Letter Designations for Different Memory Options

Memory Option	Default Letter Designation
EPROM	E:
PCMCIA	B:
Flash	E:
DRAM	R:
Battery backed-up RAM	B: or E:
Socket Flash	B:
Compact Flash	A:

A few ZPL II commands directly affect the types of memory available to Zebra printers. These commands are `~JB`, `^JB` and `~HM`

Table 45 Commands that Affect Available Memory Types



Command	Function
<code>~JB</code> (Reset Battery Dead)	<p>This command is sent to the printer if either of these conditions exist:</p> <ul style="list-style-type: none"> If the B: memory card is intentionally cleared (reinitialized). If the battery supplying power to the Battery Powered Font Card fails and is replaced. (A bad battery would show a “battery dead” condition on the printer configuration label.) <p> NOTE: If you replace the battery but do not send this command to the printer, the Battery Powered Font Card will not function.</p>
<code>^JB</code> (Initialize Flash Memory)	<p>This command is used to initialize the two types of Flash Memory available in the Zebra printers.</p> <p> NOTE: Link-OS printers use an automatic memory management system that eliminates the need to manually initialize the Flash Memory system.</p>

Table 45 Commands that Affect Available Memory Types (Continued)

Command	Function
~HM (Host Memory Status)	<p>Sending this command to the printer immediately returns a memory status message to the host. Use this command whenever you need to know the status of the memory.</p> <p>When the Host Memory Status Command, ~HM, is sent to the Zebra printer, a line of data containing three numbers is sent back to the Host. The following is an example: 1024,0780,0780</p> <ul style="list-style-type: none"> • The first value is the total amount of RAM (Random Access Memory) installed in the printer. This number is in Kilobytes. • The second value is the maximum amount of RAM available to the user. This number is in Kilobytes. • The third value is the amount of RAM currently available to the user. This number is in Kilobytes.

Shortcuts and Alternate Schemes for Writing ZPL II Scripts

ZPL II programming scripts can be written in a variety of ways. There are, however, more efficient ways to write a ZPL II script depending on the application and the commands used. The following are certain ways to write the same ZPL II script, each yielding the same result.

The Code 39 bar code shows the ZPL II script written like this:

```
^XA^F0100,75^BY3
^B3N,N,100,Y,N
^FD123ABC^XZ
```

Since it is only one field, however, the entire command can be written as a one line entry:

```
^XA^F0100,75^BY3^B3N,N,100,Y,N^FD123ABC^XZ
```

Finally, this script can be further simplified by writing it on one line, using the comma (,) delimiter to reduce the default parameters in the ^B3 command and eliminating the default parameters at the end of the ^B3 command:

```
^XA^F0100,75^BY3^B3,,100^FD123ABC^XZ
```

You might write your ZPL II scripts in any way that makes sense to you. Some programmers prefer to write out each format command and field on a line by line basis like this:

```
^XA
^PR2^FS
^LL935^FS
^LH30,30^FS
^F020,10^AF^FDZEBRA^FS
^F020,60^B3,,40^FDAA001^FS
^F020,180^AF^SNSERIAL NUMBER 0000000111,1,Y^FS
^PQ10^FS
^XZ
```

Although this script will print with no problems, it contains unnecessary ^FS (Field Separator) commands which have been placed after the format commands. Some programmers feel it is required to place a ^FS command at the end of each line, but the ^FS command is only needed to separate specific fields. Therefore, the script would transmit more quickly written like this:

```
^XA
^PR2
^LL935
^LH30,30
^F020,10^AF^FDZEBRA^FS
^F020,60^B3,,40^FDAA001^FS
^F020,180^AF^SNSERIAL NUMBER 0000000111,1,Y^FS
^PQ10
^XZ
```

Other programmers prefer to keep the format commands on one line as an organizational preference, like this:

```
^XA^PR2^LL935^LH30,30
^F020,10^AF^FDZEBRA^FS
^F020,60^B3,,40^FDAA001^FS
^F020,180^AF^SNSERIAL NUMBER 0000000111,1,Y^FS
^PQ10^XZ
```

The label will print out the same so you should develop a scripting pattern that suits your own organizational style but one which is efficient and is concerned with keeping transmission times to a minimum.

Font Shortcuts

There are times when you might include a specific font into your script and use it repeatedly within different fields. The following is an example of one way to write this script:

```
^XA
^F0120,108^A0N,89^FDA Guide to^FS
^F0120,207^A0N,89^FDZPL II^FS
^F0120,306^A0N,89^FDProgramming^FS
^F0120,405^A0N,89^FDLanguage^FS
^XZ
```

Notice that the ^FS command is used on the second to last line to close the field. Actually, it is unnecessary because the ^XZ will accomplish the same thing, so we can remove it from our script. Also, since the font and font size are not changing within the fields, this script can be simplified for quicker transmission by removing the unnecessary font entries and listing the font information once using the ^CF command (see [^CF on page 139](#)):

```
^XA
^CF0,89
^F0120,108^FDA Guide to^FS
^F0120,207^FDZPL II^FS
^F0120,306^FDProgramming^FS
^F0120,405^FDLanguage
^XZ
```

This script can be made even more efficient by including the ^FB command to identify the left origin of the text which occurs at the same place each time. For details, see [^FB on page 169](#):

```
^XA
^CF0,89
^F0120,108
^FB800,6
^FDA Guide to&\ZPL II&\Programming&\Language
^XZ
```



NOTE: The entries “\&” within the text indicate a carriage return/line feed as allowed by the ^FB command. For details, see [^FB on page 169](#).

If you wanted to change the font type or size within the script, however, you would need to include the specific font parameters within the field where the change occurs. In this case, you would not want to use the ^FB command because the change in font size (in our example below) will affect the y-axis (up and down) position of the text.

You can still use the ^CF command, but you will need to include the specific font information on the line where the change in the field occurs:

```
^XA
^CF0,89
^F0120,108^FDA Guide to^FS
^F0120,207^FDZPL II^FS
^F0120,306^A0N,110^FDProgramming^FS
^F0120,426^FDLanguage
^XZ
```

Glossary

ASCII American Standard Code for Information Interchange. A 7-bit character set that includes Latin characters, as well as control and punctuation characters.

bidirectional text layout The arrangement of characters with mixed directionality on a single line. For example, English and Arabic.

big-endian In the encoding, the most significant byte is stored first.

byte order mark BOM; indicates big-endian (BE) or little-endian (LE).

character The smallest component of a writing system that has understanding, refers to the abstract meaning not the specific shape.

character code Another term for code point.

character set A collection of characters.

character shaping Characters assume different glyphic forms depending on the context. They can be used with a script-based language.

code point An integral reference number assigned to a character.

coded character set An ordered collection of characters that are assigned an integral reference number.

combining semantic cluster Consists of an atomic character, a combining character sequence consisting of a base character plus one or more nonspacing marks, enclosing marks, combining word joiner, such as an Indic virama, or a sequence of Hangul jamos equivalent to a Hangul syllable.

diacritic A mark that is added to a letter or other character to change its value or meaning.

encoding The mapping of a character's code points to a sequence of bytes used to represent the data.

font An electronic collection of glyphs used for the visual representation of characters.

GB18030 A standard required by the People's Republic of China for operating systems of non-handheld computers.

GB 2312 A Chinese character set and encoding.

glyph The visual representation of a character, such as a shape or image. A default glyph character is typically used when the requested glyph is not available in the font.

grapheme cluster Consists of an atomic character, a combining character sequence consisting of a base character plus one or more nonspacing marks or enclosing marks, or a sequence of Hangul jamos equivalent to a Hangul syllable.

ISO 10646 An international standard that defines the Universal Character Set (UCS) and a character encoding. The UCS matches Unicode.

ISO 8859-1 An encoding standard for representing Western European languages using the Latin Alphabet.

language A system of sounds and scripts used to represent and communicate concepts, ideas, meanings, and thoughts.

ligature A glyph representing a combination of two or more characters.

little-endian In the encoding, the least significant byte is stored first.

open type A file format for scalable font files that extends the existing TrueType font file format used by Microsoft Windows and Apple Macintosh operating systems. OpenType tables support advanced layout features.

presentation form A pre-combined character, ligature or variant glyph that has a separate code point; used for compatibility.

rts/cts A method for a hardware handshake via the request-to-send/clear-to-send pins.

script A collection of symbols used to represent textual information in one or more writing systems.

Shift-JIS A shifted encoding of the Japanese character encoding standard, JIS X 0208, heavily deployed in PCs.

True type An outline font format that is scalable without quality loss.

Unicode The universal character set and encoding maintained by the Unicode Consortium.

UTF-8 The Unicode encoding that assigns each character code point to a sequence of one to four bytes.

UTF-16 A Unicode encoding form that represents Unicode code point values in the BMP with 16-bit code units and Unicode code point values in the supplementary planes with pairs of 16-bit code units.

UTF-16BE A Unicode encoding scheme based on UTF-16 that serializes the bytes in each code unit in big-endian order.

UTF-16LE A Unicode encoding scheme based on UTF-16 that serializes the bytes in each code unit in little-endian order.

