

---

# Table of Contents

## Brass Fittings

Air Brake for Copper Tubing.....	39 - 40
Air Brake for Nylon Tubing.....	34 - 35
Chrome Plated Compression.....	19
Compression.....	15 - 18
Compression for Plastic Tubing.....	24 - 26
Double Compression Threaded Sleeve.....	20
Evaporative Cooler.....	42
Flare.....	4- 9
Fusible Plugs.....	9
Garden Hose.....	55 - 56
Grease.....	63 - 65
Hose Barbs.....	48 - 49
Hose End.....	41
Inverted Flare.....	10 - 12
LPG.....	14
Miniature Barbs.....	51
Miscellaneous Supply.....	43
Pilot Light.....	20
Pipe.....	44 - 47
Poly-Connect® Flareless Tube.....	27 - 29
Push-On Hose Barbs.....	53 - 54
Quik-Disconnect® Nickel Plated.....	30
Quik-DOT® Push-In Tube.....	36 - 38
Quik-Push® Push-In Tube.....	31 - 33
Range Connector.....	13
Reusable Hose.....	55
Self-Aligning Compression.....	21 - 23
Single Barbs.....	51
Space Heater.....	12
Transition for CPVC.....	42
Welding Hose.....	52

## Brass Valves

Drain Cocks.....	61 - 62
Needle.....	57
Polished Air Cocks.....	60 - 61
Poly-Connect® Needle Valves.....	29
Self-Aligning.....	24
Shut Off Cocks.....	59 - 60
Solid Bottom Fuel Line.....	62
Truck.....	63

## Accessories

Hose Clamps.....	50
Hose Ferrules.....	50
Ice Maker Kits.....	58
Tubing.....	66

## Actual Outside Diameters of Tubing

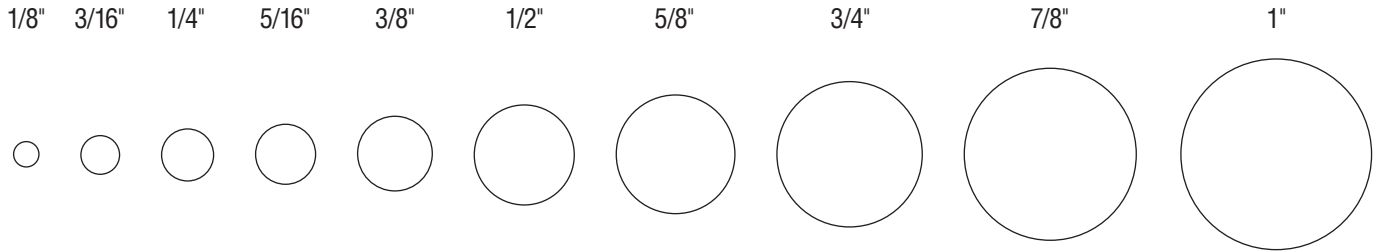

## Actual Outside Diameters of Pipe Threads

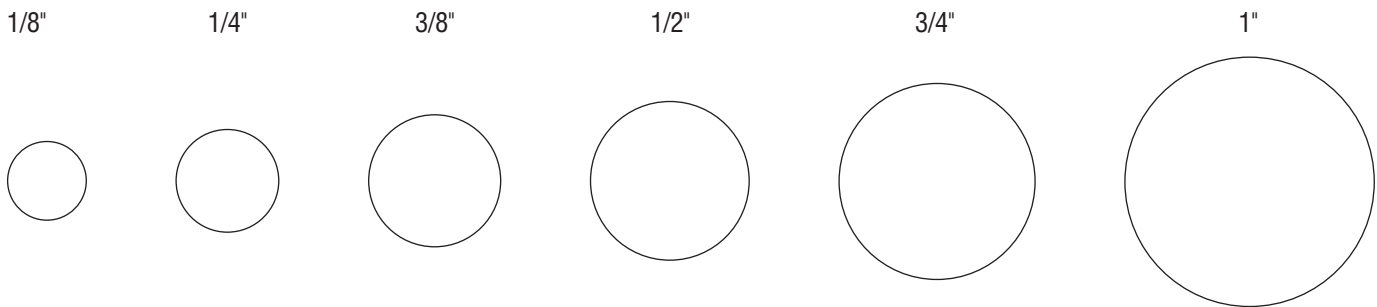

## Common Abbreviations Used in this Catalog

<b>NPT</b>	American National Standard Taper Pipe Threads
<b>NPSM</b>	American National Standard Straight Pipe Thread for Free-fitting Mechanical Joints
<b>NPTF</b>	Dryseal American National Standard Taper Pipe Thread
<b>BS</b>	British Standard Pipe Threads for Pressure Tight Joints
<b>NPSH</b>	American National Standard Straight Pipe Thread for Hose Couplings
<b>37° JIC</b>	Joint Industry Conference 37° Flare
<b>45° SAE</b>	Society of Automotive Engineers 45° Flare
<b>NH</b>	American National Standard Hose Thread
<b>UNF</b>	American National Standard Unified Fine Thread

# Thread Chart

Computer #	-02	-03	-04	-05	-06	-07	-08	-10	-12	-14	-16
O.D. Tubing Size	1/8	3/16	1/4	5/16	3/8	7/16	1/2	5/8	3/4	7/8	1
Flare 45°	5/16-24	3/8-24	7/16-20	1/2-20	5/8-18	11/16-16	3/4-16	7/8-14	1 1/16-14	1 1/4-12	1 3/8-12
Inverted Flare	5/16-28	3/8-24	7/16-24	1/2-20	5/8-18	11/16-18	3/4-18	7/8-18	1 1/16-16	1 3/16-16	1 5/16-16
Space Heater					9/16-24						
Range Connector								15/16-16			
LPG (POL)										7/8-14	
Compression	5/16-24	3/8-24	7/16-24	1/2-24	9/16-24	5/8-24	11/16-20	13/16-18	1-18	1 1/8-18	1 1/4-18
Double Compression Threaded Sleeve	5/16-24	3/8-24	7/16-24	1/2-20	9/16-20		11/16-16	7/8-18			
Self Align	5/16-24	3/8-24	7/16-24	1/2-24	9/16-24	5/8-24	11/16-20	13/16-18	1-18	1 1/8-18	1 1/4-16
Air Brake (Nylon Tube)			7/16-24		17/32-24		11/16-20	13/16-18	1-18		
Air Brake (Copper Tube)			7/16-24		17/32-24		11/16-20	13/16-18	1-18		
Flareless	5/16-24		3/8-24	7/16-24	1/2-24		11/16-20				

# Pipe Thread

Computer #	-01	-02	-04	-06	-08	-12	-16	-20	-24	-32	-40	-48
Nominal Pipe Size	1/16	1/8	1/4	3/8	1/2	3/4	1	1 1/4	1 1/2	2	2 1/2	3
Pipe	1/16-27	1/8-27	1/4-18	3/8-18	1/2-14	3/4-14	1-11 1/2	1 1/4-11 1/2	1 1/2-11 1/2	2-11 1/2	2 1/2-8	3-8

# Copper Tube (type K, L, & M) Conversion Chart Nominal to O.D.

Nominal Size	1/4	3/8	1/2	5/8	3/4
O.D. Copper Size	3/8	1/2	5/8	3/4	7/8

## Decimal and Metric Equivalents of Fractions

	DECIMAL	METRIC
1/64	.0156	0.397
1/32	.0313	0.794
3/64	.0469	1.191
1/16	.0625	1.588
5/64	.0781	1.984
3/32	.0938	2.381
7/64	.1094	2.778
1/8	.1250	3.175
9/64	.1406	3.572
5/32	.1562	3.969
11/64	.1719	4.366
3/16	.1875	4.762
13/64	.2031	5.159
7/32	.2188	5.556
15/64	.2344	5.953
1/4	.2500	6.350
17/64	.2656	6.747
9/32	.2812	7.144
19/64	.2969	7.541
5/16	.3125	7.938
21/64	.3281	8.334
11/32	.3438	8.731
23/64	.3594	9.128
3/8	.3750	9.525
25/64	.3906	9.922
13/32	.4062	10.319
27/64	.4219	10.716
7/16	.4375	11.112
29/64	.4531	11.509
15/32	.4688	11.906
31/64	.4844	12.303
1/2	.5000	12.700

	DECIMAL	METRIC
33/64	.5156	13.097
17/32	.5313	13.494
35/64	.5469	13.891
9/16	.5625	14.288
37/64	.5781	14.684
19/32	.5938	15.081
39/64	.6094	15.478
5/8	.6250	15.875
41/64	.6406	16.272
21/32	.6562	16.669
43/64	.6719	17.066
11/16	.6875	17.462
45/64	.7031	17.859
23/32	.7188	18.256
47/64	.7344	18.653
3/4	.7500	19.050
49/64	.7656	19.447
25/32	.7812	19.844
51/64	.7969	20.241
13/16	.8125	20.638
53/64	.8281	21.034
27/32	.8438	21.431
55/64	.8594	21.828
7/8	.8750	22.225
57/64	.8906	22.822
29/32	.9062	23.019
59/64	.9219	23.416
15/16	.9375	23.812
61/64	.9531	24.209
31/32	.9688	24.606
63/64	.9844	25.003
1	1.0000	25.400

# 45° Brass Flare Fittings

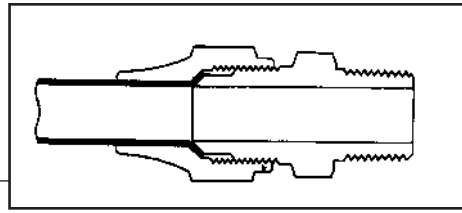

- Two piece construction – nut and body
- Use with copper, brass, aluminum, or steel tubing
- -65° to +250° F. temperature range
- Standard fittings use short nuts. Long nuts are available for higher vibration applications
- Resists mechanical pullout
- Easy to disassemble and can be reassembled many times, with no effect on the seal
- Primary uses: fuel equipment, plumbing, gases, refrigeration, and vacuum lines

## To Assemble:

- 1 Cut smooth, square end on tubing
- 2 Slide nut onto tube—threads facing end
- 3 Flare end of tube
- 4 Thread nut to body until snug, then 1/6th turn

<b>Tube O.D.</b>	1/8	3/16	1/4	5/16	3/8	7/16	1/2	5/8	3/4	7/8	1
<b>Thread Size</b>	5/16-24	3/8-24	7/16-20	1/2-20	5/8-18	1 1/16-16	3/4-16	7/8-14	1 1/16-14	1 1/4-12	1 3/8-12

## 45° Brass Flare Fittings

Computer Number	Tube O.D. Size	Weight Per 100	Price Per 100
-----------------	----------------	----------------	---------------



**441S**  
Short Flare Nut

**04014-**

02	1/8	1	80.80
03	3/16	1	68.90
04	1/4	3	70.17
05	5/16	4	93.23
06	3/8	6	97.22
07	7/16	7	473.84
08	1/2	8	148.14
10	5/8	15	210.39
12	3/4	23	589.91
14	7/8	35	917.34
16	1	50	1823.01



**441L**  
Long Flare Nut

**04041-**

02	1/8	1	199.35
03	3/16	2	116.93
04	1/4	3	95.77
05	5/16	5	143.75
06	3/8	7	194.15
08	1/2	10	292.70
10	5/8	18	482.75
12	3/4	27	1395.18

Computer Number	Tube O.D. Size	Weight Per 100	Price Per 100
-----------------	----------------	----------------	---------------

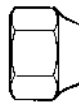

**6401S**  
Short Forged Flare Nut

**04018-**

03	3/16	4	280.69
04	1/4	5	140.57
05	5/16	6	189.47
06	3/8	8	166.98
08	1/2	10	213.57
10	5/8	13	320.50
12	3/4	25	627.01
14	7/8	27	1350.84
16	1	36	2412.57

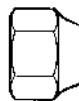

**6401SXH**  
X-Hvy Short Forged Flare Nut

**04019-**

04	1/4	6	207.92
06	3/8	8	242.57
08	1/2	11	301.98
10	5/8	16	400.99

Computer Number	Tube O.D. Size	Weight Per 100	Price Per 100
-----------------	----------------	----------------	---------------

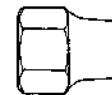

**6401L**  
Long Forged Flare Nut

**04016-**

03	3/16	5	1249.29
04	1/4	7	221.55
05	5/16	8	667.59
06	3/8	9	286.05
08	1/2	13	381.25
10	5/8	20	599.21
12	3/4	36	980.46



**6602S**  
Short Forged Reducing Nut

**04020-**

Threads x OD Tube

0403	1/4 x 3/16	5	280.79
0504	5/16 x 1/4	5	710.82
0604	3/8 x 1/4	8	210.39
0605	3/8 x 5/16	7	306.74
0806	1/2 x 3/8	8	267.79
1006	5/8 x 3/8	14	875.09
1008	5/8 x 1/2	14	418.70
1208	3/4 x 1/2	27	1150.68
1210	3/4 x 5/8	26	1139.87

# 45° Brass Flare Fittings

Computer Number	Tube O.D. Size	Weight Per 100	Price Per 100
-----------------	----------------	----------------	---------------



**463**  
Copper  
Flare Gasket

**04063-**

Computer Number	Tube O.D. Size	Weight Per 100	Price Per 100
03	3/16	1	69.24
04	1/4	1	40.40
05	5/16	1	46.82
06	3/8	1	54.56
08	1/2	1	63.75
10	5/8	1	76.01
12	3/4	1	130.63



**464**  
Copper  
Flare Bonnet

**04064-**

Computer Number	Tube O.D. Size	Weight Per 100	Price Per 100
03	3/16	1	90.51
04	1/4	1	71.61
05	5/16	1	125.83
06	3/8	1	77.74
08	1/2	1	87.16
10	5/8	1	142.42
12	3/4	1	233.51



**439**  
Plug

**04039-**

Computer Number	Tube O.D. Size	Weight Per 100	Price Per 100
03	3/16	2	201.38
04	1/4	3	75.02
05	5/16	4	223.74
06	3/8	5	122.48
08	1/2	9	182.01
10	5/8	13	290.45
12	3/4	25	1597.59



**440**  
Cap

**04040-**

Computer Number	Tube O.D. Size	Weight Per 100	Price Per 100
03	3/16	2	208.37
04	1/4	2	65.72
05	5/16	3	173.92
06	3/8	4	93.35
08	1/2	6	149.24
10	5/8	11	287.44
12	3/4	18	1048.78

Computer Number	Tube O.D. Size	Weight Per 100	Price Per 100
-----------------	----------------	----------------	---------------



**402**  
Union

**04042-**

Flare x Flare

Computer Number	Tube O.D. Size	Weight Per 100	Price Per 100
02	1/8	2	280.97
03	3/16	3	208.42
04	1/4	4	92.36
05	5/16	5	133.23
06	3/8	8	153.00
08	1/2	13	225.88
10	5/8	19	376.86
12	3/4	34	878.21
14	7/8	51	1984.27

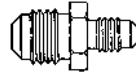

**506**  
Reducing  
Union

**04056-**

Flare x Flare

Computer Number	Tube O.D. Size	Weight Per 100	Price Per 100
0403	1/4 x 3/16	3	387.84
0504	5/16 x 1/4	5	243.28
0604	3/8 x 1/4	8	199.47
0605	3/8 x 5/16	9	437.26
0804	1/2 x 1/4	11	339.92
0806	1/2 x 3/8	13	248.71
1006	5/8 x 3/8	19	383.33
1008	5/8 x 1/2	20	380.73
1208	3/4 x 1/2	28	1099.30
1210	3/4 x 5/8	30	1462.69



**402S**  
Connector

**04082-**

Flare x Solder OD

Computer Number	Tube O.D. Size	Weight Per 100	Price Per 100
0404	1/4 x 1/4	3	360.38
0406	1/4 x 3/8	4	524.01
0606	3/8 x 3/8	7	395.87
0608	3/8 x 1/2	9	959.83
0806	1/2 x 3/8	9	863.07
0808	1/2 x 1/2	11	507.54
1010	5/8 x 5/8	16	1134.85
1012	5/8 x 3/4	21	2247.84
1212	3/4 x 3/4	28	1199.35



**403**  
Ball Check  
Valve

**04043-**

Flare x Male Pipe

Computer Number	Tube O.D. Size	Weight Per 100	Price Per 100
0402	1/4 x 1/8	5	1099.59
0604	3/8 x 1/4	9	1294.84

Computer Number	Tube O.D. Size	Weight Per 100	Price Per 100
-----------------	----------------	----------------	---------------

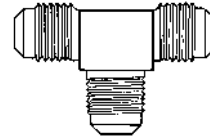

**404**  
Flare  
Tee

**04044-**

Flare Three Ends

Computer Number	Tube O.D. Size	Weight Per 100	Price Per 100
02	1/8	4	549.50
03	3/16	6	389.23
04	1/4	7	311.89
05	5/16	8	438.64
06	3/8	14	428.01
08	1/2	18	585.51
10	5/8	36	1021.38
12	3/4	54	2255.53
14	7/8	81	3719.14

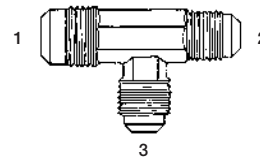

**509**  
Reducing  
Tee

**04059-**

Flare Three Ends  
Read Sizes 1-2-3

Computer Number	Tube O.D. Size	Weight Per 100	Price Per 100
040406	1/4 x 1/4 x 3/8	16	529.33
050504	5/16 x 5/16 x 1/4	14	859.89
060404	3/8 x 1/4 x 1/4	16	692.56
060406	3/8 x 1/4 x 3/8	16	699.84
060604	3/8 x 3/8 x 1/4	16	569.62
060608	3/8 x 3/8 x 1/2	21	712.15
060610	3/8 x 3/8 x 5/8	27	1536.56
080408	1/2 x 1/4 x 1/2	22	929.42
080606	1/2 x 3/8 x 3/8	22	744.18
080608	1/2 x 3/8 x 1/2	22	789.32
080804	1/2 x 1/2 x 1/4	22	1064.62
080806	1/2 x 1/2 x 3/8	23	667.42
080810	1/2 x 1/2 x 5/8	27	1197.79
080812	1/2 x 1/2 x 3/4	29	2509.21
100606	5/8 x 3/8 x 3/8	27	1039.36
100608	5/8 x 3/8 x 1/2	27	1543.84
100610	5/8 x 3/8 x 5/8	27	1587.30
100806	5/8 x 1/2 x 3/8	27	1439.51
100808	5/8 x 1/2 x 1/2	27	1449.45
100810	5/8 x 1/2 x 5/8	27	1556.73
101004	5/8 x 5/8 x 1/4	26	2139.18
101006	5/8 x 5/8 x 3/8	27	1010.86
101008	5/8 x 5/8 x 1/2	27	1087.22
121012	3/4 x 5/8 x 3/4	51	2873.87
121208	3/4 x 3/4 x 1/2	52	2842.95
121210	3/4 x 3/4 x 5/8	53	2885.49

# 45° Brass Flare Fittings

Computer Number	Tube O.D. Size	Weight Per 100	Price Per 100
-----------------	----------------	----------------	---------------

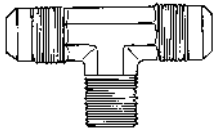

**405**  
Tee

**04045-** Flare x Male Pipe

0202	1/8 x 1/8	4	942.26
0302	3/16 x 1/8	5	421.25
0402	1/4 x 1/8	6	342.00
0404	1/4 x 1/4	9	411.54
0406	1/4 x 3/8	11	772.15
0408	1/4 x 1/2	12	1318.07
0502	5/16 x 1/8	7	460.72
0504	5/16 x 1/4	9	575.92
0602	3/8 x 1/8	11	555.00
0604	3/8 x 1/4	11	468.76
0606	3/8 x 3/8	18	594.36
0608	3/8 x 1/2	20	947.46
0612	3/8 x 3/4	20	2069.99
0804	1/2 x 1/4	20	907.69
0806	1/2 x 3/8	21	724.93
080608	1/2 x 3/8 x 1/2	24	1432.52
0808	1/2 x 1/2	25	976.76
0812	1/2 x 3/4	36	1787.23
1006	5/8 x 3/8	27	1264.43
1008	5/8 x 1/2	31	1234.32
1012	5/8 x 3/4	41	1758.85
1208	3/4 x 1/2	49	2652.67
1212	3/4 x 3/4	52	2658.80

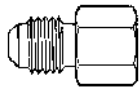

**406**  
Female  
Coupling

**04046-** Flare x Female Pipe

0202	1/8 x 1/8	2	354.55
0302	3/16 x 1/8	3	142.30
0402	1/4 x 1/8	4	95.95
0404	1/4 x 1/4	5	139.82
0406	1/4 x 3/8	6	297.73
0408	1/4 x 1/2	8	515.34
0502	5/16 x 1/8	4	150.74
0504	5/16 x 1/4	5	242.24
0506	5/16 x 3/8	6	390.32
0508	5/16 x 1/2	8	1727.35
0602	3/8 x 1/8	7	246.75
0604	3/8 x 1/4	9	152.59
0606	3/8 x 3/8	10	191.09
0608	3/8 x 1/2	13	252.12
0612	3/8 x 3/4	16	364.83
0804	1/2 x 1/4	10	264.38
0806	1/2 x 3/8	11	237.27
0808	1/2 x 1/2	14	282.41
0812	1/2 x 3/4	18	393.56
1006	5/8 x 3/8	22	362.12

CONTINUED TO NEXT COLUMN

Computer Number	Tube O.D. Size	Weight Per 100	Price Per 100
-----------------	----------------	----------------	---------------

**04046-** Flare x Female Pipe

1008	5/8 x 1/2	23	317.90
1012	5/8 x 3/4	26	421.54
1208	3/4 x 1/2	31	1501.47
1212	3/4 x 3/4	38	1269.29
1412	7/8 x 3/4	47	1488.18



**408**  
Half-Union

**04048-** Flare x Male Pipe

0202	1/8 x 1/8	2	145.83
0302	3/16 x 1/8	3	109.65
0304	3/16 x 1/4	4	687.45
0402	1/4 x 1/8	3	75.02
0404	1/4 x 1/4	5	97.97
0406	1/4 x 3/8	10	168.37
0408	1/4 x 1/2	11	314.78
0502	5/16 x 1/8	4	104.62
0504	5/16 x 1/4	5	136.18
0506	5/16 x 3/8	6	252.76
0508	5/16 x 1/2	7	893.82
0602	3/8 x 1/8	6	138.89
0604	3/8 x 1/4	7	130.80
0606	3/8 x 3/8	9	149.36
0608	3/8 x 1/2	12	220.10
0612	3/8 x 3/4	19	364.83
0704	7/16 x 1/4	9	615.40
0802	1/2 x 1/8	9	1107.09
0804	1/2 x 1/4	10	216.69
0806	1/2 x 3/8	11	228.48
0808	1/2 x 1/2	15	231.03
0812	1/2 x 3/4	21	387.90
1004	5/8 x 1/4	14	742.21
1006	5/8 x 3/8	16	315.76
1008	5/8 x 1/2	18	295.82
1012	5/8 x 3/4	23	400.84
1208	3/4 x 1/2	25	667.71
1212	3/4 x 3/4	29	664.76
1408	7/8 x 1/2	32	2157.62
1412	7/8 x 3/4	38	1653.77
1612	1 x 3/4	47	2386.16
1616	1 x 1	58	2486.56



**408XH**  
X-Hvy  
Half-Union

**04448-** Flare x Male Pipe

0404	1/4 x 1/4	5	121.34
0606	3/8 x 3/8	10	238.26
0808	1/2 x 1/2	16	385.14

Computer Number	Tube O.D. Size	Weight Per 100	Price Per 100
-----------------	----------------	----------------	---------------

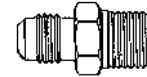

**408WT**  
Half-Union  
With FIP Tap

**04088-** Flare x Male Pipe x Female Pipe

060602	3/8 x 3/8 x 1/8	11	328.02
060806	3/8 x 1/2 x 3/8	15	403.91
080806	1/2 x 1/2 x 3/8	17	427.60

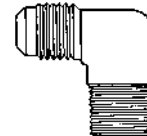

**409**  
Elbow

**04049-** Flare x Male Pipe

0202	1/8 x 1/8	2	447.43
0302	3/16 x 1/8	3	204.84
0304	3/16 x 1/4	5	431.07
0402	1/4 x 1/8	4	211.37
0404	1/4 x 1/4	5	237.50
0406	1/4 x 3/8	11	385.01
0408	1/4 x 1/2	13	512.63
0502	5/16 x 1/8	5	250.68
0504	5/16 x 1/4	6	318.02
0506	5/16 x 3/8	10	448.76
0508	5/16 x 1/2	14	794.75
0602	3/8 x 1/8	8	329.46
0604	3/8 x 1/4	9	316.69
0606	3/8 x 3/8	11	337.55
0608	3/8 x 1/2	17	433.96
0612	3/8 x 3/4	30	789.14
0802	1/2 x 1/8	8	930.64
0804	1/2 x 1/4	10	495.98
0806	1/2 x 3/8	13	427.32
0808	1/2 x 1/2	29	530.49
0812	1/2 x 3/4	30	837.06
1004	5/8 x 1/4	14	919.42
1006	5/8 x 3/8	16	718.97
1008	5/8 x 1/2	18	670.08
1012	5/8 x 3/4	33	975.84
1206	3/4 x 3/8	35	1663.31
1208	3/4 x 1/2	37	1358.30
1212	3/4 x 3/4	38	1437.95
1216	3/4 x 1	46	3353.50
1412	7/8 x 3/4	45	2527.13
1416	7/8 x 1	50	3245.30
1612	1 x 3/4	51	3555.51
1616	1 x 1	59	3651.34



# 45° Brass Flare Fittings

Computer Number	Tube O.D. Size	Weight Per 100	Price Per 100
-----------------	----------------	----------------	---------------

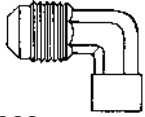

**409S**  
Elbow

**04089-** Flare x Solder OD

0404	1/4 x 1/4	5	849.89
0606	3/8 x 3/8	11	509.80
0806	1/2 x 3/8	13	1007.92
0808	1/2 x 1/2	29	969.77
1010	5/8 x 5/8	33	1607.69

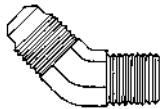

**40945**  
45° Elbow

**04095-** Flare x Male Pipe

0302	3/16 x 1/8	2	572.91
0402	1/4 x 1/8	3	324.84
0404	1/4 x 1/4	4	451.07
0406	1/4 x 3/8	4	668.34
0502	5/16 x 1/8	6	505.87
0504	5/16 x 1/4	5	463.79
0604	3/8 x 1/4	7	426.39
0606	3/8 x 3/8	9	477.66
0608	3/8 x 1/2	13	807.41
0806	1/2 x 3/8	13	549.97
0808	1/2 x 1/2	16	858.85
1008	5/8 x 1/2	23	954.22
1208	3/4 x 1/2	36	1377.95
1212	3/4 x 3/4	46	1500.03



**500**  
Elbow

**04050-** Flare x Female Pipe

0302	3/16 x 1/8	4	515.00
0402	1/4 x 1/8	5	305.94
0404	1/4 x 1/4	7	427.95
0406	1/4 x 3/8	8	570.37
0408	1/4 x 1/2	10	812.03
0502	5/16 x 1/8	6	447.66
0504	5/16 x 1/4	7	543.61
0602	3/8 x 1/8	9	468.30
0604	3/8 x 1/4	10	404.37
0606	3/8 x 3/8	13	405.35
0608	3/8 x 1/2	15	536.21
0612	3/8 x 3/4	21	747.24
0804	1/2 x 1/4	11	691.69
0806	1/2 x 3/8	13	553.38
0808	1/2 x 1/2	27	579.85
0812	1/2 x 3/4	29	676.95
1006	5/8 x 3/8	28	967.51
1008	5/8 x 1/2	31	693.95
1012	5/8 x 3/4	32	893.82
1208	3/4 x 1/2	36	1813.07
1212	3/4 x 3/4	47	2782.15
1412	7/8 x 3/4	50	3269.98

Computer Number	Tube O.D. Size	Weight Per 100	Price Per 100
-----------------	----------------	----------------	---------------

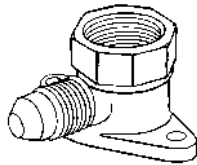

**500DE**  
Drop Ear  
Elbow

**04090-** Flare x Female Pipe

0608	3/8 x 1/2	24	1350.61
0808	1/2 x 1/2	24	1359.75
1008	5/8 x 1/2	26	1641.92

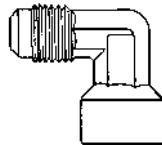

**500F**  
Elbow

**04092-** Male Flare x Female Flare

0404	1/4 x 1/4	7	786.31
0606	3/8 x 3/8	15	1016.59
0808	1/2 x 1/2	28	1535.57

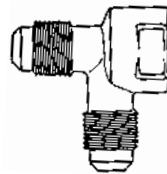

**501FP**  
Tee

Flare x  
Female Pipe x  
Flare

**04091-**

040404	1/4 x 1/4 x 1/4	13	795.50
060606	3/8 x 3/8 x 3/8	20	1054.85
060608	3/8 x 3/8 x 1/2	23	1820.70
060808	3/8 x 1/2 x 1/2	26	1844.28
080806	1/2 x 1/2 x 3/8	34	1873.30

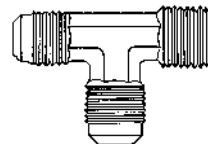

**501**  
Tee

Flare x  
Male Pipe

**04051-**

0302	3/16 x 1/8	5	470.43
0402	1/4 x 1/8	6	385.53
0404	1/4 x 1/4	7	445.23
0406	1/4 x 3/8	9	685.85
0502	5/16 x 1/8	9	526.27
0504	5/16 x 1/4	10	708.22
0602	3/8 x 1/8	12	717.18
0604	3/8 x 1/4	14	548.98
0606	3/8 x 3/8	17	599.96
0608	3/8 x 1/2	19	944.28
0804	1/2 x 1/4	18	930.64
0806	1/2 x 3/8	20	857.98
0808	1/2 x 1/2	25	1168.25
1006	5/8 x 3/8	30	1234.38
1008	5/8 x 1/2	33	1313.74
1208	3/4 x 1/2	44	2750.30
1212	3/4 x 3/4	49	2757.64

Computer Number	Tube O.D. Size	Weight Per 100	Price Per 100
-----------------	----------------	----------------	---------------

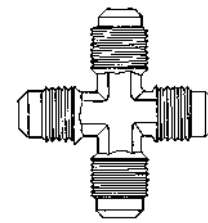

**502**  
Cross

**04052-** Flare Four Ends

04	1/4	9	1022.14
05	5/16	13	1046.47
06	3/8	19	901.56
08	1/2	28	1162.18
10	5/8	39	2407.72

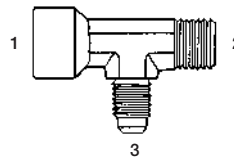

**503**  
Tee

Female Pipe x  
Male Pipe x Flare

**04053-**

020204	1/8 x 1/8 x 1/4	5	596.61
040404	1/4 x 1/4 x 1/4	6	797.06
040406	1/4 x 1/4 x 3/8	7	838.79

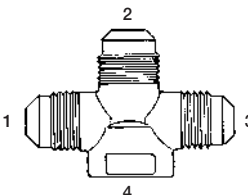

**503FP**  
Cross

Flare x Flare x  
Flare x Female Pipe

**04093-**

06060606	3/8x3/8x3/8x3/8	28	1296.92
06060608	3/8x3/8x3/8x1/2	30	1336.16
06060612	3/8x3/8x3/8x3/4	33	2041.50
06060808	3/8x3/8x1/2x1/2	34	1968.73
06081012	3/8x1/2x5/8x3/4	34	2387.83
08060612	1/2x3/8x3/8x3/4	34	2402.92
08080608	1/2x1/2x3/8x1/2	33	2296.16
08080612	1/2x1/2x3/8x3/4	33	2318.01
08080808	1/2x1/2x1/2x1/2	35	1645.57
08080812	1/2x1/2x1/2x3/4	35	1844.57
08100812	1/2x5/8x1/2x3/4	35	2868.56
10080812	5/8x1/2x1/2x3/4	35	2969.48

*We Solicit Your Inquiries  
On Any Item Not Shown  
In This Catalog*



# 45° Brass Flare Fittings

Computer Number	Tube O.D. Size	Weight Per 100	Price Per 100
-----------------	----------------	----------------	---------------

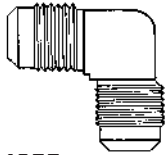

**505**  
Elbow

04055- Flare x Flare			
Computer Number	Tube O.D. Size	Weight Per 100	Price Per 100
02	1/8	3	610.66
03	3/16	4	650.54
04	1/4	5	260.97
05	5/16	6	375.70
06	3/8	8	371.89
08	1/2	15	468.64
10	5/8	23	723.14
12	3/4	32	1610.65
14	7/8	43	3176.51

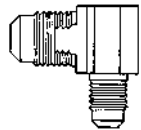

**507**  
Reducing Elbow

04057- Flare x Flare			
Computer Number	Tube O.D. Size	Weight Per 100	Price Per 100
0604	3/8 x 1/4	9	471.88
0605	3/8 x 5/16	10	608.23
0804	1/2 x 1/4	13	758.91
0806	1/2 x 3/8	16	633.95
1006	5/8 x 3/8	20	900.64
1008	5/8 x 1/2	23	901.91
1208	3/4 x 1/2	42	1676.66
1210	3/4 x 5/8	46	1782.38

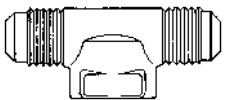

**508FP**  
Tee

04058- Flare x Flare x Female Pipe			
Computer Number	Tube O.D. Size	Weight Per 100	Price Per 100
040402	1/4 x 1/4 x 1/8	12	826.66
040404	1/4 x 1/4 x 1/4	12	899.95
060604	3/8 x 3/8 x 1/4	15	911.27
060606	3/8 x 3/8 x 3/8	16	1326.86
060608	3/8 x 3/8 x 1/2	18	1305.07
060612	3/8 x 3/8 x 3/4	21	1694.81
060808	3/8 x 1/2 x 1/2	20	1760.70
080606	1/2 x 3/8 x 3/8	20	2297.49
080806	1/2 x 1/2 x 3/8	20	1451.88
080808	1/2 x 1/2 x 1/2	20	1353.56
080812	1/2 x 1/2 x 3/4	22	2059.07
101008	5/8 x 5/8 x 1/2	26	1353.16

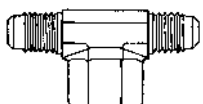

**T6**  
Tee

04096- Male Flare x Male Flare x Female Flare			
Computer Number	Tube O.D. Size	Weight Per 100	Price Per 100
040404	1/4 x 1/4 x 1/4	11	687.36

Computer Number	Tube O.D. Size	Weight Per 100	Price Per 100
-----------------	----------------	----------------	---------------

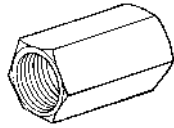

**600**  
Female Flare Connector

04060- Female Flare x Female Flare			
Computer Number	Tube O.D. Size	Weight Per 100	Price Per 100
04	1/4	7	461.65
06	3/8	12	757.53
08	1/2	20	1055.60



**601**  
Flare Reducer

04061- Female Flare x Male Flare			
Computer Number	Tube O.D. Size	Weight Per 100	Price Per 100
0403	1/4 x 3/16	5	1259.06
0406	1/4 x 3/8	9	518.12
0408	1/4 x 1/2	14	1234.49
0604	3/8 x 1/4	9	470.09
0608	3/8 x 1/2	18	576.15
0610	3/8 x 5/8	21	942.72
0804	1/2 x 1/4	16	981.73
0806	1/2 x 3/8	18	587.77
0810	1/2 x 5/8	21	896.19
1006	5/8 x 3/8	19	1376.56
1008	5/8 x 1/2	24	953.93
1012	5/8 x 3/4	30	1729.38
1210	3/4 x 5/8	44	1741.98

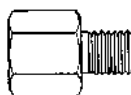

**664**  
Adapter

04066- Female Flare x Male Pipe			
Computer Number	Tube O.D. Size	Weight Per 100	Price Per 100
0402	1/4 x 1/8	5	404.77
0404	1/4 x 1/4	6	425.41
0604	3/8 x 1/4	10	631.93
0806	1/2 x 3/8	16	946.13
0808	1/2 x 1/2	18	1335.58



**700**  
Swivel Connector

04070- Flare x Flare			
Computer Number	Tube O.D. Size	Weight Per 100	Price Per 100
04	1/4	15	493.79
05	5/16	16	705.45
06	3/8	17	554.19
08	1/2	28	635.40
10	5/8	38	919.60
12	3/4	48	2139.81
14	7/8	51	5191.25

Computer Number	Tube O.D. Size	Weight Per 100	Price Per 100
-----------------	----------------	----------------	---------------

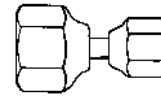

**700R**  
Swivel Connector Reducing

04075- Flare x Flare			
Computer Number	Tube O.D. Size	Weight Per 100	Price Per 100
0604	3/8 x 1/4	15	1085.77
0806	1/2 x 3/8	22	1108.26
1008	5/8 x 1/2	32	1401.36

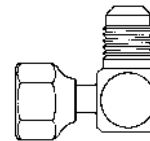

**701**  
Swivel Elbow

04071- Flare x Female Flare			
Computer Number	Tube O.D. Size	Weight Per 100	Price Per 100
0404	1/4 x 1/4	10	1634.18
0606	3/8 x 3/8	14	1916.53
0808	1/2 x 1/2	24	2418.35
1010	5/8 x 5/8	33	3127.56

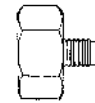

**K1**  
Cylinder Adapter

04030- Female Pipe x Flare			
Computer Number	Tube O.D. Size	Weight Per 100	Price Per 100
0804	1/2 x 1/4	12	1184.55
1204	3/4 x 1/4	15	861.45
1206	3/4 x 3/8	16	1116.46
1208	3/4 x 1/2	18	1196.11



**K1G**  
Cylinder Adapter Gasket

04032-			
Computer Number	Tube O.D. Size	Weight Per 100	Price Per 100
08	1/2	1	58.67
12	3/4	1	69.53

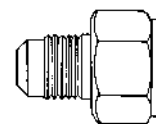

Ballcock Adapter

04087- Flare x Ballcock				
Computer Number	Tube O.D. Size	Weight Per 100	Price Per 100	
06	40375	3/8	11	908.21
08	40500	1/2	13	1096.99



**NFT5**  
Finger Tight Cap

04099-			
Computer Number	Tube O.D. Size	Weight Per 100	Price Per 100
04	1/4	2	172.07
06	3/8	4	444.19

## 45° Brass Flare Fittings

Computer Number	Tube O.D. Size	Weight Per 100	Price Per 100
-----------------	----------------	----------------	---------------



**UX1**  
X-Hvy  
Half Union

04098-		Flare x Male Pipe	
0402	1/4 x 1/8	4	1074.21
0404	1/4 x 1/4	6	977.05

Computer Number	Tube O.D. Size	Weight Per 100	Price Per 100
-----------------	----------------	----------------	---------------



**UX2**  
X-Hvy  
Union

04097-		Flare x Flare	
04	1/4	6	812.38



**406FC**  
Female  
Adapter

00093-		Compression x Female Flare	
0404	1/4 x 1/4	6	200.40

Computer Number	Tube O.D. Size	Weight Per 100	Price Per 100
-----------------	----------------	----------------	---------------



**408FC**  
Male  
Adapter

00094-		Compression x Male Flare	
0404	1/4 x 1/4	7	177.61

## Brass Fusible Plugs

Computer Number	Size	Weight Per 100	Price Per 100
-----------------	------	----------------	---------------



**FP1**  
Fusible Pipe Plug

06060-		283°	
02	FP1-A 1/8	2	1256.71
04	FP1-B 1/4	4	1888.44
06	FP1-C 3/8	6	2466.36

Computer Number	Size	Weight Per 100	Price Per 100
-----------------	------	----------------	---------------



**FP2**  
Fusible Pipe Plug

06061-		210°	
02	FP2-A 1/8	2	1256.71
04	FP2-B 1/4	4	1888.44
06	FP2-C 3/8	6	2466.36

Computer Number	Size	Weight Per 100	Price Per 100
-----------------	------	----------------	---------------



**FP3**  
Fusible Pipe Plug

06062-		168°	
02	FP3-A 1/8	2	1256.71
04	FP3-B 1/4	4	1888.44
06	FP3-C 3/8	6	2466.36

## PLEASE CONTACT US FOR OUR OTHER CATALOGS:

- Chrome Stops and Supplies
- Plumbing Valves
- Red Brass Fittings and Nipples
- Brass Repair Couplings
- Polyethylene, Aluminum and Copper Tubing
- Brass Clean Out Plugs
- Icemaker Kits
- Teflon Tape and Tube Straps
- Merchandisers

# Brass Inverted Flare

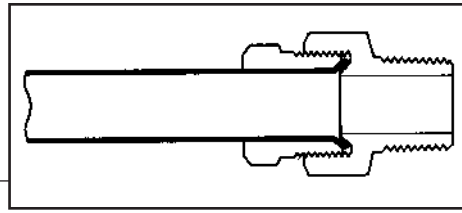

- Two piece construction – nut and body
- Use with copper, brass, aluminum, or steel tubing
- -65° to +250° F. temperature range
- Seats and threads are recessed, protecting them
- Shorter overall length, for limited space applications
- Shorter nut allows tubing to be bent closer to fitting
- Fair vibration resistance
- Resists mechanical pullout
- Easy to disassemble, and can be reassembled many times, with no effect on the seal
- Primary uses: liquids, gases, and hydraulic brake systems

## To Assemble:

- 1 Cut smooth, square end on tubing
- 2 Slide nut on tube—threads facing end
- 3 Flare end of tube
- 4 Thread nut onto body until snug, then 1/6th turn

<b>Tube O.D.</b>	1/8	3/16	1/4	5/16	3/8	7/16	1/2	5/8	3/4
<b>Thread Size</b>	5/16-28	3/8-24	7/16-24	1/2-20	5/8-18	11/16-18	3/4-18	7/8-18	1 1/16-16

## Brass Inverted Flare Fittings

Computer Number	Tube O.D. Size	Weight Per 100	Price Per 100
-----------------	----------------	----------------	---------------



**41INS**  
Steel Inverted  
Flare Nut

**04340-**

Computer Number	Tube O.D. Size	Weight Per 100	Price Per 100
02	1/8	1	64.86
03	3/16	1	32.96
04	1/4	2	31.05
05	5/16	2	36.80
06	3/8	4	49.60
08	1/2	7	86.23
10	5/8	10	217.29
12	3/4	35	364.17

Computer Number	Tube O.D. Size	Weight Per 100	Price Per 100
-----------------	----------------	----------------	---------------

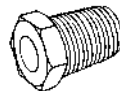

**41INL**  
Steel Long  
Inverted Flare  
Nut

**04330-**

Computer Number	Tube O.D. Size	Weight Per 100	Price Per 100
03	3/16	2	68.20
04	1/4	4	80.12
06	3/8	7	174.53

Computer Number	Tube O.D. Size	Weight Per 100	Price Per 100
-----------------	----------------	----------------	---------------

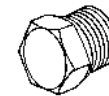

**39IN**  
Inverted Flare  
Plug

**04339-**

Computer Number	Tube O.D. Size	Weight Per 100	Price Per 100
03	3/16	1	39.39
04	1/4	2	51.46
05	5/16	3	64.37
06	3/8	4	141.14



**41INB**  
Brass Inverted  
Flare Nut

**04341-**

Computer Number	Tube O.D. Size	Weight Per 100	Price Per 100
02	1/8	1	129.47
03	3/16	1	50.81
04	1/4	2	41.58
05	5/16	2	50.32
06	3/8	4	71.13
08	1/2	7	110.36
10	5/8	10	331.78



**41INR**  
Steel Reducing  
Inverted Flare Nut

**04335-**

Computer Number	O.D. Tube x Threads	Weight Per 100	Price Per 100
0304	3/16 x 1/4	2	168.02
0305	3/16 x 5/16	2	78.87
0309	3/16 x 9/16-18	3	233.00
0405	1/4 x 5/16	3	150.73
0409	1/4 x 9/16-18	3	162.43

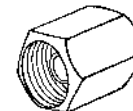

**42IN**  
Union

**04342-**

Computer Number	Tube O.D. Size	Weight Per 100	Price Per 100
02	1/8	1	125.79
03	3/16	2	99.31
04	1/4	2	101.94
05	5/16	3	104.62
06	3/8	5	161.05
08	1/2	9	312.71

# Brass Inverted Flare Fittings

Computer Number	Tube O.D. Size	Weight Per 100	Price Per 100
-----------------	----------------	----------------	---------------

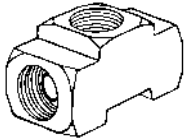

**44IN**  
Tee

Inverted Flare x  
Three Ends

04344-			
02	1/8	4	641.26
03	3/16	4	328.02
04	1/4	5	363.44
05	5/16	6	504.66
06	3/8	10	755.47
08	1/2	10	911.62

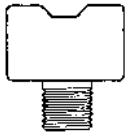

**45IN**  
Tee

Inverted Flare x  
Male Pipe

04345-			
0402	1/4 x 1/8	6	507.04
0502	5/16 x 1/8	7	547.13
0604	3/8 x 1/4	8	683.24

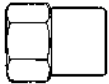

**46IN**  
Female Connector

Inverted Flare x  
Female Pipe

04346-			
0302	3/16 x 1/8	2	116.56
0402	1/4 x 1/8	3	126.15
0404	1/4 x 1/4	3	317.73
0502	5/16 x 1/8	3	118.66
0604	3/8 x 1/4	5	224.33
0806	1/2 x 3/8	9	897.98
1008	5/8 x 1/2	12	1025.10

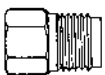

**601IN**  
Dual Master  
Cylinder Adapter

Female Inverted Flare x  
Male Inverted Flare

08661-			
0304	3/16 x 1/4	5	190.40
0305	3/16 x 5/16	5	208.30
0403	1/4 x 3/16	5	196.84
0405	1/4 x 5/16	5	199.51
0504	5/16 x 1/4	5	252.91
0506	5/16 x 3/8	5	328.06
0605	3/8 x 5/16	6	257.04

Computer Number	Tube O.D. Size	Weight Per 100	Price Per 100
-----------------	----------------	----------------	---------------

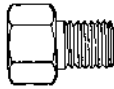

**48IN**  
Male Connector

Inverted Flare x  
Male Pipe

04348-			
0202	1/8 x 1/8	2	77.85
0302	3/16 x 1/8	2	61.34
0402	1/4 x 1/8	3	65.18
0404	1/4 x 1/4	3	79.76
0502	5/16 x 1/8	3	67.29
0504	5/16 x 1/4	3	86.92
0506	5/16 x 3/8	6	847.21
0602	3/8 x 1/8	3	147.89
0604	3/8 x 1/4	4	119.84
0606	3/8 x 3/8	6	150.40
0804	1/2 x 1/4	9	257.77
0806	1/2 x 3/8	10	225.18
0808	1/2 x 1/2	13	240.45
1008	5/8 x 1/2	14	464.17

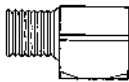

**49IN**  
Elbow

Inverted Flare x  
Male Pipe

04349-			
0202	1/8 x 1/8	4	201.62
0302	3/16 x 1/8	4	115.38
0402	1/4 x 1/8	4	88.30
0404	1/4 x 1/4	5	175.14
0502	5/16 x 1/8	5	107.21
0504	5/16 x 1/4	7	262.19
0602	3/8 x 1/8	11	299.60
0604	3/8 x 1/4	13	312.27
0606	3/8 x 3/8	18	401.01
0804	1/2 x 1/4	16	733.97
0806	1/2 x 3/8	19	483.85
0808	1/2 x 1/2	20	627.13
1008	5/8 x 1/2	24	919.35

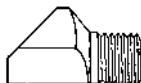

**94IN**  
45° Elbow

Inverted Flare x  
Male Pipe

04394-			
0302	3/16 x 1/8	3	201.46
0402	1/4 x 1/8	4	224.57
0502	5/16 x 1/8	4	239.27
0504	5/16 x 1/4	5	438.18
0604	3/8 x 1/4	7	444.57
0806	1/2 x 3/8	11	548.10

Computer Number	Tube O.D. Size	Weight Per 100	Price Per 100
-----------------	----------------	----------------	---------------



**664IN**  
Dual Master  
Cylinder Adapter

Female Inverted Flare x  
Male Inverted Flare

08664-			
030918	3/16(3/8-24)x3/16(9/16-18)	5	315.34
030920	3/16(3/8-24)x3/16(9/16-20)	5	283.16
0409	1/4(7/16-24)x1/4(9/16-18)	5	330.40
0809	3/16(1/2-20)x3/16(9/16-18)	5	316.19
0908	3/16(9/16-18)x3/16(1/2-20)	5	310.16

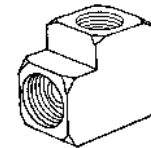

**50IN**  
Elbow

Inverted Flare x  
Female Pipe

04350-			
0302	3/16 x 1/8	4	403.81
0402	1/4 x 1/8	4	328.70
0502	5/16 x 1/8	5	389.47
0604	3/8 x 1/4	11	531.74



**51IN**  
Tee

Inverted Flare x  
Male Pipe x  
Inverted Flare

04351-			
0302	3/16 x 1/8	6	547.69
0402	1/4 x 1/8	7	POR
0502	5/16 x 1/8	8	669.64
0604	3/8 x 1/4	9	809.07

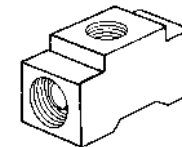

**52IN**  
Tee

Inverted Flare x  
Inverted Flare x  
FIP (Branch)

04352-			
0502	5/16 x 1/8	8	711.09
0604	3/8 x 1/4	12	757.89

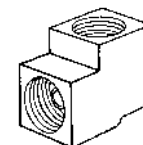

**55IN**  
Elbow

Inverted Flare x  
Inverted Flare

04355-			
04	1/4	6	343.72
06	3/8	6	POR

# Brass Inverted Flare Fittings

Computer Number	Tube O.D. Size	Weight Per 100	Price Per 100
-----------------	----------------	----------------	---------------

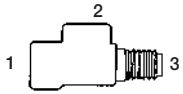

**127BT**  
Trailer Brake Tee

Inverted Flare Three Ends  
Read 1-2-3

08601	127BT01	1/4x1/4x1/4	658.46
08602	127BT02	3/16x1/4x3/16	646.48
08603	127BT03	3/16x3/16x3/16	537.41
08604	127BT04	1/4x3/16x1/4	505.22
08605	127BT05	3/16(9/16-18)x3/16x9/16-18	577.49
08606	127BT06	1/4(9/16-18)x3/16x9/16-18	645.67
08607	127BT07	3/16(9/16-20)x3/16x9/16-20	670.32
08608	127BT08	3/16(1/2-20)x3/16x1/2-20	656.36
08609	127BT09	3/16(7/16-24)x3/16x1/4	555.22
08610	127BT10	1/4x3/16x1/4 MIP	606.32

Computer Number	Tube O.D. Size	Weight Per 100	Price Per 100
-----------------	----------------	----------------	---------------

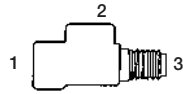

**127BTC**  
Trailer Brake Tee  
Nickel Plated

Inverted Flare Three Ends  
Read 1-2-3

08631	127BT01C	1/4x1/4x1/4	1309.17
08632	127BT02C	3/16x1/4x3/16	919.77
08633	127BT03C	3/16x3/16x3/16	857.35
08634	127BT04C	1/4x3/16x1/4	867.17
08635	127BT05C	3/16(9/16-18)x3/16x9/16-18	921.74
08636	127BT06C	1/4(9/16-18)x3/16x9/16-18	1002.02
08637	127BT07C	3/16(9/16-20)x3/16x9/16-20	1024.51
08638	127BT08C	3/16(1/2-20)x3/16x1/2-20	968.50
08639	127BT09C	3/16(7/16-24)x3/16x1/4	814.81
08640	127BT10C	1/4x3/16x1/4 MIP	864.23

Computer Number	Tube O.D. Size	Weight Per 100	Price Per 100
-----------------	----------------	----------------	---------------

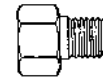

**48STA**  
Dual Master  
Cylinder Adapter

Female Inverted Flare x  
Straight Thread

08681	48STA01	3/16x1/2-20	5	626.52
08683	48STA03	1/4x7/16-20	5	460.69
08684	48STA04	1/4x1/2-20	5	402.83
08685	48STA05	5/16x1/2-20	5	481.50

Nuts seal on hex face

# Brass Space Heater Fittings (9/16-24 fine thread flare)

Computer Number	Tube O.D. Size	Weight Per 100	Price Per 100
-----------------	----------------	----------------	---------------



**800**  
Flare Nut

04800-

06	3/8	4	81.50
0604	3/8 x 1/4	6	146.29

Computer Number	Tube O.D. Size	Weight Per 100	Price Per 100
-----------------	----------------	----------------	---------------

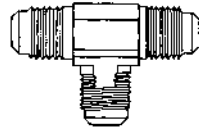

**844**  
Flare  
Tee

04844-

Flare All Ends

06	3/8	12	611.29
----	-----	----	--------

Computer Number	Tube O.D. Size	Weight Per 100	Price Per 100
-----------------	----------------	----------------	---------------

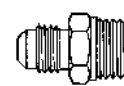

Half  
Union

04808-

Flare x  
Male Pipe

0606	803	3/8 x 3/8	8	172.24
0608	804	3/8 x 1/2	11	232.82

Computer Number	Tube O.D. Size	Weight Per 100	Price Per 100
-----------------	----------------	----------------	---------------



**800CP**  
Chrome Flare Nut

04801-

06	3/8	4	199.41
----	-----	---	--------

Computer Number	Tube O.D. Size	Weight Per 100	Price Per 100
-----------------	----------------	----------------	---------------

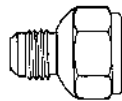

Female  
Coupling

04806-

Flare x  
Female Pipe

0606	805	3/8 x 3/8	6	181.38
0608	806	3/8 x 1/2	14	206.75
0612	807	3/8 x 3/4	17	574.71

Computer Number	Tube O.D. Size	Weight Per 100	Price Per 100
-----------------	----------------	----------------	---------------

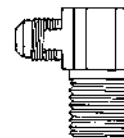

**809**  
Elbow

04809-

Flare x  
Male Pipe

0606	3/8 x 3/8	10	436.33
0608	3/8 x 1/2	11	749.20

Computer Number	Tube O.D. Size	Weight Per 100	Price Per 100
-----------------	----------------	----------------	---------------



**840**  
Flare Cap

04840-

06	3/8	4	87.05
----	-----	---	-------

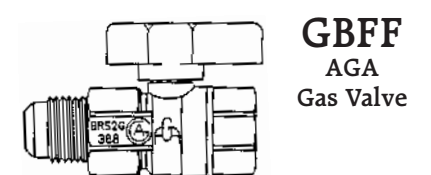

**GBFF**  
AGA  
Gas Valve

40046-

Flare x  
Female Pipe

0908	9/16-24 x 1/2	42	*
------	---------------	----	---

Computer Number	Tube O.D. Size	Weight Per 100	Price Per 100
-----------------	----------------	----------------	---------------

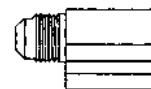

**850**  
Elbow

04850-

Flare x  
Female Pipe

0606	3/8 x 3/8	10	448.53
0608	3/8 x 1/2	11	555.52

\*Refer to Current Valve Catalog for pricing

## Brass Range Connector Fittings (15/16-16 flare thread)

Computer Number	Size	Weight Per 100	Price Per 100
-----------------	------	----------------	---------------

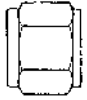

**441SRC**  
Flare Nut

04741-

15	15/16	21	298.83
----	-------	----	--------

Computer Number	Size	Weight Per 100	Price Per 100
-----------------	------	----------------	---------------

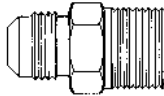

**408RC**  
Connector

04748-

Flare x Male Pipe

1508	15/16 x 1/2	24	460.96
1512	15/16 x 3/4	32	605.28
151208	15/16 x 3/4*	32	713.08

\*Tapped 1/2 Female Pipe Order 408-RCT

Computer Number	Size	Weight Per 100	Price Per 100
-----------------	------	----------------	---------------

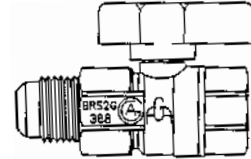

**GBFF**  
AGA  
Gas Valve

40046-

Flare x  
Female Pipe

1512	15/16 x 3/4	57	*
------	-------------	----	---

\*Refer to Current Valve Catalog for pricing

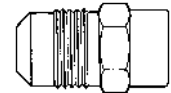

**406RC**  
Female Coupling

04746-

Flare x Female Pipe

1508	15/16 x 1/2	32	484.25
1512	15/16 x 3/4	36	567.36

## PLEASE CONTACT US FOR OUR OTHER CATALOGS:

- Chrome Stops and Supplies
- Brass Clean Out Plugs
- Plumbing Valves
- Icemaker Kits
- Red Brass Fittings and Nipples
- Teflon Tape and Tube Straps
- Brass Repair Couplings
- Merchandisers
- Polyethylene, Aluminum and Copper Tubing



# Brass LPG Fittings (POL)

- Used only for LPG applications
- Special left-handed thread (7/8 - 14)

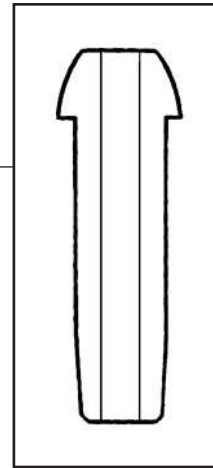

## Brass LPG Fittings (POL)

Computer Number	Size	Weight Per 100	Price Per 100
-----------------	------	----------------	---------------

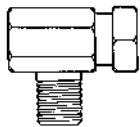

**2000**  
Tee  
Check

**05200**

Computer Number	Size	Weight Per 100	Price Per 100
	1/4	13	1382.58

Inverted Flare x  
Inverted Flare x  
Male Pipe

Computer Number	Size	Weight Per 100	Price Per 100
-----------------	------	----------------	---------------

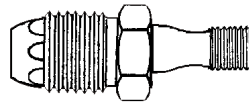

**2002AB**  
Pol Assembly

**05225**

Computer Number	Size	Weight Per 100	Price Per 100
		23	606.95

Pol x MIP

Computer Number	Size	Weight Per 100	Price Per 100
-----------------	------	----------------	---------------

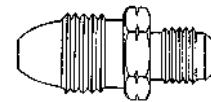

Connector

Pol x Flare

Computer Number	Size	Weight Per 100	Price Per 100	
<b>05205</b>	2005	3/8 Flare	20	598.52
<b>05206</b>	2006	1/2 Flare	21	678.46
<b>05207</b>	2007	5/8 Flare	23	795.62



**2002A**  
Standard Pol  
Tail Piece

**05220**

Computer Number	Size	Weight Per 100	Price Per 100
	1/4 MIP	14	387.43

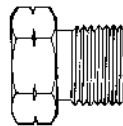

**2002BLH**  
Large Hex  
Pol Nut

**05222**

Computer Number	Size	Weight Per 100	Price Per 100
	1-1/8 Hex	16	550.78

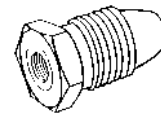

**2008**  
Connector

**05208**

Computer Number	Size	Weight Per 100	Price Per 100
	1/4 FIP	14	709.55

Pol x FIP

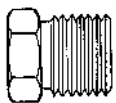

**2002B**  
Standard  
Pol Nut

**05221**

Computer Number	Size	Weight Per 100	Price Per 100
	7/8 Hex	9	219.52

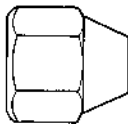

**2004**  
Pol Cap

**05204**

Computer Number	Size	Weight Per 100	Price Per 100
		13	796.48

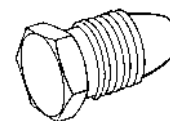

**2014**  
Pol Plug

**05214**

Computer Number	Size	Weight Per 100	Price Per 100
		17	549.50

# Brass Compression Fittings

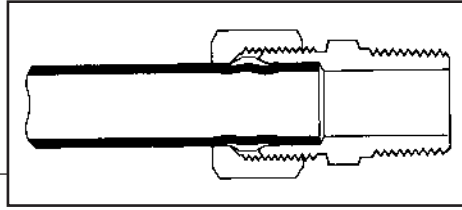

- Three piece construction—nut, sleeve (or ferrule) and body
- Use with copper, aluminum, or plastic tubing (plastic requires 60P sleeve and 61P insert)
- -65° to +250° F. temperature range
- Standard fittings use short nuts. Long nuts are available for higher vibration applications. To buy compression fittings with long nut, please add a "1" in front of the part number. (i.e. 68 = 168)
- Easy to disassemble, no flaring tool required
- Primary uses: water, gasoline, oil, and vacuum lines

## To Assemble:

- 1 Cut smooth, square end on tubing
- 2 Slide nut, then sleeve onto tube. Threads must face end
- 3 Insert tube into fitting
- 4 Thread nut onto fitting until snug, then as follows:
 

up to 1/4"	1 1/4 turns
5/16"	1 3/4 turns
3/8" and up	2 1/4 turns

Tube O.D.	1/8	3/16	1/4	5/16	3/8	7/16	1/2	5/8	3/4	7/8
Thread Size	5/16-24	3/8-24	7/16-24	1/2-24	9/16-24	5/8-24	11/16-20	13/16-18	1-18	1 1/8-18

## Brass Compression Fittings

Computer Number	Tube O.D. Size	Weight Per 100	Price Per 100
-----------------	----------------	----------------	---------------



### 60 Sleeve

00060-

Part No.	*	Tube O.D.	Weight	Price
02	*	1/8	1	10.58
03	*	3/16	1	11.50
04	*	1/4	1	11.39
05	*	5/16	1	14.33
06	*	3/8	1	13.58
07	*	7/16	1	45.49
08	*	1/2	1	28.26
10	*	5/8	1	40.40
12		3/4	2	82.65
14		7/8	3	92.94

\*Sold in bags of 100 pcs. only



### 60P Delrin Sleeve

00560-

Part No.	*	Tube O.D.	Weight	Price
04	*	1/4	1	17.28
05	*	5/16	1	36.07
06	*	3/8	1	28.73
08	*	1/2	1	33.52
10	*	5/8	1	59.25

\*Sold in bags of 100 pcs. only



### CP Compression Plug

00039-

Part No.	Code	Tube O.D.	Weight	Price
04	CP4	1/4	2	135.25
06	CP6	3/8	3	154.73
10	CP10	5/8	3	186.41

Computer Number	Tube O.D. Size	Weight Per 100	Price Per 100
-----------------	----------------	----------------	---------------



### 61 Nut

00061-

Part No.	Tube O.D.	Weight	Price
02	1/8	1	31.56
03	3/16	1	36.76
04	1/4	1	38.78
05	5/16	2	46.41
06	3/8	2	46.82
07	7/16	3	100.28
08	1/2	3	92.02
10	5/8	6	126.29
12	3/4	9	287.44
14	7/8	12	260.74

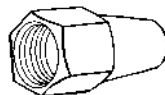

### 161 Long Nut

00161-

Part No.	Tube O.D.	Weight	Price
02	1/8	1	93.12
03	3/16	1	75.72
04	1/4	2	87.16
05	5/16	5	100.05
06	3/8	5	118.14
08	1/2	10	223.51
10	5/8	15	365.59
12	3/4	17	703.83

Computer Number	Tube O.D. Size	Weight Per 100	Price Per 100
-----------------	----------------	----------------	---------------



### 61P Brass Insert

00561-

Part No.	*	Tube O.D.	Hose I.D.	Weight	Price
02	*	1/8	.08	1	37.51
03	*	3/16	.095	1	53.81
04	*	1/4	.17	1	17.92
05	*	5/16	.187	2	39.65
06	*	3/8	.25	2	30.92
08	*	1/2	.375	3	84.97
10	*	5/8	.50	4	132.65

\*Sold in bags of 100 pcs. only



### 61CX Cap

00081-

Part No.	Tube O.D.	Weight	Price
04	1/4	2	74.97
05	5/16	2	97.86
06	3/8	3	89.13
08	1/2	4	162.59
10	5/8	7	206.87

Listed Weights

Are

Approximate

# Brass Compression Fittings

Computer Number	Tube O.D. Size	Weight Per 100	Price Per 100
-----------------	----------------	----------------	---------------



**62**  
Union

00062- Compression x Compression

02	1/8	2	170.63
03	3/16	4	174.15
04	1/4	6	184.79
05	5/16	7	222.82
06	3/8	8	234.61
07	7/16	11	572.28
08	1/2	15	382.17
10	5/8	23	518.29
12	3/4	36	1262.47
14	7/8	44	1304.89



**62R**  
Reducing Union

00082- Compression x Compression

0402	1/4 x 1/8	4	271.31
0403	1/4 x 3/16	4	230.74
0504	5/16 x 1/4	6	258.25
0604	3/8 x 1/4	8	258.94
0605	3/8 x 5/16	8	325.59
0806	1/2 x 3/8	14	392.75
1006	5/8 x 3/8	20	419.69
1008	5/8 x 1/2	21	515.00

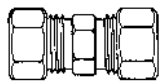

**62T**  
Tank Union  
(Drilled Through)

00092- Compression x Compression

06	3/8	8	270.22
08	1/2	15	450.03
10	5/8	23	599.91
14	7/8	44	1331.77

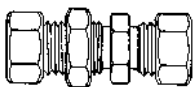

**62BH**  
Bulkhead Union  
With Locknut

00083- Compression x Compression

04	1/4	9	697.01
06	3/8	11	1263.97
08	1/2	14	2285.30



**63**  
Ball Check  
Valve

00063- Compression x Male Pipe

0202	1/8 x 1/8	1	1131.72
0302	3/16 x 1/8	3	1154.44
0402	1/4 x 1/8	5	665.74
0502	5/16 x 1/8	5	1326.97
0604	3/8 x 1/4	8	960.12

Computer Number	Tube O.D. Size	Weight Per 100	Price Per 100
-----------------	----------------	----------------	---------------

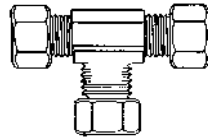

**64**  
Tee

00064- Compression Three Ends

02	1/8	6	550.26
03	3/16	7	482.69
04	1/4	10	403.16
05	5/16	11	562.63
06	3/8	15	571.82
07	7/16	15	1388.24
08	1/2	28	888.91
10	5/8	50	1257.73
12	3/4	65	3447.08
14	7/8	80	3401.88

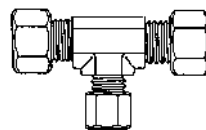

**64R**  
Reducing  
Tee

00084- Compression Three Ends

040402	1/4 x 1/4 x 1/8	8	586.50
040403	1/4 x 1/4 x 3/16	8	688.74
040406	1/4 x 1/4 x 3/8	10	754.35
050504	5/16 x 5/16 x 1/4	12	747.35
060404	3/8 x 1/4 x 1/4	22	870.29
060604	3/8 x 3/8 x 1/4	24	653.37
080804	1/2 x 1/2 x 1/4	26	1047.97
080806	1/2 x 1/2 x 3/8	40	1232.82
101004	5/8 x 5/8 x 1/4	44	1637.24
101006	5/8 x 5/8 x 3/8	45	1443.44
101008	5/8 x 5/8 x 1/2	50	1524.88

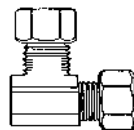

**65**  
Elbow

00065- Compression x Compression

02	1/8	4	433.85
03	3/16	5	401.48
04	1/4	7	334.32
05	5/16	8	404.31
06	3/8	10	405.00
07	7/16	11	856.08
08	1/2	21	666.72
10	5/8	30	827.75
12	3/4	40	2112.82
14	7/8	55	2850.06

Computer Number	Tube O.D. Size	Weight Per 100	Price Per 100
-----------------	----------------	----------------	---------------

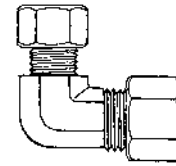

**65R**  
Reducing  
Elbow

00085- Compression x Compression

0604	3/8 x 1/4	8	586.73
0806	1/2 x 3/8	18	780.65
1006	5/8 x 3/8	24	758.28
1008	5/8 x 1/2	26	971.33

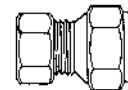

**66**  
Female Coupling

00066- Compression x Female Pipe

0202	1/8 x 1/8	2	136.64
0302	3/16 x 1/8	4	144.79
0304	3/16 x 1/4	5	571.24
0402	1/4 x 1/8	5	148.95
0404	1/4 x 1/4	6	191.90
0406	1/4 x 3/8	8	449.92
0408	1/4 x 1/2	10	567.08
0502	5/16 x 1/8	6	181.49
0504	5/16 x 1/4	7	223.86
0506	5/16 x 3/8	8	378.65
0602	3/8 x 1/8	8	205.94
0604	3/8 x 1/4	8	213.28
0606	3/8 x 3/8	10	232.12
0608	3/8 x 1/2	13	265.94
0612	3/8 x 3/4	15	1069.99
0804	1/2 x 1/4	10	621.23
0806	1/2 x 3/8	14	322.70
0808	1/2 x 1/2	16	342.93
0812	1/2 x 3/4	23	1094.44
1006	5/8 x 3/8	22	489.10
1008	5/8 x 1/2	23	438.76
1012	5/8 x 3/4	25	673.02
1208	3/4 x 1/2	27	1348.88
1212	3/4 x 3/4	30	1650.54
1408	7/8 x 1/2	32	1790.12
1412	7/8 x 3/4	34	916.77



**66S**  
Compression x  
Sweat Adapter

00086-

0610	3/8 x 5/8 O.D. (1/2 Nom. Sweat)	23	199.29
------	------------------------------------	----	--------

# Brass Compression Fittings

Computer Number	Tube O.D. Size	Weight Per 100	Price Per 100
-----------------	----------------	----------------	---------------

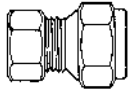

**66T**  
Tank Coupling  
(Drilled Through)

**00096-** Compression x Female Pipe

Computer Number	Tube O.D. Size	Weight Per 100	Price Per 100
0606	3/8 x 3/8	10	241.98
0608	3/8 x 1/2	13	276.56
0806	1/2 x 3/8	14	328.99
0808	1/2 x 1/2	16	351.86
1008	5/8 x 1/2	23	451.70

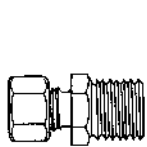

**68**  
Connector

**00068-** Compression x Male Pipe

Computer Number	Tube O.D. Size	Weight Per 100	Price Per 100
0202	1/8 x 1/8	1	133.52
0302	3/16 x 1/8	2	137.45
0304	3/16 x 1/4	3	202.07
0402	1/4 x 1/8	5	132.36
0404	1/4 x 1/4	7	153.00
0406	1/4 x 3/8	9	248.48
0408	1/4 x 1/2	11	404.31
0502	5/16 x 1/8	6	150.68
0504	5/16 x 1/4	7	188.08
0506	5/16 x 3/8	8	336.97
0508	5/16 x 1/2	9	1148.83
0602	3/8 x 1/8	8	181.61
0604	3/8 x 1/4	9	169.59
0606	3/8 x 3/8	10	206.11
0608	3/8 x 1/2	15	277.21
0612	3/8 x 3/4	24	509.45
0704	7/16 x 1/4	8	358.94
0706	7/16 x 3/8	10	472.05
0804	1/2 x 1/4	11	285.99
0806	1/2 x 3/8	12	266.98
0808	1/2 x 1/2	15	305.76
0812	1/2 x 3/4	25	531.07
1006	5/8 x 3/8	16	370.61
1008	5/8 x 1/2	18	359.52
1012	5/8 x 3/4	25	581.41
1208	3/4 x 1/2	27	828.33
1212	3/4 x 3/4	30	841.86
1408	7/8 x 1/2	30	1350.73
1412	7/8 x 3/4	40	819.49
1416	7/8 x 1	46	1751.63

Computer Number	Tube O.D. Size	Weight Per 100	Price Per 100
-----------------	----------------	----------------	---------------

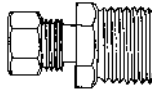

**68T**  
Tank Connector  
(Drilled Through)

**00088-** Compression x Male Pipe

Computer Number	Tube O.D. Size	Weight Per 100	Price Per 100
0302	3/16 x 1/8	5	172.82
0402	1/4 x 1/8	5	158.55
0404	1/4 x 1/4	7	173.57
0604	3/8 x 1/4	8	191.78
0606	3/8 x 3/8	9	219.18
0608	3/8 x 1/2	10	283.80
0806	1/2 x 3/8	12	298.42
0808	1/2 x 1/2	15	318.36
0812	1/2 x 3/4	21	541.70
1008	5/8 x 1/2	18	396.33
1012	5/8 x 3/4	25	642.79

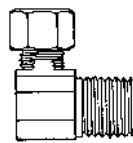

**69**  
Elbow

**00069-** Compression x Male Pipe

Computer Number	Tube O.D. Size	Weight Per 100	Price Per 100
0202	1/8 x 1/8	4	247.79
0302	3/16 x 1/8	5	255.36
0304	3/16 x 1/4	7	372.52
0402	1/4 x 1/8	5	228.89
0404	1/4 x 1/4	7	249.64
0406	1/4 x 3/8	9	402.98
0408	1/4 x 1/2	11	667.59
0502	5/16 x 1/8	7	288.48
0504	5/16 x 1/4	8	335.12
0506	5/16 x 3/8	9	528.00
0508	5/16 x 1/2	9	767.76
0602	3/8 x 1/8	8	321.71
0604	3/8 x 1/4	8	311.60
0606	3/8 x 3/8	9	387.55
0608	3/8 x 1/2	10	514.42
0612	3/8 x 3/4	11	891.57
0704	7/16 x 1/4	9	783.94
0706	7/16 x 3/8	10	787.76
0804	1/2 x 1/4	14	540.49
0806	1/2 x 3/8	15	493.03
0808	1/2 x 1/2	17	631.12
0812	1/2 x 3/4	25	1237.61
1006	5/8 x 3/8	24	688.05
1008	5/8 x 1/2	25	777.81
1012	5/8 x 3/4	25	1155.71
1208	3/4 x 1/2	32	1466.56
1212	3/4 x 3/4	35	1554.94
1408	7/8 x 1/2	38	2056.87
1412	7/8 x 3/4	45	2098.83

Computer Number	Tube O.D. Size	Weight Per 100	Price Per 100
-----------------	----------------	----------------	---------------

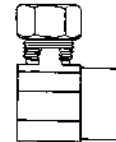

**69S**  
Compression x  
Sweat Elbow

**00089-**

Computer Number	Tube O.D. Size	Weight Per 100	Price Per 100
0610	3/8 x 5/8 O.D. (1/2 Nom. Sweat)	12	501.76

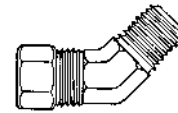

**6945**  
45° Elbow  
Compression x  
Male Pipe

**00095-**

Computer Number	Tube O.D. Size	Weight Per 100	Price Per 100
0302	3/16 x 1/8	4	567.19
0402	1/4 x 1/8	5	458.35
0404	1/4 x 1/4	6	570.25
0502	5/16 x 1/8	7	621.47
0504	5/16 x 1/4	8	684.64
0602	3/8 x 1/8	8	1286.11
0604	3/8 x 1/4	9	562.63
0606	3/8 x 3/8	10	1014.97
0806	1/2 x 3/8	17	718.74
0808	1/2 x 1/2	19	1569.96
1008	5/8 x 1/2	25	1591.81

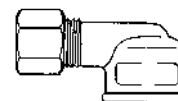

**70**  
Elbow

**00070-** Compression x Female Pipe

Computer Number	Tube O.D. Size	Weight Per 100	Price Per 100
0202	1/8 x 1/8	4	577.42
0302	3/16 x 1/8	5	422.11
0402	1/4 x 1/8	7	327.44
0404	1/4 x 1/4	8	431.77
0406	1/4 x 3/8	9	750.48
0408	1/4 x 1/2	12	820.88
0502	5/16 x 1/8	10	469.22
0504	5/16 x 1/4	10	558.75
0602	3/8 x 1/8	10	489.91
0604	3/8 x 1/4	11	460.78
0606	3/8 x 3/8	12	510.95
0608	3/8 x 1/2	13	527.54
0612	3/8 x 3/4	15	1148.08
0804	1/2 x 1/4	16	862.49
0806	1/2 x 3/8	18	661.06
0808	1/2 x 1/2	20	742.21
0812	1/2 x 3/4	23	1119.47
1006	5/8 x 3/8	22	1150.62
1008	5/8 x 1/2	25	876.83
1012	5/8 x 3/4	30	1147.50
1208	3/4 x 1/2	38	2197.79
1212	3/4 x 3/4	42	2434.13

# Brass Compression Fittings

Computer Number	Tube O.D. Size	Weight Per 100	Price Per 100
-----------------	----------------	----------------	---------------

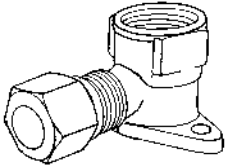

**70DE**  
Drop Ear  
Elbow

00090- Compression x Female Pipe

1008	5/8 x 1/2	28	1719.15
------	-----------	----	---------

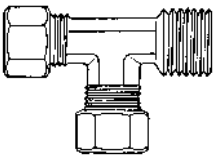

**71**  
Tee

00071- Compression x Male Pipe

0202	1/8 x 1/8	5	528.81
0302	3/16 x 1/8	5	536.85
0402	1/4 x 1/8	8	435.23
0404	1/4 x 1/4	9	519.91
0502	5/16 x 1/8	10	711.52
0504	5/16 x 1/4	11	750.36
0602	3/8 x 1/8	11	702.56
0604	3/8 x 1/4	12	626.96
0606	3/8 x 3/8	14	792.78
0806	1/2 x 3/8	22	977.05
0808	1/2 x 1/2	25	1279.52
1008	5/8 x 1/2	40	1518.64
1208	3/4 x 1/2	52	3064.15
1212	3/4 x 3/4	56	3455.57

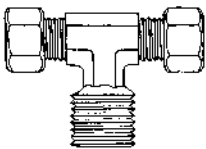

**72**  
Tee

00072- Compression x Male Pipe

0202	1/8 x 1/8	5	671.46
0302	3/16 x 1/8	6	515.87
0402	1/4 x 1/8	8	457.72
0404	1/4 x 1/4	9	531.18
0502	5/16 x 1/8	10	522.17
0504	5/16 x 1/4	11	577.02
0602	3/8 x 1/8	11	633.55
0604	3/8 x 1/4	12	532.40
0606	3/8 x 3/8	14	648.92
0608	3/8 x 1/2	16	1272.06
0804	1/2 x 1/4	19	1071.79
0806	1/2 x 3/8	22	884.40
0808	1/2 x 1/2	25	1207.90
1008	5/8 x 1/2	40	1338.42
1208	3/4 x 1/2	52	3053.63
1212	3/4 x 3/4	55	3141.14

Computer Number	Tube O.D. Size	Weight Per 100	Price Per 100
-----------------	----------------	----------------	---------------



**74**  
Tee

00074- Compression x Male Pipe x Female Pipe

040202	1/4 x 1/8 x 1/8	8	1182.18
--------	-----------------	---	---------

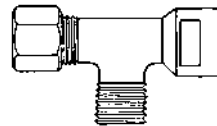

**75**  
Tee

00075- Compression x Female Pipe x Male Pipe

040202	1/4 x 1/8 x 1/8	8	758.34
040404	1/4 x 1/4 x 1/4	10	913.47

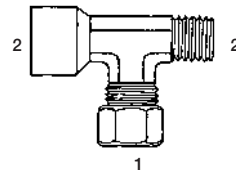

**76**  
Tee

00076- Compression x Female Pipe x Male Pipe

0202	1/8 x 1/8	7	POR
0302	3/16 x 1/8	7	879.83
0402	1/4 x 1/8	8	599.39
0404	1/4 x 1/4	9	818.62
0502	5/16 x 1/8	10	805.96
0604	3/8 x 1/4	11	864.11

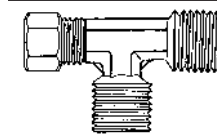

**77**  
Tee

00077- Compression x Male Pipe

0606	3/8 x 3/8	12	1174.09
------	-----------	----	---------

Computer Number	Tube O.D. Size	Weight Per 100	Price Per 100
-----------------	----------------	----------------	---------------

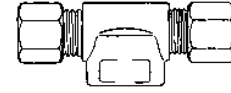

**78**  
Tee

00078- Compression x Female Pipe

0402	1/4 x 1/8	8	855.90
0404	1/4 x 1/4	9	1133.86
0602	3/8 x 1/8	10	801.22
0604	3/8 x 1/4	11	944.80
0606	3/8 x 3/8	14	1186.23
0802	1/2 x 1/8	17	1178.02
0806	1/2 x 3/8	22	1479.39
1002	5/8 x 1/8	26	1946.13

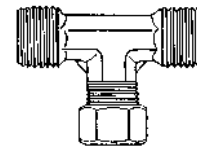

**79**  
Tee

00079- Male Pipe x Compression

0606	3/8 x 3/8	14	1428.01
------	-----------	----	---------

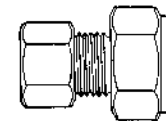

Ballcock  
Adapter

00087- Compression x Ballcock

06	40375C	3/8	12	821.40
08	40500C	1/2	15	998.21

*Drawings Are For Identification Purposes*

— ONLY —

*Patterns May Vary*

# Chrome Plated Compression Fittings

Computer Number	Tube O.D. Size	Weight Per 100	Price Per 100
-----------------	----------------	----------------	---------------



**61CP**  
Nut

00661-

04	1/4	2	72.54
06	3/8	2	110.57
07	7/16	3	178.14
08	1/2	3	124.15
10	5/8	6	166.06

Computer Number	Tube O.D. Size	Weight Per 100	Price Per 100
-----------------	----------------	----------------	---------------

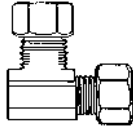

**65CP**  
Elbow

00665-

Compression x Compression			
06	3/8	18	509.85
08	1/2	24	774.98
10	5/8	26	1006.24

Computer Number	Tube O.D. Size	Weight Per 100	Price Per 100
-----------------	----------------	----------------	---------------



**68CP**  
Connector

00668-

Compression x Male Pipe			
0406	1/4 x 3/8	9	528.75
0604	3/8 x 1/4	9	479.97
0606	3/8 x 3/8	9	304.43
0608	3/8 x 1/2	10	366.11
0806	1/2 x 3/8	12	395.64
0808	1/2 x 1/2	15	420.96
1006	5/8 x 3/8	16	923.07
1008	5/8 x 1/2	18	829.49



**62CP**  
Union

00662-

Compression x Compression			
06	3/8	8	318.65
08	1/2	15	486.10
10	5/8	23	653.95

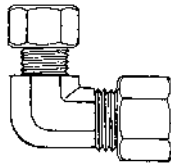

**65RCP**  
Reducing Elbow

00685-

Compression x Compression			
0806	1/2 x 3/8	18	980.17
1006	5/8 x 3/8	24	825.10

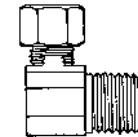

**69CP**  
Elbow

00669-

Compression x Male Pipe			
0604	3/8 x 1/4	8	473.44
0606	3/8 x 3/8	9	472.52
0608	3/8 x 1/2	10	668.69
0806	1/2 x 3/8	15	682.04
0808	1/2 x 1/2	17	739.15

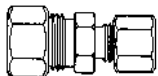

**62RCP**  
Reducing Union

00682-

Compression x Compression			
0604	3/8 x 1/4	8	434.54
0806	1/2 x 3/8	14	459.74
1006	5/8 x 3/8	19	542.74
1008	5/8 x 1/2	21	690.54

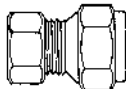

**66CP**  
Female Coupling

00666-

Compression x Female Pipe			
0606	3/8 x 3/8	10	311.14
0608	3/8 x 1/2	13	358.88
0806	1/2 x 3/8	14	429.97
0808	1/2 x 1/2	16	462.52

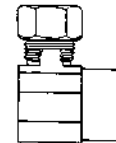

**69SCP**  
Compression x Sweat Elbow

00689-

0610	3/8 x 5/8 (1/2 Nom. Sweat)	12	599.50
------	-------------------------------	----	--------

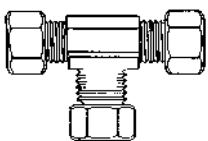

**64CP**  
Tee

00664-

Compression Three Ends			
06	3/8	15	1065.02
08	1/2	28	1174.55
10	5/8	50	1545.92

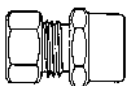

**66SCP**  
Compression x Sweat Adapter

00686-

0610	3/8 x 5/8 (1/2 Nom. Sweat)	13	326.28
------	-------------------------------	----	--------

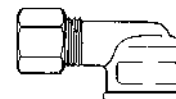

**70CP**  
Elbow

00670-

Compression x Female Pipe			
0606	3/8 x 3/8	10	587.25
0608	3/8 x 1/2	12	682.96
0806	1/2 x 3/8	17	676.66
0808	1/2 x 1/2	20	830.88



# Brass Double Compression Threaded Sleeve Fittings

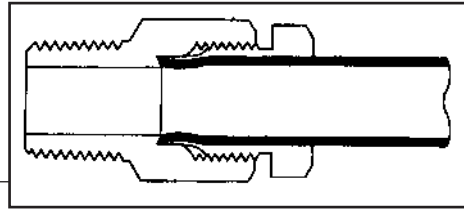

- Two piece construction – nut and body
- Use with copper, brass, aluminum, and plastic tubing (plastic requires insert 61P)
- -65° to +250° F. temperature range
- No special tubing preparation
- Fair vibration resistance
- Primary uses: automotive and gas control valves

## To Assemble:

- 1 Cut smooth, square end on tubing
- 2 Slide nut onto tube—threads facing end
- 3 Insert tube into fitting
- 4 Thread nut into fitting until snug, then 1 1/2 turns

Tube O.D.	1/8	3/16	1/4	5/16	3/8	1/2	5/8
Thread Size	5/16-24	3/8-24	7/16-24	1/2-20	9/16-20	11/16-20	7/8-18

## Brass Double Compression Threaded Sleeve Fittings

Computer Number	Tube O.D. Size	Weight Per 100	Price Per 100
-----------------	----------------	----------------	---------------



**181**  
Nut

00881-

Computer Number	Tube O.D. Size	Weight Per 100	Price Per 100
02	1/8	1	67.05
03	3/16	1	75.54
04	1/4	1	82.71
05	5/16	2	83.69
06	3/8	2	114.27
08	1/2	2	294.78
10	5/8	4	656.61

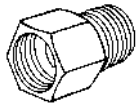

**188**  
Connector

00888- Female Compression x Male Pipe

Computer Number	Tube O.D. Size	Weight Per 100	Price Per 100
0202	1/8 x 1/8	2	97.80
0302	3/16 x 1/8	2	104.50
0304	3/16 x 1/4	3	148.55
0402	1/4 x 1/8	3	113.98
0404	1/4 x 1/4	4	190.91
0502	5/16 x 1/8	4	158.43
0504	5/16 x 1/4	5	189.30
0602	3/8 x 1/8	5	295.13
0604	3/8 x 1/4	5	320.45

Computer Number	Tube O.D. Size	Weight Per 100	Price Per 100
-----------------	----------------	----------------	---------------

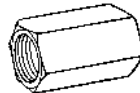

**182**  
Union

00882-

Compression x Compression

Computer Number	Tube O.D. Size	Weight Per 100	Price Per 100
02	1/8	4	918.56
03	3/16	5	925.55
04	1/4	6	481.76
05	5/16	6	528.93



**189**  
Elbow

00889- Female Compression x Male Pipe

Computer Number	Tube O.D. Size	Weight Per 100	Price Per 100
0202	1/8 x 1/8	4	490.90
0302	3/16 x 1/8	4	505.40
0402	1/4 x 1/8	5	485.69
0404	1/4 x 1/4	7	492.63
0502	5/16 x 1/8	8	449.68
0602	3/8 x 1/8	8	972.49
0604	3/8 x 1/4	8	819.20
0806	1/2 x 3/8	5	1458.24

## Pilot Light Fittings

Computer Number	Tube O.D. Size	Weight Per 100	Price Per 100
-----------------	----------------	----------------	---------------

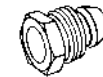

**181SP**  
Nut  
With Break-Away Sleeve

00880-

Computer Number	Tube O.D. Size	Weight Per 100	Price Per 100
02	1/8	5	372.58
03	3/16	5	405.58
04	1/4	5	149.59
06	3/8	5	561.24

\*Screws into gas control valves for furnaces, water heaters, etc.

Listed Weights

Are

Approximate

# Brass Self-Aligning Compression Fittings



- Sleeve and nut permanently attached
- Sleeve is visible after installation, helping to eliminate misaligned sleeves
- Two piece construction – nut and body
- Use with copper, brass, aluminum, or plastic tubing (plastic requires insert 61P)
- -65° to +250° F. temperature range
- Quicker assembly than flare or regular compression
- Better vibration resistance than regular compression fittings
- Can be used anywhere a regular compression fitting is used, especially when installation may be difficult

## To Assemble:

- 1 Cut smooth, square end on tubing
- 2 Slide nut over tube, threads facing end
- 3 Insert tube into fitting
- 4 Thread nut onto fitting until snug, then one more turn

Tube O.D.	1/8	3/16	1/4	5/16	3/8	1/2	5/8	3/4	7/8
Thread Size	5/16-24	3/8-24	7/16-24	1/2-24	9/16-24	11/16-20	13/16-18	1-18	1 1/8-18

## Brass Self-Aligning Compression Fittings

Computer Number	Tube O.D. Size	Weight Per 100	Price Per 100
-----------------	----------------	----------------	---------------



**61SA**  
Nut  
With Captive  
Sleeve

**00261-**

Computer Number	Tube O.D. Size	Weight Per 100	Price Per 100
02	1/8	1	152.82
03	3/16	1	156.81
04	1/4	1	130.28
05	5/16	2	178.43
06	3/8	2	159.24
08	1/2	3	238.25
10	5/8	6	284.67
12	3/4	9	798.33
14	7/8	12	1719.67

Computer Number	Tube O.D. Size	Weight Per 100	Price Per 100
-----------------	----------------	----------------	---------------



**62RSA**  
Reducing Union

**00282-** Compression x Compression

Computer Number	Tube O.D. Size	Weight Per 100	Price Per 100
0402	1/4 x 1/8	4	695.97
0403	1/4 x 3/16	5	709.96
0504	5/16 x 1/4	6	740.36
0604	3/8 x 1/4	8	651.52
0605	3/8 x 5/16	8	777.29
0806	1/2 x 3/8	14	926.36
1006	5/8 x 3/8	20	1101.67
1008	5/8 x 1/2	21	1211.20

Computer Number	Tube O.D. Size	Weight Per 100	Price Per 100
-----------------	----------------	----------------	---------------

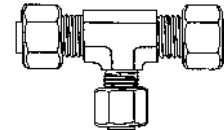

**64RSA**  
Reducing  
Tee

**00284-** Compression Three Ends

Computer Number	Tube O.D. Size	Weight Per 100	Price Per 100
040402	1/4 x 1/4 x 1/8	8	1107.39
040403	1/4 x 1/4 x 3/16	8	1171.72
050504	5/16 x 5/16 x 1/4	10	1231.37
060604	3/8 x 3/8 x 1/4	12	1282.52
080804	1/2 x 1/2 x 1/4	24	1661.87
080806	1/2 x 1/2 x 3/8	26	1708.05
101006	5/8 x 5/8 x 3/8	44	2087.33
101008	5/8 x 5/8 x 1/2	46	2384.65

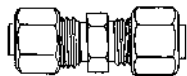

**62SA**  
Union

**00262-** Compression x Compression

Computer Number	Tube O.D. Size	Weight Per 100	Price Per 100
02	1/8	3	475.35
03	3/16	4	492.98
04	1/4	6	363.10
05	5/16	7	510.32
06	3/8	8	520.49
08	1/2	15	691.81
10	5/8	23	1085.14
12	3/4	36	2799.20
14	7/8	44	3559.56

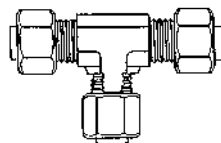

**64SA**  
Tee

**00264-** Compression Three Ends

Computer Number	Tube O.D. Size	Weight Per 100	Price Per 100
02	1/8	6	1014.04
03	3/16	7	951.50
04	1/4	10	795.67
05	5/16	11	1050.28
06	3/8	15	1009.48
08	1/2	28	1234.09
10	5/8	50	1723.02
12	3/4	65	5062.30
14	7/8	80	6170.15

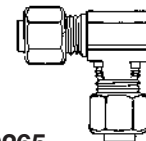

**65SA**  
Elbow

**00265-** Compression x Compression

Computer Number	Tube O.D. Size	Weight Per 100	Price Per 100
02	1/8	4	705.16
03	3/16	5	721.63
04	1/4	7	538.29
05	5/16	8	860.41
06	3/8	10	681.46
08	1/2	21	967.34
10	5/8	30	1109.59
12	3/4	40	3557.42
14	7/8	55	4654.23

# Brass Self-Aligning Compression Fittings

Computer Number	Tube O.D. Size	Weight Per 100	Price Per 100
-----------------	----------------	----------------	---------------

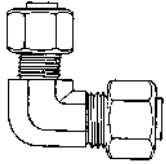

**65RSA**  
Reducing Elbow

**00285-** Compression x Compression

Computer Number	Tube O.D. Size	Weight Per 100	Price Per 100
0604	3/8 x 1/4	8	937.52
0806	1/2 x 3/8	18	1170.97
1006	5/8 x 3/8	24	1198.95
1008	5/8 x 1/2	26	1562.51

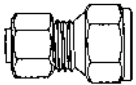

**66SA**  
Female Coupling

**00266-** Compression x Female Pipe

Computer Number	Tube O.D. Size	Weight Per 100	Price Per 100
0202	1/8 x 1/8	3	299.29
0302	3/16 x 1/8	3	324.60
0304	3/16 x 1/4	4	746.26
0402	1/4 x 1/8	5	271.54
0404	1/4 x 1/4	6	385.87
0406	1/4 x 3/8	8	607.07
0408	1/4 x 1/2	10	725.68
0502	5/16 x 1/8	6	345.82
0504	5/16 x 1/4	7	415.52
0506	5/16 x 3/8	8	560.78
0602	3/8 x 1/8	7	325.18
0604	3/8 x 1/4	8	460.84
0606	3/8 x 3/8	10	479.57
0608	3/8 x 1/2	13	512.74
0612	3/8 x 3/4	17	1284.20
0804	1/2 x 1/4	10	808.56
0806	1/2 x 3/8	14	503.21
0808	1/2 x 1/2	16	540.08
0812	1/2 x 3/4	23	1340.09
1006	5/8 x 3/8	20	881.28
1008	5/8 x 1/2	23	831.68
1012	5/8 x 3/4	26	919.19
1208	3/4 x 1/2	26	2399.05
1212	3/4 x 3/4	30	2616.78
1408	7/8 x 1/2	34	2872.95
1412	7/8 x 3/4	38	2927.86

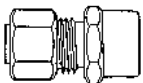

**66SSA**  
Compression x Sweat Adapter

**00286-**

Computer Number	Tube O.D. Size	Weight Per 100	Price Per 100
0610	3/8 x 5/8 O.D. (1/2 Nom. Sweat)	13	365.35

Computer Number	Tube O.D. Size	Weight Per 100	Price Per 100
-----------------	----------------	----------------	---------------

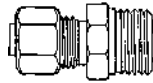

**68SA**  
Connector

**00268-** Compression x Male Pipe

Computer Number	Tube O.D. Size	Weight Per 100	Price Per 100
0202	1/8 x 1/8	3	278.65
0302	3/16 x 1/8	3	285.76
0304	3/16 x 1/4	4	354.08
0402	1/4 x 1/8	5	234.49
0404	1/4 x 1/4	7	274.61
0406	1/4 x 3/8	9	365.59
0408	1/4 x 1/2	11	519.10
0502	5/16 x 1/8	6	355.41
0504	5/16 x 1/4	7	367.49
0506	5/16 x 3/8	8	485.92
0508	5/16 x 1/2	11	1318.53
0602	3/8 x 1/8	8	324.84
0604	3/8 x 1/4	9	318.48
0606	3/8 x 3/8	10	377.67
0608	3/8 x 1/2	15	415.99
0612	3/8 x 3/4	21	765.97
0804	1/2 x 1/4	11	538.29
0806	1/2 x 3/8	12	530.14
0808	1/2 x 1/2	15	546.21
0812	1/2 x 3/4	25	750.24
1006	5/8 x 3/8	16	703.72
1008	5/8 x 1/2	18	659.27
1012	5/8 x 3/4	25	893.99
1208	3/4 x 1/2	27	1427.72
1212	3/4 x 3/4	30	1465.98
1408	7/8 x 1/2	30	2790.12
1412	7/8 x 3/4	40	2365.70
1416	7/8 x 1	48	3346.68

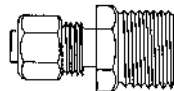

**68TSA**  
Tank Connector  
(Drilled Through)

**00288-** Compression x Male Pipe

Computer Number	Tube O.D. Size	Weight Per 100	Price Per 100
0402	1/4 x 1/8	5	284.67
0404	1/4 x 1/4	7	347.67
0604	3/8 x 1/4	9	389.69
0606	3/8 x 3/8	10	410.73
0608	3/8 x 1/2	15	479.34
0806	1/2 x 3/8	12	495.81
0808	1/2 x 1/2	15	497.95
1008	5/8 x 1/2	18	596.50
1012	5/8 x 3/4	25	952.54

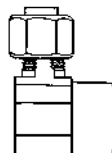

**69SSA**  
Compression x Sweat Elbow

**00289-**

Computer Number	Tube O.D. Size	Weight Per 100	Price Per 100
0610	3/8 x 5/8 O.D. (1/2 Nom. Sweat)	20	606.84

Computer Number	Tube O.D. Size	Weight Per 100	Price Per 100
-----------------	----------------	----------------	---------------

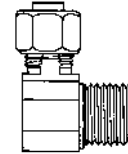

**69SA**  
Elbow

**00269-** Compression x Male Pipe

Computer Number	Tube O.D. Size	Weight Per 100	Price Per 100
0202	1/8 x 1/8	2	392.64
0302	3/16 x 1/8	3	401.71
0304	3/16 x 1/4	4	538.81
0402	1/4 x 1/8	5	382.64
0404	1/4 x 1/4	7	405.24
0406	1/4 x 3/8	9	570.49
0408	1/4 x 1/2	11	861.62
0502	5/16 x 1/8	7	468.01
0504	5/16 x 1/4	8	518.47
0506	5/16 x 3/8	9	763.42
0508	5/16 x 1/2	12	967.98
0602	3/8 x 1/8	7	497.08
0604	3/8 x 1/4	8	415.29
0606	3/8 x 3/8	9	473.79
0608	3/8 x 1/2	10	629.50
0612	3/8 x 3/4	12	1117.16
0804	1/2 x 1/4	14	896.82
0806	1/2 x 3/8	15	616.84
0808	1/2 x 1/2	17	663.26
0812	1/2 x 3/4	25	1337.03
1006	5/8 x 3/8	23	920.29
1008	5/8 x 1/2	25	991.96
1012	5/8 x 3/4	28	1491.99
1208	3/4 x 1/2	32	2384.48
1212	3/4 x 3/4	35	1864.74
1408	7/8 x 1/2	38	3581.06
1412	7/8 x 3/4	38	3668.68

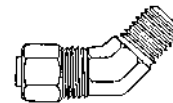

**6945SA**  
45° Elbow

**00295-** Compression x Male Pipe

Computer Number	Tube O.D. Size	Weight Per 100	Price Per 100
0302	3/16 x 1/8	4	752.96
0402	1/4 x 1/8	5	703.02
0404	1/4 x 1/4	6	798.45
0502	5/16 x 1/8	7	931.10
0504	5/16 x 1/4	8	966.36
0602	3/8 x 1/8	8	1582.32
0604	3/8 x 1/4	9	808.10
0606	3/8 x 3/8	10	1333.27
0806	1/2 x 3/8	17	953.76
0808	1/2 x 1/2	19	1676.78
1008	5/8 x 1/2	30	1756.48

# Brass Self-Aligning Compression Fittings

Computer Number	Tube O.D. Size	Weight Per 100	Price Per 100
-----------------	----------------	----------------	---------------

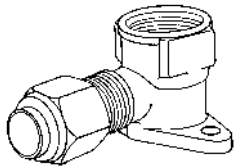

**70DESA**  
Drop Ear  
Elbow

00290- Compression x Female Pipe

1008	5/8 x 1/2	45	2124.27
------	-----------	----	---------

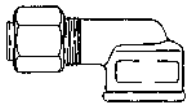

**70SA**  
Elbow

00270- Compression x Female Pipe

0202	1/8 x 1/8	4	760.30
0302	3/16 x 1/8	5	566.61
0402	1/4 x 1/8	7	498.24
0404	1/4 x 1/4	8	533.21
0406	1/4 x 3/8	9	797.41
0408	1/4 x 1/2	11	1040.86
0502	5/16 x 1/8	10	776.08
0504	5/16 x 1/4	10	817.47
0602	3/8 x 1/8	10	532.40
0604	3/8 x 1/4	11	559.27
0606	3/8 x 3/8	12	780.65
0608	3/8 x 1/2	14	816.25
0612	3/8 x 3/4	18	1389.17
0804	1/2 x 1/4	16	1074.56
0806	1/2 x 3/8	18	1090.80
0808	1/2 x 1/2	20	1178.43
0812	1/2 x 3/4	24	1339.05
1006	5/8 x 3/8	22	1521.99
1008	5/8 x 1/2	25	1061.84
1012	5/8 x 3/4	30	1470.32
1208	3/4 x 1/2	27	2816.07
1212	3/4 x 3/4	35	2867.86

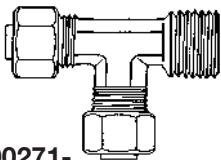

**71SA**  
Tee

00271- Compression x Male Pipe

0202	1/8 x 1/8	5	968.15
0302	3/16 x 1/8	5	988.03
0402	1/4 x 1/8	8	783.54
0404	1/4 x 1/4	9	859.72
0502	5/16 x 1/8	9	992.19
0504	5/16 x 1/4	10	1083.69
0602	3/8 x 1/8	11	1184.73
0604	3/8 x 1/4	12	1221.78
0606	3/8 x 3/8	14	1258.83
0806	1/2 x 3/8	22	1392.11
0808	1/2 x 1/2	25	1466.10
1008	5/8 x 1/2	40	1906.13
1208	3/4 x 1/2	52	4603.02
1212	3/4 x 3/4	56	4882.48

Computer Number	Tube O.D. Size	Weight Per 100	Price Per 100
-----------------	----------------	----------------	---------------

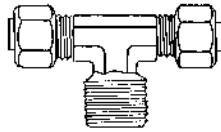

**72SA**  
Tee

00272- Compression x Male Pipe

0202	1/8 x 1/8	5	867.69
0302	3/16 x 1/8	6	880.29
0402	1/4 x 1/8	8	865.03
0404	1/4 x 1/4	9	894.63
0502	5/16 x 1/8	9	939.08
0504	5/16 x 1/4	10	1035.02
0602	3/8 x 1/8	11	1041.85
0604	3/8 x 1/4	12	950.98
0606	3/8 x 3/8	14	1103.23
0608	3/8 x 1/2	17	1649.67
0804	1/2 x 1/4	20	1315.24
0806	1/2 x 3/8	22	1436.21
0808	1/2 x 1/2	25	1680.42
1008	5/8 x 1/2	40	2148.43
1208	3/4 x 1/2	52	4691.68
1212	3/4 x 3/4	58	4993.28

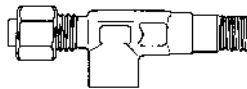

**74SA**  
Tee

00274- Compression x Male Pipe x Female Pipe

040202	1/4 x 1/8 x 1/8	8	1040.52
--------	-----------------	---	---------

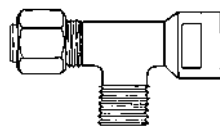

**75SA**  
Tee

00275- Compression x Female Pipe x Male Pipe

040202	1/4 x 1/8 x 1/8	8	923.70
040404	1/4 x 1/4 x 1/4	10	943.30

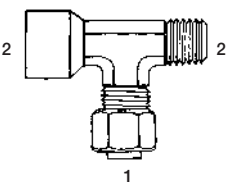

**76SA**  
Tee

00276- Compression x Female Pipe x Male Pipe

0202	1/8 x 1/8	6	POR
0302	3/16 x 1/8	7	1098.55
0402	1/4 x 1/8	8	735.10
0404	1/4 x 1/4	10	929.31
0604	3/8 x 1/4	12	972.37

Computer Number	Tube O.D. Size	Weight Per 100	Price Per 100
-----------------	----------------	----------------	---------------

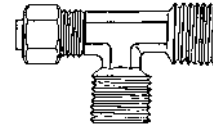

**77SA**  
Tee

00277- Compression x Male Pipe x Male Pipe

0606	3/8 x 3/8	13	1104.96
------	-----------	----	---------

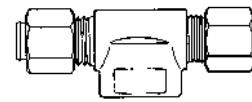

**78SA**  
Tee

00278- Compression x Female Pipe

0402	1/4 x 1/8	8	889.72
0404	1/4 x 1/4	10	1141.78
0602	3/8 x 1/8	10	1072.88
0604	3/8 x 1/4	12	1231.89
0606	3/8 x 3/8	14	1553.38
0802	1/2 x 1/8	15	1637.07
0806	1/2 x 3/8	20	1865.67
1002	5/8 x 1/8	26	2201.08

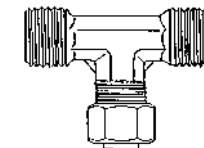

**79SA**  
Tee

00279- Male Pipe x Compression

0606	3/8 x 3/8	14	1117.97
------	-----------	----	---------



**60IS**  
In Line Sleeve

00260-

02	1/8	1	31.39
03	3/16	1	63.46
04	* 1/4	1	40.40
05	5/16	1	57.05
06	* 3/8	1	43.64
08	* 1/2	1	97.68
10	5/8	1	217.79

Use where alignment of the sleeve may be a problem, and three piece construction is desired. Use with 61 nut.

\*Sold in bags of 100 pcs. only

# Brass Self-Aligning Valves

Computer Number	Tube O.D. Size	Weight Per 100	Price Per 100
-----------------	----------------	----------------	---------------

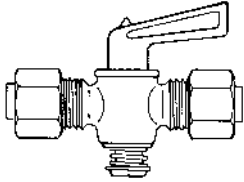

**09616-** Compression x Compression

04	28-CSA	1/4	20	1827.17
05	30-CSA	5/16	23	2137.85
06	58-CSA	3/8	30	2213.62
08	68-CSA	1/2	44	2940.81

Computer Number	Tube O.D. Size	Weight Per 100	Price Per 100
-----------------	----------------	----------------	---------------

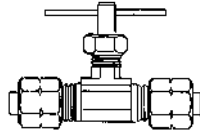

**09606-** Compression x Compression

04	106-CSA	1/4x1/4	9	1148.66
05	107-CSA	5/16x5/16	15	1466.85
06	113-CSA	3/8x3/8	15	1410.72

Computer Number	Tube O.D. Size	Weight Per 100	Price Per 100
-----------------	----------------	----------------	---------------

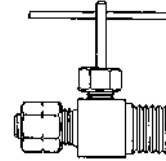

**09601-** Compression x Male Pipe

0402	101-CSA	1/4x1/8	10	959.60
0404	1101-CSA	1/4x1/4	11	1145.48
0502	102-CSA	5/16x1/8	20	1175.19
0604	143-CSA	3/8x1/4	18	1377.32

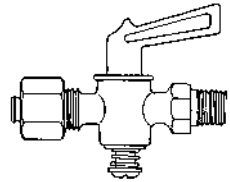

**09611-** Compression x Male Pipe

0402	27-CSA	1/4x1/8	18	1729.32
0404	227-CSA	1/4x1/4	22	1935.61
0502	29-CSA	5/16x1/8	20	1691.92
0504	229-CSA	5/16x1/4	23	2059.36
0604	57-CSA	3/8x1/4	30	2006.24
0606	557-CSA	3/8x3/8	33	2434.94
0806	67-CSA	1/2x3/8	51	3872.72

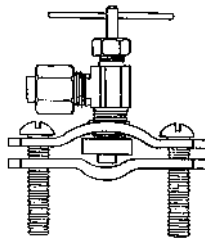

Valve With Brass Saddle

**09695-**

04	104-SCSA	1/4	30	1636.38
05	204-SCSA	5/16	33	1973.70
06	302-SCSA	3/8	30	2952.02

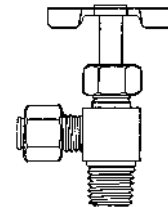

**09603-** Compression x Male Pipe

0402	103-CSA	1/4x1/8	10	736.55
0404	104-CSA	1/4x1/4	10	1369.98
0502	203-CSA	5/16x1/8	12	1075.14
0504	204-CSA	5/16x1/4	16	4104.61
0602	302-CSA	3/8x1/8	10	1723.89
0604	303-CSA	3/8x1/4	22	1520.31

# Brass Compression Fittings for Plastic Tubing

Computer Number	Tube O.D. Size	Weight Per 100	Price Per 100
-----------------	----------------	----------------	---------------



**60P**  
Delrin Sleeve

**00560-**

04	*	1/4	1	17.28
05	*	5/16	1	36.07
06	*	3/8	1	28.73
08	*	1/2	1	33.52
10	*	5/8	1	59.25

\*Sold in bags of 100 pcs. only

Computer Number	Tube O.D. Size	Weight Per 100	Price Per 100
-----------------	----------------	----------------	---------------



**61P**  
Brass Insert

**00561-**

		Hose I.D.			
02	*	1/8	.08	1	37.51
03	*	3/16	.095	1	53.81
04	*	1/4	.17	1	17.92
05	*	5/16	.187	2	39.65
06	*	3/8	.25	2	30.92
08	*	1/2	.375	3	84.97
10	*	5/8	.50	4	132.65

\*Sold in bags of 100 pcs. only

Computer Number	Tube O.D. Size	Weight Per 100	Price Per 100
-----------------	----------------	----------------	---------------



**62P**  
Union

**00562-**

04	1/4	6	224.38
05	5/16	7	316.22
06	3/8	8	328.59
08	1/2	14	452.40
10	5/8	21	587.59



# Brass Compression Fittings for Plastic Tubing

Computer Number	Tube O.D. Size	Weight Per 100	Price Per 100
-----------------	----------------	----------------	---------------



**62PC**  
Union

**00592-** Plastic x Copper

04	1/4	6	254.96
05	5/16	7	357.32
06	3/8	8	376.86
08	1/2	14	597.13
10	5/8	21	796.14

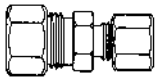

**62RP**  
Reducing Union

**00582-** Plastic x Plastic

0504	5/16 x 1/4	7	371.31
0604	3/8 x 1/4	8	330.91
0605	3/8 x 5/16	9	438.88
0806	1/2 x 3/8	14	456.39
1006	5/8 x 3/8	19	525.17
1008	5/8 x 1/2	21	597.88

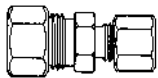

**62RPC**  
Reducing Union

**00593-** Plastic x Copper

0504	5/16 x 1/4	7	364.66
0604	3/8 x 1/4	8	297.90
0605	3/8 x 5/16	9	399.05
0806	1/2 x 3/8	14	435.29
1006	5/8 x 3/8	19	579.21
1008	5/8 x 1/2	21	598.11

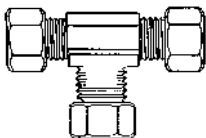

**64P**  
Tee

**00564-** Plastic Three Ends

04	1/4	10	497.66
05	5/16	11	687.88
06	3/8	15	686.95
08	1/2	28	944.34
10	5/8	48	1274.20

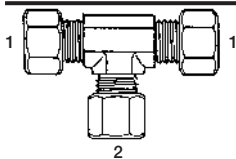

**64RP**  
Reducing Tee

**00584-** Plastic Three Ends

050504	5/16 x 5/16 x 1/4	10	914.57
060604	3/8 x 3/8 x 1/4	12	852.32
080804	1/2 x 1/2 x 1/4	21	1329.98
080806	1/2 x 1/2 x 3/8	25	1430.49
101006	5/8 x 5/8 x 3/8	40	1716.72
101008	5/8 x 5/8 x 1/2	44	1757.47

Computer Number	Tube O.D. Size	Weight Per 100	Price Per 100
-----------------	----------------	----------------	---------------

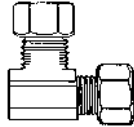

**65P**  
Elbow

**00565-** Plastic x Plastic

04	1/4	7	409.22
05	5/16	8	527.60
06	3/8	10	495.35
08	1/2	21	745.27
10	5/8	30	925.78

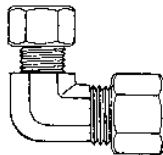

**65RP**  
Reducing Elbow

**00585-** Plastic x Plastic

0604	3/8 x 1/4	8	668.17
0806	1/2 x 3/8	18	920.64
1006	5/8 x 3/8	24	909.95
1008	5/8 x 1/2	26	1047.45

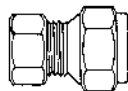

**66P**  
Female Coupling

**00566-** Plastic x Female Pipe

0402	1/4 x 1/8	5	182.53
0404	1/4 x 1/4	6	252.12
0406	1/4 x 3/8	8	485.69
0408	1/4 x 1/2	10	1109.59
0502	5/16 x 1/8	6	257.44
0504	5/16 x 1/4	7	309.81
0506	5/16 x 3/8	8	420.38
0602	3/8 x 1/8	7	269.69
0604	3/8 x 1/4	8	259.52
0606	3/8 x 3/8	10	268.02
0608	3/8 x 1/2	13	324.32
0612	3/8 x 3/4	15	1142.01
0804	1/2 x 1/4	10	683.08
0806	1/2 x 3/8	14	366.16
0808	1/2 x 1/2	16	380.04
0812	1/2 x 3/4	23	1151.03
1006	5/8 x 3/8	20	526.38
1008	5/8 x 1/2	23	494.13
1012	5/8 x 3/4	26	804.11

Computer Number	Tube O.D. Size	Weight Per 100	Price Per 100
-----------------	----------------	----------------	---------------



**68P**  
Connector

**00568-** Plastic x Male Pipe

0402	1/4 x 1/8	5	156.81
0404	1/4 x 1/4	7	176.35
0406	1/4 x 3/8	9	270.39
0408	1/4 x 1/2	11	438.18
0502	5/16 x 1/8	6	186.12
0504	5/16 x 1/4	7	209.76
0506	5/16 x 3/8	8	414.89
0508	5/16 x 1/2	9	1207.04
0602	3/8 x 1/8	8	234.67
0604	3/8 x 1/4	9	216.75
0606	3/8 x 3/8	10	254.55
0608	3/8 x 1/2	12	321.83
0612	3/8 x 3/4	18	629.56
0804	1/2 x 1/4	11	349.23
0806	1/2 x 3/8	12	317.96
0808	1/2 x 1/2	15	359.63
0812	1/2 x 3/4	20	624.76
1006	5/8 x 3/8	16	441.30
1008	5/8 x 1/2	18	408.41
1012	5/8 x 3/4	25	631.58

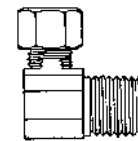

**69P**  
Elbow

**00569-** Plastic x Male Pipe

0402	1/4 x 1/8	5	255.48
0404	1/4 x 1/4	7	313.04
0406	1/4 x 3/8	9	494.65
0408	1/4 x 1/2	11	809.60
0502	5/16 x 1/8	7	318.02
0504	5/16 x 1/4	8	372.29
0506	5/16 x 3/8	9	582.57
0508	5/16 x 1/2	11	853.65
0602	3/8 x 1/8	7	368.19
0604	3/8 x 1/4	8	354.03
0606	3/8 x 3/8	9	400.96
0608	3/8 x 1/2	10	557.02
0612	3/8 x 3/4	12	1121.78
0804	1/2 x 1/4	14	653.37
0806	1/2 x 3/8	15	520.26
0808	1/2 x 1/2	17	668.75
0812	1/2 x 3/4	25	1257.79
1006	5/8 x 3/8	23	802.38
1008	5/8 x 1/2	25	894.80
1012	5/8 x 3/4	30	1270.04



# Brass Compression Fittings for Plastic Tubing

Computer Number	Tube O.D. Size	Weight Per 100	Price Per 100
-----------------	----------------	----------------	---------------

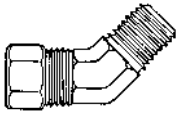

**6945P**  
45° Elbow

**00595-** Plastic x Male Pipe

0402	1/4 x 1/8	5	518.06
0404	1/4 x 1/4	6	716.95
0502	5/16 x 1/8	7	818.68
0504	5/16 x 1/4	8	872.20
0602	3/8 x 1/8	8	1366.87
0604	3/8 x 1/4	9	862.43
0606	3/8 x 3/8	10	1127.50
0806	1/2 x 3/8	17	830.47
0808	1/2 x 1/2	21	1453.03
1008	5/8 x 1/2	30	1608.11

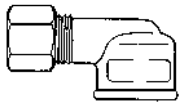

**70P**  
Elbow

**00570-** Plastic x Female Pipe

0402	1/4 x 1/8	7	373.62
0404	1/4 x 1/4	8	504.31
0406	1/4 x 3/8	9	767.76
0408	1/4 x 1/2	10	965.72
0502	5/16 x 1/8	10	664.58
0504	5/16 x 1/4	10	682.85
0602	3/8 x 1/8	10	523.96
0604	3/8 x 1/4	11	532.68
0606	3/8 x 3/8	12	625.28
0608	3/8 x 1/2	14	650.94
0612	3/8 x 3/4	17	1298.59
0804	1/2 x 1/4	16	1012.66
0806	1/2 x 3/8	18	699.44
0808	1/2 x 1/2	20	775.50
0812	1/2 x 3/4	24	1219.35
1006	5/8 x 3/8	22	1502.34
1008	5/8 x 1/2	25	1106.93
1012	5/8 x 3/4	30	1254.14

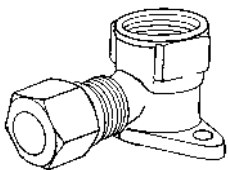

**70PDE**  
Drop Ear  
Elbow

**00590-** Plastic x Female Pipe

1008	5/8 x 1/2	28	1884.74
------	-----------	----	---------

Computer Number	Tube O.D. Size	Weight Per 100	Price Per 100
-----------------	----------------	----------------	---------------

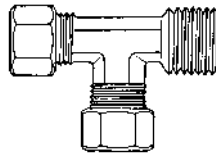

**71P**  
Tee

**00571-** Plastic x Male Pipe

0402	1/4 x 1/8	8	501.59
0404	1/4 x 1/4	9	610.60
0502	5/16 x 1/8	9	774.98
0504	5/16 x 1/4	10	924.28
0602	3/8 x 1/8	11	763.54
0604	3/8 x 1/4	12	707.18
0606	3/8 x 3/8	14	928.90
0806	1/2 x 3/8	22	1048.67
0808	1/2 x 1/2	25	1457.89
1008	5/8 x 1/2	40	1757.00

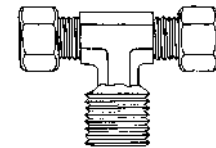

**72P**  
Tee

**00572-** Plastic x Male Pipe

0402	1/4 x 1/8	8	551.01
0404	1/4 x 1/4	9	603.09
0502	5/16 x 1/8	9	704.52
0504	5/16 x 1/4	10	748.45
0602	3/8 x 1/8	11	705.45
0604	3/8 x 1/4	12	669.67
0606	3/8 x 3/8	14	814.40
0608	3/8 x 1/2	17	1339.11
0804	1/2 x 1/4	18	1202.24
0806	1/2 x 3/8	22	988.73
0808	1/2 x 1/2	25	1432.34
1008	5/8 x 1/2	38	1566.55



**74P**  
Tee

**00574-** Plastic x Male Pipe x Female Pipe

040202	1/4 x 1/8 x 1/8	8	1039.24
--------	-----------------	---	---------

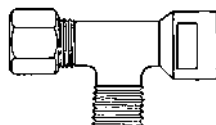

**75P**  
Tee

**00575-** Plastic x Female Pipe x Male Pipe

040202	1/4 x 1/8 x 1/8	8	857.64
040404	1/4 x 1/4 x 1/4	10	997.22

Computer Number	Tube O.D. Size	Weight Per 100	Price Per 100
-----------------	----------------	----------------	---------------

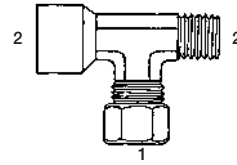

**76P**  
Tee

**00576-** Plastic x Female Pipe x Male Pipe

0402	1/4 x 1/8	8	730.48
0404	1/4 x 1/4	9	998.73
0604	3/8 x 1/4	11	1041.21

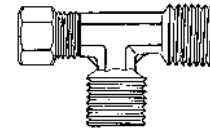

**77P**  
Tee

**00577-** Plastic x Male Pipe

0606	3/8 x 3/8	12	1127.74
------	-----------	----	---------

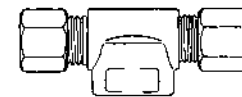

**78P**  
Tee

**00578-** Plastic x Female Pipe

0402	1/4 x 1/8	8	1048.78
0404	1/4 x 1/4	9	1195.54
0602	3/8 x 1/8	10	1217.96
0604	3/8 x 1/4	11	1415.12
0606	3/8 x 3/8	14	1740.07
0802	1/2 x 1/8	17	1836.94
0806	1/2 x 3/8	22	2401.53
1002	5/8 x 1/8	26	2487.19

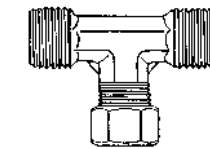

**79P**  
Tee

**00579-** Male Pipe x Plastic

0606	3/8 x 3/8	14	1247.44
------	-----------	----	---------

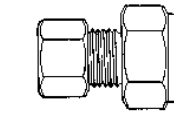

Ballcock  
Adapter

**00587-** Plastic x Ballcock

06	40375PC	3/8	12	1000.29
08	40500PC	1/2	14	1114.67

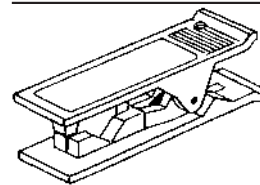

Plastic  
Tubing  
Cutter

**69410**

1/8 O.D. to 5/8 O.D.	1129.55
----------------------	---------

\* For cutting polyethylene, pex, nylon, plastic and rubber tubing.

# Poly-Connect® Brass Flareless Tube Fittings

- Three piece construction-nut, sleeve and body
- Use with copper, aluminum, plastic, or nylon tubing (copper, aluminum, and nylon tubing requires a brass sleeve)
- -65° to +250° F temperature range with brass sleeve
- -40° to +150° F temperature range with plastic sleeve
- POLY-CONNECT fittings do not cause twisting or weakening of the tube, and can stand maximum movement of the tubes
- All fittings come pre-assembled with a fixed insert in the body of the fitting which saves from 36% to 93% of the installation time

## To Assemble:

- 1 Cut tube squarely and insert tubing into fitting until it bottoms.
- 2 Then tighten only the nut with the hands, no tools required.
- 3 Can be assembled and disassembled repeatedly.

## Poly-Connect® Brass Flareless Tube Fittings

Computer Number	Tube O.D. Size	Weight Per 100	Price Per 100
-----------------	----------------	----------------	---------------

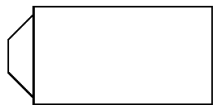

**259PF**  
Plug

02659-	Tube O.D.		
04	1/4	1	111.94
05	5/16	1	129.68
06	3/8	1	104.45
08	1/2	1	127.45

Computer Number	Tube O.D. Size	Weight Per 100	Price Per 100
-----------------	----------------	----------------	---------------

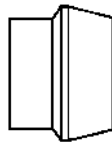

**260PFB**  
Brass Sleeve

02760-	Tube O.D.		
02	1/8	1	82.47
04	1/4	1	55.38
05	5/16	1	97.69
06	3/8	1	67.00
08	1/2	1	87.21

Computer Number	Tube O.D. Size	Weight Per 100	Price Per 100
-----------------	----------------	----------------	---------------

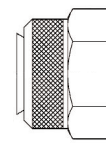

**261PFB**  
Nut & Brass Sleeve

02761-	Tube O.D.		
02	1/8	2	111.30
04	1/4	2	101.17
05	5/16	3	135.43
06	3/8	3	125.71
08	1/2	4	223.48

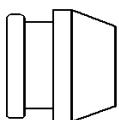

**260PF**  
Plastic Sleeve

02660-	Tube O.D.		
04	1/4	1	15.99
05	5/16	1	22.63
06	3/8	1	25.51
08	1/2	1	28.14

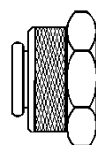

**261PF**  
Nut & Plastic Sleeve

02661-	Tube O.D.		
04	1/4	1	72.59
05	5/16	1	91.13
06	3/8	2	100.28
08	1/2	4	146.36

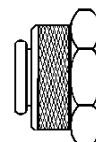

**261PFCP**  
CP Nut & Plastic Sleeve

02621-	Tube O.D.		
04	1/4	2	153.24
06	3/8	3	171.05

# Poly-Connect® Brass Flareless Tube Fittings

Computer Number	Tube O.D. Size	Weight Per 100	Price Per 100
-----------------	----------------	----------------	---------------

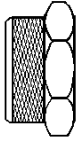

**261PF**  
Nut Only

02961-	Tube O.D.		
02	1/8	1	70.00
04	1/4	1	70.00
05	5/16	2	128.22
06	3/8	2	79.55
08	1/2	3	118.95

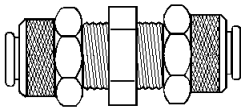

**262PF**  
Union

02662-	Tube O.D. x Tube O.D.		
02	1/8	3	434.13
04	1/4	4	363.85
05	5/16	4	605.47
06	3/8	5	416.15
08	1/2	12	697.81

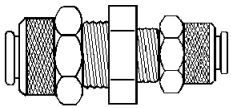

**256PF**  
Reducing Union

02656-	Tube O.D. x Tube O.D.		
0604	3/8 x 1/4	5	566.68

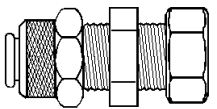

**262PFC**  
PF x Comp

02642-	Tube O.D. x Tube O.D.		
04	1/4	5	443.00
06	3/8	8	548.58

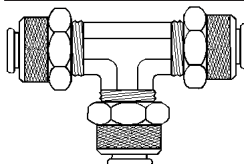

**264PF**  
Tee

02664-	Tube O.D. Three Ends		
02	1/8	6	808.38
04	1/4	7	644.25
05	5/16	9	872.06
06	3/8	10	765.79
08	1/2	13	1267.45

Computer Number	Tube O.D. Size	Weight Per 100	Price Per 100
-----------------	----------------	----------------	---------------

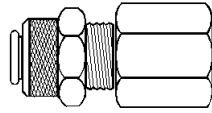

**266PF**  
Female Connector

02666-	Tube O.D. x Female Pipe		
0202	1/8 x 1/8	4	455.71
0402	1/4 x 1/8	4	395.99
0404	1/4 x 1/4	6	440.45
0502	5/16 x 1/8	4	454.37
0604	3/8 x 1/4	6	491.70
0806	1/2 x 3/8	12	728.46

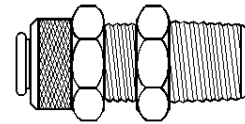

**268PF**  
Connector

02668-	Tube O.D. x Male Pipe		
0202	1/8 x 1/8	3	246.76
0400	1/4 x 10-32	3	523.48
0401	1/4 x 1/16	3	602.23
0402	1/4 x 1/8	4	201.26
0404	1/4 x 1/4	6	263.60
0406	1/4 x 3/8	9	481.38
0502	5/16 x 1/8	4	264.82
0504	5/16 x 1/4	6	379.51
0602	3/8 x 1/8	5	341.17
0604	3/8 x 1/4	7	291.62
0606	3/8 x 3/8	9	373.28
0804	1/2 x 1/4	9	1119.15
0806	1/2 x 3/8	11	484.13
0808	1/2 x 1/2	19	927.69

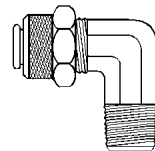

**269PF**  
Elbow

02669-	Tube O.D. x Male Pipe		
0202	1/8 x 1/8	4	387.57
0402	1/4 x 1/8	5	269.60
0404	1/4 x 1/4	6	301.13
0406	1/4 x 3/8	10	585.47
0502	5/16 x 1/8	6	411.13
0504	5/16 x 1/4	7	809.27
0602	3/8 x 1/8	6	439.15
0604	3/8 x 1/4	7	385.38
0606	3/8 x 3/8	11	519.68
0804	1/2 x 1/4	16	1000.45
0806	1/2 x 3/8	16	566.60
0808	1/2 x 1/2	18	1814.57

Computer Number	Tube O.D. Size	Weight Per 100	Price Per 100
-----------------	----------------	----------------	---------------

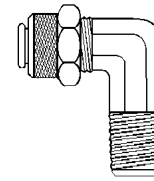

**269PFL**  
Long Elbow

02649-	Tube O.D. x Male Pipe		
0404	1/4 x 1/4	9	737.25

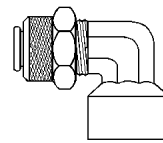

**270PF**  
Female Elbow

02670-	Tube O.D. x Female Pipe		
0202	1/8 x 1/8	8	1363.60
0402	1/4 x 1/8	9	360.36
0404	1/4 x 1/4	9	582.43
0604	3/8 x 1/4	10	520.04
0806	1/2 x 3/8	17	835.02

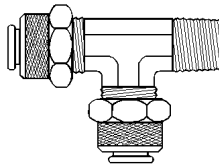

**271PF**  
Tee

02671-	Tube O.D. x Male Pipe		
0202	1/8 x 1/8	7	1397.13
0402	1/4 x 1/8	7	557.04
0404	1/4 x 1/4	11	653.04
0502	5/16 x 1/8	7	1409.51
0604	3/8 x 1/4	11	833.12
0806	1/2 x 3/8	18	1153.97

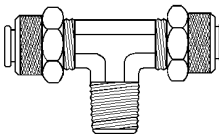

**272PF**  
Tee

02672-	Tube O.D. x Male Pipe		
0202	1/8 x 1/8	6	967.25
0402	1/4 x 1/8	7	535.95
0404	1/4 x 1/4	8	758.50
0502	5/16 x 1/8	8	806.32
0602	3/8 x 1/8	9	996.48
0604	3/8 x 1/4	11	797.04
0806	1/2 x 3/8	21	1173.44

## Poly-Connect® Brass Flareless Tube Fittings

Computer Number	Tube O.D. Size	Weight Per 100	Price Per 100
-----------------	----------------	----------------	---------------

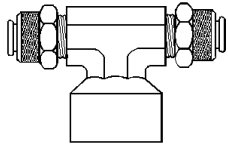

**277PF**  
Female Tee

Tube O.D. x  
Female Pipe

02677-

	Tube O.D. x Female Pipe	Weight Per 100	Price Per 100
0402	1/4 x 1/8	9	926.28
0404	1/4 x 1/4	13	1112.96
0406	1/4 x 3/8	19	1291.70

Computer Number	Tube O.D. Size	Weight Per 100	Price Per 100
-----------------	----------------	----------------	---------------

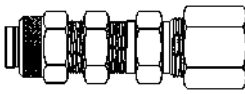

**282PFC**  
Bulkhead  
Union

02648- Tube O.D. x Tube O.D.

	Tube O.D. x Tube O.D.	Weight Per 100	Price Per 100
04	1/4	11	606.23
06	3/8	17	1483.97

Computer Number	Tube O.D. Size	Weight Per 100	Price Per 100
-----------------	----------------	----------------	---------------

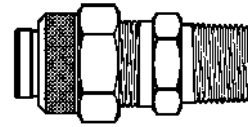

**292PF**  
Quick  
Disconnect  
Fitting

When tube is disconnected, flow  
shuts off automatically

02692-

	Tube O.D. x Male Pipe	Weight Per 100	Price Per 100
0402	1/4 x 1/8	3	1584.09
0404	1/4 x 1/4	6	1834.74
0604	3/8 x 1/4	7	2325.22

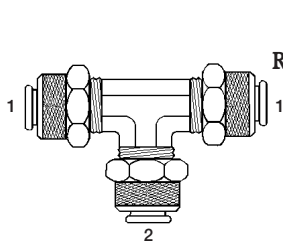

**279PF**  
Reducing Tee

Tube O.D.  
Three Ends

02679-

	Tube O.D. x Three Ends	Weight Per 100	Price Per 100
0604	3/8 x 1/4	10	1048.99

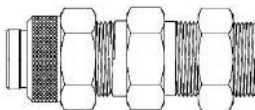

**282PFT**  
Bulkhead  
Tank

02683- Tube O.D. x Tube O.D.

	Tube O.D. x Tube O.D.	Weight Per 100	Price Per 100
04	1/4	4	717.13
06	3/8	6	733.81

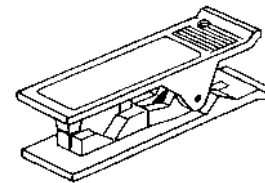

Plastic  
Tubing  
Cutter

69410

	1/8 O.D. to 5/8 O.D.	Price Per 100
		1129.55

\* For cutting polyethylene, pex, nylon, plastic and rubber tubing.

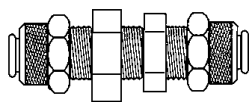

**282PF**  
Bulkhead  
Union

Tube O.D. x  
Tube O.D.

02682-

	Tube O.D. x Tube O.D.	Weight Per 100	Price Per 100
04	1/4	6	693.81
05	5/16	8	927.49
06	3/8	11	961.17
08	1/2	14	1416.07

Drawings Are For Identification Purposes

— ONLY —

Patterns May Vary

## Poly-Connect® Brass Needle Valves

Computer Number	Part Number	Tube O.D. Size	Weight Per 100	Price Per 100
-----------------	-------------	----------------	----------------	---------------

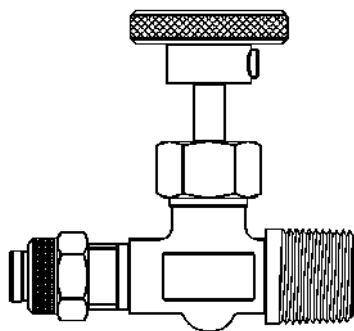

Straight

02911-

	Part Number	Tube O.D. x Male Pipe	Weight Per 100	Price Per 100
0402	101CPF	1/4 x 1/8	13	3770.93
0404	1101CPF	1/4 X 1/4	14	4042.79
0604	143CPF	3/8 x 1/4	28	3964.78

Computer Number	Part Number	Tube O.D. Size	Weight Per 100	Price Per 100
-----------------	-------------	----------------	----------------	---------------

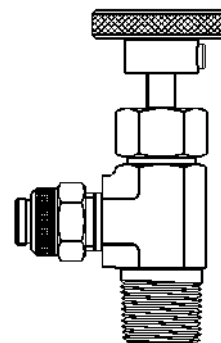

90°

02912-

	Part Number	Tube O.D. x Male Pipe	Weight Per 100	Price Per 100
0402	103CPF	1/4 x 1/8	14	3555.22
0404	104CPF	1/4 x 1/4	14	3862.39
0604	303CPF	3/8 x 1/4	23	3925.43

# Quik-Disconnect®

- Use with polyethylene, polypropylene, nylon & polyvinyl chloride tubing
- Quik-Disconnect® couplings with Poly-Connect® ends provide positive flow shut-off when coupling is disconnected, without extra valving. Available in both single and double end shut-off
- For instrumentation and other applications where repeated connections and disconnections are needed
- With a soft pressure of the thumb, the eyelet is disconnected from the body of the fitting, closing the flow automatically at one or both ends

## To Connect/ Disconnect:

Push - it's connected. Unique cam action automatically moves the locking clip and locks the coupling in an open flow position when the two sections are pushed together. Flow is in either direction. To uncouple, press the locking clip and pull apart. This action disconnects the coupling and instantly seals off the flow.

## Quik-Disconnect® Nickel Plated Brass

Computer Number	Tube O.D. Size	Weight Per 100	Price Per 100
-----------------	----------------	----------------	---------------

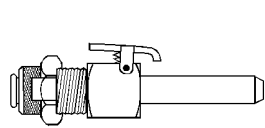

**294PFM**  
Insert  
No Check Valve

02696-	Tube O.D.		
04	1/4	6	1472.06
06	3/8	9	1962.83

Computer Number	Tube O.D. Size	Weight Per 100	Price Per 100
-----------------	----------------	----------------	---------------

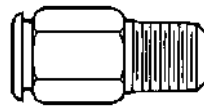

**298PFT**  
Connector  
Body with  
Check Valve

02998-	Tube O.D. x Male Pipe		
0402	1/4 x 1/8	6	1730.53
0404	1/4 x 1/4	8	2332.23
0604	3/8 x 1/4	8	2557.21

Computer Number	Tube O.D. Size	Weight Per 100	Price Per 100
-----------------	----------------	----------------	---------------

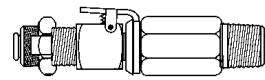

**298PF**  
Connector  
with Single  
Check Valve

02698-	Tube O.D. x Male Pipe		
0402	1/4 x 1/8	11	3025.30
0404	1/4 x 1/4	12	3602.43
0604	3/8 x 1/4	16	4071.98

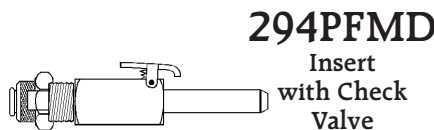

**294PFMD**  
Insert  
with Check  
Valve

02697-	Tube O.D.		
04	1/4	8	2593.81
06	3/8	11	2736.44

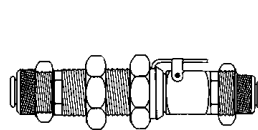

**294PF**  
Bulkhead  
with Single  
Check Valve

02694-	Tube O.D. x Tube O.D.		
04	1/4	14	4022.27
06	3/8	24	5347.00

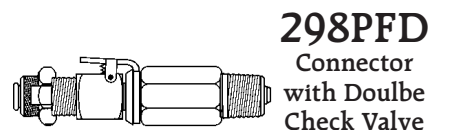

**298PFD**  
Connector  
with Double  
Check Valve

02699-	Tube O.D. x Male Pipe		
0402	1/4 x 1/8	13	4042.23
0404	1/4 x 1/4	15	4590.36
0604	3/8 x 1/4	19	4697.61

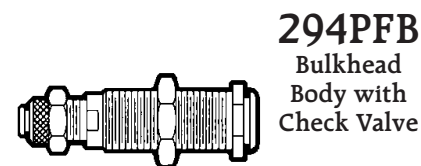

**294PFB**  
Bulkhead  
Body with  
Check Valve

02994-	Tube O.D. x Tube O.D.		
04	1/4	8	2648.30
06	3/8	16	3303.52

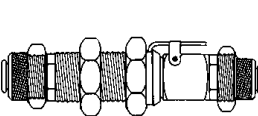

**294PFD**  
Bulkhead  
with Double  
Check Valve

02695-	Tube O.D. x Tube O.D.		
04	1/4	16	5382.19
06	3/8	26	6300.89

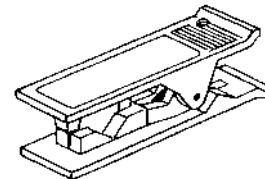

Plastic  
Tubing  
Cutter

69410	1/8 O.D. to 5/8 O.D.	1129.55
-------	----------------------	---------

\* For cutting polyethylene, pex, nylon, plastic and rubber tubing.

# Quik-Push® Brass Push-In Tube Fittings

- High quality all brass three piece construction with o'ring seal
- Use with plastic, nylon and soft metal tubing
- -40° to +200° F temperature range
- Pre-applied Teflon® based pipe sealant on all conical male pipe threads, saves assembly time, as well as installation labor
- An interior hex combined with a 20% reduction in size over the original push-in design helps assembly in limited space applications
- A new double bite collet for greater holding power
- A 37% increase in pullout performance over the original design

## Quick Connect:

- 1 Cut tube end square.
- 2 Introduce tube into fitting until it bottoms against the internal tube stop, no tools required.
- 3 Saves up to 75% of assembly time of standard air compression fittings.

## Quick Disconnect:

- 1 Press ring toward connection and pull tube with the other hand, no tools required.
- 2 In order to reuse tube, cut its previously gripped end and redo connection.

## Quik-Push® Brass Push-In Tube Fittings

Computer Number	Tube O.D. Size	Weight Per 100	Price Per 100
-----------------	----------------	----------------	---------------

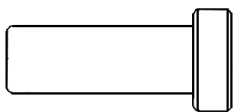

**AQ59P**  
Plastic Plug

02059-	Tube O.D.		
02	1/8	1	92.35
53	5/32	1	POR
04	1/4	1	117.81
06	3/8	1	201.38
08	1/2	1	273.48

Computer Number	Tube O.D. Size	Weight Per 100	Price Per 100
-----------------	----------------	----------------	---------------

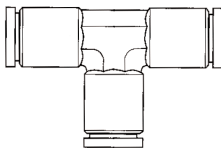

**AQ64P**  
Tee

02064-	Tube O.D. Three Ends		
02	1/8	3	POR
53	5/32	4	647.57
03	3/16	4	POR
04	1/4	5	736.64
06	3/8	9	1003.60
08	1/2	13	1428.06

Computer Number	Tube O.D. Size	Weight Per 100	Price Per 100
-----------------	----------------	----------------	---------------

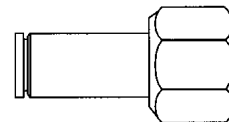

**AQ66P**  
Female Connector

02066-	Tube O.D. x Female Pipe		
0202	1/8 x 1/8	4	POR
5302	5/32 x 1/8	4	775.26
0402	1/4 x 1/8	4	619.60
0404	1/4 x 1/4	8	854.66
0604	3/8 x 1/4	9	1204.57
0606	3/8 x 3/8	10	1492.75

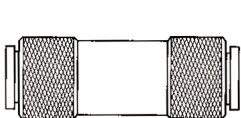

**AQ62P**  
Union

02062-	Tube O.D. x Tube O.D.		
02	1/8	3	454.25
53	5/32	3	526.03
04	1/4	3	519.88
05	5/16	4	678.74
06	3/8	5	701.70
08	1/2	7	939.72

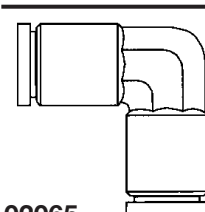

**AQ65P**  
Elbow

02065-	Tube O.D. x Tube O.D.		
02	1/8	3	619.51
53	5/32	3	638.70
04	1/4	4	554.86
06	3/8	7	809.11
08	1/2	11	1276.52

*Listed Weights*

*Are*

*Approximate*



# Quik-Push® Brass Push-In Tube Fittings

Computer Number	Tube O.D. Size	Weight Per 100	Price Per 100
-----------------	----------------	----------------	---------------

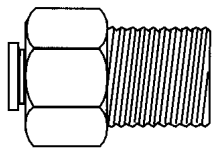

**AQ68P**  
Connector

02068-	Tube O.D. x Male Pipe		
0201	1/8 x 1/16	3	POR
0202	1/8 x 1/8	4	298.74
5300	5/32 x 10-32	2	317.81
5302	5/32 x 1/8	2	266.92
5304	5/32 x 1/4	4	449.72
0300	3/16 x 10-32	3	POR
0302	3/16 x 1/8	4	347.41
0400	1/4 x 10-32	2	557.21
0402	1/4 x 1/8	2	323.68
0404	1/4 x 1/4	4	344.66
0406	1/4 x 3/8	6	466.36
0502	5/16 x 1/8	4	644.66
0504	5/16 x 1/4	4	676.84
0602	3/8 x 1/8	4	498.02
0604	3/8 x 1/4	4	493.04
0606	3/8 x 3/8	7	547.37
0608	3/8 x 1/2	10	907.21
0804	1/2 x 1/4	11	653.04
0806	1/2 x 3/8	11	808.95
0808	1/2 x 1/2	11	1029.80

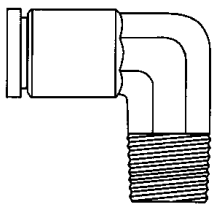

**AQ69P**  
Elbow

02069-	Tube O.D. x Male Pipe		
0202	1/8 x 1/8	3	419.39
5302	5/32 x 1/8	3	379.96
0302	3/16 x 1/8	3	452.39
0402	1/4 x 1/8	4	378.79
0404	1/4 x 1/4	5	416.15
0406	1/4 x 3/8	9	726.32
0602	3/8 x 1/8	7	578.54
0604	3/8 x 1/4	8	595.99
0606	3/8 x 3/8	8	718.54
0804	1/2 x 1/4	11	809.03
0806	1/2 x 3/8	12	790.85
0808	1/2 x 1/2	15	930.73
1006	5/8 x 3/8	14	1409.19

Computer Number	Tube O.D. Size	Weight Per 100	Price Per 100
-----------------	----------------	----------------	---------------

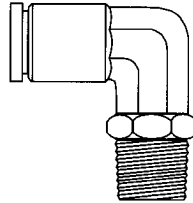

**AQ69PS**  
Swivel  
Elbow

02169-	Tube O.D. x Male Pipe		
0202	1/8 x 1/8	5	485.38
5300	5/32 x 10-32	3	797.77
5302	5/32 x 1/8	3	519.64
5304	5/32 x 1/4	7	749.76
0400	1/4 x 10-32	4	733.60
0402	1/4 x 1/8	5	493.72
0404	1/4 x 1/4	7	569.84
0406	1/4 x 3/8	8	1131.34
0602	3/8 x 1/8	8	988.38
0604	3/8 x 1/4	9	771.05
0606	3/8 x 3/8	11	809.60
0608	3/8 x 1/2	15	1406.07
0806	1/2 x 3/8	14	1040.49
0808	1/2 x 1/2	17	1237.77

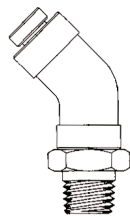

**AQ54PS**  
45° Swivel  
Elbow

02154-	Tube O.D. x Male Pipe		
0402	1/4 x 1/8	5	1410.36
0404	1/4 x 1/4	7	1496.92
0604	3/8 x 1/4	9	1790.00
0804	1/2 x 1/4	12	2094.25

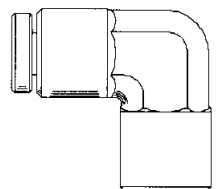

**AQ70P**  
Female  
Elbow

02070-	Tube O.D. x Female Pipe		
0202	1/8 x 1/8	4	496.56
5302	5/32 x 1/8	4	547.69
0402	1/4 x 1/8	5	705.79
0404	1/4 x 1/4	9	842.59
0604	3/8 x 1/4	9	1075.34

Computer Number	Tube O.D. Size	Weight Per 100	Price Per 100
-----------------	----------------	----------------	---------------

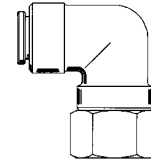

**AQ70PS**  
Female  
Swivel Elbow

02170-	Tube O.D. x Female Pipe		
0402	1/4 x 1/8	5	799.76
0404	1/4 x 1/4	9	953.85
0604	3/8 x 1/4	12	1092.63
0606	3/8 x 3/8	14	1206.15
0806	1/2 x 3/8	14	1546.52

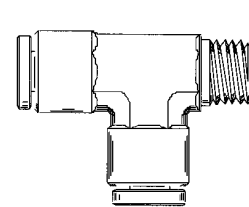

**AQ71P**  
Tee

02071-	Tube O.D. x Male Pipe		
0202	1/8 x 1/8	4	POR
5302	5/32 x 1/8	5	680.77
0302	3/16 x 1/8	5	POR
0402	1/4 x 1/8	5	728.62
0404	1/4 x 1/4	6	780.57
0602	3/8 x 1/8	8	960.08
0604	3/8 x 1/4	9	1050.08
0606	3/8 x 3/8	10	1178.30
0806	1/2 x 3/8	14	1303.08

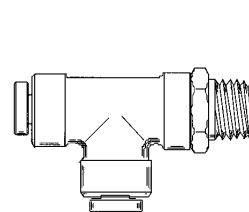

**AQ71PS**  
Swivel  
Tee

02171-	Tube O.D. x Male Pipe		
0202	1/8 x 1/8	6	POR
5302	5/32 x 1/8	6	1247.37
0402	1/4 x 1/8	7	830.61
0404	1/4 x 1/4	9	875.22
0604	3/8 x 1/4	12	1359.88
0606	3/8 x 3/8	14	1569.03
0806	1/2 x 3/8	17	1736.96
0808	1/2 x 1/2	21	1938.10

# Quik-Push® Brass Push-In Tube Fittings

Computer Number	Tube O.D. Size	Weight Per 100	Price Per 100
-----------------	----------------	----------------	---------------

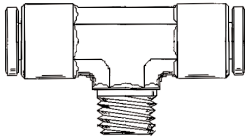

**AQ72P**  
Tee

Tube O.D. x  
Male Pipe

02072-

0202	1/8 x 1/8	4	POR
5302	5/32 x 1/8	4	706.68
0402	1/4 x 1/8	5	731.66
0404	1/4 x 1/4	6	768.74
0406	1/4 x 3/8	11	1612.27
0602	3/8 x 1/8	8	923.77
0604	3/8 x 1/4	9	977.57
0606	3/8 x 3/8	10	1092.11
0804	1/2 x 1/4	13	1511.98
0806	1/2 x 3/8	14	1347.37

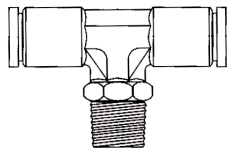

**AQ72PS**  
Swivel  
Tee

Tube O.D. x  
Male Pipe

02172-

0202	1/8 x 1/8	6	POR
5300	5/32 x 10-32	4	1133.40
5302	5/32 x 1/8	6	1133.40
0402	1/4 x 1/8	7	822.51
0404	1/4 x 1/4	8	884.17
0406	1/4 x 3/8	12	1699.84
0604	3/8 x 1/4	11	1065.59
0606	3/8 x 3/8	14	1213.77
0806	1/2 x 3/8	17	1782.79
0808	1/2 x 1/2	23	2047.21

Computer Number	Tube O.D. Size	Weight Per 100	Price Per 100
-----------------	----------------	----------------	---------------

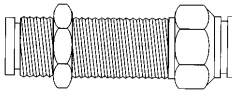

**AQ82P**  
Bulkhead  
Union

Tube O.D. x Tube O.D.

02082-

02	1/8	6	POR
53	5/32	7	850.08
03	3/16	7	POR
04	1/4	7	898.22
06	3/8	9	1163.20
08	1/2	11	1524.70

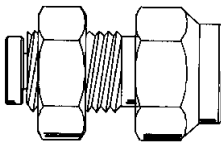

**AQ86P**  
Female Bulkhead  
Union

Tube O.D. x  
Female Pipe

02086-

0402	1/4 x 1/8	8	1045.06
0404	1/4 x 1/4	9	1229.43
0604	3/8 x 1/4	13	1335.38

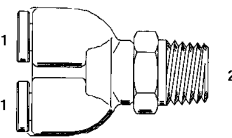

**AQ88P**  
"Y" Connector

Tube O.D. x  
Male Pipe

02088-

5302	5/32 x 1/8	6	1212.91
0402	1/4 x 1/8	7	2004.45
0404	1/4 x 1/4	7	1918.62

Computer Number	Tube O.D. Size	Weight Per 100	Price Per 100
-----------------	----------------	----------------	---------------

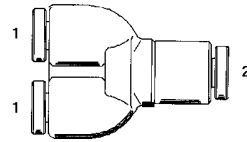

**AQ89P**  
"Y" Connector

Tube O.D. x  
Tube O.D.

02089-

5353	5/32 x 5/32	5	1162.75
5304	5/32 x 1/4	7	1681.70
0402	1/4 x 1/8	7	POR
0453	1/4 x 5/32	7	1521.46
0404	1/4 x 1/4	8	1865.55
0406	1/4 x 3/8	9	2201.05

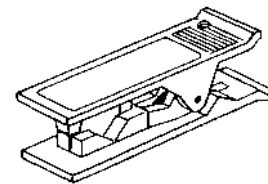

Plastic  
Tubing  
Cutter

69410

1/8 O.D. to 5/8 O.D.	1129.55
----------------------	---------

\* For cutting polyethylene, pex, nylon, plastic and rubber tubing.

## PLEASE CONTACT US FOR OUR OTHER CATALOGS:

- Chrome Stops and Supplies
- Brass Clean Out Plugs
- Plumbing Valves
- Icemaker Kits
- Red Brass Fittings and Nipples
- Teflon Tape and Tube Straps
- Brass Repair Couplings
- Merchandisers
- Polyethylene, Aluminum and Copper Tubing

# Brass Fittings for Nylon Air Brake Systems

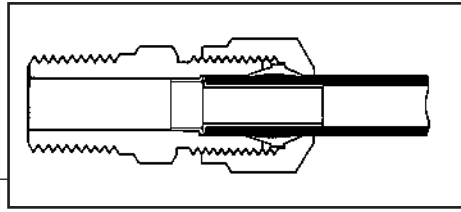

- Three piece construction – nut, sleeve and body with attached insert
- Meets S.A.E. and D.O.T. specifications for nylon air brake systems
- -40° to +200° F. temperature range
- No special tools; flaring not necessary
- Excellent vibration resistance
- Used primarily in air brake and air accessory applications

Tube O.D.	1/4	3/8	1/2	5/8	3/4
Thread Size	7/16-24	17/32-24	11/16-20	13/16-18	1-18

## To Assemble:

- 1 Cut smooth, square end on tubing
- 2 Slide nut, then sleeve, onto tube; threads must face end
- 3 Insert tube into fitting
- 4 Thread nut onto fitting until snug, then as follows:
  - for 1/4" 3 more turns
  - for 3/8" and 1/2" 4 more turns
  - for 5/8" and 3/4" 3-1/2 more turns

# Brass Fittings for Nylon Air Brake Systems

Computer Number	Tube O.D. Size	Weight Per 100	Price Per 100
-----------------	----------------	----------------	---------------



**60NA**  
Sleeve

00460-

04	1/4	1	18.99
06	3/8	1	26.19
08	1/2	1	39.47
10	5/8	1	91.50
12	3/4	1	161.01



**61NA**  
Nut

00461-

04	1/4	1	56.48
06	3/8	2	63.77
08	1/2	3	134.78
10	5/8	6	190.89
12	3/4	9	393.52



**61NSI**  
Steel Insert

00463-

04	1/4	1	50.40
06	3/8	2	54.86
08	1/2	3	82.19
10	5/8	4	190.49
12	3/4	6	237.29

Computer Number	Tube O.D. Size	Weight Per 100	Price Per 100
-----------------	----------------	----------------	---------------



**61NCI**  
Brass Insert With Crown

00473-

04	1/4	1	26.28
06	3/8	1	33.81
08	1/2	3	50.32
10	5/8	4	83.81
12	3/4	6	128.83

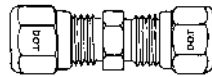

**62NA**  
Union

00462- Compression x Compression

04	1/4	6	294.98
06	3/8	8	379.35
08	1/2	15	643.56
10	5/8	23	1040.93
12	3/4	36	2023.00

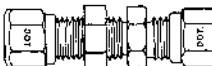

**62NABH**  
Bulkhead Union

00483- Compression x Compression

04	1/4	9	806.92
06	3/8	11	995.34
08	1/2	19	1433.56
10	5/8	24	2668.50

Computer Number	Tube O.D. Size	Weight Per 100	Price Per 100
-----------------	----------------	----------------	---------------

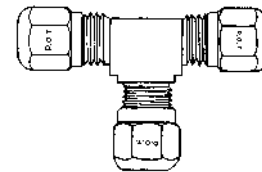

**64NA**  
Tee

00464- Compression Three Ends

04	1/4	10	676.23
06	3/8	15	702.11
08	1/2	28	1486.19
10	5/8	50	3035.06

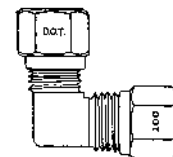

**65NA**  
Elbow

00465- Compression x Compression

04	1/4	7	564.57
06	3/8	10	606.64
08	1/2	21	1120.24
10	5/8	30	1886.44

# Brass Fittings for Nylon Air Brake Systems

Computer Number	Tube O.D. Size	Weight Per 100	Price Per 100
-----------------	----------------	----------------	---------------

**66NA**  
Female Coupling

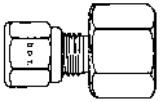

Compression x Female Pipe

00466-				
0402	1/4 x 1/8	5	307.69	
0404	1/4 x 1/4	6	403.12	
0602	3/8 x 1/8	8	346.84	
0604	3/8 x 1/4	8	398.30	
0606	3/8 x 3/8	10	498.02	
0806	1/2 x 3/8	14	726.64	
0808	1/2 x 1/2	16	762.83	
1006	5/8 x 3/8	22	1203.52	
1008	5/8 x 1/2	24	1588.26	
1208	3/4 x 1/2	31	2529.80	



**68NA**  
Connector

Compression x Male Pipe

00468-				
0402	1/4 x 1/8	5	186.44	
0404	1/4 x 1/4	7	232.43	
0406	1/4 x 3/8	9	386.64	
0602	3/8 x 1/8	8	282.96	
0604	3/8 x 1/4	9	248.02	
0606	3/8 x 3/8	10	308.50	
0608	3/8 x 1/2	15	407.17	
0804	1/2 x 1/4	11	489.15	
0806	1/2 x 3/8	12	458.26	
0808	1/2 x 1/2	15	525.34	
1006	5/8 x 3/8	16	887.85	
1008	5/8 x 1/2	18	746.76	
1208	3/4 x 1/2	27	1209.19	
1212	3/4 x 3/4	30	1413.60	

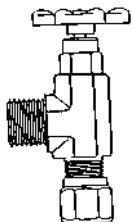

**410NA**  
Truck Valve

Male Pipe x Air Brake

08941-			
0808	1/2 x 1/2	51	2345.95

Computer Number	Tube O.D. Size	Weight Per 100	Price Per 100
-----------------	----------------	----------------	---------------

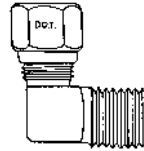

**69NA**  
Elbow

Compression x Male Pipe

00469-				
0402	1/4 x 1/8	6	274.09	
0404	1/4 x 1/4	8	322.02	
0406	1/4 x 3/8	10	603.24	
0602	3/8 x 1/8	9	390.49	
0604	3/8 x 1/4	10	391.90	
0606	3/8 x 3/8	11	404.74	
0608	3/8 x 1/2	12	695.47	
0804	1/2 x 1/4	15	744.21	
0806	1/2 x 3/8	16	595.75	
0808	1/2 x 1/2	18	779.68	
1006	5/8 x 3/8	25	1373.20	
1008	5/8 x 1/2	26	993.93	
1208	3/4 x 1/2	33	2174.09	

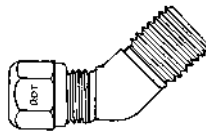

**6945NA**  
45° Elbow

Compression x Male Pipe

00495-				
0402	1/4 x 1/8	6	557.61	
0404	1/4 x 1/4	8	756.68	
0602	3/8 x 1/8	9	961.42	
0604	3/8 x 1/4	10	536.76	
0606	3/8 x 3/8	11	664.25	
0608	3/8 x 1/2	12	1090.89	
0806	1/2 x 3/8	16	800.16	
0808	1/2 x 1/2	18	1229.92	
1008	5/8 x 1/2	26	1413.16	

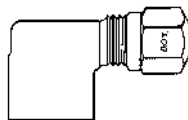

**70NA**  
Elbow

Compression x Female Pipe

00470-				
0402	1/4 x 1/8	7	484.41	
0404	1/4 x 1/4	8	1602.06	
0602	3/8 x 1/8	10	1109.15	
0604	3/8 x 1/4	11	604.41	
0606	3/8 x 3/8	12	730.16	
0806	1/2 x 3/8	18	1025.59	
0808	1/2 x 1/2	20	1415.26	
1008	5/8 x 1/2	25	1973.60	

Computer Number	Tube O.D. Size	Weight Per 100	Price Per 100
-----------------	----------------	----------------	---------------

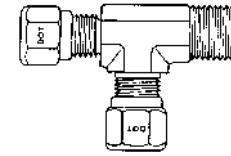

**71NA**  
Tee

Compression x Male Pipe

00471-				
0402	1/4 x 1/8	8	798.10	
0404	1/4 x 1/4	9	1214.05	
0604	3/8 x 1/4	12	702.83	
0606	3/8 x 3/8	14	1155.55	
0806	1/2 x 3/8	22	1365.38	
0808	1/2 x 1/2	25	1869.51	
1008	5/8 x 1/2	40	3626.56	

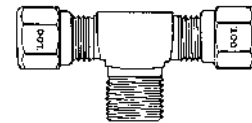

**72NA**  
Tee

Compression x Male Pipe

00472-				
0402	1/4 x 1/8	8	895.51	
0404	1/4 x 1/4	9	982.96	
0602	3/8 x 1/8	11	884.21	
0604	3/8 x 1/4	12	809.11	
0606	3/8 x 3/8	14	775.51	
0806	1/2 x 3/8	22	1104.53	
0808	1/2 x 1/2	25	1693.28	
1008	5/8 x 1/2	40	2944.13	

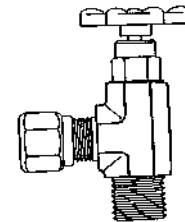

**48NA**  
Truck Valve

Air Brake x Male Pipe

08948-			
0808	1/2 x 1/2	51	2412.19

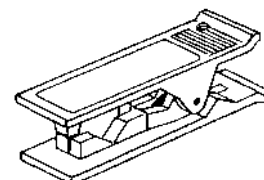

Plastic Tubing Cutter

69410		
1/8 O.D. to 5/8 O.D.		1129.55

\* For cutting polyethylene, pex, nylon, plastic and rubber tubing.

# Quik-Dot® Brass Push-In Tube Fittings

- High quality all brass three piece construction with eyelet and o'ring seal
- Meets D.O.T. FMVSS71.106 and SAE J1131 standards for air brake system requirements
- -40° to +200° F temperature range
- Use with nylon tubing that complies with SAE J 844
- Pre-applied Teflon® based pipe sealant on all conical male pipe threads, saves assembly time, as well as installation labor
- A 20% reduction in size over the original push-in design helps assembly in limited space applications and reduces weight
- A new patented double bite collet for greater holding power provides a 37% increase in pullout performance over the original design
- Unique patented swivel design on elbows and tees provide full flow capabilities
- Captive eyelet with extended length is for easy assembly and allows for full flow. Top end radius eliminates scoring of tubing I.D.

## Quick Connect:

- 1 Cut tube end square.
- 2 Introduce tube into fitting until it bottoms against the internal tube stop, no tools required.
- 3 Saves up to 75% of assembly time of standard air compression fittings.

## Quick Disconnect:

- 1 Press ring toward connection and pull tube with the other hand, no tools required.
- 2 In order to reuse tube, cut its previously gripped end and redo connection.

## Quik-Dot® Brass Push-In Tube Fittings

Computer Number	Tube O.D. Size	Weight Per 100	Price Per 100
-----------------	----------------	----------------	---------------

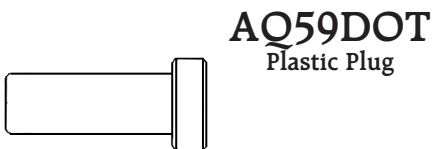

**AQ59DOT**  
Plastic Plug

02459-	Tube O.D.		
53	5/32	1	88.58
04	1/4	1	116.11
06	3/8	1	193.93
08	1/2	1	264.86

Computer Number	Tube O.D. Size	Weight Per 100	Price Per 100
-----------------	----------------	----------------	---------------

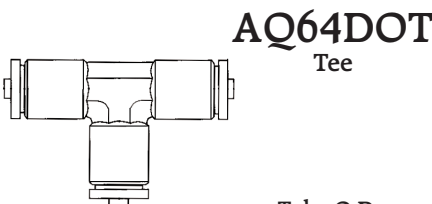

**AQ64DOT**  
Tee

02464-	Tube O.D. Three Ends		
04	1/4	6	1011.78
06	3/8	9	1267.61
08	1/2	14	1609.43

Computer Number	Tube O.D. Size	Weight Per 100	Price Per 100
-----------------	----------------	----------------	---------------



**AQ66DOT**  
Female Connector

02466-	Tube O.D. x Female Pipe		
0402	1/4 x 1/8	4	781.86
0404	1/4 x 1/4	8	885.63
0604	3/8 x 1/4	9	929.55
0606	3/8 x 3/8	9	1208.10

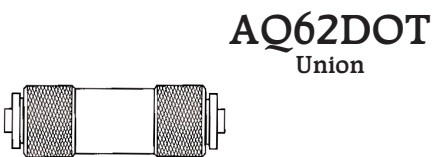

**AQ62DOT**  
Union

02462-	Tube O.D. x Tube O.D.		
53	5/32	3	831.17
04	1/4	4	595.95
06	3/8	6	747.85
08	1/2	8	1001.26
10	5/8	10	1816.48

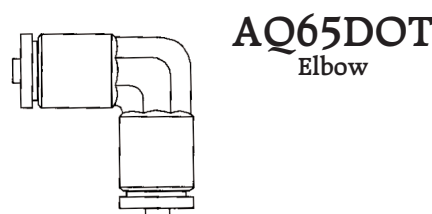

**AQ65DOT**  
Elbow

02465-	Tube O.D. x Tube O.D.		
53	5/32	3	1074.21
04	1/4	4	809.64
06	3/8	7	1001.98
08	1/2	11	1299.03

*We Solicit Your  
Inquiries On Any  
Item Not Shown  
In This Catalog*



# Quik-Dot® Brass Push-In Tube Fittings

Computer Number	Tube O.D. Size	Weight Per 100	Price Per 100
-----------------	----------------	----------------	---------------

## AQ68DOT Connector

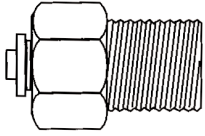

02468-	Tube O.D. x Male Pipe		
5300	5/32 x 10-3/2	2	447.13
5302	5/32 x 1/8	2	458.79
0402	1/4 x 1/8	2	387.77
0404	1/4 x 1/4	4	412.27
0406	1/4 x 3/8	6	530.45
0602	3/8 x 1/8	4	629.47
0604	3/8 x 1/4	5	669.39
0606	3/8 x 3/8	5	693.52
0608	3/8 x 1/2	11	948.14
0804	1/2 x 1/4	7	1007.21
0806	1/2 x 3/8	9	970.04
0808	1/2 x 1/2	9	1142.15
1006	5/8 x 3/8	10	1433.56
1008	5/8 x 1/2	11	1398.79
1208	3/4 x 1/2	14	1194.13
1212	3/4 x 3/4	15	1164.25

## AQ69DOT Elbow

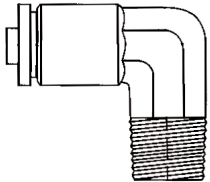

02469-	Tube O.D. x Male Pipe		
5302	5/32 x 1/8	3	566.68
0402	1/4 x 1/8	4	537.17
0404	1/4 x 1/4	5	607.81
0406	1/4 x 3/8	9	840.24
0602	3/8 x 1/8	6	938.30
0604	3/8 x 1/4	7	741.98
0606	3/8 x 3/8	8	1008.83
0608	3/8 x 1/2	11	1275.30
0804	1/2 x 1/4	13	1389.03
0806	1/2 x 3/8	11	1031.58
0808	1/2 x 1/2	15	1031.58
1006	5/8 x 3/8	15	1778.02
1008	5/8 x 1/2	20	1734.78
1208	3/4 x 1/2	31	2347.49
1212	3/4 x 3/4	32	2581.17

Computer Number	Tube O.D. Size	Weight Per 100	Price Per 100
-----------------	----------------	----------------	---------------

## AQ69DOTS Swivel Elbow

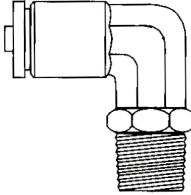

02569-	Tube O.D. x Male Pipe		
0402	1/4 x 1/8	5	630.97
0404	1/4 x 1/4	7	687.17
0406	1/4 x 3/8	8	1062.35
0602	3/8 x 1/8	6	1204.01
0604	3/8 x 1/4	10	1029.27
0606	3/8 x 3/8	11	1158.66
0608	3/8 x 1/2	15	1493.24
0806	1/2 x 3/8	13	1407.04
0808	1/2 x 1/2	17	1456.11
1006	5/8 x 3/8	15	2135.43
1008	5/8 x 1/2	20	2164.37
1212	3/4 x 3/4	43	3618.62

## AQ54DOT 45° Elbow

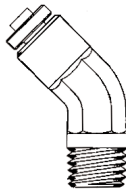

02454-	Tube O.D. x Male Pipe		
0402	1/4 x 1/8	4	809.19
0404	1/4 x 1/4	4	889.76
0604	3/8 x 1/4	4	976.64
0606	3/8 x 3/8	8	1025.75
0804	1/2 x 1/4	4	1185.02
1008	5/8 x 1/2	4	1890.73

## AQ54DOTS 45° Elbow Swivel

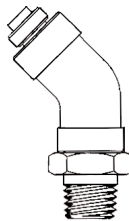

02554-	Tube O.D. x Male Pipe		
0402	1/4 x 1/8	5	878.95
0404	1/4 x 1/4	7	957.49
0602	3/8 x 1/8	7	1241.90
0604	3/8 x 1/4	9	1119.88
0804	1/2 x 1/4	12	1558.30
0806	1/2 x 3/8	16	1763.00
1008	5/8 x 1/2	22	2452.55

Computer Number	Tube O.D. Size	Weight Per 100	Price Per 100
-----------------	----------------	----------------	---------------

## AQ70DOT Female Elbow

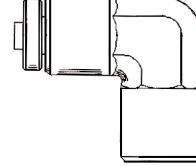

02470-	Tube O.D. x Female Pipe		
0402	1/4 x 1/8	5	733.72
0404	1/4 x 1/4	10	843.77
0406	1/4 x 3/8	10	1465.14
0604	3/8 x 1/4	9	1082.71
0606	3/8 x 3/8	21	1328.66

## AQ70DOTS Female Swivel Elbow

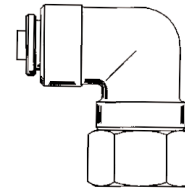

02570-	Tube O.D. x Female Pipe		
0402	1/4 x 1/8	6	842.11
0404	1/4 x 1/4	9	1041.98

## AQ71DOT Tee

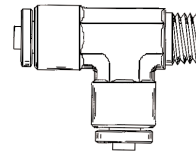

02471-	Tube O.D. x Male Pipe		
0402	1/4 x 1/8	6	908.18
0404	1/4 x 1/4	7	1000.12
0604	3/8 x 1/4	9	1278.50
0606	3/8 x 3/8	10	1294.17
0806	1/2 x 3/8	14	1956.07

## AQ71DOTS Swivel Tee

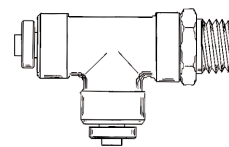

02571-	Tube O.D. x Male Pipe		
0402	1/4 x 1/8	7	1059.76
0404	1/4 x 1/4	9	1074.09
0604	3/8 x 1/4	14	1323.12
0606	3/8 x 3/8	14	1408.66
0806	1/2 x 3/8	17	1820.32
0808	1/2 x 1/2	22	2082.83



# Quik-Dot® Brass Push-In Tube Fittings

Computer Number	Tube O.D. Size	Weight Per 100	Price Per 100
-----------------	----------------	----------------	---------------

## AQ72DOT Tee

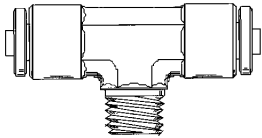

02472-	Tube O.D. x Male Pipe		
0402	1/4 x 1/8	5	929.80
0404	1/4 x 1/4	7	971.82
0604	3/8 x 1/4	9	1278.95
0606	3/8 x 3/8	10	1767.69
0804	1/2 x 1/4	13	2174.70
0806	1/2 x 3/8	14	1612.15

Computer Number	Tube O.D. Size	Weight Per 100	Price Per 100
-----------------	----------------	----------------	---------------

## AQ77DOT Female Tee

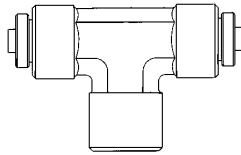

02477-	Tube O.D. x Female Pipe		
0402	1/4 x 1/8	12	1129.92

## AQ77DOTS Female Swivel Tee

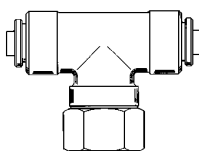

02577-	Tube O.D. x Female Pipe		
0402	1/4 x 1/8	8	1602.02
0404	1/4 x 1/4	8	1583.56
0604	3/8 x 1/4	8	1638.74

Computer Number	Tube O.D. Size	Weight Per 100	Price Per 100
-----------------	----------------	----------------	---------------

## AQ86DOT Female Bulkhead Union

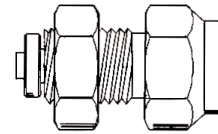

02486-	Tube O.D. x Female Pipe		
0402	1/4 x 1/8	8	955.95
0404	1/4 x 1/4	9	1148.34
0604	3/8 x 1/4	14	1203.77

## AQ72DOTS Swivel Tee

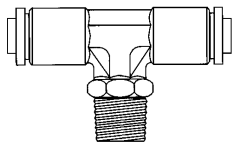

02572-	Tube O.D. x Male Pipe		
0402	1/4 x 1/8	7	1059.68
0404	1/4 x 1/4	8	1121.98
0604	3/8 x 1/4	12	1329.51
0606	3/8 x 3/8	14	1364.62
0806	1/2 x 3/8	17	1724.13
0808	1/2 x 1/2	21	2085.02

## AQ82DOT Bulkhead Union

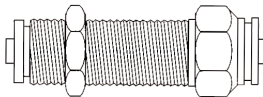

02482-	Tube O.D. x Tube O.D.		
04	1/4	8	1004.98
06	3/8	10	1212.63
08	1/2	14	1614.41
10	5/8	22	POR

## Plastic Tubing Cutter

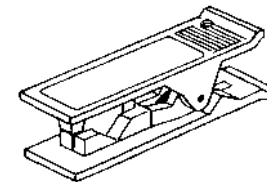

69410	1/8 O.D. to 5/8 O.D.	1129.55
-------	----------------------	---------

\* For cutting polyethylene, pex, nylon, plastic and rubber tubing.

## PLEASE CONTACT US FOR OUR OTHER CATALOGS:

- Chrome Stops and Supplies
- Brass Clean Out Plugs
- Plumbing Valves
- Icemaker Kits
- Red Brass Fittings and Nipples
- Teflon Tape and Tube Straps
- Brass Repair Couplings
- Merchandisers
- Polyethylene, Aluminum and Copper Tubing

# Brass Fittings for Copper Air Brake Systems

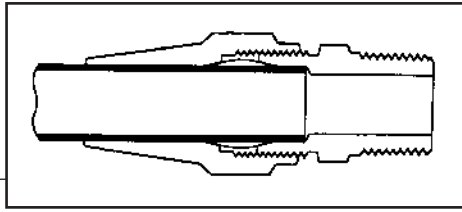

- Three piece construction – nut, sleeve (or ferrule), and body
- -65° to +250° F. temperature range
- No special tools, flaring not necessary
- Fair vibration resistance
- Used primarily in air brake and air accessory applications

Tube O.D.	1/4	3/8	1/2	5/8	3/4
Thread Size	7/16-24	17/32-24	11/16-20	13/16-18	1-18

## To Assemble:

- 1 Cut smooth, square end on tubing
- 2 Slide nut, then sleeve, onto tube; threads must face end
- 3 Insert tube into fitting
- 4 Thread nut onto fitting until snug, then as follows:  
for 1/4", 3/8" and 1/2"  
2 more turns  
for 5/8" and 3/4"  
3 more turns

# Brass Fittings for Copper Air Brake Systems

Computer Number	Tube O.D. Size	Weight Per 100	Price Per 100
-----------------	----------------	----------------	---------------



**60AB**  
Sleeve

00360-

04	1/4	1	14.13
06	3/8	1	19.64
08	1/2	1	30.97
10	5/8	1	54.41
12	3/4	2	100.04

Computer Number	Tube O.D. Size	Weight Per 100	Price Per 100
-----------------	----------------	----------------	---------------

**62ABH**  
Bulkhead Union



00383- Compression x Compression

04	1/4	12	669.43
06	3/8	18	896.23
08	1/2	34	1659.07

Computer Number	Tube O.D. Size	Weight Per 100	Price Per 100
-----------------	----------------	----------------	---------------

**65AB**  
Elbow

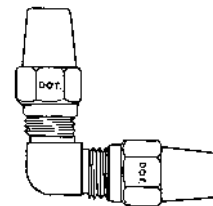

00365- Compression x Compression

04	1/4	12	344.47
06	3/8	15	550.04
08	1/2	33	745.47
10	5/8	41	1063.85

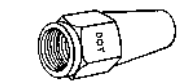

**61AB**  
Nut

00361-

04	1/4	3	61.74
06	3/8	5	85.83
08	1/2	8	161.26
10	5/8	11	231.42
12	3/4	16	390.53

**64AB**  
Tee

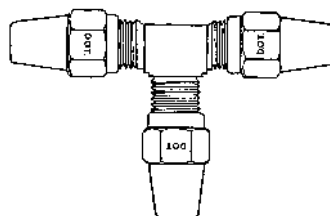

00364- Compression Three Ends

04	1/4	16	426.80
06	3/8	22	684.41
08	1/2	43	1047.33
10	5/8	57	1406.52



**62AB**  
Union

00362- Compression x Compression

04	1/4	9	221.74
06	3/8	13	323.68
08	1/2	23	551.01
10	5/8	32	807.04
12	3/4	50	1408.18

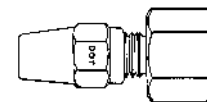

**66AB**  
Female Coupling

00366- Compression x Female Pipe

0402	1/4 x 1/8	7	141.50
0404	1/4 x 1/4	11	182.71
0602	3/8 x 1/8	9	283.28
0604	3/8 x 1/4	12	326.56
0606	3/8 x 3/8	13	403.81
0806	1/2 x 3/8	20	359.07
0808	1/2 x 1/2	26	397.89
1006	5/8 x 3/8	24	714.57
1008	5/8 x 1/2	34	628.62

# Brass Fittings for Copper Air Brake Systems

Computer Number	Tube O.D. Size	Weight Per 100	Price Per 100
-----------------	----------------	----------------	---------------

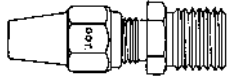

**68AB**  
Connector

Compression x Male Pipe

00368-

Computer Number	Tube O.D. Size	Weight Per 100	Price Per 100
0402	1/4 x 1/8	6	137.13
0404	1/4 x 1/4	9	149.88
0406	1/4 x 3/8	11	207.69
0602	3/8 x 1/8	8	209.64
0604	3/8 x 1/4	9	207.49
0606	3/8 x 3/8	11	269.19
0608	3/8 x 1/2	14	344.25
0804	1/2 x 1/4	18	339.11
0806	1/2 x 3/8	16	304.57
0808	1/2 x 1/2	20	401.54
1006	5/8 x 3/8	22	485.43
1008	5/8 x 1/2	24	515.47
1208	3/4 x 1/2	34	808.38
1212	3/4 x 3/4	39	845.02

Computer Number	Tube O.D. Size	Weight Per 100	Price Per 100
-----------------	----------------	----------------	---------------

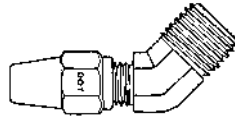

**6945AB**  
45° Elbow

Compression x Male Pipe

00395-

Computer Number	Tube O.D. Size	Weight Per 100	Price Per 100
0402	1/4 x 1/8	7	334.41
0404	1/4 x 1/4	10	479.51
0602	3/8 x 1/8	10	516.56
0604	3/8 x 1/4	11	444.86
0606	3/8 x 3/8	16	738.46
0608	3/8 x 1/2	20	930.32
0806	1/2 x 3/8	20	557.49
0808	1/2 x 1/2	26	1081.70
1008	5/8 x 1/2	36	1204.41

Computer Number	Tube O.D. Size	Weight Per 100	Price Per 100
-----------------	----------------	----------------	---------------

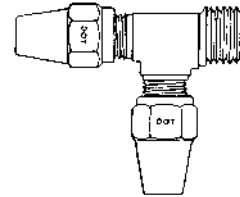

**71AB**  
Tee

Compression x Male Pipe

00371-

Computer Number	Tube O.D. Size	Weight Per 100	Price Per 100
0402	1/4 x 1/8	9	443.24
0404	1/4 x 1/4	13	482.39
0604	3/8 x 1/4	14	670.81
0606	3/8 x 3/8	18	786.36
0806	1/2 x 3/8	28	982.67
0808	1/2 x 1/2	40	1285.43
1008	5/8 x 1/2	43	1488.79

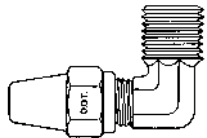

**69AB**  
Elbow

Compression x Male Pipe

00369-

Computer Number	Tube O.D. Size	Weight Per 100	Price Per 100
0402	1/4 x 1/8	8	198.34
0404	1/4 x 1/4	10	261.26
0406	1/4 x 3/8	15	333.16
0602	3/8 x 1/8	11	320.36
0604	3/8 x 1/4	12	339.07
0606	3/8 x 3/8	18	400.89
0608	3/8 x 1/2	20	621.66
0804	1/2 x 1/4	20	531.98
0806	1/2 x 3/8	22	520.89
0808	1/2 x 1/2	31	588.79
1006	5/8 x 3/8	32	721.50
1008	5/8 x 1/2	44	781.54
1208	3/4 x 1/2	57	1197.73

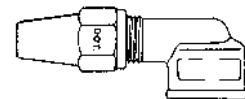

**70AB**  
Elbow

Compression x Female Pipe

00370-

Computer Number	Tube O.D. Size	Weight Per 100	Price Per 100
0402	1/4 x 1/8	9	306.48
0404	1/4 x 1/4	16	369.84
0602	3/8 x 1/8	12	463.32
0604	3/8 x 1/4	16	518.54
0606	3/8 x 3/8	18	579.31
0806	1/2 x 3/8	25	604.57
0808	1/2 x 1/2	37	686.03
1008	5/8 x 1/2	42	926.72

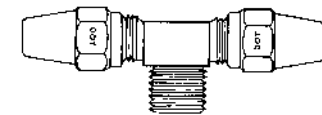

**72AB**  
Tee

Compression x Male Pipe

00372-

Computer Number	Tube O.D. Size	Weight Per 100	Price Per 100
0402	1/4 x 1/8	10	445.22
0404	1/4 x 1/4	15	501.26
0602	3/8 x 1/8	18	676.40
0604	3/8 x 1/4	18	687.94
0606	3/8 x 3/8	24	706.28
0806	1/2 x 3/8	35	938.83
0808	1/2 x 1/2	42	1128.38
1008	5/8 x 1/2	56	1536.15

*Drawings Are For Identification Purposes*

— ONLY —

*Patterns May Vary*

# Brass Hose End Fittings

Computer Number	Hose O.D. Size	Weight Per 100	Price Per 100
-----------------	----------------	----------------	---------------

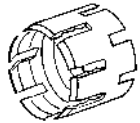

**60HE**  
Sleeve

08060-

06	3/8	2	111.70
08	1/2	2	242.02

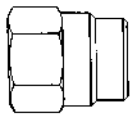

**61HE**  
Nut

08061-

06	3/8	8	195.75
08	1/2	14	294.33

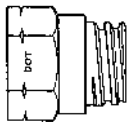

**61HES**  
Spring Guard Nut

08071-

06	3/8	8	178.99
08	1/2	14	369.15

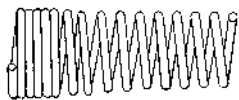

**60HSG**  
Spring Guard

08070-

06	3/8	12	100.36
08	1/2	15	268.42

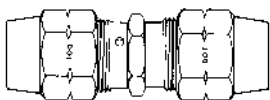

**62HE**  
Union

08062-

Compression x Compression			
06	3/8	34	1400.28
08	1/2	50	2823.48

Computer Number	Hose O.D. Size	Weight Per 100	Price Per 100
-----------------	----------------	----------------	---------------

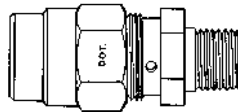

**68HE**  
Connector

Compression x  
Male Pipe

08068-

0604	3/8 x 1/4	21	566.40
0606	3/8 x 3/8	23	577.69
0608	3/8 x 1/2	24	604.33
0806	1/2 x 3/8	31	1058.95
0808	1/2 x 1/2	33	1184.45

**68HES**  
Connector  
With Spring



Compression x  
Male Pipe

08078-

0604	3/8 x 1/4	33	638.70
0606	3/8 x 3/8	35	647.49
0608	3/8 x 1/2	36	721.01
0806	1/2 x 3/8	46	1493.81
0808	1/2 x 1/2	49	1470.61

**66HEA**  
Female  
Coupling

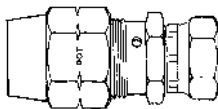

Compression x  
Female Thread

08066-

0612	3/8 x 3/4-20	25	1421.05
0814	1/2 x 7/8-20	35	1926.52

**68HEA**  
Connector  
With Adapter

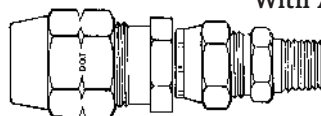

Compression x  
Male Pipe

08086-

0604	3/8 x 1/4	32	1504.25
0606	3/8 x 3/8	32	1555.34
0806	1/2 x 3/8	43	2611.82

Computer Number	Hose O.D. Size	Weight Per 100	Price Per 100
-----------------	----------------	----------------	---------------

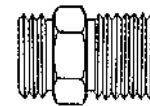

**68HEAB**  
Male  
Adapter

08088-

0604	3/8 (3/4-20) x 1/4	7	200.93
0606	3/8 (3/4-20) x 3/8	7	234.86
0806	1/2 (7/8-20) x 3/8	7	266.32
0808	1/2 (7/8-20) x 1/2	12	335.75

**68HEB**  
Connector  
Body

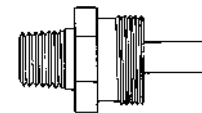

Compression x  
Male Pipe

08098-

0604	3/8 x 1/4	11	270.28
0606	3/8 x 3/8	13	281.78
0608	3/8 x 1/2	14	310.45
0806	1/2 x 3/8	15	613.20
0808	1/2 x 1/2	18	677.37

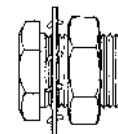

**227ACBH**  
Anchor  
Coupling

Computer Number	Female Pipe	Straight Thread	Length	Price Per 100
00397-02	1/8	5/8-18	1.50	1177.91
00397-04	1/4	3/4-16	1.50	1383.15
00398-04	1/4S	3/4-16	.94	1071.09
00397-06	3/8	1-14	1.31	1916.65
00397-08	1/2	1 1/8-14	1.50	2145.71

*Listed Weights*

*Are*

*Approximate*

## Brass Transition Fittings for CPVC

Computer Number	Size	Weight Per 100	Price Per 100
-----------------	------	----------------	---------------

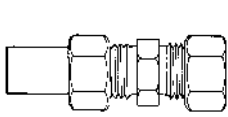

Copper Tubing Adapter

00502- CPVC x Compression

0810	T 71	1/2x5/8	26	974.97
1214	T 72	3/4x7/8	47	1767.58

Computer Number	Size	Weight Per 100	Price Per 100
-----------------	------	----------------	---------------

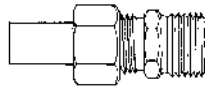

Male Iron Pipe Adapter

00508- CPVC x Male Pipe

0808	T 21	1/2x1/2	21	803.42
1212	T 22	3/4x3/4	43	1445.23

Computer Number	Size	Weight Per 100	Price Per 100
-----------------	------	----------------	---------------

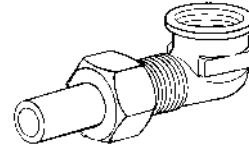

Female Iron Pipe Elbow Adapter

00507- CPVC x Female Pipe

0808	T 51	1/2x1/2	28	1339.63
------	------	---------	----	---------

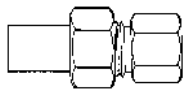

Female Iron Pipe Adapter

00506- CPVC x Female Pipe

0806	T 32	1/2x3/8	25	898.96
0808	T 31	1/2x1/2	26	833.07
1212	T 33	3/4x3/4	37	1712.85

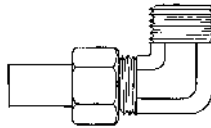

Male Iron Pipe Elbow Adapter

00509- CPVC x Male Pipe

0808	T 41	1/2x1/2	28	1169.99
------	------	---------	----	---------

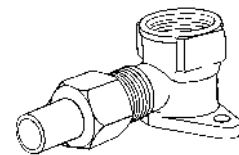

Female Drop Ear Elbow Adapter

00510- CPVC x Female Pipe

0808	T 52	1/2x1/2	31	1983.06
------	------	---------	----	---------

## Brass Evaporative Cooler Fittings

Computer Number	Tube O.D. Size	Weight Per 100	Price Per 100
-----------------	----------------	----------------	---------------



61PL Nut

00861-

04	1/4	1	79.07
----	-----	---	-------

Computer Number	Tube O.D. Size	Weight Per 100	Price Per 100
-----------------	----------------	----------------	---------------



66CPL "Special" Female Coupling

00867- Plastic x Female Tapered Compression Thread (To Adapt Plastic Tubing to Float Valve)

0404	1/4 x 1/4	3	362.93
------	-----------	---	--------

Computer Number	Tube O.D. Size	Weight Per 100	Price Per 100
-----------------	----------------	----------------	---------------

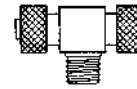

72PL Tee

00872- Plastic x Male Pipe

0402	1/4 x 1/8	7	1281.25
------	-----------	---	---------



62PL Union

00862- Plastic x Plastic

04	1/4	3	486.73
----	-----	---	--------

Plastic x Female Tapered Compression Thread (To Adapt Plastic Tubing to Float Valve)

00868- Plastic x Male Pipe

0402	1/4 x 1/8	3	308.71
------	-----------	---	--------

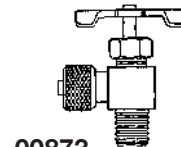

103CPL Needle Valve

00873- Plastic x Male Pipe

0402	1/4 x 1/8	7	1193.34
------	-----------	---	---------

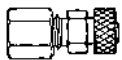

62CPL Union

00863- Compression x Plastic

04	1/4	4	505.35
----	-----	---	--------



68PL Connector

00869- Plastic x Male Pipe

0402	1/4 x 1/8	4	890.70
------	-----------	---	--------

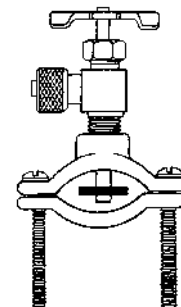

104SPL Saddle Valve

00874- Fits up to 3/4 Pipe

04	1/4	27	1817.75
----	-----	----	---------

## Miscellaneous Supply Fittings

Computer Number	Size	Weight Per 100	Price Per 100
-----------------	------	----------------	---------------

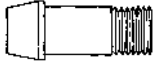

**901**  
Lav.  
Tailpiece

05901	1/4	5	187.68
-------	-----	---	--------

Computer Number	Size	Weight Per 100	Price Per 100
-----------------	------	----------------	---------------

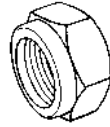

**903**  
Ballcock  
Nut

05903	7/8	6	200.45
-------	-----	---	--------

Computer Number	Size	Weight Per 100	Price Per 100
-----------------	------	----------------	---------------

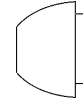

**NP-6**  
Nose Cone

05910	3/8	2	92.77
-------	-----	---	-------

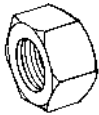

**902**  
Lav. Nut

05902	1/2	4	149.24
-------	-----	---	--------

## PLEASE CONTACT US FOR OUR OTHER CATALOGS:

- Chrome Stops and Supplies
- Brass Clean Out Plugs
- Plumbing Valves
- Icemaker Kits
- Red Brass Fittings and Nipples
- Teflon Tape and Tube Straps
- Brass Repair Couplings
- Merchandisers
- Polyethylene, Aluminum and Copper Tubing



# Brass Pipe Fittings

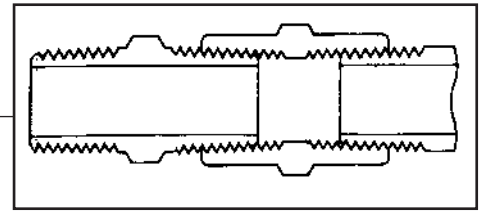

- One piece construction, available in barstock or forgings
- Used with brass or steel pipe
- All pipe threads are "American Standard Taper Pipe Threads"
- Fair vibration resistance
- Used in low to medium pressure applications
- Teflon tape or pipe sealant is recommended
- Pipe threads should be tightened 2 1/2 turns past finger tight

Tube O.D.	1/8	1/4	3/8	1/2	3/4	1
Thread Size	1/8-27	1/4-18	3/8-18	1/2-14	3/4-14	1-11 1/2

## Brass Pipe Fittings

Computer Number	Nominal Size	Weight Per 100	Price Per 100
-----------------	--------------	----------------	---------------

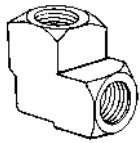

**100**  
Elbow 90°  
Barstock

Female Pipe x  
Female Pipe

06100-			
02	1/8	6	238.89
04	1/4	13	364.20
06	3/8	17	478.41
08	1/2	37	841.05
12	3/4	60	1931.33

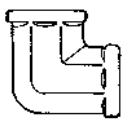

**100F**  
Elbow 90°  
Forged

Female Pipe x  
Female Pipe

06200-			
02	1/8	4	246.81
04	1/4	10	392.75
06	3/8	15	480.09
08	1/2	24	808.51
12	3/4	42	1822.43



**100R**  
Reducing Elbow  
Forged

Female Pipe x  
Female Pipe

06205-			
0402	1/4 x 1/8	11	553.15
0604	3/8 x 1/4	16	818.62
0806	1/2 x 3/8	23	1337.61

Computer Number	Nominal Size	Weight Per 100	Price Per 100
-----------------	--------------	----------------	---------------



**10045**  
Elbow 45°

Female Pipe x  
Female Pipe

06107-			
02	1/8	3	582.23
04	1/4	7	534.48

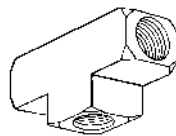

**101**  
Tee  
Barstock

Female Pipe  
Three Ends

06101-			
02	1/8	8	282.06
04	1/4	18	424.54
06	3/8	23	601.47
08	1/2	46	1029.53
12	3/4	71	2055.37

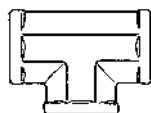

**101F**  
Tee  
Forged

Female Pipe  
Three Ends

06201-			
02	1/8	5	308.94
04	1/4	13	456.79
06	3/8	17	691.63
08	1/2	28	958.38
12	3/4	52	1873.93

Computer Number	Nominal Size	Weight Per 100	Price Per 100
-----------------	--------------	----------------	---------------

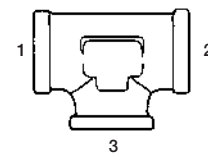

**101R**  
Reducing Tee  
Forged

Female Pipe  
Read Sizes 1-2-3

06206-			
020204	1/8 x 1/8 x 1/4	15	778.33
040402	1/4 x 1/4 x 1/8	14	664.99
060604	3/8 x 3/8 x 1/4	19	903.59
080408	1/2 x 1/4 x 1/2	28	1861.22
080806	1/2 x 1/2 x 3/8	31	1427.49
121208	3/4 x 3/4 x 1/2	61	2416.73

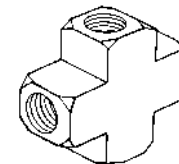

**102**  
Cross  
Barstock

Female Pipe  
Four Ends

06102-			
02	1/8	10	507.37
04	1/4	20	713.25
06	3/8	26	1000.98
08	1/2	51	1618.34
12	3/4	76	4862.25

.....  
*Drawings Are For  
 Identification Purposes  
 — Only —  
 Patterns May Vary*  
 .....

# Brass Pipe Fittings

Computer Number	Nominal Size	Weight Per 100	Price Per 100
-----------------	--------------	----------------	---------------

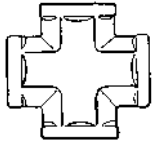

**102F**  
Cross Forged

Female Pipe Four Ends

06202-

02	1/8	10	445.87
04	1/4	13	724.99
06	3/8	17	1053.69
08	1/2	32	1442.63

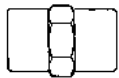

**103**  
Coupling

Female Pipe x Female Pipe

06103-

02	1/8	3	73.58
04	1/4	5	128.89
06	3/8	7	238.19
08	1/2	14	370.73
12	3/4	17	592.62

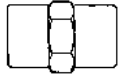

**103XH**  
X-Hvy Coupling

Female Pipe x Female Pipe

06303-

04*	1/4	9	209.11
-----	-----	---	--------

\*3/4" Hex Size

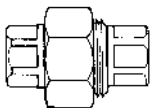

**104**  
Union

Female Pipe x Female Pipe

06104-

02	1/8	12	866.13
04	1/4	25	1405.41
06	3/8	27	2320.53
08	1/2	39	2657.24
12	3/4*	47	3042.77

\*Forged



**108**  
Cap

06108-

Female Pipe

02	1/8	3	91.90
04	1/4	5	131.90
06	3/8	4	249.64
08	1/2	6	355.76
12	3/4	18	596.03

Computer Number	Nominal Size	Weight Per 100	Price Per 100
-----------------	--------------	----------------	---------------

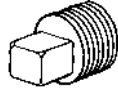

**109**  
Plug Cored Square Head

06109-

02	1/8	2	52.89
04	1/4	4	81.50
06	3/8	6	121.90
08	1/2	10	237.04
12	3/4	12	488.36
16	1	19	889.54

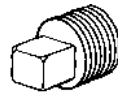

**109S**  
Plug Solid Square Head

06114-

02	1/8	2	54.17
04	1/4	5	88.50
06	3/8	7	117.21
08	1/2	13	361.78
12	3/4	20	596.76



**109AL**  
Countersunk Plug Hex Drive

06115-

02	1/8	2	64.39
04	1/4	3	88.95
06	3/8	5	180.51
08	1/2	9	287.32
12	3/4*	16	619.96

\*Square Drive



**117**  
Slotted Pipe Plug

06117-

02	1/8	1	52.60
04	1/4	2	95.43
06	3/8	4	168.37

Computer Number	Nominal Size	Weight Per 100	Price Per 100
-----------------	--------------	----------------	---------------



**110**  
Hex Bushing

Male Pipe x Female Pipe

06110-

0402	1/4 x 1/8	3	63.75
0602	3/8 x 1/8	6	129.65
0604	3/8 x 1/4	4	99.47
0802	1/2 x 1/8	10	201.14
0804	1/2 x 1/4	9	177.04
0806	1/2 x 3/8	6	149.88
1202	3/4 x 1/8	21	454.89
1204	3/4 x 1/4	19	378.24
1206	3/4 x 3/8	15	371.94
1208	3/4 x 1/2	12	277.61
1604	1 x 1/4	32	758.34
1606	1 x 3/8	31	735.56
1608	1 x 1/2	29	692.68
1612	1 x 3/4	22	633.66



**110F**  
Face Bushing

Male Pipe x Female Pipe

06140-

0604	3/8 x 1/4	3	208.14
0806	1/2 x 3/8	5	200.05
1208	3/4 x 1/2	9	290.16
1612	1 x 3/4	18	850.35



**111**  
Locknut

06111-

Female Pipe

02	1/8	2	85.78
04	1/4	4	128.37
06	3/8	5	173.11
08	1/2	7	248.77
12	3/4	8	526.96



**112**  
Close Nipple

Male Pipe x Male Pipe

06112-

02	1/8	2	48.61
04	1/4	3	80.34
06	3/8	6	114.79
08	1/2	8	179.47
12	3/4	11	402.35

# Brass Pipe Fittings

Computer Number	Nominal Size	Weight Per 100	Price Per 100
-----------------	--------------	----------------	---------------



**113**  
Long Nipple

**06113-** Male Pipe x Length

Computer Number	Nominal Size	Weight Per 100	Price Per 100
0224	1/8 x 1-1/2	3	99.01
0232	1/8 x 2	4	137.45
0240	1/8 x 2-1/2	5	160.80
0248	1/8 x 3	6	193.28
0424	1/4 x 1-1/2	5	133.52
0432	1/4 x 2	6	172.94
0440	1/4 x 2-1/2	7	239.87
0448	1/4 x 3	8	276.34
0624	3/8 x 1-1/2	7	193.23
0632	3/8 x 2	8	255.19
0640	3/8 x 2-1/2	9	306.74

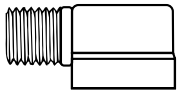

**116**  
Street Elbow 90°  
Barstock

Female Pipe x  
Male Pipe

**06116-**

Computer Number	Nominal Size	Weight Per 100	Price Per 100
02	1/8	4	156.52
04	1/4	8	239.81
06	3/8	16	398.24
08	1/2	27	751.11
12	3/4	51	1391.65

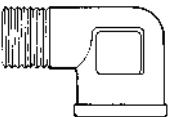

**116F**  
Street Elbow 90°  
Forged

Female Pipe x  
Male Pipe

**06216-**

Computer Number	Nominal Size	Weight Per 100	Price Per 100
02	1/8	6	317.44
04	1/4	7	356.28
06	3/8	16	475.17
08	1/2	22	806.71
12	3/4	27	1261.31



**116L**  
Street Elbow  
Barstock

**06118-** Long Pattern

Computer Number	Nominal Size	Weight Per 100	Price Per 100
02	1/8	7	224.32
04	1/4	10	348.19
06	3/8	16	485.10

Computer Number	Nominal Size	Weight Per 100	Price Per 100
-----------------	--------------	----------------	---------------

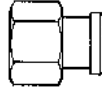

**119**  
Reducing  
Coupling

Female Pipe x  
Female Pipe

**06119-**

Computer Number	Nominal Size	Weight Per 100	Price Per 100
0402	1/4 x 1/8	4	146.18
0602	3/8 x 1/8	9	264.15
0604	3/8 x 1/4	6	220.62
0802	1/2 x 1/8	11	679.27
0804	1/2 x 1/4	11	436.74
0806	1/2 x 3/8	11	382.35
1208	3/4 x 1/2	14	682.50

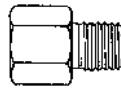

**120**  
Adapter

Female Pipe x  
Male Pipe

**06120-**

Computer Number	Nominal Size	Weight Per 100	Price Per 100
0202	1/8 x 1/8	4	92.36
0402	1/4 x 1/8	4	142.88
0404	1/4 x 1/4	4	154.79
0602	3/8 x 1/8	6	288.48
0604	3/8 x 1/4	8	243.11
0606	3/8 x 3/8	12	255.42
0804	1/2 x 1/4	12	522.11
0806	1/2 x 3/8	11	385.53
0808	1/2 x 1/2	12	398.82
1208	3/4 x 1/2	13	697.82
1212	3/4 x 3/4	14	825.10



**121**  
Plug Cored  
Hex Head

**06121-**

Computer Number	Nominal Size	Weight Per 100	Price Per 100
02	1/8	2	47.97
04	1/4	5	83.06
06	3/8	6	124.10
08	1/2	13	225.13
12	3/4	15	383.16
16	1	26	925.44

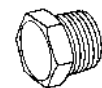

**121S**  
Plug Solid  
Hex Head

**06125-**

Computer Number	Nominal Size	Weight Per 100	Price Per 100
02	1/8	3	68.30
04	1/4	5	107.29
06	3/8	8	196.80
08	1/2	14	255.14
12	3/4	25	396.15

Computer Number	Nominal Size	Weight Per 100	Price Per 100
-----------------	--------------	----------------	---------------

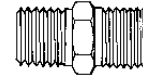

**122**  
Hex  
Nipple

Male Pipe x  
Male Pipe

**06122-**

Computer Number	Nominal Size	Weight Per 100	Price Per 100
02	1/8	3	72.37
04	1/4	5	109.59
06	3/8	6	188.89
08	1/2	11	328.71
12	3/4	17	793.25
16	1	24	1694.46

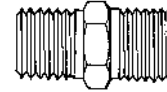

**122L**  
Long Hex  
Nipple

Male Pipe x  
Male Pipe

**06322-**

Computer Number	Nominal Size	Weight Per 100	Price Per 100
04*	1/4	6	144.90

\*OAL 1.375"

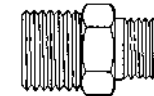

**123**  
Reducing  
Hex Nipple

Male Pipe x  
Male Pipe

**06123-**

Computer Number	Nominal Size	Weight Per 100	Price Per 100
0402	1/4 x 1/8	5	118.37
0602	3/8 x 1/8	6	225.54
0604	3/8 x 1/4	6	194.03
0804	1/2 x 1/4	12	504.77
0806	1/2 x 3/8	10	342.18
1208	3/4 x 1/2	20	785.56



**124**  
Street Elbow 45°  
Barstock

Female Pipe x  
Male Pipe

**06124-**

Computer Number	Nominal Size	Weight Per 100	Price Per 100
02	1/8	5	255.42
04	1/4	10	336.97
06	3/8	12	402.75
08	1/2	22	692.04
12	3/4	25	2104.84

# Brass Pipe Fittings

Computer Number	Nominal Size	Weight Per 100	Price Per 100
-----------------	--------------	----------------	---------------



**124F**  
Street Elbow 45°  
Forged

Female Pipe x  
Male Pipe

06224-

02	1/8	7	439.57
04	1/4	11	551.93
06	3/8	13	713.02

Computer Number	Nominal Size	Weight Per 100	Price Per 100
-----------------	--------------	----------------	---------------

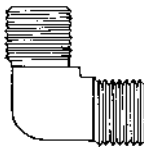

**130**  
Elbow  
Barstock

Male Pipe x  
Male Pipe

06130-

02	1/8	4	298.94
04	1/4	8	387.49
06	3/8	14	665.28

Computer Number	Nominal Size	Weight Per 100	Price Per 100
-----------------	--------------	----------------	---------------

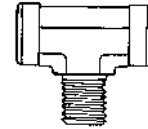

**131F**  
Tee  
Forged

Female Pipe x  
Female Pipe x  
Male Pipe

06231-

02	1/8	10	395.58
04	1/4	12	633.37
06	3/8	24	915.03
08	1/2	29	1470.55

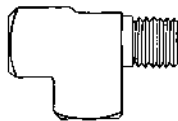

**127**  
Street Tee  
Barstock

Female Pipe x  
Male Pipe x  
Female Pipe

06127-

02	1/8	9	291.31
04	1/4	16	474.65
06	3/8	20	773.65
08	1/2	40	1489.10
12	3/4	61	3197.96

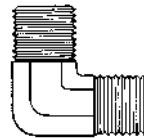

**130F**  
Elbow  
Forged

Male Pipe x  
Male Pipe

06230-

02	1/8	7	283.51
04	1/4	9	352.58
06	3/8	16	610.77
08	1/2	21	804.87

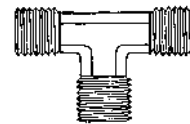

**132F**  
Tee  
Forged

Male Pipe  
Three Ends

06232-

02	1/8	6	482.63
04	1/4	7	535.46
06	3/8	16	829.49
08	1/2	21	1113.81
12	3/4	30	2533.78

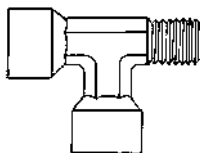

**127F**  
Street Tee  
Forged

Female Pipe x  
Male Pipe x  
Female Pipe

06227-

02	1/8	6	354.89
04	1/4	13	457.02
06	3/8	23	782.79
08	1/2	45	1626.61
12	3/4	64	3775.90

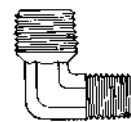

**130R**  
Reducing  
Elbow

Male Pipe x  
Male Pipe

06235-

0402	1/4 x 1/8	7	457.37
0602	3/8 x 1/8	12	517.37
0604	3/8 x 1/4	12	480.84
0806	1/2 x 3/8	18	648.11

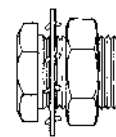

**227ACBH**  
Anchor  
Coupling

Computer Number	Female Pipe	Straight Thread	Length	Price Per 100
00397-02	1/8	5/8-18	1.50	1177.91
00397-04	1/4	3/4-16	1.50	1383.15
00398-04	1/4S	3/4-16	.94	1071.09
00397-06	3/8	1-14	1.31	1916.65
00397-08	1/2	1 1/8-14	1.50	2145.71



**128F**  
Reducing  
Street Elbow  
Forged

Female Pipe x  
Male Pipe

06228-

0204	1/8 x 1/4	9	495.52
0402	1/4 x 1/8*	7	352.58
0406	1/4 x 3/8	20	649.33
0604	3/8 x 1/4	20	726.14
0608	3/8 x 1/2	26	1035.89
0806	1/2 x 3/8	26	1262.47

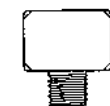

**131**  
Tee  
Barstock

Female Pipe x  
Female Pipe x  
Male Pipe

06131-

02	1/8	5	364.78
04	1/4	8	603.89
06	3/8	12	850.58
08	1/2	20	1841.22
12	3/4	32	3035.71

\*Bar Stock

*We Solicit Your  
Inquiries On Any  
Item Not Shown  
In This Catalog*

# Brass Hose Barbs

- One piece, except swivels (nut and stem)
- Use with plastic tubing or rubber hose
- +32° to 200° F. temperature range
- Intended for use with hose clamp or crimp type ferrule
- Barbed edges provide positive connection
- Excellent vibration resistance
- Barb size is hose I.D.

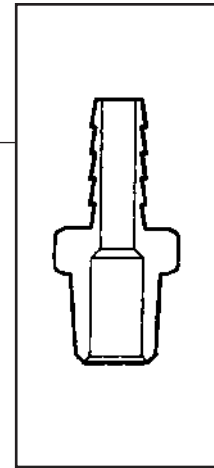

## Brass Hose Barbs

Computer Number	Hose I.D. Size	Weight Per 100	Price Per 100
-----------------	----------------	----------------	---------------

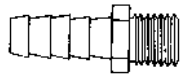

**129**

**07001-**

Barb x Male Pipe

0202	1/8 x 1/8	2	137.85
0204	1/8 x 1/4	2	233.51
0302	3/16 x 1/8	3	111.03
0304	3/16 x 1/4	2	155.25
0402	1/4 x 1/8	2	97.91
0404	1/4 x 1/4	4	106.99
0406	1/4 x 3/8	6	197.56
0408	1/4 x 1/2	10	321.37
0502	5/16 x 1/8	3	122.48
0504	5/16 x 1/4	5	137.39
0506	5/16 x 3/8	6	267.33
0602	3/8 x 1/8	4	124.39
0604	3/8 x 1/4	5	120.11
0606	3/8 x 3/8	6	172.82
0608	3/8 x 1/2	7	332.18
0612	3/8 x 3/4	10	549.33
0704	7/16 x 1/4	5	1713.60
0706	7/16 x 3/8	6	1722.79
0804	1/2 x 1/4	8	184.73
0806	1/2 x 3/8	8	195.36
0808	1/2 x 1/2	11	273.91
0812	1/2 x 3/4	16	472.92
1006	5/8 x 3/8	11	236.11
1008	5/8 x 1/2	12	332.12
1012	5/8 x 3/4	17	506.67
1206	3/4 x 3/8	13	600.25
1208	3/4 x 1/2	14	392.29
1212	3/4 x 3/4	17	493.96
1612	1 x 3/4	21	663.66
1616	1 x 1	32	1043.00
2016	1-1/4 x 1	40	1353.97

Computer Number	Hose I.D. Size	Weight Per 100	Price Per 100
-----------------	----------------	----------------	---------------



**129SWV**

**07003-**

Barb x Male Pipe Swivel

0404	1/4 x 1/4	6	505.69
0604	3/8 x 1/4	7	568.98
0606	3/8 x 3/8	8	596.90
0806	1/2 x 3/8	11	663.89
0808	1/2 x 1/2	15	833.01
1212	3/4 x 3/4	23	1277.55

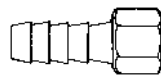

**129F**

**07002-**

Barb x Female Pipe

0202	1/8 x 1/8	2	249.99
0204	1/8 x 1/4	4	417.84
0302	3/16 x 1/8	3	264.49
0304	3/16 x 1/4	4	359.00
0402	1/4 x 1/8	3	174.15
0404	1/4 x 1/4	4	201.26
0406	1/4 x 3/8	6	347.96
0502	5/16 x 1/8	3	336.69
0504	5/16 x 1/4	4	251.60
0506	5/16 x 3/8	6	439.80
0602	3/8 x 1/8	4	291.54
0604	3/8 x 1/4	5	206.17
0606	3/8 x 3/8	7	286.46
0608	3/8 x 1/2	9	481.53
0804	1/2 x 1/4	7	485.92
0806	1/2 x 3/8	8	353.91
0808	1/2 x 1/2	9	428.12
1212	3/4 x 3/4	20	1179.81
1612	1 x 3/4	30	1319.40

Computer Number	Hose I.D. Size	Weight Per 100	Price Per 100
-----------------	----------------	----------------	---------------



**129FS**

**07008-**

Barb x NPSM Ball End Swivel

0202	1/8 x 1/8	3	210.80
0302	3/16 x 1/8	3	251.83
0304	3/16 x 1/4	4	272.53
0402	1/4 x 1/8	4	269.64
0404	1/4 x 1/4	4	184.04
0406	1/4 x 3/8	7	336.97
0504	5/16 x 1/4	4	202.59
0604	3/8 x 1/4	5	212.01
0606	3/8 x 3/8	6	238.31
0608	3/8 x 1/2	13	397.38
0806	1/2 x 3/8	8	419.63
0808	1/2 x 1/2	9	390.67
1212	3/4 x 3/4	14	691.75

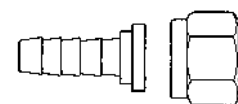

**129SAE**

**07010-**

Barb x Female Flare Swivel

0303	3/16 x 3/16	3	316.40
0304	3/16 x 1/4	3	292.24
0404	1/4 x 1/4	3	208.37
0405	1/4 x 5/16	4	357.49
0406	1/4 x 3/8	6	273.86
0505	5/16 x 5/16	5	339.69
0506	5/16 x 3/8	6	345.93
0606	3/8 x 3/8	7	304.78
0608	3/8 x 1/2	10	490.32
0808	1/2 x 1/2	11	491.76
0810	1/2 x 5/8	15	714.12

# Brass Hose Barbs

Computer Number	Hose I.D. Size	Weight Per 100	Price Per 100
-----------------	----------------	----------------	---------------

## 129UFS

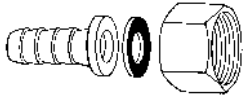

**07009-** Barb x NPSM Swivel Gasket Seat

Computer Number	Hose I.D. Size	Weight Per 100	Price Per 100
0202	1/8 x 1/8	3	389.05
0302	3/16 x 1/8	3	422.00
0304	3/16 x 1/4	4	430.32
0402	1/4 x 1/8	3	434.19
0404	1/4 x 1/4	4	334.26
0406	1/4 x 3/8	6	531.88
0504	5/16 x 1/4	5	332.47
0506	5/16 x 3/8	7	567.19
0604	3/8 x 1/4	5	456.79
0606	3/8 x 3/8	7	566.56
0608	3/8 x 1/2	11	703.31
0806	1/2 x 3/8	7	577.83
0808	1/2 x 1/2	11	750.24

## 129MSAE

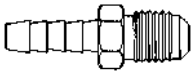

**07004-** Barb x Male Flare

Computer Number	Hose I.D. Size	Weight Per 100	Price Per 100
0205	1/8 x 5/16	3	339.69
0304	3/16 x 1/4	4	306.92
0305	3/16 x 5/16	5	353.45
0404	1/4 x 1/4	5	264.38
0405	1/4 x 5/16	6	358.88
0406	1/4 x 3/8	6	291.08
0505	5/16 x 5/16	6	324.32
0506	5/16 x 3/8	7	395.87
0606	3/8 x 3/8	7	278.60
0608	3/8 x 1/2	8	461.30
0808	1/2 x 1/2	10	563.67
0810	1/2 x 5/8	14	707.76

Computer Number	Hose I.D. Size	Weight Per 100	Price Per 100
-----------------	----------------	----------------	---------------



## 129IS

**07006-** Barb x Inverted Flare Swivel

Computer Number	Hose I.D. Size	Weight Per 100	Price Per 100
0404	1/4 x 1/4	6	1030.29
0505	5/16 x 5/16	7	1071.61
0606	3/8 x 3/8	8	1154.79
0808	1/2 x 1/2	15	1086.58
1010	5/8 x 5/8	23	1247.38

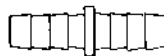

## 129S

**07014-** Barb x Barb

Computer Number	Hose I.D. Size	Weight Per 100	Price Per 100
02	1/8	2	270.56
03	3/16	2	175.37
04	1/4	2	128.61
05	5/16	3	151.49
06	3/8	4	144.96
08	1/2	5	241.60
10	5/8	7	331.43
12	3/4	11	471.42



## 129E

Elbow

**07020-** Barb x Male Pipe

Computer Number	Hose I.D. Size	Weight Per 100	Price Per 100
0302	3/16 x 1/8	3	504.19
0402	1/4 x 1/8	4	358.88
0404	1/4 x 1/4	6	370.15
0502	5/16 x 1/8	5	401.77
0504	5/16 x 1/4	6	391.31
0506	5/16 x 3/8	8	570.37
0602	3/8 x 1/8	5	368.82
0604	3/8 x 1/4	6	351.08
0606	3/8 x 3/8	7	433.85
0608	3/8 x 1/2	8	553.55
0804	1/2 x 1/4	7	615.69
0806	1/2 x 3/8	9	583.78
0808	1/2 x 1/2	11	1392.29
1006	5/8 x 3/8	10	570.72
1008	5/8 x 1/2	13	554.42

Computer Number	Hose I.D. Size	Weight Per 100	Price Per 100
-----------------	----------------	----------------	---------------

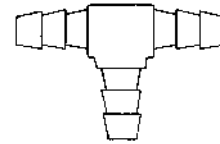

## 129T

Tee

**07024-** Barb x Barb x Barb

Computer Number	Hose I.D. Size	Weight Per 100	Price Per 100
04	1/4	7	482.71
05	5/16	10	465.06
06	3/8	13	443.64



## 12945

45° Elbow

**07045-** Barb x Male Pipe

Computer Number	Hose I.D. Size	Weight Per 100	Price Per 100
0402	1/4 x 1/8	4	389.69
0404	1/4 x 1/4	6	982.02
0502	5/16 x 1/8	5	348.71
0504	5/16 x 1/4	6	442.52
0602	3/8 x 1/8	5	446.62
0604	3/8 x 1/4	6	448.53
0606	3/8 x 3/8	7	538.99
0804	1/2 x 1/4	7	681.12
0806	1/2 x 3/8	9	574.07
1006	5/8 x 3/8	12	593.03



# Brass Hose Ferrules

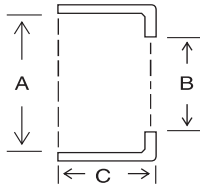

Computer Number	Reference No.	Ferrule I.D. A	Ferrule Length C	Hole Size B	Gauge	Weight Per 100	Price Per 100
60100-01	620	.410	.500	.270	.016	1	28.30
60100-02	769	.450	.562	.343	.016	1	30.24
60100-03	4750	.475	.688	.328	.020	1	35.83
60100-04	624	.500	.469	.359	.016	1	30.24
60100-05	7322	.500	1.000	.344	.025	2	45.99
60100-06	625	.525	.469	.359	.016	1	30.24
60100-07	7323	.525	1.000	.375	.025	2	48.46
60100-08	7324	.530	1.000	.437	.025	2	48.46
60100-09	626	.548	.478	.372	.016	1	35.02
60100-10	7325	.562	1.000	.437	.025	2	51.78
60100-11	KK	.575	.484	.375	.016	1	36.80
60100-12	7326	.593	1.000	.437	.025	2	51.13
60100-13	II	.625	.484	.437	.016	1	33.81
60100-14	7327	.625	1.000	.437	.025	2	54.70
60100-15	HH	.650	.484	.437	.016	1	34.62
60100-16	7328	.656	1.000	.437	.025	2	60.16
60100-17	7329	.687	1.000	.500	.025	2	57.37
60100-18	FF	.700	.563	.500	.016	1	49.92
60100-19	7330	.718	1.000	.500	.025	2	59.47
60100-20	7331	.750	1.000	.500	.025	2	61.74
60100-21	7333	.812	1.000	.625	.025	3	66.92
60100-22	AA	.830	.563	.562	.016	1	47.65
60100-23	7244A	.875	.850	.687	.025	2	64.49
60100-24	7113	.925	.875	.687	.023	2	69.03
60100-25	7104	1.150	.875	.875	.025	3	94.29

(All brass ferrules are sold in bags of 100 pcs. only)

# Miniature Worm Drive Hose Clamps – 5/16" Band

- 1/4" Hex Slotted Carbon Steel Screw
- 5/16" Wide 301 Stainless Steel Band
- Carbon Steel Housing



Computer Number	Diameter		Weight Per 100	Price Per 100
	Min.	Max.		
60200-0410	1/4"	5/8"	2	111.86
60200-0411	1/4"	11/16"	2	111.86
60200-0514	5/16"	7/8"	2	111.86
60200-0616	3/8"	1"	2	120.93

Computer Number	Diameter		Weight Per 100	Price Per 100
	Min.	Max.		
60200-0617	3/8"	1-1/16"	3	150.20
60200-0820	1/2"	1-1/4"	3	150.20
60200-0824	1/2"	1-1/2"	3	167.00
60200-1228	3/4"	1-3/4"	3	199.76

(All hose clamps are sold in bags of 100 pcs. only)

## Brass Miniature Barbs

Computer Number	Hose I.D. Size	Weight Per 100	Price Per 100
-----------------	----------------	----------------	---------------

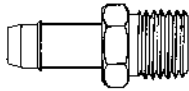

### 129BM

Mini Barb x Male Pipe

07068-

0202	*1/8 x 1/8	2	171.78
0204	*1/8 x 1/4	2	313.28
0402	1/4 x 1/8	2	231.37
0404	1/4 x 1/4	4	281.89
0606	3/8 x 3/8	6	575.69

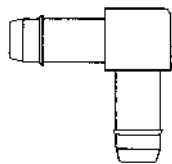

### 129BE Elbow

Mini Barb x Mini Barb

07065-

02	*1/8	4	345.93
04	1/4	6	458.99
06	3/8	8	526.73

\* Fits .188" I.D. hose

Computer Number	Hose I.D. Size	Weight Per 100	Price Per 100
-----------------	----------------	----------------	---------------

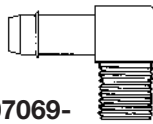

### 129EBM

Mini Barb x Male Pipe

07069-

0202	*1/8 x 1/8	3	277.32
0204	*1/8 x 1/4	3	368.76
0402	1/4 x 1/8	4	382.17
0404	1/4 x 1/4	6	458.93
0606	3/8 x 3/8	7	1080.69

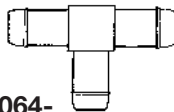

### 129HBT Tee

Mini Barb Three Ends

07064-

02	*1/8	2	469.97
04	1/4	4	539.56
06	3/8	6	584.65

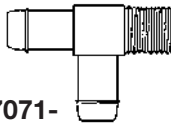

### 129TBMB

Mini Barb x Male Pipe x Mini Barb

07071-

0202	*1/8 x 1/8	5	748.50
0404	1/4 x 1/4	6	1899.42

Computer Number	Hose I.D. Size	Weight Per 100	Price Per 100
-----------------	----------------	----------------	---------------



### 129TBM

Mini Barb x Male Pipe

07072-

0202	*1/8 x 1/8	5	425.00
0402	1/4 x 1/8	6	494.88
0404	1/4 x 1/4	7	626.61
0606	3/8 x 3/8	11	5178.53

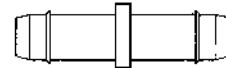

### 129SBM

Mini Barb x Mini Barb

07062-

02	*1/8	2	179.58
04	1/4	2	187.56
06	3/8	4	345.18

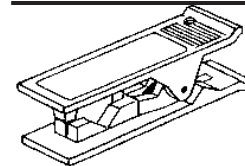

Plastic Tubing Cutter

69410

1/8 O.D. to 5/8 O.D.	1129.55
----------------------	---------

For cutting polyethylene, pex, nylon, plastic and rubber tubing.

## Brass Single Barbs

Computer Number	Hose I.D. Size	Weight Per 100	Price Per 100
-----------------	----------------	----------------	---------------

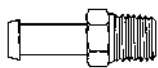

### 159 Barb x Male Pipe

08701-

0302	3/16 x 1/8	3	137.81
0402	1/4 x 1/8	2	77.81
0404	1/4 x 1/4	4	121.26
0502	5/16 x 1/8	3	82.19
0504	5/16 x 1/4	5	116.52
0602	3/8 x 1/8	4	110.97
0604	3/8 x 1/4	5	127.89
0606	3/8 x 3/8	6	197.57
0806	1/2 x 3/8	8	194.41
0808	1/2 x 1/2	11	293.28
1006	5/8 x 3/8	11	360.32
1008	5/8 x 1/2	12	284.41
1012	5/8 x 3/4	17	437.77
1208	3/4 x 1/2	14	359.80
1212	3/4 x 3/4	17	448.30

Computer Number	Hose I.D. Size	Weight Per 100	Price Per 100
-----------------	----------------	----------------	---------------

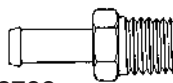

### 159IN Barb x Male Inverted Flare

08706-

0404	1/4 x 1/4	4	102.39
0405	1/4 x 5/16	5	128.62
0504	5/16 x 1/4	5	103.72
0505	5/16 x 5/16	6	115.14
0506	5/16 x 3/8	6	206.07
0605	3/8 x 5/16	6	198.95
0606	3/8 x 3/8	6	227.33

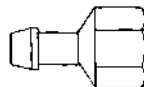

### 159FIN Barb x Female Inverted Flare

08713-

0505	5/16 x 5/16	4	333.24
0605	3/8 x 5/16	7	311.13
0606	3/8 x 3/8	7	330.93

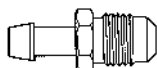

### 159MSAE

Barb x Male Flare

08704-

0606	3/8 x 3/8	7	322.87
------	-----------	---	--------

Computer Number	Hose I.D. Size	Weight Per 100	Price Per 100
-----------------	----------------	----------------	---------------

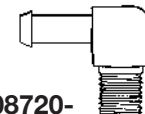

### 159E Barb x Male Pipe Elbow

08720-

0402	1/4 x 1/8	4	262.43
0502	5/16 x 1/8	5	242.51
0504	5/16 x 1/4	6	300.57
0602	3/8 x 1/8	5	345.02
0604	3/8 x 1/4	6	301.62
0606	3/8 x 3/8	7	603.93
0806	1/2 x 3/8	9	830.93
0808	1/2 x 1/2	11	1001.78
1006	5/8 x 3/8	10	704.82
1008	5/8 x 1/2	13	968.06
1208	3/4 x 1/2	16	984.01

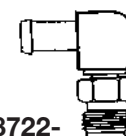

### 159EIS Barb x Inverted Flare Swivel Elbow

08722-

0404	1/4 x 1/4	5	808.87
0405	1/4 x 5/16	6	868.26
0505	5/16 x 5/16	6	887.85
0605	3/8 x 5/16	7	1020.04
0606	3/8 x 3/8	8	652.23

Drawings Are For  
Identification Purposes  
— Only —  
Patterns May Vary

# Brass Welding Hose Fittings

Computer Number	Size	Weight Per 100	Price Per 100
-----------------	------	----------------	---------------

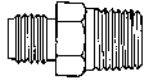

**651**  
Right Hand  
Thread

UNF Thread x  
Male Pipe

07651-

0902	9/16-18 x 1/8	5	321.46
0904	9/16-18 x 1/4	6	323.26
0906	9/16-18 x 3/8	9	346.76
0909	9/16-18 x 9/16-18*	9	323.36

\*UNF Thread

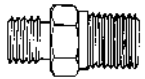

**652**  
Left Hand  
Thread

UNF Thread x  
Male Pipe

07652-

0902	9/16-18 x 1/8	5	321.46
0904	9/16-18 x 1/4	6	323.36
0906	9/16-18 x 3/8	9	346.76
0909	9/16-18 x 9/16-18*	8	323.36

\*UNF Thread

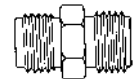

**656**  
Union

07656-

NPSM x NPSM

0404	1/4 x 1/4	5	260.45
0606	3/8 x 3/8	8	382.59
0808	1/2 x 1/2	10	493.44
1212	3/4 x 3/4	14	622.06

Computer Number	Size	Weight Per 100	Price Per 100
-----------------	------	----------------	---------------

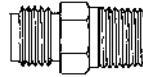

**654**  
Male Adapter

NPSM x  
Male Pipe

07654-

0202	1/8 x 1/8	3	208.46
0402	1/4 x 1/8	4	160.93
0404	1/4 x 1/4	5	134.21
0406	1/4 x 3/8	9	266.84
0602	3/8 x 1/8	6	272.02
0604	3/8 x 1/4	6	308.91
0606	3/8 x 3/8	8	283.20
0608	3/8 x 1/2	12	565.06
0806	1/2 x 3/8	11	443.04
0808	1/2 x 1/2	14	434.74
1212	3/4 x 3/4	18	600.81

**655**  
Female Adapter

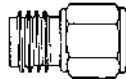

NPSM x  
Female Pipe

07655-

0402	1/4 x 1/8	4	259.23
0404	1/4 x 1/4	5	292.02
0406	1/4 x 3/8	6	394.98
0604	3/8 x 1/4	8	423.00
0606	3/8 x 3/8	8	380.57
0806	1/2 x 3/8	11	555.26
0808	1/2 x 1/2	12	574.01

Computer Number	Size	Weight Per 100	Price Per 100
-----------------	------	----------------	---------------



**129FWL**  
Left Hand  
Thread For  
Acetylene  
Line

07639-

Barb x NPSM

0306	3/16 x 3/8-24	2	236.11
0309	3/16 x 9/16-18	6	236.11
0409	1/4 x 9/16-18	7	198.66
0509	5/16 x 9/16-18	7	243.64
0609	3/8 x 9/16-18	8	250.73

**129FWR**  
Right Hand  
Thread For  
Oxygen  
Line



07629-

Barb x NPSM

0306	3/16 x 3/8-24	2	236.11
0309	3/16 x 9/16-18	6	236.11
0409	1/4 x 9/16-18	6	198.66
0509	5/16 x 9/16-18	7	243.64
0609	3/8 x 9/16-18	7	250.73

*Drawings Are For Identification Purposes*

— ONLY —

*Patterns May Vary*

# Brass Push-On Hose Barbs

- One piece construction
- Use with push-on type hose
- No hose clamp or ferrule needed
- Excellent vibration resistance
- Barb size is hose I.D.

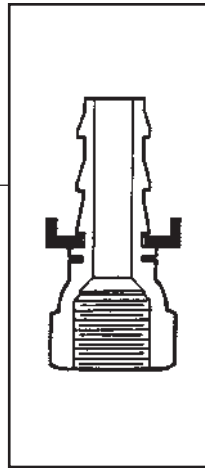

## To Assemble:

- 1 Cut smooth, square end on hose
- 2 Insert fitting until all barbs are covered
- 3 Place end of fitting against a flat object, grip hose one inch from end
- 4 Push until cap covers end of hose

## Brass Push-On Hose Barbs

Computer Number	Hose I.D. Size	Weight Per 100	Price Per 100
-----------------	----------------	----------------	---------------

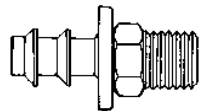

**129PO1**

Barb x Male Pipe

07201-

Computer Number	Hose I.D. Size	Weight Per 100	Price Per 100
0402	1/4 x 1/8	3	157.68
0404	1/4 x 1/4	5	186.35
0406	1/4 x 3/8	6	302.93
0502	5/16 x 1/8	4	295.30
0504	5/16 x 1/4	5	285.13
0602	3/8 x 1/8	6	265.53
0604	3/8 x 1/4	6	217.85
0606	3/8 x 3/8	7	259.52
0608	3/8 x 1/2	12	418.88
0612	3/8 x 3/4	16	879.25
0804	1/2 x 1/4	10	411.59
0806	1/2 x 3/8	10	291.54
0808	1/2 x 1/2	13	390.32
0812	1/2 x 3/4	18	629.10
1006	5/8 x 3/8	16	769.09
1008	5/8 x 1/2	17	533.67
1012	5/8 x 3/4	20	721.40
1208	3/4 x 1/2	24	700.59
1212	3/4 x 3/4	21	733.14

Computer Number	Hose I.D. Size	Weight Per 100	Price Per 100
-----------------	----------------	----------------	---------------

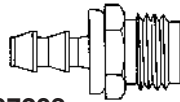

**129PO3**

Barb x NPSM

07203-

Computer Number	Hose I.D. Size	Weight Per 100	Price Per 100
0402	1/4 x 1/8	3	479.97
0404	1/4 x 1/4	4	515.06
0406	1/4 x 3/8	6	562.86
0602	3/8 x 1/8	6	570.60
0604	3/8 x 1/4	6	688.80
0606	3/8 x 3/8	7	780.65
0608	3/8 x 1/2	11	968.79
0806	1/2 x 3/8	9	747.53
0808	1/2 x 1/2	12	936.88
0812	1/2 x 3/4	18	1005.32
1008	5/8 x 1/2	18	867.12
1012	5/8 x 3/4	20	1090.17
1208	3/4 x 1/2	27	1090.17
1212	3/4 x 3/4	22	1090.17

Computer Number	Hose I.D. Size	Weight Per 100	Price Per 100
-----------------	----------------	----------------	---------------

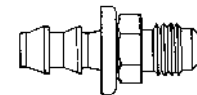

**129PO5**

Barb x 37° Flare (JIC)

07205-

Computer Number	Hose I.D. Size	Weight Per 100	Price Per 100
0404	1/4 x 1/4	4	438.91
0405	1/4 x 5/16	5	389.28
0406	1/4 x 3/8	6	523.32
0604	3/8 x 1/4	7	426.80
0605	3/8 x 5/16	7	442.11
0606	3/8 x 3/8	7	524.01
0608	3/8 x 1/2	11	571.41
0808	1/2 x 1/2	13	574.24
0810	1/2 x 5/8	15	600.60
1008	5/8 x 1/2	19	794.23
1010	5/8 x 5/8	21	864.34
1210	3/4 x 5/8	29	966.30
1212	3/4 x 3/4	30	1244.70

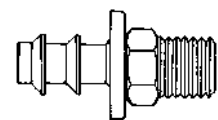

**129PO2**

Barb x Male Pipe Swivel

07202-

Computer Number	Hose I.D. Size	Weight Per 100	Price Per 100
0404	1/4 x 1/4	6	526.21
0604	3/8 x 1/4	8	541.18
0606	3/8 x 3/8	9	608.17
0806	1/2 x 3/8	12	658.05
0808	1/2 x 1/2	16	781.40
1212	3/4 x 3/4	26	1298.07

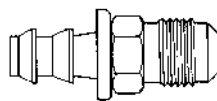

**129PO4**

Barb x 45° Flare (SAE)

07204-

Computer Number	Hose I.D. Size	Weight Per 100	Price Per 100
0404	1/4 x 1/4	4	244.73
0405	1/4 x 5/16	5	283.57
0406	1/4 x 3/8	7	457.02
0604	3/8 x 1/4	7	405.47
0605	3/8 x 5/16	7	436.16
0606	3/8 x 3/8	8	371.94
0608	3/8 x 1/2	11	573.03
0808	1/2 x 1/2	14	809.03
0810	1/2 x 5/8	16	692.68
1008	5/8 x 1/2	21	798.10
1010	5/8 x 5/8	21	947.57
1210	3/4 x 5/8	29	965.84
1212	3/4 x 3/4	22	1317.41

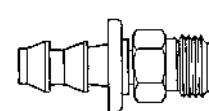

**129PO6**

Barb x Inverted Flare Swivel

07206-

Computer Number	Hose I.D. Size	Weight Per 100	Price Per 100
0403	1/4 x 3/16	4	366.57
0404	1/4 x 1/4	4	380.15
0405	1/4 x 5/16	4	401.42
0504	5/16 x 1/4	5	446.45
0505	5/16 x 5/16	5	457.78
0506	5/16 x 3/8	7	757.53
0605	3/8 x 5/16	6	498.29
0606	3/8 x 3/8	7	434.08
0608	3/8 x 1/2	11	946.88
0806	1/2 x 3/8	12	1065.25
0808	1/2 x 1/2	12	555.63
1010	5/8 x 5/8	17	1171.14

# Brass Push-On Hose Barbs

Computer Number	Hose I.D. Size	Weight Per 100	Price Per 100
-----------------	----------------	----------------	---------------

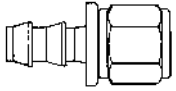

**129PO7**  
Barb x  
Female Pipe

**07207-**

0402	1/4 x 1/8	4	313.91
0404	1/4 x 1/4	6	320.21
0406	1/4 x 3/8	7	537.89
0504	5/16 x 1/4	5	261.31
0602	3/8 x 1/8	5	460.38
0604	3/8 x 1/4	6	338.07
0606	3/8 x 3/8	7	367.90
0608	3/8 x 1/2	10	784.75
0804	1/2 x 1/4	7	637.42
0806	1/2 x 3/8	8	354.08
0808	1/2 x 1/2	11	495.23
0812	1/2 x 3/4	22	1456.96
1008	5/8 x 1/2	14	1142.30
1012	5/8 x 3/4	24	1704.46
1212	3/4 x 3/4	23	1763.59



**129PO8**  
Barb x  
NPSM Ball End

**07208-**

- Swivel -

0402	1/4 x 1/8	3	556.61
0404	1/4 x 1/4	6	562.11
0406	1/4 x 3/8	9	790.65
0604	3/8 x 1/4	8	676.32
0606	3/8 x 3/8	10	727.47
0608	3/8 x 1/2	11	909.31
0808	1/2 x 1/2	13	981.85
0812	1/2 x 3/4	19	1396.97
1012	5/8 x 3/4	20	1524.82
1212	3/4 x 3/4	23	1532.39

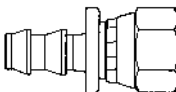

**129PO9**  
Barb x  
NPSM Gasket Seat

**07209-**

- Swivel -

0402	1/4 x 1/8	3	612.83
0404	1/4 x 1/4	6	613.20
0406	1/4 x 3/8	8	888.96
0604	3/8 x 1/4	7	732.09
0606	3/8 x 3/8	9	932.03
0608	3/8 x 1/2	11	1056.70
0808	1/2 x 1/2	11	1056.70
0812	1/2 x 3/4	18	1556.79
1012	5/8 x 3/4	19	1609.79
1212	3/4 x 3/4	21	1569.67

Computer Number	Hose I.D. Size	Weight Per 100	Price Per 100
-----------------	----------------	----------------	---------------



**129PO10**  
Barb x  
Dual Seat Flare  
45° SAE - 37° JIC

**07210-**

- Swivel -

0404	1/4 x 1/4	4	238.37
0405	1/4 x 5/16	5	310.39
0505	5/16 x 5/16	5	341.31
0608	3/8 x 1/2	10	451.88
0808	1/2 x 1/2	11	470.67
0810	1/2 x 5/8	13	730.25
1008	5/8 x 1/2	14	757.64
1010	5/8 x 5/8	18	812.21
1210	3/4 x 5/8	24	919.60

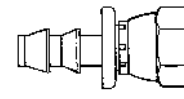

**129PO11**  
Barb x  
Female  
45° SAE Flare

**07211-**

- Swivel -

0406	1/4 x 3/8	8	384.37
0506	5/16 x 3/8	7	399.17
0606	3/8 x 3/8	9	405.24
0806	1/2 x 3/8	11	735.10
1212	3/4 x 3/4	33	893.41

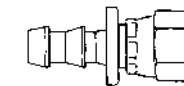

**129PO12**  
Barb x  
Female  
37° JIC Flare

**07212-**

- Swivel -

0406	1/4 x 3/8	6	355.24
0606	3/8 x 3/8	7	284.78
1212	3/4 x 3/4	23	893.41

.....  
*Listed Weights  
Are Approximate*  
.....

Computer Number	Hose I.D. Size	Weight Per 100	Price Per 100
-----------------	----------------	----------------	---------------

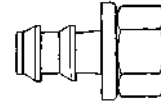

**129PO13**  
Barb x  
Rigid Inverted  
Flare

**07213-**

0403	1/4 x 3/16	3	261.26
0404	1/4 x 1/4	3	261.26
0405	1/4 x 5/16	3	287.27
0605	3/8 x 5/16	5	459.68
0606	3/8 x 3/8	6	345.76
0808	1/2 x 1/2	9	753.19

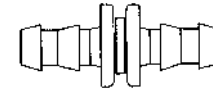

**129PO14**  
Barb x Barb

**07214-**

04	1/4	3	223.05
05	5/16	4	283.97
06	3/8	6	267.73
08	1/2	6	343.22
10	5/8	14	538.75
12	3/4	16	699.55

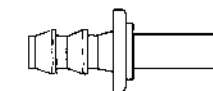

**129PO15**  
Barb x  
I.D. Tube Shank

**07215-**

0403	1/4 x 3/16	2	327.73
0404	1/4 x 1/4	2	311.66
0405	1/4 x 5/16	3	342.87
0606	3/8 x 3/8	4	414.02
0808	1/2 x 1/2	5	480.20
1010	5/8 x 5/8	9	761.46



**129PO20**  
Barb x Male Pipe  
Elbow

**07220-**

0402	1/4 x 1/8	4	590.66
0404	1/4 x 1/4	6	648.57
0502	5/16 x 1/8	5	1138.78
0504	5/16 x 1/4	6	1261.72
0602	3/8 x 1/8	5	721.29
0604	3/8 x 1/4	6	711.17
0606	3/8 x 3/8	7	746.60
0608	3/8 x 1/2	8	1117.16
0806	1/2 x 3/8	9	1073.11
0808	1/2 x 1/2	11	1246.86
1008	5/8 x 1/2	13	1495.34
1012	5/8 x 3/4	19	3115.14
1212	3/4 x 3/4	24	1983.23

## Brass Reusable Hose Fittings

Computer Number	Hose I.D. Size	Weight Per 100	Price Per 100
-----------------	----------------	----------------	---------------



**129RU16**  
Reusable Insert

**07216-** I.D. x O.D. x Female NPSM

030604	3/16 x 3/8 x 1/4	11	1128.66
030704	3/16 x 7/16 x 1/4	12	1540.25
040804	1/4 x 1/2 x 1/4	14	1145.02
040806	1/4 x 1/2 x 3/8	16	1584.24
040904	1/4 x 9/16 x 1/4	15	1625.86
040906	1/4 x 9/16 x 3/8	17	1625.86
041004	1/4 x 5/8 x 1/4	16	1208.31
041006	1/4 x 5/8 x 3/8	19	1375.64
050904	5/16 x 9/16 x 1/4	14	1266.98
051004	5/16 x 5/8 x 1/4	15	1292.58
051104	5/16 x 11/16 x 1/4	19	1242.76
061004	3/8 x 5/8 x 1/4	16	1347.95
061006	3/8 x 5/8 x 3/8	19	1473.26
061008	3/8 x 5/8 x 1/2	22	1704.98
061104	3/8 x 11/16 x 1/4	20	1405.52
061106	3/8 x 11/16 x 3/8	23	1537.71
061108	3/8 x 11/16 x 1/2	26	1782.21
061204	3/8 x 3/4 x 1/4	17	1357.38
061206	3/8 x 3/4 x 3/8	20	1563.66
061208	3/8 x 3/4 x 1/2	23	1807.98
081408	1/2 x 7/8 x 1/2	33	2181.20
081508	1/2 x 15/16 x 1/2	37	2245.53
081608	1/2 x 1 x 1/2	40	2361.36

Computer Number	Hose I.D. Size	Weight Per 100	Price Per 100
-----------------	----------------	----------------	---------------

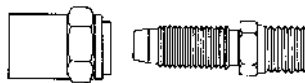

**129RU17**  
Reusable Insert

**07217-** I.D. x O.D. x Male NPSM

030602	3/16 x 3/8 x 1/8	6	720.07
030604	3/16 x 3/8 x 1/4	8	863.82
030702	3/16 x 7/16 x 1/8	7	738.86
030704	3/16 x 7/16 x 1/4	9	902.20
040802	1/4 x 1/2 x 1/8	9	861.39
040804	1/4 x 1/2 x 1/4	10	840.12
040806	1/4 x 1/2 x 3/8	12	1151.55
040902	1/4 x 9/16 x 1/8	10	885.79
040904	1/4 x 9/16 x 1/4	11	924.28
040906	1/4 x 9/16 x 3/8	13	1173.57
041002	1/4 x 5/8 x 1/8	11	933.64
041004	1/4 x 5/8 x 1/4	12	948.15
041006	1/4 x 5/8 x 3/8	15	1128.55
050904	5/16 x 9/16 x 1/4	12	1091.21
050906	5/16 x 9/16 x 3/8	14	1220.39
051004	5/16 x 5/8 x 1/4	12	1005.89
051006	5/16 x 5/8 x 3/8	15	1243.68
051104	5/16 x 11/16 x 1/4	16	1040.23
051106	5/16 x 11/16 x 3/8	18	1352.00
061004	3/8 x 5/8 x 1/4	13	1183.57
061006	3/8 x 5/8 x 3/8	17	1106.75
061008	3/8 x 5/8 x 1/2	19	1432.63

*Continued to Next Column*

Computer Number	Hose I.D. Size	Weight Per 100	Price Per 100
-----------------	----------------	----------------	---------------

**07217-**

061104	3/8 x 11/16 x 1/4	17	1083.75
061106	3/8 x 11/16 x 3/8	20	1095.14
061108	3/8 x 11/16 x 1/2	23	1500.72
061204	3/8 x 3/4 x 1/4	14	1062.02
061206	3/8 x 3/4 x 3/8	17	1097.51
061208	3/8 x 3/4 x 1/2	20	1518.06
081404	1/2 x 7/8 x 1/4	26	1893.87
081406	1/2 x 7/8 x 3/8	28	1950.40
081408	1/2 x 7/8 x 1/2	31	2128.31
081504	1/2 x 15/16 x 1/4	30	1948.61
081506	1/2 x 15/16 x 3/8	32	2017.34
081508	1/2 x 15/16 x 1/2	36	1994.16
081604	1/2 x 1 x 1/4	33	2080.74
081606	1/2 x 1 x 3/8	35	2129.99
081608	1/2 x 1 x 1/2	38	2302.58

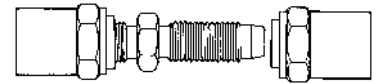

**129RU18**  
Reusable Splicer

**07218-** I.D. x O.D.

0408	1/4 x 1/2	16	1608.40
0409	1/4 x 9/16	19	1712.33
0410	1/4 x 5/8	19	1745.16
0610	3/8 x 5/8	23	1838.62
0611	3/8 x 11/16	25	1953.52
0612	3/8 x 3/4	21	1962.31

## Brass Garden Hose Fittings

Computer Number	Hose I.D. Size	Weight Per 100	Price Per 100
-----------------	----------------	----------------	---------------

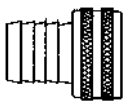

**329NPSM**  
Barb x  
Female NPSM

**07040-**

0612	3/8 x 3/4	9	470.49
0812	1/2 x 3/4	10	475.06
1012	5/8 x 3/4	11	476.50
1212	3/4 x 3/4	14	491.18

Computer Number	Hose I.D. Size	Weight Per 100	Price Per 100
-----------------	----------------	----------------	---------------

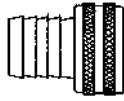

**329F**  
Barb x  
Female Hose

**07046-**

0612	3/8 x 3/4	9	487.14
0812	1/2 x 3/4	10	443.73
1012	5/8 x 3/4	11	443.73
1212	3/4 x 3/4	14	458.99

Computer Number	Hose I.D. Size	Weight Per 100	Price Per 100
-----------------	----------------	----------------	---------------

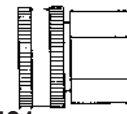

Female Hose x  
Female Pipe

**07401-**

- Swivel -

1208	S1	3/4 x 1/2	9	424.60
1212	S2	3/4 x 3/4	12	479.97

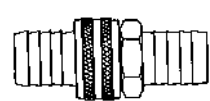

**329MF**  
Garden Hose  
Barb Set

**07042-**

06	3/8	20	815.10
08	1/2	22	746.02
10	5/8	24	764.87
12	3/4	28	856.13

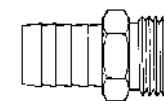

**329M**  
Barb x  
Male Hose

**07048-**

0612	3/8 x 3/4	11	419.80
0812	1/2 x 3/4	12	419.80
1012	5/8 x 3/4	13	419.80
1212	3/4 x 3/4	14	454.02

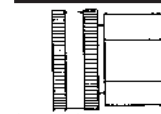

Female Hose x  
Female Pipe

**07400-**

EXTRA  
HEAVY

- Swivel -

1208	S1-XHVV	3/4 x 1/2	11	830.53
------	---------	-----------	----	--------

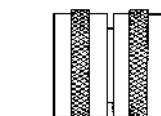

**S3**  
Female Hose x  
Female Hose

**07403-**

- Swivel -

12		3/4	9	451.88
----	--	-----	---	--------



# Brass Garden Hose Fittings

Computer Number	Hose I.D. Size	Weight Per 100	Price Per 100
-----------------	----------------	----------------	---------------

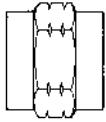

**S3S**  
Female Hose x  
Female Hose

**07402-** - Solid -

12	3/4	14	385.82
----	-----	----	--------

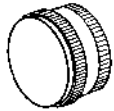

Hose Cap

**07404-** Brass

12	S4	3/4	4	196.17
----	----	-----	---	--------

**07408-** Zinc

12	S4Z	3/4	3	138.60
----	-----	-----	---	--------



**GHW**  
Garden Hose  
Washer

**07405-**

12	3/4	1	28.61
----	-----	---	-------

Sold in bags of 100 only

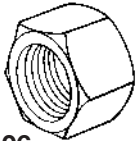

**GHN1**  
Garden Hose  
Nut

**07406-** Hex

12	3/4	3	264.32
----	-----	---	--------

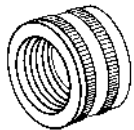

**GHN2**  
Garden Hose  
Nut

**07407-** Round

12	3/4	2	209.18
----	-----	---	--------

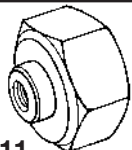

Female Hose  
Tapped Female  
Pipe

**07411-**

1202	GHC1	3/4 x 1/8	8	369.80
1204	GHC2	3/4 x 1/4	8	408.36

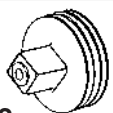

**GHP**  
Garden Hose Plug

**07412-**

12	3/4	3	749.15
----	-----	---	--------

Computer Number	Part No.	Hose I.D. Size	Weight Per 100	Price Per 100
-----------------	----------	----------------	----------------	---------------

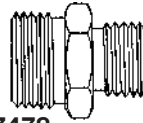

Male Hose x  
Male Pipe

**07478-**

1206	77EV	3/4x3/8	15	599.33
1208	78EV	3/4x1/2	15	335.88
120808	78EVC	3/4x1/2x1/2*	15	535.17
121208	79EVT	3/4x3/4x1/2**	15	342.70

\*Tapped 1/2 Nom. Sweat  
\*\*Tapped 1/2 Female Pipe

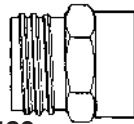

Male Hose x  
Female Pipe

**07480-**

1204	74EV	3/4 x 1/4	19	599.50
1206	75EV	3/4 x 3/8	15	575.46
1208	80EV	3/4 x 1/2	11	271.54
1212	81EV	3/4 x 3/4	19	371.19

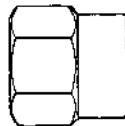

Female Hose x  
Female Pipe

**07482-**

1208	82EV	3/4 x 1/2	15	395.47
1212	83EV	3/4 x 3/4	18	395.18

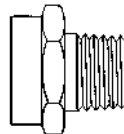

Female Hose x  
Male Pipe

**07484-**

1208	84EV	3/4x1/2	13	346.40
1212	85EV	3/4x3/4	14	357.55
121208	85EVT	3/4x3/4x1/2*	14	404.31

\*Tapped 1/2 Female Pipe

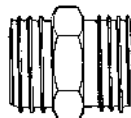

Male Hose x  
Male Hose

**07486-**

1212	86EV	3/4x3/4	16	374.14
121208	86EVT	3/4x3/4x1/2*	16	375.99

\*Tapped 1/2 Female Pipe

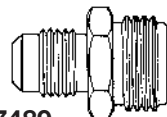

Flare x  
Male Hose

**07489-**

0612	88EV	3/8 x 3/4	14	805.21
0812	89EV	1/2 x 3/4	15	1205.94
1012	90EV	5/8 x 3/4	17	1237.09

Computer Number	Part No.	Hose I.D. Size	Weight Per 100	Price Per 100
-----------------	----------	----------------	----------------	---------------

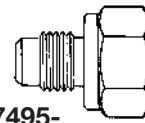

Flare x  
Female Hose

**07495-**

0612	94EV	3/8 x 3/4	16	602.22
0812	95EV	1/2 x 3/4	16	630.60
1012	96EV	5/8 x 3/4	18	921.22

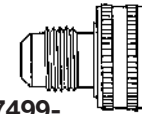

Flare x  
Female Hose

**07499-** - Swivel -

0612	99EV	3/8 x 3/4	10	681.06
0812	100EV	1/2 x 3/4	13	748.28

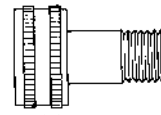

Female Hose x  
Male Pipe

**07420-** - Swivel -

1204	102EV	3/4 x 1/4	13	656.90
1206	103EV	3/4 x 3/8	14	663.37
1208	104EV	3/4 x 1/2	17	702.21

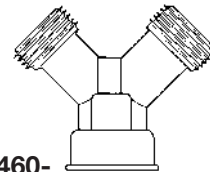

**86Y**  
"Y" Coupling  
Zinc

**07460-** Hose Three Ends

12	3/4	14	720.13
----	-----	----	--------

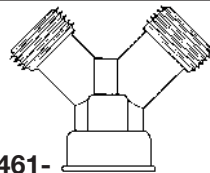

**86YRB**  
"Y" Coupling  
Cast Brass

**07461-** Hose Three Ends

12	3/4	26	980.87
----	-----	----	--------

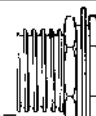

**87EV**  
Cooler Drain Fitting  
Male Hose x Female Pipe  
with Locknut & Gasket

**07487-**

1208	3/4 x 1/2	11	692.44
------	-----------	----	--------

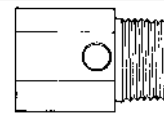

Evaporative  
Cooler Fitting

**07492-** Female Pipe x Male Pipe

0808	91EV	1/2 x 1/2	8	581.41
1212	92EV	3/4 x 3/4	12	776.89

Tapped 1/8 Female Pipe

**07493-** Female Hose x Male Hose

1212	93EV	3/4 x 3/4	12	691.87
------	------	-----------	----	--------

Tapped 1/8 Female Pipe

# Brass Needle Valves

Computer Number	Part No.	Size	Weight Per 100	Price Per 100
-----------------	----------	------	----------------	---------------

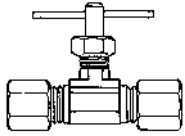

Compression x Compression

**09106-** Straight

04	106-C	1/4 x 1/4	9	759.20
05	107-C	5/16x5/16	15	1038.61
06	113-C	3/8 x 3/8	15	934.74

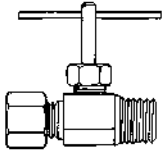

Compression x Male Pipe

**09101-** Straight

0302	133-C	3/16 x 1/8	8	3640.01
0402	101-C	1/4 x 1/8	10	739.15
0404	1101-C	1/4 x 1/4	11	931.85
0502	102-C	5/16 x 1/8	20	981.56
0604	143-C	3/8 x 1/4	18	1136.98

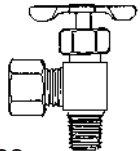

Compression x Male Pipe

**09103-** 90° Elbow

0302	33-C	3/16 x 1/8	17	1135.19
0402	103-C	1/4 x 1/8	10	544.30
0404	104-C	1/4 x 1/4	10	1305.24
0502	203-C	5/16 x 1/8	12	956.76
0504	204-C	5/16 x 1/4	16	3668.57
0602	302-C	3/8 x 1/8	10	1113.75
0604	303-C	3/8 x 1/4	22	1374.09

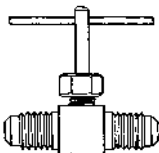

Flare x Flare

**09110-** Straight

04	110-SAE	1/4 x 1/4	15	841.11
06	115-SAE	3/8 x 3/8	20	1034.74

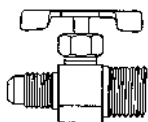

Flare x Male Pipe

**09104-** Straight

0402	104-SAE	1/4 x 1/8	18	1061.90
0404	1104-SAE	1/4 x 1/4	14	1389.22
0502	106-SAE	5/16x1/8	14	3582.91
0504	1106-SAE	5/16x1/4	16	2452.45
0604	108-SAE	3/8 x 1/4	18	1324.14

Computer Number	Part No.	Size	Weight Per 100	Price Per 100
-----------------	----------	------	----------------	---------------

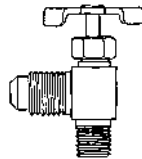

Flare x Male Pipe

**09102-** 90° Elbow

0402	103-SAE	1/4 x 1/8	9	958.73
0604	303-SAE	3/8 x 1/4	20	1637.88

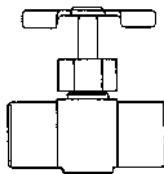

Female Pipe x Female Pipe

**09134-** Straight

02	304-P	1/8 x 1/8	10	768.86
04	3304-P	1/4 x 1/4	17	989.30

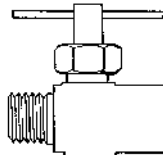

Male Pipe x Female Pipe

**09135-** Straight

02	305-P	1/8 x 1/8	9	673.08
04	3305-P	1/4 x 1/4	16	1011.33

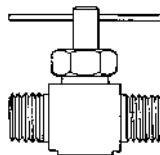

Male Pipe x Male Pipe

**09108-** Straight

02	108-P	1/8 x 1/8	9	897.35
04	110-P	1/4 x 1/4	15	989.59

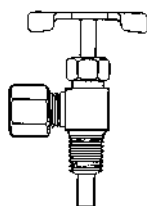

Compression x Male Pipe

**09194-** 90° Elbow

0402	104HV	1/4 x 1/8	13	597.71
------	-------	-----------	----	--------

Computer Number	Part No.	Size	Weight Per 100	Price Per 100
-----------------	----------	------	----------------	---------------

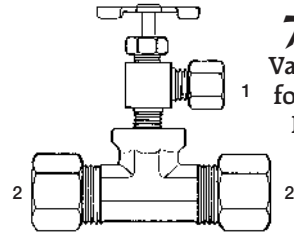

**78AWV**  
Valve with Tee for Ice Maker-Humidifier

**09178-** Read 1 x 2

0406	1/4 x 3/8	22	1335.76
0408	1/4 x 1/2	32	1617.82
0410	1/4 x 5/8	41	2301.08
0606	3/8 x 3/8	28	1793.48

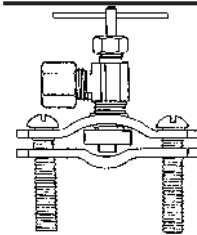

Valve with Saddle fits up to 3/4 Pipe

**09195-**

04	104-SC	1/4	30	1370.55
05	204-SC	5/16	33	1631.35
06	302-SC	3/8	30	1851.80

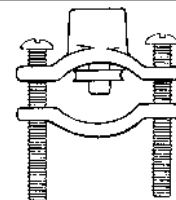

**109S**  
Brass Saddle 1/8 Female Pipe fits up to 3/4 Pipe

09190	1/8	20	807.70
-------	-----	----	--------

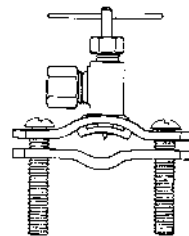

**104SCSD**  
Self Drilling Valve Assembly fits 3/8" thru 1-3/8" O.D. Copper Tubing

**09199-**

04	1/4	25	988.73
----	-----	----	--------

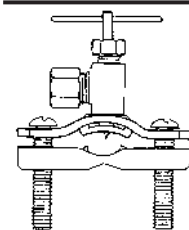

**104SDHB**  
Self Drilling Valve Assembly fits 3/8" thru 1-3/8" O.D. Copper Tubing with Heavy Bracket

**09198-**

04	1/4	25	1009.60
----	-----	----	---------

## Ice Maker Kits

- All Kits Individually Packaged in Attractive, Durable Bags
- Easy to Understand Instructions printed on Each Package
  - Six Stock Kits for any type installation

### 60001

- 25' - Polyethylene Tubing
- 1 - 104SCSD Self Tapping Saddle Valve
- 1 - 62 1/4 Compression Union
- 1 - 68 1/4xl/8 Compression x MIP Connector
- 1 - 69 1/4xl/8 Compression x MIP Elbow
- 3 - 60P 1/4 Delrin Sleeve
- 3 - 61P 1/4 Brass Insert

### 60008

- 25' - Polyethylene Tubing
- 1 - 104SCSD Self Tapping Saddle Valve
- 1 - 62 1/4 Compression Union
- 3 - 60P 1/4 Delrin Sleeve
- 3 - 61P 1/4 Brass Insert

### 60002

- 25' - Copper Tubing
- 1 - 104SCSD Self Tapping Saddle Valve
- 1 - 62 1/4 Compression Union
- 1 - 68 1/4xl/8 Compression x MIP Connector
- 1 - 69 1/4xl/8 Compression x MIP Elbow

### 60004

- 10' - Copper Tubing
- 1 - 104SCSD Self Tapping Saddle Valve
- 1 - 62 1/4 Compression Union
- 1 - 68 1/4xl/8 Compression x MIP Connector
- 1 - 69 1/4xl/8 Compression x MIP Elbow

### 60005

- 15' - Copper Tubing
- 1 - 104SCSD Self Tapping Saddle Valve
- 1 - 62 1/4 Compression Union
- 1 - 68 1/4xl/8 Compression x MIP Connector
- 1 - 69 1/4xl/8 Compression x MIP Elbow

### 60006

- 15' - Copper Tubing
- 1 - 104SCSD Self Tapping Saddle Valve
- 1 - 62 1/4 Compression Union
- 1 - 406FC 1/4xl/4 Female Flare x Compression Connector

Refer to Current Ice Maker Kits Sheet for Pricing

# Brass Shut Off Cocks

Computer Number	Part No.	Size	Weight Per 100	Price Per 100
-----------------	----------	------	----------------	---------------

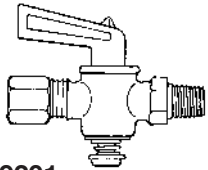

Tube x Male Pipe

**09201-**

0402	27-C	1/4 x 1/8	18	1420.84
0404	227-C	1/4 x 1/4	22	1682.79
0502	29-C	5/16 x 1/8	20	1431.82
0504	229-C	5/16 x 1/4	23	1780.88
0604	57-C	3/8 x 1/4	30	1847.11
0606	557-C	3/8 x 3/8	33	2121.78
0806	67-C	1/2 x 3/8	51	3413.90

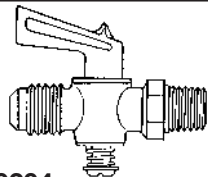

Flare x Male Pipe

**09204-**

0402	27-SAE	1/4 x 1/8	17	1423.09
0404	227-SAE	1/4 x 1/4	22	1586.44
0502	29-SAE	5/16 x 1/8	20	1464.42
0504	229-SAE	5/16 x 1/4	23	1681.23
0604	57-SAE	3/8 x 1/4	30	1722.50
0606	557-SAE	3/8 x 3/8	33	2127.04
0608	577-SAE	3/8 x 1/2	38	2523.14
0806	67-SAE	1/2 x 3/8	50	2532.28
0808	77-SAE	1/2 x 1/2	62	2559.33
1008	1077-SAE	5/8 x 1/2	75	3496.67

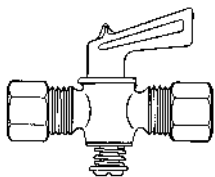

Tube x Tube

**09206-**

04	28-C	1/4 x 1/4	20	1483.32
05	30-C	5/16 x 5/16	23	1779.72
06	58-C	3/8 x 3/8	30	1829.95
08	68-C	1/2 x 1/2	44	2318.36

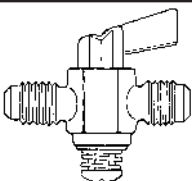

Flare x Flare

**09210-**

04	28-SAE	1/4 x 1/4	20	1447.95
05	30-SAE	5/16x5/16	23	1633.14
06	58-SAE	3/8 x 3/8	27	1729.72
08	68-SAE	1/2 x 1/2	43	2107.68
10	1010-SAE	5/8 x 5/8	79	3462.74

Computer Number	Part No.	Size	Weight Per 100	Price Per 100
-----------------	----------	------	----------------	---------------

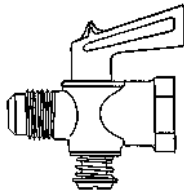

Male Flare x Female Flare

**09259-**

06	159-SAE	3/8	39	3666.54
----	---------	-----	----	---------

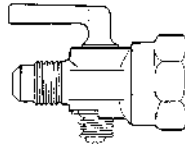

Flare x Female Pipe

**09205-**

0606	163-SAE	3/8 x 3/8	40	2304.89
0608	161-SAE	3/8 x 1/2	37	2322.98
0808	164-SAE	1/2 x 1/2	40	2372.75
0812	166-SAE	1/2 x 3/4	101	4080.39
0908	*161-SSAE	9/16 x 1/2	38	2460.60
1008	1667-SAE	5/8 x 1/2	110	4373.73
1012	167-SAE	5/8 x 3/4	104	4099.12
1512	167-RC	15/16x3/4	115	4901.67

\*9/16-24 Thread

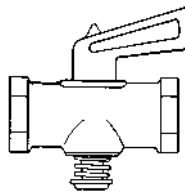

Female Pipe x Female Pipe

**09234-**

02	31-P	1/8 x 1/8	16	1307.67
04	32-P	1/4 x 1/4	20	1403.27
06	40-P	3/8 x 3/8	54	2423.84
08	80-P	1/2 x 1/2	77	2630.65

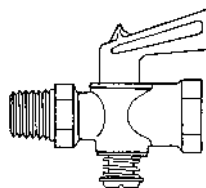

Male Pipe x Female Pipe

**09235-**

02	48-P	1/8 x 1/8	18	1334.37
04	49-P	1/4 x 1/4	20	1358.42
06	50-P	3/8 x 3/8	40	2169.93
08	51-P	1/2 x 1/2	60	3569.79

Computer Number	Part No.	Size	Weight Per 100	Price Per 100
-----------------	----------	------	----------------	---------------

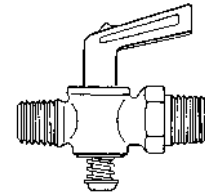

Male Pipe x Male Pipe

**09208-**

02	76-P	1/8 x 1/8	18	1416.62
04	77-P	1/4 x 1/4	23	1477.54
06	78-P	3/8 x 3/8	38	2370.15

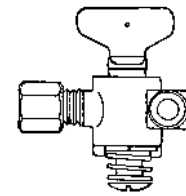

Compression x Male Pipe

**09289-**

Left Angle

0402	89-CL	1/4 x 1/8	18	3401.13
------	-------	-----------	----	---------

**09290-**

(Shown)Right Angle

0402	89-CR	1/4 x 1/8	18	3401.13
------	-------	-----------	----	---------

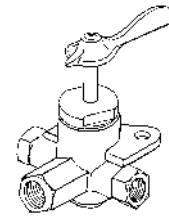

**108AMC**  
Three-Way Heavy-Duty

**09508-**

Female Pipe Three Ends

02	1/8	70	4355.46
04	1/4	72	3945.60
06	3/8	78	4425.23

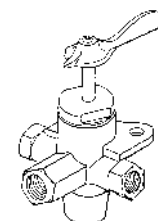

**114AMC**  
Four-Way Heavy-Duty

**09514-**

Female Pipe Four Ends

04	1/4	70	3955.08
06	3/8	80	4415.05

# Brass Shut Off Cocks

Computer Number	Part No.	Size	Weight Per 100	Price Per 100
-----------------	----------	------	----------------	---------------

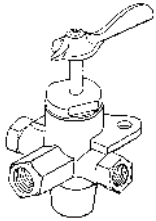

**115AMC**  
Four-Way  
Heavy-Duty  
(With Long Stem)

09515-

Female Pipe  
Four Ends

04	1/4	70	4148.88
06	3/8	80	4707.64

Computer Number	Part No.	Size	Weight Per 100	Price Per 100
-----------------	----------	------	----------------	---------------

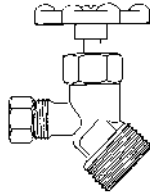

Oil Drum  
And Tank Valve

09530-

Compression x  
Male Pipe

0612	7-OVC	3/8 x 3/4	54	2325.87
------	-------	-----------	----	---------

Computer Number	Part No.	Size	Weight Per 100	Price Per 100
-----------------	----------	------	----------------	---------------

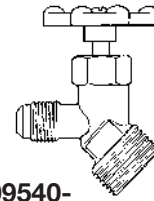

Oil Drum  
And Tank Valve

09540-

Flare x Male Pipe

0606	5-OV	3/8 x 3/8	54	2219.92
0608	6-OV	3/8 x 1/2	54	1903.93
0612	7-OV	3/8 x 3/4	54	1951.10
0808	70-OV	1/2 x 1/2	54	2669.55
0812	8-OV	1/2 x 3/4	54	2885.67

# Brass Polished Air Cocks

All air cocks are spring bottom. Nut bottom air cocks are available on request.

Computer Number	Part No.	Size	Weight Per 100	Price Per 100
-----------------	----------	------	----------------	---------------

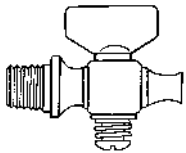

Male Pipe x  
Bibb Nose

Tee Handle -  
Round Shoulder

09306-02	6-PAC	1/8	12	1382.06
09307-04	7-PAC	1/4	14	1414.94

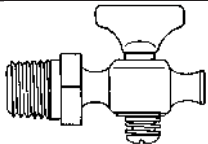

Male Pipe x  
Bibb Nose

Tee Handle -  
Hex Shoulder

09363-02	63-PAC	1/8	14	1565.98
09364-04	64-PAC	1/4	16	1507.31
09308-06	8-PAC	3/8	18	1588.75
09309-08	9-PAC	1/2	21	1768.56

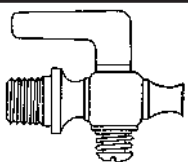

Male Pipe x  
Bibb Nose

Lever Handle -  
Round Shoulder

09312-02	12-PAC	1/8	12	1438.70
09313-04	13-PAC	1/4	13	1474.25

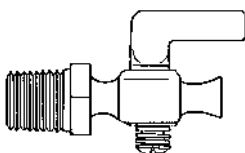

Male Pipe x  
Bibb Nose

Lever Handle -  
Hex Shoulder

09365-02	65-PAC	1/8	14	1531.76
09366-04	66-PAC	1/4	16	1579.85
09314-06	14-PAC	3/8	18	1624.01
09315-08	15-PAC	1/2	20	1801.34

Computer Number	Part No.	Size	Weight Per 100	Price Per 100
-----------------	----------	------	----------------	---------------

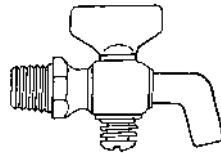

Male Pipe x  
Bent Nose

Tee Handle -  
Hex Shoulder

09326-02	26-PAC	1/8	14	2463.84
09327-04	27-PAC	1/4	15	2471.30
09328-06	28-PAC	3/8	28	3583.60
09333-08	33-PAC	1/2	36	3984.62

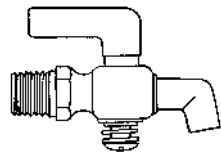

Male Pipe x  
Bent Nose

Lever Handle -  
Hex Shoulder

09329-02	29-PAC	1/8	14	2439.56
09330-04	30-PAC	1/4	15	2449.22
09331-06	31-PAC	3/8	29	3447.71
09332-08	32-PAC	1/2	36	3961.84

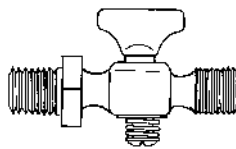

Male Pipe x  
Male Pipe

Tee Handle -  
Hex Shoulder

09318-02	18-PAC	1/8	14	1827.29
09319-04	19-PAC	1/4	17	1876.42
09320-06	20-PAC	3/8	20	1975.60
09321-08	21-PAC	1/2	33	2667.64

Computer Number	Part No.	Size	Weight Per 100	Price Per 100
-----------------	----------	------	----------------	---------------

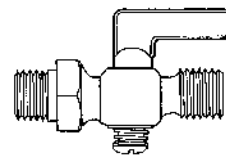

Male Pipe x  
Male Pipe

Lever Handle -  
Hex Shoulder

09322-02	22-PAC	1/8	14	1892.14
09323-04	23-PAC	1/4	18	1959.30
09324-06	24-PAC	3/8	21	2219.58
09325-08	25-PAC	1/2	34	2636.78

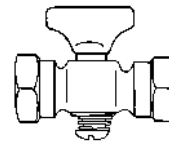

Female Pipe x  
Female Pipe

Tee Handle -  
Hex Shoulder

09355-02	55-PAC	1/8	15	1826.71
09356-04	56-PAC	1/4	18	1840.12
09357-06	57-PAC	3/8	25	2526.21
09357-08	57A-PAC	1/2	30	2934.56

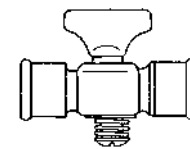

Female Pipe x  
Female Pipe

Tee Handle -  
Round Shoulder

09337-02	37-PAC	1/8	14	1676.08
09338-04	38-PAC	1/4	15	1679.84
09339-06	39-PAC	3/8	23	2251.08
09339-08	39A-PAC	1/2	32	2434.65

## Brass Polished Air Cocks

All air cocks are spring bottom. Nut bottom air cocks are available on request.

Computer Number	Part No.	Size	Weight Per 100	Price Per 100
-----------------	----------	------	----------------	---------------

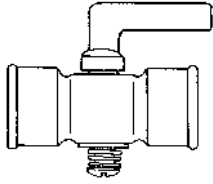

Female Pipe x Female Pipe

Lever Handle - Round Shoulder

09343-02	43-PAC	1/8	13	1812.84
09344-04	44-PAC	1/4	15	1819.02
09345-06	45-PAC	3/8	22	2345.24
09345-08	45A-PAC	1/2	29	2522.16

Computer Number	Part No.	Size	Weight Per 100	Price Per 100
-----------------	----------	------	----------------	---------------

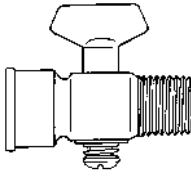

Female Pipe x Male Pipe

Tee Handle - Round Shoulder

09340-02	40-PAC	1/8	12	1625.57
09341-04	41-PAC	1/4	15	1631.41
09342-06	42-PAC	3/8	22	2412.75
09342-08	42A-PAC	1/2	28	2916.18

Computer Number	Part No.	Size	Weight Per 100	Price Per 100
-----------------	----------	------	----------------	---------------

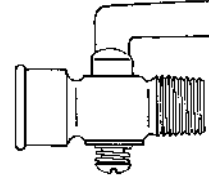

Female Pipe x Male Pipe

Lever Handle - Round Shoulder

09346-02	46-PAC	1/8	12	1748.68
09347-04	47-PAC	1/4	15	1780.07
09348-06	48-PAC	3/8	23	2348.93
09348-08	48A-PAC	1/2	28	2411.01

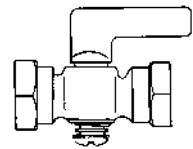

Female Pipe x Female Pipe

Lever Handle - Hex Shoulder

09358-02	58-PAC	1/8	15	2053.06
09359-04	59-PAC	1/4	17	1926.71
09360-06	60-PAC	3/8	25	2522.68
09360-08	60A-PAC	1/2	32	2768.45

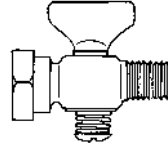

Female Pipe x Male Pipe

Tee Handle - Hex Shoulder

09349-02	49-PAC	1/8	12	1770.82
09350-04	50-PAC	1/4	15	1838.27
09351-06	51-PAC	3/8	23	2468.06
09351-08	51A-PAC	1/2	30	2595.62

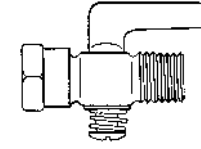

Female Pipe x Male Pipe

Lever Handle - Hex Shoulder

09352-02	52-PAC	1/8	13	1672.91
09353-04	53-PAC	1/4	16	1684.58
09354-06	54-PAC	3/8	23	2306.57
09354-08	54A-PAC	1/2	30	2572.22

## Brass Drain Cocks

Computer Number	Part No.	Size	Weight Per 100	Price Per 100
-----------------	----------	------	----------------	---------------

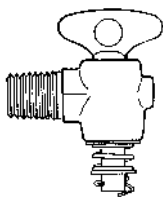

Tee Handle Drain Cock

09403-

02	37-P	1/8	11	1714.75
04	38-P	1/4	15	1606.96

Computer Number	Part No.	Size	Weight Per 100	Price Per 100
-----------------	----------	------	----------------	---------------

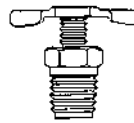

Tee Handle External Seat

09432-

02	320-P	1/8	3	190.77
04	321-P	1/4	4	209.70
06	322-P	3/8	6	576.79
08	323-P	1/2	11	2273.97

Computer Number	Part No.	Size	Weight Per 100	Price Per 100
-----------------	----------	------	----------------	---------------

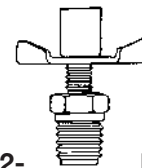

Tee Handle With Bibb External Seat

09442-

		Hose I.D.			
02	420-P	1/8	1/4	04	534.53
04	421-P	1/4	3/8	05	388.42

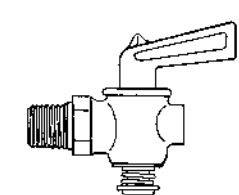

Lever Handle Drain Cock

09404-

02	41-P	1/8	11	1267.32
04	42-P	1/4	16	1293.45
06	43-P	3/8	22	1619.73
08	44-P	1/2	37	2075.19

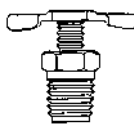

Tee Handle External Seat With O-Ring

09436-

04	327-P	1/4	7	558.06
----	-------	-----	---	--------



Tee Handle Internal Seat

09440-

02	300-P	1/8	6	492.98
04	301-P	1/4	11	527.25

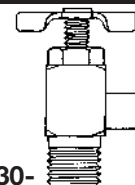

Tee Handle With Bibb Internal Seat

09430-

		(for 3/8 I.D. Hose)			
02	302-P	1/8	9	841.28	
04	303-P	1/4	10	816.37	



## Brass Drain Cocks

Computer Number	Part No.	Size	Weight Per 100	Price Per 100
-----------------	----------	------	----------------	---------------

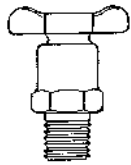

Forged Tee Handle  
Internal Seat

**09420-**

02	200-P	1/8	5	1027.41
04	201-P	1/4	8	864.69
06	202-P	3/8	10	1266.22

Computer Number	Part No.	Size	Weight Per 100	Price Per 100
-----------------	----------	------	----------------	---------------



Air Tank Valve

09460-02	500P	1/8	5	418.93
09460-04	501P	1/4	6	592.39
09462-02	510P	1/8 Long	7	522.87

Computer Number	Part No.	Size	Weight Per 100	Price Per 100
-----------------	----------	------	----------------	---------------

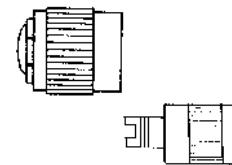

Air Tank Valve  
Cap

**09469-**

02	Plastic Dome Cap		2	67.80
04	Metal Dome Cap		3	132.25
06	Metal Slotted Cap		5	139.47

## Brass Solid Bottom Fuel Line Valves

Computer Number	Part No.	Size	Weight Per 100	Price Per 100
-----------------	----------	------	----------------	---------------

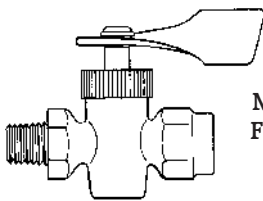

Male Pipe x  
Female Pipe

**09500-**

02	5600	1/8	22	3015.89
04	5600A	1/4	25	3196.69
06	5600B	3/8	32	3461.24

Computer Number	Part No.	Size	Weight Per 100	Price Per 100
-----------------	----------	------	----------------	---------------

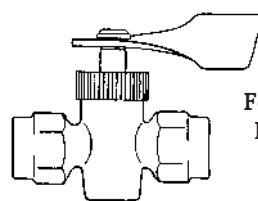

Female Pipe x  
Female Pipe

**09502-**

02	5602	1/8	26	3233.45
04	5602A	1/4	28	3372.11
06	5602B	3/8	32	3750.76

Computer Number	Part No.	Size	Weight Per 100	Price Per 100
-----------------	----------	------	----------------	---------------

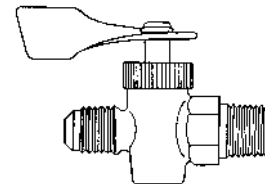

Flare x  
Male Pipe

**09505-**

0402	5605	1/4 x 1/8	20	3215.36
0404	5605A	1/4 x 1/4	27	3356.85
0502	5605B	5/16 x 1/8	20	3258.24
0504	5605C	5/16 x 1/4	21	3360.84
0604	5605D	3/8 x 1/4	22	3054.50
0606	5605E	3/8 x 3/8	27	3384.36
0608	5605F	3/8 x 1/2	32	4832.31
0806	5605G	1/2 x 3/8	32	3612.10

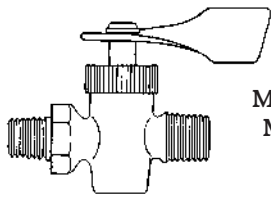

Male Pipe x  
Male Pipe

**09501-**

02	5601	1/8	20	3216.80
04	5601A	1/4	23	3308.07
06	5601B	3/8	31	3860.29

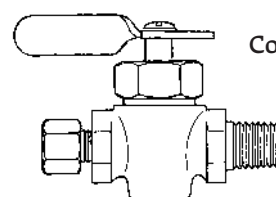

Compression x  
Male Pipe

**09503-**

0404	5603A	1/4 x 1/4	22	3653.77
0604	5603D	3/8 x 1/4	25	3562.33
0606	5603E	3/8 x 3/8	31	3656.83

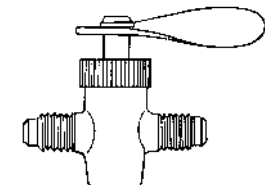

Flare x  
Flare

**09506-**

04	5606	1/4	22	3255.59
05	5606A	5/16	22	3284.25
06	5606B	3/8	23	2999.47
08	5606C	1/2	26	3208.02

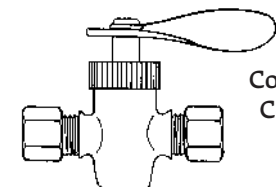

Compression x  
Compression

**09504-**

04	5604	1/4	17	3362.23
05	5604A	5/16	18	3425.98
06	5604B	3/8	19	3260.61
08	5604C	1/2	23	3707.35

## Brass Truck Valves

Computer Number	Size	Weight Per 100	Price Per 100
-----------------	------	----------------	---------------

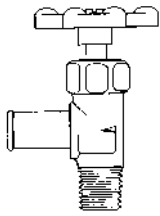

**44TV**  
Barb x  
Male Pipe

08944-

0606	3/8 x 3/8	19	1324.09
0806	1/2 x 3/8	26	1947.98
1006	5/8 x 3/8	24	1410.53
1008	5/8 x 1/2	37	2221.09
1206	3/4 x 3/8	50	2863.77
1208	3/4 x 1/2	72	2816.40

Computer Number	Size	Weight Per 100	Price Per 100
-----------------	------	----------------	---------------

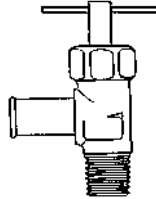

**44TVPH**  
Pin Handle  
Barb x  
Male Pipe

08947-

0606	3/8 x 3/8	19	1404.86
1006	5/8 x 3/8	37	1496.32

Computer Number	Size	Weight Per 100	Price Per 100
-----------------	------	----------------	---------------

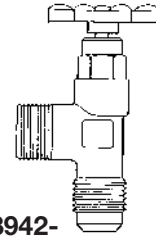

**412TV**  
Male Pipe x  
Flare

08942-

1008	5/8 x 1/2	41	2006.80
------	-----------	----	---------

**45TV**  
Female Pipe x  
Male Pipe

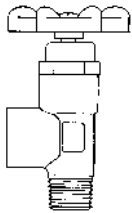

08945-

0606	3/8 x 3/8	27	1818.30
0608	3/8 x 1/2	33	2087.29
0808	1/2 x 1/2	35	2297.57

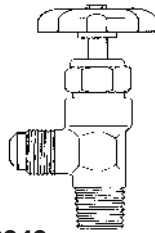

**49TV**  
Flare x  
Male Pipe

08949-

0604	3/8 x 1/4	19	1689.23
0606	3/8 x 3/8	22	1774.09
0608	3/8 x 1/2	26	2095.26
0806	1/2 x 3/8	29	1950.85
0808	1/2 x 1/2	53	3033.89
1008	5/8 x 1/2	41	2021.66
1208	3/4 x 1/2	64	4172.59

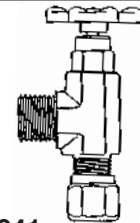

**410NA**  
Male Pipe x  
Air Brake

08941-

0808	1/2 x 1/2	51	2345.95
------	-----------	----	---------

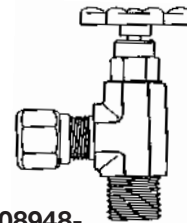

**48NA**  
Air Brake x  
Male Pipe

08948-

0808	1/2 x 1/2	51	2412.19
------	-----------	----	---------

## Grease Fittings

Computer Number	Part Number	Weight Per 100	Price Per 100
-----------------	-------------	----------------	---------------



Button Head  
1/8 Pipe Thread

08302	1184	2	293.39
-------	------	---	--------

Computer Number	Part Number	Weight Per 100	Price Per 100
-----------------	-------------	----------------	---------------



Short  
1/8 Pipe Thread

08310	1610	2	73.93
-------	------	---	-------

Computer Number	Part Number	Weight Per 100	Price Per 100
-----------------	-------------	----------------	---------------



Extra Long  
1/8 Pipe Thread

08312	1669	5	291.83
-------	------	---	--------



Button Head  
1/4 Pipe Thread

08304	1186	2	332.29
-------	------	---	--------



Long  
1/8 Pipe Thread

08311	1607	4	206.35
-------	------	---	--------



30°  
1/8 Pipe Thread

08313	1611	3	154.15
-------	------	---	--------

# Grease Fittings

Computer Number	Part Number	Weight Per 100	Price Per 100
-----------------	-------------	----------------	---------------

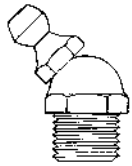

45°  
1/8 Pipe Thread

08314	1688	3	143.29
-------	------	---	--------

Computer Number	Part Number	Weight Per 100	Price Per 100
-----------------	-------------	----------------	---------------



Long  
1/4-28 Taper  
Thread

08342	1652	3	69.07
-------	------	---	-------

Computer Number	Part Number	Weight Per 100	Price Per 100
-----------------	-------------	----------------	---------------

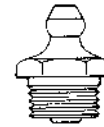

3/8-24 UNF  
Thread

08352	1710	3	106.35
-------	------	---	--------

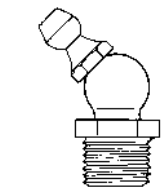

65°  
1/8 Pipe Thread

08315	1612	3	151.20
-------	------	---	--------

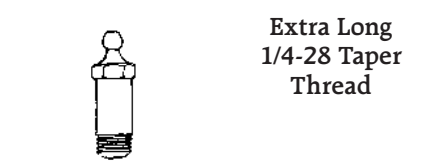

Extra Long  
1/4-28 Taper  
Thread

08343	1680	5	111.15
-------	------	---	--------

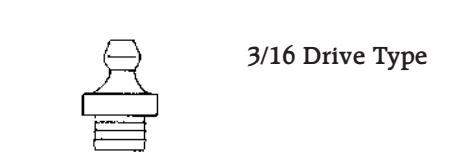

3/16 Drive Type

08373	1728	3	63.75
-------	------	---	-------

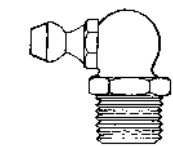

90°  
1/8 Pipe Thread

08316	1613	3	143.29
-------	------	---	--------

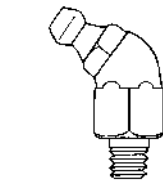

45°  
1/4-28 Taper  
Thread

08346	1637	3	122.36
-------	------	---	--------

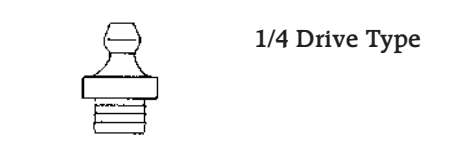

1/4 Drive Type

08374	1743	3	75.66
-------	------	---	-------

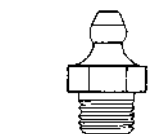

1/4 Pipe Thread

08321	1627	2	148.20
-------	------	---	--------

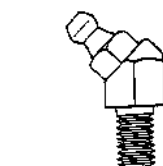

45° Long  
1/4-28 Taper  
Thread

08347	1636	3	206.87
-------	------	---	--------

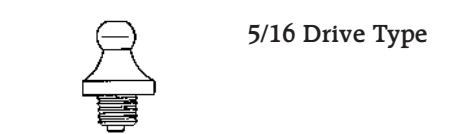

5/16 Drive Type

08375	1608	3	69.30
-------	------	---	-------

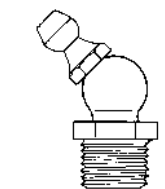

65°  
1/4 Pipe Thread

08324	1629	3	248.14
-------	------	---	--------

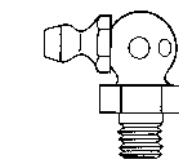

90°  
1/4-28 Taper  
Thread

08349	1911	3	119.53
-------	------	---	--------

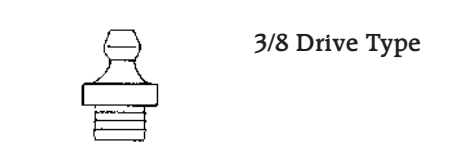

3/8 Drive Type

08376	1666	3	153.34
-------	------	---	--------

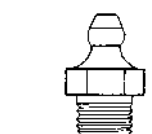

Short  
1/4-28 Taper  
Thread

08341	1641	2	50.05
-------	------	---	-------



5/16-24 UNF  
Thread

08351	1711	2	88.78
-------	------	---	-------

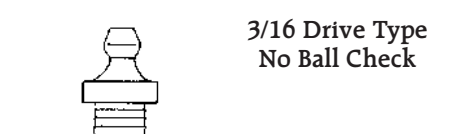

3/16 Drive Type  
No Ball Check

08377	1957	3	91.90
-------	------	---	-------

# Grease Fittings

Computer Number	Part Number	Weight Per 100	Price Per 100
-----------------	-------------	----------------	---------------



5/16 Drive Type  
No Ball Check

08378	1699	3	81.09
-------	------	---	-------

Computer Number	Part Number	Weight Per 100	Price Per 100
-----------------	-------------	----------------	---------------

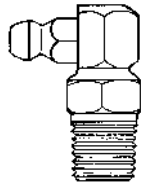

90° Self Tapping  
1/4-28 Thread

08386	3054	4	193.98
-------	------	---	--------

Computer Number	Part Number	Weight Per 100	Price Per 100
-----------------	-------------	----------------	---------------

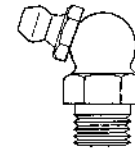

45°  
8MM x 1

08395	7445	4	163.29
-------	------	---	--------

Computer Number	Part Number	Weight Per 100	Price Per 100
-----------------	-------------	----------------	---------------

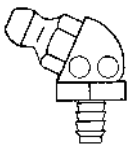

3/16 Drive Type  
65° Elbow  
No Ball Check

08379	1646	4	177.68
-------	------	---	--------

Computer Number	Part Number	Weight Per 100	Price Per 100
-----------------	-------------	----------------	---------------



6MM x 1

08391	8601	3	58.03
-------	------	---	-------

Computer Number	Part Number	Weight Per 100	Price Per 100
-----------------	-------------	----------------	---------------

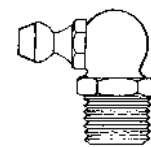

90°  
8MM x 1

08396	7490	4	167.22
-------	------	---	--------

Computer Number	Part Number	Weight Per 100	Price Per 100
-----------------	-------------	----------------	---------------

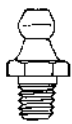

Self Tapping  
1/8 Pipe Thread

08382	1720	3	132.13
-------	------	---	--------

Computer Number	Part Number	Weight Per 100	Price Per 100
-----------------	-------------	----------------	---------------

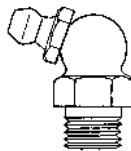

45°  
6MM x 1

08392	7045	3	155.25
-------	------	---	--------

Computer Number	Part Number	Weight Per 100	Price Per 100
-----------------	-------------	----------------	---------------



10MM x 1

08397	9301	4	93.69
-------	------	---	-------

Computer Number	Part Number	Weight Per 100	Price Per 100
-----------------	-------------	----------------	---------------



Self Tapping  
1/4-28 Thread

08384	3038	3	58.55
-------	------	---	-------

Computer Number	Part Number	Weight Per 100	Price Per 100
-----------------	-------------	----------------	---------------

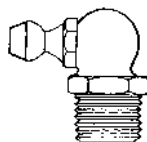

90°  
6MM x 1

08393	7090	3	155.25
-------	------	---	--------

Computer Number	Part Number	Weight Per 100	Price Per 100
-----------------	-------------	----------------	---------------

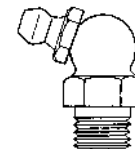

45°  
10MM x 1

08398	7845	4	174.73
-------	------	---	--------

Computer Number	Part Number	Weight Per 100	Price Per 100
-----------------	-------------	----------------	---------------

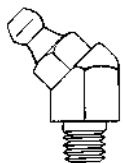

45° Self Tapping  
1/4-28 Thread

08385	3053	3	220.45
-------	------	---	--------

Computer Number	Part Number	Weight Per 100	Price Per 100
-----------------	-------------	----------------	---------------



8MM x 1

08394	8901	4	78.61
-------	------	---	-------

Computer Number	Part Number	Weight Per 100	Price Per 100
-----------------	-------------	----------------	---------------

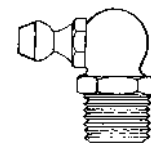

90°  
10MM x 1

08399	7890	4	174.73
-------	------	---	--------

# Tubing

## Polyethylene

Computer Number	O.D.	I.D.	Wall Thickness	
61000-04	1/4	.1700	.0400	**
61000-05	5/16	.1875	.0625	**
61000-06	3/8	.2500	.0625	**
61000-08	1/2	.3750	.0625	**
61000-10	5/8	.5000	.0625	**
61000-12	3/4	.6250	.0625	**
61010-04*	1/4	.1700	.0400	**

\*1000 ft. coil

		Price Per 100
69410*	Plastic Tubing Cutter 1/8 O.D. to 5/8 O.D.	1129.55

\* For cutting polyethylene, pex, nylon, plastic and rubber tubing.

- Non-Toxic, Odorless, Tasteless
- Excellent Chemical Resistance
- 100 Ft. Coils
- Milky White Color

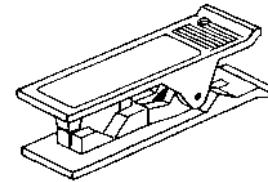

## Aluminum

Computer Number	O.D.	Wall Thickness	
61020-02	1/8	.0350	**
61020-03	3/16	.0350	**
61020-04	1/4	.0350	**
61020-05	5/16	.0350	**
61020-06	3/8	.0350	**
61020-07	7/16	.0350	**
61020-08	1/2	.0350	**
61020-10	5/8	.0350	**

- 1435 Alloy
- "O" Temper
- Dead Soft
- 50 Ft. Coils

## Copper Utility Tubing

Computer Number	O.D.	Length	
61060-0410	1/4	10'	**
61060-0415	1/4	15'	**
61060-0420	1/4	20'	**
61060-0425	1/4	25'	**
61060-0610	3/8	10'	**
61060-0615	3/8	15'	**
61060-0620	3/8	20'	**
61060-0625	3/8	25'	**
61060-0810	1/2	10'	**
61060-0815	1/2	15'	**
61060-0820	1/2	20'	**
61060-0825	1/2	25'	** *
61060-1010	5/8	10'	**
61060-1020	5/8	20'	**

- Available Packaged or Bulk

\*\* Refer to Current Tubing Sheet for Pricing.

# Index by Computer Number

Computer Number	Page Number	Computer Number	Page Number	Computer Number	Page Number	Computer Number	Page Number	Computer Number	Page Number
00039-04	15	00065-03	16	00068-0608	17	00070-0406	17	00075-040202	18
00039-06	15	00065-04	16	00068-0612	17	00070-0408	17	00075-040404	18
00039-10	15	00065-05	16	00068-0704	17	00070-0502	17	00076-0202	18
00060-02	15	00065-06	16	00068-0706	17	00070-0504	17	00076-0302	18
00060-03	15	00065-07	16	00068-0804	17	00070-0602	17	00076-0402	18
00060-04	15	00065-08	16	00068-0806	17	00070-0604	17	00076-0404	18
00060-05	15	00065-10	16	00068-0808	17	00070-0606	17	00076-0502	18
00060-06	15	00065-12	16	00068-0812	17	00070-0608	17	00076-0604	18
00060-07	15	00065-14	16	00068-1006	17	00070-0612	17	00077-0606	18
00060-08	15	00066-0202	16	00068-1008	17	00070-0804	17	00078-0402	18
00060-10	15	00066-0302	16	00068-1012	17	00070-0806	17	00078-0404	18
00060-12	15	00066-0304	16	00068-1208	17	00070-0808	17	00078-0602	18
00060-14	15	00066-0402	16	00068-1212	17	00070-0812	17	00078-0604	18
00061-02	15	00066-0404	16	00068-1408	17	00070-1006	17	00078-0606	18
00061-03	15	00066-0406	16	00068-1412	17	00070-1008	17	00078-0802	18
00061-04	15	00066-0408	16	00068-1416	17	00070-1012	17	00078-0806	18
00061-05	15	00066-0502	16	00069-0202	17	00070-1208	17	00078-1002	18
00061-06	15	00066-0504	16	00069-0302	17	00070-1212	17	00079-0606	18
00061-07	15	00066-0506	16	00069-0304	17	00071-0202	18	00081-04	15
00061-08	15	00066-0602	16	00069-0402	17	00071-0302	18	00081-05	15
00061-10	15	00066-0604	16	00069-0404	17	00071-0402	18	00081-06	15
00061-12	15	00066-0606	16	00069-0406	17	00071-0404	18	00081-08	15
00061-14	15	00066-0608	16	00069-0408	17	00071-0502	18	00081-10	15
00062-02	16	00066-0612	16	00069-0502	17	00071-0504	18	00082-0402	16
00062-03	16	00066-0804	16	00069-0504	17	00071-0602	18	00082-0403	16
00062-04	16	00066-0806	16	00069-0506	17	00071-0604	18	00082-0504	16
00062-05	16	00066-0808	16	00069-0508	17	00071-0606	18	00082-0604	16
00062-06	16	00066-0812	16	00069-0602	17	00071-0806	18	00082-0605	16
00062-07	16	00066-1006	16	00069-0604	17	00071-0808	18	00082-0806	16
00062-08	16	00066-1008	16	00069-0606	17	00071-1008	18	00082-1006	16
00062-10	16	00066-1012	16	00069-0608	17	00071-1208	18	00082-1008	16
00062-12	16	00066-1208	16	00069-0612	17	00071-1212	18	00083-04	16
00062-14	16	00066-1212	16	00069-0704	17	00072-0202	18	00083-06	16
00063-0202	16	00066-1408	16	00069-0706	17	00072-0302	18	00083-08	16
00063-0302	16	00066-1412	16	00069-0804	17	00072-0402	18	00084-040402	16
00063-0402	16	00068-0202	17	00069-0806	17	00072-0404	18	00084-040403	16
00063-0502	16	00068-0302	17	00069-0808	17	00072-0502	18	00084-040406	16
00063-0604	16	00068-0304	17	00069-0812	17	00072-0504	18	00084-050504	16
00064-02	16	00068-0402	17	00069-1006	17	00072-0602	18	00084-060404	16
00064-03	16	00068-0404	17	00069-1008	17	00072-0604	18	00084-060604	16
00064-04	16	00068-0406	17	00069-1012	17	00072-0606	18	00084-080804	16
00064-05	16	00068-0408	17	00069-1208	17	00072-0608	18	00084-080806	16
00064-06	16	00068-0502	17	00069-1212	17	00072-0804	18	00084-101004	16
00064-07	16	00068-0504	17	00069-1408	17	00072-0806	18	00084-101006	16
00064-08	16	00068-0506	17	00069-1412	17	00072-0808	18	00084-101008	16
00064-10	16	00068-0508	17	00070-0202	17	00072-1008	18	00085-0604	16
00064-12	16	00068-0602	17	00070-0302	17	00072-1208	18	00085-0806	16
00064-14	16	00068-0604	17	00070-0402	17	00072-1212	18	00085-1006	16
00065-02	16	00068-0606	17	00070-0404	17	00074-040202	18	00085-1008	16



# Index by Computer Number

Computer Number	Page Number	Computer Number	Page Number	Computer Number	Page Number	Computer Number	Page Number	Computer Number	Page Number
00260-05	23	00266-0506	22	00269-0404	22	00271-0502	23	00282-0806	21
00260-06	23	00266-0602	22	00269-0406	22	00271-0504	23	00282-1006	21
00260-08	23	00266-0604	22	00269-0408	22	00271-0602	23	00282-1008	21
00260-10	23	00266-0606	22	00269-0502	22	00271-0604	23	00284-040402	21
00261-02	21	00266-0608	22	00269-0504	22	00271-0606	23	00284-040403	21
00261-03	21	00266-0612	22	00269-0506	22	00271-0806	23	00284-050504	21
00261-04	21	00266-0804	22	00269-0508	22	00271-0808	23	00284-060604	21
00261-05	21	00266-0806	22	00269-0602	22	00271-1008	23	00284-080804	21
00261-06	21	00266-0808	22	00269-0604	22	00271-1208	23	00284-080806	21
00261-08	21	00266-0812	22	00269-0606	22	00271-1212	23	00284-101006	21
00261-10	21	00266-1006	22	00269-0608	22	00272-0202	23	00284-101008	21
00261-12	21	00266-1008	22	00269-0612	22	00272-0302	23	00285-0604	22
00261-14	21	00266-1012	22	00269-0804	22	00272-0402	23	00285-0806	22
00262-02	21	00266-1208	22	00269-0806	22	00272-0404	23	00285-1006	22
00262-03	21	00266-1212	22	00269-0808	22	00272-0502	23	00285-1008	22
00262-04	21	00266-1408	22	00269-0812	22	00272-0504	23	00286-0610	22
00262-05	21	00266-1412	22	00269-1006	22	00272-0602	23	00288-0402	22
00262-06	21	00268-0202	22	00269-1008	22	00272-0604	23	00288-0404	22
00262-08	21	00268-0302	22	00269-1012	22	00272-0606	23	00288-0604	22
00262-10	21	00268-0304	22	00269-1208	22	00272-0608	23	00288-0606	22
00262-12	21	00268-0402	22	00269-1212	22	00272-0804	23	00288-0608	22
00262-14	21	00268-0404	22	00269-1408	22	00272-0806	23	00288-0806	22
00264-02	21	00268-0406	22	00269-1412	22	00272-0808	23	00288-0808	22
00264-03	21	00268-0408	22	00270-0202	23	00272-1008	23	00288-1008	22
00264-04	21	00268-0502	22	00270-0302	23	00272-1208	23	00288-1012	22
00264-05	21	00268-0504	22	00270-0402	23	00272-1212	23	00289-0610	22
00264-06	21	00268-0506	22	00270-0404	23	00274-040202	23	00290-1008	23
00264-08	21	00268-0508	22	00270-0406	23	00275-040202	23	00295-0302	22
00264-10	21	00268-0602	22	00270-0408	23	00275-040404	23	00295-0402	22
00264-12	21	00268-0604	22	00270-0502	23	00276-0202	23	00295-0404	22
00264-14	21	00268-0606	22	00270-0504	23	00276-0302	23	00295-0502	22
00265-02	21	00268-0608	22	00270-0602	23	00276-0402	23	00295-0504	22
00265-03	21	00268-0612	22	00270-0604	23	00276-0404	23	00295-0602	22
00265-04	21	00268-0804	22	00270-0606	23	00276-0604	23	00295-0604	22
00265-05	21	00268-0806	22	00270-0608	23	00277-0606	23	00295-0606	22
00265-06	21	00268-0808	22	00270-0612	23	00278-0402	23	00295-0806	22
00265-08	21	00268-0812	22	00270-0804	23	00278-0404	23	00295-0808	22
00265-10	21	00268-1006	22	00270-0806	23	00278-0602	23	00295-1008	22
00265-12	21	00268-1008	22	00270-0808	23	00278-0604	23	00360-04	39
00265-14	21	00268-1012	22	00270-0812	23	00278-0606	23	00360-06	39
00266-0202	22	00268-1208	22	00270-1006	23	00278-0802	23	00360-08	39
00266-0302	22	00268-1212	22	00270-1008	23	00278-0806	23	00360-10	39
00266-0304	22	00268-1408	22	00270-1012	23	00278-1002	23	00360-12	39
00266-0402	22	00268-1412	22	00270-1208	23	00279-0606	23	00361-04	39
00266-0404	22	00268-1416	22	00270-1212	23	00282-0402	21	00361-06	39
00266-0406	22	00269-0202	22	00271-0202	23	00282-0403	21	00361-08	39
00266-0408	22	00269-0302	22	00271-0302	23	00282-0504	21	00361-10	39
00266-0502	22	00269-0304	22	00271-0402	23	00282-0604	21	00361-12	39
00266-0504	22	00269-0402	22	00271-0404	23	00282-0605	21	00362-04	39
00362-06	39								
00362-08	39								
00362-10	39								
00362-12	39								
00364-04	39								
00364-06	39								
00364-08	39								
00364-10	39								
00365-04	39								
00365-06	39								
00365-08	39								
00365-10	39								
00366-0402	39								
00366-0404	39								
00366-0602	39								
00366-0604	39								
00366-0606	39								
00366-0806	39								
00366-0808	39								
00366-1006	39								
00366-1008	39								
00368-0402	40								
00368-0404	40								
00368-0406	40								
00368-0602	40								
00368-0604	40								
00368-0606	40								
00368-0806	40								
00368-0808	40								
00368-1008	40								
00368-1212	40								
00369-0402	40								
00369-0404	40								
00369-0406	40								
00369-0602	40								
00369-0604	40								
00369-0606	40								
00369-0608	40								
00369-0804	40								
00369-0806	40								
00369-0808	40								
00369-1006	40								
00369-1008	40								
00369-1208	40								
00370-0402	40								

# Index by Computer Number

Computer Number	Page Number	Computer Number	Page Number	Computer Number	Page Number	Computer Number	Page Number	Computer Number	Page Number
00370-0404	40	00462-04	34	00469-0804	35	00506-0806	42	00566-0808	25
00370-0602	40	00462-06	34	00469-0806	35	00506-0808	42	00566-0812	25
00370-0604	40	00462-08	34	00469-0808	35	00506-1212	42	00566-1006	25
00370-0606	40	00462-10	34	00469-1006	35	00507-0808	42	00566-1008	25
00370-0806	40	00462-12	34	00469-1008	35	00508-0808	42	00566-1012	25
00370-0808	40	00463-04	34	00469-1208	35	00508-1212	42	00568-0402	25
00370-1008	40	00463-06	34	00470-0402	35	00509-0808	42	00568-0404	25
00371-0402	40	00463-08	34	00470-0404	35	00510-0808	42	00568-0406	25
00371-0404	40	00463-10	34	00470-0602	35	00560-04	15, 24	00568-0408	25
00371-0604	40	00463-12	34	00470-0604	35	00560-05	15, 24	00568-0502	25
00371-0606	40	00464-04	34	00470-0606	35	00560-06	15, 24	00568-0504	25
00371-0806	40	00464-06	34	00470-0806	35	00560-08	15, 24	00568-0506	25
00371-0808	40	00464-08	34	00470-0808	35	00560-10	15, 24	00568-0508	25
00371-1008	40	00464-10	34	00470-1008	35	00561-02	15, 24	00568-0602	25
00372-0402	40	00465-04	34	00471-0402	35	00561-03	15, 24	00568-0604	25
00372-0404	40	00465-06	34	00471-0404	35	00561-04	15, 24	00568-0606	25
00372-0602	40	00465-08	34	00471-0604	35	00561-05	15, 24	00568-0608	25
00372-0604	40	00465-10	34	00471-0606	35	00561-06	15, 24	00568-0612	25
00372-0606	40	00466-0402	35	00471-0806	35	00561-08	15, 24	00568-0804	25
00372-0806	40	00466-0404	35	00471-0808	35	00561-10	15, 24	00568-0806	25
00372-0808	40	00466-0602	35	00471-1008	35	00562-04	24	00568-0808	25
00372-1008	40	00466-0604	35	00472-0402	35	00562-05	24	00568-0812	25
00383-04	39	00466-0606	35	00472-0404	35	00562-06	24	00568-1006	25
00383-06	39	00466-0806	35	00472-0602	35	00562-08	24	00568-1008	25
00383-08	39	00466-0808	35	00472-0604	35	00562-10	24	00568-1012	25
00395-0402	40	00466-1006	35	00472-0606	35	00564-04	25	00569-0402	25
00395-0404	40	00466-1008	35	00472-0806	35	00564-05	25	00569-0404	25
00395-0602	40	00466-1208	35	00472-0808	35	00564-06	25	00569-0406	25
00395-0604	40	00468-0402	35	00472-1008	35	00564-08	25	00569-0408	25
00395-0606	40	00468-0404	35	00473-04	34	00564-10	25	00569-0502	25
00395-0608	40	00468-0406	35	00473-06	34	00565-04	25	00569-0504	25
00395-0806	40	00468-0602	35	00473-08	34	00565-05	25	00569-0506	25
00395-0808	40	00468-0604	35	00473-10	34	00565-06	25	00569-0508	25
00395-1008	40	00468-0606	35	00473-12	34	00565-08	25	00569-0602	25
00397-02	41, 47	00468-0608	35	00483-04	34	00565-10	25	00569-0604	25
00397-04	41, 47	00468-0804	35	00483-06	34	00566-0402	25	00569-0606	25
00397-06	41, 47	00468-0806	35	00483-08	34	00566-0404	25	00569-0608	25
00397-08	41, 47	00468-0808	35	00483-10	34	00566-0406	25	00569-0612	25
00398-04	41, 47	00468-1006	35	00495-0402	35	00566-0408	25	00569-0804	25
00460-04	34	00468-1008	35	00495-0404	35	00566-0502	25	00569-0806	25
00460-06	34	00468-1208	35	00495-0602	35	00566-0504	25	00569-0808	25
00460-08	34	00468-1212	35	00495-0604	35	00566-0506	25	00569-0812	25
00460-10	34	00469-0402	35	00495-0606	35	00566-0602	25	00569-1006	25
00460-12	34	00469-0404	35	00495-0608	35	00566-0604	25	00569-1008	25
00461-04	34	00469-0406	35	00495-0806	35	00566-0606	25	00569-1012	25
00461-06	34	00469-0602	35	00495-0808	35	00566-0608	25	00570-0402	26
00461-08	34	00469-0604	35	00495-1008	35	00566-0612	25	00570-0404	26
00461-10	34	00469-0606	35	00502-0810	42	00566-0804	25	00570-0406	26
00461-12	34	00469-0608	35	00502-1214	42	00566-0806	25	00570-0408	26

# Index by Computer Number

Computer Number	Page Number	Computer Number	Page Number	Computer Number	Page Number	Computer Number	Page Number	Computer Number	Page Number
00578-0806	26	00662-08	19	00880-04	20	02065-06	31	02071-0402	32
00578-1002	26	00662-10	19	00880-06	20	02065-08	31	02071-0404	32
00579-0606	26	00664-06	19	00881-02	20	02065-53	31	02071-0602	32
00582-0504	25	00664-08	19	00881-03	20	02066-0202	31	02071-0604	32
00582-0604	25	00664-10	19	00881-04	20	02066-0402	31	02071-0606	32
00582-0605	25	00665-06	19	00881-05	20	02066-0404	31	02071-0806	32
00582-0806	25	00665-08	19	00881-06	20	02066-0604	31	02071-5302	32
00582-1006	25	00665-10	19	00881-08	20	02066-0606	31	02072-0202	33
00582-1008	25	00666-0606	19	00881-10	20	02066-5302	31	02072-0402	33
00584-050504	25	00666-0608	19	00882-02	20	02068-0201	32	02072-0404	33
00584-060604	25	00666-0806	19	00882-03	20	02068-0202	32	02072-0406	33
00584-080804	25	00666-0808	19	00882-04	20	02068-0300	32	02072-0602	33
00584-080806	25	00668-0406	19	00882-05	20	02068-0302	32	02072-0604	33
00584-101006	25	00668-0604	19	00888-0202	20	02068-0400	32	02072-0606	33
00584-101008	25	00668-0606	19	00888-0302	20	02068-0402	32	02072-0804	33
00585-0604	25	00668-0608	19	00888-0304	20	02068-0404	32	02072-0806	33
00585-0806	25	00668-0806	19	00888-0402	20	02068-0406	32	02072-5302	33
00585-1006	25	00668-0808	19	00888-0404	20	02068-0502	32	02082-02	33
00585-1008	25	00668-1006	19	00888-0502	20	02068-0504	32	02082-03	33
00587-06	26	00668-1008	19	00888-0504	20	02068-0602	32	02082-04	33
00587-08	26	00669-0604	19	00888-0602	20	02068-0604	32	02082-06	33
00590-1008	26	00669-0606	19	00888-0604	20	02068-0606	32	02082-08	33
00592-04	25	00669-0608	19	00889-0202	20	02068-0608	32	02082-53	33
00592-05	25	00669-0806	19	00889-0302	20	02068-0804	32	02086-0402	33
00592-06	25	00669-0808	19	00889-0402	20	02068-0806	32	02086-0404	33
00592-08	25	00670-0606	19	00889-0404	20	02068-0808	32	02086-0604	33
00592-10	25	00670-0608	19	00889-0502	20	02068-5300	32	02088-0402	33
00593-0504	25	00670-0806	19	00889-0602	20	02068-5302	32	02088-0404	33
00593-0604	25	00670-0808	19	00889-0604	20	02068-5304	32	02088-5302	33
00593-0605	25	00682-0604	19	00889-0806	20	02069-0202	32	02089-0402	33
00593-0806	25	00682-0806	19	02059-02	31	02069-0302	32	02089-0404	33
00593-1006	25	00682-1006	19	02059-04	31	02069-0402	32	02089-0406	33
00593-1008	25	00682-1008	19	02059-06	31	02069-0404	32	02089-0453	33
00595-0402	26	00685-0806	19	02059-08	31	02069-0406	32	02089-5304	33
00595-0404	26	00685-1006	19	02059-53	31	02069-0602	32	02089-5353	33
00595-0502	26	00686-0610	19	02062-02	31	02069-0604	32	02154-0402	32
00595-0504	26	00689-0610	19	02062-04	31	02069-0606	32	02154-0404	32
00595-0602	26	00861-04	42	02062-05	31	02069-0804	32	02154-0604	32
00595-0604	26	00862-04	42	02062-06	31	02069-0806	32	02154-0804	32
00595-0606	26	00863-04	42	02062-08	31	02069-0808	32	02169-0202	32
00595-0806	26	00866-0402	42	02062-53	31	02069-1006	32	02169-0400	32
00595-0808	26	00867-0404	42	02064-02	31	02069-5302	32	02169-0402	32
00595-1008	26	00868-0402	42	02064-03	31	02070-0202	32	02169-0404	32
00661-04	19	00869-0402	42	02064-04	31	02070-0402	32	02169-0406	32
00661-06	19	00872-0402	42	02064-06	31	02070-0404	32	02169-0602	32
00661-07	19	00873-0402	42	02064-08	31	02070-0604	32	02169-0604	32
00661-08	19	00874-04	42	02064-53	31	02070-5302	32	02169-0606	32
00661-10	19	00880-02	20	02065-02	31	02071-0202	32	02169-0608	32
00662-06	19	00880-03	20	02065-04	31	02071-0302	32	02169-0806	32
								02169-0808	32
								02169-5300	32
								02169-5302	32
								02169-5304	32
								02170-0402	32
								02170-0404	32
								02170-0604	32
								02170-0606	32
								02170-0806	32
								02171-0202	32
								02171-0402	32
								02171-0404	32
								02171-0604	32
								02171-0606	32
								02171-0806	32
								02171-0808	32
								02171-5302	32
								02172-0202	33
								02172-0402	33
								02172-0404	33
								02172-0406	33
								02172-0604	33
								02172-0606	33
								02172-0806	33
								02172-0808	33
								02172-5300	33
								02172-5302	33
								02454-0402	37
								02454-0404	37
								02454-0604	37
								02454-0606	37
								02454-0804	37
								02454-1008	37
								02459-04	36
								02459-06	36
								02459-08	36
								02459-53	36
								02462-04	36
								02462-06	36
								02462-08	36
								02462-10	36
								02462-53	36
								02464-04	36
								02464-06	36
								02464-08	36
								02465-04	36
								02465-06	36
								02465-08	36
								02465-53	36

# Index by Computer Number

Computer Number	Page Number	Computer Number	Page Number	Computer Number	Page Number	Computer Number	Page Number	Computer Number	Page Number	Computer Number	Page Number
02466-0402	36	02472-0804	38	02642-06	28	02669-0404	28	02698-0402	30	04016-12	4
02466-0404	36	02472-0806	38	02648-04	29	02669-0406	28	02698-0404	30	04018-03	4
02466-0604	36	02477-0402	38	02648-06	29	02669-0502	28	02698-0604	30	04018-04	4
02466-0606	36	02482-04	38	02649-0404	28	02669-0504	28	02699-0402	30	04018-05	4
02468-0402	37	02482-06	38	02656-0604	28	02669-0602	28	02699-0404	30	04018-06	4
02468-0404	37	02482-08	38	02659-04	27	02669-0604	28	02699-0604	30	04018-08	4
02468-0406	37	02482-10	38	02659-05	27	02669-0606	28	02760-02	27	04018-10	4
02468-0602	37	02486-0402	38	02659-06	27	02669-0804	28	02760-04	27	04018-12	4
02468-0604	37	02486-0404	38	02659-08	27	02669-0806	28	02760-05	27	04018-14	4
02468-0606	37	02486-0604	38	02660-04	27	02669-0808	28	02760-06	27	04018-16	4
02468-0608	37	02554-0402	37	02660-05	27	02670-0202	28	02760-08	27	04019-04	4
02468-0804	37	02554-0404	37	02660-06	27	02670-0402	28	02761-02	27	04019-06	4
02468-0806	37	02554-0602	37	02660-08	27	02670-0404	28	02761-04	27	04019-08	4
02468-0808	37	02554-0604	37	02661-04	27	02670-0604	28	02761-05	27	04019-10	4
02468-1006	37	02554-0804	37	02661-05	27	02670-0806	28	02761-06	27	04020-0403	4
02468-1008	37	02554-0806	37	02661-06	27	02671-0202	28	02761-08	27	04020-0504	4
02468-1208	37	02554-1008	37	02661-08	27	02671-0402	28	02911-0402	29	04020-0604	4
02468-1212	37	02569-0402	37	02662-02	28	02671-0404	28	02911-0404	29	04020-0605	4
02468-5300	37	02569-0404	37	02662-04	28	02671-0502	28	02911-0604	29	04020-0806	4
02468-5302	37	02569-0406	37	02662-05	28	02671-0604	28	02912-0402	29	04020-1006	4
02469-0402	37	02569-0602	37	02662-06	28	02671-0806	28	02912-0404	29	04020-1008	4
02469-0404	37	02569-0604	37	02662-08	28	02672-0202	28	02912-0604	29	04020-1208	4
02469-0406	37	02569-0606	37	02664-02	28	02672-0402	28	02961-02	28	04020-1210	4
02469-0602	37	02569-0608	37	02664-04	28	02672-0404	28	02961-04	28	04030-0804	8
02469-0604	37	02569-0806	37	02664-05	28	02672-0502	28	02961-05	28	04030-1204	8
02469-0606	37	02569-0808	37	02664-06	28	02672-0602	28	02961-06	28	04030-1206	8
02469-0608	37	02569-1006	37	02664-08	28	02672-0604	28	02961-08	28	04030-1208	8
02469-0804	37	02569-1008	37	02666-0202	28	02672-0806	28	02994-04	30	04032-08	8
02469-0806	37	02569-1212	37	02666-0402	28	02677-0402	29	02994-06	30	04032-12	8
02469-0808	37	02570-0402	37	02666-0404	28	02677-0404	29	02998-0402	30	04039-03	5
02469-1006	37	02570-0404	37	02666-0502	28	02677-0406	29	02998-0404	30	04039-04	5
02469-1008	37	02571-0402	37	02666-0604	28	02679-0604	29	02998-0604	30	04039-05	5
02469-1208	37	02571-0404	37	02666-0806	28	02682-04	29	04014-02	4	04039-06	5
02469-1212	37	02571-0604	37	02668-0202	28	02682-05	29	04014-03	4	04039-08	5
02469-5302	37	02571-0606	37	02668-0400	28	02682-06	29	04014-04	4	04039-10	5
02470-0402	37	02571-0806	37	02668-0401	28	02682-08	29	04014-05	4	04039-12	5
02470-0404	37	02571-0808	37	02668-0402	28	02683-04	29	04014-06	4	04040-03	5
02470-0406	37	02572-0402	38	02668-0404	28	02683-06	29	04014-07	4	04040-04	5
02470-0604	37	02572-0404	38	02668-0406	28	02692-0402	29	04014-08	4	04040-05	5
02470-0606	37	02572-0604	38	02668-0502	28	02692-0404	29	04014-10	4	04040-06	5
02471-0402	37	02572-0606	38	02668-0504	28	02692-0604	29	04014-12	4	04040-08	5
02471-0404	37	02572-0806	38	02668-0602	28	02694-04	30	04014-14	4	04040-10	5
02471-0604	37	02572-0808	38	02668-0604	28	02694-06	30	04014-16	4	04040-12	5
02471-0606	37	02577-0402	38	02668-0606	28	02695-04	30	04016-03	4	04041-02	4
02471-0806	37	02577-0404	38	02668-0804	28	02695-06	30	04016-04	4	04041-03	4
02472-0402	38	02577-0604	38	02668-0806	28	02696-04	30	04016-05	4	04041-04	4
02472-0404	38	02621-04	27	02668-0808	28	02696-06	30	04016-06	4	04041-05	4
02472-0604	38	02621-06	27	02669-0202	28	02697-04	30	04016-08	4	04041-06	4
02472-0606	38	02642-04	28	02669-0402	28	02697-06	30	04016-10	4	04041-08	4

# Index by Computer Number

Computer Number	Page Number	Computer Number	Page Number	Computer Number	Page Number	Computer Number	Page Number	Computer Number	Page Number
04041-10	4	04046-0406	6	04048-1408	6	04050-0804	7	04056-0806	5
04041-12	4	04046-0408	6	04048-1412	6	04050-0806	7	04056-1006	5
04042-02	5	04046-0502	6	04048-1612	6	04050-0808	7	04056-1008	5
04042-03	5	04046-0504	6	04048-1616	6	04050-0812	7	04056-1208	5
04042-04	5	04046-0506	6	04049-0202	6	04050-1006	7	04056-1210	5
04042-05	5	04046-0508	6	04049-0302	6	04050-1008	7	04057-0604	8
04042-06	5	04046-0602	6	04049-0304	6	04050-1012	7	04057-0605	8
04042-08	5	04046-0604	6	04049-0402	6	04050-1208	7	04057-0804	8
04042-10	5	04046-0606	6	04049-0404	6	04050-1212	7	04057-0806	8
04042-12	5	04046-0608	6	04049-0406	6	04050-1412	7	04057-1006	8
04042-14	5	04046-0612	6	04049-0408	6	04051-0302	7	04057-1008	8
04043-0402	5	04046-0804	6	04049-0502	6	04051-0402	7	04057-1208	8
04043-0604	5	04046-0806	6	04049-0504	6	04051-0404	7	04057-1210	8
04044-02	5	04046-0808	6	04049-0506	6	04051-0406	7	04058-040402	8
04044-03	5	04046-0812	6	04049-0508	6	04051-0502	7	04058-040404	8
04044-04	5	04046-1006	6	04049-0602	6	04051-0504	7	04058-060604	8
04044-05	5	04046-1008	6	04049-0604	6	04051-0602	7	04058-060606	8
04044-06	5	04046-1012	6	04049-0606	6	04051-0604	7	04058-060608	8
04044-08	5	04046-1208	6	04049-0608	6	04051-0606	7	04058-060612	8
04044-10	5	04046-1212	6	04049-0612	6	04051-0608	7	04058-060808	8
04044-12	5	04046-1412	6	04049-0802	6	04051-0804	7	04058-080606	8
04044-14	5	04048-0202	6	04049-0804	6	04051-0806	7	04058-080806	8
04045-0202	6	04048-0302	6	04049-0806	6	04051-0808	7	04058-080808	8
04045-0302	6	04048-0304	6	04049-0808	6	04051-1006	7	04058-080812	8
04045-0402	6	04048-0402	6	04049-0812	6	04051-1008	7	04058-101008	8
04045-0404	6	04048-0404	6	04049-1004	6	04051-1208	7	04059-040406	5
04045-0406	6	04048-0406	6	04049-1006	6	04051-1212	7	04059-050504	5
04045-0408	6	04048-0408	6	04049-1008	6	04052-04	7	04059-060404	5
04045-0502	6	04048-0502	6	04049-1012	6	04052-05	7	04059-060406	5
04045-0504	6	04048-0504	6	04049-1206	6	04052-06	7	04059-060604	5
04045-0602	6	04048-0506	6	04049-1208	6	04052-08	7	04059-060608	5
04045-0604	6	04048-0508	6	04049-1212	6	04052-10	7	04059-060610	5
04045-0606	6	04048-0602	6	04049-1216	6	04053-020204	7	04059-080408	5
04045-0608	6	04048-0604	6	04049-1412	6	04053-040404	7	04059-080606	5
04045-0612	6	04048-0606	6	04049-1416	6	04053-040406	7	04059-080608	5
04045-0804	6	04048-0608	6	04049-1612	6	04055-02	8	04059-080804	5
04045-0806	6	04048-0612	6	04049-1616	6	04055-03	8	04059-080806	5
04045-080608	6	04048-0704	6	04050-0302	7	04055-04	8	04059-080810	5
04045-0808	6	04048-0802	6	04050-0402	7	04055-05	8	04059-080812	5
04045-0812	6	04048-0804	6	04050-0404	7	04055-06	8	04059-100606	5
04045-1006	6	04048-0806	6	04050-0406	7	04055-08	8	04059-100608	5
04045-1008	6	04048-0808	6	04050-0408	7	04055-10	8	04059-100610	5
04045-1012	6	04048-0812	6	04050-0502	7	04055-12	8	04059-100806	5
04045-1208	6	04048-1004	6	04050-0504	7	04055-14	8	04059-100808	5
04045-1212	6	04048-1006	6	04050-0602	7	04056-0403	5	04059-100810	5
04046-0202	6	04048-1008	6	04050-0604	7	04056-0504	5	04059-101004	5
04046-0302	6	04048-1012	6	04050-0606	7	04056-0604	5	04059-101006	5
04046-0402	6	04048-1208	6	04050-0608	7	04056-0605	5	04059-101008	5
04046-0404	6	04048-1212	6	04050-0612	7	04056-0804	5	04059-121012	5
								04059-121208	5
								04059-121210	5
								04060-04	8
								04060-06	8
								04060-08	8
								04061-0403	8
								04061-0406	8
								04061-0408	8
								04061-0604	8
								04061-0608	8
								04061-0610	8
								04061-0804	8
								04061-0806	8
								04061-0810	8
								04061-1006	8
								04061-1008	8
								04061-1012	8
								04061-1210	8
								04063-03	5
								04063-04	5
								04063-05	5
								04063-06	5
								04063-08	5
								04063-10	5
								04063-12	5
								04064-03	5
								04064-04	5
								04064-05	5
								04064-06	5
								04064-08	5
								04064-10	5
								04064-12	5
								04066-0402	8
								04066-0404	8
								04066-0604	8
								04066-0806	8
								04066-0808	8
								04070-04	8
								04070-05	8
								04070-06	8
								04070-08	8
								04070-10	8
								04070-12	8
								04070-14	8
								04071-0404	8
								04071-0606	8
								04071-0808	8
								04071-1010	8
								04075-0604	8

# Index by Computer Number

Computer Number	Page Number	Computer Number	Page Number	Computer Number	Page Number	Computer Number	Page Number	Computer Number	Page Number
04075-0806	8	04095-0504	7	04344-03	11	04351-0604	11	05910	43
04075-1008	8	04095-0604	7	04344-04	11	04352-0502	11	06060-02	9
04082-0404	5	04095-0606	7	04344-05	11	04352-0604	11	06060-04	9
04082-0406	5	04095-0608	7	04344-06	11	04355-04	11	06060-06	9
04082-0606	5	04095-0806	7	04344-08	11	04355-06	11	06061-02	9
04082-0608	5	04095-0808	7	04345-0402	11	04394-0302	11	06061-04	9
04082-0806	5	04095-1008	7	04345-0502	11	04394-0402	11	06061-06	9
04082-0808	5	04095-1208	7	04345-0604	11	04394-0502	11	06062-02	9
04082-1010	5	04095-1212	7	04346-0302	11	04394-0504	11	06062-04	9
04082-1012	5	04096-040404	8	04346-0402	11	04394-0604	11	06062-06	9
04082-1212	5	04097-04	9	04346-0404	11	04394-0806	11	06100-02	44
04087-06	8	04098-0402	9	04346-0502	11	04448-0404	6	06100-04	44
04087-08	8	04098-0404	9	04346-0604	11	04448-0606	6	06100-06	44
04088-060602	6	04099-04	8	04346-0806	11	04448-0808	6	06100-08	44
04088-060806	6	04099-06	8	04346-1008	11	04741-15	13	06100-12	44
04088-080806	6	04330-03	10	04348-0202	11	04746-1508	13	06101-02	44
04089-0404	7	04330-04	10	04348-0302	11	04746-1512	13	06101-04	44
04089-0606	7	04330-06	10	04348-0402	11	04748-1508	13	06101-06	44
04089-0806	7	04335-0304	10	04348-0404	11	04748-1512	13	06101-08	44
04089-0808	7	04335-0305	10	04348-0502	11	04748-151208	13	06101-12	44
04089-1010	7	04335-0309	10	04348-0504	11	04800-06	12	06102-02	44
04090-0608	7	04335-0405	10	04348-0506	11	04800-0604	12	06102-04	44
04090-0808	7	04335-0409	10	04348-0602	11	04801-06	12	06102-06	44
04090-1008	7	04339-03	10	04348-0604	11	04802-06	12	06102-08	44
04091-040404	7	04339-04	10	04348-0606	11	04806-0606	12	06102-12	44
04091-060606	7	04339-05	10	04348-0804	11	04806-0608	12	06103-02	45
04091-060608	7	04339-06	10	04348-0806	11	04806-0612	12	06103-04	45
04091-060808	7	04340-02	10	04348-0808	11	04808-0606	12	06103-06	45
04091-080806	7	04340-03	10	04348-1008	11	04808-0608	12	06103-08	45
04092-0404	7	04340-04	10	04349-0202	11	04809-0606	12	06103-12	45
04092-0606	7	04340-05	10	04349-0302	11	04809-0608	12	06104-02	45
04092-0808	7	04340-06	10	04349-0402	11	04840-06	12	06104-04	45
04093-06060606	7	04340-08	10	04349-0404	11	04844-06	12	06104-06	45
04093-06060608	7	04340-10	10	04349-0502	11	04850-0606	12	06104-08	45
04093-06060612	7	04340-12	10	04349-0504	11	04850-0608	12	06104-12	45
04093-06060808	7	04341-02	10	04349-0602	11	05200	14	06107-02	44
04093-06081012	7	04341-03	10	04349-0604	11	05204	14	06107-04	44
04093-08060612	7	04341-04	10	04349-0606	11	05205	14	06108-02	45
04093-08080608	7	04341-05	10	04349-0804	11	05206	14	06108-04	45
04093-08080612	7	04341-06	10	04349-0806	11	05207	14	06108-06	45
04093-08080808	7	04341-08	10	04349-0808	11	05208	14	06108-08	45
04093-08080812	7	04341-10	10	04349-1008	11	05214	14	06108-12	45
04093-08100812	7	04342-02	10	04350-0302	11	05220	14	06109-02	45
04093-10080812	7	04342-03	10	04350-0402	11	05221	14	06109-04	45
04095-0302	7	04342-04	10	04350-0502	11	05222	14	06109-06	45
04095-0402	7	04342-05	10	04350-0604	11	05225	14	06109-08	45
04095-0404	7	04342-06	10	04351-0302	11	05901	43	06109-12	45
04095-0406	7	04342-08	10	04351-0402	11	05902	43	06109-16	45
04095-0502	7	04344-02	11	04351-0502	11	05903	43	06110-0402	45



# Index by Computer Number

Computer Number	Page Number	Computer Number	Page Number	Computer Number	Page Number	Computer Number	Page Number	Computer Number	Page Number
06117-02	45	06125-06	46	06224-04	47	07001-0706	48	07004-0808	49
06117-04	45	06125-08	46	06224-06	47	07001-0804	48	07004-0810	49
06117-06	45	06125-12	46	06227-02	47	07001-0806	48	07006-0404	49
06118-02	46	06127-02	47	06227-04	47	07001-0808	48	07006-0505	49
06118-04	46	06127-04	47	06227-06	47	07001-0812	48	07006-0606	49
06118-06	46	06127-06	47	06227-08	47	07001-1006	48	07006-0808	49
06119-0402	46	06127-08	47	06227-12	47	07001-1008	48	07006-1010	49
06119-0602	46	06127-12	47	06228-0204	47	07001-1012	48	07008-0202	48
06119-0604	46	06130-02	47	06228-0402	47	07001-1206	48	07008-0302	48
06119-0802	46	06130-04	47	06228-0406	47	07001-1208	48	07008-0304	48
06119-0804	46	06130-06	47	06228-0604	47	07001-1212	48	07008-0402	48
06119-0806	46	06131-02	47	06228-0608	47	07001-1612	48	07008-0404	48
06119-1208	46	06131-04	47	06228-0806	47	07001-1616	48	07008-0406	48
06120-0202	46	06131-06	47	06230-02	47	07001-2016	48	07008-0504	48
06120-0402	46	06131-08	47	06230-04	47	07002-0202	48	07008-0604	48
06120-0404	46	06131-12	47	06230-06	47	07002-0204	48	07008-0606	48
06120-0602	46	06140-0604	45	06230-08	47	07002-0302	48	07008-0608	48
06120-0604	46	06140-0806	45	06231-02	47	07002-0304	48	07008-0806	48
06120-0606	46	06140-1208	45	06231-04	47	07002-0402	48	07008-0808	48
06120-0804	46	06140-1612	45	06231-06	47	07002-0404	48	07008-1212	48
06120-0806	46	06200-02	44	06231-08	47	07002-0406	48	07009-0202	49
06120-0808	46	06200-04	44	06232-02	47	07002-0502	48	07009-0302	49
06120-1208	46	06200-06	44	06232-04	47	07002-0504	48	07009-0304	49
06120-1212	46	06200-08	44	06232-06	47	07002-0506	48	07009-0402	49
06121-02	46	06200-12	44	06232-08	47	07002-0602	48	07009-0404	49
06121-04	46	06201-02	44	06232-12	47	07002-0604	48	07009-0406	49
06121-06	46	06201-04	44	06235-0402	47	07002-0606	48	07009-0504	49
06121-08	46	06201-06	44	06235-0602	47	07002-0608	48	07009-0506	49
06121-12	46	06201-08	44	06235-0604	47	07002-0804	48	07009-0604	49
06121-16	46	06201-12	44	06235-0806	47	07002-0806	48	07009-0606	49
06122-02	46	06202-02	45	06303-04	45	07002-0808	48	07009-0608	49
06122-04	46	06202-04	45	06322-04	46	07002-1212	48	07009-0806	49
06122-06	46	06202-06	45	07001-0202	48	07002-1612	48	07009-0808	49
06122-08	46	06202-08	45	07001-0204	48	07003-0404	48	07010-0303	48
06122-12	46	06205-0402	44	07001-0302	48	07003-0604	48	07010-0304	48
06122-16	46	06205-0604	44	07001-0304	48	07003-0606	48	07010-0404	48
06123-0402	46	06205-0806	44	07001-0402	48	07003-0806	48	07010-0405	48
06123-0602	46	06206-020204	44	07001-0404	48	07003-0808	48	07010-0406	48
06123-0604	46	06206-040402	44	07001-0406	48	07003-1212	48	07010-0505	48
06123-0804	46	06206-060604	44	07001-0408	48	07004-0205	49	07010-0506	48
06123-0806	46	06206-080408	44	07001-0502	48	07004-0304	49	07010-0606	48
06123-1208	46	06206-080806	44	07001-0504	48	07004-0305	49	07010-0608	48
06124-02	46	06206-121208	44	07001-0506	48	07004-0404	49	07010-0808	48
06124-04	46	06216-02	46	07001-0602	48	07004-0405	49	07010-0810	48
06124-06	46	06216-04	46	07001-0604	48	07004-0406	49	07014-02	49
06124-08	46	06216-06	46	07001-0606	48	07004-0505	49	07014-03	49
06124-12	46	06216-08	46	07001-0608	48	07004-0506	49	07014-04	49
06125-02	46	06216-12	46	07001-0612	48	07004-0606	49	07014-05	49
06125-04	46	06224-02	47	07001-0704	48	07004-0608	49	07014-06	49

# Index by Computer Number

Computer Number	Page Number	Computer Number	Page Number	Computer Number	Page Number	Computer Number	Page Number	Computer Number	Page Number	Computer Number	Page Number
07062-06	51	07203-0404	53	07206-0808	53	07211-0806	54	07217-030704	55	07220-0808	54
07064-02	51	07203-0406	53	07206-1010	53	07211-1212	54	07217-040802	55	07220-1008	54
07064-04	51	07203-0602	53	07207-0402	54	07212-0406	54	07217-040804	55	07220-1012	54
07064-06	51	07203-0604	53	07207-0404	54	07212-0606	54	07217-040806	55	07220-1212	54
07065-02	51	07203-0606	53	07207-0406	54	07212-1212	54	07217-040902	55	07400-1208	55
07065-04	51	07203-0608	53	07207-0504	54	07213-0403	54	07217-040904	55	07401-1208	55
07065-06	51	07203-0806	53	07207-0602	54	07213-0404	54	07217-040906	55	07401-1212	55
07068-0202	51	07203-0808	53	07207-0604	54	07213-0405	54	07217-041002	55	07402-12	56
07068-0204	51	07203-0812	53	07207-0606	54	07213-0605	54	07217-041004	55	07403-12	55
07068-0402	51	07203-1008	53	07207-0608	54	07213-0606	54	07217-041006	55	07404-12	56
07068-0404	51	07203-1012	53	07207-0804	54	07213-0808	54	07217-050904	55	07405-12	56
07068-0606	51	07203-1208	53	07207-0806	54	07214-04	54	07217-050906	55	07406-12	56
07069-0202	51	07203-1212	53	07207-0808	54	07214-05	54	07217-051004	55	07407-12	56
07069-0204	51	07204-0404	53	07207-0812	54	07214-06	54	07217-051006	55	07408-12	56
07069-0402	51	07204-0405	53	07207-1008	54	07214-08	54	07217-051104	55	07411-1202	56
07069-0404	51	07204-0406	53	07207-1012	54	07214-10	54	07217-051106	55	07411-1204	56
07069-0606	51	07204-0604	53	07207-1212	54	07214-12	54	07217-061004	55	07412-12	56
07071-0202	51	07204-0605	53	07208-0402	54	07215-0403	54	07217-061006	55	07420-1204	56
07071-0404	51	07204-0606	53	07208-0404	54	07215-0404	54	07217-061008	55	07420-1206	56
07072-0202	51	07204-0608	53	07208-0406	54	07215-0405	54	07217-061104	55	07420-1208	56
07072-0402	51	07204-0808	53	07208-0604	54	07215-0606	54	07217-061106	55	07460-12	56
07072-0404	51	07204-0810	53	07208-0606	54	07215-0808	54	07217-061108	55	07461-12	56
07072-0606	51	07204-1008	53	07208-0608	54	07215-1010	54	07217-061204	55	07478-1206	56
07201-0402	53	07204-1010	53	07208-0808	54	07216-030604	55	07217-061206	55	07478-1208	56
07201-0404	53	07204-1210	53	07208-0812	54	07216-030704	55	07217-061208	55	07478-120808	56
07201-0406	53	07204-1212	53	07208-1012	54	07216-040804	55	07217-081404	55	07478-121208	56
07201-0502	53	07205-0404	53	07208-1212	54	07216-040806	55	07217-081406	55	07480-1204	56
07201-0504	53	07205-0405	53	07209-0402	54	07216-040904	55	07217-081408	55	07480-1206	56
07201-0602	53	07205-0406	53	07209-0404	54	07216-040906	55	07217-081504	55	07480-1208	56
07201-0604	53	07205-0604	53	07209-0406	54	07216-041004	55	07217-081506	55	07480-1212	56
07201-0606	53	07205-0605	53	07209-0604	54	07216-041006	55	07217-081508	55	07482-1208	56
07201-0608	53	07205-0606	53	07209-0606	54	07216-050904	55	07217-081604	55	07482-1212	56
07201-0612	53	07205-0608	53	07209-0608	54	07216-051004	55	07217-081606	55	07484-1208	56
07201-0804	53	07205-0808	53	07209-0808	54	07216-051104	55	07217-081608	55	07484-1212	56
07201-0806	53	07205-0810	53	07209-0812	54	07216-061004	55	07218-0408	55	07484-121208	56
07201-0808	53	07205-1008	53	07209-1012	54	07216-061006	55	07218-0409	55	07486-1212	56
07201-0812	53	07205-1010	53	07209-1212	54	07216-061008	55	07218-0410	55	07486-121208	56
07201-1006	53	07205-1210	53	07210-0404	54	07216-061104	55	07218-0610	55	07487-1208	56
07201-1008	53	07205-1212	53	07210-0405	54	07216-061106	55	07218-0611	55	07489-0612	56
07201-1012	53	07206-0403	53	07210-0505	54	07216-061108	55	07218-0612	55	07489-0812	56
07201-1208	53	07206-0404	53	07210-0608	54	07216-061204	55	07220-0402	54	07489-1012	56
07201-1212	53	07206-0405	53	07210-0808	54	07216-061206	55	07220-0404	54	07492-0808	56
07202-0404	53	07206-0504	53	07210-0810	54	07216-061208	55	07220-0502	54	07492-1212	56
07202-0604	53	07206-0505	53	07210-1008	54	07216-081408	55	07220-0504	54	07493-1212	56
07202-0606	53	07206-0506	53	07210-1010	54	07216-081508	55	07220-0602	54	07495-0612	56
07202-0806	53	07206-0605	53	07210-1210	54	07216-081608	55	07220-0604	54	07495-0812	56
07202-0808	53	07206-0606	53	07211-0406	54	07217-030602	55	07220-0606	54	07495-1012	56
07202-1212	53	07206-0608	53	07211-0506	54	07217-030604	55	07220-0608	54	07499-0612	56
07203-0402	53	07206-0806	53	07211-0606	54	07217-030702	55	07220-0806	54	07499-0812	56

# Index by Computer Number

Computer Number	Page Number	Computer Number	Page Number	Computer Number	Page Number	Computer Number	Page Number	Computer Number	Page Number
07629-0306	52	08068-0606	41	08378	65	08684	12	08944-1008	63
07629-0309	52	08068-0608	41	08379	65	08685	12	08944-1206	63
07629-0409	52	08068-0806	41	08382	65	08701-0302	51	08944-1208	63
07629-0509	52	08068-0808	41	08384	65	08701-0402	51	08945-0606	63
07629-0609	52	08070-06	41	08385	65	08701-0404	51	08945-0608	63
07639-0306	52	08070-08	41	08386	65	08701-0502	51	08945-0808	63
07639-0309	52	08071-06	41	08391	65	08701-0504	51	08947-0606	63
07639-0409	52	08071-08	41	08392	65	08701-0602	51	08947-1006	63
07639-0509	52	08078-0604	41	08393	65	08701-0604	51	08948-0808	35, 63
07639-0609	52	08078-0606	41	08394	65	08701-0606	51	08949-0604	63
07651-0902	52	08078-0608	41	08395	65	08701-0806	51	08949-0606	63
07651-0904	52	08078-0806	41	08396	65	08701-0808	51	08949-0608	63
07651-0906	52	08078-0808	41	08397	65	08701-1006	51	08949-0806	63
07651-0909	52	08086-0604	41	08398	65	08701-1008	51	08949-0808	63
07652-0902	52	08086-0606	41	08399	65	08701-1012	51	08949-1008	63
07652-0904	52	08086-0806	41	08601	12	08701-1208	51	08949-1208	63
07652-0906	52	08088-0604	41	08602	12	08701-1212	51	09101-0302	57
07652-0909	52	08088-0606	41	08603	12	08704-0606	51	09101-0402	57
07654-0202	52	08088-0806	41	08604	12	08706-0404	51	09101-0404	57
07654-0402	52	08088-0808	41	08605	12	08706-0405	51	09101-0502	57
07654-0404	52	08098-0604	41	08606	12	08706-0504	51	09101-0604	57
07654-0406	52	08098-0606	41	08607	12	08706-0505	51	09102-0402	57
07654-0602	52	08098-0608	41	08608	12	08706-0506	51	09102-0604	57
07654-0604	52	08098-0806	41	08609	12	08706-0605	51	09103-0302	57
07654-0606	52	08098-0808	41	08610	12	08706-0606	51	09103-0402	57
07654-0608	52	08302	63	08631	12	08713-0505	51	09103-0404	57
07654-0806	52	08304	63	08632	12	08713-0605	51	09103-0502	57
07654-0808	52	08310	63	08633	12	08713-0606	51	09103-0504	57
07654-1212	52	08311	63	08634	12	08720-0402	51	09103-0602	57
07655-0402	52	08312	63	08635	12	08720-0502	51	09103-0604	57
07655-0404	52	08313	63	08636	12	08720-0504	51	09104-0402	57
07655-0406	52	08314	64	08637	12	08720-0602	51	09104-0404	57
07655-0604	52	08315	64	08638	12	08720-0604	51	09104-0502	57
07655-0606	52	08316	64	08639	12	08720-0606	51	09104-0504	57
07655-0806	52	08321	64	08640	12	08720-0806	51	09104-0604	57
07655-0808	52	08324	64	08661-0304	11	08720-0808	51	09106-04	57
07656-0404	52	08341	64	08661-0305	11	08720-1006	51	09106-05	57
07656-0606	52	08342	64	08661-0403	11	08720-1008	51	09106-06	57
07656-0808	52	08343	64	08661-0405	11	08720-1208	51	09108-02	57
07656-1212	52	08346	64	08661-0504	11	08722-0404	51	09108-04	57
08060-06	41	08347	64	08661-0506	11	08722-0405	51	09110-04	57
08060-08	41	08349	64	08661-0605	11	08722-0505	51	09110-06	57
08061-06	41	08351	64	08664-030918	11	08722-0605	51	09134-02	57
08061-08	41	08352	64	08664-030920	11	08722-0606	51	09134-04	57
08062-06	41	08373	64	08664-0409	11	08941-0808	35, 63	09135-02	57
08062-08	41	08374	64	08664-0809	11	08942-1008	63	09135-04	57
08066-0612	41	08375	64	08664-0908	11	08944-0606	63	09178-0406	57
08066-0814	41	08376	64	08681	12	08944-0806	63	09178-0408	57
08068-0604	41	08377	64	08683	12	08944-1006	63	09178-0410	57
								09178-0606	57
								09190	57
								09194-0402	57
								09195-04	57
								09195-05	57
								09195-06	57
								09198-04	57
								09199-04	57
								09201-0402	59
								09201-0404	59
								09201-0502	59
								09201-0504	59
								09201-0604	59
								09201-0606	59
								09201-0806	59
								09204-0402	59
								09204-0404	59
								09204-0502	59
								09204-0504	59
								09204-0604	59
								09204-0606	59
								09204-0608	59
								09204-0806	59
								09204-0808	59
								09204-1008	59
								09205-0606	59
								09205-0608	59
								09205-0808	59
								09205-0812	59
								09205-0908	59
								09205-1008	59
								09205-1012	59
								09205-1512	59
								09206-04	59
								09206-05	59
								09206-06	59
								09206-08	59
								09208-02	59
								09208-04	59
								09208-06	59
								09210-04	59
								09210-05	59
								09210-06	59
								09210-08	59
								09210-10	59
								09234-02	59
								09234-04	59
								09234-06	59
								09234-08	59

# Index by Computer Number

Computer Number	Page Number	Computer Number	Page Number	Computer Number	Page Number	Computer Number	Page Number	Computer Number	Page Number		
09235-02	59	09343-02	61	09432-02	61	09506-04	62	09616-06	24	60200-0411	50
09235-04	59	09344-04	61	09432-04	61	09506-05	62	09616-08	24	60200-0514	50
09235-06	59	09345-06	61	09432-06	61	09506-06	62	09695-04	24	60200-0616	50
09235-08	59	09345-08	61	09432-08	61	09506-08	62	09695-05	24	60200-0617	50
09259-06	59	09346-02	61	09436-04	61	09508-02	59	09695-06	24	60200-0820	50
09289-0402	59	09347-04	61	09440-02	61	09508-04	59	40046-0908	12	60200-0824	50
09290-0402	59	09348-06	61	09440-04	61	09508-06	59	40046-1512	13	60200-1228	50
09306-02	60	09348-08	61	09442-02	61	09514-04	59	60001	58	61000-04	66
09307-04	60	09349-02	61	09442-04	61	09514-06	59	60002	58	61000-05	66
09308-06	60	09350-04	61	09460-02	62	09515-04	60	60004	58	61000-06	66
09309-08	60	09351-06	61	09460-04	62	09515-06	60	60005	58	61000-08	66
09312-02	60	09351-08	61	09462-02	62	09530-0612	60	60006	58	61000-10	66
09313-04	60	09352-02	61	09469-02	62	09540-0606	60	60008	58	61000-12	66
09314-06	60	09353-04	61	09469-04	62	09540-0608	60	60100-01	50	61010-04	66
09315-08	60	09354-06	61	09469-06	62	09540-0612	60	60100-02	50	61020-02	66
09318-02	60	09354-08	61	09500-02	62	09540-0808	60	60100-03	50	61020-03	66
09319-04	60	09355-02	60	09500-04	62	09540-0812	60	60100-04	50	61020-04	66
09320-06	60	09356-04	60	09500-06	62	09601-0402	24	60100-05	50	61020-05	66
09321-08	60	09357-06	60	09501-02	62	09601-0404	24	60100-06	50	61020-06	66
09322-02	60	09357-08	60	09501-04	62	09601-0502	24	60100-07	50	61020-07	66
09323-04	60	09358-02	61	09501-06	62	09601-0604	24	60100-08	50	61020-08	66
09324-06	60	09359-04	61	09502-02	62	09603-0402	24	60100-09	50	61020-10	66
09325-08	60	09360-06	61	09502-04	62	09603-0404	24	60100-10	50	61060-0410	66
09326-02	60	09360-08	61	09502-06	62	09603-0502	24	60100-11	50	61060-0415	66
09327-04	60	09363-02	60	09503-0404	62	09603-0504	24	60100-12	50	61060-0420	66
09328-06	60	09364-04	60	09503-0604	62	09603-0602	24	60100-13	50	61060-0425	66
09329-02	60	09365-02	60	09503-0606	62	09603-0604	24	60100-14	50	61060-0610	66
09330-04	60	09366-04	60	09504-04	62	09606-04	24	60100-15	50	61060-0615	66
09331-06	60	09403-02	61	09504-05	62	09606-05	24	60100-16	50	61060-0620	66
09332-08	60	09403-04	61	09504-06	62	09606-06	24	60100-17	50	61060-0625	66
09333-08	60	09404-02	61	09504-08	62	09611-0402	24	60100-18	50	61060-0810	66
09337-02	60	09404-04	61	09505-0402	62	09611-0404	24	60100-19	50	61060-0815	66
09338-04	60	09404-06	61	09505-0404	62	09611-0502	24	60100-20	50	61060-0820	66
09339-06	60	09404-08	61	09505-0502	62	09611-0504	24	60100-21	50	61060-0825	66
09339-08	60	09420-02	62	09505-0504	62	09611-0604	24	60100-22	50	61060-1010	66
09340-02	61	09420-04	62	09505-0604	62	09611-0606	24	60100-23	50	61060-1020	66
09341-04	61	09420-06	62	09505-0606	62	09611-0806	24	60100-24	50	69410	26,29,30,33
09342-06	61	09430-02	61	09505-0608	62	09616-04	24	60100-25	50		35,38,51,66
09342-08	61	09430-04	61	09505-0806	62	09616-05	24	60200-0410	50		

# Index by Part Number

Part Number	Page Number	Part Number	Page Number	Part Number	Page Number	Part Number	Page Number	Part Number	Page Number
100	44	109S	45	129FWR	52	159MSAE	51	2004	14
10045	44	109S	57	129HBT	51	159SAE	59	2005	14
100EV	56	110	45	129IS	49	15PAC	60	2006	14
100F	44	1101C	57	129MSAE	49	1607	63	2007	14
100R	44	1101CPF	29	129PO1	53	1608	64	2008	14
101	44	1101CSA	24	129PO10	54	161	15	200P	62
1010SAE	59	1104SAE	57	129PO11	54	1610	63	2014	14
101C	57	1106SAE	57	129PO12	54	1611	63	201P	62
101CPF	29	110F	45	129PO13	54	1612	64	202P	62
101CSA	24	110P	57	129PO14	54	1613	64	203C	57
101F	44	110SAE	57	129PO15	54	161SAE	59	203CSA	24
101R	44	111	45	129PO2	53	161SSAE	59	204C	57
102	44	112	45	129PO20	54	1627	64	204CSA	24
102C	57	113	46	129PO3	53	1629	64	204SC	57
102CSA	24	113C	57	129PO4	53	1636	64	204SCSA	24
102EV	56	113CSA	24	129PO5	53	1637	64	20PAC	60
102F	45	114AMC	59	129PO6	53	163SAE	59	21PAC	60
103	45	115AMC	60	129PO7	54	1641	64	227ACBH	41, 47
103C	57	115SAE	57	129PO8	54	1646	65	227C	59
103CPF	29	116	46	129PO9	54	164SAE	59	227CSA	24
103CPL	42	116F	46	129RU16	55	1652	64	227SAE	59
103CSA	24	116L	46	129RU17	55	1666	64	229C	59
103EV	56	117	45	129RU18	55	1667SAE	59	229CSA	24
103SAE	57	1184	63	129S	49	1669	63	229SAE	59
103XH	45	1186	63	129SAE	48	166SAE	59	22PAC	60
104	45	119	46	129SBM	51	167RC	59	23PAC	60
104C	57	120	46	129SWV	48	167SAE	59	24PAC	60
104CPF	29	121	46	129T	49	1680	64	256PF	28
104CSA	24	121S	46	129TBM	51	1688	64	259PF	27
104EV	56	122	46	129TBMB	51	1699	65	25PAC	60
104HV	57	122L	46	129UFS	49	1710	64	260PF	27
104SAE	57	123	46	12PAC	60	1711	64	260PFB	27
104SC	57	124	46	130	47	1720	65	261PF	27
104SCSA	24	124F	47	130F	47	1728	64	261PFB	27
104SCSD	57	127	47	130R	47	1743	64	261PFCP	27
104SDHB	57	127BT	12	131	47	181	20	261PFN	28
104SPL	42	127BTC	12	131F	47	181SP	20	262PF	28
106C	57	127F	47	132F	47	182	20	262PFC	28
106CSA	24	128	47	133C	57	188	20	264PF	28
106SAE	57	128F	47	13PAC	60	189	20	266PF	28
1077SAE	59	129	48	143C	57	18PAC	60	268PF	28
107C	57	12945	49	143CPF	29	1911	64	269PF	28
107CSA	24	129BE	51	143CSA	24	1957	64	269PFL	28
108	45	129BM	51	14PAC	60	19PAC	60	26PAC	60
108AMC	59	129E	49	159	51	2000	14	270PF	28
108P	57	129EBM	51	159E	51	2002A	14	271PF	28
108SAE	57	129F	48	159EIS	51	2002AB	14	272PF	28
109	45	129FS	48	159FIN	51	2002B	14	277PF	29
109AL	45	129FWL	52	159IN	51	2002BLH	14	279PF	29
								27C	59
								27CSA	24
								27PAC	60
								27SAE	59
								282PF	29
								282PFC	29
								282PFT	29
								28C	59
								28CSA	24
								28PAC	60
								28SAE	59
								292PF	29
								294PF	30
								294PFB	30
								294PFD	30
								294PFM	30
								294PFMD	30
								298PF	30
								298PFD	30
								298PFT	30
								29C	59
								29CSA	24
								29PAC	60
								29SAE	59
								300P	61
								301P	61
								302C	57
								302CSA	24
								302P	61
								302SC	57
								302SCSA	24
								3038	65
								303C	57
								303CPF	29
								303CSA	24
								303P	61
								303SAE	57
								304P	57
								3053	65
								3054	65
								305P	57
								30C	59
								30CSA	24
								30PAC	60
								30SAE	59
								31P	59
								31PAC	60
								320P	61
								321P	61

# Index by Part Number

Part Number	Page Number	Part Number	Page Number	Part Number	Page Number	Part Number	Page Number	Part Number	Page Number
322P.....	61	411NR.....	10	501FP.....	7	5605E.....	62	61NCI.....	34
323P.....	61	411NS.....	10	501P.....	62	5605F.....	62	61NSI.....	34
327P.....	61	41P.....	61	502.....	7	5605G.....	62	61P.....	15, 24
329F.....	55	41PAC.....	61	503.....	7	5606.....	62	61PL.....	42
329M.....	55	420P.....	61	503FP.....	7	5606A.....	62	61SA.....	21
329M/F.....	55	421P.....	61	505.....	8	5606B.....	62	62.....	16
329NPSM.....	55	42A PAC.....	61	506.....	5	5606C.....	62	62AB.....	39
32P.....	59	42IN.....	10	507.....	8	56PAC.....	60	62ABH.....	39
32PAC.....	60	42P.....	61	508FP.....	8	577SAE.....	59	62BH.....	16
3304P.....	57	42PAC.....	61	509.....	5	57A PAC.....	60	62CP.....	19
3305P.....	57	439.....	5	50IN.....	11	57C.....	59	62CPL.....	42
33C.....	57	43P.....	61	50P.....	59	57CSA.....	24	62HE.....	41
33PAC.....	60	43PAC.....	61	50PAC.....	61	57PAC.....	60	62NA.....	34
37P.....	61	440.....	5	510P.....	62	57SAE.....	59	62NABH.....	34
37PAC.....	60	441L.....	4	51A PAC.....	61	58C.....	59	62P.....	24
38P.....	61	441S.....	4	51IN.....	11	58CSA.....	24	62PC.....	25
38PAC.....	60	441SRC.....	13	51P.....	59	58PAC.....	61	62PL.....	42
39APAC.....	60	44IN.....	11	51PAC.....	61	58SAE.....	59	62R.....	16
39IN.....	10	44P.....	61	52IN.....	11	59PAC.....	61	62RCP.....	19
39PAC.....	60	44PAC.....	61	52PAC.....	61	5OV.....	60	62RP.....	25
402.....	5	44TV.....	63	53PAC.....	61	60.....	15	62RPC.....	25
402S.....	5	44TVPH.....	63	54A PAC.....	61	600.....	8	62RSA.....	21
403.....	5	45A PAC.....	61	54PAC.....	61	60001.....	58	62SA.....	21
40375.....	8	45IN.....	11	557C.....	59	60002.....	58	62T.....	16
40375C.....	18	45PAC.....	61	557CSA.....	24	60004.....	58	63.....	16
40375PC.....	26	45TV.....	63	557SAE.....	59	60005.....	58	63PAC.....	60
404.....	5	463.....	5	55IN.....	11	60006.....	58	64.....	16
405.....	6	464.....	5	55PAC.....	60	60008.....	58	6401L.....	4
40500.....	8	46IN.....	11	5600.....	62	601.....	8	6401S.....	4
40500C.....	18	46PAC.....	61	5600A.....	62	601IN.....	11	6401SXH.....	4
40500PC.....	26	47PAC.....	61	5600B.....	62	60A PAC.....	61	64AB.....	39
406.....	6	48A PAC.....	61	5601.....	62	60AB.....	39	64CP.....	19
406FC.....	9	48IN.....	11	5601A.....	62	60HE.....	41	64NA.....	34
406RC.....	13	48NA.....	35, 63	5601B.....	62	60HSG.....	41	64P.....	25
408.....	6	48P.....	59	5602.....	62	60IS.....	23	64PAC.....	60
408FC.....	9	48PAC.....	61	5602A.....	62	60NA.....	34	64R.....	16
408RC.....	13	48STA01.....	12	5602B.....	62	60P.....	15, 24	64RP.....	25
408RCT.....	13	48STA03.....	12	5603A.....	62	60PAC.....	61	64RSA.....	21
408WT.....	6	48STA04.....	12	5603D.....	62	61.....	15	64SA.....	21
408XH.....	6	48STA05.....	12	5603E.....	62	61000.....	66	65.....	16
409.....	6	49IN.....	11	5604.....	62	61010.....	66	651.....	52
40945.....	7	49P.....	59	5604A.....	62	61020.....	66	652.....	52
409S.....	7	49PAC.....	61	5604B.....	62	61060.....	66	654.....	52
40P.....	59	49TV.....	63	5604C.....	62	61AB.....	39	655.....	52
40PAC.....	61	500.....	7	5605.....	62	61CP.....	19	656.....	52
410NA.....	35, 63	500DE.....	7	5605A.....	62	61CX.....	15	65AB.....	39
412TV.....	63	500F.....	7	5605B.....	62	61HE.....	41	65CP.....	19
411NB.....	10	500P.....	62	5605C.....	62	61HES.....	41	65NA.....	34
411NL.....	10	501.....	7	5605D.....	62	61NA.....	34	65P.....	25



# Index by Part Number

Computer Number	Page Number	Computer Number	Page Number	Computer Number	Page Number	Computer Number	Page Number	Computer Number	Page Number		
69AB	40	72P	26	79P	26	89CL	59	AQ69DOT	37	GHN2	56
69CP	19	72PL	42	79SA	23	89CR	59	AQ69DOTS	37	GHP	56
69NA	35	72SA	23	7OV	60	89EV	56	AQ69P	32	GHW	56
69P	25	74	18	7OVC	60	8OV	60	AQ69PS	32	K1	8
69PL	42	7445	65	7PAC	60	8PAC	60	AQ70DOT	37	K1G	8
69S	17	7490	65	800	12	901	43	AQ70DOTS	37	METAL DOME	
69SA	22	74EV	56	800CP	12	902	43	AQ70P	32	CAP	62
69SCP	19	74P	26	800R	12	903	43	AQ70PS	32	METAL	
69SSA	22	74SA	23	802	12	90EV	56	AQ71DOT	37	SLOTTED CAP	62
6OV	60	75	18	803	12	91EV	56	AQ71DOTS	37	NFT5	8
6PAC	60	75EV	56	804	12	92EV	56	AQ71P	32	NP-6	43
70	17	75P	26	805	12	9301	65	AQ71PS	32	PLASTIC	
700	8	75SA	23	806	12	93EV	56	AQ72DOT	38	DOME CAP	62
700R	8	76	18	807	12	94EV	56	AQ72DOTS	38	S1	55
701	8	76P	26	809	12	94IN	11	AQ72P	33	S1-XHVY	55
7045	65	76-P	59	80EV	56	95EV	56	AQ72PS	33	S2	55
7090	65	76SA	23	80P	59	96EV	56	AQ77DOT	38	S3	55
70AB	40	77	18	81EV	56	99EV	56	AQ77DOTS	38	S3S	56
70CP	19	77EV	56	82EV	56	9PAC	60	AQ82DOT	38	S4	56
70DE	18	77P	26	83EV	56	AQ54DOT	37	AQ82P	33	S4Z	56
70DESA	23	77-P	59	840	12	AQ54DOTS	37	AQ86DOT	38	T21	42
70NA	35	77SA	23	844	12	AQ54PS	32	AQ86P	33	T22	42
70OV	60	77SAE	59	84EV	56	AQ59DOT	36	AQ88P	33	T31	42
70P	26	78	18	850	12	AQ59P	31	AQ89P	33	T32	42
70PDE	26	7845	65	85EV	56	AQ62DOT	36	CP10	15	T33	42
70SA	23	7890	65	85EVT	56	AQ62P	31	CP4	15	T41	42
71	18	78AWV	57	8601	65	AQ64DOT	36	CP6	15	T51	42
71AB	40	78EV	56	86EV	56	AQ64P	31	FP1	9	T52	42
71NA	35	78EVC	56	86EVT	56	AQ65DOT	36	FP2	9	T6	8
71P	26	78P	26	86Y	56	AQ65P	31	FP3	9	T71	42
71SA	23	78-P	59	86YRB	56	AQ66DOT	36	GBFF	12, 13	T72	42
72	18	78SA	23	87EV	56	AQ66P	31	GHC1	56	UX1	9
72AB	40	79	18	88EV	56	AQ68DOT	37	GHC2	56	UX2	9
72NA	35	79EVT	56	8901	65	AQ68P	32	GHN1	56		

# Notes